

MARKS PUBLISHED FOR OPPOSITION

The following marks are published in compliance with section 12(a) of the Trademark Act of 1946. Applications for the registration of marks in more than one class have been filed as provided in section 30 of said act as amended by Public Law 772, 87th Congress, approved Oct. 9, 1962, 76 Stat. 769. Opposition under section 13 may be filed within thirty days of the date of this publication. See rules 2.101 to 2.105.

A separate fee of two hundred dollars for opposing each mark in each class must accompany the opposition.

SECTION 1.— INTERNATIONAL CLASSIFICATION

The short titles associated below with the international class numbers are terms designed merely for quick identification and are not an official part of the international classification. The full names of international classes are given in section 6.1 of the trademark rules of practice.

The designation "U.S. Cl." appearing in this section refers to the U.S. class in effect prior to Sep. 1, 1973 rather than the international class which applies to applications filed on or after that date. For adoption of international classification see notice in the OFFICIAL GAZETTE of Jun. 26, 1973 (911 O.G. TM 210).

Application in more than one class

SN 76-362,898. AT&T INTELLECTUAL PROPERTY II, L.P.,
RENO, NV. FILED 1-25-2002.

CLASS 44—MEDICAL, BEAUTY AND AGRICULTURAL SERVICES

FOR PROVIDING AN INTERACTIVE COMPUTER DATABASE IN THE FIELD OF HEALTH INFORMATION (U.S. CLS. 100 AND 101).
ROBERT C. CLARK JR., EXAMINING ATTORNEY



SN 76-581,156. NASPERS LIMITED, CAPE TOWN, 8000,
SOUTH AFRICA, FILED 3-16-2004.

OWNER OF U.S. REG. NOS. 2,086,348, 2,090,445 AND
2,181,197.
NO CLAIM IS MADE TO THE EXCLUSIVE RIGHT TO
USE "WORLDNET", APART FROM THE MARK AS
SHOWN.

CLASS 35—ADVERTISING AND BUSINESS

FOR PROVIDING AN INTERACTIVE COMPUTER DATABASE IN THE FIELD OF BUSINESS INFORMATION (U.S. CLS. 100, 101 AND 102).

CLASS 36—INSURANCE AND FINANCIAL

FOR PROVIDING AN INTERACTIVE DATA BASE IN THE FIELDS OF FINANCIAL INFORMATION (U.S. CLS. 100, 101 AND 102).

CLASS 39—TRANSPORTATION AND STORAGE

FOR PROVIDING AN INTERACTIVE COMPUTER DATABASE IN THE FIELD OF TRANSPORTATION INFORMATION (U.S. CLS. 100 AND 105).

CLASS 41—EDUCATION AND ENTERTAINMENT

FOR PROVIDING AN INTERACTIVE COMPUTER DATABASE IN THE FIELD OF SPORTS AND EDUCATION (U.S. CLS. 100, 101 AND 107).



PRIORITY CLAIMED UNDER SEC. 44(D) ON SOUTH AFRICA APPLICATION NO. 2003/21002, FILED 11-28-2003, REG. NO. 2003/21002, DATED 11-28-2003, EXPIRES 11-28-2013.

PRIORITY CLAIMED UNDER SEC. 44(D) ON SOUTH AFRICA APPLICATION NO. 2003/21001, FILED 11-28-2003, REG. NO. 2003/21001, DATED 11-28-2003, EXPIRES 11-28-2013.

PRIORITY CLAIMED UNDER SEC. 44(D) ON SOUTH AFRICA APPLICATION NO. 2003/21000, FILED 11-28-2003, REG. NO. 2003/21000, DATED 11-28-2003, EXPIRES 11-28-2013.

PRIORITY CLAIMED UNDER SEC. 44(D) ON SOUTH AFRICA APPLICATION NO. 2003/20999, FILED 11-28-2003, REG. NO. 2003/20999, DATED 11-28-2003, EXPIRES 11-28-2013.

PRIORITY CLAIMED UNDER SEC. 44(D) ON SOUTH AFRICA APPLICATION NO. 2003/20998, FILED 11-28-2003, REG. NO. 2003/20998, DATED 11-28-2003, EXPIRES 11-28-2013.

OWNER OF SOUTH AFRICA REG. NO. 1997/06756, DATED 5-7-1997, EXPIRES 5-7-2014.

CLASS 9—ELECTRICAL AND SCIENTIFIC APPARATUS

FOR PRERECORDED DISCS FEATURING MUSIC AND LITERARY WORKS; COMPUTER HARDWARE; COMPUTER SOFTWARE, NAMELY, DATABASE MANAGEMENT SOFTWARE, DOWNLOADABLE SOFTWARE FOR USE IN DATABASE MANAGEMENT, COMPUTER SOFTWARE TO ENHANCE THE AUDIO-VISUAL CAPABILITIES OF MULTIMEDIA APPLICATIONS, NAMELY, FOR THE INTEGRATION OF TEXT, AUDIO, GRAPHICS, STILL IMAGES AND MOVING PICTURES, COMMUNICATION SOFTWARE FOR CONNECTING COMPUTER NETWORK USERS AND COMPUTER OR ELECTRONIC NETWORKS; ELECTRONIC PUBLICATIONS, NAMELY, BOOKS, MANUALS, NEWSPAPERS, NEWSLETTERS, MAGAZINES AND PERIODICALS APPLICABLE TO PRIMARY, SECONDARY AND UNIVERSITY-LEVEL EDUCATIONAL CURRICULUM IN THE FIELDS OF SCHOOL, TERTIARY AND CORPORATE EDUCATION AND TRAINING COURSES IN ENGLISH, LANGUAGE ARTS, READING AND WRITING, MATHEMATICS, SCIENCE, SOCIAL STUDIES, CURRENT AFFAIRS, BUSINESS AND BUSINESS MANAGEMENT, FINANCE AND ECONOMICS, COMPUTER SCIENCE, ARCHITECTURE, ART, ENGINEERING, LAW, AND MEDICINE, ALL RECORDED ON COMPUTER MEDIA; ELECTRONIC DATABASE IN THE NATURE OF AUDIO, VIDEO AND/OR MULTIMEDIA CONTENT FEATURING CURRENT EVENTS AND GENERAL NEWS INFORMATION RECORDED ON COMPUTER MEDIA; ELECTRONIC NOTICE BOARDS (U.S. CLS. 21, 23, 26, 36 AND 38).

CLASS 16—PAPER GOODS AND PRINTED MATTER

FOR PRINTED MATTER, NAMELY, BOOKS, NEWSPAPERS, MAGAZINES AND NEWSLETTERS FEATURING CURRENT EVENTS AND GENERAL INFORMATION FOR GENERAL CIRCULATION, MUSICAL WORKS AND LITERARY WORK OF FICTION OR NON-FICTION ON A VARIETY OF TOPICS; PHOTOGRAPHS; STATIONERY; ARTISTS' MATERIALS, NAMELY, PENS, PASTELS AND BRUSHES; PRINTED INSTRUCTIONAL AND TEACHING MATERIALS FEATURING PRIMARY, SECONDARY AND UNIVERSITY-LEVEL EDUCATIONAL CURRICULUM IN THE FIELDS OF SCHOOL, TERTIARY AND CORPORATE EDUCATION AND TRAINING COURSES IN ENGLISH, LANGUAGE ARTS, READING AND WRITING, MATHEMATICS, SCIENCE, SOCIAL STUDIES, CURRENT AFFAIRS, BUSINESS AND BUSINESS MANAGEMENT, FINANCE AND ECONOMICS, COMPUTER SCIENCE, ARCHITECTURE, ART, ENGINEERING, LAW, AND MEDICINE; PLASTIC MATERIALS FOR PACKAGING, NAMELY, BAGS; PRINTERS' TYPE; PRINTING BLOCKS (U.S. CLS. 2, 5, 22, 23, 29, 37, 38 AND 50).

CLASS 35—ADVERTISING AND BUSINESS

FOR ADVERTISING, MARKETING AND PROMOTIONAL SERVICES, PREPARATION AND PLACEMENT OF ADVERTISEMENTS IN PRINTED AND ELECTRONIC MEDIA; ELECTRONIC BILLBOARD ADVERTISING; BUSINESS INFORMATION SERVICES; BUSINESS ADMINISTRATION SERVICES; RETAIL AND WHOLESALE SERVICES, NAMELY, TELEPHONIC, COMPUTERIZED AND ELECTRONIC RETAILING AND ORDERING SERVICES FEATURING PRINTED MATTER AND GENERAL CONSUMER MERCHANDISE; COLLECTION AND PROVISION OF BUSINESS, COMMERCIAL, STATISTICAL AND MARKETING INFORMATION; DATABASE MANAGEMENT SERVICES; NEWS CLIPPING SERVICES; ALL OF THE FOREGOING SERVICES ALSO PROVIDED BY MEANS OF TELEPHONIC COMMUNICATION, ON-LINE FROM A COMPUTER DATABASE, A GLOBAL COMPUTER NETWORK, THE INTERNET OR ANY OTHER ELECTRONIC, WIRELESS OR AUTOMATED MEANS; INFORMATION SERVICES, NAMELY, PROVIDING INFORMATION TO THE CONSUMING PUBLIC VIA A GLOBAL COMPUTER NETWORK FEATURING INFORMATION AND DATA FOR BUSINESS PURPOSES; THE PROVISION OF DATABASES FEATURING INFORMATION AND DATA FOR BUSINESS PURPOSES (U.S. CLS. 100, 101 AND 102).

CLASS 38—COMMUNICATION

FOR SERVICES OF ALL KINDS RELATING TO TELECOMMUNICATION AND INFORMATION SERVICES, NAMELY, ELECTRONIC TRANSMISSION OF DATA; ELECTRONIC MAIL SERVICES; PROVIDING ON-LINE ELECTRONIC BULLETIN BOARDS FOR THE TRANSMISSION OF MESSAGES OF GENERAL INTEREST; PROVISION OF MULTIPLE USER ACCESS TO A GLOBAL COMPUTER NETWORK; PROVIDING ON-LINE CHAT ROOMS FOR THE TRANSMISSION OF MESSAGES OF GENERAL INTEREST; ELECTRONIC COMMUNICATION BY MEANS OF COMPUTERS, ELECTRONIC MAIL AND A GLOBAL COMPUTER NETWORK; COMPUTER AIDED TRANSMISSION OF MESSAGES AND IMAGES, WIRELESS DIGITAL MESSAGING SERVICES; SATELLITE TRANSMISSION SERVICES; BROADCASTING SERVICES, NAMELY, AUDIO, VIDEO, RADIO, TELEVISION AND SATELLITE BROADCASTING SERVICES; PROVIDING TELECOMMUNICATION CONNECTIONS TO A GLOBAL COMPUTER NETWORK (U.S. CLS. 100, 101 AND 104).

CLASS 41—EDUCATION AND ENTERTAINMENT

FOR EDUCATIONAL SERVICES, NAMELY, PROVIDING TRAINING, CLASSES, SEMINARS, CONFERENCES AND PROGRAMS AT SCHOOL, TERTIARY AND CORPORATE LEVELS FEATURING PRIMARY, SECONDARY AND UNIVERSITY-LEVEL EDUCATIONAL CURRICULUM IN ENGLISH, LANGUAGE ARTS, READING AND WRITING, MATHEMATICS, SCIENCE, SOCIAL STUDIES, CURRENT AFFAIRS, BUSINESS AND BUSINESS MANAGEMENT, FINANCE AND ECONOMICS, COMPUTER SCIENCE, ARCHITECTURE, ART, ENGINEERING, LAW, AND MEDICINE; SPORTING AND CULTURAL SERVICES, NAMELY, PROVIDING ON-LINE INFORMATION REGARDING SPORTING AND CULTURAL EVENTS AND OTHER EVENTS OF GENERAL INTEREST; PUBLICATION SERVICES, NAMELY, PUBLISHING OF BOOKS, NEWSPAPERS, NEWSLETTERS, MAGAZINES, AND MANUALS; PROVIDING ON-LINE ELECTRONIC PUBLICATIONS, NAMELY, BOOKS, NEWSPAPERS, NEWSLETTERS, MAGAZINES AND PERIODICALS FEATURING PRIMARY, SECONDARY AND UNIVERSITY-LEVEL EDUCATIONAL CURRICULUM IN THE FIELDS OF SCHOOL, TERTIARY AND CORPORATE EDUCATION AND TRAINING COURSES IN ENGLISH, LANGUAGE ARTS, READING AND WRITING, MATHEMATICS, SCIENCE, SOCIAL STUDIES, CURRENT AFFAIRS, BUSINESS AND BUSINESS MANAGEMENT, FINANCE AND ECONOMICS, COMPUTER SCIENCE, ARCHITECTURE, ART, ENGINEERING, LAW, AND MEDICINE; LIBRARY SERVICES; PROVISION OF NEWS IN THE NATURE OF CURRENT EVENT REPORTING; ALL OF THE FOREGOING SERVICES PROVIDED ON-LINE FROM A COMPUTER DATABASE, A GLOBAL COMPUTER NETWORK, THE INTERNET OR ANY OTHER ELECTRONIC, WIRELESS OR AUTOMATED MEANS; INFORMATION SERVICES, IN THE NATURE OF NEWS REPORTING; ALL OF THE FOREGOING SERVICES PROVIDED ONLINE FROM A COMPUTER DATABASE, A GLOBAL COMPUTER NETWORK THE INTERNET OR ANY OTHER ELECTRONIC, WIRELESS OR AUTOMATED MEANS; INFORMATION SERVICES, NAMELY, PROVIDING INFORMATION TO THE CONSUMING PUBLIC VIA A GLOBAL COMPUTER NETWORK RELATING TO EDUCATION AND TEACHING; THE PROVISION OF DATABASES FEATURING INFORMATION RELATING TO EDUCATION AND TEACHING (U.S. CLS. 100, 101 AND 107).

CLASS 42—SCIENTIFIC AND COMPUTER SERVICES

FOR INFORMATION TECHNOLOGY AND COMPUTER RELATED SERVICES FOR OTHERS, NAMELY, COMPUTER PROGRAMMING, MAINTENANCE AND UPDATING OF COMPUTER SOFTWARE, COMPUTER SOFTWARE DESIGN, RECOVERY OF COMPUTER DATA; CREATING AND MAINTAINING WEBSITES FOR OTHERS; SPECIALIST SERVICES RELATING TO RESEARCH, NAMELY, PRODUCT RESEARCH; ALL OF THE FOREGOING SERVICES ALSO PROVIDED BY MEANS OF TELEPHONE COMMUNICATION, ON-LINE FROM A COMPUTER DATABASE, A GLOBAL COMPUTER NETWORK, THE INTERNET OR ANY OTHER ELECTRONIC OR WIRELESS MEANS (U.S. CLS. 100 AND 101).

HEATHER THOMPSON, EXAMINING ATTORNEY

SN 76-656,872. VALDES ENGINEERING COMPANY, LOMBARD, IL. FILED 3-15-2006.

VEC

THE MARK CONSISTS OF STANDARD CHARACTERS WITHOUT CLAIM TO ANY PARTICULAR FONT, STYLE, SIZE, OR COLOR.

CLASS 35—ADVERTISING AND BUSINESS

FOR PROJECT MANAGEMENT SERVICE FOR OTHERS IN THE FIELD OF ENGINEERING; ELECTRONIC DOCUMENT MANAGEMENT SERVICES, NAMELY, ELECTRONIC DOCUMENT INDEXING AND CONTROL FOR OTHERS IN THE FIELD OF ENGINEERING (U.S. CLS. 100, 101 AND 102).

SN 76-656,871. VALDES ENGINEERING COMPANY, LOMBARD, IL. FILED 3-15-2006.

VALDES

CLASS 37—CONSTRUCTION AND REPAIR

FOR CONSTRUCTION MANAGEMENT SERVICES (U.S. CLS. 100, 103 AND 106).

CLASS 42—SCIENTIFIC AND COMPUTER SERVICES

FOR ENGINEERING SERVICES; DESIGN FOR OTHERS IN THE FIELD OF ENGINEERING; ENGINEERING CONSULTATION; AND TECHNICAL SUPPORT, NAMELY, TROUBLESHOOTING OF COMPUTER HARDWARE AND SOFTWARE PROBLEMS IN THE FIELD OF ENGINEERING (U.S. CLS. 100 AND 101).

TINA L. SNAPP, EXAMINING ATTORNEY

SN 76-659,785. KABUSHIKI KAISHA TAITO, CHIYODAKU, TOKYO, JAPAN, FILED 5-9-2006.

THE MARK CONSISTS OF STANDARD CHARACTERS WITHOUT CLAIM TO ANY PARTICULAR FONT, STYLE, SIZE, OR COLOR.
SEC. 2(F).

CLASS 35—ADVERTISING AND BUSINESS

FOR PROJECT MANAGEMENT SERVICE FOR OTHERS IN THE FIELD OF ENGINEERING; ELECTRONIC DOCUMENT MANAGEMENT SERVICES, NAMELY, ELECTRONIC DOCUMENT INDEXING AND CONTROL FOR OTHERS IN THE FIELD OF ENGINEERING (U.S. CLS. 100, 101 AND 102).

FIRST USE 8-31-1992; IN COMMERCE 8-31-1992.

CLASS 37—CONSTRUCTION AND REPAIR

FOR CONSTRUCTION MANAGEMENT SERVICES (U.S. CLS. 100, 103 AND 106).

FIRST USE 8-31-1992; IN COMMERCE 8-31-1992.

CLASS 42—SCIENTIFIC AND COMPUTER SERVICES

FOR ENGINEERING SERVICES; DESIGN FOR OTHERS IN THE FIELD OF ENGINEERING; ENGINEERING CONSULTATION; AND TECHNICAL SUPPORT, NAMELY, TROUBLESHOOTING OF COMPUTER HARDWARE AND SOFTWARE PROBLEMS IN THE FIELD OF ENGINEERING (U.S. CLS. 100 AND 101).

FIRST USE 8-31-1992; IN COMMERCE 8-31-1992.

TINA L. SNAPP, EXAMINING ATTORNEY

**CLASS 28—TOYS AND SPORTING GOODS**

FOR COIN-OPERATED AMUSEMENT MACHINES; COIN-OPERATED VIDEO GAMES (U.S. CLS. 22, 23, 38 AND 50).

CLASS 41—EDUCATION AND ENTERTAINMENT

FOR PROVIDING AMUSEMENT ARCADE SERVICES, NAMELY, PROVIDING AMUSEMENT FACILITIES AND ENTERTAINMENT IN THE NATURE OF ELECTRONIC GAMING AND PROVIDING INFORMATION IN THE FIELD OF ENTERTAINMENT; ENTERTAINMENT SERVICES, NAMELY, PROVIDING AN ON-LINE COMPUTER GAME; ENTERTAINMENT SERVICES IN THE NATURE OF COMPETITIONS IN THE FIELD OF COMPUTER GAMES AND PROVIDING GAME SCORE RANKING INFORMATION; RENTAL OF AMUSEMENT PARK MACHINES; RENTAL OF COIN-OPERATED GAME MACHINES AND RENTAL OF VIDEO GAME MACHINES FOR ARCADE USE (U.S. CLS. 100, 101 AND 107).

DANIEL BRODY, EXAMINING ATTORNEY

NO CLAIM IS MADE TO THE EXCLUSIVE RIGHT TO USE "GREEN", APART FROM THE MARK AS SHOWN.

SN 76-677,379. VEMICS, INC., NANUET, NY. FILED 5-25-2007.

IMEDICOR

THE MARK CONSISTS OF STANDARD CHARACTERS WITHOUT CLAIM TO ANY PARTICULAR FONT, STYLE, SIZE, OR COLOR.

CLASS 38—COMMUNICATION

FOR PROVIDING ONLINE CHAT ROOMS AND ELECTRONIC BULLETIN BOARDS FOR THE TRANSMISSION OF MESSAGES AMONG COMPUTER USERS, NAMELY, AMONG MEDICAL PRACTITIONERS IN ORDER TO FACILITATE PRACTICE PRODUCTIVITY VIA THE EXCHANGE OF INFORMATION REGARDING EDUCATION, INFORMATION, AND IDEAS THROUGH SECURED AND UNSECURED COMMUNICATIONS; AND ELECTRONIC EXCHANGE OF DATA STORED IN DATABASES ACCESSIBLE VIA TELECOMMUNICATIONS NETWORKS FOR USE BY MEDICAL PRACTITIONERS IN ORDER TO FACILITATE PRACTICE PRODUCTIVITY VIA THE EXCHANGE OF INFORMATION REGARDING EDUCATION, INFORMATION, AND IDEAS THROUGH SECURED AND UNSECURED COMMUNICATIONS (U.S. CLS. 100, 101 AND 104).

FIRST USE 10-10-2007; IN COMMERCE 10-10-2007.

CLASS 41—EDUCATION AND ENTERTAINMENT

FOR PROVIDING A WEBSITE FEATURING EDUCATIONAL INFORMATION FOR MEDICAL PRACTITIONERS, NAMELY, PROVIDING ONLINE INFORMATION REGARDING CERTIFIED CONTINUING MEDICAL EDUCATION PROGRAMS AND EDUCATIONAL INFORMATION REGARDING EDUCATIONAL PROGRAMS FEATURING SPECIFIC MEDICAL PRODUCTS (U.S. CLS. 100, 101 AND 107).

FIRST USE 10-10-2007; IN COMMERCE 10-10-2007.

CLASS 44—MEDICAL, BEAUTY AND AGRICULTURAL SERVICES

FOR PROVIDING A WEBSITE FEATURING MEDICAL INFORMATION FOR USE BY MEDICAL PRACTITIONERS IN ORDER TO FACILITATE PRACTICE PRODUCTIVITY; PROVIDING INFORMATION REGARDING SPECIFIC MEDICAL PRODUCTS (U.S. CLS. 100 AND 101).

FIRST USE 10-10-2007; IN COMMERCE 10-10-2007.
SUE LAWRENCE, EXAMINING ATTORNEY

SN 76-685,502. SAFEWAY INC., PLEASANTON, CA. FILED 1-3-2008.

BRIGHT GREEN

THE MARK CONSISTS OF STANDARD CHARACTERS WITHOUT CLAIM TO ANY PARTICULAR FONT, STYLE, SIZE, OR COLOR.

CLASS 3—COSMETICS AND CLEANING PREPARATIONS

FOR LAUNDRY DETERGENT, LAUNDRY BLEACH, LIQUID FABRIC SOFTENER, FABRIC SOFTENER SHEETS, LAUNDRY STAIN REMOVER, FABRIC STARCH, ALL-PURPOSE CLEANER, ALL PURPOSE CLEANING WIPES, BABY WIPES, CARPET CLEANER, FLOOR CLEANING PREPARATIONS, DISINFECTANT SOAPS, DRAIN AND SEPTIC CARE PRODUCTS, NAMELY, DRAIN OPENERS, OVEN CLEANER, FURNITURE CARE PRODUCTS, NAMELY, FURNITURE POLISHES, GLASS CLEANER, CLEANING PREPARATIONS FOR USE ON METAL; DISHWASHING DETERGENTS, DISHWASHING DETERGENT ADDITIVES, NAMELY, DECALCIFYING PREPARATIONS FOR CLEANING METAL POTS AND PANS, AUTOMATIC DISHWASHING DETERGENTS IN THE FORMS OF TABLETS, LIQUIDS, GELS AND POWDERS; HAIR CARE PRODUCTS, NAMELY, SHAMPOO AND CONDITIONER; ORAL CARE PRODUCTS, NAMELY, TOOTH PASTE, AT HOME TEETH WHITENING KITS, NON-MEDICATED ORAL RINSE, MOUTHWASH, DENTURE CLEANING PREPARATIONS; FOOT CARE PRODUCTS, NAMELY, NON-MEDICATED FOOT CREAMS AND SOAKS; SHOE CARE PRODUCTS, NAMELY, SHOE POLISH AND CREAMS; ALL OF THE AFOREMENTIONED GOODS BEING MANUFACTURED IN AN ENVIRONMENTALLY FRIENDLY MANNER AND/OR CONSISTING OF ENVIRONMENTALLY FRIENDLY COMPONENTS (U.S. CLS. 1, 4, 6, 50, 51 AND 52).

CLASS 4—LUBRICANTS AND FUELS

FOR FIREPLACE LOGS, CHARCOAL, LIGHTER FLUID AND CANDLES; ALL OF THE AFOREMENTIONED GOODS BEING MANUFACTURED IN AN ENVIRONMENTALLY FRIENDLY MANNER AND/OR CONSISTING OF ENVIRONMENTALLY FRIENDLY COMPONENTS (U.S. CLS. 1, 6 AND 15).

CLASS 5—PHARMACEUTICALS

FOR LAUNDRY FABRIC DEODORIZERS; PEST CONTROL PRODUCTS, NAMELY, PESTICIDES; ADULT INCONTINENCE PADS; FEMININE CARE PRODUCTS, NAMELY, SANITARY NAPKINS AND TAMPONS; FIRST AID BANDAGES FOR SKIN WOUNDS; AIR FRESHENERS; DISINFECTANT TOILET BOWL CLEANERS; CARPET DEODORIZERS; ALL PURPOSE DISINFECTANTS, ALL PURPOSE DISINFECTING AND DEODORIZING PREPARATIONS, CONTACT LENS DISINFECTANTS, DISINFECTANT BATHROOM CLEANERS, DISINFECTANTS FOR HYGIENIC PURPOSES, DISINFECTANTS FOR SANITARY PURPOSES, MEDICATED DISINFECTING HAND WASH; FOOT CARE PRODUCTS, NAMELY, MEDICATED FOOT CREAMS AND SOAKS; ORAL ANALGESICS; MEDICATED ORAL MOUTH RINSE; BREASTFEEDING SUPPLIES, NAMELY, NURSING PADS; FLEA COLLARS; PET REPELLENT, NAMELY, SPRAYS USED TO TRAIN PETS TO KEEP OFF FURNITURE; VETERINARY PREPARATIONS FOR PETS, NAMELY, FLEA AND TICK SPRAYS, MEDICATED FLEA AND TICK BATHS, AND FLEA AND TICK MEDICINES; ALL OF THE AFOREMENTIONED GOODS BEING MANUFACTURED IN AN ENVIRONMENTALLY FRIENDLY MANNER AND/OR CONSISTING OF ENVIRONMENTALLY FRIENDLY COMPONENTS (U.S. CLS. 6, 18, 44, 46, 51 AND 52).

CLASS 6—METAL GOODS

FOR ALUMINUM FOIL BEING MANUFACTURED IN AN ENVIRONMENTALLY FRIENDLY MANNER AND/OR CONSISTING OF ENVIRONMENTALLY FRIENDLY COMPONENTS (U.S. CLS. 2, 12, 13, 14, 23, 25 AND 50).

CLASS 8—HAND TOOLS

FOR DISPOSABLE RAZORS; CUTLERY; UTENSILS, NAMELY, SPOONS, FORKS, AND KNIVES FOR USE FOR FEEDING BABIES; NAIL CLIPPERS; HAIR TRIMMERS FOR PETS, NAIL TRIMMERS FOR PETS; ALL OF THE AFOREMENTIONED GOODS BEING MANUFACTURED IN AN ENVIRONMENTALLY FRIENDLY MANNER AND/OR CONSISTING OF ENVIRONMENTALLY FRIENDLY COMPONENTS (U.S. CLS. 23, 28 AND 44).

CLASS 9—ELECTRICAL AND SCIENTIFIC APPARATUS

FOR BATTERIES AND BATTERY CHARGERS; ELECTRIC OUTLET COVERS; BABY MONITORS; ALL OF THE AFOREMENTIONED GOODS BEING MANUFACTURED IN AN ENVIRONMENTALLY FRIENDLY MANNER AND/OR CONSISTING OF ENVIRONMENTALLY FRIENDLY COMPONENTS (U.S. CLS. 21, 23, 26, 36 AND 38).

CLASS 10—MEDICAL APPARATUS

FOR NURSING SUPPLIES, NAMELY, BOTTLES, DISPOSABLE BABY BOTTLE LINERS, BABY BOTTLE NIPPLES; BREASTFEEDING SUPPLIES, NAMELY, BREAST PUMPS, BREAST MILK STORAGE BOTTLES; CUPS ADAPTED FOR FEEDING BABIES AND CHILDREN; PACIFIERS, PACIFIER HOLDERS BEING PACIFIER CLIPS, TEething RINGS; FEVER THERMOMETERS, NASAL ASPIRATORS; ALL OF THE AFOREMENTIONED GOODS BEING MANUFACTURED IN AN ENVIRONMENTALLY FRIENDLY MANNER AND/OR CONSISTING OF ENVIRONMENTALLY FRIENDLY COMPONENTS (U.S. CLS. 26, 39 AND 44).

CLASS 11—ENVIRONMENTAL CONTROL APPARATUS

FOR LIGHT BULBS; WATER FILTRATION PRODUCTS, NAMELY, FILTERS FOR DRINKING WATER, WATER FILTRATION PITCHERS SOLD EMPTY; ELECTRIC BABY BOTTLE WARMERS; ALL OF THE AFOREMENTIONED GOODS BEING MANUFACTURED IN AN ENVIRONMENTALLY FRIENDLY MANNER AND/OR CONSISTING OF ENVIRONMENTALLY FRIENDLY COMPONENTS (U.S. CLS. 13, 21, 23, 31 AND 34).

CLASS 16—PAPER GOODS AND PRINTED MATTER

FOR BATH TISSUE, PAPER TOWELS AND PAPER NAPKINS, FACIAL TISSUE, TOILET TISSUE, PAPER COFFEE FILTERS FOR COFFEE MAKERS, REUSABLE PLASTIC FOOD STORAGE BAGS FOR HOUSEHOLD USE, PLASTIC WRAP, PAPER LUNCH BAGS, WAX PAPER, WAX PAPER FOR FREEZER USE; PLASTIC COOKING BAGS FOR OVEN USE; COOKING BAGS FOR MICROWAVE USE; GARBAGE BAGS OF PAPER OR PLASTIC, TRASH BAGS, PAPER REFUSE BAGS, LAWN DISPOSAL BAGS, TABLE COVERS OF PAPER; DISPOSABLE DIAPERS AND DISPOSABLE TRAINING PANTS; ALL OF THE AFOREMENTIONED GOODS BEING MANUFACTURED IN AN ENVIRONMENTALLY FRIENDLY MANNER AND/OR CONSISTING OF ENVIRONMENTALLY FRIENDLY COMPONENTS (U.S. CLS. 2, 5, 22, 23, 29, 37, 38 AND 50).

CLASS 18—LEATHER GOODS

FOR PET ACCESSORIES, NAMELY, LEASHES, COLLARS, CHARMS FOR COLLARS, PET CLOTHES, PET COLLAR ACCESSORIES, NAMELY, BOWS, RAWHIDE CHEWS, DIAPERS FOR DOGS; ALL OF THE AFOREMENTIONED GOODS BEING MANUFACTURED IN AN ENVIRONMENTALLY FRIENDLY MANNER AND/OR CONSISTING OF ENVIRONMENTALLY FRIENDLY COMPONENTS, AND NONE OF THE AFOREMENTIONED GOODS BEING IN THE COLORS GREEN OR BRIGHT GREEN (U.S. CLS. 1, 2, 3, 22 AND 41).

CLASS 20—FURNITURE AND ARTICLES NOT OTHERWISE CLASSIFIED

FOR DRINKING STRAWS; BOOSTER SEATS; CAT SCRATCHING POSTS, CAT SCRATCHING PADS; BEDS FOR HOUSEHOLD PETS; ALL OF THE AFOREMENTIONED GOODS BEING MANUFACTURED IN AN ENVIRONMENTALLY FRIENDLY MANNER AND/OR CONSISTING OF ENVIRONMENTALLY FRIENDLY COMPONENTS, AND NONE OF THE AFOREMENTIONED GOODS BEING IN THE COLORS GREEN OR BRIGHT GREEN (U.S. CLS. 2, 13, 22, 25, 32 AND 50).

CLASS 21—HOUSEWARES AND GLASS

FOR BROOMS, MOPS, BRUSHES, NAMELY, SINK SCRUBBING BRUSHES, DISHWASHING BRUSHES, KITCHEN UTILITY BRUSHES FOR SCRUBBING AND SCRAPING, ALL PURPOSE KITCHEN BRUSHES FOR SCRUBBING AND SCRAPING, BLENDER BRUSHES IN THE NATURE OF DISHWASHING BRUSHES ADAPTED FOR CLEANING BLENDERS, BOTTLE BRUSHES IN THE NATURE OF DISHWASHING BRUSHES ADAPTED FOR CLEANING BOTTLES, BASTING BRUSHES, TOILET BRUSHES, HAIR BRUSHES, NAIL BRUSHES, MAKE-UP BRUSHES, FLOOR BRUSHES, SHAVING BRUSHES, RUBBER HOUSEHOLD GLOVES, SCOURING PADS FOR CLEANING, CLEANING SPONGES; DENTAL FLOSS; PLASTIC FOOD STORAGE CONTAINERS FOR HOUSEHOLD OR DOMESTIC USE; COOKWARE, NAMELY, POTS, PANS, COOKIE SHEETS; HOUSEHOLD AND SERVING UTENSILS, NAMELY, SPATULAS, LADLES, SERVING SPOONS, SLOTTED SPOONS, AND MIXING SPOONS; BAKEWARE; OVENWARE; PAPER AND PLASTIC PLATES, BOWLS AND CUPS; MANUAL TOOTHBRUSHES, POWER TOOTH BRUSHES; INTERDENTAL IMPLEMENTS, NAMELY, INTERDENTAL CLEANERS FOR ORAL HYGIENE PURPOSES; PORTABLE ORAL CARE, NAMELY, TRAVEL TOOTHBRUSHES; PLASTIC WATER BOTTLES SOLD EMPTY AND CONTAINING BUILT IN WATER FILTERS; BABY FEEDING ACCESSORIES, NAMELY, BOWLS, PLATES, AND TRAINING CUPS FOR BABIES AND CHILDREN; BABY HAIR COMBS, BABY HAIR BRUSHES, BABY TOOTHBRUSHES; PET FEEDING BOWLS; PET GROOMING NEEDS, NAMELY, BRUSHES AND COMBS; TOOTHBRUSHES FOR PETS; PET CLEANING CLOTHS; ALL OF THE AFOREMENTIONED GOODS BEING MANUFACTURED IN AN ENVIRONMENTALLY FRIENDLY MANNER AND/OR CONSISTING OF ENVIRONMENTALLY FRIENDLY COMPONENTS; ALL OF THE AFOREMENTIONED GOODS BEING MANUFACTURED IN AN ENVIRONMENTALLY FRIENDLY MANNER AND/OR CONSISTING OF ENVIRONMENTALLY FRIENDLY COMPONENTS (U.S. CLS. 2, 13, 23, 29, 30, 33, 40 AND 50).

CLASS 24—FABRICS

FOR WASH CLOTHS, CHILDREN'S BLANKETS; ALL OF THE AFOREMENTIONED GOODS BEING MANUFACTURED IN AN ENVIRONMENTALLY FRIENDLY MANNER AND/OR CONSISTING OF ENVIRONMENTALLY FRIENDLY COMPONENTS (U.S. CLS. 42 AND 50).

CLASS 25—CLOTHING

FOR PANTYHOSE; CLOTH DIAPERS; ALL OF THE AFOREMENTIONED GOODS BEING MANUFACTURED IN AN ENVIRONMENTALLY FRIENDLY MANNER AND/OR CONSISTING OF ENVIRONMENTALLY FRIENDLY COMPONENTS, AND NONE OF THE AFOREMENTIONED GOODS BEING IN THE COLORS GREEN OR BRIGHT GREEN (U.S. CLS. 22 AND 39).

CLASS 27—FLOOR COVERINGS

FOR NON-SLIP BATH TUB MATS, BEING MANUFACTURED IN AN ENVIRONMENTALLY FRIENDLY MANNER AND/OR CONSISTING OF ENVIRONMENTALLY FRIENDLY COMPONENTS, AND NONE OF THE AFOREMENTIONED GOODS BEING IN THE COLORS GREEN OR BRIGHT GREEN (U.S. CLS. 19, 20, 37, 42 AND 50).

CLASS 31—NATURAL AGRICULTURAL PRODUCTS

FOR CAT LITTER, BEING MANUFACTURED IN AN ENVIRONMENTALLY FRIENDLY MANNER AND/OR CONSISTING OF ENVIRONMENTALLY FRIENDLY COMPONENTS (U.S. CLS. 1 AND 46).

LYDIA BELZER, EXAMINING ATTORNEY

CLASS 14—JEWELRY

FOR JEWELRY CHARMS (U.S. CLS. 2, 27, 28 AND 50).

CLASS 18—LEATHER GOODS

FOR BACKPACKS (U.S. CLS. 1, 2, 3, 22 AND 41).
RICHARD WHITE, EXAMINING ATTORNEY

SN 76-685,767. AUGENTIUS FUND ADMINISTRATION, LLP, LONDON, SE1 9RA, UNITED KINGDOM, FILED 1-15-2008.

SN 76-688,075. REICHBORN, PER K, GREENWICH, CT. FILED 3-21-2008.

AUGENTIUS

THE MARK CONSISTS OF STANDARD CHARACTERS WITHOUT CLAIM TO ANY PARTICULAR FONT, STYLE, SIZE, OR COLOR.

PRIORITY CLAIMED UNDER SEC. 44(D) ON ERP CMNTY TM OFC APPLICATION NO. 006436695, FILED 11-14-2007, REG. NO. 006436695, DATED 10-27-2008, EXPIRES 11-14-2017.

CLASS 35—ADVERTISING AND BUSINESS

FOR FINANCIAL RECORDS MANAGEMENT SERVICES; PROVISION OF FINANCIAL STATEMENTS AND ANALYSIS PREPARATION FOR BUSINESS; PROVIDING FINANCIAL REPORTS FOR OTHERS; BUSINESS MANAGEMENT CONSULTANCY SERVICES; ADMINISTRATION OF BUSINESS PAYROLL FOR OTHERS; ADVISORY SERVICES RELATING TO BUSINESS MANAGEMENT AND BUSINESS OPERATIONS; PROVISION OF BUSINESS ADMINISTRATION AND OFFICE WORK; BUSINESS ASSISTANCE OUTSOURCING SERVICES; ACCOUNTING SERVICES; MANAGEMENT AND ADMINISTRATION OF PRIVATE EQUITY AND PROPERTY FUNDS; ACCOUNTING AND BUSINESS AUDITING SERVICES; BUSINESS INFORMATION AND ACCOUNTING ADVISORY SERVICES; PERSONNEL MANAGEMENT; FINANCIAL CUSTODY SERVICES, NAMELY, REGISTERING THE OWNERSHIP OF STOCKS, BONDS, FUNDS, OPTIONS, FUTURES, SWAPS AND FORWARDS (U.S. CLS. 100, 101 AND 102).

CLASS 36—INSURANCE AND FINANCIAL

FOR FINANCIAL CONSULTATION SERVICES; FINANCIAL INFORMATION PROCESSING SERVICES; FINANCIAL PORTFOLIO MANAGEMENT AND ANALYSIS SERVICES; INVESTMENT CONSULTATION AND MANAGEMENT SERVICES FOR STORED INVESTMENTS (U.S. CLS. 100, 101 AND 102).

HEATHER THOMPSON, EXAMINING ATTORNEY

SN 76-687,179. WALGREEN CO., DEERFIELD, IL. FILED 2-28-2008.

SNAPPERZ

THE MARK CONSISTS OF STANDARD CHARACTERS WITHOUT CLAIM TO ANY PARTICULAR FONT, STYLE, SIZE, OR COLOR.

SPEEDCLEAN

THE MARK CONSISTS OF STANDARD CHARACTERS WITHOUT CLAIM TO ANY PARTICULAR FONT, STYLE, SIZE, OR COLOR.

CLASS 1—CHEMICALS

FOR CHEMICAL FOR DISSOLVING SCALE FROM PIPES (U.S. CLS. 1, 5, 6, 10, 26 AND 46).

CLASS 9—ELECTRICAL AND SCIENTIFIC APPARATUS

FOR INSPECTION AND TEST EQUIPMENT FOR SMOKE STACK EFFICIENCY, NAMELY, STACK TESTER WITH PROBE TO MEASURE COMBUSTION GAS COMPONENTS, TEMPERATURE, EXCESS AIR AND COMBUSTION EFFICIENCY; LEAK DETECTORS FOR HEAT EXCHANGER, CHILLER AND CONDENSER TUBES, NAMELY, PNEUMATIC GUNS WITH TUBE SEALS; AND THERMOMETERS (U.S. CLS. 21, 23, 26, 36 AND 38).

TASNEM HUSSAIN, EXAMINING ATTORNEY

SN 76-688,652. HERAEUS KULZER GMBH, D-63450 HANAU, FED REP GERMANY, FILED 4-16-2008.

one2fresh

THE MARK CONSISTS OF STANDARD CHARACTERS WITHOUT CLAIM TO ANY PARTICULAR FONT, STYLE, SIZE, OR COLOR.

PRIORITY CLAIMED UNDER SEC. 44(D) ON FED REP GERMANY APPLICATION NO. 30777766.9, FILED 11-29-2007, REG. NO. 30777766, DATED 2-1-2008, EXPIRES 11-30-2017.

CLASS 3—COSMETICS AND CLEANING PREPARATIONS

FOR BODY AND BEAUTY CARE COSMETICS; BREATH FRESHENER SPRAYS; ORAL HYGIENE AGENTS, NOT FOR MEDICAL PURPOSES, IN PARTICULAR MOUTH RINSES AND MOUTH SPRAYS, BREATH FRESHENER, NAMELY, PEPPERMINT ESSENCE, TOOTH POLISH, POLISHING PREPARATIONS FOR DENTURES, TOOTH BLEACHING GELS, TOOTH CLEANING PREPARATIONS, TOOTHPASTE (U.S. CLS. 1, 4, 6, 50, 51 AND 52).

CLASS 5—PHARMACEUTICALS

FOR PHARMACEUTICAL, VETERINARY, DENTAL AND MEDICAL PRODUCTS, NAMELY, HYGIENE PREPARATIONS FOR MEDICAL PURPOSES, NAMELY, DISINFECTANTS FOR HYGIENE PURPOSES, MEDICATED BATH PREPARATIONS, MEDICATED HAND WASH, AND MEDICATED MOUTHWASH; DISINFECTING AGENTS, IN PARTICULAR ANTIBIOTICS; DRUGS FOR DENTAL PURPOSES, NAMELY, PAIN RELIEF MEDICATION, ANESTHETICS FOR SURGICAL AND NON-SURGICAL USE, GASES FOR DENTAL USE, AND ANTICAVITY MOUTH RINSES; BIOLOGICAL PREPARATIONS FOR MEDICAL PURPOSES; CHEMICAL PREPARATIONS FOR MEDICAL PURPOSES FOR THE TREATMENT OF INFECTIOUS DISEASES AND DENTAL DISEASES; CHEMICAL PREPARATIONS FOR MEDICAL PURPOSES FOR USE IN DERMATOLOGY, DENTAL MEDICINE, AND DISEASES OF THE HUMAN BODY; DISINFECTING AGENTS FOR HYGIENIC PURPOSES; CHEWING GUM FOR MEDICAL PURPOSES; MOUTH RINSES FOR MEDICAL PURPOSES; MEDICATED LOZENGES; PHARMACEUTICAL PREPARATIONS, NAMELY, PEPPERMINT FOR USE IN THE TREATMENT OF DENTAL DISEASES; PHARMACEUTICAL PREPARATIONS FOR THE TREATMENT OF INFECTIOUS DISEASES; PHARMACEUTICAL PREPARATIONS FOR USE IN DERMATOLOGY AND THE FIELD OF DENTAL MEDICINE (U.S. CLS. 6, 18, 44, 46, 51 AND 52).

KIM MONINGHOFF, EXAMINING ATTORNEY

SN 76-690,170. SAFEWAY INC., PLEASANTON, CA. FILED 5-30-2008.



OWNER OF U.S. REG. NO. 3,477,124.
THE COLOR(S) BROWN AND WHITE IS/ARE CLAIMED AS A FEATURE OF THE MARK.

THE MARK CONSISTS OF TWO WHITE BIRDS FACING EACH OTHER, BETWEEN WHICH IS A HATCHLING IN WHITE AND PEERING UP FROM THE BOTTOM HALF OF AN EGGSHELL, BELOW WHICH APPEARS A BROWN RECTANGLE WITH A WHITE BORDER AND POINTED BOTTOM EDGE, INSIDE WHICH APPEARS THE WORDING "MOM TO MOM" IN WHITE, BELOW WHICH APPEARS THE WORDING "SHARING WISDOM" IN WHITE.

CLASS 3—COSMETICS AND CLEANING PREPARATIONS

FOR SUNSCREEN CREAMS, LOTIONS, AND STICKS (U.S. CLS. 1, 4, 6, 50, 51 AND 52).

CLASS 5—PHARMACEUTICALS

FOR OVER THE COUNTER MEDICATIONS FOR BABIES AND CHILDREN, NAMELY, MEDICATED DECONGESTANT CHEST RUBS, MEDICATED DIAPER RASH OINTMENT, PHARMACEUTICAL PREPARATIONS FOR NUMBING PAIN CAUSED BY TEETHING, ANTI-FLATULENT PHARMACEUTICAL PREPARATIONS; PEDIATRIC ELECTROLYTE DRINKS, PEDIATRIC NUTRITION DRINKS, NAMELY, LIQUID NUTRITIONAL SUPPLEMENTS (U.S. CLS. 6, 18, 44, 46, 51 AND 52).

CLASS 8—HAND TOOLS

FOR NAIL CLIPPERS (U.S. CLS. 23, 28 AND 44).

CLASS 9—ELECTRICAL AND SCIENTIFIC APPARATUS

FOR ELECTRICAL OUTLET COVERS (U.S. CLS. 21, 23, 26, 36 AND 38).

CLASS 10—MEDICAL APPARATUS

FOR TEETHING RINGS; THERMOMETERS FOR MEDICAL USE (U.S. CLS. 26, 39 AND 44).

CLASS 21—HOUSEWARES AND GLASS

FOR SIPPY CUPS; BABY GROOMING SUPPLIES, NAMELY, BRUSHES FOR HAIR GROOMING, COMBS, BABY BOTTLE AND BABY BOTTLE NIPPLE SCRUBBING BRUSHES (U.S. CLS. 2, 13, 23, 29, 30, 33, 40 AND 50).

CLASS 24—FABRICS

FOR BABY BLANKETS (U.S. CLS. 42 AND 50).

CLASS 25—CLOTHING

FOR BABY BIBS, NOT MADE OF PAPER, NAMELY, COTTON, TERRY AND VINYL; CLOTHING, NAMELY, CHILDREN'S ONE-PIECE GARMENTS, SOCKS, SHIRTS, PANTS AND NIGHTIES (U.S. CLS. 22 AND 39).

CLASS 28—TOYS AND SPORTING GOODS

FOR TOYS, NAMELY, STUFFED ANIMALS, RATTLES (U.S. CLS. 22, 23, 38 AND 50).

CLASS 32—LIGHT BEVERAGES

FOR BOTTLED WATER FOR BABIES, FRUIT JUICES FOR BABIES (U.S. CLS. 45, 46 AND 48).
EDWARD FENNESSY, EXAMINING ATTORNEY

SN 76-691,548. PERNELL & ROBINSON, INC., NEW YORK, NY. FILED 7-24-2008.

JON P

THE MARK CONSISTS OF STANDARD CHARACTERS WITHOUT CLAIM TO ANY PARTICULAR FONT, STYLE, SIZE, OR COLOR.

THE MARK DOES NOT IDENTIFY AN INDIVIDUAL AND IS ARBITRARY.

CLASS 18—LEATHER GOODS

FOR (BASED ON INTENT TO USE) LEATHER GOODS, NAMELY, LUGGAGE, WALLETS, POCKET BOOKS, CARRYING BAGS, KEY CHAINS, CLUTCHES, BRIEF-CASES, AND BOOK BAGS (U.S. CLS. 1, 2, 3, 22 AND 41).

CLASS 25—CLOTHING

FOR (BASED ON USE IN COMMERCE) CLOTHING AND APPAREL, NAMELY, T-SHIRTS, SHIRTS, BLOUSES, PANTS, SLACKS, JEANS, SKIRTS, SHORTS, JUMPSUITS, JACKETS, RAINCOATS, BUSINESS SUITS, SWEATERS, SOCKS, BELTS, PANTIES, UNDERWEAR, ROBES, GOWNS, PAJAMAS, LINGERIE, HATS, CAPS, GLOVES, AND SCARVES; ACTIVEWEAR, NAMELY, TRACKSUITS, SWEAT SUITS, SWEAT SHIRTS WITH HOODS, LEGGINGS, TANK TOPS, SPORTS BRAS, AND SWEAT BANDS; SHOES, BOOTS, AND SANDALS (U.S. CLS. 22 AND 39).

FIRST USE 2-0-2008; IN COMMERCE 2-0-2008.
KEVON CHISOLM, EXAMINING ATTORNEY

SN 76-693,276. DAVID ARMS ONLINE, LLC, BRENTWOOD, TN. FILED 10-2-2008.

IGBOK

THE MARK CONSISTS OF STANDARD CHARACTERS WITHOUT CLAIM TO ANY PARTICULAR FONT, STYLE, SIZE, OR COLOR.

CLASS 25—CLOTHING

FOR CLOTHING, NAMELY, SHIRTS, TEE-SHIRTS, SWEATSHIRTS, HATS, VISORS, PULLOVERS, JACKETS, SWEATPANTS, AND VESTS (U.S. CLS. 22 AND 39).

CLASS 45—PERSONAL AND LEGAL SERVICES

FOR WEBSITE FEATURING SPIRITUAL INFORMATION AND SPIRITUALLY UPLIFTING MESSAGES OF HOPE (U.S. CLS. 100 AND 101).

KIM SAITO, EXAMINING ATTORNEY

SN 76-692,851. HU M I SECURITY CONSULT SERVICES, LLC, BALTIMORE, MD. FILED 9-15-2008.



NO CLAIM IS MADE TO THE EXCLUSIVE RIGHT TO USE "SECURITY CONSULT SERVICES, LLC", APART FROM THE MARK AS SHOWN.

THE COLOR(S) BLACK, PURPLE AND WHITE IS/ARE CLAIMED AS A FEATURE OF THE MARK.

THE MARK CONSISTS OF A BLACK MAGNIFYING GLASS WITH THE LETTERS "HU" "M" AND "I" IN THE GLASS PORTION IN WHITE AND THE WORDING "SECURITY CONSULT SERVICES, LLC" IN THE HANDLE, ALSO IN WHITE AND UNDERLINED WITH A WHITE LINE; THE GLASS PORTION OF THE DESIGN HAVING A PURPLE AND WHITE REFLECTION ABOVE THE LETTERING.

CLASS 35—ADVERTISING AND BUSINESS

FOR CONDUCTING SURVEYS TO ASSESS SECURITY NEEDS OF COMPANIES (U.S. CLS. 100, 101 AND 102).

CLASS 41—EDUCATION AND ENTERTAINMENT

FOR TRAINING OF DEFENSIVE TACTICS IN THE FIELD OF INTELLIGENCE AND SECURITY (U.S. CLS. 100, 101 AND 107).

CLASS 42—SCIENTIFIC AND COMPUTER SERVICES

FOR RESEARCH IN THE FIELD OF INTELLIGENCE AND SECURITY (U.S. CLS. 100 AND 101).
RAUL CORDOVA, EXAMINING ATTORNEY

SN 76-696,222. THE UNITED METHODIST PUBLISHING HOUSE, NASHVILLE, TN. FILED 3-9-2009.



THE MARK CONSISTS OF THE WORDS "LIVE B.I.G." IN OUTLINED LETTERS ON A CLOUD BACKGROUND WITH A BIRD FORMING THE DOT ABOVE THE LETTER "I" IN "B.I.G." BELOW THE CLOUD IS THE WORDING "HEAR, SEE, AND LIVE YOUR BELIEF IN GOD" IN A WAVY LINE AND IN STYLIZED LETTERING.

CLASS 9—ELECTRICAL AND SCIENTIFIC APPARATUS

FOR PRERECORDED VIDEOS AND DVDS IN THE FIELD OF RELIGION, CHRISTIANITY AND FAMILY VALUES (U.S. CLS. 21, 23, 26, 36 AND 38).

CLASS 16—PAPER GOODS AND PRINTED MATTER

FOR PUBLICATIONS, NAMELY, BOOKS, BROCHURES AND PAMPHLETS IN THE FIELD OF RELIGION, CHRISTIANITY AND FAMILY VALUES (U.S. CLS. 2, 5, 22, 23, 29, 37, 38 AND 50).

LINDA POWELL, EXAMINING ATTORNEY

SN 76-696,860. FERREE & ASSOCIATES, INC., GIG HARBOR, WA. FILED 4-14-2009.

SN 77-019,686. TECHNO PROTECTION INC., THETFORD MINES, QUEBEC, CANADA, FILED 10-12-2006.

SECUREEMPLOY

THE MARK CONSISTS OF STANDARD CHARACTERS WITHOUT CLAIM TO ANY PARTICULAR FONT, STYLE, SIZE, OR COLOR.

CLASS 35—ADVERTISING AND BUSINESS

FOR EMPLOYMENT HIRING, RECRUITING, PLACEMENT, STAFFING AND CAREER NETWORKING SERVICES; PROVIDING AN ON-LINE SEARCHABLE DATABASE FEATURING EMPLOYMENT OPPORTUNITIES; VENDOR-ON-PREMISE SERVICES, NAMELY, THE ADMINISTRATION OF THE EMPLOYMENT PROCESS ON-SITE, INCLUDING RESUME REVIEW AND CHECKING, EMPLOYMENT APPLICATION ACQUISITION, ADVERTISING FOR RECRUITMENT, CONDUCT OF INTERVIEWS AND REFERENCE CHECKING; RESUME PREPARATION; MANAGEMENT AND BUSINESS CONSULTING SERVICES IN THE FIELD OF TRAINING AND RECRUITMENT; BUSINESS MANAGEMENT CONSULTING; DIRECT MAIL ADVERTISING; PREPARING AND PLACING ADVERTISEMENTS FOR OTHERS; PERSONNEL PLACEMENT AND RECRUITMENT (U.S. CLS. 100, 101 AND 102).

FIRST USE 2-5-1986; IN COMMERCE 2-5-1986.

CLASS 41—EDUCATION AND ENTERTAINMENT

FOR DESKTOP PUBLISHING FOR OTHERS (U.S. CLS. 100, 101 AND 107).

FIRST USE 2-5-1986; IN COMMERCE 2-5-1986.
KATHRYN COWARD, EXAMINING ATTORNEY

SN 76-697,198. VENROD TRADING COMPANY INC., SAN JUAN, PUERTO RICO, FILED 5-4-2009.

YES

THE MARK CONSISTS OF STANDARD CHARACTERS WITHOUT CLAIM TO ANY PARTICULAR FONT, STYLE, SIZE, OR COLOR.

CLASS 1—CHEMICALS

FOR ARTIFICIAL SWEETENERS (U.S. CLS. 1, 5, 6, 10, 26 AND 46).

CLASS 30—STAPLE FOODS

FOR NATURAL SWEETENERS, SUGAR SUBSTITUTES (U.S. CL. 46).
MICHAEL ENGEL, EXAMINING ATTORNEY

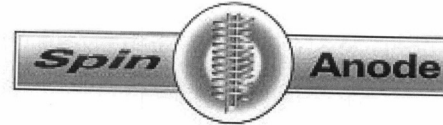

OWNER OF CANADA REG. NO. TMA715544, DATED 5-30-2008, EXPIRES 5-30-2023.

NO CLAIM IS MADE TO THE EXCLUSIVE RIGHT TO USE "ANODE", APART FROM THE MARK AS SHOWN.

CLASS 9—ELECTRICAL AND SCIENTIFIC APPARATUS

FOR PROTECTION SYSTEMS UTILIZING AN ELECTROCHEMICAL PROCESS TO IMMUNIZE METALLIC STRUCTURES AGAINST CORROSION, COMPRISED IN WHOLE OR IN PART OF ANODES; METAL POSTS, ELECTRIC CABLES, RECTIFIERS AND JUNCTION BOXES (U.S. CLS. 21, 23, 26, 36 AND 38).

CLASS 37—CONSTRUCTION AND REPAIR

FOR INSTALLATION OF PROTECTION SYSTEMS UTILIZING AN ELECTROCHEMICAL PROCESS TO IMMUNIZE METALLIC STRUCTURES AGAINST CORROSION (U.S. CLS. 100, 103 AND 106).
SHARON MEIER, EXAMINING ATTORNEY

SN 77-025,768. K. ROSE PUBLISHING, INC., NASHVILLE, TN. FILED 10-20-2006.

I DIDN'T KNOW THAT

THE MARK CONSISTS OF STANDARD CHARACTERS WITHOUT CLAIM TO ANY PARTICULAR FONT, STYLE, SIZE, OR COLOR.

CLASS 16—PAPER GOODS AND PRINTED MATTER

FOR A SERIES OF BOOKS, SYNDICATED NEWSPAPER ARTICLES, AND SYNDICATED MAGAZINE ARTICLES, AIMED AT THE GENERAL PUBLIC, IN THE NATURE OF PROVIDING DEFINITIONS AND WORD AND PHRASE ORIGINS (U.S. CLS. 2, 5, 22, 23, 29, 37, 38 AND 50).

CLASS 41—EDUCATION AND ENTERTAINMENT

FOR ENTERTAINMENT IN THE NATURE OF RADIO FEATURES IN THE NATURE OF PROVIDING DEFINITIONS AND WORD AND PHRASE ORIGINS (U.S. CLS. 100, 101 AND 107).
CHRISTINA SOBRAL, EXAMINING ATTORNEY

SN 77-043,616. ROOSTER PRODUCTS INTERNATIONAL, INC., SAN ANTONIO, TX. FILED 11-14-2006.

SN 77-046,807. URANIUM ONE INC., TORONTO, ON, CANADA, FILED 11-17-2006.

MONSTER

THE MARK CONSISTS OF STANDARD CHARACTERS WITHOUT CLAIM TO ANY PARTICULAR FONT, STYLE, SIZE, OR COLOR.

CLASS 8—HAND TOOLS

FOR TOOL APRONS (U.S. CLS. 23, 28 AND 44).
FIRST USE 11-24-1999; IN COMMERCE 11-24-1999.

CLASS 9—ELECTRICAL AND SCIENTIFIC APPARATUS

FOR KNEEPADS FOR WORKERS (U.S. CLS. 21, 23, 26, 36 AND 38).
FIRST USE 11-24-1999; IN COMMERCE 11-24-1999.

CLASS 18—LEATHER GOODS

FOR TOOL BAGS SOLD EMPTY; LEATHER AND NYLON TOOL POUCHES SOLD EMPTY (U.S. CLS. 1, 2, 3, 22 AND 41).
FIRST USE 11-24-1999; IN COMMERCE 11-24-1999.
CHRISIE B. KING, EXAMINING ATTORNEY

SN 77-045,661. GROUP PURCHASING SOLUTIONS, LLC, NEWPORT BEACH, CA. FILED 11-16-2006.

Cornerstone Retreat

THE MARK CONSISTS OF STANDARD CHARACTERS WITHOUT CLAIM TO ANY PARTICULAR FONT, STYLE, SIZE, OR COLOR.

NO CLAIM IS MADE TO THE EXCLUSIVE RIGHT TO USE "RETREAT", APART FROM THE MARK AS SHOWN.

CLASS 16—PAPER GOODS AND PRINTED MATTER

FOR PRINTED INSTRUCTIONAL, EDUCATIONAL AND TEACHING MATERIALS IN THE FIELD OF REFERRAL SELLING TECHNIQUES (U.S. CLS. 2, 5, 22, 23, 29, 37, 38 AND 50).

CLASS 41—EDUCATION AND ENTERTAINMENT

FOR EDUCATIONAL SERVICES, NAMELY, CONDUCTING REFERRAL SELLING SEMINARS AND DISTRIBUTING COURSE MATERIALS IN CONNECTION THEREWITH (U.S. CLS. 100, 101 AND 107).
ERIN FALK, EXAMINING ATTORNEY

URANIUM ONE

THE MARK CONSISTS OF STANDARD CHARACTERS WITHOUT CLAIM TO ANY PARTICULAR FONT, STYLE, SIZE, OR COLOR.

PRIORITY CLAIMED UNDER SEC. 44(D) ON CANADA APPLICATION NO. 1304351, FILED 5-19-2006, REG. NO. TMA700358, DATED 11-6-2007, EXPIRES 11-6-2022.

OWNER OF CANADA REG. NO. TMA700358, DATED 11-6-2007, EXPIRES 11-6-2022.

NO CLAIM IS MADE TO THE EXCLUSIVE RIGHT TO USE "URANIUM", APART FROM THE MARK AS SHOWN.

CLASS 1—CHEMICALS

FOR (BASED ON INTENT TO USE) (BASED ON 44(E)) URANIUM; RARE EARTH ELEMENTS, URANIUM OXIDE (U.S. CLS. 1, 5, 6, 10, 26 AND 46).

CLASS 6—METAL GOODS

FOR (BASED ON INTENT TO USE) BASE METAL ORES, NAMELY, COPPER, ALUMINUM, LEAD, NICKEL, TIN AND ZINC (U.S. CLS. 2, 12, 13, 14, 23, 25 AND 50).

CLASS 14—JEWELRY

FOR (BASED ON INTENT TO USE) (BASED ON 44(E)) REFINED METALS AND METALLIFEROUS PRODUCTS, NAMELY, GOLD, GOLD DORE AND SILVER; PRECIOUS METAL ORES, NAMELY, GOLD AND SILVER (U.S. CLS. 2, 27, 28 AND 50).

CLASS 36—INSURANCE AND FINANCIAL

FOR (BASED ON INTENT TO USE) (BASED ON 44(E)) FINANCIAL SERVICES, NAMELY, MONEY LENDING TO OWNERS OF MINERAL AND MINERAL EXPLORATION PROPERTIES (U.S. CLS. 100, 101 AND 102).

CLASS 37—CONSTRUCTION AND REPAIR

FOR (BASED ON INTENT TO USE) (BASED ON 44(E)) MINING EXTRACTION SERVICES (U.S. CLS. 100, 103 AND 106).

CLASS 42—SCIENTIFIC AND COMPUTER SERVICES

FOR (BASED ON INTENT TO USE) (BASED ON 44(E)) MINERAL EXPLORATION AND MINING EXPLORATION SERVICES (U.S. CLS. 100 AND 101).
TRICIA SONNEBORN, EXAMINING ATTORNEY

SN 77-051,355. LIEB CELLARS, LLC, CUTCHOGUE, NY.
FILED 11-27-2006.

SN 77-051,881. BRANDGROUP GMBH, BECHTSRIETH, FED
REP GERMANY, FILED 11-28-2006.

NORTH FORK, NOT NAPA VALLEY

MEEYOO

THE MARK CONSISTS OF STANDARD CHARACTERS WITHOUT CLAIM TO ANY PARTICULAR FONT, STYLE, SIZE, OR COLOR.

SEC. 2(F) AS TO "NORTH FORK".

THE 2(F) IN PART CLAIM IS RESTRICTED TO CLASS(ES)
33

CLASS 25—CLOTHING

FOR T-SHIRTS (U.S. CLS. 22 AND 39).
FIRST USE 8-1-2007; IN COMMERCE 8-1-2007.

CLASS 33—WINES AND SPIRITS

FOR WINES (U.S. CLS. 47 AND 49).
FIRST USE 3-1-2001; IN COMMERCE 3-1-2001.
SUSAN HAYASH, EXAMINING ATTORNEY

THE MARK CONSISTS OF STANDARD CHARACTERS WITHOUT CLAIM TO ANY PARTICULAR FONT, STYLE, SIZE, OR COLOR.

PRIORITY CLAIMED UNDER SEC. 44(D) ON ERPNCMNTY TM OFC APPLICATION NO. 005419171, FILED 10-26-2006, REG. NO. 005419171, DATED 11-9-2007, EXPIRES 10-26-2016.

THE WORDING "MEEYOO" HAS NO MEANING IN A FOREIGN LANGUAGE.

CLASS 9—ELECTRICAL AND SCIENTIFIC APPARATUS

FOR APPARATUS FOR RECORDING, TRANSMISSION OR REPRODUCTION OF SOUND AND IMAGES; BLANK MAGNETIC DATA CARRIERS; PRE-RECORDED MAGNETIC DATA CARRIERS FEATURING MUSIC, PICTURES, MOVIES AND DATA MATERIAL SELECTED BY CUSTOMERS; BLANK COMPACT DISCS AND RECORDABLE DVDS; PRE-RECORDED CDS AND DVDS FEATURING MUSIC, PICTURES, MOVIES AND DATA MATERIAL SELECTED BY CUSTOMERS; COMPUTER PROGRAMS AND SOFTWARE HAVING FUNCTIONS SELECTED BY CUSTOMERS, NAMELY, ACCOUNTING SOFTWARE, CHILDREN'S EDUCATIONAL SOFTWARE, COMMUNICATION SOFTWARE FOR CONNECTING TO GLOBAL COMPUTER NETWORKS, COMPUTER SOFTWARE FOR ADMINISTRATION OF COMPUTER NETWORKS, LAN (LOCAL AREA NETWORK) OPERATING SOFTWARE, COMPUTER DATABASE MANAGEMENT SOFTWARE, SOFTWARE FOR THE EXCHANGE, STORAGE REPRODUCTION, SYSTEMATIC RECORDING OF DATA, CONNECTION, EDITING, ORGANIZING, MODIFYING, BOOKMARKING, TRANSMISSION, STORAGE AND SHARING OF DATA INFORMATION, SOFTWARE FOR PROCESSING IMAGES, GRAPHICS AND TEXT, COMPUTER GRAPHICS SOFTWARE, GRAPHICAL USER INTERFACE SOFTWARE, COMPUTER SOFTWARE TO ENABLE THE TRANSMISSION OF PHOTOGRAPHS TO MOBILE TELEPHONES, WEBSITE DEVELOPMENT SOFTWARE, COMPUTER SOFTWARE PROGRAMS FOR THE INTEGRATION OF TEXT, AUDIO, GRAPHICS, STILL IMAGES AND MOVING PICTURES INTO AN INTERACTIVE DELIVERY FOR MULTIMEDIA APPLICATIONS, COMPUTER SOFTWARE FOR ORGANIZING AND VIEWING DIGITAL IMAGES AND PHOTOGRAPHS, COMPUTER SOFTWARE USED FOR THE CONTROL OF VOICE CONTROLLED INFORMATION AND COMMUNICATION DEVICES, COMPUTER SOFTWARE FOR PROCESSING DIGITAL MUSIC FILES, COMPUTER ANTI-VIRUS SOFTWARE, COMPUTER COMMUNICATION SOFTWARE TO ALLOW CUSTOMERS TO ACCESS BANK ACCOUNT INFORMATION AND TRANSACT BANK BUSINESS, COMPUTER E-COMMERCE SOFTWARE TO ALLOW USERS TO PERFORM ELECTRONIC BUSINESS TRANSACTIONS VIA A GLOBAL COMPUTER NETWORK, GAME SOFTWARE, COMPUTER SCREENSAVER SOFTWARE, AND COMPUTER SEARCH ENGINE SOFTWARE; VENDING MACHINES AND MECHANICS FOR MONEY OPERATED VENDING MACHINES; CASH REGISTERS; CALCULATORS; DATA PROCESSORS; AND COMPUTER HARDWARE (U.S. CLS. 21, 23, 26, 36 AND 38).

SN 77-051,762. PIVOTAL BRANDS INC., OAKVILLE, ONTARIO, CANADA, FILED 11-28-2006.

SANTE NUTRA

THE MARK CONSISTS OF STANDARD CHARACTERS WITHOUT CLAIM TO ANY PARTICULAR FONT, STYLE, SIZE, OR COLOR.

PRIORITY CLAIMED UNDER SEC. 44(D) ON CANADA APPLICATION NO. 1325506, FILED 11-23-2006, REG. NO. TMA728,467, DATED 11-14-2008, EXPIRES 11-14-2023.

NO CLAIM IS MADE TO THE EXCLUSIVE RIGHT TO USE "SANTE", APART FROM THE MARK AS SHOWN.

THE FOREIGN WORDING IN THE MARK TRANSLATES INTO ENGLISH AS HEALTH.

CLASS 5—PHARMACEUTICALS

FOR NUTRITIONAL SUPPLEMENTS (U.S. CLS. 6, 18, 44, 46, 51 AND 52).

CLASS 29—MEATS AND PROCESSED FOODS

FOR PROTEIN FOR USE AS A FOOD ADDITIVE OR FOOD FILLER; SNACK FOOD, NAMELY, PROTEIN BASED, NUTRIENT-DENSE SNACK BARS (U.S. CL. 46).

CLASS 32—LIGHT BEVERAGES

FOR BEVERAGES, NAMELY, ENERGY DRINKS AND SPORT DRINKS; NON-ALCOHOLIC BEVERAGES, NAMELY, ENERGY DRINKS AND SPORT DRINKS; FRUIT JUICE DRINKS (U.S. CLS. 45, 46 AND 48).
KATHRYN COWARD, EXAMINING ATTORNEY

CLASS 38—COMMUNICATION

FOR TRANSFER OF DATA BY TELECOMMUNICATION; PROVISION OF ACCESS TO ELECTRONIC SITES; PROVIDING MULTIPLE USE ACCESS TO GLOBAL COMPUTER INFORMATION NETWORKS FOR THE TRANSFER AND DISSEMINATION OF A WIDE RANGE OF INFORMATION; PROVIDING ACCESS TO ON-LINE PLATFORMS, INTERNET PORTALS AND INTERNET CHAT ROOMS; PROVIDING ON-LINE CHAT ROOMS AND ELECTRONIC BULLETIN BOARDS FOR TRANSMISSION OF MESSAGES AMONG USERS IN FIELDS OF INTEREST SELECTED BY THE USER; ELECTRONIC TRANSMISSION OF MESSAGES AND IMAGES VIA COMPUTER TERMINALS; TRANSMISSION OF MESSAGES OVER ELECTRONIC MEDIA TO INTERNET ADDRESSES (U.S. CLS. 100, 101 AND 104).

CLASS 42—SCIENTIFIC AND COMPUTER SERVICES

FOR DESIGN AND DEVELOPMENT FOR OTHERS OF COMPUTER HARDWARE AND SOFTWARE; PERFORMING COMPUTER SOFTWARE UP-DATING FOR OTHERS; INSTALLATION OF COMPUTER SOFTWARE; CONSULTING SERVICES IN THE FIELD OF DESIGN, SELECTION, IMPLEMENTATION AND USE OF COMPUTER HARDWARE AND SOFTWARE SYSTEMS FOR OTHERS; DIGITAL IMAGE PROCESSING; SOFTWARE BASED COMPUTER NETWORK DESIGN FOR OTHERS; MAINTENANCE OF COMPUTER SOFTWARE ON A SERVER IN COMPUTER NETWORKS; MANAGEMENT OF ELECTRONIC DATA ON SERVERS, NAMELY, HOSTING MAINTAINING AND DISPLAYING WEBSITES, DATABASES AND IMAGES OF OTHERS ON SERVERS; CREATING, DESIGNING AND MAINTAINING WEB SITES AND NETWORK WEB PAGES FOR OTHERS; UPDATING HOMEPAGES; CONSULTANCY IN THE FIELD OF DESIGNING HOME PAGES AND INTERNET PAGES; COMPUTER SECURITY SERVICE, NAMELY, RESTRICTING ACCESS TO AND BY COMPUTER NETWORKS TO AND OF UNDESIRE WEB SITES, MEDIA, INDIVIDUALS AND FACILITIES; PROVIDING SEARCH ENGINES FOR OBTAINING DATA ON A GLOBAL COMPUTER NETWORK; COMPUTER SITE DESIGN; COMPUTER PROJECT MANAGEMENT SERVICES (U.S. CLS. 100 AND 101).

MARIA-VICTORIA SUAREZ, EXAMINING ATTORNEY

SN 77-052,964, LUFTHANSA SYSTEMS AKTIENGESELLSCHAFT, 65451 KELSTERBACH, FED REP GERMANY, FILED 11-29-2006.

AIRANGE

THE MARK CONSISTS OF STANDARD CHARACTERS WITHOUT CLAIM TO ANY PARTICULAR FONT, STYLE, SIZE, OR COLOR.

PRIORITY CLAIMED UNDER SEC. 44(D) ON ERPN CMNTY TM OFC APPLICATION NO. 5362439, FILED 9-22-2006, REG. NO. 005362439, DATED 3-6-2008, EXPIRES 9-22-2016.

CLASS 9—ELECTRICAL AND SCIENTIFIC APPARATUS

FOR COMPUTER SOFTWARE FOR MANAGING PASSENGER TRANSPORT OPERATIONS (U.S. CLS. 21, 23, 26, 36 AND 38).

CLASS 16—PAPER GOODS AND PRINTED MATTER

FOR MANUALS FOR COMPUTER SOFTWARE FOR PROVIDING AERONAUTICAL INFORMATION AND DATA, AND FOR PROVIDING INFORMATION AND DATA ABOUT NAVIGATION CONTROL, FLIGHT ROUTES AND DISTANCES, FLIGHT DEPARTURES AND ARRIVALS, RESERVATIONS AND BOOKINGS OF AIR TRANSPORT, TICKETING FOR AIR PASSENGERS, FREQUENT FLYER PROGRAMS FOR AIR PASSENGERS, AIRPORT CHECK-IN OF PASSENGERS, CHECK-IN OF FREIGHT AND LUGGAGE AT AIRPORTS, AIR TRANSPORT OF PASSENGERS, AIR TRANSPORT OF FREIGHT AND LUGGAGE (U.S. CLS. 2, 5, 22, 23, 29, 37, 38 AND 50).

CLASS 38—COMMUNICATION

FOR TELECOMMUNICATIONS AND DATA COMMUNICATION SERVICES, NAMELY, TRANSMISSION OF VOICE, DATA, GRAPHICS AND DOCUMENTS BY MEANS OF CABLE AND SATELLITE TRANSMISSIONS; PROVIDING TELECOMMUNICATIONS CONNECTIONS TO A GLOBAL COMPUTER NETWORK; ELECTRONIC COMPUTER-AIDED TRANSMISSION OF DATA AND IMAGES VIA CABLE, SATELLITE, COMPUTER, COMPUTER NETWORKS, TELEPHONE AND OTHER TELECOMMUNICATIONS MEANS; PROVIDING MULTIPLE-USER ACCESS TO A GLOBAL COMPUTER INFORMATION NETWORK (U.S. CLS. 100, 101 AND 104).

CLASS 39—TRANSPORTATION AND STORAGE

FOR AIR TRANSPORT; PROVIDING INFORMATION AND DATA ABOUT FLIGHTS AND OPERATIONS, NAMELY, AERONAUTICAL INFORMATION AND DATA, INFORMATION AND DATA ABOUT NAVIGATION CONTROL, FLIGHT ROUTES AND DISTANCES, FLIGHT DEPARTURES AND ARRIVALS, RESERVATIONS AND BOOKINGS OF AIR TRANSPORT, TICKETING FOR AIR PASSENGERS, FREQUENT FLYER PROGRAMS FOR AIR PASSENGERS, AIRPORT CHECK-IN OF PASSENGERS, CHECK-IN OF FREIGHT AND LUGGAGE AT AIRPORTS, AIR TRANSPORT OF PASSENGERS, AIR TRANSPORT OF FREIGHT AND LUGGAGE; ELECTRONIC STORAGE OF DATA; ON-LINE COMPUTER DATABASE FEATURING AERONAUTICAL INFORMATION AND DATA, INFORMATION AND DATA ABOUT NAVIGATION CONTROL, FLIGHT ROUTES AND DISTANCES, FLIGHT DEPARTURES AND ARRIVALS, RESERVATIONS AND BOOKINGS OF AIR TRANSPORT, TICKETING FOR AIR PASSENGERS, FREQUENT FLYER PROGRAMS FOR AIR PASSENGERS, AIRPORT CHECK-IN OF PASSENGERS, CHECK-IN OF FREIGHT AND LUGGAGE AT AIRPORTS, AIR TRANSPORT OF PASSENGERS, AIR TRANSPORT OF FREIGHT AND LUGGAGE (U.S. CLS. 100 AND 105).

CLASS 42—SCIENTIFIC AND COMPUTER SERVICES

FOR DESIGN AND DEVELOPMENT OF COMPUTER SOFTWARE; CONSULTING IN THE FIELD OF SOFTWARE APPLICATION; PROVIDING ONLINE NON-DOWNLOADABLE SOFTWARE FOR MANAGING AIRLINE PASSENGER OPERATIONS AND FOR MANAGING AERONAUTICAL INFORMATION AND DATA, INFORMATION AND DATA ABOUT NAVIGATION CONTROL, FLIGHT ROUTES AND DISTANCES, FLIGHT DEPARTURES AND ARRIVALS, RESERVATIONS AND BOOKINGS OF AIR TRANSPORT, TICKETING FOR AIR PASSENGERS, FREQUENT FLYER PROGRAMS FOR AIR PASSENGERS, AIRPORT CHECK-IN OF PASSENGERS, CHECK-IN OF FREIGHT AND LUGGAGE AT AIRPORTS, AIR TRANSPORT OF PASSENGERS, AIR TRANSPORT OF FREIGHT AND LUGGAGE; PROVIDING NON-DOWNLOADABLE SOFTWARE VIA THE INTERNET AND OTHER DATA NETWORKS IN THE FIELD OF AIRLINE BUSINESS MANAGEMENT (U.S. CLS. 100 AND 101).

PAUL MORENO, EXAMINING ATTORNEY

SN 77-059,421. VICINI S.P.A., SAN MAURO PASCOLI, ITALY, FILED 12-7-2006.

SN 77-089,557. VALTA LIMITED, MAUREN, LIECHTENSTEIN, FILED 1-24-2007.

Popeline

PRIORITY CLAIMED UNDER SEC. 44(D) ON ITALY APPLICATION NO. MI2006C00621, FILED 6-12-2006, REG. NO. 1164250, DATED 1-16-2009, EXPIRES 6-12-2016.

CLASS 18—LEATHER GOODS

FOR LEATHER AND IMITATIONS OF LEATHER, AND GOODS MADE OF THESE MATERIALS, NAMELY, HANDBAGS; TRUNKS AND TRAVELING BAGS; UMBRELLAS, PARASOLS AND WALKING STICKS; WHIPS, HARNESS AND SADDLERY (U.S. CLS. 1, 2, 3, 22 AND 41).

CLASS 25—CLOTHING

FOR CLOTHING, NAMELY, SHIRTS, T-SHIRTS, POLO SHIRTS, PANTS, SKIRTS, SKIRT SUITS, DRESSES, EVENING DRESSES, MEN'S SUITS, SUITS OF LEATHER, JACKETS, LEATHER JACKETS, COATS, LEATHER COATS, RAINCOATS, MANTLES, TIES, BOW TIES, BELTS AND LEATHER CLOTHING BELTS, CLOTHING TOPS, BOTTOMS, BATHING SUITS, BATHING COSTUMES, BIKINIS AND FOOTWEAR, NAMELY, SHOES, BOOTS, SANDALS AND SLIPPERS (U.S. CLS. 22 AND 39).

DEBRA LEE, EXAMINING ATTORNEY

SN 77-062,393. KEMPE-WEST ENTERPRISES LTD., COQUITLAM, CANADA, FILED 12-12-2006.

RINEGOLD

THE MARK CONSISTS OF STANDARD CHARACTERS WITHOUT CLAIM TO ANY PARTICULAR FONT, STYLE, SIZE, OR COLOR.

PRIORITY CLAIMED UNDER SEC. 44(D) ON CANADA APPLICATION NO. 1307205, FILED 6-28-2006, REG. NO. 742623, DATED 6-25-2009, EXPIRES 6-25-2024.

CLASS 29—MEATS AND PROCESSED FOODS

FOR PROCESSED POTATOES, NAMELY, INSTANT POTATOES, FRENCH FRIED POTATOES, FRIED POTATOES, POTATO CHIPS, POTATO CRISPS, POTATO DUMPLINGS, POTATO FRITTERS, POTATO PANCAKES AND POTATO STICKS (U.S. CL. 46).

CLASS 31—NATURAL AGRICULTURAL PRODUCTS

FOR FRESH, RAW AND UNPROCESSED POTATOES (U.S. CLS. 1 AND 46).

ELLEN PERKINS, EXAMINING ATTORNEY

RED DEVIL

THE MARK CONSISTS OF STANDARD CHARACTERS WITHOUT CLAIM TO ANY PARTICULAR FONT, STYLE, SIZE, OR COLOR.

OWNER OF LIECHTENSTEIN REG. NO. 14820, DATED 1-11-2008, EXPIRES 1-11-2018.

OWNER OF U.S. REG. NOS. 2,254,017 AND 2,304,452.

CLASS 5—PHARMACEUTICALS

FOR NUTRITIONAL SUPPLEMENTS; NUTRITIONAL SUPPLEMENTS IN CHEWABLE FORM; CAFFEINE PREPARATIONS FOR STIMULATIVE USE; CAFFEINE IMPREGNATED DISSOLVABLE STRIPS FOR USE AS A STIMULANT; ENERGY BOOSTING GUM FOR USE AS A DIETARY SUPPLEMENT; CHEWS ENHANCED WITH CAFFEINE AND VITAMINS FOR USE AS A DIETARY SUPPLEMENT; CHEWING GUM ENHANCED WITH CAFFEINE AND VITAMINS FOR USE AS A DIETARY SUPPLEMENT (U.S. CLS. 6, 18, 44, 46, 51 AND 52).

CLASS 30—STAPLE FOODS

FOR CHEWS IN THE NATURE OF CANDY; CANDY; CONFECTIONERY, NAMELY, ICE CREAM AND FROZEN CONFECTIONS (U.S. CL. 46).

HOWARD B. LEVINE, EXAMINING ATTORNEY

SN 77-109,712. OC OERLIKON CORPORATION AG, PFÄFFIKON, CH-8808 PFÄFFIKON SZ, SWITZERLAND, FILED 2-16-2007.

oerlikon
fairfield drive systems

NO CLAIM IS MADE TO THE EXCLUSIVE RIGHT TO USE "DRIVE SYSTEMS", APART FROM THE MARK AS SHOWN.

THE COLOR(S) RED IS/ARE CLAIMED AS A FEATURE OF THE MARK.

THE MARK CONSISTS OF THE PHRASE "OERLIKON FAIRFIELD DRIVE SYSTEMS" WHICH IS ALL IN RED.

CLASS 7—MACHINERY

FOR MACHINES AND OFF - HIGHWAY MOBILE MACHINERY USED IN ROAD CONSTRUCTION OPERATIONS, NAMELY, ASPHALT ROAD PAVERS, SLIP FORM PAVERS IN THE FORM OF CONCRETE PAVING MACHINES, SURFACE MILLING APPARATUS AND APPARATUS FOR MAKING CONCRETE CURBS AND CONCRETE GUTTERS, GRADERS, ASPHALT MIXERS, ROADWAY PATCHING MACHINES IN THE FORM OR CONCRETE PAVING MACHINES, ROAD MARKING MACHINES IN THE FORM OF SELF-PROPELLED HIGHWAY STRIPPERS THAT INCORPORATE APPLICATORS FOR APPLYING HIGHWAY STRIPES AND LINES, BRUSH CUTTERS, CONCRETE FORMING MACHINES, EARTH COMPACTING MACHINES, NAMELY, SOIL STABILIZERS AND COMPACTORS FOR SURFACE PREPARATION, ASPHALT ROLLERS AND COMPACTORS, AND APPARATUS FOR ROADWAY BARRIER PLACEMENT; HEAVY CONSTRUCTION OPERATIONS MACHINERY, NAMELY, MOBILE CRANES, POWER

OPERATED LIFTING AND MOVING EQUIPMENT, NAMELY, ROUGH TERRAIN LIFTS, FORK LIFTS, TELESCOPIC LOAD HANDLERS, ELEVATING WORK PLATFORMS, EARTH MOVING MACHINES, NAMELY, TRENCHERS, CABLE PLOWS FOR DIGGING NARROW TRENCHES AND CABLE LAYERS, HORIZONTAL DRILLING AND BORING MACHINES, CABLE TENSIONERS, NAMELY, REEL LIFTS TO SUPPORT AND MOVE CABLE REELS FROM THE GROUND TO A TRUCK, CABLE REELS, CONCRETE CLEANING MACHINE IN THE NATURE OF A PARTICLE BLAST CLEANING MACHINES; EARTH MOVING MACHINES, NAMELY, FRONT-END LOADERS AND BULLDOZERS; MINING UNDERGROUND AND OPEN - PIT MINING MACHINERY, NAMELY, MOBILE DRILLS, ROCK CRUSHERS, BLAST HOLE DRILLS, MILLING CUTTERS, CONVEYORS, HIGH WALL MINERS AND LOW SEAM MINERS IN THE NATURE OF EXCAVATORS, ROOF BOLTERS, CONTINUOUS MINERS, FEEDER BREAKERS; AGRICULTURAL MACHINES, NAMELY, HARVESTERS, POWER-OPERATED SPRAYERS, SOIL MIXERS, CROP SEED PLANTERS, MOBILE PLOWS, HAY BALERS, MECHANICAL PLANT FERTILIZER FEEDERS, MECHANICAL SPREADERS, COMBINES, WINDROWERS, AGITATORS FOR CIRCULATING LIQUID MEDIA, FEED PROCESSORS, NAMELY, ANIMAL FEED GRINDERS AND DRYING MACHINES, ANIMAL FEED CONVEYORS; FORESTRY OPERATIONS MACHINES, NAMELY, DE-LIMBERS, POWER-OPERATED SAWS, LOG LOADERS, LOG SKIDDERS, TREE FELLERS AND BUNCHERS, TREE HARVESTERS, POWERED TREE TRIMMERS, TREE PLANTERS, LOG GRINDERS, MOBILE MULCHERS, DE-BARKERS, STUMP GRINDERS, STUMP SHREDDERS, PULP REFINING MACHINES, NAMELY, PULP AND PAPER GRINDERS, PULP AND PAPER CUTTERS, LUMBER CONVEYORS; RAILROAD EQUIPMENT APPLICATIONS MACHINES, NAMELY, RAILWAY MAINTENANCE AND RAILWAY REPAIR MACHINES IN THE NATURE OF ANCHOR APPLICATORS, ANCHOR REMOVERS, MULTI-FUNCTION RAILWAY MAINTENANCE MACHINES, RAIL GAUGING MACHINES, RAIL GRINDERS, RAIL DRILLS, RAIL PRE-GAGERS, RAIL LIFTERS, RAIL SCREW SPIKE DRIVERS, RAIL SCREW SPIKE PULLERS, SPIKE FEEDERS, SPIKE DRIVERS, SPIKE PULLERS, TIE ADZERS, TIE BORERS, TIE PLATE LAYING MACHINES, TRACK INSPECTORS AND RAIL LAYERS, RAILROAD TRACK BED TAMPERS, AND BRUSH CUTTERS; INDUSTRIAL MACHINERY, NAMELY, CONVEYORS, MATERIAL HANDLERS, NAMELY, CONVEYOR BELTS, INDUSTRIAL ROCK CRUSHERS, INDUSTRIAL FODDER MIXERS, SHREDDERS, AND INDUSTRIAL STREET SWEEPERS; MOTORS AND ENGINES NOT FOR LAND USE, NAMELY, PLANETARY GEAR MOTORS, MACHINE COUPLINGS AND TRANSMISSION COMPONENTS, NAMELY, GEARS FOR MACHINES; PARTS FOR MOTORS NOT FOR LAND USE, NAMELY, BRUSHES; TRANSMISSION PARTS FOR MACHINES, NAMELY, GEARS AND SPEED CHANGE GEARS, PLANETARY GEARS, ANGULAR GEARS, TWO-SPEED CHANGE GEARS, GEAR HEADS AND ASSOCIATED INTERMEDIATE GEARS FOR MACHINES; INTERMEDIATE GEARS FOR MACHINES; PARTS OF MACHINES, NAMELY, FORCE TRANSFER MECHANISMS FOR MECHANICAL BRANCH DRIVES IN THE FORM OF AN INTERMEDIATE GEAR, STATIC AND DYNAMIC BRAKES THAT ARE APPLIED AND RELEASED BY HYDRAULIC SPRINGS, REAR WHEEL DRIVES AND PLANETARY DRIVES FOR INDUSTRIAL MACHINES; GEARS, SHAFTS, DIFFERENTIALS OF ALL TYPES AND REPLACEMENT PARTS THEREFOR, FOR MACHINES; HYDRAULIC AND MECHANICAL APPARATUS FOR GEAR CHANGING, NAMELY, CLUTCHES FOR MACHINES; TORQUE CONVERTERS FOR MACHINES, REDUCTION GEARS FOR MACHINES, GEAR AND ENGINE TORQUE REDUCERS, FOR MACHINES, APPARATUS FOR GEAR SYNCHRONIZATION, NAMELY, CLUTCHES FOR MACHINES; COMBUSTION ENGINES FOR BOATS; MULTI-SPEED AND TWO-SPEED GEAR CHANGERS USED TO PROPEL OR POSITION THE MACHINERY OR COMPONENTS THEREOF AND TO INCREASE, DECREASE, OR OTHERWISE CHANGE OR ALTER THE TORQUE OR SPEED OF THE MACHINE OR THE COMPONENTS THEREOF; MACHINE TRANSMISSION PARTS, NAMELY, GEARS FOR MACHINES; MACHINE COUPLINGS; APPARATUS FOR GEAR SYNCHRONIZATION, NAMELY, CLUTCHES FOR MACHINES (U.S. CLS. 13, 19, 21, 23, 31, 34 AND 35).

CLASS 12—VEHICLES

FOR VEHICLES, NAMELY, AUTOMOBILES; APPARATUS FOR LOCOMOTION BY LAND, AIR OR WATER, NAMELY, TRAINS, AIRPLANES AND BOATS, AND REPLACEMENT PARTS THEREFOR, NAMELY, GEARS, GEARING, GEAR ASSEMBLIES AND CLUTCHES INCLUDING MULTI-SPEED AND TWO-SPEED GEAR CHANGERS USED TO PROPEL OR POSITION THE VEHICLES OR COMPONENTS THEREOF AND TO INCREASE, DECREASE, OR OTHERWISE CHANGE OR ALTER THE TORQUE OR SPEED OF THE VEHICLE OR THE COMPONENTS THEREOF IN OFF-HIGHWAY VEHICLES USED ON LAND AND SEA; COMBUSTION ENGINES AND ENGINES FOR LAND VEHICLES; MACHINE COUPLINGS AND TRANSMISSION COMPONENTS FOR LAND VEHICLES; GEARS AND SPEED CHANGE GEARS, PLANET GEARS, ANGULAR GEARS, TWO-SPEED CHANGE GEARS, GEAR HEADS AND ASSOCIATED INTERMEDIATE GEARS FOR LAND VEHICLES; FORCE TRANSFER MECHANISMS FOR MECHANICAL BRANCH DRIVES IN THE FORM OF AN INTERMEDIATE GEAR, STATIC AND DYNAMIC BRAKES, APPLIED AND RELEASED BY HYDRAULIC SPRINGS, REAR WHEEL DRIVES AND PLANETARY DRIVES FOR LAND VEHICLES, GEARS, SHAFTS, DIFFERENTIALS OF ALL TYPES AND REPLACEMENT PARTS THEREFOR FOR LAND VEHICLES; STEERING GEAR CASINGS, HYDRAULIC AND MECHANICAL APPARATUS FOR GEAR CHANGING, NAMELY, CLUTCHES, TORQUE CONVERTERS, AXLES, REDUCTION GEARS, GEAR AND ENGINE TORQUE REDUCERS FOR LAND VEHICLES; STEERING GEAR CASINGS FOR LAND VEHICLES; CONCRETE HAULING BUGGIES FOR TRANSPORTING CONCRETE (U.S. CLS. 19, 21, 23, 31, 35 AND 44).

ANTHONY RINKER, EXAMINING ATTORNEY

SN 77-117,213. ACCELERATION EMARKETING (PROPRIETARY) LIMITED, WESTERN CAPE, SOUTH AFRICA, FILED 2-27-2007.



THE MARK CONSISTS OF THE WORD "ACCELERATION" AND PARALLELOGRAM WITH SUPERSCRIPED DASH DESIGN.

CLASS 9—ELECTRICAL AND SCIENTIFIC APPARATUS

FOR COMPUTER SOFTWARE FOR DATABASE INTEGRATION, MARKETING AUTOMATION, WORKFLOW PROCESS, INTEGRATED REPORTING AND DISTRIBUTED MARKETING COMMUNICATION IN THE FIELD OF MARKETING TECHNOLOGY SERVICES AND SOLUTIONS (U.S. CLS. 21, 23, 26, 36 AND 38).

CLASS 35—ADVERTISING AND BUSINESS

FOR CONSULTATION IN THE FIELD OF DIGITAL MARKETING, NAMELY, BUSINESS MANAGEMENT CONSULTATION IN THE FIELD OF DIGITAL MARKETING, BUSINESS OPERATIONS CONSULTATION IN THE FIELD OF DIGITAL MARKETING, CONSULTATION IN THE FIELD OF ADVERTISING AND SALES STRATEGY, CONSULTATION IN THE FIELD OF ELECTRONIC MARKETING, CONSULTATION IN THE FIELD OF ELECTRONIC MAIL DIGITAL MARKETING, CONSULTATION IN THE FIELD OF PAID SEARCH DIGITAL MARKETING, CONSULTATION IN THE FIELD OF ADVERTISER ADVERTISING OPERATIONS, CONSULTATION IN THE FIELD OF ELECTRONIC PUBLISHER ADVERTISER OPERATIONS, AND CONSULTATION IN THE FIELD OF ON-LINE DIGITAL MARKETING ANALYSIS (U.S. CLS. 100, 101 AND 102).
JENNIFER MARTIN, EXAMINING ATTORNEY

CLASS 9—ELECTRICAL AND SCIENTIFIC APPARATUS

FOR DOWNLOADABLE APPLICATIONS FOR PROVIDING USERS WITH GUIDES TO TELEVISION SCHEDULES AND GUIDES TO ON-DEMAND CONTENT, ALLOWING USERS TO CHAT IN REAL TIME WITH OTHER USERS ABOUT CONTENT THEY ARE VIEWING, ALLOWING USERS TO TAG CONTENT FOR SUBSEQUENT REMINDERS OR RECORDING ON A HOME PERSONAL VIDEO RECORDER (PVR), ALLOWING USERS TO ENTER DETAILS OF THEIR VIEWS ON PARTICULAR CONTENT AND REGISTER THEIR LIKES, DISLIKES AND OTHER VIEWS, ALL BY MEANS OF COMPUTERS, PERSONAL DIGITAL ASSISTANT COMPUTERS, AND MOBILE PHONES, EACH CONNECTED TO THE INTERNET; COMPUTER SOFTWARE FOR PROVIDING USERS WITH GUIDES TO TELEVISION SCHEDULES AND GUIDES TO ON-DEMAND CONTENT, ALLOWING USERS TO CHAT IN REAL TIME WITH OTHER USERS ABOUT CONTENT THEY ARE VIEWING, ALLOWING USERS TO TAG CONTENT FOR SUBSEQUENT REMINDERS OR RECORDING ON A HOME PERSONAL VIDEO RECORDER (PVR), ALLOWING USERS TO ENTER DETAILS OF THEIR VIEWS ON PARTICULAR CONTENT AND REGISTER THEIR LIKES, DISLIKES AND OTHER VIEWS, ALL BY MEANS OF COMPUTERS, PERSONAL DIGITAL ASSISTANT COMPUTERS, AND MOBILE PHONES, EACH CONNECTED TO THE INTERNET; COMPUTER SOFTWARE FOR PROVIDING USERS WITH GUIDES TO TELEVISION SCHEDULES AND GUIDES TO ON-DEMAND CONTENT, ALLOWING USERS TO CHAT IN REAL TIME WITH OTHER USERS ABOUT CONTENT THEY ARE WATCHING, ALLOWING USERS TO TAG CONTENT FOR SUBSEQUENT REMINDERS OR RECORDING ON A HOME PERSONAL VIDEO RECORDER (PVR), ALLOWING USERS TO ENTER DETAILS OF THEIR VIEWS ON PARTICULAR CONTENT AND REGISTER THEIR LIKES, DISLIKES AND OTHER VIEWS, ALL BY MEANS OF COMPUTERS, PERSONAL DIGITAL ASSISTANT COMPUTERS, AND MOBILE PHONES, EACH CONNECTED TO THE INTERNET; DOWNLOADABLE ELECTRONIC PUBLICATIONS IN THE NATURE OF SCHEDULES, LISTINGS OF CONTENT AVAILABLE ON-DEMAND, IN THE FORM OF BOTH FORMAL CATALOGUES FROM COMMERCIAL SERVICE PROVIDERS AND OPEN LISTINGS OF USER-GENERATED CONTENT, IN THE FIELD OF DISCOVERY, MANAGEMENT, DISCUSSION AND PLANNING OF MEDIA CONSUMPTION (U.S. CLS. 21, 23, 26, 36 AND 38).

SN 77-125,177. VIZIMO LIMITED, WOODBRIDGE, UNITED KINGDOM, FILED 3-8-2007.

**CLASS 38—COMMUNICATION**

FOR TELECOMMUNICATION SERVICES, NAMELY, PROVIDING ON-LINE CHAT ROOMS FOR TRANSMISSION OF MESSAGES AMONG COMPUTER USERS CONCERNING TELEVISION, MOVIES AND ONLINE MULTIMEDIA CONTENT BEING VIEWED BY THE USERS; PROVIDING ACCESS TO DATABASES; PROVISION OF ON-LINE FORUMS FOR TRANSMISSION OF MESSAGES AMONG COMPUTER USERS CONCERNING MULTIMEDIA CONTENT BEING VIEWED BY THE USERS (U.S. CLS. 100, 101 AND 104).

CLASS 41—EDUCATION AND ENTERTAINMENT

FOR PROVISION OF ON-LINE ELECTRONIC PUBLICATIONS IN THE NATURE OF SCHEDULES, LISTINGS OF CONTENT AVAILABLE ON-DEMAND IN THE FORM OF BOTH FORMAL CATALOGUES FROM COMMERCIAL SERVICE PROVIDERS AND OPEN LISTINGS OF USER-GENERATED CONTENT, IN THE FIELD OF DISCOVERY, MANAGEMENT, DISCUSSION AND PLANNING OF MEDIA CONSUMPTION (U.S. CLS. 100, 101 AND 107).

BRIDGETT SMITH, EXAMINING ATTORNEY

PRIORITY CLAIMED UNDER SEC. 44(D) ON ERPN CMNTY TM OFC APPLICATION NO. 005740824, FILED 3-7-2007.

OWNER OF ERPN CMNTY TM OFC REG. NO. 005740824, DATED 5-15-2008, EXPIRES 3-7-2017.

THE COLOR(S) BLACK, RED, WHITE, ORANGE IS/ARE CLAIMED AS A FEATURE OF THE MARK.

THE MARK CONSISTS OF A RED TEARDROP SHAPED CIRCLE OUTLINED IN BLACK, WITH A WHITE "V" INSIDE ADJACENT TO THE LETTERS "VIZI" IN RED AND THE LETTERS "MO" IN ORANGE.

SN 77-125,504. EYC LIMITED, RICHMOND, UNITED KINGDOM, FILED 3-8-2007.

EYC

THE MARK CONSISTS OF STANDARD CHARACTERS WITHOUT CLAIM TO ANY PARTICULAR FONT, STYLE, SIZE, OR COLOR.

PRIORITY CLAIMED UNDER SEC. 44(D) ON ERPNCMNTY TM OFC APPLICATION NO. 005317755, FILED 9-15-2006, REG. NO. 005317755, DATED 8-17-2007, EXPIRES 9-15-2016.

CLASS 35—ADVERTISING AND BUSINESS

FOR ADVERTISING; BUSINESS MANAGEMENT; BUSINESS ADMINISTRATION; OFFICE FUNCTIONS (U.S. CLS. 100, 101 AND 102).

CLASS 42—SCIENTIFIC AND COMPUTER SERVICES

FOR SCIENTIFIC AND TECHNOLOGICAL RESEARCH SERVICES AND RESEARCH AND DESIGN SERVICES RELATING THERETO FOR OTHERS IN THE FIELD OF MARKETING; INDUSTRIAL ANALYSIS AND RESEARCH SERVICES IN THE FIELD OF MARKETING; DESIGN AND DEVELOPMENT OF COMPUTER HARDWARE AND SOFTWARE (U.S. CLS. 100 AND 101).

CLASS 45—PERSONAL AND LEGAL SERVICES

FOR LEGAL SERVICES (U.S. CLS. 100 AND 101).
DAVID ELTON, EXAMINING ATTORNEY

SN 77-150,727. LG ELECTRONICS INC., SEOUL, REPUBLIC OF KOREA, FILED 4-6-2007.

M-VSB

THE MARK CONSISTS OF STANDARD CHARACTERS WITHOUT CLAIM TO ANY PARTICULAR FONT, STYLE, SIZE, OR COLOR.

OWNER OF REPUBLIC OF KOREA REG. NO. 0023002, DATED 4-18-2008, EXPIRES 4-18-2018.

CLASS 9—ELECTRICAL AND SCIENTIFIC APPARATUS

FOR MPEG AUDIO LAYER-3 MP3 PLAYERS; COMPACT DISC PLAYERS; DRY CELL BATTERIES; AUDIO SPEAKERS; TELEPHONE SETS; ACOUSTIC DIAPHRAGMS FOR MICROPHONE AND SPEAKERS; HEADPHONES; FACSIMILE MACHINES; SOUND RECORDING STRIPS; RESISTANCE MEASURING DEVICES; ELECTRIC OUTLETS; CHARGERS FOR ELECTRIC BATTERIES; TRANSISTORS; RADIO TUNERS; DIGITAL VERSATILE DISC (DVD) PLAYERS; RECORDED AUDIOTAPES OF MUSIC; SOUND REPRODUCTION APPARATUS; AMPLIFIERS; LOUD SPEAKING APPARATUS AND INSTRUMENTS; RECORDED VIDEOTAPES OF MUSIC; VIDEO TAPE RECORDERS; JUKEBOXES FOR MUSIC; AUDIO CASSETTE PLAYERS; TELEVISION SETS; VIDEO CAMERAS FOR BROADCASTING; SOUND RECORDING APPARATUS AND INSTRUMENTS; AMUSEMENT APPARATUS ADAPTED FOR USE WITH TELEVISION RECEIVERS ONLY; PORTABLE COMMUNICATION APPARATUS, NAMELY, RADIOS, HANDSETS, WALKI-TALKIES, SATELLITE TELEPHONES, LAND LINE TELEPHONES, DIGITAL CELLULAR PHONES; VIDEO DISC PLAYERS; AUDIO AND VIDEO RECEIVERS; WOOFERS; HEAD CLEANING TAPES FOR AUDIO AND VIDEO RECORDERS; PERSONAL DIGITAL ASSISTANTS (PDA); PORTABLE MULTIMEDIA PLAYERS (PMP); DIGITAL MULTIMEDIA BROADCASTING (DMB) RECEIVERS; NOTEBOOK COMPUTERS; LAPTOP COMPUTERS; BLANK CD-ROMS FOR SOUND OR VIDEO RECORDING; LIGHT EMITTING DIODES; LIQUID CRYSTAL DISPLAY (LCD) PANELS (U.S. CLS. 21, 23, 26, 36 AND 38).

CLASS 38—COMMUNICATION

FOR COMMUNICATIONS BY FIBER OPTIC NETWORKS; DATA COMMUNICATION, NAMELY, ELECTRONIC TRANSMISSION OF DATA AMONG USERS OR COMPUTERS; WIRELESS COMMUNICATION, NAMELY, WIRELESS BROADBAND COMMUNICATION SERVICES AND WIRELESS ELECTRONIC TRANSMISSION OF VOICE SIGNALS, DATA, FACSIMILES, IMAGES AND INFORMATION; VALUE ADDED NETWORK COMMUNICATION, NAMELY, TELEPHONE TELECOMMUNICATION SERVICES PROVIDED VIA PREPAID TELEPHONE CALLING CARDS; REMOTE SCREEN COMMUNICATION, NAMELY, PROVIDING FACILITIES AND EQUIPMENT FOR VIDEO CONFERENCING; RENTAL OF TELECOMMUNICATION EQUIPMENT; COMMUNICATION BY COMPUTER TERMINALS; CELLULAR TELEPHONE COMMUNICATION; CABLE TELEVISION BROADCASTING; PROVIDING INFORMATION ABOUT TELECOMMUNICATION; COMPUTER AIDED TRANSMISSION OF MESSAGES AND IMAGES; PROVIDING MULTIPLE-USER ACCESS TO A GLOBAL COMPUTER NETWORK; PROVIDING ON-LINE ELECTRONIC BULLETIN BOARDS FOR TRANSMISSION OF MESSAGES AMONG COMPUTER USERS IN THE FIELD OF GENERAL INTEREST; EDUCATION TELEVISION AND RADIO BROADCASTING; RADIO BROADCASTING; CABLE TELEVISION BROADCASTING; INTERNET BROADCASTING; TELEVISION BROADCASTING (U.S. CLS. 100, 101 AND 104).
JASON BLAIR, EXAMINING ATTORNEY

SN 77-174,733. MICHAEL HILL FRANCHISE PTY LIMITED, MURARRIE, AUSTRALIA, FILED 5-7-2007.

michael hill

PRIORITY CLAIMED UNDER SEC. 44(D) ON NEW ZEALAND APPLICATION NO. 764496, FILED 3-5-2007, REG. NO. 764496, DATED 3-5-2007, EXPIRES 3-5-2017.

OWNER OF NEW ZEALAND REG. NO. 1142450, DATED 10-24-2006, EXPIRES 10-24-2016.

OWNER OF U.S. REG. NO. 3,141,257.

THE NAME(S), PORTRAIT(S), AND/OR SIGNATURE(S) SHOWN IN THE MARK IDENTIFIES "MICHAEL HILL", WHOSE CONSENT(S) TO REGISTER IS SUBMITTED.

SN 77-178,592. PARTNERED BEVERAGES LLC, BILLINGS, MT. FILED 5-11-2007.

MOUNTAIN MUDD

CLASS 14—JEWELRY

FOR JEWELRY, INCLUDING RINGS, PENDANTS, EARRINGS, CHARMS, CHAINS, BRACELETS AND BANGLES; ORNAMENTS OF PRECIOUS METAL; RINGS; PRECIOUS STONES INCLUDING DIAMONDS, OPALS, PEARLS AND COLORED STONES; GOODS IN PRECIOUS METALS AND THEIR ALLOYS OR COATED THEREWITH INCLUDING GOODS OF GOLD, SILVER AND PLATINUM, NAMELY, RINGS, PENDANTS, EARRINGS, CHARMS, CHAINS, BRACELETS, BROOCHES, BANGLES, WATCHES AND CLOCKS; CHRONOLOGICAL, HOROLOGICAL AND CHRONOMETRIC INSTRUMENTS INCLUDING WATCHES AND CLOCKS; JEWELRY CASES AND CASKETS OF PRECIOUS METAL; JEWELRY CASES AND CASKETS NOT OF PRECIOUS METAL; PARTS AND ACCESSORIES OF EACH OF THE FOREGOING FALLING INTO THIS CLASS (U.S. CLS. 2, 27, 28 AND 50).

CLASS 20—FURNITURE AND ARTICLES NOT OTHERWISE CLASSIFIED

FOR SEASHELL, AMBER AND MOTHER OF PEARL FOR USE IN JEWELRY, ORNAMENTS AND TRINKETS, JEWELRY CASES AND CASKETS AND CHRONOLOGICAL, HOROLOGICAL AND CHRONOMETRIC INSTRUMENTS (U.S. CLS. 2, 13, 22, 25, 32 AND 50).

CLASS 35—ADVERTISING AND BUSINESS

FOR ADVERTISING FOR OTHERS OF JEWELRY AND PRECIOUS STONES, PRECIOUS METALS AND THEIR ALLOYS, ORNAMENTS, PEWTER AND TRINKETS, JEWELRY CASES AND CASKETS, GOODS OF SHELL, AMBER AND MOTHER-OF-PEARL, CHRONOLOGICAL, HOROLOGICAL AND CHRONOMETRIC INSTRUMENTS INCLUDING WATCHES AND CLOCKS, AND PARTS AND ACCESSORIES OF EACH OF THE FOREGOING; RETAIL STORE SERVICES AND WHOLESALE STORES FEATURING JEWELRY AND PRECIOUS STONES, PRECIOUS METALS AND THEIR ALLOYS, ORNAMENTS, PEWTER AND TRINKETS, JEWELRY CASES AND CASKETS, GOODS OF SHELL, AMBER AND MOTHER-OF-PEARL, CHRONOLOGICAL, HOROLOGICAL AND CHRONOMETRIC INSTRUMENTS INCLUDING WATCHES AND CLOCKS, AND PARTS AND ACCESSORIES OF EACH OF THE FOREGOING; PROVISION OF ALL OF THE AFOREMENTIONED SERVICES ELECTRONICALLY, INCLUDING VIA THE INTERNET (U.S. CLS. 100, 101 AND 102).

CLASS 37—CONSTRUCTION AND REPAIR

FOR REPAIR AND MAINTENANCE SERVICES OF JEWELRY, PRECIOUS STONES, PRECIOUS METALS AND THEIR ALLOYS, ORNAMENTS, PEWTER AND TRINKETS, JEWELRY CASES AND CASKETS, GOODS OF SHELL, AMBER, MOTHER-OF-PEARL, CHRONOLOGICAL, HOROLOGICAL AND CHRONOMETRIC INSTRUMENTS, AND PARTS AND ACCESSORIES OF EACH OF THE FOREGOING (U.S. CLS. 100, 103 AND 106).

JAMES STEIN, EXAMINING ATTORNEY

THE MARK CONSISTS OF STANDARD CHARACTERS WITHOUT CLAIM TO ANY PARTICULAR FONT, STYLE, SIZE, OR COLOR.

OWNER OF U.S. REG. NOS. 2,160,321, 2,534,948 AND OTHERS.

CLASS 21—HOUSEWARES AND GLASS

FOR CERAMIC COFFEE MUGS, STEEL COFFEE MUGS, PLASTIC COFFEE MUGS, DRINKING GLASSES AND STEEL THERMAL INSULATED BEVERAGE CONTAINERS (U.S. CLS. 2, 13, 23, 29, 30, 33, 40 AND 50).

FIRST USE 3-17-1994; IN COMMERCE 1-4-1997.

CLASS 35—ADVERTISING AND BUSINESS

FOR FOOD AND BEVERAGE KIOSK SERVICES; FOOD AND BEVERAGE KIOSK FRANCHISING SERVICES, NAMELY, RENTAL OF FOOD AND BEVERAGE KIOSKS; FRANCHISING, NAMELY, CONSULTATION AND ASSISTANCE IN BUSINESS MANAGEMENT, ORGANIZATION AND PROMOTION AND OFFERING TECHNICAL ASSISTANCE IN THE ESTABLISHMENT AND OPERATION OF FOOD AND BEVERAGE KIOSKS AND CAFES FOR PROVIDING FOOD AND DRINK; ONLINE RETAIL STORE SERVICES AND RETAIL STORE SERVICES FEATURING COFFEE, COFFEE CUPS, CERAMIC MUGS, PLASTIC COFFEE MUGS, STAINLESS STEEL COFFEE MUGS, DVDS FEATURING INSTRUCTIONS AND INFORMATION FOR FRANCHISEES, CLOTHING, NAMELY, HATS, BEANIES, SHIRTS, VESTS, JACKETS, TOY MODEL CARS; DISTRIBUTORSHIP SERVICES FEATURING COFFEE, COFFEE CUPS, CERAMIC MUGS, PLASTIC COFFEE MUGS, STAINLESS STEEL COFFEE MUGS, DVDS FEATURING INSTRUCTIONS AND INFORMATION IN THE AREA OF BUSINESS MANAGEMENT, ORGANIZATION AND OPERATION, TOY MODEL CARS AND CLOTHING, NAMELY, HATS, BEANIES, SHIRTS, VESTS, JACKETS (U.S. CLS. 100, 101 AND 102).

FIRST USE 3-17-1994; IN COMMERCE 1-4-1997.

CLASS 43—HOTEL AND RESTAURANT SERVICES

FOR MOBILE CAFE SERVICES FOR PROVIDING FOOD AND DRINK; CAFE SERVICES FOR PROVIDING FOOD AND DRINK (U.S. CLS. 100 AND 101).

FIRST USE 3-17-1994; IN COMMERCE 1-4-1997.

CHRISTINE BLOMQUIST, EXAMINING ATTORNEY

SN 77-178,618. PARTNERED BEVERAGES LLC, BILLINGS, MT. FILED 5-11-2007.



OWNER OF U.S. REG. NOS. 2,160,321, 2,534,948 AND OTHERS.

THE MARK CONSISTS OF THE WORDS "MOUNTAIN MUDD" IN STYLIZED FORMAT UNDERNEATH THE IMAGE OF A COFFEE CUP, AND UNDERSCORED BY A HORIZONTAL BLACK LINE.

CLASS 21—HOUSEWARES AND GLASS

FOR CERAMIC COFFEE MUGS, STEEL COFFEE MUGS, PLASTIC COFFEE MUGS, DRINKING GLASSES AND STEEL THERMAL INSULATED BEVERAGE CONTAINERS (U.S. CLS. 2, 13, 23, 29, 30, 33, 40 AND 50).

FIRST USE 3-17-1994; IN COMMERCE 1-4-1997.

CLASS 35—ADVERTISING AND BUSINESS

FOR FOOD AND BEVERAGE KIOSK SERVICES; FOOD AND BEVERAGE KIOSK FRANCHISING SERVICES, NAMELY, RENTAL OF FOOD AND BEVERAGE KIOSKS; FRANCHISING, NAMELY, CONSULTATION AND ASSISTANCE IN BUSINESS MANAGEMENT, ORGANIZATION AND PROMOTION AND OFFERING TECHNICAL ASSISTANCE IN THE ESTABLISHMENT AND OPERATION OF FOOD AND BEVERAGE KIOSKS AND CAFES FOR PROVIDING FOOD AND DRINK; ONLINE RETAIL STORE SERVICES AND RETAIL STORE SERVICES FEATURING COFFEE, COFFEE CUPS, CERAMIC MUGS, PLASTIC COFFEE MUGS, STAINLESS STEEL COFFEE MUGS, DVDS FEATURING INSTRUCTIONS AND INFORMATION FOR FRANCHISEES, CLOTHING, NAMELY, HATS, BEANIES, SHIRTS, VESTS, JACKETS, TOY MODEL CARS; DISTRIBUTORSHIP SERVICES FEATURING COFFEE, COFFEE CUPS, CERAMIC MUGS, PLASTIC COFFEE MUGS, STAINLESS STEEL COFFEE MUGS, DVDS FEATURING INSTRUCTIONS AND INFORMATION IN THE AREA OF BUSINESS MANAGEMENT, ORGANIZATION AND OPERATION, TOY MODEL CARS AND CLOTHING, NAMELY, HATS, BEANIES, SHIRTS, VESTS, JACKETS (U.S. CLS. 100, 101 AND 102).

FIRST USE 3-17-1994; IN COMMERCE 1-4-1997.

CLASS 43—HOTEL AND RESTAURANT SERVICES

FOR MOBILE CAFE SERVICES FOR PROVIDING FOOD AND DRINK; CAFE SERVICES FOR PROVIDING FOOD AND DRINK (U.S. CLS. 100 AND 101).

FIRST USE 3-17-1994; IN COMMERCE 1-4-1997.

CHRISTINE BLOMQUIST, EXAMINING ATTORNEY

SN 77-178,989. THE CANADIAN WILD RICE MERCANTILE LTD., THUNDER BAY, CANADA, FILED 5-11-2007.



PRIORITY CLAIMED UNDER SEC. 44(D) ON CANADA APPLICATION NO. 1324828, FILED 11-14-2006.

OWNER OF CANADA REG. NO. TMA743,113, DATED 7-8-2009, EXPIRES 7-8-2024.

NO CLAIM IS MADE TO THE EXCLUSIVE RIGHT TO USE "CANADIAN", APART FROM THE MARK AS SHOWN.

THE MARK CONSISTS OF A MAPLE LEAF OVER THE WORDS "WILDLY CANADIAN" ON A BANNER.

CLASS 3—COSMETICS AND CLEANING PREPARATIONS

FOR FRAGRANCES FOR PERSONAL USE; HAIR SHAMPOO; SOAPS FOR PERSONAL USE; HAND CREAMS; NON-MEDICATED OINTMENTS FOR THE PREVENTION AND TREATMENT OF SUNBURN (U.S. CLS. 1, 4, 6, 50, 51 AND 52).

CLASS 25—CLOTHING

FOR FOOTWEAR; HEADWEAR; PANTS; SHIRTS; SHORTS; VESTS (U.S. CLS. 22 AND 39).

CLASS 29—MEATS AND PROCESSED FOODS

FOR DEHYDRATED FRUIT SNACKS; DRIED BEANS; PROCESSED EDIBLE SEEDS (U.S. CL. 46).

CLASS 30—STAPLE FOODS

FOR HONEY; MAPLE SYRUP; PANCAKE MIXES; PANCAKE SYRUP; RICE; RICE STARCH FLOUR; TEA; BUCKWHEAT FLOUR; BARLEY FLOUR (U.S. CL. 46).

CLASS 31—NATURAL AGRICULTURAL PRODUCTS

FOR DRIED FLOWER WREATHS; FRESH WHEAT; UNPROCESSED FRUITS; UNPROCESSED MUSHROOMS; UNPROCESSED OATS; UNPROCESSED VEGETABLES; UNPROCESSED WHEAT; UNPROCESSED EDIBLE SEEDS; UNPROCESSED BEANS; RYE SEED; RAW WHEAT (U.S. CLS. 1 AND 46).

SUSAN STIGLITZ, EXAMINING ATTORNEY

SN 77-179,055. GB GROUP PLC, CHESTER, UNITED KINGDOM, FILED 5-11-2007.

ID3

THE MARK CONSISTS OF STANDARD CHARACTERS WITHOUT CLAIM TO ANY PARTICULAR FONT, STYLE, SIZE, OR COLOR.

CLASS 9—ELECTRICAL AND SCIENTIFIC APPARATUS

FOR COMPUTER SOFTWARE FOR IDENTITY VERIFICATION, CREDIT CHECKING AND CREDIT REFERENCING; COMPUTER SOFTWARE FOR COLLECTING, ORGANIZING, MANAGING, UPDATING, ANALYZING, AUTHENTICATING AND REPORTING DATA FOR USE IN THE FIELD OF FRAUD PREVENTION; COMPUTER SOFTWARE FOR AUTHENTICATING, ENCRYPTING, CERTIFYING AND AUTHORIZING DATA IN ORDER TO PROVIDE SECURITY IN ELECTRONIC TRANSACTIONS; APPARATUS FOR USE IN SECURITY CONTROL, NAMELY, COMPUTER HARDWARE AND COMPUTER SOFTWARE FOR TRANSMITTING AND RECEIVING IDENTITY VERIFICATION DATA (U.S. CLS. 21, 23, 26, 36 AND 38).

CLASS 35—ADVERTISING AND BUSINESS

FOR PROVISION OF DATA PROCESSING SERVICES IN THE FORM OF COLLECTING, ORGANIZING, MANAGING, UPDATING, COMPARING, ANALYZING FOR BUSINESS PURPOSES, AND REPORTING FOR BUSINESS PURPOSES ON DATA IN THE FIELDS OF IDENTITY VERIFICATION, PREVENTION OF IDENTITY FRAUD, CREDIT CHECKING, AND CREDIT REFERENCING; CREDIT CHECKING AND REFERENCING SERVICES, NAMELY, PREPARING, ANALYZING AND MONITORING CREDIT REPORTS AND PROVIDING AN ALERT OR REPORT AS TO ANY CHANGES THEREIN; PROVISION OF DATA BASE MANAGEMENT SERVICES AND ADVISORY CONSULTING SERVICES IN RELATION THERETO (U.S. CLS. 100, 101 AND 102).

CLASS 36—INSURANCE AND FINANCIAL

FOR PROVISION OF EXTENDED WARRANTIES FOR AUTHORIZATION, AUTHENTICATION, ENCRYPTION AND CERTIFICATION SERVICES THAT ARE USED IN PROVIDING SECURITY FOR ELECTRONIC TRANSACTIONS AND COMMUNICATIONS THAT TAKE PLACE OVER THE INTERNET AND OTHER COMPUTER NETWORKS; CONSULTANCY, INFORMATION AND ADVISORY SERVICES IN RELATION THERETO (U.S. CLS. 100, 101 AND 102).

CLASS 38—COMMUNICATION

FOR TELECOMMUNICATIONS SERVICES, NAMELY, PROVISION OF ACCESS TO ONLINE ELECTRONIC DATABASES RELATING TO IDENTITY VERIFICATION (U.S. CLS. 100, 101 AND 104).

CLASS 45—PERSONAL AND LEGAL SERVICES

FOR IDENTITY THEFT AND FRAUD PREVENTION SERVICES, NAMELY, ANALYSIS, VERIFICATION AND VALIDATION OF DATA FOR CUSTOMERS OR BUSINESSES BY PROVIDING AUTHENTICATION OF PERSONAL IDENTIFICATION INFORMATION SUCH AS ADDRESS RECORDS, BIRTH AND DEATH REGISTERS, AND BY A FINANCIAL IDENTITY AND FINANCIAL HISTORY MONITORING SERVICE; IDENTIFICATION VERIFICATION SERVICES, NAMELY, PROVIDING AUTHENTICATION OF PERSONAL IDENTITY DOCUMENTS SUCH AS PASSPORTS, UTILITY BILLS, AND PAYMENT CARDS; IDENTIFICATION VERIFICATION SERVICES, NAMELY, PROVIDING AUTHENTICATION OF PERSONAL IDENTIFICATION INFORMATION; PREVENTION OF IDENTITY FRAUD BY MONITORING AND ANALYZING CREDIT REPORTS, THE INTERNET AND PUBLIC RECORDS (U.S. CLS. 100 AND 101).

LYDIA BELZER, EXAMINING ATTORNEY

SN 77-183,991. TENNESSEE DEPARTMENT OF TRANSPORTATION, NASHVILLE, TN. FILED 5-17-2007.



NO CLAIM IS MADE TO THE EXCLUSIVE RIGHT TO USE "STOP LITTER" AND "SPONSORED BY TDOT AND KEEP TENNESSEE BEAUTIFUL", APART FROM THE MARK AS SHOWN.

THE COLOR(S) BLACK, WHITE, YELLOW, GREY IS/ARE CLAIMED AS A FEATURE OF THE MARK.

THE MARK CONSISTS OF THE WORDING "STOPLITTER". THE COLOR YELLOW APPEARS ON THE WORD "STOP", ON THE LETTERS "I" AND "T" IN "LITTER", ON

THE WORDING "TENNESSEE'S HAD ENOUGH", AND ON THE WORDING "SPONSORED BY TDOT AND KEEP TENNESSEE BEAUTIFUL"; THE COLOR WHITE APPEARS ON THE LETTERS "L","T","E", AND "R" IN THE WORD "LITTER"; THE COLOR BLACK APPEARS ON THE RECTANGLE BEHIND THE WORDING "STOPLITTER"; THE COLOR GREY APPEARS ON THE RECTANGLE BEHIND THE WORDING "TENNESSEE'S HAD ENOUGH" AND "SPONSORED BY TDOT AND KEEP TENNESSEE BEAUTIFUL".

CLASS 16—PAPER GOODS AND PRINTED MATTER

FOR PRINTED VISUALS IN THE NATURE OF PROMOTIONAL MATERIALS PROMOTING THE NEED FOR NOT LITTERING, NAMELY, BUMPER STICKERS, DECALS, PAMPHLETS, BROCHURES, AND PENCILS IN THE FIELD OF LITTER PREVENTION AND LITTER CLEANUP (U.S. CLS. 2, 5, 22, 23, 29, 37, 38 AND 50).

FIRST USE 3-13-2006; IN COMMERCE 5-25-2006.

CLASS 35—ADVERTISING AND BUSINESS

FOR PROMOTING PUBLIC AWARENESS OF THE NEED FOR NOT LITTERING (U.S. CLS. 100, 101 AND 102).

FIRST USE 3-13-2006; IN COMMERCE 5-25-2006.

COLLEEN DOMBROW, EXAMINING ATTORNEY

SN 77-191,039. UHLIG, LLC, OVERLAND PARK, KS. FILED 5-25-2007.

Illustratus

THE MARK CONSISTS OF STANDARD CHARACTERS WITHOUT CLAIM TO ANY PARTICULAR FONT, STYLE, SIZE, OR COLOR.

CLASS 16—PAPER GOODS AND PRINTED MATTER

FOR NEWSLETTERS FEATURING TOPICS OF GENERAL INTEREST, BUSINESS, LEGAL ADVICE, FICTIONAL STORIES, NEWS, CROSSWORD PUZZLES, WORD AND NUMBER GAMES, INFORMATION ABOUT COMMUNITY EVENTS, HOME OWNERSHIP, REAL ESTATE, HOME MAINTENANCE, RETIREMENT, GARDENING, ENTERTAINMENT, HEALTH, COOKING AND FITNESS (U.S. CLS. 2, 5, 22, 23, 29, 37, 38 AND 50).

FIRST USE 10-24-2004; IN COMMERCE 10-24-2004.

CLASS 35—ADVERTISING AND BUSINESS

FOR ADVERTISING SERVICES, NAMELY, PROVIDING ADVERTISING SPACE IN NEWSLETTERS (U.S. CLS. 100, 101 AND 102).

FIRST USE 4-29-2006; IN COMMERCE 4-29-2006.

CLASS 41—EDUCATION AND ENTERTAINMENT

FOR NEWSLETTER PUBLICATION SERVICES (U.S. CLS. 100, 101 AND 107).

FIRST USE 10-24-2004; IN COMMERCE 10-24-2004.

NORA BUCHANAN WILL, EXAMINING ATTORNEY

SN 77-208,308. PASSION PARTIES, INC., LAS VEGAS, NV.
FILED 6-18-2007.

PASSION DIVA

THE MARK CONSISTS OF STANDARD CHARACTERS WITHOUT CLAIM TO ANY PARTICULAR FONT, STYLE, SIZE, OR COLOR.

PRIORITY CLAIMED UNDER SEC. 44(D) ON CANADA APPLICATION NO. 1328969, FILED 12-20-2006, REG. NO. TMA717475, DATED 6-26-2008, EXPIRES 6-26-2023.

CLASS 5—PHARMACEUTICALS

FOR NON-EDIBLE GELS FOR USE AS PERSONAL LUBRICANTS; HERBAL SUPPLEMENTS, NAMELY, FOR ENHANCING SEXUAL ENJOYMENT, SEXUAL RESPONSE AND A HEALTHY SEXUAL LIFESTYLE (U.S. CLS. 6, 18, 44, 46, 51 AND 52).

CLASS 9—ELECTRICAL AND SCIENTIFIC APPARATUS

FOR PRE-RECORDED ROMANTIC COMPACT AND DIGITAL DISCS, AUDIO AND VIDEO CASSETTES, ALL FEATURING INSTRUCTIONAL AUDIO-VISUAL CINEMATIC PRESENTATIONS (U.S. CLS. 21, 23, 26, 36 AND 38).

CLASS 10—MEDICAL APPARATUS

FOR NON-ELECTRIC AND ELECTRIC MASSAGERS; ADULT SENSUAL AND NOVELTY AIDS AND TOYS, NAMELY, VIBRATORS, BENWA BALLS, DILDOS, C-RINGS, MASTURBATION SLEEVES, ANAL WANDS AND ANAL PLUGS (U.S. CLS. 26, 39 AND 44).

CLASS 16—PAPER GOODS AND PRINTED MATTER

FOR BLANK JOURNALS, DIARIES, STICKERS, DECALS, CALENDARS, GREETING CARDS AND DOCUMENT PORTFOLIO COVERS; PUBLICATIONS, NAMELY, BOOKS IN THE FIELD OF SEXUAL AWARENESS; PRINTED SALES AIDS AND PROMOTIONAL MATERIAL FOR USE BY OTHERS IN THE SELLING OF THE APPLICANT'S GOODS, NAMELY, PRINTED PAMPHLETS, LEAFLETS, CATALOGS, MAIL RESPONSE CARDS, STICKERS, LABELS, AND MANUALS; PUBLICATIONS, NAMELY, NEWSLETTERS, BROCHURES, AND PAMPHLETS FEATURING INFORMATION ON ADULT SENSUAL AND NOVELTY AIDS AND TOYS, AIDS FOR SEXUAL ENHANCEMENT, AND SEXUAL AWARENESS (U.S. CLS. 2, 5, 22, 23, 29, 37, 38 AND 50).

CLASS 25—CLOTHING

FOR CLOTHING, NAMELY, T-SHIRTS, SCARVES AND HATS; LINGERIE; UNDERGARMENTS (U.S. CLS. 22 AND 39).

CLASS 35—ADVERTISING AND BUSINESS

FOR MARKETING SERVICES, NAMELY, PROVIDING INFORMATIONAL WEB PAGES FOR INDEPENDENT CONSULTANTS, DEMONSTRATORS AND OTHER INDIVIDUALS DESIGNED TO GENERATE SALES TRAFFIC VIA HYPERLINKS TO OTHER WEB SITES THAT SELL THE APPLICANT'S WARES DIRECTLY TO THE CONSUMER BY MEANS OF PRIVATE DEMONSTRATIONS AND GROUP GATHERINGS OF CONSUMERS IN A PARTY PLAN (U.S. CLS. 100, 101 AND 102).

CLASS 41—EDUCATION AND ENTERTAINMENT

FOR ENTERTAINMENT SERVICES, NAMELY, PUBLISHING OF BOOKS; ENTERTAINMENT SERVICES IN THE NATURE OF MOTION PICTURES AND SONGS PRODUCTION; PROVIDING ON-LINE PUBLICATIONS, NAMELY, PAMPHLETS, LEAFLETS, CATALOGS, INFORMATIONAL CARDS, LABELS, AND MANUALS, ALL FEATURING SALES AIDS AND PROMOTIONAL MATERIAL FOR USE BY OTHERS IN THE SELLING OF THE APPLICANT'S GOODS (U.S. CLS. 100, 101 AND 107).
AISHA SALEM, EXAMINING ATTORNEY

SN 77-210,800. NOVOSOM AG, HALLE, FED REP GERMANY, FILED 6-20-2007.

SMARTICLES

THE MARK CONSISTS OF STANDARD CHARACTERS WITHOUT CLAIM TO ANY PARTICULAR FONT, STYLE, SIZE, OR COLOR.

PRIORITY CLAIMED UNDER SEC. 44(D) ON ERPNCMNTY TM OFC APPLICATION NO. 006003032, FILED 6-14-2007, REG. NO. 006003032, DATED 1-9-2009, EXPIRES 6-14-2017.

CLASS 3—COSMETICS AND CLEANING PREPARATIONS

FOR SOAPS; PERFUMERY; ESSENTIAL OILS; PREPARATIONS FOR BODY AND BEAUTY CARE, NAMELY, COSMETIC PREPARATIONS FOR BODY CARE, HAIR CARE PREPARATIONS; NON-MEDICATED OINTMENTS, LOTIONS, CREAMS AND GELS, SKIN SOAP, SHAVING CREAM, SHAVING SOAP, DENTIFRICES, ALL AFORE-MENTIONED INCLUDING ALSO LIPOSOMES OR NANO CAPSULES OR MICROCAPSULES (U.S. CLS. 1, 4, 6, 50, 51 AND 52).

CLASS 4—LUBRICANTS AND FUELS

FOR LIPIDS AND LIPID MIXTURES FOR THE MANUFACTURE OF DRUG AND MEDICATION DELIVERY SYSTEMS OF ACTIVE INGREDIENTS (U.S. CLS. 1, 6 AND 15).

CLASS 5—PHARMACEUTICALS

FOR PHARMACEUTICAL AND VETERINARY PREPARATIONS CONTAINING LIPOSOMES, NANO CAPSULES AND MICROCAPSULES FOR USE AS DRUG DELIVERY AGENTS CONSISTING OF COMPOUNDS THAT FACILITATE DELIVERY OF A WIDE RANGE OF PHARMACEUTICALS; SANITARY PREPARATIONS FOR MEDICAL PURPOSES; DIETETIC FOODS FOR MEDICAL PURPOSES; BABY FOOD; MEDICAL PLASTERS; MATERIALS FOR DRESSING, NAMELY, BANDAGES AND GAUZE; DENTAL FILING MATERIAL FOR STOPPING TEETH AND DENTAL WAX FOR DENTAL PURPOSES; PESTICIDES, FUNGICIDES, HERBICIDES; ALL AFORE-MENTIONED INCLUDING ALSO LIPOSOMES OR NANO CAPSULES OR MICROCAPSULES (U.S. CLS. 6, 18, 44, 46, 51 AND 52).

CLASS 42—SCIENTIFIC AND COMPUTER SERVICES

FOR SCIENTIFIC AND TECHNOLOGICAL SERVICES AND RESEARCH WORKS AND DESIGN RELATED THERETO IN THE FIELDS OF PHARMACY, FOOD, COSMETICS AND BIOTECHNOLOGY; INDUSTRIAL ANALYSIS AND RESEARCH SERVICES IN THE FIELD OF PHARMACY, FOOD, COSMETICS AND BIOTECHNOLOGY; SERVICES OF CHEMICAL LABORATORIES, CHEMICAL RESEARCH, CHEMICAL ANALYSES; SCIENTIFIC RESEARCH AND PRODUCT RESEARCH AND DEVELOPMENT IN THE FIELD OF PHARMACY, FOOD, COSMETICS AND BIOTECHNOLOGY (U.S. CLS. 100 AND 101).

CLASS 45—PERSONAL AND LEGAL SERVICES

FOR PROVIDING AND LICENSING KNOW-HOW, NAMELY, LEGAL SERVICES IN THE NATURE OF DRAWING UP OF LICENSING AGREEMENTS AND LICENSING OF INTELLECTUAL PROPERTY IN THE FIELDS OF PHARMACY, FOOD, COSMETICS AND BIOTECHNOLOGY (U.S. CLS. 100 AND 101).
RON FAIRBANKS, EXAMINING ATTORNEY

SN 77-214,189. MGMT. TV, INC., WICHITA, KS. FILED 6-25-2007.

LINKWRITER

THE MARK CONSISTS OF STANDARD CHARACTERS WITHOUT CLAIM TO ANY PARTICULAR FONT, STYLE, SIZE, OR COLOR.

CLASS 38—COMMUNICATION

FOR ELECTRONIC DISSEMINATION OF DATA COLLECTED USING A DIGITAL PEN (U.S. CLS. 100, 101 AND 104).
FIRST USE 8-17-2004; IN COMMERCE 8-17-2004.

CLASS 42—SCIENTIFIC AND COMPUTER SERVICES

FOR COLLECTION OF DATA FOR OTHERS USING A DIGITAL PEN (U.S. CLS. 100 AND 101).
FIRST USE 8-17-2004; IN COMMERCE 8-17-2004.
MATTHEW EINSTEIN, EXAMINING ATTORNEY

SN 77-214,534. PURE INGENUITY INC., KINGSTON, ONTARIO, CANADA, FILED 6-25-2007.

PURE INGENUITY

THE MARK CONSISTS OF STANDARD CHARACTERS WITHOUT CLAIM TO ANY PARTICULAR FONT, STYLE, SIZE, OR COLOR.

PRIORITY CLAIMED UNDER SEC. 44(D) ON CANADA APPLICATION NO. 1329955, FILED 1-2-2007, REG. NO. TMA722531, DATED 8-27-2008, EXPIRES 8-27-2023.

CLASS 7—MACHINERY

FOR CUSTOMIZED STAINLESS STEEL MANUFACTURING EQUIPMENT AND CONVEYORS, NAMELY, MACHINES FOR THE MANUFACTURE OF PHARMACEUTICALS, FOODS AND BEVERAGES, COSMETICS AND INDUSTRIAL CHEMICALS (U.S. CLS. 13, 19, 21, 23, 31, 34 AND 35).

CLASS 42—SCIENTIFIC AND COMPUTER SERVICES

FOR DESIGN AND FABRICATION OF CUSTOMIZED MANUFACTURING EQUIPMENT FOR OTHERS, NAMELY, CUSTOM ENGINEERING DESIGN SERVICES OF A VARIETY OF TYPES OF MANUFACTURING EQUIPMENT (U.S. CLS. 100 AND 101).
CAROL SPILLS, EXAMINING ATTORNEY

SN 77-214,718. MEISTER, JEANNE C., NEW YORK, NY. FILED 6-25-2007.

CorporateU

THE MARK CONSISTS OF STANDARD CHARACTERS WITHOUT CLAIM TO ANY PARTICULAR FONT, STYLE, SIZE, OR COLOR.

CLASS 35—ADVERTISING AND BUSINESS

FOR ADVICE IN THE FIELD OF BUSINESS MANAGEMENT AND MARKETING; ASSISTANCE, ADVISORY SERVICES AND CONSULTANCY WITH REGARD TO BUSINESS PLANNING, BUSINESS ANALYSIS, BUSINESS MANAGEMENT, AND BUSINESS ORGANIZATION; BUSINESS CONSULTATION; BUSINESS CONSULTING SERVICES IN THE FIELD OF BUSINESS KNOWLEDGE TRANSFER THROUGH AUDIO TOOLS, NAMELY, RECORDING INTERVIEWS WITH SUBJECT MATTER EXPERTS FOR AN ORGANIZATION'S CAPTURE AND FUTURE USE; BUSINESS INFORMATION IN THE FIELD OF CORPORATE TRAINING AND EDUCATION; BUSINESS MANAGEMENT AND CONSULTATION; BUSINESS MEETING PLANNING; BUSINESS RESEARCH AND SURVEYS; CONSULTANCY SERVICES REGARDING BUSINESS STRATEGIES; INFORMATION SERVICES RELATING TO BUSINESS MATTERS; MANAGEMENT AND BUSINESS CONSULTING SERVICES IN THE FIELD OF CORPORATE TRAINING AND EDUCATION; PROVIDING BUSINESS INFORMATION, ALSO VIA INTERNET, THE CABLE NETWORK OR OTHER FORMS OF DATA TRANSFER; EDUCATION LEADERSHIP DEVELOPMENT; RECRUITMENT OF STUDENTS FOR HIGHER EDUCATION INSTITUTIONS (U.S. CLS. 100, 101 AND 102).

CLASS 41—EDUCATION AND ENTERTAINMENT

FOR BUSINESS TRAINING; EDUCATIONAL SERVICES IN THE NATURE OF CORPORATE TRAINING SCHOOLS; ARRANGEMENT OF TRAINING COURSES IN TEACHING INSTITUTES; ARRANGING PROFESSIONAL WORKSHOP AND TRAINING COURSES; COMPUTER EDUCATION TRAINING SERVICES; PUBLICATION OF DOCUMENTS IN THE FIELD OF TRAINING, SCIENCE, PUBLIC LAW AND SOCIAL AFFAIRS; ARRANGING AND CONDUCTING EDUCATIONAL CONFERENCES; CONDUCTING EDUCATIONAL EXHIBITIONS IN THE NATURE OF CORPORATE TRAINING; EDUCATION SERVICES IN THE NATURE OF COURSES AT THE UNIVERSITY LEVEL; EDUCATIONAL RESEARCH (U.S. CLS. 100, 101 AND 107).

ANDREA SAUNDERS, EXAMINING ATTORNEY

SN 77-219,331. C.S. LEWIS PTE LTD., #03-07 BEACH CENTRE, SINGAPORE, FILED 6-29-2007.

THE VOYAGE OF THE DAWN TREADER

THE MARK CONSISTS OF STANDARD CHARACTERS WITHOUT CLAIM TO ANY PARTICULAR FONT, STYLE, SIZE, OR COLOR.

OWNER OF SINGAPORE REG. NO. T05/26397G, DATED 12-23-2005, EXPIRES 12-23-2015.

OWNER OF SINGAPORE REG. NO. T05/26396I, DATED 12-23-2005, EXPIRES 12-23-2015.

OWNER OF SINGAPORE REG. NO. T05/26395J, DATED 12-23-2005, EXPIRES 12-23-2015.

OWNER OF SINGAPORE REG. NO. T05/26392F, DATED 12-23-2005, EXPIRES 12-23-2015.

OWNER OF SINGAPORE REG. NO. T05/26391H, DATED 12-23-2005, EXPIRES 12-23-2015.

OWNER OF SINGAPORE REG. NO. T05/26390Z, DATED 12-23-2005, EXPIRES 12-23-2015.

OWNER OF SINGAPORE REG. NO. T05/26389F, DATED 12-23-2005, EXPIRES 12-23-2015.

OWNER OF SINGAPORE REG. NO. T05/26387Z, DATED 12-23-2005, EXPIRES 12-23-2015.

OWNER OF SINGAPORE REG. NO. T05/26385C, DATED 12-23-2005, EXPIRES 12-23-2015.

CLASS 3—COSMETICS AND CLEANING PREPARATIONS

FOR SOAPS; PERFUMERY, ESSENTIAL OILS FOR PERSONAL USE, COSMETICS, HAIR LOTIONS; DENTIFRICES; PRE-SHAVE LOTION; AFTER SHAVE LOTION; SHAVING CREAM, LOTION, GEL AND FOAM; AFTER SHAVE CREAM AND EMULSION; SKIN MOISTURE LOTION, EMULSION AND CREAM; DEODORANTS FOR PERSONAL USE; DEODORANT AND ANTI-PERSPIRANT CREAM; TALCUM POWDER; DEODORANTS AND ANTIPERSPIRANTS IN THE FORM OF STICKS, LOTIONS, ATOMIZERS AND ROLL-ON DEVICES; SPRAY-ON TALCUM POWDER; BODY CREAM AND LOTION; HAND CREAM; NON-MEDICATED HAND BALM; MASSAGE CREAM, GEL AND OIL; NON-MEDICINAL MOUTHWASH; HAIR CARE PREPARATIONS; TOOTHPASTE; NON-MEDICATED MOUTHWASHES; TOILETRIES, NAMELY, FACIAL CLEANSERS, FACIAL MOISTURIZERS, FACE CREAMS, FACE LOTIONS, FACE GELS, EYE CREAMS, EYE GELS, EYE MAKEUP REMOVER, FACIAL MAKEUP REMOVER, SKIN CLEANSING LOTIONS, SKIN CLEANSING CREAMS, SKIN CLEANSING GELS; NON-MEDICATED ANTI-WRINKLE CREAMS, LOTIONS AND GELS; NON-MEDICATED SKIN REPAIR CREAMS, LOTIONS AND GELS; NON-MEDICATED SKIN BLEMISH PREPARATIONS; FACIAL TONER, BODY GEL, BODY OIL, BODY POWDER, BODY TONERS, BODY CLEANSERS, NON-MEDICATED BATH SALTS, BATH POWDER, BATH OIL, BATH HERBS, BATH GELS; FACIAL AND BODY SPRAYS; BODY WASHES; SKIN BALANCING LOTIONS, CREAMS AND GELS; NON-MEDICATED FACIAL SKIN OIL CONTROLLERS; SKIN FIRING PREPARATIONS; EYE LOTIONS, NON-MEDICATED SKIN RENEWAL CREAM; COSMETICS, NAMELY, FACE AND BODY MASKS, SKIN REFRESHING LOTIONS AND SPRAYS; NON-MEDICATED SKIN CARE PREPARATIONS FOR EXFOLIATING THE FACE AND BODY; FACE AND BODY SUNSCREENS; FACE AND BODY SELF-TANNING PREPARATIONS; LIP SUNSCREEN PREPARATIONS; SUN TAN LOTIONS; AFTER-SUN SOOTHING AND MOISTURIZING PREPARATIONS; LIP BALM (U.S. CLS. 1, 4, 6, 50, 51 AND 52).

CLASS 14—JEWELRY

FOR JEWELRY, BRACELETS, RINGS BEING JEWELRY, NECKLACES, EARRINGS, PINS BEING JEWELRY, COSTUME JEWELRY, PRECIOUS METALS AND PRECIOUS METAL ALLOYS; PRECIOUS AND SEMI-PRECIOUS GEMSTONES, JEWELRY BOXES OF PRECIOUS METAL; JEWELRY CASES OF PRECIOUS METAL; CLOCKS AND WATCHES; JEWELRY BOXES NOT OF METAL (U.S. CLS. 2, 27, 28 AND 50).

CLASS 18—LEATHER GOODS

FOR GOODS MADE OF LEATHER AND LEATHER IMITATIONS, NAMELY, SUITCASES, LUGGAGE, TRAVEL BAGS, GARMENT BAGS FOR TRAVEL, SHOE BAGS FOR TRAVEL, TOILETRY BAGS SOLD EMPTY, COSMETIC BAGS SOLD EMPTY, CARRY-ON BAGS, PURSES, HANDBAGS, SHOULDER BAGS, CLUTCH BAGS, TOTE BAGS, DUFFEL BAGS, BEACH BAGS, BILLFOLDS, WALLETS, KEY CASES, KNAPSACKS, FANNY PACKS, WAIST PACKS, UMBRELLAS, PARASOLS, TRUNKS, BACKPACKS, ATTACHE CASES, BOOK BAGS, BRIEF CASES, DOCUMENT CASES, BUSINESS CASES, ALL-PURPOSE SPORTS BAGS, GYM BAGS, ATHLETIC BAGS (U.S. CLS. 1, 2, 3, 22 AND 41).

CLASS 20—FURNITURE AND ARTICLES NOT OTHERWISE CLASSIFIED

FOR FURNITURE, MIRRORS, FURNITURE FRAMES, PICTURE FRAMES, EMBROIDERY FRAMES, BOOK RESTS, BOOK STANDS, DECORATIVE MOBILES, NON-TOY STUFFED ANIMALS, PLASTIC FIGURINES, FABRIC FIGURINES, GAZING WATER GLOBES, HANGERS FOR CLOTHES, DISPENSERS FOR PILLS AND CAPSULES SOLD EMPTY, PLASTIC PILLBOXES, INFLATABLE PLASTIC SIGNS, PLASTIC BANNERS, PLASTIC CAKE DECORATIONS, PLASTIC CAPS, PLASTIC KEY CHAINS, KEY HOLDERS AND KEY RINGS, PLASTIC BADGE HOLDERS, PLASTIC NOVELTY LICENSE PLATES, PLASTIC GIFT PACKAGE DECORATIONS, PLASTIC HOLIDAY ORNAMENTS EXCLUDING CHRISTMAS TREE ORNAMENTS, DRINKING STRAWS, TOY CHESTS, NON-ELECTRIC FANS FOR PERSONAL USE, FLAGPOLES, GLASS FOR USE IN FRAMING ART; GOODS OF WOOD, CORK, REED, CANE, WICKER, HORN, BONE, IVORY, WHALEBONE, SHELL, AMBER, MOTHER-OF-PEARL, MEERSCHAUM, PLASTER, PLASTIC, COLD CAST RESIN AND WAX, NAMELY, BUSTS, FIGURINES, DESKTOP STATUARY, SCULPTURES, STATUES, STATUETTES, LETTER BOXES AND ORNAMENTS NOT FOR CHRISTMAS; WIND CHIMES; TOWEL HOOKS NOT OF METAL; WINE RACKS; PLASTIC BOTTLE STOPPERS (U.S. CLS. 2, 13, 22, 25, 32 AND 50).

CLASS 21—HOUSEWARES AND GLASS

FOR HOUSEHOLD AND KITCHEN UTENSILS, NAMELY, SPATULAS, STRAINERS, TURNERS, SIEVES, GRATERS, POT AND PAN SCRAPERS, ROLLING PINS, WHISKS, SKIMMERS, BASTING SPOONS, ICE CREAM SCOOPS, SERVING FORKS, FORKS FOR BARBECUING, MIXING SPOONS, SERVING SPOONS, SLOTTED SPOONS, COOKING SKEWERS; SCRUBBING COMBS, SPONGES AND BRUSHES; POLISHED PLATE GLASS, CERAMIC, GLASSWARE, PORCELAIN AND EARTHENWARE, NAMELY, BOWLS, PLATES, DISHES, CANISTER SETS, COFFEE CUPS, CANTEENS, CARAFES, CARVING BOARDS, GRAVY BOATS, ICE BUCKETS, MEAL TRAYS, SERVING TRAYS NOT OF PRECIOUS METAL; LUNCHBOXES, COLANDERS, PLATES, CUPS, ELECTRIC AND NON-ELECTRIC TOOTHBRUSHES, BOTTLES SOLD EMPTY, BOTTLE OPENERS, MUGS; GLASS STORAGE JUGS, DRINKING GLASSES, SHOT GLASSES, GLASS STORAGE JARS, SPICE RACKS, BEVERAGE GLASSWARE, BEVERAGE STIRRERS, DEMITASSE SETS CONSISTING OF CUPS AND SAUCERS, SUGAR AND CREAMER SETS FEATURING SUGAR BOWLS NOT OF PRECIOUS METAL AND CREAMER PITCHERS, COFFEE POTS NOT OF PRECIOUS METAL, PLANT AND FLOWER BASKETS; WICKER, STRAW, WOOD AND CLOTH BASKETS; PLASTIC BUCKETS, WOVEN FABRIC BUCKETS, TEA CADDIES, TEA SETS; COOKERY MOLDS, POTS AND PANS; COOKIE SHEETS; SERVING UTENSILS, NAMELY, LADLES, CAKE SER-

VERS, PIE SERVERS, TONGS; COASTERS NOT OF PAPER AND NOT TABLE LINEN, COCKTAIL SHAKERS, COOKIE CUTTERS, CORK SCREWS, CORN COB HOLDERS, DECANTERS, FLASKS, PLASTIC HOUSEHOLD GLOVES FOR GENERAL USE, DINNERWARE, CONTAINERS FOR HOUSEHOLD USE, ALL PURPOSE PORTABLE HOUSEHOLD CONTAINERS, CONTAINERS FOR HOUSEHOLD USE, NAMELY, GLOBES, BABY BATH TUBS, BACK SCRATCHERS, BAKEWARE, BAKING DISHES, BARWARE, NAMELY, CORKSCREWS, WINE GLASSES, CARAFES, DECANTERS, COOLERS FOR WINE AND CHAMPAGNE, WINE POURERS, BOTTLE OPENERS, CRUMB SCRAPERS, FLASKS, CHAMPAGNE OPENERS, STAINLESS STEEL COCKTAIL SETS COMPRISED OF COCKTAIL PICKS AND SHAKERS SOLD TOGETHER AS A UNIT, SELTZER BOTTLES, HIGH BALL GLASSES AND WINE GOBLET; CRYSTAL, CHINA, EARTHENWARE, GLASS, PORCELAIN AND TERRA COTTA BUSTS; CANDLESTICKS NOT OF PRECIOUS METAL, CERAMIC FIGURINES, CLEANING CLOTHS, CLOTHES PINS, PAPER TOWEL DISPENSERS, SOAP DISPENSERS, FOAM DRINK HOLDERS, HAIR BRUSHES, HAIR COMBS, CERAMIC AND PORCELAIN HOLIDAY ORNAMENTS EXCLUDING CHRISTMAS TREE ORNAMENTS, INCENSE BURNERS, NAPKIN HOLDERS, NAPKIN RINGS NOT OF PRECIOUS METAL, ORNAMENTAL GLASS SPHERES, PAPER CUPS AND PLATES, PLASTIC CUPS AND PLATES, PEPPER GRINDERS AND MILLS, PORTABLE COOLERS, POTTIES FOR CHILDREN, RECIPE BOXES, SALT AND PEPPER SHAKERS, SHOE HORNS, SHOE TREES, TOILET PAPER HOLDERS, TOOTHPICKS, TOOTHPICK HOLDERS, TRASH CANS, TOWEL BARS; TOWEL HOLDERS, NAMELY, RINGS AND RAILS; URNS, WATERING CANS, ALL OF THE FOREGOING GOODS NOT MADE OF PRECIOUS METAL; CONSUMER COSMETICS BRUSHES (U.S. CLS. 2, 13, 23, 29, 30, 33, 40 AND 50).

CLASS 24—FABRICS

FOR TEXTILE AND TEXTILE GOODS, NAMELY, MATTRESS COVERS, MATTRESS PADS, BED COVERS, BED BLANKETS, BED CANOPIES, BED LINEN, BED PADS, BED SHEETS, BED SPREADS, BLANKET THROWS, COMFORTERS, COVERLETS, CRIB BUMPERS, CRIB CANOPIES, DUST RUFFLES, EIDERDOWN COVERS, EIDERDOWNS, PILLOW CASES, PILLOW COVERS, PILLOW SHAMS, RECEIVING BLANKETS, SHAMS, DUVETS, DUVET COVERS, QUILTS, TABLE COVERS, TABLE LINEN, TOWELS, AFGHANS, BARBECUE MITTS, BATH LINEN, BURP CLOTHS, CLOTH BANNERS, CLOTH DOILIES, CLOTH FLAGS, CLOTH LABELS, CLOTH PENNANTS, CURTAINS, DISH CLOTHS, DRAPERIES, FABRIC FLAGS, FABRIC TABLE RUNNERS, FABRIC TABLE TOPPERS, FABRIC VALANCES, FELT PENNANTS, FITTED TOILET LID COVERS MADE OF FABRIC OR FABRIC SUBSTITUTES, HANDKERCHIEFS, HOUSEHOLD LINEN, KIT COMPRISED OF FABRICS FOR MAKING QUILTS, LAP ROBES, LAP RUGS, OVEN MITTS, POT HOLDERS, SHOWER CURTAINS, SHROUDS, SWAGS, TABLE CLOTHS NOT OF PAPER, TABLE LINEN, NAMELY, COASTERS, NAPKINS, PLACE MATS, TEXTILE WALL HANGINGS, WASHCLOTHS, WASHING MITTS (U.S. CLS. 42 AND 50).

CLASS 29—MEATS AND PROCESSED FOODS

FOR MEAT, FISH, POULTRY AND GAME; MEAT EXTRACTS; PRESERVED, DRIED AND COOKED FRUITS AND VEGETABLES; JELLIES, JAMS, COMPOTES; EGGS, MILK AND MILK PRODUCTS, NAMELY, HALF AND HALF, MILK BASED BEVERAGES CONTAINING FRUITS AND FRUIT JUICE, MILK BEVERAGES WITH HIGH MILK CONTENT, MILK DRINKS CONTAINING FRUITS, MILK POWDER, MILK-BASED BEVERAGE CONTAINING COFFEE, POWDERED MILK FOR FOOD PURPOSES, SOY MILK, SOY-BASED FOOD BEVERAGE USED AS A MILK SUBSTITUTE, COTTAGE CHEESE, SOUR CREAM, CHEESES, BUTTERS, EGG NOG, CREAM, MARGARINE, CRÈME FRAICHE, YOGURT, YOGURT DRINKS, CURD, MILK-BASED FOOD BEVERAGES AND MILK PRODUCTS EXCLUDING ICE CREAM, ICE MILK AND FROZEN YOGURT; EDIBLE OILS AND FATS (U.S. CL. 46).

CLASS 30—STAPLE FOODS

FOR COFFEE, TEA, COCOA, SUGAR, RICE, TAPIOCA, SAGO, ARTIFICIAL COFFEE; FLOUR AND PREPARATIONS MADE FROM CEREALS, BREAD, PASTRY AND CONFECTIONERY PRODUCTS, NAMELY, CHOCOLATES AND CANDIES, COOKIES, FUDGE, CHEWING GUM, CHOCOLATE COVERED NUTS, CHOCOLATE BISCUITS, FROZEN CONFECTIONS, FREEZABLE LIQUID FOR USE IN MAKING FROZEN CONFECTIONS, ICE CREAM, ICE CREAM DRINKS, ICE CREAM MIXES AND POWDERS, ICING, ICE CREAM SUBSTITUTE, ICE-CREAM CAKES, PRALINES, NOUGAT, MARZIPAN, CANDY BARS, CHOCOLATE CHIPS, CHOCOLATE TRUFFLES, PIES, CAKES, CREAM BUNS AND CREAM PUFFS; EDIBLE ICES; HONEY, TREACLE; YEAST, BAKING-POWDER; SALT, MUSTARD; VINEGAR, SAUCES, CONDIMENTS, NAMELY, KETCHUP, MAYONNAISE, RELISHES, SALSAS, MARINADES, GLAZES, CHOCOLATE SYRUP; ICE; BEVERAGES MADE OF TEA; COFFEE-BASED BEVERAGES; TEA-BASED BEVERAGES, TEA BEVERAGES FLAVORED WITH FRUIT JUICE, FROZEN COFFEE BEVERAGES; MIXES IN THE NATURE OF CONCENTRATES, SYRUPS OR POWDERS USED IN THE PREPARATION OF TEA BASED BEVERAGES (U.S. CL. 46).

CLASS 32—LIGHT BEVERAGES

FOR BEERS; MINERAL AND AERATED WATERS AND OTHER NON-ALCOHOLIC DRINKS, NAMELY, SOFT DRINKS, DRINKING WATERS, FLAVORED WATERS, ENERGY DRINKS, SPORTS DRINKS, COFFEE FLAVORED SOFT DRINKS; TEA-FLAVORED SOFT DRINKS; FRUIT DRINKS AND FRUIT JUICES; SYRUPS, CONCENTRATES, POWDERS, NON-ALCOHOLIC FRUIT EXTRACTS AND OTHER PREPARATIONS FOR MAKING BEVERAGES IN THE NATURE OF FRUIT DRINKS, FRUIT JUICES, LEMONADES, SOFT DRINKS, FRUIT DRINKS, FLAVORED WATERS, MINERAL AND AERATED WATERS, ENERGY DRINKS, NON-ALCOHOLIC BEVERAGES WITH TEA FLAVOR (U.S. CLS. 45, 46 AND 48).

JAMES LOVELACE, EXAMINING ATTORNEY

SN 77-225,753. FMR LLC, BOSTON, MA. FILED 7-10-2007.

DATAMANAGER FROM NATIONAL FINANCIAL

THE MARK CONSISTS OF STANDARD CHARACTERS WITHOUT CLAIM TO ANY PARTICULAR FONT, STYLE, SIZE, OR COLOR.

OWNER OF U.S. REG. NOS. 3,095,398, 3,232,540 AND 3,232,541.

NO CLAIM IS MADE TO THE EXCLUSIVE RIGHT TO USE "DATAMANAGER" OR "FINANCIAL", APART FROM THE MARK AS SHOWN.

SEC. 2(F) AS TO "NATIONAL FINANCIAL".

CLASS 35—ADVERTISING AND BUSINESS

FOR FINANCIAL RECORDS MANAGEMENT (U.S. CLS. 100, 101 AND 102).

CLASS 36—INSURANCE AND FINANCIAL

FOR FINANCIAL MANAGEMENT, NAMELY, AGGREGATION OF INFORMATION ABOUT MULTIPLE FINANCIAL ACCOUNTS AND DATA (U.S. CLS. 100, 101 AND 102).

MATTHEW MCDOWELL, EXAMINING ATTORNEY

SN 77-236,308. BIOARTS INTERNATIONAL, LTD., MILL VALLEY, CA. FILED 7-23-2007.

BIOARTS

THE MARK CONSISTS OF STANDARD CHARACTERS WITHOUT CLAIM TO ANY PARTICULAR FONT, STYLE, SIZE, OR COLOR.

CLASS 39—TRANSPORTATION AND STORAGE

FOR STORAGE SERVICES FOR BIOLOGICAL TISSUE, GENETIC MATERIAL AND OTHER BIOLOGICAL MATERIAL (U.S. CLS. 100 AND 105).

CLASS 40—MATERIAL TREATMENT

FOR CRYOPRESERVATION OF BIOLOGICAL TISSUE, GENETIC MATERIAL AND OTHER BIOLOGICAL MATERIAL (U.S. CLS. 100, 103 AND 106).

CLASS 42—SCIENTIFIC AND COMPUTER SERVICES

FOR SCIENTIFIC CONSULTATION AND PROVIDING SCIENTIFIC INFORMATION IN THE FIELD OF PRESERVATION OF ENDANGERED SPECIES; MEDICAL AND SCIENTIFIC RESEARCH AND DEVELOPMENT SERVICES IN THE FIELDS OF ANIMAL CLONING, GENE THERAPY, GENE MANIPULATION AND GENETIC DIAGNOSTICS; DNA ANALYSIS AND PROFILING; BIOLOGICAL AND CLINICAL SPECIMEN PROCESSING SERVICES; BIOPSY PROCESSING SERVICES; ANIMAL AND BIOLOGICAL CLONING SERVICES; OOCYTE MATURATION AND ASSESSMENT; SCIENTIFIC SERVICES, NAMELY, IN VITRO MATURATION AND ASSESSMENT; DESIGN AND DEVELOPMENT OF SPECIMEN SHIPPERS; DATABASE DESIGN AND DEVELOPMENT SERVICES, NAMELY, DESIGNING BIOLOGICAL AND CHEMICAL DATABASES FOR THE IDENTIFICATION AND ANALYSIS OF GENES AND PROTEINS; GENOMIC ID AND PARENTAGE ANALYSIS SERVICES; DESIGN AND DEVELOPMENT OF COMPUTER SOFTWARE AND DATA, NAMELY, COMPUTER SOFTWARE AND DATA FOR BIOLOGICAL AND CHEMICAL ANALYSIS; TECHNICAL SUPPORT SERVICES, NAMELY, TROUBLESHOOTING OF COMPUTER SOFTWARE PROBLEMS; COMPUTER SUPPORT SERVICES, NAMELY, DATA UPDATE SERVICES; DESIGN AND DEVELOPMENT OF BIOINFORMATIC TECHNOLOGY PLATFORMS FOR TARGET IDENTIFICATION AND VALIDATION, PROTEIN STRUCTURE AND FUNCTION PREDICTIONS, AND BIOLOGICAL MODEL SELECTION AND INTERPRETATION; DESIGN AND DEVELOPMENT OF MICROENGINEERED DEVICES; DESIGN AND DEVELOPMENT OF NON-SURGICAL EMBRYO TRANSFER METHODS; EMBRYO ASSESSMENT, NAMELY, THE USE OF BIO-IMAGING, GENE EXPRESSION ANALYSIS OR ANALYSIS OF METABOLIC BY-PRODUCTS FOR ASSESSING THE VIABILITY OF OVA AND SOMATIC CELLS, AND EMBRYOS PRODUCED BY CLONING OR OTHER MEANS FOR SCIENTIFIC AND RESEARCH PURPOSES; ALL AFOREMENTIONED SERVICES FOR SCIENTIFIC PURPOSES (U.S. CLS. 100 AND 101).

CLASS 44—MEDICAL, BEAUTY AND AGRICULTURAL SERVICES

FOR GENE BANK SERVICES IN THE NATURE OF GENE HARVESTING; CELL CULTURING SERVICES, NAMELY, MEDICAL, CLONING AND RESEARCH SERVICES; CATTERY SERVICES IN THE NATURE OF BREEDING CATS; CANINE BOARDING SERVICES IN THE NATURE OF BREEDING DOGS; GENETIC TESTING AND GENE REARRANGEMENT SERVICES, MOLECULAR GENETIC TESTING, TISSUE CULTURE TESTING; EMBRYO ASSESSMENT, NAMELY, THE USE OF BIO-IMAGING, GENE EXPRESSION ANALYSIS OR ANALYSIS OF METABOLIC BY-PRODUCTS FOR ASSESSING THE VIABILITY OF OVA AND SOMATIC CELLS, AND EMBRYOS PRODUCED BY CLONING OR OTHER MEANS FOR MEDICAL PURPOSES; CHARITABLE AND PHILANTHROPIC SERVICES, NAMELY, CLONING, GENE BANKING AND PRODUCTION OF TRANSGENIC ANIMAL PRODUCTS IN THE FIELD OF PRESERVATION OF ENDANGERED SPECIES (U.S. CLS. 100 AND 101).

CLASS 45—PERSONAL AND LEGAL SERVICES

FOR LICENSING OF INTELLECTUAL PROPERTY (U.S. CLS. 100 AND 101).

KEVON CHISOLM, EXAMINING ATTORNEY

SN 77-237,151. GIOCHI PREZIOSI S.P.A., MILANO, ITALY, FILED 7-24-2007.

MY LIFE ANOTHER LIFE IN YOUR HANDS

THE MARK CONSISTS OF STANDARD CHARACTERS WITHOUT CLAIM TO ANY PARTICULAR FONT, STYLE, SIZE, OR COLOR.

CLASS 9—ELECTRICAL AND SCIENTIFIC APPARATUS

FOR SCIENTIFIC, NAUTICAL, SURVEYING, MEASURING, SIGNALING, CHECKING (SUPERVISION), LIFE-SAVING AND TEACHING APPARATUS AND INSTRUMENTS, NAMELY, EMERGENCY SIGNAL TRANSMITTERS, LIFE-SAVING RAFTS, NAVIGATIONAL BUOYS, BUOYANCY COMPENSATOR DEVICES FOR DIVERS, BUOYANCY COMPENSATOR JACKETS FOR USE IN SCUBA DIVING, OIL AND GAS WELL DOWNHOLE SURVEY AND MEASUREMENT EQUIPMENT, SURVEYORS' LEVELS, TAPE MEASURES, DISTANCE MEASURING APPARATUS, LEVEL MEASURING MACHINES FOR SURVEYING, LENGTH MEASURING GAUGES, BEVELS, RAIN GAUGES, RHEOMETERS FOR MEASURING THE VISCOSITY AND VISCOELASTICITY OF FLUIDS, PORTABLE ELECTRONIC RECORDERS FOR MEASURING AND RECORDING MULTIPLE VOLTAGE, CURRENT AND THERMOCOUPLE READINGS FROM VARIOUS TRANSDUCERS, CABLES FOR ELECTRICAL AND OPTICAL SIGNAL TRANSMISSION SYSTEMS, DIGITAL SIGNAL PROCESSORS, ELECTRONIC SWITCHERS FOR AUDIO AND VIDEO SIGNALS, DIRECTIONAL COMPASSES, TRANSMITTERS OF ELECTRONIC SIGNALS, PROTECTIVE HELMETS, LIFE PRESERVERS, LIFE SAVING VESTS, BULLET-PROOF VESTS AND CLOTHING, LIFE NETS, MEDICAL TEACHING MANNEQUINS, ELECTRONIC PENS, LIGHT PENS, CALCULATORS, KEYBOARDS AND MICE FOR COMPUTERS, TELEPHONE SETS WITH SCREEN AND KEYBOARD COMPUTERS, COMPUTER HARD DISKS; APPARATUS AND INSTRUMENTS FOR CONDUCTING, SWITCHING, TRANSFORMING, ACCUMULATING, REGULATING OR CONTROLLING ELECTRICITY, NAMELY, APPA-

RATUS AND INSTRUMENTS FOR CONVEYING, DISTRIBUTING, TRANSFORMING, STORING, REGULATING OR CONTROLLING ELECTRIC CURRENT, CIRCUITS FOR HEAVY CURRENT, CURRENT CONVERTERS, CURRENT RECTIFIERS, ELECTRICAL EDDY CURRENT TEST EQUIPMENT, INSTRUMENTS AND APPARATUS FOR CONTROLLING ELECTRIC CURRENT, NAMELY, ELECTRICAL CONTROLLERS FOR MAGNETIC BEARING CONTROL, PORTABLE ELECTRONIC RECORDER FOR MEASURING AND RECORDING MULTIPLE VOLTAGE, CURRENT AND THERMOCOUPLE READINGS FROM VARIOUS TRANSDUCERS; PHOTOGRAPHIC APPARATUS AND INSTRUMENTS, NAMELY, PHOTOGRAPHIC CAMERAS, PHOTOGRAPHIC EXPOSURE METERS, PHOTOGRAPHIC FILTERS, PHOTOGRAPHIC FLASH UNITS FOR CAMERAS, PHOTOGRAPHIC FLASHBULBS, PHOTOGRAPHIC PROJECTORS, BAGS FOR CAMERAS AND PHOTOGRAPHIC EQUIPMENT, CASES FOR PHOTOGRAPHIC APPARATUS; CINEMATOGRAPHIC APPARATUS AND INSTRUMENTS, NAMELY, CINEMATOGRAPHIC CAMERAS, CINEMATOGRAPHIC FILM, CINEMATOGRAPHIC MACHINES AND APPARATUS, CINEMATOGRAPHIC PROJECTORS, EXPOSED CINEMATOGRAPHIC FILM, SOUND RECORDING APPARATUS AND INSTRUMENTS (CINEMATOGRAPHIC APPARATUS); OPTICAL APPARATUS AND INSTRUMENTS, NAMELY, OPTICAL MIRRORS, GLASSES, SUNGLASSES, SPECTACLES; WEIGHING APPARATUS AND INSTRUMENTS, NAMELY, SCALES AND BALANCES; APPARATUS FOR RECORDING, TRANSMISSION OR REPRODUCTION OF SOUND OR IMAGES; BLANK MAGNETIC DATA CARRIERS, RECORDING DISCS, NAMELY, APPARATUS FOR DOWNLOADING, RECORDING, TRANSMISSION OR REPRODUCTION OF SOUND OR IMAGES, COMPACT DISC PLAYERS, VIDEO PLAYERS, NAMELY, VIDEO DISC PLAYERS, DVD PLAYERS, PORTABLE MEDIA PLAYERS, MP3 PLAYERS; PRE RECORDED COMPACTS DISCS, LASER DISCS, OPTICAL DISCS, COMPUTER DISCS AND LASER DISCS FEATURING MUSIC AND PICTURES, NAMELY, DIGITAL VIDEO DISCS, AND MOTION PICTURE FILMS CONTAINING SPECIALLY COMPOSED MUSIC AND IMAGES INCORPORATING SOUNDS AND VIEWS OF LANDSCAPES FOR PRIVATE USERS AS WELL AS FOR ENTERTAINMENT USE; COMPUTER SOFTWARE FOR PROCESSING DIGITAL MUSIC AND VIDEO FILES AND COMPUTER SOFTWARE FOR MANIPULATING DIGITAL AUDIO AND VIDEO INFORMATION FOR USE IN AUDIO AND VIDEO MEDIA APPLICATIONS; AUTOMATIC VENDING MACHINES AND COIN COUNTING OR SORTING MACHINES; CASH REGISTERS, POCKET-SIZED ELECTRONIC CALCULATORS; DATA PROCESSING EQUIPMENT AND COMPUTERS APPLIANCES FOR DATA PROCESSING AND FOR INPUT, OUTPUT AND STORAGE OF DATA, NAMELY, COMPUTERS; FIRE-EXTINGUISHERS; COMPUTER ACTION GAME SOFTWARE AND CARTRIDGES; COMPUTER SIMULATION GAME SOFTWARE AND CARTRIDGES; VIDEO GAME SOFTWARE AND CARTRIDGES (U.S. CLS. 21, 23, 26, 36 AND 38).

CLASS 28—TOYS AND SPORTING GOODS

FOR GAMES AND PLAYTHINGS, NAMELY, ACTION-TYPE TARGET GAMES, ARCADE GAMES, BOARD GAMES, CARD GAMES, COMPUTER ACTION GAMES, COMPUTER SIMULATION GAME PROGRAMS AND VIDEO GAME PROGRAMS ALL SOLD AS PART OF AN ARCADE TYPE-ELECTRONIC VIDEO GAME AND AS A HAND HELD UNIT FOR VIDEO GAMES; PADDLE BALL GAMES, PARLOUR GAMES, NAMELY, BOARD GAMES, CARD GAMES; PIN-BALL TYPE GAMES, PUZZLES, RING GAMES, ROLE-PAYING GAMES, TABLE TENNIS, TARGET GAMES, WORD GAMES, NAMELY, MANIPULATIVE PUZZLES, JIGSAW PUZZLES, WORD MEMORY GAMES, WORD BOARD GAMES, WORD PARTY GAMES, WORD CARD GAMES, WORD MANIPULATIVE GAMES, WORD PUZZLES; GYMNASIAC AND SPORTING ARTICLES, NAMELY, BALANCE BEAMS, HORIZONTAL BARS, RINGS, RHYTHMIC GYMNASIAC HOOPS, RIBBONS AND ROPES, TRAMPOLINES, TRAINING STOOLS; DECORATIONS FOR CHRISTMAS TREES, PLAYING CARDS (U.S. CLS. 22, 23, 38 AND 50).

FRANK LATTUCA, EXAMINING ATTORNEY

SN 77-240,417. YOUNG & YOUNG TRADING CO., LTD., SCARBOROUGH, CANADA, FILED 7-27-2007.



PRIORITY CLAIMED UNDER SEC. 44(D) ON CANADA APPLICATION NO. 1338964, FILED 3-12-2007, REG. NO. TMA739,510, DATED 5-6-2009, EXPIRES 5-6-2024.

NO CLAIM IS MADE TO THE EXCLUSIVE RIGHT TO USE "BRAND" AND "SINCE 1960", APART FROM THE MARK AS SHOWN.

THE NON-LATIN CHARACTER(S) IN THE MARK TRANSLITERATES INTO YU YEE, AND THIS MEANS AS YOU WISH IN ENGLISH.

CLASS 21—HOUSEWARES AND GLASS

FOR BAMBOO COOKING SKEWERS; CHOPSTICKS; SUSHI ROLLING MAT; SUSHI ROLLING MATS OF PAPER (U.S. CLS. 2, 13, 23, 29, 30, 33, 40 AND 50).

CLASS 29—MEATS AND PROCESSED FOODS

FOR CHOW MEIN; CANNED ASPARAGUS SPEARS; CANNED BABY CORN; CANNED BABY FUNGUS, NAMELY, WON YEE; DRIED BAMBOO LEAVES; BAMBOO SHOOT TIPS WITH CHILI; CANNED BAMBOO SHOOTS; CANNED BEAN SPROUTS; BEANCURD STICKS; BEANCURD WITH BAMBOO SHOOTS; CANNED BLACK BEANS; DRIED BLACK FUNGUS; BRAISED BAMBOO SHOOT TIPS; CHILI OIL; CANNED COCONUT MEAT; DICED VEGETABLE CHOP SUEY; DRIED AND CANNED SHIITAKE MUSHROOMS; CANNED GINGKO NUTS; HOT AND SOUR SOUP; CANNED LILY SPROUTS; PROCESSED LONGAN; CANNED LOTUS NUTS; CANNED LOTUS SEEDS; CANNED LYCHEE; CANNED MANGO SLICES; MOCK ABALONE, NAMELY, SEAFOOD SUBSTITUTE; MOCK CHICKEN, MOCK DUCK, MOCK SAUSAGE, NAMELY, POULTRY AND MEAT SUBSTITUTES; DRIED MUNG BEANS; CANNED OYSTER MUSHROOMS; CANNED ABALONE MUSHROOMS; DRIED PEANUT KERNELS; PEELED SOY BEANS; PICKLED CABBAGE AND BAMBOO SHOOTS; PICKLED LEEKS; CANNED PINEAPPLE; PURE SESAME OIL; QUAIL EGGS; DRIED RED BEANS; SALTED BLACK BEANS; SALTED MUSTARD GREENS; SAMBEAN BEANCURD SHEETS; PROCESSED SNOW CABBAGE WITH BAMBOO SHOOTS; PROCESSED SNOW CABBAGE WITH SOY BEANS; FROZEN SOY BEANS IN SHELL, NAMELY, EDAMAME; CANNED STRAW MUSHROOM; THAI TOM YAM SOUP, NAMELY, HOT AND SOUR SOUP; TOM KHA COCONUT SOUP; VEGETABLE GREEN CURRY SOUP; VEGETABLE RED CURRY SOUP; VEGETABLE YELLOW CURRY SOUP; VEGETARIAN CHOP SUEY; CANNED WATER CHESTNUTS; CANNED WINTER BAMBOO SHOOTS; CANNED GRASS JELLY (U.S. CL. 46).

CLASS 30—STAPLE FOODS

FOR CHOW MEIN NOODLES; BLACK BEAN PASTE, BLACK BEAN SAUCE; BLACK GLUTINOUS RICE FLOUR; BROWN RICE VERMICELLI, BROWN SUGAR SLABS; CARROT NOODLE; CARROT RICE VERMICELLI; CHINA RICE VERMICELLI; CHUKA SOBA RAMEN; EXTRA HOT CHILI SAUCE; GLUTINOUS RICE FLOUR; STICKY, SWEET BLACK GLUTINOUS RICE; GREEN BEAN PASTE; GREEN TEA PASTE; FORTUNE COOKIES; HOISIN SAUCE; INSTANT LONGLIFE EGG NOODLE; JASMINE SCENTED, FRAGRANT RICE; JINJIANG RICE VINEGAR; KONGMOON RICE VERMICELLI; LOTUS SEED PASTE; LUNGKOW VERMICELLI, NAMELY, MUNG BEAN THREAD; MINCED GARLIC; MINCED GINGER; MINI CHOCOLATE ROLLS; MINI STRAWBERRY ROLLS; OYSTER SAUCE; PICKLED GINGER; PLUM SAUCE; PRUNE BEAN PASTE; RED BEAN PASTE; RED RICE; RICE FLOUR; RICE STICK NOODLES; ROCK SUGAR; SATAY SAUCE; SHANDONG LO MEIN; SHANGHAI NOODLES; SHORT GRAIN, STICKY, SWEET, GLUTINOUS RICE; SWEET AND SOUR CHILI SAUCE; SOY SAUCE; SPINACH NOODLE; SPINACH RICE VERMICELLI; SWEET AND SOUR SAUCE; SWEET SOY SAUCE; SWEET AND HOT GREEN MUSTARD; TAPIOCA STARCH FLOUR; TAPIOCA PEARLS; TEOCHEW CHILI PASTE; TERIYAKI SAUCE; THAI STICKY, SWEET GLUTINOUS RICE; UDON NOODLES; VEGETARIAN OYSTER SAUCE; WHITE RICE VINEGAR; WHITE SOMEN; RICE PAPER PASTA (U.S. CL. 46).

CLASS 32—LIGHT BEVERAGES

FOR COCONUT JUICE; COCONUT MILK (U.S. CLS. 45, 46 AND 48).
APRIL ROACH, EXAMINING ATTORNEY

SN 77-240,566. HEBREW HOME OF GREATER WASHINGTON, INC., ROCKVILLE, MD. FILED 7-27-2007.

LESSONS OF A LIFETIME: THE
ETHICAL WILL PROJECT OF
THE HEBREW HOME

THE MARK CONSISTS OF STANDARD CHARACTERS WITHOUT CLAIM TO ANY PARTICULAR FONT, STYLE, SIZE, OR COLOR.

NO CLAIM IS MADE TO THE EXCLUSIVE RIGHT TO USE "THE ETHICAL WILL PROJECT OF THE HEBREW HOME", APART FROM THE MARK AS SHOWN.

CLASS 35—ADVERTISING AND BUSINESS

FOR ADMINISTRATION OF CULTURAL AND EDUCATIONAL PROGRAMS IN THE FIELD OF ETHICAL WILLS (U.S. CLS. 100, 101 AND 102).
FIRST USE 7-5-2007; IN COMMERCE 7-5-2007.

CLASS 41—EDUCATION AND ENTERTAINMENT

FOR TRAINING OTHERS TO CONDUCT AND RECORD ETHICAL WILLS; CUSTOM WRITING SERVICES, NAMELY, ASSISTING INDIVIDUALS TO PREPARE AND PRESERVE PERSONAL HISTORY NARRATIVES, NAMELY, ETHICAL WILLS, THROUGH INTERVIEWS AND RECORDING THE RESPONSES; AND EDUCATIONAL RESEARCH REGARDING ETHICAL WILLS (U.S. CLS. 100, 101 AND 107).

FIRST USE 7-5-2007; IN COMMERCE 7-5-2007.
PRISCILLA MILTON, EXAMINING ATTORNEY

SN 77-240,719. VB VENTURES PTY LTD, FORTITUDE VALLEY, AUSTRALIA, FILED 7-27-2007.



PRIORITY CLAIMED UNDER SEC. 44(D) ON AUSTRALIA APPLICATION NO. 1174562, FILED 5-4-2007, REG. NO. 1174562, DATED 5-4-2007, EXPIRES 5-4-2017.

CLASS 35—ADVERTISING AND BUSINESS

FOR BUSINESS MANAGEMENT AND SUPERVISION IN RELATION TO LOYALTY PROGRAMS OR INCENTIVE SCHEMES; BUSINESS MANAGEMENT AND CONSULTATION IN THE FIELD OF THE SUPPLY OF REDEEMABLE VOUCHERS, CASH VOUCHERS, TRAVEL VOUCHERS, DISCOUNT VOUCHERS, REDEEMABLE COUPONS, LOYALTY CARDS, STORED VALUE CARDS, DISCOUNT CARDS, LOYALTY AWARD POINTS OR MILEAGE POINTS IN CONNECTION WITH LOYALTY PROGRAMS OR INCENTIVE SCHEMES THAT RELATE TO PRODUCTS OR SERVICES SUPPLIED BY OTHERS (U.S. CLS. 100, 101 AND 102).

CLASS 36—INSURANCE AND FINANCIAL

FOR FINANCIAL SERVICES ASSOCIATED WITH LOYALTY PROGRAMS OR INCENTIVE SCHEMES, NAMELY, ISSUANCE OF TOKENS OF VALUE, VOUCHERS OR POINTS ACCUMULATED THROUGH THE USE OF CREDIT CARDS AND DEBIT CARDS FOR TRANSPORTATION SERVICES, ENTERTAINMENT, SPORTING OR CULTURAL ACTIVITIES, AND FOOD, BEVERAGE OR ACCOMMODATION SERVICES (U.S. CLS. 100, 101 AND 102).

CLASS 39—TRANSPORTATION AND STORAGE

FOR TRANSPORTATION AND TRAVEL SERVICES IN RELATION TO AIR, ROAD, RAIL AND SEA TRANSPORT, NAMELY, PRIORITY BOARDING FOR PASSENGERS, PRIORITY CHECK-IN SERVICES FOR PASSENGERS, PRIORITY CHECK-IN SERVICES FOR BAGGAGE, SEATING RESERVATION SERVICES AND BAGGAGE RESERVATION SERVICES; CHAUFFEUR SERVICES; PROVIDING DRIVER AND PARKING VALET SERVICES; PROVIDING VEHICLE PARKING FACILITIES; PROVISION OF TRANSPORTATION SERVICES AND TRAVEL ARRANGEMENT SERVICES IN RELATION TO AIR, ROAD, RAIL AND SEA TRANSPORT VIA REDEMPTION OF REWARDS FROM LOYALTY PROGRAMS OR INCENTIVE SCHEMES; TRANSPORT SERVICES AND TRAVEL ARRANGEMENT SERVICES IN RELATION TO AIR, ROAD, RAIL AND SEA TRANSPORT, WITH A LOYALTY PROGRAM OR INCENTIVE PROGRAM INVOLVING REWARDS, IN THE NATURE OF LOYALTY AWARD POINTS OR MILEAGE POINTS (U.S. CLS. 100 AND 105).

CLASS 41—EDUCATION AND ENTERTAINMENT

FOR PROVISION OF ENTERTAINMENT, SPORTING AND CULTURAL ACTIVITIES IN THE NATURE OF MUSIC CONCERTS, EDUCATIONAL CONVENTIONS AND ATHLETIC COMPETITIONS VIA REDEMPTION OF REWARDS FROM LOYALTY PROGRAMS OR INCENTIVE SCHEMES; ENTERTAINMENT, SPORTING AND CULTURAL ACTIVITIES IN THE NATURE OF LIVE MUSIC CONCERTS, EDUCATIONAL CONVENTIONS AND ATHLETIC COMPETITIONS WITH A LOYALTY PROGRAM OR INCENTIVE PROGRAM INVOLVING REWARDS IN THE NATURE OF LOYALTY AWARD POINTS; TICKET RESERVATION AND BOOKING SERVICES FOR ENTERTAINMENT EVENTS AND PACKAGES (U.S. CLS. 100, 101 AND 107).

CLASS 43—HOTEL AND RESTAURANT SERVICES

FOR PROVISION OF FOOD, BEVERAGE OR TEMPORARY ACCOMMODATION SERVICES VIA REDEMPTION OF REWARDS FROM LOYALTY PROGRAMS OR INCENTIVE SCHEMES; PROVISION OF FOOD, BEVERAGE OR TEMPORARY ACCOMMODATION SERVICES FOR TRAVELLERS' RELAXATION, NAMELY, PASSENGER LOUNGE FACILITIES, VIA REDEMPTION OF REWARDS FROM LOYALTY PROGRAMS OR INCENTIVE SCHEMES; PROVISION OF FOOD, BEVERAGE AND TEMPORARY ACCOMMODATIONS, WITH A LOYALTY PROGRAM OR INCENTIVE PROGRAM INVOLVING REWARDS, IN THE NATURE OF LOYALTY AWARD POINTS (U.S. CLS. 100 AND 101).

STEVEN R. FINE, EXAMINING ATTORNEY

CLASS 36—INSURANCE AND FINANCIAL

FOR FINANCIAL SERVICES ASSOCIATED WITH LOYALTY PROGRAMS OR INCENTIVE SCHEMES, NAMELY, ISSUANCE OF TOKENS OF VALUE, VOUCHERS OR POINTS ACCUMULATED THROUGH THE USE OF CREDIT CARDS AND DEBIT CARDS FOR TRANSPORTATION SERVICES, ENTERTAINMENT, SPORTING OR CULTURAL ACTIVITIES, AND FOOD, BEVERAGE OR ACCOMMODATION SERVICES (U.S. CLS. 100, 101 AND 102).

CLASS 39—TRANSPORTATION AND STORAGE

FOR TRANSPORTATION AND TRAVEL SERVICES IN RELATION TO AIR, ROAD, RAIL AND SEA TRANSPORT, NAMELY, PRIORITY BOARDING FOR PASSENGERS, PRIORITY CHECK-IN SERVICES FOR PASSENGERS, PRIORITY CHECK-IN SERVICES FOR BAGGAGE, SEATING RESERVATION SERVICES AND BAGGAGE RESERVATION SERVICES; CHAUFFEUR SERVICES; PROVIDING DRIVER AND PARKING VALET SERVICES; PROVIDING VEHICLE PARKING FACILITIES; PROVISION OF TRANSPORTATION SERVICES AND TRAVEL ARRANGEMENT SERVICES IN RELATION TO AIR, ROAD, RAIL AND SEA TRANSPORT VIA REDEMPTION OF REWARDS FROM LOYALTY PROGRAMS OR INCENTIVE SCHEMES; TRANSPORT SERVICES AND TRAVEL ARRANGEMENT SERVICES IN RELATION TO AIR, ROAD, RAIL AND SEA TRANSPORT, WITH A LOYALTY PROGRAM OR INCENTIVE PROGRAM INVOLVING REWARDS, IN THE NATURE OF LOYALTY AWARD POINTS OR MILEAGE POINTS (U.S. CLS. 100 AND 105).

SN 77-240,740. VB VENTURES PTY LTD, FORTITUDE VALLEY, AUSTRALIA, FILED 7-27-2007.



PRIORITY CLAIMED UNDER SEC. 44(D) ON AUSTRALIA APPLICATION NO. 1174566, FILED 5-4-2007, REG. NO. 1174566, DATED 5-4-2007, EXPIRES 5-4-2017.

CLASS 35—ADVERTISING AND BUSINESS

FOR BUSINESS MANAGEMENT AND SUPERVISION IN RELATION TO LOYALTY PROGRAMS OR INCENTIVE SCHEMES; BUSINESS MANAGEMENT AND CONSULTATION IN THE FIELD OF THE SUPPLY OF REDEEMABLE VOUCHERS, CASH VOUCHERS, TRAVEL VOUCHERS, DISCOUNT VOUCHERS, REDEEMABLE COUPONS, LOYALTY CARDS, STORED VALUE CARDS, DISCOUNT CARDS, LOYALTY AWARD POINTS OR MILEAGE POINTS IN CONNECTION WITH LOYALTY PROGRAMS OR INCENTIVE SCHEMES THAT RELATE TO PRODUCTS OR SERVICES SUPPLIED BY OTHERS (U.S. CLS. 100, 101 AND 102).

CLASS 41—EDUCATION AND ENTERTAINMENT

FOR PROVISION OF ENTERTAINMENT, SPORTING AND CULTURAL ACTIVITIES IN THE NATURE OF MUSIC CONCERTS, EDUCATIONAL CONVENTIONS AND ATHLETIC COMPETITIONS VIA REDEMPTION OF REWARDS FROM LOYALTY PROGRAMS OR INCENTIVE SCHEMES; ENTERTAINMENT, SPORTING AND CULTURAL ACTIVITIES IN THE NATURE OF LIVE MUSIC CONCERTS, EDUCATIONAL CONVENTIONS AND ATHLETIC COMPETITIONS WITH A LOYALTY PROGRAM OR INCENTIVE PROGRAM INVOLVING REWARDS IN THE NATURE OF LOYALTY AWARD POINTS; TICKET RESERVATION AND BOOKING SERVICES FOR ENTERTAINMENT EVENTS AND PACKAGES (U.S. CLS. 100, 101 AND 107).

CLASS 43—HOTEL AND RESTAURANT SERVICES

FOR PROVISION OF FOOD, BEVERAGE OR TEMPORARY ACCOMMODATION SERVICES VIA REDEMPTION OF REWARDS FROM LOYALTY PROGRAMS OR INCENTIVE SCHEMES; PROVISION OF FOOD, BEVERAGE OR TEMPORARY ACCOMMODATION SERVICES FOR TRAVELLERS' RELAXATION, NAMELY, PASSENGER LOUNGE FACILITIES, VIA REDEMPTION OF REWARDS FROM LOYALTY PROGRAMS OR INCENTIVE SCHEMES; PROVISION OF FOOD, BEVERAGE AND TEMPORARY ACCOMMODATIONS, WITH A LOYALTY PROGRAM OR INCENTIVE PROGRAM INVOLVING REWARDS, IN THE NATURE OF LOYALTY AWARD POINTS (U.S. CLS. 100 AND 101).

STEVEN R. FINE, EXAMINING ATTORNEY

SN 77-248,823. THE VITEC GROUP PLC, SUFFOLK, UNITED KINGDOM, FILED 8-7-2007.

CAMERA DYNAMICS

THE MARK CONSISTS OF STANDARD CHARACTERS WITHOUT CLAIM TO ANY PARTICULAR FONT, STYLE, SIZE, OR COLOR.

PRIORITY CLAIMED UNDER SEC. 44(D) ON ERPN CMNTY TM OFC APPLICATION NO. 006116875, FILED 7-11-2007, REG. NO. 006116875, DATED 4-30-2008, EXPIRES 7-11-2017.

NO CLAIM IS MADE TO THE EXCLUSIVE RIGHT TO USE "CAMERA", APART FROM THE MARK AS SHOWN.

CLASS 9—ELECTRICAL AND SCIENTIFIC APPARATUS

FOR SOUND-ON-FILM RECORDING AND REPRODUCING APPARATUS, NAMELY, SOUND RECORDERS, AUDIO RECORDERS, LIVE-SOUND RECORDERS, SOUND EDITING EQUIPMENT, SOUND RECORDING SYSTEMS, SOUND MIXING EQUIPMENT; TELEVISION AND VIDEO SIGNAL PROCESSING APPARATUS AND INSTRUMENTS, NAMELY, RECEIVERS, TRANSMITTERS, AMPLIFIERS, WIRELESS RECEIVERS AND WIRELESS TRANSMITTERS; APPARATUS FOR USE IN THE TREATMENT OF CINEMATOGRAPHIC FILMS IN THE PROCESS OF PREPARING THEM FOR EXHIBITION; DATA PROCESSING EQUIPMENT; COMPUTER SOFTWARE FOR USE TO FACILITATE THE OPERATION OF THE PRIOR APPARATUS; COMPUTER HARDWARE; COMPUTER-BASED INTERCOMMUNICATION SYSTEMS CONSISTING OF BASE STATION(S) AND INDIVIDUAL REMOTE WIRED OR WIRELESS RECEIVER(S)/TRANSMITTER(S); COMPUTER CONTROLLED GUIDANCE APPARATUS AND INSTRUMENTS, NAMELY, COMPUTER CONTROLLED ROBOTIC CAMERAS, ROBOTIC PEDESTALS, ROBOTIC HEIGHT DRIVES, MECHANICAL, HYDRAULIC, CABLE BORNE, PNEUMATIC, GEARED, WORM DRIVE OR TRACTION ELEVATORS FOR USE WITH ROBOTIC CAMERAS; CINEMATOGRAPHIC CAMERAS, ROBOTIC CAMERAS, TELEVISION CAMERAS, VIDEO CAMERAS; CAMERA CONTROL APPARATUS; CAMERA HEADS, MOUNTING HEADS, PAN AND TILT HEADS; HEAD CONTROL UNITS; TELEVISION AND VIDEO CAMERA PEDESTALS; ROBOTIC PEDESTALS; HEIGHT DRIVES FOR USE WITH PEDESTALS; MECHANICAL, HYDRAULIC, CABLE BORNE, PNEUMATIC, GEARED, WORM DRIVE, OR TRACTION ELEVATORS FOR USE WITH CAMERAS; TRIPODS, MONOPODS, STANDS FOR PHOTOGRAPHIC EQUIPMENT, VIDEO AND/OR AUDIO EQUIPMENT, CAMERAS, MICROPHONES AND/OR LIGHTING APPARATUS, CAMERA DOLLIES; GROUND SPREADERS WITH AND WITHOUT ROLLERS FOR POSITIONALLY FIXING TRIPOD LEGS; FIXED, ADJUSTABLE, TELESCOPIC, MANUALLY OR POWER OPERATED SUPPORTS; PLATFORMS FOR PHOTOGRAPHIC EQUIPMENT, VIDEO AND/OR AUDIO EQUIPMENT, CAMERAS, MICROPHONES AND/OR LIGHTING APPARATUS; MICROPHONE BOOM POLES; QUICK-ACTION CLAMPING PLATES; TROLLEYS; PHOTOMETRIC DEVICES; VIDEO RECORDERS AND RECORDING APPARATUS, NAMELY, DATA RECORDERS, HARD DRIVE RECORDERS, DIGITAL DATA RECORDERS, MASTER RECORDERS, AND VISUAL DISPLAY UNITS; TELEPROMPTERS; SCRIPT PROMPTERS, STAND-ALONE SCRIPT PROMPTERS, WIRELESS SCRIPT PROMPTERS; BATTERIES, POWER SUPPLIES, BATTERY CHARGERS; CARRYING CASES FOR PHOTOGRAPHIC, BROADCASTING AND FILM EQUIPMENT; PARTS AND FITTINGS FOR ALL THE AFORESAID GOODS (U.S. CLS. 21, 23, 26, 36 AND 38).

CLASS 11—ENVIRONMENTAL CONTROL APPARATUS

FOR ILLUMINATION APPARATUS, NAMELY, SPOT-LIGHTS, LAMPS, LUMINAIRES, ON-CAMERA LIGHTS AND STUDIO LIGHTS; MANUALLY OR REMOTE CONTROLLED YOKES FOR ILLUMINATION APPARATUS, NAMELY, SPOTLIGHTS, LAMPS, LUMINAIRES, ON-CAMERA LIGHTS AND STUDIO LIGHTS; MANUALLY OR REMOTE CONTROLLED FLAPS FOR CONTROLLING THE LIGHT SCATTERING OF ILLUMINATION APPARATUS, NAMELY, SPOTLIGHTS, LAMPS, LUMINAIRES, ON-CAMERA LIGHTS AND STUDIO LIGHTS; TRIPODS AND STANDS FOR USE WITHIN ILLUMINATION APPARATUS, NAMELY, SPOTLIGHTS, LAMPS, LUMINAIRES, ON-CAMERA LIGHTS AND STUDIO LIGHTS; PARTS AND FITTINGS FOR ALL THE AFORESAID GOODS (U.S. CLS. 13, 21, 23, 31 AND 34).

CLASS 38—COMMUNICATION

FOR RENTAL OF BROADCAST AND TELECOMMUNICATIONS APPARATUS; RENTAL OF WIRED AND WIRELESS INTERCOMMUNICATION SYSTEMS, WIRELESS BROADCAST TRANSMISSION AND RECEPTION EQUIPMENT (U.S. CLS. 100, 101 AND 104).

CLASS 41—EDUCATION AND ENTERTAINMENT

FOR RENTAL OF CINEMATOGRAPHIC APPARATUS, TELEVISION APPARATUS, TELEVISION STUDIO APPARATUS; RENTAL OF ELECTRICAL AND ELECTRONIC APPARATUS, NAMELY, WIRELESS CAMERA SYSTEMS, WIRED AND WIRELESS CAMERA CONTROL SYSTEMS, AUDIO CONTROL SYSTEMS, LIGHTING CONTROL SYSTEMS, ROBOTIC CAMERA EQUIPMENT; RENTAL OF TELEPROMPTERS, SCRIPT PROMPTERS, STAND-ALONE SCRIPT PROMPTERS, WIRELESS SCRIPT PROMPTERS; RENTAL OF PHOTOGRAPHIC APPARATUS FOR RECORDING, TRANSMISSION OR REPRODUCTION OF SOUND OR IMAGES; RENTAL OF PARTS AND FITTINGS FOR ALL THE AFORESAID GOODS (U.S. CLS. 100, 101 AND 107).

CLASS 42—SCIENTIFIC AND COMPUTER SERVICES

FOR RENTAL OF COMPUTER HARDWARE (U.S. CLS. 100 AND 101).
GIANCARLO CASTRO, EXAMINING ATTORNEY

SN 77-254,672. HYDRO-RAIN, INC., NORTH SALT LAKE, UT. FILED 8-14-2007.

BUILT FOR SPEED

THE MARK CONSISTS OF STANDARD CHARACTERS WITHOUT CLAIM TO ANY PARTICULAR FONT, STYLE, SIZE, OR COLOR.

CLASS 9—ELECTRICAL AND SCIENTIFIC APPARATUS

FOR TIMERS AND TIMING DEVICES, NAMELY, PROGRAMMABLE AND ELECTRONIC TIMERS; MOISTURE MEASURING INSTRUMENTS, NAMELY, MOISTURE SENSORS; CONTROLLERS AND TIMERS FOR IRRIGATION AND SPRINKLER WATERING SYSTEMS; ANALOGUE AND DIGITAL CONTROL APPARATUS, NAMELY, CONTROLLERS FOR IRRIGATION VALVES; PARTS, FITTINGS AND ACCESSORIES THEREOF, NAMELY, DIALS, MANIFOLDS, BUTTONS, AND WIRES (U.S. CLS. 21, 23, 26, 36 AND 38).

CLASS 11—ENVIRONMENTAL CONTROL APPARATUS

FOR IRRIGATION SYSTEMS COMPRISING TIMERS, SPRINKLERS, AND VALVES USED FOR IRRIGATION; IRRIGATION FITTINGS, NAMELY, JOINTS, COUPLERS, AND TEES; IRRIGATION SPRINKLERS; IRRIGATION VALVES; IRRIGATION VALVE BOXES; LAWN WATERING SYSTEMS COMPRISING TIMERS, SPRINKLERS, VALVES, PIPES, AND VALVE BOXES; AND AGRICULTURAL INSTALLATIONS, NAMELY, TIMERS, SPRINKLERS, VALVES, PIPES, AND VALVE BOXES FOR RESIDENTIAL IRRIGATION; PARTS OF AND ACCESSORIES THEREOF, NAMELY, DRAINS, RISERS, CLAMPS, CAPS, AND WIRES FAUCETS; FAUCET SPRAYERS; IRRIGATION DEVICES, NAMELY, IRRIGATION SPRINKLERS (U.S. CLS. 13, 21, 23, 31 AND 34).

CLASS 17—RUBBER GOODS

FOR NON-METAL SOAKER HOSES AND COUPLINGS FOR IRRIGATION USE; IRRIGATION SPRAY NOZZLES; PARTS AND ACCESSORIES, NAMELY, NON-METAL MANIFOLDS AND CONNECTORS USED FOR CONNECTION/COUPLING WITH HOSES; REPAIR KITS COMPRISED OF NON-METAL HOSE COLLARS AND HOSE MENDERS (U.S. CLS. 1, 5, 12, 13, 35 AND 50).

CLASS 21—HOUSEWARES AND GLASS

FOR WATERING DEVICES, NAMELY, LAWN SPRINKLERS; HOSE NOZZLES AND SPOUTS FOR HOSE PIPES; LAWN SPRINKLERS; WATERING CANS; SPRAY GUNS FOR WATERING; FLEXIBLE PLASTIC RISERS (U.S. CLS. 2, 13, 23, 29, 30, 33, 40 AND 50).
KEVON CHISOLM, EXAMINING ATTORNEY

SN 77-260,610. ORGANICE SOFTWARE-GMBH, 12165 BERLIN, FED REP GERMANY, FILED 8-21-2007.

CLASS 9—ELECTRICAL AND SCIENTIFIC APPARATUS

FOR COMPUTER PROGRAMS FOR USE IN CREATING DATABASES, FOR DATABASE MANAGEMENT, FOR DATABASE MANAGEMENT IN THE FIELD OF CUSTOMER RELATIONSHIP MANAGEMENT (CRM), FOR DOCUMENT MANAGEMENT (DMS), FOR ENTERPRISE CONTENT MANAGEMENT (ECM), AND FOR COMPUTER TELEPHONY INTEGRATION (CTI); COMPUTER PROGRAMS FOR USE IN PROJECT MANAGEMENT, POSTAL DELIVERY MANAGEMENT, PERSONAL FINANCE MANAGEMENT; COMPUTER PROGRAMS FOR USE AS A SPREAD SHEET AND WORD PROCESSING; COMPUTER PROGRAMS FOR COMMUNICATION, NAMELY, CONNECTING COMPUTER NETWORK USERS AND GLOBAL COMPUTER NETWORKS, FOR CRYPTOGRAPHY, FOR CREATING DIGITAL SIGNATURE, FOR COST MANAGEMENT, FOR USE AS COST CALCULATORS; COMPUTER PROGRAMS FOR USE AS SOFTWARE DEVELOPMENT TOOL; COMPUTER PROGRAMS FOR USE IN INTERFACE, VIEWER AND OPTICAL CHARACTER RECOGNITION; COMPUTER PROGRAMS FOR USE IN IMAGING AND ARCHIVING DOCUMENTS; INSTRUCTIONAL COMPUTER MANUAL PROGRAMS SOLD WITH THE COMPUTER PROGRAM AS A UNIT (U.S. CLS. 21, 23, 26, 36 AND 38).

CLASS 16—PAPER GOODS AND PRINTED MATTER

FOR PRINTED COMPUTER MANUALS FOR COMPUTER PROGRAMS FOR USE IN DATABASES, DATABASE MANAGEMENT, CRM, DMS, ECM, CTI, FOR USE IN PROJECT MANAGEMENT, POSTAL MANAGEMENT, PERSONAL MANAGEMENT, FOR USE AS A SPREADSHEET, WORD PROCESSING, FOR USE IN COMMUNICATION, CRYPTOGRAPHY, DIGITAL SIGNATURE, COST MANAGEMENT, COST CALCULATORS, FOR USE AS SOFTWARE DEVELOPMENT TOOL, FOR USE IN INTERFACE, VIEWER AND OPTICAL CHARACTER RECOGNITION, AND FOR USE IN IMAGING AND ARCHIVING (U.S. CLS. 2, 5, 22, 23, 29, 37, 38 AND 50).
CHERYL CLAYTON, EXAMINING ATTORNEY

SN 77-268,862. APPLIED RESEARCH ASSOCIATES NZ LIMITED, CHRISTCHURCH, NEW ZEALAND, FILED 8-30-2007.

ORGANICE

SILHOUETTE

THE MARK CONSISTS OF STANDARD CHARACTERS WITHOUT CLAIM TO ANY PARTICULAR FONT, STYLE, SIZE, OR COLOR.

PRIORITY CLAIMED UNDER SEC. 44(D) ON ERP CMNTY TM OFC APPLICATION NO. 005723821, FILED 2-28-2007, REG. NO. 005723821, DATED 3-1-2008, EXPIRES 2-28-2017.

THE MARK CONSISTS OF STANDARD CHARACTERS WITHOUT CLAIM TO ANY PARTICULAR FONT, STYLE, SIZE, OR COLOR.

OWNER OF NEW ZEALAND REG. NO. 754708, DATED 8-2006, EXPIRES 9-8-2016.

CLASS 9—ELECTRICAL AND SCIENTIFIC APPARATUS

FOR COMPUTER HARDWARE FOR ENABLING THE IMAGING, MEASUREMENT, AND MODELING OF SURFACES BY RECORDING, ORGANIZING, TRANSMITTING, MANIPULATING, AND REVIEWING TEXT, DATA, IMAGE, GRAPHICS, AUDIO AND MULTIMEDIA FILES TAKEN OF SURFACES; COMPUTER PERIPHERAL DEVICES IN THE NATURE OF PORTABLE AND HANDHELD DIGITAL ELECTRONIC DEVICES THAT MAY ATTACH AND DETACH FROM COMPUTERS FOR STORING CAPTURED IMAGES AND SURFACE MODELS AND MEDIA RELATING TO THE IMAGING, MODELING, AND DOCUMENTING OF SURFACES; COMPUTER SOFTWARE FOR ENABLING THE IMAGING, MEASUREMENT, AND MODELING OF SURFACES BY RECORDING, ORGANIZING, TRANSMITTING, MANIPULATING, AND REVIEWING TEXT, DATA, IMAGE, GRAPHICS, AUDIO AND MULTIMEDIA FILES TAKEN OF SURFACES; COMPUTER HARDWARE AND COMPUTER PERIPHERAL DEVICES IN THE NATURE OF PORTABLE AND HANDHELD DIGITAL ELECTRONIC DEVICES THAT MAY ATTACH AND DETACH FROM COMPUTERS, ALL FOR MEDICAL USE, FOR THE CAPTURE, ANALYSIS AND STORAGE OF INFORMATION RELATING TO WOUNDS, DERMATOLOGICAL CONDITIONS, AND PATIENT PHYSIOLOGICAL INFORMATION, NAMELY, FOR RECORDING, ORGANIZING, TRANSMITTING, MANIPULATING, AND REVIEWING TEXT, DATA, IMAGE, GRAPHICS, AUDIO AND MULTIMEDIA FILES RELATING TO THE STATUS OF WOUNDS, DERMATOLOGICAL CONDITIONS, AND PATIENT PHYSIOLOGICAL INFORMATION (U.S. CLS. 21, 23, 26, 36 AND 38).

CLASS 10—MEDICAL APPARATUS

FOR APPARATUS FOR USE IN THE DIAGNOSIS AND TREATMENT OF WOUNDS, DERMATOLOGICAL CONDITIONS, AND PATIENT PHYSIOLOGICAL CONDITIONS, NAMELY, FOR IMAGING EXPOSED WOUND AND SKIN SURFACES ENABLING COMPUTER MODELING AND MEASUREMENT OF WOUNDS, DERMATOLOGICAL CONDITIONS AND PATIENT PHYSIOLOGICAL CONDITIONS (U.S. CLS. 26, 39 AND 44).

LYDIA BELZER, EXAMINING ATTORNEY

SN 77-276,215. RECKITT BENCKISER INC., PARSIPPANY, NJ. FILED 9-11-2007.

SPREADING HEALTH

THE MARK CONSISTS OF STANDARD CHARACTERS WITHOUT CLAIM TO ANY PARTICULAR FONT, STYLE, SIZE, OR COLOR.

OWNER OF ERPN CMNTY TM OFC REG. NO. 6258693, DATED 8-8-2008, EXPIRES 9-6-2017.

CLASS 3—COSMETICS AND CLEANING PREPARATIONS

FOR ALL PURPOSE TOILET AND BATHROOM CLEANING PREPARATIONS; ANTIBACTERIAL SOAPS; SOAPS FOR PERSONAL USE; HAND CLEANING PREPARATIONS; NON-MEDICATED HANDWASHES IN THE NATURE OF SOAPS; LIQUID SOAPS FOR HANDS, FACE AND BODY; WIPES AND TISSUES IMPREGNATED WITH CLEANING PREPARATIONS; GENERAL PURPOSE CLEANERS WITH DISINFECTING PROPERTIES FOR CLEANING (U.S. CLS. 1, 4, 6, 50, 51 AND 52).

CLASS 5—PHARMACEUTICALS

FOR ALL PURPOSE DISINFECTING AND DEODORIZING PREPARATIONS; ALL-PURPOSE DISINFECTANT SPRAY; ANTI-BACTERIAL CLEANERS; SANITIZING PREPARATIONS FOR HOUSEHOLD, COMMERCIAL, INDUSTRIAL AND INSTITUTIONAL USE; HAND SANITIZING PREPARATIONS; ANTIBACTERIAL CLEANERS; ANTIBACTERIAL HANDWASH; ANTIBACTERIAL BARRIER CREAMS, LOTIONS AND GELS FOR THE SKIN TO PROVIDE A PROTECTIVE BARRIER AGAINST GERMS, DIRT AND CHEMICALS; ANTIBACTERIAL HAND LOTIONS, CREAMS AND GELS; ANTIBACTERIAL SKIN PROTECTION LOTIONS, CREAMS AND GELS; GERMICIDES; DEODORIZERS AND SANITIZERS FOR BATHROOMS AND TOILETS; WIPES AND TISSUES IMPREGNATED WITH DISINFECTING PREPARATIONS (U.S. CLS. 6, 18, 44, 46, 51 AND 52).

CHRISTINE COOPER, EXAMINING ATTORNEY

SN 77-276,401. FORT KNOCKS LIMITED, SANTA BARBARA, CA. FILED 9-11-2007.

KNOCK ON WOOD

THE MARK CONSISTS OF STANDARD CHARACTERS WITHOUT CLAIM TO ANY PARTICULAR FONT, STYLE, SIZE, OR COLOR.

OWNER OF U.S. REG. NO. 2,714,686.

CLASS 16—PAPER GOODS AND PRINTED MATTER

FOR PAPER GOODS, NAMELY, GREETING CARDS (U.S. CLS. 2, 5, 22, 23, 29, 37, 38 AND 50).

CLASS 20—FURNITURE AND ARTICLES NOT OTHERWISE CLASSIFIED

FOR NOVELTY GIFT ITEMS, NAMELY, DECORATIVELY PACKAGED GOOD LUCK CHARMS (U.S. CLS. 2, 13, 22, 25, 32 AND 50).

MARCIE MILONE, EXAMINING ATTORNEY

SN 77-278,630. IPEX CAPITAL MANAGEMENT LIMITED LIABILITY PARTNERSHIP, LONDON, UNITED KINGDOM, FILED 9-13-2007.

IPEX CAPITAL

THE MARK CONSISTS OF STANDARD CHARACTERS WITHOUT CLAIM TO ANY PARTICULAR FONT, STYLE, SIZE, OR COLOR.

PRIORITY CLAIMED UNDER SEC. 44(D) ON UNITED KINGDOM APPLICATION NO. 6252035, FILED 9-4-2007, REG. NO. 006252035, DATED 2-9-2009, EXPIRES 9-4-2017.

NO CLAIM IS MADE TO THE EXCLUSIVE RIGHT TO USE "CAPITAL", APART FROM THE MARK AS SHOWN.

CLASS 35—ADVERTISING AND BUSINESS

FOR BUSINESS MANAGEMENT AND ORGANIZATION ADVISORY AND CONSULTANCY SERVICES; BUSINESS DEVELOPMENT SERVICES, NAMELY, PROVIDING START-UP AND EARLY STAGE SUPPORT FOR BUSINESSES OF OTHERS; BUSINESS MANAGEMENT CONSULTING SERVICES AND BUSINESS ORGANIZATION CONSULTING SERVICES; PROVISION OF BUSINESS INFORMATION (U.S. CLS. 100, 101 AND 102).

CLASS 36—INSURANCE AND FINANCIAL

FOR VENTURE CAPITAL SERVICES, NAMELY, PROVIDING FINANCING AND FUNDRAISING TO EMERGING AND START-UP COMPANIES, AND ADVISORY AND CONSULTANCY SERVICES PROVIDED THEREWITH; INVESTMENT FUND SERVICES AND ADVISORY AND CONSULTANCY SERVICES PROVIDED THEREWITH; PROVISION OF FINANCIAL INFORMATION, AND ADVISORY AND CONSULTANCY SERVICES PROVIDED THEREWITH; FINANCIAL MANAGEMENT SERVICES AND FINANCIAL CONSULTING SERVICES, AND ADVISORY AND CONSULTANCY SERVICES PROVIDED THEREWITH; INVESTMENT MANAGEMENT SERVICES, AND ADVISORY AND CONSULTANCY SERVICES PROVIDED THEREWITH (U.S. CLS. 100, 101 AND 102).

STEPHANIE ALI, EXAMINING ATTORNEY

SN 77-281,335. BUCCELLATI HOLDING ITALIA SPA, MILAN, ITALY, FILED 9-17-2007.

BUCCELLATI

THE MARK CONSISTS OF STANDARD CHARACTERS WITHOUT CLAIM TO ANY PARTICULAR FONT, STYLE, SIZE, OR COLOR.

OWNER OF ITALY REG. NO. 492707, DATED 4-27-1988, RENEWED AS REG. NO. 812323, DATED 10-26-2007, EXPIRES 11-5-2017.

OWNER OF U.S. REG. NOS. 838,777, 2,156,171 AND OTHERS.
SEC. 2(F).

CLASS 3—COSMETICS AND CLEANING PREPARATIONS

FOR PERFUMES, COSMETICS, ESSENTIAL OILS, HAIR LOTIONS AND SOAPS (U.S. CLS. 1, 4, 6, 50, 51 AND 52).

CLASS 8—HAND TOOLS

FOR CUTLERY, NAMELY, FORKS, SPOONS, AND KNIVES (U.S. CLS. 23, 28 AND 44).

CLASS 9—ELECTRICAL AND SCIENTIFIC APPARATUS

FOR EYEWEAR AND COMPONENT PARTS THEREOF (U.S. CLS. 21, 23, 26, 36 AND 38).

CLASS 16—PAPER GOODS AND PRINTED MATTER

FOR PENS AND OTHER WRITING INSTRUMENTS; LEATHER AND IMITATIONS OF LEATHER CHECKBOOK HOLDERS (U.S. CLS. 2, 5, 22, 23, 29, 37, 38 AND 50).

CLASS 18—LEATHER GOODS

FOR LEATHER AND IMITATIONS OF LEATHER, AND GOODS MADE OF THESE MATERIALS AND NOT INCLUDED IN OTHER CLASSES, NAMELY, TRUNKS, HAT BOXES FOR TRAVEL, CLUTCH BAGS, BRIEFCASES, WALLETS, POCKET WALLETS, CREDIT CARD CASES, BUSINESS CARD CASES, KEY CASES AND CHANGE PURSES, BILL HOLDERS, NAMELY, POCKET WALLETS; TRAVELING TRUNKS; TRAVELING BAGS, NAMELY, SUITCASES; TRAVELING BAGS; TRAVELING BAGS, NAMELY, LUGGAGE; TRAVELING BAGS, NAMELY, GARMENT BAGS FOR TRAVEL; BRIEFCASE-TYPE PORTFOLIOS; UMBRELLAS; ANIMAL CARRIERS RUCKSACKS, HAVERSACKS, LEATHER OR TEXTILE SHOPPING BAGS; BEACH BAGS; HANDBAGS; VANITY CASES USED AS TRAVELING BAGS SOLD EMPTY; TOTE BAGS AND TRAVEL SATCHELS; UMBRELLAS AND PARASOLS (U.S. CLS. 1, 2, 3, 22 AND 41).

CLASS 20—FURNITURE AND ARTICLES NOT OTHERWISE CLASSIFIED

FOR PICTURE FRAMES MADE OF WOOD, CORK, REED, CANE, WICKER, HORN, BONE, IVORY, WHALEBONE, SHELL, AMBER, MOTHER-OF-PEARL, MEERSCHAUM AND SUBSTITUTES FOR ALL THESE MATERIALS OR OF PLASTIC (U.S. CLS. 2, 13, 22, 25, 32 AND 50).

FIRST USE 1-0-1952; IN COMMERCE 1-0-1952.

CLASS 21—HOUSEWARES AND GLASS

FOR HOUSEHOLD OR KITCHEN UTENSILS NOT OF PRECIOUS METAL OR COATED THEREWITH, NAMELY, SPATULAS, WHISKS; CONTAINERS NOT OF PRECIOUS METAL OR COATED THEREWITH FOR HOUSEHOLD OR KITCHEN USE; GLASSWARE NOT INCLUDED IN OTHER CLASSES, NAMELY, BEVERAGE GLASSWARE, PORCELAIN NOT INCLUDED IN OTHER CLASSES, NAMELY, ORNAMENTS OF PORCELAIN; EARTHENWARE NOT INCLUDED IN OTHER CLASSES, NAMELY, JARS FOR JAMS AND JELLIES OF EARTHENWARE; DISHES; SERVING DISHES (U.S. CLS. 2, 13, 23, 29, 30, 33, 40 AND 50).

CLASS 24—FABRICS

FOR TEXTILES GOODS NOT INCLUDED IN OTHER CLASSES, NAMELY, TABLECLOTHS, DISH CLOTHS, TABLE NAPKINS OF TEXTILE, FACE TOWELS OF TEXTILE, AND FEATHER BED (U.S. CLS. 42 AND 50).

CLASS 25—CLOTHING

FOR CLOTHING, NAMELY, SHIRTS, PANTS, BELTS AND DRESSING GOWNS; HEADGEAR, NAMELY, HATS; FOOTWEAR, NAMELY, SHOES (U.S. CLS. 22 AND 39).

CLASS 34—SMOKERS' ARTICLES

FOR SMOKERS ARTICLES, NAMELY, ASHTRAYS, CIGARETTE CASES, LIGHTERS, MATCHES, STORAGE CASES FOR CIGARS, PIPE HOLDERS AND PIPES (U.S. CLS. 2, 8, 9 AND 17).

CLASS 35—ADVERTISING AND BUSINESS

FOR RETAIL STORE SERVICES AND ONLINE RETAIL STORE SERVICES FEATURING JEWELRY, WATCHES, PRECIOUS METALS AND GOODS MADE OF PRECIOUS METALS, PRECIOUS STONES, COSMETICS, PERFUMERY, HAIR CARE PREPARATIONS, CUTLERY, EYEWEAR, PAPER GOODS, PRINTED MATTER, WRITING INSTRUMENTS, LEATHER GOODS AND IMITATION OF LEATHER GOODS, FURNITURE, HOUSEHOLD AND KITCHEN UTENSILS, TEXTILE FABRICS AND TEXTILE GOODS, CLOTHING, FOOTWEAR, HEADWEAR, AND SMOKER'S ARTICLES (U.S. CLS. 100, 101 AND 102).

FIRST USE 1-0-1952; IN COMMERCE 1-0-1952.

SAMUEL E. SHARPER JR., EXAMINING ATTORNEY

SN 77-298,201. HENRY PRODUCTIONS PARTNERSHIP,
LOUISVILLE, KY. FILED 10-8-2007.

SN 77-292,587. COHERENT LOGIC LIMITED, LONDON,
UNITED KINGDOM, FILED 10-1-2007.

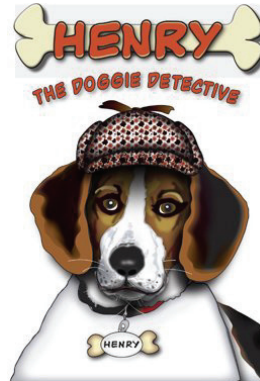

COHERENT LOGIC

THE MARK CONSISTS OF STANDARD CHARACTERS WITHOUT CLAIM TO ANY PARTICULAR FONT, STYLE, SIZE, OR COLOR.

PRIORITY CLAIMED UNDER SEC. 44(D) ON ERP N CMNTY TM OFC APPLICATION NO. 006184411, FILED 8-9-2007, REG. NO. 006184411, DATED 7-7-2008, EXPIRES 8-9-2017.

CLASS 9—ELECTRICAL AND SCIENTIFIC APPARATUS

FOR COMPUTER HARDWARE; COMPUTER SOFTWARE FOR DATABASE MANAGEMENT AND DATA INTEGRATION FOR USE IN THE FIELD OF SCIENTIFIC RESEARCH; COMPUTER SOFTWARE FOR BIOINFORMATICS AND INFORMATION MANAGEMENT, NAMELY, DATA ANALYSIS, DATA RETRIEVAL AND DATABASE MANAGEMENT IN THE FIELD OF LIFE SCIENCES RESEARCH (U.S. CLS. 21, 23, 26, 36 AND 38).

CLASS 35—ADVERTISING AND BUSINESS

FOR COMPILATION OF STATISTICS; PROVIDING STATISTICAL EVALUATIONS OF MARKET DATA; PROVIDING STATISTICAL INFORMATION FOR BUSINESS PURPOSES; COMPILING BUSINESS STATISTICS FOR OTHERS; STATISTICAL DATA COMPILING AND ANALYZING RELATING TO BUSINESS MANAGEMENT; INFORMATION AND CONSULTANCY SERVICES RELATING TO THE PREPARATION OF STATISTICS FOR BUSINESS PURPOSES (U.S. CLS. 100, 101 AND 102).

CLASS 42—SCIENTIFIC AND COMPUTER SERVICES

FOR STATISTICAL DATA-ACQUISITION AND COLLECTION FOR CALIBRATION AND COORDINATE-MEASUREMENT PURPOSES; SCIENTIFIC RESEARCH AND DESIGN FOR OTHERS IN THE FIELD OF COMPUTERS, LIFE SCIENCES AND STATISTICS; DESIGN AND DEVELOPMENT OF COMPUTER HARDWARE AND SOFTWARE; COMPILATION AND ANALYSIS OF STATISTICAL DATA FOR USE IN SCIENTIFIC RESEARCH; COMPILATION AND ANALYSIS OF STATISTICAL DATA RELATING TO MEDICAL RESEARCH; DEVELOPMENT AND CREATION OF COMPUTER PROGRAMS FOR DATA PROCESSING (U.S. CLS. 100 AND 101).

JAMES LOVELACE, EXAMINING ATTORNEY

THE COLOR(S) BROWN, BLACK, WHITE, RED, TAN, CREAM AND OFF-WHITE IS/ARE CLAIMED AS A FEATURE OF THE MARK.

THE MARK CONSISTS OF "HENRY" IN RED, INSIDE AN OUTLINE OF AN OFF-WHITE OR CREAM AND TAN COLORED DOG BONE, "THE DOGGIE DETECTIVE" CAPTIONED UNDERNEATH THE BONE IN RED, HENRY THE DOG FEATURED IN BROWN, BLACK AND WHITE, WITH A RED, BLACK AND WHITE CHECKED HAT ON HIS HEAD, RED COLLAR AROUND HIS NECK WITH A TAN AND CREAM COLORED BONE-SHAPED DOG TAG HANGING FROM THE COLLAR WITH THE WORD "HENRY" IN BLACK LETTERS AND WHITE BACKGROUND ON THE DOG TAG, AND A WHITE BACKGROUND.

CLASS 16—PAPER GOODS AND PRINTED MATTER

FOR CHILDREN'S BOOKS; CHILDREN'S STORYBOOKS (U.S. CLS. 2, 5, 22, 23, 29, 37, 38 AND 50).

CLASS 28—TOYS AND SPORTING GOODS

FOR TWO AND THREE DIMENSIONAL POSITIONABLE TOY FIGURES SOLD AS A UNIT WITH EDUCATIONAL BOOKS; PLUSH TOYS; STUFFED DOLLS AND ANIMALS; STUFFED TOY ANIMALS; STUFFED TOYS (U.S. CLS. 22, 23, 38 AND 50).

LINDSEY RUBIN, EXAMINING ATTORNEY

SN 77-300,998. MDIALOG CORPORATION, TORONTO, ONTARIO, CANADA, FILED 10-10-2007.



PRIORITY CLAIMED UNDER SEC. 44(D) ON CANADA APPLICATION NO. 1365281, FILED 9-26-2007.

PRIORITY CLAIMED UNDER SEC. 44(D) ON CANADA APPLICATION NO. 1365706, FILED 9-28-2007, REG. NO. TMA729305, DATED 11-24-2008, EXPIRES 11-24-2023.

THE MARK CONSISTS OF THE LETTER "M" IN AN IRREGULAR PARALLELOGRAM CONTAINED WITHIN A QUOTE BOX, FOLLOWED BY THE WORD "DIALOG".

CLASS 38—COMMUNICATION

FOR VIDEO BROADCASTING SERVICES FOR THE PURPOSE OF ELECTRONIC TRANSMISSION OF USER-GENERATED HIGH-RESOLUTION VIDEOS VIA INTERNET (U.S. CLS. 100, 101 AND 104).

SN 77-305,391. TIO NETWORKS CORPORATION, BURNABY, CANADA, FILED 10-16-2007.

CLASS 42—SCIENTIFIC AND COMPUTER SERVICES

FOR PROVIDING A WEBSITE FEATURING TEMPORARY USE OF NON-DOWNLOADABLE SOFTWARE ALLOWING WEBSITE USERS TO UPLOAD ONLINE VIDEOS FOR SHARING WITH OTHERS FOR ENTERTAINMENT PURPOSES; PROVIDING A WEBSITE THAT GIVES COMPUTER USERS THE ABILITY TO UPLOAD AND SHARE USER-GENERATED, HIGH RESOLUTION VIDEOS; PROVIDING INTERNET-BASED COMPUTER SEARCH ENGINES FOR OBTAINING USER-GENERATED, HIGH RESOLUTION VIDEOS (U.S. CLS. 100 AND 101).

KATINA MISTER, EXAMINING ATTORNEY



SN 77-302,441. MAGNA STEYR FAHRZEUGTECHNIK AG & CO KG, GRAZ, AUSTRIA, FILED 10-12-2007.

HYSUV

THE MARK CONSISTS OF STANDARD CHARACTERS WITHOUT CLAIM TO ANY PARTICULAR FONT, STYLE, SIZE, OR COLOR.

PRIORITY CLAIMED UNDER SEC. 44(D) ON AUSTRIA APPLICATION NO. AM2725/2007, FILED 4-12-2007, REG. NO. 239720, DATED 7-20-2007, EXPIRES 7-20-2017.

CLASS 12—VEHICLES

FOR LAND VEHICLES AND STRUCTURAL PARTS THEREFOR; APPARATUS FOR LOCOMOTION BY LAND, NAMELY, PASSENGER VEHICLES, OFF-ROAD VEHICLES (U.S. CLS. 19, 21, 23, 31, 35 AND 44).

CLASS 16—PAPER GOODS AND PRINTED MATTER

FOR PAPER, CARDBOARD AND GOODS MADE FROM THESE MATERIALS, NOT INCLUDED IN OTHER CLASSES, NAMELY, PRE-PRINTED WRITING PADS AND STATIONERY (U.S. CLS. 2, 5, 22, 23, 29, 37, 38 AND 50).

CLASS 25—CLOTHING

FOR CLOTHING, NAMELY, HATS, TEE SHIRTS, PULLOVERS, AND OUTER GARMENTS, NAMELY, JACKETS, SWEATERS, BASEBALL CAPS (U.S. CLS. 22 AND 39).

SARA THOMAS, EXAMINING ATTORNEY

OWNER OF U.S. REG. NO. 3,143,314.

THE COLOR(S) BLACK, WHITE, AND ORANGE IS/ARE CLAIMED AS A FEATURE OF THE MARK.

THE MARK CONSISTS OF A BLACK FIELD WITH THE WORD "MY" CENTERED THEREIN AND A CIRCULAR ORANGE FIELD WITH A WHITE BORDER AND THE WORD "TIO" CENTERED THEREIN. THE BLACK FIELD IS QUASI-RECTANGULAR WITH THE LEFT TOP AND BOTTOM CORNERS ROUNDED AND THE RIGHT SIDE FORMING A CONVEX CURVE PARTIALLY SURROUNDING THE LEFT HALF OF THE ORANGE CIRCLE. THE WORD "MY" IS WHITE IN LOWERCASE, SANS SERIF FONT. THE WORD "TIO" IS WHITE IN ITALIC, SANS SERIF CAPITAL LETTERS WITH ROUNDED ENDS. THERE IS A WHITE ACUTE ACCENT OVER THE "I" THAT APPEARS AS A BRUSH STROKE STARTING NARROWLY AND THICKENING UPWARD FROM LEFT TO RIGHT. THE GRAY BOX IS USED TO INDICATE BACKGROUND ONLY AND IS NOT CLAIMED AS A FEATURE OF THE MARK.

THE ENGLISH TRANSLATION OF THE WORD "TIO" IN THE MARK IS "UNCLE".

CLASS 35—ADVERTISING AND BUSINESS

FOR COMPUTER SERVICES, NAMELY, PROCESSING COUPONS AND REBATES; DEVELOPING PROMOTIONAL CAMPAIGNS FOR BUSINESSES; AND DATA PROCESSING SERVICES (U.S. CLS. 100, 101 AND 102).

CLASS 36—INSURANCE AND FINANCIAL

FOR COMPUTER SERVICES, NAMELY, PROVIDING SELF-SERVICE AND ASSISTED BILL PAYMENTS AND PREPAYMENTS ON-LINE AND VIA AUTOMATED KIOSKS; FINANCIAL E-SERVICES, NAMELY, AUTOMATED CASH AND COIN COUNTING, SORTING AND CONVERTING SERVICES, BANKING SERVICES, NAMELY, CASH DISPENSING, MONEY TRANSFERRING, CHECK CASHING, AND PREPAID CREDIT CARD REVALUING; MONEY ORDER SERVICES, NAMELY, MONEY ORDER DISPENSING AND REDEMPTION; ELECTRONIC PAYMENT, NAMELY, ELECTRONIC PROCESSING AND TRANSMISSION OF BILL PAYMENT DATA; BILL PAYMENT SERVICES; PROVIDING REBATE REDEMPTION FOR PARTICIPATING ESTABLISHMENTS OF OTHERS; ISSUING CREDIT CARDS; CREDIT AND CASH CARD SERVICES; CREDIT CARD TRANSACTION PROCESSING; AND PROVIDING ELECTRONIC PROCESSING OF ELECTRONIC FUNDS TRANSFER, AUTOMATED CLEARING-HOUSE (ACH), CREDIT CARD, DEBIT CARD, ELECTRONIC CHECK, AND ELECTRONIC PAYMENTS (U.S. CLS. 100, 101 AND 102).

SANI KHOURI, EXAMINING ATTORNEY

SN 77-311,252. GRAPE TECHNOLOGY GROUP, INC., BETHLEHEM, PA. FILED 10-23-2007.

M8

THE MARK CONSISTS OF STANDARD CHARACTERS WITHOUT CLAIM TO ANY PARTICULAR FONT, STYLE, SIZE, OR COLOR.

CLASS 35—ADVERTISING AND BUSINESS

FOR TELEPHONE DIRECTORY ASSISTANCE SERVICES, NAMELY, PROVIDING TELEPHONE NUMBERS, FACSIMILE NUMBERS, NAMES AND ADDRESSES; PROVIDING AN ONLINE COMMERCIAL INFORMATION DIRECTORY ON THE INTERNET; TELEPHONE DIRECTORY ASSISTANCE SERVICES DELIVERED OVER THE TELEPHONE AND ONLINE; PROVIDING ONLINE ENHANCED DIRECTORY INFORMATION SERVICES ALSO FEATURING HYPERLINKS TO OTHER WEB SITES; TELEPHONE AND COMMERCIAL INFORMATION DIRECTORY SERVICES PROVIDED VIA ONLINE, MOBILE AND WIRELESS ELECTRONIC MEDIA; ENHANCED COMMERCIAL INFORMATION DIRECTORY ASSISTANCE SERVICE, NAMELY, PROVIDING ONLINE, MOBILE AND WIRELESS TELEPHONE SERVICES WHICH DIRECT THE USER THROUGH HYPERTEXT LINKS TO THE WEB SITES OF OTHERS; PROMOTING THE GOODS AND SERVICES OF OTHERS THROUGH ONLINE, MOBILE AND WIRELESS PHONE SERVICES BY PROVIDING HYPERLINKS TO THE WEB SITES OF OTHERS; TELEPHONE OPERATOR SERVICES (U.S. CLS. 100, 101 AND 102).

CLASS 45—PERSONAL AND LEGAL SERVICES

FOR PERSONAL CONCIERGE SERVICES FOR OTHERS COMPRISING MAKING REQUESTED PERSONAL ARRANGEMENTS AND RESERVATIONS, RUNNING ERRANDS AND PROVIDING CUSTOMER SPECIFIC INFORMATION TO MEET INDIVIDUAL NEEDS, ALL RENDERED IN BUSINESS ESTABLISHMENTS, OFFICE BUILDINGS, HOTELS, RESIDENTIAL COMPLEXES AND HOMES (U.S. CLS. 100 AND 101).
STEVEN PEREZ, EXAMINING ATTORNEY

SN 77-312,170. XCONNECT GLOBAL NETWORKS LIMITED, LONDON, UNITED KINGDOM, FILED 10-24-2007.

XCONNECT

THE MARK CONSISTS OF STANDARD CHARACTERS WITHOUT CLAIM TO ANY PARTICULAR FONT, STYLE, SIZE, OR COLOR.

CLASS 9—ELECTRICAL AND SCIENTIFIC APPARATUS

FOR ELECTRICAL AND ELECTRONIC APPARATUS, NAMELY, ELECTRONIC CIRCUITS, ELECTRONIC CODING UNITS, ELECTRONIC CIRCUIT BOARDS FOR VOICE AND VIDEO OVER INTERNET PROTOCOL (VOIP); DVDS AND CD ROMS FEATURING DATA AND PROGRAMS; TELECOMMUNICATIONS APPARATUS AND INSTRUMENTS, NAMELY, TELEPHONES, TELECOMMUNICATION CABLES, TELECOMMUNICATION EXCHANGERS, PORTABLE TELECOMMUNICATION INSTANT MESSAGING DEVICES, MODEMS, ADSL DEVICES, NAMELY, ADSL MODEMS, SPLITTERS AND MICROFILTERS; ISDN DEVICES, NAMELY, ISDN TELEPHONE EXCHANGES, TELEPHONES, MODEMS AND ROUTERS; VOIP APPARATUS, NAMELY, VOIP TELEPHONE EXCHANGES, TELEPHONES, MODEMS, AND ROUTERS; CALCULATING MACHINES, DATA PROCESSING EQUIPMENT AND COMPUTERS; COMPUTERS; COMPUTER HARDWARE; COMPUTER HARDWARE AND SOFTWARE FOR TRANSMISSION OF VOICE AND VIDEO OVER INTERNET PROTOCOL (VOIP); PARTS AND FITTINGS FOR ALL THE AFORESAID (U.S. CLS. 21, 23, 26, 36 AND 38).

CLASS 38—COMMUNICATION

FOR TELECOMMUNICATIONS, NAMELY, TELECOMMUNICATIONS ACCESS SERVICES, TRANSMISSION OF WEB CASTS, WIRELESS TELEPHONE SERVICES; TELECOMMUNICATION SERVICES OVER THE INTERNET, NAMELY, VOICE OVER INTERNET PROTOCOL (VOIP); CELLULAR TELEPHONE COMMUNICATION; COMMUNICATION BY COMPUTER TERMINALS; INFORMATION ABOUT TELECOMMUNICATIONS TRANSMISSION, ELECTRONIC DATA TRANSMISSION SERVICES; PROVISION OF VOICE AND VIDEO OVER INTERNET PROTOCOL (VOIP), PEER-TO-PEER COMMUNICATIONS BY WAY OF VOIP; PROVISION OF TELECOMMUNICATIONS CONNECTIONS TO A GLOBAL COMPUTER NETWORK; PROVISION OF ACCESS TO DATABASES; PROVISION OF USER ACCESS TO A GLOBAL COMPUTER NETWORK; PROVIDING ONLINE COMMUNICATIONS LINKS WHICH TRANSFER THE WEBSITE USE TO OTHER LOCAL AND GLOBAL WEB PAGES; PROVISION OF HIGH SPEED TO AREA NETWORKS AND A GLOBAL COMPUTER INFORMATION NETWORK; COMPUTER-AIDED TRANSMISSION OF DATA, MESSAGES AND IMAGES; CABLE, RADIO OR TELEVISION BROADCASTING; ADVISORY, CONSULTANCY AND INFORMATION RELATING TO ALL THE AFORESAID (U.S. CLS. 100, 101 AND 104).

CLASS 42—SCIENTIFIC AND COMPUTER SERVICES

FOR DESIGN AND DEVELOPMENT OF COMPUTER HARDWARE AND SOFTWARE; COMPUTER PROGRAMMING; COMPUTER HARDWARE AND SOFTWARE CONSULTANCY AND DESIGN; INFORMATION ABOUT COMPUTERS PROVIDED ONLINE FROM A COMPUTER DATABASE OR VIA THE INTERNET; HOSTING WEBSITES; CREATING, DESIGNING, AND MAINTAINING WEBSITES; INSTALLATION, RENTAL AND MAINTENANCE OF COMPUTER SOFTWARE; COMPUTER HARDWARE AND SOFTWARE SERVICES RELATING TO TELECOMMUNICATIONS, VOICE OR VIDEO OVER INTERNET PROTOCOL (VOIP) APPLICATIONS; CREATING AND MAINTAINING WEBSITES FOR OTHERS; HOSTING WEBSITES OF OTHERS ON A COMPUTER SERVER FOR A GLOBAL COMPUTER NETWORK; INSTALLATION AND MAINTENANCE OF COMPUTER SOFTWARE; PROVIDING TEMPORARY USE OF ONLINE, NON-DOWNLOADABLE COMPUTER SOFTWARE THAT ALLOW SUBSCRIBERS TO UTILIZE VOIP COMMUNICATION SERVICES; ADVISORY, CONSULTANCY AND INFORMATION RELATING TO ALL THE AFORESAID (U.S. CLS. 100 AND 101).
SUSAN STIGLITZ, EXAMINING ATTORNEY

SN 77-314,063. TBD FINANCES, BRUXELLES, BELGIUM,
FILED S.R. 10-26-2007; AM. P.R. 7-31-2009.



PRIORITY CLAIMED UNDER SEC. 44(D) ON ERP
CMNTY TM OFC APPLICATION NO. 006298641, FILED 9-
21-2007, REG. NO. 006292734, DATED 8-12-2008, EXPIRES 8-
12-2018.

THE STIPLING IS FOR SHADING PURPOSES ONLY.
THE NAME "DERICHEBOURG" DOES NOT IDENTIFY A
LIVING INDIVIDUAL.

THE MARK CONSISTS OF THE NAME "DERICHE-
BOURG" UNDERLINED AND WHICH LETTERS "RICH"
ARE SURMOUNTED BY A GRAPHIC ELEMENT CONSIST-
ING IN A MARCHING BUFFALO ON WHICH A SEVEN
TEETH GEAR-WHEEL APPEARS..

CLASS 37—CONSTRUCTION AND REPAIR

FOR 44(E): CLEANING OF BUILDING EXTERIOR
SURFACES (U.S. CLS. 100, 103 AND 106).

CLASS 39—TRANSPORTATION AND STO- RAGE

FOR 1(B): GARBAGE COLLECTION (U.S. CLS. 100
AND 105).

CLASS 40—MATERIAL TREATMENT

FOR 1(B): DESTRUCTION OF TRASH; TRASH INCIN-
ERATION; RECYCLING; SORTING OF WASTE AND
RECYCLABLE MATERIAL; DESTRUCTION OF WASTE;
INCINERATION OF WASTE (U.S. CLS. 100, 103 AND
106).

CLASS 44—MEDICAL, BEAUTY AND AGRI- CULTURAL SERVICES

FOR 1(B): GARDENER AND GARDENING SERVICES;
LANDSCAPE GARDENING DESIGN FOR OTHERS (U.S.
CLS. 100 AND 101).

SALLY SHIH, EXAMINING ATTORNEY

SN 77-332,858. LINEA MARKETING GROUP INC., MARK-
HAM, CANADA, FILED 11-19-2007.

TOTE DU JOUR

THE MARK CONSISTS OF STANDARD CHARACTERS
WITHOUT CLAIM TO ANY PARTICULAR FONT, STYLE,
SIZE, OR COLOR.

NO CLAIM IS MADE TO THE EXCLUSIVE RIGHT TO
USE "TOTE", APART FROM THE MARK AS SHOWN.

CLASS 18—LEATHER GOODS

FOR BAGS, NAMELY, LEATHER AND IMITATION
LEATHER BAGS, SHOULDER BAGS, BAGS FOR CAR-
RYING BABIES' ACCESSORIES, BEACH BAGS, CANVAS
SHOPPING BAGS, CARRY-ALL BAGS, DIAPER BAGS,
GENERAL PURPOSE BAGS FOR CARRYING YOGA
EQUIPMENT, WINE BAGS WITH HANDLES FOR CAR-
RYING OR HOLDING WINE, TOTE BAGS, AND CAR-
RYING CASES (U.S. CLS. 1, 2, 3, 22 AND 41).

CLASS 21—HOUSEWARES AND GLASS

FOR THERMAL INSULATED BAGS FOR FOOD OR
BEVERAGES (U.S. CLS. 2, 13, 23, 29, 30, 33, 40 AND 50).
KATHERINE STOIDES, EXAMINING ATTORNEY

SN 77-333,127. THE STRATEGIC COACH INC., TORONTO,
ON, CANADA, FILED 11-19-2007.

EXPERIENCE LIFETIME GROWTH

THE MARK CONSISTS OF STANDARD CHARACTERS
WITHOUT CLAIM TO ANY PARTICULAR FONT, STYLE,
SIZE, OR COLOR.

PRIORITY CLAIMED UNDER SEC. 44(D) ON CANADA
APPLICATION NO. 1365546, FILED 9-28-2007.

OWNER OF CANADA REG. NO. TMA732306, DATED 1-
13-2009, EXPIRES 1-13-2024.

CLASS 9—ELECTRICAL AND SCIENTIFIC APPARATUS

FOR ELECTRONIC PUBLICATIONS, NAMELY, IN-
STRUCTIONAL GUIDES IN THE FIELD OF PROFES-
SIONAL AND PERSONAL DEVELOPMENT RECORDED
ON DVDS AND COMPACT DISCS; EDUCATIONAL
COMPUTER SOFTWARE FEATURING INSTRUCTION
IN PROFESSIONAL AND PERSONAL DEVELOPMENT
FOR USE WITH INDIVIDUAL SELF-STUDY AND DUR-
ING CLASSROOM INSTRUCTION IN THE FIELD OF
PROFESSIONAL AND PERSONAL DEVELOPMENT (U.S.
CLS. 21, 23, 26, 36 AND 38).

CLASS 16—PAPER GOODS AND PRINTED MATTER

FOR PRINTED PUBLICATIONS, NAMELY, BOOKS,
MANUALS IN THE FIELD OF PROFESSIONAL AND
PERSONAL DEVELOPMENT (U.S. CLS. 2, 5, 22, 23, 29,
37, 38 AND 50).

CLASS 35—ADVERTISING AND BUSINESS

FOR BUSINESS MANAGEMENT (U.S. CLS. 100, 101
AND 102).

CLASS 41—EDUCATION AND ENTERTAIN- MENT

FOR EDUCATIONAL SERVICES, NAMELY, CON-
SULTING, CONDUCTING SEMINARS, WORKSHOPS
AND PRIVATE INDIVIDUAL SELF-STUDY INSTRU-
CTIONAL COURSES IN THE FIELD OF PROFESSIONAL
AND PERSONAL DEVELOPMENT (U.S. CLS. 100, 101
AND 107).

RENEE SERVANCE, EXAMINING ATTORNEY

SN 77-343,408. LIPOINT INC., TUCSON, AZ. FILED 12-4-2007.

LiPoint

THE MARK CONSISTS OF STANDARD CHARACTERS WITHOUT CLAIM TO ANY PARTICULAR FONT, STYLE, SIZE, OR COLOR.

CLASS 5—PHARMACEUTICALS

FOR DERMATOLOGICAL PHARMACEUTICAL PRODUCTS; DRUG DELIVERY AGENTS CONSISTING OF COMPOUNDS THAT FACILITATE DELIVERY OF A WIDE RANGE OF PHARMACEUTICALS; INHALED PHARMACEUTICAL PREPARATIONS FOR THE TREATMENT OF RESPIRATORY DISEASES AND DISORDERS; PHARMACEUTICAL PREPARATIONS FOR INHALATION FOR THE TREATMENT OF PULMONARY HYPERTENSION; PHARMACEUTICAL PREPARATIONS FOR OCULAR OR INTRAOCULAR SURGERY; PHARMACEUTICAL PREPARATIONS FOR SKIN CARE; PHARMACEUTICAL PREPARATIONS FOR THE PREVENTION AND TREATMENT OF DISORDERS OF THE NERVOUS SYSTEM, THE IMMUNE SYSTEM, THE CARDIO-VASCULAR SYSTEM, THE METABOLIC SYSTEM, THE RESPIRATORY SYSTEM, THE MUSCULO-SKELETAL SYSTEM, THE GENITOURINARY SYSTEM; FOR THE TREATMENT OF INFLAMMATORY DISORDERS; FOR USE IN DERMATOLOGY, ONCOLOGY, HEMATOLOGY AND IN TISSUE AND ORGAN TRANSPLANTATION, IN OPHTHALMOLOGY AND FOR GASTROENTEROLOGICAL DISORDERS; ALMOND OIL FOR PHARMACEUTICAL PURPOSES; PHARMACEUTICAL PRODUCTS AND PREPARATIONS FOR CHLOASMA; PHARMACEUTICAL PRODUCTS AND PREPARATIONS FOR HYDRATING THE SKIN DURING PREGNANCY; PHARMACEUTICAL PRODUCTS AND PREPARATIONS FOR PREGNANCY BLEMISHES; PHARMACEUTICAL PRODUCTS AND PREPARATIONS FOR PREVENTING SKIN BLEMISHES DURING PREGNANCY; PHARMACEUTICAL PRODUCTS AND PREPARATIONS TO PREVENT STRETCH MARKS; PHARMACEUTICAL PRODUCTS AND PREPARATIONS TO PREVENT SWELLING IN THE LEGS; PHARMACEUTICAL PRODUCTS FOR OPHTHALMOLOGICAL USE; PHARMACEUTICAL PRODUCTS FOR SKIN CARE FOR ANIMALS; PHARMACEUTICAL PRODUCTS FOR THE TREATMENT OF BONE DISEASES; PHARMACEUTICAL PRODUCTS FOR THE TREATMENT OF VIRAL AND INFECTIOUS DISEASES, FOR THE TREATMENT OF CANCER; PHARMACEUTICAL PRODUCTS FOR TREATING RESPIRATORY DISEASES AND ASTHMA; PHARMACEUTICAL SKIN LOTIONS; PHARMACEUTICAL SOLUTIONS USED IN DIALYSIS; PHARMACEUTICALS FOR THE TREATMENT OF ERECTILE DYSFUNCTION; PHARMACEUTICALS, NAMELY, ANTI-INFECTIVES; PHARMACEUTICALS, NAMELY, ANTIHELMINTICS; PHARMACEUTICALS, NAMELY, INDUCERS OF ERECTIONS; PHARMACEUTICALS, NAMELY, LIPID LOWERING AGENTS; PHARMACEUTICALS, NAMELY, PSYCHOTROPICS; PLANT EXTRACTS FOR MEDICAL, VETERINARY AND PHARMACEUTICAL PURPOSES; POTASSIUM PREPARATIONS FOR PHARMACEUTICAL PURPOSES; UNIT DOSE CAPSULES SOLD EMPTY FOR PHARMACEUTICAL USE; VITAMIN AND MINERAL PREPARATIONS FOR USE AS INGREDIENTS IN THE FOOD AND PHARMACEUTICAL INDUSTRY; YEAST OR YEAST EXTRACTS FOR MEDICAL, VETERINARY OR PHARMACEUTICAL PURPOSES; PHARMACEUTICAL PREPARATIONS FOR THE PREVENTION AND TREATMENT OF OCULAR DISORDERS OR DISEASES, FOR THE TREATMENT OF BACTERIA-BASED DISEASES, AND FOR THE TREATMENT OF DIABETES, AND ANTI-INFECTIVE PREPARATIONS, ANTIVIRAL PREPARATIONS, ANTIBIOTICS, ANTIFUNGAL PREPARATIONS AND VACCINES; PHARMACEUTICAL PREPARATIONS FOR THE TREATMENT OF EYE DISEASES AND CONDITIONS; PHARMACEUTICAL PREPARATIONS FOR THE TREATMENT OF HEART RHYTHM DISORDERS; PHARMACEUTICAL PREPARA-

TIONS FOR THE TREATMENT OF HORMONAL DISORDERS AND THE PREVENTION OF OSTEOPOROSIS; PHARMACEUTICAL PREPARATIONS FOR THE TREATMENT OF INFECTIOUS DISEASES; PHARMACEUTICAL PREPARATIONS FOR TREATING ALLERGIC RHINITIS AND ASTHMA; PHARMACEUTICAL PREPARATIONS FOR TREATING DIABETES; PHARMACEUTICAL PREPARATIONS FOR TREATING SKIN DISORDERS; PHARMACEUTICAL PREPARATIONS FOR USE IN CHEMOTHERAPY; PHARMACEUTICAL PREPARATIONS FOR USE IN DERMATOLOGY; PHARMACEUTICAL PREPARATIONS FOR USE IN UROLOGY; PHARMACEUTICAL PREPARATIONS FOR WOUNDS; PHARMACEUTICAL PREPARATIONS NAMELY, ANTIDEPRESSANTS; PHARMACEUTICAL PREPARATIONS NAMELY, APPETITE SUPPRESSANTS; PHARMACEUTICAL PREPARATIONS, NAMELY, A BLOOD CLOTTING AID AND DELIVERY SYSTEM FOR USE IN HUMAN AND VETERINARY MEDICINE; PHARMACEUTICAL PREPARATIONS, NAMELY, A DRUG DELIVERY SYSTEM COMPRISING POLYMER-BASED ORAL TABLETS FOR THE CONTINUOUS RELEASE OF A WIDE VARIETY OF THERAPEUTIC AGENTS; PHARMACEUTICAL PREPARATIONS, NAMELY, ANTICOAGULANTS; PHARMACEUTICAL PRODUCTS AND PREPARATIONS AGAINST DRY SKIN CAUSED BY PREGNANCY; INJECTABLE PHARMACEUTICALS FOR TREATMENT OF ANAPHYLACTIC REACTIONS; INTRAVENOUS FLUIDS USED FOR REHYDRATION, NUTRITION AND THE DELIVERY OF PHARMACEUTICAL PREPARATIONS; OCULAR PHARMACEUTICALS; PHARMACEUTICAL ANTI-ALLERGIC PREPARATIONS AND SUBSTANCES; PHARMACEUTICAL ANTITUSSIVE-COLD PREPARATIONS; PHARMACEUTICAL FOR THE TREATMENT OF ERECTILE DYSFUNCTION; PHARMACEUTICAL PREPARATION FOR THE TREATMENT OF GOUT; PHARMACEUTICAL PREPARATIONS ACTING ON THE CENTRAL NERVOUS SYSTEM; PHARMACEUTICAL PREPARATIONS AND SUBSTANCES FOR THE TREATMENT OF GASTRO-INTESTINAL DISEASES; ALMOND OILS FOR PHARMACEUTICAL PURPOSES; ANTI-DIABETIC PHARMACEUTICALS; ANTIBACTERIAL PHARMACEUTICALS; ANTIMICROBIAL PREPARATIONS FOR INHIBITING MICROBIOLOGICAL DECOMPOSITION IN FOOD, BEVERAGES, ANIMAL FEED AND PHARMACEUTICALS; ANTIMICROBIAL PRESERVATIVES FOR COSMETICS AND PHARMACEUTICALS; ASTRINGENTS; CARDIOVASCULAR PHARMACEUTICALS (U.S. CLS. 6, 18, 44, 46, 51 AND 52).

CLASS 10—MEDICAL APPARATUS

FOR INJECTION DEVICE FOR PHARMACEUTICALS; MEDICAL APPARATUS FOR FACILITATING THE INHALATION OF PHARMACEUTICAL PREPARATIONS; MEDICAL APPARATUS FOR INTRODUCING PHARMACEUTICAL PREPARATIONS INTO THE HUMAN BODY (U.S. CLS. 26, 39 AND 44).

CLASS 42—SCIENTIFIC AND COMPUTER SERVICES

FOR PHARMACEUTICAL DRUG DEVELOPMENT SERVICES; RESEARCH AND DEVELOPMENT OF VACCINES AND MEDICINES; CONDUCTING EARLY EVALUATIONS IN THE FIELD OF NEW PHARMACEUTICALS; DEVELOPMENT OF PHARMACEUTICAL PREPARATIONS AND MEDICINES; PHARMACEUTICAL PRODUCT EVALUATION; PHARMACEUTICAL RESEARCH AND DEVELOPMENT; PHARMACEUTICAL RESEARCH SERVICES; PROVIDING MEDICAL AND SCIENTIFIC RESEARCH INFORMATION IN THE FIELD OF PHARMACEUTICALS AND CLINICAL TRIALS; RESEARCH ON THE SUBJECT OF PHARMACEUTICALS; TESTING, INSPECTION OR RESEARCH OF PHARMACEUTICALS, COSMETICS OR FOODSTUFF (U.S. CLS. 100 AND 101).

RICHARD WHITE, EXAMINING ATTORNEY

SN 77-344,244. OCEANUS AUTOMOTIVE, LLC, AUSTIN, TX. FILED 12-5-2007.

CARGIRL

THE MARK CONSISTS OF STANDARD CHARACTERS WITHOUT CLAIM TO ANY PARTICULAR FONT, STYLE, SIZE, OR COLOR.

CLASS 35—ADVERTISING AND BUSINESS

FOR PROVIDING CONSUMER PRODUCT INFORMATION VIA THE INTERNET; PROVIDING A WEB SITE WHERE CONSUMERS CAN BOTH OBTAIN AND SHARE INFORMATION CONCERNING AUTOMOBILE SHOPPING AND FIND AND POST RATINGS, REVIEWS AND RECOMMENDATIONS ON AUTOMOTIVE RELATED PRODUCTS AND SERVICES; CONSUMER INFORMATION AND ADVICE FOR CONSUMERS, ALL IN THE FIELD OF AUTOMOBILE BUYING AND AUTOMOBILE SHOPPING; DISSEMINATION OF ADVERTISING FOR OTHERS VIA THE INTERNET; PROVIDING ON-LINE CONSUMER INFORMATION IN THE FIELD OF AUTOMOBILE SHOPPING (U.S. CLS. 100, 101 AND 102).

CLASS 41—EDUCATION AND ENTERTAINMENT

FOR ON-LINE JOURNALS, NAMELY, BLOGS ON THE SUBJECT OF AUTOMOBILE SHOPPING AND MAINTENANCE (U.S. CLS. 100, 101 AND 107).
WILLIAM ROSSMAN, EXAMINING ATTORNEY

CLASS 9—ELECTRICAL AND SCIENTIFIC APPARATUS

FOR MEASURING, SIGNALING AND SUPERVISION EQUIPMENT FOR MANAGEMENT OF WATER FLOWS AND LEVELS, COMPRISED OF ELECTRONIC CONTROLS AND COMPUTER SOFTWARE USED FOR MANAGING AND REMOTELY MONITORING WATER FLOWS AND LEVELS IN PIPES, CHANNELS AND AQUEDUCTS, NAMELY, ELECTRONIC METERS FOR MEASURING AND MONITORING WATER FLOWS AND LEVELS; COMPUTER SOFTWARE USED FOR DATA ACQUISITION FROM ELECTRONIC METERS, COMPUTER SOFTWARE USED FOR MANAGING WATER FLOWS AND LEVELS; COMPUTER SOFTWARE USED FOR SCHEDULING CUSTOMER ORDERS, COMPUTER SOFTWARE USED FOR CONNECTING TO COMMUNICATIONS NETWORKS, COMPUTER SOFTWARE USE FOR LODGING AND MODIFYING CUSTOMER ORDERS, COMPUTER SOFTWARE USED FOR SUPERVISING PLANNERS AND MANAGERS, COMPUTER SOFTWARE USED FOR DATABASE MANAGEMENT AND MODELING; AND ELECTRONIC INTERFACES FOR CONNECTING TO COMMUNICATIONS NETWORKS AND TRANSMITTING DATA USED IN MANAGING WATER FLOWS AND LEVELS; ELECTRONIC METERS, ELECTRONIC MONITORS AND COMPUTER SOFTWARE FOR CONNECTING TO COMMUNICATIONS NETWORKS TO ALLOW REMOTE MEASURING, MONITORING AND REGULATING WATER FLOWS AND METAL GATES IN PIPES, CHANNELS AND AQUEDUCTS ALL SOLD AS COMPONENT PARTS OF WATER FLOW REGULATION CONTROL SYSTEMS (U.S. CLS. 21, 23, 26, 36 AND 38).
FIRST USE 6-30-2006; IN COMMERCE 6-30-2006.

CLASS 11—ENVIRONMENTAL CONTROL APPARATUS

FOR WATER FLOW REGULATORS FOR REGULATING WATER FLOW IN PIPES, CHANNELS AND AQUEDUCTS (U.S. CLS. 13, 21, 23, 31 AND 34).
FIRST USE 6-30-2006; IN COMMERCE 6-30-2006.

CLASS 42—SCIENTIFIC AND COMPUTER SERVICES

FOR WATER SUPPLY MANAGEMENT AND CONTROL SERVICES, NAMELY, THE MONITORING AND CONTROL OF WATER FLOW VOLUME, THE MEASUREMENT OF WATER FLOW, AND THE MONITORING AND MEASURING OF WATER SUPPLY LEVELS (U.S. CLS. 100 AND 101).
FIRST USE 6-30-2006; IN COMMERCE 6-30-2006.
JULIE WATSON, EXAMINING ATTORNEY

SN 77-348,491. RUBICON RESEARCH PTY LTD, HAWTHORN, VICTORIA, AUSTRALIA, FILED 12-10-2007.

RUBICON

THE MARK CONSISTS OF STANDARD CHARACTERS WITHOUT CLAIM TO ANY PARTICULAR FONT, STYLE, SIZE, OR COLOR.

SN 77-349,407. IDAHOAN FOODS, LLC, LEWISVILLE, ID. FILED 12-11-2007.



OWNER OF U.S. REG. NOS. 814,136, 3,113,411 AND 3,354,943.

NO CLAIM IS MADE TO THE EXCLUSIVE RIGHT TO USE "FOODS", APART FROM THE MARK AS SHOWN.

THE MARK CONSISTS OF THE WORDS "IDAHOAN FOODS" BETWEEN TWO CURVED RIBBON BANNERS, WITH THE WORDS OVER A BACKGROUND OF DESIGN OF MOUNTAINS.

SEC. 2(F) AS TO "IDAHOAN".

CLASS 29—MEATS AND PROCESSED FOODS

FOR INSTANT POTATOES; PROCESSED POTATOES; PROCESSED VEGETABLES; FROZEN POTATOES, DEHYDRATED POTATOES, SHREDDED POTATOES, DICED POTATOES, POTATO FLAKES, AND POTATO SLICES; FROZEN, DEHYDRATED AND PROCESSED POTATOES AND VEGETABLES; PROCESSED POTATO MIXES; MICROWAVEABLE SIDE DISHES CONSISTING PRIMARILY OF PROCESSED VEGETABLES; PROCESSED AND DEHYDRATED BEANS, GARLIC AND TOMATOES (U.S. CL. 46).

CLASS 30—STAPLE FOODS

FOR MACARONI AND CHEESE; SAUCES AND MIXES, NAMELY, DRY SEASONING MIXES FOR GRAVY, SEASONED COATINGS AND SAUCES FOR USE WITH VEGETABLES AND MEATS (U.S. CL. 46).

CLASS 31—NATURAL AGRICULTURAL PRODUCTS

FOR FRESH POTATOES; RAW POTATOES; FRESH ONIONS; RAW ONIONS (U.S. CLS. 1 AND 46).
BARNEY CHARLON, EXAMINING ATTORNEY

SN 77-350,177. IDAHOAN FOODS, LLC, LEWISVILLE, ID.
FILED 12-12-2007.

IDAHOAN FOODS

THE MARK CONSISTS OF STANDARD CHARACTERS WITHOUT CLAIM TO ANY PARTICULAR FONT, STYLE, SIZE, OR COLOR.

OWNER OF U.S. REG. NOS. 814,136, 3,113,411 AND 3,354,943.

NO CLAIM IS MADE TO THE EXCLUSIVE RIGHT TO USE "FOODS", APART FROM THE MARK AS SHOWN. SEC. 2(F) AS TO "IDAHOAN".

CLASS 29—MEATS AND PROCESSED FOODS

FOR INSTANT POTATOES; PROCESSED POTATOES; PROCESSED VEGETABLES; FROZEN POTATOES, DEHYDRATED POTATOES, SHREDDED POTATOES, DICED POTATOES, POTATO FLAKES, AND POTATO SLICES; FROZEN, DEHYDRATED AND PROCESSED POTATOES AND VEGETABLES; PROCESSED POTATO MIXES; MICROWAVEABLE SIDE DISHES CONSISTING PRIMARILY OF PROCESSED VEGETABLES; PROCESSED AND DEHYDRATED BEANS, GARLIC AND TOMATOES (U.S. CL. 46).

CLASS 30—STAPLE FOODS

FOR MACARONI AND CHEESE; SAUCES AND MIXES, NAMELY, DRY SEASONING MIXES FOR GRAVY, SEASONED COATINGS AND SAUCES FOR USE WITH VEGETABLES AND MEATS (U.S. CL. 46).

CLASS 31—NATURAL AGRICULTURAL PRODUCTS

FOR FRESH POTATOES; RAW POTATOES; FRESH ONIONS; RAW ONIONS (U.S. CLS. 1 AND 46).
BARNEY CHARLON, EXAMINING ATTORNEY

SN 77-350,198. RANDOLPH HOSPITAL, INC., ASHEBORO, NC. FILED 12-12-2007.

SOAR

THE MARK CONSISTS OF STANDARD CHARACTERS WITHOUT CLAIM TO ANY PARTICULAR FONT, STYLE, SIZE, OR COLOR.

CLASS 16—PAPER GOODS AND PRINTED MATTER

FOR PRINTED MATERIALS, NAMELY, INFORMATIONAL FLIERS, POSTERS, RECIPE AND PHYSICAL ACTIVITY CARDS FEATURING INFORMATION ABOUT A CAMPAIGN FOCUSING ON HELPING PARENTS AND CARETAKERS BALANCE PROPER NUTRITION AND PHYSICAL ACTIVITY FOR THEIR CHILDREN IN ORDER TO ACHIEVE AND SUSTAIN A HEALTHY LIFESTYLE (U.S. CLS. 2, 5, 22, 23, 29, 37, 38 AND 50).
FIRST USE 12-5-2007; IN COMMERCE 12-5-2007.

CLASS 41—EDUCATION AND ENTERTAINMENT

FOR EDUCATIONAL SERVICES, NAMELY, A PROGRAM IN THE NATURE OF PHYSICAL ACTIVITY CLASSES AND EDUCATIONAL SEMINARS FOCUSING ON HELPING PARENTS AND CARETAKERS BALANCE PROPER NUTRITION AND PHYSICAL ACTIVITY FOR THEIR CHILDREN IN ORDER TO ACHIEVE AND SUSTAIN A HEALTHY LIFESTYLE (U.S. CLS. 100, 101 AND 107).

FIRST USE 12-5-2007; IN COMMERCE 12-5-2007.
SHANNON TWOHIG, EXAMINING ATTORNEY

SN 77-351,290. IDEASTREAM CONSUMER PRODUCTS, LLC, CLEVELAND, OH. FILED 12-13-2007.

GRAFFITI

THE MARK CONSISTS OF STANDARD CHARACTERS WITHOUT CLAIM TO ANY PARTICULAR FONT, STYLE, SIZE, OR COLOR.

CLASS 16—PAPER GOODS AND PRINTED MATTER

FOR SCHOOL SUPPLIES, NAMELY, PENCIL OR PEN BOXES, POUCHES AND CASES; SCHOOL SUPPLIES, NAMELY, BOOK COVERS, FOLDERS, BINDERS, ZIPPER BINDERS, NOTEBOOKS, NOTE PADS, NOTE PAD HOLDERS, NOTELETS, SCHOOL WRITING BOOKS, WRITING PAPER PADS, WIRE BOUND NOTEBOOKS, PAPER NOTE TABLETS, CLIPBOARDS, BOOK MARKS; SCHOOL SUPPLIES, NAMELY, WRITING INSTRUMENTS, MARKERS; SCHOOL SUPPLY KITS CONTAINING VARIOUS COMBINATIONS OF SELECTED SCHOOL SUPPLIES, NAMELY, WRITING INSTRUMENTS, PENS, PENCILS, MECHANICAL PENCILS, ERASERS, MARKERS, CRAYONS, HIGHLIGHTERS, FOLDERS, NOTEBOOKS, PAPER, PROTRACTORS, PAPER CLIPS, PENCIL SHARPENERS, WRITING GRIPS, GLUE AND BOOK MARKS; SCHOOL SUPPLIES, NAMELY, LUNCH BAGS (U.S. CLS. 2, 5, 22, 23, 29, 37, 38 AND 50).

CLASS 18—LEATHER GOODS

FOR SCHOOL SUPPLIES, NAMELY, BACK PACKS AND TOTE BAGS (U.S. CLS. 1, 2, 3, 22 AND 41).
ANDREW RHIM, EXAMINING ATTORNEY

SN 77-356,154. LI KA SHING FOUNDATION LIMITED, HONG KONG, HONG KONG, FILED 12-19-2007.

LI KA SHING FOUNDATION

THE MARK CONSISTS OF STANDARD CHARACTERS WITHOUT CLAIM TO ANY PARTICULAR FONT, STYLE, SIZE, OR COLOR.

OWNER OF HONG KONG REG. NO. 300168020, DATED 4-4-2003, EXPIRES 4-3-2013.

OWNER OF HONG KONG REG. NO. 300150524, DATED 4-4-2003, EXPIRES 4-3-2013.

OWNER OF HONG KONG REG. NO. 300150515, DATED 4-4-2003, EXPIRES 4-3-2013.

NO CLAIM IS MADE TO THE EXCLUSIVE RIGHT TO USE "FOUNDATION", APART FROM THE MARK AS SHOWN.

THE NAME "LI KA SHING" IS THE NAME OF A LIVING INDIVIDUAL WHOSE CONSENT IS OF RECORD.

CLASS 36—INSURANCE AND FINANCIAL

FOR CHARITABLE FUND RAISING RELATING TO MEDICAL AND HEALTH CARE, EDUCATION, SOCIAL WELFARE, SPORT AND CULTURE, DISASTER RELIEF, REHABILITATION SERVICES, ALLEVIATION OF POVERTY, HANDICAPPED SERVICES, SERVICES FOR THE DEPRIVED, CULTURE AND HERITAGE PRESERVATION, ACADEMIC SCHOLARSHIP, COMMUNITY SERVICES AND OTHER CHARITABLE SERVICES, AND DISBURSEMENT OF FUNDS IN CONNECTION WITH PROGRAMS THAT PROVIDE THE ABOVE CHARITABLE SERVICES (U.S. CLS. 100, 101 AND 102).

CLASS 41—EDUCATION AND ENTERTAINMENT

FOR PROVIDING EDUCATIONAL AND TRAINING SERVICES, NAMELY, CONDUCTING WORKSHOPS AND SEMINARS RELATING TO MEDICAL AND HEALTH CARE, SOCIAL WELFARE AND OTHER SERVICES OF A CHARITABLE NATURE; EDUCATIONAL SERVICES, NAMELY, PROVIDING COURSES OF INSTRUCTION AT THE COLLEGE OR TERTIARY, SECONDARY, PRIMARY LEVELS AND NURSERY SCHOOL SERVICES; ORGANIZING EDUCATIONAL AND ENTERTAINMENT COMPETITIONS IN THE FIELD OF ATHLETICS AND ENCOURAGING INTERCOLLEGIATE ATHLETIC PROGRAMS BY ORGANIZING AND CONDUCTING EDUCATIONAL PROGRAMS AND ACTIVITIES FOR INTERCOLLEGIATE ATHLETES AND ALUMNI; ORGANIZATION OF EDUCATIONAL SEMINARS IN THE FIELDS OF HEALTHCARE, SOCIAL AND COMMUNITY WELFARE, CULTURE AND THE ARTS, ORGANIZING COMMUNITY FESTIVALS AND FETES, NAMELY, ART EXHIBITIONS, LIVE MUSIC CONCERTS, DANCE PERFORMANCES AND OTHER PERFORMING ARTS FOR EDUCATIONAL PURPOSES; ORGANIZATION OF CONFERENCES RELATING TO ENTERTAINMENT, EDUCATION, TRAINING IN THE FIELDS OF HEALTHCARE, SOCIAL AND COMMUNITY WELFARE, CULTURE AND THE ARTS; PROVIDING INFORMATION RELATING TO EDUCATION, EDUCATIONAL TRAINING, ENTERTAINMENT IN THE NATURE OF ART EXHIBITIONS, LIVE MUSIC CONCERTS, DANCE PERFORMANCES AND OTHER PERFORMING ARTS AND RECREATION IN THE NATURE OF ATHLETIC TOURNAMENTS; ORGANIZATION OF EXHIBITIONS FOR CULTURAL AND EDUCATIONAL PURPOSES; ORGANISING AND CONDUCTING EDUCATIONAL CONFERENCES, CONGRESSES AND SEMINARS IN THE FIELDS OF HEALTHCARE, SOCIAL AND COMMUNITY WELFARE, CULTURE AND THE ARTS; ORGANIZING COMMUNITY SPORTING EVENTS AND CULTURAL EVENTS; PROVIDING RECREATIONAL FACILITIES; ENTERTAINMENT SERVICES IN THE NATURE OF ATHLETIC TOURNAMENTS, ART EXHIBITIONS, LIVE MUSIC CONCERTS, DANCE PERFORMANCES AND OTHER PERFORMING ARTS FOR THE PURPOSE OF PROMOTING CHARITABLE CAUSES; PUBLICATION OF BOOKS AND NEWSLETTERS AND ON-LINE ELECTRONIC PUBLISHING OF BULLETINS ALL RELATING TO THE AFORESAID SERVICES; EDUCATIONAL RESEARCH (U.S. CLS. 100, 101 AND 107).

CLASS 42—SCIENTIFIC AND COMPUTER SERVICES

FOR MEDICAL RESEARCH AND HEALTHCARE RESEARCH (U.S. CLS. 100 AND 101).

CLASS 43—HOTEL AND RESTAURANT SERVICES

FOR RETIREMENT HOMES AND DAY NURSERIES FOR CHILD CARE (U.S. CLS. 100 AND 101).

CLASS 44—MEDICAL, BEAUTY AND AGRICULTURAL SERVICES

FOR PROVIDING HEALTH CARE, MEDICAL ASSISTANCE, PHYSIOTHERAPY, CONVALESCENT HOMES, MEDICAL CLINICS, REST HOMES, SANATORIUMS, HOSPITAL, NURSING SERVICE, DENTISTRY SERVICES; NURSING HOMES (U.S. CLS. 100 AND 101).
MARLENE BELL, EXAMINING ATTORNEY

SN 77-378,576. COTTON BOWL ATHLETIC ASSOCIATION, DALLAS, TX. FILED 1-23-2008.

NATIONAL COLLEGE FOOTBALL DAY

THE MARK CONSISTS OF STANDARD CHARACTERS WITHOUT CLAIM TO ANY PARTICULAR FONT, STYLE, SIZE, OR COLOR.
SEC. 2(F).

CLASS 14—JEWELRY

FOR LAPEL PINS (U.S. CLS. 2, 27, 28 AND 50).
FIRST USE 11-0-2004; IN COMMERCE 11-0-2004.

CLASS 16—PAPER GOODS AND PRINTED MATTER

FOR POSTCARDS (U.S. CLS. 2, 5, 22, 23, 29, 37, 38 AND 50).
FIRST USE 11-0-2004; IN COMMERCE 11-0-2004.

CLASS 41—EDUCATION AND ENTERTAINMENT

FOR ENTERTAINMENT SERVICES, NAMELY, ARRANGING AND CONDUCTING COLLEGIATE ATHLETIC EVENTS (U.S. CLS. 100, 101 AND 107).
FIRST USE 11-0-2004; IN COMMERCE 11-0-2004.
KIM MONINGHOFF, EXAMINING ATTORNEY

CLASS 41—EDUCATION AND ENTERTAINMENT

FOR PRODUCTION AND DISTRIBUTION OF ENTERTAINMENT AND EDUCATIONAL MOTION PICTURE FILMS ON A WIDE VARIETY OF THEMES; MULTIMEDIA ENTERTAINMENT SERVICES IN THE NATURE OF RECORDING, PRODUCTION AND POST-PRODUCTION SERVICES IN THE FIELDS OF MUSIC, VIDEO, AND FILMS; PROVIDING AN INTERNET WEB SITE CONTAINING RELATED FILMS, VIDEOS, PHOTOGRAPHS, AND FILM INDUSTRY REFERENCE MATERIAL, NAMELY, REFERENCE MATERIAL ON FILMS, ACTORS, DIRECTORS, HISTORY OF FILMS, AND ENTERTAINMENT NEWS; PRODUCTION OF AUDIO AND VIDEO RECORDINGS ON A WIDE VARIETY OF THEMES; PRODUCTION OF LIVE ENTERTAINMENT PERFORMANCES AND SHOWS, NAMELY, TELEVISION SHOWS AND SHORT SUBJECT VIDEOS; ONLINE PUBLISHING OF ELECTRONIC PUBLICATIONS FOR OTHERS, NAMELY, IN THE FIELD OF FILM, VIDEO, TELEVISION AND INTERNET AND ENTERTAINMENT NEWS, NAMELY, ONLINE ELECTRONIC PUBLISHING OF ELECTRONIC PUBLICATIONS FOR OTHERS IN THE NATURE OF BOOKS, MAGAZINES, PERIODICALS, IN THE FIELD OF FILM, VIDEO, TELEVISION AND INTERNET AND ENTERTAINMENT NEWS; PRODUCTION OF AUDIO AND AUDIOVISUAL RECORDINGS; RENTAL OF AUDIO AND AUDIOVISUAL RECORDINGS, NAMELY, FILMS, MOTION PICTURES, TELEVISION PROGRAMMING, VIDEOS (U.S. CLS. 100, 101 AND 107).

ERIN FALK, EXAMINING ATTORNEY

SN 77-386,409. MORIRIN CO., LTD., AICHI-KEN, JAPAN, FILED 2-1-2008.

SN 77-379,554. SPIRIT EMX LLC, LOS ANGELES, CA. FILED 1-24-2008.

watch. feel. share.

THE STIPPLING IS FOR SHADING PURPOSES ONLY.
THE MARK CONSISTS OF STYLIZED WORDING "WATCH" "FEEL" AND "SHARE" IN A HORIZONTAL LINE WITH THE THREE WORDS SEPARATED BY TWO PERIODS AND ENDING IN A PERIOD.

CLASS 9—ELECTRICAL AND SCIENTIFIC APPARATUS

FOR PRE-RECORDED AUDIO AND VIDEO RECORDINGS OF MOTION PICTURE FILMS FEATURING INSPIRATIONAL, LIFE-AFFIRMING STORIES AND EDUCATIONAL MOTION PICTURE FILMS IN THE FIELD OF SPIRITUALITY, ETHICS AND SELF-IMPROVEMENT; PRE-RECORDED AUDIO AND VIDEO RECORDINGS FEATURING TELEVISION PROGRAMS IN THE FIELD OF SPIRITUALITY, ETHICS, SELF-ENLIGHTENMENT AND SELF-IMPROVEMENT; PRE-RECORDED DIGITAL VIDEO DISCS, PRE-RECORDED VIDEOTAPES, PRE-RECORDED AUDIOTAPES AND COMPACT DISCS FEATURING MUSIC (U.S. CLS. 21, 23, 26, 36 AND 38).

DEOCELL

THE MARK CONSISTS OF STANDARD CHARACTERS WITHOUT CLAIM TO ANY PARTICULAR FONT, STYLE, SIZE, OR COLOR.

CLASS 23—YARNS AND THREADS

FOR THREAD; YARN; COTTON THREAD AND YARN; SILK THREADS AND YARNS; SPUN WOOL; DARNING THREAD AND YARN; ELASTIC THREAD; ELASTIC YARN; HEMP THREAD AND YARN; FIBERGLASS THREAD FOR TEXTILE USE (U.S. CL. 43).

CLASS 24—FABRICS

FOR CLOTH AND FABRIC, NAMELY, COTTON FABRICS, BEDSPREADS, QUILTS, COMFORTERS, DUVETS, DUVET COVERS, BED BLANKETS, CUSHION COVERS, BED LINEN, BED SHEET, BED SPREADS (U.S. CLS. 42 AND 50).

CLASS 25—CLOTHING

FOR CLOTHING, NAMELY, SHIRTS, T-SHIRTS, POLO SHIRTS, SWEATSHIRTS, OVER SHIRTS, SWEATER SHIRTS, JACKET SHIRTS, LADIES' SHIRTS, BLOUSES, PULLOVERS, INFANT WEAR, CHILDREN'S WEAR, NAMELY, SHIRTS, JACKETS, COATS, SWEATERS, DRESSES, SKIRTS AND TROUSERS; TROUSERS, JACKETS, COATS, DUFFLE COATS, DRESSES, SKIRTS, MEN'S SUITS, SLIPOVER JACKETS, SHIRT JACKETS, BLOUSONS, SHIRT BLOUSONS, SCARVES, SHAWLS, GLOVES; KNITWEAR, NAMELY, PULLOVERS, SLIPOVERS, JACKETS, BLOUSONS, SHIRT BLOUSONS, SWEATERS, DRESSES, SKIRTS, TROUSERS, SHIRTS, BLOUSES, CAPS, HEAD SCARVES, SCARVES, STOCKINGS, SOCKS, NECKTIES, GLOVES AND BED JACKETS; GOLF WEAR, NAMELY, GOLF SHIRTS, GOLF VESTS, GOLF SHORTS, GOLF PANTS (U.S. CLS. 22 AND 39).

WENDY GOODMAN, EXAMINING ATTORNEY

SN 77-389,690. TATA SONS LIMITED, MUMBAI, INDIA, FILED 2-6-2008.

TATA COMMUNICATIONS

THE MARK CONSISTS OF STANDARD CHARACTERS WITHOUT CLAIM TO ANY PARTICULAR FONT, STYLE, SIZE, OR COLOR.

OWNER OF U.S. REG. NOS. 2,814,916, 2,824,913 AND 2,929,070.

NO CLAIM IS MADE TO THE EXCLUSIVE RIGHT TO USE "COMMUNICATIONS", APART FROM THE MARK AS SHOWN.

SN 77-386,719. DAESTRA NEW ZEALAND LIMITED, DUNEDIN, NEW ZEALAND, FILED 2-1-2008.



PRIORITY CLAIMED UNDER SEC. 44(D) ON NEW ZEALAND APPLICATION NO. 773201, FILED 8-1-2007.

THE MARK CONSISTS OF THE WORD "TRACPLUS" WITH A DESIGN ELEMENT CONSISTING OF TWO ELLIPSES FORMING A STYLIZED CROSS SHAPE, EACH ELLIPSE HAVING LIGHTER AND DARKER SHADED HALVES.

CLASS 9—ELECTRICAL AND SCIENTIFIC APPARATUS

FOR (BASED ON USE IN COMMERCE) (BASED ON 44(D) PRIORITY APPLICATION) COMPUTER HARDWARE AND SOFTWARE SYSTEMS COMPRISED OF TRACKING DEVICES INCLUDING FIXED AND MOBILE SATELLITE AND CELLULAR TRACKERS, GPS RECEIVERS, COMMUNICATION DEVICES, NAMELY, TRANSMITTERS AND RECEIVERS FOR TEXT MESSAGES, VOICE AND DATA, SATELLITE AND CELLULAR TRANSCEIVERS, ANTENNAS, BATTERY PACKS, SOLAR PANELS, AND ELECTRONIC MAPS INCLUDING MAPS SHOWING THE CURRENT AND HISTORICAL LOCATION AND STATUS OF A TRANSMITTER AND/OR ITS MOVEMENT OR CHANGES, FOR MONITORING, TRACKING, LOCATING AND PUBLISHING THE POSITION AND STATUS OF AIRCRAFT, VESSELS, VEHICLES, PEOPLE, ANIMALS, FREIGHT AND OTHER OBJECTS (U.S. CLS. 21, 23, 26, 36 AND 38).

FIRST USE 6-9-2006; IN COMMERCE 6-21-2007.

CLASS 35—ADVERTISING AND BUSINESS

FOR (BASED ON INTENT TO USE) (BASED ON 44(D) PRIORITY APPLICATION) BUSINESS MANAGEMENT AND ADMINISTRATION SERVICES, NAMELY, MONITORING, TRACKING, LOCATING AND PUBLISHING THE POSITIONS OF AIRCRAFT, VESSELS, VEHICLES, PEOPLE, ANIMALS, FREIGHT AND OTHER OBJECTS FOR COMMERCIAL PURPOSES; PROVIDING AN ONLINE COMPUTER DATABASE FOR THE MONITORING, TRACKING, LOCATING AND PUBLISHING THE POSITIONS OF AIRCRAFT, VESSELS, VEHICLES, PEOPLE, ANIMALS, FREIGHT AND OTHER OBJECTS FOR BUSINESS PURPOSES (U.S. CLS. 100, 101 AND 102).

JEAN IM, EXAMINING ATTORNEY

CLASS 37—CONSTRUCTION AND REPAIR

FOR CONSTRUCTION, INSTALLATION AND MAINTENANCE OF FIBER OPTIC TELECOMMUNICATIONS NETWORKS, TECHNICAL FACILITIES AND TERRESTRIAL AND SUB-SEA COMMUNICATIONS NETWORKS (U.S. CLS. 100, 103 AND 106).

CLASS 38—COMMUNICATION

FOR COMMUNICATIONS SERVICES, NAMELY, LOCAL AND LONG DISTANCE TRANSMISSION OF VOICE, VIDEO AND DATA VIA FIBER OPTIC NETWORKS, PROVIDING MULTIPLE USERS ACCESS TO GLOBAL COMPUTER NETWORK, SATELLITE COMMUNICATIONS AND VOICE OVER INTERNET PROTOCOL (VOIP) SERVICES (U.S. CLS. 100, 101 AND 104).

CLASS 42—SCIENTIFIC AND COMPUTER SERVICES

FOR SCIENTIFIC RESEARCH AND DEVELOPMENT; INDUSTRIAL RESEARCH IN THE FIELD OF TELECOMMUNICATIONS; COMPUTER SERVICES FOR FACILITATING COMPUTERIZED COMMUNICATIONS, NAMELY, PROVIDING TECHNICAL SUPPORT SERVICES, NAMELY, MONITORING OF NETWORK SYSTEMS, HOSTING AND MAINTAINING AN ONLINE WEB SITE FOR OTHERS TO DISPLAY THEIR PRODUCTS OR SERVICES; COMPUTER PROGRAMMING SERVICES; APPLICATION SERVICE PROVIDER (ASP), NAMELY, HOSTING OF COMPUTER SOFTWARE APPLICATIONS OF OTHERS (U.S. CLS. 100 AND 101).

STEVEN JACKSON, EXAMINING ATTORNEY

SN 77-391,956. MTU AERO ENGINES GMBH, 80995 MUNCHEN, FED REP GERMANY, FILED 2-8-2008.

MAKE YOUR BUSINESS FLY

THE MARK CONSISTS OF STANDARD CHARACTERS WITHOUT CLAIM TO ANY PARTICULAR FONT, STYLE, SIZE, OR COLOR.

PRIORITY CLAIMED UNDER SEC. 44(D) ON ERPN CMNTY TM OFC APPLICATION NO. 006207691, FILED 8-17-2007, REG. NO. 006207691, DATED 6-6-2008, EXPIRES 8-17-2017.

CLASS 7—MACHINERY

FOR AERO ENGINES, IN PARTICULAR JET ENGINES AND PROPELLER TURBO JET ENGINES; GAS TURBINE ENGINES NOT FOR LAND VEHICLES, IN PARTICULAR SHAFT OUTPUT ENGINES, PARTS OF THE AFORESAID GOODS, IN PARTICULAR TURBO COMPRESSORS, EXHAUST GASH TURBO CHARGERS, MECHANICALLY DRIVEN COMPRESSORS, TRANSMISSION COMPONENTS FOR AIRCRAFT ENGINES, NAMELY, BEARINGS, SHAFTS, BELTS, GEARS, GEAR CONTROLS, AND CLUTCHES; LIQUID AND FUEL PUMPS, PUMP DRIVES, RADIAL AND AXIAL BLOWERS, FANS, GUIDE GRIDS FOR TURBO ENGINES, GAS FLOW CONTROL FOR USE IN AIRCRAFT ENGINES AND GAS TURBINES, NAMELY, GAS REGULATORS, THROTTLES AND NOZZLES, AXIAL AND RADIAL TURBINES, SOUND ABSORBERS, NAMELY, MUFFLERS, FUEL PIPES, FUEL REGULATORS, NAMELY, FUEL VALVES, PUMPS, INJECTION NOZZLES AND FUEL GAUGES ALL SOLD AS A UNIT; FUEL GAUGES, FUEL INJECTION PUMPS, NOZZLES AND VALVES, PNEUMATIC STARTING MOTORS, FIXED AND DETACHABLE MACHINE COUPLINGS, HYDRAULIC TRANSMISSION COMPONENTS FOR AIRCRAFT ENGINES, NAMELY, PUMPS, VALVES, LINES AND HOSES AND MACHINE COUPLINGS, OIL AND FUEL FILTERS, HYDRAULIC FLUID FILTERS FOR USE IN AIRCRAFT ENGINES AND GAS TURBINES, CENTRIFUGES, BEARINGS FOR SHAFTS, AXLES, ROTORS AND TRANSMISSION COMPONENTS, COGGED WHEELS, IGNITORS FOR IGNITING A FUEL MIXTURE IN AN INTERNAL COMBUSTION ENGINE; IGNITION DEVICES, NAMELY, SPARK PLUGS; HOUSINGS AND ASSEMBLY DEVICES FOR DRIVES, NAMELY, MACHINE TOOLS FOR ASSEMBLING DRIVES; GASKETS, NAMELY, BRUSHES, LABYRINTH AND AXIAL FACE END GASKETS; ROTORS FOR TURBO ENGINES; DISCS, NAMELY, ROTOR OR BLADE WHEELS; STATORS, NAMELY, DEVICES WHERE STATOR BLADES ARE PLACED; HOUSINGS, NAMELY, CASES FOR TURBO ENGINES, BLADES FOR TURBO ENGINES, PROPELLING NOZZLES FOR FLIGHT DRIVES; STRUCTURAL PARTS AND COMPONENT PARTS FOR THE AFORESAID GOODS ALL SOLD AS A UNIT; COMPONENT PARTS OF TURBO ENGINES MADE OF FIBER REINFORCED COMPOSITES, CERAMICS AND METALS, NAMELY, TURBINE SHAFTS, ROTOR BLADES AND CASINGS; METAL WORKING MACHINES; COOLERS, NAMELY, OIL, FUEL AND COOLANT COOLERS FOR MOTORS AND ENGINES; RADIATORS FOR MOTORS AND ENGINES; BURNERS, NAMELY, JET BURNERS FOR TURBINE ENGINES; AND FLAME ARRESTORS USED TO PREVENT THE SPREAD OF FLAMES FROM THE THRUST CHARTERS OF JET ENGINES (U.S. CLS. 13, 19, 21, 23, 31, 34 AND 35).

CLASS 9—ELECTRICAL AND SCIENTIFIC APPARATUS

FOR TEST BEDS FOR AERO ENGINES AND GAS TURBINES; ELECTRONIC CONTROLLERS; PROTECTIVE EYE GLASSES (U.S. CLS. 21, 23, 26, 36 AND 38).

CLASS 11—ENVIRONMENTAL CONTROL APPARATUS

FOR COMBUSTION CHAMBERS (U.S. CLS. 13, 21, 23, 31 AND 34).

CLASS 16—PAPER GOODS AND PRINTED MATTER

FOR PRINTED MATERIALS AND PUBLICATIONS, NAMELY, BOOKS, MAGAZINES, MANUALS, NEWSLETTERS, REPORTS, BROCHURES, CATALOGS, PERIODICALS, JOURNALS, BOOKLETS, TEACHING MATERIAL AND LEAFLETS IN THE FIELD OF AERO ENGINES AND GAS TURBINES AS WELL AS PARTS THEREOF, AND THE DESIGN, DEVELOPMENT, MANUFACTURE, REPAIR, MAINTENANCE, SERVICE, ASSEMBLY, DISMANTLING, OVERHAULING AND TESTING OF AERO ENGINES AND GAS TURBINES AS WELL AS PARTS THEREOF (U.S. CLS. 2, 5, 22, 23, 29, 37, 38 AND 50).

CLASS 25—CLOTHING

FOR CLOTHING, IN PARTICULAR T-SHIRTS, FLEECE JACKETS, RAIN COATS; HEADWEAR, NAMELY, BASEBALL CAPS (U.S. CLS. 22 AND 39).

CLASS 35—ADVERTISING AND BUSINESS

FOR PROJECT MANAGEMENT SERVICES FOR OTHERS IN THE FIELD OF AERO ENGINES AND GAS TURBINES AS WELL AS PARTS THEREOF, AND THE DEVELOPMENT, MANUFACTURE, REPAIR, MAINTENANCE, SERVICE, ASSEMBLY, DISMANTLING, AND OVERHAULING AND TESTING OF AERO ENGINES AND GAS TURBINES AS WELL AS PARTS THEREOF (U.S. CLS. 100, 101 AND 102).

CLASS 37—CONSTRUCTION AND REPAIR

FOR REPAIR, MAINTENANCE, SERVICING, DISMANTLING, AND OVERHAULING OF AERO ENGINES, IN PARTICULAR JET ENGINES AND PROPELLER TURBO JET ENGINES, GAS TURBINES, IN PARTICULAR SHAFT OUTPUT ENGINES AND PARTS THEREOF, NAMELY, TURBO COMPRESSORS, TURBO CHARGER, MECHANICALLY DRIVEN COMPRESSORS, TRANSMISSION COMPONENTS, LIQUID AND FUEL PUMPS, PUMP DRIVES, RADIAL AND AXIAL BLOWERS, FANS, GUIDE GRIDS FOR TURBO ENGINES, GAS FLOW CONTROL, AXIAL AND RADIAL TURBINES, SOUND ABSORBERS, FUEL PIPES, FUEL REGULATORS, FUEL GAUGE DEVICES, FUEL INJECTION PUMPS, NOZZLE AND VALVES, PNEUMATIC STARTING MOTORS, FIXED AND DETACHABLE MACHINE COUPLINGS, HYDRAULIC TRANSMISSION COMPONENTS AND COUPLINGS, OIL AND FUEL FILTERS, FLUID FILTERS, CENTRIFUGES, BEARINGS FOR SHAFTS, AXLES, ROTORS AND TRANSMISSION COMPONENTS, COGGED WHEELS, IGNITORS, IGNITION DEVICES, PROFILED TUBES AND MANIFOLDS, HOUSINGS, ASSEMBLY DEVICES FOR DRIVES, CONTROL GEAR, GASKETS, NAMELY, BRUSHES, LABYRINTH AND ROTATING MECHANICAL SEAL, GASKET RINGS, COMPRESSOR ROTORS, DISCS, STATORS, ROTORS, INTEGRALLY BLADED ROTORS AND HOUSINGS FOR TURBO ENGINES, BLADES, NAMELY, VANES AND ROTOR BLADES FOR TURBO ENGINES, THRUST-NOZZLES FOR AERO ENGINES AS WELL AS COMPONENTS AND PARTS OF THE AFORESAID GOODS; TECHNICAL CONSULTATION RELATING TO THE REPAIR, MAINTENANCE, DISMANTLING, OVERHAULING OF AERO ENGINES AND GAS TURBINES AS WELL AS PARTS THEREOF (U.S. CLS. 100, 103 AND 106).

CLASS 40—MATERIAL TREATMENT

FOR METAL TREATMENT; MILL WORKING; GRINDING; ELECTROPLATING; SOLDERING; WELDING, IN PARTICULAR INERTIA FRICTION WELDING, LINEAR FRICTION WELDING AND HIGH FREQUENCY INDUCTION WELDING; COATING BY ELECTROPLATING; REMOVAL OF PROTECTIVE COATINGS; APPLICATION OF PROTECTIVE COATINGS; METAL CASTING; METAL HARDENING; CUSTOM MANUFACTURING OF AERO ENGINES, IN PARTICULAR JET ENGINES AND PROPELLER TURBO JET ENGINES, GAS TURBINES, IN PARTICULAR SHAFT OUTPUT ENGINES AND PARTS THEREOF, NAMELY, TURBO COMPRESSORS, TURBO CHARGER, MECHANICALLY DRIVEN COMPRESSORS, TRANSMISSION COMPONENTS, LIQUID AND FUEL PUMPS, PUMP DRIVES, RADIAL AND AXIAL BLOWERS, FANS, GUIDE GRIDS FOR TURBO ENGINES, GAS FLOW CONTROL, AXIAL AND RADIAL TURBINES, SOUND ABSORBERS, FUEL PIPES, FUEL REGULATORS, FUEL GAUGE DEVICES, FUEL INJECTION PUMPS, NOZZLE AND VALVES, PNEUMATIC STARTING MOTORS, FIXED AND DETACHABLE MACHINE COUPLINGS, HYDRAULIC TRANSMISSION COMPONENTS AND COUPLINGS, OIL AND FUEL FILTERS, FLUID FILTERS, CENTRIFUGES, BEARINGS FOR SHAFTS, AXLES, ROTORS AND TRANSMISSION COMPONENTS, COGGED WHEELS, IGNITORS, IGNITION DEVICES, PROFILED TUBES AND MANIFOLDS, HOUSINGS, ASSEMBLY DEVICES FOR DRIVES, CONTROL GEAR, GASKETS, NAMELY, BRUSHES, LABYRINTH AND

ROTATING MECHANICAL SEAL, GASKET RINGS, COMPRESSOR ROTORS, DISCS, STATORS, ROTORS, INTEGRALLY BLADED ROTORS AND HOUSINGS FOR TURBO ENGINES, BLADES, NAMELY, VANES AND ROTOR BLADES FOR TURBO ENGINES, THRUST-NOZZLES FOR AERO ENGINES AS WELL AS COMPONENTS AND PARTS OF THE AFORESAID GOODS; ASSEMBLY OF PRODUCTS FOR OTHERS; TECHNICAL CONSULTATION AS IT PERTAINS TO THE CUSTOM MANUFACTURE AND ASSEMBLY OF AERO ENGINES AND GAS TURBINES AS WELL AS PARTS THEREOF (U.S. CLS. 100, 103 AND 106).

CLASS 41—EDUCATION AND ENTERTAINMENT

FOR EDUCATIONAL SERVICES, NAMELY, CONDUCTING TRAINING COURSES, SEMINARS, WORKSHOPS AND SYMPOSIA IN THE FIELD OF AERO ENGINES AND GAS TURBINES AS WELL AS PARTS THEREOF, AND THE DEVELOPMENT, MANUFACTURE, REPAIR, MAINTENANCE, SERVICE, ASSEMBLY, DISMANTLING AND OVERHAULING AND TESTING OF AERO ENGINES AND GAS TURBINES AS WELL AS PARTS THEREOF; PROVIDING OF ONLINE NON-DOWNLOADABLE PUBLICATIONS IN THE NATURE OF MAGAZINES, MANUALS, NEWSLETTERS, IN THE FIELD OF AERO ENGINES AND GAS TURBINES AS WELL AS PARTS THEREOF, AND THE DEVELOPMENT, MANUFACTURE, REPAIR, MAINTENANCE, SERVICE, ASSEMBLY, DISMANTLING AND OVERHAULING AND TESTING OF AERO ENGINES AND GAS TURBINES AS WELL AS PARTS THEREOF; DESKTOP-PUBLISHING FOR OTHERS; SPECIAL EVENT PLANNING (U.S. CLS. 100, 101 AND 107).

CLASS 42—SCIENTIFIC AND COMPUTER SERVICES

FOR DESIGN, DEVELOPMENT AND TESTING OF AERO ENGINES, IN PARTICULAR JET ENGINES AND PROPELLER TURBO JET ENGINES, GAS TURBINES, IN PARTICULAR SHAFT OUTPUT ENGINES AND PARTS THEREOF, NAMELY, TURBO COMPRESSORS, TURBO CHARGER, MECHANICALLY DRIVEN COMPRESSORS, TRANSMISSION COMPONENTS, LIQUID AND FUEL PUMPS, PUMP DRIVES, RADIAL AND AXIAL BLOWERS, FANS, GUIDE GRIDS FOR TURBO ENGINES, GAS FLOW CONTROL, AXIAL AND RADIAL TURBINES, SOUND ABSORBERS, FUEL PIPES, FUEL REGULATORS, FUEL GAUGE DEVICES, FUEL INJECTION PUMPS, NOZZLE AND VALVES, PNEUMATIC STARTING MOTORS, FIXED AND DETACHABLE MACHINE COUPLINGS, HYDRAULIC TRANSMISSION COMPONENTS AND COUPLINGS, OIL AND FUEL FILTERS, FLUID FILTERS, CENTRIFUGES, BEARINGS FOR SHAFTS, AXLES, ROTORS AND TRANSMISSION COMPONENTS, COGGED WHEELS, IGNITORS, IGNITION DEVICES, PROFILED TUBES AND MANIFOLDS, HOUSINGS, ASSEMBLY DEVICES FOR DRIVES, CONTROL GEAR, GASKETS, NAMELY, BRUSHES, LABYRINTH AND ROTATING MECHANICAL SEAL, GASKET RINGS, COMPRESSOR ROTORS, DISCS, STATORS, ROTORS, INTEGRALLY BLADED ROTORS AND HOUSINGS FOR TURBO ENGINES, BLADES, NAMELY, VANES AND ROTOR BLADES FOR TURBO ENGINES, THRUST-NOZZLES FOR AERO ENGINES AS WELL AS COMPONENTS AND PARTS OF THE AFORESAID GOODS; TECHNICAL CONSULTATION RELATING TO THE DESIGN, DEVELOPMENT AND TESTING OF AERO ENGINES AND GAS TURBINES AS WELL AS PARTS THEREOF; SCIENTIFIC AND INDUSTRIAL RESEARCH RELATING TO THE DESIGN, DEVELOPMENT, MANUFACTURE, REPAIR, MAINTENANCE, ASSEMBLY, DISMANTLING, OVERHAULING AND TESTING OF AERO ENGINES AND GAS TURBINES AS WELL AS PARTS THEREOF; MONITORING, DIAGNOSIS AND PROGNOSIS OF AERO ENGINES, IN PARTICULAR JET ENGINES AND PROPELLER TURBO JET ENGINES, GAS TURBINES AND PARTS THEREOF; RESEARCH AND DEVELOPMENT IN THE FIELD OF CONSTRUCTION PRINCIPLES; ENGINEERING SERVICES IN THE MENTIONED FIELDS; RESEARCH AND DEVELOPMENT OF TECHNOLOGY RELATING TO THE DEVELOPMENT, MANUFACTURE, REPAIR, MAINTENANCE, ASSEMBLY, DISMANTLING AND OVER-

HAULING AND TESTING OF AERO ENGINES AND GAS TURBINES AS WELL AS PARTS THEREOF (U.S. CLS. 100 AND 101).

ALICE BENMAMAN, EXAMINING ATTORNEY

SN 77-392,511. MTU AERO ENGINES GMBH, 80995 MUNCHEN, FED REP GERMANY, FILED 2-8-2008.



PRIORITY CLAIMED UNDER SEC. 44(D) ON ERPNCMNTY TM OFC APPLICATION NO. 006311691, FILED 9-26-2007, REG. NO. 006311691, DATED 7-23-2008, EXPIRES 9-26-2017.

NO CLAIM IS MADE TO THE EXCLUSIVE RIGHT TO USE "AERO SOLUTIONS", APART FROM THE MARK AS SHOWN.

CLASS 7—MACHINERY

FOR AERO ENGINES, IN PARTICULAR JET ENGINES AND PROPELLER TURBO JET ENGINES; GAS TURBINE ENGINES NOT FOR LAND VEHICLES, IN PARTICULAR SHAFT OUTPUT ENGINES, PARTS OF THE AFORESAID GOODS, IN PARTICULAR TURBO COMPRESSORS, EXHAUST GAS TURBO CHARGERS, MECHANICALLY DRIVEN COMPRESSORS, TRANSMISSION COMPONENTS FOR AIRCRAFT ENGINES, NAMELY, BEARINGS, SHAFTS, BELTS, GEARS, GEAR CONTROLS, AND CLUTCHES; LIQUID AND FUEL PUMPS, PUMP DRIVES, RADIAL AND AXIAL BLOWERS, FANS, GUIDE GRIDS FOR TURBO ENGINES, GAS FLOW CONTROL FOR USE IN AIRCRAFT ENGINES AND GAS TURBINES, NAMELY, GAS REGULATORS, THROTTLES AND NOZZLES, AXIAL AND RADIAL TURBINES, SOUND ABSORBERS, NAMELY, MUFFLERS, FUEL PIPES, FUEL REGULATORS, NAMELY, FUEL VALVES, PUMPS, INJECTION NOZZLES AND FUEL GAUGES ALL SOLD AS A UNIT; FUEL GAUGES, FUEL INJECTION PUMPS, NOZZLES AND VALVES, PNEUMATIC STARTING MOTORS, FIXED AND DETACHABLE MACHINE COUPLINGS, HYDRAULIC TRANSMISSION COMPONENTS FOR AIRCRAFT ENGINES, NAMELY, PUMPS, VALVES, LINES AND HOSES AND MACHINE COUPLINGS, OIL AND FUEL FILTERS, HYDRAULIC FLUID FILTERS FOR USE IN AIRCRAFT ENGINES AND GAS TURBINES, CENTRIFUGES, BEARINGS FOR SHAFTS, AXLES, ROTORS AND TRANSMISSION COMPONENTS, COGGED WHEELS, IGNITORS FOR IGNITING A FUEL MIXTURE IN AN INTERNAL COMBUSTION ENGINE; IGNITION DEVICES, NAMELY, SPARK PLUGS; HOUSINGS AND ASSEMBLY DEVICES FOR DRIVES, NAMELY, MACHINE TOOLS FOR ASSEMBLING DRIVES; GASKETS, NAMELY, BRUSHES, LABYRINTH AND AXIAL FACE END GASKETS; ROTORS FOR TURBO ENGINES; DISCS, NAMELY, ROTOR OR BLADE WHEELS; STATORS, NAMELY, DEVICES WHERE STATOR BLADES ARE PLACED; HOUSINGS, NAMELY, CASES FOR TURBO ENGINES, BLADES FOR TURBO ENGINES, PROPELLING NOZZLES FOR FLIGHT DRIVES; STRUCTURAL PARTS AND COMPONENT PARTS FOR THE AFORESAID GOODS ALL SOLD AS A UNIT; COMPONENT PARTS OF TURBO ENGINES MADE OF FIBER REINFORCED COMPOSITES, CERAMICS AND METALS, NAMELY, TURBINE SHAFTS, ROTOR BLADES AND CASINGS; METAL WORKING MACHINES; COOLERS, NAMELY, OIL, FUEL AND COOLANT COOLERS FOR MOTORS AND ENGINES; RADIATORS FOR MOTORS AND ENGINES; BURNERS, NAMELY, JET BURNERS FOR TURBINE ENGINES; AND FLAME ARRESTORS USED TO PREVENT THE SPREAD OF FLAMES FROM THE THRUST CHAMBERS OF JET ENGINES (U.S. CLS. 13, 19, 21, 23, 31, 34 AND 35).

CLASS 9—ELECTRICAL AND SCIENTIFIC APPARATUS

FOR TEST BEDS FOR AERO ENGINES AND GAS TURBINES; ELECTRONIC CONTROLLERS; PROTECTIVE EYE GLASSES (U.S. CLS. 21, 23, 26, 36 AND 38).

CLASS 11—ENVIRONMENTAL CONTROL APPARATUS

FOR COMBUSTION CHARTERS (U.S. CLS. 13, 21, 23, 31 AND 34).

CLASS 16—PAPER GOODS AND PRINTED MATTER

FOR PRINTED MATERIALS AND PUBLICATIONS, NAMELY, BOOKS, MAGAZINES, MANUALS, NEWSLETTERS, REPORTS, BROCHURES, CATALOGS, PERIODICALS, JOURNALS, BOOKLETS, TEACHING MATERIAL AND LEAFLETS IN THE FIELD OF AERO ENGINES AND GAS TURBINES AS WELL AS PARTS THEREOF, AND THE DESIGN, DEVELOPMENT, MANUFACTURE, REPAIR, MAINTENANCE, SERVICE, ASSEMBLY, DISMANTLING, OVERHAULING AND TESTING OF AERO ENGINES AND GAS TURBINES AS WELL AS PARTS THEREOF (U.S. CLS. 2, 5, 22, 23, 29, 37, 38 AND 50).

CLASS 25—CLOTHING

FOR CLOTHING, IN PARTICULAR T-SHIRTS, FLEECE JACKETS, RAIN COATS; HEADWEAR, NAMELY, BASEBALL CAPS (U.S. CLS. 22 AND 39).

CLASS 35—ADVERTISING AND BUSINESS

FOR PROJECT MANAGEMENT SERVICES FOR OTHERS IN THE FIELD OF AERO ENGINES AND GAS TURBINES AS WELL AS PARTS THEREOF, AND THE DEVELOPMENT, MANUFACTURE, REPAIR, MAINTENANCE, SERVICE, ASSEMBLY, DISMANTLING, AND OVERHAULING AND TESTING OF AERO ENGINES AND GAS TURBINES AS WELL AS PARTS THEREOF (U.S. CLS. 100, 101 AND 102).

CLASS 40—MATERIAL TREATMENT

FOR METAL TREATMENT; MILL WORKING; GRINDING; ELECTROPLATING; SOLDERING; WELDING, IN PARTICULAR INERTIA FRICTION WELDING, LINEAR FRICTION WELDING AND HIGH FREQUENCY INDUCTION WELDING; COATING BY ELECTROPLATING; REMOVAL OF PROTECTIVE COATINGS; APPLICATION OF PROTECTIVE COATINGS; METAL CASTING; METAL HARDENING; CUSTOM MANUFACTURING OF AERO ENGINES, IN PARTICULAR JET ENGINES AND PROPELLER TURBO JET ENGINES, GAS TURBINES, IN PARTICULAR SHAFT OUTPUT ENGINES AND PARTS THEREOF, NAMELY, TURBO COMPRESSORS, TURBO CHARGER, MECHANICALLY DRIVEN COMPRESSORS, TRANSMISSION COMPONENTS, LIQUID AND FUEL PUMPS, PUMP DRIVES, RADIAL AND AXIAL BLOWERS, FANS, GUIDE GRIDS FOR TURBO ENGINES, GAS FLOW CONTROL, AXIAL AND RADIAL TURBINES, SOUND ABSORBERS, FUEL PIPES, FUEL REGULATORS, FUEL GAUGE DEVICES, FUEL INJECTION PUMPS, NOZZLE AND VALVES, PNEUMATIC STARTING MOTORS, FIXED AND DETACHABLE MACHINE COUPLINGS, HYDRAULIC TRANSMISSION COMPONENTS AND COUPLINGS, OIL AND FUEL FILTERS, FLUID FILTERS, CENTRIFUGES, BEARINGS FOR SHAFTS, AXLES, ROTORS AND TRANSMISSION COMPONENTS, COGGED WHEELS, IGNITORS, IGNITION DEVICES, PROFILED TUBES AND MANIFOLDS, HOUSINGS, ASSEMBLY DEVICES FOR DRIVES, CONTROL GEAR, GASKETS, NAMELY, BRUSHES, LABYRINTH AND

ROTATING MECHANICAL SEAL, GASKET RINGS, COMPRESSOR ROTORS, DISCS, STATORS, ROTORS, INTEGRALLY BLADED ROTORS AND HOUSINGS FOR TURBO ENGINES, BLADES, NAMELY, VANES AND ROTOR BLADES FOR TURBO ENGINES, THRUST NOZZLES FOR AERO ENGINES AS WELL AS COMPONENTS AND PARTS OF THE AFORESAID GOODS; ASSEMBLY OF PRODUCTS FOR OTHERS; TECHNICAL CONSULTATION AS IT PERTAINS TO THE CUSTOM MANUFACTURE AND ASSEMBLY OF AERO ENGINES AND GAS TURBINES AS WELL AS PARTS THEREOF (U.S. CLS. 100, 103 AND 106).

CLASS 41—EDUCATION AND ENTERTAINMENT

FOR EDUCATIONAL SERVICES, NAMELY, CONDUCTING TRAINING COURSES, SEMINARS, WORKSHOPS AND SYMPOSIA IN THE FIELD OF AERO ENGINES AND GAS TURBINES AS WELL AS PARTS THEREOF, AND THE DEVELOPMENT, MANUFACTURE, REPAIR, MAINTENANCE, SERVICE, ASSEMBLY, DISMANTLING AND OVERHAULING AND TESTING OF AERO ENGINES AND GAS TURBINES AS WELL AS PARTS THEREOF; PROVIDING OF ONLINE NON-DOWNLOADABLE PUBLICATIONS IN THE NATURE OF MAGAZINES, MANUALS, NEWSLETTERS, IN THE FIELD OF AERO ENGINES AND GAS TURBINES AS WELL AS PARTS THEREOF, AND THE DEVELOPMENT, MANUFACTURE, REPAIR, MAINTENANCE, SERVICE, ASSEMBLY, DISMANTLING AND OVERHAULING AND TESTING OF AERO ENGINES AND GAS TURBINES AS WELL AS PARTS THEREOF; DESKTOP-PUBLISHING FOR OTHERS; SPECIAL EVENT PLANNING (U.S. CLS. 100, 101 AND 107).

CLASS 42—SCIENTIFIC AND COMPUTER SERVICES

FOR TECHNICAL CONSULTATION RELATING TO THE DESIGN, DEVELOPMENT, AND TESTING OF AERO ENGINES AND GAS TURBINES AS WELL AS PARTS THEREOF; SCIENTIFIC AND INDUSTRIAL RESEARCH RELATING TO THE DESIGN, DEVELOPMENT, MANUFACTURE, REPAIR, MAINTENANCE, ASSEMBLY, DISMANTLING, OVERHAULING AND TESTING OF AERO ENGINES AND GAS TURBINES AS WELL AS PARTS THEREOF; MONITORING, DIAGNOSIS AND PROGNOSIS OF AERO ENGINES, IN PARTICULAR JET ENGINES AND PROPELLER TURBO JET ENGINES, GAS TURBINES AND PARTS THEREOF; RESEARCH AND DEVELOPMENT IN THE FIELD OF CONSTRUCTION PRINCIPLES; ENGINEERING SERVICES IN THE MENTIONED FIELDS; RESEARCH AND DEVELOPMENT OF TECHNOLOGY RELATING TO THE DEVELOPMENT, MANUFACTURE, REPAIR, MAINTENANCE, ASSEMBLY, DISMANTLING AND OVERHAULING AND TESTING OF AERO ENGINES AND GAS TURBINES AS WELL AS PARTS THEREOF AND THE DESIGN, DEVELOPMENT, REPAIR, MAINTENANCE, SERVICE, DISMANTLING, OVERHAULING AND TESTING OF AERO ENGINES, IN PARTICULAR JET ENGINES AND PROPELLER TURBO JET ENGINES; GAS TURBINES, IN PARTICULAR SHAFT OUTPUT ENGINES AND PARTS THEREOF, NAMELY, TURBO COMPRESSORS, TURBO CHARGERS, MECHANICALLY DRIVEN COMPRESSORS, TRANSMISSION COMPONENTS, LIQUID AND FUEL PUMPS, PUMP DRIVES, RADIAL AND AXIAL BLOWERS, FANS, GUIDE GRIDS FOR TURBO ENGINES, GAS FLOW CONTROL, AXIAL AND RADIAL TURBINES, SOUND ABSORBERS, FUEL PIPES, FUEL REGULATORS, FUEL GAUGE DEVICES, FUEL INJECTION PUMPS, NOZZLES AND VALVES, PNEUMATIC STARTING MOTORS, FIXED AND DETACHABLE MACHINE COUPLINGS, HYDRAULIC TRANSMISSION COMPONENTS AND COUPLINGS, OIL AND FUEL FILTERS, FLUID FILTERS, CENTRIFUGES, BEARINGS FOR SHAFTS, AXLES, ROTORS AND TRANSMISSION COMPONENTS, COGGED WHEELS, IGNITORS, IGNITION DEVICES, PROFILED TUBES AND MANIFOLDS, HOUSINGS, ASSEMBLY DEVICES FOR DRIVES, CONTROL GEAR, GASKETS, NAMELY, BRUSHES, LABYRINTH AND ROTATING MECHANICAL SEALS, GASKET RINGS, COMPRESSOR ROTORS, DISCS, STATORS, ROTORS, INTEGRALLY BLADED ROTORS AND HOUSINGS, NAMELY, FOR TURBO ENGINES, BLADES, NAMELY, VANES AND

ROTOR BLADES FOR TURBO ENGINES, THRUST NOZZLES FOR AERO ENGINES AS WELL AS COMPONENTS AND PARTS OF THE AFORESAID GOODS (U.S. CLS. 100 AND 101).

ALICE BENMAMAN, EXAMINING ATTORNEY

SN 77-392,542. AROW GLOBAL INC., WINNIPEG, CANADA, FILED 2-8-2008.

AROW GLOBAL

THE MARK CONSISTS OF STANDARD CHARACTERS WITHOUT CLAIM TO ANY PARTICULAR FONT, STYLE, SIZE, OR COLOR.

NO CLAIM IS MADE TO THE EXCLUSIVE RIGHT TO USE "GLOBAL", APART FROM THE MARK AS SHOWN.

CLASS 40—MATERIAL TREATMENT

FOR CUSTOM MANUFACTURING SERVICES, NAMELY, CUSTOM MANUFACTURING OF LAND VEHICLE WINDOWS, WINDOW SYSTEMS, DOORS, DOOR SYSTEMS, COMPONENTS, NAMELY, LINEAR ENCLOSURES, GRILLES, DIFFUSERS, VENTS, BLOWERS, FANS, PARCEL RACKS, PANELS, SIDING, ELECTRONIC CIRCUIT CARD ASSEMBLIES, WIRE HARNESSSES, INTEGRATED ELECTRONIC SYSTEMS, SEATS, UPHOLSTERY, BODIES, CHASIS AND BAGGAGE DOORS AND LAND VEHICLE SUBASSEMBLIES (U.S. CLS. 100, 103 AND 106).

FIRST USE 4-1-2005; IN COMMERCE 4-1-2005.

CLASS 42—SCIENTIFIC AND COMPUTER SERVICES

FOR DESIGN SERVICES, NAMELY, DESIGN OF LAND VEHICLE WINDOWS, WINDOW SYSTEMS, DOORS, DOOR SYSTEMS, COMPONENTS, NAMELY, LINEAR ENCLOSURES, GRILLES, DIFFUSERS, VENTS, BLOWERS, FANS, PARCEL RACKS, PANELS, SIDING, ELECTRONIC CIRCUIT CARD ASSEMBLIES, WIRE HARNESSSES, INTEGRATED ELECTRONIC SYSTEMS, SEATS, UPHOLSTERY, BODIES, CHASIS AND BAGGAGE DOORS AND LAND VEHICLE SUBASSEMBLIES (U.S. CLS. 100 AND 101).

FIRST USE 4-1-2005; IN COMMERCE 4-1-2005.

TIMOTHY FINNEGAN, EXAMINING ATTORNEY

SN 77-397,487. CITRUS DRINK VENTURES, INC., FORT LAUDERDALE, FL. FILED 2-14-2008.

SANTIVERI GREEN

THE MARK CONSISTS OF STANDARD CHARACTERS WITHOUT CLAIM TO ANY PARTICULAR FONT, STYLE, SIZE, OR COLOR.

NO CLAIM IS MADE TO THE EXCLUSIVE RIGHT TO USE "GREEN", APART FROM THE MARK AS SHOWN.

THE WORDING "SANTIVERI" HAS NO MEANING IN A FOREIGN LANGUAGE.

CLASS 3—COSMETICS AND CLEANING PREPARATIONS

FOR COSMETICS, HAIR SHAMPOOS AND CONDITIONERS, PERFUMES, SOAPS FOR BODY CARE AND PERSONAL USE (U.S. CLS. 1, 4, 6, 50, 51 AND 52).

CLASS 5—PHARMACEUTICALS

FOR DIETARY SUPPLEMENTS, VITAMINS (U.S. CLS. 6, 18, 44, 46, 51 AND 52).

CLASS 29—MEATS AND PROCESSED FOODS

FOR FOOD PRODUCTS, NAMELY, MEATS, FISH, FRUITS, NAMELY, PROCESSED, CANNED FRUITS AND VEGETABLES, NAMELY, FROZEN, CANNED, PRESERVED, MILK, COOKING OILS (U.S. CL. 46).

CLASS 30—STAPLE FOODS

FOR BAKED GOODS, NAMELY, BREADS, PASTRIES, CONFECTIONERY, NAMELY, FROZEN CONFECTIONARY, HONEY, COFFEE, RICE, CEREALS, NAMELY, READY TO EAT CEREALS (U.S. CL. 46).

CLASS 31—NATURAL AGRICULTURAL PRODUCTS

FOR FRUITS, NAMELY, FRESH, RAW OR UNPROCESSED; UNPROCESSED VEGETABLES (U.S. CLS. 1 AND 46).

CLASS 32—LIGHT BEVERAGES

FOR BEER, NON-ALCOHOLIC DRINKS, NAMELY, SOFT DRINKS, MINERAL WATER (U.S. CLS. 45, 46 AND 48).

CLASS 35—ADVERTISING AND BUSINESS

FOR RETAIL STORE SERVICES AND SHOPS FEATURING NATURAL PRODUCTS, ADVERTISING AND BUSINESS SERVICES, NAMELY, SECURING AIRTIME ON ALL FORMS OF MEDIA COMMUNICATIONS STATIONS, SYSTEMS, NETWORKS, AND SERVICES FOR THE PURPOSE OF PROMOTING THE GOODS AND SERVICES OF OTHERS (U.S. CLS. 100, 101 AND 102).

CLASS 43—HOTEL AND RESTAURANT SERVICES

FOR RESTAURANT SERVICES (U.S. CLS. 100 AND 101).

CLASS 44—MEDICAL, BEAUTY AND AGRICULTURAL SERVICES

FOR BEAUTY SERVICES, NAMELY, BEAUTY SALONS, HYGIENIC AND BEAUTY CARE (U.S. CLS. 100 AND 101).

PRISCILLA MILTON, EXAMINING ATTORNEY

SN 77-399,915. SAFERACK, LLC, ANDREWS, SC. FILED 2-19-2008.

SAFERACK

THE MARK CONSISTS OF STANDARD CHARACTERS WITHOUT CLAIM TO ANY PARTICULAR FONT, STYLE, SIZE, OR COLOR.

CLASS 6—METAL GOODS

FOR FALL PROTECTION EQUIPMENT AND COMPONENTS THEREOF FOR FALL RESTRAINT AND FALL ARREST AND MADE PRIMARILY OF METAL, NAMELY, GANGWAYS, STAIRS, SAFETY CAGES, SAFETY GATES, AND HANDRAIL SYSTEMS AND PLATFORMS FOR FALL RESTRAINT AND FALL ARREST COMPRISED OF ONE OR MORE OF THE FOLLOWING: HANDRAILS, LOADING RACKS AND RAMPS (U.S. CLS. 2, 12, 13, 14, 23, 25 AND 50).
FIRST USE 1-0-2004; IN COMMERCE 1-0-2004.

CLASS 9—ELECTRICAL AND SCIENTIFIC APPARATUS

FOR FALL PROTECTION EQUIPMENT AND COMPONENTS THEREOF FOR FALL RESTRAINT AND FALL ARREST, NAMELY, CLIMBING PROTECTION AND ANCHOR SYSTEMS COMPRISED OF ONE OR MORE OF THE FOLLOWING: SAFETY RESTRAINTS AND HARNESES OTHER THAN FOR VEHICLE SEATS OR SPORTS EQUIPMENT, LANYARDS FOR FALL PROTECTION PURPOSES, AND LIFELINE CABLES AND METAL TROLLEY BEAMS FOR ATTACHMENT TO LANYARDS FOR FALL PROTECTION PURPOSES (U.S. CLS. 21, 23, 26, 36 AND 38).

FIRST USE 11-0-2003; IN COMMERCE 11-0-2003.
MARCIE MILONE, EXAMINING ATTORNEY

SN 77-403,148. BUSINESS INTELLIGENCE ADVISORS, INC., BOSTON, MA. FILED 2-21-2008.

BUSINESS INTELLIGENCE ADVISORS

THE MARK CONSISTS OF STANDARD CHARACTERS WITHOUT CLAIM TO ANY PARTICULAR FONT, STYLE, SIZE, OR COLOR.

OWNER OF U.S. REG. NOS. 3,077,139, 3,130,284 AND OTHERS.

NO CLAIM IS MADE TO THE EXCLUSIVE RIGHT TO USE "ADVISORS", APART FROM THE MARK AS SHOWN. SEC. 2(F).

CLASS 16—PAPER GOODS AND PRINTED MATTER

FOR PRINTED MATTER, NAMELY, JOURNALS, NEWSLETTERS, BULLETINS, PAMPHLETS, REPORTS AND INSTRUCTIONAL AND TEACHING MATERIALS IN THE FIELDS OF FINANCIAL ADVISORY SERVICES, INVESTMENT SERVICES, IMPLEMENTATION OF BUSINESS INTELLIGENCE, AND PERSONNEL RECRUITMENT AND MANAGEMENT ADVICE SERVICES (U.S. CLS. 2, 5, 22, 23, 29, 37, 38 AND 50).
FIRST USE 9-30-2001; IN COMMERCE 9-30-2001.

CLASS 35—ADVERTISING AND BUSINESS

FOR BUSINESS CONSULTATION SERVICES; ADVISING OTHERS IN THE FIELD OF BUSINESS INTELLIGENCE; DEVELOPING AND PROVIDING BUSINESS INTELLIGENCE; PERSONNEL RECRUITMENT AND MANAGEMENT ADVICE; STRATEGIC INTERVIEWING FOR OTHERS FOR BUSINESS PURPOSES; CONSULTANCY SERVICES RELATING TO THE ASSESSMENT, DEVELOPMENT AND APPLICATION OF HUMAN RESOURCES; BUSINESS MANAGEMENT CONSULTATION REGARDING EMPLOYMENT AND PERSONNEL; PREPARATION OF BUSINESS REPORTS ALL RELATING TO THE AFORESAID SERVICES; BUSINESS INVESTIGATION SERVICES, NAMELY, NON-COERCIVE INTERROGATION AND DECEPTION DETECTION SERVICES (U.S. CLS. 100, 101 AND 102).

FIRST USE 2-28-2002; IN COMMERCE 2-28-2002.

CLASS 36—INSURANCE AND FINANCIAL

FOR FINANCIAL ADVISORY SERVICES, NAMELY, INVESTMENT ANALYSIS AND RESEARCH, MONITORING, COLLECTING AND ANALYZING INFORMATION FOR USE IN MAKING FINANCIAL DECISIONS (U.S. CLS. 100, 101 AND 102).

FIRST USE 2-28-2002; IN COMMERCE 2-28-2002.

CLASS 41—EDUCATION AND ENTERTAINMENT

FOR CAREER TRAINING BY EXECUTIVE COACHING, EDUCATIONAL SERVICES, NAMELY, CONFERENCES, TRAINING COURSES, TESTING, WORKSHOPS AND DISTRIBUTING COURSE MATERIALS IN CONNECTION THEREWITH ALL IN THE FIELDS OF INVESTMENT SERVICES, FINANCIAL ADVISORY SERVICES AND PERSONNEL RECRUITMENT AND MANAGEMENT ADVICE SERVICES, EDUCATIONAL SERVICES, NAMELY, CONDUCTING FORMAL AND INFORMAL PROGRAMS IN THE FIELD OF IMPLEMENTING BUSINESS INTELLIGENCE, USING ON-LINE ACTIVITIES AND INTERACTIVE EXHIBITS, AND PRINTABLE MATERIALS DISTRIBUTED THEREWITH (U.S. CLS. 100, 101 AND 107).

FIRST USE 2-28-2002; IN COMMERCE 2-28-2002.

CLASS 45—PERSONAL AND LEGAL SERVICES

FOR GENERAL INVESTIGATIVE SERVICES, NAMELY, NON-COERCIVE INTERROGATION AND DECEPTION DETECTION SERVICES, PHYSICAL SECURITY ASSESSMENT SERVICES FOR BUSINESSES (U.S. CLS. 100 AND 101).

FIRST USE 2-28-2002; IN COMMERCE 2-28-2002.
NANCY CLARKE, EXAMINING ATTORNEY

SN 77-403,358. VIALINK, INC., DAVIE, FL. FILED 2-21-2008.

LINKING MINDS TO MATTER

THE MARK CONSISTS OF STANDARD CHARACTERS WITHOUT CLAIM TO ANY PARTICULAR FONT, STYLE, SIZE, OR COLOR.

CLASS 37—CONSTRUCTION AND REPAIR

FOR MAINTAINING SURVEYING AND MAPPING COMPUTER-HARDWARE SYSTEMS FOR OTHERS (U.S. CLS. 100, 103 AND 106).

CLASS 42—SCIENTIFIC AND COMPUTER SERVICES

FOR SURVEYING AND MAPPING CONSULTING SERVICES, NAMELY, DESIGNING AND IMPLEMENTING SURVEYING AND MAPPING COMPUTER HARDWARE AND SOFTWARE SYSTEMS FOR OTHERS WITH SURVEYING AND MAPPING DATA IN A QUERY-ABLE DATABASE FOR OTHERS; MAINTAINING SURVEYING AND MAPPING COMPUTER-SOFTWARE SYSTEMS FOR OTHERS (U.S. CLS. 100 AND 101).

BRENDAN REGAN, EXAMINING ATTORNEY



SN 77-403,419. SOURCE MANAGEMENT INVESTMENTS, LLC, AUBURN, WA. FILED 2-22-2008.

SMI

THE MARK CONSISTS OF STANDARD CHARACTERS WITHOUT CLAIM TO ANY PARTICULAR FONT, STYLE, SIZE, OR COLOR.

CLASS 6—METAL GOODS

FOR METAL MINNOW AND CRAYFISH TRAPS; METAL CRAB TRAPS; FISH TRAP HARNESSSES SPECIALLY ADAPTED FOR METAL TRAPS; METAL SHRIMP TRAPS (U.S. CLS. 2, 12, 13, 14, 23, 25 AND 50).

CLASS 28—TOYS AND SPORTING GOODS

FOR RECREATIONAL FISHING EQUIPMENT, NAMELY, HOOKS, SWIVELS, FISHING SNAPS AND SPLIT RINGS, SINKERS AND SINKER SLIDES, FISHING FLOATS, FLOAT AND SINKER STOPS, LURES INCLUDING SPINNERS, SPOONS AND FLIES, FISHING LINE, FISHING LEADERS, FISHING RIGS, FISHING BEADS, LIVE-FISH STORAGE BASKETS, FISH STRINGERS, FISH CREELS, FISHING ROD HOLDERS, FISHING ROD RACKS, FISHING BELLS, TACKLE AND BAIT BOXES, HOOK REMOVERS (U.S. CLS. 22, 23, 38 AND 50).

CAROLINE WOOD, EXAMINING ATTORNEY



SN 77-403,421. SOURCE MANAGEMENT INVESTMENTS, LLC, AUBURN, WA. FILED 2-22-2008.



THE MARK CONSISTS OF THE LETTERS "SMI" WITH THE DESIGN OF A FISH HOOK LOOPED AROUND THE LETTER "M".

CLASS 6—METAL GOODS

FOR METAL MINNOW AND CRAYFISH TRAPS; METAL CRAB TRAPS; FISH TRAP HARNESSSES SPECIALLY ADAPTED FOR METAL TRAPS; METAL SHRIMP TRAPS (U.S. CLS. 2, 12, 13, 14, 23, 25 AND 50).

CLASS 28—TOYS AND SPORTING GOODS

FOR RECREATIONAL FISHING EQUIPMENT, NAMELY, HOOKS, SWIVELS, FISHING SNAPS AND SPLIT RINGS, SINKERS AND SINKER SLIDES, FISHING FLOATS, FLOAT AND SINKER STOPS, LURES INCLUDING SPINNERS, SPOONS AND FLIES, FISHING LINE, FISHING LEADERS, FISHING RIGS, FISHING BEADS, LIVE-FISH STORAGE BASKETS, FISH STRINGERS, FISH CREELS, FISHING ROD HOLDERS, FISHING ROD RACKS, FISHING BELLS, TACKLE AND BAIT BOXES, HOOK REMOVERS (U.S. CLS. 22, 23, 38 AND 50).

CAROLINE WOOD, EXAMINING ATTORNEY



SN 77-405,099. CAMBRIOS TECHNOLOGIES CORPORATION, MOUNTAIN VIEW, CA. FILED 2-25-2008.

CLEAROHM

THE MARK CONSISTS OF STANDARD CHARACTERS WITHOUT CLAIM TO ANY PARTICULAR FONT, STYLE, SIZE, OR COLOR.

CLASS 1—CHEMICALS

FOR CHEMICAL PHOTOSENSITIZER SOLUTION, PHOTORESIST AND ETCHANT SOLUTIONS FOR PATTERNING CONDUCTIVE AND OPTICAL FILMS INCLUDING CONDUCTIVE AND OPTICAL FILMS FOR USE IN THIN-FILM TRANSISTORS; CHEMICAL TONING AND FIXING SOLUTIONS FOR STABILIZING CONDUCTIVE OR OPTICAL FILMS; CHEMICAL DEVELOPING SOLUTIONS FOR CONDUCTIVE AND OPTICAL FILMS FOR USE IN THIN-FILM TRANSISTORS; CHEMICAL AGENTS AND ADDITIVES FOR PROTECTION AND IMPROVING ADHESION OF CONDUCTIVE OR OPTICAL FILMS, NAMELY, POLYMERIC COATINGS; CHEMICAL DILUENTS AND SOLVENTS FOR BLENDING WITH CONDUCTIVE AND OPTICAL COATINGS IN THE NATURE OF CONDUCTIVE AND OPTICAL INKS FOR FABRICATING CONDUCTIVE AND OPTICALLY ACTIVE FILMS FOR FABRICATING CONDUCTIVE AND OPTICAL MATERIALS (U.S. CLS. 1, 5, 6, 10, 26 AND 46).

CLASS 2—PAINTS

FOR COATING SOLUTIONS CONSISTING OF CONDUCTIVE AND OPTICAL COATINGS IN THE NATURE OF CONDUCTIVE AND OPTICAL INKS FOR FABRICATING CONDUCTIVE AND OPTICAL MATERIALS, NAMELY, ELECTRICAL CONDUCTORS, POLARIZERS AND QUARTER-WAVE PLATES; BINDER MATERIALS, FOR PROTECTING AND IMPROVING ADHESION OF CONDUCTIVE OR OPTICAL FILMS, NAMELY, FIXATIVES FOR INDUSTRIAL USE IN THE NATURE OF A POLYMERIC PROTECTIVE COATING (U.S. CLS. 6, 11 AND 16).

CLASS 3—COSMETICS AND CLEANING PREPARATIONS

FOR WASHING AND CLEANING SOLUTIONS FOR CLEANING SUBSTRATE SURFACES BEFORE COATING WITH COATING SOLUTIONS; WASHING AND CLEANING SOLUTIONS FOR CLEANING PRODUCTION EQUIPMENT USED WITH COATING SOLUTIONS (U.S. CLS. 1, 4, 6, 50, 51 AND 52).

CLASS 9—ELECTRICAL AND SCIENTIFIC APPARATUS

FOR CONDUCTIVE AND OPTICAL MATERIALS, NAMELY, ELECTRICAL CONDUCTOR AND POLARIZATION MAINTAINING OPTICAL FIBERS (U.S. CLS. 21, 23, 26, 36 AND 38).

CLASS 16—PAPER GOODS AND PRINTED MATTER

FOR PLASTIC TRANSFERS SHEETS (U.S. CLS. 2, 5, 22, 23, 29, 37, 38 AND 50).

CLASS 17—RUBBER GOODS

FOR POLYMER FILMS USED FOR MANUFACTURING ELECTRONIC CIRCUITS; POLYMER FILMS FOR ELECTROMAGNETIC RADIATION SHIELDING IN ELECTRONIC PRODUCTS; ADHESIVE-COATED PLASTIC SHEETS (U.S. CLS. 1, 5, 12, 13, 35 AND 50).
SANDRA MANIOS, EXAMINING ATTORNEY

CLASS 36—INSURANCE AND FINANCIAL

FOR QUOTATION OF STOCK EXCHANGES PRICES; FINANCIAL INFORMATION SERVICES; EXCHANGE SERVICES RELATING TO SHARES, SECURITIES, COMMODITIES, CREDIT DEFAULT SWAPS, FUTURES AND OPTIONS; ORGANIZATION OF TRADING MARKETS FOR FINANCIAL SERVICES AND FINANCIAL INSTRUMENTS; ORGANIZATION AND OPERATION OF TRADING MARKETS FOR FINANCIAL SERVICES AND FINANCIAL INSTRUMENTS; INFORMATION AND ADVISORY SERVICES RELATING TO THE AFORESAID SERVICES; PROVIDING A COMPUTERIZED DATABASE IN THE FIELDS OF TRADING OF SECURITIES, SHARES, COMMODITIES, CREDIT DEFAULT SWAPS, FUTURES AND OPTIONS (U.S. CLS. 100, 101 AND 102).

CLASS 42—SCIENTIFIC AND COMPUTER SERVICES

FOR COMPUTER PROGRAMMING; COMPUTER RENTAL; MAINTENANCE OF COMPUTER SOFTWARE; COMPUTER SOFTWARE DESIGN; COMPUTER SOFTWARE ANALYSIS; RENTAL OF COMPUTER SOFTWARE (U.S. CLS. 100 AND 101).
HEATHER THOMPSON, EXAMINING ATTORNEY

SN 77-408,550. BANKOLE-HAMEED, SHEHU, NAPERVILLE, IL. FILED 2-28-2008.

XPRSURSLF

THE MARK CONSISTS OF STANDARD CHARACTERS WITHOUT CLAIM TO ANY PARTICULAR FONT, STYLE, SIZE, OR COLOR.

CLASS 25—CLOTHING

FOR SHORT-SLEEVED OR LONG-SLEEVED T-SHIRTS; T-SHIRTS; DRESS SHIRTS; SHIRT FRONTS (U.S. CLS. 22 AND 39).

CLASS 40—MATERIAL TREATMENT

FOR IMPRINTING MESSAGES ON T-SHIRTS (U.S. CLS. 100, 103 AND 106).
BARBARA A. GOLD, EXAMINING ATTORNEY

SN 77-408,695. JOLIE MARIEE CO., LTD, TOSHIMA-KU, TOKYO, JAPAN, FILED 2-28-2008.

デコ電

THE MARK DOES NOT IDENTIFY A LIVING INDIVIDUAL.

THE WORDING DEKODEN HAS NO MEANING IN A FOREIGN LANGUAGE.

THE NON-LATIN CHARACTERS IN THE MARK TRANSLITERATE TO DEKODEN, AND THIS MEANS DEKODEN IN ENGLISH.

SN 77-407,901. LIFFE ADMINISTRATION AND MANAGEMENT, LONDON, UNITED KINGDOM, FILED 2-27-2008.

BCLEAR

THE MARK CONSISTS OF STANDARD CHARACTERS WITHOUT CLAIM TO ANY PARTICULAR FONT, STYLE, SIZE, OR COLOR.

OWNER OF UNITED KINGDOM REG. NO. 2394380, DATED 2-24-2006, EXPIRES 6-15-2015.

CLASS 9—ELECTRICAL AND SCIENTIFIC APPARATUS

FOR COMPUTERS; COMPUTER PROGRAMS AND COMPUTER SOFTWARE IN THE FIELDS OF TRADING OF SECURITIES, SHARES, COMMODITIES, CREDIT DEFAULT SWAPS, FUTURES AND OPTIONS; PRE-RECORDED MAGNETIC DATA CARRIERS AND RECORDING DISCS FEATURING FINANCIAL INFORMATION IN THE FIELDS OF TRADING OF SECURITIES, SHARES, COMMODITIES, CREDIT DEFAULT SWAPS, FUTURES AND OPTIONS (U.S. CLS. 21, 23, 26, 36 AND 38).

CLASS 9—ELECTRICAL AND SCIENTIFIC APPARATUS

FOR STRAP AND NECKPIECE FOR MOBILE PHONE; CASES FOR MOBILE PHONES; COMPUTER GAME CONSOLES ADOPTED FOR USE WITH AN EXTERNAL DISPLAY SCREEN OR MONITOR; COMPUTER APPLICATION SOFTWARE FOR MOBILE PHONES; DOWNLOADABLE RING TONES FOR MOBILE PHONES; EYEGLASSES (U.S. CLS. 21, 23, 26, 36 AND 38).

SN 77-408,763. PET INCORPORATED, MINNEAPOLIS, MN. FILED 2-28-2008.



CLASS 14—JEWELRY

FOR PRECIOUS METALS; ORNAMENTS OF PRECIOUS METAL; UNWROUGHT AND SEMI-WROUGHT PRECIOUS STONES AND THEIR IMITATIONS (U.S. CLS. 2, 27, 28 AND 50).
KELLY MCCOY, EXAMINING ATTORNEY

OWNER OF U.S. REG. NOS. 1,952,902, 3,359,082 AND OTHERS.
THE COLOR(S) RED IS/ARE CLAIMED AS A FEATURE OF THE MARK.
THE MARK CONSISTS OF A RED TILE ROOF DESIGN. SEC. 2(F).

SN 77-408,736. LOVABLE LABELS INC., MISSISSAUGA, ONTARIO, CANADA, FILED 2-28-2008.

CLASS 29—MEATS AND PROCESSED FOODS

FOR PROCESSED JALAPENOS; CANNED VEGETABLES; REFRIED BEANS (U.S. CL. 46).
FIRST USE 11-30-1978; IN COMMERCE 11-30-1978.

CLASS 30—STAPLE FOODS

FOR PACKAGED TACO SHELLS; TOSTADO SHELLS; DRY TACO SEASONING MIX; DRY ENCHILADA SAUCE MIX; DRY CHILI SEASONING MIX; DRY BURRITO SEASONING MIX; DRY FAJITA SEASONING MIX; TACO SAUCE; SALSA; ENCHILADA SAUCE; TACO DINNER KITS CONSISTING OF TACO SHELLS, TACO SAUCE AND DRY TACO SEASONING MIX; TORTILLAS; SPANISH RICE; AND CANNED CHEESE SAUCE (U.S. CL. 46).
FIRST USE 11-30-1978; IN COMMERCE 11-30-1978.
NANCY CLARKE, EXAMINING ATTORNEY



SN 77-409,709. PERRY EQUIPMENT CORPORATION, MINERAL WELLS, TX. FILED 2-29-2008.

NO CLAIM IS MADE TO THE EXCLUSIVE RIGHT TO USE "LABELS", APART FROM THE MARK AS SHOWN.



CLASS 16—PAPER GOODS AND PRINTED MATTER

FOR PERSONALIZED ADHESIVE LABELS, PERSONALIZED ADHESIVE SHOE LABELS, PERSONALIZED STICKER LABELS, PERSONALIZED VINYL ALLERGY LABELS, PERSONALIZED ADHESIVE HOUSEHOLD LABELS (U.S. CLS. 2, 5, 22, 23, 29, 37, 38 AND 50).

OWNER OF U.S. REG. NO. 797,203.
THE MARK CONSISTS OF THE WORDS "PECO FACET" WITH A CRESCENT DESIGN AROUND THE "PECO" PORTION.

CLASS 42—SCIENTIFIC AND COMPUTER SERVICES

FOR DESIGN OF CUSTOM LABELS FOR OTHERS (U.S. CLS. 100 AND 101).
CAROLINE WOOD, EXAMINING ATTORNEY

CLASS 6—METAL GOODS

FOR VESSELS MADE OF METAL FOR USE IN PETROLEUM PRODUCTION AND PROCESSING (U.S. CLS. 2, 12, 13, 14, 23, 25 AND 50).

CLASS 7—MACHINERY

FOR FILTERS AND SEPARATORS FOR LIQUIDS, SOLIDS, AND GASES, FOR USE AS PARTS OF ENGINES, MOTORS, OR MACHINES, NAMELY, MACHINES USED IN THE FOLLOWING INDUSTRIES: ENVIRONMENTAL, AVIATION, NATURAL GAS, POWER GENERATION, PETROCHEMICAL, REFINING, PETROLEUM PRODUCTION AND PROCESSING, MARINE, MILITARY, GENERAL INDUSTRIAL, CHEMICAL PRODUCTION, FOOD AND BEVERAGE PRODUCTION, ELECTRONICS PRODUCTION, POLYMERS PRODUCTION, AND PULP AND PAPER PRODUCTION (U.S. CLS. 13, 19, 21, 23, 31, 34 AND 35).

CLASS 9—ELECTRICAL AND SCIENTIFIC APPARATUS

FOR MONITORS FOR POLLUTION CONTROL EQUIPMENT, NAMELY, MONITORS FOR THE DETECTION OF POLLUTION AND CONTAMINANTS IN AIR, GAS, LIQUID, AND FUEL STREAMS AND PIPELINES (U.S. CLS. 21, 23, 26, 36 AND 38).

CLASS 11—ENVIRONMENTAL CONTROL APPARATUS

FOR OIL, GAS, AIR, AND WATER FILTERS, COALESCERS, AND SEPARATORS FOR USE IN PETROLEUM PRODUCTION AND PROCESSING; WATER POLLUTION FILTERS AND SEPARATORS FOR THE CLEANING, DECONTAMINATION, OR PURIFICATION OF WATER AND PARTS THEREFOR; AIR POLLUTION FILTERS AND SEPARATORS FOR THE CLEANING, DECONTAMINATION, OR PURIFICATION OF AIR AND PARTS THEREFOR; FILTERS AND SEPARATORS FOR THE CLEANING, DECONTAMINATION, PURIFICATION, OR SEPARATING OF LIQUIDS, SOLIDS AND GASES; ALL OF THE FORGOING FOR USE OTHER THAN AS PARTS OF MACHINES, ENGINES OR MOTORS (U.S. CLS. 13, 21, 23, 31 AND 34).

SUE LAWRENCE, EXAMINING ATTORNEY

SN 77-411,138. SEACHANGE INTERNATIONAL, INC., MAYNARD, MA. FILED 3-3-2008.

VOODLE

THE MARK CONSISTS OF STANDARD CHARACTERS WITHOUT CLAIM TO ANY PARTICULAR FONT, STYLE, SIZE, OR COLOR.

CLASS 38—COMMUNICATION

FOR TRANSMISSION AND BROADCAST OF CONTENT, DATA, SOUND, IMAGES, AUDIO-VISUAL MATERIALS; TRANSMISSION AND BROADCAST OF CONTENT, DATA, SOUND, IMAGES, AND AUDIO-VISUAL MATERIALS FOUND ONLINE AND ON COMPUTER NETWORKS OVER CABLE, INTERNET, MOBILE, VOICE, BROADCAST, SATELLITE, DIGITAL TELEVISION AND BROADCAST NETWORKS AND OTHER AUDIO AND AUDIO-VIDEO INFORMATION DISTRIBUTION NETWORKS (U.S. CLS. 100, 101 AND 104).

CLASS 41—EDUCATION AND ENTERTAINMENT

FOR COMPUTER SERVICES, NAMELY, PROVIDING A WEBSITE IN THE FIELDS OF INTERACTIVE ENTERTAINMENT, TELEVISION PROGRAMMING AND USER GENERATED ENTERTAINMENT CONTENT (U.S. CLS. 100, 101 AND 107).

CLASS 42—SCIENTIFIC AND COMPUTER SERVICES

FOR ACTING AS AN APPLICATION SERVICE PROVIDER TO HOST COMPUTER APPLICATION SOFTWARE FOR SEARCHING AND RETRIEVING INFORMATION FROM DATABASES AND COMPUTER NETWORKS IN THE FIELDS OF BROADCASTING AND ENTERTAINMENT; PROVIDING ON-LINE, NON-DOWNLOADABLE COMPUTER SOFTWARE FOR THE COLLECTION, EDITING, ORGANIZING, BROADCAST, TRANSMISSION, STORAGE AND SHARING OF CONTENT, DATA AND INFORMATION FOUND ONLINE AND FOR THE TRANSMISSION AND BROADCASTING OF CONTENT ON CABLE, INTERNET, MOBILE, VOICE, BROADCAST, SATELLITE, DIGITAL TELEVISION NETWORKS AND OTHER AUDIO AND AUDIO-VIDEO INFORMATION DISTRIBUTION NETWORKS (U.S. CLS. 100 AND 101).

JEFF DEFORD, EXAMINING ATTORNEY

SN 77-414,978. UNIVERSITY OF THE SCIENCES IN PHILADELPHIA, PHILADELPHIA, PA. FILED 3-6-2008.

PHILADELPHIA COLLEGE OF
PHARMACY

THE MARK CONSISTS OF STANDARD CHARACTERS WITHOUT CLAIM TO ANY PARTICULAR FONT, STYLE, SIZE, OR COLOR.

SEC. 2(F).

CLASS 35—ADVERTISING AND BUSINESS

FOR BUSINESS RESEARCH SERVICES, NAMELY, PROVIDING AND FACILITATING PHARMACOECONOMICS RESEARCH FOR IMPROVING UTILIZATION, COSTS, AND REIMBURSEMENTS THROUGH APPLIED PHARMACOECONOMICS FOR THE PHARMACEUTICAL AND HEALTH CARE INDUSTRIES (U.S. CLS. 100, 101 AND 102).

FIRST USE 0-0-1821; IN COMMERCE 0-0-1821.

CLASS 41—EDUCATION AND ENTERTAINMENT

FOR EDUCATIONAL SERVICES, NAMELY, PROVIDING COURSES OF INSTRUCTION AT THE UNDERGRADUATE, GRADUATE, AND POST-GRADUATE LEVELS; PROVIDING EDUCATIONAL RESEARCH PROGRAMS FOR ALL ASPECTS OF PHARMACEUTICAL STUDY; PROVIDING CONTINUING EDUCATION CONFERENCES, SEMINARS AND WORKSHOPS IN THE FIELDS OF PHARMACEUTICAL STUDY, HEALTH CARE, AND HEALTH SCIENCES; CONDUCTING CONFERENCES AND SEMINARS RELATED TO THE STUDY OF PHARMACY AND THE PHARMACEUTICAL AND HEALTH CARE INDUSTRIES; PUBLICATION OF NEWSLETTERS, NEWS BRIEFS, AND MONOGRAPHS FOR PHARMACISTS AND HEALTH CARE PROFESSIONALS (U.S. CLS. 100, 101 AND 107).

FIRST USE 0-0-1821; IN COMMERCE 0-0-1821.

TEJBIR SINGH, EXAMINING ATTORNEY

SN 77-415,227. KINGFISHER AIRLINES LIMITED, BANGALORE, INDIA, FILED 3-6-2008.



NO CLAIM IS MADE TO THE EXCLUSIVE RIGHT TO USE "AIRLINES", APART FROM THE MARK AS SHOWN.

CLASS 39—TRANSPORTATION AND STORAGE

FOR AIR TRANSPORT SERVICES; PACKAGING ARTICLES FOR TRANSPORTATION AND STORAGE OF GOODS; COORDINATING TRAVEL ARRANGEMENTS FOR INDIVIDUALS AND FOR GROUPS; AIRLINE TRANSPORTATION SERVICES (U.S. CLS. 100 AND 105).

CLASS 43—HOTEL AND RESTAURANT SERVICES

FOR PROVIDING FOOD AND DRINK IN ASSOCIATION WITH AIR TRANSPORT SERVICES; PROVIDING TEMPORARY ACCOMMODATION IN ASSOCIATION WITH AIR TRANSPORT SERVICES (U.S. CLS. 100 AND 101).

BARBARA GAYNOR, EXAMINING ATTORNEY

SN 77-417,560. JAMES HARDIE INTERNATIONAL FINANCE B.V., AMSTERDAM, NETHERLANDS, FILED 3-10-2008.

HARDIEWRAP

THE MARK CONSISTS OF STANDARD CHARACTERS WITHOUT CLAIM TO ANY PARTICULAR FONT, STYLE, SIZE, OR COLOR.

OWNER OF U.S. REG. NOS. 2,869,643, 3,257,963 AND OTHERS.

CLASS 6—METAL GOODS

FOR METAL BUILDING FLASHING (U.S. CLS. 2, 12, 13, 14, 23, 25 AND 50).

CLASS 17—RUBBER GOODS

FOR NON-WOVEN, NON-PERFORATED POLYOLEFIN BARRIERS USED IN THE CONSTRUCTION INDUSTRY AS A WATER VAPOR BARRIER, MOISTURE BARRIER, AND AIR INFILTRATION BARRIER TO PROTECT AND COVER BUILDING STRUCTURES (U.S. CLS. 1, 5, 12, 13, 35 AND 50).

CLASS 19—NON-METALLIC BUILDING MATERIALS

FOR NON-METAL BUILDING FLASHING; TAPE, NAMELY, SEAM TAPE, WHICH IS MADE OUT OF POLYPROPYLENE COATED WITH AN ADHESIVE AND USED TO JOIN BARRIER MATERIALS AND COVER WALL, ATTIC, AND OTHER AREAS OF OUTSIDE BUILDING STRUCTURES (U.S. CLS. 1, 12, 33 AND 50).

GISELLE AGOSTO, EXAMINING ATTORNEY

SN 77-419,991. MATHENA, INC., EL RENO, OK. FILED 3-12-2008.

MATHENA

THE MARK CONSISTS OF STANDARD CHARACTERS WITHOUT CLAIM TO ANY PARTICULAR FONT, STYLE, SIZE, OR COLOR.
SEC. 2(F).

CLASS 7—MACHINERY

FOR CENTRIFUGAL PUMPS; PETROLEUM INDUSTRY POWER-OPERATED EQUIPMENT FOR DRILLING FLUID PROCESSING AND SOLIDS CONTROL, NAMELY, SHAKERS; POWER OPERATED PRESSURE CONTROL EQUIPMENT FOR USE IN DRILLING OIL, NAMELY, CHOKES AND DEGASSERS FOR EXTRACTING GAS FROM FLUID DURING OIL PRODUCTION AND DUAL MUD GAS SEPARATORS FOR HORIZONTAL DRILLING BEING COMPONENTS OF MANIFOLDS (U.S. CLS. 13, 19, 21, 23, 31, 34 AND 35).

FIRST USE 4-30-1990; IN COMMERCE 4-30-1990.

CLASS 11—ENVIRONMENTAL CONTROL APPARATUS

FOR IGNITION SYSTEMS COMPRISED OF A GAS SUPPLY TUBE WITH A NOZZLE AND AN ELECTRICAL IGNITER TO CREATE A FLAME AT THE NOZZLE FOR OIL AND GAS DRILLING AND PRODUCTION OPERATIONS, NAMELY, FOR IGNITING WASTE GASES BEING DISCHARGED FROM A WELL; MUD GAS SEPARATORS, NAMELY, SEPARATORS FOR THE CLEANING AND PURIFICATION OF DRILLING MUD; GAS EXTRACTION DEVICES, NAMELY, DEGASSER OF GAS AND EXTRACTORS OF LIQUID FOR USE IN EXTRACTING GASES FROM DRILLING FLUIDS; AND PRESSURE CONTROL EQUIPMENT, NAMELY, CHOKES AND DEGASSERS FOR SEPARATING GAS FROM FLUID DURING OIL PRODUCTION; POWER OPERATED PRESSURE CONTROL EQUIPMENT FOR USE IN DRILLING OIL, NAMELY, CHOKES, AND DEGASSERS FOR EXTRACTING GAS FROM FLUID DURING OIL PRODUCTION AND DUAL MUD GAS SEPARATORS FOR HORIZONTAL DRILLING (U.S. CLS. 13, 21, 23, 31 AND 34).

FIRST USE 4-30-1990; IN COMMERCE 4-30-1990.

CLASS 37—CONSTRUCTION AND REPAIR

FOR RENTAL OF OIL AND GAS WELL DRILLING, PRODUCTION AND WORK-OVER EQUIPMENT (U.S. CLS. 100, 103 AND 106).

FIRST USE 4-30-1990; IN COMMERCE 4-30-1990.
MYRIAH HABEEB, EXAMINING ATTORNEY

SN 77-420,051. JUNG HEBE- UND TRANSPORTTECHNIK GMBH, WAIBLINGEN, FED REP GERMANY, FILED 3-12-2008.

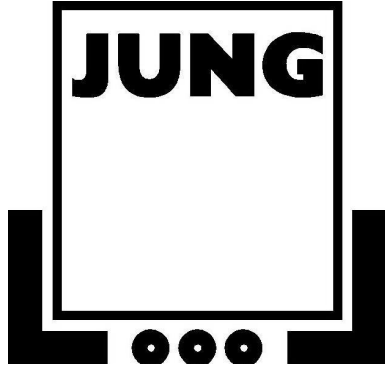

CLASS 7—MACHINERY

FOR LIFTING DEVICES, NAMELY, HYDRAULIC PUMPS, INCLUDING HYDRAULIC JACKS, HYDRAULIC JACKS WITH PUMPS SOLD AS A SET, HYDRAULIC JACKS WITH PUSH BACK/TRANSPORT UNITS SOLD AS A SET, HYDRAULIC HAND PUMPS (U.S. CLS. 13, 19, 21, 23, 31, 34 AND 35).

FIRST USE 10-18-1994; IN COMMERCE 10-18-1994.

CLASS 12—VEHICLES

FOR TRANSPORT VEHICLES, NAMELY, TRANSPORT DOLLIES (U.S. CLS. 19, 21, 23, 31, 35 AND 44).

FIRST USE 10-25-1994; IN COMMERCE 10-25-1994.

CLASS 20—FURNITURE AND ARTICLES NOT OTHERWISE CLASSIFIED

FOR NON-METAL CASTORS (U.S. CLS. 2, 13, 22, 25, 32 AND 50).

FIRST USE 10-25-1994; IN COMMERCE 10-25-1994. JEFF DEFORD, EXAMINING ATTORNEY

SN 77-420,119. MATHENA, INC., EL RENO, OK. FILED 3-12-2008.



THE MARK CONSISTS OF LETTER "M" SUPERIMPOSED OVER A SQUARE WITH HORIZONTAL LINES.

CLASS 7—MACHINERY

FOR CENTRIFUGAL PUMPS; PETROLEUM INDUSTRY POWER-OPERATED EQUIPMENT FOR DRILLING FLUID PROCESSING AND SOLIDS CONTROL, NAMELY, SHAKERS; POWER OPERATED PRESSURE CONTROL EQUIPMENT FOR USE IN DRILLING OIL, NAMELY, CHOKES AND DEGASSERS FOR EXTRACTING GAS FROM FLUID DURING OIL PRODUCTION AND DUAL MUD GAS SEPARATORS FOR HORIZONTAL DRILLING BEING COMPONENTS OF MANIFOLDS (U.S. CLS. 13, 19, 21, 23, 31, 34 AND 35).

FIRST USE 11-30-2005; IN COMMERCE 11-30-2005.

CLASS 11—ENVIRONMENTAL CONTROL APPARATUS

FOR IGNITION SYSTEMS COMPRISED OF A GAS SUPPLY TUBE WITH A NOZZLE AND AN ELECTRICAL IGNITER TO CREATE A FLAME AT THE NOZZLE FOR OIL AND GAS DRILLING AND PRODUCTION OPERATIONS, NAMELY, FOR IGNITING WASTE GASES BEING DISCHARGED FROM A WELL; MUD GAS SEPARATORS, NAMELY, SEPARATORS FOR THE CLEANING AND PURIFICATION OF DRILLING MUD; GAS EXTRACTION DEVICES, NAMELY, DEGASSER OF GAS AND EXTRACTORS OF LIQUID FOR USE IN EXTRACTING GASES FROM DRILLING FLUIDS; AND PRESSURE CONTROL EQUIPMENT, NAMELY, CHOKES AND DEGASSERS FOR SEPARATING GAS FROM FLUID DURING OIL PRODUCTION; POWER OPERATED PRESSURE CONTROL EQUIPMENT FOR USE IN DRILLING OIL, NAMELY, CHOKES, AND DEGASSERS FOR EXTRACTING GAS FROM FLUID DURING OIL PRODUCTION AND DUAL MUD GAS SEPARATORS FOR HORIZONTAL DRILLING (U.S. CLS. 13, 21, 23, 31 AND 34).

FIRST USE 11-30-2005; IN COMMERCE 11-30-2005.

CLASS 37—CONSTRUCTION AND REPAIR

FOR RENTAL OF OIL AND GAS WELL DRILLING, PRODUCTION AND WORK-OVER EQUIPMENT (U.S. CLS. 100, 103 AND 106).

FIRST USE 11-30-2005; IN COMMERCE 11-30-2005. MYRIAH HABEEB, EXAMINING ATTORNEY

SN 77-420,158. MATHENA, INC., EL RENO, OK. FILED 3-12-2008.

TRIED AND TRUE

THE MARK CONSISTS OF STANDARD CHARACTERS WITHOUT CLAIM TO ANY PARTICULAR FONT, STYLE, SIZE, OR COLOR.

CLASS 7—MACHINERY

FOR CENTRIFUGAL PUMPS; PETROLEUM INDUSTRY POWER-OPERATED EQUIPMENT FOR DRILLING FLUID PROCESSING AND SOLIDS CONTROL, NAMELY, SHAKERS; POWER OPERATED PRESSURE CONTROL EQUIPMENT FOR USE IN DRILLING OIL, NAMELY, CHOKES AND DEGASSERS FOR EXTRACTING GAS FROM FLUID DURING OIL PRODUCTION AND DUAL MUD GAS SEPARATORS FOR HORIZONTAL DRILLING BEING COMPONENTS OF MANIFOLDS (U.S. CLS. 13, 19, 21, 23, 31, 34 AND 35).

CLASS 11—ENVIRONMENTAL CONTROL APPARATUS

FOR IGNITION SYSTEMS COMPRISED OF A GAS SUPPLY TUBE WITH A NOZZLE AND AN ELECTRICAL IGNITER TO CREATE A FLAME AT THE NOZZLE FOR OIL AND GAS DRILLING AND PRODUCTION OPERATIONS, NAMELY, FOR IGNITING WASTE GASES BEING DISCHARGED FROM A WELL; MUD GAS SEPARATORS, NAMELY, SEPARATORS FOR THE CLEANING AND PURIFICATION OF DRILLING MUD; GAS EXTRACTION DEVICES, NAMELY, DEGASSER OF GAS AND EXTRACTORS OF LIQUID FOR USE IN EXTRACTING GASES FROM DRILLING FLUIDS; AND PRESSURE CONTROL EQUIPMENT, NAMELY, CHOKES AND DEGASSERS FOR SEPARATING GAS FROM FLUID DURING OIL PRODUCTION; POWER OPERATED PRESSURE CONTROL EQUIPMENT FOR USE IN DRILLING OIL, NAMELY, CHOKES, AND DEGASSERS FOR EXTRACTING GAS FROM FLUID DURING OIL PRODUCTION AND DUAL MUD GAS SEPARATORS FOR HORIZONTAL DRILLING (U.S. CLS. 13, 21, 23, 31 AND 34).

CLASS 37—CONSTRUCTION AND REPAIR

FOR RENTAL OF OIL AND GAS WELL DRILLING, PRODUCTION AND WORK-OVER EQUIPMENT (U.S. CLS. 100, 103 AND 106).
MYRIAH HABEEB, EXAMINING ATTORNEY

SN 77-420,667. CITRUS DRINK VENTURES, INC., FORT LAUDERDALE, FL. FILED 3-13-2008.

ALOVE-GREEN

THE MARK CONSISTS OF STANDARD CHARACTERS WITHOUT CLAIM TO ANY PARTICULAR FONT, STYLE, SIZE, OR COLOR.

CLASS 5—PHARMACEUTICALS

FOR DIETARY SUPPLEMENTS AND DIETARY AIDS IN THE NATURE OF FOOD SUPPLEMENTS AND VITAMINS (U.S. CLS. 6, 18, 44, 46, 51 AND 52).

CLASS 29—MEATS AND PROCESSED FOODS

FOR FOOD PRODUCTS, NAMELY, MEATS, FISH, FRUITS, NAMELY, PROCESSED, CANNED, AND PRESERVED FRUITS, AND VEGETABLES, NAMELY, FROZEN, CANNED, AND PRESERVED VEGETABLES, MILK, AND COOKING OILS (U.S. CL. 46).

CLASS 30—STAPLE FOODS

FOR BAKED GOODS, NAMELY, BREADS, PASTRIES, CONFECTIONERY, NAMELY, FROZEN CONFECTIONERIES, TEAS, HONEY, COFFEE, RICE, CEREALS, NAMELY, READY TO EAT CEREALS, BREAKFAST CEREALS, PREPARATIONS MADE FROM CEREAL (U.S. CL. 46).

CLASS 31—NATURAL AGRICULTURAL PRODUCTS

FOR UNPROCESSED CEREALS; FRUITS, NAMELY, FRESH, RAW, OR UNPROCESSED FRUITS; UNPROCESSED VEGETABLES (U.S. CLS. 1 AND 46).

CLASS 32—LIGHT BEVERAGES

FOR BEER, NON-ALCOHOLIC DRINKS, NAMELY, SODAS, SOFT DRINKS, MINERAL WATER (U.S. CLS. 45, 46 AND 48).

CLASS 36—INSURANCE AND FINANCIAL

FOR INSURANCE SERVICES, NAMELY, ADMINISTRATION OF LIFE INSURANCE; AND FINANCIAL SERVICES, NAMELY, FINANCIAL PLANNING (U.S. CLS. 100, 101 AND 102).

CLASS 43—HOTEL AND RESTAURANT SERVICES

FOR RESTAURANT SERVICES (U.S. CLS. 100 AND 101).
PRISCILLA MILTON, EXAMINING ATTORNEY

SN 77-421,529. AMERICAN SPECIALTY HEALTH INCORPORATED, SAN DIEGO, CA. FILED 3-13-2008.

Healthroads Connected!

THE MARK CONSISTS OF STANDARD CHARACTERS WITHOUT CLAIM TO ANY PARTICULAR FONT, STYLE, SIZE, OR COLOR.

OWNER OF U.S. REG. NOS. 2,726,245, 3,307,058 AND 3,352,208.

CLASS 9—ELECTRICAL AND SCIENTIFIC APPARATUS

FOR COMPUTER INTERFACES AND SOFTWARE TO BE UTILIZED WITH PEDOMETERS, ACCELEROMETERS, TREADMILLS, ELLIPTICAL EXERCISE MACHINES, STATIONARY BICYCLES AND WEIGHT LIFTING EQUIPMENT FOR DOWNLOADING THE PHYSICAL ACTIVITY DATA STORED BY THE PEDOMETERS, ACCELEROMETERS, TREADMILLS, ELLIPTICAL EXERCISE MACHINES, STATIONARY BICYCLES AND WEIGHT LIFTING EQUIPMENT INTO A WEBSITE FOR GENERAL FITNESS, ATHLETIC AND MEDICAL USE; COMPUTER INTERFACES AND SOFTWARE TO BE UTILIZED WITH WEIGHT SCALES, BLOOD PRESSURE MONITORS, AND BLOOD GLUCOSE MONITORS FOR DOWNLOADING THE PHYSIOLOGICAL DATA STORED BY THE WEIGHT SCALES, BLOOD PRESSURE MONITORS, AND BLOOD GLUCOSE MONITORS INTO A WEBSITE FOR GENERAL FITNESS, ATHLETIC AND MEDICAL USE (U.S. CLS. 21, 23, 26, 36 AND 38).

CLASS 35—ADVERTISING AND BUSINESS

FOR PROVIDING ASSISTANCE, FITNESS EVALUATION AND CONSULTATION TO HEALTH PLANS AND CORPORATE CLIENTS TO HELP THEIR MEMBER AND EMPLOYEES MAKE HEALTH AND WELLNESS CHANGES IN THEIR DAILY LIVING TO INCREASE PRODUCTIVITY AND LOWER HEALTH CARE COSTS (U.S. CLS. 100, 101 AND 102).

CLASS 41—EDUCATION AND ENTERTAINMENT

FOR PHYSICAL FITNESS COUNSELING (U.S. CLS. 100, 101 AND 107).

CLASS 42—SCIENTIFIC AND COMPUTER SERVICES

FOR PROVIDING A WEBSITE FEATURING TEMPORARY USE OF NON-DOWNLOADABLE SOFTWARE THAT GIVES USERS THE ABILITY TO UPLOAD DATA STORED IN ELECTRONIC DEVICES, MEDICAL DEVICES, AND EXERCISE EQUIPMENT FOR MEASURING AND TRACKING PROGRESS IN FITNESS, EXERCISE, AND WELLNESS PROGRAMS (U.S. CLS. 100 AND 101).

CLASS 44—MEDICAL, BEAUTY AND AGRICULTURAL SERVICES

FOR NUTRITION COUNSELING AND DIET PLANNING; PROVIDING ASSISTANCE, NUTRITIONAL EVALUATION, AND CONSULTATION TO ASSIST PEOPLE WITH MAKING DIET AND NUTRITION CHANGES TO IMPROVE HEALTH; PROVIDING ASSISTANCE, FITNESS EVALUATION AND CONSULTATION TO INDIVIDUALS TO HELP THEM MAKE HEALTH AND WELLNESS CHANGES IN THEIR DAILY LIVING TO IMPROVE HEALTH (U.S. CLS. 100 AND 101).

MARK SPARACINO, EXAMINING ATTORNEY

SN 77-421,552. AMERICAN SPECIALTY HEALTH INCORPORATED, SAN DIEGO, CA. FILED 3-13-2008.

Silver&Fit Connected!

THE MARK CONSISTS OF STANDARD CHARACTERS WITHOUT CLAIM TO ANY PARTICULAR FONT, STYLE, SIZE, OR COLOR.

OWNER OF U.S. REG. NO. 3,269,939.

CLASS 9—ELECTRICAL AND SCIENTIFIC APPARATUS

FOR COMPUTER INTERFACES AND SOFTWARE TO BE UTILIZED WITH PEDOMETERS, ACCELEROMETERS, TREADMILLS, ELLIPTICAL EXERCISE MACHINES, STATIONARY BICYCLES AND WEIGHT LIFTING EQUIPMENT FOR DOWNLOADING THE PHYSICAL ACTIVITY DATA STORED BY THE PEDOMETERS, ACCELEROMETERS, TREADMILLS, ELLIPTICAL EXERCISE MACHINES, STATIONARY BICYCLES AND WEIGHT LIFTING EQUIPMENT INTO A WEBSITE FOR GENERAL FITNESS, ATHLETIC AND MEDICAL USE; COMPUTER INTERFACES AND SOFTWARE TO BE UTILIZED WITH WEIGHT SCALES, BLOOD PRESSURE MONITORS, AND BLOOD GLUCOSE MONITORS FOR DOWNLOADING THE PHYSIOLOGICAL DATA STORED BY THE WEIGHT SCALES, BLOOD PRESSURE MONITORS, AND BLOOD GLUCOSE MONITORS INTO A WEBSITE FOR GENERAL FITNESS, ATHLETIC AND MEDICAL USE (U.S. CLS. 21, 23, 26, 36 AND 38).

CLASS 35—ADVERTISING AND BUSINESS

FOR PROVIDING ASSISTANCE, FITNESS EVALUATION AND CONSULTATION TO HEALTH PLANS AND CORPORATE CLIENTS TO HELP THEIR MEMBER AND EMPLOYEES MAKE HEALTH AND WELLNESS CHANGES IN THEIR DAILY LIVING TO INCREASE PRODUCTIVITY AND LOWER HEALTH CARE COSTS (U.S. CLS. 100, 101 AND 102).

CLASS 41—EDUCATION AND ENTERTAINMENT

FOR PHYSICAL FITNESS COUNSELING (U.S. CLS. 100, 101 AND 107).

CLASS 42—SCIENTIFIC AND COMPUTER SERVICES

FOR PROVIDING A WEBSITE FEATURING TEMPORARY USE OF NON-DOWNLOADABLE SOFTWARE THAT GIVES USERS THE ABILITY TO UPLOAD DATA STORED IN ELECTRONIC DEVICES, MEDICAL DEVICES, AND EXERCISE EQUIPMENT FOR MEASURING AND TRACKING PROGRESS IN FITNESS, EXERCISE, AND WELLNESS PROGRAMS (U.S. CLS. 100 AND 101).

CLASS 44—MEDICAL, BEAUTY AND AGRICULTURAL SERVICES

FOR NUTRITION COUNSELING AND DIET PLANNING; PROVIDING ASSISTANCE, NUTRITIONAL EVALUATION, AND CONSULTATION TO ASSIST PEOPLE WITH MAKING DIET AND NUTRITION CHANGES TO IMPROVE HEALTH; PROVIDING ASSISTANCE, FITNESS EVALUATION AND CONSULTATION TO INDIVIDUALS TO HELP THEM MAKE HEALTH AND WELLNESS CHANGES IN THEIR DAILY LIVING TO IMPROVE HEALTH (U.S. CLS. 100 AND 101).

MARK SPARACINO, EXAMINING ATTORNEY

SN 77-421,569. AMERICAN SPECIALTY HEALTH INCORPORATED, SAN DIEGO, CA. FILED 3-13-2008.

FitnessCoach Connected!

THE MARK CONSISTS OF STANDARD CHARACTERS WITHOUT CLAIM TO ANY PARTICULAR FONT, STYLE, SIZE, OR COLOR.

OWNER OF U.S. REG. NO. 3,361,066.

NO CLAIM IS MADE TO THE EXCLUSIVE RIGHT TO USE "FITNESS COACH", APART FROM THE MARK AS SHOWN.

CLASS 9—ELECTRICAL AND SCIENTIFIC APPARATUS

FOR COMPUTER INTERFACES AND SOFTWARE TO BE UTILIZED WITH PEDOMETERS, ACCELEROMETERS, TREADMILLS, ELLIPTICAL EXERCISE MACHINES, STATIONARY BICYCLES AND WEIGHT LIFTING EQUIPMENT FOR DOWNLOADING THE PHYSICAL ACTIVITY DATA STORED BY THE PEDOMETERS, ACCELEROMETERS, TREADMILLS, ELLIPTICAL EXERCISE MACHINES, STATIONARY BICYCLES AND WEIGHT LIFTING EQUIPMENT INTO A WEBSITE FOR GENERAL FITNESS, ATHLETIC AND MEDICAL USE; COMPUTER INTERFACES AND SOFTWARE TO BE UTILIZED WITH WEIGHT SCALES, BLOOD PRESSURE MONITORS, AND BLOOD GLUCOSE MONITORS FOR DOWNLOADING THE PHYSIOLOGICAL DATA STORED BY THE WEIGHT SCALES, BLOOD PRESSURE MONITORS, AND BLOOD GLUCOSE MONITORS INTO A WEBSITE FOR GENERAL FITNESS, ATHLETIC AND MEDICAL USE (U.S. CLS. 21, 23, 26, 36 AND 38).

CLASS 35—ADVERTISING AND BUSINESS

FOR PROVIDING ASSISTANCE, FITNESS EVALUATION AND CONSULTATION TO HEALTH PLANS AND CORPORATE CLIENTS TO HELP THEIR MEMBER AND EMPLOYEES MAKE HEALTH AND WELLNESS CHANGES IN THEIR DAILY LIVING TO INCREASE PRODUCTIVITY AND LOWER HEALTH CARE COSTS (U.S. CLS. 100, 101 AND 102).

CLASS 41—EDUCATION AND ENTERTAINMENT

FOR PHYSICAL FITNESS COUNSELING (U.S. CLS. 100, 101 AND 107).

CLASS 42—SCIENTIFIC AND COMPUTER SERVICES

FOR PROVIDING A WEBSITE FEATURING TEMPORARY USE OF NON-DOWNLOADABLE SOFTWARE THAT GIVES USERS THE ABILITY TO UPLOAD DATA STORED IN ELECTRONIC DEVICES, MEDICAL DEVICES, AND EXERCISE EQUIPMENT FOR MEASURING AND TRACKING PROGRESS IN FITNESS, EXERCISE, AND WELLNESS PROGRAMS (U.S. CLS. 100 AND 101).

CLASS 44—MEDICAL, BEAUTY AND AGRICULTURAL SERVICES

FOR NUTRITION COUNSELING AND DIET PLANNING; PROVIDING ASSISTANCE, NUTRITIONAL EVALUATION, AND CONSULTATION TO ASSIST PEOPLE WITH MAKING DIET AND NUTRITION CHANGES TO IMPROVE HEALTH; PROVIDING ASSISTANCE, FITNESS EVALUATION AND CONSULTATION TO INDIVIDUALS TO HELP THEM MAKE HEALTH AND WELLNESS CHANGES IN THEIR DAILY LIVING TO IMPROVE HEALTH (U.S. CLS. 100 AND 101).
MARK SPARACINO, EXAMINING ATTORNEY

CLASS 25—CLOTHING

FOR SOUVENIR CLOTHING, COMMEMORATING A RESTAURANT AND COCKTAIL LOUNGE OF THE SAME NAME, NAMELY, APRONS, ASCOTS, ATHLETIC FOOTWEAR, ATHLETIC SHOES, ATHLETIC UNIFORMS, BANDANAS, BASEBALL CAPS, BATH SLIPPERS, BATHING CAPS, BATHING SUITS, BATHING TRUNKS, BATHROBES, BEACH COVER-UPS, BEACH SHOES, BEACHWEAR, BEANIES, BELTS, BERETS, BERMUDA SHORTS, BIKINIS, BLAZERS, BLOUSES, BODY SHAPERS, BODY SUITS, BOXER SHORTS, BRAS, BRASSIERES, BRIEFS, CAMP SHIRTS, CAPS, CARDIGANS, CHEF'S HATS, WRAP-AROUNDS, COATS, COLLARS, CROP TOPS, CUFFS, DENIM JACKETS, EAR MUFFS, GOLF SHIRTS, GYM SHORTS, HALTER TOPS, HATS, HEAD BANDS, HEADWEAR, INFANT WEAR, JACKETS, JEANS, JOGGING SUITS, LEATHER JACKETS, LEG WARMERS, LEGGINGS, LIGHT-REFLECTING JACKETS, LINGERIE, LOUNGEWEAR, MOCK TURTLE-NECK SWEATERS, MONEY BELTS, MUFFLERS, NECK BANDS, NECKWEAR, NIGHT SHIRTS, PAJAMAS, PANTIES, PANTS, POLO SHIRTS, PONCHOS, PULLOVERS, RAIN JACKETS, SANDALS, SASHES, SCARVES, SHAWLS, SHIRTS, SHOES, SHORTS, SLEEP SHIRTS, SLEEPWEAR, SLIPPERS, SNEAKERS, SOCKS, SPORT COATS, SPORT SHIRTS, SUN VISORS, SWEAT BANDS, SWEAT PANTS, SWEAT SHIRTS, SWEAT SHORTS, SWEAT SUITS, SWEATERS, SWEAT SOCKS, SWIM CAPS, SWIM TRUNKS, SWIM WEAR, SWIMMING CAPS, SWIMSUITS, TANK TOPS, T-SHIRTS, VISORS, V-NECK SWEATERS, WIND RESISTANT JACKETS, WRIST BANDS, AND WRISTBANDS CONTAINING A COOLING SUBSTANCE TO COOL THE WEARER (U.S. CLS. 22 AND 39).

CLASS 43—HOTEL AND RESTAURANT SERVICES

FOR RESTAURANT AND COCKTAIL LOUNGE SERVICES (U.S. CLS. 100 AND 101).
JENNIFER VASQUEZ, EXAMINING ATTORNEY

SN 77-426,001. DIRTBAG MUSIC, INC., SAN DIEGO, CA. FILED 3-19-2008.

DBMUSIC

THE MARK CONSISTS OF STANDARD CHARACTERS WITHOUT CLAIM TO ANY PARTICULAR FONT, STYLE, SIZE, OR COLOR.
OWNER OF U.S. REG. NOS. 3,308,851 AND 3,345,488.

CLASS 9—ELECTRICAL AND SCIENTIFIC APPARATUS

FOR ELECTRONIC AND DIGITAL MEDIA, NAMELY, AUDIO CDS FEATURING MUSIC, MP3 CDS FEATURING MUSIC, AND DIGITAL AUDIO MUSIC IN DOWNLOADABLE FORMAT (U.S. CLS. 21, 23, 26, 36 AND 38).

CLASS 35—ADVERTISING AND BUSINESS

FOR ONLINE RETAIL STORE SERVICES FEATURING DOWNLOADABLE PRE-RECORDED MUSIC AND VIDEOS, SALES PROMOTION SERVICES RELATING TO MUSIC ARTISTS AND MUSIC LABELS; AUDIENCE RATING DETERMINATION FOR RADIO BROADCASTS AND OTHER MUSICAL PERFORMANCES, NAMELY, PROVIDING THE RESULTS OF RATINGS BASED ON LISTENER EVALUATIONS AND FREQUENCY OF MUSIC SELECTION, DATES, TIMES AND LOCATIONS OF MUSIC EVENTS (U.S. CLS. 100, 101 AND 102).

DRINK

THE MARK CONSISTS OF STANDARD CHARACTERS WITHOUT CLAIM TO ANY PARTICULAR FONT, STYLE, SIZE, OR COLOR.

SN 77-422,237. CANAL GROUP, INC., CHICAGO, IL. FILED 3-14-2008.

CLASS 38—COMMUNICATION

FOR STREAMING MUSIC VIDEOS ON THE INTERNET (U.S. CLS. 100, 101 AND 104).

CLASS 41—EDUCATION AND ENTERTAINMENT

FOR ENTERTAINMENT SERVICES, NAMELY, PROVIDING A WEBSITE FEATURING, LEGALLY LICENSED MUSIC, INFORMATION ABOUT ARTISTS AND MUSIC LABEL MATERIALS FOR DOWNLOAD BY CONSUMERS AND PROVIDING A WEBSITE ON A GLOBAL COMPUTER NETWORK FEATURING PRE-RECORDED MUSIC; PROVIDING A WEBSITE WHERE USERS CAN POST RATINGS, REVIEWS AND RECOMMENDATIONS ON EVENTS AND ACTIVITIES IN THE FIELD OF ENTERTAINMENT AND MUSIC, NAMELY, PROVIDING THE RESULTS OF RATINGS BASED ON LISTENER EVALUATIONS AND FREQUENCY OF MUSIC SELECTION, DATES, TIMES AND LOCATIONS OF MUSIC EVENTS; PROVIDING NEWS RELATED TO MUSIC AND MUSICAL PERFORMERS (U.S. CLS. 100, 101 AND 107).

CLASS 45—PERSONAL AND LEGAL SERVICES

FOR ONLINE SOCIAL NETWORKING SERVICES (U.S. CLS. 100 AND 101).
BRENDAN REGAN, EXAMINING ATTORNEY

SN 77-426,616. CREATIVE CAPERS ENTERTAINMENT INC., MONTROSE, CA. FILED 3-19-2008.

HouseBroken

THE MARK CONSISTS OF STANDARD CHARACTERS WITHOUT CLAIM TO ANY PARTICULAR FONT, STYLE, SIZE, OR COLOR.

CLASS 18—LEATHER GOODS

FOR CLOTHING FOR DOMESTIC PETS; COLLARS FOR PETS; COLLARS FOR PETS BEARING MEDICAL INFORMATION; GARMENTS FOR PETS; PET ACCESSORIES, NAMELY, CANVAS, VINYL AND LEATHER POUCHES FOR HOLDING DISPOSABLE BAGS TO PLACE PET WASTE IN; PET ACCESSORIES, NAMELY, SPECIALLY DESIGNED CANVAS, VINYL OR LEATHER BAGS ATTACHED TO ANIMAL LEASHES FOR HOLDING SMALL ITEMS SUCH AS KEYS, CREDIT CARDS, MONEY OR DISPOSABLE BAGS FOR DISPOSING OF PET WASTE; PET CLOTHING; PET COLLAR ACCESSORIES, NAMELY, BOWS AND CHARMS; PET COLLAR ACCESSORIES, NAMELY, CHARMS; PET PRODUCTS IN THE NATURE OF A RESTRAINING DEVICE, NAMELY, TIE-OUT STAKES AND TIE-OUT CHAINS (U.S. CLS. 1, 2, 3, 22 AND 41).

CLASS 20—FURNITURE AND ARTICLES NOT OTHERWISE CLASSIFIED

FOR BEDS FOR HOUSEHOLD PETS; CRATE COVERS FOR PETS; DEVICE FOR SCRATCHING PETS AND HUMANS, NAMELY, A GLOVE FOR SCRATCHING PETS AND HUMANS; PET CRATES; PET CUSHIONS; PET FURNITURE; PET RAMP; PLAYHOUSES FOR PETS; PORTABLE BEDS FOR PETS (U.S. CLS. 2, 13, 22, 25, 32 AND 50).

CLASS 21—HOUSEWARES AND GLASS

FOR BRUSHES FOR PETS; CAGES FOR HOUSEHOLD PETS; CAGES FOR PETS; FEEDING VESSELS FOR PETS; PET BRUSHES; PET FEEDING DISHES; PET TREAT JARS; SCOOPS FOR THE DISPOSAL OF PET WASTE (U.S. CLS. 2, 13, 23, 29, 30, 33, 40 AND 50).

CLASS 27—FLOOR COVERINGS

FOR PET FEEDING MATS (U.S. CLS. 19, 20, 37, 42 AND 50).

CLASS 28—TOYS AND SPORTING GOODS

FOR PET TOYS; PET TOYS CONTAINING CATNIP; PET TOYS MADE OF ROPE; TOYS FOR DOMESTIC PETS; CHILDREN'S MULTIPLE ACTIVITY TOYS; PLUSH TOYS; TOY MOBILES; TEDDY BEARS; CHRISTMAS STOCKINGS; CHRISTMAS TREE ORNAMENTS AND DECORATIONS (U.S. CLS. 22, 23, 38 AND 50).

CLASS 41—EDUCATION AND ENTERTAINMENT

FOR ENTERTAINMENT IN THE NATURE OF ONGOING TELEVISION PROGRAMS IN THE FIELD OF ANIMATED COMEDY AND VARIETY PROGRAMMING (U.S. CLS. 100, 101 AND 107).

CLASS 44—MEDICAL, BEAUTY AND AGRICULTURAL SERVICES

FOR PROVIDING ON-LINE INFORMATION VIA THE INTERNET IN THE FIELDS OF ANIMALS AND PETS, RELATING TO BREEDING, SELECTION OF THE ANIMALS AND PETS, CARE, GROOMING, FEEDING AND NUTRITION (U.S. CLS. 100 AND 101).
GEORGIA CARTY, EXAMINING ATTORNEY

SN 77-428,940. L.A. SPAS, INC., ANAHEIM, CA. FILED 3-22-2008.

L.A. SPAS

THE MARK CONSISTS OF STANDARD CHARACTERS WITHOUT CLAIM TO ANY PARTICULAR FONT, STYLE, SIZE, OR COLOR.

OWNER OF U.S. REG. NO. 1,707,975.
SEC. 2(F).

CLASS 9—ELECTRICAL AND SCIENTIFIC APPARATUS

FOR ELECTRICAL COMPONENTS FOR USE IN CONNECTION WITH HOT TUBS, NAMELY, HOT TUB FUSES, GROUND FAULT CIRCUIT INTERRUPTORS AND LOAD CENTERS, TRANSFORMERS, RELAYS, SENSORS, PC BOARDS, UNIONS, UPPER CONTROLS AND OVERLAYS, AIR CONTROLLERS AND INJECTORS, FIBER OPTICS, AND TIME CLOCKS (U.S. CLS. 21, 23, 26, 36 AND 38).

FIRST USE 0-0-1990; IN COMMERCE 0-0-1990.

CLASS 11—ENVIRONMENTAL CONTROL APPARATUS

FOR HOT TUBS; STRUCTURAL HOT TUB COMPONENT PARTS; AND HOT TUB ACCESSORIES, NAMELY, WATER JETS, ELECTRICAL COMPONENTS IN THE NATURE OF HEATERS AND PUMPS, ALL FOR USE IN CONNECTION WITH HOT TUBS (U.S. CLS. 13, 21, 23, 31 AND 34).

FIRST USE 0-0-1990; IN COMMERCE 0-0-1990.

CLASS 20—FURNITURE AND ARTICLES NOT OTHERWISE CLASSIFIED

FOR PILLOWS FOR USE IN CONNECTION WITH HOT TUBS (U.S. CLS. 2, 13, 22, 25, 32 AND 50).

FIRST USE 0-0-1990; IN COMMERCE 0-0-1990.

CLASS 35—ADVERTISING AND BUSINESS

FOR RETAIL STORE SERVICES FEATURING HOT TUB PARTS AND HOT TUB ACCESSORIES OF OTHERS, NAMELY, ACRYLIC REPAIR KITS, AIR CONTROLLERS AND INJECTORS, BLOWERS, COVER LIFTS, DRAINS AND SUCTIONS, FIBER OPTICS, FILTERS, FUSES, GROUND FAULT CIRCUIT INTERRUPTORS AND LOAD CENTERS, HARDWARE, HEATERS, JETS, JET SEQUENCERS, LIGHTS, LOWER CONTROL ASSEMBLIES, MANIFOLDS, OZONE, PC BOARDS, PILLOWS, PLUMBING, PRESSURE SWITCHES, PUMPS, RELAYS, SENSORS, SKIRT COMPONENTS, TIME CLOCKS, TRANSFORMERS, UNIONS, UPPER CONTROLS AND OVERLAYS, VALVES, WEIRS, WOOD ACCESSORIES AND WOOD STAINS (U.S. CLS. 100, 101 AND 102).

FIRST USE 0-0-1990; IN COMMERCE 0-0-1990.
ALLISON SCHRODY, EXAMINING ATTORNEY

SN 77-430,527. TLP, INC., DALLAS, TX. FILED 3-25-2008.

IDEAS THAT MOVE PEOPLE TO
BRANDS

THE MARK CONSISTS OF STANDARD CHARACTERS WITHOUT CLAIM TO ANY PARTICULAR FONT, STYLE, SIZE, OR COLOR.

CLASS 35—ADVERTISING AND BUSINESS

FOR ADVERTISING, MARKETING, AND PUBLIC RELATIONS SERVICES, NAMELY, PROMOTING AND MARKETING THE GOODS AND SERVICES OF OTHERS THROUGH ALL PUBLIC COMMUNICATION MEANS; INTERACTIVE MARKETING SERVICES; PRODUCTION OF INTERACTIVE MARKETING MATERIALS, NAMELY, PRODUCTION OF ADVERTISING AND MARKETING MATTER AND COMMERCIALS (U.S. CLS. 100, 101 AND 102).

CLASS 42—SCIENTIFIC AND COMPUTER SERVICES

FOR GRAPHIC DESIGN; DESIGN OF WEB SITES FOR OTHERS (U.S. CLS. 100 AND 101).

MARCIE MILONE, EXAMINING ATTORNEY

SN 77-432,797. HOME FOCUS DEVELOPMENT LTD., ROAD TOWN, BR. VIRGIN ISLANDS, FILED 3-27-2008.

DIGITCARDS

THE MARK CONSISTS OF STANDARD CHARACTERS WITHOUT CLAIM TO ANY PARTICULAR FONT, STYLE, SIZE, OR COLOR.

PRIORITY CLAIMED UNDER SEC. 44(D) ON ERPN CMNTY TM OFC APPLICATION NO. 006706485, FILED 2-28-2008, REG. NO. 006706485, DATED 2-9-2009, EXPIRES 2-28-2018.

CLASS 9—ELECTRICAL AND SCIENTIFIC APPARATUS

FOR FOLDING RULERS; GRADUATED RULERS; TAPE RULERS (U.S. CLS. 21, 23, 26, 36 AND 38).

CLASS 16—PAPER GOODS AND PRINTED MATTER

FOR WRITING UTENSILS AND MATERIALS, NAMELY, PENCILS AND PENCIL SHARPENERS, BALLPENS, BRUSHES, MARKERS, CHALK, STAPLERS, OFFICE HOLE PUNCHERS, UNGRADUATED RULERS, DRAWING RULERS, DRAFTING RULERS; INK FOR WRITING INSTRUMENTS, POUCHES FOR WRITING INSTRUMENTS, STATIONERY, BOOKMARKS, PEN HOLDERS, ERASERS, DRAFTING COMPASSES, DRAWING COMPASSES, PROTRACTORS FOR STATIONERY OR OFFICE USE, FLEXIBLE CURVES, NAMELY, DRAFTING CURVES, FRENCH CURVES, T-SQUARES, PANTOGRAPHS, STENCILS, DRAWING TRIANGLES, CRAYONS, CHARCOAL PENCILS; CARDBOARD AND PAPER ARTICLES, NAMELY, BOXES OF PAPER OR BOXES OF CARDBOARD; SCRAPBOOKS; ALBUMS, NAMELY, ALBUMS FOR COINS, PHOTOGRAPHS, MEDALS, STAMPS, EVENTS, STICKERS, TRADING CARDS, AND BUSINESS CARDS; WRITING PADS; WRITING BLOCKS, NAMELY, MEMO BLOCKS OR PRINTING BLOCKS; NOTEBOOKS; BLANK WRITING BOOKLETS; WRAPPING PAPER; GREETING CARDS; TRADING CARDS; LABELS, NAMELY, PRINTED PAPER LABELS FOR TOYS, ADDRESS LABELS, ADHESIVE LABELS, BAR CODE LABELS, PAPER LABELS AND SHIPPING LABELS; STICKERS; TAGS OF EVERY SORT, NAMELY, PAPER GIFT TAGS, PAPER HANG TAGS, CARDBOARD HANG TAGS, PAPER IDENTIFICATION TAGS, PAPER TAGS, PRICE TAGS, AND TAGS FOR INDEX CARDS; PENCIL AND PEN CASES; COLLECTIBLE ITEMS, NAMELY, TRADING CARDS AND STICKERS (U.S. CLS. 2, 5, 22, 23, 29, 37, 38 AND 50).

CLASS 28—TOYS AND SPORTING GOODS

FOR GAMES AND TOYS, NAMELY, BOARD GAMES, CARD GAMES, ACTION TYPE TARGET GAMES, PARLOUR GAMES; ROLE PLAY GAMES, FLASH CARD GAMES, MEMORY GAMES; BEANBAGS; TOY BUILDING BLOCKS; CARDBOARD AND PLASTIC CAPS FOR TOY GUNS AND TOY GUNS; MECHANICAL ACTION TOYS; KITES; ELECTRIC ACTION FIGURES; ELECTRIC ACTION FIGURES WITH LIGHTS AND SOUNDS; COLLECTIBLE ITEMS, NAMELY, ACTION FIGURES, AND PLASTIC TOY FIGURINES; TOY FINGER RINGS; TOY NECKLACES; TOY KEY RINGS; TOY BRACELETS; YO-YOS; SPINNING TOPS; PLASTIC TOYS, NAMELY, PLASTIC TOY HOOPS, PLASTIC CHARACTER TOYS; TOYS INCORPORATING MAGNETS, NAMELY, MAGNETIC FIGURINES, MAGNETIC STACKING TOYS, TOY MAGNETS, MAGNETIC DARTS; TOY CONTAINERS, NAMELY, TOY BOXES; PLUSH TOYS; FLYING DISCS; GLASS ORNAMENTS BEING CHRISTMAS TREE ORNAMENTS; CHRISTMAS TREE DECORATIONS EXCEPT CONFECTIONERY OR ILLUMINATION ARTICLES; COSTUME MASKS; STUFFED TOY ANIMALS IN VARIOUS SIZES; EQUIPMENT SOLD AS A UNIT FOR

PLAYING CARD GAMES; GAME BOARDS FOR TRADING CARD GAMES; TOY STAMPS WITH FIGURES; TOY AND WATER PISTOLS, GUNS, AND CANNONS; DOLLS AND BABY DOLLS; BALLOONS; BATHTUB TOYS; SKATEBOARDS; ICE SKATES; ROLLER SKATES; INLINE SKATES; SURF BOARDS AND SWIM BOARDS; BALLS, NAMELY, FOOTBALLS AND HANDBALLS; ELECTRONIC TOYS, NAMELY, ELECTRONIC ACTION TOYS, ELECTRONIC LEARNING TOYS, HAND-HELD ELECTRONIC GAMES, ARCADE-TYPE ELECTRONIC VIDEO GAMES, ARCADE-TYPE ELECTRONIC EDUCATION VIDEO GAMES; JIGSAW PUZZLES (U.S. CLS. 23, 38 AND 50).

CLASS 30—STAPLE FOODS

FOR CONFECTIONERY, NAMELY, SWEETS, GUM DROPS, BOILED SWEETS, LOLLIPOPS OF ANY KIND, PASTILLES, WINE GUM CANDY, FRUIT JELLIES, BUBBLE GUM, CHEWING GUM, JELLY BEANS, LICORICE, CHOCOLATE, MARZIPAN, ICE CREAM, ICE LOLLIES, CANDY STRIPS, LIQUID CANDY, CANDY GEL, CANDY JUICE, MARSHMALLOWS, CANDY FOAM, CANDY POWDER, BISCUITS, CAKES, COOKIES AND PASTRIES (U.S. CL. 46).

BRENDAN MCCAULEY, EXAMINING ATTORNEY

SN 77-434,269. ASURAGEN, INC., AUSTIN, TX. FILED 3-28-2008.

mirna
THERAPEUTICS

NO CLAIM IS MADE TO THE EXCLUSIVE RIGHT TO USE "MIRNA THERAPEUTICS", APART FROM THE MARK AS SHOWN.

THE MARK CONSISTS OF THE STYLIZED WORDING "MIRNA THERAPEUTICS" COMBINED WITH A CURVED LINE THAT PARTIALLY UNDERLINES THE TERM "MIRNA" AND INTERSECTS WITH THE LETTER "R" TO FORM A PRESCRIPTION SYMBOL.

CLASS 1—CHEMICALS

FOR MEDICAL AND BIOLOGICAL PREPARATIONS FOR RESEARCH, LABORATORY, AND MEDICAL LABORATORY USE, NAMELY, PREPARATIONS FOR THE MODULATION OF GENE EXPRESSIONS FOR USE IN REGULATING DNA, TRANSCRIPTION, RNA AND TRANSLATION PROCESSES (U.S. CLS. 1, 5, 6, 10, 26 AND 46).

CLASS 5—PHARMACEUTICALS

FOR MEDICAL AND BIOLOGICAL THERAPEUTIC PREPARATIONS FOR PHARMACEUTICAL AND CLINICAL USE, NAMELY, PREPARATIONS FOR THE MODULATION OF GENE EXPRESSIONS FOR USE IN REGULATING DNA, TRANSCRIPTION, RNA AND TRANSLATION PROCESSES (U.S. CLS. 6, 18, 44, 46, 51 AND 52).

KIM MONINGHOFF, EXAMINING ATTORNEY

SN 77-434,890. ARTBEADS.COM, INC., GIG HARBOR, WA. FILED 3-28-2008.

ARTBEADS

THE MARK CONSISTS OF STANDARD CHARACTERS WITHOUT CLAIM TO ANY PARTICULAR FONT, STYLE, SIZE, OR COLOR.

OWNER OF U.S. REG. NO. 3,287,581.
SEC. 2(F).

CLASS 14—JEWELRY

FOR COMPONENTS FOR SPECIFIC USE IN THE MANUFACTURE OF JEWELRY NOT INCLUDING BEADS, NAMELY, BEAD CAPS, SPACER BARS, CLASPS, JUMP RINGS, SPLIT RINGS, BAILS, STATIONS, LINKS, EXTENDER CHAINS, BANGLES, CRIMPS, CONES, CHARMS, PENDANTS, ZIPPER PULLS, EYE PIN, HEAD PIN, EARWIRE, WIRE, CHANDELIER WIRE, THREAD, EAR THREAD, EARRING HOOPS, CORD, RIBBON, EARRING CLIPS, EARRING CLUTCHES, EARRING POSTS, AND LEVER BACKS; JEWELRY, NAMELY, BRACELETS, NECKLACES, EARRINGS, AND CHANDELIER EARRINGS; WATCH FACES (U.S. CLS. 2, 27, 28 AND 50).

FIRST USE 1-31-2000; IN COMMERCE 1-31-2000.

CLASS 41—EDUCATION AND ENTERTAINMENT

FOR PROVIDING ENTERTAINMENT INFORMATION AND TUTORIALS ONLINE ABOUT THE HOBBY OF JEWELRY-MAKING (U.S. CLS. 100, 101 AND 107).

FIRST USE 1-31-2000; IN COMMERCE 1-31-2000.
CORY BOONE, EXAMINING ATTORNEY

SN 77-437,221. GIRL AMBITION, INC., DANVILLE, CA. FILED 4-1-2008.



CLASS 16—PAPER GOODS AND PRINTED MATTER

FOR PRINTED PERIODICALS IN THE NATURE OF A NEWSLETTER FEATURING GAMES, VIDEOS, AND ARTS AND CRAFTS FOR GIRLS (U.S. CLS. 2, 5, 22, 23, 29, 37, 38 AND 50).

CLASS 25—CLOTHING

FOR CLOTHING, NAMELY, SHIRTS, SHORTS, CAPS, DRESSES, PANTS, SHOES, SWEATERS, SWEATSHIRTS, AND JACKETS (U.S. CLS. 22 AND 39).

CLASS 38—COMMUNICATION

FOR PROVIDING AN ON-LINE ACTIVITY SERVICE FOR GIRLS TO EMAIL AND INSTANT MESSAGE FRIENDS (U.S. CLS. 100, 101 AND 104).

CLASS 41—EDUCATION AND ENTERTAINMENT

FOR ENTERTAINMENT SERVICES, NAMELY, AN ON-LINE ACTIVITY FOR GIRLS TO PLAY GAMES, WATCH VIDEOS, FIND ARTS AND CRAFTS ACTIVITIES, TAKE QUIZZES, ENTER CONTESTS, AND CREATE AVATARS (U.S. CLS. 100, 101 AND 107).
EMILY CARLSEN, EXAMINING ATTORNEY

CLASS 5—PHARMACEUTICALS

FOR DIETARY SUPPLEMENTS; DIETARY FOOD SUPPLEMENTS; DIETARY AND NUTRITIONAL SUPPLEMENTS; NUTRITIONAL ADDITIVES FOR MEDICAL PURPOSES FOR USE IN FOODS AND DIETARY FOOD SUPPLEMENTS FOR HUMAN CONSUMPTION; FOOD SUPPLEMENTS; NUTRITIONAL SUPPLEMENTS; HERBAL SUPPLEMENTS; HOMEOPATHIC SUPPLEMENTS; NUTRACEUTICALS FOR USE AS A DIETARY SUPPLEMENT; DIETARY FOOD SUPPLEMENT FOR HUMAN CONSUMPTION; ALL OF THE AFOREMENTIONED GOODS CONTAINING STEVIA (U.S. CLS. 6, 18, 44, 46, 51 AND 52).
FIRST USE 4-1-2000; IN COMMERCE 4-1-2000.

CLASS 30—STAPLE FOODS

FOR NATURAL SWEETENER; SUGAR SUBSTITUTES; SUGARFREE SWEETS; SUGARLESS SWEETS; EXTRACTS USED AS FLAVORING; FLAVOR ENHANCERS USED IN FOOD AND BEVERAGE PRODUCTS; FLAVORING ADDITIVES FOR NON-NUTRITIONAL PURPOSES; FLAVORINGS FOR BEVERAGES; FLAVORINGS FOR FOODS; FLAVORINGS, OTHER THAN ESSENTIAL OILS, FOR CAKES; FLAVORING SYRUP; FOOD ADDITIVES FOR NON-NUTRITIONAL PURPOSES FOR USE AS A FLAVORING; HONEY SUBSTITUTES; TOPPING SYRUP; ALL OF THE AFOREMENTIONED GOODS CONTAINING STEVIA (U.S. CL. 46).
FIRST USE 4-1-2000; IN COMMERCE 4-1-2000.
DAVID YONTEF, EXAMINING ATTORNEY

SN 77-437,816. BOULDER AYURVEDA LLC, BOULDER, CO. FILED 4-2-2008.

VIBRANT LOTUS

THE MARK CONSISTS OF STANDARD CHARACTERS WITHOUT CLAIM TO ANY PARTICULAR FONT, STYLE, SIZE, OR COLOR.
NO CLAIM IS MADE TO THE EXCLUSIVE RIGHT TO USE "LOTUS", APART FROM THE MARK AS SHOWN.

CLASS 5—PHARMACEUTICALS

FOR DIETARY SUPPLEMENTS AND DIETARY SUPPLEMENT DRINK MIXES (U.S. CLS. 6, 18, 44, 46, 51 AND 52).

CLASS 30—STAPLE FOODS

FOR CHAI MASALA TEAS, TEAS, AND CHAI TEAS (U.S. CL. 46).
STEVEN R. FINE, EXAMINING ATTORNEY

SN 77-438,501. UNITED AMERICAN INDUSTRIES, INC., GILBERT, AZ. FILED 4-2-2008.

STEVIA CLEAR

THE MARK CONSISTS OF STANDARD CHARACTERS WITHOUT CLAIM TO ANY PARTICULAR FONT, STYLE, SIZE, OR COLOR.
SEC. 2(F).

SN 77-439,028. SENTRY SELECT CAPITAL CORP., TORONTO, ONTARIO, CANADA, FILED 4-3-2008.

ASAP

THE MARK CONSISTS OF STANDARD CHARACTERS WITHOUT CLAIM TO ANY PARTICULAR FONT, STYLE, SIZE, OR COLOR.

CLASS 35—ADVERTISING AND BUSINESS

FOR ORDER FULFILLMENT SERVICES, NAMELY, FACILITATING THE SHIPMENT OF GOODS BY IDENTIFYING, ENLISTING AND COORDINATING WITH THIRD PARTY FIRMS TO FILL ORDERS PLACED BY BUSINESS ESTABLISHMENTS FOR DELIVERY SERVICES BY VARIOUS DIVERSE MODES OF TRANSPORTATION (U.S. CLS. 100, 101 AND 102).

CLASS 36—INSURANCE AND FINANCIAL

FOR FINANCIAL SERVICES, NAMELY, PROVIDING BRIDGE, MEZZANINE FINANCING AND MORTGAGING (U.S. CLS. 100, 101 AND 102).

CLASS 39—TRANSPORTATION AND STORAGE

FOR TRANSPORTATION SERVICES TO FACILITATE THE SHIPMENT OF GOODS, NAMELY, SHIPPING AND DELIVERY SERVICES, NAMELY, PICKUP, TRANSPORTATION AND DELIVERY OF PACKAGES AND LETTERS BY VARIOUS MODES OF TRANSPORTATION (U.S. CLS. 100 AND 105).
LINDSEY RUBIN, EXAMINING ATTORNEY

SN 77-440,000. L'OREAL, PARIS, FRANCE, FILED 4-4-2008.

SN 77-441,486. STEYR MANNLICHER HOLDING GMBH, KLEINRAMING, AUSTRIA, FILED 4-7-2008.

DERCOS

THE MARK CONSISTS OF STANDARD CHARACTERS WITHOUT CLAIM TO ANY PARTICULAR FONT, STYLE, SIZE, OR COLOR.

OWNER OF FRANCE REG. NO. 93485923, DATED 10-1-1993, EXPIRES 10-1-2013.

CLASS 3—COSMETICS AND CLEANING PREPARATIONS

FOR HAIR SHAMPOO AND HAIR MOUSSE (U.S. CLS. 1, 4, 6, 50, 51 AND 52).

CLASS 5—PHARMACEUTICALS

FOR MEDICATED LOTION FOR SEBORRHEA AND DANDRUFF (U.S. CLS. 6, 18, 44, 46, 51 AND 52).
TINA L. SNAPP, EXAMINING ATTORNEY

SN 77-440,923. RAZORTOOTH DESIGN, LLC, BROOKLYN, NY. FILED 4-5-2008.

RAZORTOOTH DESIGN

THE MARK CONSISTS OF STANDARD CHARACTERS WITHOUT CLAIM TO ANY PARTICULAR FONT, STYLE, SIZE, OR COLOR.

NO CLAIM IS MADE TO THE EXCLUSIVE RIGHT TO USE "DESIGN", APART FROM THE MARK AS SHOWN.

CLASS 20—FURNITURE AND ARTICLES NOT OTHERWISE CLASSIFIED

FOR : HANGING MODULAR SCREENS MADE OF ETHYL VINYL ACETATE FOR USE AS A SPACE DIVIDER (U.S. CLS. 2, 13, 22, 25, 32 AND 50).

CLASS 42—SCIENTIFIC AND COMPUTER SERVICES

FOR FURNITURE DESIGN SERVICES; SCULPTURE DESIGN SERVICES; MODULAR SCREEN SYSTEM DESIGN SERVICES; WALL CLADDING DESIGN SERVICES; LIGHTING DESIGN SERVICES; WATER FEATURES DESIGN; AND DESIGN OF DISPLAYS FOR USE IN MERCHANDISING (U.S. CLS. 100 AND 101).

FIRST USE 2-1-2005; IN COMMERCE 2-1-2005.
PATRICIA EVANKO, EXAMINING ATTORNEY



PRIORITY CLAIMED UNDER SEC. 44(D) ON AUSTRIA APPLICATION NO. AM7521/2007, FILED 10-30-2007, REG. NO. 242846, DATED 1-15-2008, EXPIRES 10-15-2018.

OWNER OF U.S. REG. NOS. 1,129,211, 2,236,472 AND OTHERS.

CLASS 8—HAND TOOLS

FOR SIDEARMS, NOT INCLUDING FIREARMS, NAMELY, KNIVES INCLUDING COMBAT, MILITARY, HUNTING, FISHING AND SPORTS KNIVES; SWORDS; SABRES; BILLY CLUBS AND NIGHTSTICKS; CARRYING CASES AND BAGS FOR SIDE ARMS AND SIDE ARM ACCESSORIES, NOT INCLUDING FIREARMS (U.S. CLS. 23, 28 AND 44).

CLASS 9—ELECTRICAL AND SCIENTIFIC APPARATUS

FOR OPTICAL LENS SIGHTS; TELESCOPIC LASER SIGHTS; TELESCOPIC SIGHTS; NIGHT VISION GLASSES; CARRYING CASES AND BAGS FOR FIREARM ACCESSORIES IN THE NATURE OF TELESCOPIC OR OPTICAL LENS FIREARM SIGHTS (U.S. CLS. 21, 23, 26, 36 AND 38).

CLASS 13—FIREARMS

FOR FIREARMS; PRECISION, TARGET, SNIPER AND ASSAULT GUNS; SEMI-AUTOMATIC AND FULLY-AUTOMATIC GUNS; RIFLES AND SHOTGUNS; PISTOLS AND REVOLVERS; GRENADE LAUNCHERS; STRUCTURAL PARTS FOR ALL AFOREMENTIONED GOODS; ACCESSORIES FOR ALL AFOREMENTIONED GOODS, NAMELY, STANDS AND TRIPODS, AMMUNITION CARTRIDGES, SILENCERS, AMMUNITION AND PROJECTILES; EXPLOSIVES; HOLSTERS AND AMMUNITION BELTS; CARRYING CASES AND BAGS FOR FIREARMS, AMMUNITION AND PROJECTILES (U.S. CLS. 2 AND 9).

CLASS 18—LEATHER GOODS

FOR GENERAL PURPOSE CARRYING BAGS FOR USE BY MILITARY PERSONNEL AND MARKS MEN BUT NOT INTENDED FOR CARRYING WEAPONS OR AMMUNITION; HUNTING BAGS (U.S. CLS. 1, 2, 3, 22 AND 41).

SHANNON TWOHIG, EXAMINING ATTORNEY

SN 77-445,011. JHHA CORPORATION, NEW YORK, NY. FILED 4-10-2008.



OWNER OF U.S. REG. NO. 2,728,327.
NO CLAIM IS MADE TO THE EXCLUSIVE RIGHT TO USE "JEWISH HOME LIFECARE", APART FROM THE MARK AS SHOWN.

THE COLOR(S) DARK GRAY, DARK RED AND DARK YELLOW IS/ARE CLAIMED AS A FEATURE OF THE MARK.

THE MARK CONSISTS OF THE WORDING "JEWISH HOME LIFECARE" APPEARING IN DARK GRAY AND TWO BLADES OF GRASS, ONE BLADE IN DARK RED AND ANOTHER IN DARK YELLOW.

CLASS 39—TRANSPORTATION AND STORAGE

FOR TRANSPORTATION OF THE ELDERLY BY VAN AND BUS (U.S. CLS. 100 AND 105).

CLASS 41—EDUCATION AND ENTERTAINMENT

FOR CONDUCTING TRAINING PROGRAMS ON MEDICAL CARE AND PHARMACOLOGY FOR THE ELDERLY AND ON ETHICS RELATED TO CARE FOR THE ELDERLY; MEDICAL, NURSING AND SOCIAL SERVICES PERSONNEL TRAINING SERVICES IN THE FIELD OF GERIATRIC CARE; CONDUCTING EDUCATIONAL PROGRAMS FOR THE ELDERLY RELATED TO CARING FOR THEIR PHYSICAL AND MENTAL WELL-BEING; EDUCATIONAL RESEARCH FOR OTHERS RELATING TO ISSUES AFFECTING THE ELDERLY AND CAREGIVERS FOR THE ELDERLY (U.S. CLS. 100, 101 AND 107).

CLASS 42—SCIENTIFIC AND COMPUTER SERVICES

FOR MEDICAL, PHARMACEUTICAL AND PSYCHOSOCIAL RESEARCH FOR OTHERS RELATING TO ISSUES AFFECTING THE ELDERLY AND CAREGIVERS FOR THE ELDERLY IN THE FIELDS OF THE AGING EXPERIENCE OF THE ELDERLY AND RELATING TO SERVICES FOR THE ELDERLY TO CONTRIBUTE TO THE QUALITY OF THEIR CARE AND OF THEIR LIFE AND FOR FAMILIES OF PERSONS WITH CHRONIC ILLNESS (U.S. CLS. 100 AND 101).

CLASS 43—HOTEL AND RESTAURANT SERVICES

FOR PROVIDING COMMUNITY CENTERS FOR SOCIAL GATHERINGS AND MEETINGS FOR THE ELDERLY; PROVIDING SENIOR HOUSING FACILITIES FOR THE ELDERLY, NAMELY, PROVIDING INDEPENDENT LIVING FACILITIES FOR THE ELDERLY; PROVIDING ADULT DAY CARE SERVICES FOR THE ELDERLY (U.S. CLS. 100 AND 101).

CLASS 44—MEDICAL, BEAUTY AND AGRICULTURAL SERVICES

FOR NUTRITION COUNSELING FOR THE ELDERLY; NURSING CARE FOR THE ELDERLY; NURSING HOMES FOR THE ELDERLY; MEDICAL SERVICES FOR THE ELDERLY; ARRANGING FOR KIDNEY DIALYSIS SERVICES; IN-HOME HEALTH CARE SERVICES, NAMELY, NURSING SERVICES, HOME HEALTH AIDE SERVICES, PROVIDING PHYSICAL AND MENTAL REHABILITATION FACILITIES, FOOD NUTRITION CONSULTATION, SPEECH THERAPY; SOCIAL REHABILITATION, NAMELY, PROVIDING OCCUPATIONAL THERAPY SERVICES CONCERNING ACTIVITIES OF DAILY LIVING (U.S. CLS. 100 AND 101).

CLASS 45—PERSONAL AND LEGAL SERVICES

FOR IN-HOME SUPPORT AND SOCIAL WORK SERVICES TO SENIOR PERSONS, NAMELY, GERIATRIC CARE MANAGEMENT SERVICES AND PERSONAL AFFAIRS MANAGEMENT SERVICES IN THE NATURE OF THE COORDINATION OF NECESSARY SERVICES AND CARE FOR THE ELDERLY; CASE MANAGEMENT SERVICES, NAMELY, COORDINATION OF LEGAL, SOCIAL AND PSYCHOLOGICAL SERVICES FOR THE ELDERLY (U.S. CLS. 100 AND 101).

ANDREW RHIM, EXAMINING ATTORNEY

SN 77-445,804. RECKITT & COLMAN (OVERSEAS) LIMITED, HULL, ENGLAND, FILED 4-11-2008.

FORCE OF NATURE

THE MARK CONSISTS OF STANDARD CHARACTERS WITHOUT CLAIM TO ANY PARTICULAR FONT, STYLE, SIZE, OR COLOR.

CLASS 3—COSMETICS AND CLEANING PREPARATIONS

FOR HOUSEHOLD CLEANING PREPARATIONS; ALL-PURPOSE CLEANING PREPARATIONS; PRE-MOISTENED TOWELETTES AND DISPOSABLE WIPES IMPREGNATED WITH HOUSEHOLD CLEANING PREPARATIONS (U.S. CLS. 1, 4, 6, 50, 51 AND 52).

CLASS 5—PHARMACEUTICALS

FOR ALL PURPOSE DISINFECTING AND DEODORIZING PREPARATIONS; ANTIBACTERIAL CLEANERS; SANITIZING PREPARATIONS FOR HOUSEHOLD USE; GERMICIDES; WIPES IMPREGNATED WITH ANTIBACTERIAL PREPARATIONS; SANITIZING WIPES NONE BEING FOR USE ON THE PERSON (U.S. CLS. 6, 18, 44, 46, 51 AND 52).

AMY C. KEAN, EXAMINING ATTORNEY

SN 77-448,726. GENERAL NANO, LLC, CINCINNATI, OH. FILED 4-15-2008.

BLACK COTTON

THE MARK CONSISTS OF STANDARD CHARACTERS WITHOUT CLAIM TO ANY PARTICULAR FONT, STYLE, SIZE, OR COLOR.

NO CLAIM IS MADE TO THE EXCLUSIVE RIGHT TO USE "BLACK", APART FROM THE MARK AS SHOWN.

CLASS 1—CHEMICALS

FOR VERTICALLY ALIGNED CARBON NANOTUBES, NAMELY, TUBULAR CARBON MOLECULES USED AS RAW MATERIALS IN THE MANUFACTURE OF A WIDE VARIETY OF GOODS, EXCLUDING SMALL SCALE ELECTRONIC AND MECHANICAL APPLICATIONS (U.S. CLS. 1, 5, 6, 10, 26 AND 46).

CLASS 9—ELECTRICAL AND SCIENTIFIC APPARATUS

FOR VERTICALLY ALIGNED CARBON NANOTUBES, NAMELY, TUBULAR CARBON MOLECULES USED IN SMALL SCALE ELECTRONIC AND MECHANICAL APPLICATIONS (U.S. CLS. 21, 23, 26, 36 AND 38).

STEVEN R. FOSTER, EXAMINING ATTORNEY

SN 77-449,772. BEATBOTS LLC, PITTSBURGH, PA. FILED 4-16-2008.

BEATBOTS

THE MARK CONSISTS OF STANDARD CHARACTERS WITHOUT CLAIM TO ANY PARTICULAR FONT, STYLE, SIZE, OR COLOR.

CLASS 9—ELECTRICAL AND SCIENTIFIC APPARATUS

FOR ROBOTS FOR PERSONAL OR HOBBY USE; LABORATORY ROBOTS; PRE-RECORDED DIGITAL MEDIA FEATURING EDUCATION AND ENTERTAINMENT OF GENERAL INTEREST TO CHILDREN, PARENTS, AND FAMILIES; CHILDREN'S EDUCATIONAL SOFTWARE; COMPUTER GAME SOFTWARE; MOUSEPADS (U.S. CLS. 21, 23, 26, 36 AND 38).

CLASS 25—CLOTHING

FOR SHIRTS; T-SHIRTS; PANTS; SHORTS; JACKETS; SWEATERS; SOCKS; UNDERWEAR; SLEEPWEAR; SWIMWEAR; INFANT WEAR; HATS; SCARVES; SMOCKS; VESTS; OVERALLS; NECKTIES; BELTS; FOOTWEAR; MASQUERADE COSTUMES (U.S. CLS. 22 AND 39).

CLASS 28—TOYS AND SPORTING GOODS

FOR TOY ROBOTS; BATTERY OPERATED ACTION TOYS; ELECTRONIC ACTION TOYS; PLUSH TOYS; TOY FIGURES; PUPPETS (U.S. CLS. 22, 23, 38 AND 50).

CLASS 42—SCIENTIFIC AND COMPUTER SERVICES

FOR TECHNOLOGY CONSULTATION AND RESEARCH IN THE FIELD OF ROBOTICS; INDUSTRIAL DESIGN; SOFTWARE DESIGN AND DEVELOPMENT; MECHANICAL ENGINEERING; LEASING OF USER-PROGRAMMABLE ROBOTS (U.S. CLS. 100 AND 101).
KATHERINE CHANG, EXAMINING ATTORNEY

SN 77-450,009. GSM (OPERATIONS) PTY LTD, QUEENSLAND, AUSTRALIA, FILED 4-16-2008.

BE THE CHANGE

THE MARK CONSISTS OF STANDARD CHARACTERS WITHOUT CLAIM TO ANY PARTICULAR FONT, STYLE, SIZE, OR COLOR.

PRIORITY CLAIMED UNDER SEC. 44(D) ON AUSTRALIA APPLICATION NO. 1205294, FILED 10-18-2007.

OWNER OF AUSTRALIA REG. NO. 1205294, DATED 3-2-2009, EXPIRES 10-18-2017.

CLASS 9—ELECTRICAL AND SCIENTIFIC APPARATUS

FOR DOWNLOADABLE ELECTRONIC PUBLICATIONS IN THE NATURE OF ELECTRONIC BOOKS, MAGAZINES, BROCHURES, INFORMATION SHEETS AND PAMPHLETS IN THE FIELD OF ETHICAL AND RESPONSIBLE BUSINESS PRACTICES LEADING TO EQUITABLE SOCIAL OUTCOMES, POSITIVE SOCIAL OUTCOMES OR POSITIVE ENVIRONMENTAL OUTCOMES, AND DOWNLOADABLE ELECTRONIC PUBLICATIONS IN THE NATURE OF ELECTRONIC BOOKS, MAGAZINES, BROCHURES, INFORMATION SHEETS AND PAMPHLETS IN THE FIELD OF ENVIRONMENTALLY SUSTAINABLE OR ENVIRONMENTALLY FRIENDLY MANUFACTURING, DISTRIBUTION AND RETAILING OF GOODS; PRE-RECORDED MEDIA, NAMELY, DVDS, VIDEOTAPES, CDS, MULTIMEDIA SOFTWARE RECORDED ON CD-ROMS OR COMPUTER READABLE MEMORY, ALL FEATURING INFORMATION AND ENTERTAINMENT RELATION TO ETHICAL AND RESPONSIBLE BUSINESS PRACTICES LEADING TO EQUITABLE SOCIAL OUTCOMES, POSITIVE SOCIAL OUTCOMES, POSITIVE ENVIRONMENTAL OUTCOMES, ENVIRONMENTAL SUSTAINABILITY OR ENVIRONMENTALLY FRIENDLY BUSINESS PRACTICES; MP3 PLAYERS; AUDIO EQUIPMENT FOR PLAYING RECORDED MUSIC, NAMELY, CD PLAYERS, DOCKING STATIONS FOR MP3 PLAYERS, STEREOs, SPEAKERS (U.S. CLS. 21, 23, 26, 36 AND 38).

CLASS 41—EDUCATION AND ENTERTAINMENT

FOR PROVIDING NON-DOWNLOADABLE ELECTRONIC PUBLICATIONS IN THE NATURE OF ELECTRONIC BOOKS, MAGAZINES, BROCHURES, INFORMATION SHEETS AND PAMPHLETS IN THE FIELD OF ETHICAL AND RESPONSIBLE BUSINESS PRACTICES LEADING TO EQUITABLE SOCIAL OUTCOMES, POSITIVE SOCIAL OUTCOMES OR POSITIVE ENVIRONMENTAL OUTCOMES, ENVIRONMENTAL SUSTAINABILITY OR ENVIRONMENTALLY FRIENDLY BUSINESS PRACTICES; ELECTRONIC PUBLICATION IN THE NATURE OF ELECTRONIC BOOKS, MAGAZINES, BROCHURES, INFORMATION SHEETS AND PAMPHLETS FEATURING INFORMATION ON A WIDE RANGE OF TOPICS VIA ON-LINE AND OVER A GLOBAL COMPUTER NETWORK; TRAINING AND EDUCATION, NAMELY, TRAINING AND EDUCATION IN THE NATURE OF COURSES, SEMINARS, CLASSES, WORKSHOPS, TUTORIALS, AND ONLINE LESSONS RELATING TO ETHICAL AND RESPONSIBLE BUSINESS PRACTICES LEADING TO EQUITABLE SOCIAL OUTCOMES, POSITIVE SOCIAL OUTCOMES OR POSITIVE ENVIRONMENTAL OUTCOMES; ARRANGING AND HOLDING EDUCATIONAL SEMINARS AND CONFERENCES RELATING TO ETHICAL AND RESPONSIBLE BUSINESS PRACTICES LEADING TO EQUITABLE SOCIAL OUTCOMES, POSITIVE SOCIAL OUTCOMES OR POSITIVE ENVIRONMENTAL OUTCOMES; TRAINING AND EDUCATION, NAMELY, TRAINING AND EDUCATION IN THE NATURE OF COURSES, SEMINARS, CLASSES, WORKSHOPS, TUTORIALS, AND ONLINE LESSONS RELATING TO ENVIRONMENTALLY SUSTAINABLE OR ENVIRONMENTALLY FRIENDLY MANUFACTURING, DISTRIBUTION AND RETAILING OF GOODS; ARRANGING AND HOLDING EDUCATIONAL SEMINARS AND CONFERENCES RELATING TO ENVIRONMENTALLY SUSTAINABLE OR ENVIRONMENTALLY FRIENDLY MANUFACTURING, DISTRIBUTION AND RETAILING OF GOODS; ORGANIZATION AND OPERATION OF SURFING SCHOOLS; PERSONAL COACHING FOR SURFING, SURF SKIING, WAKE BOARDING, BODY BOARDING, KITE BOARDING, BODY SURFING, AND OTHER WATER SPORTS AND EXTREME SPORTS; ORGANIZATION AND OPERATION OF SPORTING EVENTS, NAMELY, SURFING COMPETITIONS, WAKE BOARDING COMPETITIONS, BODY BOARDING COMPETITIONS, KITE BOARDING COMPETITIONS, BODY SURFING COMPETITIONS, WIND SURFING COMPETITIONS, SNOWBOARDING COMPETITIONS AND SKATEBOARDING COMPETITIONS; SPORTS INFORMATION SERVICES, NAMELY, PROVIDING INSTRUCTIONAL VIDEOS, TEXT AND GRAPHICS ABOUT WATER SPORTS AND ACTION BOARD SPORTS VIA AN ONLINE WEBSITE; SPORTS INSTRUCTION

SERVICES, NAMELY, PROVIDING WORKSHOPS IN THE FIELD OF SURFING, WAKE BOARDING, BODY BOARDING, KITE BOARDING, BODY SURFING, SKATEBOARDING, ACTION BOARD SPORTS AND EXTREME SPORTS; SPORTS TUITION, NAMELY, PROVIDING INDIVIDUAL INSTRUCTION IN THE FIELD OF SURFING, SURF SKIING, WAKE BOARDING, BODY BOARDING, KITE BOARDING, BODY SURFING, SKATEBOARDING, ACTION BOARD SPORTS AND EXTREME SPORTS; ENTERTAINMENT SERVICES, NAMELY, PROVISION OF LIVE ACTION SHOWS, LIVE MUSIC SHOWS; TELEVISION AND RADIO PROGRAMMES VIA THE WORLD WIDE WEB OF AN EDUCATIONAL AND/OR ENTERTAINING NATURE IN THE FIELD OF ALL ACTION BOARD SPORTS AND EXTREME SPORTS; PRODUCTION OF MOVIES OF AN EDUCATIONAL AND/OR ENTERTAINING NATURE IN THE FIELD OF ALL ACTION BOARD SPORTS AND EXTREME SPORTS (U.S. CLS. 100, 101 AND 107).
DARRYL SPRULL, EXAMINING ATTORNEY

CLASS 44—MEDICAL, BEAUTY AND AGRICULTURAL SERVICES

FOR MEDICAL SERVICES; MEDICAL ASSISTANCE SERVICES PROVIDED VIA TELECOMMUNICATION AND GLOBAL COMPUTER NETWORKS FOR INDIVIDUALS WITH HEALTH PROBLEMS; MEDICAL ASSISTANCE SERVICES IN THE NATURE OF MEDICAL INFORMATION PROVIDED TO MEDICAL PROFESSIONALS FROM REMOTE LOCATIONS VIA THE INTERNET AND GLOBAL COMPUTER NETWORKS THROUGH THE USE OF ARCHIVED MEDICAL IMAGES AND A DATA STORAGE AND RETRIEVAL SYSTEM; PROVIDING MEDICAL ASSISTANCE IN THE FORM OF HEALTH CARE INFORMATION BY TELEPHONE AND THE INTERNET; VETERINARY ASSISTANCE SERVICES PROVIDED VIA TELECOMMUNICATION AND GLOBAL COMPUTER NETWORKS FOR PETS WITH HEALTH PROBLEMS; HYGIENIC AND BEAUTY CARE FOR HUMAN BEINGS OR ANIMALS; MEDICAL DIAGNOSTIC TESTING, MONITORING AND REPORTING SERVICES; REMOTE TESTING, MONITORING AND REPORTING MEDICAL DIAGNOSTIC SERVICES; PROVIDING AN INTERNET WEB SITE FOR MEDICAL PROFESSIONALS AND MEDICAL PATIENTS THAT ALLOWS FOR THE EXCHANGE OF INFORMATION FROM REMOTE LOCATIONS THAT CAN BE ACCESSED IN REAL TIME BY MEDICAL PROFESSIONALS FOR PURPOSES OF MONITORING AND DIAGNOSING MEDICAL CONDITIONS; PROVIDING AN INTERNET WEB SITE FOR MEDICAL PROFESSIONALS AND MEDICAL PATIENTS THAT ALLOWS FOR THE EXCHANGE OF INFORMATION FROM REMOTE LOCATIONS USING ELECTRONIC PATIENT MONITORING DEVICES THAT FEED INFORMATION TO THE WEB SITE THAT CAN BE ACCESSED IN REAL TIME BY MEDICAL PROFESSIONALS FOR PURPOSES OF MONITORING AND DIAGNOSING MEDICAL CONDITIONS; MEDICAL INFORMATION, NAMELY, CONSUMER-AUTHORIZED CLINICAL LABORATORY TESTING SERVICES THAT REPORT RESULTS DIRECTLY TO THE PATIENT (U.S. CLS. 100 AND 101).
CHRIS WELLS, EXAMINING ATTORNEY

SN 77-450,818. ISEEU GLOBAL LIMITED, BRACKNELL, BERKSHIRE, UNITED KINGDOM, FILED 4-17-2008.

SN 77-450,843. ISEEU GLOBAL LIMITED, BRACKNELL, BERKSHIRE, UNITED KINGDOM, FILED 4-17-2008.



S STREAM

PRIORITY CLAIMED UNDER SEC. 44(D) ON ERP CMNTY TM OFC APPLICATION NO. 006799902, FILED 3-20-2008, REG. NO. 006799902, DATED 12-4-2008, EXPIRES 3-20-2018.

THE MARK CONSISTS OF THE LETTERS "ISEEU", WITH THE LETTERS "SEE" UNDERLINED AND LEFT AND RIGHT BRACKETS ON BOTH SIDES OF THE LETTERS.

CLASS 10—MEDICAL APPARATUS

FOR SURGICAL AND MEDICAL APPARATUS AND INSTRUMENTS FOR USE IN GENERAL SURGERY, SURGICAL APPARATUS AND INSTRUMENTS FOR MEDICAL, DENTAL OR VETERINARY USE (U.S. CLS. 26, 39 AND 44).

THE MARK CONSISTS OF STANDARD CHARACTERS WITHOUT CLAIM TO ANY PARTICULAR FONT, STYLE, SIZE, OR COLOR.

PRIORITY CLAIMED UNDER SEC. 44(D) ON ERP CMNTY TM OFC APPLICATION NO. 006799233, FILED 3-20-2008, REG. NO. 006799233, DATED 12-4-2008, EXPIRES 3-20-2018.

NO CLAIM IS MADE TO THE EXCLUSIVE RIGHT TO USE "STREAM", APART FROM THE MARK AS SHOWN.

CLASS 9—ELECTRICAL AND SCIENTIFIC APPARATUS

FOR APPARATUS FOR RECORDING, TRANSMISSION OR REPRODUCTION OF SOUND AND IMAGES; PRERECORDED MAGNETIC DATA CARRIERS FEATURING DATA REGARDING MEDICAL, VETERINARY, DENTAL AND BEAUTY CARE SERVICES; PRERECORDED OPTICAL DATA CARRIERS FEATURING DATA REGARDING MEDICAL, VETERINARY, DENTAL AND BEAUTY CARE SERVICES; RECORDING DISCS, NAMELY, PRERECORDED CDS, VIDEO TAPES, LASER DISKS AND DVDS, FEATURING DATA REGARDING MEDICAL, VETERINARY, DENTAL AND BEAUTY CARE SERVICES; SOLID-STATE RECORDING DEVICES, NAMELY, PRERECORDED SOLID STATE DISKS FEATURING DATA REGARDING MEDICAL, VETERINARY, DENTAL AND BEAUTY CARE SERVICES; COMPUTER HARDWARE, COMPUTER HARDWARE PERIPHERAL DEVICES, COMPUTER HARDWARE FOR TELECOMMUNICATIONS; MOBILE COMPUTERS, NAMELY, PORTABLE PERSONAL COMPUTERS, NOTEBOOKS AND LAPTOP COMPUTERS; TELECOMMUNICATION DEVICES, NAMELY, MOBILE PHONES, CELL PHONES, CELLULAR PHONES, VIDEO PHONES, DIGITAL PHONES, DIGITAL CELLULAR PHONES, INTERNET PHONES, HANDS FREE KITS FOR PHONES, INTEROPERABLE COMMUNICATION SYSTEM DESIGNED TO PROVIDE RADIO, STREAMING VIDEO, WIRELESS INTERNET AND VOIP PHONE, FOR TRANSMITTING MACHINE-READABLE DATA INCLUDING IMAGE DATA; REAL-TIME MONITORING EQUIPMENT, NAMELY, COMPUTER HARDWARE AND COMPUTER SOFTWARE FOR RECORDING, TRANSMITTING AND REPORTING DATA FOR USE WITH MEDICAL DIAGNOSIS AND TREATMENT OF PATIENTS; COMPUTER SOFTWARE FOR USE WITH MEDICAL PATIENT MONITORING EQUIPMENT, COMPUTER SOFTWARE FOR RECEIVING, PROCESSING, STORING, TRANSMITTING AND DISPLAYING DATA; COMPUTER SOFTWARE FOR PROCESSING IMAGES, GRAPHICS AND TEXT; COMPUTER SOFTWARE FOR PROCESSING DIGITAL IMAGES OF THE ANATOMY FOR DIAGNOSIS AND TREATMENT (U.S. CLS. 21, 23, 26, 36 AND 38).

CLASS 10—MEDICAL APPARATUS

FOR SURGICAL AND MEDICAL APPARATUS AND INSTRUMENTS FOR USE IN GENERAL SURGERY, SURGICAL APPARATUS AND INSTRUMENTS FOR MEDICAL, DENTAL OR VETERINARY USE (U.S. CLS. 26, 39 AND 44).

CLASS 44—MEDICAL, BEAUTY AND AGRICULTURAL SERVICES

FOR MEDICAL SERVICES; MEDICAL ASSISTANCE SERVICES PROVIDED VIA TELECOMMUNICATION AND GLOBAL COMPUTER NETWORKS FOR INDIVIDUALS WITH HEALTH PROBLEMS; MEDICAL ASSISTANCE SERVICES IN THE NATURE OF MEDICAL INFORMATION PROVIDED TO MEDICAL PROFESSIONALS FROM REMOTE LOCATIONS VIA THE INTERNET AND GLOBAL COMPUTER NETWORKS THROUGH THE USE OF ARCHIVED MEDICAL IMAGES AND A DATA STORAGE AND RETRIEVAL SYSTEM; PROVIDING MEDICAL ASSISTANCE IN THE FORM OF HEALTH CARE INFORMATION BY TELEPHONE AND THE INTERNET; VETERINARY ASSISTANCE SERVICES PROVIDED VIA TELECOMMUNICATION AND GLOBAL COMPUTER NETWORKS FOR PETS WITH HEALTH PROBLEMS; HYGIENIC AND BEAUTY CARE FOR HUMAN BEINGS OR ANIMALS; MEDICAL DIAGNOSTIC TESTING, MONITORING AND REPORTING SERVICES; REMOTE TESTING, MONITORING AND REPORTING MEDICAL DIAGNOSTIC SERVICES; PROVIDING AN INTERNET WEB SITE FOR MEDICAL PROFESSIONALS AND MEDICAL PATIENTS THAT ALLOWS FOR THE EXCHANGE OF INFORMATION FROM REMOTE LOCATIONS THAT CAN BE ACCESSED IN REAL TIME BY MEDICAL PROFESSIONALS FOR PURPOSES OF MONITORING AND DIAGNOSING MEDICAL CONDITIONS; PROVID-

ING AN INTERNET WEB SITE FOR MEDICAL PROFESSIONALS AND MEDICAL PATIENTS THAT ALLOWS FOR THE EXCHANGE OF INFORMATION FROM REMOTE LOCATIONS USING ELECTRONIC PATIENT MONITORING DEVICES THAT FEED INFORMATION TO THE WEB SITE THAT CAN BE ACCESSED IN REAL TIME BY MEDICAL PROFESSIONALS FOR PURPOSES OF MONITORING AND DIAGNOSING MEDICAL CONDITIONS; MEDICAL INFORMATION, NAMELY, CONSUMER-AUTHORIZED CLINICAL LABORATORY TESTING SERVICES THAT REPORT RESULTS DIRECTLY TO THE PATIENT (U.S. CLS. 100 AND 101).

CHRIS WELLS, EXAMINING ATTORNEY

SN 77-451,971. NOVARTIS AG, BASEL, SWITZERLAND, FILED 4-18-2008.

TRIAMINIC PURE REMEDIES

THE MARK CONSISTS OF STANDARD CHARACTERS WITHOUT CLAIM TO ANY PARTICULAR FONT, STYLE, SIZE, OR COLOR.

OWNER OF U.S. REG. NOS. 2,791,532, 2,964,389 AND 2,999,019.

NO CLAIM IS MADE TO THE EXCLUSIVE RIGHT TO USE "PURE REMEDIES", APART FROM THE MARK AS SHOWN.

CLASS 5—PHARMACEUTICALS

FOR MEDICATIONS, NAMELY, NASAL PREPARATIONS FOR RELIEF OF COLD SYMPTOMS, COUGH SYRUPS, NON-MEDICATED PREPARATIONS FOR RELIEF OF NASAL AND CHEST CONGESTION; MEDICATED PREPARATIONS FOR RELIEF OF COLD AND ALLERGY SYMPTOMS; ELECTROLYTE REPLACEMENT FLUID (U.S. CLS. 6, 18, 44, 46, 51 AND 52).

CLASS 10—MEDICAL APPARATUS

FOR EXTERNAL NASAL DILATORS; NASAL ASPIRATORS; MEDICAL NASAL PUFFERS AND ADMINISTRATORS FOR PREPARATIONS AND SUBSTANCES FOR THE TREATMENT, RELIEF AND PREVENTION OF HAY FEVER, COLDS, AND ALLERGIES (U.S. CLS. 26, 39 AND 44).

BARNEY CHARLON, EXAMINING ATTORNEY

SN 77-452,326. PROFITS RUN, INC., WIXOM, MI. FILED 4-18-2008.

FOREX PROFIT ACCELERATOR

THE MARK CONSISTS OF STANDARD CHARACTERS WITHOUT CLAIM TO ANY PARTICULAR FONT, STYLE, SIZE, OR COLOR.

NO CLAIM IS MADE TO THE EXCLUSIVE RIGHT TO USE "FOREX PROFIT", APART FROM THE MARK AS SHOWN.

CLASS 9—ELECTRICAL AND SCIENTIFIC APPARATUS

FOR PRE-RECORDED CDS, CD-ROMS, DVDS, DVD-ROMS AND VIDEOS FEATURING EDUCATIONAL STUDY COURSE MATERIAL IN THE FIELDS OF INVESTMENTS AND TRADING (U.S. CLS. 21, 23, 26, 36 AND 38).

FIRST USE 9-1-2007; IN COMMERCE 9-1-2007.

CLASS 16—PAPER GOODS AND PRINTED MATTER

FOR PRINTED MATERIALS, NAMELY, GUIDES, MANUALS AND BOOKS FEATURING EDUCATIONAL STUDY COURSE MATERIAL IN THE FIELDS OF INVESTMENTS AND TRADING (U.S. CLS. 2, 5, 22, 23, 29, 37, 38 AND 50).

FIRST USE 9-1-2007; IN COMMERCE 9-1-2007.

JAY FLOWERS, EXAMINING ATTORNEY

SN 77-456,075. MARTHA STEWART LIVING OMNIMEDIA, INC., NEW YORK, NY. FILED 4-23-2008.

MARTHA STEWART CELEBRATE

SN 77-455,863. URL PHARMA, INC., PHILADELPHIA, PA. FILED 4-23-2008.



NO CLAIM IS MADE TO THE EXCLUSIVE RIGHT TO USE "PHARMA", APART FROM THE MARK AS SHOWN.

THE MARK CONSISTS OF A CIRCLE CONTAINING THE LETTERS "URL", ABOVE AND TO THE LEFT OF THE CIRCLE IS A CRESCENT SHAPE, AND TO THE RIGHT OF THE CIRCLE IS THE WORDING "PHARMA".

CLASS 5—PHARMACEUTICALS

FOR PRESCRIPTION AND NON-PRESCRIPTION MEDICINAL AND PHARMACEUTICAL PREPARATIONS INCLUDING TABLETS, CAPSULES, EMULSIONS, CREAMS, OINTMENTS, SUPPOSITORIES, INHALABLE FORMS, AND TRANSDERMAL FORMS FOR USE IN THE TREATMENT OF DISEASES AND AILMENTS AFFECTING THE GASTROINTESTINAL TRACT, BLOOD, CARDIOVASCULAR SYSTEM, SKIN, REPRODUCTIVE SYSTEM, ENDOCRINE SYSTEM, IMMUNE SYSTEM, CENTRAL NERVOUS SYSTEM, PERIPHERAL NERVOUS SYSTEM, RESPIRATORY SYSTEM, MUSCULOSKELETAL SYSTEM, AND SPECIAL SENSES; FULL LINE OF PRESCRIPTION AND NON-PRESCRIPTION MEDICINAL AND PHARMACEUTICAL PREPARATIONS (U.S. CLS. 6, 18, 44, 46, 51 AND 52).

CLASS 42—SCIENTIFIC AND COMPUTER SERVICES

FOR RESEARCH AND DEVELOPMENT SERVICES IN THE FIELD OF PRESCRIPTION AND NONPRESCRIPTION MEDICINAL AND PHARMACEUTICAL PREPARATIONS (U.S. CLS. 100 AND 101).

CHRISTINA SOBRAL, EXAMINING ATTORNEY

THE MARK CONSISTS OF STANDARD CHARACTERS WITHOUT CLAIM TO ANY PARTICULAR FONT, STYLE, SIZE, OR COLOR.

OWNER OF U.S. REG. NOS. 3,435,783 AND 3,455,782.

THE NAME(S), PORTRAIT(S), AND/OR SIGNATURE(S) SHOWN IN THE MARK IDENTIFIES "MARTHA STEWART", WHOSE CONSENT(S) TO REGISTER IS MADE OF RECORD.

CLASS 2—PAINTS

FOR FOOD COLORS FOR DOMESTIC USE; ICING COLOR PIGMENTS; ICING COLORS IN THE NATURE OF FOOD COLORANTS (U.S. CLS. 6, 11 AND 16).

CLASS 4—LUBRICANTS AND FUELS

FOR CANDLES (U.S. CLS. 1, 6 AND 15).

CLASS 6—METAL GOODS

FOR METAL FOIL; ALUMINUM FOIL PAPER; GENERAL PURPOSE METAL STORAGE CONTAINERS; METAL BOXES (U.S. CLS. 2, 12, 13, 14, 23, 25 AND 50).

CLASS 8—HAND TOOLS

FOR FLATWARE; PICNIC TABLEWARE, NAMELY, KNIVES, FORK AND SPOONS (U.S. CLS. 23, 28 AND 44).

CLASS 11—ENVIRONMENTAL CONTROL APPARATUS

FOR LANTERNS; ELECTRIC LIGHT DECORATIVE STRINGS; CANDY AND CHOCOLATE MELTING TOOLS, NAMELY, BUTANE TORCHES FOR COOKING (U.S. CLS. 13, 21, 23, 31 AND 34).

CLASS 16—PAPER GOODS AND PRINTED MATTER

FOR PAPER PARTY FAVORS; PAPER BOXES; PAPER BOARDS; GIFT BOXES; PAPER PARTY DECORATIONS; PAPER PARTY DECORATIONS, NAMELY, TABLE AND CHAIR DECORATIONS; PARTY ORNAMENTS OF PAPER; PARTY BAGS MADE OF PAPER AND PLASTIC; PAPER CAKE DECORATIONS; DECORATIVE PAPER CENTERPIECES; STENCILS; PRINTED PATTERNS FOR FOOD; TRANSFERS FOR FOOD; FOOD-SAFE MARKERS; PACKAGING CONTAINERS OF PAPER; PAPER LABELS; PENS; MARKERS; GIFT PACKAGE DECORATIONS, NAMELY, GIFT WRAP PAPER AND BOWS OF PAPER; CELLOPHANE BAGS FOR PACKAGING; PLASTIC FOOD STORAGE BAGS; BAKING PAPERS, NAMELY, PARCHMENT AND WAX PAPER; BAKING BAGS, NAMELY, PLASTIC FOOD CONTAINER BAGS FOR USE IN BAKING; GIFT PACKAGING STORAGE, NAMELY, STORAGE CONTAINERS MADE OF PAPER; FOOD WRAP STORAGE, NAMELY, STORAGE CONTAINERS MADE OF PAPER; PLASTIC WRAP; PLASTIC FOIL; TISSUE PAPER; PAPER RIBBONS; BAGS, NAMELY, PAPER GIFT BAGS, PAPER SHOPPING BAGS AND PLASTIC PACKAGING BAGS; PAPER TABLE-CLOTHS; PAPER NAPKINS; PAPER RUNNERS; PAPER PICNIC CLOTHS; STATIONERY; INVITATION CARDS; SAVE-THE-DATE CARDS; THANK-YOU CARDS; NOTE CARDS; PLACE CARDS; CALENDARS; GUEST BOOKS; PAPER FOR WRAPPING AND PACKAGING; WRAPPING PAPER SETS COMPRISING GIFT WRAP PAPER AND PAPER GIFT WRAP BOWS; PACKAGE TIES, NAMELY, PAPER GIFT WRAPPING RIBBONS; PAPER TAGS (U.S. CLS. 2, 5, 22, 23, 29, 37, 38 AND 50).

CLASS 18—LEATHER GOODS

FOR BAGS, NAMELY, CANVAS SHOPPING, MESH SHOPPING, WICKER SHOPPING, AND TEXTILE SHOPPING BAGS (U.S. CLS. 1, 2, 3, 22 AND 41).

CLASS 20—FURNITURE AND ARTICLES NOT OTHERWISE CLASSIFIED

FOR PLASTIC DECORATIONS FOR FOOD; PLASTIC CAKE DECORATIONS; PARTY ORNAMENTS OF PLASTIC; PACKAGING CONTAINERS OF PLASTIC; PLASTIC BOXES; PLASTIC LABELS; PLASTIC TAGS, NAMELY, HANG TAGS; DOWELS NOT OF METAL; NON-METAL HANDLES FOR CARRYING SHOPPING AND FOOD BAGS; DISPLAY STANDS; DISPLAY BOARDS; DISPLAY RACKS; DISPLAY PLATFORMS IN THE NATURE OF FURNITURE; RING PILLOWS; GIFT PACKAGE DECORATIONS MADE OF PLASTIC; GIFT PACKAGING STORAGE, NAMELY, STORAGE SHELVES AND RACKS; FOOD WRAP STORAGE, NAMELY, STORAGE, SHELVES, RACKS AND PLASTIC BOXES; CAKE AND CUPCAKE TOPPERS AND PICKS, NAMELY, PLASTIC CAKE DECORATIONS (U.S. CLS. 2, 13, 22, 25, 32 AND 50).

CLASS 21—HOUSEWARES AND GLASS

FOR PASTRY BAGS; PASTRY BAG HOLDERS; ICING BAGS, NAMELY, CONFECTIONER'S DECORATING BAGS; ROLLING PINS; COOKIE CUTTERS; COOKIE-CUTTER MAKING KITS COMPRISING COOKIE CUTTERS, PATTERNS AND SUGAR SPRINKLES; COOKIE PRESSES; FITTED PICNIC BASKETS; CONTAINERS FOR HOUSEHOLD OR KITCHEN USE; CAKE AND COOKIE DECORATING TOOLS, NAMELY, COOKIE CUTTERS, STENCILS, CAKE BRUSHES, CAKE MOLDS; CANDY AND CHOCOLATE MAKING TOOLS, NAMELY, CHOCOLATE MOLDS, CONFECTIONER'S DECORATING BAGS; CANDY AND CHOCOLATE MELTING TOOLS, NAMELY, DOUBLE BOILERS, POTS; CANDY MOLDS; TOOL CADDIES, NAMELY, CADDIES FOR HOLDING COOKING, BAKING AND DECORATING UTENSILS FOR KITCHEN OR HOUSEHOLD USE; TOOL STORAGE, NAMELY, PLASTIC STORAGE CONTAINERS FOR KITCHEN UTENSILS; CAKE AND COOKIE DECORATING SETS COMPRISING COOKIE CUTTERS, CAKE BRUSHES, CAKE MOLDS, SUGAR SPRINKLES, ICING AND FOOD COLORING; CAKE DECORATING TIPS FOR ATTACHMENT TO PASTRY BAGS; CAKE DECORATING ACCESSORIES, NAMELY, CONFECTIONER'S DECORATING BAGS, CAKE BRUSHES; CAKE STANDS; CUPCAKE STANDS; RECIPE BOXES; CANDY BOXES; BAKING BOXES IN THE NATURE OF BREAD BOXES; BAKING CONTAINERS IN THE NATURE OF DISHES; PAPER BAKING CUPS; BAKING TINS, NAMELY CAKE AND MUFFIN TINS; CARRYING CASES FOR FOOD, NAMELY, THERMAL INSULATED FOOD CONTAINERS AND CAKE, COOKIE AND PIE CARRYING CONTAINERS; PAPER PLATES; PAPER AND PLASTIC CUPS; TABLE PLACE CARD HOLDERS; NOT OF PRECIOUS METAL; SERVING PLATTERS; PICNIC ACCESSORIES, NAMELY, FITTED PICNIC BASKETS, WINE GLASSES, CORKSCREWS; FLOWER BASKETS; BAKING PAPERS, NAMELY, PAPER BAKING CUPS; GIFT PACKAGING STORAGE, NAMELY, PLASTIC STORAGE CONTAINERS FOR HOUSEHOLD USE; FOOD WRAP STORAGE, NAMELY, PLASTIC STORAGE CONTAINERS FOR HOUSEHOLD USE; FOOD TRANSPORT BAGS, NAMELY, THERMAL INSULATED BAGS FOR FOOD STORAGE (U.S. CLS. 2, 13, 23, 29, 30, 33, 40 AND 50).

NER'S DECORATING BAGS, CAKE BRUSHES; CAKE STANDS; CUPCAKE STANDS; RECIPE BOXES; CANDY BOXES; BAKING BOXES IN THE NATURE OF BREAD BOXES; BAKING CONTAINERS IN THE NATURE OF DISHES; PAPER BAKING CUPS; BAKING TINS, NAMELY CAKE AND MUFFIN TINS; CARRYING CASES FOR FOOD, NAMELY, THERMAL INSULATED FOOD CONTAINERS AND CAKE, COOKIE AND PIE CARRYING CONTAINERS; PAPER PLATES; PAPER AND PLASTIC CUPS; TABLE PLACE CARD HOLDERS; NOT OF PRECIOUS METAL; SERVING PLATTERS; PICNIC ACCESSORIES, NAMELY, FITTED PICNIC BASKETS, WINE GLASSES, CORKSCREWS; FLOWER BASKETS; BAKING PAPERS, NAMELY, PAPER BAKING CUPS; GIFT PACKAGING STORAGE, NAMELY, PLASTIC STORAGE CONTAINERS FOR HOUSEHOLD USE; FOOD WRAP STORAGE, NAMELY, PLASTIC STORAGE CONTAINERS FOR HOUSEHOLD USE; FOOD TRANSPORT BAGS, NAMELY, THERMAL INSULATED BAGS FOR FOOD STORAGE (U.S. CLS. 2, 13, 23, 29, 30, 33, 40 AND 50).

CLASS 22—CORDAGE AND FIBERS

FOR TWINE; CORD; VINYL GROUND CLOTH; CANVAS AND MESH FOOD STORAGE BAGS; FOOD TRANSPORT BAGS, NAMELY, CANVAS BAGS FOR FOOD STORAGE; PACKAGE TIES, NAMELY, PLASTIC TIES FOR HOME USE (U.S. CLS. 1, 2, 7, 19, 22, 42 AND 50).

CLASS 26—FANCY GOODS

FOR ARTIFICIAL GARLANDS AND WREATHS; ARTIFICIAL FLOWERS; RIBBONS (U.S. CLS. 37, 39, 40, 42 AND 50).

CLASS 28—TOYS AND SPORTING GOODS

FOR BALLOONS; STREAMERS; PAPER PARTY HATS; PARTY FAVORS IN THE NATURE OF SMALL TOYS; PARTY FAVORS IN THE NATURE OF CRACKERS AND NOISEMAKERS; CONFETTI (U.S. CLS. 22, 23, 38 AND 50).

CLASS 30—STAPLE FOODS

FOR ICINGS; ICING GELS; FONDANT, GUM SWEETS, AND ALMOND, VANILLA AND CHOCOLATE PASTE AND ACCESSORIES, NAMELY, EDIBLE CAKE DECORATIONS, ICING MIXES; EDIBLE CAKE DECORATIONS; CANDY SPRINKLES; SUGARS; CANDIES; COOKIES; GINGERBREAD HOUSES; CANDY KITS COMPRISING CANDY, FLAVOR ENHANCERS AND SUGAR FOR MAKING CANDY AND CANDY DECORATING; FLAVOR ENHANCERS USED IN FOOD AND BEVERAGE PRODUCTS; FLAVORINGS, OTHER THAN ESSENTIAL OILS, FOR CAKES OR CANDY; CAKE AND COOKIE DECORATING TOOLS, NAMELY, EDIBLE CAKE AND COOKIE DECORATIONS, AND CANDY SPRINKLES; CAKE AND CUPCAKE TOPPERS AND PICKS, NAMELY, EDIBLE CAKE DECORATIONS (U.S. CL. 46).

CARRIE GENOVESE, EXAMINING ATTORNEY

SN 77-458,632. THE BONE ROOM, BERKELEY, CA. FILED 4-25-2008.

The Bone Room

THE MARK CONSISTS OF STANDARD CHARACTERS WITHOUT CLAIM TO ANY PARTICULAR FONT, STYLE, SIZE, OR COLOR.

NO CLAIM IS MADE TO THE EXCLUSIVE RIGHT TO USE "BONE", APART FROM THE MARK AS SHOWN.

CLASS 16—PAPER GOODS AND PRINTED MATTER

FOR HUMAN AND ANIMAL SKELETONS, OR PARTS OF SKELETONS FOR EDUCATIONAL PURPOSES; REPLICATIONS OF HUMAN AND ANIMAL SKELETONS, OR PARTS OF SKELETONS FOR EDUCATIONAL PURPOSES; FOSSILS FOR EDUCATIONAL PURPOSES; REPLICATIONS OF FOSSILS FOR EDUCATIONAL PURPOSES; PRESERVED INSECT SPECIMENS WITH OR WITHOUT DECORATIVE FRAMES FOR EDUCATIONAL PURPOSES (U.S. CLS. 2, 5, 22, 23, 29, 37, 38 AND 50).

FIRST USE 1-14-1988; IN COMMERCE 1-14-1988.

CLASS 20—FURNITURE AND ARTICLES NOT OTHERWISE CLASSIFIED

FOR UNWORKED OR PARTLY WORKED MATERIAL, NAMELY, ANIMAL BONE; ARTIFICIAL BONES FOR MEDICAL INSTRUCTIONAL PURPOSES; TAXIDERM, NAMELY, STUFFED ANIMALS; HUMAN AND ANIMAL SKELETONS, OR PARTS OF SKELETONS NOT FOR EDUCATIONAL PURPOSES; REPLICATIONS OF HUMAN AND ANIMAL SKELETONS, OR PARTS OF SKELETONS NOT FOR EDUCATIONAL PURPOSES; FOSSILS NOT FOR EDUCATIONAL PURPOSES; REPLICATIONS OF FOSSILS NOT FOR EDUCATIONAL PURPOSES; PRESERVED INSECT SPECIMENS WITH OR WITHOUT DECORATIVE FRAMES NOT FOR EDUCATIONAL PURPOSES (U.S. CLS. 2, 13, 22, 25, 32 AND 50).

FIRST USE 1-14-1988; IN COMMERCE 1-14-1988.
JULIE GUTTADAURO, EXAMINING ATTORNEY

SN 77-461,656. KARG, KLAUS, KAMMERSTEIN, FED REP GERMANY, FILED 4-30-2008.

KARG

THE MARK CONSISTS OF STANDARD CHARACTERS WITHOUT CLAIM TO ANY PARTICULAR FONT, STYLE, SIZE, OR COLOR.

PRIORITY CLAIMED UNDER SEC. 44(D) ON ERN CMNTY TM OFC APPLICATION NO. 006590244, FILED 12-28-2007, REG. NO. 006590244, DATED 12-11-2008, EXPIRES 12-28-2017.

THE ENGLISH TRANSLATION OF "KARG" IN THE MARK IS "MEAGER, SPARSE OR BARREN"

CLASS 29—MEATS AND PROCESSED FOODS

FOR CRISPS AND CHIPS, NAMELY, POTATO CRISPS AND FRUIT CHIPS (U.S. CL. 46).

CLASS 30—STAPLE FOODS

FOR BREAD, GLUTEN-FREE BREAD; PASTRY AND CONFECTIONERY, NAMELY, BREAD-BASED CONFECTIONERY IN THE NATURE OF SMALLER PIECES OF CRISP BREAD OR OTHER BREAD, AND CRISP BREAD OR OTHER BREAD COVERED WITH CHOCOLATE, SUGAR OR OTHER TOPPINGS; CEREAL BARS, NAMELY, READY TO EAT, CEREAL DERIVED FOOD BARS; CRISP BREAD, GLUTEN-FREE CRISP BREAD, DRY FLAT BREAD, GLUTEN-FREE DRY FLAT BREAD, CRUSTY BREAD AND GLUTEN-FREE CRUSTY BREAD; CRACKERS; PASTRIES, NAMELY, SAVORY PASTRIES AND SWEET PASTRIES; SNACKS, NAMELY, SNACK CAKES, RICE-BASED SNACK FOODS, CEREAL BASED SNACK FOODS, GRANOLA SNACKS; GLUTEN-FREE PASTRIES AND SNACKS, NAMELY, SNACK CAKES, RICE-BASED SNACK FOODS, CEREAL-BASED SNACK FOODS, GRANOLA SNACKS; SNACKS, NAMELY, BREAD BASED SNACKS IN THE NATURE OF SNACK CAKES, CEREAL BASED SNACK FOODS, GRANOLA SNACKS; SNACKS WITH ANY KIND OF TOPPING, NAMELY, SNACK CAKES, RICE-BASED SNACK FOODS, CEREAL BASED SNACK FOODS, GRANOLA SNACKS; COOKIES, BISCUITS; GINGERBREAD; RUSKS (U.S. CL. 46).

CLASS 35—ADVERTISING AND BUSINESS

FOR COMMERCIAL SERVICES, NAMELY, ADVERTISING, PROMOTIONS, LOGISTICS MANAGEMENT, BUSINESS MANAGEMENT, BUSINESS CONSULTING, MARKET RESEARCH IN THE FIELD OF CRISPS AND CHIPS, INCLUDING POTATO CRISPS AND FRUIT CHIPS, AND IN THE FIELD OF BREAD, PASTRY AND CONFECTIONERY, CEREAL BARS, CRISP BREAD, DRY FLAT BREAD, CRUSTY BREAD, SNACKS, INCLUDING CEREAL SNACKS, CRACKERS, PASTRIES, INCLUDING SAVORY PASTRIES AND SNACKS, COOKIES, BISCUITS, GINGERBREAD, RUSKS; COLLECTION OF THE AFORESAID GOODS TO ENABLE CONSUMERS TO VIEW AND PURCHASE THESE GOODS, NAMELY, PRESENTATIONS, TASTINGS, AND DISTRIBUTION OF ANY KIND OF THE ABOVE GOODS FOR ADVERTISING PURPOSES; RETAIL OUTLETS, CATALOGUE ORDERING SERVICES AND ONLINE RETAIL STORE SERVICES FEATURING CRISPS AND CHIPS, INCLUDING POTATO CRISPS AND FRUIT CHIPS, AND BREAD, PASTRY AND CONFECTIONERY, CEREAL BARS, CRISP BREAD, DRY FLAT BREAD, CRUSTY BREAD, SNACKS, INCLUDING CEREAL SNACKS, CRACKERS, PASTRIES, INCLUDING SAVORY PASTRIES AND SNACKS, COOKIES, BISCUITS, GINGERBREAD, RUSKS; ORGANIZATION OF EXHIBITIONS IN HALLS, RETAIL OUTLETS AND EXHIBITION HALLS, FOR COMMERCIAL OR ADVERTISING PURPOSES; DEMONSTRATION OF GOODS, NAMELY, PRESENTATIONS AND TASTINGS FOR ADVERTISING PURPOSES; SALES PROMOTION FOR THIRD PARTIES (U.S. CLS. 100, 101 AND 102).

JENNY PARK, EXAMINING ATTORNEY

SN 77-462,203. SENDERO BUSINESS SERVICES, INC., DALLAS, TX. FILED 4-30-2008.



NO CLAIM IS MADE TO THE EXCLUSIVE RIGHT TO USE "BUSINESS SERVICES", APART FROM THE MARK AS SHOWN.

THE MARK CONSISTS OF A WINDING PATH WITH THE WORDS "SENDERO BUSINESS SERVICES" ON THE RIGHT SIDE.

THE FOREIGN WORDING IN THE MARK TRANSLATES INTO ENGLISH AS PATH.

CLASS 35—ADVERTISING AND BUSINESS

FOR BUSINESS MANAGEMENT CONSULTATION, NAMELY, DESIGNING AND REFINING BUSINESS PROCESSES TO SUPPORT AN ORGANIZATION'S BUSINESS STRATEGY AND OBJECTIVES, DESIGNING AND ESTABLISHING A FRAMEWORK FOR INTEGRATING INFORMATION TECHNOLOGY WITH AN ORGANIZATION'S BUSINESS OBJECTIVES, ANALYZING AN ORGANIZATION'S STRUCTURE, PROCESSES, EMPLOYEES AND CULTURE AND PROVIDING RECOMMENDATIONS FOR IMPROVEMENT WHERE NECESSARY, ANALYZING AND PROVIDING RECOMMENDATIONS FOR WORKFORCE OPTIMIZATION AND STRUCTURING, AND CONSULTATION ON INTERNAL CORPORATE COMMUNICATION (U.S. CLS. 100, 101 AND 102).

FIRST USE 10-6-2004; IN COMMERCE 10-6-2004.

CLASS 42—SCIENTIFIC AND COMPUTER SERVICES

FOR CONSULTING IN THE FIELD OF INFORMATION TECHNOLOGY (U.S. CLS. 100 AND 101).

FIRST USE 10-6-2004; IN COMMERCE 10-6-2004.
GINA FINK, EXAMINING ATTORNEY

SN 77-462,775. TOKAI CORPORATION, TOKYO, JAPAN,
FILED 5-1-2008.

YONEKI

THE MARK CONSISTS OF STANDARD CHARACTERS WITHOUT CLAIM TO ANY PARTICULAR FONT, STYLE, SIZE, OR COLOR.

CLASS 6—METAL GOODS

FOR MANUALLY OPERATED METAL VALVES, NAMELY, GATE VALVES, GLOBE VALVES, AND CHECK VALVES (U.S. CLS. 2, 12, 13, 14, 23, 25 AND 50).

CLASS 9—ELECTRICAL AND SCIENTIFIC APPARATUS

FOR ELECTRICALLY OPERATED METAL VALVES, NAMELY, GATE VALVES, GLOBE VALVES, AND CHECK VALVES (U.S. CLS. 21, 23, 26, 36 AND 38).

RONALD AIKENS, EXAMINING ATTORNEY

SN 77-469,459. NATIONAL GRID ELECTRICITY TRANSMISSION PLC., LONDON, UNITED KINGDOM, FILED 5-8-2008.

ngrid

THE MARK CONSISTS OF STANDARD CHARACTERS WITHOUT CLAIM TO ANY PARTICULAR FONT, STYLE, SIZE, OR COLOR.

CLASS 1—CHEMICALS

FOR TREATED WATER FOR INDUSTRIAL USE; CHEMICALS FOR USE IN INDUSTRY AND SCIENCE; GASES, NAMELY, HYDROCARBONS, METHANE, ETHANE, PENTANE, CARBONIC HYDRATES (U.S. CLS. 1, 5, 6, 10, 26 AND 46).

CLASS 4—LUBRICANTS AND FUELS

FOR GAS, FUELS, OILS, NAMELY, NATURAL GAS, LIQUEFIED NATURAL GAS, PETROLEUM, MINERAL OILS FOR INDUSTRIAL PURPOSES, CRUDE OILS, GASOLINE, DIESEL OIL, KEROSENE, OILS PRODUCED BY REFINING MINERAL OILS, NAMELY, GASOLINE, DIESEL FUEL, HEATING OIL, KEROSENE, AND LIQUEFIED PETROLEUM GAS; MOTOR OILS; FUEL OIL AND HEATING OIL (U.S. CLS. 1, 6 AND 15).

CLASS 6—METAL GOODS

FOR METAL PIPES AND TUBES FOR OIL AND GAS CONVEYANCE AND PLUMBING; METAL PIPES FOR GAS TRANSFER; METAL PIPES FOR FUEL TRANSFER; METAL PIPES FOR WATER TRANSFER; METAL PIPE COUPLINGS; PARTS AND FITTINGS FOR ALL OF THE AFORESAID GOODS (U.S. CLS. 2, 12, 13, 14, 23, 25 AND 50).

CLASS 7—MACHINERY

FOR PIPE INSTALLATION MACHINES AND PARTS THEREFOR, ALL FOR USE WITH OIL AND GAS DRILLING AND TRANSMISSION AND DISTRIBUTION OF OIL, GAS, WATER AND ELECTRICITY; PUMPS FOR OIL AND GAS DRILLING; COMPRESSORS FOR OIL AND GAS DRILLING MACHINES; GROUND WATER PUMPS FOR USE IN CONNECTION WITH OIL AND GAS DRILLING; PARTS AND FITTINGS FOR ALL OF THE AFORESAID GOODS (U.S. CLS. 13, 19, 21, 23, 31, 34 AND 35).

CLASS 8—HAND TOOLS

FOR HAND TOOLS, NAMELY, DRILLS, PLIERS, SCREWDRIVERS, NUT DRIVERS, ADJUSTABLE WRENCHES, BENDING TOOLS FOR PIPES, SHEARS, SHOVELS, SHEET METAL SHRINKING AND STRETCHING DEVICES, HAND-OPERATED PUMPS; PARTS AND FITTINGS FOR ALL OF THE AFORESAID GOODS (U.S. CLS. 23, 28 AND 44).

CLASS 9—ELECTRICAL AND SCIENTIFIC APPARATUS

FOR HIGH VOLTAGE TRANSFORMERS; POWER TRANSFORMERS; ELECTRONIC AND SCIENTIFIC APPARATUS AND INSTRUMENTS, NAMELY, ELECTRIC CONDUCTORS, ELECTRIC SWITCHES, ELECTRIC TRANSFORMERS, ELECTRIC ACCUMULATORS, VOLTAGE REGULATORS, ELECTRICAL CONTROLLING DEVICES, ALL FOR TRANSMISSION AND DISTRIBUTION OF ELECTRICITY; COMPUTER PROGRAMS RELATING TO THE GENERATION, SUPPLY, DISTRIBUTION AND TRANSMISSION OF ELECTRICITY, GAS AND WATER FOR USE IN DATABASE MANAGEMENT; COMPUTER SOFTWARE TO AUTOMATE DATA WAREHOUSING; COMPUTER SOFTWARE FOR ASSET MAINTENANCE AND MANAGEMENT; COMPUTER SOFTWARE FOR PLANT AUTOMATION, NAMELY, INTEGRATING MACHINE AUTOMATIONS; COMPUTER SOFTWARE FOR EQUIPMENT MONITORING AND DIAGNOSTICS AND FOR GENERATING PRODUCTION REPORTS; COMPUTER SOFTWARE FOR USE IN CALCULATING PHYSIOCHEMICAL PROPERTIES OF FUELS; COMPUTER SOFTWARE FOR AUTOMATION AND MANAGEMENT OF COMMERCIAL PROCESSES; COMPUTER SOFTWARE FOR USE IN CALCULATING AMOUNTS OF FUEL USED BY PRODUCERS, REFINERS AND CONSUMERS; COMPUTER SOFTWARE FOR SIMULATION, MODELING AND ANALYSIS OF NETWORKS AND PIPELINES; COMPUTER SOFTWARE FOR USE IN FORECASTING ENERGY CONSUMPTION AND DEMAND; FUEL METERS, GAS

METERS, OIL METERS, WATER METERS AND ELECTRIC METERS; MEASURING AND SIGNALING APPARATUS AND INSTRUMENTS, NAMELY, FUEL GAUGES, GAS GAUGES, OIL GAUGES, WATER GAUGES AND ELECTRIC GAUGES; COMPUTER HARDWARE; COMPUTER PERIPHERALS; FUEL DISPENSING, METERING AND STORAGE APPARATUS AND INSTRUMENTS AND SYSTEMS, NAMELY, METERED FUEL PUMPS FOR SERVICE STATIONS AND NATURAL GAS METERS; TELECOMMUNICATIONS AND COMMUNICATIONS APPARATUS AND INSTRUMENTS, NAMELY, FIBER OPTIC CABLES, OPTICAL SWITCHES AND MULTIPLEXERS, FUEL CELL PROCESSORS, ANTENNAS, TELECOMMUNICATIONS TOWERS AND RADIO MASTS; MONITORING AND SUPERVISION APPARATUS AND INSTRUMENTS, NAMELY, PROBES FOR TESTING INTEGRATED CIRCUITS, AND DIGITAL TRANSMITTERS; MAGNETICALLY ENCODED CREDIT, CHARGE AND DEBIT CARDS; BLANK SMART CARDS; ENCODED MAGNETIC CARDS; PARTS AND FITTINGS FOR ALL OF THE AFORESAID GOODS (U.S. CLS. 21, 23, 26, 36 AND 38).

CLASS 16—PAPER GOODS AND PRINTED MATTER

FOR PRINTED MATTER, NAMELY, BROCHURES AND PAMPHLETS REGARDING THE TELECOMMUNICATIONS, GAS, ELECTRICITY, WATER AND OIL INDUSTRIES; PERIODICAL PUBLICATIONS, NAMELY, PRINTED PERIODICALS FEATURING INFORMATION ABOUT THE TELECOMMUNICATIONS, GAS, ELECTRICITY, WATER AND OIL INDUSTRIES; PRINTED MANUALS FEATURING INFORMATION ABOUT THE TELECOMMUNICATIONS, GAS, ELECTRICITY, WATER AND OIL INDUSTRIES (U.S. CLS. 2, 5, 22, 23, 29, 37, 38 AND 50).

CLASS 17—RUBBER GOODS

FOR PIPES, NAMELY, NON-METAL FLEXIBLE PLASTIC PIPES FOR CARRYING FUEL, OIL AND GAS; FLEXIBLE PLASTIC PIPES FOR PLUMBING PURPOSES; RUBBER STOPPERS FOR STOPPING THE FLOW OF LIQUID IN A PIPE; NON-METAL PIPE SEALS FOR PREVENTING THE FLOW OF LIQUID IN A PIPE EITHER TEMPORARILY OR PERMANENTLY; NON-METAL PIPE COUPLINGS; RUBBER GLANDS FOR PREVENTING FLUID LEAKAGE ALONG OR ABOUT A MOVEABLE ROD OR SHAFT, NAMELY, PROTECTIVE FLEXIBLE-PIPE GLANDS OF RUBBER; ELECTRICAL INSULATING TAPE, ELECTRICAL INSULATING RUBBER PRODUCTS, INSULATING SLEEVES FOR POWER LINES, INSULATING OIL FOR TRANSFORMERS; PARTS AND FITTINGS FOR ALL OF THE AFORESAID GOODS (U.S. CLS. 1, 5, 12, 13, 35 AND 50).

CLASS 35—ADVERTISING AND BUSINESS

FOR CREDIT CARD REGISTRATION SERVICES; BUSINESS CONSULTANCY SERVICES; INDUSTRIAL CONSULTANCY SERVICES, NAMELY, ADVICE IN THE FIELD OF BUSINESS MANAGEMENT OF UTILITY, ELECTRICITY, GAS, WATER AND CONSTRUCTION INDUSTRIES; MARKETING, NAMELY, BUSINESS MARKETING AND DIRECT MARKETING FOR OTHERS; PROMOTING PUBLIC AWARENESS OF THE NEED FOR ENERGY CONSERVATION AND PROVIDING INFORMATION IN THE FIELD OF ENERGY EFFICIENCY AND ENERGY AUDITING SERVICES; POWER PLANT MANAGEMENT STUDIES, NAMELY, MARKET REPORTS AND RESEARCH STUDIES; PROMOTING THE GOODS AND SERVICES OF OTHERS THROUGH THE DISTRIBUTION OF DISCOUNT CARDS; BUSINESS MANAGEMENT OF PROJECTS RELATING TO ELECTRICITY, OIL, TELECOMMUNICATIONS AND GAS, AND CONSULTANCY SERVICES RELATED THERETO; ADVICE AND CONSULTANCY SERVICES RELATING TO ALL OF THE AFORESAID SERVICES (U.S. CLS. 100, 101 AND 102).

CLASS 36—INSURANCE AND FINANCIAL

FOR FINANCIAL SERVICES, NAMELY, FINANCIAL CLEARING HOUSES AND DEBT SETTLEMENT SERVICES ALL RELATING TO THE GENERATION, SUPPLY, DISTRIBUTION AND TRANSMISSION OF ELECTRICITY, GAS OR WATER; BROKERAGE OF ELECTRIC AND GAS COMMODITIES; PREPAID PREVENTIVE MAINTENANCE SERVICE PLANS FOR HEATING, VENTILATING AND AIR CONDITIONING SYSTEMS FOR HOMES AND BUSINESSES; PROVISION OF LOAN AND CREDIT FACILITIES, NAMELY, CREDIT AND LOAN SERVICES; DIRECT DEBITTING, NAMELY, ACCOUNTS PAYABLE DEBITING SERVICES; LEASING OF REAL PROPERTY; FINANCING OF PROJECTS; ACQUISITION SERVICES, NAMELY, ACQUISITIONS RELATING TO TELECOMMUNICATION, TRANSMISSION AND BROADCASTING FACILITIES; REAL ESTATE MANAGEMENT; REAL ESTATE PROCUREMENT FOR OTHERS; ADVICE AND CONSULTANCY SERVICES RELATING TO ALL OF THE AFORESAID SERVICES (U.S. CLS. 100, 101 AND 102).

CLASS 37—CONSTRUCTION AND REPAIR

FOR INSTALLATION, MAINTENANCE AND REPAIR OF TELECOMMUNICATIONS EQUIPMENT APPARATUS, INSTRUMENTS, NETWORKS AND SYSTEMS; INSTALLATION, REPAIR AND MAINTENANCE OF WIRELESS NETWORKS, FIBER OPTIC NETWORKS AND DISTRIBUTED ANTENNA SYSTEM NETWORKS; INSTALLATION, MAINTENANCE AND REPAIR OF APPARATUS AND INSTRUMENTS, NETWORKS AND SYSTEMS FOR USE IN THE SUPPLY AND DISTRIBUTION OF ELECTRICITY, GAS, WATER AND TELECOMMUNICATIONS; INSTALLATION, MAINTENANCE AND REPAIR OF HEATING, AIR CONDITIONING, INDOOR AIR QUALITY, WATER HEATING AND POOL HEATING EQUIPMENT FOR HOMES AND BUSINESSES; INSTALLATION, REPAIR, EMERGENCY SERVICING AND MAINTENANCE OF GAS, ELECTRICITY AND WATER APPLIANCES, APPARATUS AND INSTRUMENTS; LAYING, REPAIR, MAINTENANCE, REPLACEMENT AND REFURBISHMENT OF PIPELINES; PLANNING AND LAYING OUT OF POWER PLANT FACILITIES; INSTALLATION OF INDUSTRIAL DUCTWORK AND PIPING; REPAIR OF ROADS AND PATHS; INSTALLATION OF INSULATING MATERIALS; BUILDING CONSTRUCTION SERVICES; CONSTRUCTION, MAINTENANCE, REPAIR AND RENOVATION OF PROPERTY; CONSTRUCTION MANAGEMENT, NAMELY, MANAGEMENT AND COORDINATION OF HEATING PLAN CONVERSIONS, HIGH PURITY WATER AND PROCESS PIPING SYSTEMS INSTALLATION, FIRE PROTECTION SYSTEMS INSTALLATION, WASTEWATER SYSTEMS INSTALLATION, PLUMBING AND POWER PIPING SYSTEMS INSTALLATIONS AND COGENERATION SYSTEMS INSTALLATIONS; CONSULTANCY SERVICES REGARDING THE INSTALLATION AND MAINTENANCE OF TELECOMMUNICATION, TRANSMISSION AND BROADCASTING EQUIPMENT, APPARATUS AND INSTRUMENTS; FACILITIES MANAGEMENT SERVICES, NAMELY, MAINTENANCE AND REPAIR OF BOILER, CHILLER, REFRIGERATION, INDUSTRIAL PIPING AND ENGINE SYSTEMS AND BUILDING AUTOMATION CONTROLS; MAINTENANCE OF WIRELESS NETWORKS, FIBER OPTIC NETWORKS AND DISTRIBUTED ANTENNA SYSTEM NETWORKS; WASTE DISPOSAL FOR OTHERS; ADVICE AND CONSULTANCY SERVICES RELATING TO ALL OF THE AFORESAID SERVICES (U.S. CLS. 100, 103 AND 106).

CLASS 38—COMMUNICATION

FOR VOICE, IMAGE AND DATA TRANSMISSION SERVICES PROVIDED BY MEANS OF FIBER OPTIC CABLES, TELEPHONE LINES, RADIO AND MICROWAVE TRANSMISSION AND SATELLITE TRANSMISSION; PROVIDING ACCESS TO A CELLULAR PHONE NETWORK; NETWORK PROVIDER SERVICES, NAMELY, PROVIDING ACCESS TO TELECOMMUNICATION NETWORKS, GLOBAL COMPUTER INFORMATION NETWORKS, DIGITAL NETWORKS, WIDE AREA NETWORKS, BROAD BAND NETWORKS, OPTICAL NETWORKS, WIRELESS NETWORKS, SATELLITE NETWORKS, ELECTRONIC COMMUNICATIONS NETWORKS; TELEVISION, SATELLITE, RADIO AND

DIGITAL BROADCASTING SERVICES; CONSULTANCY SERVICES RELATING TO THE GENERATION, SUPPLY, DISTRIBUTION AND TRANSMISSION OF TELECOMMUNICATIONS; BROADCASTING AND TRANSMISSION VIA WIRELESS MEDIA OF ANALOG, DIGITAL, AUDIO, VIDEO, PAGER, RADIO, MICROWAVE, TELEVISION, DATA AND EMERGENCY SIGNALS; PROVIDING SHARED WIRELESS AND FIBER COMMUNICATIONS TRANSMISSIONS SITES AND INFRASTRUCTURE FOR USE BY MULTIPLE BROADCASTERS AND TELECOMMUNICATIONS OPERATORS; PROVIDING ACCESS TO A DATABASE PERTAINING TO ENERGY PRODUCTION AND DISTRIBUTION, NAMELY, FUEL SOURCES, STORAGE, DISTRIBUTION, TRANSMISSION AND SUPPLY; ADVICE AND CONSULTANCY SERVICES RELATING TO ALL OF THE AFORESAID SERVICES (U.S. CLS. 100, 101 AND 104).

CLASS 39—TRANSPORTATION AND STORAGE

FOR TRANSMISSION OF GAS THROUGH PIPELINES; ELECTRICITY DISTRIBUTION; STORAGE, DISTRIBUTION AND TRANSPORTATION OF LIQUEFIED PETROLEUM GAS; DISTRIBUTION AND SUPPLY OF ELECTRICITY AND OTHER FORMS OF ENERGY OR SOURCES OF POWER; DISTRIBUTION, SUPPLY, TRANSPORTATION AND STORAGE OF FUEL AND GAS; TRANSMISSION, SUPPLY AND DISTRIBUTION OF ELECTRICITY TO AND FROM COMMERCIAL RESIDENTIAL AND INDUSTRIAL PREMISES; PROVIDING INFORMATION IN THE FIELD OF TRANSMISSION AND DISTRIBUTION OF OIL, GAS, WATER AND ELECTRICITY; ADVICE AND CONSULTANCY SERVICES RELATING TO ALL OF THE AFORESAID SERVICES (U.S. CLS. 100 AND 105).

CLASS 40—MATERIAL TREATMENT

FOR OIL TREATMENT SERVICES, GAS TREATMENT SERVICES, FUEL TREATMENT SERVICES; WATER TREATMENT SERVICES; POWER GENERATION SERVICES; INDUSTRIAL TOXIC WASTE DISPOSAL; PRODUCTION OF GAS; CONSULTANCY SERVICES RELATING TO THE GENERATION OF ELECTRICITY, GAS AND WATER; ADVICE AND CONSULTANCY SERVICES RELATING TO ALL OF THE AFORESAID SERVICES (U.S. CLS. 100, 103 AND 106).

CLASS 42—SCIENTIFIC AND COMPUTER SERVICES

FOR UTILITY METER READING SERVICES, NAMELY, FUEL METER READING, OIL METER READING, GAS METER READING, WATER METER READING AND ELECTRIC METER READING; ELECTRICITY AND NATURAL GAS SERVICES, NAMELY, METERING; MEASURING OF WATER, NAMELY, DATA COLLECTION IN RELATION TO MEASURING OF WATER CONSUMPTION; MEASURING OF OIL, NAMELY, DATA COLLECTION IN RELATION TO MEASURING OF OIL CONSUMPTION; MEASURING GAS CONSUMPTION; DESIGN OF WIRELESS NETWORKS, FIBER OPTIC NETWORKS AND DISTRIBUTED ANTENNA SYSTEM NETWORKS; DESIGN, TECHNICAL SUPPORT AND COMPUTER PROJECT MANAGEMENT RELATING TO TELECOMMUNICATIONS NETWORKS AND SYSTEMS; SAFETY CHECKING OF DOMESTIC APPLIANCES AND PIPEWORK; SCIENTIFIC RESEARCH, DEVELOPMENT AND ENGINEERING IN THE FIELD OF ENERGY AND THE ENVIRONMENTAL IMPACT OF ENERGY AND POWER SYSTEMS; DEVELOPMENT OF ENVIRONMENTALLY-FRIENDLY FORMS OF ENERGY AND POWER; ARCHITECTURAL SERVICES RELATING TO LAND DEVELOPMENT; LAND SURVEYING, SURVEYING OF OIL BEDS AND FIELDS; AERIAL LASER SURVEYS; GAS EXPLORATION; COMPUTER PROGRAMMING SERVICES; MAINTENANCE AND UPDATING OF COMPUTER SOFTWARE; DESIGN OF COMPUTER SOFTWARE AND PROGRAMMING; INSPECTION OF PIPE-LINES; ENGINEERING SERVICES FOR TELECOMMUNICATIONS AND DATA NETWORKING AND FOR GENERATION, SUPPLY, DISTRIBUTION AND TRANSMISSION OF ELECTRICITY, GAS, WATER, FUEL AND OIL;

ENGINEERING SERVICES, NAMELY, ENVIRONMENTAL, GEOTECHNICAL, BIOTECHNICAL, STRUCTURAL, CIVIL AND ARCHITECTURAL; ENERGY-RELATED ENGINEERING CONSULTING SERVICES, NAMELY, EVALUATION OF ENERGY REQUIREMENTS AND PROVIDING HEATING AND POWER ENGINEERING DESIGN; ENGINEERING DESIGN; DESIGN OF GAS, FUEL, ELECTRICITY, WATER AND OIL TRANSMISSION AND DISTRIBUTION NETWORKS; DESIGN OF WIRELESS TELECOMMUNICATIONS NETWORKS, FIBER OPTIC NETWORKS AND DISTRIBUTED ANTENNA SYSTEM NETWORKS; CHEMICAL RESEARCH; GEOLOGICAL RESEARCH; SCIENTIFIC RESEARCH; TECHNICAL PLANNING SERVICES REGARDING INSTALLATION AND MAINTENANCE OF BROADCASTING, TELECOMMUNICATION AND TRANSMISSION EQUIPMENT, APPARATUS AND INSTRUMENTS; ADVICE AND CONSULTANCY SERVICES RELATING TO ALL OF THE AFORESAID SERVICES (U.S. CLS. 100 AND 101).

JAY FLOWERS, EXAMINING ATTORNEY

SN 77-469,971. THE FORUM FOR THE FUTURE, LONDON ECIV 3QN, UNITED KINGDOM, FILED 5-9-2008.



OWNER OF ERPN CMNTY TM OFC REG. NO. 006907968, DATED 2-6-2009, EXPIRES 5-12-2018.

THE MARK CONSISTS OF A STYLIZED LEAF DESIGN IN A SHADED RECTANGLE ADJACENT TO THE STYLIZED WORDING "FORUM FOR THE FUTURE".

CLASS 9—ELECTRICAL AND SCIENTIFIC APPARATUS

FOR ELECTRONIC DOWNLOADABLE PUBLICATIONS, NAMELY, BOOKS, REPORTS, NEWSLETTERS, LEAFLETS, MAGAZINES AND BROCHURES IN THE FIELDS OF SUSTAINABLE DEVELOPMENT, CLIMATE CHANGE, AND ENVIRONMENTAL PROTECTION (U.S. CLS. 21, 23, 26, 36 AND 38).

CLASS 16—PAPER GOODS AND PRINTED MATTER

FOR PRINTED MATTER, NAMELY, BOOKS, REPORTS, NEWSLETTERS, LEAFLETS, MAGAZINES, POSTERS, BROCHURES AND PRINTED INSTRUCTIONAL AND TEACHING MATERIALS, ALL IN THE FIELDS OF SUSTAINABLE DEVELOPMENT, CLIMATE CHANGE, AND ENVIRONMENTAL PROTECTION (U.S. CLS. 2, 5, 22, 23, 29, 37, 38 AND 50).

CLASS 35—ADVERTISING AND BUSINESS

FOR BUSINESS AND ECONOMIC FORECASTING AND ANALYSIS, ADVICE, RESEARCH, AND CONSULTATION SERVICES, PARTICULARLY RELATED TO SUSTAINABLE DEVELOPMENT, CLIMATE CHANGE, AND ENVIRONMENTAL PROTECTION; PROMOTING PUBLIC AWARENESS CAMPAIGNS IN THE FIELDS OF SUSTAINABLE DEVELOPMENT, CLIMATE CHANGE, AND ENVIRONMENTAL PROTECTION (U.S. CLS. 100, 101 AND 102).

CLASS 36—INSURANCE AND FINANCIAL

FOR CHARITABLE FUNDRAISING SERVICES (U.S. CLS. 100, 101 AND 102).

CLASS 41—EDUCATION AND ENTERTAINMENT

FOR EDUCATIONAL SERVICES AND TRAINING SERVICES, NAMELY, COURSES, CLASSES, SEMINARS, LECTURES AND WORKSHOPS IN THE FIELDS OF SUSTAINABLE DEVELOPMENT, CLIMATE CHANGE AND ENVIRONMENTAL PROTECTION; PUBLISHING OF ELECTRONIC PUBLICATIONS; PUBLISHING OF BOOKS, MAGAZINES, TEXTS, LEAFLETS, REPORTS, NEWSLETTERS AND EDUCATIONAL MATERIALS; EDUCATIONAL EXAMINATION; EDUCATIONAL SERVICES, NAMELY, DEVELOPING AND CONDUCTING COURSES, PRESENTATIONS, SEMINARS, CONFERENCES, CONGRESSES, SYMPOSIA, COLLOQUIA, WORKSHOPS, AND EXHIBITIONS IN THE FIELDS OF SUSTAINABLE DEVELOPMENT, CLIMATE CHANGE AND ENVIRONMENTAL PROTECTION (U.S. CLS. 100, 101 AND 107).

CLASS 42—SCIENTIFIC AND COMPUTER SERVICES

FOR SCIENTIFIC RESEARCH AND RESEARCH CONSULTATION IN THE FIELDS OF SUSTAINABLE DEVELOPMENT, CLIMATE CHANGE, AND ENVIRONMENTAL PROTECTION, AND PROVISION OF REPORTS RELATING THERETO (U.S. CLS. 100 AND 101).

JORDAN BAKER, EXAMINING ATTORNEY

SN 77-473,856. AIR DIMENSIONS, INC., DEERFIELD BEACH, FL. FILED 5-14-2008.

WE PASS. . .YOUR GAS!

THE MARK CONSISTS OF STANDARD CHARACTERS WITHOUT CLAIM TO ANY PARTICULAR FONT, STYLE, SIZE, OR COLOR.

CLASS 7—MACHINERY

FOR MOTOR DRIVEN AIR PUMPS; DIAPHRAGM PUMPS; DIAPHRAGM COMPRESSORS; VACUUM PUMPS; PUMPS FOR TAKING GAS SAMPLES WHICH ARE THEN ANALYZED (U.S. CLS. 13, 19, 21, 23, 31, 34 AND 35).

FIRST USE 0-0-1989; IN COMMERCE 0-0-1989.

CLASS 9—ELECTRICAL AND SCIENTIFIC APPARATUS

FOR SAMPLING PUMPS FOR PERFORMING GAS SAMPLE ANALYSIS (U.S. CLS. 21, 23, 26, 36 AND 38).

FIRST USE 0-0-1989; IN COMMERCE 0-0-1989.

CLASS 40—MATERIAL TREATMENT

FOR CUSTOM MANUFACTURE OF SAMPLING PUMPS FOR GAS ANALYSIS, MOTOR DRIVEN AIR PUMPS, DIAPHRAGM PUMPS, DIAPHRAGM COMPRESSORS, SAMPLING PUMPS AND VACUUM PUMPS (U.S. CLS. 100, 103 AND 106).

FIRST USE 0-0-1989; IN COMMERCE 0-0-1989.

CLASS 42—SCIENTIFIC AND COMPUTER SERVICES

FOR DESIGN AND ENGINEERING OF SAMPLING PUMPS FOR GAS ANALYSIS, MOTOR DRIVEN AIR PUMPS, DIAPHRAGM PUMPS, DIAPHRAGM COMPRESSORS, SAMPLING PUMPS AND VACUUM PUMPS (U.S. CLS. 100 AND 101).

FIRST USE 0-0-1989; IN COMMERCE 0-0-1989.
KAREN K. BUSH, EXAMINING ATTORNEY

SN 77-474,220. THALES AVIONICS, INC., IRVINE, CA. FILED 5-14-2008.

GATESYNC

THE MARK CONSISTS OF STANDARD CHARACTERS WITHOUT CLAIM TO ANY PARTICULAR FONT, STYLE, SIZE, OR COLOR.

CLASS 9—ELECTRICAL AND SCIENTIFIC APPARATUS

FOR INTEGRATED MULTI-FREQUENCY RADIO HARDWARE AND SOFTWARE FOR HIGH-SPEED WIRELESS DATA TRANSFER, INCLUDING ANTENNAS (U.S. CLS. 21, 23, 26, 36 AND 38).

CLASS 35—ADVERTISING AND BUSINESS

FOR DATA MANAGEMENT SERVICES OF MULTI-RADIO EQUIPMENT USING PROPRIETARY TECHNOLOGY (U.S. CLS. 100, 101 AND 102).

CLASS 38—COMMUNICATION

FOR ELECTRONIC DATA TRANSMISSION VIA HIGH-SPEED, HIGH QUALITY OF SERVICE (QOS) BROADBAND WIRELESS TRANSMISSION SYSTEMS DESIGNED TO DELIVER MEDIA CONTENT AND AIRCRAFT OPERATIONAL DATA TO, AND IN-FLIGHT ENTERTAINMENT SYSTEMS AND OTHER OPERATIONAL AIRCRAFT DATA FROM, AIRCRAFT (U.S. CLS. 100, 101 AND 104).

LAURIE KAUFMAN, EXAMINING ATTORNEY

SN 77-475,679. IRIS NATION WORLDWIDE LIMITED, LONDON SE1 9DY, UNITED KINGDOM, FILED 5-15-2008.

UNDER THE INFLUENCE

THE MARK CONSISTS OF STANDARD CHARACTERS WITHOUT CLAIM TO ANY PARTICULAR FONT, STYLE, SIZE, OR COLOR.

PRIORITY CLAIMED UNDER SEC. 44(D) ON UNITED KINGDOM APPLICATION NO. 2487406, FILED 5-13-2008, REG. NO. 2487406, DATED 5-13-2008, EXPIRES 5-13-2018.

CLASS 35—ADVERTISING AND BUSINESS

FOR ADVERTISING, MARKETING AND PROMOTIONAL SERVICES; PUBLIC RELATIONS SERVICES; BUSINESS MANAGEMENT AND ORGANIZATION CONSULTANCY SERVICES; BUSINESS CONSULTANCY; MARKET RESEARCH SERVICES; BUSINESS INFORMATION SERVICES; ARRANGING AND CONDUCTING EXHIBITIONS FOR BUSINESS PURPOSES; NONE OF THE FOREGOING IN THE FIELD OF TOURISM, TRAVEL, ENTERTAINMENT ATTRACTIONS, ECONOMIC DEVELOPMENT, BUSINESS AND INTERESTS IN THE STATE OF FLORIDA (U.S. CLS. 100, 101 AND 102).

CLASS 41—EDUCATION AND ENTERTAINMENT

FOR EDUCATIONAL SERVICES, NAMELY, ARRANGING AND CONDUCTING SEMINARS, LECTURES, CONVENTIONS, CONFERENCES, SYMPOSIUMS AND WORKSHOPS IN THE FIELD OF ADVERTISING AND MARKETING; ARRANGING AND CONDUCTING EDUCATIONAL CONFERENCES, CONVENTIONS AND LECTURES RELATING TO BUSINESS ADVERTISING AND MARKETING; ORGANIZATION OF EDUCATIONAL EVENTS FOR COMMERCIAL ADVERTISING PURPOSES (U.S. CLS. 100, 101 AND 107).

GINA FINK, EXAMINING ATTORNEY

SN 77-477,089. STATE BOARD OF GOVERNORS, ACTING BY AND THROUGH COLORADO STATE UNIVERSITY, DENVER, CO. FILED 5-16-2008.



NO CLAIM IS MADE TO THE EXCLUSIVE RIGHT TO USE "NATIVE PLANT" AS TO CLASS 41 AND PRINTED VISUALS IN THE NATURE OF PROMOTIONAL MATERIALS AND PRINTED CERTIFICATES, APART FROM THE MARK AS SHOWN.

THE MARK CONSISTS OF A FULL CIRCLE CONTAINING THE WORDS "NATIVE PLANT" AT THE TOP, INSIDE THE OUTER CIRCLE, AND THE WORD "MASTER" AT THE BOTTOM, INSIDE THE OUTER CIRCLE. INSIDE THAT OUTER FULL CIRCLE IS AN INNER FULL CIRCLE WITH A PLANT DESIGN INSIDE IT.

SEC. 2(F) AS TO "NATIVE PLANT MASTER".

SN 77-476,897. MARLIGEN BIOSCIENCES, INC., IJAMSVILLE, MD. FILED 5-16-2008.

CLASS 16—PAPER GOODS AND PRINTED MATTER

FOR PRINTED PAPER LABELS; STICKERS; ADVERTISING SIGNS OF PAPER OR CARDBOARD; PRINTED PAPER SIGNS; POSTERS; PRINTED VISUALS IN THE NATURE OF PROMOTIONAL MATERIALS; PENS; NOTEPADS; PRINTED CERTIFICATES (U.S. CLS. 2, 5, 22, 23, 29, 37, 38 AND 50).

FIRST USE 5-0-1997; IN COMMERCE 5-0-1997.

CLASS 41—EDUCATION AND ENTERTAINMENT

FOR EDUCATIONAL SERVICES, NAMELY, PROVIDING COURSES AT VARIOUS OUTDOOR LOCATIONS IN THE FIELD OF PLANT IDENTIFICATION; PROVIDING A WEBSITE FEATURING INFORMATION ABOUT COURSE OFFERINGS AT VARIOUS OUTDOOR LOCATIONS IN THE FIELD OF PLANT IDENTIFICATION; NONE OF THE FOREGOING SERVICES BEING FOR THE PURPOSES FOR A POST-SECONDARY MASTERS DEGREE (U.S. CLS. 100, 101 AND 107).

FIRST USE 5-0-1997; IN COMMERCE 5-0-1997.

DAYNA BROWNE, EXAMINING ATTORNEY

VANTAGE

THE MARK CONSISTS OF STANDARD CHARACTERS WITHOUT CLAIM TO ANY PARTICULAR FONT, STYLE, SIZE, OR COLOR.

CLASS 1—CHEMICALS

FOR RESEARCH REAGENTS AND KITS COMPRISED OF RESEARCH REAGENTS FOR MULTIPLEX ASSAYS USED TO IDENTIFY, OBSERVE AND EXAMINE GENE EXPRESSION, TRANSCRIPTIONAL REGULATION, PROTEIN-PROTEIN INTERACTIONS, AND PROTEIN EXPRESSION, MODIFICATION AND REGULATION (U.S. CLS. 1, 5, 6, 10, 26 AND 46).

CLASS 42—SCIENTIFIC AND COMPUTER SERVICES

FOR RESEARCH FOR OTHERS IN THE FIELD OF LIFE SCIENCES, DRUG DISCOVERY AND DEVELOPMENT, AND DISCOVERY AND DEVELOPMENT OF MOLECULAR DIAGNOSTICS THAT EMPLOY MULTIPLEX TESTING TO IDENTIFY, OBSERVE AND EXAMINE GENE EXPRESSION, TRANSCRIPTIONAL REGULATION, PROTEIN-PROTEIN INTERACTIONS, AND PROTEIN EXPRESSION, MODIFICATION AND REGULATION (U.S. CLS. 100 AND 101).

APRIL ROACH, EXAMINING ATTORNEY

SN 77-478,386. KPMG LLP, NEW YORK, NY. FILED 5-19-2008.

NINTH ELEMENT

THE MARK CONSISTS OF STANDARD CHARACTERS WITHOUT CLAIM TO ANY PARTICULAR FONT, STYLE, SIZE, OR COLOR.

CLASS 35—ADVERTISING AND BUSINESS

FOR BUSINESS RISK MANAGEMENT; BUSINESS RISK MANAGEMENT CONSULTATION; BUSINESS MANAGEMENT CONSULTING SERVICES IN THE FIELD OF DATA ANALYTICS, DATA ANALYTICS AUDITING AND MONITORING (U.S. CLS. 100, 101 AND 102).

CLASS 36—INSURANCE AND FINANCIAL

FOR FINANCIAL RISK MANAGEMENT; FINANCIAL RISK MANAGEMENT CONSULTATION (U.S. CLS. 100, 101 AND 102).

PAUL CROWLEY, EXAMINING ATTORNEY

CLASS 42—SCIENTIFIC AND COMPUTER SERVICES

FOR PROVIDING AN ON LINE NON-DOWNLOADABLE SOFTWARE PROGRAM FEATURING PHYSICAL ACTIVITY THAT INCORPORATES THE USE OF A COMPUTER PERIPHERAL DEVICE IN WHICH FEET, RATHER THAN HANDS VIA KEYBOARD OR MOUSE MANIPULATION, INTERACT WITH SOFTWARE OR ONLINE PROGRAMS; PROVIDING A WEBSITE FEATURING INFORMATION, EDUCATIONAL RESOURCES, NAMELY, AN ON LINE NON-DOWNLOADABLE SOFTWARE PROGRAM AND ON LINE NON-DOWNLOADABLE TEACHER TRAINING SOFTWARE PROGRAM FOR USE WITH SPORTS AND GAMES THAT CAN BE PLAYED BY USING THE COMPUTER PERIPHERAL DEVICE IN WHICH FEET, RATHER THAN HANDS VIA KEYBOARD OR MOUSE MANIPULATION, INTERACT WITH SOFTWARE OR ONLINE PROGRAMS (U.S. CLS. 100 AND 101).

DAVID MURRAY, EXAMINING ATTORNEY

SN 77-480,868. INVENTEAM, LLC, BEND, OR. FILED 5-22-2008.

SN 77-481,977. BRAUNVIEH BEEF LLC, BRASSTOWN, NC. FILED 5-23-2008.

FOOTGAMING

THE MARK CONSISTS OF STANDARD CHARACTERS WITHOUT CLAIM TO ANY PARTICULAR FONT, STYLE, SIZE, OR COLOR.

CLASS 9—ELECTRICAL AND SCIENTIFIC APPARATUS

FOR ELECTRONIC PUBLICATIONS, NAMELY, USER MANUALS AND GUIDE BOOKS FEATURING INFORMATION IN THE FIELD OF WORKPLACE WELLNESS AND DETAILING THE USE OF EDUCATIONAL TECHNOLOGY TOOLS FOR USE WITH A COMPUTER PERIPHERAL DEVICE IN WHICH FEET, RATHER THAN HANDS VIA KEYBOARD OR MOUSE MANIPULATION, INTERACT WITH SOFTWARE OR ONLINE PROGRAMS, RECORDED ON COMPUTER MEDIA (U.S. CLS. 21, 23, 26, 36 AND 38).

CLASS 16—PAPER GOODS AND PRINTED MATTER

FOR EDUCATIONAL PUBLICATIONS, NAMELY, LEARNING PROGRAM MANUALS AND GUIDE BOOKS IN THE FIELD OF WORKPLACE WELLNESS AND EDUCATION DETAILING THE USE OF EDUCATIONAL TECHNOLOGY TOOLS FOR USE WITH A COMPUTER PERIPHERAL DEVICE IN WHICH FEET, RATHER THAN HANDS VIA KEYBOARD OR MOUSE MANIPULATION, INTERACT WITH SOFTWARE OR ONLINE PROGRAMS (U.S. CLS. 2, 5, 22, 23, 29, 37, 38 AND 50).

CLASS 41—EDUCATION AND ENTERTAINMENT

FOR EDUCATIONAL SERVICES, NAMELY, PROVIDING ON-LINE INTERACTIVE LEARNING PROGRAMS IN THE FIELD OF WORKPLACE WELLNESS AND EDUCATIONAL TECHNOLOGY TOOLS VIA THE USE OF A COMPUTER PERIPHERAL DEVICE IN WHICH FEET, RATHER THAN HANDS VIA KEYBOARD OR MOUSE MANIPULATION, INTERACT WITH SOFTWARE OR ONLINE PROGRAMS (U.S. CLS. 100, 101 AND 107).

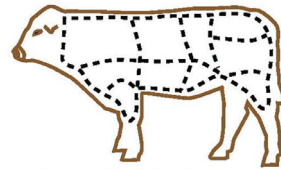

**BRAUNVIEH
BEEF
LLC.**

NO CLAIM IS MADE TO THE EXCLUSIVE RIGHT TO USE "BRAUNVIEH BEEF LLC.", APART FROM THE MARK AS SHOWN.

THE COLOR(S) BROWN AND BLACK IS/ARE CLAIMED AS A FEATURE OF THE MARK.

THE MARK CONSISTS OF A FULL PROFILE OF A COW DRAWN IN BROWN. ON THE COW ARE DRAWN BUTCHER'S CUTS IN SEGMENTED BLACK LINES. UNDER THE COW IS A WIDE BROWN LINE. UNDER THE LINE IS "BRAUNVIEH" IN CENTERED BLACK CAPITAL LETTERS IN WHICH THE "A" IS AN INVERTED "V" AND THE "N" IS AN INVERTED "U". UNDER THOSE LETTERS IS "BEEF" IN CENTERED BLACK CAPITAL LETTERS. UNDER THOSE LETTERS IS A BROWN LINE, WHICH IS THINNER THAN THE PRIOR LINE. UNDER THAT LINE ARE THE BLACK CAPITAL LETTERS "LLC.". THERE IS A BLACK PERIOD AFTER THE LETTERS "LLC."

THE ENGLISH TRANSLATION OF THE GERMAN WORD "BRAUNVIEH" IN THE MARK IS "BROWN CATTLE". IT REFERS TO A BREED OF CATTLE ORIGINATING IN SWITZERLAND.

CLASS 29—MEATS AND PROCESSED FOODS

FOR BEEF (U.S. CL. 46).

CLASS 35—ADVERTISING AND BUSINESS

FOR WHOLESALE DISTRIBUTORSHIPS FEATURING BRAUNVIEH CATTLE (U.S. CLS. 100, 101 AND 102).

ALEXANDER L. POWERS, EXAMINING ATTORNEY

SN 77-487,257. ALISON DIAMOND, NEW YORK, NY. FILED 5-30-2008.

Homeohound

THE MARK CONSISTS OF STANDARD CHARACTERS WITHOUT CLAIM TO ANY PARTICULAR FONT, STYLE, SIZE, OR COLOR.

CLASS 3—COSMETICS AND CLEANING PREPARATIONS

FOR ORGANIC AND HOMEOPATHIC PET CARE SUPPLIES AND ACCESSORIES, NAMELY, NON-MEDICATED PET SHAMPOO AND CONDITIONER (U.S. CLS. 1, 4, 6, 50, 51 AND 52).

CLASS 18—LEATHER GOODS

FOR ORGANIC AND HOMEOPATHIC PET CARE SUPPLIES AND ACCESSORIES, NAMELY, COLLARS FOR PETS (U.S. CLS. 1, 2, 3, 22 AND 41).

CLASS 20—FURNITURE AND ARTICLES NOT OTHERWISE CLASSIFIED

FOR ORGANIC AND HOMEOPATHIC PET CARE SUPPLIES AND ACCESSORIES, NAMELY, BEDS FOR HOUSEHOLD PETS (U.S. CLS. 2, 13, 22, 25, 32 AND 50).

CLASS 21—HOUSEWARES AND GLASS

FOR ORGANIC AND HOMEOPATHIC PET CARE SUPPLIES AND ACCESSORIES, NAMELY, PET BRUSHES (U.S. CLS. 2, 13, 23, 29, 30, 33, 40 AND 50).
TRACY FLETCHER, EXAMINING ATTORNEY

SN 77-490,742. NEW ENGLAND COMPLEX SYSTEMS, INC., DBA NECSI, NEWTON, MA. FILED 6-4-2008.

KNOWLEDGE MAGAZINE

THE MARK CONSISTS OF STANDARD CHARACTERS WITHOUT CLAIM TO ANY PARTICULAR FONT, STYLE, SIZE, OR COLOR.

NO CLAIM IS MADE TO THE EXCLUSIVE RIGHT TO USE "MAGAZINE", APART FROM THE MARK AS SHOWN.

CLASS 9—ELECTRICAL AND SCIENTIFIC APPARATUS

FOR ELECTRONIC PUBLICATIONS, NAMELY, JOURNALS, BOOKS, MANUALS, MAGAZINES AND PERIODICALS FEATURING SCIENTIFIC TOPICS RECORDED ON COMPUTER MEDIA OR DOWNLOADABLE (U.S. CLS. 21, 23, 26, 36 AND 38).

FIRST USE 6-11-2009; IN COMMERCE 6-11-2009.

CLASS 16—PAPER GOODS AND PRINTED MATTER

FOR PUBLICATIONS, NAMELY, JOURNALS, BOOKS, MANUALS, MAGAZINES, AND PERIODICALS IN THE FIELDS OF SCIENTIFIC TOPICS (U.S. CLS. 2, 5, 22, 23, 29, 37, 38 AND 50).

FIRST USE 6-11-2009; IN COMMERCE 6-11-2009.

MICHELLE DUBOIS, EXAMINING ATTORNEY

SN 77-493,229. MIHLFELD & ASSOCIATES, INC., SPRINGFIELD, MO. FILED 6-6-2008.

GOLOGIX

THE MARK CONSISTS OF STANDARD CHARACTERS WITHOUT CLAIM TO ANY PARTICULAR FONT, STYLE, SIZE, OR COLOR.

CLASS 35—ADVERTISING AND BUSINESS

FOR BUSINESS MANAGEMENT SERVICES AND CONSULTING SERVICES, NAMELY, CONTINGENCY BASED CONSULTING FOCUSED ON SUPPLY CHAIN COST REDUCTION INITIATIVES, LOGISTICS MANAGEMENT, REVERSE LOGISTICS, SUPPLY CHAIN SERVICES, VENDOR NEGOTIATIONS, AND SUPPLY CHAIN VISIBILITY; FREIGHT LOGISTICS MANAGEMENT, NAMELY, INVOICE AUDITING AND FREIGHT PAYMENT SERVICES FOR OTHERS (U.S. CLS. 100, 101 AND 102).

CLASS 42—SCIENTIFIC AND COMPUTER SERVICES

FOR PROVIDING TEMPORARY USE OF ON-LINE NON-DOWNLOADABLE SOFTWARE FOR USE IN FREIGHT SHIPPING AND COST MANAGEMENT (U.S. CLS. 100 AND 101).

EMILY CARLSEN, EXAMINING ATTORNEY

SN 77-496,529. TEQUILA CUERVO LA ROJENA, S.A. DE C.V., CODIGO, MEXICO, FILED 6-11-2008.

CUERVO DE MAYO

THE MARK CONSISTS OF STANDARD CHARACTERS WITHOUT CLAIM TO ANY PARTICULAR FONT, STYLE, SIZE, OR COLOR.

OWNER OF U.S. REG. NOS. 3,312,495 AND 3,354,452.

THE FOREIGN WORDING IN THE MARK TRANSLATES INTO ENGLISH AS RAVEN OF MAY.

CLASS 32—LIGHT BEVERAGES

FOR NON-ALCOHOLIC COCKTAIL MIXES FOR MAKING MARGARITAS (U.S. CLS. 45, 46 AND 48).

CLASS 33—WINES AND SPIRITS

FOR TEQUILA (U.S. CLS. 47 AND 49).

JOHN DWYER, EXAMINING ATTORNEY

SN 77-497,480. CASTANOS & FLORES, INC., DBA BONITA LEARNING ACADEMY, CHULA VISTA, CA. FILED 6-12-2008.



NO CLAIM IS MADE TO THE EXCLUSIVE RIGHT TO USE "BONITA LEARNING ACADEMY", APART FROM THE MARK AS SHOWN.

THE MARK CONSISTS OF THE PHRASE "BONITA LEARNING ACADEMY" WITH A STYLIZED DEPICTION OF A PERSON READING A BOOK ABOVE THE PHRASE.

CLASS 16—PAPER GOODS AND PRINTED MATTER

FOR EDUCATIONAL PUBLICATIONS, NAMELY, HANDOUTS AND WORKBOOKS IN THE FIELDS OF PRE AND MIDDLE SCHOOL EDUCATION AND SPANISH LANGUAGE EDUCATION (U.S. CLS. 2, 5, 22, 23, 29, 37, 38 AND 50).

FIRST USE 1-1-1998; IN COMMERCE 1-1-1998.

CLASS 41—EDUCATION AND ENTERTAINMENT

FOR EDUCATIONAL SERVICES, NAMELY, CONDUCTING CLASSES FOR CHILDREN IN THE FIELD OF SPANISH LANGUAGE AND DISTRIBUTION OF COURSE MATERIAL IN CONNECTION THEREWITH (U.S. CLS. 100, 101 AND 107).

FIRST USE 1-1-1998; IN COMMERCE 1-1-1998.
SHARON MEIER, EXAMINING ATTORNEY

SN 77-497,771. CENTER FOR HEALTH DESIGN, INC., CONCORD, CA. FILED 6-12-2008.

EDAC: Evidence-based Design Accreditation and Certification

THE MARK CONSISTS OF STANDARD CHARACTERS WITHOUT CLAIM TO ANY PARTICULAR FONT, STYLE, SIZE, OR COLOR.

NO CLAIM IS MADE TO THE EXCLUSIVE RIGHT TO USE "EVIDENCE-BASED DESIGN ACCREDITATION AND CERTIFICATION", APART FROM THE MARK AS SHOWN.

CLASS 41—EDUCATION AND ENTERTAINMENT

FOR EDUCATION SERVICES, NAMELY, MENTORING IN THE FIELD OF COURSES, SEMINARS, CLASSES, SYMPOSIA, EDUCATIONAL COMPETITIONS, AND WORKSHOPS IN THE FIELD OF EVIDENCE-BASED DESIGN FOR HEALTHCARE PROJECTS; PROVIDING RECOGNITION AND INCENTIVES BY THE WAY OF AWARDS TO DEMONSTRATE EXCELLENCE IN THE FIELD OF HEALTHCARE DESIGN (U.S. CLS. 100, 101 AND 107).

FIRST USE 9-1-2007; IN COMMERCE 9-1-2007.

CLASS 42—SCIENTIFIC AND COMPUTER SERVICES

FOR RESEARCH IN THE FIELD OF HEALTHCARE DESIGN; ACCREDITATION SERVICES, NAMELY, DEVELOPING, EVALUATING, AND MAINTAINING TESTING STANDARDS FOR HEALTHCARE PROJECTS, HEALTHCARE PROFESSIONALS, AND HEALTH CARE FACILITY DESIGN (U.S. CLS. 100 AND 101).

FIRST USE 9-1-2007; IN COMMERCE 9-1-2007.
JOHN DALIER, EXAMINING ATTORNEY

SN 77-499,497. EQUIP, INC., MARION, NC. FILED 6-16-2008.

EQUIP INTERNATIONAL

THE MARK CONSISTS OF STANDARD CHARACTERS WITHOUT CLAIM TO ANY PARTICULAR FONT, STYLE, SIZE, OR COLOR.

OWNER OF U.S. REG. NO. 3,196,900.

NO CLAIM IS MADE TO THE EXCLUSIVE RIGHT TO USE "INTERNATIONAL", APART FROM THE MARK AS SHOWN.

CLASS 41—EDUCATION AND ENTERTAINMENT

FOR MISSIONARY WORK, NAMELY, TRAINING MISSIONARIES AND NATIONAL WORKERS IN CONNECTION WITH RELIEF AND DEVELOPMENT WORK (U.S. CLS. 100, 101 AND 107).

FIRST USE 5-20-1983; IN COMMERCE 5-20-1983.

CLASS 43—HOTEL AND RESTAURANT SERVICES

FOR MISSIONARY WORK, NAMELY, SENDING AND FIELDING MISSIONARIES FOR RELIEF AND DEVELOPMENT WORK, NAMELY, PROVIDING FOOD, TEMPORARY SHELTER, AND FURNITURE TO THOSE IN NEED (U.S. CLS. 100 AND 101).

FIRST USE 5-20-1983; IN COMMERCE 5-20-1983.

CLASS 44—MEDICAL, BEAUTY AND AGRICULTURAL SERVICES

FOR MISSIONARY WORK, NAMELY, SENDING AND FIELDING MISSIONARIES FOR RELIEF AND DEVELOPMENT WORK, NAMELY, PROVIDING HEALTH CARE TO THOSE IN NEED (U.S. CLS. 100 AND 101).

FIRST USE 5-20-1983; IN COMMERCE 5-20-1983.

CLASS 45—PERSONAL AND LEGAL SERVICES

FOR MISSIONARY SERVICES (U.S. CLS. 100 AND 101).

FIRST USE 5-20-1983; IN COMMERCE 5-20-1983.

ANNE FARRELL, EXAMINING ATTORNEY

SN 77-499,790. GERBER CHILDRENSWEAR LLC, GREENVILLE, SC. FILED 6-16-2008.

ALL-IN-ONE

THE MARK CONSISTS OF STANDARD CHARACTERS WITHOUT CLAIM TO ANY PARTICULAR FONT, STYLE, SIZE, OR COLOR.

OWNER OF U.S. REG. NO. 3,613,428.

CLASS 16—PAPER GOODS AND PRINTED MATTER

FOR BIBS FOR CHILDREN AND INFANTS MADE OF PAPER (U.S. CLS. 2, 5, 22, 23, 29, 37, 38 AND 50).

CLASS 25—CLOTHING

FOR BIBS FOR CHILDREN AND INFANTS MADE OF PLASTIC; CLOTH BIBS (U.S. CLS. 22 AND 39).
SUSAN RICHARDS, EXAMINING ATTORNEY

SN 77-502,324. SPEARMINT RHINO COMPANIES WORLDWIDE, INC., NORCO, CA. FILED 6-18-2008.



THE COLOR(S) BLACK, GOLD, BROWN, TAN AND WHITE IS/ARE CLAIMED AS A FEATURE OF THE MARK.

THE MARK CONSISTS OF THE APPEARANCE AND INTERIOR DESIGN OF AN ADULT CABARET EVOKING THE INTERIOR OF A VICTORIAN-ERA ENGLISH GENTLEMEN'S CLUB THROUGH THE COMBINATION OF: CUSTOM-DESIGNED TAN AND LEOPARD PRINT CARPETING; BROWN MARBLEIZED AND BURLED WOOD DESIGN ACHIEVED THROUGH MULTIPLE LAYERS OF WALL PAINT; INTERIOR WINDOWS WITH BROWN AWNINGS; ENTRYWAY WITH ROUNDED BLACK AWNING; GOLD CHANDELIER LIGHT FIXTURES; GOLD CANDELABRA WALL SCONCES WITH BLACK SHADES; BLACK LANTERN SCONCES WITH CLEAR GLASS PANELS; CENTER RECTANGULAR STAGE WITH BLACK AND DARK BROWN STONE SURFACES AND GOLD RAILINGS ON TOP; BLACK BARREL-SHAPED CHAIRS SURROUNDING ROUND BLACK TABLES SUPPORTING GOLD TABLE LAMPS WITH WHITE LAMP SHADES; BLACK BAR STOOLS WITH ROUNDED BACKS SURROUNDING DARK BROWN WOOD PUB TABLES SUPPORTING MINIATURE GOLD LAMPS WITH CLEAR GLASS GLOBES; AND LARGE, GOLD AND ORNATE PICTURE FRAMES DISPLAYED ON THE WALLS. THE RECESSED BUTTON-TUFTED SEATING BOOTH IS NOT EXCLUSIVELY CLAIMED AS A FEATURE OF THE MARK.

SEC. 2(F).

CLASS 41—EDUCATION AND ENTERTAINMENT

FOR ADULT ENTERTAINMENT SERVICES IN THE NATURE OF ADULT CABARETS, NIGHTCLUBS AND SHOW CLUBS FEATURING NUDE, SEMI-NUDE, EROTIC DANCING, AND LAP AND TABLE DANCING (U.S. CLS. 100, 101 AND 107).

FIRST USE 10-15-1992; IN COMMERCE 10-15-1992.

CLASS 43—HOTEL AND RESTAURANT SERVICES

FOR RESTAURANT AND BAR SERVICES; PREPARATION AND SERVING OF FOOD AND DRINK (U.S. CLS. 100 AND 101).

FIRST USE 10-15-1992; IN COMMERCE 10-15-1992.

ANDREW LEASER, EXAMINING ATTORNEY

SN 77-503,861. MST HOUSTON HOLDINGS, LLC, HOUSTON, TX. FILED 6-20-2008.



THE MARK CONSISTS OF OF A RECTANGLE WITH AN IMAGE OF A SAW BLADE. BELOW THE RECTANGLE IS THE STYLIZED TEXT "METAL SAWING TECHNOLOGY". SEC. 2(F) AS TO "METAL SAWING TECHNOLOGY".

CLASS 7—MACHINERY

FOR BAND SAW BLADES ; BAND SAW MACHINES (U.S. CLS. 13, 19, 21, 23, 31, 34 AND 35).

FIRST USE 1-1-1990; IN COMMERCE 1-1-1990.

CLASS 35—ADVERTISING AND BUSINESS

FOR INDUSTRIAL DISTRIBUTORSHIPS FEATURING MACHINES AND BLADES (U.S. CLS. 100, 101 AND 102).

FIRST USE 1-1-1990; IN COMMERCE 1-1-1990.

CLASS 37—CONSTRUCTION AND REPAIR

FOR MAINTENANCE AND/OR REPAIR OF INDUSTRIAL MACHINES AND BLADES (U.S. CLS. 100, 103 AND 106).

FIRST USE 1-1-1990; IN COMMERCE 1-1-1990.

GRETTA YAO, EXAMINING ATTORNEY

SN 77-505,796. PHYSIK INSTRUMENTE (PI) GMBH & CO. KG, KARLSRUHE, FED REP GERMANY, FILED 6-23-2008.

PICOACTUATOR

THE MARK CONSISTS OF STANDARD CHARACTERS WITHOUT CLAIM TO ANY PARTICULAR FONT, STYLE, SIZE, OR COLOR.

PRIORITY CLAIMED UNDER SEC. 44(D) ON FED REP GERMANY APPLICATION NO. 302008009681, FILED 2-14-2008, REG. NO. 302008009681, DATED 8-27-2008, EXPIRES 2-15-2018.

CLASS 7—MACHINERY

FOR ELECTROMOTIVE DRIVES FOR SINGLE-AXIS AND MULTI-AXIS POSITIONING SYSTEMS, PIEZOELECTRIC DRIVES FOR SINGLE-AXIS AND MULTI-AXIS POSITIONING SYSTEMS; PIEZOELECTRIC MOTORS FOR PRECISION MICROPOSITIONING APPARATUS; PIEZOELECTRIC TILTING PLATFORMS FOR ACTIVE LENS SYSTEMS OPTICS MACHINES, NAMELY, MOTORIZED PLATFORMS USING PIEZOELECTRIC PROPERTIES FOR HOLDING, TRANSPORTING, AND TILTING OPTICAL ELEMENTS AND ACTIVE OPTICS (U.S. CLS. 13, 19, 21, 23, 31, 34 AND 35).

CLASS 9—ELECTRICAL AND SCIENTIFIC APPARATUS

FOR SCIENTIFIC APPARATUS AND INSTRUMENTS, NAMELY, PRECISION MICROPOSITIONING APPARATUS; DATA PROCESSING APPARATUS, NAMELY, COMPUTERS AND COMPUTER SOFTWARE FOR OPERATING PRECISION MICROPOSITIONING APPARATUS; CONTROLLERS FOR PRECISION MICROPOSITIONING APPARATUS; INTEGRATED DISPLACEMENT SENSORS FOR MECHANICAL POSITIONING SYSTEMS; PIEZOELECTRIC MULTILAYER ACTUATORS; PIEZOELECTRIC ULTRASONIC TRANSDUCERS; AND FEED-THROUGH CAPACITORS (U.S. CLS. 21, 23, 26, 36 AND 38).

CLASS 42—SCIENTIFIC AND COMPUTER SERVICES

FOR DEVELOPMENT OF COMPUTER SOFTWARE AND LEASING OF COMPUTER SOFTWARE; ENGINEERING SERVICES; AND SERVICES IN THE FIELD OF PHYSICAL RESEARCH, NAMELY, MECHANICAL, ELECTRICAL AND OPTICAL RESEARCH (U.S. CLS. 100 AND 101).

KIM SAITO, EXAMINING ATTORNEY

SN 77-512,693. PERFORMANCE ROOF SYSTEMS, INC., KANSAS CITY, MO. FILED 7-1-2008.



OWNER OF U.S. REG. NOS. 1,803,745, 2,983,877 AND OTHERS.

THE COLOR(S) BLACK AND GOLD IS/ARE CLAIMED AS A FEATURE OF THE MARK.

THE MARK CONSISTS OF THE WORD "DERBISOLAR" IN BLACK LETTERS OUTLINED IN GOLD, SEMI-SURROUNDED BY A BLACK ELLIPSE, WITH A BLACK ELECTRON SYMBOL, OUTLINED IN GOLD, INSIDE A GOLD CIRCLE ABOVE THE FIRST LETTER "E". THE COLOR WHITE IN THE MARK IS TRANSPARENT BACKGROUND THAT IS NOT PART OF THE MARK. THE COLOR GRAY REPRESENTS SHADING AND IS NOT PART OF THE MARK.

CLASS 9—ELECTRICAL AND SCIENTIFIC APPARATUS

FOR PHOTOVOLTAIC CELLS AND MODULES; APPARATUS FOR CONVERTING ELECTRONIC RADIATION TO ELECTRICAL ENERGY, NAMELY, PHOTOVOLTAIC CLADDING PANELS, PHOTOVOLTAIC SOLAR MODULES, AND PHOTOVOLTAIC SOLAR HYBRID MODULES; SOLAR CELLS; APPARATUS FOR THE CONTROL OF ELECTRICITY, NAMELY, INSTRUMENTS AND CONDUITS FOR ELECTRICALLY INVERTING, CONDUCTING, COMBINING, SWITCHING, TRANSFORMING, RECTIFYING, STORING, ACCUMULATING, REGULATING, AND MONITORING ELECTRIC CURRENT; PANEL METERS, NAMELY, AN ELECTRONIC INSTRUMENT THAT DISPLAYS AN INPUT SIGNAL IN EITHER A DIGITAL OR ANALOG FORM FOR USE IN DISPLAYING, MONITORING, AND CONTROLLING ELECTRIC CURRENT; COMPUTER SOFTWARE FOR USE IN MONITORING AND CONTROLLING ELECTRIC CURRENT (U.S. CLS. 21, 23, 26, 36 AND 38).

CLASS 17—RUBBER GOODS

FOR POLYMER SEALANT FOR USE IN CONNECTION WITH THE INSTALLATION OF FLOORING; POLYMER-BASED PATCHING AND SEALING COMPOUNDS FOR MASONRY AND WOOD (U.S. CLS. 1, 5, 12, 13, 35 AND 50).

CLASS 19—NON-METALLIC BUILDING MATERIALS

FOR MEMBRANES, LAMINATES, COMPOSITES, SYNTHETICS, SEMI-SYNTHETICS, POLYMERS, AND BITUMINOUS PRODUCTS FOR BUILDING PURPOSES, NAMELY, NONMETAL SUB-FLOOR MEMBRANE FOR RESIDENTIAL AND COMMERCIAL SOUNDPROOFING USE, GLUE-LAMINATED WOOD, LAMINATE FLOORING, LAMINATED DRYWALL, LAMINATED FLAT GLASS, COMPOSITE PANELS COMPOSED PRIMARILY OF NONMETAL MATERIALS, NON-WOVEN TEXTILES MADE OF SYNTHETIC AND SEMI-SYNTHETIC FIBERS FOR USE IN THE BUILDING INDUSTRY, SYNTHETIC FLOORING MATERIALS OR WALL-CLADDINGS, AND BITUMEN-BASED DRIVEWAY SEALANT; BITUMINOUS COATINGS, MEMBRANES, NON-METAL LAMINATES, NON-METAL COMPOSITES AND NON-METAL POLYMERS FOR ROOFING; ASPHALT AND BITUMEN (U.S. CLS. 1, 12, 33 AND 50).

CLASS 37—CONSTRUCTION AND REPAIR

FOR BUILDING REPAIR; INSTALLATION SERVICES, NAMELY, INSTALLATION OF SOLAR CELLS, MODULES, AND PANELS AND PHOTOVOLTAIC CELLS, MODULES AND PANELS (U.S. CLS. 100, 103 AND 106).
KIM MONINGHOFF, EXAMINING ATTORNEY

SN 77-516,642. SMINK, INC., DALLAS, TX. FILED 7-8-2008.

Smink

THE MARK CONSISTS OF STANDARD CHARACTERS WITHOUT CLAIM TO ANY PARTICULAR FONT, STYLE, SIZE, OR COLOR.

THE NAME "SMINK" IDENTIFIES A LIVING INDIVIDUAL WHOSE CONSENT IS OF RECORD.

SEC. 2(F).

CLASS 6—METAL GOODS

FOR WROUGHT IRON DECORATIVE ARTWORK (U.S. CLS. 2, 12, 13, 14, 23, 25 AND 50);
FIRST USE 10-27-1988; IN COMMERCE 10-27-1988.

CLASS 16—PAPER GOODS AND PRINTED MATTER

FOR PHOTOGRAPHS; PRINTED MATTER, NAMELY, ART PRINTS, PRINTED ART REPRODUCTIONS; ORIGINAL ARTWORK CONSISTING PRIMARILY OF PAPER, CLOTH, PAINT, AND INK, NAMELY, ART PICTURES, ART ETCHINGS, ART PRINTS, PAINTINGS, AND CALLIGRAPHIC WORKS (U.S. CLS. 2, 5, 22, 23, 29, 37, 38 AND 50).
FIRST USE 10-27-1988; IN COMMERCE 10-27-1988.

CLASS 20—FURNITURE AND ARTICLES NOT OTHERWISE CLASSIFIED

FOR HOME FURNISHINGS, NAMELY, FURNITURE, BEDS, MATTRESSES, PILLOWS AND BOLSTERS, BED FRAMES; ARTWORK, NAMELY, SCULPTURES OF BONE, IVORY, PLASTIC, PLASTER, WAX AND WOOD; ORIGINAL ARTWORK CONSISTING PRIMARILY OF BONE, IVORY, PLASTIC, PLASTER, WAX AND WOOD, NAMELY, WORKS OF ART PRIMARILY OF BONE, IVORY, PLASTIC, PLASTER, WAX AND WOOD (U.S. CLS. 2, 13, 22, 25, 32 AND 50).
FIRST USE 10-27-1988; IN COMMERCE 10-27-1988.

CLASS 24—FABRICS

FOR BED LINENS AND BED COVERS MADE OF FABRICS; HOME FURNISHINGS IN THE NATURE OF BEDDING, NAMELY, BED BLANKETS, BED CANOPIES, BED SHEETS, BED SKIRTS, BEDSPREADS, FEATHER BEDS (U.S. CLS. 42 AND 50).
FIRST USE 10-27-1988; IN COMMERCE 10-27-1988.

CLASS 27—FLOOR COVERINGS

FOR HOME FURNISHINGS, NAMELY, RUGS (U.S. CLS. 19, 20, 37, 42 AND 50).
FIRST USE 10-27-1988; IN COMMERCE 10-27-1988.
JAY BESCH, EXAMINING ATTORNEY

CLASS 5—PHARMACEUTICALS

FOR DIETETIC FOODS ADAPTED FOR MEDICAL USE; FORTIFYING FOOD FOR MEDICAL USE, NAMELY, FOOD FOR BABIES, INFANTS, CHILDREN, ADULTS, ELDERLY PEOPLE, PEOPLE WITH MEDICAL CONDITIONS, PEOPLE WITH DISEASES AND INVALIDS; NUTRITIONAL DIETARY SUPPLEMENTS FOR MEDICAL USE (U.S. CLS. 6, 18, 44, 46, 51 AND 52).

CLASS 10—MEDICAL APPARATUS

FOR SURGICAL AND MEDICAL APPARATUS AND INSTRUMENTS FOR USE IN GENERAL SURGERY; MEDICAL APPARATUS FOR ADMINISTERING FOOD, NAMELY, FEED-PUMPS AND INTRAVENOUS OR ENTERAL FEEDING TUBES AND PARTS THEREFOR (U.S. CLS. 26, 39 AND 44).

CLASS 44—MEDICAL, BEAUTY AND AGRICULTURAL SERVICES

FOR MEDICAL ASSISTANCE; MEDICAL AND PHARMACEUTICAL CONSULTATION; CONSULTATION AND ADVISING IN THE FIELD OF FOOD NUTRITION; CONSULTATION AND CARE IN THE SUBJECTS OF HYGIENE AND HEALTH (U.S. CLS. 100 AND 101).
KIMBERLY PERRY, EXAMINING ATTORNEY

SN 77-517,444. N.V. NUTRICIA, ZOETERMEER, NETHERLANDS, FILED 7-8-2008.

SN 77-517,194. N.V. NUTRICIA, ZOETERMEER, NETHERLANDS, FILED 7-8-2008.



PRIORITY CLAIMED UNDER SEC. 44(D) ON BENELUX APPLICATION NO. 1151779, FILED 1-24-2008, REG. NO. 0838568, DATED 2-19-2008, EXPIRES 1-24-2018.

NO CLAIM IS MADE TO THE EXCLUSIVE RIGHT TO USE "ADVANCED MEDICAL NUTRITION", APART FROM THE MARK AS SHOWN.

THE COLOR(S) PURPLE, WHITE IS/ARE CLAIMED AS A FEATURE OF THE MARK.

THE MARK CONSISTS OF THE WORDS "NUTRICIA ADVANCED MEDICAL NUTRITION" IN SPECIAL TYPE LETTERS WITH A DESIGN OF CROSSED LINES WITH A SEMICIRCLE BISECTING THE HORIZONTAL LINE ALL IN WHITE ON A PURPLE RECTANGLE.



PRIORITY CLAIMED UNDER SEC. 44(D) ON BENELUX APPLICATION NO. 1151772, FILED 1-24-2008, REG. NO. 0838567, DATED 2-19-2008, EXPIRES 1-24-2018.

NO CLAIM IS MADE TO THE EXCLUSIVE RIGHT TO USE "ADVANCED MEDICAL NUTRITION", APART FROM THE MARK AS SHOWN.

THE COLOR(S) PURPLE, DARK PURPLE IS/ARE CLAIMED AS A FEATURE OF THE MARK.

THE MARK CONSISTS OF THE WORDS "NUTRICIA ADVANCED MEDICAL NUTRITION" IN SPECIAL TYPE LETTERS WITH A DESIGN OF CROSSED LINES WITH A SEMICIRCLE BISECTING THE HORIZONTAL LINE ALL IN PURPLE AND DARK PURPLE.

CLASS 5—PHARMACEUTICALS

FOR DIETETIC FOODS ADAPTED FOR MEDICAL USE; FORTIFYING FOOD FOR MEDICAL USE, NAMELY, FOOD FOR BABIES, INFANTS, CHILDREN, ADULTS, ELDERLY PEOPLE, PEOPLE WITH MEDICAL CONDITIONS, PEOPLE WITH DISEASES AND INVALIDS; NUTRITIONAL DIETARY SUPPLEMENTS FOR MEDICAL USE (U.S. CLS. 6, 18, 44, 46, 51 AND 52).

CLASS 10—MEDICAL APPARATUS

FOR SURGICAL AND MEDICAL APPARATUS AND INSTRUMENTS FOR USE IN GENERAL SURGERY; MEDICAL APPARATUS FOR ADMINISTERING FOOD, NAMELY, FEED-PUMPS AND INTRAVENOUS OR ENT-ERAL FEEDING TUBES AND PARTS THEREFOR (U.S. CLS. 26, 39 AND 44).

SN 77-527,127. CARLSON, GERALD A., OREGON CITY, OR. FILED 7-21-2008.

CLASS 44—MEDICAL, BEAUTY AND AGRICULTURAL SERVICES

FOR MEDICAL ASSISTANCE; MEDICAL AND PHAR-MACEUTICAL CONSULTATION; CONSULTATION AND ADVISING IN THE FIELD OF FOOD NUTRITION; CONSULTATION AND CARE IN THE SUBJECTS OF HYGIENE AND HEALTH (U.S. CLS. 100 AND 101).
KIMBERLY PERRY, EXAMINING ATTORNEY

BUYLOCALONLY.COM HOME OF
THEZIPDOG

THE MARK CONSISTS OF STANDARD CHARACTERS WITHOUT CLAIM TO ANY PARTICULAR FONT, STYLE, SIZE, OR COLOR.

CLASS 35—ADVERTISING AND BUSINESS

FOR ON-LINE BUSINESS DIRECTORY FEATURING HOSTED WEBSITES FOR LOCAL BUSINESSES AND THAT DISPLAY ADVERTISEMENT LISTINGS FOR THE LOCAL BUSINESSES FOR PEOPLE TO FIND BUSINESSES NEAR THEIR HOME OR WORK OR OTHER DESTINATIONS (U.S. CLS. 100, 101 AND 102).

SN 77-520,259. IMAGESTOREHOUSE.COM. LLC, DBA IM-AGESTOREHOUSE, JACKSONVILLE, FL. FILED 7-11-2008.

CLASS 42—SCIENTIFIC AND COMPUTER SERVICES

FOR HOSTING OF WEB SITES FOR LOCAL BUSI-NESSSES FEATURING ADVERTISEMENTS OF THE LO-CAL BUSINESSES THAT CORRESPOND TO PRINTED COUPONS PUBLISHED TO SPECIFIC COMMUNITIES FOR DIRECTING PEOPLE TO THE HOSTED WEBSITES AND FOR PEOPLE TO FIND BUSINESSES NEAR THEIR HOME OR WORK OR OTHER DESTINATIONS (U.S. CLS. 100 AND 101).

YAT SYE, LEE, EXAMINING ATTORNEY



NO CLAIM IS MADE TO THE EXCLUSIVE RIGHT TO USE "END TO END DOCUMENT MANAGEMENT SOLU-TIONS", APART FROM THE MARK AS SHOWN.

THE COLOR(S) BLUE IS/ARE CLAIMED AS A FEATURE OF THE MARK.

THE MARK CONSISTS OF THREE MEDIUM BLUE POINTED IMAGES OF SHEETS OF PAPER ON THE LEFT SIDE OF THE MARK DISSOLVING INTO SEVERAL LINES OF LIGHTER BLUE-COLORED "0"S AND "1"S AND A FAINT LIGHT BLUE CHECKERBOARD PATTERN ON THE RIGHT SIDE OF THE MARK. ON THE LOWER, MIDDLE-CENTER OF THE MARK IN DARK BLUE LETTERS OVER THE PATTERN OF THE MARK IS THE WORDING "IM-AGESTOREHOUSE". DIRECTLY BELOW THE WORD "IM-AGESTOREHOUSE" IN LIGHTER BLUE LETTERS ARE THE WORDS "END TO END DOCUMENT MANAGEMENT SOLUTIONS".

SN 77-528,694. TOOKTY, NORFOLK, VA. FILED 7-22-2008.

TOOKTY

THE MARK CONSISTS OF STANDARD CHARACTERS WITHOUT CLAIM TO ANY PARTICULAR FONT, STYLE, SIZE, OR COLOR.

CLASS 40—MATERIAL TREATMENT

FOR ELECTRONIC IMAGING, SCANNING, DIGITIZ-ING, ALTERATION AND/OR RETOUCHING OF PHOTOGRAPHIC IMAGES, BLUEPRINTS, AND X-RAYS (U.S. CLS. 100, 103 AND 106).

FIRST USE 1-1-2000; IN COMMERCE 1-1-2000.

CLASS 35—ADVERTISING AND BUSINESS

FOR BUSINESS MANAGEMENT CONSULTATION (U.S. CLS. 100, 101 AND 102).

FIRST USE 7-10-2008; IN COMMERCE 7-10-2008.

CLASS 42—SCIENTIFIC AND COMPUTER SERVICES

FOR DOCUMENT DATA TRANSFER FROM ONE COMPUTER FORMAT TO ANOTHER; CONVERSION OF DOCUMENTS FROM PHYSICAL TO ELECTRONIC MEDIA (U.S. CLS. 100 AND 101).

FIRST USE 1-1-2000; IN COMMERCE 1-1-2000.

STEVEN R. FOSTER, EXAMINING ATTORNEY

CLASS 42—SCIENTIFIC AND COMPUTER SERVICES

FOR DESIGN, CREATION, HOSTING AND MAINTEN-ANCE OF INTERNET SITES FOR THIRD PARTIES (U.S. CLS. 100 AND 101).

FIRST USE 7-22-2008; IN COMMERCE 7-22-2008.

HANNO RITTNER, EXAMINING ATTORNEY

SN 77-529,921. REPUBLIC OF TEXAS BIKER RALLY, INC., AUSTIN, TX. FILED 7-23-2008.

R.O.T. Biker Rally

THE MARK CONSISTS OF STANDARD CHARACTERS WITHOUT CLAIM TO ANY PARTICULAR FONT, STYLE, SIZE, OR COLOR.

NO CLAIM IS MADE TO THE EXCLUSIVE RIGHT TO USE "BIKER RALLY", APART FROM THE MARK AS SHOWN.
SEC. 2(F).

CLASS 26—FANCY GOODS

FOR CLOTHING ACCESSORIES, NAMELY, CLOTH PATCHES FOR CLOTHING, ORNAMENTAL NOVELTY PINS AND PIN HANGERS, AND BELT BUCKLES (U.S. CLS. 37, 39, 40, 42 AND 50).

FIRST USE 1-10-1998; IN COMMERCE 1-10-1998.

CLASS 41—EDUCATION AND ENTERTAINMENT

FOR ENTERTAINMENT AND EDUCATIONAL SERVICES, NAMELY, ORGANIZING, ARRANGING AND CONDUCTING MOTORCYCLE RALLIES AND CONFERENCES, EVENTS, FESTIVALS AND SEMINARS IN THE FIELDS OF MOTORCYCLES, MOTORCYCLE RIDING, MOTORCYCLE CONSTRUCTION, MAINTENANCE AND REPAIR, AND MOTORCYCLE LIFESTYLES (U.S. CLS. 100, 101 AND 107).

FIRST USE 1-10-1998; IN COMMERCE 1-10-1998.
GRETTA YAO, EXAMINING ATTORNEY

SN 77-531,099. MBO PARTNERS, INC., HERNDON, VA. FILED 7-24-2008.

FIND OUT WHAT YOU CAN DO

THE MARK CONSISTS OF STANDARD CHARACTERS WITHOUT CLAIM TO ANY PARTICULAR FONT, STYLE, SIZE, OR COLOR.

CLASS 36—INSURANCE AND FINANCIAL

FOR PROVIDING EMPLOYMENT BENEFIT SERVICES, NAMELY, PROCESSING, ADMINISTERING AND MANAGING EMPLOYEE BENEFIT PLANS CONCERNING INSURANCE AND FINANCE; PROVIDING ARTICLES AND NEWS BRIEFS REGARDING EMPLOYEE BENEFITS CONCERNING INSURANCE AND FINANCES; PROVIDING PERSONALIZED REPORTS AND SUMMARIES OF EMPLOYEE BENEFITS CONCERNING INSURANCE AND FINANCE (U.S. CLS. 100, 101 AND 102).

FIRST USE 3-1-2007; IN COMMERCE 3-1-2007.

CLASS 42—SCIENTIFIC AND COMPUTER SERVICES

FOR PROVIDING INFORMATION TECHNOLOGY CONSULTING, COMPUTER SYSTEM ANALYSIS, COMPUTER SYSTEMS INTEGRATION, COMPUTER SYSTEMS DEVELOPMENT, WEBSITE DEVELOPMENT FOR OTHERS, AND SOFTWARE APPLICATION DEVELOPMENT (U.S. CLS. 100 AND 101).

FIRST USE 3-1-2007; IN COMMERCE 3-1-2007.
EMILY CHUO, EXAMINING ATTORNEY

SN 77-531,146. M.J. CARLYLE AND COMPANY, CULVER CITY, CA. FILED 7-25-2008.



THE MARK CONSISTS OF THE WORDS "MAKE LOVE NOT TRASH", ONE WORD PER LINE. THE VERTICAL PENSTROKE OF THE LETTER "L" IS IN THE FORM OF ANGEL'S WINGS..

CLASS 18—LEATHER GOODS

FOR HANDBAGS (U.S. CLS. 1, 2, 3, 22 AND 41).
FIRST USE 2-1-2008; IN COMMERCE 2-1-2008.

CLASS 25—CLOTHING

FOR WEARABLE GARMENTS AND CLOTHING, NAMELY, SHIRTS (U.S. CLS. 22 AND 39).
FIRST USE 2-1-2008; IN COMMERCE 2-1-2008.
BRIAN PINO, EXAMINING ATTORNEY

SN 77-531,961. GREAT TRANSFORMATIONS, LLC, TEMPE, AZ. FILED 7-25-2008.



NO CLAIM IS MADE TO THE EXCLUSIVE RIGHT TO USE "DESIGNS", APART FROM THE MARK AS SHOWN.
THE COLOR(S) GREEN IS/ARE CLAIMED AS A FEATURE OF THE MARK.

THE MARK CONSISTS OF A STYLIZED GREEN SCRIPT ENDING WITH A GREEN LEAF THAT IS THE WORD "SAGESSE" DOMINANTLY LARGE AND CENTERED IN THE MARK. THE WORD "DESIGNS" APPEARS IN GREEN NON-STYLIZED LOWER CASE UNDERNEATH "SAGESSE." THE WORDING "REAL ART REAL WORDS REAL LIFE" APPEARS IN GREEN IN THE SMALLEST FONT ABOVE THE WORD "SAGESSE".

THE ENGLISH TRANSLATION OF "SAGESSE" IN THE MARK IS WISDOM.

CLASS 9—ELECTRICAL AND SCIENTIFIC APPARATUS

FOR AUDIO AND VIDEO RECORDINGS FEATURING MUSIC, SPOKEN WORD, AND POETRY (U.S. CLS. 21, 23, 26, 36 AND 38).

FIRST USE 5-1-2008; IN COMMERCE 5-1-2008.

CLASS 16—PAPER GOODS AND PRINTED MATTER

FOR GREETING CARDS (U.S. CLS. 2, 5, 22, 23, 29, 37, 38 AND 50).

FIRST USE 5-1-2008; IN COMMERCE 5-1-2008.
YAT SYE, LEE, EXAMINING ATTORNEY

SN 77-532,147. M.J. CARLYLE AND COMPANY, CULVER CITY, CA. FILED 7-26-2008.

MAKE LOVE NOT TRASH

THE MARK CONSISTS OF STANDARD CHARACTERS WITHOUT CLAIM TO ANY PARTICULAR FONT, STYLE, SIZE, OR COLOR.

CLASS 18—LEATHER GOODS

FOR HANDBAGS (U.S. CLS. 1, 2, 3, 22 AND 41).
FIRST USE 2-1-2008; IN COMMERCE 2-1-2008.

CLASS 25—CLOTHING

FOR WEARABLE GARMENTS AND CLOTHING, NAMELY, SHIRTS (U.S. CLS. 22 AND 39).
FIRST USE 2-1-2008; IN COMMERCE 2-1-2008.
BRIAN PINO, EXAMINING ATTORNEY

SN 77-532,712. MYRIAM CAMPO-GOLDMAN, HOLLYWOOD, FL. FILED 7-28-2008.



THE COLOR(S) DEEP GREEN AND LIGHT GREEN IS/ ARE CLAIMED AS A FEATURE OF THE MARK.

THE MARK CONSISTS OF TWO SYMBOLIZED PEOPLE STANDING IN A SEMICIRCLE BACKGROUND. THE TWO SYMBOLIZED PEOPLE ARE IN DEEP GREEN COLOR. THE SEMICIRCLE BACKGROUND IS FILLED WITH LIGHT GREEN COLORS.

CLASS 41—EDUCATION AND ENTERTAINMENT

FOR EDUCATIONAL SERVICES, NAMELY, PROVIDING CLASSES, SEMINARS, AND WORKSHOPS IN THE FIELDS OF PERSONAL RELATIONSHIPS AND SOCIETAL BEHAVIOR; EDUCATIONAL SERVICES, NAMELY, DEVELOPING CURRICULUM FOR OTHERS IN THE FIELD OF YOUTH AND FAMILY COUNSELING; ANTI-BULLYING EDUCATION AND COACHING SERVICES IN THE FORM OF SEMINARS, TRAINING, AND CLASSES; PROVIDING EDUCATIONAL MENTORING SERVICES AND PROGRAMS IN THE FIELD OF YOUTH COUNSELING FOR IMPROVING EMPATHY BEHAVIOR, NON-VIOLENT BEHAVIOR, FREEDOM OF DRUGS AND VIOLENCE, AND UNDERSTANDING OF VICTIMIZATION IMPACT; EDUCATIONAL SERVICES, NAMELY, CONDUCTING CLASSES, SEMINARS, AND WORKSHOPS IN THE FIELD OF YOUTH COUNSELING AND FAMILY COUNSELING (U.S. CLS. 100, 101 AND 107).

CLASS 45—PERSONAL AND LEGAL SERVICES

FOR PROVIDING YOUTH AND FAMILY COUNSELING IN THE FIELD OF UNDERSTANDING AND APPRECIATING DIVERSITY; PROVIDING INDIVIDUAL COUNSELING SESSIONS IN THE FIELDS OF PERSONAL RELATIONSHIPS AND SOCIETAL BEHAVIOR; EDUCATIONAL SERVICES, NAMELY, PROVIDING DIRECT COUNSELING SESSIONS IN THE FIELDS OF PERSONAL RELATIONSHIPS AND SOCIETAL BEHAVIOR (U.S. CLS. 100 AND 101).

JULIE VEPPUMTHARA, EXAMINING ATTORNEY

SN 77-532,946. INQ ENTERPRISES LIMITED, NASSAU, NEW PROVIDENCE, BAHAMAS, FILED 7-28-2008.



THE MARK CONSISTS OF THE LETTER "Q" WITH CIRCLE DESIGNS APPEARING WITHIN THE LETTER.

CLASS 9—ELECTRICAL AND SCIENTIFIC APPARATUS

FOR MOBILE TELEPHONES; MOBILE INTERNET DEVICES, NAMELY, PERSONAL DIGITAL ASSISTANTS AND MOBILE TELEPHONES WITH INTERNET ACCESS CAPABILITIES; ELECTRONIC MEMORY CARDS; MAGNETICALLY CODED MOBILE NETWORK CREDIT TOP-UP CARDS, NAMELY, CREDIT OR DEBIT CARDS BY WHICH CONSUMERS CAN REDEEM PRE-PAID CREDIT FOR A MOBILE SERVICE ACCOUNT; MOBILE TELEPHONES; STANDS FOR TELEPHONES; TELEPHONE EARPIECES; CASES FOR MOBILE DEVICES, NAMELY, CASES FOR PERSONAL DIGITAL ASSISTANTS AND MOBILE PHONES (U.S. CLS. 21, 23, 26, 36 AND 38).

CLASS 16—PAPER GOODS AND PRINTED MATTER

FOR PRINTED MATTER, NAMELY, PRINTED GUIDES FOR MARKETING, ADVERTISING AND SELLING MOBILE TELEPHONE AND MOBILE INTERNET DEVICES, MOBILE TELEPHONE AND DATA NETWORK SERVICES, AND MOBILE TELEPHONE AND DATA NETWORK APPLICATIONS; PRINTED INSTRUCTIONAL AND TEACHING MATERIALS IN THE FIELD OF MOBILE TELEPHONES, MOBILE INTERNET DEVICES, MOBILE TELEPHONE SERVICES, DATA NETWORK SERVICES, MOBILE TELEPHONE APPLICATIONS AND DATA NETWORK APPLICATIONS; MOBILE NETWORK CREDIT TOP-UP CARDS WITHOUT MAGNETIC CODING, NAMELY, CREDIT OR DEBIT CARDS BY WHICH CONSUMERS CAN REDEEM PRE-PAID CREDIT FOR A MOBILE SERVICE ACCOUNT (U.S. CLS. 2, 5, 22, 23, 29, 37, 38 AND 50).

CLASS 35—ADVERTISING AND BUSINESS

FOR BUSINESS PROJECT MANAGEMENT; ADVERTISING, MARKETING AND PROMOTIONAL SERVICES; COMPILATION OF ADVERTISEMENTS FOR USE AS WEB PAGES ON THE INTERNET; PREPARATION AND PRESENTATION OF AUDIO VISUAL DISPLAYS FOR ADVERTISING PURPOSES; RETAIL STORE SERVICES FEATURING MOBILE TELEPHONE AND MOBILE INTERNET DEVICES; ON-LINE RETAIL STORE SERVICES FEATURING MOBILE TELEPHONE AND MOBILE INTERNET DEVICES; PROVISION OF INFORMATION AND ADVICE RELATING TO ALL THE AFORESAID SERVICES (U.S. CLS. 100, 101 AND 102).

CLASS 36—INSURANCE AND FINANCIAL

FOR PROVISION OF AN ELECTRONIC TOP-UP CREDIT SYSTEM FOR MOBILE TELECOMMUNICATIONS SERVICES ONLINE, NAMELY, ISSUING CREDIT OR DEBIT CARDS BY WHICH CONSUMERS CAN REDEEM PRE-PAID CREDIT FOR A MOBILE TELEPHONE SERVICE ACCOUNT (U.S. CLS. 100, 101 AND 102).

CLASS 38—COMMUNICATION

FOR TELECOMMUNICATIONS SERVICES, NAMELY, MOBILE TELEPHONE SERVICES; MOBILE INTERNET SERVICES, NAMELY, INTERNET SERVICE PROVIDER, INTERNET BROADCASTING SERVICES AND INTERNET ACCESS PROVIDER SERVICES; ELECTRONIC MAIL SERVICES; PROVIDING USER ACCESS TO THE INTERNET; PROVIDING TELECOMMUNICATIONS CONNECTIONS TO THE INTERNET OR DATABASES; PROVIDING ONLINE INTERACTIVE BULLETIN BOARDS FOR TRANSMISSION OF MESSAGES AMONG USERS IN THE FIELD OF GENERAL INTEREST; PROVISION OF INFORMATION AND ADVICE RELATING TO THE FOREGOING (U.S. CLS. 100, 101 AND 104).

CLASS 40—MATERIAL TREATMENT

FOR MANUFACTURE OF TELECOMMUNICATIONS APPARATUS ALL TO THE ORDER AND OR SPECIFICATION OF OTHERS; PROVISION OF INFORMATION AND ADVICE RELATING TO THE AFORESAID SERVICES (U.S. CLS. 100, 103 AND 106).

CLASS 42—SCIENTIFIC AND COMPUTER SERVICES

FOR DESIGN CONSULTANCY SERVICES IN THE FIELD OF MOBILE TELEPHONES AND MOBILE INTERNET DEVICES; DESIGN CONSULTANCY SERVICES IN THE FIELD OF MOBILE TELEPHONE SERVICES AND APPLICATIONS, AND DATA NETWORK SERVICES AND APPLICATIONS; DESIGN OF TELECOMMUNICATIONS APPARATUS, MOBILE TELEPHONE HANDSETS AND ACCESSORIES FOR MOBILE TELEPHONE HANDSETS (U.S. CLS. 100 AND 101).
BRENDAN MCCAULEY, EXAMINING ATTORNEY

SN 77-532,978. ERP ACCESSORIES, LLC, MAPLE GROVE, MN. FILED 7-28-2008.



NO CLAIM IS MADE TO THE EXCLUSIVE RIGHT TO USE "DASHBOARD", APART FROM THE MARK AS SHOWN.

THE MARK CONSISTS OF THE TERMS "DASHBOARD GEAR" UNDERNEATH TWO SETS OF GEARS.

CLASS 9—ELECTRICAL AND SCIENTIFIC APPARATUS

FOR COMPUTER SOFTWARE FOR DATA WAREHOUSING, REPORTING, AND BUSINESS INTELLIGENCE IN THE FIELD OF ENTERPRISE REPORTING (U.S. CLS. 21, 23, 26, 36 AND 38).

FIRST USE 3-16-2008; IN COMMERCE 3-16-2008.

CLASS 42—SCIENTIFIC AND COMPUTER SERVICES

FOR CONSULTING SERVICES IN THE FIELDS OF DATA WAREHOUSING, DESIGNING AND IMPLEMENTING OF BUSINESS REPORTING, BUSINESS INTELLIGENCE AND ENTERPRISE RESOURCE PLANNING SOFTWARE APPLICATIONS (U.S. CLS. 100 AND 101).

FIRST USE 3-16-2008; IN COMMERCE 3-16-2008.
KATHRYN COWARD, EXAMINING ATTORNEY

SN 77-534,173. ANALYTICON DISCOVERY GMBH, POTSDAM, FED REP GERMANY, FILED 7-29-2008.

NATDIVERSE

THE MARK CONSISTS OF STANDARD CHARACTERS WITHOUT CLAIM TO ANY PARTICULAR FONT, STYLE, SIZE, OR COLOR.

OWNER OF ERPNTY TM OFC REG. NO. 002323376, DATED 9-10-2002, EXPIRES 7-31-2011.

CLASS 1—CHEMICALS

FOR CHEMICAL AND BIOCHEMICAL PURE SUBSTANCES OF NATIVE ORIGIN, NAMELY, PLANTS, MICROORGANISMS AND MARINE ORGANISMS, MODIFIED BY SEMI-SYNTHETIC MEANS FOR USE IN THE SCREENING OF SUBSTANCES WITH BIOLOGICAL AND/OR BIOCHEMICAL ACTIVITIES FOR THE PHARMACEUTICAL AND/OR AGRICULTURAL INDUSTRIES; CHEMICAL AND BIOCHEMICAL PURE SYNTHETIC SUBSTANCES, BASED ON THE MODEL OF NATURALLY OCCURRING PURE SUBSTANCES FOR USE IN THE SCREENING OF SUBSTANCES WITH BIOLOGICAL AND/OR BIOCHEMICAL ACTIVITIES FOR THE PHARMACEUTICAL AND/OR AGRICULTURAL INDUSTRIES (U.S. CLS. 1, 5, 6, 10, 26 AND 46).

CLASS 42—SCIENTIFIC AND COMPUTER SERVICES

FOR CHEMICAL AND/OR BIOCHEMICAL LABORATORY RESEARCH, NAMELY, THE PREPARATION OF SYNTHETIC VARIANTS OF PURE SUBSTANCES FROM PLANTS, MICROORGANISMS AND MARINE MICROORGANISMS USING CHEMICAL METHODS; REALIZATION OF TOTAL SYNTHESSES OF PURE SUBSTANCES BASED ON THE MODEL OF ISOLATED NATURALLY OCCURRING PURE SUBSTANCES BY STRUCTURAL ANALYSIS AND SCREENING OF SUBSTANCES FOR BIOLOGICAL AND/OR BIOCHEMICAL ACTIVITY (U.S. CLS. 100 AND 101).

TRACY CROSS, EXAMINING ATTORNEY

SN 77-536,023. BUNN-O-MATIC CORPORATION, SPRINGFIELD, IL. FILED 7-31-2008.



THE MARK CONSISTS OF A BRANCH DESIGN CONSISTING OF THREE LEAVES AND FOUR COFFEE CHERRIES ALL INSIDE A PARTIALLY SOLID RECTANGLE AND THE WORDS "RESPECT" ABOVE AND "EARTH" BELOW THE RECTANGLE.

CLASS 7—MACHINERY

FOR ELECTRIC BEVERAGE MAKING SUBSTANCE GRINDERS, NAMELY, COFFEE GRINDERS (U.S. CLS. 13, 19, 21, 23, 31, 34 AND 35).

CLASS 11—ENVIRONMENTAL CONTROL APPARATUS

FOR ELECTRIC COFFEE BREWERS, TEA BREWERS, AND ICED TEA BREWERS; HEATED AND REFRIGERATED BEVERAGE DISPENSING UNITS FOR DOMESTIC AND COMMERCIAL USE AND COMPONENTS THEREFOR; ELECTRIC MACHINES FOR PREPARING AND DISPENSING HEATED WATER; ELECTRIC DOCKING SYSTEMS COMPRISING DISPENSERS, SERVERS, WARMING STATIONS AND STANDS FOR BEVERAGE DISPENSING UNITS; REFRIGERATION EQUIPMENT, NAMELY, BEVERAGE CHILLING UNITS FOR COMMERCIAL AND DOMESTIC USE AND COMPONENTS THEREFOR; ELECTRIC MACHINES FOR PREPARING AND DISPENSING FROZEN OR SEMI-FROZEN BEVERAGES (U.S. CLS. 13, 21, 23, 31 AND 34).

CLASS 21—HOUSEWARES AND GLASS

FOR BEVERAGE DISPENSING EQUIPMENT, NAMELY, NON-ELECTRIC DECANTERS, CARAFES, SERVERS, AND DISPENSERS (U.S. CLS. 2, 13, 23, 29, 30, 33, 40 AND 50).

MAYUR VAGHANI, EXAMINING ATTORNEY

SN 77-536,182. CALWAX LLC, UTICA, NY. FILED 7-31-2008.

CALWAX

THE MARK CONSISTS OF STANDARD CHARACTERS WITHOUT CLAIM TO ANY PARTICULAR FONT, STYLE, SIZE, OR COLOR.

CLASS 3—COSMETICS AND CLEANING PREPARATIONS

FOR WAXES FOR POLISHING JEWELRY; WAXES FOR USE IN HAIR REMOVAL (U.S. CLS. 1, 4, 6, 50, 51 AND 52).

FIRST USE 0-0-1965; IN COMMERCE 0-0-1965.

CLASS 4—LUBRICANTS AND FUELS

FOR WAXES FOR CANDLE MAKING, NAMELY, WAX, RAW MATERIAL WAX, SOY WAX, NATURAL WAXES, PARAFFIN WAXES, MICRO CRYSTALLINE WAXES, MACHINEABLE WAXES AND SYNTHETIC WAXES; CASTING WAXES USED TO INJECT INTO MOLDS TO CREATE VARIOUS TYPES OF INJECTION MOLD PARTS; SYNTHETIC WAXES FOR USE AS A HARDENER; ART WAX; SCULPTING WAX; COATING WAXES FOR COATING FOOD AND NON-FOOD PRODUCTS; COATING WAXES FOR USE AS A HARDENER; ROSEBUSH WAX, SCALE WAX, SLACK WAX AND SYNTHETIC WAX FOR USE IN CANDLE MAKING OR FOR USE IN THE MANUFACTURE OF OTHER PRODUCTS; CANDLE WAX; CANDLE WAX BLENDS; CANDLES; NATURAL WAX, MICRO CRYSTALLINE WAX AND SOY WAX FOR USE IN THE MANUFACTURE OF OTHER PRODUCTS; CARVING WAXES FOR USE BY SCULPTORS AND ARTISTS; POULTRY AND DUCK WAXES FOR USE IN DE-FEATHERING; WAX FOR USE AS A LUBRICANT TO KEEP METAL FROM MELTING DURING THE METAL FORMING PROCESS (U.S. CLS. 1, 6 AND 15).

FIRST USE 0-0-1965; IN COMMERCE 0-0-1965.

CLASS 5—PHARMACEUTICALS

FOR DENTAL WAX (U.S. CLS. 6, 18, 44, 46, 51 AND 52).
FIRST USE 0-0-1965; IN COMMERCE 0-0-1965.

CLASS 16—PAPER GOODS AND PRINTED MATTER

FOR SEALING WAX (U.S. CLS. 2, 5, 22, 23, 29, 37, 38 AND 50).
FIRST USE 0-0-1965; IN COMMERCE 0-0-1965.

CLASS 28—TOYS AND SPORTING GOODS

FOR SURFBOARD WAX; SKI AND SNOWBOARD WAX; SKATEBOARD WAX (U.S. CLS. 22, 23, 38 AND 50).
FIRST USE 0-0-2008; IN COMMERCE 0-0-2008.

CLASS 42—SCIENTIFIC AND COMPUTER SERVICES

FOR PRODUCT RESEARCH AND DEVELOPMENT (U.S. CLS. 100 AND 101).
FIRST USE 0-0-1965; IN COMMERCE 0-0-1965.
DAWN FELDMAN, EXAMINING ATTORNEY

SN 77-537,207. RON JON SURF SHOP OF FLA., INC., COCOA BEACH, FL. FILED 8-1-2008.

SURFING'S EVOLUTION EXPERIENCE

THE MARK CONSISTS OF STANDARD CHARACTERS WITHOUT CLAIM TO ANY PARTICULAR FONT, STYLE, SIZE, OR COLOR.

CLASS 16—PAPER GOODS AND PRINTED MATTER

FOR BUMPER STICKERS, DECALS, POSTCARDS, POSTERS, NOTE PAPER, STATIONERY, GREETING CARDS, PENS, PENCILS (U.S. CLS. 2, 5, 22, 23, 29, 37, 38 AND 50).

CLASS 25—CLOTHING

FOR MEN'S, WOMEN'S AND CHILDREN'S SPORTSWEAR, NAMELY, SWEATSHIRTS, SWEAT PANTS, SWEAT SHORTS, T-SHIRTS, SHIRTS, BATHING SUITS, BEACH COVER-UPS, CAPS, HEADBANDS, HATS, VISORS, SHOES, SOCKS, SANDALS, WET SUITS, JACKETS, PONCHOS, DRESSES, BLOUSES, SKIRTS, SHORTS AND PANTS (U.S. CLS. 22 AND 39).

CLASS 28—TOYS AND SPORTING GOODS

FOR TOYS, NAMELY, BEACH BALLS, SOCCER BALLS, BASKET BALLS, KICK BALLS, FOOTBALLS, TOY BEAN BAGS FOR KICKING AND TOSSING, PADDLE BALL SETS, STUFFED ANIMALS, PUPPETS, DOLLS, ACTION FIGURES, TOY FLYING DISKS, BEAN BAG TOYS, TOY STUFFED PILLOWS, TOY CARS AND OTHER TOY VEHICLES, INFLATABLE RIDE ON TOYS, SWIM FLOATS FOR RECREATIONAL USE, INFLATABLE TUBES FOR RECREATIONAL USE, KITES, TOY BEACH BUCKETS AND SHOVELS, SAND TOY SETS, MINIATURE GOLF SETS, SQUEAK TOYS, WIND UP TOYS, TOY MUSICAL INSTRUMENTS; GAMES, NAMELY, BOARD GAMES, PLAYING CARDS, AND PUZZLES; SPORTING EQUIPMENT NAMELY, SURFBOARDS, SURFBOARD LEASHES, BODY BOARDS, KITE BOARDS, SKATEBOARDS, SKIMBOARDS, BOOGEY BOARDS, AND SWIM FINS (U.S. CLS. 22, 23, 38 AND 50).

CLASS 35—ADVERTISING AND BUSINESS

FOR ON-LINE RETAIL GIFT SHOP SERVICES AND RETAIL GIFT SHOP SERVICES FEATURING CLOTHING AND ACCESSORIES, BEACH AND SURF GEAR, SPORTING AND RECREATIONAL GOODS, EQUIPMENT AND ACCESSORIES, TOYS AND GAMES, HOUSEHOLD GOODS, AND SOUVENIRS, NOVELTY ITEMS AND GIFTS (U.S. CLS. 100, 101 AND 102).

CLASS 41—EDUCATION AND ENTERTAINMENT

FOR MUSEUM SERVICES (U.S. CLS. 100, 101 AND 107).
HEATHER SAPP, EXAMINING ATTORNEY

SN 77-536,517. SKI UTAH, INC., SALT LAKE CITY, UT. FILED 7-31-2008.



THE MARK CONSISTS OF A STYLIZED VERSION OF A SNOWFLAKE.

CLASS 21—HOUSEWARES AND GLASS

FOR MUGS (U.S. CLS. 2, 13, 23, 29, 30, 33, 40 AND 50).
FIRST USE 3-1-2007; IN COMMERCE 3-1-2007.

CLASS 25—CLOTHING

FOR CLOTHING, NAMELY, T-SHIRTS, SWEATSHIRTS AND HATS (U.S. CLS. 22 AND 39).
FIRST USE 3-1-2007; IN COMMERCE 3-1-2007.

CLASS 35—ADVERTISING AND BUSINESS

FOR ADVERTISING AND BUSINESS PROMOTION, NAMELY, PROMOTING THE GOODS AND SERVICES OF OTHERS, INCLUDING SKI ACCOMMODATIONS OF OTHERS, BY PREPARING AND PLACING ADVERTISEMENTS IN MAGAZINES, DIRECT MAIL ADVERTISEMENTS, AND OVER THE INTERNET (U.S. CLS. 100, 101 AND 102).
FIRST USE 3-1-2007; IN COMMERCE 3-1-2007.
KATHY DE JONGE, EXAMINING ATTORNEY

SN 77-539,525. MAVRA VAGIONI, PALAIO PSYCHIKO, GREECE, FILED 8-5-2008.



NO CLAIM IS MADE TO THE EXCLUSIVE RIGHT TO USE "LINE" AND "HOMEMADE COSMETICS", APART FROM THE MARK AS SHOWN.

THE COLOR(S) YELLOW, BLACK, WHITE, RED, ORANGE, GREEN, BLUE, PURPLE IS/ARE CLAIMED AS A FEATURE OF THE MARK.

THE MARK CONSISTS OF THE WORDS "FRESH LINE" IN A CIRCLE, WITH DEPICTIONS OF FRUITS AND FLOWERS ON EITHER SIDE, WITH THE WORDING "FRESH HOMEMADE COSMETICS" UNDERNEATH. THE COLOR YELLOW APPEARS IN THE SQUARE BACKGROUND ELEMENT, THE COLOR WHITE IN THE OVAL BACKGROUND ELEMENT, THE COLOR BLACK IN THE WORDING AND THE UPPER AND LOWER OVAL ELEMENTS AND THE COLORS YELLOW, WHITE, RED, ORANGE, PURPLE, BLACK, PINK AND GREEN IN THE DEPICTIONS OF VARIOUS PLANTS AND FRUITS FORMING THE BORDER OF THE OVAL.

CLASS 3—COSMETICS AND CLEANING PREPARATIONS

FOR COSMETIC PRODUCTS, NAMELY, FACE AND BODY CREAMS, BUBBLE BATHS, LOTIONS, SHAMPOOS, PERFUMES, TOILET WATERS, DEODORANTS; COSMETIC PRODUCTS FOR CHILDREN, NAMELY, SHAMPOO, BUBBLE BATHS, LIQUID SOAP, SOLID SOAP; COSMETIC PRODUCTS FOR PREGNANT WOMEN, NAMELY, BODY LOTIONS AND BODY CREAMS (U.S. CLS. 1, 4, 6, 50, 51 AND 52).

CLASS 45—PERSONAL AND LEGAL SERVICES

FOR GIFT WRAPPING (U.S. CLS. 100 AND 101).
MICHAEL WEBSTER, EXAMINING ATTORNEY

SN 77-540,274. BULLFROG POWER INC., TORONTO, ONTARIO, CANADA, FILED 8-6-2008.



NO CLAIM IS MADE TO THE EXCLUSIVE RIGHT TO USE "POWER", APART FROM THE MARK AS SHOWN.

THE MARK CONSISTS OF THE WORDS "BULLFROG POWER" WHICH HAVE A FROG SUPERIMPOSED AS JUMPING OVER THEM.

CLASS 35—ADVERTISING AND BUSINESS

FOR PROVIDING ENERGY EFFICIENCY PROGRAMS TO COMMERCIAL AND RESIDENTIAL CUSTOMERS TO ASSIST THEM IN CREATING A MORE ENERGY EFFICIENT ENVIRONMENT; PROVIDING ENERGY UTILIZATION PROGRAMS TO COMMERCIAL AND RESIDENTIAL CUSTOMERS TO ASSIST THEM IN UTILIZING ENERGY IN A COST EFFECTIVE MANNER; RETAIL STORE SERVICES IN THE FIELD OF PRODUCTS AND SERVICES RELATED TO: ENERGY CONSERVATION, ENERGY EFFICIENCY, ENERGY PLANNING AND ENERGY MANAGEMENT; REDUCING THE ENVIRONMENTAL IMPACT OF HOMES AND BUSINESSES; AND PROVIDING ALTERNATIVE SOURCES OF ENERGY; AND ALL DELIVERED THROUGH DIRECT MAIL, WEBSITE AND TELEPHONE SALES; ENERGY AUDIT SERVICES AND THE ISSUANCE RENEWABLE ENERGY CERTIFICATES THAT ARE USED BY COMPANIES TO PROVE THAT THEY USE GREEN POWER, AND ARE ENVIRONMENTALLY-CONSCIOUS AND USE GREEN INNOVATIONS, AND TO ASSIST IN MARKETING TO COMMERCIAL AND RESIDENTIAL CUSTOMERS (U.S. CLS. 100, 101 AND 102).

CLASS 36—INSURANCE AND FINANCIAL

FOR FINANCING SERVICES TO CUSTOMERS FOR ENERGY EFFICIENT PROGRAMS AND SERVICES (U.S. CLS. 100, 101 AND 102).

CLASS 39—TRANSPORTATION AND STORAGE

FOR DISTRIBUTION OF SUPPLY OF ELECTRICITY (U.S. CLS. 100 AND 105).

CLASS 41—EDUCATION AND ENTERTAINMENT

FOR SERVICES OF OPERATING A WEBSITE FEATURING NEWS, EDUCATION, AND GAMES RELATED TO ENERGY SUPPLY, ENERGY EFFICIENCY AND ENERGY CONSERVATION (U.S. CLS. 100, 101 AND 107).
LINDA MICKLEBURGH, EXAMINING ATTORNEY

SN 77-541,754. COLLECTIVE CASE, INC., NEW YORK, NY. FILED 8-7-2008.



THE COLOR(S) RED, SILVER, AND BLACK IS/ARE CLAIMED AS A FEATURE OF THE MARK.

THE MARK CONSISTS OF A SILVER CROSS APPEARING ON A RED BACKGROUND WITH THE WORDING "SWISS MOBILITY" BELOW IN BLACK, ALL ON A SILVER SHIELD SHAPED BACKGROUND.

CLASS 9—ELECTRICAL AND SCIENTIFIC APPARATUS

FOR ELECTRONIC DEVICE CARRYING CASES AND HOLDERS FOR COMPUTERS, CAMERAS, PERSONAL DIGITAL ASSISTANTS, MUSIC PLAYERS, EAR-PHONES, AND TELEPHONES (U.S. CLS. 21, 23, 26, 36 AND 38).

CLASS 18—LEATHER GOODS

FOR LUGGAGE, BACKPACKS, BRIEFCASES, PURSES, SHOULDER BAGS (U.S. CLS. 1, 2, 3, 22 AND 41).

KATHERINE CONNOLLY, EXAMINING ATTORNEY

SN 77-542,728. ARM LIMITED, CAMBRIDGE, UNITED KINGDOM, FILED 8-8-2008.



PRIORITY CLAIMED UNDER SEC. 44(D) ON ERPN CMNTY TM OFC APPLICATION NO. EU006667596, FILED 2-14-2008, REG. NO. 006667596, DATED 1-22-2009, EXPIRES 2-14-2018.

THE MARK CONSISTS OF THE WORDING "ARM CONNECTED", EACH ENCLOSED WITHIN A RECTANGLE, AND NEXT TO THE WORD "ARM" IS A DIVIDED CIRCULAR DESIGN CREATED BY TWO ARROWS, ENCLOSED IN WHICH IS A LARGE SQUARE CONTAINING A SMALLER SQUARE.

CLASS 9—ELECTRICAL AND SCIENTIFIC APPARATUS

FOR COMPUTER HARDWARE; INTEGRATED CIRCUITS; MICROPROCESSORS; MICROPROCESSOR CORES; MACRO CELLS; MICROCONTROLLERS; PRINTED CIRCUIT BOARDS; TELEPHONES; MOBILE COMPUTING DEVICES, NAMELY, PORTABLE COMPUTERS, LAPTOP COMPUTERS, NOTEBOOK COMPUTERS, SUBNOTEBOOK COMPUTERS, ULTRA-MOBILE COMPUTERS, TABLET COMPUTERS, INTERNET TABLET COMPUTERS, PERSONAL PORTABLE COMPUTERS, PERSONAL DIGITAL ASSISTANTS, PERSONAL DIGITAL ASSISTANTS WITH INTEGRATED MOBILE TELEPHONE FUNCTIONALITY, MOBILE TELEPHONES, HANDHELD GAME CONSOLES, GPS NAVIGATION DEVICES AND PERSONAL MEDIA PLAYERS; COMPUTER SOFTWARE FOR THE DESIGN, DEVELOPMENT, MODELLING, SIMULATION, COMPILING, DEBUGGING, VERIFICATION, CONSTRUCTION AND INTERFACING OF ELECTRICAL AND ELECTRONIC EQUIPMENT, INTEGRATED CIRCUITS, MICROPROCESSORS, MICROPROCESSOR CORES, IP CORES, MACRO CELLS, MICROCONTROLLERS, AND PRINTED CIRCUIT BOARDS; SOFTWARE DEFINING THE HARDWARE DESIGN OF INTEGRATED CIRCUITS, MICROPROCESSORS, MICROPROCESSOR CORES, IP CORES, MACRO CELLS, MICROCONTROLLERS AND PRINTED CIRCUIT BOARDS; COMPUTER SOFTWARE FOR THE DESIGN AND DEVELOPMENT OF APPLICATION SOFTWARE AND OPERATING SYSTEM SOFTWARE (U.S. CLS. 21, 23, 26, 36 AND 38).

CLASS 16—PAPER GOODS AND PRINTED MATTER

FOR INSTRUCTION AND DEVELOPMENT MANUALS, DATASHEETS AND BROCHURES ALL IN THE AREA OF DESIGN AND DEVELOPMENT OF ELECTRICAL EQUIPMENT, ELECTRONIC EQUIPMENT, COMPUTING EQUIPMENT, COMPUTER SOFTWARE, INTEGRATED CIRCUITS, MICROPROCESSORS, MICROPROCESSOR CORES, IP CORES, MACRO CELLS, MICROCONTROLLERS AND PRINTED CIRCUIT BOARDS, SOFTWARE FOR DESIGN, DEVELOPMENT, MODELLING, SIMULATION, COMPILING, DE-BUGGING, VERIFICATION, CONSTRUCTION AND INTERFACING OF ELECTRICAL AND ELECTRONIC EQUIPMENT, INTEGRATED CIRCUITS, MICROPROCESSORS, MICROPROCESSOR CORES, IP CORES, MACRO CELLS, MICROCONTROLLERS AND PRINTED CIRCUIT BOARDS; PAPER LABELS FOR AFFIXING TO COMPUTER HARDWARE, TELEPHONES, SMART PHONES, ELECTRICAL AND ELECTRONIC EQUIPMENT, COMPUTER SOFTWARE AND DIGITAL CAMERAS (U.S. CLS. 2, 5, 22, 23, 29, 37, 38 AND 50).

CLASS 37—CONSTRUCTION AND REPAIR

FOR MAINTENANCE SERVICES RELATING TO: COMPUTING HARDWARE, INTEGRATED CIRCUITS, MICROPROCESSORS, MICROPROCESSOR CORES, IP CORES, MACRO CELLS, MICROCONTROLLERS AND PRINTED CIRCUIT BOARDS (U.S. CLS. 100, 103 AND 106).

CLASS 42—SCIENTIFIC AND COMPUTER SERVICES

FOR DESIGN SERVICES RELATING TO ELECTRICAL EQUIPMENT, ELECTRONIC EQUIPMENT, COMPUTING EQUIPMENT, COMPUTER SOFTWARE, INTEGRATED CIRCUITS, MICROPROCESSORS, MICROPROCESSOR CORES, IP CORES, MACRO CELLS, MICROCONTROLLERS AND PRINTED CIRCUIT BOARDS, AND COMPUTER SOFTWARE FOR DESIGN, DEVELOPMENT, MODELLING, SIMULATION, COMPILING, DE-BUGGING, VERIFICATION, CONSTRUCTION AND INTERFACING OF ELECTRICAL AND ELECTRONIC EQUIPMENT, INTEGRATED CIRCUITS, MICROPROCESSORS, MICROPROCESSOR CORES, IP CORES, MACRO CELLS, MICROCONTROLLERS AND PRINTED CIRCUIT BOARDS; RESEARCH, DEVELOPMENT, DESIGN, AND TECHNICAL CONSULTATION IN THE FIELDS OF: ELECTRICAL EQUIPMENT, ELECTRONIC EQUIPMENT, COMPUTING EQUIPMENT, COMPUTER SOFTWARE, INTEGRATED CIRCUITS, MICROPROCESSORS, MICROPROCESSOR CORES, IP CORES, MACRO CELLS, MICROCONTROLLERS AND PRINTED CIRCUIT BOARDS, AND COMPUTER SOFTWARE FOR DESIGN, DEVELOPMENT, MODELLING, SIMULATION, COMPILING, DE-BUGGING, VERIFICATION, CONSTRUCTION AND INTERFACING OF ELECTRICAL AND ELECTRONIC EQUIPMENT, INTEGRATED CIRCUITS, MICROPROCESSORS, MICROPROCESSOR CORES, IP CORES, MACRO CELLS, MICROCONTROLLERS AND PRINTED CIRCUIT BOARDS; MAINTENANCE SERVICES RELATING TO: COMPUTER SOFTWARE, SOFTWARE FOR THE DESIGN, DEVELOPMENT, MODELLING, SIMULATION, COMPILING, DE-BUGGING, VERIFICATION, CONSTRUCTION AND INTERFACING OF ELECTRICAL AND ELECTRONIC EQUIPMENT, INTEGRATED CIRCUITS, MICROPROCESSORS, MICROPROCESSOR CORES, IP CORES, MACRO CELLS, MICROCONTROLLERS AND PRINTED CIRCUIT BOARDS (U.S. CLS. 100 AND 101).

TINA L. SNAPP, EXAMINING ATTORNEY

SN 77-542,751. ARM LIMITED, CAMBRIDGE, UNITED KINGDOM, FILED 8-8-2008.



OWNER OF ERPN CMNTY TM OFC REG. NO. 003321403, DATED 7-21-2005, EXPIRES 8-20-2013.

THE MARK CONSISTS OF A DIVIDED CIRCULAR DESIGN CREATED BY TWO ARROWS, ENCLOSED IN WHICH IS A LARGE SQUARE CONTAINING A SMALLER SQUARE.

CLASS 9—ELECTRICAL AND SCIENTIFIC APPARATUS

FOR COMPUTER HARDWARE; INTEGRATED CIRCUITS; MICROPROCESSORS; MICROPROCESSOR CORES; MACRO CELLS; MICROCONTROLLERS; PRINTED CIRCUIT BOARDS; TELEPHONES; MOBILE COMPUTING DEVICES, NAMELY, PORTABLE COMPUTERS, LAPTOP COMPUTERS, NOTEBOOK COMPUTERS, SUBNOTEBOOK COMPUTERS, ULTRA-MOBILE COMPUTERS, TABLET COMPUTERS, INTERNET TABLET COMPUTERS, PERSONAL PORTABLE COMPUTERS, PERSONAL DIGITAL ASSISTANTS, PERSONAL DIGITAL ASSISTANTS WITH INTEGRATED MOBILE TELEPHONE FUNCTIONALITY, MOBILE TELEPHONES, HANDHELD GAME CONSOLES, GPS NAVIGATION DEVICES AND PERSONAL MEDIA PLAYERS; COMPUTER SOFTWARE FOR THE DESIGN, DEVELOPMENT, MODELLING, SIMULATION, COMPILING, DEBUGGING, VERIFICATION, CONSTRUCTION AND INTERFACING OF ELECTRICAL AND ELECTRONIC EQUIPMENT; INTEGRATED CIRCUITS, MICROPROCESSORS, MICROPROCESSOR CORES, IP CORES, MACRO CELLS, MICROCONTROLLERS, AND PRINTED CIRCUIT BOARDS; SOFTWARE DEFINING THE HARDWARE DESIGN OF INTEGRATED CIRCUITS, MICROPROCESSORS, MICROPROCESSOR CORES, IP CORES, MACRO CELLS, MICROCONTROLLERS AND PRINTED CIRCUIT BOARDS; COMPUTER SOFTWARE FOR THE DESIGN AND DEVELOPMENT OF APPLICATION SOFTWARE AND OPERATING SYSTEM SOFTWARE (U.S. CLS. 21, 23, 26, 36 AND 38).

CLASS 16—PAPER GOODS AND PRINTED MATTER

FOR INSTRUCTION AND DEVELOPMENT MANUALS, DATASHEETS AND BROCHURES ALL IN THE AREA OF DESIGN AND DEVELOPMENT OF ELECTRICAL EQUIPMENT, ELECTRONIC EQUIPMENT, COMPUTING EQUIPMENT, COMPUTER SOFTWARE, INTEGRATED CIRCUITS, MICROPROCESSORS, MICROPROCESSOR CORES, IP CORES, MACRO CELLS, MICROCONTROLLERS AND PRINTED CIRCUIT BOARDS, SOFTWARE FOR DESIGN, DEVELOPMENT, MODELLING, SIMULATION, COMPILING, DE-BUGGING, VERIFICATION, CONSTRUCTION AND INTERFACING OF ELECTRICAL AND ELECTRONIC EQUIPMENT, INTEGRATED CIRCUITS, MICROPROCESSORS, MICROPROCESSOR CORES, IP CORES, MACRO CELLS, MICROCONTROLLERS AND PRINTED CIRCUIT BOARDS; PAPER LABELS FOR AFFIXING TO COMPUTER HARDWARE, TELEPHONES, SMART PHONES, ELECTRICAL AND ELECTRONIC EQUIPMENT, COMPUTER SOFTWARE AND DIGITAL CAMERAS (U.S. CLS. 2, 5, 22, 23, 29, 37, 38 AND 50).

CLASS 37—CONSTRUCTION AND REPAIR

FOR MAINTENANCE SERVICES RELATING TO: COMPUTING HARDWARE, INTEGRATED CIRCUITS, MICROPROCESSORS, MICROPROCESSOR CORES, IP CORES, MACRO CELLS, MICROCONTROLLERS AND PRINTED CIRCUIT BOARDS (U.S. CLS. 100, 103 AND 106).

CLASS 42—SCIENTIFIC AND COMPUTER SERVICES

FOR DESIGN SERVICES RELATING TO ELECTRICAL EQUIPMENT, ELECTRONIC EQUIPMENT, COMPUTING EQUIPMENT, COMPUTER SOFTWARE, INTEGRATED CIRCUITS, MICROPROCESSORS, MICROPROCESSOR CORES, IP CORES, MACRO CELLS, MICROCONTROLLERS AND PRINTED CIRCUIT BOARDS, AND COMPUTER SOFTWARE FOR DESIGN, DEVELOPMENT, MODELLING, SIMULATION, COMPILING, DE-BUGGING, VERIFICATION, CONSTRUCTION AND INTERFACING OF ELECTRICAL AND ELECTRONIC EQUIPMENT, INTEGRATED CIRCUITS, MICROPROCESSORS, MICROPROCESSOR CORES, IP CORES, MACRO CELLS, MICROCONTROLLERS AND PRINTED CIRCUIT BOARDS; RESEARCH, DEVELOPMENT, DESIGN, AND TECHNICAL CONSULTATION IN THE FIELDS OF: ELECTRICAL EQUIPMENT, ELECTRONIC EQUIPMENT, COMPUTING EQUIPMENT, COMPUTER SOFTWARE, INTEGRATED CIRCUITS, MICROPROCESSORS, MICROPROCESSOR CORES, IP CORES, MACRO CELLS, MICROCONTROLLERS AND PRINTED CIRCUIT BOARDS, AND COMPUTER SOFTWARE FOR DESIGN, DEVELOPMENT, MODELLING, SIMULATION, COMPILING, DE-BUGGING, VERIFICATION, CONSTRUCTION AND INTERFACING OF ELECTRICAL AND ELECTRONIC EQUIPMENT, INTEGRATED CIRCUITS, MICROPROCESSORS, MICROPROCESSOR CORES, IP CORES, MACRO CELLS, MICROCONTROLLERS AND PRINTED CIRCUIT BOARDS; MAINTENANCE SERVICES RELATING TO: COMPUTER SOFTWARE, SOFTWARE FOR THE DESIGN, DEVELOPMENT, MODELLING, SIMULATION, COMPILING, DE-BUGGING, VERIFICATION, CONSTRUCTION AND INTERFACING OF ELECTRICAL AND ELECTRONIC EQUIPMENT, INTEGRATED CIRCUITS, MICROPROCESSORS, MICROPROCESSOR CORES, IP CORES, MACRO CELLS, MICROCONTROLLERS AND PRINTED CIRCUIT BOARDS (U.S. CLS. 100 AND 101).

TINA L. SNAPP, EXAMINING ATTORNEY

SN 77-543,388. MOVING NAMES, LLC, STERLING, VA.
FILED 8-11-2008.

TWO GUYS AND A TRUCK

THE MARK CONSISTS OF STANDARD CHARACTERS WITHOUT CLAIM TO ANY PARTICULAR FONT, STYLE, SIZE, OR COLOR.

SUBJECT TO CONCURRENT USE PROCEEDING WITH REGISTRATION NUMBERS 1953964, 2020083, 3006814 AND 3006815 OWNED BY TWO MEN AND A TRUCK/INTERNATIONAL, INC., 3400 BELLE CHASE WAY, LANSING, MI 48911, APPLICANT CLAIMS EXCLUSIVE RIGHT TO USE THE MARK IN THE AREA COMPRISING THE DISTRICT OF COLUMBIA AND THE STATES OF MARYLAND AND VIRGINIA.

CLASS 35—ADVERTISING AND BUSINESS

FOR FRANCHISE SERVICES, NAMELY, OFFERING BUSINESS MANAGEMENT ASSISTANCE IN THE ESTABLISHMENT AND OPERATION OF MOVING VAN AND FURNITURE STORAGE BUSINESSES (U.S. CLS. 100, 101 AND 102).

FIRST USE 10-1-1987; IN COMMERCE 10-1-1987.

CLASS 39—TRANSPORTATION AND STORAGE

FOR FURNITURE STORAGE; MOVING VAN SERVICES (U.S. CLS. 100 AND 105).

FIRST USE 10-1-1987; IN COMMERCE 10-1-1987.
FONG HSU, EXAMINING ATTORNEY

CLASS 35—ADVERTISING AND BUSINESS

FOR BUSINESS SERVICES, NAMELY, CONSULTING SERVICES IN THE FIELD OF STRATEGIC BUSINESS MANAGEMENT FOR NOT FOR PROFIT ENTITIES; CONSULTATION SERVICES FOR NOT-FOR-PROFIT ENTITIES IN THE FIELD OF SUSTAINABLE ECONOMIC DEVELOPMENT (U.S. CLS. 100, 101 AND 102).

FIRST USE 7-1-2008; IN COMMERCE 7-1-2008.

CLASS 36—INSURANCE AND FINANCIAL

FOR CONSULTATION SERVICES FOR NOT-FOR-PROFIT ENTITIES IN THE FIELD OF CHARITABLE FUNDRAISING (U.S. CLS. 100, 101 AND 102).

CLASS 40—MATERIAL TREATMENT

FOR CONSULTATION SERVICES FOR NOT-FOR-PROFIT ENTITIES IN THE FIELD OF WATER TREATMENT (U.S. CLS. 100, 103 AND 106).

CLASS 41—EDUCATION AND ENTERTAINMENT

FOR CONSULTATION SERVICES FOR NOT-FOR-PROFIT ENTITIES IN THE FIELD OF EDUCATION (U.S. CLS. 100, 101 AND 107).

CLASS 44—MEDICAL, BEAUTY AND AGRICULTURAL SERVICES

FOR CONSULTATION SERVICES FOR NOT-FOR-PROFIT ENTITIES IN THE FIELD OF HEALTH CARE, NAMELY, PERSONAL HYGIENE CONSULTATION; CONSULTATION IN THE FIELD OF MEDICAL CARE FOR PEOPLE WITH DISABILITIES (U.S. CLS. 100 AND 101).

DAVID MURRAY, EXAMINING ATTORNEY

SN 77-544,193. GLOBAL HEALTH AND EDUCATION FOUNDATION, DANVILLE, CA. FILED 8-11-2008.



NO CLAIM IS MADE TO THE EXCLUSIVE RIGHT TO USE "GLOBAL HEALTH & EDUCATION FOUNDATION", APART FROM THE MARK AS SHOWN.

THE MARK CONSISTS OF A GLOBE DESIGN SURROUNDED BY A CIRCLE CONTAINING THE WORDING "GLOBAL HEALTH & EDUCATION FOUNDATION" AND THE IMAGE OF A CADUCEUS AND AN OPEN BOOK. FOUR POINTS, LOCATED AT NORTH, SOUTH, EAST AND WEST, ARE BEHIND THE GLOBE AND CIRCLE DESIGN.

SN 77-545,059. RVDA EDUCATION FOUNDATION, FAIRFAX, VA. FILED 8-12-2008.



NO CLAIM IS MADE TO THE EXCLUSIVE RIGHT TO USE "LEARNING CENTER", APART FROM THE MARK AS SHOWN.

THE MARK CONSISTS OF THE WORD, "RV" SUPERIMPOSED OVER AN ARROW FORMING A SEMI-CIRCLE AROUND THE WORDS, "LEARNING CENTER".

SEC. 2(F) AS TO "RV".

CLASS 16—PAPER GOODS AND PRINTED MATTER

FOR PRINTED PUBLICATIONS, NAMELY, MAGAZINES, MANUALS AND GUIDES IN THE FIELD OF RECREATIONAL VEHICLES (U.S. CLS. 2, 5, 22, 23, 29, 37, 38 AND 50).

FIRST USE 12-12-2002; IN COMMERCE 12-12-2002.

CLASS 41—EDUCATION AND ENTERTAINMENT

FOR EDUCATIONAL SERVICES, NAMELY, CONDUCTING CONFERENCES, WORKSHOPS, SEMINARS, CERTIFICATION PROGRAMS AND CLASSES IN THE FIELD OF RECREATIONAL VEHICLES; AND NON-DOWNLOADABLE ELECTRONIC PUBLICATIONS AVAILABLE VIA GLOBAL COMPUTER NETWORK IN THE NATURE OF MAGAZINES, MANUALS AND GUIDES IN THE FIELD OF RECREATIONAL VEHICLES (U.S. CLS. 100, 101 AND 107).

FIRST USE 12-12-2002; IN COMMERCE 12-12-2002.
ELLEN BURNS, EXAMINING ATTORNEY

SN 77-546,599. PYRO NOVELTIES, INC., LA HABRA, CA.
FILED 8-13-2008.

XTREME PYRO

THE MARK CONSISTS OF STANDARD CHARACTERS WITHOUT CLAIM TO ANY PARTICULAR FONT, STYLE, SIZE, OR COLOR.

OWNER OF U.S. REG. NO. 3,161,254.
SEC. 2(F).

CLASS 25—CLOTHING

FOR HATS; SWEAT SHIRTS; T-SHIRTS (U.S. CLS. 22 AND 39).

FIRST USE 4-1-2003; IN COMMERCE 4-1-2003.

CLASS 26—FANCY GOODS

FOR EMBROIDERED PATCHES FOR CLOTHING (U.S. CLS. 37, 39, 40, 42 AND 50).

FIRST USE 4-1-2003; IN COMMERCE 4-1-2003.
MATTHEW EINSTEIN, EXAMINING ATTORNEY

SN 77-547,965. STATE REGULATORY REGISTRY LLC,
WASHINGTON, DC. FILED 8-15-2008.

NMLS

THE MARK CONSISTS OF STANDARD CHARACTERS WITHOUT CLAIM TO ANY PARTICULAR FONT, STYLE, SIZE, OR COLOR.

CLASS 35—ADVERTISING AND BUSINESS

FOR ONLINE RETAIL STORE SERVICES AND MAIL-ORDER CATALOG SERVICES FEATURING BOOKLETS, MANUALS, AND ANALOG AND DIGITAL MATERIALS DEALING WITH THE FINANCIAL SERVICES INDUSTRY; ONLINE RETAIL STORE SERVICES AND MAIL-ORDER CATALOG SERVICES FEATURING BOOKLETS, MANUALS, AND ANALOG AND DIGITAL MATERIALS DEALING WITH THE MORTGAGE INDUSTRY; ASSOCIATION SERVICES, NAMELY, PROMOTING THE INTERESTS OF FINANCIAL SERVICES COMPANIES AND PROFESSIONALS AND THEIR STATE AND FEDERAL GOVERNMENT REGULATORS; ASSOCIATION SERVICES, NAMELY, PROMOTING THE INTERESTS OF MORTGAGE INDUSTRY COMPANIES AND PROFES-

SIONALS AND THEIR STATE AND FEDERAL GOVERNMENT REGULATORS; PROVIDING FOR OTHERS AN ONLINE COMPUTER DATABASE OF BUSINESS INFORMATION REGARDING FINANCIAL SERVICES COMPANIES AND PROFESSIONALS AND THEIR PROFESSIONAL BACKGROUND, BUSINESS PRACTICES, CONDUCT, EMPLOYMENT, AND DISCIPLINARY STATUS; PROVIDING FOR OTHERS AN ONLINE COMPUTER DATABASE OF BUSINESS INFORMATION REGARDING MORTGAGE INDUSTRY COMPANIES AND PROFESSIONALS AND THEIR PROFESSIONAL BACKGROUND, BUSINESS PRACTICES, CONDUCT, EMPLOYMENT, AND DISCIPLINARY STATUS; PROVIDING FOR OTHERS BUSINESS INFORMATION REGARDING FINANCIAL SERVICES COMPANIES AND PROFESSIONALS AND THEIR PROFESSIONAL BACKGROUND, BUSINESS PRACTICES, CONDUCT, EMPLOYMENT, AND DISCIPLINARY STATUS IN RESPONSE TO TELEPHONE AND E-MAIL INQUIRIES; PROVIDING FOR OTHERS BUSINESS INFORMATION REGARDING MORTGAGE INDUSTRY COMPANIES AND PROFESSIONALS AND THEIR PROFESSIONAL BACKGROUND, BUSINESS PRACTICES, CONDUCT, EMPLOYMENT, AND DISCIPLINARY STATUS IN RESPONSE TO TELEPHONE AND E-MAIL INQUIRIES; PROVIDING BUSINESS ADVISORY SERVICES CONCERNING THE REGULATION OF THE FINANCIAL SERVICES INDUSTRY, NAMELY, CREATING PROPOSED RULES AND RULE CHANGES FOR OTHERS IN THE FINANCIAL SERVICES INDUSTRY TO INCREASE TRANSPARENCY; PROVIDING BUSINESS ADVISORY SERVICES CONCERNING THE REGULATION OF THE MORTGAGE INDUSTRY, NAMELY, CREATING PROPOSED RULES AND RULE CHANGES FOR OTHERS IN THE MORTGAGE INDUSTRY TO INCREASE TRANSPARENCY; PROVIDING BUSINESS ADVISORY SERVICES CONCERNING THE REGULATION OF THE FINANCIAL SERVICES INDUSTRY, NAMELY, CREATING PROPOSED RULES AND RULE CHANGES FOR STATES THAT GOVERN THE CONDUCT OF COMPANIES AND PROFESSIONALS IN THE FINANCIAL SERVICES INDUSTRY; PROVIDING BUSINESS ADVISORY SERVICES CONCERNING THE REGULATION OF THE MORTGAGE INDUSTRY, NAMELY, CREATING PROPOSED RULES AND RULE CHANGES FOR STATES THAT GOVERN THE CONDUCT OF COMPANIES AND PROFESSIONALS IN THE MORTGAGE INDUSTRY; PROCESSING OF COMPLAINTS REGARDING THE BUSINESS CONDUCT OF COMPANIES AND PROFESSIONALS IN THE FINANCIAL SERVICES INDUSTRY; PROCESSING OF COMPLAINTS REGARDING THE BUSINESS CONDUCT OF COMPANIES AND PROFESSIONALS IN THE MORTGAGE INDUSTRY; TESTING AND EXAMINATION TO DETERMINE THE PROFESSIONAL COMPETENCY OF COMPANIES AND PROFESSIONALS IN THE FINANCIAL SERVICES INDUSTRY AND STATE AND FEDERAL GOVERNMENT REGULATORS OF THE FINANCIAL SERVICES INDUSTRY; TESTING AND EXAMINATION TO DETERMINE THE PROFESSIONAL COMPETENCY OF COMPANIES AND PROFESSIONALS IN THE MORTGAGE INDUSTRY AND STATE AND FEDERAL GOVERNMENT REGULATORS OF THE MORTGAGE INDUSTRY; DATA MANAGEMENT SERVICES, NAMELY, COLLECTION, AGGREGATION, AND REPORTING OF FINANCIAL SERVICES INDUSTRY DATA; DATA MANAGEMENT SERVICES, NAMELY, COLLECTION, AGGREGATION, AND REPORTING OF MORTGAGE INDUSTRY DATA; PROVIDING SERVICES TO THE FINANCIAL SERVICES INDUSTRY AND TO STATE AND FEDERAL GOVERNMENT REGULATORS OF THE FINANCIAL SERVICES INDUSTRY, NAMELY, PROVIDING AN ONLINE WEBSITE FOR STATE-REGULATED FINANCIAL SERVICES COMPANIES AND PROFESSIONALS TO APPLY FOR, AMEND, RENEW, AND SURRENDER LICENSES VIA THE INTERNET; PROVIDING SERVICES TO THE MORTGAGE INDUSTRY AND TO STATE AND FEDERAL GOVERNMENT REGULATORS OF THE MORTGAGE INDUSTRY, NAMELY, PROVIDING AN ONLINE WEBSITE FOR STATE-REGULATED MORTGAGE INDUSTRY COMPANIES AND PROFESSIONALS TO APPLY FOR, AMEND, RENEW, AND SURRENDER LICENSES VIA THE INTERNET; PROVIDING AN ONLINE COMPUTER DATABASE OF INFORMATION IN THE FIELDS OF FINANCIAL SERVICES INDUSTRY BUSINESS MANAGEMENT AND BUSINESS OPERATIONS; PROVIDING AN ONLINE COMPUTER DATABASE OF INFORMATION IN THE

FIELDS OF MORTGAGE INDUSTRY BUSINESS MANAGEMENT AND BUSINESS OPERATIONS (U.S. CLS. 100, 101 AND 102).

SN 77-548,321. SPACE FLORIDA, KENNEDY SPACE CENTER, FL. FILED 8-15-2008.

CLASS 36—INSURANCE AND FINANCIAL

FOR PROVIDING GRANTS AND FUNDING FOR RESEARCH, PROJECTS, FELLOWSHIPS, SEMINARS, SYMPOSIUMS, ROUNDTABLES, AND CLASSES, ALL IN THE FIELDS OF FINANCIAL SERVICES INDUSTRY REGULATIONS, COMPLIANCE, MANAGEMENT, AND OPERATIONS; PROVIDING GRANTS AND FUNDING FOR RESEARCH, PROJECTS, FELLOWSHIPS, SEMINARS, SYMPOSIUMS, ROUNDTABLES, AND CLASSES, ALL IN THE FIELDS OF MORTGAGE INDUSTRY REGULATIONS, COMPLIANCE, MANAGEMENT, AND OPERATIONS; PROVIDING FOR OTHERS AN ONLINE COMPUTER DATABASE OF FINANCIAL INFORMATION REGARDING FINANCIAL SERVICES COMPANIES AND PROFESSIONALS; PROVIDING FOR OTHERS AN ONLINE COMPUTER DATABASE OF FINANCIAL INFORMATION REGARDING MORTGAGE INDUSTRY COMPANIES AND PROFESSIONALS; PROVIDING FOR OTHERS FINANCIAL INFORMATION REGARDING FINANCIAL SERVICES COMPANIES AND PROFESSIONALS IN RESPONSE TO TELEPHONE AND E-MAIL INQUIRIES; PROVIDING FOR OTHERS FINANCIAL INFORMATION REGARDING MORTGAGE INDUSTRY COMPANIES AND PROFESSIONALS IN RESPONSE TO TELEPHONE AND E-MAIL INQUIRIES (U.S. CLS. 100, 101 AND 102).

CLASS 41—EDUCATION AND ENTERTAINMENT

FOR EDUCATIONAL SERVICES, NAMELY, CONDUCTING MEETINGS, SEMINARS, CONFERENCES, CLASSES, AND WORKSHOPS IN THE FIELDS OF FINANCIAL SERVICES INDUSTRY REGULATIONS, COMPLIANCE, MANAGEMENT, AND OPERATIONS, AND PROVIDING CONTINUING EDUCATION PROGRAMS FOR FINANCIAL SERVICES INDUSTRY COMPANIES AND PROFESSIONALS AND STATE AND FEDERAL GOVERNMENT REGULATORS OF THE FINANCIAL SERVICES INDUSTRY; EDUCATIONAL SERVICES, NAMELY, CONDUCTING MEETINGS, SEMINARS, CONFERENCES, CLASSES, AND WORKSHOPS IN THE FIELDS OF MORTGAGE INDUSTRY REGULATIONS, COMPLIANCE, MANAGEMENT, AND OPERATIONS, AND PROVIDING CONTINUING EDUCATION PROGRAMS FOR MORTGAGE INDUSTRY COMPANIES AND PROFESSIONALS AND STATE AND FEDERAL GOVERNMENT REGULATORS OF THE MORTGAGE INDUSTRY (U.S. CLS. 100, 101 AND 107).

CLASS 45—PERSONAL AND LEGAL SERVICES

FOR PROVIDING AN ONLINE COMPUTER DATABASE OF INFORMATION IN THE FIELDS OF FINANCIAL SERVICES INDUSTRY REGULATIONS AND REGULATORY COMPLIANCE; PROVIDING AN ONLINE COMPUTER DATABASE OF INFORMATION IN THE FIELDS OF MORTGAGE INDUSTRY REGULATIONS AND REGULATORY COMPLIANCE (U.S. CLS. 100 AND 101).

BRIAN CALLAGHAN, EXAMINING ATTORNEY

THE PLACE FOR SPACE

THE MARK CONSISTS OF STANDARD CHARACTERS WITHOUT CLAIM TO ANY PARTICULAR FONT, STYLE, SIZE, OR COLOR.

NO CLAIM IS MADE TO THE EXCLUSIVE RIGHT TO USE "SPACE", APART FROM THE MARK AS SHOWN.

CLASS 35—ADVERTISING AND BUSINESS

FOR BUSINESS DEVELOPMENT SERVICES, NAMELY, PROVIDING START-UP AND RELOCATION SUPPORT FOR BUSINESSES OF OTHERS IN THE FIELD OF SPACE, NAMELY, BUSINESSES IN THE FIELD OF AEROSPACE, AND PROMOTING THE ATTRACTION, RETENTION AND EXPANSION OF SPACE-RELATED BUSINESSES, NAMELY, BUSINESSES RELATED TO THE FIELD OF AEROSPACE, IN THE STATE OF FLORIDA; BUSINESS VENTURE DEVELOPMENT AND FORMATION CONSULTING SERVICES FOR THE SPACE INDUSTRY, NAMELY, THE AEROSPACE INDUSTRY; BUSINESS RELOCATION CONSULTING; BUSINESS CONSULTING AND BUSINESS INFORMATION FOR SPACE-RELATED ENTERPRISES, NAMELY, ENTERPRISES RELATED TO THE FIELD OF AEROSPACE (U.S. CLS. 100, 101 AND 102).

CLASS 36—INSURANCE AND FINANCIAL

FOR FINANCIAL SERVICES, NAMELY, FINANCIAL CONSULTING SERVICES AND ARRANGING FINANCIAL INCENTIVES FOR SPACE-RELATED BUSINESSES, NAMELY, BUSINESSES IN THE FIELD OF AEROSPACE; SUPPORTING SCIENTIFIC RESEARCH AND DEVELOPMENT IN THE FIELD OF AEROSPACE BY PROVIDING FINANCIAL SUPPORT THEREFOR (U.S. CLS. 100, 101 AND 102).

CLASS 41—EDUCATION AND ENTERTAINMENT

FOR EDUCATIONAL SERVICES, NAMELY, DEVELOPING, ARRANGING, AND CONDUCTING EDUCATIONAL CONFERENCES AND PROGRAMS AND PROVIDING COURSES OF INSTRUCTION IN THE FIELDS OF SPACE TRAVEL, SPACE EXPLORATION, SPACE-BASED SCIENTIFIC RESEARCH, ECONOMIC OPPORTUNITIES AND INCENTIVES FOR SPACE-RELATED BUSINESSES, NAMELY, BUSINESSES IN THE FIELD OF AEROSPACE, AND OTHER TOPICS RELEVANT TO SPACE RELATED BUSINESSES, NAMELY, BUSINESSES IN THE FIELD OF AEROSPACE, AND DISTRIBUTING COURSE MATERIAL IN CONNECTION THEREWITH; DEVELOPING EDUCATIONAL MANUALS FOR OTHERS IN THE FIELD OF AEROSPACE (U.S. CLS. 100, 101 AND 107).

CLASS 42—SCIENTIFIC AND COMPUTER SERVICES

FOR CONDUCTING SCIENTIFIC RESEARCH AND DEVELOPMENT IN THE FIELD OF AEROSPACE (U.S. CLS. 100 AND 101).

THOMAS MANOR, EXAMINING ATTORNEY

SN 77-548,323. BLISS CHOCOLAT, LLC, BREVARD, NC.
FILED 8-15-2008.



NO CLAIM IS MADE TO THE EXCLUSIVE RIGHT TO USE "CHOCOLAT" AND "GOURMET CHOCOLATS SINCE 1921", APART FROM THE MARK AS SHOWN.

THE MARK CONSISTS OF THE WORDS "BLISS CHOCOLAT" WRITTEN IN A FANCIFUL SCRIPT ABOVE THE PHRASE "GOURMET CHOCOLATS SINCE 1921" PRINTED IN UPPER-CASE LETTERS, ALL ABOVE A STYLIZED DESIGN OF A HEART.

THE ENGLISH TRANSLATION OF "CHOCOLAT" IN THE MARK IS CHOCOLATE.

CLASS 30—STAPLE FOODS

FOR CHOCOLATE CANDIES AND CHOCOLATE CANDY BARS (U.S. CL. 46).

FIRST USE 11-15-2006; IN COMMERCE 11-15-2006.

CLASS 35—ADVERTISING AND BUSINESS

FOR RETAIL AND WHOLESALE STORES FEATURING CHOCOLATES; ONLINE RETAIL AND WHOLESALE STORES FEATURING CHOCOLATES (U.S. CLS. 100, 101 AND 102).

FIRST USE 3-31-2007; IN COMMERCE 3-31-2007.

CLASS 40—MATERIAL TREATMENT

FOR MANUFACTURE OF CHOCOLATES TO ORDER AND/OR SPECIFICATION OF OTHERS (U.S. CLS. 100, 103 AND 106).

FIRST USE 3-31-2007; IN COMMERCE 3-31-2007.
THOMAS MANOR, EXAMINING ATTORNEY

SN 77-548,666. BIG CREEK GOLF, LLC, MILLINGTON, TN.
FILED 8-15-2008.

MIRIMICHI

THE MARK CONSISTS OF STANDARD CHARACTERS WITHOUT CLAIM TO ANY PARTICULAR FONT, STYLE, SIZE, OR COLOR.

CLASS 3—COSMETICS AND CLEANING PREPARATIONS

FOR SKIN CARE PRODUCTS, NAMELY, SOAPS, LOTIONS, CREAMS; FACIAL AND BODY COSMETICS; MASSAGE LOTIONS AND CREAMS; EXFOLIANTS; HAIR SHAMPOOS AND CONDITIONERS; NAIL CARE PRODUCTS, NAMELY, VARNISHES, STRENGTHENERS, SOFTENERS AND HARDENERS, NAIL POLISH BASE COAT, NAIL CREAM, NAIL POLISH REMOVERS, CUTICLE CONDITIONERS AND REMOVING PREPARATIONS, CUTICLE CREAM, NAIL TIPS, NAIL STENCILS, NAIL BUFFING PREPARATIONS, AND NAIL POLISH (U.S. CLS. 1, 4, 6, 50, 51 AND 52).

CLASS 9—ELECTRICAL AND SCIENTIFIC APPARATUS

FOR PRE-RECORDED VIDEO TAPES, DVDS AND CDS RELATED TO THE GAME OF GOLF, GOLF INSTRUCTION, GOLF TOURNAMENTS AND GOLF COURSE DESIGN; COMPUTER SOFTWARE FOR PROVIDING INTERACTIVE GOLF INSTRUCTION; COMPUTER SOFTWARE FOR USE IN SCHEDULING AND MANAGING GOLF INSTRUCTION AND GOLF TOURNAMENTS; COMPUTER SOFTWARE FOR USE IN MANAGING GOLF COURSES, FOR SCHEDULING GOLF COURSE MAINTENANCE, AND FOR MEASURING THE CARBON FOOTPRINT OF GOLF COURSES; GOLF SCOPES (U.S. CLS. 21, 23, 26, 36 AND 38).

CLASS 16—PAPER GOODS AND PRINTED MATTER

FOR BOOKS IN THE FIELDS OF GOLF AND GOLF COURSE DESIGN; SOUVENIR PROGRAMS, JOURNALS AND MANUALS PERTAINING TO GOLF; POSTERS AND LITHOGRAPHIC PRINTS, CALENDARS, STATIONERY AND WRITING INSTRUMENTS; BOOKS IN THE FIELD OF HEALTH, BEAUTY, EXERCISE AND FITNESS (U.S. CLS. 2, 5, 22, 23, 29, 37, 38 AND 50).

CLASS 18—LEATHER GOODS

FOR GOLF TRAVEL BAGS AND GOLF UMBRELLAS, HANDBAGS, PURSES, GARMENT BAGS FOR TRAVEL; CARRY ON BAGS; SPORTS BAGS; BACKPACKS; TOTE BAGS; SHAVING BAGS SOLD EMPTY; SHOE BAGS FOR TRAVEL; TOILETRY CASES SOLD EMPTY; KEY CASES; WALKING STICKS (U.S. CLS. 1, 2, 3, 22 AND 41).

CLASS 21—HOUSEWARES AND GLASS

FOR BEVERAGE WARE, NAMELY, GLASSWARE, GLASS AND CERAMIC TUMBLERS, GLASS DECANTERS; CUPS AND MUGS; PORTABLE COOLERS AND INSULATED CONTAINERS FOR CANS FOR DOMESTIC USE (U.S. CLS. 2, 13, 23, 29, 30, 33, 40 AND 50).

CLASS 24—FABRICS

FOR GOLF BAG TOWELS; SPA AND BATH TOWELS (U.S. CLS. 42 AND 50).

CLASS 25—CLOTHING

FOR CLOTHING, NAMELY, HATS, SHORTS, SHIRTS, PANTS, SWEATERS, VISORS, SKIRTS, SOCKS, SHOES; SPIKES AND CLEATS FOR ATTACHMENTS TO GOLF SHOES TO PREVENT SLIPPING; VESTS; JACKET; COATS; SUN VISORS; BELTS; RESORT AND SPA CLOTHING, NAMELY, TANK TOPS, CAPS WITH VISORS, JOGGING SUITS, SWEAT PANTS, SWEAT SHIRTS, WARM UP SUITS, T-SHIRTS, SKORTS, LEGGINGS, LEOTARDS; BATH ROBES AND SLIPPERS; SWIMWEAR (U.S. CLS. 22 AND 39).

CLASS 28—TOYS AND SPORTING GOODS

FOR SPORTING GOODS, NAMELY, GOLF BAGS, GOLF CLUBS, GOLF IRONS, CASES FOR GOLF CLUBS, GOLF TEES AND BALL MARKERS; DIVOT REPAIR TOOLS; HEAD COVERS FOR GOLF CLUBS; GOLF ACCESSORY POUCHES AND HOLDERS FOR GOLF BALLS AND TEES; GOLF GLOVES; PLAYING CARDS (U.S. CLS. 22, 23, 38 AND 50).

CLASS 34—SMOKERS' ARTICLES

FOR SMOKER'S ARTICLES, NAMELY, SMOKING PIPES, CIGAR AND CIGARETTE LIGHTERS, CIGAR CUTTERS, CIGAR AND CIGARETTE CASES, HUMIDORS, CIGAR AND CIGARETTE HOLDERS AND MATCHES (U.S. CLS. 2, 8, 9 AND 17).

CLASS 41—EDUCATION AND ENTERTAINMENT

FOR PROVIDING GOLF FACILITIES; CONDUCTING, ORGANIZING AND SPONSORING GOLF TOURNAMENTS; GOLF CLUB SERVICES; PROVIDING NEWS AND INFORMATION ON THE SPORT OF GOLF; PROVIDING A WEB SITE WITH INFORMATION ON GOLF COURSES, GOLF LESSONS AND GOLF TOURNAMENTS; RENTAL OF GOLF EQUIPMENT; PROVIDING GOLF INSTRUCTION; HEALTH CLUB SERVICES, NAMELY, PROVIDING INSTRUCTION AND CONSULTATION IN THE FIELD OF PHYSICAL EXERCISE; PROVIDING USE OF EXERCISE EQUIPMENT; PROVIDING FITNESS AND EXERCISE FACILITIES (U.S. CLS. 100, 101 AND 107).

CLASS 43—HOTEL AND RESTAURANT SERVICES

FOR RESTAURANT SERVICES, BAR AND COCKTAIL LOUNGE SERVICES; PROVISION OF GENERAL PURPOSES FACILITIES FOR MEETINGS, CONFERENCES AND EXHIBITIONS; PROVISION OF BANQUET AND SOCIAL FUNCTION FACILITIES FOR SPECIAL OCCASIONS (U.S. CLS. 100 AND 101).

CLASS 44—MEDICAL, BEAUTY AND AGRICULTURAL SERVICES

FOR SALON AND DAY SPA SERVICES, NAMELY, COSMETIC SKIN, FACIAL, HAIR AND BODY CARE SERVICES, NAIL CARE, MANICURES, PEDICURES, FACIALS, BODY WAXING SERVICES, MASSAGES, BEAUTY SALON SERVICES; HEALTH SPA SERVICES FOR HEALTH AND WELLNESS OF THE BODY AND SPIRIT OFFERED AT A RESORT (U.S. CLS. 100 AND 101).

CHRIS WELLS, EXAMINING ATTORNEY

SN 77-549,474. CALIFORNIA INSTITUTE OF TECHNOLOGY, PASADENA, CA. FILED 8-18-2008.



OWNER OF U.S. REG. NO. 2,395,364.
THE MARK CONSISTS OF THE STYLIZED CAPITAL LETTERS "J", "P", AND "L" IN THAT ORDER.
SEC. 2(F).

CLASS 9—ELECTRICAL AND SCIENTIFIC APPARATUS

FOR CDS AND DVDS IN THE FIELDS OF THE EARTH AND ENVIRONMENTAL SCIENTIFIC STUDIES, AERONAUTICS, ASTRONOMY AND SPACE SCIENCES AND ENGINEERING; DOWNLOADABLE BROCHURES/MAGAZINES IN THE FIELDS OF THE EARTH AND THE ENVIRONMENT, AERONAUTICS, ASTRONOMY AND SPACE SCIENCES AND ENGINEERING (U.S. CLS. 21, 23, 26, 36 AND 38).
FIRST USE 12-1-1982; IN COMMERCE 10-7-1983.

CLASS 41—EDUCATION AND ENTERTAINMENT

FOR EDUCATION SERVICES, NAMELY, PROVIDING NON-DOWNLOADABLE BROCHURES AND PAMPHLETS IN THE FIELDS OF THE EARTH AND THE ENVIRONMENT, AERONAUTICS, ASTRONOMY AND SPACE SCIENCES AND ENGINEERING (U.S. CLS. 100, 101 AND 107).
FIRST USE 12-1-1982; IN COMMERCE 10-7-1983.

CLASS 42—SCIENTIFIC AND COMPUTER SERVICES

FOR SCIENTIFIC RESEARCH AND DEVELOPMENT; PROVIDING SCIENTIFIC INFORMATION ON A WEBSITE OF THE EARTH AND ENVIRONMENT STUDIES, AERONAUTICS, ASTRONOMY AND SPACE SCIENCES AND ENGINEERING (U.S. CLS. 100 AND 101).
FIRST USE 12-1-1982; IN COMMERCE 10-7-1983.
RAUL CORDOVA, EXAMINING ATTORNEY

SN 77-550,183. INTERNATIONAL TANG SOO DO FEDERATION, INC., MONROEVILLE, PA. FILED 8-19-2008.



OWNER OF U.S. REG. NOS. 2,124,834 AND 2,124,844.
NO CLAIM IS MADE TO THE EXCLUSIVE RIGHT TO USE "TANG SOO DO FEDERATION" AND THE NON-LATIN CHARACTERS THAT TRANSLITERATE TO "TANG SOO DO", APART FROM THE MARK AS SHOWN.
THE NON-LATIN CHARACTERS IN THE CENTER OF THE CENTRAL CIRCLE OF THE MARK TRANSLITERATE TO "DO" AND THIS MEANS "WAY OF LIFE" IN ENGLISH. THE NON-LATIN CHARACTERS IN THE CIRCULAR BORDER OF THE MARK TRANSLITERATE TO "TANG SOO DO" AND THIS MEANS "DEFENSE AND STRIKE" "HAND" AND "WAY" IN ENGLISH.
SEC. 2(F) AS TO "INTERNATIONAL TANG SOO DO FEDERATION".

CLASS 41—EDUCATION AND ENTERTAINMENT

FOR MARTIAL ARTS INSTRUCTION, AND DEVELOPING AND ESTABLISHING TECHNIQUES IN MARTIAL ARTS INSTRUCTION (U.S. CLS. 100, 101 AND 107).
FIRST USE 3-1-2008; IN COMMERCE 3-1-2008.

CLASS 200—COLLECTIVE MEMBERSHIP

FOR INDICATING MEMBERSHIP IN AN ORGANIZATION OF MARTIAL ARTS INSTRUCTORS.
FIRST USE 3-1-2008; IN COMMERCE 3-1-2008.
HEATHER BIDDULPH, EXAMINING ATTORNEY

SN 77-550,298. STATE REGULATORY REGISTRY LLC,
WASHINGTON, DC. FILED 8-19-2008.



THE MARK CONSISTS OF THE LETTERS NMLS WITH THE DESIGN OF A ROOF ABOVE THEM AND A STRAIGHT LINE BELOW THEM .

CLASS 35—ADVERTISING AND BUSINESS

FOR ONLINE RETAIL STORE SERVICES AND MAIL-ORDER CATALOG SERVICES FEATURING BOOKLETS, MANUALS, AND ANALOG AND DIGITAL MATERIALS DEALING WITH THE FINANCIAL SERVICES INDUSTRY; ONLINE RETAIL STORE SERVICES AND MAIL-ORDER CATALOG SERVICES FEATURING BOOKLETS, MANUALS, AND ANALOG AND DIGITAL MATERIALS DEALING WITH THE MORTGAGE INDUSTRY; ASSOCIATION SERVICES, NAMELY, PROMOTING THE INTERESTS OF FINANCIAL SERVICES COMPANIES AND PROFESSIONALS AND THEIR STATE AND FEDERAL GOVERNMENT REGULATORS; ASSOCIATION SERVICES, NAMELY, PROMOTING THE INTERESTS OF MORTGAGE INDUSTRY COMPANIES AND PROFESSIONALS AND THEIR STATE AND FEDERAL GOVERNMENT REGULATORS; PROVIDING FOR OTHERS AN ONLINE COMPUTER DATABASE OF BUSINESS INFORMATION REGARDING FINANCIAL SERVICES COMPANIES AND PROFESSIONALS AND THEIR PROFESSIONAL BACKGROUND, BUSINESS PRACTICES, CONDUCT, EMPLOYMENT, AND DISCIPLINARY STATUS; PROVIDING FOR OTHERS AN ONLINE COMPUTER DATABASE OF BUSINESS INFORMATION REGARDING MORTGAGE INDUSTRY COMPANIES AND PROFESSIONALS AND THEIR PROFESSIONAL BACKGROUND, BUSINESS PRACTICES, CONDUCT, EMPLOYMENT, AND DISCIPLINARY STATUS; PROVIDING FOR OTHERS BUSINESS INFORMATION REGARDING FINANCIAL SERVICES COMPANIES AND PROFESSIONALS AND THEIR PROFESSIONAL BACKGROUND, BUSINESS PRACTICES, CONDUCT, EMPLOYMENT, AND DISCIPLINARY STATUS IN RESPONSE TO TELEPHONE AND E-MAIL INQUIRIES; PROVIDING FOR OTHERS BUSINESS INFORMATION REGARDING MORTGAGE INDUSTRY COMPANIES AND PROFESSIONALS AND THEIR PROFESSIONAL BACKGROUND, BUSINESS PRACTICES, CONDUCT, EMPLOYMENT, AND DISCIPLINARY STATUS IN RESPONSE TO TELEPHONE AND E-MAIL INQUIRIES; PROVIDING BUSINESS ADVISORY SERVICES CONCERNING THE REGULATION OF THE FINANCIAL SERVICES INDUSTRY, NAMELY, DEVELOPMENT FOR OTHERS OF FINANCIAL SERVICES INDUSTRY RULES TO INCREASE TRANSPARENCY; PROVIDING BUSINESS ADVISORY SERVICES CONCERNING THE REGULATION OF THE MORTGAGE INDUSTRY, NAMELY, DEVELOPMENT FOR OTHERS OF MORTGAGE INDUSTRY RULES TO INCREASE TRANSPARENCY; ASSOCIATION SERVICES, NAMELY, CREATING RULES FOR STATES THAT GOVERN THE CONDUCT OF COMPANIES AND PROFESSIONALS IN THE FINANCIAL SERVICES INDUSTRY; ASSOCIATION SERVICES, NAMELY, CREATING RULES FOR STATES THAT GOVERN THE CONDUCT OF COMPANIES AND PROFESSIONALS IN THE MORTGAGE INDUSTRY; PROCESSING OF COMPLAINTS REGARDING THE BUSINESS CONDUCT OF COMPANIES AND PROFESSIONALS IN THE FINANCIAL SERVICES INDUSTRY; PROCESSING OF COMPLAINTS REGARDING THE BUSINESS CONDUCT OF COMPANIES AND PROFESSIONALS IN THE MORTGAGE INDUSTRY; TESTING AND EXAMINATION TO DETERMINE THE PROFESSIONAL COMPETENCY OF COMPANIES AND PROFESSIONALS IN THE FINANCIAL SERVICES INDUSTRY

AND STATE AND FEDERAL GOVERNMENT REGULATORS OF THE FINANCIAL SERVICES INDUSTRY; TESTING AND EXAMINATION TO DETERMINE THE PROFESSIONAL COMPETENCY OF COMPANIES AND PROFESSIONALS IN THE MORTGAGE INDUSTRY AND STATE AND FEDERAL GOVERNMENT REGULATORS OF THE MORTGAGE INDUSTRY; DATA MANAGEMENT SERVICES, NAMELY, COLLECTION, AGGREGATION, AND REPORTING OF FINANCIAL SERVICES INDUSTRY DATA; DATA MANAGEMENT SERVICES, NAMELY, COLLECTION, AGGREGATION, AND REPORTING OF MORTGAGE INDUSTRY DATA; PROVIDING SERVICES TO THE FINANCIAL SERVICES INDUSTRY AND TO STATE AND FEDERAL GOVERNMENT REGULATORS OF THE FINANCIAL SERVICES INDUSTRY, NAMELY, PROVIDING AN ONLINE WEBSITE FOR STATE-REGULATED FINANCIAL SERVICES COMPANIES AND PROFESSIONALS TO APPLY FOR, AMEND, RENEW, AND SURRENDER LICENSES VIA THE INTERNET; PROVIDING SERVICES TO THE MORTGAGE INDUSTRY AND TO STATE AND FEDERAL GOVERNMENT REGULATORS OF THE MORTGAGE INDUSTRY, NAMELY, PROVIDING AN ONLINE WEBSITE FOR STATE-REGULATED MORTGAGE INDUSTRY COMPANIES AND PROFESSIONALS TO APPLY FOR, AMEND, RENEW, AND SURRENDER LICENSES VIA THE INTERNET; PROVIDING AN ONLINE COMPUTER DATABASE OF INFORMATION IN THE FIELDS OF FINANCIAL SERVICES INDUSTRY BUSINESS MANAGEMENT AND BUSINESS OPERATIONS; PROVIDING AN ONLINE COMPUTER DATABASE OF INFORMATION IN THE FIELDS OF MORTGAGE INDUSTRY BUSINESS MANAGEMENT AND BUSINESS OPERATIONS (U.S. CLS. 100, 101 AND 102).

CLASS 36—INSURANCE AND FINANCIAL

FOR PROVIDING GRANTS AND FUNDING FOR RESEARCH, PROJECTS, FELLOWSHIPS, SEMINARS, SYMPOSIUMS, ROUNDTABLES, AND CLASSES, ALL IN THE FIELDS OF FINANCIAL SERVICES INDUSTRY REGULATIONS, COMPLIANCE, MANAGEMENT, AND OPERATIONS; PROVIDING GRANTS AND FUNDING FOR RESEARCH, PROJECTS, FELLOWSHIPS, SEMINARS, SYMPOSIUMS, ROUNDTABLES, AND CLASSES, ALL IN THE FIELDS OF MORTGAGE INDUSTRY REGULATIONS, COMPLIANCE, MANAGEMENT, AND OPERATIONS; PROVIDING FOR OTHERS AN ONLINE COMPUTER DATABASE OF FINANCIAL INFORMATION REGARDING FINANCIAL SERVICES COMPANIES AND PROFESSIONALS AND THEIR PROFESSIONAL BACKGROUND, BUSINESS PRACTICES, CONDUCT, EMPLOYMENT, AND DISCIPLINARY STATUS; PROVIDING FOR OTHERS AN ONLINE COMPUTER DATABASE OF FINANCIAL INFORMATION REGARDING MORTGAGE INDUSTRY COMPANIES AND PROFESSIONALS AND THEIR PROFESSIONAL BACKGROUND, BUSINESS PRACTICES, CONDUCT, EMPLOYMENT, AND DISCIPLINARY STATUS; PROVIDING FOR OTHERS FINANCIAL INFORMATION REGARDING FINANCIAL SERVICES COMPANIES AND PROFESSIONALS AND THEIR PROFESSIONAL BACKGROUND, BUSINESS PRACTICES, CONDUCT, EMPLOYMENT, AND DISCIPLINARY STATUS IN RESPONSE TO TELEPHONE AND E-MAIL INQUIRIES; PROVIDING FOR OTHERS FINANCIAL INFORMATION REGARDING MORTGAGE INDUSTRY COMPANIES AND PROFESSIONALS AND THEIR PROFESSIONAL BACKGROUND, BUSINESS PRACTICES, CONDUCT, EMPLOYMENT, AND DISCIPLINARY STATUS IN RESPONSE TO TELEPHONE AND E-MAIL INQUIRIES (U.S. CLS. 100, 101 AND 102).

CLASS 41—EDUCATION AND ENTERTAINMENT

FOR EDUCATIONAL SERVICES, NAMELY, CONDUCTING MEETINGS, SEMINARS, CONFERENCES, CLASSES, AND WORKSHOPS IN THE FIELDS OF FINANCIAL SERVICES INDUSTRY REGULATIONS, COMPLIANCE, MANAGEMENT, AND OPERATIONS, AND PROVIDING CONTINUING EDUCATION PROGRAMS FOR FINANCIAL SERVICES INDUSTRY COMPANIES AND PROFESSIONALS AND STATE AND FEDERAL GOVERNMENT REGULATORS OF THE FINANCIAL SERVICES INDUSTRY; EDUCATIONAL SERVICES, NAMELY, CONDUCTING MEETINGS, SEMINARS, CONFERENCES, CLASSES, AND WORKSHOPS IN THE FIELDS OF MORTGAGE INDUSTRY REGULATIONS, COMPLIANCE, MANAGEMENT, AND OPERATIONS, AND PROVIDING CONTINUING EDUCATION PROGRAMS FOR MORTGAGE INDUSTRY COMPANIES AND PROFESSIONALS AND STATE AND FEDERAL GOVERNMENT REGULATORS OF THE MORTGAGE INDUSTRY (U.S. CLS. 100, 101 AND 107).

CLASS 45—PERSONAL AND LEGAL SERVICES

FOR PROVIDING AN ONLINE COMPUTER DATABASE OF INFORMATION IN THE FIELDS OF FINANCIAL SERVICES INDUSTRY REGULATIONS AND REGULATORY COMPLIANCE; PROVIDING AN ONLINE COMPUTER DATABASE OF INFORMATION IN THE FIELDS OF MORTGAGE INDUSTRY REGULATIONS AND REGULATORY COMPLIANCE (U.S. CLS. 100 AND 101).

BRIAN CALLAGHAN, EXAMINING ATTORNEY

SN 77-550,641. MCDONNELL, KATHRYN J., DBA KATHRYN J. MCDONNELL, HOPEWELL JUNCTION, NY. FILED 8-19-2008.

CLIC

THE MARK CONSISTS OF STANDARD CHARACTERS WITHOUT CLAIM TO ANY PARTICULAR FONT, STYLE, SIZE, OR COLOR.

CLASS 9—ELECTRICAL AND SCIENTIFIC APPARATUS

FOR COMPUTER SOFTWARE AND HARDWARE TO CREATE A TELEVISION REMOTE CONTROL FEEDBACK SYSTEM TO ENABLE EVERY HOSPITAL PATIENT TO DAILY INFORM AND EVALUATE THEIR HEALTH CARE PROVIDERS TO BETTER ENSURE PATIENT SAFETY IN HEALTH CARE INSTITUTIONS (U.S. CLS. 21, 23, 26, 36 AND 38).

CLASS 42—SCIENTIFIC AND COMPUTER SERVICES

FOR PROVIDING COMPUTER MONITORING SERVICE WHICH TRACKS HARDWARE AND SOFTWARE PERFORMANCE AND PROCESSES OF A TELEVISION REMOTE CONTROL FEEDBACK SYSTEM THAT ENABLES EVERY HOSPITAL PATIENT TO DAILY INFORM AND EVALUATE THEIR HEALTH CARE PROVIDERS TO BETTER INSURE PATIENT SAFETY IN HEALTHCARE INSTITUTIONS (U.S. CLS. 100 AND 101).

ZACHARY BELLO, EXAMINING ATTORNEY

SN 77-554,076. ICON HEALTH & FITNESS, INC., LOGAN, UT. FILED 8-22-2008.

IFIT MOBILE

THE MARK CONSISTS OF STANDARD CHARACTERS WITHOUT CLAIM TO ANY PARTICULAR FONT, STYLE, SIZE, OR COLOR.

NO CLAIM IS MADE TO THE EXCLUSIVE RIGHT TO USE "MOBILE", APART FROM THE MARK AS SHOWN.

CLASS 9—ELECTRICAL AND SCIENTIFIC APPARATUS

FOR PORTABLE ELECTRONIC DEVICES TO BE CARRIED OR WORN BY INDIVIDUALS FOR RECEIVING AND PROVIDING TO THE USER EXERCISE, FITNESS AND/OR NUTRITIONAL INFORMATION, ENTERTAINMENT CONTENT AND/OR MOTIVATION CONTENT, FOR MEASURING, MONITORING AND/OR STORING DATA INDICATIVE OF ONE OR MORE PHYSIOLOGICAL CONDITIONS OF THE USER DURING EXERCISE, FOR STORING OTHER PERSONAL, FITNESS, NUTRITIONAL AND/OR LIFESTYLE INFORMATION AND/OR DATA FOR THE USER, AND/OR FOR TRANSFERRING OR TRANSMITTING SUCH INFORMATION AND DATA TO OTHER ELECTRONIC DEVICES AND/OR SYSTEMS, EITHER IN REAL TIME OR AT A LATER TIME; COMPUTER SOFTWARE IN THE FIELD OF EXERCISE, FITNESS AND NUTRITION, NAMELY, SOFTWARE FOR USE BY INDIVIDUALS TO HELP THEM MAKE PHYSICAL FITNESS, STRENGTH, CONDITIONING, EXERCISE AND NUTRITIONAL IMPROVEMENT IN THEIR DAILY LIVING; COMPUTER INTERFACES AND ANALYSIS, MONITORING, FEEDBACK, INSTRUCTIONAL, AND MOTIVATIONAL SOFTWARE FOR TO BE UTILIZED WITH PORTABLE MONITORS FOR ATHLETIC, EXERCISE, FITNESS, AND NUTRITIONAL USE; ELECTRONIC CONTROLLERS INCORPORATED INTO EXERCISE MACHINES; Pedometers; AND ACCELEROMETERS (U.S. CLS. 21, 23, 26, 36 AND 38).

CLASS 10—MEDICAL APPARATUS

FOR ELECTRONIC EXERCISE MONITORS, NAMELY, A HEART RATE MONITOR; ELECTRONIC EXERCISE MONITOR FEATURING A GPS RECEIVER, NAMELY, A HEART RATE MONITOR; EXERCISE MACHINES FOR THERAPEUTIC PURPOSES; HEART MONITORS TO BE WORN DURING EXERCISE; AND PHYSICAL EXERCISE APPARATUS, FOR MEDICAL PURPOSES (U.S. CLS. 26, 39 AND 44).

CLASS 28—TOYS AND SPORTING GOODS

FOR EXERCISE MACHINES (U.S. CLS. 22, 23, 38 AND 50).

CLASS 35—ADVERTISING AND BUSINESS

FOR PROVIDING ASSISTANCE, FITNESS EVALUATION AND CONSULTATION TO CORPORATE CLIENTS TO TO HELP MAKE HEALTH, WELLNESS AND NUTRITIONAL CHANGES IN THEIR EMPLOYEES' DAILY LIVING (U.S. CLS. 100, 101 AND 102).

CLASS 41—EDUCATION AND ENTERTAINMENT

FOR COUNSELING SERVICES IN THE FIELD PHYSICAL FITNESS; PHYSICAL FITNESS CONSULTATION; PROVIDING A WEB SITE FEATURING INFORMATION ON EXERCISE AND FITNESS; PROVIDING AN ONLINE COMPUTER DATABASE FEATURING INFORMATION REGARDING EXERCISE AND FITNESS; PROVIDING ASSISTANCE, PERSONAL TRAINING AND PHYSICAL FITNESS CONSULTATION TO INDIVIDUALS TO HELP THEM MAKE PHYSICAL FITNESS, STRENGTH, CONDITIONING, AND EXERCISE IMPROVEMENT IN THEIR DAILY LIVING; PROVIDING INFORMATION IN THE FIELD OF EXERCISE TRAINING; AND PROVIDING INFORMATION ON PHYSICAL EXERCISE (U.S. CLS. 100, 101 AND 107).

CLASS 44—MEDICAL, BEAUTY AND AGRICULTURAL SERVICES

FOR MEDICAL TESTING SERVICES, NAMELY, FITNESS EVALUATION, PROVIDING ASSISTANCE, AND CONSULTATION TO INDIVIDUALS TO HELP MAKE HEALTH, WELLNESS AND NUTRITIONAL CHANGES IN THEIR DAILY LIVING (U.S. CLS. 100 AND 101).
SHAUNIA CARLYLE, EXAMINING ATTORNEY

CLASS 16—PAPER GOODS AND PRINTED MATTER

FOR TRADING CARDS (U.S. CLS. 2, 5, 22, 23, 29, 37, 38 AND 50).

CLASS 28—TOYS AND SPORTING GOODS

FOR TOYS AND GAMES, NAMELY, TOY ACTION FIGURES, DOLLS, TOY JEWELRY, TOY JEWELRY BOXES, TOY PLAYSETS FOR DOLLS AND ACTION FIGURES; BACKPACK CLIPS, NAMELY, PLUSH TOYS, TOY FIGURES, AND DOLLS THAT CLIP ONTO A BACKPACK; TOYS AND GAMES, NAMELY, TOY ACTION FIGURES, DOLLS, TOY JEWELRY, TOY JEWELRY BOXES, TOY PLAYSETS FOR DOLLS AND ACTION FIGURES, AND HANDHELD UNITS FOR PLAYING ELECTRONIC GAMES THAT OPERATE INTERACTIVELY WITH OTHER TOYS, GAMES, DEVICES AND ONLINE ENTERTAINMENT WEBSITES; TOYS AND GAMES, NAMELY, TOY ACTION FIGURES, DOLLS, TOY JEWELRY, TOY JEWELRY BOXES, TOY PLAYSETS FOR DOLLS AND ACTION FIGURES, AND HANDHELD UNITS FOR PLAYING ELECTRONIC GAMES THAT RECEIVE AND TRANSMIT ELECTRONIC CONTENT FROM AND TO OTHER TOYS, GAMES, DEVICES AND ONLINE ENTERTAINMENT WEBSITES (U.S. CLS. 22, 23, 38 AND 50).

JAY FLOWERS, EXAMINING ATTORNEY

SN 77-554,157. CLICKTECH, LLC, PASADENA, CA. FILED 8-22-2008.



NO CLAIM IS MADE TO THE EXCLUSIVE RIGHT TO USE "TECHNOLOGY", APART FROM THE MARK AS SHOWN.

THE COLOR(S) ORANGE, GRADIENTS OF ORANGE, GRAY, GRADIENTS OF GRAY, BLACK, YELLOW, GRADIENTS OF YELLOW, BLUE, AND GRADIENTS OF BLUE IS/ARE CLAIMED AS A FEATURE OF THE MARK.

THE MARK CONSISTS OF THE TERM "CLICKABLES", WHEREIN THE PORTION "CLICK" IS ORANGE WITH GRADIENTS THEREOF, AND THE PORTION "ABLES" IS GRAY WITH GRADIENTS THEREOF; OVER THE "I" IN THE "CLICK" PORTION, THERE APPEARS A GRAPHIC OF FOUR GRAY DOTS (WITH GRADIENT SHADING) THAT FORM A SHAPE OF A "Y"; THERE IS A BLUE LINE (WITH GRADIENT SHADING) THAT UNDERLINES THE TERM "CLICKABLES"; THE TERM "TECHNOLOGY" IS YELLOW WITH GRADIENT SHADING THAT HAS A BLACK BACKGROUND THAT EXTENDS TO A CUSTOMIZED SHAPE THAT FRAMES THE LOGO DESIGN.

CLASS 9—ELECTRICAL AND SCIENTIFIC APPARATUS

FOR ELECTRONIC MEMORIES AND COMPUTER SOFTWARE FOR LINKING TO AND ACCESSING INFORMATION STORED IN STORAGE MEDIUM, NAMELY, THE INTERNET, CD ROMS, COMPUTER MEMORIES, AND MEMORY CHIPS; INTERACTIVE VIDEO GAMES OF VIRTUAL REALITY COMPRISED OF COMPUTER HARDWARE AND SOFTWARE; DIGITAL TRADING CARDS IN THE NATURE OF MULTIMEDIA SOFTWARE RECORDED ON MAGNETIC MEDIA FEATURING GAMES; TRADING CARDS IN THE FORM OF PRE-RECORDED ELECTRONIC AND DIGITAL MEDIA FEATURING GAMES (U.S. CLS. 21, 23, 26, 36 AND 38).

SN 77-554,351. MARVELOUS PET SUPPLIES LLC, BROOKLYN, NY. FILED 8-24-2008.

Marvelous Pet Supplies

THE MARK CONSISTS OF STANDARD CHARACTERS WITHOUT CLAIM TO ANY PARTICULAR FONT, STYLE, SIZE, OR COLOR.

NO CLAIM IS MADE TO THE EXCLUSIVE RIGHT TO USE "PET SUPPLIES", APART FROM THE MARK AS SHOWN.

CLASS 6—METAL GOODS

FOR METAL CAGES FOR WILD ANIMALS (U.S. CLS. 2, 12, 13, 14, 23, 25 AND 50).

CLASS 21—HOUSEWARES AND GLASS

FOR CAGES FOR HOUSEHOLD PETS; CAGES FOR PETS; PERCHES FOR BIRD CAGES (U.S. CLS. 2, 13, 23, 29, 30, 33, 40 AND 50).

KAREN SEVERSON, EXAMINING ATTORNEY

SN 77-554,816. SATCON TECHNOLOGY CORPORATION, BOSTON, MA. FILED 8-25-2008.

EDGE

THE MARK CONSISTS OF STANDARD CHARACTERS WITHOUT CLAIM TO ANY PARTICULAR FONT, STYLE, SIZE, OR COLOR.

CLASS 9—ELECTRICAL AND SCIENTIFIC APPARATUS

FOR POWER CONTROL PRODUCT, NAMELY, GRID-CONNECTED ELECTRONICS IN THE NATURE OF CONVERTERS, INVERTERS, MICROCONVERTERS, MICROINVERTERS, AND SOFTWARE FOR CONTROLLING THE CONVERTERS, INVERTERS, MICROCONVERTERS, MICROINVERTERS FOR USE IN CONNECTION WITH RENEWABLE AND ALTERNATIVE ENERGY SOURCES, NAMELY SOLAR ENERGY, WIND ENERGY, HYDRAULIC FLOW ENERGY, AND FUEL CELLS; POWER CONDITIONING PRODUCTS, NAMELY, GRID-CONNECTED ELECTRONICS IN THE NATURE OF CONVERTERS, INVERTERS, MICROCONVERTERS, MICROINVERTERS, AND SOFTWARE FOR CONTROLLING THE CONVERTERS, INVERTERS, MICROCONVERTERS, MICROINVERTERS FOR USE IN CONNECTION WITH RENEWABLE AND ALTERNATIVE ENERGY SOURCES, NAMELY, SOLAR ENERGY, WIND ENERGY, HYDRAULIC FLOW ENERGY AND FUEL CELLS; AND POWER CONVERSION PRODUCTS, NAMELY GRID-CONNECTED ELECTRONICS IN THE NATURE OF CONVERTERS, INVERTERS, MICROCONVERTERS, MICROINVERTERS, AND CONTROL SYSTEMS COMPRISING A DEVICE FOR CONTROLLING THE SWITCHING FUNCTION OF THE CONVERTERS, INVERTERS, MICROCONVERTERS, AND MICROINVERTERS FOR USE IN CONNECTION WITH RENEWABLE AND ALTERNATIVE ENERGY SOURCES, NAMELY, SOLAR ENERGY, WIND ENERGY, HYDRAULIC FLOW ENERGY AND FUEL CELLS (U.S. CLS. 21, 23, 26, 36 AND 38).

CLASS 42—SCIENTIFIC AND COMPUTER SERVICES

FOR ENGINEERING SERVICES, NAMELY, FOR DEVELOPMENT AND DESIGN OF POWER CONTROL PRODUCTS, NAMELY, GRID-CONNECTED ELECTRONICS IN THE NATURE OF CONVERTERS, INVERTERS, MICROCONVERTERS, MICROINVERTERS, AND SOFTWARE THEREFOR FOR USE IN CONNECTION WITH RENEWABLE AND ALTERNATIVE ENERGY SOURCES, NAMELY, SOLAR ENERGY, WIND ENERGY, HYDRAULIC FLOW ENERGY, AND FUEL CELLS; FOR DEVELOPMENT AND DESIGN OF POWER CONDITIONING PRODUCTS, NAMELY, CONVERTERS, INVERTERS, MICROCONVERTERS, MICROINVERTERS, AND SOFTWARE THEREFOR FOR USE IN CONNECTION WITH RENEWABLE AND ALTERNATIVE ENERGY SOURCES, NAMELY, SOLAR ENERGY, WIND ENERGY, HYDRAULIC FLOW ENERGY, AND FUEL CELLS; AND DEVELOPMENT AND DESIGN OF CONVERTERS, INVERTERS, MICROCONVERTERS, MICROINVERTERS, AND CONTROL SYSTEMS FOR CONVERTERS, INVERTERS, MICROCONVERTERS AND MICROINVERTERS FOR POWER CONTROL, POWER CONDITIONING, POWER MANAGEMENT, AND POWER CONVERSION INDUSTRIES FOR USE IN CONNECTION WITH RENEWABLE AND ALTERNATIVE ENERGY SOURCES, NAMELY, SOLAR ENERGY, WIND ENERGY, HYDRAULIC FLOW ENERGY, AND FUEL CELLS (U.S. CLS. 100 AND 101).

LINDA ESTRADA, EXAMINING ATTORNEY

SN 77-555,551. CREATIVE JUMP SYSTEMS, INC., DBA JUMP INTERNATIONAL, HILLIARD, OH. FILED 8-26-2008.

JUMP ASIAN EXPRESS

THE MARK CONSISTS OF STANDARD CHARACTERS WITHOUT CLAIM TO ANY PARTICULAR FONT, STYLE, SIZE, OR COLOR.

NO CLAIM IS MADE TO THE EXCLUSIVE RIGHT TO USE "ASIAN EXPRESS", APART FROM THE MARK AS SHOWN.

CLASS 29—MEATS AND PROCESSED FOODS

FOR PREPARED MEALS CONSISTING PRIMARILY OF MEAT, FISH, POULTRY OR VEGETABLES; PREPARED VEGETABLE-BASED ENTREES (U.S. CL. 46).
FIRST USE 11-30-1998; IN COMMERCE 11-30-1998.

CLASS 30—STAPLE FOODS

FOR EGG ROLLS; NOODLES; RICE; PREPARED MEALS CONSISTING PRIMARILY OF PASTA OR RICE (U.S. CL. 46).
FIRST USE 11-30-1998; IN COMMERCE 11-30-1998.
JUDITH HELFMAN, EXAMINING ATTORNEY

SN 77-555,905. ADVENTURE DIVERS, INC., FT. LAUDERDALE, FL. FILED 8-26-2008.

DIVERS DISCOUNT FLORIDA

THE MARK CONSISTS OF STANDARD CHARACTERS WITHOUT CLAIM TO ANY PARTICULAR FONT, STYLE, SIZE, OR COLOR.
SEC. 2(F).

CLASS 35—ADVERTISING AND BUSINESS

FOR RETAIL STORE AND ON-LINE RETAIL STORE SERVICES FEATURING SNORKELING AND SCUBA GEAR, CLOTHING, AND ACCESSORIES (U.S. CLS. 100, 101 AND 102).
FIRST USE 1-31-2000; IN COMMERCE 1-31-2000.

CLASS 41—EDUCATION AND ENTERTAINMENT

FOR SNORKELING AND SCUBA INSTRUCTION (U.S. CLS. 100, 101 AND 107).
FIRST USE 1-31-2000; IN COMMERCE 1-31-2000.
VERNA BETH RIRIE, EXAMINING ATTORNEY

SN 77-556,000. BIG CREEK GOLF, LLC, MILLINGTON, TN. FILED 8-26-2008.

MIRIMICHI LAKES

THE MARK CONSISTS OF STANDARD CHARACTERS WITHOUT CLAIM TO ANY PARTICULAR FONT, STYLE, SIZE, OR COLOR.

NO CLAIM IS MADE TO THE EXCLUSIVE RIGHT TO USE "LAKES", APART FROM THE MARK AS SHOWN.

CLASS 3—COSMETICS AND CLEANING PREPARATIONS

FOR SKIN CARE PRODUCTS, NAMELY, SOAPS, LOTIONS, CREAMS; FACIAL AND BODY COSMETICS; MASSAGE LOTIONS AND CREAMS; EXFOLIANTS; HAIR SHAMPOOS AND CONDITIONERS; NAIL CARE PRODUCTS, NAMELY, VARNISHES, STRENGTHENERS, SOFTENERS AND HARDENERS, NAIL POLISH BASE COAT, NAIL CREAM, NAIL POLISH REMOVERS, CUTICLE CONDITIONERS AND REMOVING PREPARATIONS, CUTICLE CREAM, NAIL TIPS, NAIL STENCILS, NAIL BUFFING PREPARATIONS, AND NAIL POLISH (U.S. CLS. 1, 4, 6, 50, 51 AND 52).

CLASS 9—ELECTRICAL AND SCIENTIFIC APPARATUS

FOR PRE-RECORDED VIDEO TAPES, DVDS AND CDS RELATED TO THE GAME OF GOLF, GOLF INSTRUCTION, GOLF TOURNAMENTS AND GOLF COURSE DESIGN; COMPUTER SOFTWARE FOR PROVIDING INTERACTIVE GOLF INSTRUCTION; COMPUTER SOFTWARE FOR USE IN SCHEDULING AND MANAGING GOLF INSTRUCTION AND GOLF TOURNAMENTS; COMPUTER SOFTWARE FOR USE IN MANAGING GOLF COURSES, FOR SCHEDULING GOLF COURSE MAINTENANCE, AND FOR MEASURING THE CARBON FOOTPRINT OF GOLF COURSES; GOLF SCOPES (U.S. CLS. 21, 23, 26, 36 AND 38).

CLASS 16—PAPER GOODS AND PRINTED MATTER

FOR BOOKS IN THE FIELD OF GOLF, SOUVENIR PROGRAMS, JOURNALS AND MANUALS PERTAINING TO GOLF, POSTERS AND LITHOGRAPHIC PRINTS, CALENDARS, STATIONERY AND WRITING INSTRUMENTS; BOOKS IN THE FIELD OF HEALTH, BEAUTY, EXERCISE AND FITNESS (U.S. CLS. 2, 5, 22, 23, 29, 37, 38 AND 50).

CLASS 18—LEATHER GOODS

FOR GOLF TRAVEL BAGS AND GOLF UMBRELLAS, HANDBAGS, PURSES, GARMENT BAGS FOR TRAVEL; CARRY ON BAGS; SPORTS BAGS; BACKPACKS; TOTE BAGS; SHAVING BAGS SOLD EMPTY; SHOE BAGS FOR TRAVEL; TOILETRY CASES SOLD EMPTY; KEY CASES; WALKING STICKS (U.S. CLS. 1, 2, 3, 22 AND 41).

CLASS 21—HOUSEWARES AND GLASS

FOR BEVERAGE WARE, NAMELY, GLASSWARE, GLASS AND CERAMIC TUMBLERS, GLASS DECANTERS; CUPS AND MUGS; PORTABLE COOLERS AND INSULATED CONTAINERS FOR CANS FOR DOMESTIC USE (U.S. CLS. 2, 13, 23, 29, 30, 33, 40 AND 50).

CLASS 25—CLOTHING

FOR CLOTHING, NAMELY, HATS, SHORTS, SHIRTS, PANTS, SWEATERS, VISORS, SKIRTS, SOCKS, SHOES; SPIKES AND CLEATS FOR ATTACHMENTS TO GOLF SHOES TO PREVENT SLIPPING; VESTS; JACKETS; COATS; SUN VISORS; BELTS; RESORT AND SPA CLOTHING, NAMELY, TANK TOPS, CAPS WITH VISORS, JOGGING SUITS, SWEAT PANTS, SWEAT SHIRTS, WARM UP SUITS, T-SHIRTS, SKORTS, LEGGINGS, LEOTARDS; BATH ROBES AND SLIPPERS; SWIMWEAR (U.S. CLS. 22 AND 39).

CLASS 28—TOYS AND SPORTING GOODS

FOR SPORTING GOODS, NAMELY, GOLF BAGS, GOLF CLUBS, GOLF IRONS, CASES FOR GOLF CLUBS, GOLF TEES AND BALL MARKERS; DIVOT REPAIR TOOLS; HEAD COVERS FOR GOLF CLUBS; GOLF ACCESSORY POUCHES AND HOLDERS FOR GOLF BALLS AND TEES; GOLF GLOVES; PLAYING CARDS (U.S. CLS. 22, 23, 38 AND 50).

CLASS 34—SMOKERS' ARTICLES

FOR SMOKER'S ARTICLES, NAMELY, SMOKING PIPES, CIGAR AND CIGARETTE LIGHTERS, CIGAR CUTTERS, CIGAR AND CIGARETTE CASES, HUMIDORS, CIGAR AND CIGARETTE HOLDERS AND MATCHES (U.S. CLS. 2, 8, 9 AND 17).

CLASS 41—EDUCATION AND ENTERTAINMENT

FOR PROVIDING GOLF FACILITIES; CONDUCTING AND ORGANIZING GOLF TOURNAMENTS; GOLF CLUB SERVICES; PROVIDING NEWS AND INFORMATION ON THE SPORT OF GOLF; PROVIDING A WEB SITE WITH INFORMATION ON GOLF COURSES, GOLF LESSONS AND GOLF TOURNAMENTS; RENTAL OF GOLF EQUIPMENT; PROVIDING GOLF INSTRUCTION; HEALTH CLUB SERVICES, NAMELY, PROVIDING INSTRUCTION AND CONSULTATION IN THE FIELD OF PHYSICAL EXERCISE; PROVIDING USE OF EXERCISE EQUIPMENT; PROVIDING FITNESS AND EXERCISE FACILITIES (U.S. CLS. 100, 101 AND 107).

CLASS 43—HOTEL AND RESTAURANT SERVICES

FOR RESTAURANT SERVICES, BAR AND COCKTAIL LOUNGE SERVICES; PROVISION OF GENERAL PURPOSES FACILITIES FOR MEETINGS, CONFERENCES AND EXHIBITIONS; PROVISION OF BANQUET AND SOCIAL FUNCTION FACILITIES FOR SPECIAL OCCASIONS (U.S. CLS. 100 AND 101).

CLASS 44—MEDICAL, BEAUTY AND AGRICULTURAL SERVICES

FOR SALON AND DAY SPA SERVICES, NAMELY, COSMETIC SKIN, FACIAL, HAIR AND BODY CARE SERVICES, NAIL CARE, MANICURES, PEDICURES, FACIALS, BODY WAXING SERVICES, MASSAGES, BEAUTY SALON SERVICES; HEALTH SPA SERVICES FOR HEALTH AND WELLNESS OF THE BODY AND SPIRIT OFFERED AT A RESORT (U.S. CLS. 100 AND 101).

CHRIS WELLS, EXAMINING ATTORNEY

SN 77-556,678. KATHLEEN A. MCCREARY, DBA IRISH TAILS, TAMPA, FL. FILED 8-27-2008.

IRISH TAILS

THE MARK CONSISTS OF STANDARD CHARACTERS WITHOUT CLAIM TO ANY PARTICULAR FONT, STYLE, SIZE, OR COLOR.

CLASS 18—LEATHER GOODS

FOR PURSES, COIN PURSES, TOTE BAGS, MAKE-UP CASES, SOLD EMPTY (U.S. CLS. 1, 2, 3, 22 AND 41). FIRST USE 10-0-1997; IN COMMERCE 10-0-1997.

CLASS 25—CLOTHING

FOR SWEATERS, JACKETS, VESTS, COATS, SHAWLS, CAPES, BELTS, HATS, SCARVES, AND BABY WEAR, NAMELY, BABY BOOTIES AND BABY CAPS (U.S. CLS. 22 AND 39). FIRST USE 10-0-1997; IN COMMERCE 10-0-1997. BONNIE LUKEN, EXAMINING ATTORNEY

SN 77-557,789. SALTER, MAURICE M., LOS ANGELES, CA. FILED 8-28-2008.

ENROLLMENT MAXIMIZER

THE MARK CONSISTS OF STANDARD CHARACTERS WITHOUT CLAIM TO ANY PARTICULAR FONT, STYLE, SIZE, OR COLOR.

NO CLAIM IS MADE TO THE EXCLUSIVE RIGHT TO USE "ENROLLMENT", APART FROM THE MARK AS SHOWN.

CLASS 35—ADVERTISING AND BUSINESS

FOR DEVELOPMENT AND MANAGEMENT OF EDUCATIONAL FINANCE REPAYMENT PROGRAMS FOR EDUCATIONAL INSTITUTIONS AND EMPLOYERS (U.S. CLS. 100, 101 AND 102).

FIRST USE 6-1-2008; IN COMMERCE 6-15-2008.

CLASS 36—INSURANCE AND FINANCIAL

FOR PROCESSING OF EDUCATIONAL FINANCE REPAYMENTS AND EDUCATIONAL FINANCE REPAYMENT PROGRAMS FOR EDUCATIONAL INSTITUTIONS AND EMPLOYERS (U.S. CLS. 100, 101 AND 102).

FIRST USE 6-1-2008; IN COMMERCE 6-15-2008.
JEFF DEFORD, EXAMINING ATTORNEY

SN 77-558,560. INTUIT INC., MOUNTAIN VIEW, CA. FILED 8-29-2008.

FREE YOUR BUSINESS

THE MARK CONSISTS OF STANDARD CHARACTERS WITHOUT CLAIM TO ANY PARTICULAR FONT, STYLE, SIZE, OR COLOR.

CLASS 9—ELECTRICAL AND SCIENTIFIC APPARATUS

FOR COMPUTER SOFTWARE FOR USE IN ACCOUNTING, INVOICING, PAYMENT PROCESSING, PAYROLL MANAGEMENT, AND PAYROLL PROCESSING; COMPUTER SOFTWARE FOR USE IN BUSINESS MANAGEMENT, CUSTOMER RELATIONSHIP MANAGEMENT, ENTERPRISE RESOURCE PLANNING, AND HUMAN RESOURCES MANAGEMENT; COMPUTER SOFTWARE FOR USE IN FINANCIAL MANAGEMENT; COMPUTER SOFTWARE FOR USE IN INVENTORY MANAGEMENT, PARTS AND MATERIALS MANAGEMENT, ORDER TRACKING AND FULFILLMENT; COMPUTER SOFTWARE FOR USE IN JOB COSTING, ESTIMATING, TRACKING AND REPORTING; COMPUTER SOFTWARE FOR USE IN RETAIL STORE MANAGEMENT; COMPUTER SOFTWARE FOR POINT-OF-SALE AND MERCHANT ACCOUNT APPLICATIONS (U.S. CLS. 21, 23, 26, 36 AND 38).

CLASS 42—SCIENTIFIC AND COMPUTER SERVICES

FOR PROVIDING ONLINE, NON-DOWNLOADABLE COMPUTER SOFTWARE FOR USE IN ACCOUNTING, INVOICING, PAYMENT PROCESSING, PAYROLL MANAGEMENT, AND PAYROLL PROCESSING; PROVIDING ONLINE, NON-DOWNLOADABLE COMPUTER SOFTWARE FOR USE IN BUSINESS MANAGEMENT, CUSTOMER RELATIONSHIP MANAGEMENT, ENTERPRISE RESOURCE PLANNING, AND HUMAN RESOURCES MANAGEMENT; PROVIDING ONLINE, NON-DOWNLOADABLE COMPUTER SOFTWARE FOR USE IN FINANCIAL MANAGEMENT; PROVIDING ONLINE, NON-DOWNLOADABLE COMPUTER SOFTWARE FOR USE IN INVENTORY MANAGEMENT, PARTS AND MATERIALS MANAGEMENT, ORDER TRACKING AND FULFILLMENT; PROVIDING ONLINE, NON-DOWNLOADABLE COMPUTER SOFTWARE FOR USE IN JOB COSTING, ESTIMATING; PROVIDING ONLINE, NON-DOWNLOADABLE COMPUTER SOFTWARE FOR USE IN RETAIL STORE MANAGEMENT; PROVIDING ONLINE, NON-DOWNLOADABLE COMPUTER SOFTWARE FOR POINT-OF-SALE AND MERCHANT ACCOUNT APPLICATIONS; PROVIDING ONLINE NON-DOWNLOADABLE COMPUTER SOFTWARE DEVELOPMENT TOOLS AND TEMPLATES FOR DATA AND DATABASE MANAGEMENT; PROVIDING ONLINE NON-DOWNLOADABLE COMPUTER SOFTWARE FOR ORGANIZING AND SHARING DATA WITH OTHERS; PROVIDING ONLINE NON-DOWNLOADABLE COMPUTER SOFTWARE FOR MULTIPLE-USER COLLABORATION ON THE COMPILATION AND ANALYSIS OF DATA; PROVIDING ONLINE NON-DOWNLOADABLE COMPUTER SOFTWARE FOR THE PROVISION OF ONLINE STORE SERVICES; APPLICATION SERVICE PROVIDER (ASP), NAMELY, HOSTING COMPUTER SOFTWARE APPLICATIONS FOR OTHERS; PROVIDING TECHNICAL SUPPORT, NAMELY, TROUBLESHOOTING OF COMPUTER SOFTWARE AND OF ONLINE, NON-DOWNLOADABLE COMPUTER SOFTWARE PROBLEMS; INTEGRATION, CUSTOMIZATION, AND MAINTENANCE OF COMPUTER SOFTWARE FOR OTHERS; DATA HOSTING SERVICES; HOSTING OF WEB SITES FOR OTHERS; TECHNICAL SUPPORT SERVICES, NAMELY, TROUBLESHOOTING OF COMPUTER HARDWARE AND SOFTWARE PROBLEMS, MONITORING OF NETWORK SYSTEMS, PROVIDING BACK-UP COMPUTER PROGRAMS AND FACILITIES; PROVIDING TEMPORARY USE OF ONLINE NON-DOWNLOADABLE COMPUTER SOFTWARE IN THE NATURE OF WEB PAGE DESIGN TEMPLATES, SCRIPTS, FORMS, AND OTHER DESIGN AND DEVELOPMENT TOOLS FOR BUSINESS WEB SITES AND ONLINE STORES (U.S. CLS. 100 AND 101).

PRISCILLA MILTON, EXAMINING ATTORNEY

SN 77-559,136. AGATI, INC., CHICAGO, IL. FILED 8-29-2008.

AGATI

THE MARK CONSISTS OF STANDARD CHARACTERS WITHOUT CLAIM TO ANY PARTICULAR FONT, STYLE, SIZE, OR COLOR.
SEC. 2(F).

CLASS 40—MATERIAL TREATMENT

FOR MANUFACTURE OF FURNITURE FOR OTHERS (U.S. CLS. 100, 103 AND 106).

FIRST USE 12-31-1987; IN COMMERCE 12-31-1987.

CLASS 42—SCIENTIFIC AND COMPUTER SERVICES

FOR DESIGN OF FURNITURE FOR OTHERS (U.S. CLS. 100 AND 101).
FIRST USE 12-31-1987; IN COMMERCE 12-31-1987.
JERI J. FICKES, EXAMINING ATTORNEY

SN 77-559,399. SAN JOSE AWNING COMPANY, INC., SAN JOSE, CA. FILED 8-29-2008.

CLASS 42—SCIENTIFIC AND COMPUTER SERVICES

FOR COMPUTER SOFTWARE CONSULTANCY; COMPUTER SOFTWARE INSTALLATION AND MAINTENANCE; DESIGN OF COMPUTER NETWORKS AND SOFTWARE FOR OTHERS FOR THE 3D GRAPHICS DESIGN INDUSTRY; DEVELOPING COMPUTER SOFTWARE; PERIODIC UPGRADING OF COMPUTER SOFTWARE FOR OTHERS; SOFTWARE DESIGN AND DEVELOPMENT (U.S. CLS. 100 AND 101).
FIRST USE 4-15-2008; IN COMMERCE 4-15-2008.
KELLEY WELLS, EXAMINING ATTORNEY

SN 77-561,132. HARMONY OUTDOOR LIVING, INC., BURLINGTON, WI. FILED 9-3-2008.

CHOOSE PROFESSIONALISM

THE MARK CONSISTS OF STANDARD CHARACTERS WITHOUT CLAIM TO ANY PARTICULAR FONT, STYLE, SIZE, OR COLOR.

CLASS 37—CONSTRUCTION AND REPAIR

FOR CONTRACTOR SERVICES, NAMELY, INSTALLATION OF AWNINGS, SCREENS AND SHADES (U.S. CLS. 100, 103 AND 106).
FIRST USE 8-27-2008; IN COMMERCE 8-27-2008.

CLASS 42—SCIENTIFIC AND COMPUTER SERVICES

FOR DESIGN SERVICES, NAMELY, DESIGN OF AWNINGS, SCREENS AND SHADES (U.S. CLS. 100 AND 101).
FIRST USE 8-27-2008; IN COMMERCE 8-27-2008.
NAPOLEON SHARMA, EXAMINING ATTORNEY

SN 77-560,103. BRAINSTORM MULTIMEDIA, S.L., MADRID, SPAIN, FILED 9-2-2008.

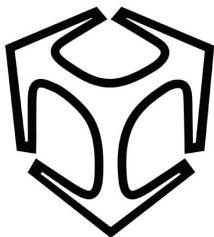

THE MARK CONSISTS OF 3 ARROWS UNITED BY THE CENTER.

CLASS 9—ELECTRICAL AND SCIENTIFIC APPARATUS

FOR COMPUTER GRAPHICS SOFTWARE (U.S. CLS. 21, 23, 26, 36 AND 38).
FIRST USE 4-15-2008; IN COMMERCE 4-15-2008.

CREATION BEGINS WITH THE ELEMENTS

THE MARK CONSISTS OF STANDARD CHARACTERS WITHOUT CLAIM TO ANY PARTICULAR FONT, STYLE, SIZE, OR COLOR.

CLASS 11—ENVIRONMENTAL CONTROL APPARATUS

FOR FIREPLACES, OVENS, BRICK OVENS, FIRE PITS AND FIRE PIT TABLES, ALL FOR OUTDOOR USE (U.S. CLS. 13, 21, 23, 31 AND 34).
FIRST USE 7-12-2008; IN COMMERCE 7-12-2008.

CLASS 20—FURNITURE AND ARTICLES NOT OTHERWISE CLASSIFIED

FOR LARGE KITCHEN-TYPE CABINETS IN THE NATURE OF CABINET ISLANDS DESIGNED FOR OUTDOOR USE (U.S. CLS. 2, 13, 22, 25, 32 AND 50).
FIRST USE 7-12-2008; IN COMMERCE 7-12-2008.
JOHN DALIER, EXAMINING ATTORNEY

SN 77-561,159. HARMONY OUTDOOR LIVING, INC., BURLINGTON, WI. FILED 9-3-2008.



THE MARK CONSISTS OF THREE VERTICALLY DISPOSED RECTANGULAR BLOCKS, THE CENTER BLOCK BEING SLIGHTLY TALLER THAN THE TWO BLOCKS THAT FLANK IT, ONE TO THE LEFT AND ONE TO THE RIGHT, THE BLOCKS HAVING RAGGED EDGES, THE LEFT BLOCK HAVING A SUPERIMPOSED REPRESENTATION OF A SUN, THE CENTER BLOCK HAVING A SUPERIMPOSED REPRESENTATION OF FLAMES, AND THE RIGHT BLOCK HAVING A SUPERIMPOSED REPRESENTATION OF A CRESCENT MOON, ALL OF THE BLOCKS BEING DISPOSED ABOVE THE WORD "HARMONY" IN STANDARD CHARACTERS.

CLASS 11—ENVIRONMENTAL CONTROL APPARATUS

FOR FIREPLACES, OVENS, BRICK OVENS, FIRE PITTS AND FIRE PIT TABLES, ALL FOR OUTDOOR USE (U.S. CLS. 13, 21, 23, 31 AND 34).

FIRST USE 7-12-2008; IN COMMERCE 7-12-2008.

CLASS 20—FURNITURE AND ARTICLES NOT OTHERWISE CLASSIFIED

FOR LARGE KITCHEN-TYPE CABINETS IN THE NATURE OF CABINET ISLANDS DESIGNED FOR OUTDOOR USE IN INTERNATIONAL (U.S. CLS. 2, 13, 22, 25, 32 AND 50).

FIRST USE 7-12-2008; IN COMMERCE 7-12-2008.
JOHN DALIER, EXAMINING ATTORNEY

SN 77-561,595. CUMMINS-ALLISON CORP., MOUNT PROSPECT, IL. FILED 9-3-2008.

SN 77-561,592. CUMMINS-ALLISON CORP., MOUNT PROSPECT, IL. FILED 9-3-2008.



COINMAX

THE MARK CONSISTS OF STANDARD CHARACTERS WITHOUT CLAIM TO ANY PARTICULAR FONT, STYLE, SIZE, OR COLOR.

THE MARK CONSISTS OF A PENNY HAVING A FACE AND TWO HANDS; THE PENNY'S LEFT HAND CONTAINS CURRENCY; THE PENNY'S RIGHT HAND CONTAINS A JAR OF COINS.

CLASS 16—PAPER GOODS AND PRINTED MATTER

FOR PRINTED VISUALS IN THE NATURE OF PROMOTIONAL MATERIALS AND INFORMATION GRAPHICS IN THE FORM OF WINDOW CLING STICKERS, POSTERS, PAPER BANNERS, PRINTED PAPER SIGNS, PAPER LABELS, DECALS, STICKERS, AND ADVERTISING MATERIALS AS GOODS IN TRADE, NAMELY, PRINTED ADVERTISING HANDOUTS IN THE FIELD OF COIN PROCESSING (U.S. CLS. 2, 5, 22, 23, 29, 37, 38 AND 50).

FIRST USE 12-11-2006; IN COMMERCE 12-11-2006.

CLASS 16—PAPER GOODS AND PRINTED MATTER

FOR PRINTED VISUALS IN THE NATURE OF PROMOTIONAL MATERIALS AND INFORMATION GRAPHICS IN THE FORM OF WINDOW CLING STICKERS, POSTERS, PAPER BANNERS, PRINTED PAPER SIGNS, PAPER LABELS, DECALS, STICKERS, AND ADVERTISING MATERIALS AS GOODS IN TRADE, NAMELY, PRINTED ADVERTISING HANDOUTS IN THE FIELD OF COIN PROCESSING (U.S. CLS. 2, 5, 22, 23, 29, 37, 38 AND 50).

FIRST USE 4-14-2009; IN COMMERCE 4-14-2009.

CLASS 19—NON-METALLIC BUILDING MATERIALS

FOR NON-LUMINOUS, NON-MECHANICAL PRINTED PLASTIC SIGNS FOR PROMOTIONAL USE, NAMELY, OUTDOOR SIGNS, INDOOR SIGNS, POINT OF PURCHASE SIGNS, FLOOR SIGNS, DOOR SIGNS, EASEL SIGNS IN THE FIELD OF COIN PROCESSING (U.S. CLS. 1, 12, 33 AND 50).

FIRST USE 12-11-2006; IN COMMERCE 12-11-2006.

CLASS 19—NON-METALLIC BUILDING MATERIALS

FOR NON-LUMINOUS, NON-MECHANICAL PRINTED PLASTIC SIGNS FOR PROMOTIONAL USE, NAMELY, OUTDOOR SIGNS, INDOOR SIGNS, POINT OF PURCHASE SIGNS, FLOOR SIGNS, DOOR SIGNS, EASEL SIGNS IN THE FIELD OF COIN PROCESSING (U.S. CLS. 1, 12, 33 AND 50).

FIRST USE 4-14-2009; IN COMMERCE 4-14-2009.

CLASS 20—FURNITURE AND ARTICLES NOT OTHERWISE CLASSIFIED

FOR PROMOTIONAL MATERIALS, NAMELY, PRINTED PLASTIC BANNERS AND PLASTIC LABELS IN THE FIELD OF COIN PROCESSING (U.S. CLS. 2, 13, 22, 25, 32 AND 50).

FIRST USE 12-11-2006; IN COMMERCE 12-11-2006.
STEVEN PEREZ, EXAMINING ATTORNEY

CLASS 20—FURNITURE AND ARTICLES NOT OTHERWISE CLASSIFIED

FOR PROMOTIONAL MATERIALS, NAMELY, PRINTED PLASTIC BANNERS AND PLASTIC LABELS IN THE FIELD OF COIN PROCESSING (U.S. CLS. 2, 13, 22, 25, 32 AND 50).

FIRST USE 4-14-2009; IN COMMERCE 4-14-2009.
STEVEN PEREZ, EXAMINING ATTORNEY

SN 77-561,773. HIBIX CORPORATION, PLEASANTON, CA.
FILED 9-3-2008.

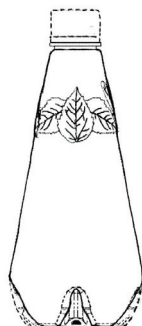

THE MARK CONSISTS OF THE CONFIGURATION OF A BEVERAGE BOTTLE, CONICAL IN SHAPE WITH A PATTERN OF LEAVES SURROUNDING THE UPPER NECK OF THE BOTTLE AND A TAPERED BASE REVEALING FIVE TRIANGULAR INDENTATIONS. THE BROKEN LINES ARE NOT A PART OF THE MARK AND SERVE ONLY TO SHOW THE PLACEMENT OF THE MARK.

CLASS 5—PHARMACEUTICALS

FOR NUTRACEUTICALS, NAMELY, NUTRACEUTICAL BEVERAGES FOR USE AS A DIETARY SUPPLEMENT; NUTRITIONALLY FORTIFIED BEVERAGES (U.S. CLS. 6, 18, 44, 46, 51 AND 52).

CLASS 32—LIGHT BEVERAGES

FOR NON-ALCOHOLIC FRUIT EXTRACTS USED IN THE PREPARATION OF BEVERAGES; PREPARATIONS FOR MAKING FRUIT DRINKS; FRUIT FLAVORED BEVERAGES; NON-ALCOHOLIC BEVERAGES CONTAINING FRUIT JUICES; NON-ALCOHOLIC BEVERAGES, NAMELY, CARBONATED BEVERAGES; NON-ALCOHOLIC HIBISCUS EXTRACTS FOR USE AS AN INGREDIENT IN BEVERAGES (U.S. CLS. 45, 46 AND 48).

COLLEEN KEARNEY, EXAMINING ATTORNEY

SN 77-563,035. INTRALOT SA, ATHENS, GREECE, FILED 9-5-2008.

LOTOS HORIZON

THE MARK CONSISTS OF STANDARD CHARACTERS WITHOUT CLAIM TO ANY PARTICULAR FONT, STYLE, SIZE, OR COLOR.

CLASS 9—ELECTRICAL AND SCIENTIFIC APPARATUS

FOR SOFTWARE FOR THE OPERATIONAL MANAGEMENT OF GAMES, NAMELY, LOTTERY GAMES, COMPUTER GAMES, VIDEO GAMES, INSTANT GAMES, SPORTS BETTING GAMES AND ENTERTAINMENT GAMES (U.S. CLS. 21, 23, 26, 36 AND 38).

CLASS 35—ADVERTISING AND BUSINESS

FOR TELECOMMUNICATION NETWORK MANAGEMENT SERVICES FOR OTHERS, NAMELY, THE OPERATION AND ADMINISTRATION OF TELECOMMUNICATION SYSTEMS AND NETWORKS FOR THE PURPOSE OF PROVIDING LOTTERY, PARIMUTUEL AND BETTING SERVICES (U.S. CLS. 100, 101 AND 102).

CLASS 36—INSURANCE AND FINANCIAL

FOR PROVIDING SECURE FINANCIAL TRANSACTION PROCESSING SERVICES FOR LOTTERY VENDORS, NAMELY, CHECK PROCESSING, CREDIT CARD PAYMENT PROCESSING, DEBIT CARD TRANSACTION PROCESSING SERVICES, CASH PAYMENT PROCESSING (U.S. CLS. 100, 101 AND 102).

CLASS 41—EDUCATION AND ENTERTAINMENT

FOR OPERATION OF LOTTERIES, INSTANT LOTTERIES, NUMERICAL LOTTERIES; BETTING SERVICES; ADMINISTRATION OF LOTTERIES AND GAMES OF CHANCE FOR OTHERS; EDUCATION SERVICES, NAMELY, PROVIDING COURSES AND SEMINARS IN THE FIELD OF LOTTERY OPERATION, PROVIDING OF TRAINING, NAMELY, COURSES AND SEMINARS IN THE FIELD OF LOTTERY SYSTEMS OPERATION, ENTERTAINMENT, NAMELY, PROVIDING CASINO SERVICES, PRODUCTION OF TELEVISION SHOWS; PROVIDING SPORTING AND CULTURAL ACTIVITIES, NAMELY, ORGANIZING COMMUNITY SPORTING AND CULTURAL EVENTS (U.S. CLS. 100, 101 AND 107).

HEATHER BIDDULPH, EXAMINING ATTORNEY

SN 77-563,473. DAIMLER AG, 70327 STUTTGART, FED REP GERMANY, FILED 9-5-2008.

CAR2GO

THE MARK CONSISTS OF STANDARD CHARACTERS WITHOUT CLAIM TO ANY PARTICULAR FONT, STYLE, SIZE, OR COLOR.

CLASS 12—VEHICLES

FOR LAND VEHICLES, IN PARTICULAR USED MOTOR VEHICLES AND COMMERCIAL VEHICLES (U.S. CLS. 19, 21, 23, 31, 35 AND 44).

CLASS 25—CLOTHING

FOR ARTICLES OF APPAREL, NAMELY, T-SHIRTS, SWEATSHIRTS, TIES, GLOVES, ANORAKS, PONCHOS, JACKETS, VESTS, SWEATERS, SPORT SHIRTS, SCARVES, BELTS, FOOTWEAR, HEADWEAR, NAMELY, HATS, CAPS, AVIATOR-STYLE CAPS (U.S. CLS. 22 AND 39).

CLASS 28—TOYS AND SPORTING GOODS

FOR TOYS, IN PARTICULAR TOY MODEL VEHICLES (U.S. CLS. 22, 23, 38 AND 50).

CLASS 35—ADVERTISING AND BUSINESS

FOR ADVERTISING, IN PARTICULAR ADVERTISING FOR OTHERS IN AND ON MOTOR VEHICLES (U.S. CLS. 100, 101 AND 102).

CLASS 36—INSURANCE AND FINANCIAL

FOR ACCIDENT INSURANCE UNDERWRITING; LEASE PURCHASE FINANCING OF VEHICLES, IN PARTICULAR MOTOR VEHICLES AND COMMERCIAL VEHICLES (U.S. CLS. 100, 101 AND 102).

CLASS 38—COMMUNICATION

FOR TELECOMMUNICATION SERVICES, NAMELY, RENTAL OF CAR PHONES (U.S. CLS. 100, 101 AND 104).

CLASS 39—TRANSPORTATION AND STORAGE

FOR RENTAL OF VEHICLES, IN PARTICULAR MOTOR VEHICLES AND COMMERCIAL VEHICLES, RENTAL OF VEHICLE ACCESSORIES, IN PARTICULAR LUGGAGE RACKS, CHILD SEATS, TRAILERS, SNOW-CHAINS; VEHICLES TOWING SERVICES, IN PARTICULAR IN THE FIELD OF RECOVERY SERVICES; ORGANIZATION, PROVISION, RESERVATION AND BOOKING OF TRAVEL, EXCURSIONS, VEHICLE RENTAL AND CITY VISITS; TRANSPORTATION OF PEOPLE AND GOODS BY MOTOR VEHICLES TRAVEL AGENCY SERVICES, NAMELY, MAKING RESERVATIONS AND BOOKING FOR TRANSPORTATION; TOUR GUIDE SERVICES, CHAUFFEUR SERVICES, COURIER SERVICES, RENTAL OF GARAGES (U.S. CLS. 100 AND 105).

CLASS 41—EDUCATION AND ENTERTAINMENT

FOR EDUCATION SERVICES, NAMELY, VEHICLE DRIVER SAFETY TRAINING, AND TRAINING IN THE USE OF DRIVING OF VEHICLES (U.S. CLS. 100, 101 AND 107).

ALLISON SCHRODY, EXAMINING ATTORNEY

SN 77-565,259. VISUAL ODYSSEY, INC., TEMPLE, GA. FILED 9-9-2008.

Visual Odyssey

THE MARK CONSISTS OF STANDARD CHARACTERS WITHOUT CLAIM TO ANY PARTICULAR FONT, STYLE, SIZE, OR COLOR.

CLASS 9—ELECTRICAL AND SCIENTIFIC APPARATUS

FOR COMPUTER SOFTWARE FOR EDUCATION REGARDING HUMAN ANATOMY (U.S. CLS. 21, 23, 26, 36 AND 38).

FIRST USE 1-11-2001; IN COMMERCE 1-11-2001.

CLASS 16—PAPER GOODS AND PRINTED MATTER

FOR PRINTED EDUCATIONAL AND ANATOMICAL CHARTS (U.S. CLS. 2, 5, 22, 23, 29, 37, 38 AND 50).

FIRST USE 12-1-1983; IN COMMERCE 12-1-1983.
MARK T. MULLEN, EXAMINING ATTORNEY

SN 77-566,082. JAGEX LIMITED, CAMBRIDGE, UNITED KINGDOM, FILED 9-9-2008.



PRIORITY CLAIMED UNDER SEC. 44(D) ON UNITED KINGDOM APPLICATION NO. 2491753, FILED 7-3-2008, REG. NO. 2491753, DATED 7-3-2008, EXPIRES 7-3-2018.

OWNER OF U.S. REG. NOS. 2,829,952 AND 3,373,023.

THE MARK CONSISTS OF THE STYLIZED WORD "RUNESCAPE" WITH A VERTICAL SWORD BETWEEN THE "E" AND "S" AND EACH OF THE LETTERS APPEARING ON TOP OF A JAGGED SHAPE.

CLASS 9—ELECTRICAL AND SCIENTIFIC APPARATUS

FOR DOWNLOADABLE TELEPHONE RING TONES; DOWNLOADABLE SCREEN-SAVERS; DOWNLOADABLE WALLPAPERS (U.S. CLS. 21, 23, 26, 36 AND 38).

CLASS 16—PAPER GOODS AND PRINTED MATTER

FOR BOOKS IN THE FIELD OF ONLINE COMPUTER GAMES; PLAYER'S GUIDES IN THE FIELD OF ONLINE COMPUTER GAMES; INSTRUCTIONAL AND TEACHING MATERIALS EXCEPT APPARATUS IN THE FIELD OF ONLINE COMPUTER GAMES; PRINTED PUBLICATIONS, NAMELY, MAGAZINES IN THE FIELD OF ONLINE COMPUTER GAMES; LEAFLETS IN THE FIELD OF ONLINE COMPUTER GAMES; BROCHURES IN THE FIELD OF ONLINE COMPUTER GAMES; POSTERS (U.S. CLS. 2, 5, 22, 23, 29, 37, 38 AND 50).

CLASS 25—CLOTHING

FOR ARTICLES OF CLOTHING, NAMELY, T-SHIRTS, HATS AND CAPS (U.S. CLS. 22 AND 39).

CLASS 28—TOYS AND SPORTING GOODS

FOR TOYS, NAMELY STUFFED TOY ANIMALS, PLASTIC CHARACTER TOYS, MODELED PLASTIC TOY FIGURINES, ACTION FIGURES AND ACCESSORIES THEREFOR; BOARD GAMES; PLAYING CARDS (U.S. CLS. 22, 23, 38 AND 50).

CLASS 41—EDUCATION AND ENTERTAINMENT

FOR ENTERTAINMENT SERVICES, NAMELY, PROVIDING ONLINE COMPUTER GAMES; ELECTRONIC GAMES SERVICES, NAMELY PROVIDING ONLINE COMPUTER GAMES; PROVISION OF GAMES BY MEANS OF LOCAL COMPUTER NETWORKS, GLOBAL COMPUTER NETWORKS, THE INTERNET, CABLE OR WIRE COMMUNICATIONS SERVICES, WIRELESS TELECOMMUNICATIONS SERVICES AND BROADBAND TELECOMMUNICATIONS SERVICES (U.S. CLS. 100, 101 AND 107).

Laurie Kaufman, Examining Attorney

SN 77-566,638. X-DIGITAL SYSTEMS, INC., SAN DIEGO, CA.
FILED 9-10-2008.

CLICKONRADIO

THE MARK CONSISTS OF STANDARD CHARACTERS WITHOUT CLAIM TO ANY PARTICULAR FONT, STYLE, SIZE, OR COLOR.

OWNER OF U.S. REG. NO. 2,762,036.

CLASS 9—ELECTRICAL AND SCIENTIFIC APPARATUS

FOR COMPUTER SOFTWARE FOR THE DOWNLOADING, STORAGE, SELECTION, RETRIEVAL, CUSTOMIZATION AND PLAYBACK, AND THE VISUAL DISPLAY OF PROGRAMMING CHOICES OF MUSIC, RADIO PROGRAMS, ADVERTISEMENTS AND INFORMATION RELATED THERETO VIA GLOBAL COMPUTER NETWORKS (U.S. CLS. 21, 23, 26, 36 AND 38).

FIRST USE 9-15-2008; IN COMMERCE 9-15-2008.

CLASS 35—ADVERTISING AND BUSINESS

FOR DISSEMINATION OF ADVERTISING FOR OTHERS VIA A GLOBAL COMPUTER NETWORK OR TELECOMMUNICATIONS NETWORKS (U.S. CLS. 100, 101 AND 102).

FIRST USE 9-15-2008; IN COMMERCE 9-15-2008.

CLASS 38—COMMUNICATION

FOR BROADCASTING OF INFORMATION RELATED TO MUSIC, RADIO PROGRAMS AND ADVERTISEMENTS VIA GLOBAL COMPUTER NETWORKS; TRANSMISSION AND DELIVERY OF MUSIC, RADIO PROGRAMS, ADVERTISEMENTS, AND INFORMATION RELATED THERETO VIA GLOBAL COMPUTER NETWORKS; TRANSMISSION AND DELIVERY OF USER GENERATED PERSONAL MESSAGES TO OTHER USERS VIA GLOBAL COMPUTER NETWORKS (U.S. CLS. 100, 101 AND 104).

FIRST USE 9-15-2008; IN COMMERCE 9-15-2008.

CLASS 41—EDUCATION AND ENTERTAINMENT

FOR DISTRIBUTION OF RADIO PROGRAMS FOR OTHERS; PROVISION OF INFORMATION RELATING TO DISTRIBUTION OF RADIO PROGRAMS; PROVIDING INFORMATION IN THE FIELD OF MUSIC VIA GLOBAL COMPUTER NETWORKS (U.S. CLS. 100, 101 AND 107).

FIRST USE 9-15-2008; IN COMMERCE 9-15-2008.

KIM SAITO, EXAMINING ATTORNEY

SN 77-568,340. QC INC, LINCOLN, NE. FILED 9-11-2008.

Quick Connect

THE MARK CONSISTS OF STANDARD CHARACTERS WITHOUT CLAIM TO ANY PARTICULAR FONT, STYLE, SIZE, OR COLOR.

CLASS 35—ADVERTISING AND BUSINESS

FOR RETAIL STORE SERVICES FEATURING COMPUTERS, COMPUTER HARDWARE AND COMPUTER SOFTWARE (U.S. CLS. 100, 101 AND 102).

FIRST USE 1-31-1996; IN COMMERCE 1-31-1996.

CLASS 37—CONSTRUCTION AND REPAIR

FOR COMPUTER INSTALLATION AND REPAIR; INSTALLATION AND REPAIR OF COMPUTER HARDWARE; INSTALLATION OF COMPUTER NETWORKS; INSTALLATION OF COMPUTER SYSTEMS; INSTALLATION, MAINTENANCE AND REPAIR OF COMPUTER HARDWARE; MAINTENANCE AND REPAIR OF COMPUTER HARDWARE; MAINTENANCE AND REPAIR OF COMPUTER NETWORKS; REPAIR OF COMPUTER HARDWARE; REPAIR OF DAMAGED COMPUTERS (U.S. CLS. 100, 103 AND 106).

FIRST USE 1-31-1996; IN COMMERCE 1-31-1996.

CLASS 41—EDUCATION AND ENTERTAINMENT

FOR COMPUTER EDUCATION TRAINING; COMPUTER EDUCATION TRAINING SERVICES; EDUCATION SERVICES, NAMELY, PROVIDING TUTORING IN THE FIELDS OF COMPUTERS, COMPUTER HARDWARE, WEB SITE CREATION AND DESIGN, AND COMPUTER SOFTWARE; TRAINING IN THE USE AND OPERATION OF COMPUTERS, COMPUTER HARDWARE, AND COMPUTER SOFTWARE; TRAINING SERVICES IN THE FIELD OF WEB SITE CREATION AND DESIGN (U.S. CLS. 100, 101 AND 107).

FIRST USE 1-31-1996; IN COMMERCE 1-31-1996.

CLASS 42—SCIENTIFIC AND COMPUTER SERVICES

FOR COMPUTER CONSULTATION; COMPUTER NETWORK DESIGN FOR OTHERS; COMPUTER SERVICES, NAMELY, MONITORING AND REPORTING ON THE PERFORMANCE, AVAILABILITY, AND ERRORS OF WEB SITES OF OTHERS; COMPUTER SERVICES, NAMELY, CREATING AND MAINTAINING WEB SITES FOR OTHERS; COMPUTER SERVICES, NAMELY, DESIGNING AND IMPLEMENTING NETWORK WEB PAGES FOR OTHERS; COMPUTER SERVICES, NAMELY, DESIGNING AND IMPLEMENTING WEB SITES FOR OTHERS; COMPUTER SERVICES, NAMELY, HOSTING OF INSPECTION, TESTING, AND QUALITY CONTROL SERVICES' DIGITAL CONTENT OF OTHERS; COMPUTER SERVICES, NAMELY, MANAGING WEB SITES FOR OTHERS; COMPUTER SERVICES, NAMELY, MONITORING THE WEB SITES OF OTHERS TO IMPROVE SCALABILITY AND PERFORMANCE OF WEB SITES OF OTHERS; COMPUTER SERVICES, NAMELY, MONITORING, TESTING, ANALYZING, AND REPORTING ON THE INTERNET TRAFFIC CONTROL AND CONTENT CONTROL OF THE WEB SITES OF OTHERS; COMPUTER TECHNOLOGY SUPPORT SERVICES, NAMELY, HELP DESK SERVICES; CONSULTATION SERVICES IN THE FIELDS OF SELECTION, IMPLEMENTATION AND USE OF COMPUTER HARDWARE AND SOFTWARE SYSTEMS FOR OTHERS; CONSULTING SERVICES IN THE FIELD OF DESIGN, SELECTION, IMPLEMENTATION AND USE OF COMPUTER HARDWARE AND SOFTWARE SYSTEMS FOR OTHERS; CREATING OR MAINTAINING WEB SITES FOR OTHERS; CREATING, DESIGNING AND MAINTAINING WEB SITES; CREATION AND MAINTENANCE OF WEB SITES FOR OTHERS; DESIGN AND DEVELOPMENT OF NETWORKS; DESIGN AND DEVELOPMENT OF WIRELESS COMPUTER NETWORKS; DESIGN, CREATION, HOSTING, MAINTENANCE OF WEB SITES FOR OTHERS; HOSTING THE WEB SITES OF OTHERS ON A COMPUTER SERVER FOR A GLOBAL COMPUTER NETWORK; INSTALLATION, MAINTENANCE AND REPAIR OF COMPUTER SOFTWARE; INTEGRATION OF COMPUTER SYSTEMS AND NETWORKS; IT CONSULTING SERVICES; IT INTEGRATION SERVICES; MAINTENANCE OF COMPUTER SOFTWARE; PLANNING, DEVELOPMENT AND TECHNICAL SUPPORT OF ELECTRONIC COMMUNICATIONS NETWORKS; PROVIDING PLANNING AND ENGINEERING SERVICES IN THE FIELD OF INFOR-

MATION AND COMMUNICATIONS NETWORKS; REPAIR OF COMPUTER SOFTWARE; REPAIR OF DAMAGED COMPUTER PROGRAMS; TECHNICAL SUPPORT SERVICES, NAMELY, TROUBLESHOOTING OF COMPUTER HARDWARE AND SOFTWARE PROBLEMS; TECHNICAL SUPPORT SERVICES, NAMELY, TROUBLESHOOTING OF COMPUTER SOFTWARE PROBLEMS; TECHNICAL SUPPORT, NAMELY, MONITORING OF NETWORK SYSTEMS; WEB SITE DESIGN; WEB SITE DEVELOPMENT FOR OTHERS; WEB SITE HOSTING SERVICES (U.S. CLS. 100 AND 101).

FIRST USE 1-31-1996; IN COMMERCE 1-31-1996.
GINA FINK, EXAMINING ATTORNEY

SN 77-568,718. CRUTCHALL RESOURCE RECYCLING COMPANY LLC, DBA CRUTCHALL RESOURCE RECYCLING LLC, WYOMING, MI. FILED 9-12-2008.



THE COLOR(S) GREEN, WHITE AND YELLOW-GREEN IS/ARE CLAIMED AS A FEATURE OF THE MARK.

THE MARK CONSISTS OF A HOUSE WITH A GREEN ROOF AND A YELLOW-GREEN STRUCTURE; A WHITE LEAF WITH A GREEN STEM; A GREEN ROAD WITH WHITE LINES.

CLASS 19—NON-METALLIC BUILDING MATERIALS

FOR ASPHALT; ASPHALT COMPOSITION PAVING; ASPHALT PATCHING COMPOUND MADE OF A TAR BASE; GRAVEL; TAR-BASED CONCRETE AND ASPHALT PATCHING COMPOUND (U.S. CLS. 1, 12, 33 AND 50).

FIRST USE 7-1-2008; IN COMMERCE 7-1-2008.

CLASS 40—MATERIAL TREATMENT

FOR MATERIAL TREATMENT SERVICES IN CONNECTION WITH RECYCLING; RECYCLING; RECYCLING OF WASTE; RECYCLING OF WASTE AND TRASH (U.S. CLS. 100, 103 AND 106).

FIRST USE 7-1-2008; IN COMMERCE 7-1-2008.
JILL PRATER, EXAMINING ATTORNEY

SN 77-568,745. CRUTCHALL RESOURCE RECYCLING COMPANY LLC, DBA CRUTCHALL RESOURCE RECYCLING LLC, WYOMING, MI. FILED 9-12-2008.

roofs **2** roads

NO CLAIM IS MADE TO THE EXCLUSIVE RIGHT TO USE "ROOFS 2 ROADS", APART FROM THE MARK AS SHOWN.

THE COLOR(S) GREEN AND YELLOW-GREEN IS/ARE CLAIMED AS A FEATURE OF THE MARK.

THE MARK CONSISTS OF THE WORD "ROOFS" STYLIZED AND GREEN; THE NUMBER "2" STYLIZED AND YELLOW-GREEN; THE WORD "ROADS" STYLIZED AND GREEN.

CLASS 19—NON-METALLIC BUILDING MATERIALS

FOR ASPHALT; ASPHALT COMPOSITION PAVING; ASPHALT PATCHING COMPOUND MADE OF A TAR BASE; GRAVEL; TAR-BASED CONCRETE AND ASPHALT PATCHING COMPOUND (U.S. CLS. 1, 12, 33 AND 50).

FIRST USE 7-1-2008; IN COMMERCE 7-1-2008.

CLASS 40—MATERIAL TREATMENT

FOR MATERIAL TREATMENT SERVICES IN CONNECTION WITH RECYCLING; RECYCLING; RECYCLING OF WASTE; RECYCLING OF WASTE AND TRASH (U.S. CLS. 100, 103 AND 106).

FIRST USE 7-1-2008; IN COMMERCE 7-1-2008.

JILL PRATER, EXAMINING ATTORNEY

SN 77-572,963. AQUATIC HABITATS, INC., APOPKA, FL. FILED 9-18-2008.

AQUATIC HABITATS

THE MARK CONSISTS OF STANDARD CHARACTERS WITHOUT CLAIM TO ANY PARTICULAR FONT, STYLE, SIZE, OR COLOR.

SEC. 2(F).

CLASS 39—TRANSPORTATION AND STORAGE

FOR DISTRIBUTION SERVICES, NAMELY, DELIVERY OF AQUATIC LAB ANIMAL REARING AND HOLDING TANKS (U.S. CLS. 100 AND 105).

FIRST USE 7-31-1998; IN COMMERCE 7-31-1998.

CLASS 40—MATERIAL TREATMENT

FOR MANUFACTURING OF AQUATIC LAB ANIMAL REARING AND HOLDING TANKS FOR OTHERS (U.S. CLS. 100, 103 AND 106).

FIRST USE 7-31-1998; IN COMMERCE 7-31-1998.
TAMARA FRAZIER, EXAMINING ATTORNEY

SN 77-573,448. PELOTON SERVICES, INC., DBA BRIX26, SAN FRANCISCO, CA. FILED 9-18-2008.

BRIX26°

THE MARK CONSISTS OF STANDARD CHARACTERS WITHOUT CLAIM TO ANY PARTICULAR FONT, STYLE, SIZE, OR COLOR.

CLASS 35—ADVERTISING AND BUSINESS

FOR ON-LINE RETAIL STORE SERVICES FEATURING WINE (U.S. CLS. 100, 101 AND 102).
FIRST USE 2-0-2005; IN COMMERCE 2-0-2005.

CLASS 39—TRANSPORTATION AND STORAGE

FOR WINE CLUB SERVICES FEATURING PERIODIC SHIPMENTS OF WINE TO MEMBERS (U.S. CLS. 100 AND 105).
FIRST USE 2-0-2005; IN COMMERCE 2-0-2005.
ANDREA HACK, EXAMINING ATTORNEY

SN 77-573,809. BRULINES LIMITED, STOCKTON ON TESS, UNITED KINGDOM, FILED 9-18-2008.

I-DRAFT

THE MARK CONSISTS OF STANDARD CHARACTERS WITHOUT CLAIM TO ANY PARTICULAR FONT, STYLE, SIZE, OR COLOR.

CLASS 9—ELECTRICAL AND SCIENTIFIC APPARATUS

FOR SCIENTIFIC, WEIGHING, MEASURING AND CHECKING (SUPERVISION) APPARATUS AND INSTRUMENTS FOR MEASURING THERMAL PROPERTIES SUCH AS THE RESISTANCE TO ELECTRICAL CONDUCTIVITY AT A GIVEN TEMPERATURE; FLOW METERS; SENSING AND MONITORING APPARATUS AND INSTRUMENTS AND APPARATUS AND INSTRUMENTS FOR MEASURING ELECTRICAL PROPERTIES, NAMELY, FOR SENSING THE FLOW OF LIQUIDS AND MONITORING FOR QUALITY CONTROL THE FLOW OF LIQUIDS AND FOR MEASURING THE RESISTANCE TO ELECTRICAL CONDUCTIVITY AT A GIVEN TEMPERATURE; APPARATUS AND INSTRUMENTS FOR IDENTIFYING, MEASURING, SENSING AND CHECKING THE VOLUME, TEMPERATURE AND CONDUCTIVITY OF LIQUIDS; APPARATUS AND INSTRUMENTS FOR AUTOMATICALLY CONTROLLING AND/OR MONITORING THE LEVEL AND/OR FLOW OF LIQUIDS, NAMELY, THE FLOW METER TURBINE, THERMISTOR AND ELECTRICAL NODES TO MEASURE THE VOLUMETRIC, THERMAL AND RESISTANCE TO AN ELECTRICAL INPUT, NOT FOR MEDICAL USE; SCIENTIFIC, ELECTRIC AND ELECTRONIC APPARATUS AND INSTRUMENTS ALL FOR RECEIVING, PROCESSING, TRANSMITTING, STORING, RELAYING, INPUTTING OR OUTPUTTING OF DATA IN THE NATURE OF TIME, VOLUME, THERMAL AND ELECTRIC RESISTANCE DATA; MONITORING APPARATUS FOR USE WITH THE AFORESAID GOODS, NAMELY, CONTROL UNITS AND INSPECTION CONTROL PANELS FOR MONITORING AND CONTROLLING THE FLOW OF LIQUIDS; COMMUNICATIONS AND TELECOMMUNICATIONS APPARATUS AND INSTRUMENTS, NAMELY, WIRELESS RECEIVERS AND WIRED MODEMS; DATA LOGGING AND STORAGE DEVICES, NAMELY, EMBEDDED MICROCONTROLLERS, FLASH MEMORY CARDS, MEMORY BOARDS AND EPROM CIRCUITS; COMPUTER PROGRAMS AND COMPUTER SOFTWARE FOR IDENTIFICATION OF FLOW LIQUID STATE, TEMPERATURE AND VOLUME WITHIN THE FIELD OF DISPENSING AND QUALITY MONITORING; SIGNAL AND DATA MEDIA, NAMELY, DOWNLOADABLE AUDIO AND VIDEO RECORDINGS IN THE FIELD OF TEMPORAL, VOLUMETRIC, THERMAL AND ELECTRICAL RESISTANCE OF LIQUIDS; PARTS AND FITTINGS FOR ALL THE AFORESAID GOODS (U.S. CLS. 21, 23, 26, 36 AND 38).

CLASS 37—CONSTRUCTION AND REPAIR

FOR REPAIR, MAINTENANCE, AND INSTALLATION OF ELECTRICAL AND ELECTRONIC APPARATUS AND INSTRUMENTS FOR DATA PROCESSING, COMMUNICATIONS SYSTEMS AND APPARATUS, AND COMPUTER NETWORKS; CONSULTING IN THE FIELD OF COMPUTER SYSTEM INSTALLATION (U.S. CLS. 100, 103 AND 106).

CLASS 41—EDUCATION AND ENTERTAINMENT

FOR TRAINING IN THE FIELD OF INSTALLATION, MAINTENANCE AND OPERATION OF COMPUTER HARDWARE COMMUNICATION SYSTEMS AND APPARATUS, COMPUTER NETWORK SYSTEMS AND COMPUTER SUPPORT SOFTWARE (U.S. CLS. 100, 101 AND 107).

CLASS 42—SCIENTIFIC AND COMPUTER SERVICES

FOR DEVELOPMENT AND CONSULTANCY SERVICES IN THE FIELD OF COMPUTER SOFTWARE AND COMPUTER DATABASE SYSTEMS; COMPUTER HARDWARE DEVELOPMENT; CONSULTANCY IN THE FIELD OF EMBEDDED HARDWARE FOR THE PURPOSE OF FLOW DEVELOPMENT, COMMUNICATIONS AND MONITORING TECHNOLOGY; CONSULTANCY AND TECHNICAL SUPPORT SERVICES IN RELATION TO COMPUTER MANAGEMENT SUPPORT SOFTWARE; CONSULTING IN THE FIELD OF COMPUTER HARDWARE; CONSULTING IN THE FIELD OF LIQUID FLOW MONITORING (U.S. CLS. 100 AND 101).
KIMBERLY FRYE, EXAMINING ATTORNEY

SN 77-573,843. BRULINES LIMITED, STOCKTON ON TESS, UNITED KINGDOM, FILED 9-18-2008.

I-DRAFT

THE MARK CONSISTS OF STANDARD CHARACTERS WITHOUT CLAIM TO ANY PARTICULAR FONT, STYLE, SIZE, OR COLOR.

CLASS 9—ELECTRICAL AND SCIENTIFIC APPARATUS

FOR SCIENTIFIC, WEIGHING, MEASURING AND CHECKING (SUPERVISION) APPARATUS AND INSTRUMENTS FOR MEASURING THERMAL PROPERTIES SUCH AS THE RESISTANCE TO ELECTRICAL CONDUCTIVITY AT A GIVEN TEMPERATURE; FLOW METERS; SENSING AND MONITORING APPARATUS AND INSTRUMENTS AND APPARATUS AND INSTRUMENTS FOR MEASURING ELECTRICAL PROPERTIES, NAMELY, FOR SENSING THE FLOW OF LIQUIDS AND MONITORING FOR QUALITY CONTROL THE FLOW OF LIQUIDS AND FOR MEASURING THE RESISTANCE TO ELECTRICAL CONDUCTIVITY AT A GIVEN TEMPERATURE; APPARATUS AND INSTRUMENTS FOR IDENTIFYING, MEASURING, SENSING AND CHECKING THE VOLUME, TEMPERATURE AND CONDUCTIVITY OF LIQUIDS; APPARATUS AND INSTRUMENTS FOR AUTOMATICALLY CONTROLLING AND/OR MONITORING THE LEVEL AND/OR FLOW OF LIQUIDS, NAMELY, THE FLOW METER TURBINE, THERMISTOR AND ELECTRICAL NODES TO MEASURE THE VOLUMETRIC, THERMAL AND RESISTANCE TO AN ELECTRICAL INPUT, NOT FOR MEDICAL USE; SCIENTIFIC, ELECTRIC AND ELECTRONIC APPARATUS AND INSTRUMENTS ALL FOR RECEIVING, PROCESSING, TRANSMITTING, STORING, RELAYING, INPUTTING OR OUTPUTTING OF DATA IN THE NATURE OF TIME, VOLUME, THERMAL AND ELECTRIC RESISTANCE DATA; MONITORING APPARATUS FOR USE WITH THE AFORESAID GOODS, NAMELY, CONTROL UNITS AND INSPECTION CONTROL PANELS FOR MONITORING AND CONTROLLING THE FLOW OF LIQUIDS; COMMUNICATIONS AND TELECOMMUNICATIONS APPARATUS AND INSTRUMENTS, NAMELY, WIRELESS RECEIVERS AND WIRED MODEMS; DATA LOGGING AND STORAGE DEVICES, NAMELY, EMBEDDED MICROCONTROLLERS, FLASH MEMORY CARDS, MEMORY BOARDS AND EPROM CIRCUITS; COMPUTER PROGRAMS AND COMPUTER SOFTWARE FOR IDENTIFICATION OF FLOW LIQUID STATE, TEMPERATURE AND VOLUME WITHIN THE FIELD OF DISPENSING AND QUALITY MONITORING; SIGNAL AND DATA MEDIA, NAMELY, DOWNLOADABLE AUDIO AND VIDEO RECORDINGS IN THE FIELD OF TEMPORAL, VOLUMETRIC, THERMAL AND ELECTRICAL RESISTANCE OF LIQUIDS; PARTS AND FITTINGS FOR ALL THE AFORESAID GOODS (U.S. CLS. 21, 23, 26, 36 AND 38).

CLASS 37—CONSTRUCTION AND REPAIR

FOR REPAIR, MAINTENANCE, AND INSTALLATION OF ELECTRICAL AND ELECTRONIC APPARATUS AND INSTRUMENTS FOR DATA PROCESSING, COMMUNICATIONS SYSTEMS AND APPARATUS, AND COMPUTER NETWORKS; CONSULTING IN THE FIELD OF COMPUTER SYSTEM INSTALLATION (U.S. CLS. 100, 103 AND 106).

CLASS 41—EDUCATION AND ENTERTAINMENT

FOR TRAINING IN THE FIELD OF INSTALLATION, MAINTENANCE AND OPERATION OF COMPUTER HARDWARE COMMUNICATION SYSTEMS AND APPARATUS, COMPUTER NETWORK SYSTEMS AND COMPUTER SUPPORT SOFTWARE (U.S. CLS. 100, 101 AND 107).

CLASS 42—SCIENTIFIC AND COMPUTER SERVICES

FOR DEVELOPMENT AND CONSULTANCY SERVICES IN THE FIELD OF COMPUTER SOFTWARE AND COMPUTER DATABASE SYSTEMS; COMPUTER HARDWARE DEVELOPMENT; CONSULTANCY IN THE FIELD OF EMBEDDED HARDWARE FOR THE PURPOSE OF FLOW DEVELOPMENT, COMMUNICATIONS AND MONITORING TECHNOLOGY; CONSULTANCY AND TECHNICAL SUPPORT SERVICES IN RELATION TO COMPUTER MANAGEMENT SUPPORT SOFTWARE; CONSULTING IN THE FIELD OF COMPUTER HARDWARE; CONSULTING IN THE FIELD OF LIQUID FLOW MONITORING (U.S. CLS. 100 AND 101).

KIMBERLY FRYE, EXAMINING ATTORNEY

SN 77-573,853. GREENZYS LLC, MAHWAY, NJ. FILED 9-18-2008.

GREENZYS

THE MARK CONSISTS OF STANDARD CHARACTERS WITHOUT CLAIM TO ANY PARTICULAR FONT, STYLE, SIZE, OR COLOR.

CLASS 9—ELECTRICAL AND SCIENTIFIC APPARATUS

FOR DIGITAL MEDIA, NAMELY, PRE-RECORDED VIDEO CASSETTES, DIGITAL VIDEO DISCS, DIGITAL VERSATILE DISCS, DOWNLOADABLE AUDIO AND VIDEO RECORDINGS, DVDS, FLASH DRIVES, AND HIGH DEFINITION DIGITAL DISKS FEATURING EDUCATIONAL AND ENTERTAINMENT PROGRAMMING FOR CHILDREN; COMPUTER GAME PROGRAM CARTRIDGES, CASSETTES, DISCS AND TAPES AND INSTRUCTION MANUALS SOLD AS A UNIT THEREWITH (U.S. CLS. 21, 23, 26, 36 AND 38).

CLASS 16—PAPER GOODS AND PRINTED MATTER

FOR PAPER PRODUCTS, NAMELY, CHILDREN'S BOOKS, SCRAPBOOKS, BUMPER STICKERS, STICKERS, POSTERS, BLANK CARDS, PRINTS, MAGAZINES FEATURING INFORMATION ABOUT ENVIRONMENTAL ISSUES, WORKBOOKS IN THE FIELD OF ENVIRONMENTAL ISSUES, ADDRESS BOOKS, STATIONERY, CALENDARS, FOLDERS, ENVELOPES, POSTCARDS, GREETING CARDS, BUSINESS CARDS, ADHESIVE NOTE PADS, PAPER HANG TAGS FOR CLOTHING, BLANK JOURNALS AND DIARIES (U.S. CLS. 2, 5, 22, 23, 29, 37, 38 AND 50).

CLASS 25—CLOTHING

FOR SHIRTS, JACKETS, PANTS, JEANS, UNDERWEAR, COATS, SHOES, SCARVES, GLOVES, SLIPPERS, SOCKS, HATS, CAPS, SWEATERS, T-SHIRTS, SKIRTS, HOSIERY, BELTS, LEOTARDS; EXERCISE CLOTHING, NAMELY, SHIRTS, PANTS, SHORTS AND TOPS FOR EXERCISING; SLEEPWEAR (U.S. CLS. 22 AND 39).

CLASS 28—TOYS AND SPORTING GOODS

FOR TOYS, NAMELY, DOLLS, DOLL ACCESSORIES, ACTION FIGURES, PLUSH TOYS, POSEABLE PLAY FIGURES AND ACCESSORIES THEREFOR; SCALE MODEL PLAY FIGURE KITS COMPOSED OF PLASTIC, VINYL AND RESIN MOLDS; CHILDREN'S DRESS-UP ACCESSORIES; DOLLHOUSES AND DOLL FURNITURE; ART ACTIVITY TOYS, BATHTUB TOYS AND WATER-SQUIRTING TOYS; RIDE-ON TOYS AND TOY VEHICLES; FLYING DISCS, KITES, YO-YO'S AND BALLOONS; ELECTRONIC HAND-HELD GAME UNITS; BOARD GAMES AND GAME EQUIPMENT SOLD AS A UNIT FOR PLAYING A BOARD GAME, A MANIPULATIVE GAME, A PARLOR GAME, AND AN ACTION-TYPE TARGET GAME; CARD GAMES AND EQUIPMENT SOLD AS A UNIT FOR PLAYING A CARD GAME; STAND-ALONE VIDEO OUTPUT GAME MACHINES; COIN-OPERATED PINBALL GAME MACHINES; JIGSAW AND MANIPULATIVE PUZZLES; PAPER FACE MASKS AND COSTUME MASKS; HAND PUPPETS; CRIB MOBILES AND MOBILES FOR CHILDREN; SKATEBOARDS, SURFBOARDS AND ICE SKATES; BALLS, NAMELY, PLAYGROUND BALLS, SOCCER BALLS, BASEBALLS AND BASKETBALLS; BASEBALL AND SOFTBALL GLOVES; SWIMMING FLOATS FOR RECREATIONAL USE; KICKBOARD FLOATATION DEVICES FOR RECREATIONAL USE; SWIM BOARDS FOR RECREATIONAL USE; SWIM FINS; TOY BAKEWARE AND TOY COOKWARE; TOY BANKS; TOY SNOW GLOBES; AND CHRISTMAS TREE ORNAMENTS (U.S. CLS. 22, 23, 38 AND 50).

CLASS 41—EDUCATION AND ENTERTAINMENT

FOR ENTERTAINMENT SERVICES, NAMELY, PROVIDING ONLINE INTERACTIVE COMPUTER GAMES, COMPUTERIZED ONLINE RENTAL SERVICES FEATURING CONSUMER ELECTRONICS IN THE NATURE OF MOTION PICTURE FEATURE FILMS, TELEVISION PROGRAMS AND PRERECORDED DVDS IN A VARIETY OF GENRES (U.S. CLS. 100, 101 AND 107).

COLLEEN KEARNEY, EXAMINING ATTORNEY

SN 77-573,878. YOTAGS, INC., PLEASANTON, CA. FILED 9-18-2008.

YOTAGS

THE MARK CONSISTS OF STANDARD CHARACTERS WITHOUT CLAIM TO ANY PARTICULAR FONT, STYLE, SIZE, OR COLOR.

CLASS 20—FURNITURE AND ARTICLES NOT OTHERWISE CLASSIFIED

FOR PLASTIC LABELS AND TAGS, NAMELY, CODED IDENTIFICATION LABELS AND TAGS OF PLASTIC FOR AFFIXING TO CLOTHING, PET ITEMS, AND PERSONAL EFFECTS FOR USE IN IDENTIFYING OWNERSHIP AND FOR RETRIEVAL OF LOST ITEMS (U.S. CLS. 2, 13, 22, 25, 32 AND 50).

CLASS 24—FABRICS

FOR FABRIC LABELS AND TAGS, NAMELY, CODED IDENTIFICATION LABELS AND TAGS OF FABRIC FOR AFFIXING TO CLOTHING, PET ITEMS, AND PERSONAL EFFECTS FOR USE IN IDENTIFYING OWNERSHIP AND FOR RETRIEVAL OF LOST ITEMS (U.S. CLS. 42 AND 50).

CLASS 45—PERSONAL AND LEGAL SERVICES

FOR PROVIDING A WEBSITE THAT GIVES USERS THE ABILITY TO LIST FOUND ITEMS AND TO SEARCH FOR LOST ITEMS IDENTIFIED WITH CODED IDENTIFICATION LABELS AND TAGS (U.S. CLS. 100 AND 101).

SHANNON TWOHIG, EXAMINING ATTORNEY

SN 77-574,242. RED SKY BRANDS, LLC, RYE, NY. FILED 9-19-2008.



DesignMyHome

THE COLOR(S) BLACK AND RED IS/ARE CLAIMED AS A FEATURE OF THE MARK.

THE MARK CONSISTS OF THE WORDS "DESIGN MY HOME" BELOW A DESIGN COMPONENT. THE COLOR RED APPEARS IN THE CIRCLE AND THE WORDING "DESIGN MY HOME" AND THE COLOR BLACK APPEARS IN THE DESIGN.

CLASS 20—FURNITURE AND ARTICLES NOT OTHERWISE CLASSIFIED

FOR FURNITURE; MIRRORS; DRAPERY HARDWARE AND ACCESSORIES, NAMELY, TRAVERSE RODS, POLES, CURTAIN HOOKS, CURTAIN RODS AND FINIALS; MATTRESSES; ART FRAMES; PICTURE FRAMES; TEA CARTS; TOY CHESTS; OUTDOOR FURNITURE; WINE RACKS; FITTED FABRIC FURNITURE COVERS; PILLOWS (U.S. CLS. 2, 13, 22, 25, 32 AND 50).

CLASS 24—FABRICS

FOR FABRICS FOR CURTAINS; DRAPERIES; WINDOW TOP TREATMENTS, NAMELY, FABRIC VALANCES, POUFS AND SWAGS; UPHOLSTERY FABRICS AND UNFITTED FURNITURE COVERS; HOUSEHOLD LINENS; KITCHEN LINENS; BATH LINENS; BED LINENS; TOWELS; WASHCLOTHS; SHOWER CURTAINS; BED SHEETS; BATH SHEETS; BED BLANKETS; RECEIVING BLANKETS; BLANKETS FOR OUTDOOR USE; THROWS; COMFORTERS; BEDSPREADS; TEXTILE NAPKINS; DUVETS AND DUVET COVERS; COVERLETS; DUST RUFFLES; QUILTS; TABLECLOTHS NOT OF PAPER; TABLE LINENS AND PLACE MATS NOT OF PAPER; BOX SPRING COVERS; SHAMS; CURTAINS; DRAPERY; PILLOWCASES (U.S. CLS. 42 AND 50).

SAIMA MAKHDOOM, EXAMINING ATTORNEY

SN 77-575,477. AKEMI, INC., HOUSTON, TX. FILED 9-22-2008.

BODY COOLER

THE MARK CONSISTS OF STANDARD CHARACTERS WITHOUT CLAIM TO ANY PARTICULAR FONT, STYLE, SIZE, OR COLOR.

OWNER OF U.S. REG. NO. 1,907,779.

CLASS 18—LEATHER GOODS

FOR PET PRODUCTS, NAMELY, PET CLOTHING IN THE NATURE OF WRAPS AND BANDANAS; PET COLLARS (U.S. CLS. 1, 2, 3, 22 AND 41).
FIRST USE 7-0-1993; IN COMMERCE 7-0-1993.

CLASS 20—FURNITURE AND ARTICLES NOT OTHERWISE CLASSIFIED

FOR PET PRODUCTS, NAMELY, PET MATS IN THE NATURE OF CUSHIONS; CRATE COVERS FOR PETS (U.S. CLS. 2, 13, 22, 25, 32 AND 50).
FIRST USE 7-0-1993; IN COMMERCE 7-0-1993.
DAVID ELTON, EXAMINING ATTORNEY

SN 77-576,430. HANDMEDOWNS, INC., BEVERLY HILLS, CA. FILED 9-23-2008.



THE MARK CONSISTS OF THE WORDS "HAND-ME-DOWNS" WITH A CLOTHES LINE HANGING ABOVE. THE CLOTHES LINE IS HOLDING CLOTHES, A TEDDY BEAR, SHOES, HAT AND BIB.

CLASS 35—ADVERTISING AND BUSINESS

FOR ONLINE RETAIL STORE SERVICES FEATURING CLOTHING, TOYS AND BABY AND TODDLER GEAR, NAMELY, STROLLERS, SWINGS, HIGHCHAIRS, SLINGS, BOUNCERS, EXERCISER/ROCKING SAUCERS, FURNITURE, CRIBS, TODDLER BEDS; PROVIDING AN ON-LINE SEARCHABLE DATABASE FEATURING CLASSIFIED AD LISTINGS; ADVERTISING, ADVERTISEMENT SERVICES AND RELATED CONSULTING; ADVERTISING, INCLUDING PROMOTION RELATING TO THE SALE OF ARTICLES, GOODS AND SERVICES FOR THIRD PARTIES BY THE TRANSMISSION OF ADVERTISING MATERIAL AND THE DISSEMINATION OF ADVERTISING MESSAGES ON COMPUTER NETWORKS; ELECTRONIC COMMERCE SERVICES, NAMELY, PROVIDING INFORMATION ABOUT PRODUCTS AND SERVICES VIA TELECOMMUNICATION NETWORKS FOR ADVERTISING AND SALES PURPOSES; INTERNET LISTING SERVICES OF CLASSIFIED ADS; INTERNET LISTINGS OF CHILD CARE SERVICES; PROMOTING THE CHARITABLE SERVICES OF OTHERS, NAMELY, PROVIDING INDIVIDUALS WITH INFORMATION FOR THE PURPOSE OF MAKING MONETARY AND NON-MONETARY DONATIONS TO CHARITIES (U.S. CLS. 100, 101 AND 102).

CLASS 42—SCIENTIFIC AND COMPUTER SERVICES

FOR PROVIDING A SEARCH ENGINE FOR OBTAINING DATA ON A GLOBAL COMPUTER NETWORK (U.S. CLS. 100 AND 101).
AISHA CLARKE, EXAMINING ATTORNEY

SN 77-577,495. PSC MANAGEMENT LIMITED PARTNERSHIP, PLANO, TX. FILED 9-24-2008.

2020 VISION OF THE ROAD AHEAD

THE MARK CONSISTS OF STANDARD CHARACTERS WITHOUT CLAIM TO ANY PARTICULAR FONT, STYLE, SIZE, OR COLOR.

CLASS 9—ELECTRICAL AND SCIENTIFIC APPARATUS

FOR DOWNLOADABLE CORPORATE PUBLICATIONS, NAMELY, NEWSLETTERS AND ARTICLES, IN THE FIELD OF COMPUTERS AND RELATED INFORMATION TECHNOLOGY (U.S. CLS. 21, 23, 26, 36 AND 38).

CLASS 35—ADVERTISING AND BUSINESS

FOR BUSINESS CONSULTING SERVICES (U.S. CLS. 100, 101 AND 102).

CLASS 41—EDUCATION AND ENTERTAINMENT

FOR PROVIDING ON-LINE CORPORATE PUBLICATIONS, NAMELY, NEWSLETTERS AND ARTICLES IN THE FIELD OF COMPUTERS AND RELATED INFORMATION TECHNOLOGY (U.S. CLS. 100, 101 AND 107).

CLASS 42—SCIENTIFIC AND COMPUTER SERVICES

FOR COMPUTER AND INFORMATION TECHNOLOGY SERVICES, NAMELY, CONSULTATION SERVICES REGARDING COMPUTER HARDWARE AND SOFTWARE AND INFORMATION TECHNOLOGY (U.S. CLS. 100 AND 101).

APRIL HESIK, EXAMINING ATTORNEY

SN 77-578,344. PENNWELL CORPORATION, TULSA, OK. FILED 9-25-2008.



OWNER OF U.S. REG. NOS. 1,338,305, 1,343,190 AND 3,365,411.

NO CLAIM IS MADE TO THE EXCLUSIVE RIGHT TO USE "LIVE", APART FROM THE MARK AS SHOWN.

THE MARK CONSISTS OF THE STYLIZED TERMS "CMM" AND "LIVE" WITH "LIVE" APPEARING IN FRONT OF AND PARTIALLY BENEATH "CMM".

CLASS 35—ADVERTISING AND BUSINESS

FOR CONDUCTING AN ON-LINE TRADESHOW EXHIBITION IN THE FIELD OF CONVERTING MACHINERY AND MATERIALS; PROMOTING THE GOODS AND SERVICES OF OTHERS IN THE FIELD OF CONVERTING MACHINERY AND MATERIALS BY PROVIDING LINKS TO THE WEB SITES OF OTHERS (U.S. CLS. 100, 101 AND 102).

FIRST USE 5-1-2008; IN COMMERCE 5-1-2008.

CLASS 38—COMMUNICATION

FOR PROVIDING ONLINE CHAT ROOMS FOR TRANSMISSION OF ELECTRONIC MESSAGES RELATING TO THE FIELD OF CONVERTING MACHINERY AND MATERIALS (U.S. CLS. 100, 101 AND 104).

FIRST USE 5-1-2008; IN COMMERCE 5-1-2008.
SANJEEV VOHRA, EXAMINING ATTORNEY

SN 77-578,846. ASSET INTERNATIONAL, INC., STAMFORD, CT. FILED 9-25-2008.

PLANSPONSOR OTI

THE MARK CONSISTS OF STANDARD CHARACTERS WITHOUT CLAIM TO ANY PARTICULAR FONT, STYLE, SIZE, OR COLOR.

OWNER OF U.S. REG. NOS. 2,379,235, 2,914,633 AND OTHERS.

SEC. 2(F) AS TO "PLANSPONSOR".

CLASS 36—INSURANCE AND FINANCIAL

FOR FINANCIAL SERVICES, NAMELY, PROVIDING INDEXES FOR TARGET DATE FUNDS (U.S. CLS. 100, 101 AND 102).

CLASS 42—SCIENTIFIC AND COMPUTER SERVICES

FOR PROVIDING NON-DOWNLOADABLE SOFTWARE FOR PROVIDING INDEXES FOR TARGET DATE FUNDS (U.S. CLS. 100 AND 101).

DAVON HATCHETT, EXAMINING ATTORNEY

SN 77-579,425. BAYTEK INTERNATIONAL TECHNOLOGY CO., LTD, TAIPEI CITY, TAIWAN, FILED 9-26-2008.



NO CLAIM IS MADE TO THE EXCLUSIVE RIGHT TO USE "LIGHTING SOLUTIONS", APART FROM THE MARK AS SHOWN.

THE COLOR(S) DARK BLUE, ORANGE AND YELLOW IS/ARE CLAIMED AS A FEATURE OF THE MARK.

THE MARK CONSISTS OF THE WORD "BAYTEK" IN DARK BLUE ABOVE THE WORDING "LIGHTING SOLUTIONS" IN SMALLER FONT, ALSO IN DARK BLUE, ABOVE A DESIGN OF LIGHT CONSISTING OF AN ORANGE LINE IN A STYLIZED ARRANGEMENT ABOVE FOUR LIGHTRAYS EXTENDING THEREFROM, WITH EACH LIGHTRAY BEING YELLOW IN THE MIDDLE AND ORANGE ON THE OUTSIDE.

CLASS 9—ELECTRICAL AND SCIENTIFIC APPARATUS

FOR ELECTRONIC LED SIGNS, LED AND HID LIGHT CONTROLS, LIGHT EMITTING DIODE (LED)-DISPLAYS, LIGHT EMITTING DIODES (LEDs), MEMORY BOARDS, MEMORY CARDS, MEMORY EXPANSION MODULES (U.S. CLS. 21, 23, 26, 36 AND 38).

CLASS 11—ENVIRONMENTAL CONTROL APPARATUS

FOR LED (LIGHT EMITTING DIODES) LIGHTING FIXTURES FOR USE IN DISPLAY, COMMERCIAL, INDUSTRIAL, RESIDENTIAL, AND ARCHITECTURAL ACCENT LIGHTING APPLICATIONS, LED (LIGHT EMITTING DIODE) LIGHTING FIXTURES, LED AND HID LIGHT FIXTURES, LED LIGHT ASSEMBLIES FOR STREET LIGHTS, SIGNS, COMMERCIAL LIGHTING, AUTOMOBILES, BUILDINGS, AND OTHER ARCHITECTURAL USES, LED LIGHT BULBS, LED LIGHTING FIXTURES FOR INDOOR AND OUTDOOR LIGHTING APPLICATIONS, RED LED FLASHLIGHTS FOR ILLUMINATION PURPOSES (U.S. CLS. 13, 21, 23, 31 AND 34).

CLASS 35—ADVERTISING AND BUSINESS

FOR ADVISORY AND CONSULTANCY SERVICES RELATING TO EXPORT, EXPORT SERVICES, EXPORT PROMOTION INFORMATION AND SERVICES, EXPORT AGENCY SERVICES FOR THE GOODS OF OTHERS, EXPORT AND IMPORT AGENCIES, GOODS IMPORT-EXPORT AGENCIES, IMPORT AND EXPORT AGENCIES (U.S. CLS. 100, 101 AND 102).

DAVID ELTON, EXAMINING ATTORNEY

SN 77-579,629. FURNITURE.COM, INC., WALTHAM, MA. FILED 9-26-2008.

BLUEPORT COMMERCE

THE MARK CONSISTS OF STANDARD CHARACTERS WITHOUT CLAIM TO ANY PARTICULAR FONT, STYLE, SIZE, OR COLOR.

NO CLAIM IS MADE TO THE EXCLUSIVE RIGHT TO USE "COMMERCE", APART FROM THE MARK AS SHOWN.

CLASS 35—ADVERTISING AND BUSINESS

FOR PRODUCT MERCHANDISING IN THE NATURE OF BUSINESS CONSULTING SERVICES, NAMELY, PROVIDING BUSINESS ADVICE TO OTHERS ON DEVELOPING ONLINE RETAIL WEBSITES, DEVELOPING DIRECT MARKETING CAMPAIGNS, AND DEVELOPING CUSTOMER SERVICE PROGRAMS (U.S. CLS. 100, 101 AND 102).

CLASS 42—SCIENTIFIC AND COMPUTER SERVICES

FOR PROVIDING TEMPORARY USE OF NONDOWN-LOADABLE SOFTWARE, NAMELY, PROVIDING AN E-COMMERCE SOFTWARE PLATFORM FOR USE AS A MANAGED SOLUTION (SAAS) IN THE FIELD OF ONLINE RETAIL STORE SALES FOR USE IN MANAGING ELECTRONIC BUSINESS AND RETAIL TRANSACTIONS; DEVELOPMENT OF NEW TECHNOLOGY FOR OTHERS IN THE FIELD OF ONLINE RETAIL STORE SALES (U.S. CLS. 100 AND 101).

HOWARD B. LEVINE, EXAMINING ATTORNEY

SN 77-580,181. LEXIGEN SCIENCE AND LAW CONSULTANTS, INC., SAN FRANCISCO, CA. FILED 9-26-2008.

LEXIGEN

THE MARK CONSISTS OF STANDARD CHARACTERS WITHOUT CLAIM TO ANY PARTICULAR FONT, STYLE, SIZE, OR COLOR.

CLASS 41—EDUCATION AND ENTERTAINMENT

FOR TRAINING AND TEACHING COURSES OF INSTRUCTION ALL RELATED TO SCIENTIFIC EVALUATION OF DNA EVIDENCE, EXPERT ANALYSIS OF DNA EVIDENCE, AND LITIGATION SUPPORT RELATED TO THE SCIENTIFIC EVALUATION OF DNA EVIDENCE (U.S. CLS. 100, 101 AND 107).

CLASS 42—SCIENTIFIC AND COMPUTER SERVICES

FOR CONSULTING SERVICES RELATED TO SCIENTIFIC EVALUATION OF DNA EVIDENCE AND EXPERT ANALYSIS OF DNA EVIDENCE (U.S. CLS. 100 AND 101).

CLASS 45—PERSONAL AND LEGAL SERVICES

FOR CONSULTING SERVICES IN THE FIELD OF LITIGATION SUPPORT (U.S. CLS. 100 AND 101).

ANDREA SAUNDERS, EXAMINING ATTORNEY

SN 77-581,360. BROADSOFT, INC., GAITHERSBURG, MD. FILED 9-29-2008.

BROADSOFT Xchange

THE MARK CONSISTS OF STANDARD CHARACTERS WITHOUT CLAIM TO ANY PARTICULAR FONT, STYLE, SIZE, OR COLOR.

NO CLAIM IS MADE TO THE EXCLUSIVE RIGHT TO USE "EXCHANGE", APART FROM THE MARK AS SHOWN.

CLASS 38—COMMUNICATION

FOR PROVIDING A SECURE ACCESS WEB SITE FEATURING INFORMATION IN THE FIELD OF TELECOMMUNICATIONS (U.S. CLS. 100, 101 AND 104).

CLASS 42—SCIENTIFIC AND COMPUTER SERVICES

FOR PROVIDING A SECURED-ACCESS WEBSITE THAT GIVES REGISTERED USERS THE ABILITY TO UPLOAD, VIEW, COPY, PRINT, DOWNLOAD AND SHARE DOCUMENTS AND IMAGES IN THE FIELD OF TELECOMMUNICATIONS (U.S. CLS. 100 AND 101).

SUSAN STIGLITZ, EXAMINING ATTORNEY

SN 77-581,652. GASS HOLDINGS, INC., PORTLAND, OR. FILED 9-29-2008.

GASS

THE MARK CONSISTS OF STANDARD CHARACTERS WITHOUT CLAIM TO ANY PARTICULAR FONT, STYLE, SIZE, OR COLOR.

CLASS 38—COMMUNICATION

FOR BROADCASTING OF PROGRAMS ABOUT AUTOMOBILE STOCK CAR RACING VIA AUDIO, CABLE TELEVISION, INTERNET, RADIO AND VIDEO (U.S. CLS. 100, 101 AND 104).

CLASS 41—EDUCATION AND ENTERTAINMENT

FOR ENTERTAINMENT SERVICES, NAMELY, PRODUCTION OF TELEVISION PROGRAMS FEATURING MOTORSPORTS RACING; ENTERTAINMENT SERVICES, NAMELY, PRODUCTION OF TELEVISION PROGRAMS FEATURING BEHIND THE SCENES INFORMATION REGARDING MOTORSPORTS RACING; ENTERTAINMENT SERVICES, NAMELY, PRODUCTION OF TELEVISION PROGRAMS FEATURING MOTORSPORTS STOCK CAR AUTOMOBILE RACERS AND THEIR LIVES (U.S. CLS. 100, 101 AND 107).

NANCY CLARKE, EXAMINING ATTORNEY

SN 77-582,073. ALLING, JOHN PAUL, FOLSOM, CA. FILED 9-30-2008.

Sensible Gardener

THE MARK CONSISTS OF STANDARD CHARACTERS WITHOUT CLAIM TO ANY PARTICULAR FONT, STYLE, SIZE, OR COLOR.

OWNER OF U.S. REG. NO. 3,527,281.

NO CLAIM IS MADE TO THE EXCLUSIVE RIGHT TO USE "GARDENER", APART FROM THE MARK AS SHOWN.

CLASS 35—ADVERTISING AND BUSINESS

FOR ADVERTISING, MARKETING AND PROMOTIONAL SERVICES FOR GARDENING SERVICES AND GARDENING RELATED INFORMATION; PROVIDING GARDENING INFORMATION, NAMELY, CONSUMER INFORMATION ON OUTDOOR FURNISHINGS (U.S. CLS. 100, 101 AND 102).

CLASS 37—CONSTRUCTION AND REPAIR

FOR PROVIDING GARDENING INFORMATION, NAMELY, INFORMATION ON HARDSCAPE, NAMELY, CONSTRUCTION ELEMENTS SUCH AS STAMPED CONCRETE PAVERS AND PATHWAYS; LANDSCAPE IRRIGATION, NAMELY, INFORMATION ON INSTALLATION AND MAINTENANCE OF IRRIGATION SYSTEMS; INFORMATION ON INSTALLATION OF LIGHTING SYSTEMS, NAMELY, LOW VOLTAGE LIGHTING AND TIMED-LIGHTING SYSTEMS (U.S. CLS. 100, 103 AND 106).

CLASS 44—MEDICAL, BEAUTY AND AGRICULTURAL SERVICES

FOR PROVIDING GARDENING INFORMATION, NAMELY, INFORMATION ON LANDSCAPE DESIGN, PLANT AND TREE CARE, ECO-FRIENDLY GARDENING, FERTILIZING AND LAWN CARE (U.S. CLS. 100 AND 101).

EUGENIA MARTIN, EXAMINING ATTORNEY

SN 77-583,142. LUCINI ITALIA COMPANY, MIAMI, FL. FILED 10-1-2008.

**TRADITIONAL FOOD FOR
MODERN LIFE**

THE MARK CONSISTS OF STANDARD CHARACTERS WITHOUT CLAIM TO ANY PARTICULAR FONT, STYLE, SIZE, OR COLOR.

CLASS 29—MEATS AND PROCESSED FOODS

FOR FROZEN VEGETABLES; CANNED VEGETABLES; JARRED VEGETABLES; SOUPS; CHEESE; OLIVE OIL; JARRED TOMATOES; CANNED TOMATOES; FROZEN ENTREES CONSISTING PRIMARILY OF MEAT, FISH, POULTRY, OR VEGETABLES (U.S. CL. 46).

CLASS 30—STAPLE FOODS

FOR MAYONNAISE; SAUCES; PASTA SAUCE; FROZEN PASTA; RISOTTO; RICE; PROCESSED GRAINS; VINEGAR; FROZEN ENTREES CONSISTING PRIMARILY OF PASTA OR RICE (U.S. CL. 46).

CHERYL CLAYTON, EXAMINING ATTORNEY

SN 77-584,319. NORGES STATSBANER AS, 0048 OSLO, NORWAY, FILED 10-2-2008.



PRIORITY CLAIMED UNDER SEC. 44(D) ON NORWAY APPLICATION NO. 200811043, FILED 9-2-2008, REG. NO. 2498503, DATED 11-4-2008, EXPIRES 11-4-2018.

NO CLAIM IS MADE TO THE EXCLUSIVE RIGHT TO USE "NORWAY" AND "FJORDTOURS.COM", APART FROM THE MARK AS SHOWN.

THE COLOR(S) BLUE, GREEN, BLACK AND GRAY IS/ARE CLAIMED AS A FEATURE OF THE MARK.

THE MARK CONSISTS OF THE WORDS "NORWAY IN A NUTSHELL" OVER THE WORDS "FJORDTOURS.COM", ALL TO THE RIGHT OF A STYLIZED MOUNTAIN AND WATER DESIGN. THE COLOR BLUE APPEARS IN THE "NORWAY IN A NUTSHELL" WORDING, AS WELL AS THE WATER DESIGN IN THE MARK. THE COLOR GREEN APPEARS IN THE MOUNTAIN DESIGN IN THE MARK. THE COLOR BLACK APPEARS IN THE "FJORD" WORDING, AS WELL AS THE SHADOWS IN THE MARK, AND THE COLOR GRAY APPEARS IN THE "TOURS.COM" WORDING IN THE MARK.

CLASS 39—TRANSPORTATION AND STORAGE

FOR ARRANGING OF CRUISES; ARRANGING OF TOURS, INCLUDING PASSENGER TRANSPORT BY RAILWAY, BUS AND BOAT; TRAVEL GUIDE SERVICES; RESERVATION AND BOOKING OF SEATS FOR TRAVEL; ORGANIZATION OF SIGHTSEEING TOURS; RENTAL OF TOURING COACHES; RENTAL OF RAILWAY CARRIAGES (U.S. CLS. 100 AND 105).

CLASS 43—HOTEL AND RESTAURANT SERVICES

FOR HOTEL RESERVATION SERVICES; PROVIDING TEMPORARY ACCOMMODATIONS, NAMELY, HOTELS AND PENSIONS; MAKING RESERVATIONS FOR TEMPORARY ACCOMMODATIONS FOR OTHERS; RESTAURANTS; SELF-SERVICE RESTAURANTS; TOURIST HOMES (U.S. CLS. 100 AND 101).

KHANH LE, EXAMINING ATTORNEY

SN 77-584,585. ANANTARA SOLUTIONS PRIVATE LIMITED, TARAMANI, CHENNAI, INDIA, FILED 10-2-2008.

**second generation
outsourcing**

THE MARK CONSISTS OF STANDARD CHARACTERS WITHOUT CLAIM TO ANY PARTICULAR FONT, STYLE, SIZE, OR COLOR.

NO CLAIM IS MADE TO THE EXCLUSIVE RIGHT TO USE "OUTSOURCING", APART FROM THE MARK AS SHOWN.

CLASS 35—ADVERTISING AND BUSINESS

FOR ASSISTANCE, ADVISORY SERVICES AND CONSULTANCY WITH REGARD TO BUSINESS PLANNING, BUSINESS ANALYSIS, BUSINESS MANAGEMENT, AND BUSINESS ORGANIZATION; BUSINESS ADVISORY SERVICES, CONSULTANCY AND INFORMATION; BUSINESS CONSULTATION SERVICES; BUSINESS CONSULTING AND INFORMATION SERVICES; BUSINESS CONSULTING SERVICES IN THE FIELD OF ORGANIZATIONAL CHANGE MANAGEMENT; BUSINESS CONSULTING SERVICES RELATING TO PRODUCT DISTRIBUTION, OPERATIONS MANAGEMENT SERVICES, LOGISTICS, REVERSE LOGISTICS, SUPPLY CHAIN, AND PRODUCTION SYSTEMS AND DISTRIBUTION SOLUTIONS; BUSINESS CONSULTING SERVICES, NAMELY, PROVIDING ASSISTANCE IN DEVELOPMENT OF BUSINESS STRATEGIES AND CREATIVE IDEATION; BUSINESS MANAGEMENT CONSULTANCY SERVICES; CONSULTANCY SERVICES REGARDING BUSINESS STRATEGIES; CONSULTING SERVICES IN BUSINESS ORGANIZATION AND MANAGEMENT; INFORMATION, ADVISORY AND CONSULTANCY SERVICES RELATING TO BUSINESS AND MANAGEMENT OR BUSINESS ADMINISTRATION, INCLUDING SUCH SERVICES PROVIDED ON LINE OR VIA THE INTERNET (U.S. CLS. 100, 101 AND 102).

FIRST USE 10-19-2006; IN COMMERCE 10-19-2006.

CLASS 42—SCIENTIFIC AND COMPUTER SERVICES

FOR CONSULTING SERVICES IN THE FIELD OF COMPUTER-BASED INFORMATION SYSTEMS FOR BUSINESSES; CONSULTING SERVICES IN THE FIELD OF IDENTIFICATION, SUPPORT, AND IMPLEMENTATION OF COMPUTER-BASED INFORMATION SYSTEMS FOR BUSINESSES (U.S. CLS. 100 AND 101).

FIRST USE 10-19-2006; IN COMMERCE 10-19-2006.
PRISCILLA MILTON, EXAMINING ATTORNEY

SN 77-585,064. PLURIS VALUATION ADVISORS, LLC, NEW YORK, NY. FILED 10-3-2008.

PLURIS

THE MARK CONSISTS OF STANDARD CHARACTERS WITHOUT CLAIM TO ANY PARTICULAR FONT, STYLE, SIZE, OR COLOR.

CLASS 36—INSURANCE AND FINANCIAL

FOR FINANCIAL SERVICES, NAMELY, FISCAL VALUATIONS AND ASSESSMENTS OF SECURITIES, INVESTMENTS, STOCK-BASED COMPENSATION, PURCHASE PRICE ALLOCATION, ASSET IMPAIRMENT, PUBLIC OFFERING OF COMPANIES, AND FAIR MARKET VALUE OF ASSETS (U.S. CLS. 100, 101 AND 102).

FIRST USE 9-8-2006; IN COMMERCE 9-8-2006.

CLASS 45—PERSONAL AND LEGAL SERVICES

FOR PROVIDING EXPERT WITNESS SERVICES IN LEGAL MATTERS AND ALTERNATIVE DISPUTE RESOLUTION SERVICES IN THE FIELD OF SECURITIES, INVESTMENTS AND TAXATION (U.S. CLS. 100 AND 101).

FIRST USE 9-8-2006; IN COMMERCE 9-8-2006.
PAULA MAHONEY, EXAMINING ATTORNEY

SN 77-585,238. INFINITY PAIN SOLUTIONS & WELLNESS CENTER, LLC, PERRYSBURG, OH. FILED 10-3-2008.

INFINITY PAIN SOLUTIONS & WELLNESS CENTER

THE MARK CONSISTS OF STANDARD CHARACTERS WITHOUT CLAIM TO ANY PARTICULAR FONT, STYLE, SIZE, OR COLOR.

NO CLAIM IS MADE TO THE EXCLUSIVE RIGHT TO USE "PAIN SOLUTIONS & WELLNESS CENTER", APART FROM THE MARK AS SHOWN.

CLASS 5—PHARMACEUTICALS

FOR HEALTH AND LIFE-STYLE ENHANCEMENT PRODUCTS, NAMELY, HERBAL SUPPLEMENTS, DIETARY AND NUTRITIONAL SUPPLEMENTS, APPETITE SUPPRESSANTS, SMOKING CESSATION PREPARATIONS, HERBAL TOPICAL CREAMS AND GELS FOR PAIN RELIEF, PREPARATIONS FOR PAIN RELIEF, NATURAL SUPPLEMENTS FOR TREATING DEPRESSION AND ANXIETY, ANTI-INFLAMMATORIES, BANDAGES FOR DRESSINGS, HERBAL MALE ENHANCEMENT CAPSULES, AND MAGNETIC BRACELETS FOR MEDICAL PURPOSES (U.S. CLS. 6, 18, 44, 46, 51 AND 52).

CLASS 44—MEDICAL, BEAUTY AND AGRICULTURAL SERVICES

FOR PROVIDING HEALTH AND LIFE-STYLE ENHANCEMENT SERVICES, NAMELY, ALTERNATIVE MEDICINE SERVICES, WEIGHT LOSS PROGRAM SERVICES, DIETARY AND NUTRITIONAL GUIDANCE, SMOKING CESSATION TREATMENT SERVICES, BODY CARE SERVICES IN THE NATURE OF BODY WRAPS, ACUPUNCTURE SERVICES, AROMATHERAPY SERVICES, THE TREATMENT OF SLEEP DISORDERS, CONSULTATION IN THE FIELD OF MENTAL HEALTH AND WELLNESS, AND PROVIDING ASSISTANCE, FITNESS EVALUATION, AND CONSULTATION TO INDIVIDUALS TO HELP THEM MAKE HEALTH, WELLNESS, AND NUTRITIONAL CHANGES IN THEIR DAILY LIVING TO IMPROVE HEALTH (U.S. CLS. 100 AND 101).

PAM WILLIS, EXAMINING ATTORNEY

SN 77-585,250. LOUISVILLE LADDER INC., LOUISVILLE, KY. FILED 10-3-2008.

PRO SERIES

THE MARK CONSISTS OF STANDARD CHARACTERS WITHOUT CLAIM TO ANY PARTICULAR FONT, STYLE, SIZE, OR COLOR.

NO CLAIM IS MADE TO THE EXCLUSIVE RIGHT TO USE "SERIES", APART FROM THE MARK AS SHOWN.

CLASS 6—METAL GOODS

FOR METAL STEPLADDERS AND LADDERS (U.S. CLS. 2, 12, 13, 14, 23, 25 AND 50).

CLASS 20—FURNITURE AND ARTICLES NOT OTHERWISE CLASSIFIED

FOR NON-METAL STEPLADDERS AND LADDERS
(U.S. CLS. 2, 13, 22, 25, 32 AND 50).
RONALD AIKENS, EXAMINING ATTORNEY

SN 77-585,776. JANGUS MUSIC, INC., LAGUNA NIGUEL,
CA. FILED 10-5-2008.



THE MARK CONSISTS OF MARK INCLUDES THE LETTER "W" BLENDED WITH THE LETTER "I" WITH THREE CURVED LINES ABOVE THE DOT OVER THE LETTER "I".

CLASS 9—ELECTRICAL AND SCIENTIFIC APPARATUS

FOR AUDIO AND VIDEO ELECTRONIC EQUIPMENT AND MUSICAL INSTRUMENT EFFECTORS FOR PROFESSIONAL AND CONSUMER USE, NAMELY, HARD DISK RECORDERS, MONITORS, SPEAKERS, AMPLIFIERS, SEQUENCERS, SIGNAL PROCESSORS, SIGNAL DELAYS, ELECTRONIC ECHO UNITS, MIXERS, DIGITAL PROCESSORS, OPTICAL INTERFACES, VOCAL AND INSTRUMENTAL EFFECTS PROCESSORS; COMPUTER PORTS FOR EDITING, MANAGING, AND MIXING AUDIO, SOUND, ELECTRONIC MUSICAL KEYBOARDS AND ELECTRIC GUITARS; STORAGE SOLUTIONS, NAMELY, COMPUTER STORAGE DEVICES BEING HIGH-SPEED STORAGE SUBSYSTEMS FOR STORAGE AND BACKUP OF ELECTRONIC DATA EITHER LOCALLY OR VIA A TELECOMMUNICATIONS NETWORK AND PARTS THEREFOR; COMPUTER ACCESSORIES, NAMELY, COMPUTER KEYBOARDS, COMPUTER MODEMS AND WEBCAMS AND PARTS THEREFOR; WIRELESS COMMUNICATIONS SOLUTIONS, NAMELY, WIRELESS TELEPHONES, ANTENNAE FOR WIRELESS COMMUNICATION DEVICES AND PARTS THEREFOR; ELECTRONIC SOUND RECORDING EQUIPMENT AND MUSICAL INSTRUMENT EFFECTORS, NAMELY, SOUND AMPLIFIERS, SEQUENCERS, SIGNAL PROCESSORS, SIGNAL DELAYS, ELECTRONIC ECHO UNITS, MUSICAL KEYBOARD EFFECTS PROCESSORS AND ELECTRIC GUITAR EFFECTS PROCESSORS; PRE-RECORDED AUDIO TAPES, DISCS AND CASSETTES, VIDEO TAPES, DISCS AND CASSETTES, DIGITAL AUDIO AND AUDIO VIDEO TAPES AND DISCS, CDS, DVDS, LASER DISCS, LARGE STORAGE OPTICAL DISCS, SOLID-STATE MEDIA AND PHONOGRAPH RECORDS FEATURING MUSIC AND ENTERTAINMENT; THEATRICAL AND MUSICAL SOUND AND VIDEO RECORDINGS; VIRTUAL REALITY GAME SOFTWARE; DOWNLOADABLE RING TONES, MUSIC, MP3S, GRAPHICS, GAMES, IMAGES AND VIDEOS FOR WIRELESS COMMUNICATION DEVICES; COMPUTER GAME DISCS, COMPUTER IMAGES RECORDED ON COMPUTER FEATURING MUSIC VIDEOS AND THEATRICAL PRODUCTIONS AND COMPUTER VIDEO RECORDINGS FEATURING MUSIC VIDEOS AND THEATRICAL PRODUCTIONS; COMPUTER GAME SOFTWARE; VIDEO GAME SOFTWARE, TAPES, CARTRIDGES AND CASSETTES DISCS, CDS, DVDS, LASER DISCS, LARGE STORAGE OPTICAL DISCS AND SOLID-STATE MEDIA; MOUSE PADS; PORTABLE AND HANDHELD DIGITAL ELECTRONIC DEVICES FOR RECORDING, ORGANIZING, TRANSMITTING, MANIPULATING, AND REVIEWING TEXT,

DATA AND AUDIO FILES; AND DIGITAL ELECTRONIC DEVICES FOR RECORDING, ORGANIZING, TRANSMITTING, MANIPULATING, AND REVIEWING TEXT, DATA AND AUDIO FILES FOR VEHICLES; AUDIO RECORDINGS FEATURING MUSIC; HEALING AND EDUCATIONAL MUSIC CDS AND DVDS; COMPUTER PROGRAMS FOR DOCUMENT MANAGEMENT; COMPUTER PROGRAMS FOR EDITING IMAGES INCLUDING 3D IMAGES, SOUND AND VIDEO; COMPUTER SOFTWARE FOR CREATING SEARCHABLE DATABASES OF INFORMATION AND DATA; COMPUTER SOFTWARE FOR MANIPULATING DIGITAL AUDIO INFORMATION FOR USE IN AUDIO MEDIA APPLICATIONS; COMPUTER SOFTWARE FOR ORGANIZING AND VIEWING DIGITAL IMAGES AND PHOTOGRAPHS; COMPUTER SOFTWARE FOR PROCESSING DIGITAL MUSIC FILES; COMPUTER SOFTWARE FOR THE COLLECTION, EDITING, ORGANIZING, MODIFYING, BOOK MARKING, TRANSMISSION, STORAGE AND SHARING OF DATA AND INFORMATION; COMPUTER SOFTWARE FOR USE IN THE ENCRYPTION AND DECRYPTION OF DIGITAL FILES, INCLUDING AUDIO, VIDEO, TEXT, BINARY, STILL IMAGES, 3D IMAGES, GRAPHICS AND MULTIMEDIA FILES; COMPUTER SOFTWARE FOR USE IN THE SAFEGUARDING OF DIGITAL FILES, INCLUDING, AUDIO, VIDEO, TEXT, BINARY, STILL IMAGES, GRAPHICS AND MULTIMEDIA FILES; COMPUTER SOFTWARE FOR RETRIEVING, PLAYING, PURCHASING, AND CONTROLLING ACCESS TO MEDIA VIA COMMUNICATIONS NETWORKS; DOWNLOADABLE MUSICAL SOUND RECORDINGS; DOWNLOADABLE VIDEO RECORDINGS FEATURING MUSIC AND MUSIC EVENTS; ELECTRONIC PUBLICATIONS RECORDED ON COMPUTER MEDIA IN THE NATURE OF A NEWSLETTER AND INFORMATIONAL POSTINGS IN THE NATURE OF LETTERS AND NOTES IN THE FIELD OF MUSIC; DOWNLOADABLE AUDIO FILES, MULTIMEDIA FILES, TEXT FILES, E-MAILS, WRITTEN DOCUMENTS, AUDIO MATERIAL, VIDEO MATERIAL AND GAMES FEATURING INFORMATION IN THE FORM OF DOWNLOADABLE SHORT EDUCATIONAL/TRAINING COMMUNICATIONS IN THE FIELD OF INCREASED PRODUCTIVITY FOR MUSICIANS AND ARTISTS; DOWNLOADABLE MP3 FILES, MP3 RECORDINGS, ON-LINE DISCUSSION BOARDS, WEBCASTS AND PODCASTS FEATURING MUSIC, AUDIO BOOKS AND NEWS BROADCASTS; DOWNLOADABLE MULTIMEDIA FILE CONTAINING ARTWORK, TEXT, AUDIO, VIDEO, GAMES, AND INTERNET WEB LINKS RELATING TO ARTISTIC WORKS BY A DIVERSE GROUP OF ARTISTS PERFORMING IN DIGITAL MEDIA; DOWNLOADABLE MUSICAL SOUND RECORDINGS; DOWNLOADABLE RING TONES, GRAPHICS AND MUSIC VIA A GLOBAL COMPUTER NETWORK AND WIRELESS DEVICES; DOWNLOADABLE VIDEO RECORDINGS FEATURING MUSIC SELF IMPROVEMENT; MUSICAL SOUND RECORDINGS; MUSICAL VIDEO RECORDINGS; SOUND RECORDINGS FEATURING MUSIC; VIDEO RECORDINGS FEATURING MUSIC; VISUAL RECORDINGS AND AUDIOVISUAL RECORDINGS FEATURING MUSIC AND ANIMATION. ELECTRONIC SOUND RECORDING EQUIPMENT AND MUSICAL INSTRUMENT EFFECTORS, NAMELY, SOUND AMPLIFIERS, SEQUENCERS, SIGNAL PROCESSORS, SIGNAL DELAYS, ELECTRONIC ECHO UNITS, AND PARTS THEREFOR; DIGITAL AUDIO RECORDERS; DIGITAL AUDIO SOUND EDITORS; DIGITAL AUDIO SOUND MIXERS; SUNGLASSES; ELECTRONIC SOUND SYNTHESIZERS; HARD DISK RECORDERS, MONITORS, SPEAKERS, AMPLIFIERS, SEQUENCERS, SIGNAL PROCESSORS, SIGNAL DELAYS, ELECTRONIC ECHO UNITS, MIXERS, DIGITAL PROCESSORS, OPTICAL INTERFACES, VOCAL AND INSTRUMENTAL EFFECTS PROCESSORS, COMPUTER PORTS FOR EDITING, MANAGING, AND MIXING AUDIO (U.S. CLS. 21, 23, 26, 36 AND 38).
FIRST USE 9-1-2008; IN COMMERCE 9-1-2008.

CLASS 15—MUSICAL INSTRUMENTS

FOR MUSIC SYNTHESIZERS, ELECTRONIC GUITARS, ELECTRONIC DRUM AND PERCUSSION MACHINES; ELECTRONIC PIANOS, ELECTRONIC ORGANS AND RHYTHM MACHINES, NAMELY, AUTOMATIC REPETITIVE RHYTHM INSTRUMENTS; MUSICAL KEYBOARDS, AND ELECTRIC GUITARS AND PARTS THEREFORE (U.S. CLS. 2, 21 AND 36).
FIRST USE 9-1-2008; IN COMMERCE 9-1-2008.

CLASS 25—CLOTHING

FOR CLOTHING, NAMELY, SUITS, STOCKINGS, UNDER GARMENTS, SHIRTS, T-SHIRTS, PANTS, SKIRTS, DRESSES, JACKETS, COATS, BLAZERS, SWEATERS, SCARVES, HATS, HEADWEAR, BATHROBES, SHORTS, SOCKS, BELTS, GLOVES, JEANS, NECKWEAR, SWIMWEAR, BEACHWEAR, FOOTWEAR, VISORS, SLEEP MASKS, CLOTH BIBS, NIGHTWEAR, OUTERWEAR, NAMELY, PARKAS, WIND VESTS, AND COATS, WRAPS AND WRISTBANDS (U.S. CLS. 22 AND 39).
FIRST USE 9-1-2008; IN COMMERCE 9-1-2008.
RON FAIRBANKS, EXAMINING ATTORNEY

CLASS 41—EDUCATION AND ENTERTAINMENT

FOR PROVIDING A WEBSITE FEATURING TRIVIA, PUZZLES, RIDDLES, WORD GAMES, DIGITAL ENTERTAINMENT IMAGES, FICTIONAL AND NON-FICTIONAL STORIES; PROVIDING ONLINE INFORMATION IN THE ACADEMIC FIELDS OF CREATIVITY, IDEATION, PERCEPTION, OUT OF THE BOX THINKING, MUSIC, ART, PHILOSOPHY, HISTORY, FAMILY VALUES, HUMOR AND SPORTS; ELECTRONIC PUBLISHING SERVICES, NAMELY, PUBLISHING OF ONLINE WORKS OF OTHERS FEATURING USER-CREATED TEXT, AUDIO, VIDEO, AND GRAPHICS; PROVIDING ON-LINE JOURNALS AND WEB LOGS FEATURING GENERAL INTEREST, CREATIVITY, IDEATION, PERCEPTION, OUT OF THE BOX THINKING, FAITH, SPIRITUALITY, ROMANCE, MUSIC, ART, LAW, PHILOSOPHY, HISTORY, FAMILY, HEALTH, COOKING, HOME AND GARDEN, NATURE, TRAVEL, HUMOR AND SPORTS; ON-LINE PUBLISHING OF ELECTRONIC PUBLICATIONS; ENTERTAINMENT SERVICES, NAMELY, PROVIDING ON-LINE COMPUTER GAMES AND CONTESTS; ON-LINE JOURNALS, NAMELY, BLOGS FEATURING PERSONAL INFORMATION AND OPINIONS IN FIELDS OF GENERAL INTEREST, CREATIVITY, IDEATION, PERCEPTION, OUT OF THE BOX THINKING, FAITH, SPIRITUALITY, ROMANCE, MUSIC, ART, LAW, PHILOSOPHY, HISTORY, FAMILY, HEALTH, COOKING, HOME AND GARDEN, NATURE, TRAVEL, HUMOR AND SPORTS (U.S. CLS. 100, 101 AND 107).
CAROLINE WOOD, EXAMINING ATTORNEY

SN 77-586,388. NOT-NOT, INC., TEMPLE TERRACE, FL. FILED 10-6-2008.

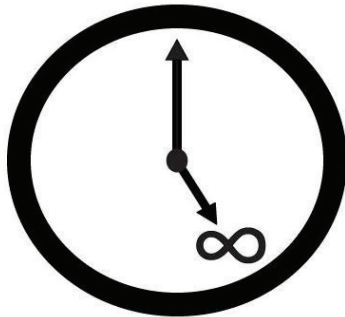

THE MARK CONSISTS OF AN INFINITY SYMBOL WITHIN A FACE OF A CLOCK.

CLASS 25—CLOTHING

FOR CLOTHING, NAMELY, HATS, SHIRTS, UNDERWEAR, SOCKS AND TIES (U.S. CLS. 22 AND 39).

SN 77-587,888. DEVO, INC., LOS ANGELES, CA. FILED 10-7-2008.



THE COLOR(S) RED IS/ARE CLAIMED AS A FEATURE OF THE MARK.
THE MARK CONSISTS OF A THREE-DIMENSIONAL RED PYRAMID WITH A FLAT TOP. THE PYRAMID CONSISTS OF FOUR TIERS, WHICH DECREASE IN SIZE FROM BOTTOM TO TOP.

CLASS 9—ELECTRICAL AND SCIENTIFIC APPARATUS

FOR SOUND AND VISUAL RECORDINGS FEATURING MUSICAL PERFORMANCES AND MUSIC VIDEOS (U.S. CLS. 21, 23, 26, 36 AND 38).
FIRST USE 7-1-1980; IN COMMERCE 7-1-1980.

CLASS 41—EDUCATION AND ENTERTAINMENT

FOR ENTERTAINMENT SERVICES, NAMELY, RENDERING LIVE MUSICAL PERFORMANCES BY A VOCAL AND INSTRUMENTAL GROUP (U.S. CLS. 100, 101 AND 107).
FIRST USE 7-1-1980; IN COMMERCE 7-1-1980.

TRACY WHITTAKER-BROWN, EXAMINING ATTORNEY

CLASS 42—SCIENTIFIC AND COMPUTER SERVICES

FOR CLINICAL RESEARCH SERVICES, NAMELY, COLLECTION, CALIBRATION, AND REPORTING OF DATA IN CONNECTION WITH CLINICAL TRIALS OF PHARMACEUTICALS AND MEDICAL DEVICES; TESTING AND PRODUCT DEVELOPMENT OF BIOPHARMACEUTICALS AND MEDICAL DEVICES LABORATORY RESEARCH, NAMELY, GENOTYPING AND PHENOTYPING OF ANIMALS, CUSTOM ASSAY DEVELOPMENT; LABORATORY ANIMAL SCIENTIFIC RESEARCH AND TESTING AND AVIAN EGG DEVELOPMENT AND TESTING SERVICES FOR THE PURPOSE OF SCIENTIFIC RESEARCH AND NEW PRODUCT RESEARCH AND DEVELOPMENT; RESEARCH AND DEVELOPMENT OF CHEMICALS, AGROCHEMICALS, PHARMACEUTICALS, BIOLOGICS, VACCINES AND MEDICAL DEVICES; SCIENTIFIC TESTING OF CHEMICALS, AGROCHEMICALS, PHARMACEUTICALS, BIOLOGICS, VACCINES, AND MEDICAL DEVICES; BIOPHARMACEUTICAL RESEARCH DESIGN AND SCIENTIFIC TESTING SERVICES; PRODUCT SAFETY TESTING FOR PHARMACEUTICALS, BIOPHARMACEUTICALS, CHEMICALS, PESTICIDES, MEDICAL DEVICES, VACCINES, AND BIOLOGICS; TOXICOLOGICAL SAFETY TESTING SERVICES FOR PHARMACEUTICALS, CHEMICALS, AGROCHEMICALS, AND CONSUMER PRODUCTS; RESEARCH AND SCIENTIFIC TESTING OF PHARMACEUTICALS, BIOPHARMACEUTICALS, BIOLOGICS, AND MEDICAL DEVICES FOR THE PRESENCE OF ENDOTOXINS; REVIEWING STANDARDS AND PRACTICES TO ASSURE COMPLIANCE WITH FEDERAL FOOD, DRUG AND ENVIRONMENTAL LAWS AND REGULATIONS; REVIEWING STANDARDS AND PRACTICES AND PREPARING REPORTS RELATING TO COMPLIANCE WITH ENVIRONMENTAL SAFETY LAWS AND REGULATIONS; ANIMAL MEDICAL RESEARCH AND TESTING SERVICES AND AVIAN EGG DEVELOPMENT AND TESTING SERVICES FOR THE PURPOSE OF MEDICAL RESEARCH; CONSULTING SERVICES IN THE FIELDS OF SCIENTIFIC AND MEDICAL RESEARCH; LABORATORY SERVICES IN THE FIELDS OF PRODUCT DEVELOPMENT AND SCIENTIFIC AND MEDICAL RESEARCH; TESTING SERVICES IN THE FIELDS OF PRODUCT DEVELOPMENT AND SCIENTIFIC AND MEDICAL RESEARCH; PRODUCT DEVELOPMENT SERVICES; REVIEWING STANDARDS AND PRACTICES TO ASSURE COMPLIANCE WITH FEDERAL LAWS AND REGULATIONS; CONSULTING SERVICES AND SUPPORT SERVICES FOR CLINICAL TRIALS, CLINICAL TRIAL MANAGEMENT, AND CLINICAL TRIAL RECRUITING; CONDUCTING CLINICAL TRIALS; TOXICOLOGY SERVICES (U.S. CLS. 100 AND 101).

SN 77-587,899. HARLAN HOLDINGS, INC., WILMINGTON, DE. FILED 10-7-2008.



THE MARK CONSISTS OF THE WORD "HARLAN" WITH A DEPICTION OF A MOLECULE OVERLAPPING THE LETTER "A".

CLASS 1—CHEMICALS

FOR CHEMICAL, BIOCHEMICAL, AND BIOLOGICAL PREPARATIONS FOR SCIENTIFIC, PHARMACEUTICAL, BIOLOGICAL, MEDICAL, AND BIOMEDICAL RESEARCH AND DEVELOPMENT, AND DIAGNOSTIC PREPARATIONS FOR SCIENTIFIC AND RESEARCH USE (U.S. CLS. 1, 5, 6, 10, 26 AND 46).

CLASS 5—PHARMACEUTICALS

FOR MEDICATED ANIMAL FEED (U.S. CLS. 6, 18, 44, 46, 51 AND 52).

CLASS 10—MEDICAL APPARATUS

FOR MEDICAL AND SURGICAL CATHETERS FOR LABORATORY ANIMALS (U.S. CLS. 26, 39 AND 44).

CLASS 31—NATURAL AGRICULTURAL PRODUCTS

FOR LIVE LABORATORY ANIMALS; FERTILIZED AND UNFERTILIZED AVIAN EGGS FOR SCIENTIFIC, PHARMACEUTICAL, BIOLOGICAL, BIOMEDICAL, AND MEDICAL RESEARCH, DEVELOPMENT, AND MANUFACTURING; ANIMAL EMBRYOS; ANIMAL FEED (U.S. CLS. 1 AND 46).

CLASS 44—MEDICAL, BEAUTY AND AGRICULTURAL SERVICES

FOR LABORATORY ANIMAL BREEDING; LABORATORY ANIMAL PRECONDITIONING, NAMELY, HOLDING AND FEEDING ANIMALS SPECIAL DIETS AND/OR SUPPLEMENTS OR ALLOWING ANIMALS TO DEVELOP TO CERTAIN AGES BEFORE SUPPLYING THEM TO CUSTOMERS, PERFORMING SURGICAL MANIPULATIONS ON ANIMALS, RECORDING AND MEASURING VARIOUS PHENOTYPIC PARAMETERS; GENETIC TESTING OF ANIMALS AND EGGS; CONSULTING SERVICES IN THE FIELD OF LABORATORY ANIMAL CARETAKING; SURGICAL SERVICES; ANIMAL BREEDING; ANIMAL HUSBANDRY; GENETIC TESTING OF ANIMALS; SURGERY ON ANIMALS; AND HEALTH TESTING OF ANIMALS (U.S. CLS. 100 AND 101).

ANDREW LEASER, EXAMINING ATTORNEY

SN 77-588,198. VITAL CHOICE SEAFOOD, INC., BELLINGHAM, WA. FILED 10-8-2008.

CUBECYCLE

THE MARK CONSISTS OF STANDARD CHARACTERS WITHOUT CLAIM TO ANY PARTICULAR FONT, STYLE, SIZE, OR COLOR.

CLASS 35—ADVERTISING AND BUSINESS

FOR PROMOTING PUBLIC AWARENESS OF ENVIRONMENTALLY RESPONSIBLE HARVESTING, MANUFACTURING, SHIPPING, PACKAGING, AND MARKETING PRACTICES RELATED TO THE DISTRIBUTION OF FOOD DIRECTLY TO CONSUMERS (U.S. CLS. 100, 101 AND 102).
FIRST USE 7-23-2008; IN COMMERCE 7-23-2008.

CLASS 40—MATERIAL TREATMENT

FOR RECYCLING SERVICES, FEATURING THE USE OF FOAM PACKAGING MATERIAL (U.S. CLS. 100, 103 AND 106).
FIRST USE 7-23-2008; IN COMMERCE 7-23-2008.
JAY FLOWERS, EXAMINING ATTORNEY

SN 77-588,282. BED BATH & BEYOND PROCUREMENT CO. INC., FARMINGDALE, NY. FILED 10-8-2008.

PALAIS ROYALE

THE MARK CONSISTS OF STANDARD CHARACTERS WITHOUT CLAIM TO ANY PARTICULAR FONT, STYLE, SIZE, OR COLOR.

THE ENGLISH TRANSLATION OF "PALAIS ROYALE" IS ROYAL PALACE.

CLASS 20—FURNITURE AND ARTICLES NOT OTHERWISE CLASSIFIED

FOR DECORATIVE PILLOWS (U.S. CLS. 2, 13, 22, 25, 32 AND 50).

CLASS 21—HOUSEWARES AND GLASS

FOR BATHROOM ACCESSORIES, NAMELY, TOOTHBRUSH HOLDERS, SHOWER CADDIES, SOAP DISHES, GARBAGE CANS AND BATHROOM CUPS (U.S. CLS. 2, 13, 23, 29, 30, 33, 40 AND 50).

CLASS 24—FABRICS

FOR BEDDING, NAMELY, SHEETS, DUVETS, COMFORTERS, BLANKETS, MATTRESS PADS, QUILTS AND THROWS; WINDOW TREATMENTS, NAMELY, CURTAINS, DRAPERY, FABRIC VALANCES, AND SWAGS; TABLECLOTHS NOT OF PAPER; PLACEMATS NOT OF PAPER; TEXTILE NAPKINS; BATH TOWELS, HAND TOWELS AND FACE TOWELS; BATHROOM ACCESSORIES, NAMELY, SHOWER CURTAINS (U.S. CLS. 42 AND 50).

CLASS 27—FLOOR COVERINGS

FOR FABRIC BATH MATS (U.S. CLS. 19, 20, 37, 42 AND 50).
LINDA LAVACHE, EXAMINING ATTORNEY

SN 77-588,871. GOOGLE INC., MOUNTAIN VIEW, CA. FILED 10-8-2008.



OWNER OF U.S. REG. NOS. 3,525,802 AND 3,525,803.
THE MARK CONSISTS OF THE WORD "YOU" AND THE WORD "TUBE" IN A VIEWING MONITOR.

CLASS 9—ELECTRICAL AND SCIENTIFIC APPARATUS

FOR DOWNLOADABLE SOFTWARE TO ENABLE UPLOADING, POSTING, SHOWING, DISPLAYING, TAGGING, BLOGGING, SHARING AND OTHERWISE PROVIDING ELECTRONIC MEDIA OR INFORMATION OVER THE INTERNET AND OTHER COMMUNICATIONS NETWORKS; APPLICATION PROGRAM INTERFACE (API) THAT ENABLES DEVELOPERS TO INTEGRATE VIDEO CONTENT AND FUNCTIONALITY INTO WEBSITES, SOFTWARE APPLICATIONS, AND DEVICES (U.S. CLS. 21, 23, 26, 36 AND 38).
FIRST USE 1-24-2008; IN COMMERCE 1-24-2008.

CLASS 35—ADVERTISING AND BUSINESS

FOR ADVERTISING AND PROMOTIONAL SERVICES ON BEHALF OF OTHERS; PROMOTIONAL SERVICES, NAMELY, PROMOTING THE GOODS AND SERVICES OF OTHERS THROUGH ONLINE ENTERTAINMENT, ONLINE EDUCATION, AND SHARING OF MULTIMEDIA CONTENT VIA THE INTERNET AND OTHER COMMUNICATIONS NETWORKS; DEVELOPING AND PROVIDING MARKETING PROGRAMS FOR ADVERTISERS, MARKETERS, AND CONTENT PROVIDERS; PROVIDING A WEBSITE WHERE ADVERTISERS, MARKETERS, AND CONTENT PROVIDERS CAN REACH, ENGAGE, AND INTERACT WITH ONLINE USERS FOR THE PURPOSES OF PROMOTION OR ADVERTISING (U.S. CLS. 100, 101 AND 102).
FIRST USE 3-15-2006; IN COMMERCE 3-15-2006.

CLASS 38—COMMUNICATION

FOR AUDIO, VIDEO AND MULTIMEDIA BROADCASTING VIA THE INTERNET AND OTHER COMMUNICATIONS NETWORKS; WEBCASTING SERVICES; TRANSMISSION OF MESSAGES, DATA AND CONTENT VIA THE INTERNET AND OTHER COMMUNICATIONS NETWORKS; PROVIDING FORUMS AND CHAT ROOMS FOR THE TRANSMISSION OF MESSAGES, COMMENTS AND MULTIMEDIA CONTENT AMONG USERS IN THE FIELD OF GENERAL INTEREST VIA THE INTERNET AND OTHER COMMUNICATIONS NETWORKS; TRANSMISSION OF ELECTRONIC MEDIA, MULTIMEDIA CONTENT, VIDEOS, MOVIES, PICTURES, IMAGES, TEXT, PHOTOS, USER-GENERATED CONTENT, AUDIO CONTENT, AND INFORMATION VIA THE INTERNET AND OTHER COMMUNICATIONS NETWORKS; PROVIDING COMMUNITY FORUMS FOR USERS TO POST, SEARCH, WATCH, SHARE, CRITIQUE, RATE, AND COMMENT ON, VIDEOS AND OTHER MULTIMEDIA CONTENT VIA THE INTERNET AND OTHER COMMUNICATIONS NETWORKS (U.S. CLS. 100, 101 AND 104).
FIRST USE 4-24-2005; IN COMMERCE 4-24-2005.

CLASS 41—EDUCATION AND ENTERTAINMENT

FOR ENTERTAINMENT AND EDUCATIONAL SERVICES, NAMELY, PROVIDING A WEBSITE FEATURING USER-GENERATED CONTENT, NAMELY, ELECTRONIC MEDIA, MULTIMEDIA CONTENT, VIDEOS, MOVIES, PICTURES, IMAGES, TEXT, PHOTOS, AUDIO CONTENT, AND RELATED INFORMATION VIA THE INTERNET AND OTHER COMMUNICATIONS NETWORKS ON A WIDE VARIETY OF TOPICS AND SUBJECTS; PROVIDING ONLINE JOURNALS, NAMELY, BLOGS FEATURING INFORMATION ON THE SUBJECT OF THE ABOVE-LISTED USER-GENERATED WEBSITE CONTENT; ONLINE DIGITAL VIDEO, AUDIO AND MULTIMEDIA ENTERTAINMENT PUBLISHING SERVICES; ONLINE DIGITAL PUBLISHING SERVICES; ENTERTAINMENT SERVICES, NAMELY, CONDUCTING CONTESTS (U.S. CLS. 100, 101 AND 107).

FIRST USE 4-24-2005; IN COMMERCE 4-24-2005.

CLASS 42—SCIENTIFIC AND COMPUTER SERVICES

FOR PROVIDING TEMPORARY USE OF NON-DOWNLOADABLE SOFTWARE TO ENABLE UPLOADING, CAPTURING, POSTING, SHOWING, EDITING, PLAYING, STREAMING, VIEWING, PREVIEWING, DISPLAYING, TAGGING, BLOGGING, SHARING, MANIPULATING, DISTRIBUTING, PUBLISHING, REPRODUCING, AND OTHERWISE PROVIDING ELECTRONIC MEDIA, MULTIMEDIA CONTENT, VIDEOS, MOVIES, PICTURES, IMAGES, TEXT, PHOTOS, USER-GENERATED CONTENT, AUDIO CONTENT AND INFORMATION VIA THE INTERNET AND OTHER COMMUNICATIONS NETWORKS; PROVIDING TEMPORARY USE OF NON-DOWNLOADABLE SOFTWARE TO ENABLE SHARING OF MULTIMEDIA CONTENT AND COMMENTS AMONG USERS; PROVIDING TEMPORARY USE OF NON-DOWNLOADABLE SOFTWARE TO ENABLE CONTENT PROVIDERS TO TRACK MULTIMEDIA CONTENT; PROVIDING TEMPORARY USE OF NON-DOWNLOADABLE ANALYTICS SOFTWARE, NAMELY, SOFTWARE THAT PROVIDES STATISTICS ABOUT THE BEHAVIOR OF VIEWERS OF ONLINE VIDEOS, MOVIES, PICTURES, IMAGES, TEXT, PHOTOS, GAMES AND OTHER USER-GENERATED CONTENT; HOSTING OF WEBSITES FEATURING MULTIMEDIA CONTENT FOR OTHERS; HOSTING MULTIMEDIA ENTERTAINMENT AND EDUCATIONAL CONTENT FOR OTHERS; PROVIDING A WEB SITE THAT GIVES COMPUTER USERS THE ABILITY TO UPLOAD AND SHARE USER-GENERATED VIDEOS, ESSAYS AND ARTICLES ON A WIDE VARIETY OF TOPICS AND SUBJECTS (U.S. CLS. 100 AND 101).

FIRST USE 4-24-2005; IN COMMERCE 4-24-2005.
LAURA KOVALSKY, EXAMINING ATTORNEY

SN 77-589,010. FACEBOOK, INC, PALO ALTO, CA. FILED 10-9-2008.

SOUNDBOARD

THE MARK CONSISTS OF STANDARD CHARACTERS WITHOUT CLAIM TO ANY PARTICULAR FONT, STYLE, SIZE, OR COLOR.

CLASS 35—ADVERTISING AND BUSINESS

FOR INFORMATION SERVICES RELATING TO NATIONAL AND INTERNATIONAL POLITICS; PROVIDING ONLINE SEARCHABLE DATABASES FEATURING NEWS AND INFORMATION IN THE FIELD OF NATIONAL AND INTERNATIONAL POLITICS (U.S. CLS. 100, 101 AND 102).

CLASS 38—COMMUNICATION

FOR PROVIDING AN ONLINE FORUM VIA GLOBAL COMMUNICATION NETWORKS FOR THE EXCHANGE OF MESSAGES AND AUDIO AND VIDEO CONTENT IN THE FIELDS OF CURRENT EVENT NEWS, NATIONAL AND INTERNATIONAL POLITICS, AND GENERAL INTEREST; BROADCASTING AND TRANSMITTING AUDIO AND VIDEO CONTENT (U.S. CLS. 100, 101 AND 104).

CLASS 41—EDUCATION AND ENTERTAINMENT

FOR ELECTRONIC PUBLISHING SERVICES, NAMELY, PUBLISHING OF TEXT, GRAPHIC, AUDIO AND VIDEO WORKS OF OTHERS ONLINE IN THE FIELDS OF CURRENT EVENT NEWS, NATIONAL AND INTERNATIONAL POLITICS, AND GENERAL INTEREST; PROVIDING ONLINE JOURNALS AND WEBLOGS IN THE FIELDS OF CURRENT EVENT NEWS, NATIONAL AND INTERNATIONAL POLITICS, AND GENERAL INTEREST (U.S. CLS. 100, 101 AND 107).

CLASS 42—SCIENTIFIC AND COMPUTER SERVICES

FOR COMPUTER SERVICES, NAMELY, HOSTING ONLINE WEB FACILITIES FOR OTHERS FOR ORGANIZING AND CONDUCTING MEETINGS, GATHERINGS AND INTERACTIVE DISCUSSIONS; APPLICATION SERVICE PROVIDER SERVICES, NAMELY, HOSTING SERVICES FOR TEXTUAL, AUDIO AND VIDEO CONTENT VIA GLOBAL COMMUNICATION NETWORKS IN THE FIELDS OF CURRENT EVENT NEWS, NATIONAL AND INTERNATIONAL POLITICS, AND GENERAL INTEREST (U.S. CLS. 100 AND 101).

CLASS 45—PERSONAL AND LEGAL SERVICES

FOR ONLINE SOCIAL NETWORKING SERVICES (U.S. CLS. 100 AND 101).
JACLYN KIDWELL, EXAMINING ATTORNEY

SN 77-589,057. FAMILPLAN CONSULTING LTD OY, FI-02160 ESPOO, FINLAND, FILED 10-9-2008.

WANDA

THE MARK CONSISTS OF STANDARD CHARACTERS WITHOUT CLAIM TO ANY PARTICULAR FONT, STYLE, SIZE, OR COLOR.

PRIORITY CLAIMED UNDER SEC. 44(D) ON ERPNTY TM OFC APPLICATION NO. 007297922, FILED 10-8-2008, REG. NO. 007297922, DATED 5-28-2009, EXPIRES 10-8-2018.

CLASS 5—PHARMACEUTICALS

FOR INTRAUTERINE CONTRACEPTIVE PREPARATIONS USED FOR FEMALE CONTRACEPTION AND FOR TREATMENT OF ANEMIA CAUSED BY MENSTRUAL BLOOD LOSS (U.S. CLS. 6, 18, 44, 46, 51 AND 52).

CLASS 10—MEDICAL APPARATUS

FOR INTRAUTERINE CONTRACEPTIVE DEVICES (U.S. CLS. 26, 39 AND 44).
TAMARA FRAZIER, EXAMINING ATTORNEY

SN 77-589,058. SERVIDYNE, INC., ATLANTA, GA. FILED 10-9-2008.



THE COLOR(S) GREEN, YELLOW, AND ORANGE IS/ARE CLAIMED AS A FEATURE OF THE MARK.

THE MARK CONSISTS OF TWO SETS OF THREE PARALLEL LINES IN THE COLORS, GREEN, YELLOW, ORANGE, GREEN, YELLOW, AND ORANGE, FROM LEFT TO RIGHT.

CLASS 9—ELECTRICAL AND SCIENTIFIC APPARATUS

FOR COMPUTER SOFTWARE FOR USE IN MANAGING EMPLOYEES WHO SERVE BUILDING RESIDENTS IN COMMERCIAL INSTITUTIONAL FACILITIES (U.S. CLS. 21, 23, 26, 36 AND 38).

FIRST USE 7-26-2008; IN COMMERCE 7-26-2008.

CLASS 36—INSURANCE AND FINANCIAL

FOR WEB-BASED PROPERTY MANAGEMENT AND SERVICES SOLUTIONS FEATURING FULLY AUTOMATED MAINTENANCE MANAGEMENT USING THE INTERNET AND WIRELESS HANDHELD DEVICES, NAMELY, REAL PROPERTY MANAGEMENT, INCLUDING COMMERCIAL, INSTITUTIONAL, INDUSTRIAL, RETAIL AND HOSPITALITY PROPERTIES (U.S. CLS. 100, 101 AND 102).

FIRST USE 7-26-2008; IN COMMERCE 7-26-2008.

CLASS 37—CONSTRUCTION AND REPAIR

FOR PROVIDING MAINTENANCE AND SERVICE REQUEST SOLUTIONS, NAMELY, PROVIDING MAINTENANCE OF ENERGY FACILITIES TO AID IN THE REDUCTION OF BUILDING OPERATING AND OWNERSHIP COSTS; BUILDING COMMISSIONING, NAMELY, PROVIDING CONSTRUCTION CONSULTATION; INSTALLATION OF ENERGY SAVING SYSTEMS THAT REDUCE ENERGY CONSUMPTION AND OPERATING COSTS TO COMMERCIAL, INDUSTRIAL AND INSTITUTIONAL FACILITIES; LIGHTING SERVICES, NAMELY, INSTALLATION AND MAINTENANCE OF ENERGY-EFFICIENT LIGHTING SYSTEMS; GROUP RELAMP SERVICES, NAMELY, INSTALLATION AND REPLACEMENT OF ENTIRE LIGHTING SYSTEMS AT A PREDETERMINED TIME; INSTALLATION AND RETROFITTING OF HVAC ENERGY EFFICIENCY SYSTEMS (U.S. CLS. 100, 103 AND 106).

FIRST USE 7-26-2008; IN COMMERCE 7-26-2008.

CLASS 42—SCIENTIFIC AND COMPUTER SERVICES

FOR ENGINEERING SERVICES, NAMELY, ANALYSIS OF ENVIRONMENTAL CONTROL SYSTEMS TO DETERMINE THE MINIMUM ATTAINABLE ENERGY CONSUMPTION LEVELS OF THE SYSTEMS; ENGINEERING IN THE FIELD OF OPTIMAL FACILITY PERFORMANCE TO AID IN THE REDUCTION OF BUILDING AND OWNERSHIP COSTS; ENGINEERING DESIGN SERVICES; MONITORING ELECTRIC POWER CONSUMPTION AND PROVIDING ANALYSIS; TESTING, ANALYSIS AND EVALUATION OF THE GOODS AND SERVICES OF OTHERS FOR THE PURPOSE OF CERTIFICATION FOR GOVERNMENT AND PRIVATE ENERGY CERTIFICATION PROGRAMS; ENERGY MODELING, NAMELY, ENGINEERING IN THE FIELD OF ENERGY; MECHANICAL ELECTRICAL AND PLUMBING SURVEYS, NAMELY, CONDUCTING ENGINEERING SURVEYS; DESIGNING, INSTALLING AND SUPPORTING COMPUTERIZED MAINTENANCE AND SERVICE REQUEST SYSTEMS; DESIGNING, INSTALLING AND SUPPORTING FACILITY MANAGEMENT SOFTWARE APPLICATIONS; LIGHTING SERVICES, NAMELY, DESIGN OF ENERGY-EFFICIENT LIGHTING SYSTEMS; POWER TECHNOLOGY SERVICES, NAMELY, PROVIDING ENGINEERING SERVICES FOR THE DEVELOPMENT OF PROJECTS FOR ONSITE POWER PLANTS AND DISTRIBUTED RESOURCES; CONDUCTING PREVENTATIVE MAINTENANCE ENGINEERING SURVEYS (U.S. CLS. 100 AND 101).

FIRST USE 7-26-2008; IN COMMERCE 7-26-2008.

FRED CARL, EXAMINING ATTORNEY

SN 77-589,241. BADGER LADDER INC., GREEN BAY, WI. FILED 10-9-2008.

TITAN

THE MARK CONSISTS OF STANDARD CHARACTERS WITHOUT CLAIM TO ANY PARTICULAR FONT, STYLE, SIZE, OR COLOR.

CLASS 6—METAL GOODS

FOR METAL LADDERS AND STEPLADDERS (U.S. CLS. 2, 12, 13, 14, 23, 25 AND 50).

FIRST USE 4-1-2008; IN COMMERCE 4-1-2008.

CLASS 20—FURNITURE AND ARTICLES NOT OTHERWISE CLASSIFIED

FOR NON-METAL LADDERS AND STEPLADDERS (U.S. CLS. 2, 13, 22, 25, 32 AND 50).

FIRST USE 4-1-2008; IN COMMERCE 4-1-2008.

SHANNON TWOHIG, EXAMINING ATTORNEY

SN 77-589,329. OVATION, INC., NASHVILLE, TN. FILED 10-9-2008.



OVATION

THE MARK CONSISTS OF THE LETTERS "OVATION" WITH A PARTIALLY OPENED BOX OR CUBE ABOVE THE LETTER "N".

CLASS 35—ADVERTISING AND BUSINESS

FOR BUSINESS MEETING PLANNING, ARRANGING AND CONDUCTING BUSINESS CONFERENCES AND PROVIDING FACILITIES FOR BUSINESS MEETINGS, PROVIDING ON-LINE REGISTRATION SERVICES FOR BUSINESS MEETINGS AND FOR LIVE CORPORATE BUSINESS EVENTS (U.S. CLS. 100, 101 AND 102).

CLASS 41—EDUCATION AND ENTERTAINMENT

FOR ARRANGING AND CONDUCTING EDUCATIONAL CONFERENCES, SPECIAL EVENT PLANNING CONSULTATION SERVICES (U.S. CLS. 100, 101 AND 107).

LINDA MICKLEBURGH, EXAMINING ATTORNEY

SN 77-589,984. NOVO NORDISK A/S, BAGSVAERD, DENMARK, FILED 10-10-2008.

DIABETES QUALITY CIRCLE

THE MARK CONSISTS OF STANDARD CHARACTERS WITHOUT CLAIM TO ANY PARTICULAR FONT, STYLE, SIZE, OR COLOR.

OWNER OF DENMARK REG. NO. VR200801652, DATED 4-29-2008, EXPIRES 4-29-2018.

NO CLAIM IS MADE TO THE EXCLUSIVE RIGHT TO USE "DIABETES", APART FROM THE MARK AS SHOWN.

CLASS 16—PAPER GOODS AND PRINTED MATTER

FOR PERIODICAL PUBLICATION, NAMELY, BROCHURES AND PAMPHLETS CONCERNING DIABETES SICKNESS AND TREATMENT; PRINTED MATTER, NAMELY, INSTRUCTIONAL AND TEACHING MATERIAL IN THE FIELD OF DIABETES SICKNESS AND TREATMENT (U.S. CLS. 2, 5, 22, 23, 29, 37, 38 AND 50).

CLASS 41—EDUCATION AND ENTERTAINMENT

FOR EDUCATION SERVICES AND TRAINING, NAMELY, PROVIDING WORKSHOPS AND SEMINARS IN THE FIELD OF DIABETES TREATMENT AND LIFESTYLE AWARENESS (U.S. CLS. 100, 101 AND 107).

CLASS 44—MEDICAL, BEAUTY AND AGRICULTURAL SERVICES

FOR MEDICAL SERVICES (U.S. CLS. 100 AND 101). SAMUEL E. SHARPER JR., EXAMINING ATTORNEY

SN 77-590,043. LAKOSKY, LEE, SALEM, IA. AND LAKOSKY, TIFFANY, SALEM, IA. FILED 10-10-2008.

The Crush

THE MARK CONSISTS OF STANDARD CHARACTERS WITHOUT CLAIM TO ANY PARTICULAR FONT, STYLE, SIZE, OR COLOR.

CLASS 3—COSMETICS AND CLEANING PREPARATIONS

FOR BATH AND BODY PRODUCTS, NAMELY, BODY DEODORANTS; SHAMPOOS (U.S. CLS. 1, 4, 6, 50, 51 AND 52).

CLASS 9—ELECTRICAL AND SCIENTIFIC APPARATUS

FOR OPTICAL APPARATUSES AND INSTRUMENTS, NAMELY, RANGE FINDERS, BINOCULARS, FIREARM SCOPES, NAMELY, GUN SCOPES, RIFLE SCOPES, SPOTTING SCOPES; ELECTRONIC DEVICES FOR ANIMAL LOCATING AND TRACKING PROGRAMMED TO USE GLOBAL POSITIONING SYSTEMS (GPS); GLOBAL POSITIONING SYSTEM (GPS); GLOBAL POSITIONING SYSTEM (GPS) CONSISTING OF COMPUTERS, COMPUTER SOFTWARE, TRANSMITTERS, RECEIVERS, AND NETWORK INTERFACE DEVICES; PRE-RECORDED CDS, VIDEO TAPES, LASER DISKS AND DVDS FEATURING LIVE GAME HUNTING; DOWNLOADABLE MULTIMEDIA FILES CONTAINING ARTWORK, TEXT, AUDIO, VIDEO, GAMES, AND INTERNET WEB LINKS RELATING TO LIVE GAME HUNTING; CHRONOGRAPHS, NAMELY, SPECIALIZED TIME RECORDING APPARATUSES (U.S. CLS. 21, 23, 26, 36 AND 38).

CLASS 12—VEHICLES

FOR ALL TERRAIN VEHICLE AFTER MARKET REPLACEMENT PARTS AND ACCESSORIES, NAMELY, MUD FLAPS, FENDERS, STEERING WHEEL COVERS, WHEEL COVERS, SEAT COVERS, FITTED AND SEMI-FITTED VEHICLE COVERS, HUB CAPS, HUB CAP COVERS, PANNIER BAGS FOR ALL TERRAIN VEHICLES, AND SEAT CUSHIONS (U.S. CLS. 19, 21, 23, 31, 35 AND 44).

CLASS 13—FIREARMS

FOR FIREARMS, GUN CASES, SIGHTS FOR FIREARMS, REPLACEMENT STOCKS/FOREARMS FOR FIREARMS, SHOULDER SLING STRAPS FOR FIREARMS, CHOKES FOR FIREARMS, RECOIL PADS FOR FIREARMS (U.S. CLS. 2 AND 9).

CLASS 14—JEWELRY

FOR JEWELRY AND IMITATION JEWELRY (U.S. CLS. 2, 27, 28 AND 50).

CLASS 18—LEATHER GOODS

FOR DUFFEL BAGS, WAIST BAGS, BACK PACKS (U.S. CLS. 1, 2, 3, 22 AND 41).

CLASS 25—CLOTHING

FOR GLOVES, HATS, BOOTS, HEADGEAR IN THE NATURE OF FACE MASKS, NAMELY, TOBOGGAN HATS, SKI MASKS, SKULL CAPS AND SNOW CAPS TO KEEP THE FACE WARM DURING OUTDOOR ACTIVITIES, JACKETS, SHIRTS, PANTS, SWEAT-SHIRTS, VESTS, PARKAS, RAINWEAR (U.S. CLS. 22 AND 39).

CLASS 28—TOYS AND SPORTING GOODS

FOR HUNTING GAME CALLS, NAMELY, MOUTH CALLS, BOX CALLS, ELECTRONIC CALLS, GRUNT CALLS; IMPLEMENTS FOR ARCHERY, NAMELY, BOWS, OPEN BOW SIGHTS, NON-TELESCOPIC BOW SIGHTS, RESTS, RELEASES, STABILIZERS, CASES, ARROWS, BROAD HEADS, ARROW WRAPS, ARROW FLETCHING DEVICES, NAMELY, FINS, VANES AND FEATHERS ATTACHED NEAR THE BACK OF ARROWS, BOW STRINGS; ANIMAL HUNTING DECOYS AND ACCESSORIES THEREFOR, NAMELY, NON-MOTORIZED DECOY BODIES; HUNTING BLINDS; HUNTING STANDS; HUNTING SLING SHOTS; HUNTER'S SCENT CAMOUFLAGE, NAMELY, HUMAN ODOR COVER SCENTS FOR USE IN HUNTING (U.S. CLS. 22, 23, 38 AND 50).

CLASS 41—EDUCATION AND ENTERTAINMENT

FOR TELEVISION ENTERTAINMENT, NAMELY, PRODUCTION OF TELEVISION SHOWS (U.S. CLS. 100, 101 AND 107).

MARLENE BELL, EXAMINING ATTORNEY

SN 77-590,048. LAKOSKY, LEE, SALEM, IA. AND LAKOSKY, TIFFANY, SALEM, IA. FILED 10-10-2008.

The Crush with Lee and Tiffany

THE MARK CONSISTS OF STANDARD CHARACTERS WITHOUT CLAIM TO ANY PARTICULAR FONT, STYLE, SIZE, OR COLOR.

CLASS 3—COSMETICS AND CLEANING PREPARATIONS

FOR BATH AND BODY PRODUCTS, NAMELY, BODY DEODORANTS; SHAMPOOS (U.S. CLS. 1, 4, 6, 50, 51 AND 52).

CLASS 9—ELECTRICAL AND SCIENTIFIC APPARATUS

FOR OPTICAL APPARATUSES AND INSTRUMENTS, NAMELY, RANGE FINDERS, BINOCULARS, FIREARM SCOPES, NAMELY, GUN SCOPES, RIFLE SCOPES, SPOTTING SCOPES; ELECTRONIC DEVICES FOR ANIMAL LOCATING AND TRACKING PROGRAMMED TO USE GLOBAL POSITIONING SYSTEMS (GPS); GLOBAL POSITIONING SYSTEM (GPS); GLOBAL POSITIONING SYSTEM (GPS) CONSISTING OF COMPUTERS, COMPUTER SOFTWARE, TRANSMITTERS, RECEIVERS, AND NETWORK INTERFACE DEVICES; PRE-RECORDED CDS, VIDEO TAPES, LASER DISKS AND DVDS FEATURING LIVE GAME HUNTING; DOWNLOADABLE MULTIMEDIA FILES CONTAINING ARTWORK, TEXT, AUDIO, VIDEO, GAMES, AND INTERNET WEB LINKS RELATING TO LIVE GAME HUNTING; CHRONOGRAPHS, NAMELY, SPECIALIZED TIME RECORDING APPARATUSES (U.S. CLS. 21, 23, 26, 36 AND 38).

CLASS 12—VEHICLES

FOR ALL TERRAIN VEHICLE AFTER MARKET REPLACEMENT PARTS AND ACCESSORIES, NAMELY, MUD FLAPS, FENDERS, STEERING WHEEL COVERS, WHEEL COVERS, SEAT COVERS, FITTED AND SEMI-FITTED VEHICLE COVERS, HUB CAPS, HUB CAP COVERS, PANNIER BAGS FOR ALL TERRAIN VEHICLES, AND SEAT CUSHIONS (U.S. CLS. 19, 21, 23, 31, 35 AND 44).

CLASS 13—FIREARMS

FOR FIREARMS, GUN CASES, SIGHTS FOR FIREARMS, REPLACEMENT STOCKS/FOREARMS FOR FIREARMS, SHOULDER SLING STRAPS FOR FIREARMS, CHOKES FOR FIREARMS, RECOIL PADS FOR FIREARMS (U.S. CLS. 2 AND 9).

CLASS 14—JEWELRY

FOR JEWELRY AND IMITATION JEWELRY (U.S. CLS. 2, 27, 28 AND 50).

CLASS 18—LEATHER GOODS

FOR DUFFEL BAGS, WAIST BAGS, BACK PACKS (U.S. CLS. 1, 2, 3, 22 AND 41).

CLASS 25—CLOTHING

FOR GLOVES, HATS, BOOTS, HEADGEAR IN THE NATURE OF FACE MASKS, NAMELY, TOBOGGAN HATS, SKI MASKS, SKULL CAPS AND SNOW CAPS TO KEEP THE FACE WARM DURING OUTDOOR ACTIVITIES, JACKETS, SHIRTS, PANTS, SWEAT-SHIRTS, VESTS, PARKAS, RAINWEAR (U.S. CLS. 22 AND 39).

CLASS 28—TOYS AND SPORTING GOODS

FOR HUNTING GAME CALLS, NAMELY, MOUTH CALLS, BOX CALLS, ELECTRONIC CALLS, GRUNT CALLS; IMPLEMENTS FOR ARCHERY, NAMELY, BOWS, OPEN BOW SIGHTS, NON-TELESCOPIC BOW SIGHTS, RESTS, RELEASES, STABILIZERS, CASES, ARROWS, BROAD HEADS, ARROW WRAPS, ARROW FLETCHING DEVICES, NAMELY, FINS, VANES AND FEATHERS ATTACHED NEAR THE BACK OF ARROWS, BOW STRINGS; ANIMAL HUNTING DECOYS AND ACCESSORIES THEREFOR, NAMELY, NON-MOTORIZED DECOY BODIES; HUNTING BLINDS; HUNTING STANDS; HUNTING SLING SHOTS; HUNTER'S SCENT CAMOUFLAGE, NAMELY, HUMAN ODOR COVER SCENTS FOR USE IN HUNTING (U.S. CLS. 22, 23, 38 AND 50).

CLASS 41—EDUCATION AND ENTERTAINMENT

FOR TELEVISION ENTERTAINMENT, NAMELY, PRODUCTION OF TELEVISION SHOWS (U.S. CLS. 100, 101 AND 107).

MARLENE BELL, EXAMINING ATTORNEY

SN 77-590,065. LAKOSKY, LEE, SALEM, IA. AND LAKOSKY, TIFFANY, SALEM, IA. FILED 10-10-2008.

The Crush by Tiffany

THE MARK CONSISTS OF STANDARD CHARACTERS WITHOUT CLAIM TO ANY PARTICULAR FONT, STYLE, SIZE, OR COLOR.

CLASS 3—COSMETICS AND CLEANING PREPARATIONS

FOR BATH AND BODY PRODUCTS, NAMELY, BODY DEODORANTS; SHAMPOOS (U.S. CLS. 1, 4, 6, 50, 51 AND 52).

CLASS 9—ELECTRICAL AND SCIENTIFIC APPARATUS

FOR OPTICAL APPARATUSES AND INSTRUMENTS, NAMELY, RANGE FINDERS, BINOCULARS, FIREARM SCOPES, NAMELY, GUN SCOPES, RIFLE SCOPES, SPOTTING SCOPES; ELECTRONIC DEVICES FOR ANIMAL LOCATING AND TRACKING PROGRAMMED TO USE GLOBAL POSITIONING SYSTEMS (GPS); GLOBAL POSITIONING SYSTEM (GPS); GLOBAL POSITIONING SYSTEM (GPS) CONSISTING OF COMPUTERS, COMPUTER SOFTWARE, TRANSMITTERS, RECEIVERS, AND NETWORK INTERFACE DEVICES; PRE-RECORDED CDS, VIDEO TAPES, LASER DISKS AND DVDS FEATURING LIVE GAME HUNTING; DOWNLOADABLE MULTIMEDIA FILES CONTAINING ARTWORK, TEXT, AUDIO, VIDEO, GAMES, AND INTERNET WEB LINKS RELATING TO LIVE GAME HUNTING; CHRONOGRAPHS, NAMELY, SPECIALIZED TIME RECORDING APPARATUSES (U.S. CLS. 21, 23, 26, 36 AND 38).

CLASS 12—VEHICLES

FOR ALL TERRAIN VEHICLE AFTER MARKET REPLACEMENT PARTS AND ACCESSORIES, NAMELY, MUD FLAPS, FENDERS, STEERING WHEEL COVERS, WHEEL COVERS, SEAT COVERS, FITTED AND SEMI-FITTED VEHICLE COVERS, HUB CAPS, HUB CAP COVERS, PANNIER BAGS FOR ALL TERRAIN VEHICLES, AND SEAT CUSHIONS (U.S. CLS. 19, 21, 23, 31, 35 AND 44).

CLASS 13—FIREARMS

FOR FIREARMS, GUN CASES, SIGHTS FOR FIREARMS, REPLACEMENT STOCKS/FOREARMS FOR FIREARMS, SHOULDER SLING STRAPS FOR FIREARMS, CHOKES FOR FIREARMS, RECOIL PADS FOR FIREARMS (U.S. CLS. 2 AND 9).

CLASS 18—LEATHER GOODS

FOR DUFFEL BAGS, WAIST BAGS, BACK PACKS (U.S. CLS. 1, 2, 3, 22 AND 41).

CLASS 25—CLOTHING

FOR GLOVES, HATS, BOOTS, HEADGEAR IN THE NATURE OF FACE MASKS, NAMELY, TOBOGGAN HATS, SKI MASKS, SKULL CAPS AND SNOW CAPS TO KEEP THE FACE WARM DURING OUTDOOR ACTIVITIES, JACKETS, SHIRTS, PANTS, SWEAT-SHIRTS, VESTS, PARKAS, RAINWEAR (U.S. CLS. 22 AND 39).

CLASS 28—TOYS AND SPORTING GOODS

FOR HUNTING GAME CALLS, NAMELY, MOUTH CALLS, BOX CALLS, ELECTRONIC CALLS, GRUNT CALLS; IMPLEMENTS FOR ARCHERY, NAMELY, BOWS, OPEN BOW SIGHTS, NON-TELESCOPIC BOW SIGHTS, RESTS, RELEASES, STABILIZERS, CASES, ARROWS, BROAD HEADS, ARROW WRAPS, ARROW FLETCHING DEVICES, NAMELY, FINNS, VANES AND FEATHERS ATTACHED NEAR THE BACK OF ARROWS, BOW STRINGS; ANIMAL HUNTING DECOYS AND ACCESSORIES THEREFOR, NAMELY, NON-MOTORIZED DECOY BODIES; HUNTING BLINDS; HUNTING STANDS; HUNTING SLING SHOTS; HUNTER'S SCENT CAMOUFLAGE, NAMELY, HUMAN ODOR COVER SCENTS FOR USE IN HUNTING (U.S. CLS. 22, 23, 38 AND 50).

CLASS 41—EDUCATION AND ENTERTAINMENT

FOR TELEVISION ENTERTAINMENT, NAMELY, PRODUCTION OF TELEVISION SHOWS (U.S. CLS. 100, 101 AND 107).

MARLENE BELL, EXAMINING ATTORNEY

SN 77-590,349. VALVO, CARMEN MARC, NEW YORK, NY. FILED 10-10-2008.

CMV CARMEN MARC VALVO

THE MARK CONSISTS OF STANDARD CHARACTERS WITHOUT CLAIM TO ANY PARTICULAR FONT, STYLE, SIZE, OR COLOR.

OWNER OF U.S. REG. NOS. 1,613,982 AND 2,411,091.

THE NAME "CARMEN MARC VALVO" IDENTIFIES A LIVING INDIVIDUAL WHOSE CONSENT IS OF RECORD.

CLASS 3—COSMETICS AND CLEANING PREPARATIONS

FOR FRAGRANCES, NAMELY, PERFUME, EAU DE TOILETTE, COLOGNE, AND ROOM FRAGRANCES; BATH PRODUCTS IN THE NATURE OF BUBBLE BATH, BATH BEADS, BATH FOAM, BATH AND SHOWER GELS, BATH LOTIONS, BATH POWDER, PERFUME BODY MIST, BATH SOAP, SHAMPOO, HAIR CONDITIONER, NON-MEDICATED BATH SALTS, NON-MEDICATED BATH FIZZERS, NON-MEDICATED CREAM BATH, BATH OILS (U.S. CLS. 1, 4, 6, 50, 51 AND 52).

CLASS 8—HAND TOOLS

FOR CUTLERY, NAMELY, FORKS, KNIVES, AND SPOONS (U.S. CLS. 23, 28 AND 44).

CLASS 9—ELECTRICAL AND SCIENTIFIC APPARATUS

FOR EYEWEAR, NAMELY, EYE GLASSES, SUNGLASSES (U.S. CLS. 21, 23, 26, 36 AND 38).

CLASS 14—JEWELRY

FOR JEWELRY (U.S. CLS. 2, 27, 28 AND 50).

CLASS 18—LEATHER GOODS

FOR HANDBAGS; SMALL LEATHER ACCESSORIES, NAMELY, KEY CASES, KEY CHAINS, TOILETRY CASES SOLD EMPTY, COIN PURSES, CREDIT CARD CASES, BUSINESS CARD CASES, IDENTIFICATION TAGS FOR LUGGAGE, PET COLLARS, LEASHES FOR ANIMALS (U.S. CLS. 1, 2, 3, 22 AND 41).

CLASS 20—FURNITURE AND ARTICLES NOT OTHERWISE CLASSIFIED

FOR HOME FURNISHINGS, NAMELY, PICTURE FRAMES, MIRRORS, FLOOR CUSHIONS, PILLOWS, AND COAT RACKS; FURNITURE (U.S. CLS. 2, 13, 22, 25, 32 AND 50).

CLASS 21—HOUSEWARES AND GLASS

FOR CHINA, NAMELY, DISHES, CUPS, MUGS, SAUCERS, BOWLS, SERVING PLATTERS, SERVING TRAYS, TEAPOTS, CREAMERS AND SUGAR SETS COMPRISED OF SUGAR BOWLS AND CREAMER PITCHERS; DRINKING GLASSES, GLASS STEMWARE, GLASS MUGS; BATH PRODUCTS IN THE NATURE OF SOAP DISHES (U.S. CLS. 2, 13, 23, 29, 30, 33, 40 AND 50).

CLASS 24—FABRICS

FOR BED LINENS, HOME FURNISHINGS IN THE NATURE OF BED BLANKETS, CHILDREN'S BLANKETS, WOOLEN BLANKETS, BLANKETS FOR OUTDOOR USE, TRAVEL BLANKET THROWS, PET BLANKETS, THROWS, BED SHEETS, BATH SHEETS, BATH TOWELS, SHOWER CURTAINS (U.S. CLS. 42 AND 50).

CLASS 25—CLOTHING

FOR CLOTHING, NAMELY, PANTS, JEANS, OVERALLS, SHORTS, SHIRTS, SWEATERS, JACKETS IN ALL FABRICATIONS AND WEIGHTS, COATS, OVERCOATS, VESTS, T-SHIRTS, SWEATSHIRTS, SWEATPANTS, NECKTIES, UNDERWEAR, SLEEPWEAR, SCARVES, SHAWLS, WORKOUT GEAR, NAMELY, WARM-UP SUITS, JOGGING SUITS, GYM SUITS, SWEAT SUITS, SPORT SHORTS, AND GYM SHORTS; SOCKS, AND BRASSIERES; RAINWEAR; SUITS, SKIRTS, GLOVES, STOCKINGS, BELTS, BATHING SUITS, BEACH ROBES AND BEACHWEAR, BATHROBES, PAJAMAS, BLOUSES, DRESSES; LINGERIE; SWIMWEAR; HOSIERY; HEADWEAR; FOOTWEAR; AND MONEY BELTS (U.S. CLS. 22 AND 39).

LINDSEY RUBIN, EXAMINING ATTORNEY

SN 77-590,377. RUWITCH, THOMAS E., ST. LOUIS, MO. FILED 10-10-2008.



THE COLOR(S) BLACK, BLUE, ORANGE AND RED IS/ ARE CLAIMED AS A FEATURE OF THE MARK.

THE MARK CONSISTS OF THE COLORS BLACK, BLUE, ORANGE AND RED WITH THE COLOR BLACK APPEARING IN THE WORDING "GENERATION BIG" AND "*BOLD*INNOVATIVE*GENEROUS*" AND THE COLORS BLUE, ORANGE, AND RED APPEARING IN THE ASTERISK DESIGN COMPRISED OF A BLUE LINE, ORANGE LINE, AND RED LINE, ALL INTERSECTING.

CLASS 9—ELECTRICAL AND SCIENTIFIC APPARATUS

FOR AUDIO-VISUAL MEDIA, NAMELY, CDS, DVDS AND PRE-RECORDED DIGITAL MEDIA ALL IN THE FIELD OF FINANCIAL PLANNING AND FINANCIAL CONSULTING (U.S. CLS. 21, 23, 26, 36 AND 38).

CLASS 16—PAPER GOODS AND PRINTED MATTER

FOR BOOKS, BROCHURES, PRINTED TRAINING MATERIAL, PRINTED MEDIA, NAMELY, MAGAZINES, JOURNALS, NEWSLETTERS AND A SERIES OF HAND-OUTS ALL IN THE FIELD OF FINANCIAL PLANNING AND FINANCIAL CONSULTING (U.S. CLS. 2, 5, 22, 23, 29, 37, 38 AND 50).

CLASS 36—INSURANCE AND FINANCIAL

FOR FINANCIAL SERVICES, NAMELY, FINANCIAL PLANNING AND FINANCIAL CONSULTING (U.S. CLS. 100, 101 AND 102).

CLASS 41—EDUCATION AND ENTERTAINMENT

FOR EDUCATIONAL SERVICES, NAMELY, PROVIDING SEMINARS, LECTURES, WORKSHOPS, WEBINARS, AND TELESEMINARS, IN THE FIELD OF FINANCIAL PLANNING AND FINANCIAL CONSULTING AND DISTRIBUTION OF TRAINING MATERIAL IN CONNECTION THEREWITH (U.S. CLS. 100, 101 AND 107).

BARNEY CHARLON, EXAMINING ATTORNEY

SN 77-590,656. LAO DONG PTE. LTD., PASIG CITY, PHILIPPINES, FILED 10-10-2008.



NO CLAIM IS MADE TO THE EXCLUSIVE RIGHT TO USE "SINCE 1950", APART FROM THE MARK AS SHOWN.

THE COLOR(S) REDDISH-ORANGE, BLACK AND WHITE IS/ARE CLAIMED AS A FEATURE OF THE MARK. THE MARK CONSISTS OF A BLACK CENTER CIRCLE SURROUNDED BY A THICK REDDISH-ORANGE CIRCLE, AND AN OUTER THIN REDDISH-ORANGE CIRCLE, WITH CHINESE CHARACTERS IN WHITE IN THE CENTER AND THE ENGLISH WORDS "SINCE 1950" IN WHITE AROUND THE THICK REDDISH-ORANGE CIRCLE.

THE NON-LATIN CHARACTERS IN THE MARK TRANSLITERATE TO LAO DONG AND THIS MEANS THE OLD PRESIDENT OR THE OLD CHAIRMAN IN ENGLISH.

CLASS 29—MEATS AND PROCESSED FOODS

FOR FOOD PRODUCTS FOR CONSUMPTION, NAMELY, COOKED PREPARATIONS USING BEEF, PORK, CHICKEN, POULTRY AND GAME, EGGS, MILK, AND MILK PRODUCTS, MEAT EXTRACTS, SAUSAGE, FISH, SHRIMP, PRESERVED, DRIED AND COOKED FRUITS AND VEGETABLES, TOFU, KROPECK, NAMELY, CHIPS MADE FROM SHRIMP OR VEGETABLES (U.S. CL. 46).

CLASS 30—STAPLE FOODS

FOR FOOD PRODUCTS FOR CONSUMPTION, NAMELY, RICE, CONGEE, NOODLES, DUMPLINGS, SIPOAO, SIOMAI, BUCHI, BEVERAGES WITH COFFEE, TEA, TAPIOCA, SAGO, PREPARATIONS MADE FROM CEREALS, NAMELY, PROCESSED OATS, OATMEAL, BREAKFAST CEREALS, PROCESSED CEREAL FLAKES AND CEREAL TOPPING FOR CONGEE, BREAD, PASTRY AND CONFECTIONERY, NAMELY, RICE CRACKERS, SUGARED BEANS, ICE CANDIES, ICE CREAM, CARAMELS, CANDIES, COOKIES, CREAM PUFFS, SPONGE CAKES, CHEWING GUM, NOUGAT, SAUCES AND SPICES (U.S. CL. 46).

CLASS 43—HOTEL AND RESTAURANT SERVICES

FOR RESTAURANT SERVICES; SELF-SERVICE AND FAST-FOOD RESTAURANT SERVICES, CATERING SERVICES, CAFETERIA SERVICES, AND CAFE SERVICES (U.S. CLS. 100 AND 101).
VIVIAN MICZNIK FIRST, EXAMINING ATTORNEY

CLASS 38—COMMUNICATION

FOR LEASING OF DARK FIBER AND THE PROVISION OF CO-LOCATION SERVICES FOR VOICE, VIDEO, AND DATA COMMUNICATION APPLICATIONS AND TELECOMMUNICATIONS SERVICES, NAMELY, PRIVATE-LINE SERVICE, PROVIDING AN INTERNET CONNECTION OVER ETHERNET/ETHERNET DATA SERVICES, TIME DIVISION MULTIPLEXING (TDM) SERVICES, NAMELY, PROVIDING FOR THE TRANSMISSION OF MULTIPLE DIGITIZED DATA, VOICE, AND VIDEO SIGNALS USING BROADBAND NETWORKS, PROVIDING CONNECTIONS TO LOCAL AREA NETWORK (LAN), PROVIDING CONNECTIONS TO MANAGED NETWORK SERVICE, INTERNET SERVICE PROVIDER, PROVIDING FOR THE MANAGEMENT OF DATA SIGNAL TRAFFIC AND RELATED SUPPORT FACILITIES AND SYSTEMS, NAMELY, PROVIDING CUSTOMER AND TECHNICAL SUPPORT FOR COVERED SERVICES (U.S. CLS. 100, 101 AND 104).
FRANK LATTUCA, EXAMINING ATTORNEY

SN 77-591,415. UNITED POLICYHOLDERS, SAN FRANCISCO, CA. FILED 10-13-2008.

SN 77-591,097. LT LLC, BOXBOROUGH, MA. FILED 10-13-2008.



NO CLAIM IS MADE TO THE EXCLUSIVE RIGHT TO USE "FIBER NETWORKS", APART FROM THE MARK AS SHOWN.

THE MARK CONSISTS OF THE WORD "LIGHTTOWER" IN BOLD FACE LOWER CASE LETTERS WITH A SWOOSH BEGINNING IN THE LETTER "L" AND ENDING ABOVE THE LETTER "T", ALL ABOVE A LINE THAT BEGINS UNDER THE LETTER "L" AND ENDS UNDER THE LETTER "T" FOLLOWED BY THE WORDS "FIBER NETWORKS" IN SMALLER LOWER CASE LETTERS.

CLASS 37—CONSTRUCTION AND REPAIR

FOR CONSTRUCTION OF TELECOMMUNICATIONS INFRASTRUCTURE ASSETS, NAMELY, WIRELESS COMMUNICATION TOWERS, OPTICAL FIBER SYSTEMS, AND NETWORKING HARDWARE (U.S. CLS. 100, 103 AND 106).

ROADMAP TO RECOVERY

THE MARK CONSISTS OF STANDARD CHARACTERS WITHOUT CLAIM TO ANY PARTICULAR FONT, STYLE, SIZE, OR COLOR.

CLASS 16—PAPER GOODS AND PRINTED MATTER

FOR PRINTED PUBLICATIONS IN THE NATURE OF TIP SHEETS, BROCHURES, PRESENTATION HAND-OUTS, NEWSLETTERS AND BOOKS, FEATURING EDUCATIONAL INFORMATION AND SUPPORT RELATING TO DISASTER RECOVERY, POST-DISASTER INSURANCE ISSUES AND POST-DISASTER FINANCIAL ISSUES (U.S. CLS. 2, 5, 22, 23, 29, 37, 38 AND 50).
FIRST USE 10-31-2005; IN COMMERCE 10-31-2005.

CLASS 41—EDUCATION AND ENTERTAINMENT

FOR PROVIDING ONLINE CONSUMER INFORMATION RELATING TO DISASTER RECOVERY, POST-DISASTER INSURANCE ISSUES AND POST-DISASTER FINANCIAL ISSUES, NAMELY, ONLINE NEWSLETTERS, BROCHURES, PAMPHLETS AND TIP SHEETS; PROVIDING ONLINE AND LIVE EDUCATIONAL SEMINARS, MEETINGS AND CONFERENCES FEATURING INFORMATION AND SUPPORT RELATING TO DISASTER RECOVERY, POST-DISASTER RECOVERY, POST-DISASTER INSURANCE ISSUES AND POST-DISASTER FINANCIAL ISSUES AND DISTRIBUTING RESOURCES IN THE NATURE OF COURSE MATERIAL THEREWITH (U.S. CLS. 100, 101 AND 107).

FIRST USE 10-31-2005; IN COMMERCE 10-31-2005.
HEATHER THOMPSON, EXAMINING ATTORNEY

SN 77-591,563. GROUP O, INC., FORMERLY GROUP O COMPANIES, MILAN, IL. FILED 10-13-2008.

SN 77-591,614. BR CONSULTING, INC., SEDONA, AZ. FILED 10-13-2008.



THE COLOR(S) GOLD, ORANGE, BLUE, GREEN AND BLACK IS/ARE CLAIMED AS A FEATURE OF THE MARK. THE MARK CONSISTS OF A GOLD POLYGON OF GEOMETRIC FIGURES WITH THE WORDS "GROUP O" IN BLACK BELOW THE POLYGON. THE LETTER "O" HAS A BLACK MACRON ABOVE IT. BELOW THE WORDS THERE ARE THREE RECTANGLES WHICH ARE GREEN, BLUE AND ORANGE.

CLASS 35—ADVERTISING AND BUSINESS

FOR ARRANGING AND CONDUCTING INCENTIVE REWARD PROGRAMS TO PROMOTE THE SALE OF FOOD AND BEVERAGE, TELECOMMUNICATIONS, FINANCIAL SERVICES, HEALTH CARE, AND TECHNOLOGY.; BUSINESS MANAGEMENT CONSULTING WITH RELATION TO STRATEGY, MARKETING, SALES, OPERATION, PRODUCT DESIGN PARTICULARLY SPECIALIZING IN THE USE OF ANALYTIC AND STATISTIC MODELS FOR THE UNDERSTANDING AND PREDICTING OF CONSUMERS, BUSINESSES, AND MARKET TRENDS AND ACTIONS; BUSINESS PROCESS OUTSOURCING SERVICES IN THE FIELD OF KITTING, PAINTING, PACKAGING AND DISTRIBUTION; OPERATION OF TELEPHONE CALL CENTERS FOR OTHERS; PROVIDING INCENTIVE AWARD PROGRAMS FOR CUSTOMERS AND EMPLOYEES THROUGH THE DISTRIBUTION OF PREPAID STORED VALUE CARDS FOR THE PURPOSE OF PROMOTING AND REWARDING LOYALTY (U.S. CLS. 100, 101 AND 102).

FIRST USE 0-0-1992; IN COMMERCE 0-0-1992.

CLASS 39—TRANSPORTATION AND STORAGE

FOR SUPPLY CHAIN, LOGISTICS AND REVERSE LOGISTICS SERVICES, NAMELY, STORAGE, TRANSPORTATION AND DELIVERY OF DOCUMENTS, PACKAGES, RAW MATERIALS, AND OTHER FREIGHT FOR OTHERS BY AIR, RAIL, SHIP OR TRUCK; WAREHOUSING SERVICES, NAMELY, STORAGE, DISTRIBUTION, PICK-UP, AND PACKING FOR SHIPMENT OF DOCUMENTS, PACKAGES, RAW MATERIALS, AND OTHER FREIGHT FOR OTHERS (U.S. CLS. 100 AND 105).

FIRST USE 0-0-1992; IN COMMERCE 0-0-1992. JENNIFER MARTIN, EXAMINING ATTORNEY

ChunHwa

THE MARK CONSISTS OF STANDARD CHARACTERS WITHOUT CLAIM TO ANY PARTICULAR FONT, STYLE, SIZE, OR COLOR.

THE ENGLISH TRANSLATION OF "CHUNHWA" IN THE MARK IS "BECOMING HEAVEN".

CLASS 39—TRANSPORTATION AND STORAGE

FOR CONDUCTING MEDITATION TOURS (U.S. CLS. 100 AND 105).

FIRST USE 6-28-2008; IN COMMERCE 6-28-2008.

CLASS 41—EDUCATION AND ENTERTAINMENT

FOR EDUCATIONAL SERVICES, NAMELY, CONDUCTING CLASSES, LECTURES, CONFERENCES IN THE FIELD OF MEDITATION, RELAXATION, AND ENERGY HEALING TO ENHANCE MENTAL, EMOTIONAL AND PHYSICAL CAPABILITIES; ORGANIZATION OF EXHIBITIONS FOR CULTURAL OR EDUCATIONAL PURPOSES (U.S. CLS. 100, 101 AND 107).

FIRST USE 6-28-2008; IN COMMERCE 6-28-2008. TARA PATE, EXAMINING ATTORNEY

SN 77-592,559. LT LLC, BOXBOROUGH, MA. FILED 10-14-2008.

LIGHTOWER

THE MARK CONSISTS OF STANDARD CHARACTERS WITHOUT CLAIM TO ANY PARTICULAR FONT, STYLE, SIZE, OR COLOR.

CLASS 37—CONSTRUCTION AND REPAIR

FOR CONSTRUCTION OF TELECOMMUNICATIONS INFRASTRUCTURE ASSETS, NAMELY, WIRELESS COMMUNICATION TOWERS, OPTICAL FIBER SYSTEMS, AND NETWORKING HARDWARE (U.S. CLS. 100, 103 AND 106).

FIRST USE 5-0-2007; IN COMMERCE 5-0-2007.

CLASS 38—COMMUNICATION

FOR LEASING OF DARK FIBER AND THE PROVISION OF CO-LOCATION SERVICES FOR VOICE, VIDEO, AND DATA COMMUNICATION APPLICATIONS AND TELECOMMUNICATIONS SERVICES, NAMELY, PRIVATE-LINE SERVICE, PROVIDING AN INTERNET CONNECTION OVER ETHERNET/ETHERNET DATA SERVICES, TIME DIVISION MULTIPLEXING (TDM) SERVICES, NAMELY, PROVIDING FOR THE TRANSMISSION OF MULTIPLE DIGITIZED DATA, VOICE, AND VIDEO SIGNALS USING BROADBAND NETWORKS, PROVIDING CONNECTIONS TO LOCAL AREA NETWORK (LAN), PROVIDING CONNECTIONS TO MANAGED NETWORK SERVICE, INTERNET SERVICE PROVIDER, PROVIDING FOR THE MANAGEMENT OF DATA SIGNAL TRAFFIC AND RELATED SUPPORT FACILITIES AND SYSTEMS, NAMELY, PROVIDING CUSTOMER AND TECHNICAL SUPPORT FOR COVERED SERVICES (U.S. CLS. 100, 101 AND 104).

FIRST USE 5-0-2007; IN COMMERCE 5-0-2007.
FRANK LATTUCA, EXAMINING ATTORNEY

SN 77-593,045. CARLOS Y. BENAVIDES III, LAREDO, TX.
FILED 10-15-2008.

DON'T GET SCREWED ON THE
RIVER

THE MARK CONSISTS OF STANDARD CHARACTERS WITHOUT CLAIM TO ANY PARTICULAR FONT, STYLE, SIZE, OR COLOR.

CLASS 16—PAPER GOODS AND PRINTED MATTER

FOR PLAYING CARD GUIDES (U.S. CLS. 2, 5, 22, 23, 29, 37, 38 AND 50).

SN 77-592,713. CONSUMERPSYCH LABS, INC., DBA BRANDPSYCH LABS, INC., ITHACA, NY. FILED 10-14-2008.

CLASS 28—TOYS AND SPORTING GOODS

FOR CASINO-STYLE BETTING, GAMBLING, AND CARD PLAYING EQUIPMENT, NAMELY, PLAYING CARDS, CHIPS, CHIP CASES, GAMING TABLES, CARD SHUFFLERS, PLAYING CARD SHOES, POKER TABLES, AND CASES FOR CHIPS, GAME BOARD (U.S. CLS. 22, 23, 38 AND 50).

DOMINICK J. SALEMI, EXAMINING ATTORNEY

SMALL PLATE

THE MARK CONSISTS OF STANDARD CHARACTERS WITHOUT CLAIM TO ANY PARTICULAR FONT, STYLE, SIZE, OR COLOR.

CLASS 9—ELECTRICAL AND SCIENTIFIC APPARATUS

FOR PROVIDING DOWNLOADABLE COMPUTER SOFTWARE FOR WEIGHT LOSS AND WEIGHT MANAGEMENT (U.S. CLS. 21, 23, 26, 36 AND 38).

CLASS 44—MEDICAL, BEAUTY AND AGRICULTURAL SERVICES

FOR PROVIDING WEIGHT LOSS PROGRAM SERVICES; PROVIDING PROGRAMS AND SERVICES TO ENCOURAGE AND MANAGE WEIGHT LOSS, DIETS, EATING HABITS, APPETITES AND RELATED ACTIVITIES, NAMELY, PROVIDING DIETARY AND NUTRITIONAL GUIDANCE, WEIGHT REDUCTION DIET PLANNING AND SUPERVISION, PROVIDING WEIGHT LOSS PROGRAM SERVICES; PROVIDING WEIGHT LOSS CONSULTATION SERVICES TO INDIVIDUALS, ORGANIZATIONS, GROUPS AND COMMUNITIES ENGAGED IN WEIGHT LOSS PROGRAMS; PROVIDING INFORMATION ON MAINTAINING A HEALTHY LIFESTYLE, WEIGHT LOSS AND WEIGHT MANAGEMENT; PROVIDING INFORMATION REGARDING THE BENEFITS OF WEIGHT LOSS AND WEIGHT MANAGEMENT; PROVIDING WEIGHT LOSS PROGRAM SERVICES; WEIGHT REDUCTION DIET PLANNING AND SUPERVISION; PROVIDING WELLNESS SERVICES, NAMELY, CONDUCTING ON-LINE PERSONAL WEIGHT LOSS AND WEIGHT MANAGEMENT ASSESSMENTS AND HEALTH ENHANCEMENT PROGRAMS BY MEANS OF PERFORMANCE TRACKING, REWARD AND INCENTIVE PROGRAMS (U.S. CLS. 100 AND 101).

ALYSSA STEEL, EXAMINING ATTORNEY

SN 77-593,148. IMAGINVENTURE SA, LUGANO, SWITZERLAND, FILED 10-15-2008.

WAVATAR

THE MARK CONSISTS OF STANDARD CHARACTERS WITHOUT CLAIM TO ANY PARTICULAR FONT, STYLE, SIZE, OR COLOR.

CLASS 9—ELECTRICAL AND SCIENTIFIC APPARATUS

FOR COMPUTER DEVICES FOR VIDEOGAMES, NAMELY, VIDEO GAME INTERACTIVE REMOTE CONTROL UNITS WITH INTEGRATED SOFTWARE CODES FOR USE IN THE CREATION OF VIRTUAL REPRESENTATION OF ONLINE GAMES USERS, VIDEO GAME INTERACTIVE REMOTE CONTROL UNITS WITH INTEGRATED SOFTWARE CODES FOR USE IN THE CREATION OF VIRTUAL CURRENCY TO BE USED IN ONLINE GAMES; COMPUTER DEVICES FOR VIDEOGAMES, NAMELY, PLAYER-OPERATED ELECTRONIC CONTROLLERS FOR ELECTRONIC VIDEO GAME MACHINES WITH INTEGRATED SOFTWARE CODES FOR USE IN THE CREATION OF VIRTUAL REPRESENTATION OF ONLINE GAMES USERS, PLAYER-OPERATED ELECTRONIC CONTROLLERS FOR ELECTRONIC VIDEO GAME MACHINES WITH INTEGRATED SOFTWARE CODES FOR USE IN THE CREATION OF VIRTUAL CURRENCY TO BE USED IN ONLINE GAMES (U.S. CLS. 21, 23, 26, 36 AND 38).

CLASS 28—TOYS AND SPORTING GOODS

FOR TOYS, GAMES AND PLAYTHINGS, NAMELY, ELECTRIC AND ELECTRONIC ACTION TOYS AND BY-PRODUCTS FROM ONLINE GAMES IN THE FORM OF COLLECTABLE AND POSITIONABLE TOY FIGURES, BATTERY OPERATED ACTION TOYS, AND BATTERY-POWERED COMPUTER GAMES WITH LCD SCREEN WHICH FEATURES ANIMATION AND SOUND EFFECTS (U.S. CLS. 22, 23, 38 AND 50).

SN 77-593,249. VALVO, CARMEN MARC, NEW YORK, NY. FILED 10-15-2008.

CLASS 42—SCIENTIFIC AND COMPUTER SERVICES

FOR COMPUTER GAME SOFTWARE DEVELOPMENT SERVICES FOR OTHERS (U.S. CLS. 100 AND 101).
THEODORE MCBRIDE, EXAMINING ATTORNEY

CARMEN MARC VALVO

THE MARK CONSISTS OF STANDARD CHARACTERS WITHOUT CLAIM TO ANY PARTICULAR FONT, STYLE, SIZE, OR COLOR.

OWNER OF U.S. REG. NOS. 1,613,982 AND 2,411,091.

THE NAME "CARMEN MARC VALVO" IDENTIFIES A LIVING INDIVIDUAL WHOSE CONSENT IS OF RECORD.

SN 77-593,167. IMAGINVENTURE SA, LUGANO, SWITZERLAND, FILED 10-15-2008.

WAZ\$

THE MARK CONSISTS OF STANDARD CHARACTERS WITHOUT CLAIM TO ANY PARTICULAR FONT, STYLE, SIZE, OR COLOR.

CLASS 3—COSMETICS AND CLEANING PREPARATIONS

FOR FRAGRANCES, NAMELY, PERFUME, EAU DE TOILETTE, COLOGNE, AND ROOM FRAGRANCES; BATH PRODUCTS IN THE NATURE OF BUBBLE BATH, BATH BEADS, BATH FOAM, BATH AND SHOWER GELS, BATH LOTIONS, BATH POWDER, PERFUME BODY MIST, BATH SOAP, SHAMPOO, HAIR CONDITIONER, NON-MEDICATED BATH SALTS, NON-MEDICATED BATH FIZZERS, NON-MEDICATED CREAM BATH, BATH OILS (U.S. CLS. 1, 4, 6, 50, 51 AND 52).

CLASS 8—HAND TOOLS

FOR CUTLERY, NAMELY, FORKS, KNIVES, AND SPOONS (U.S. CLS. 23, 28 AND 44).

CLASS 9—ELECTRICAL AND SCIENTIFIC APPARATUS

FOR COMPUTER DEVICES FOR VIDEOGAMES, NAMELY, VIDEO GAME INTERACTIVE REMOTE CONTROL UNITS WITH INTEGRATED SOFTWARE CODES FOR USE IN THE CREATION OF VIRTUAL REPRESENTATION OF ONLINE GAMES USERS, VIDEO GAME INTERACTIVE REMOTE CONTROL UNITS WITH INTEGRATED SOFTWARE CODES FOR USE IN THE CREATION OF VIRTUAL CURRENCY TO BE USED IN ONLINE GAMES; COMPUTER DEVICES FOR VIDEOGAMES, NAMELY, PLAYER-OPERATED ELECTRONIC CONTROLLERS FOR ELECTRONIC VIDEO GAME MACHINES WITH INTEGRATED SOFTWARE CODES FOR USE IN THE CREATION OF VIRTUAL REPRESENTATION OF ONLINE GAMES USERS, PLAYER-OPERATED ELECTRONIC CONTROLLERS FOR ELECTRONIC VIDEO GAME MACHINES WITH INTEGRATED SOFTWARE CODES FOR USE IN THE CREATION OF VIRTUAL CURRENCY TO BE USED IN ONLINE GAMES (U.S. CLS. 21, 23, 26, 36 AND 38).

CLASS 9—ELECTRICAL AND SCIENTIFIC APPARATUS

FOR EYEWEAR, NAMELY, EYE GLASSES, SUNGLASSES (U.S. CLS. 21, 23, 26, 36 AND 38).

CLASS 14—JEWELRY

FOR JEWELRY (U.S. CLS. 2, 27, 28 AND 50).

CLASS 18—LEATHER GOODS

FOR HANDBAGS; SMALL LEATHER ACCESSORIES, NAMELY, KEY CASES, KEY CHAINS, TOILETRY CASES SOLD EMPTY, COIN PURSES, CREDIT CARD CASES, BUSINESS CARD CASES, IDENTIFICATION TAGS FOR LUGGAGE, PET COLLARS, LEASHES FOR ANIMALS (U.S. CLS. 1, 2, 3, 22 AND 41).

CLASS 28—TOYS AND SPORTING GOODS

FOR TOYS, GAMES AND PLAYTHINGS, NAMELY, ELECTRIC AND ELECTRONIC ACTION TOYS AND BY-PRODUCTS FROM ONLINE GAMES IN THE FORM OF COLLECTABLE AND POSITIONABLE TOY FIGURES, BATTERY OPERATED ACTION TOYS, AND BATTERY-POWERED COMPUTER GAMES WITH LCD SCREEN WHICH FEATURES ANIMATION AND SOUND EFFECTS (U.S. CLS. 22, 23, 38 AND 50).

CLASS 20—FURNITURE AND ARTICLES NOT OTHERWISE CLASSIFIED

FOR HOME FURNISHINGS, NAMELY, PICTURE FRAMES, MIRRORS, FLOOR CUSHIONS, PILLOWS, AND COAT RACKS; FURNITURE (U.S. CLS. 2, 13, 22, 25, 32 AND 50).

CLASS 42—SCIENTIFIC AND COMPUTER SERVICES

FOR COMPUTER GAME SOFTWARE DEVELOPMENT SERVICES FOR OTHERS (U.S. CLS. 100 AND 101).
THEODORE MCBRIDE, EXAMINING ATTORNEY

CLASS 21—HOUSEWARES AND GLASS

FOR CHINA, NAMELY, DISHES, CUPS, MUGS, SAUCERS, BOWLS, SERVING PLATTERS, SERVING TRAYS, TEAPOTS, CREAMERS AND SUGAR SETS COMPRISED OF SUGAR BOWLS AND CREAMER PITCHERS; DRINKING GLASSES, GLASS STEMWARE, GLASS MUGS; BATH PRODUCTS IN THE NATURE OF SOAP DISHES (U.S. CLS. 2, 13, 23, 29, 30, 33, 40 AND 50).

CLASS 24—FABRICS

FOR BED LINENS, HOME FURNISHINGS IN THE NATURE OF BED BLANKETS, CHILDREN'S BLANKETS, WOOLEN BLANKETS, BLANKETS FOR OUTDOOR USE, TRAVEL BLANKET TROWS, PET BLANKETS, TROWS, BED SHEETS, BATH SHEETS, BATH TOWELS, SHOWER CURTAINS (U.S. CLS. 42 AND 50).

CLASS 25—CLOTHING

FOR CLOTHING, NAMELY, PANTS, JEANS, OVERALLS, SHORTS, SHIRTS, SWEATERS, JACKETS IN ALL FABRICATIONS AND WEIGHTS, COATS, OVERCOATS, VESTS, T-SHIRTS, SWEATSHIRTS, SWEATPANTS, NECKTIES, UNDERWEAR, SLEEPWEAR, SCARVES, SHAWLS, WORKOUT GEAR, NAMELY, WARM-UP SUITS, JOGGING SUITS, GYM SUITS, SWEAT SUITS, SPORT SHORTS, AND GYM SHORTS; SOCKS, AND BRASSIERES; RAINWEAR; SUITS, SKIRTS, GLOVES, STOCKINGS, BELTS, BATHING SUITS, BEACH ROBES AND BEACHWEAR, BATHROBES, PAJAMAS, BLOUSES, DRESSES; LINGERIE; SWIMWEAR; HOSIERY; HEADWEAR; FOOTWEAR; AND MONEY BELTS (U.S. CLS. 22 AND 39).

LINDSEY RUBIN, EXAMINING ATTORNEY

SN 77-593,274. MCLEOD, SEBASTIAN C., PARKVILLE, MO. FILED 10-15-2008.

EZ CURTAIN

THE MARK CONSISTS OF STANDARD CHARACTERS WITHOUT CLAIM TO ANY PARTICULAR FONT, STYLE, SIZE, OR COLOR.

NO CLAIM IS MADE TO THE EXCLUSIVE RIGHT TO USE "CURTAIN", APART FROM THE MARK AS SHOWN.

CLASS 6—METAL GOODS

FOR METAL WINDOW TREATMENT BRACKETS (U.S. CLS. 2, 12, 13, 14, 23, 25 AND 50).

CLASS 20—FURNITURE AND ARTICLES NOT OTHERWISE CLASSIFIED

FOR NON-METAL WINDOW TREATMENT BRACKETS (U.S. CLS. 2, 13, 22, 25, 32 AND 50).

KOURTNEE HODGES, EXAMINING ATTORNEY

SN 77-593,281. EVACUCORP, INC., LOUISVILLE, KY. FILED 10-15-2008.

EVACUPOD

THE MARK CONSISTS OF STANDARD CHARACTERS WITHOUT CLAIM TO ANY PARTICULAR FONT, STYLE, SIZE, OR COLOR.

THE WORDING "EVACUPOD" HAS NO MEANING IN A FOREIGN LANGUAGE.

CLASS 10—MEDICAL APPARATUS

FOR RAPID INFLATABLE EMERGENCY EVACUATION DEVICES, NAMELY, GURNEYS AND STRETCHERS (U.S. CLS. 26, 39 AND 44).

CLASS 20—FURNITURE AND ARTICLES NOT OTHERWISE CLASSIFIED

FOR RAPID INFLATABLE EMERGENCY EVACUATION DEVICES, NAMELY, INFLATABLE MATTRESSES (U.S. CLS. 2, 13, 22, 25, 32 AND 50).

LORETTA C. BECK, EXAMINING ATTORNEY

SN 77-593,545. SCHMOLZ + BICKENBACH KG, DUSSELDORF, FED REP GERMANY, FILED 10-15-2008.



OWNER OF FED REP GERMANY REG. NO. 302008019254, DATED 6-6-2008, EXPIRES 3-31-2018.
THE MARK CONSISTS OF A HEXAGON ENCOMPASSING FOUR TRIANGLES.

CLASS 1—CHEMICALS

FOR CHEMICALS FOR METAL TEMPERING AND METAL BRAZING; FINISHING PREPARATIONS, NAMELY, CHEMICALS FOR USE IN THE MANUFACTURE OF STEEL; ALUMINUM CHLORIDE; ALUMINUM IODIDE; ALUMINUM SILICATE; ALUMINA SYNTHETIC RESIN; FOUNDRY SAND, NAMELY, PIT-IRON-SAND; FOUNDRY SAND; CHEMICALS FOR USE IN FACILITATING THE ALLOYING OF METALS; SALTS FOR COLORING METAL, NAMELY, METAL PLATING CHEMICAL COMPOSITIONS; METAL HARDENING PREPARATIONS, NAMELY, CHEMICALS FOR USE IN THE HARDENING OF METAL; CONTACT CEMENTS (U.S. CLS. 1, 5, 6, 10, 26 AND 46).

CLASS 6—METAL GOODS

FOR COMMON METALS AND ALLOYS THEREOF, UNWROUGHT AND SEMI-WORKED, FOR FURTHER MANUFACTURE; BUILDING MATERIALS OF METAL, NAMELY, BUILDING CURTAIN WALLS, COMPOSITE PANELS AND BUILDING WALL FRAMING; SEMI-FINISHED PRODUCTS OF METAL, NAMELY, STEEL IN THE FORM OF SHEETS, PLATES, FOILS, COILS AND PIPES; RAILWAY MATERIAL OF METAL, ALSO AS SEMI-FINISHED PRODUCTS, NAMELY, MATERIALS OF METAL FOR RAILWAY CONSTRUCTION AND METALLIC MATERIALS FOR RAILWAY TRACKS; LOCKSMITH AND IRONMONGERY PRODUCTS, NAMELY, METAL LOCKS AND COMMON METAL DRAWER PULLS; METAL KEY BLANKS; ORES, NAMELY, CHROME IRON ORES, COBALT ORES, COPPER ORES, IRON ORES, LEAD ORES MANGANESE ORES, MOLYBDENUM ORES, NICKEL ORES, TIN ORES, TUNGSTEN ORES, ZINC ORES; UNWROUGHT STEEL; SEMI-WROUGHT STEEL; STAINLESS STEEL; IRON AND STEELS; FLAT STEEL, PROFILE STEEL, SECTIONAL STEEL, WIDE FLANGED BEAMS MADE OF STEEL, BAR STEEL, ROUND STEEL, HEXAGON STEEL, SQUARE STEEL, VALVE STEEL, HIGH-GRADE CONSTRUCTIONAL STEEL, CASE-HARDENED STEEL, HEAT-TREATED STEEL AND NITRIDED STEEL, IMPROVED MACHINABILITY STEEL, STRIP STEEL, WIDE

STRIP AND SPLIT STRIP STEEL; TOOL AND HIGH SPEED STEEL BAR, HOLLOW STEEL BARS, STEEL FORGING, STEEL IN SHEET FORM, COLD WORK STEEL, HOT WORK STEEL, PLASTIC MOLD STEEL, DIE STEEL, TOOL STEEL FOR SPRING STEEL COLLETS, HIGH SPEED STEEL, PRECISION FLAT STEEL, PRECISION FLAT STEEL OF COLD WORK STEEL, PRECISION FLAT STEEL OF HOT WORK STEEL, PRECISION FLAT STEEL OF PLASTIC MOLD STEEL; STEEL TUBES; SEAMLESS STEEL TUBES; WELDED STEEL TUBES; STEEL BOILER PIPES; SEAMLESS PRECISION STEEL TUBES; WELDED PRECISION STEEL TUBES; STEEL BOILER TUBES, STEEL CYLINDER TUBES, STEEL CONSTRUCTION TUBES, STEEL RAIL TUBES, METAL SHEET TUBES, STEEL TUBES, STEEL BARS, SEAMLESS HYDRAULIC CONDUCTION STEEL TUBES, WELDED SPECIAL ROLLING STEEL TUBES, SQUARE STEEL TUBES; RECTANGULAR STEEL TUBES; THREADED STEEL PIPE; HOLLOW-DRAWN BRIGHT STEEL PIPES, ENGINE BUILDING STEEL PIPES, FINE GRIT-BLASTED STEELS, FINE GRIT-BLASTED STEEL PIPES, DRILLED STEEL PIPES, DRINK PIPELINES OF METAL, HEAT RESISTANT EXHAUST PIPES OF METAL, METAL PIPE FITTINGS; ELBOWS OF METAL FOR PIPES, METAL PIPE REDUCERS, METAL PIPE JOINTS, NAMELY, T-PIECES, UNTURNED WELDING METAL FLANGES, METAL FLANGES, PROFILES, NAMELY, BRIGHT STEEL PROFILES, PROFILES OF COLD AND HOT ROLLED STRIP STEEL, SURFACE PROCESSED, SENDZIMIR GALVANIZED, MADE OF STAINLESS AND ACID RESISTANT HIGH-GRADE OF STEEL, OF PLASTIC COATED STRIP STEEL, OF VARNISHED STRIP STEEL, PROFILES OF DEFORMABLE NON-IRON METAL STRIPS, ALSO PIERCED AND PUNCHED, BRIGHT STEEL PROFILES, SQUARES, HEXAGONS, FLATS AND SPECIAL PROFILES, ALSO HOT ROLLED; PREFORMED STEEL FOR USE IN THE MANUFACTURE OF PISTON RODS AND GEAR SHAFTS; METAL CABLE WIRE; NON-ELECTRIC CABLES OF COMMON METAL; STEEL WIRES, WIRES OF STAINLESS STEEL, PULLED STEEL WIRE, STEEL WIRE ROD IN COILS, STEEL WIRE ON SPOOLS AND UNCOILING DEVICES, COLD-HEADED WIRE MADE OF RUST-PROOF STAINLESS STEEL, SPRING WIRE, WEAVING WIRE AND ROPE WIRE, FINISHED MACHINE WIRE, BLANK WIRE, PRE-DRAWING WIRE, HEAT RESISTANT WIRE, TROLLEY WIRE OF METAL; WIRE ROPES AND WELDING WIRES OF METAL, HOT ROLLED, ANNEALED RESPECTIVELY QUENCHED METAL WIRE ROD, METAL WIRE ROD IN COILS WITH VARIOUS DIAMETERS FOR THE MANUFACTURE OF REINFORCING STEEL MATS AND DISTANCE PIECES, METAL WIRE ROD FORMED BY DEEP DRAWING, WIRE ROD FOR THE MANUFACTURE OF CHAINS AND METAL ALLOYED WIRE ROD; UNALLOYED METAL WIRE ROD; BRIGHT DRAWN PIN WIRE; SEMI-FINISHED METAL PIN WIRE; METAL CASES, NAMELY, GENERAL PURPOSE METAL STORAGE CONTAINERS; METAL SHEETS, STEEL SHEETS, SHEETS MADE OF STAINLESS STEEL, LASER CUT STEEL SHEETS, THIN METAL SHEETS, HOT AND COLD-ROLLED THIN STEEL SHEETS, GALVANIZED AND COATED STEEL SHEETS, HEAVY STEEL PLATES, HOT-ROLLED STEEL SHEETS, PICKLED STEEL SHEETS, GREASED STEEL SHEETS METAL BOILER PLATES, ALLOYED METAL-PLATED STEEL SHEETS, GALVANIZED SHEET METAL, COATED SHEET METAL, STEEL CHEQUER PLATES, STEEL TEAR PLATE, WIDE FLAT STEEL, STEEL PLATES CUT TO DIMENSION, FLAME CUT STEEL PLATES, TINPLATE STEEL STRIPS; GOODS MADE OF STAINLESS STEEL, NAMELY, TUBES OF STAINLESS STEEL; CAST STEEL; STEEL FRAMES FOR BUILDING; BALLS OF STEEL; STEEL ALLOYS; STEEL MASTS FOR TRAFFIC LIGHTS AND FLAGPOLES; WHITE ALLOY FOR TIN PLATES; STAINLESS STEEL AND CAST STEEL, FOUNDRY MOLDS OF METAL; FOUNDRY CHILL-MOLDS; UNWROUGHT CAST IRON; SEMI-WROUGHT CAST IRON; WROUGHT STEEL CHIPS; ALUMINUM ALLOY, ALUMINUM INGOTS; GOODS OF ALUMINUM, NAMELY, ALUMINUM ALLOYS, ALUMINUM INGOTS, ALUMINUM RECOGNITIONS PLAQUES, ALUMINUM SIDING; ALUMINUM WIRE; ALUMINUM FOIL; UNWROUGHT COPPER; SEMI-WROUGHT COPPER; UNINSULATED COPPER WIRE; COMMON METALS, NAMELY, UNWROUGHT BRASS; SEMI-WROUGHT BRASS; CHROMIUM ALLOY, CHROMIUM INGOTS; NICKEL (U.S. CLS. 2, 12, 13, 14, 23, 25 AND 50).

CLASS 7—MACHINERY

FOR MACHINES AND MACHINE TOOLS FOR THE CUTTING AND FORMING OF MATERIALS; IRON POWER OPERATED SAWS, STEEL POWER OPERATED SAWS, PUNCHING PRESSES FOR METALWORKING; METALWORKING MACHINE TOOLS; FORGING MOULDS; FOUNDRY MACHINES, NAMELY, CORE SAND MIXER, LIQUID DOSING SYSTEMS, INJECTION MOLDING MACHINES, CUT OFF MACHINES; METAL WORKING MACHINES, NAMELY, MACHINING CENTERS; STEEL TORQUE CONVERTERS NOT FOR LAND VEHICLES; PRE-FINISHED MECHANICALLY DRIVEN THERMIONIC TOOLS, CAST OR FORGED, NAMELY, HOT WORK TOOLS, NAMELY FINISH MACHINED MANDREL BARS, PRE-FINISHED MANDREL BARS, PILGER MANDRELS AND PRE-MATERIAL FOR PIERCERS; GAS TURBINE ENGINES NOT FOR LAND VEHICLES AND REPLACEMENT PARTS; PARTS OF COMPRESSORS FOR MACHINES, NAMELY PUMP BODIES, FORGING MOULDS AND PILGER MANDRELS FOR PIPE PRODUCING, ROLLING MILL PARTS, NAMELY ROLLING PLUGS FOR SEAMLESS PIPE PRODUCTION; CAST IRON MACHINE STANDS, CANTILEVER, MACHINE PART STRAIGHTENING ROLLS FOR METAL BARS, METAL STRIPES, METAL SHEETS, METAL PIPES; MACHINE PARTS, NAMELY, MOLDING TOOLS FOR MANUFACTURING OF COMPOSITE PARTS AND COMPONENTS FOR CAR BODY PANELS; ROLLING MILL FITTINGS FOR PROFILE LINE AS PARTS OF MACHINES; PUMPS AND FITTINGS, NAMELY FOR CHEMICAL INDUSTRY COMPRESSORS FOR MACHINES; TURBINES NOT FOR LAND VEHICLES; ROLLERS, NAMELY MACHINE PART STRAIGHTENING ROLLS, PLUG ROLLS AND PILGER ROLLS FOR ROLLING MILLS; MACHINE PARTS, NAMELY, METAL MANDREL BENDERS, STEEL DIES FOR USE WITH MACHINE TOOLS; ROLLER BEARINGS AS PARTS OF MACHINES, NAMELY STRAIGHTENING, FORMING AND REDUCING ROLLERS; MECHANICAL MACHINE TOOLS FOR ALL MANUFACTURING TECHNIQUES FOR SEAMLESS AND WELDED CAST TUBES AND FORGED TUBES, GAS TURBINES, WATER PUMPS, DOSING PUMPS, OIL PUMPS, FEED PUMPS, RADIAL PISTON DISTRIBUTOR PUMPS, PRESS DIES FOR METAL FORMING TO USE IN THE AUTOMOBILE INDUSTRY; INTERNAL COMBUSTION ENGINE PARTS, NAMELY, PISTONS AND PISTON RINGS; MACHINE PARTS, NAMELY, MILL-STONES, FLEXIBLE SHAFT COUPLINGS, BEARINGS, BEARING HOUSINGS, BEARING INSERTS, ROLLER BEARINGS, BUSHINGS, BLADES, GRINDSTONES, HOODS, NOZZLES WHICH ARE PARTS OF POWER-OPERATED SPRAYERS, WORK HOLDING FIXTURES FOR PRECISION MACHINING APPLICATIONS, CYLINDERS; MACHINE PARTS THAT HEAT AND MAINTAIN TEMPERATURE IN MACHINE PIPING SYSTEMS, NAMELY, STEAM JACKETING, ELECTRICAL TRACING, AND INSULATION SOLD AS INTEGRAL COMPONENTS OF FINISHED MACHINES (U.S. CLS. 13, 19, 21, 23, 31, 34 AND 35).

CLASS 12—VEHICLES

FOR VEHICLES, NAMELY, AUTOMOBILES AND LAND VEHICLES; STRUCTURAL PARTS FOR AUTOMOBILES AND VEHICLES; ACCESSORIES FOR AUTOMOBILES, NAMELY, DRIVE SHAFTS FOR LAND VEHICLES, AXLES FOR LAND VEHICLES, DRIVE GEAR BLANKS FOR LAND VEHICLES (U.S. CLS. 19, 21, 23, 31, 35 AND 44).

CLASS 16—PAPER GOODS AND PRINTED MATTER

FOR CARDBOARD; POSTERS; PRINTER'S TYPE (U.S. CLS. 2, 5, 22, 23, 29, 37, 38 AND 50).

CLASS 21—HOUSEWARES AND GLASS

FOR STEEL WOOL FOR CLEANING (U.S. CLS. 2, 13, 23, 29, 30, 33, 40 AND 50).

CLASS 40—MATERIAL TREATMENT

FOR TREATMENT OF METAL; TREATMENT OF METAL, NAMELY, ALLOYING, HEAT TREATMENT, COLD FORMING, ROLLING, WASHING, LASER CUTTING, PEELING, TURNING, HYDROFORMING, ANNEALING OF METALS, CASTING OF METALS, PLATING OF METALS, PRESSING, PUNCHING, SAWING, DRILLING, GRINDING, PLANING, SANDBLASTING; PROVIDING MATERIAL TREATMENT INFORMATION (U.S. CLS. 100, 103 AND 106).
 NAAKWAMA ANKRAH, EXAMINING ATTORNEY

SN 77-593,580. MAGTEK, INC., SEAL BEACH, CA. FILED 10-15-2008.



QwicKey
Swipe. Don't type.

THE MARK CONSISTS OF THE LITERAL ELEMENT OF THE MARK "QWICKEY SWIPE. DON'T TYPE." IN STYLIZED FORM.

CLASS 9—ELECTRICAL AND SCIENTIFIC APPARATUS

FOR ELECTRONIC CARD READERS; COMPUTER SOFTWARE FOR ALLOWING USERS TO ACCESS ONLINE USER PROFILES AND PERFORM SECURE ELECTRONIC BUSINESS TRANSACTIONS VIA THE INTERNET (U.S. CLS. 21, 23, 26, 36 AND 38).

CLASS 42—SCIENTIFIC AND COMPUTER SERVICES

FOR COMPUTER SERVICES, NAMELY, HOSTING AND MAINTAINING ONLINE WEBSITES FOR OTHERS WHICH ALLOW USERS TO UPLOAD AND ACCESS AN ONLINE PROFILE FOR USE IN PERFORMING SECURE ELECTRONIC BUSINESS TRANSACTIONS VIA THE INTERNET (U.S. CLS. 100 AND 101).

COLLEEN KEARNEY, EXAMINING ATTORNEY

SN 77-593,824. U.S. DEPARTMENT OF EDUCATION, FEDERAL STUDENT AID, WASHINGTON, DC. FILED 10-16-2008.

I'm going.

THE MARK CONSISTS OF STANDARD CHARACTERS WITHOUT CLAIM TO ANY PARTICULAR FONT, STYLE, SIZE, OR COLOR.
 SEC. 2(F).

CLASS 36—INSURANCE AND FINANCIAL

FOR COLLEGE COUNSELING SERVICES, NAMELY, ASSISTING STUDENTS IN APPLYING FOR SCHOLARSHIPS AND FINANCIAL AID (U.S. CLS. 100, 101 AND 102).

FIRST USE 6-1-2008; IN COMMERCE 6-1-2008.

CLASS 41—EDUCATION AND ENTERTAINMENT

FOR EDUCATIONAL SERVICES, NAMELY, CONDUCTING SEMINARS, CLASSES, CONFERENCES AND WORKSHOPS IN THE FIELD OF FINANCIAL AID AND DISTRIBUTION OF TRAINING MATERIAL IN CONNECTION THEREWITH (U.S. CLS. 100, 101 AND 107).

FIRST USE 6-1-2008; IN COMMERCE 6-1-2008.
 WILLIAM BRECKENFELD, EXAMINING ATTORNEY

SN 77-593,877. LUMIN, LAWRENCEVILLE, GA. FILED 10-16-2008.

Lumin

THE MARK CONSISTS OF STANDARD CHARACTERS WITHOUT CLAIM TO ANY PARTICULAR FONT, STYLE, SIZE, OR COLOR.

CLASS 9—ELECTRICAL AND SCIENTIFIC APPARATUS

FOR CONSUMER ELECTRONIC PRODUCTS, NAMELY, AUDIO AMPLIFIERS, AUDIO SPEAKERS, AUDIO RECEIVERS, ELECTRICAL AUDIO AND SPEAKER CABLES AND CONNECTORS, HOME THEATER SYSTEMS, AUDIO DECODERS, VIDEO DECODERS, SPEAKERS, POWER CONVERSION DEVICES, POWER CONVERTERS, AND POWER INVERTERS (U.S. CLS. 21, 23, 26, 36 AND 38).

FIRST USE 7-1-2007; IN COMMERCE 7-1-2007.

CLASS 44—MEDICAL, BEAUTY AND AGRICULTURAL SERVICES

FOR MEDICAL DIAGNOSTIC TESTING, MONITORING AND REPORTING SERVICES (U.S. CLS. 100 AND 101).

FIRST USE 7-1-2007; IN COMMERCE 7-1-2007.

RUSS HERMAN, EXAMINING ATTORNEY

SN 77-594,049. UNITED WAY OF THE BAY AREA, SAN FRANCISCO, CA. FILED 10-16-2008.



THE COLOR(S) BLUE, GREEN, AND WHITE IS/ARE CLAIMED AS A FEATURE OF THE MARK.

THE MARK CONSISTS OF THE WORDING "MATCH BRIDGE" IN THE COLOR WHITE INSIDE A RECTANGLE THAT IS BLUE ON THE TOP AND GREEN ON THE BOTTOM AND SEPARATED BY A CURVED WHITE LINE.

CLASS 35—ADVERTISING AND BUSINESS

FOR PROVIDING CAREER AND JOB RELATED SERVICES TO YOUTHS, NAMELY, PROVIDING EMPLOYMENT AND CAREER PLACEMENT SERVICES AND PROVIDING EMPLOYMENT SEARCHES, REFERRALS, RECRUITING, PLACEMENT, STAFFING AND CAREER NETWORKING SERVICES TO EMPLOYERS; PROVIDING CAREER INFORMATION; BUSINESS NETWORKING SERVICES; PAYROLL PROCESSING SERVICES (U.S. CLS. 100, 101 AND 102).

CLASS 41—EDUCATION AND ENTERTAINMENT

FOR CAREER COUNSELING SERVICES; EDUCATIONAL SERVICES, NAMELY, DEVELOPING CURRICULUM FOR OTHERS IN THE FIELD OF CAREER COUNSELING; PROVIDING TRAINING SERVICES FOR CAREER COUNSELORS AND EDUCATORS ON THE SUBJECT OF CAREER COUNSELING; CAREER TRAINING AND EDUCATION SERVICES, NAMELY, CONDUCTING CLASSES, SEMINARS AND TRAINING PROGRAMS REGARDING INDIVIDUALS' CAREERS AND JOB SKILL DEVELOPMENT (U.S. CLS. 100, 101 AND 107).

KEVIN DINALLO, EXAMINING ATTORNEY

SN 77-594,475. GRAPHIC UMBRELLA COMPANY, FORMERLY MURRAY PRESS, INC., MIAMI, FL. FILED 10-16-2008.

GRAPHIC UMBRELLA

THE MARK CONSISTS OF STANDARD CHARACTERS WITHOUT CLAIM TO ANY PARTICULAR FONT, STYLE, SIZE, OR COLOR.

NO CLAIM IS MADE TO THE EXCLUSIVE RIGHT TO USE "GRAPHIC", APART FROM THE MARK AS SHOWN.

CLASS 40—MATERIAL TREATMENT

FOR PRINTING, NAMELY, PRINTING OF STATIONARY, BROCHURES, PRESENTATION FOLDERS, NEWSLETTERS, INVITATIONS, FORMS, LABELS, AND ENVELOPES, ALL ON PAPER; PRINTING SIGNS AND BANNERS (U.S. CLS. 100, 103 AND 106).

FIRST USE 10-15-2008; IN COMMERCE 10-15-2008.

CLASS 42—SCIENTIFIC AND COMPUTER SERVICES

FOR GRAPHIC DESIGN; WEBSITE DESIGN, DEVELOPMENT AND HOSTING OF WEBSITES FOR OTHERS; COMPUTER SERVICES, NAMELY, SEARCH ENGINE OPTIMIZATION (U.S. CLS. 100 AND 101).

FIRST USE 10-15-2008; IN COMMERCE 10-15-2008.
WILLIAM ROSSMAN, EXAMINING ATTORNEY

SN 77-594,534. GRAPHIC UMBRELLA COMPANY, FORMERLY MURRAY PRESS, INC., MIAMI, FL. FILED 10-16-2008.



NO CLAIM IS MADE TO THE EXCLUSIVE RIGHT TO USE "GRAPHIC", APART FROM THE MARK AS SHOWN.

THE MARK CONSISTS OF AN OPEN UMBRELLA WHERE THE "U" IN "UMBRELLA" FORMS THE HANDLE OF THE UMBRELLA.

CLASS 40—MATERIAL TREATMENT

FOR PRINTING, NAMELY, PRINTING OF STATIONARY, BROCHURES, PRESENTATION FOLDERS, NEWSLETTERS, INVITATIONS, FORMS, LABELS, AND ENVELOPES, ALL ON PAPER; PRINTING SIGNS AND BANNERS (U.S. CLS. 100, 103 AND 106).

FIRST USE 10-15-2008; IN COMMERCE 10-15-2008.

CLASS 42—SCIENTIFIC AND COMPUTER SERVICES

FOR GRAPHIC DESIGN; WEBSITE DESIGN, DEVELOPMENT, AND HOSTING OF WEBSITES FOR OTHERS; COMPUTER SERVICES, NAMELY, SEARCH ENGINE OPTIMIZATION (U.S. CLS. 100 AND 101).

FIRST USE 10-15-2008; IN COMMERCE 10-15-2008.

WILLIAM ROSSMAN, EXAMINING ATTORNEY

SN 77-594,645. CASABELLA HOLDINGS, LLC, BLAUVELT, NY. FILED 10-16-2008.

CASABELLA

THE MARK CONSISTS OF STANDARD CHARACTERS WITHOUT CLAIM TO ANY PARTICULAR FONT, STYLE, SIZE, OR COLOR.

OWNER OF U.S. REG. NOS. 1,976,718 AND 2,651,483.
THE ENGLISH TRANSLATION OF "CASABELLA" IN THE MARK IS "BEAUTIFUL HOUSE."

CLASS 21—HOUSEWARES AND GLASS

FOR EXFOLIATING MITT (U.S. CLS. 2, 13, 23, 29, 30, 33, 40 AND 50).

CLASS 24—FABRICS

FOR TOWELS; TOWELS, NAMELY, FABRIC HAIR WRAPS, AND FABRIC BODY WRAPS (U.S. CLS. 42 AND 50).

KOURTNEE HODGES, EXAMINING ATTORNEY

SN 77-595,411. SILICON IMAGE, INC., SUNNYVALE, CA.
FILED 10-17-2008.

LIQUIDPLAY

THE MARK CONSISTS OF STANDARD CHARACTERS WITHOUT CLAIM TO ANY PARTICULAR FONT, STYLE, SIZE, OR COLOR.

CLASS 9—ELECTRICAL AND SCIENTIFIC APPARATUS

FOR CONSUMER ELECTRONIC DEVICES, NAMELY, TELEVISION SET-TOP BOXES, DIGITAL AUDIO AND VIDEO RECORDERS AND PLAYERS, LASER DISC RECORDERS AND PLAYERS, MP3 RECORDERS AND PLAYERS, PERSONAL STEREOS, VIDEO GAME MACHINES FOR USE WITH EXTERNAL DISPLAY SCREEN OR MONITOR, SET-TOP BOXES FOR USE IN PLAYING COMPUTER GAMES, VIDEO GAME MACHINES FOR USE WITH TELEVISIONS AND COMPUTER MONITORS, PORTABLE AND CELL PHONES; PORTABLE MEDIA PLAYERS, PORTABLE AND HANDHELD DIGITAL ELECTRONIC DEVICES FOR RECORDING, ORGANIZING, TRANSMITTING, MANIPULATING, AND REVIEWING TEXT, DATA, IMAGE, AND AUDIO FILES; CABLE, SATELLITE AND TERRESTRIAL DIGITAL SET TOP BOXES; DIGITAL VIDEO DISK (DVD) PLAYERS AND RECORDERS; DIGITAL VIDEO HOME SYSTEM (VHS) PLAYERS AND RECORDERS; PERSONAL VIDEO RECORDERS; CABLE BOXES, NAMELY, RECEIVERS FOR RECEIVING CABLE TELEVISION; CAMERAS; AUDIO VIDEO RECEIVERS; INTEGRATED TELEVISIONS; TELEVISION MONITORS; HOME THEATER SYSTEMS; STORAGE BOXES IN THE NATURE OF EXTERNAL COMPUTER BACKUP AND STORAGE SYSTEMS WITH MULTIPLE REMOVABLE RAID DRIVERS; COMPUTER HARDWARE; INTEGRATED CIRCUITS AND SEMICONDUCTORS; COMPUTER SOFTWARE, NAMELY, COMPUTER SOFTWARE INTERFACE FOR USE IN CONNECTING, CONTROLLING AND NETWORKING A WIDE VARIETY OF PERSONAL COMPUTER DEVICES, COMPONENTS, AND PERIPHERALS; COMPUTER SOFTWARE FOR USE AS AN INTERFACE BETWEEN AUDIO/VIDEO SOURCES AND AUDIO/VIDEO REPEATER DEVICES; COMPUTER SOFTWARE FOR USE AS AN INTERFACE BETWEEN AUDIO/VIDEO SOURCES AND AUDIO/VIDEO MONITORS; COMPUTER SOFTWARE INTERFACE FOR USE IN CONNECTING, CONTROLLING AND NETWORKING A WIDE VARIETY OF CONSUMER ELECTRONIC DEVICES, COMPONENTS, AND PERIPHERALS; CONNECTORS, CABLES, AND COMPONENTS THEREOF, NAMELY, ELECTRONIC CABLES, ELECTRONIC CONNECTORS, AND ELECTRONIC COMPUTER COMPONENTS; COMPUTER PERIPHERALS, CABLE MODEMS, GATEWAY ROUTERS IN THE NATURE OF COMPUTER CONTROL HARDWARE FOR CONNECTING TO THE INTERNET, AND COMPUTER MULTIMEDIA SWITCHES; COMPUTER SOFTWARE FOR THE INTEROPERABILITY OF COMPUTERS AND CONSUMER ELECTRONICS TO RECEIVE AND PLAY DIGITAL CONTENT AND INSTRUCTIONAL MANUALS SOLD THEREWITH (U.S. CLS. 21, 23, 26, 36 AND 38).

CLASS 35—ADVERTISING AND BUSINESS

FOR ASSOCIATION SERVICES, NAMELY, PROMOTING THE INTERESTS OF MANUFACTURERS OF COMPUTERS, COMPUTER HARDWARE, COMPUTER SOFTWARE, AND CONSUMER ELECTRONIC DEVICES; PROMOTING THE DEVELOPMENT AND ADOPTION OF A VOLUNTARY DIGITAL INTERFACE SPECIFICATION THAT PROVIDES AN INTEROPERABLE METHOD OF CONNECTING COMPUTER AND COMMUNICATIONS HARDWARE, CONSUMER ELECTRONIC DEVICES, COMPONENTS, AND PERIPHERALS; PROMOTING THE DEVELOPMENT AND ADOPTION OF A SPECIFICATION FOR INTEROPERABILITY OF COMPUTERS AND CONSUMER ELECTRONICS TO RECEIVE AND PLAY DIGITAL CONTENT; ELECTRONIC COMMERCE SERVICES, NAMELY PROVIDING CONSUMER PRODUCT INFORMATION VIA THE INTERNET (U.S. CLS. 100, 101 AND 102).

CLASS 42—SCIENTIFIC AND COMPUTER SERVICES

FOR TESTING SERVICES, NAMELY, PRODUCT AND MATERIAL TESTING; TESTING SERVICES, NAMELY, TESTING THE GOODS OF OTHERS FOR THE PURPOSE OF STANDARDS COMPLIANCE; COMPUTER SERVICES, NAMELY, DEVELOPING INTEROPERABILITY AND SECURITY STANDARDS FOR RECEIVING AND PLAYING DIGITAL CONTENT ACROSS CONSUMER ELECTRONIC DEVICES AND COMPUTERS; TECHNICAL SUPPORT SERVICES, NAMELY TROUBLESHOOTING COMPUTER SOFTWARE AND HARDWARE PROBLEMS (U.S. CLS. 100 AND 101).
ROBIN CHOSID, EXAMINING ATTORNEY

SN 77-595,951. MICHAELS STORES PROCUREMENT COMPANY, INC., IRVING, TX. FILED 10-20-2008.

ARTMINDS

THE MARK CONSISTS OF STANDARD CHARACTERS WITHOUT CLAIM TO ANY PARTICULAR FONT, STYLE, SIZE, OR COLOR.

CLASS 8—HAND TOOLS

FOR ARTISTS' HAND TOOLS FOR SHAPING, SCULPTING, AND SCORING CLAY AND MODELING COMPOUNDS, NAMELY, SCULPTING KNIVES, FOLDING KNIVES, TRIM BLADES; SCISSORS; ARTISTS' HAND TOOLS FOR CUTTING CLAY AND MODELING COMPOUNDS, NAMELY, ART KNIVES, CRAFT KNIVES, PUTTY KNIVES; ARTISTS' HAND TOOLS, NAMELY, PICKS AND SCRAPERS FOR USE WITH CLAY AND MODELING COMPOUNDS (U.S. CLS. 23, 28 AND 44).

CLASS 16—PAPER GOODS AND PRINTED MATTER

FOR ART SUPPLIES, NAMELY, ARTISTS' BRUSHES, PAINTING PALETTES, ART PADS, ART PAPER, ARTISAN GLUE, ART AND CRAFT PAINT KITS; NEWSLETTERS ON ARTS AND CRAFTS, BOOKS IN THE FIELD OF CRAFTS, ARTS AND CRAFTS PROJECT SHEETS IN THE NATURE OF INSTRUCTION SHEETS; STICKERS; STAMP INK PADS; INK STAMPS MADE OF RUBBER AND FOAM; INK STAMPS MADE OF WOOD AND ACRYLIC FOR USE IN ARTS AND CRAFT PROJECTS; STENCILS; IRON-ON TRANSFERS; MEMORY BOOKS, SCRAPBOOKS, WEDDING ALBUMS, PHOTOGRAPH ALBUMS, MOUNTING PAPER AND CRAFT PAPER; MOLDS FOR MODELING CLAYS; PRINTED INSTRUCTIONAL AND TEACHING MATERIALS IN THE FIELD OF ASSEMBLING AND DISPLAYING MEMORABILIA AND PHOTOGRAPHS AND CREATING MEMORY BOOKS, SCRAPBOOKS, AND WEDDING AND PHOTOGRAPH ALBUMS; ARTS AND CRAFTS CLAY KITS, MODELING CLAY, ADHESIVE TAPE FOR STATIONERY OR HOUSEHOLD PURPOSES, GLUE FOR STATIONERY OR HOUSEHOLD USE, STICKERS, WORD PUZZLES IN THE NATURE OF CROSSWORD AND REBUS PUZZLES; MAGAZINES IN THE FIELD OF CRAFTING; APPLIQUES IN THE FORM OF DECALS; PAPER APPLIQUES IN THE FORM OF DECALS (U.S. CLS. 2, 5, 22, 23, 29, 37, 38 AND 50).

PAUL CROWLEY, EXAMINING ATTORNEY

SN 77-596,005. C-QUEST CAPITAL LLC, WASHINGTON, DC. FILED 10-20-2008.

C-QUEST CAPITAL

THE MARK CONSISTS OF STANDARD CHARACTERS WITHOUT CLAIM TO ANY PARTICULAR FONT, STYLE, SIZE, OR COLOR.

NO CLAIM IS MADE TO THE EXCLUSIVE RIGHT TO USE "CAPITAL", APART FROM THE MARK AS SHOWN.

CLASS 36—INSURANCE AND FINANCIAL

FOR COMMODITY DEVELOPMENT AND EXCHANGE SERVICES, NAMELY, DEVELOPMENT, BROKERAGE AND TRADING OF CARBON CREDITS FOR THE PURPOSE OF MEETING MANDATORY OR VOLUNTARY GREENHOUSE GAS EMISSIONS REDUCTIONS, NAMELY, CARBON EMISSIONS REDUCTIONS TARGETS; BROKERAGE IN THE FIELD OF RENEWABLE ENERGY CERTIFICATES, CARBON CREDITS, EMISSIONS CREDITS AND ECOSYSTEM SERVICES; ENVIRONMENTAL BROKERAGE SERVICES IN THE AREA OF POLLUTION CREDITS, NAMELY, GREENHOUSE GASES, NAMELY, ARRANGING EXCHANGES OF CARBON OFFSET CREDITS FOR OTHER ASSETS; ENERGY AND ENVIRONMENTAL BROKERAGE AND DEALER SERVICES, NAMELY, TRADING, BUYING, AND SELLING OF ENERGY, AGRICULTURAL AND FOREST FINANCIAL PRODUCTS FOR OTHERS; VENTURE CAPITAL FINANCING; ENERGY COMMODITIES TRADING FOR OTHERS; COMMODITY TRADING FOR OTHERS, NAMELY, ENERGY-RELATED FINANCIAL INSTRUMENT TRADING FOR OTHERS; FINANCIAL RISK MANAGEMENT AND HEDGE FUND INVESTMENT SERVICES FOR THE ENERGY INDUSTRY; COMMODITY TRADING FOR OTHERS, NAMELY, DERIVATIVES TRADING; FINANCIAL SERVICES, NAMELY, BROKERAGE OF POLLUTION AND CARBON OFFSET CREDITS, FINANCIAL ASSET MANAGEMENT; PROVIDING FINANCIAL INFORMATION, NAMELY, INFORMATION RELATING TO THE TRADING OF CARBON CREDITS AMONG BUSINESSES FOR THE PURPOSE OF REDUCTION OF CARBON EMISSIONS (U.S. CLS. 100, 101 AND 102).

CLASS 42—SCIENTIFIC AND COMPUTER SERVICES

FOR SCIENTIFIC AND TECHNOLOGICAL RESEARCH AND TECHNICAL CONSULTING SERVICES IN THE FIELD OF ENVIRONMENTAL SCIENCE, NAMELY, QUANTIFICATION OF GREENHOUSE GAS EMISSIONS; SCIENTIFIC AND TECHNOLOGICAL RESEARCH AND TECHNICAL CONSULTATION AND ASSISTANCE IN THE FIELD OF ENVIRONMENTAL SCIENCE TO REDUCE AND MITIGATE GREENHOUSE GAS EMISSIONS; TECHNICAL CONSULTATION IN THE FIELD OF ENVIRONMENTAL SCIENCE FOR SEQUESTRATION PROJECTS IN RENEWABLE ENERGY; ENVIRONMENTAL CONSULTING SERVICES IN THE NATURE OF DESIGNING PROJECTS THAT REDUCE OR MITIGATE GREENHOUSE GAS EMISSIONS, AND TECHNICAL ASSISTANCE TO VERIFY EMISSION REDUCTIONS FOR THE PURPOSE OF CERTIFICATION; SCIENTIFIC AND TECHNICAL RESEARCH ASSISTANCE FOR GREENHOUSE GAS MITIGATION AND SEQUESTRATION PROJECTS IN RENEWABLE ENERGY, ENERGY EFFICIENCY, AND SUSTAINABLE LAND USE AND FORESTRY (U.S. CLS. 100 AND 101).

COURTNEY MCCORMICK, EXAMINING ATTORNEY

SN 77-596,074. STORM MANUFACTURING GROUP, INC., TORRANCE, CA. FILED 10-20-2008.

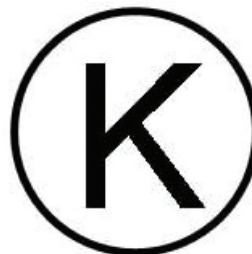

THE MARK CONSISTS OF THE LETTER "K" WITHIN A CIRCLE.

CLASS 6—METAL GOODS

FOR METAL PIPE FITTINGS; METAL HOSE FITTINGS (U.S. CLS. 2, 12, 13, 14, 23, 25 AND 50). FIRST USE 6-30-2008; IN COMMERCE 6-30-2008.

CLASS 7—MACHINERY

FOR METAL VALVES BEING PARTS OF MACHINES, NAMELY, AIR COMPRESSORS, BUSES, CONSTRUCTION AND INDUSTRIAL EQUIPMENT, CARPET AND FLOOR CLEANING MACHINES; VALVES FOR HYDRAULIC MACHINERY, NAMELY, METAL FLOW CONTROL VALVES (U.S. CLS. 13, 19, 21, 23, 31, 34 AND 35).

FIRST USE 1-1-1970; IN COMMERCE 1-1-1970.

CLASS 9—ELECTRICAL AND SCIENTIFIC APPARATUS

FOR AUTOMATIC VALVES; AUTOMATIC SAFETY RELIEF VALVES; ELECTRONIC VALVES FOR CONTROLLING GAS OR FLUIDS, NAMELY, BURNER VALVES; CONTROL VALVES FOR REGULATING THE FLOW OF GASES AND LIQUIDS; MANUALLY-ACTUATED FLOW CONTROL VALVES FOR REGULATING THE FLOW OF GASES AND LIQUIDS; QUICK OPENING, SELF-CLOSING CONTROL VALVES FOR REGULATING THE FLOW OF GASES AND LIQUIDS (U.S. CLS. 21, 23, 26, 36 AND 38).

FIRST USE 1-1-1970; IN COMMERCE 1-1-1970.

CLASS 11—ENVIRONMENTAL CONTROL APPARATUS

FOR STEAM VALVES (U.S. CLS. 13, 21, 23, 31 AND 34).
FIRST USE 1-1-1970; IN COMMERCE 1-1-1970.
ROBERT C. CLARK JR., EXAMINING ATTORNEY

CLASS 6—METAL GOODS

FOR METAL LOCKSETS, METAL LOCKS, METAL DOOR KNOBS; DECORATIVE HARDWARE OF METAL, NAMELY, DOOR KICK PLATES, HOUSE NUMBERS, HOUSE LETTERS, DOOR BUMPERS AND DOOR STOPS (U.S. CLS. 2, 12, 13, 14, 23, 25 AND 50).

CLASS 21—HOUSEWARES AND GLASS

FOR KNOBS MADE OF PORCELAIN, GLASS AND CERAMICS; BATHROOM ACCESSORIES, NAMELY, TOWEL BARS, TOWEL RINGS, AND TOILET PAPER HOLDERS (U.S. CLS. 2, 13, 23, 29, 30, 33, 40 AND 50).
LINDA LAVACHE, EXAMINING ATTORNEY

SN 77-596,128. THE DEVELOPERS GROUP, BROOKLYN, NY. FILED 10-20-2008.

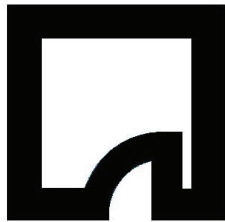

THE MARK CONSISTS OF A MODIFIED SQUARE. THE BOTTOM OF THE SQUARE IS NOT A STRAIGHT LINE; PART OF THE LINE INDENTS AS A CURVED LINE MEETING A STRAIGHT LINE THAT RUNS PERPENDICULARLY TO THE BOTTOM OF THE SQUARE.

SN 77-596,282. IKS TECHNOLOGIES, INC., CYPRESS, CA. FILED 10-20-2008.

innovative self-serve
solutions

THE MARK CONSISTS OF STANDARD CHARACTERS WITHOUT CLAIM TO ANY PARTICULAR FONT, STYLE, SIZE, OR COLOR.

NO CLAIM IS MADE TO THE EXCLUSIVE RIGHT TO USE "SELF-SERVE", APART FROM THE MARK AS SHOWN.

CLASS 35—ADVERTISING AND BUSINESS

FOR REAL ESTATE MARKETING SERVICES IN THE FIELD OF CONDOMINIUMS, CO-OPS AND APARTMENTS; MARKET RESEARCH SERVICES (U.S. CLS. 100, 101 AND 102).
FIRST USE 8-0-2008; IN COMMERCE 8-0-2008.

CLASS 9—ELECTRICAL AND SCIENTIFIC APPARATUS

FOR INTERACTIVE COMPUTER KIOSKS COMPRISING OF COMPUTERS, COMPUTER HARDWARE, COMPUTER PERIPHERALS, AND COMPUTER OPERATING SOFTWARE. FOR USE IN A VARIETY OF APPLICATIONS, NAMELY, ALLOWING USERS TO ACCESS INFORMATION, MARKET GOODS AND SERVICES, OBTAIN GOODS AND SERVICES, AND CARRY OUT TRANSACTIONS VIA REMOTE CONNECTIVITY TO A GLOBAL COMPUTER NETWORK (U.S. CLS. 21, 23, 26, 36 AND 38).
FIRST USE 5-1-2007; IN COMMERCE 5-1-2007.

CLASS 36—INSURANCE AND FINANCIAL

FOR COMMERCIAL AND RESIDENTIAL REAL ESTATE AGENCY SERVICES; PROVIDING REAL ESTATE LISTINGS AND REAL ESTATE INFORMATION VIA THE INTERNET; REAL ESTATE CONSULTATION (U.S. CLS. 100, 101 AND 102).
FIRST USE 8-0-2008; IN COMMERCE 8-0-2008.

CLASS 40—MATERIAL TREATMENT

FOR CUSTOM MANUFACTURE OF KIOSKS TO ORDER AND/OR SPECIFICATION OF OTHERS; MANUFACTURING SERVICES FOR OTHERS IN THE FIELD OF KIOSKS (U.S. CLS. 100, 103 AND 106).
FIRST USE 5-1-2007; IN COMMERCE 5-1-2007.
CURTIS FRENCH, EXAMINING ATTORNEY

CLASS 37—CONSTRUCTION AND REPAIR

FOR REAL ESTATE DEVELOPMENT (U.S. CLS. 100, 103 AND 106).
FIRST USE 8-0-2008; IN COMMERCE 8-0-2008.
REBECCA EISINGER, EXAMINING ATTORNEY

SN 77-596,208. STOCK BUILDING SUPPLY LLC, RALEIGH, NC. FILED 10-20-2008.

SN 77-596,590. JACOBS CENTER FOR NEIGHBORHOOD INNOVATION, SAN DIEGO, CA. FILED 10-20-2008.

FORTIS

DIAMOND MANAGEMENT

THE MARK CONSISTS OF STANDARD CHARACTERS WITHOUT CLAIM TO ANY PARTICULAR FONT, STYLE, SIZE, OR COLOR.

THE MARK CONSISTS OF STANDARD CHARACTERS WITHOUT CLAIM TO ANY PARTICULAR FONT, STYLE, SIZE, OR COLOR.

NO CLAIM IS MADE TO THE EXCLUSIVE RIGHT TO USE "MANAGEMENT", APART FROM THE MARK AS SHOWN.

CLASS 35—ADVERTISING AND BUSINESS

FOR PROMOTING PUBLIC AWARENESS OF COMMUNITY DEVELOPMENT FOR THE PURPOSE OF POSITIVE SOCIAL AND ECONOMIC OUTCOMES IN THE COMMUNITY, JOB DEVELOPMENT, ENTREPRENEUR DEVELOPMENT AND CULTURAL DEVELOPMENT (U.S. CLS. 100, 101 AND 102).

FIRST USE 5-0-2000; IN COMMERCE 5-0-2000.

CLASS 36—INSURANCE AND FINANCIAL

FOR PROPERTY SERVICES, NAMELY, LEASING AND RENTAL OF REAL ESTATE, CULTURAL CENTERS AND SHOPPING CENTERS AND MANAGEMENT OF COMMERCIAL REAL ESTATE, CULTURAL CENTERS AND SHOPPING CENTERS; SHOPPING CENTER SERVICES, NAMELY, RENTAL OF SHOPPING CENTER SPACE; COMMERCIAL PROPERTY MANAGEMENT SERVICES (U.S. CLS. 100, 101 AND 102).

FIRST USE 5-0-2000; IN COMMERCE 5-0-2000.

CLASS 37—CONSTRUCTION AND REPAIR

FOR REAL ESTATE DEVELOPMENT AND CONSTRUCTION OF COMMERCIAL AND RESIDENTIAL PROPERTY (U.S. CLS. 100, 103 AND 106).

FIRST USE 5-0-2000; IN COMMERCE 5-0-2000.

CLASS 41—EDUCATION AND ENTERTAINMENT

FOR EDUCATIONAL SERVICES, NAMELY, PROVIDING TRAINING IN THE FIELDS OF BUSINESS AND COMMUNITY DEVELOPMENT, PROPERTY MANAGEMENT, AND COMMUNITY ASSET BUILDING (U.S. CLS. 100, 101 AND 107).

FIRST USE 5-0-2000; IN COMMERCE 5-0-2000.
CURTIS FRENCH, EXAMINING ATTORNEY

SN 77-596,658. THE BOLDT GROUP, INC., APPLETON, WI. FILED 10-21-2008.

BoldThinking

THE MARK CONSISTS OF STANDARD CHARACTERS WITHOUT CLAIM TO ANY PARTICULAR FONT, STYLE, SIZE, OR COLOR.

OWNER OF U.S. REG. NOS. 1,431,493, 2,819,720 AND OTHERS.

CLASS 37—CONSTRUCTION AND REPAIR

FOR CONSTRUCTION, REPAIR, AND RENOVATION OF COMMERCIAL, INDUSTRIAL, GOVERNMENTAL, INSTITUTIONAL, EDUCATIONAL, RECREATIONAL, HEALTHCARE, AND RELIGIOUS BUILDINGS AND POWER AND BIOENERGY FACILITIES; AND CONSTRUCTION OF WIND TURBINES; PROVIDE REAL ESTATE DEVELOPMENT, CONSTRUCTION PROJECT PLANNING AND DEVELOPMENT, CONSTRUCTION MANAGEMENT UTILIZING INTEGRATED LEAN PROJECT DELIVERY (ILPD) METHODS, AND GENERAL CONSTRUCTION CONTRACTING SERVICES RELATED TO THE ABOVE-MENTIONED MARKETS (U.S. CLS. 100, 103 AND 106).

FIRST USE 1-1-2007; IN COMMERCE 1-1-2007.

CLASS 42—SCIENTIFIC AND COMPUTER SERVICES

FOR ARCHITECTURAL DESIGN AND ENGINEERING SERVICES; CONCEPTUAL DESIGN OF COMMERCIAL, INDUSTRIAL, GOVERNMENTAL, INSTITUTIONAL, EDUCATIONAL, RECREATIONAL, HEALTHCARE, AND RELIGIOUS BUILDINGS AND POWER AND BIOENERGY FACILITIES AND OTHER BUILDINGS (U.S. CLS. 100 AND 101).

FIRST USE 1-1-2007; IN COMMERCE 1-1-2007.

MATTHEW EINSTEIN, EXAMINING ATTORNEY

SN 77-597,987. SNELL, PETER, SAN DIEGO, CA. FILED 10-22-2008.

TIPMEISTER

THE MARK CONSISTS OF STANDARD CHARACTERS WITHOUT CLAIM TO ANY PARTICULAR FONT, STYLE, SIZE, OR COLOR.

CLASS 6—METAL GOODS

FOR METAL COIN BANKS; METAL CONTAINERS FOR RECEIVING AND STORING TIPS AND GRATUITIES; METAL CONTAINERS FOR USE IN RESTAURANTS AND RETAIL ESTABLISHMENTS TO RECEIVE AND STORE COINS AND PAPER MONEY (U.S. CLS. 2, 12, 13, 14, 23, 25 AND 50).

CLASS 20—FURNITURE AND ARTICLES NOT OTHERWISE CLASSIFIED

FOR NON-METAL CONTAINERS FOR RECEIVING AND STORING TIPS AND GRATUITIES FOR COMMERCIAL USE; NON-METAL CONTAINERS FOR USE IN RESTAURANTS AND RETAIL ESTABLISHMENTS TO RECEIVE AND STORE COINS AND PAPER MONEY; NON-METAL CONTAINERS FOR COMMERCIAL USE (U.S. CLS. 2, 13, 22, 25, 32 AND 50).

TIMOTHY FINNegan, EXAMINING ATTORNEY

SN 77-598,250. NAIL LABO CO. LTD., SHIBUYA-KU, TOKYO, JAPAN, FILED 10-22-2008.

LED GEL Presto

THE MARK CONSISTS OF STANDARD CHARACTERS WITHOUT CLAIM TO ANY PARTICULAR FONT, STYLE, SIZE, OR COLOR.

NO CLAIM IS MADE TO THE EXCLUSIVE RIGHT TO USE "LED GEL", APART FROM THE MARK AS SHOWN.

CLASS 3—COSMETICS AND CLEANING PREPARATIONS

FOR NAIL CARE PREPARATIONS, NAIL POLISH, NAIL VARNISH, NAIL STRENGTHENER, CUTICLE REMOVING PREPARATIONS, NAIL GROOMING PRODUCTS, NAMELY, TIPS, GLUE, LACQUER AND GLITTER, NAIL HARDENERS, NAIL POLISH BASE COAT, NAIL POLISH TOP COAT, AND VARNISH-REMOVING PREPARATIONS, FALSE NAILS (U.S. CLS. 1, 4, 6, 50, 51 AND 52).

CLASS 11—ENVIRONMENTAL CONTROL APPARATUS

FOR APPARATUS FOR DRYING AND HARDENING NAIL GEL, NAIL POLISH, OR NAIL VARNISH, NAMELY, DESICCANT UNITS, DRYING APPARATUS IN THE NATURE OF ELECTRIC NAIL DRYERS, LED NAIL DRYERS, DRYING APPARATUS AND INSTALLATIONS, NAMELY, ELECTRIC NAIL DRYERS, AND LAMPS (U.S. CLS. 13, 21, 23, 31 AND 34).

SHANNON TWOHIG, EXAMINING ATTORNEY

SN 77-598,925. STRATEGIES FOR L.I.F.E., INC., LAS VEGAS, NV. FILED 10-23-2008.

STRATEGIES FOR L.I.F.E.

THE MARK CONSISTS OF STANDARD CHARACTERS WITHOUT CLAIM TO ANY PARTICULAR FONT, STYLE, SIZE, OR COLOR.

CLASS 35—ADVERTISING AND BUSINESS

FOR CONSULTING SERVICES IN BUSINESS LEADERSHIP DEVELOPMENT AND BUSINESS MANAGEMENT (U.S. CLS. 100, 101 AND 102).

FIRST USE 7-30-2001; IN COMMERCE 7-30-2001.

CLASS 41—EDUCATION AND ENTERTAINMENT

FOR PERSONAL COACHING SERVICES IN THE FIELD OF SELF-IMPROVEMENT (U.S. CLS. 100, 101 AND 107).

FIRST USE 7-30-2001; IN COMMERCE 7-30-2001.

MARGERY A. TIERNEY, EXAMINING ATTORNEY

SN 77-599,023. STARLINE PUBLICATIONS, INC., PARAMUS, NJ. FILED 10-23-2008.

URBAN INK

THE MARK CONSISTS OF STANDARD CHARACTERS WITHOUT CLAIM TO ANY PARTICULAR FONT, STYLE, SIZE, OR COLOR.

OWNER OF U.S. REG. NO. 3,385,011.

CLASS 18—LEATHER GOODS

FOR TRUNKS, TRAVELLING BAGS, TOTE BAGS (U.S. CLS. 1, 2, 3, 22 AND 41).

CLASS 25—CLOTHING

FOR CLOTHING, NAMELY, SWEATSHIRTS, HOODED SWEATSHIRTS, T-SHIRTS, JACKETS, SHIRTS, PANTS, JEANS, BLOUSES, WARM-UP SUITS AND BANDANAS; HEADGEAR, NAMELY, CAPS AND HATS; AND FOOTWEAR (U.S. CLS. 22 AND 39).

NANCY CLARKE, EXAMINING ATTORNEY

SN 77-599,087. 359711 ALBERTA LTD., CALGARY, ALBERTA, CANADA, FILED 10-23-2008.

GET RIPPED

THE MARK CONSISTS OF STANDARD CHARACTERS WITHOUT CLAIM TO ANY PARTICULAR FONT, STYLE, SIZE, OR COLOR.

CLASS 9—ELECTRICAL AND SCIENTIFIC APPARATUS

FOR (BASED ON USE IN COMMERCE) DIGITAL MEDIA, NAMELY, PRE-RECORDED VIDEO CASSETTES, DIGITAL VIDEO DISCS, DIGITAL VERSATILE DISCS, AND DVDS FEATURING PHYSICAL FITNESS INSTRUCTION AND PERSONAL HEALTH INFORMATION (U.S. CLS. 21, 23, 26, 36 AND 38).

FIRST USE 12-1-2004; IN COMMERCE 12-1-2004.

CLASS 16—PAPER GOODS AND PRINTED MATTER

FOR (BASED ON INTENT TO USE) PRINTED MATTER, NAMELY, BOOKS, SERIES OF MAGAZINE ARTICLES AND NEWSLETTERS BASED ON HEALTH AND PERSONAL FITNESS (U.S. CLS. 2, 5, 22, 23, 29, 37, 38 AND 50).

CLASS 25—CLOTHING

FOR (BASED ON INTENT TO USE) CLOTHING, NAMELY, T-SHIRTS, TANK TOPS, SWEATSHIRTS, JACKETS AND CAPS (U.S. CLS. 22 AND 39).

CLASS 41—EDUCATION AND ENTERTAINMENT

FOR (BASED ON INTENT TO USE) PHYSICAL FITNESS INSTRUCTION (U.S. CLS. 100, 101 AND 107).

MARIA-VICTORIA SUAREZ, EXAMINING ATTORNEY

SN 77-599,449. ANALYTE MEDIA, INC., CHICAGO, IL.
FILED 10-23-2008.

ANALYTE MEDIA

THE MARK CONSISTS OF STANDARD CHARACTERS WITHOUT CLAIM TO ANY PARTICULAR FONT, STYLE, SIZE, OR COLOR.

NO CLAIM IS MADE TO THE EXCLUSIVE RIGHT TO USE "MEDIA", APART FROM THE MARK AS SHOWN.

CLASS 35—ADVERTISING AND BUSINESS

FOR ELECTRONIC DATA COLLECTION AND DATA SUBMISSION SERVICES FOR BUSINESS PURPOSES IN THE FIELDS OF MEDICINE AND HEALTHCARE; ON-LINE LEAD GENERATION, LEAD DATA ENTRY, LEAD CAPTURE, COLLECTION AND PROCESSING, NAMELY, ELECTRONIC PROCESSING OF MARKETING LEADS, LEAD INVENTORY MANAGEMENT, LEAD DISTRIBUTION IN THE FIELD OF MEDICINE, NAMELY, MEDICAL PROVIDERS, HOSPITALS, CLINICS AND PROVIDERS OF HEALTH AND WELLNESS PRODUCTS AND SERVICES; PROVIDING ON-LINE RETAIL STORE SERVICES AVAILABLE VIA A GLOBAL COMPUTER NETWORK FEATURING CONSUMER HEALTHCARE PRODUCTS AND SERVICES (U.S. CLS. 100, 101 AND 102).

CLASS 45—PERSONAL AND LEGAL SERVICES

FOR IDENTIFICATION VERIFICATION SERVICES, NAMELY, PROVIDING AUTHENTICATION OF PERSONAL IDENTIFICATION INFORMATION (U.S. CLS. 100 AND 101).

JILL PRATER, EXAMINING ATTORNEY

SN 77-599,688. STROKIN, LLC, CHASKA, MN. FILED 10-24-2008.

SOL MAR

THE MARK CONSISTS OF STANDARD CHARACTERS WITHOUT CLAIM TO ANY PARTICULAR FONT, STYLE, SIZE, OR COLOR.

THE ENGLISH TRANSLATION OF "SOL MAR" IN THE MARK IS SUN SEA.

CLASS 11—ENVIRONMENTAL CONTROL APPARATUS

FOR OUTDOOR LIGHTING PRODUCTS, NAMELY, PAVER LIGHTS, PATH LIGHTS, GARDEN LIGHTS, ROCK LIGHTS (U.S. CLS. 13, 21, 23, 31 AND 34).

CLASS 18—LEATHER GOODS

FOR PATIO UMBRELLAS (U.S. CLS. 1, 2, 3, 22 AND 41).

CLASS 20—FURNITURE AND ARTICLES NOT OTHERWISE CLASSIFIED

FOR OUTDOOR FURNITURE (U.S. CLS. 2, 13, 22, 25, 32 AND 50).

DOUGLAS LEE, EXAMINING ATTORNEY

SN 77-599,722. BOWDEN GROUP, HONOLULU, HI. FILED 10-24-2008.

HAWAIIAN CROWN

THE MARK CONSISTS OF STANDARD CHARACTERS WITHOUT CLAIM TO ANY PARTICULAR FONT, STYLE, SIZE, OR COLOR.

OWNER OF U.S. REG. NO. 3,302,088.

NO CLAIM IS MADE TO THE EXCLUSIVE RIGHT TO USE "HAWAIIAN", APART FROM THE MARK AS SHOWN.

CLASS 25—CLOTHING

FOR CLOTHING, NAMELY, HATS, SHIRTS, T-SHIRTS, VISORS, PANTS, SHORTS, SLACKS, GOLF SHIRTS (U.S. CLS. 22 AND 39).

CLASS 29—MEATS AND PROCESSED FOODS

FOR PROCESSED MACADAMIA NUTS; SHELLED MACADAMIA NUTS (U.S. CL. 46).

CLASS 30—STAPLE FOODS

FOR COFFEE; CHOCOLATE; CHOCOLATE COVERED MACADAMIA NUTS (U.S. CL. 46).

COURTNEY MCCORMICK, EXAMINING ATTORNEY

SN 77-599,797. A.B.C. COMPOUNDING CO., INC., MORROW, GA. FILED 10-24-2008.



THE MARK CONSISTS OF THE WORDS AND LETTERS "THE CDDS" OVER THE WORD "FORCE", WITH A DESIGN OF A DISPENSING NOZZLE WITH STREAMING LIQUID DISPENSING INTO A READY-TO-USE BOTTLE WITH A DROPLET, ALL TO THE LEFT OF THE WORDS AND LETTERS "THE CDDS FORCE" AND THE DESIGN OF A GLOBE/WORLD ON THE INTERIOR OF THE LETTER "O" IN THE WORD "FORCE".

CLASS 3—COSMETICS AND CLEANING PREPARATIONS

FOR ALL-PURPOSE CLEANING PREPARATIONS; GLASS AND MULTI-SURFACE CLEANING PREPARATIONS; CARPET CLEANING PREPARATIONS; FLOOR CLEANING PREPARATIONS; POT AND PAN CLEANING PREPARATIONS; DEGREASERS, NAMELY, DEGREASING PREPARATIONS FOR USE ON FLOORS, WALLS, TABLES, COUNTERS AND OTHER HARD SURFACES; HYDROGEN PEROXIDE CLEANING PREPARATIONS (U.S. CLS. 1, 4, 6, 50, 51 AND 52).

FIRST USE 6-10-2008; IN COMMERCE 6-25-2008.

CLASS 5—PHARMACEUTICALS

FOR ODOR NEUTRALIZERS, NAMELY, ROOM AIR FRESHENERS; ALL PURPOSE DISINFECTANTS; SANITIZERS, NAMELY, SANITIZING PREPARATIONS FOR HOSPITAL USE, CAFETERIA USE, AND HOUSEHOLD USE, AND HAND-SANITIZING PREPARATIONS (U.S. CLS. 6, 18, 44, 46, 51 AND 52).

FIRST USE 6-10-2008; IN COMMERCE 6-25-2008.

CLASS 21—HOUSEWARES AND GLASS

FOR LIQUID DISPENSERS, NAMELY, MANUALLY ACTUATED WATER PRESSURIZED PUMP DISPENSERS FOR ATTACHMENT TO CONTAINERS FOR USE IN DISPENSING LIQUIDS (U.S. CLS. 2, 13, 23, 29, 30, 33, 40 AND 50).

FIRST USE 6-10-2008; IN COMMERCE 6-25-2008.

TINA BROWN, EXAMINING ATTORNEY

SN 77-599,834. A.B.C. COMPOUNDING CO., INC., MORROW, GA. FILED 10-24-2008.



OWNER OF U.S. REG. NO. 2,727,994.

THE MARK CONSISTS OF THE WORD "LYNX" OVER THE WORD "LAB" WITH THE REPRESENTATIVE DESIGN OF A CAT'S EYE, NOSE AND WHISKER ABOVE THE LETTER "L" OF THE WORD "LYNX" AND A DESIGN OF A DISPENSING NOZZLE WITH STREAMING LIQUID DISPENSING INTO A READY-TO-USE BOTTLE WITH A DROPLET, ALL TO THE LEFT OF THE WORDS "LYNX LAB".

CLASS 3—COSMETICS AND CLEANING PREPARATIONS

FOR ALL-PURPOSE CLEANING PREPARATIONS; GLASS AND MULTI-SURFACE CLEANING PREPARATIONS; CARPET CLEANING PREPARATIONS; FLOOR CLEANING PREPARATIONS; POT AND PAN CLEANING PREPARATIONS; DEGREASERS, NAMELY, DEGREASING PREPARATIONS FOR USE ON FLOORS, WALLS, TABLES, COUNTERS AND OTHER HARD SURFACES; HYDROGEN PEROXIDE CLEANING PREPARATIONS (U.S. CLS. 1, 4, 6, 50, 51 AND 52).

FIRST USE 6-10-2008; IN COMMERCE 6-25-2008.

CLASS 5—PHARMACEUTICALS

FOR ODOR NEUTRALIZERS, NAMELY, ROOM AIR FRESHENERS; ALL PURPOSE DISINFECTANTS; SANITIZERS, NAMELY, SANITIZING PREPARATIONS FOR HOSPITAL USE, CAFETERIA USE, AND HOUSEHOLD USE, AND HAND-SANITIZING PREPARATIONS (U.S. CLS. 6, 18, 44, 46, 51 AND 52).

FIRST USE 6-10-2008; IN COMMERCE 6-25-2008.

CLASS 21—HOUSEWARES AND GLASS

FOR LIQUID DISPENSERS, NAMELY, MANUALLY ACTUATED WATER PRESSURIZED PUMP DISPENSERS FOR ATTACHMENT TO CONTAINERS FOR USE IN DISPENSING LIQUIDS (U.S. CLS. 2, 13, 23, 29, 30, 33, 40 AND 50).

FIRST USE 6-10-2008; IN COMMERCE 6-25-2008.

TINA BROWN, EXAMINING ATTORNEY

SN 77-600,266. NATIONAL BANK OF ABU DHABI, ABU DHABI, UNITED ARAB EMIR., FILED 10-24-2008.

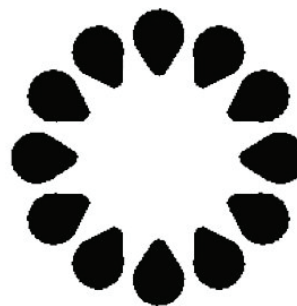

THE MARK CONSISTS OF A CIRCLE MADE UP OF TWELVE INDIVIDUAL TEARDROP DESIGNS.

CLASS 16—PAPER GOODS AND PRINTED MATTER

FOR PRINTED MATERIALS, NAMELY, BROCHURES, PAMPHLETS, AND PERIODIC MAGAZINES DEALING WITH BANKING AND INVESTMENT (U.S. CLS. 2, 5, 22, 23, 29, 37, 38 AND 50).

CLASS 36—INSURANCE AND FINANCIAL

FOR BANKING AND FINANCIAL SERVICES, NAMELY, INVESTMENT BANKING; PRIVATE EQUITY INVESTING; ASSET MANAGEMENT; PRIVATE BANKING; OPERATING SERVICES, NAMELY, STOCK CUSTODIAL SERVICES; PAYMENT AND TREASURY SERVICES, NAMELY, CORPORATE MONEY MANAGEMENT, AND INSTITUTIONAL TRUST FUND MANAGEMENT SERVICES; RETAIL BANKING SERVICES, NAMELY, DEPOSITS ACCOUNTS, HOME MORTGAGE LENDING AND SERVICING, CREDIT AND DEBIT CARDS, AUTO LENDING AND BANKING; FINANCIAL BANKING SERVICES TO SMALL AND MIDDLE MARKET BUSINESSES; FINANCIAL BANKING SUPPORT IN THE FORM OF LOANS FOR COMMUNITY DEVELOPMENT; ELECTRONIC COMMERCE PAYMENT SERVICES, NAMELY, ESTABLISHING FUNDED ACCOUNTS USED TO PURCHASE GOODS AND SERVICES ON THE INTERNET; INSURANCE AND REAL ESTATE INVESTMENT SERVICES (U.S. CLS. 100, 101 AND 102).

RICHARD A. STRASER, EXAMINING ATTORNEY

SN 77-600,311. NATIONAL BANK OF ABU DHABI, ABU DHABI, UNITED ARAB EMIR., FILED 10-24-2008.

SN 77-600,332. NATIONAL BANK OF ABU DHABI, ABU DHABI, UNITED ARAB EMIR., FILED 10-24-2008.



NBAD
بنك أبوظبي الوطني

THE COLOR(S) GREEN, GRAY IS/ARE CLAIMED AS A FEATURE OF THE MARK.

THE MARK CONSISTS OF A CIRCLE MADE UP OF TWELVE INDIVIDUAL TEARDROP DESIGNS WITH THE LOWER LEFT PORTION IN GREEN AND THE UPPER RIGHT PORTION IN GRAY.

CLASS 16—PAPER GOODS AND PRINTED MATTER

FOR PRINTED MATERIALS, NAMELY, BROCHURES, PAMPHLETS, AND PERIODIC MAGAZINES DEALING WITH BANKING AND INVESTMENT (U.S. CLS. 2, 5, 22, 23, 29, 37, 38 AND 50).

CLASS 36—INSURANCE AND FINANCIAL

FOR BANKING AND FINANCIAL SERVICES, NAMELY, INVESTMENT BANKING; PRIVATE EQUITY INVESTING; ASSET MANAGEMENT; PRIVATE BANKING; OPERATING SERVICES, NAMELY, STOCK CUSTODIAL SERVICES; PAYMENT AND TREASURY SERVICES, NAMELY, CORPORATE MONEY MANAGEMENT, AND INSTITUTIONAL TRUST FUND MANAGEMENT SERVICES; RETAIL BANKING SERVICES, NAMELY, DEPOSITS ACCOUNTS, HOME MORTGAGE LENDING AND SERVICING, CREDIT AND DEBIT CARDS, AUTO LENDING AND BANKING; FINANCIAL BANKING SERVICES TO SMALL AND MIDDLE MARKET BUSINESSES; FINANCIAL BANKING SUPPORT IN THE FORM OF LOANS FOR COMMUNITY DEVELOPMENT; ELECTRONIC COMMERCE PAYMENT SERVICES, NAMELY, ESTABLISHING FUNDED ACCOUNTS USED TO PURCHASE GOODS AND SERVICES ON THE INTERNET; INSURANCE AND REAL ESTATE INVESTMENT SERVICES (U.S. CLS. 100, 101 AND 102).

RICHARD A. STRASER, EXAMINING ATTORNEY

NO CLAIM IS MADE TO THE EXCLUSIVE RIGHT TO USE "NATIONAL BANK OF ABU DHABI" IN ARABIC LETTERS, APART FROM THE MARK AS SHOWN.

THE COLOR(S) GREEN, GRAY IS/ARE CLAIMED AS A FEATURE OF THE MARK.

THE MARK CONSISTS OF THE LETTERS "NBAD" ABOVE ARABIC WORDING TRANSLATED AS "NATIONAL BANK OF ABU DHABI" WITH "NB" IN GREEN AND "AD" IN GRAY.

THE ENGLISH TRANSLATION OF THE ARABIC LETTERS IN THE MARK IS NATIONAL BANK OF ABU-DHABI.

THE NON-LATIN CHARACTERS IN THE MARK TRANSLITERATE TO "BANK ABU-DHABI AL-WATANI" AND THIS MEANS NATIONAL BANK OF ABU-DHABI IN ENGLISH.

CLASS 16—PAPER GOODS AND PRINTED MATTER

FOR PRINTED MATERIALS, NAMELY, BROCHURES, PAMPHLETS, AND PERIODIC MAGAZINES DEALING WITH BANKING AND INVESTMENT (U.S. CLS. 2, 5, 22, 23, 29, 37, 38 AND 50).

CLASS 36—INSURANCE AND FINANCIAL

FOR BANKING AND FINANCIAL SERVICES, NAMELY, INVESTMENT BANKING; PRIVATE EQUITY INVESTING; ASSET MANAGEMENT; PRIVATE BANKING; OPERATING SERVICES, NAMELY, STOCK CUSTODIAL SERVICES; PAYMENT AND TREASURY SERVICES, NAMELY, CORPORATE MONEY MANAGEMENT, AND INSTITUTIONAL TRUST FUND MANAGEMENT SERVICES; RETAIL BANKING SERVICES, NAMELY, DEPOSITS ACCOUNTS, HOME MORTGAGE LENDING AND SERVICING, CREDIT AND DEBIT CARDS, AUTO LENDING AND BANKING; FINANCIAL BANKING SERVICES TO SMALL AND MIDDLE MARKET BUSINESSES; FINANCIAL BANKING SUPPORT IN THE FORM OF LOANS FOR COMMUNITY DEVELOPMENT; ELECTRONIC COMMERCE PAYMENT SERVICES, NAMELY, ESTABLISHING FUNDED ACCOUNTS USED TO PURCHASE GOODS AND SERVICES ON THE INTERNET; INSURANCE AND REAL ESTATE INVESTMENT SERVICES (U.S. CLS. 100, 101 AND 102).

RICHARD A. STRASER, EXAMINING ATTORNEY

SN 77-600,363. INOVIOBIOLOGIC INC., CALGARY, ALBERTA, CANADA, FILED 10-24-2008.

PGX DAILY WILL CHANGE YOUR LIFE, EVEN IF YOU DON'T

THE MARK CONSISTS OF STANDARD CHARACTERS WITHOUT CLAIM TO ANY PARTICULAR FONT, STYLE, SIZE, OR COLOR.

OWNER OF U.S. REG. NOS. 2,950,112 AND 3,238,779. NO CLAIM IS MADE TO THE EXCLUSIVE RIGHT TO USE "DAILY", APART FROM THE MARK AS SHOWN.

CLASS 5—PHARMACEUTICALS

FOR DIETARY AND NUTRITIONAL SUPPLEMENTS (U.S. CLS. 6, 18, 44, 46, 51 AND 52). FIRST USE 12-14-2007; IN COMMERCE 12-26-2007.

CLASS 16—PAPER GOODS AND PRINTED MATTER

FOR (BASED ON INTENT TO USE) PUBLICATIONS, NAMELY, BOOKS, MAGAZINES, PERIODICALS, PAMPHLETS, BROCHURES, NEWSLETTERS, FLYERS, ADVERTISING SIGNS OF PAPER AND PRODUCT MANUALS FOR THE BENEFIT OF THIRD PARTIES IN THE FIELDS OF DIETARY AND NUTRITIONAL SUPPLEMENTS (U.S. CLS. 2, 5, 22, 23, 29, 37, 38 AND 50). CHARLOTTE CORWIN, EXAMINING ATTORNEY

SN 77-600,597. RUOCCO, JAMES A, FREEPORT, NY. FILED 10-25-2008.



THE COLOR(S) BLACK, BLUE, GRAY, GREEN, ORANGE, RED, YELLOW, AND WHITE IS/ARE CLAIMED AS A FEATURE OF THE MARK.

THE MARK CONSISTS OF THE STYLIZED WORD "X-LATOR" AND DESIGN. THE "X" AND ARROW HYPHEN ARE IN BLACK. THE WORDING "LATOR" IS IN BLACK WITH GRAY OUTLINE. TO THE LEFT OF THE "X" IS A SERIES OF BLACK RECTANGLES AND SQUARES OUTLINED IN GRAY. UNDER THE WORDING "LATOR" IS A TRIANGLE DESIGN WITH GRAY OUTLINE ON THE RIGHT SIDE. THE INTERIOR OF THE TRIANGLE IS RED AT THE TOP PROGRESSING LOWER TO ORANGE, YELLOW, GREEN AND BLUE. THE DESIGN AND WORDING IN THE MARK ARE CONTAINED IN A RED OVAL WITH A WHITE BACKGROUND WITHIN.

CLASS 9—ELECTRICAL AND SCIENTIFIC APPARATUS

FOR INTERFACES AND PERIPHERAL DEVICES FOR COMPUTERS (U.S. CLS. 21, 23, 26, 36 AND 38).

CLASS 42—SCIENTIFIC AND COMPUTER SERVICES

FOR DATA CONVERSION OF COMPUTER PROGRAM DATA OR INFORMATION (U.S. CLS. 100 AND 101). BRIAN PINO, EXAMINING ATTORNEY

SN 77-600,636. SHIFTING GEARS CYCLING, LLC, SANTA MONICA, CA. FILED 10-25-2008.

shifting gears

THE MARK CONSISTS OF STANDARD CHARACTERS WITHOUT CLAIM TO ANY PARTICULAR FONT, STYLE, SIZE, OR COLOR.

CLASS 25—CLOTHING

FOR ATHLETIC APPAREL, NAMELY, SHIRTS, PANTS, JACKETS, FOOTWEAR, HATS AND CAPS, ATHLETIC UNIFORMS; CYCLISTS' JERSEYS; JERSEYS; KERCHIEFS; SLEEVELESS JERSEYS; SPORTS JERSEYS; TANK TOPS (U.S. CLS. 22 AND 39). FIRST USE 12-1-2000; IN COMMERCE 12-1-2000.

CLASS 41—EDUCATION AND ENTERTAINMENT

FOR ENTERTAINMENT SERVICES, NAMELY, PARTICIPATION IN CYCLING EVENTS (U.S. CLS. 100, 101 AND 107). FIRST USE 12-0-1999; IN COMMERCE 12-0-1999. JIM RINGLE, EXAMINING ATTORNEY

SN 77-601,411. MAPLE LEAF FOODS INC., TORONTO, ONTARIO, CANADA, FILED 10-27-2008.



ThinkFOOD!

OWNER OF U.S. REG. NOS. 2,712,390, 2,902,664 AND 3,163,010.

THE MARK CONSISTS OF A MAPLE LEAF IN A WHITE WAVY STRIPE WITH BLACK LINES OVER A BLACK WAVY RECTANGLE.

CLASS 16—PAPER GOODS AND PRINTED MATTER

FOR PRINTED MATERIALS, NAMELY, NEWSLETTERS, BROCHURES, BOOKLETS, AND PAMPHLETS RELATING TO THE FOOD INDUSTRY; PENS, PENCILS, AND NOTEPADS, AND PRINTED AWARDS (U.S. CLS. 2, 5, 22, 23, 29, 37, 38 AND 50).

CLASS 41—EDUCATION AND ENTERTAINMENT

FOR OPERATION OF AN EDUCATIONAL TRAINING CENTER THAT IS OPEN TO THE PUBLIC, WHICH PROVIDES COURSES OF INSTRUCTION TO WORKING PROFESSIONALS IN THE FOOD INDUSTRY (U.S. CLS. 100, 101 AND 107).

MICHAEL KEATING, EXAMINING ATTORNEY

SN 77-601,467. COM-PAC INTERNATIONAL, INC., CARBONDALE, IL. FILED 10-27-2008.

PINCH 'N PULL

THE MARK CONSISTS OF STANDARD CHARACTERS WITHOUT CLAIM TO ANY PARTICULAR FONT, STYLE, SIZE, OR COLOR.

CLASS 10—MEDICAL APPARATUS

FOR RECLOSABLE MEDICAL BAGS SOLD EMPTY (U.S. CLS. 26, 39 AND 44).

CLASS 16—PAPER GOODS AND PRINTED MATTER

FOR RECLOSABLE BAGS, NAMELY, PLASTIC OR PAPER BAGS FOR HOUSEHOLD USE, PLASTIC OR PAPER BAGS FOR MERCHANDISE PACKAGING, LUNCH BAGS, GROCERY BAGS (U.S. CLS. 2, 5, 22, 23, 29, 37, 38 AND 50).

ERNEST SHOSHO, EXAMINING ATTORNEY

SN 77-601,415. CSC HOLDINGS, INC., BETHPAGE, NY. FILED 10-27-2008.



OWNER OF U.S. REG. NOS. 3,021,926, 3,482,838 AND OTHERS.

NO CLAIM IS MADE TO THE EXCLUSIVE RIGHT TO USE "BUSINESS", APART FROM THE MARK AS SHOWN.

THE MARK CONSISTS OF THE WORDS "OPTIMUM BUSINESS" IN A STYLIZED FONT, WITH THE WORD "OPTIMUM" LOCATED WITHIN A CIRCLE COMPRISED OF A THREE CRESCENTS, AND THE WORD "BUSINESS" LOCATED TO THE RIGHT OF THE CIRCLE.

CLASS 38—COMMUNICATION

FOR CABLE TELEVISION TRANSMISSION AND BROADCASTING SERVICES; TRANSMISSION AND BROADCASTING OF TELEVISION PROGRAMS, DATA, SOUND, TEXT, IMAGES, VIDEO, AND VIDEO-ON-DEMAND, BY MEANS OF CABLE NETWORKS, SATELLITE, COMPUTER TERMINAL, THE GLOBAL COMPUTER NETWORK, FIBER OPTICS NETWORKS, AND MODEMS THAT ENABLE COMMUNICATIONS; PROVIDING MULTIPLE USE ACCESS TO THE INTERNET BY MEANS OF A CABLE NETWORK; PROVIDING TELECOMMUNICATIONS CONNECTIONS TO A GLOBAL COMPUTER NETWORK; PROVIDING TELECOMMUNICATIONS CONNECTIONS BETWEEN TELEPHONES AND COMPUTERS FOR TRANSFER OF VOICE AND DATA BY MEANS OF A GLOBAL COMPUTER NETWORK; AND TELECOMMUNICATIONS SERVICES, NAMELY, PERSONAL COMMUNICATION SERVICES AND LOCAL, REGIONAL AND LONG DISTANCE TELEPHONE SERVICES (U.S. CLS. 100, 101 AND 104).

FIRST USE 12-0-2007; IN COMMERCE 12-0-2007.

CLASS 41—EDUCATION AND ENTERTAINMENT

FOR ENTERTAINMENT SERVICES, NAMELY, TELEVISION PROGRAMMING AND PRODUCTION SERVICES, DISTRIBUTION OF ENTERTAINMENT AND EDUCATIONAL PROGRAMMING AND VIDEO-ON-DEMAND TELEVISION PROGRAMMING, PROVIDING ON-LINE CABLE TELEVISION SCHEDULES AND ON-LINE REVIEWS OF CABLE TELEVISION PROGRAMS; PROVIDING ON-LINE INTERACTIVE VIDEO GAMES VIA TELEVISION AND THE INTERNET, AND PROVIDING INFORMATION ON-LINE RELATING TO COMPUTER GAMES (U.S. CLS. 100, 101 AND 107).

FIRST USE 12-0-2007; IN COMMERCE 12-0-2007.
BARBARA GAYNOR, EXAMINING ATTORNEY

SN 77-601,575. TUMBLR, INC., NEW YORK, NY. FILED 10-27-2008.

TUMBLR

THE MARK CONSISTS OF STANDARD CHARACTERS WITHOUT CLAIM TO ANY PARTICULAR FONT, STYLE, SIZE, OR COLOR.

CLASS 41—EDUCATION AND ENTERTAINMENT

FOR ELECTRONIC PUBLISHING SERVICES, NAMELY, PUBLISHING OF ONLINE WORKS OF OTHERS FEATURING ELECTRONIC MEDIA, MULTIMEDIA CONTENTS, VIDEOS, MOVIES, PICTURES, IMAGES, TEXT, PHOTOS, USER-GENERATED CONTENT, AND RELATED INFORMATION VIA THE INTERNET AND OTHER COMMUNICATIONS NETWORKS; ELECTRONIC PUBLISHING OF BLOGS OF OTHERS (U.S. CLS. 100, 101 AND 107).

FIRST USE 2-19-2007; IN COMMERCE 2-19-2007.

CLASS 45—PERSONAL AND LEGAL SERVICES

FOR INTERNET BASED SOCIAL NETWORKING SERVICES ALLOWING USERS TO COMMUNICATE AND SHARE, STORE, TRANSMIT, VIEW, AND DOWNLOAD TEXT, IMAGES, AUDIO AND VIDEO CONTENT, AND OTHER MULTIMEDIA MATERIALS (U.S. CLS. 100 AND 101).

FIRST USE 2-19-2007; IN COMMERCE 2-19-2007.
GINA HAYES, EXAMINING ATTORNEY

SN 77-601,657. CARD, KENT, WOODLAND HILLS, CA. FILED 10-27-2008.



THE MARK CONSISTS OF STYLIZED LETTERS "AD" AND THE WORD "AMERICANDRIFTER" AT THE BOTTOM.

CLASS 16—PAPER GOODS AND PRINTED MATTER

FOR STICKERS, DECALS, HEAT TRANSFERS; POSTERS; MOUNTED AND/OR UNMOUNTED PHOTOGRAPHS, AND MAGAZINES DEALING WITH AUTOMOBILE RACING (U.S. CLS. 2, 5, 22, 23, 29, 37, 38 AND 50).

CLASS 25—CLOTHING

FOR T-SHIRTS, SWEATSHIRTS, SHORTS, PANTS AND HEADGEAR, NAMELY, HEADBANDS AND CAPS (U.S. CLS. 22 AND 39).
DANNEAN HETZEL, EXAMINING ATTORNEY

SN 77-602,385. USHIO DENKI KABUSHIKI KAISHA, CHIYODA-KU, TOKYO, JAPAN, FILED 10-28-2008.



THE MARK CONSISTS OF STANDARD CHARACTERS WITHOUT CLAIM TO ANY PARTICULAR FONT, STYLE, SIZE, OR COLOR.

CLASS 5—PHARMACEUTICALS

FOR DIAGNOSTIC PREPARATIONS FOR MEDICAL AND VETERINARY USE (U.S. CLS. 6, 18, 44, 46, 51 AND 52).

CLASS 10—MEDICAL APPARATUS

FOR DIAGNOSTIC APPARATUS AND INSTRUMENTS, NAMELY, BLOOD ANALYZERS (U.S. CLS. 26, 39 AND 44).
DARRYL SPRUILL, EXAMINING ATTORNEY

SN 77-602,519. UNITED STATIONERS SUPPLY CO., DEERFIELD, IL. FILED 10-28-2008.



THE MARK CONSISTS OF STANDARD CHARACTERS WITHOUT CLAIM TO ANY PARTICULAR FONT, STYLE, SIZE, OR COLOR.

CLASS 35—ADVERTISING AND BUSINESS

FOR SCHEDULING OF MAINTENANCE, SERVICE, AND REPAIR FOR COMPUTERS, COMPUTER HARDWARE, PRINTERS, AND COPIERS IN A COMPUTER NETWORK FOR OTHERS (U.S. CLS. 100, 101 AND 102).

CLASS 36—INSURANCE AND FINANCIAL

FOR PROVIDING WARRANTIES AND EXTENDED WARRANTIES FOR OTHERS ON COMPUTERS, COMPUTER HARDWARE, PRINTERS, COPIERS AND SOFTWARE; FINANCING OF COMPUTERS, COMPUTER HARDWARE, PRINTERS, COPIERS AND SOFTWARE FOR OTHERS (U.S. CLS. 100, 101 AND 102).

CLASS 37—CONSTRUCTION AND REPAIR

FOR MANAGED PRINT SERVICES, NAMELY, INSTALLING, CONFIGURING, SERVICING AND REPAIRING, INCLUDING PROVISION OF REPLACEMENT PARTS AND SUPPLIES, COMPUTERS, COMPUTER HARDWARE, PRINTERS AND COPIERS IN A COMPUTER NETWORK (U.S. CLS. 100, 103 AND 106).

CLASS 42—SCIENTIFIC AND COMPUTER SERVICES

FOR MANAGED PRINT SERVICES, NAMELY, MONITORING THE STATUS AND PERFORMANCE OF COMPUTERS, COMPUTER HARDWARE, PRINTERS, AND COPIERS IN A COMPUTER NETWORK (U.S. CLS. 100 AND 101).
TOBY BULLOFF, EXAMINING ATTORNEY

SN 77-602,559. SHAWNIMALS, LLC, CHICAGO, IL. FILED 10-28-2008.



THE MARK CONSISTS OF STANDARD CHARACTERS WITHOUT CLAIM TO ANY PARTICULAR FONT, STYLE, SIZE, OR COLOR.

CLASS 9—ELECTRICAL AND SCIENTIFIC APPARATUS

FOR VIDEO GAME SOFTWARE; VIDEO GAME PROGRAMS (U.S. CLS. 21, 23, 26, 36 AND 38).

CLASS 28—TOYS AND SPORTING GOODS

FOR TOYS, NAMELY, PLUSH TOYS AND TOY FIGURES (U.S. CLS. 22, 23, 38 AND 50).

CLASS 35—ADVERTISING AND BUSINESS

FOR ONLINE RETAIL STORE SERVICES FEATURING TOYS, GAMES, VIDEO GAMES, STICKERS, CARTOON PRINTS, CLOTHING, AND PRINTED PUBLICATIONS (U.S. CLS. 100, 101 AND 102).
WILLIAM P. SHANAHAN, EXAMINING ATTORNEY

SN 77-602,566. POP ART, INC., PORTLAND, OR. FILED 10-28-2008.

LEAD WITH INTERACTIVE

THE MARK CONSISTS OF STANDARD CHARACTERS WITHOUT CLAIM TO ANY PARTICULAR FONT, STYLE, SIZE, OR COLOR.

NO CLAIM IS MADE TO THE EXCLUSIVE RIGHT TO USE "INTERACTIVE", APART FROM THE MARK AS SHOWN.

CLASS 35—ADVERTISING AND BUSINESS

FOR INTERACTIVE ADVERTISING AGENCY SERVICES; CREATING ONLINE ADVERTISING IN THE NATURE OF SOCIAL NETWORKS, INTERACTIVE PROMOTIONS, EMAIL PROMOTIONS, AND DIGITAL CONTENT, AND CREATING PRINTED ADVERTISEMENTS AND ADVERTISING MATERIALS, ALL FOR THE SALE OF PRODUCTS AND SERVICES FOR OTHERS; MARKETING SERVICES AND BUSINESS CONSULTING SERVICES IN THE FIELDS OF WEB SITE DESIGN, ONLINE COMMUNICATIONS, DATABASE DESIGN AND DEVELOPMENT, AND COMPUTER SOFTWARE (U.S. CLS. 100, 101 AND 102).

CLASS 42—SCIENTIFIC AND COMPUTER SERVICES

FOR COMPUTER SOFTWARE DESIGN SERVICES; DEVELOPMENT AND PROGRAMMING SERVICES; WEB SITE DESIGN, DEVELOPMENT, AND HOSTING SERVICES; CONSULTING SERVICES IN THE FIELDS OF COMPUTER PROGRAMMING, DATABASE DESIGN AND DEVELOPMENT, DESIGNING DIGITAL IMAGES, AND VISUAL DESIGNS FOR USE IN INTERACTIVE MEDIA (U.S. CLS. 100 AND 101).

PRISCILLA MILTON, EXAMINING ATTORNEY

SN 77-602,834. DON'T BUILD UNTIL, LLC, ALEXANDRIA, VA. FILED 10-29-2008.



until ...

NO CLAIM IS MADE TO THE EXCLUSIVE RIGHT TO USE THE PROHIBITION SYMBOL, APART FROM THE MARK AS SHOWN.

THE COLOR(S) RED, BLACK, WHITE IS/ARE CLAIMED AS A FEATURE OF THE MARK.

THE MARK CONSISTS OF WORD "BUILD" IN BLACK CAPITAL ITALICIZED LETTERS; OVERLAID WITH INTERNATIONAL DO NOT SYMBOL (CIRCLE WITH SLASH) IN RED; WORD "UNTIL" IN BLACK LOWER-CASE ITALICIZED SCRIPT LETTERS FOLLOWED BY THREE PERIODS; ALL ON A WHITE BACKGROUND.

CLASS 9—ELECTRICAL AND SCIENTIFIC APPARATUS

FOR EDUCATIONAL CDS AND DVDS IN THE FIELDS OF CONSTRUCTION, ARCHITECTURE, AND ENGINEERING (U.S. CLS. 21, 23, 26, 36 AND 38).
FIRST USE 10-21-2008; IN COMMERCE 10-21-2008.

CLASS 16—PAPER GOODS AND PRINTED MATTER

FOR EDUCATIONAL PUBLICATIONS, NAMELY, BOOKS, HAND-OUTS, WORKBOOKS, AND TEXT-BOOKS, ALL IN THE FIELDS OF CONSTRUCTION, ARCHITECTURE, ENGINEERING (U.S. CLS. 2, 5, 22, 23, 29, 37, 38 AND 50).
FIRST USE 10-21-2008; IN COMMERCE 10-21-2008.

CLASS 41—EDUCATION AND ENTERTAINMENT

FOR EDUCATION SERVICES, NAMELY, PROVIDING CLASSES, SEMINARS, WORKSHOPS IN THE FIELDS OF CONSTRUCTION, ARCHITECTURE, ENGINEERING (U.S. CLS. 100, 101 AND 107).
FIRST USE 10-21-2008; IN COMMERCE 10-21-2008.
JASON BLAIR, EXAMINING ATTORNEY

SN 77-602,902. CONOPCO, INC., ENGLEWOOD CLIFFS, NJ. FILED 10-29-2008.



OWNER OF U.S. REG. NOS. 144,708, 1,019,516 AND OTHERS.

THE COLOR(S) GREEN AND BLACK IS/ARE CLAIMED AS A FEATURE OF THE MARK.

THE MARK CONSISTS OF THE STYLIZED TERM "BREYERS" IN BLACK AND IN FRONT OF A GRAPHIC OF A GREEN LEAF.

CLASS 29—MEATS AND PROCESSED FOODS

FOR YOGHURT AND YOGHURT BASED BEVERAGES (U.S. CL. 46).

CLASS 30—STAPLE FOODS

FOR ICE CREAMS, WATER ICES, FROZEN CONFECTIONERY, FROZEN YOGHURT, FROZEN DAIRY DESSERTS, FROZEN DESSERTS CONSISTING PRIMARILY OF FRUIT AND CREAM OR CREAM SUBSTITUTES, SHERBETS, FROZEN SHAKES (U.S. CL. 46).

CLASS 43—HOTEL AND RESTAURANT SERVICES

FOR ICE CREAM PARLOR SERVICES (U.S. CLS. 100 AND 101).
ALYSSA STEEL, EXAMINING ATTORNEY

SN 77-603,117. NUM LIP ENTERTAINMENT, INC., VAN NUYS, CA. FILED 10-29-2008.



NO CLAIM IS MADE TO THE EXCLUSIVE RIGHT TO USE "ENT", APART FROM THE MARK AS SHOWN.

THE COLOR(S) PINK, RED, PURPLE, BLACK AND GRAY IS/ARE CLAIMED AS A FEATURE OF THE MARK.

THE MARK CONSISTS OF THE WORD "NUM" IN PINK, WITH A RED STAR IN THE MIDDLE OF THE "U" WITH THE WORD "LIP" IN RED, UNDERNEATH, WITH THE SILHOUETTE OF A WOMAN IN PLACE OF THE LETTER "I" ALSO IN RED, WITH THE WORD "ENT" UNDERNEATH IN PURPLE. THE LETTERS OF THE LITERAL PORTIONS BEING SHADOWED IN BLACK AND GRAY, ALL ON A LIGHTLY STRIATED PINK BACKGROUND.

CLASS 9—ELECTRICAL AND SCIENTIFIC APPARATUS

FOR DIGITAL MEDIA, NAMELY, DVDS AND DOWNLOADABLE AUDIOVISUAL FILES FEATURING ADULT-THEMED ENTERTAINMENT, DOWNLOADABLE FILMS AND DVDS FEATURING ADULT-THEMED ENTERTAINMENT, AND DVDS FEATURING ADULT-THEMED ENTERTAINMENT (U.S. CLS. 21, 23, 26, 36 AND 38).

FIRST USE 10-23-2008; IN COMMERCE 10-23-2008.

CLASS 41—EDUCATION AND ENTERTAINMENT

FOR PRODUCTION OF DVDS AND DOWNLOADABLE AUDIOVISUAL FILES FEATURING ADULT-THEMED ENTERTAINMENT, AND ENTERTAINMENT SERVICES, NAMELY, PROVIDING A WEB SITE FEATURING ADULT-THEMED PHOTOGRAPHS, VIDEOS AND DOWNLOADABLE AUDIOVISUAL FILES (U.S. CLS. 100, 101 AND 107).

FIRST USE 10-23-2008; IN COMMERCE 10-23-2008.
HANNO RITTNER, EXAMINING ATTORNEY

SN 77-603,152. CVS PHARMACY, INC., WOONSOCKET, RI. FILED 10-29-2008.

PROACTIVE SPECIALTY CARE

THE MARK CONSISTS OF STANDARD CHARACTERS WITHOUT CLAIM TO ANY PARTICULAR FONT, STYLE, SIZE, OR COLOR.

NO CLAIM IS MADE TO THE EXCLUSIVE RIGHT TO USE "SPECIALTY CARE", APART FROM THE MARK AS SHOWN.

CLASS 35—ADVERTISING AND BUSINESS

FOR RETAIL PHARMACY SERVICES; PHARMACEUTICAL COST MANAGEMENT FOR THE HEALTH CARE BENEFIT PLANS OF OTHERS; PHARMACEUTICAL COST MANAGEMENT SERVICES AND DRUG UTILIZATION REVIEW SERVICES FOR PATIENTS WITH COMPLEX OR CHRONIC MEDICAL CONDITIONS (U.S. CLS. 100, 101 AND 102).

CLASS 36—INSURANCE AND FINANCIAL

FOR PHARMACEUTICAL BENEFIT MANAGEMENT SERVICES (U.S. CLS. 100, 101 AND 102).

CLASS 44—MEDICAL, BEAUTY AND AGRICULTURAL SERVICES

FOR HEALTH CARE SERVICES, NAMELY, DISEASE MANAGEMENT PROGRAMS AND WELLNESS PROGRAMS; THERAPEUTIC PHARMACEUTICAL CONSULTATION SERVICES; PHARMACEUTICAL ADVICE (U.S. CLS. 100 AND 101).

DAVID YONTEF, EXAMINING ATTORNEY

SN 77-603,166. CVS PHARMACY, INC., WOONSOCKET, RI. FILED 10-29-2008.

PROACTIVE PHARMACY CHOICE

THE MARK CONSISTS OF STANDARD CHARACTERS WITHOUT CLAIM TO ANY PARTICULAR FONT, STYLE, SIZE, OR COLOR.

NO CLAIM IS MADE TO THE EXCLUSIVE RIGHT TO USE "PHARMACY", APART FROM THE MARK AS SHOWN.

CLASS 35—ADVERTISING AND BUSINESS

FOR RETAIL PHARMACY SERVICES; PHARMACEUTICAL COST MANAGEMENT FOR THE HEALTH CARE BENEFIT PLANS OF OTHERS; PHARMACEUTICAL COST MANAGEMENT SERVICES AND DRUG UTILIZATION REVIEW SERVICES FOR PATIENTS WITH COMPLEX OR CHRONIC MEDICAL CONDITIONS (U.S. CLS. 100, 101 AND 102).

CLASS 36—INSURANCE AND FINANCIAL

FOR PHARMACEUTICAL BENEFIT MANAGEMENT SERVICES (U.S. CLS. 100, 101 AND 102).

CLASS 44—MEDICAL, BEAUTY AND AGRICULTURAL SERVICES

FOR HEALTH CARE SERVICES, NAMELY, DISEASE MANAGEMENT PROGRAMS AND WELLNESS PROGRAMS; THERAPEUTIC PHARMACEUTICAL CONSULTATION SERVICES; PHARMACEUTICAL ADVICE (U.S. CLS. 100 AND 101).

DAVID YONTEF, EXAMINING ATTORNEY

SN 77-603,170. CVS PHARMACY, INC., WOONSOCKET, RI.
FILED 10-29-2008.

MATTHEW KLINE, EXAMINING ATTORNEY

PROACTIVE SPECIALTY MANAGEMENT

THE MARK CONSISTS OF STANDARD CHARACTERS WITHOUT CLAIM TO ANY PARTICULAR FONT, STYLE, SIZE, OR COLOR.

NO CLAIM IS MADE TO THE EXCLUSIVE RIGHT TO USE "SPECIALTY MANAGEMENT", APART FROM THE MARK AS SHOWN.

CLASS 35—ADVERTISING AND BUSINESS

FOR RETAIL PHARMACY SERVICES; PHARMACEUTICAL COST MANAGEMENT FOR THE HEALTH CARE BENEFIT PLANS OF OTHERS; PHARMACEUTICAL COST MANAGEMENT SERVICES AND DRUG UTILIZATION REVIEW SERVICES FOR PATIENTS WITH COMPLEX OR CHRONIC MEDICAL CONDITIONS (U.S. CLS. 100, 101 AND 102).

CLASS 36—INSURANCE AND FINANCIAL

FOR PHARMACEUTICAL BENEFIT MANAGEMENT SERVICES (U.S. CLS. 100, 101 AND 102).

CLASS 44—MEDICAL, BEAUTY AND AGRICULTURAL SERVICES

FOR HEALTH CARE SERVICES, NAMELY, DISEASE MANAGEMENT PROGRAMS AND WELLNESS PROGRAMS; THERAPEUTIC PHARMACEUTICAL CONSULTATION SERVICES; PHARMACEUTICAL ADVICE (U.S. CLS. 100 AND 101).

DAVID YONTEF, EXAMINING ATTORNEY

SN 77-603,234. BRADLEY'S FINE JEWELERS, INC., FT MYERS, FL. FILED 10-29-2008.



THE MARK CONSISTS OF THE WORDS "THE E GENERATION" IN A STYLIZED FORMAT WITH THE LETTER "E" WITHIN A CIRCULAR DESIGN.

CLASS 14—JEWELRY

FOR JEWELRY; CLOCKS, WATCHES (U.S. CLS. 2, 27, 28 AND 50).

CLASS 41—EDUCATION AND ENTERTAINMENT

FOR EDUCATIONAL SERVICES, NAMELY COURSES OF INSTRUCTION, PROGRAMS SEMINARS, ON-LINE SEMINARS IN THE FIELDS OF THE ENVIRONMENT, EDUCATION, ETHICS, PERSONAL HEALTH, FITNESS AND PERSONAL GROWTH AND INFORMATION IN THE FIELDS OF THE ENVIRONMENT, EDUCATION, ETHICS, PERSONAL HEALTH, FITNESS AND PERSONAL GROWTH PROVIDED OVER THE INTERNET (U.S. CLS. 100, 101 AND 107).

SN 77-604,455. SEARS BRANDS, LLC, HOFFMAN ESTATES, IL. FILED 10-30-2008.

WISHTORY

THE MARK CONSISTS OF STANDARD CHARACTERS WITHOUT CLAIM TO ANY PARTICULAR FONT, STYLE, SIZE, OR COLOR.

CLASS 35—ADVERTISING AND BUSINESS

FOR RETAIL DEPARTMENT STORE SERVICES, ON-LINE RETAIL DEPARTMENT STORE SERVICES, AND CATALOG ORDERING SERVICES AND ON-LINE ORDERING SERVICES FEATURING DEPARTMENT STORE GOODS (U.S. CLS. 100, 101 AND 102).

CLASS 39—TRANSPORTATION AND STORAGE

FOR SHIPPING OF DEPARTMENT STORE GOODS (U.S. CLS. 100 AND 105).

BARBARA GAYNOR, EXAMINING ATTORNEY

SN 77-604,597. MOBDUB, LLC, NEW YORK, NY. FILED 10-30-2008.

MOBDUB

THE MARK CONSISTS OF STANDARD CHARACTERS WITHOUT CLAIM TO ANY PARTICULAR FONT, STYLE, SIZE, OR COLOR.

CLASS 9—ELECTRICAL AND SCIENTIFIC APPARATUS

FOR COMPUTER SOFTWARE FOR USE IN VIDEO EDITING ASSOCIATING COMMENTARY AND ANNOTATING, BY MEANS OF SUBTITLING, CAPTIONING AND TELETXT FOR FEATURE FILMS, TELEVISION PROGRAMS, VIDEOS AND DIGITAL MEDIA IN GENERAL; COMPUTER SOFTWARE THAT PROVIDES WEB-BASED ACCESS TO APPLICATIONS AND SERVICES THROUGH A WEB OPERATING SYSTEM OR PORTAL INTERFACE THAT MAY BE DOWNLOADED FROM A GLOBAL COMPUTER NETWORK (U.S. CLS. 21, 23, 26, 36 AND 38).

CLASS 41—EDUCATION AND ENTERTAINMENT

FOR PROVIDING A WEB SITE FEATURING A SEARCHABLE DATABASE OF INFORMATION RELATED TO VIDEOS, MULTIMEDIA CONTENT AND PHOTOS IN THE FIELD OF ENTERTAINMENT, POP CULTURE, CURRENT EVENTS, EDUCATION AND SPORTS; ENTERTAINMENT, EDUCATION AND NEWS SERVICES, NAMELY, PROVIDING AN ONLINE INTERACTIVE DATABASE OF PHOTOS, MULTIMEDIA CONTENT, AND LINKS AND REFERENCES TO VIDEOS IN THE FIELD OF ENTERTAINMENT, POP CULTURE, CURRENT EVENTS, EDUCATION AND SPORTS (U.S. CLS. 100, 101 AND 107).

SN 77-605,300. NIPPON MINING HOLDINGS, INC., MINATO-KU, TOKYO, JAPAN, FILED 10-31-2008.

CLASS 42—SCIENTIFIC AND COMPUTER SERVICES

FOR PROVIDING A WEB SITE PROVIDING TEMPORARY USE OF NON-DOWNLOADABLE SOFTWARE ALLOWING USERS TO UPLOAD LINKS TO VIDEOS, AND TO POST, ANNOTATE, PERSIST COMMENTARY ON, EDIT, SUBTITLE, CAPTION, AND DISPLAY ONLINE VIDEOS FOR SHARING WITH OTHERS FOR ENTERTAINMENT, EDUCATION AND NEWS PURPOSES; APPLICATION SERVICE PROVIDER, NAMELY, PROVIDING, HOSTING, MANAGING, DEVELOPING, REPORTING AND MAINTAINING APPLICATIONS AND SOFTWARE FOR VIDEO ANNOTATIONS, METADATA AND COMMENTARY; PROVIDING ON-LINE NON-DOWNLOADABLE COMPUTER SOFTWARE THAT PROVIDES WEB-BASED ACCESS TO APPLICATIONS AND SERVICES THROUGH A WEB OPERATING SYSTEM OR PORTAL INTERFACE (U.S. CLS. 100 AND 101).

KRISTIN CARLSON, EXAMINING ATTORNEY

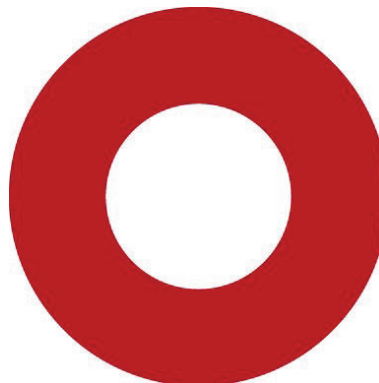

SN 77-605,268. NIPPON MINING HOLDINGS, INC., MINATO-KU, TOKYO, JAPAN, FILED 10-31-2008.

THE COLOR(S) RED IS/ARE CLAIMED AS A FEATURE OF THE MARK.

THE MARK CONSISTS OF A RED CIRCLE.

○ NIPPON MINING & METALS

NO CLAIM IS MADE TO THE EXCLUSIVE RIGHT TO USE "NIPPON MINING & METALS", APART FROM THE MARK AS SHOWN.

THE COLOR(S) RED AND BLACK IS/ARE CLAIMED AS A FEATURE OF THE MARK.

THE MARK CONSISTS OF A RED CIRCLE AND TO THE RIGHT HAND SIDE OF THE CIRCLE THERE APPEARS THE WORDING "NIPPON MINING & METALS" IN STYLIZED BLACK LETTERING.

THE ENGLISH TRANSLATION OF "NIPPON" IN THE MARK IS JAPAN.

CLASS 1—CHEMICALS

FOR CHEMICAL PREPARATIONS AND AGENTS USED IN THE PLATING PROCESSES; COPPER SULPHATE (U.S. CLS. 1, 5, 6, 10, 26 AND 46).

CLASS 6—METAL GOODS

FOR COMMON METALS, UNWROUGHT OR SEMI-WORKED, FOR FURTHER MANUFACTURE; METAL FOIL; STAINLESS STEELS; FOILS AND POWDER OF COPPER OR ITS ALLOYS; METAL SPUTTERING TARGETS (U.S. CLS. 2, 12, 13, 14, 23, 25 AND 50).

JAMES GRIFFIN, EXAMINING ATTORNEY

CLASS 1—CHEMICALS

FOR CHEMICAL PREPARATIONS AND AGENTS USED IN THE PLATING PROCESSES; COPPER SULPHATE; SPUTTERING TARGETS MADE OF METAL OXIDE, METAL NITRIDE OR METAL SILICIDE FOR USE IN SPUTTERING PROCESS OF DEPOSITING A THIN LAYER OF METAL OXIDE, METAL NITRIDE OR METAL SILICIDE ON SUBSTRATES (U.S. CLS. 1, 5, 6, 10, 26 AND 46).

CLASS 6—METAL GOODS

FOR COMMON METALS, UNWROUGHT OR SEMI-WORKED, FOR FURTHER MANUFACTURE; METAL FOIL; STAINLESS STEELS; FOILS AND POWDER OF COPPER OR ITS ALLOYS; METAL SPUTTERING TARGETS; SPUTTERING TARGETS MADE OF METAL ALLOY FOR USE IN SPUTTERING PROCESS OF DEPOSITING A THIN LAYER OF METAL ALLOY ON SUBSTRATES (U.S. CLS. 2, 12, 13, 14, 23, 25 AND 50).

CLASS 9—ELECTRICAL AND SCIENTIFIC APPARATUS

FOR ELECTRODES FOR USE IN SPUTTERING PROCESS OF DEPOSITING A THIN LAYER OF METAL, METAL ALLOY, METAL OXIDE, METAL NITRIDE OR METAL SILICIDE ON SUBSTRATES; SEMICONDUCTORS (U.S. CLS. 21, 23, 26, 36 AND 38).

JAMES GRIFFIN, EXAMINING ATTORNEY

SN 77-605,385. BODY METABOLISM INSTITUTE, CAULFIELD NORTH, AUSTRALIA, FILED 10-31-2008.

SN 77-605,477. IXE GRUPO FINANCIERO S.A.B. DE C.V., MEXICO CITY, MEXICO, FILED 10-31-2008.



NO CLAIM IS MADE TO THE EXCLUSIVE RIGHT TO USE "BODY METABOLISM INSTITUTE", APART FROM THE MARK AS SHOWN.

THE MARK CONSISTS OF THE TEXT "BMI BODY METABOLISM INSTITUTE" IN A STYLIZED FORMAT.

CLASS 5—PHARMACEUTICALS

FOR BRACELETS INFUSED WITH AROMA FOR WEIGHT MANAGEMENT PURPOSES (U.S. CLS. 6, 18, 44, 46, 51 AND 52).

FIRST USE 4-30-2008; IN COMMERCE 4-30-2008.

CLASS 9—ELECTRICAL AND SCIENTIFIC APPARATUS

FOR PRE-RECORDED COMPACT DISCS REGARDING WEIGHT MANAGEMENT (U.S. CLS. 21, 23, 26, 36 AND 38).

FIRST USE 4-30-2008; IN COMMERCE 4-30-2008.

CLASS 16—PAPER GOODS AND PRINTED MATTER

FOR PRINTED MATTER, NAMELY, GUIDES, MAGAZINES AND BROCHURES REGARDING WEIGHT MANAGEMENT, DIET, HEALTH AND NUTRITION (U.S. CLS. 2, 5, 22, 23, 29, 37, 38 AND 50).

FIRST USE 4-30-2008; IN COMMERCE 4-30-2008.

CLASS 44—MEDICAL, BEAUTY AND AGRICULTURAL SERVICES

FOR WEIGHT MANAGEMENT SERVICES, NAMELY, WEIGHT REDUCTION DIET PLANNING AND SUPERVISION (U.S. CLS. 100 AND 101).

FIRST USE 3-31-2008; IN COMMERCE 3-31-2008. MATTHEW PAPPAS, EXAMINING ATTORNEY

EL
BAN
CODE
UNO

THE MARK CONSISTS OF THE FOUR WORDS STACKED IN FOUR LINES ON TOP OF EACH OTHER.

THE FOREIGN WORDING IN THE MARK TRANSLATES INTO ENGLISH AS ONE'S BANK.

CLASS 9—ELECTRICAL AND SCIENTIFIC APPARATUS

FOR CREDIT CARDS AND DEBIT CARDS THAT HAVE AN ELECTRONIC OR MAGNETIC BAND (U.S. CLS. 21, 23, 26, 36 AND 38).

CLASS 16—PAPER GOODS AND PRINTED MATTER

FOR BLANK CHECKS; CREDIT AND DEBIT CARDS MADE OUT OF PAPER OR PLASTIC THAT DO NOT HAVE AN ELECTRONIC OR MAGNETIC BAND (U.S. CLS. 2, 5, 22, 23, 29, 37, 38 AND 50).

JOHN E. MICHOS, EXAMINING ATTORNEY

SN 77-606,179. NATURIFE BRANDS LLC, SALINAS, CA. FILED 11-3-2008.

NATURIFE

THE MARK CONSISTS OF STANDARD CHARACTERS WITHOUT CLAIM TO ANY PARTICULAR FONT, STYLE, SIZE, OR COLOR.

OWNER OF U.S. REG. NOS. 2,069,613 AND 3,471,633.

CLASS 29—MEATS AND PROCESSED FOODS

FOR FRUIT CONCENTRATES AND PUREES USED AS INGREDIENTS IN FOOD (U.S. CL. 46).

CLASS 30—STAPLE FOODS

FOR FRUIT FLAVORINGS, EXCEPT ESSENCES (U.S. CL. 46).

CLASS 32—LIGHT BEVERAGES

FOR FRUIT POWDERS, NAMELY, DRIED CONCENTRATES USED IN THE PREPARATION OF NON-ALCOHOLIC BEVERAGES; NON-ALCOHOLIC FRUIT EXTRACTS USED IN THE PREPARATION OF BEVERAGES; CONCENTRATES, SYRUPS OR POWDERS USED IN THE PREPARATION OF SOFT DRINKS (U.S. CLS. 45, 46 AND 48).

CLASS 33—WINES AND SPIRITS

FOR FRUIT EXTRACTS USED IN THE PREPARATION OF ALCOHOLIC BEVERAGES; FRUIT POWDERS, NAMELY, DRIED CONCENTRATES USED IN THE PREPARATION OF ALCOHOLIC BEVERAGES (U.S. CLS. 47 AND 49).

MELVIN AXILBUND, EXAMINING ATTORNEY

CLASS 38—COMMUNICATION

FOR TELECOMMUNICATIONS SERVICES, NAMELY, PROVIDING TELECOMMUNICATIONS ACCESS SERVICES; TELECOMMUNICATION ACCESS SERVICES, NAMELY, PROVIDING MULTIPLE USER BANDWIDTH AND DEDICATED ACCESS TO THE INTERNET TO ENABLE ELECTRONIC ACCESS TO COMPUTER SOFTWARE, WEBSITES, SOFTWARE APPLICATIONS, ELECTRONIC DATABASES, DIGITAL CONTENT, AND BUSINESS COMPUTER SOFTWARE APPLICATIONS OF OTHERS ACCESSIBLE VIA THE INTERNET (U.S. CLS. 100, 101 AND 104).

CLASS 42—SCIENTIFIC AND COMPUTER SERVICES

FOR HOSTING WEBSITES, SOFTWARE APPLICATIONS, COMPUTER SOFTWARE, ELECTRONIC DATABASES, DIGITAL CONTENT, AND BUSINESS COMPUTER SOFTWARE APPLICATIONS OF OTHERS ACCESSIBLE VIA THE INTERNET; HOSTING IN THE NATURE OF LEASING, CONFIGURING, UPDATING, MONITORING, OPTIMIZING, REPAIRING AND TROUBLESHOOTING COMPUTER SERVERS AND OTHER COMPUTER HARDWARE THAT SUPPORT HOSTED WEBSITES, SOFTWARE APPLICATIONS, COMPUTER SOFTWARE, ELECTRONIC DATABASES, DIGITAL CONTENT, AND BUSINESS COMPUTER SOFTWARE APPLICATIONS OF OTHERS ACCESSIBLE VIA THE INTERNET; HOSTING IN THE NATURE OF LEASING, CONFIGURING, UPDATING, MONITORING, OPTIMIZING, REPAIRING AND TROUBLESHOOTING COMPUTER SOFTWARE THAT SUPPORTS HOSTED WEBSITES, SOFTWARE APPLICATIONS, COMPUTER SOFTWARE, ELECTRONIC DATABASES, DIGITAL CONTENT, AND BUSINESS SOFTWARE APPLICATIONS OF OTHERS ACCESSIBLE VIA THE INTERNET; PROVIDING DATA BACKUP AND RESTORATION SERVICES FOR HOSTED WEBSITES, SOFTWARE APPLICATIONS, COMPUTER SOFTWARE, ELECTRONIC DATABASES, DIGITAL CONTENT, AND BUSINESS COMPUTER SOFTWARE APPLICATIONS OF OTHERS ACCESSIBLE VIA THE INTERNET; NETWORK SECURITY MANAGEMENT IN THE NATURE OF FIREWALL SERVICES, VIRTUAL PRIVATE NETWORK SERVICES AND VIRUS PROTECTION (U.S. CLS. 100 AND 101).

JENNIFER HETU, EXAMINING ATTORNEY

SN 77-606,193. SOFTLAYER TECHNOLOGIES, INC., PLANO, TX. FILED 11-3-2008.



THE COLOR(S) RED, WHITE, AND BLACK IS/ARE CLAIMED AS A FEATURE OF THE MARK.
THE MARK CONSISTS OF "THREE BARS," WHERE THE TOP BAR IS RED, FOLLOWED BY A WHITE BAR/SPACE, FOLLOWED BY A BLACK BAR, FOLLOWED BY A WHITE BAR/SPACE, AND ENDING WITH A RED BAR .

SN 77-606,360. VUKA LIMITED, ST. HELIER, JERSEY, FILED 11-3-2008.



THE MARK CONSISTS OF A CONCENTRIC CIRCLE DESIGN OVERLAPPED BY A SECOND, NON-CONCENTRIC CIRCLE.

CLASS 35—ADVERTISING AND BUSINESS

FOR PROVIDING ONLINE BUSINESS ACCOUNT ADMINISTRATION SERVICE FOR OTHERS IN THE FIELD OF WEB HOSTING; CUSTOMER SERVICE IN THE FIELD OF WEB HOSTING SERVICES; CUSTOMER SERVICE IN THE FIELD OF HOSTING WEBSITES, SOFTWARE APPLICATIONS, COMPUTER SOFTWARE, ELECTRONIC DATABASES, DIGITAL CONTENT, AND BUSINESS COMPUTER SOFTWARE APPLICATIONS OF OTHERS ACCESSIBLE VIA THE INTERNET; CUSTOMER SERVICE IN THE FIELD OF LEASING, CONFIGURING, UPDATING, MONITORING, OPTIMIZING, REPAIRING AND TROUBLESHOOTING COMPUTER SERVERS AND OTHER COMPUTER HARDWARE THAT SUPPORT HOSTED WEBSITES, SOFTWARE APPLICATIONS, COMPUTER SOFTWARE, ELECTRONIC DATABASES, DIGITAL CONTENT, AND BUSINESS COMPUTER SOFTWARE APPLICATIONS OF OTHERS ACCESSIBLE VIA THE INTERNET; CUSTOMER SERVICE IN THE FIELD OF BANDWIDTH PROVISION TO OTHERS; CUSTOMER SERVICE IN THE FIELD OF MANAGED DATA STORAGE, BACKUP AND RESTORATION; CUSTOMER SERVICE IN THE FIELD OF NETWORK SECURITY MANAGEMENT (U.S. CLS. 100, 101 AND 102).

CLASS 5—PHARMACEUTICALS

FOR VITAMINS AND MEAL REPLACEMENT BARS (U.S. CLS. 6, 18, 44, 46, 51 AND 52).

CLASS 32—LIGHT BEVERAGES

FOR ENERGY DRINKS, SPORTS DRINKS, BOTTLED WATER, FRUIT BEVERAGES AND SOFT DRINKS (U.S. CLS. 45, 46 AND 48).

ALLISON HALL, EXAMINING ATTORNEY

SN 77-606,581. STATE POLICY NETWORK, ARLINGTON, VA. FILED 11-4-2008.

STATE POLICY NETWORK

THE MARK CONSISTS OF STANDARD CHARACTERS WITHOUT CLAIM TO ANY PARTICULAR FONT, STYLE, SIZE, OR COLOR.
SEC. 2(F).

SN 77-606,565. STATE POLICY NETWORK, ARLINGTON, VA. FILED 11-4-2008.

SPN

THE MARK CONSISTS OF STANDARD CHARACTERS WITHOUT CLAIM TO ANY PARTICULAR FONT, STYLE, SIZE, OR COLOR.

CLASS 16—PAPER GOODS AND PRINTED MATTER

FOR PRINTED PUBLICATIONS, NAMELY, NEWSLETTERS, BROCHURES AND REPORTS IN THE FIELD OF DOMESTIC POLICY ISSUES, THE PRINCIPLES OF A FREE SOCIETY AND AMERICA'S FEDERALIST SYSTEM (U.S. CLS. 2, 5, 22, 23, 29, 37, 38 AND 50).

FIRST USE 3-24-1992; IN COMMERCE 3-24-1992.

CLASS 35—ADVERTISING AND BUSINESS

FOR ASSOCIATION SERVICES, NAMELY, PROMOTING THE INTERESTS OF INDEPENDENT, NON-PROFIT, MARKET ORIENTED, STATE-FOCUSED THINK TANKS; PROMOTING THE PUBLIC AWARENESS OF THE STATE-BASED, FREE MARKET THINK TANK MOVEMENT; PROVISION OF BUSINESS CONSULTATION SERVICES TO ASSIST STATE-BASED, FREE MARKET THINK TANKS; ARRANGING AND HOSTING BUSINESS NETWORKING EVENTS TO FACILITATE THE EXCHANGE OF INNOVATIVE POLICY PROPOSALS AND ORGANIZATIONAL MANAGEMENT TECHNIQUES AMONGST STATE-BASED, FREE MARKET THINK TANKS (U.S. CLS. 100, 101 AND 102).

FIRST USE 3-24-1992; IN COMMERCE 3-24-1992.

CLASS 41—EDUCATION AND ENTERTAINMENT

FOR EDUCATIONAL SERVICES, NAMELY, ARRANGING AND CONDUCTING CONFERENCES, SEMINARS, CLASSES, WORKSHOPS AND SYMPOSIA IN THE FIELD OF INDEPENDENT, NON-PROFIT, MARKET ORIENTED, STATE-FOCUSED THINK TANKS AND THE THINK TANK MOVEMENT; PROVIDING ON-LINE PUBLICATIONS IN THE NATURE OF NEWSLETTERS, BROCHURES AND REPORTS IN THE FIELD OF DOMESTIC POLICY ISSUES, THE PRINCIPLES OF A FREE SOCIETY AND AMERICA'S FEDERALIST SYSTEM (U.S. CLS. 100, 101 AND 107).

FIRST USE 3-24-1992; IN COMMERCE 3-24-1992.
LAURA KOVALSKY, EXAMINING ATTORNEY

CLASS 16—PAPER GOODS AND PRINTED MATTER

FOR PRINTED PUBLICATIONS, NAMELY, NEWSLETTERS, BROCHURES AND REPORTS IN THE FIELD OF DOMESTIC POLICY ISSUES, THE PRINCIPLES OF A FREE SOCIETY AND AMERICA'S FEDERALIST SYSTEM (U.S. CLS. 2, 5, 22, 23, 29, 37, 38 AND 50).

FIRST USE 3-24-1992; IN COMMERCE 3-24-1992.

CLASS 35—ADVERTISING AND BUSINESS

FOR ASSOCIATION SERVICES, NAMELY, PROMOTING THE INTERESTS OF INDEPENDENT, NON-PROFIT, MARKET ORIENTED, STATE-FOCUSED THINK TANKS; PROMOTING THE PUBLIC AWARENESS OF THE STATE-BASED, FREE MARKET THINK TANK MOVEMENT; PROVISION OF BUSINESS CONSULTATION SERVICES TO ASSIST STATE-BASED, FREE MARKET THINK TANKS; ARRANGING AND HOSTING BUSINESS NETWORKING EVENTS TO FACILITATE THE EXCHANGE OF INNOVATIVE POLICY PROPOSALS AND ORGANIZATIONAL MANAGEMENT TECHNIQUES AMONGST STATE-BASED, FREE MARKET THINK TANKS (U.S. CLS. 100, 101 AND 102).

FIRST USE 3-24-1992; IN COMMERCE 3-24-1992.

CLASS 41—EDUCATION AND ENTERTAINMENT

FOR EDUCATIONAL SERVICES, NAMELY, ARRANGING AND CONDUCTING CONFERENCES, SEMINARS, CLASSES, WORKSHOPS AND SYMPOSIA IN THE FIELD OF INDEPENDENT, NON-PROFIT, MARKET ORIENTED, STATE-FOCUSED THINK TANKS AND THE THINK TANK MOVEMENT; PROVIDING ON-LINE PUBLICATIONS IN THE NATURE OF NEWSLETTERS, BROCHURES AND REPORTS IN THE FIELD OF DOMESTIC POLICY ISSUES, THE PRINCIPLES OF A FREE SOCIETY AND AMERICA'S FEDERALIST SYSTEM (U.S. CLS. 100, 101 AND 107).

FIRST USE 3-24-1992; IN COMMERCE 3-24-1992.

LAURA KOVALSKY, EXAMINING ATTORNEY

SN 77-606,588. VUKA LIMITED, ST. HELIER, JERSEY, FILED 11-4-2008.

INTELLIGENT ENERGY

THE MARK CONSISTS OF STANDARD CHARACTERS WITHOUT CLAIM TO ANY PARTICULAR FONT, STYLE, SIZE, OR COLOR.

NO CLAIM IS MADE TO THE EXCLUSIVE RIGHT TO USE "ENERGY", APART FROM THE MARK AS SHOWN.

CLASS 5—PHARMACEUTICALS

FOR VITAMINS AND MEAL REPLACEMENT BARS (U.S. CLS. 6, 18, 44, 46, 51 AND 52).

CLASS 32—LIGHT BEVERAGES

FOR ENERGY DRINKS, SPORTS DRINKS, BOTTLED WATER, FRUIT BEVERAGES AND SOFT DRINKS (U.S. CLS. 45, 46 AND 48).

ALLISON HALL, EXAMINING ATTORNEY

SN 77-606,758. FERREIRA, SILVIO LUIZ, INDAIATUBA, BRAZIL, FILED 11-4-2008.



NO CLAIM IS MADE TO THE EXCLUSIVE RIGHT TO USE "OPTICAS", APART FROM THE MARK AS SHOWN.

THE MARK CONSISTS OF THE WORDS "OPTICAS IPANEMA" IN STYLIZED LETTERS OVER AN IRREGULAR RING.

THE ENGLISH TRANSLATION OF "OPTICAS" IN THE MARK IS "OPTICIANS' SHOP".

CLASS 9—ELECTRICAL AND SCIENTIFIC APPARATUS

FOR OPTICAL INSTRUMENTS, NAMELY, CONTACT LENSES, EYEGLASSES, SUNGLASSES, OPHTHALMIC FRAMES, CASES, PARTS AND FITTINGS THEREOF (U.S. CLS. 21, 23, 26, 36 AND 38).

CLASS 35—ADVERTISING AND BUSINESS

FOR ON-LINE RETAIL STORE SERVICES FEATURING OPTICAL INSTRUMENTS, NAMELY, CONTACT LENSES, EYEGLASSES, SUNGLASSES, OPHTHALMIC FRAMES, CASES, PARTS AND FITTINGS THEREOF; RETAIL SHOPS FEATURING OPTICAL INSTRUMENTS, NAMELY, CONTACT LENSES, EYEGLASSES, SUNGLASSES, OPHTHALMIC FRAMES, CASES, PARTS AND FITTINGS THEREOF; RETAIL STORE SERVICES FEATURING OPTICAL INSTRUMENTS, NAMELY, CONTACT LENSES, EYEGLASSES, SUNGLASSES, OPHTHALMIC FRAMES, CASES, PARTS AND FITTINGS THEREOF (U.S. CLS. 100, 101 AND 102).

CAROLINE WOOD, EXAMINING ATTORNEY

SN 77-606,856. AMAZON TECHNOLOGIES, INC., RENO, NV. FILED 11-4-2008.



OWNER OF U.S. REG. NOS. 2,078,496, 3,414,814 AND OTHERS.

NO CLAIM IS MADE TO THE EXCLUSIVE RIGHT TO USE "VIDEO ON DEMAND", APART FROM THE MARK AS SHOWN.

THE MARK CONSISTS OF THE WORDS "AMAZON VIDEO ON DEMAND" WITH THE ELECTRONIC PLAY BUTTON SYMBOL USED TO REPLACE THE LETTER "O" IN THE WORD "AMAZON" AND AN ARROW BELOW THE WORD "AMAZON" POINTING TO THE PLAY BUTTON.

CLASS 35—ADVERTISING AND BUSINESS

FOR ONLINE RETAIL STORE SERVICES FEATURING STREAMING AND DOWNLOADABLE PRE-RECORDED DIGITAL MEDIA CONTENT IN THE FIELDS OF ENTERTAINMENT, EDUCATION, SPORTS, COMEDY, DRAMA, MUSIC AND MUSIC VIDEOS; ADVERTISING SERVICES, NAMELY, DISSEMINATION OF ADVERTISING FOR OTHERS VIA AN ON-LINE ELECTRONIC COMMUNICATIONS NETWORK AND PROVIDING AN ON-LINE COMMERCIAL INFORMATION DIRECTORY FOR DIGITAL MEDIA ENTHUSIASTS (U.S. CLS. 100, 101 AND 102).

FIRST USE 9-3-2008; IN COMMERCE 9-3-2008.

CLASS 38—COMMUNICATION

FOR STREAMING CONTENT IN THE FIELDS OF ENTERTAINMENT, EDUCATION, SPORTS, COMEDY, DRAMA, MUSIC AND MUSIC VIDEOS VIA A GLOBAL COMPUTER NETWORK; TRANSMISSION OF DIGITAL MEDIA CONTENT IN THE NATURE OF FULL-LENGTH AND PARTIAL LENGTH CLIPS FROM MOTION PICTURES, TELEVISION PROGRAMMING, VIDEOS, MUSIC VIDEOS, AND MUSIC; TRANSMISSION OF VIDEOS; PODCASTING AND WEBCASTING SERVICES; ENTERTAINMENT AND EDUCATIONAL SERVICES, NAMELY, DISTRIBUTION OF ENTERTAINMENT AND EDUCATIONAL PROGRAMMING FOR OTHERS BY MEANS OF DIGITAL MEDIA TRANSMISSION OVER THE INTERNET (U.S. CLS. 100, 101 AND 104).

FIRST USE 9-3-2008; IN COMMERCE 9-3-2008.

CLASS 41—EDUCATION AND ENTERTAINMENT

FOR ONLINE JOURNALS, NAMELY, BLOGS FEATURING THE FIELDS OF ENTERTAINMENT, SPORTS, COMEDY, DRAMA, MUSIC AND MUSIC VIDEOS (U.S. CLS. 100, 101 AND 107).

FIRST USE 9-3-2008; IN COMMERCE 9-3-2008.

CLASS 42—SCIENTIFIC AND COMPUTER SERVICES

FOR HOSTING OF DIGITAL MEDIA CONTENT ON THE INTERNET; HOSTING AND MAINTAINING AN ONLINE COMMUNITY FEATURING DIGITAL MEDIA IN THE FIELDS OF ENTERTAINMENT, EDUCATION, SPORTS, COMEDY, DRAMA, MUSIC AND MUSIC VIDEOS VIA A GLOBAL COMPUTER NETWORK (U.S. CLS. 100 AND 101).

FIRST USE 9-3-2008; IN COMMERCE 9-3-2008.

RAUL CORDOVA, EXAMINING ATTORNEY

SN 77-606,862. KRAUT, GARY LEE, TRENTON, NJ. FILED 11-4-2008.

France Revisited

THE MARK CONSISTS OF STANDARD CHARACTERS WITHOUT CLAIM TO ANY PARTICULAR FONT, STYLE, SIZE, OR COLOR.

NO CLAIM IS MADE TO THE EXCLUSIVE RIGHT TO USE "FRANCE", APART FROM THE MARK AS SHOWN.

CLASS 9—ELECTRICAL AND SCIENTIFIC APPARATUS

FOR (BASED ON USE IN COMMERCE) ELECTRONIC PUBLICATIONS, NAMELY, MAGAZINES, NEWSLETTERS FEATURING TRAVEL, TOURISM, ESSAYS, STORIES, ADVICE, REVIEWS, COMMENTARY RECORDED ON COMPUTER MEDIA; (BASED ON INTENT TO USE) DOWNLOADABLE ELECTRONIC PUBLICATIONS IN THE NATURE OF BOOKS, BOOKLETS, SERIES OF ARTICLES IN THE FIELD OF TRAVEL, TOURISM, FOOD AND DRINK (U.S. CLS. 21, 23, 26, 36 AND 38).

FIRST USE 4-17-2008; IN COMMERCE 7-1-2008.

CLASS 16—PAPER GOODS AND PRINTED MATTER

FOR (BASED ON USE IN COMMERCE) NEWSLETTERS IN THE FIELD OF TRAVEL, TOURISM; PHOTOGRAPHS; (BASED ON INTENT TO USE) GUIDE BOOKS FEATURING TRAVEL, TOURISM AND RESTAURANTS; TRAVEL BOOKS (U.S. CLS. 2, 5, 22, 23, 29, 37, 38 AND 50).

FIRST USE 4-17-2008; IN COMMERCE 7-1-2008.

CLASS 39—TRANSPORTATION AND STORAGE

FOR (BASED ON USE IN COMMERCE) ARRANGING OF TOURS; ESCORTING TRAVELLERS; ORGANIZATION OF EXCURSIONS, SIGHTSEEING TOURS, HOLIDAYS, TOURS AND TRAVEL; ORGANIZATION, BOOKING AND ARRANGEMENT OF EXCURSIONS, DAY TRIPS AND SIGHTSEEING TOURS; PROVIDING INFORMATION, NEWS AND COMMENTARY IN THE FIELD OF TRAVEL; TOUR CONDUCTING OR ESCORTING; TOUR GUIDE SERVICES; TOUR ORGANIZING; TRAVEL AND TOUR INFORMATION SERVICE; TRAVEL GUIDE AND TRAVEL INFORMATION SERVICES (U.S. CLS. 100 AND 105).

FIRST USE 4-17-2008; IN COMMERCE 7-1-2008.

CLASS 41—EDUCATION AND ENTERTAINMENT

FOR (BASED ON USE IN COMMERCE) ARRANGING FOR TICKET RESERVATIONS FOR SHOWS AND OTHER ENTERTAINMENT EVENTS; BOOKING OF SEATS FOR SHOWS AND SPORTS EVENTS; EDUCATIONAL SERVICES, NAMELY, CONDUCTING CLASSES, SEMINARS, WORKSHOPS, ONLINE COURSES IN THE FIELD OF TRAVEL, TRAVEL WRITING AND DISTRIBUTION OF COURSE MATERIAL IN CONNECTION THEREWITH; EDUCATIONAL SERVICES, NAMELY, DEVELOPING, ARRANGING, AND CONDUCTING EDUCATIONAL CONFERENCES AND PROGRAMS AND PROVIDING COURSES OF INSTRUCTION IN THE FIELD OF TRAVEL WRITING; ENTERTAINMENT SERVICES, NAMELY, PROVIDING ONLINE REVIEWS OF BOOKS, MOVIES, SHOWS, EVENTS; ENTERTAINMENT SERVICES, NAMELY, WINE AND FOOD TASTINGS; TICKET RESERVATION AND BOOKING SERVICES FOR ENTERTAINMENT, SPORTING AND CULTURAL EVENTS; TRANSLATION; WRITING OF TEXTS; ENTERTAINMENT SERVICES, NAMELY, PROVIDING A WEB SITE FEATURING PHOTOGRAPHIC, AUDIO, VIDEO AND PROSE PRESENTATIONS, REVIEWS, ESSAYS AND STORIES FEATURING TRAVEL AND TOURISM (U.S. CLS. 100, 101 AND 107).

FIRST USE 4-17-2008; IN COMMERCE 7-1-2008.
INGA ERVIN, EXAMINING ATTORNEY

SN 77-606,872. NATIONAL ASSOCIATION FOR THE SPECIALTY FOOD TRADE, INC., NEW YORK, NY. FILED 11-4-2008.



OWNER OF U.S. REG. NOS. 2,493,694, 3,178,965 AND OTHERS.

THE MARK CONSISTS OF THE STYLIZED WORDING "SPECIALTYFOOD.COM THE INNOVATIVE HUB OF THE SPECIALTY FOOD MARKET" APPEARING IN THE RECTANGLE SURROUNDING ALL THE WORDS.

SEC. 2(F) AS TO "SPECIALTYFOOD.COM".

CLASS 9—ELECTRICAL AND SCIENTIFIC APPARATUS

FOR DOWNLOADABLE ELECTRONIC PUBLICATIONS IN THE NATURE OF MAGAZINES IN THE FIELD OF SPECIALTY FOOD FOR THE FOOD INDUSTRY (U.S. CLS. 21, 23, 26, 36 AND 38).

CLASS 16—PAPER GOODS AND PRINTED MATTER

FOR MAGAZINE CONTAINING INFORMATION OF INTEREST TO THE GOURMET FOOD INDUSTRY (U.S. CLS. 2, 5, 22, 23, 29, 37, 38 AND 50).

CLASS 35—ADVERTISING AND BUSINESS

FOR BUSINESS INFORMATION SERVICES, NAMELY, COMPILATION AND PROVISION OF A WIDE RANGE OF INFORMATION CONCERNING THE FOOD TRADE, TRADE SHOWS, TRADE SHOW EXHIBITIONS AND TRADE SHOW EXHIBITORS AND THEIR PRODUCTS AND SERVICES; PROVIDING COMMERCIAL BUSINESS AND COMMERCIAL INFORMATION VIA THE INTERNET ABOUT A WIDE RANGE OF TOPICS CONCERNING THE FOOD INDUSTRY, NAMELY, INFORMATION CONCERNING THE FOOD TRADE, TRADE SHOWS, TRADE SHOW EXHIBITIONS AND TRADE SHOW EXHIBITORS AND THEIR PRODUCTS AND SERVICES, SPECIALTY FOOD STORES, BUSINESS TRENDS, MARKETING TRENDS, ONLINE BUSINESS DIRECTORIES FEATURING A SEARCHABLE LISTING OF FOOD MANUFACTURERS, IMPORTERS, DISTRIBUTORS, AGENTS, BROKERS, AND PUBLISHERS, WITH LINKS TO THE RETAIL ONLINE WEB SITES OF OTHERS THAT CAN BE USED TO ASSIST WITH FINDING PRODUCTS OF OTHERS FOR PURCHASE, AND RELATED BUSINESS INFORMATION FOR COMMERCIAL AND PURCHASING PURPOSES (U.S. CLS. 100, 101 AND 102).

ALLISON HALL, EXAMINING ATTORNEY

SN 77-607,895. GRO-ECO, LLC, MADISON, FL. FILED 11-5-2008.

EVERY PLANT MAKES A DIFFERENCE

THE MARK CONSISTS OF STANDARD CHARACTERS WITHOUT CLAIM TO ANY PARTICULAR FONT, STYLE, SIZE, OR COLOR.

CLASS 31—NATURAL AGRICULTURAL PRODUCTS

FOR LIVE PLANTS (U.S. CLS. 1 AND 46).
FIRST USE 4-30-2008; IN COMMERCE 4-30-2008.

CLASS 44—MEDICAL, BEAUTY AND AGRICULTURAL SERVICES

FOR PLANT NURSERIES (U.S. CLS. 100 AND 101).
FIRST USE 4-30-2008; IN COMMERCE 4-30-2008.
THOMAS MANOR, EXAMINING ATTORNEY

CLASS 38—COMMUNICATION

FOR TELECOMMUNICATIONS SERVICES, NAMELY, PROVIDING TELECOMMUNICATIONS ACCESS SERVICES; TELECOMMUNICATION ACCESS SERVICES, NAMELY, PROVIDING MULTIPLE USER BANDWIDTH AND DEDICATED ACCESS TO THE INTERNET TO ENABLE ELECTRONIC ACCESS TO COMPUTER SOFTWARE, WEBSITES, SOFTWARE APPLICATIONS, ELECTRONIC DATABASES, DIGITAL CONTENT, AND BUSINESS COMPUTER SOFTWARE APPLICATIONS OF OTHERS ACCESSIBLE VIA THE INTERNET (U.S. CLS. 100, 101 AND 104).

FIRST USE 6-30-2005; IN COMMERCE 1-23-2006.

CLASS 42—SCIENTIFIC AND COMPUTER SERVICES

FOR HOSTING WEBSITES, SOFTWARE APPLICATIONS, COMPUTER SOFTWARE, ELECTRONIC DATABASES, DIGITAL CONTENT, AND BUSINESS COMPUTER SOFTWARE APPLICATIONS OF OTHERS ACCESSIBLE VIA THE INTERNET; HOSTING IN THE NATURE OF LEASING, CONFIGURING, UPDATING, MONITORING, OPTIMIZING, REPAIRING AND TROUBLESHOOTING COMPUTER SERVERS AND OTHER COMPUTER HARDWARE THAT SUPPORT HOSTED WEBSITES, SOFTWARE APPLICATIONS, COMPUTER SOFTWARE, ELECTRONIC DATABASES, DIGITAL CONTENT, AND BUSINESS COMPUTER SOFTWARE APPLICATIONS OF OTHERS ACCESSIBLE VIA THE INTERNET; HOSTING IN THE NATURE OF LEASING, CONFIGURING, UPDATING, MONITORING, OPTIMIZING, REPAIRING AND TROUBLESHOOTING COMPUTER SOFTWARE THAT SUPPORTS HOSTED WEBSITES, SOFTWARE APPLICATIONS, COMPUTER SOFTWARE, ELECTRONIC DATABASES, DIGITAL CONTENT, AND BUSINESS COMPUTER SOFTWARE APPLICATIONS OF OTHERS ACCESSIBLE VIA THE INTERNET; PROVIDING DATA BACKUP AND RESTORATION SERVICES FOR HOSTED WEBSITES, SOFTWARE APPLICATIONS, COMPUTER SOFTWARE, ELECTRONIC DATABASES, DIGITAL CONTENT, AND BUSINESS COMPUTER SOFTWARE APPLICATIONS OF OTHERS ACCESSIBLE VIA THE INTERNET; NETWORK SECURITY MANAGEMENT IN THE NATURE OF FIREWALL SERVICES, VIRTUAL PRIVATE NETWORK SERVICES AND VIRUS PROTECTION (U.S. CLS. 100 AND 101).

FIRST USE 6-30-2005; IN COMMERCE 1-23-2006.
JENNIFER HETU, EXAMINING ATTORNEY

SN 77-608,130. SOFTLAYER TECHNOLOGIES, INC., PLANO, TX. FILED 11-5-2008.



The logo for SOFTLAYER features the word "SOFTLAYER" in a bold, sans-serif font. The letter "E" in "LAYER" is stylized with a red horizontal bar through its middle. The "E" in "SOFT" is also stylized with a red horizontal bar through its middle.

THE COLOR(S) RED AND BLACK IS/ARE CLAIMED AS A FEATURE OF THE MARK.

THE MARK CONSISTS OF THE WORD "SOFTLAYER", WHERE THE COLOR BLACK APPEARS IN THE WORDING "SOFTLAYER". THE COLOR BLACK APPEARS IN THE LETTER "E" IN THE MIDDLE BAR. THE COLOR RED APPEARS IN THE LETTER "E" IN THE TOP AND BOTTOM BARS.

CLASS 35—ADVERTISING AND BUSINESS

FOR PROVIDING ONLINE BUSINESS ACCOUNT ADMINISTRATION SERVICE FOR OTHERS IN THE FIELD OF WEB HOSTING; CUSTOMER SERVICE IN THE FIELD OF WEB HOSTING SERVICES; CUSTOMER SERVICE IN THE FIELD OF HOSTING WEBSITES, SOFTWARE APPLICATIONS, COMPUTER SOFTWARE, ELECTRONIC DATABASES, DIGITAL CONTENT, AND BUSINESS COMPUTER SOFTWARE APPLICATIONS OF OTHERS ACCESSIBLE VIA THE INTERNET; CUSTOMER SERVICE IN THE FIELD OF LEASING, CONFIGURING, UPDATING, MONITORING, OPTIMIZING, REPAIRING AND TROUBLESHOOTING COMPUTER SERVERS AND OTHER COMPUTER HARDWARE THAT SUPPORT HOSTED WEBSITES, SOFTWARE APPLICATIONS, COMPUTER SOFTWARE, ELECTRONIC DATABASES, DIGITAL CONTENT, AND BUSINESS COMPUTER SOFTWARE APPLICATIONS OF OTHERS ACCESSIBLE VIA THE INTERNET; CUSTOMER SERVICE IN THE FIELD OF BANDWIDTH PROVISION TO OTHERS; CUSTOMER SERVICE IN THE FIELD OF MANAGED DATA STORAGE, BACKUP AND RESTORATION; CUSTOMER SERVICE IN THE FIELD OF NETWORK SECURITY MANAGEMENT (U.S. CLS. 100, 101 AND 102).

FIRST USE 6-30-2005; IN COMMERCE 1-23-2006.

SN 77-608,655. SOFTLAYER TECHNOLOGIES, INC., PLANO, TX. FILED 11-6-2008.



The logo for KnowledgeLayer features the word "KnowledgeLayer" in a serif font. The "e" in "Layer" is stylized with a red horizontal bar through its middle.

THE MARK CONSISTS OF STANDARD CHARACTERS WITHOUT CLAIM TO ANY PARTICULAR FONT, STYLE, SIZE, OR COLOR.

CLASS 38—COMMUNICATION

FOR PROVIDING AN ON-LINE COMPUTER DATABASE IN THE FIELD OF TELECOMMUNICATION ACCESS SERVICES (U.S. CLS. 100, 101 AND 104).

FIRST USE 11-15-2007; IN COMMERCE 11-15-2007.

CLASS 42—SCIENTIFIC AND COMPUTER SERVICES

FOR PROVIDING AN ON-LINE COMPUTER DATABASE IN THE FIELD OF WEB SITE HOSTING SERVICES AND APPLICATION SERVICE PROVIDER (ASP) SERVICES, NAMELY, HOSTING COMPUTER SOFTWARE APPLICATIONS OF OTHERS (U.S. CLS. 100 AND 101).

FIRST USE 11-15-2007; IN COMMERCE 11-15-2007.
JENNIFER HETU, EXAMINING ATTORNEY

SN 77-610,248. JUMBUCK ENTERTAINMENT LTD, MELBOURNE, VICTORIA, AUSTRALIA, FILED 11-7-2008.

AUGMENT

THE MARK CONSISTS OF STANDARD CHARACTERS WITHOUT CLAIM TO ANY PARTICULAR FONT, STYLE, SIZE, OR COLOR.

CLASS 9—ELECTRICAL AND SCIENTIFIC APPARATUS

FOR COMPUTER AND ELECTRONIC SOFTWARE FOR PLAYING GAMES AND OTHER ENTERTAINMENT ON WIRELESS DEVICES; HEADPHONES AND EARPHONES; PORTABLE ELECTRONIC DEVICES AND ULTRA-PORTAL COMPUTERS THAT DISPLAY IMAGES, TEXT AND VIDEO (U.S. CLS. 21, 23, 26, 36 AND 38).

CLASS 38—COMMUNICATION

FOR TELECOMMUNICATION SERVICES, NAMELY, TRANSMISSION OF WEBCASTS; ONLINE WEB COMMUNITY SERVICE WHERE USERS CAN COMMUNICATE USING TEXT, IMAGES OR VIDEO; TELECOMMUNICATION SERVICES, NAMELY, TRANSMISSION OF VOICE, DATA, GRAPHICS, IMAGES, AUDIO AND VIDEO BY MEANS OF TELECOMMUNICATIONS NETWORKS, WIRELESS COMMUNICATION NETWORKS AND THE INTERNET (U.S. CLS. 100, 101 AND 104).

ALEXANDER L. POWERS, EXAMINING ATTORNEY

SN 77-610,784. FRIEND BUILDING CENTER OF BURLINGTON, INC., BURLINGTON, MA. FILED 11-10-2008.

THE PROJECT PRO!

THE MARK CONSISTS OF STANDARD CHARACTERS WITHOUT CLAIM TO ANY PARTICULAR FONT, STYLE, SIZE, OR COLOR.

CLASS 35—ADVERTISING AND BUSINESS

FOR RETAIL AND WHOLESALE BUILDING AND CONSTRUCTION MATERIAL STORE SERVICES (U.S. CLS. 100, 101 AND 102).

FIRST USE 1-22-1988; IN COMMERCE 1-22-1988.

CLASS 37—CONSTRUCTION AND REPAIR

FOR CONSTRUCTION SERVICES, NAMELY, CONSTRUCTION OF BUILDINGS AND BUILDING RENOVATION SERVICES (U.S. CLS. 100, 103 AND 106).

FIRST USE 1-22-1988; IN COMMERCE 1-22-1988.
BARBARA BROWN, EXAMINING ATTORNEY

SN 77-611,506. NORIDIAN MUTUAL INSURANCE COMPANY, FARGO, ND. FILED 11-10-2008.

PROVIDERCAST

THE MARK CONSISTS OF STANDARD CHARACTERS WITHOUT CLAIM TO ANY PARTICULAR FONT, STYLE, SIZE, OR COLOR.

CLASS 38—COMMUNICATION

FOR PODCASTING SERVICES; TELECOMMUNICATION SERVICES, NAMELY, TRANSMISSION OF PODCASTS (U.S. CLS. 100, 101 AND 104).

FIRST USE 3-29-2007; IN COMMERCE 3-29-2007.

CLASS 41—EDUCATION AND ENTERTAINMENT

FOR ENTERTAINMENT SERVICES, NAMELY, PROVIDING PODCASTS IN THE FIELD OF HEALTH AND HEALTH INSURANCE (U.S. CLS. 100, 101 AND 107).

FIRST USE 3-29-2007; IN COMMERCE 3-29-2007.
DORITT L. CARROLL, EXAMINING ATTORNEY

SN 77-612,648. SALES, CHARLENE, BANSTEAD, SURREY, UNITED KINGDOM, FILED 11-12-2008.



OWNER OF UNITED KINGDOM REG. NO. 2446957, DATED 8-24-2007, EXPIRES 2-16-2017.

NO CLAIM IS MADE TO THE EXCLUSIVE RIGHT TO USE "YOGA", APART FROM THE MARK AS SHOWN.

THE COLOR(S) GREEN IS/ARE CLAIMED AS A FEATURE OF THE MARK.

THE MARK CONSISTS OF THE WORDS "YOGA RHYTHM" APPEARING IN A GREEN COLOR TO THE RIGHT OF A DESIGN CONSISTING OF THE OUTLINE OF A GREEN SEMICIRCLE HOLDING A SMALL, SOLID GREEN COLORED CIRCLE ABOVE A HORIZONTAL GREEN LINE.

CLASS 9—ELECTRICAL AND SCIENTIFIC APPARATUS

FOR VIDEO RECORDINGS, COMPACT DISCS, AND MOTION PICTURE FILMS FEATURING OR ABOUT YOGA (U.S. CLS. 21, 23, 26, 36 AND 38).

CLASS 16—PAPER GOODS AND PRINTED MATTER

FOR PRINTED LEAFLETS, PAMPHLETS, INSTRUCTIONAL, EDUCATIONAL, AND TEACHING MATERIAL IN THE FIELD OF YOGA; PHOTOGRAPHS (U.S. CLS. 2, 5, 22, 23, 29, 37, 38 AND 50).

CLASS 25—CLOTHING

FOR CLOTHING, NAMELY, T-SHIRTS, SWEAT-SHIRTS, TROUSERS, LEGGINGS, JUMPERS, UNDER-GARMENTS, CROP TOPS, SHORTS, JACKETS, COATS, SCARVES, AND GLOVES, FOOTWEAR AND HEAD-GEAR, NAMELY, HATS, CAPS, HEADBANDS, AND SWEATBANDS (U.S. CLS. 22 AND 39).

CLASS 27—FLOOR COVERINGS

FOR MATS, NAMELY, GYMNASIUM EXERCISE MATS AND FLOOR MATS (U.S. CLS. 19, 20, 37, 42 AND 50).

CLASS 41—EDUCATION AND ENTERTAINMENT

FOR ORGANISING COMMUNITY FESTIVALS FEATURING A VARIETY OF ACTIVITIES, NAMELY, SPORTING EVENTS; SPORTS TRAINING SERVICES; ORGANISATION OF SPORTS COMPETITIONS; EDUCATIONAL SERVICES, NAMELY, PROVIDING WORKSHOPS, CLASSES AND SEMINARS IN THE FIELD OF YOGA AND PHYSICAL EXERCISE, TRAINING SERVICES IN THE FIELD OF YOGA AND PHYSICAL EXERCISE (U.S. CLS. 100, 101 AND 107).

ANTHONY RINKER, EXAMINING ATTORNEY

SN 77-612,684. BLUE RIDGE PUBLISHING, INC., POWDER SPRINGS, GA. FILED 11-12-2008.

LIVING A BETTER LIFE

THE MARK CONSISTS OF STANDARD CHARACTERS WITHOUT CLAIM TO ANY PARTICULAR FONT, STYLE, SIZE, OR COLOR.

CLASS 16—PAPER GOODS AND PRINTED MATTER

FOR EDUCATIONAL PUBLICATIONS, NAMELY, BOOKS, HANDOUTS, PAMPHLETS, AND WORKSHEETS IN THE FIELD OF BUDGETING AND MANAGING MONEY (U.S. CLS. 2, 5, 22, 23, 29, 37, 38 AND 50).
FIRST USE 11-1-2000; IN COMMERCE 4-1-2001.

CLASS 41—EDUCATION AND ENTERTAINMENT

FOR EDUCATIONAL SERVICES, NAMELY, PROVIDING A WEBSITE THAT DISPLAYS EDUCATIONAL INFORMATION AND CLASSES IN THE FIELD OF BUDGETING AND MANAGING MONEY (U.S. CLS. 100, 101 AND 107).

FIRST USE 11-1-2001; IN COMMERCE 4-1-2001.
JORDAN BAKER, EXAMINING ATTORNEY

SN 77-613,018. NIMBUS WATER SYSTEMS INC., TORONTO, ONTARIO, CANADA, FILED 11-12-2008.

BOTTLELESS

THE MARK CONSISTS OF STANDARD CHARACTERS WITHOUT CLAIM TO ANY PARTICULAR FONT, STYLE, SIZE, OR COLOR.

CLASS 9—ELECTRICAL AND SCIENTIFIC APPARATUS

FOR BOTTLED WATER VENDING MACHINES AND KIOSKS (U.S. CLS. 21, 23, 26, 36 AND 38).

CLASS 11—ENVIRONMENTAL CONTROL APPARATUS

FOR WATER COOLERS; PROPRIETARY EQUIPMENT FOR THE TREATMENT AND PURIFICATION OF WATER, NAMELY, WATER PURIFICATION AND FILTRATION APPARATUS, WATER PURIFICATION INSTALLATIONS, WATER PURIFICATION TANKS, WATER PURIFICATION UNITS, WATER PURIFYING APPARATUS, CARTRIDGE FILTRATION UNITS, CHEMICAL STERILIZATION UNITS, REVERSE OSMOSIS WATER PURIFICATION UNITS, REVERSE OSMOSIS FILTRATION UNITS, ULTRAVIOLET STERILIZATION UNITS; AND MACHINES AND EQUIPMENT FOR DISPENSING WATER, NAMELY, REFRIGERATED BEVERAGE DISPENSING UNITS (U.S. CLS. 13, 21, 23, 31 AND 34).

CLASS 21—HOUSEWARES AND GLASS

FOR REFILLABLE PLASTIC WATER BOTTLES, CONTAINERS AND JUGS SOLD EMPTY; AND MACHINES AND EQUIPMENT FOR DISPENSING WATER, NAMELY, PORTABLE WATER DISPENSERS (U.S. CLS. 2, 13, 23, 29, 30, 33, 40 AND 50).

CLASS 32—LIGHT BEVERAGES

FOR BOTTLED WATER, TREATED WATER, NAMELY, REVERSE OSMOSIS FILTERED DRINKING WATER AND PURIFIED WATER; REVERSE OSMOSIS DRINKING WATER; DEMINERALIZED DRINKING WATER (U.S. CLS. 45, 46 AND 48).
KATHERINE CONNOLLY, EXAMINING ATTORNEY

SN 77-613,093. TEOLI MEDIA INC., LAVAL, CANADA, FILED 11-12-2008.



THE COLOR(S) RED AND YELLOW IS/ARE CLAIMED AS A FEATURE OF THE MARK.

THE MARK CONSISTS OF THE WORDS "MOMMYSAVESBIG" IN ALL RED CHARACTERS EXCEPT THE DOLLAR SIGN REPRESENTING THE LETTER "S" WHICH APPEARS IN YELLOW .

CLASS 35—ADVERTISING AND BUSINESS

FOR ON-LINE SERVICES TO FACILITATE THE SALE OF GOODS AND SERVICES BY OTHERS VIA A COMPUTER NETWORK AND PROVIDING EVALUATIVE FEEDBACK AND RATINGS OF SELLERS GOODS AND SERVICES, THE VALUE AND PRICES OF SELLERS GOODS AND SERVICES, BUYERS AND SELLERS PERFORMANCE, BUYERS AND SELLERS PROMOTIONS AND DISCOUNTED PRICES ON THEIR GOODS AND SERVICES, DELIVERY AND OVERALL TRADING EXPERIENCE IN CONNECTION THEREWITH; ADVERTISING THE WARES AND SERVICES OF OTHERS; ELECTRONIC BILLBOARD ADVERTISING, NAMELY, ADVERTISING THE MESSAGES OF OTHERS; ELECTRONIC AND ON-LINE AUCTIONING OF BUYERS AND SELLERS GOODS AND SERVICES (U.S. CLS. 100, 101 AND 102).

FIRST USE 1-0-2008; IN COMMERCE 1-0-2008.

CLASS 38—COMMUNICATION

FOR PROVIDING ON-LINE ELECTRONIC BULLETIN BOARDS FOR TRANSMISSION OF MESSAGES AMONG COMPUTER USERS CONCERNING RATINGS OF SELLERS OF GOODS AND SERVICES AND THE OVERALL SHOPPING EXPERIENCE; PROVIDING ON-LINE, INTERACTIVE BULLETIN BOARD FOR POSTING, PROMOTIONS, SALE AND RESALE OF ITEMS VIA A GLOBAL COMPUTER NETWORK (U.S. CLS. 100, 101 AND 104).

FIRST USE 1-0-2008; IN COMMERCE 1-0-2008.
G. MAYERSCHOFF, EXAMINING ATTORNEY

SN 77-613,366. ALLSTATE INSURANCE COMPANY, NORTHBROOK, IL. FILED 11-13-2008.

ALLSTATE DEALER SERVICES

THE MARK CONSISTS OF STANDARD CHARACTERS WITHOUT CLAIM TO ANY PARTICULAR FONT, STYLE, SIZE, OR COLOR.

OWNER OF U.S. REG. NOS. 717,683, 3,451,424 AND OTHERS.

NO CLAIM IS MADE TO THE EXCLUSIVE RIGHT TO USE "DEALER SERVICES", APART FROM THE MARK AS SHOWN.

CLASS 36—INSURANCE AND FINANCIAL

FOR INSURANCE UNDERWRITING SERVICES IN THE FIELD OF AUTO PROTECTION, EXCESS WEAR AND TEAR PROTECTION, GAP, VEHICLE SERVICE CONTRACTS AND CREDIT LIFE INSURANCE; PREPAID PREVENTIVE MAINTENANCE SERVICE PLANS FOR AUTOMOBILES; DEBT CANCELLATION SERVICES USING PROCEEDS FROM AUTOMOBILE INSURANCE (U.S. CLS. 100, 101 AND 102).

CLASS 37—CONSTRUCTION AND REPAIR

FOR AUTOMOTIVE MAINTENANCE AND REPAIR; EMERGENCY ROADSIDE ASSISTANCE SERVICES, NAMELY, RESPONDING TO CALLS FOR ROADSIDE ASSISTANCE, FLAT TIRE CHANGING, EMERGENCY FUEL SUPPLYING, AND BATTERY JUMP STARTING (U.S. CLS. 100, 103 AND 106).

CLASS 40—MATERIAL TREATMENT

FOR ETCHING OF TRACEABLE IDENTIFICATION NUMBERS ON AUTOMOBILE WINDOWS, SO AS TO IDENTIFY A PARTICULAR AUTOMOBILE RECOVERED AFTER THEFT (U.S. CLS. 100, 103 AND 106).

MATTHEW EINSTEIN, EXAMINING ATTORNEY

SN 77-613,384. DEPARTMENT OF THE ARMY, WEST POINT, NY. FILED 11-13-2008.

DUTY HONOR COUNTRY

THE MARK CONSISTS OF STANDARD CHARACTERS WITHOUT CLAIM TO ANY PARTICULAR FONT, STYLE, SIZE, OR COLOR.

OWNER OF U.S. REG. NOS. 1,261,989 AND 1,274,265.

CLASS 19—NON-METALLIC BUILDING MATERIALS

FOR CAST STONE GARDEN ORNAMENTS (U.S. CLS. 1, 12, 33 AND 50).

FIRST USE 9-0-1923; IN COMMERCE 9-0-2000.

CLASS 24—FABRICS

FOR THROW BLANKETS (U.S. CLS. 42 AND 50).

FIRST USE 9-0-1923; IN COMMERCE 9-0-2000.

CLASS 26—FANCY GOODS

FOR CROSS STITCH KITS, CONSISTING OF FABRIC, NEEDLE AND THREAD (U.S. CLS. 37, 39, 40, 42 AND 50).

FIRST USE 9-0-1923; IN COMMERCE 9-0-2000.

CLASS 41—EDUCATION AND ENTERTAINMENT

FOR EDUCATIONAL SERVICES, NAMELY, PROVIDING CLASSES AND COURSES OF INSTRUCTION IN THE FIELDS OF UNDERGRADUATE STUDIES, PHYSICAL EDUCATION AND MILITARY TRAINING (U.S. CLS. 100, 101 AND 107).

FIRST USE 9-0-1923; IN COMMERCE 9-0-1923.

APRIL ROACH, EXAMINING ATTORNEY

SN 77-613,443. DEPARTMENT OF THE ARMY, WEST POINT, NY. FILED 11-13-2008.

LONG GRAY LINE

THE MARK CONSISTS OF STANDARD CHARACTERS WITHOUT CLAIM TO ANY PARTICULAR FONT, STYLE, SIZE, OR COLOR.

CLASS 16—PAPER GOODS AND PRINTED MATTER

FOR BUMPER STICKERS AND WINDOW DECALS (U.S. CLS. 2, 5, 22, 23, 29, 37, 38 AND 50).

FIRST USE 9-0-1902; IN COMMERCE 9-0-2000.

CLASS 21—HOUSEWARES AND GLASS

FOR DRINKING GLASSES, CUPS, AND MUGS (U.S. CLS. 2, 13, 23, 29, 30, 33, 40 AND 50).
FIRST USE 9-0-1902; IN COMMERCE 9-0-2000.

CLASS 26—FANCY GOODS

FOR CROSS STITCH KITS, CONSISTING OF CLOTH, NEEDLE AND THREAD (U.S. CLS. 37, 39, 40, 42 AND 50).
FIRST USE 9-0-1902; IN COMMERCE 9-0-2000.

CLASS 41—EDUCATION AND ENTERTAINMENT

FOR EDUCATIONAL SERVICES, NAMELY, PROVIDING CLASSES AND COURSES OF INSTRUCTION IN UNDERGRADUATE STUDIES, PHYSICAL EDUCATION AND MILITARY TRAINING (U.S. CLS. 100, 101 AND 107).
FIRST USE 9-0-1902; IN COMMERCE 9-0-2000.
APRIL ROACH, EXAMINING ATTORNEY

CLASS 41—EDUCATION AND ENTERTAINMENT

FOR EDUCATIONAL SERVICES, NAMELY, PROVIDING CLASSES AND COURSES OF INSTRUCTION IN THE FIELDS OF UNDERGRADUATE STUDIES, PHYSICAL EDUCATION AND MILITARY TRAINING (U.S. CLS. 100, 101 AND 107).
FIRST USE 1-0-1975; IN COMMERCE 1-0-1975.
APRIL ROACH, EXAMINING ATTORNEY

SN 77-613,866. FRANKLIN INTERNATIONAL, INC., COLUMBUS, OH. FILED 11-13-2008.

ADVANCED SOLVENT ADHESIVES

THE MARK CONSISTS OF STANDARD CHARACTERS WITHOUT CLAIM TO ANY PARTICULAR FONT, STYLE, SIZE, OR COLOR.
NO CLAIM IS MADE TO THE EXCLUSIVE RIGHT TO USE "SOLVENT ADHESIVES", APART FROM THE MARK AS SHOWN.

SN 77-613,708. DEPARTMENT OF THE ARMY, WEST POINT, NY. FILED 11-13-2008.

CLASS 1—CHEMICALS

FOR ADHESIVES OTHER THAN FOR STATIONERY OR HOUSEHOLD PURPOSES (U.S. CLS. 1, 5, 6, 10, 26 AND 46).

CLASS 17—RUBBER GOODS

FOR ADHESIVE SEALANTS FOR GENERAL USE (U.S. CLS. 1, 5, 12, 13, 35 AND 50).
JAY BESCH, EXAMINING ATTORNEY

U S M A

THE MARK CONSISTS OF STANDARD CHARACTERS WITHOUT CLAIM TO ANY PARTICULAR FONT, STYLE, SIZE, OR COLOR.
OWNER OF U.S. REG. NOS. 1,261,989, 2,340,917 AND OTHERS.

SN 77-614,113. GARY AUGUSTUS, BOCA RATON, FL. FILED 11-13-2008.

CLASS 16—PAPER GOODS AND PRINTED MATTER

FOR STATIONERY, WRITING PAPER, NOTE PADS, ENVELOPES, PENS, PENCILS, AND PAPER NAME BADGES (U.S. CLS. 2, 5, 22, 23, 29, 37, 38 AND 50).
FIRST USE 1-0-1975; IN COMMERCE 1-0-1990.

FIGHT FOR A CAUSE

THE MARK CONSISTS OF STANDARD CHARACTERS WITHOUT CLAIM TO ANY PARTICULAR FONT, STYLE, SIZE, OR COLOR.

CLASS 21—HOUSEWARES AND GLASS

FOR DRINKING GLASSES, MUGS, TRAVEL MUGS, CUPS, AND PLASTIC WATER BOTTLES SOLD EMPTY (U.S. CLS. 2, 13, 23, 29, 30, 33, 40 AND 50).
FIRST USE 1-0-1975; IN COMMERCE 1-0-1990.

CLASS 16—PAPER GOODS AND PRINTED MATTER

FOR EVENT PROGRAMS (U.S. CLS. 2, 5, 22, 23, 29, 37, 38 AND 50).

CLASS 26—FANCY GOODS

FOR CROSS STITCH KITS, CONSISTING OF CLOTH, NEEDLE AND THREAD (U.S. CLS. 37, 39, 40, 42 AND 50).
FIRST USE 1-0-1975; IN COMMERCE 1-0-1990.

CLASS 35—ADVERTISING AND BUSINESS

FOR BUSINESS SERVICES, NAMELY, DEVELOPING FUND RAISING CAMPAIGNS FOR OTHERS (U.S. CLS. 100, 101 AND 102).

CLASS 28—TOYS AND SPORTING GOODS

FOR STUFFED TOY ANIMALS (U.S. CLS. 22, 23, 38 AND 50).
FIRST USE 1-0-1975; IN COMMERCE 1-0-1990.

CLASS 38—COMMUNICATION

FOR TELEVISION AND RADIO BROADCASTING SERVICES (U.S. CLS. 100, 101 AND 104).

CLASS 41—EDUCATION AND ENTERTAINMENT

FOR ENTERTAINMENT SERVICES, NAMELY, AN ON-GOING SERIES FEATURING A VARIETY OF SHOWS IN THE FIELD OF SPORTS PROVIDED THROUGH INTERNET AND NETWORK BROADCASTING, NAMELY, TELEVISION, WEBCAST, AND RADIO BROADCASTS (U.S. CLS. 100, 101 AND 107).
JENNY PARK, EXAMINING ATTORNEY

SN 77-615,973. FRANKLIN INTERNATIONAL, INC., COLUMBUS, OH. FILED 11-17-2008.



SN 77-614,329. FRANKLIN INTERNATIONAL, INC., COLUMBUS, OH. FILED 11-14-2008.

**SUPERIOR PERFORMANCE
WITHOUT COMPROMISE**

THE MARK CONSISTS OF STANDARD CHARACTERS WITHOUT CLAIM TO ANY PARTICULAR FONT, STYLE, SIZE, OR COLOR.

THE MARK CONSISTS OF A STYLIZED CARICATURE OF THE TOP PORTION OF A MAN WEARING A HARD HAT, OVERALLS AND A SHIRT AND HOLDING ADHESIVE CONTAINER TUBE IN HIS HAND.

CLASS 1—CHEMICALS

FOR CONSTRUCTION INDUSTRY ADHESIVES (U.S. CLS. 1, 5, 6, 10, 26 AND 46).

CLASS 1—CHEMICALS

FOR ADHESIVES OTHER THAN FOR STATIONERY OR HOUSEHOLD PURPOSES (U.S. CLS. 1, 5, 6, 10, 26 AND 46).

CLASS 17—RUBBER GOODS

FOR ADHESIVE SEALANTS FOR GENERAL USE (U.S. CLS. 1, 5, 12, 13, 35 AND 50).
JAY BESCH, EXAMINING ATTORNEY

CLASS 17—RUBBER GOODS

FOR ADHESIVE SEALANTS FOR GENERAL USE (U.S. CLS. 1, 5, 12, 13, 35 AND 50).
JAY BESCH, EXAMINING ATTORNEY

SN 77-615,435. FRANKLIN INTERNATIONAL, INC., COLUMBUS, OH. FILED 11-17-2008.

PROVANTAGE

THE MARK CONSISTS OF STANDARD CHARACTERS WITHOUT CLAIM TO ANY PARTICULAR FONT, STYLE, SIZE, OR COLOR.

SN 77-615,978. FRANKLIN INTERNATIONAL, INC., COLUMBUS, OH. FILED 11-17-2008.

ADVANCED SOLVENT TECHNOLOGY

THE MARK CONSISTS OF STANDARD CHARACTERS WITHOUT CLAIM TO ANY PARTICULAR FONT, STYLE, SIZE, OR COLOR.
NO CLAIM IS MADE TO THE EXCLUSIVE RIGHT TO USE "SOLVENT TECHNOLOGY", APART FROM THE MARK AS SHOWN.

CLASS 1—CHEMICALS

FOR ADHESIVES OTHER THAN FOR STATIONERY OR HOUSEHOLD PURPOSES USED IN CONSTRUCTION AND REPAIR (U.S. CLS. 1, 5, 6, 10, 26 AND 46).

CLASS 1—CHEMICALS

FOR ADHESIVES OTHER THAN FOR STATIONERY OR HOUSEHOLD PURPOSES (U.S. CLS. 1, 5, 6, 10, 26 AND 46).

CLASS 16—PAPER GOODS AND PRINTED MATTER

FOR ADHESIVES FOR HOUSEHOLD PURPOSES USED IN CONSTRUCTION AND REPAIR (U.S. CLS. 2, 5, 22, 23, 29, 37, 38 AND 50).
JAY BESCH, EXAMINING ATTORNEY

CLASS 17—RUBBER GOODS

FOR ADHESIVE SEALANTS FOR GENERAL USE (U.S. CLS. 1, 5, 12, 13, 35 AND 50).
JAY BESCH, EXAMINING ATTORNEY

SN 77-616,377. IDEARC MEDIA LLC, DFW AIRPORT, TX.
FILED 11-18-2008.

SUPERSITE

THE MARK CONSISTS OF STANDARD CHARACTERS WITHOUT CLAIM TO ANY PARTICULAR FONT, STYLE, SIZE, OR COLOR.
SEC. 2(F).

CLASS 38—COMMUNICATION

FOR PROVIDING E-MAIL SERVICES (U.S. CLS. 100, 101 AND 104).
FIRST USE 10-0-1998; IN COMMERCE 10-0-1998.

CLASS 42—SCIENTIFIC AND COMPUTER SERVICES

FOR DESIGNING, DEVELOPING, MANAGING, MAINTAINING AND HOSTING WEB SITES FOR OTHERS (U.S. CLS. 100 AND 101).
FIRST USE 10-0-1998; IN COMMERCE 10-0-1998.

CLASS 45—PERSONAL AND LEGAL SERVICES

FOR REGISTRATION OF DOMAIN NAMES FOR IDENTIFICATION OF USERS ON THE INTERNET (U.S. CLS. 100 AND 101).
FIRST USE 10-0-1998; IN COMMERCE 10-0-1998.
ANDREA SAUNDERS, EXAMINING ATTORNEY

SN 77-616,619. CVS PHARMACY, INC., WOONSOCKET, RI.
FILED 11-18-2008.

PROACTIVE MEDICATION MANAGEMENT

THE MARK CONSISTS OF STANDARD CHARACTERS WITHOUT CLAIM TO ANY PARTICULAR FONT, STYLE, SIZE, OR COLOR.
NO CLAIM IS MADE TO THE EXCLUSIVE RIGHT TO USE "MEDICATION MANAGEMENT", APART FROM THE MARK AS SHOWN.

CLASS 35—ADVERTISING AND BUSINESS

FOR RETAIL PHARMACY SERVICES; PHARMACEUTICAL COST MANAGEMENT FOR THE HEALTH CARE BENEFIT PLANS OF OTHERS; PHARMACEUTICAL COST MANAGEMENT SERVICES AND DRUG UTILIZATION REVIEW SERVICES FOR PATIENTS WITH COMPLEX OR CHRONIC MEDICAL CONDITIONS; THERAPEUTIC PHARMACEUTICAL BUSINESS SERVICES, NAMELY, BUSINESS MANAGEMENT OF DRUG THERAPY PROGRAMS AND BUSINESS ADMINISTRATION CONSULTATION REGARDING PHYSICIAN SUPPORT (U.S. CLS. 100, 101 AND 102).

CLASS 36—INSURANCE AND FINANCIAL

FOR PHARMACEUTICAL BENEFIT MANAGEMENT SERVICES (U.S. CLS. 100, 101 AND 102).

CLASS 44—MEDICAL, BEAUTY AND AGRICULTURAL SERVICES

FOR HEALTH CARE SERVICES, NAMELY, DISEASE MANAGEMENT PROGRAMS AND WELLNESS PROGRAMS; THERAPEUTIC PHARMACEUTICAL CONSULTATION SERVICES; PHARMACEUTICAL ADVICE (U.S. CLS. 100 AND 101).

DAVID YONTEF, EXAMINING ATTORNEY

SN 77-617,985. UWIZ TECHNOLOGY CO., LTD., TAOYUAN COUNTY 32063, TAIWAN, FILED 11-19-2008.

GigaClean

THE MARK CONSISTS OF THE STYLIZED WORDS "GIGACLEAN".

CLASS 1—CHEMICALS

FOR CHEMICAL SLURRY FOR USE IN SEMICONDUCTOR WAFER POLISHING; CHEMICAL DEVELOPERS AND SENSITIZERS FOR USE ON SEMICONDUCTOR WAFERS; CHEMICALS FOR INDUSTRIAL USES; PHOTORESISTS; PHOTORESISTS FOR SEMICONDUCTOR DEVICES; CHEMICAL ETCHING INHIBITORS ADAPTED FOR MANUFACTURING INTEGRATED CIRCUITS; CHEMICAL SOLVENTS ADAPTED FOR MANUFACTURING ELECTRONIC PARTS; CHEMICALS FOR SCIENTIFIC USES (U.S. CLS. 1, 5, 6, 10, 26 AND 46).

CLASS 3—COSMETICS AND CLEANING PREPARATIONS

FOR SEMICONDUCTOR WAFER CLEANING AGENTS (U.S. CLS. 1, 4, 6, 50, 51 AND 52).
JEFFREY LOOK, EXAMINING ATTORNEY

SN 77-617,992. UWIZ TECHNOLOGY CO., LTD., TAOYUAN COUNTY 32063, TAIWAN, FILED 11-19-2008.

UWiZ

THE MARK CONSISTS OF THE STYLIZED WORD "UWiZ".

CLASS 1—CHEMICALS

FOR CHEMICAL SLURRY FOR USE IN SEMICONDUCTOR WAFER POLISHING; CHEMICAL DEVELOPERS AND SENSITIZERS FOR USE ON SEMICONDUCTOR WAFERS; CHEMICALS FOR INDUSTRIAL USES; PHOTORESISTS; PHOTORESISTS FOR SEMICONDUCTOR DEVICES; CHEMICAL ETCHING INHIBITORS ADAPTED FOR MANUFACTURING INTEGRATED CIRCUITS; CHEMICAL SOLVENTS ADAPTED FOR MANUFACTURING ELECTRONIC PARTS; CHEMICALS FOR SCIENTIFIC USES (U.S. CLS. 1, 5, 6, 10, 26 AND 46).

CLASS 3—COSMETICS AND CLEANING PREPARATIONS

FOR SEMICONDUCTOR WAFER CLEANING AGENTS (U.S. CLS. 1, 4, 6, 50, 51 AND 52).
JEFFREY LOOK, EXAMINING ATTORNEY

SN 77-618,043. ISCA TECHNOLOGIES, INC., RIVERSIDE, CA. FILED 11-19-2008.

ZUMBA

THE MARK CONSISTS OF STANDARD CHARACTERS WITHOUT CLAIM TO ANY PARTICULAR FONT, STYLE, SIZE, OR COLOR.

THE WORDING "ZUMBA" HAS NO MEANING IN A FOREIGN LANGUAGE.

CLASS 5—PHARMACEUTICALS

FOR PESTICIDES (U.S. CLS. 6, 18, 44, 46, 51 AND 52).

CLASS 21—HOUSEWARES AND GLASS

FOR INSECT TRAPS AND LURES (U.S. CLS. 2, 13, 23, 29, 30, 33, 40 AND 50).
LAURA KOVALSKY, EXAMINING ATTORNEY

SN 77-618,203. RAPAPORT MARTIN, LAS VEGAS, NV. FILED 11-20-2008.

RAPX

THE MARK CONSISTS OF STANDARD CHARACTERS WITHOUT CLAIM TO ANY PARTICULAR FONT, STYLE, SIZE, OR COLOR.

CLASS 35—ADVERTISING AND BUSINESS

FOR OPERATING ONLINE MARKETPLACES FOR THE TRADING OF DIAMONDS, PRECIOUS GEMS, AND JEWELRY; NEGOTIATION AND SETTLEMENT OF COMMERCIAL TRANSACTIONS FOR THIRD PARTIES, NAMELY, TRANSACTIONS INVOLVING DIAMONDS, PRECIOUS GEMS AND JEWELRY; PROVIDING AN ONLINE COMPUTER DATABASE FEATURING TRADE INFORMATION IN THE FIELD OF JEWELRY, DIAMONDS, PRECIOUS GEMSTONES, SEMI-PRECIOUS GEMSTONES, PRECIOUS GEMS, SEMI-PRECIOUS GEMS, WATCHES AND PRE-OWNED, USED, SECOND-HAND AND ESTATE JEWELRY; PROVIDING INFORMATION MANAGEMENT SERVICES, NAMELY, TRANSACTION INFORMATION, SHIPMENT PROCESSING, PREPARING SHIPPING DOCUMENTS AND INVOICES, TRACKING DOCUMENTS, PACKAGES AND FREIGHT OVER COMPUTER NETWORKS, INTRANETS AND INTERNETS; MAINTAINING ONLINE WEBSITE FEATURING DATA AND INFORMATION IN THE FIELD OF DIAMONDS, PRECIOUS GEMS AND JEWELRY, NAMELY, PRICING, AVAILABILITY AND MARKET REPORTS; COMPILATION AND PROVISION OF TRADE AND BUSINESS PRICE AND STATISTICAL INFORMATION RELATED TO DIAMONDS, PRECIOUS GEMS AND JEWELRY, NAMELY, ASKING PRICES, TRANSACTION PRICES, PRICES STATISTICS AND TRENDS, AND PRICE INDICES (U.S. CLS. 100, 101 AND 102).

CLASS 36—INSURANCE AND FINANCIAL

FOR DIAMOND AND PRECIOUS GEM APPRAISAL; PROVIDING ONLINE BROKERAGE AND FINANCIAL CLEARING HOUSE SERVICES IN THE FIELD OF DIAMONDS, PRECIOUS GEMS AND JEWELRY; PROVIDING FINANCIAL INFORMATION IN THE FIELD OF DIAMONDS, PRECIOUS GEMS AND JEWELRY; PROVIDING A DATABASE OF APPRAISAL INFORMATION IN THE FIELD OF DIAMONDS, PRECIOUS GEMS AND JEWELRY (U.S. CLS. 100, 101 AND 102).

CLASS 42—SCIENTIFIC AND COMPUTER SERVICES

FOR GEMOLOGICAL SERVICES, NAMELY, GRADING AND CERTIFYING DIAMONDS AND PRECIOUS GEMS; COMPUTER SOFTWARE PROGRAMMING SERVICES FOR THE JEWELRY, DIAMONDS, PRECIOUS GEMSTONES, SEMI-PRECIOUS GEMSTONES, PRECIOUS GEMS, SEMI-PRECIOUS GEMS, WATCHES, AND PRE-OWNED, USED, SECOND-HAND AND ESTATE JEWELRY INDUSTRIES (U.S. CLS. 100 AND 101).
ANDREW LEASER, EXAMINING ATTORNEY

SN 77-618,204. RAPAPORT MARTIN, LAS VEGAS, NV. FILED 11-20-2008.

RAPAPORT DIAMOND EXCHANGE

THE MARK CONSISTS OF STANDARD CHARACTERS WITHOUT CLAIM TO ANY PARTICULAR FONT, STYLE, SIZE, OR COLOR.

OWNER OF U.S. REG. NOS. 2,325,987, 2,715,130 AND 2,892,676.

NO CLAIM IS MADE TO THE EXCLUSIVE RIGHT TO USE "DIAMOND EXCHANGE", APART FROM THE MARK AS SHOWN.

SEC. 2(F).

CLASS 35—ADVERTISING AND BUSINESS

FOR OPERATING ONLINE MARKETPLACES FOR THE TRADING OF DIAMONDS, PRECIOUS GEMS, AND JEWELRY; NEGOTIATION AND SETTLEMENT OF COMMERCIAL TRANSACTIONS FOR THIRD PARTIES, NAMELY, TRANSACTIONS INVOLVING DIAMONDS, PRECIOUS GEMS AND JEWELRY; PROVIDING AN ONLINE COMPUTER DATABASE FEATURING TRADE INFORMATION IN THE FIELD OF JEWELRY, DIAMONDS, PRECIOUS GEMSTONES, SEMI-PRECIOUS GEMSTONES, PRECIOUS GEMS, SEMI-PRECIOUS GEMS, WATCHES AND PRE-OWNED, USED, SECOND-HAND AND ESTATE JEWELRY; PROVIDING INFORMATION MANAGEMENT SERVICES, NAMELY, TRANSACTION INFORMATION, SHIPMENT PROCESSING, PREPARING SHIPPING DOCUMENTS AND INVOICES, TRACKING DOCUMENTS, PACKAGES AND FREIGHT OVER COMPUTER NETWORKS, INTRANETS AND INTERNETS; MAINTAINING ONLINE WEBSITE FEATURING DATA AND INFORMATION IN THE FIELD OF DIAMONDS, PRECIOUS GEMS AND JEWELRY, NAMELY, PRICING, AVAILABILITY AND MARKET REPORTS; COMPILATION AND PROVISION OF TRADE AND BUSINESS PRICE AND STATISTICAL INFORMATION RELATED TO DIAMONDS, PRECIOUS GEMS AND JEWELRY, NAMELY, ASKING PRICES, TRANSACTION PRICES, PRICES STATISTICS AND TRENDS, AND PRICE INDICES (U.S. CLS. 100, 101 AND 102).

CLASS 36—INSURANCE AND FINANCIAL

FOR DIAMOND AND PRECIOUS GEM APPRAISAL; PROVIDING ONLINE BROKERAGE AND FINANCIAL CLEARING HOUSE SERVICES IN THE FIELD OF DIAMONDS, PRECIOUS GEMS AND JEWELRY; PROVIDING FINANCIAL INFORMATION IN THE FIELD OF DIAMONDS, PRECIOUS GEMS AND JEWELRY; PROVIDING A DATABASE OF APPRAISAL INFORMATION IN THE FIELD OF DIAMONDS, PRECIOUS GEMS AND JEWELRY (U.S. CLS. 100, 101 AND 102).

CLASS 42—SCIENTIFIC AND COMPUTER SERVICES

FOR GEMOLOGICAL SERVICES, NAMELY, GRADING AND CERTIFYING DIAMONDS AND PRECIOUS GEMS; COMPUTER SOFTWARE PROGRAMMING SERVICES IN THE FIELD OF JEWELRY, DIAMONDS, PRECIOUS GEMSTONES, SEMI-PRECIOUS GEMSTONES, PRECIOUS GEMS, SEMI-PRECIOUS GEMS, WATCHES, AND PRE-OWNED, USED, SECOND-HAND AND ESTATE JEWELRY INDUSTRIES (U.S. CLS. 100 AND 101).

ANDREW LEASER, EXAMINING ATTORNEY

SN 77-619,318. GNU FOODS, LLC, NEW YORK, NY. FILED 11-21-2008.

FOOD THAT WORKS

THE MARK CONSISTS OF STANDARD CHARACTERS WITHOUT CLAIM TO ANY PARTICULAR FONT, STYLE, SIZE, OR COLOR.

OWNER OF U.S. REG. NO. 3,621,786.

CLASS 5—PHARMACEUTICALS

FOR FOOD SUPPLEMENT, NAMELY, READY-TO-EAT MINERAL, VITAMIN, DIETARY AND NUTRITIONAL SUPPLEMENT BAR, MEAL REPLACEMENT BAR, FOOD SUPPLEMENT BAR WITH FIBER, LAXATIVE BAR, A SUPPLEMENT BAR SUPPORTING HEART HEALTH, LAXATIVES (U.S. CLS. 6, 18, 44, 46, 51 AND 52).

FIRST USE 6-1-2009; IN COMMERCE 6-29-2009.

CLASS 29—MEATS AND PROCESSED FOODS

FOR FRUIT AND NUT-BASED SNACK FOOD BARS (U.S. CL. 46).

FIRST USE 6-1-2009; IN COMMERCE 6-29-2009.

CLASS 30—STAPLE FOODS

FOR CEREAL AND GRAIN-BASED SNACK FOOD BARS (U.S. CL. 46).

FIRST USE 6-1-2009; IN COMMERCE 6-29-2009.

MICHAEL LITZAU, EXAMINING ATTORNEY

SN 77-621,253. SCOTTS COMPANY LLC, THE, MARYSVILLE, OH. FILED 11-25-2008.



Live Total Health
In Everything I Do

NO CLAIM IS MADE TO THE EXCLUSIVE RIGHT TO USE "HEALTH", APART FROM THE MARK AS SHOWN.

THE MARK CONSISTS OF A FLOWER, A BROKEN VERTICAL LINE, AND THE WORDING "LIVE TOTAL HEALTH" "IN EVERYTHING I DO".

CLASS 35—ADVERTISING AND BUSINESS

FOR RETAIL PHARMACY SERVICES (U.S. CLS. 100, 101 AND 102).

FIRST USE 10-31-2005; IN COMMERCE 10-31-2005.

CLASS 41—EDUCATION AND ENTERTAINMENT

FOR HEALTH CLUB SERVICES, NAMELY, PROVIDING INSTRUCTION AND EQUIPMENT IN THE FIELD OF PHYSICAL EXERCISE (U.S. CLS. 100, 101 AND 107).

FIRST USE 10-31-2005; IN COMMERCE 10-31-2005.

CLASS 44—MEDICAL, BEAUTY AND AGRICULTURAL SERVICES

FOR MEDICAL SERVICES; PROVIDING ASSISTANCE, FITNESS EVALUATION AND CONSULTATION TO INDIVIDUALS TO HELP THEIR HEALTH, WELLNESS AND NUTRITIONAL CHANGES IN THEIR DAILY LIVING TO INCREASE PRODUCTIVITY AND LOWER HEALTH CARE COSTS (U.S. CLS. 100 AND 101).

FIRST USE 10-31-2005; IN COMMERCE 10-31-2005.

DAVID C. REIHNER, EXAMINING ATTORNEY

SN 77-621,585. PRIMUS PHARMACEUTICALS, INC., SCOTTSDALE, AZ. FILED 11-25-2008.

SN 77-622,608. CITY-WIDE TASK FORCE ON HOUSING COURT, INC., NEW YORK, NY. FILED 11-26-2008.

PRIMUS PHARMACEUTICALS

THE MARK CONSISTS OF STANDARD CHARACTERS WITHOUT CLAIM TO ANY PARTICULAR FONT, STYLE, SIZE, OR COLOR.

NO CLAIM IS MADE TO THE EXCLUSIVE RIGHT TO USE "PHARMACEUTICALS", APART FROM THE MARK AS SHOWN.

CLASS 3—COSMETICS AND CLEANING PREPARATIONS

FOR COSMETICS (U.S. CLS. 1, 4, 6, 50, 51 AND 52).

CLASS 5—PHARMACEUTICALS

FOR PRESCRIPTION PRODUCTS, NAMELY, PRESCRIPTION VITAMINS AND PRESCRIPTION DRUGS FOR TREATING BACTERIAL AND VIRAL DISEASES AND CONDITIONS, BONE HEALTH, HEART PROBLEMS, DIABETES, DIGESTIVE PROBLEMS AND CARDIOVASCULAR, NEUROLOGICAL, GASTROENTEROLOGICAL, OPHTHALMIC, DERMATOLOGICAL AND NEPHROLOGICAL DISEASES AND CONDITIONS; FOOD FOR MEDICALLY RESTRICTED DIETS; MEDICAL FOODS FOR USE IN THE DIETARY MANAGEMENT OF PATIENTS WITH HEART PROBLEMS, DIABETES, DIGESTIVE PROBLEMS AND BACTERIAL, VIRAL, CARDIOVASCULAR, BONE HEALTH, NEUROLOGICAL, GASTROENTEROLOGICAL, OPHTHALMIC, DERMATOLOGICAL AND NEPHROLOGICAL DISEASES AND CONDITIONS; DIETETIC FOODS ADAPTED FOR MEDICAL USE; DIETARY SUPPLEMENTS; MEDICAL DEVICES FOR SKIN CARE, NAMELY, A TOPICAL APPLICATION IN THE NATURE OF A WOUND DRESSING (U.S. CLS. 6, 18, 44, 46, 51 AND 52).

REBECCA EISINGER, EXAMINING ATTORNEY

SN 77-621,742. FIAT GROUP AUTOMOBILES S.P.A., TORINO, ITALY, FILED 11-25-2008.



THE MARK CONSISTS OF THE STYLIZED BLOCK LETTERS "JITDM" WITH THE LETTER "M" SMALLER THAN "JTD".

CLASS 7—MACHINERY

FOR FUEL INJECTORS FOR INTERNAL COMBUSTION ENGINES (U.S. CLS. 13, 19, 21, 23, 31, 34 AND 35).

CLASS 12—VEHICLES

FOR MOTOR VEHICLES, NAMELY, AUTOMOBILES, TRUCKS, VANS, SPORT UTILITY VEHICLES AND STRUCTURAL PARTS THEREFOR (U.S. CLS. 19, 21, 23, 31, 35 AND 44).

TAMARA FRAZIER, EXAMINING ATTORNEY

HOUSING COURT ANSWERS

THE MARK CONSISTS OF STANDARD CHARACTERS WITHOUT CLAIM TO ANY PARTICULAR FONT, STYLE, SIZE, OR COLOR.

NO CLAIM IS MADE TO THE EXCLUSIVE RIGHT TO USE "HOUSING COURT", APART FROM THE MARK AS SHOWN.

CLASS 35—ADVERTISING AND BUSINESS

FOR PUBLIC ADVOCACY CONCERNING HOUSING COURT ISSUES; PROVIDING REFERRALS TO COMMUNITY-BASED CHARITABLE SERVICE ORGANIZATIONS, FREE LEGAL SERVICES PROVIDERS, AND FINANCIAL ASSISTANCE CHARITIES (U.S. CLS. 100, 101 AND 102).

CLASS 45—PERSONAL AND LEGAL SERVICES

FOR PROVIDING INFORMATION IN THE FIELD OF GENERAL LEGAL INFORMATION ABOUT HOUSING COURT AND HOUSING COURT PROCEDURES (U.S. CLS. 100 AND 101).

SHANNON TWOHIG, EXAMINING ATTORNEY

SN 77-624,239. FLORIDA SURPLUS LINES SERVICE OFFICE, TALLAHASSEE, FL. FILED 12-1-2008.



THE COLOR(S) DARK BLUE, LIGHT BLUE AND WHITE IS/ARE CLAIMED AS A FEATURE OF THE MARK.

THE MARK CONSISTS OF THE DESIGN OF THREE DARK BLUE PALM TREES OVER THE ACRONYM "FSLSO" IN THE COLOR WHITE WITHIN A DARK BLUE BAND. THE DESIGN ELEMENTS AND ACRONYM ARE ALL CONTAINED WITHIN A DARK BLUE CIRCLE WITH A LIGHT BLUE CENTER.

CLASS 9—ELECTRICAL AND SCIENTIFIC APPARATUS

FOR COMPUTER SOFTWARE THAT PROVIDES WEB-BASED ACCESS TO APPLICATIONS AND SERVICES THROUGH A WEB OPERATING SYSTEM OR PORTAL INTERFACE (U.S. CLS. 21, 23, 26, 36 AND 38).

FIRST USE 11-1-2008; IN COMMERCE 11-1-2008.

CLASS 16—PAPER GOODS AND PRINTED MATTER

FOR BROCHURES ABOUT SURPLUS LINES INSURANCE; PUBLICATIONS, NAMELY, BROCHURES, BOOKLETS, AND TEACHING MATERIALS IN THE FIELD OF SURPLUS LINES INSURANCE (U.S. CLS. 2, 5, 22, 23, 29, 37, 38 AND 50).

FIRST USE 11-1-2008; IN COMMERCE 11-1-2008.
JEFFERY COWARD, EXAMINING ATTORNEY

SN 77-624,733. TORAY KABUSHIKI KAISHA (TORAY INDUSTRIES, INC.), CHUO-KU, TOKYO, JAPAN, FILED 12-2-2008.

LIGHTYGRAM

THE MARK CONSISTS OF STANDARD CHARACTERS WITHOUT CLAIM TO ANY PARTICULAR FONT, STYLE, SIZE, OR COLOR.

PRIORITY CLAIMED UNDER SEC. 44(D) ON JAPAN APPLICATION NO. 2008-089405, FILED 11-5-2008, REG. NO. 5242935, DATED 6-26-2009, EXPIRES 6-26-2019.

THE WORDING "LIGHTYGRAM" HAS NO MEANING IN A FOREIGN LANGUAGE.

CLASS 20—FURNITURE AND ARTICLES NOT OTHERWISE CLASSIFIED

FOR SLEEPING BAGS (U.S. CLS. 2, 13, 22, 25, 32 AND 50).

CLASS 24—FABRICS

FOR TEXTILE PIECE GOODS, NAMELY, WOVEN, NON-WOVEN, KNITTED AND NETTED FABRICS MADE OF WHOLLY OR PARTIALLY OF SYNTHETIC FIBERS FOR USE IN THE MANUFACTURE OF CLOTHING AND SLEEPING BAG (U.S. CLS. 42 AND 50).

CLASS 25—CLOTHING

FOR CLOTHING, NAMELY, DOWNJACKETS, DOWNCOATS, WIND-RESISTANT JACKETS, RAINWEARS (U.S. CLS. 22 AND 39).

KATHY DE JONGE, EXAMINING ATTORNEY

SN 77-625,147. INTELERON CONSULTING GROUP, LLC, ORLAND PARK, IL. FILED 12-3-2008.

Inteleron

THE MARK CONSISTS OF STANDARD CHARACTERS WITHOUT CLAIM TO ANY PARTICULAR FONT, STYLE, SIZE, OR COLOR.

CLASS 35—ADVERTISING AND BUSINESS

FOR ACCOUNTING SERVICES AND PROVIDING ACCOUNTING ADVICE AND CONSULTATION (U.S. CLS. 100, 101 AND 102).

FIRST USE 4-1-2007; IN COMMERCE 4-1-2007.

CLASS 42—SCIENTIFIC AND COMPUTER SERVICES

FOR COMPUTER SERVICES DESIGNING, DEVELOPING, PROGRAMMING, INSTALLING AND MAINTAINING COMPUTER SOFTWARE FINANCIAL MANAGEMENT SYSTEMS (U.S. CLS. 100 AND 101).

FIRST USE 4-1-2007; IN COMMERCE 4-1-2007.
DAWN FELDMAN, EXAMINING ATTORNEY

SN 77-625,152. INTELERON CONSULTING GROUP, LLC, ORLAND PARK, IL. FILED 12-3-2008.

Inteleron Consulting Group

THE MARK CONSISTS OF STANDARD CHARACTERS WITHOUT CLAIM TO ANY PARTICULAR FONT, STYLE, SIZE, OR COLOR.

NO CLAIM IS MADE TO THE EXCLUSIVE RIGHT TO USE "CONSULTING GROUP", APART FROM THE MARK AS SHOWN.

CLASS 35—ADVERTISING AND BUSINESS

FOR ACCOUNTING SERVICES AND PROVIDING ACCOUNTING ADVICE AND CONSULTATION (U.S. CLS. 100, 101 AND 102).

FIRST USE 4-1-2007; IN COMMERCE 4-1-2007.

CLASS 42—SCIENTIFIC AND COMPUTER SERVICES

FOR COMPUTER SERVICES DESIGNING, DEVELOPING, PROGRAMMING, INSTALLING AND MAINTAINING COMPUTER SOFTWARE FINANCIAL MANAGEMENT SYSTEMS (U.S. CLS. 100 AND 101).

FIRST USE 4-1-2007; IN COMMERCE 4-1-2007.
DAWN FELDMAN, EXAMINING ATTORNEY

SN 77-625,791. RCN TELECOM SERVICES, INC., HERNDON, VA. FILED 12-3-2008.



OWNER OF U.S. REG. NOS. 2,471,719, 2,872,508 AND OTHERS.

NO CLAIM IS MADE TO THE EXCLUSIVE RIGHT TO USE "GLOBAL", APART FROM THE MARK AS SHOWN.

THE MARK CONSISTS OF THE WORDS "RCN GLOBAL PASSPORT" WITH A SWOOSH LINE THROUGH "RCN" AND A STAR TO THE RIGHT OF "RCN" WITH THE "O" IN "GLOBAL" APPEARING AS AN EARTH DESIGN WITH CONTINENTS.

CLASS 38—COMMUNICATION

FOR GLOBAL CABLE TELEVISION TRANSMISSION AND GLOBAL VIDEO ON DEMAND TRANSMISSION SERVICES (U.S. CLS. 100, 101 AND 104).

CLASS 41—EDUCATION AND ENTERTAINMENT

FOR CABLE TELEVISION PROGRAMMING SERVICES AND VIDEO ON DEMAND PROGRAMMING SERVICES PROVIDED VIA A GLOBAL NETWORK (U.S. CLS. 100, 101 AND 107).

ERIN FALK, EXAMINING ATTORNEY

SN 77-626,595. WERNER PADDLES, INC., SULTAN, WA.
FILED 12-4-2008.

WERNER

THE MARK CONSISTS OF STANDARD CHARACTERS WITHOUT CLAIM TO ANY PARTICULAR FONT, STYLE, SIZE, OR COLOR.

OWNER OF U.S. REG. NOS. 1,805,988 AND 2,858,005.

CLASS 12—VEHICLES

FOR PADDLES FOR SELF-PROPELLED WATER CRAFT, NAMELY, CANOE AND KAYAK PADDLES (U.S. CLS. 19, 21, 23, 31, 35 AND 44).

FIRST USE 8-0-1996; IN COMMERCE 8-0-1996.

CLASS 28—TOYS AND SPORTING GOODS

FOR PADDLES FOR SELF-PROPELLED WATER CRAFT, NAMELY, STAND UP SURF PADDLES (U.S. CLS. 22, 23, 38 AND 50).

FIRST USE 5-25-2007; IN COMMERCE 5-25-2007.

MATTHEW EINSTEIN, EXAMINING ATTORNEY

SN 77-626,805. LOMBAO, NÉSTOR C., 6312 STEINHAUSEN,
SWITZERLAND, FILED 12-4-2008.

UNAMITE

THE MARK CONSISTS OF STANDARD CHARACTERS WITHOUT CLAIM TO ANY PARTICULAR FONT, STYLE, SIZE, OR COLOR.

THE WORDING "UNAMITE" HAS NO MEANING IN A FOREIGN LANGUAGE.

CLASS 9—ELECTRICAL AND SCIENTIFIC APPARATUS

FOR COMPUTER HARDWARE AND SOFTWARE, IN PARTICULAR FOR CREATION, INSTALLATION AND EXECUTION OF MAINFRAME AND CLIENT/SERVER APPLICATIONS, FOR INTEGRATION OF A COMPANY'S FINANCE, PRODUCTION AND SALES FUNCTIONS AND FOR ADMINISTRATION OF CUSTOMER SERVICE AND SUPPORT SERVICES OF A COMPANY (U.S. CLS. 21, 23, 26, 36 AND 38).

CLASS 35—ADVERTISING AND BUSINESS

FOR BUSINESS CONSULTING SERVICES; BUSINESS MANAGEMENT AND MARKETING CONSULTING SERVICES; BUSINESS CONSULTING AND BUSINESS ADMINISTRATION; BUSINESS MANAGEMENT PLANNING; ACCOUNTING SERVICES; CREATION OF ECONOMIC FORECASTS AND ECONOMIC ANALYSES; CREATION OF BUSINESS EXPERTISES, NAMELY, BUSINESS APPRAISALS AND EVALUATIONS IN BUSINESS MATTERS IN ALL BUSINESS FIELDS, INCLUDING AEROSPACE AND DEFENSE, ELECTRONICS, TELECOMMUNICATIONS, AUTOMOTIVE, BASIC MATERIALS, CONSUMER INDUSTRIES, MEDIA, PHARMACEUTICALS AND MEDICAL PRODUCTS, RETAIL, ENERGY, BANKING, SECURITIES, HEALTHCARE, INSURANCE AND TRANSPORTATION; MERGER AND ACQUISITION CONSULTING, NAMELY, BUSINESS CONSULTING FOR PURCHASE AND SALE OF COMPANIES; NEGOTIATION AND CONCLUSION OF MERGER AND ACQUISITION AGREEMENTS FOR THIRD PARTIES INVOLVING THE PURCHASE AND SALE OF COMPANIES; COMPILING AND AUTHORIZING OF BUSINESS REPORTS; BUSINESS MANAGEMENT; SERVICES OF A TAX CONSULTANT, NAMELY, AUTHORIZING OF TAX DECLARATIONS; INDUSTRIAL ASSET MANAGEMENT SERVICES, NAMELY, AUCTIONING, LIQUIDATION AND REMARKETING INDUSTRIAL ASSETS OF OTHERS; PROVIDING A DATABASE FOR SERVICES IN THE AREAS OF BUSINESS MANAGEMENT CONSULTING (U.S. CLS. 100, 101 AND 102).

CLASS 36—INSURANCE AND FINANCIAL

FOR BUSINESS LIQUIDATION CONSULTING (U.S. CLS. 100, 101 AND 102).

CLASS 38—COMMUNICATION

FOR TELECOMMUNICATIONS SERVICES, NAMELY, TRANSMISSION OF VOICE, DATA, GRAPHICS, IMAGES, AUDIO AND VIDEO BY MEANS OF TELECOMMUNICATIONS NETWORKS, WIRELESS COMMUNICATION NETWORKS, AND THE INTERNET; TRANSMISSION OF INFORMATION IN DATABASES VIA A TELECOMMUNICATIONS NETWORK; COMPUTER AIDED TRANSMISSION OF MESSAGES AND IMAGES, IN PARTICULAR VIA THE INTERNET; INFORMATION SERVICES RELATING TO TELECOMMUNICATIONS AND COMPUTER COMMUNICATIONS; COMPUTER-AIDED TRANSMISSION OF MESSAGES AND IMAGES; MESSAGE SENDING VIA ELECTRONIC MEDIA; SERVICES OF AN INTERNET PROVIDER, NAMELY PROVIDING INTERNET ACCESS; TRANSMISSION AND SENDING OF DATABASE INFORMATION VIA TELECOMMUNICATIONS NETWORKS; INCLUDING ALL THE AFORESAID SERVICES IN CONNECTION WITH ELECTRONIC COMMERCE (U.S. CLS. 100, 101 AND 104).

CLASS 42—SCIENTIFIC AND COMPUTER SERVICES

FOR CONDUCTING SCIENTIFIC DATABASE AND INTERNET RESEARCH FOR THIRD PARTIES; CONSULTING SERVICES IN THE FIELD OF INFORMATION TECHNOLOGY; COMPUTER SERVICES, NAMELY, CREATING INDEXES OF INFORMATION, SITES AND OTHER RESOURCES AVAILABLE ON COMPUTER NETWORKS; DEVELOPMENT AND CREATION OF COMPUTER SYSTEMS AND COMPUTER SOFTWARE; WEB SITE DESIGN; PROVIDING TECHNICAL SUPPORT FOR WEB PAGES; PROVIDING A DATABASE FOR SERVICES IN THE AREAS OF INFORMATION TECHNOLOGY AND COMPUTER SYSTEMS, EXCLUDING INSTALLATION AND MONITORING FOR SECURITY PURPOSES; INSTALLATION, MAINTENANCE AND REPAIR OF COMPUTER SOFTWARE (U.S. CLS. 100 AND 101).

KIM MONINGHOFF, EXAMINING ATTORNEY

SN 77-629,177. ASPEN HOLDINGS, INC., OMAHA, NE.
FILED 12-9-2008.

SN 77-631,005. L'OREAL, PARIS, FRANCE, FILED 12-11-2008.

INSURING AMERICA'S SMALL
BUSINESS

THE MARK CONSISTS OF STANDARD CHARACTERS
WITHOUT CLAIM TO ANY PARTICULAR FONT, STYLE,
SIZE, OR COLOR.
SEC. 2(F).

CLASS 35—ADVERTISING AND BUSINESS

FOR CUSTOMER RELATIONSHIP MANAGEMENT
SERVICES FOR OTHERS; BUSINESS RISK MANAGE-
MENT SERVICES (U.S. CLS. 100, 101 AND 102).
FIRST USE 12-0-2002; IN COMMERCE 12-0-2002.

CLASS 36—INSURANCE AND FINANCIAL

FOR UNDERWRITING WORKER'S COMPENSATION
INSURANCE; CLAIMS PROCESSING; CLAIMS ADJUST-
ING; CLAIMS ADMINISTRATION; INSURANCE CON-
SULTING; INSURANCE AGENCY SERVICES;
INSURANCE ADMINISTRATION SERVICES (U.S. CLS.
100, 101 AND 102).
FIRST USE 12-0-2002; IN COMMERCE 12-0-2002.
GINA HAYES, EXAMINING ATTORNEY

SN 77-629,515. QUALITY NATURALLY! FOODS, INC., CITY
OF INDUSTRY, CA. FILED 12-9-2008.

QNF

THE MARK CONSISTS OF STANDARD CHARACTERS
WITHOUT CLAIM TO ANY PARTICULAR FONT, STYLE,
SIZE, OR COLOR.

CLASS 30—STAPLE FOODS

FOR MIXES FOR BAKERY GOODS; MIXES FOR
PANCAKES, BISCUITS, CORNBREAD, HOT CHOCO-
LATE, HOT AND COLD CAPPUCCINO DRINKS, SEA-
SONED COATINGS FOR FRYING AND BAKING
FOODS, TEMPURA BATTER AND CHURRO MIX; CUS-
TOM-BLENDED MIXES FOR ALL OF THE FOREGOING
(U.S. CL. 46).
FIRST USE 1-9-1991; IN COMMERCE 1-9-1991.

CLASS 35—ADVERTISING AND BUSINESS

FOR PACKAGING BAKERY AND FOOD MIXES TO
THE ORDER AND SPECIFICATION OF OTHERS (U.S.
CLS. 100, 101 AND 102).
FIRST USE 1-9-1991; IN COMMERCE 1-9-1991.

CLASS 40—MATERIAL TREATMENT

FOR CUSTOM BLENDING SERVICES FOR OTHERS
IN THE FIELD OF BAKERY AND FOOD MIXES (U.S.
CLS. 100, 103 AND 106).
FIRST USE 1-9-1991; IN COMMERCE 1-9-1991.
BARBARA GAYNOR, EXAMINING ATTORNEY

DM5

THE MARK CONSISTS OF STANDARD CHARACTERS
WITHOUT CLAIM TO ANY PARTICULAR FONT, STYLE,
SIZE, OR COLOR.

PRIORITY CLAIMED UNDER SEC. 44(D) ON FRANCE
APPLICATION NO. 083584694, FILED 6-26-2008, REG. NO.
083584694, DATED 6-26-2008, EXPIRES 6-26-2018.

CLASS 1—CHEMICALS

FOR CHEMICALS USED IN THE COMPOSITION OF
HAIR PRODUCTS (U.S. CLS. 1, 5, 6, 10, 26 AND 46).

**CLASS 3—COSMETICS AND CLEANING PRE-
PARATIONS**

FOR SHAMPOOS; PRODUCTS FOR HAIR STYLING
AND HAIR CARE, NAMELY, GELS, MOUSSES, BALMS,
CREAM, WAX, NON-MEDICATED SERUMS AND LO-
TIONS; HAIR LACQUERS; HAIR COLOURING AND
HAIR DECOLORANT PREPARATIONS; PERMANENT
WAVING AND CURLING PREPARATIONS; ESSENTIAL
OILS FOR PERSONAL USE (U.S. CLS. 1, 4, 6, 50, 51 AND
52).

PATRICIA EVANKO, EXAMINING ATTORNEY

SN 77-631,068. FLAGSTONE REINSURANCE HOLDINGS
LTD., HAMILTON HM11, BERMUDA, FILED 12-11-2008.

GALENA SYSTEMS

THE MARK CONSISTS OF STANDARD CHARACTERS
WITHOUT CLAIM TO ANY PARTICULAR FONT, STYLE,
SIZE, OR COLOR.

NO CLAIM IS MADE TO THE EXCLUSIVE RIGHT TO
USE "SYSTEMS", APART FROM THE MARK AS SHOWN.

CLASS 36—INSURANCE AND FINANCIAL

FOR INSURANCE SERVICES, NAMELY, WRITING
PROPERTY AND CASUALTY INSURANCE (U.S. CLS.
100, 101 AND 102).

**CLASS 42—SCIENTIFIC AND COMPUTER
SERVICES**

FOR CONSULTING IN THE FIELD OF INFORMA-
TION TECHNOLOGY (U.S. CLS. 100 AND 101).
FRANK LATTUCA, EXAMINING ATTORNEY

SN 77-631,236. BP FRANCHISING, LLC, SOUTHURY, CT.
FILED 12-11-2008.

SN 77-631,737. INTERNATIONAL BUSINESS MACHINES
CORPORATION, ARMONK, NY. FILED 12-12-2008.



OWNER OF U.S. REG. NOS. 3,429,422 AND 3,544,990.
NO CLAIM IS MADE TO THE EXCLUSIVE RIGHT TO
USE "BUSINESS PARTNER MARKETING COACH", APART
FROM THE MARK AS SHOWN.

THE MARK CONSISTS OF A COMBINED LOWER CASE
"B" AND "P" OUTLINED IN A RECTANGLE HAVING
ROUNDED CORNERS WITH THE LITERAL ELEMENTS
"BUSINESS PARTNER MARKETING COACH" ON THE
RIGHT SIDE OF THE RECTANGLE.

CLASS 35—ADVERTISING AND BUSINESS

FOR BUSINESS MARKETING SERVICES; BUSINESS
MARKETING CONSULTING SERVICES; DISTRIBUTORSHIPS
IN THE FIELD OF PROMOTIONAL PRODUCTS AND
SPECIALTY ADVERTISING GOODS FOR OTHERS;
FRANCHISING SERVICES, NAMELY, CONSULTATION
AND ASSISTANCE IN BUSINESS MANAGEMENT,
ORGANIZATION AND PROMOTION; OPERATION OF
A BUSINESS FOR OTHERS, NAMELY, COPYING AND
PRINTING CENTERS; COPYING DOCUMENTS FOR
OTHERS; PRODUCTION OF TELEVISION
COMMERCIALS (U.S. CLS. 100, 101 AND 102).

CLASS 40—MATERIAL TREATMENT

FOR EMBROIDERY AND SCREEN PRINTING OF
CLOTHING FOR OTHERS; MANUFACTURING OF
SIGNS AND BANNERS FOR OTHERS; MANUFACTURING
OF TRADE SHOW DISPLAYS FOR OTHERS;
MANUFACTURING OF PROMOTIONAL PRODUCTS
AND SPECIALTY ADVERTISING GOODS FOR OTHERS
(U.S. CLS. 100, 103 AND 106).

CLASS 41—EDUCATION AND ENTERTAINMENT

FOR BUSINESS COACHING SERVICES, NAMELY,
TRAINING IN THE FIELD OF BUSINESS DEVELOPMENT;
BUSINESS COACHING SERVICES, NAMELY,
TRAINING IN THE FIELD OF FRANCHISING AND
SEARCHING FOR AND SELECTION OF FRANCHISE
OPPORTUNITIES; PRODUCTION OF VIDEO CASSETTES
AND VIDEO DISCS FOR OTHERS (U.S. CLS.
100, 101 AND 107).

CLASS 42—SCIENTIFIC AND COMPUTER SERVICES

FOR GRAPHIC DESIGN SERVICES; CREATING AND
DESIGNING WEB SITES FOR OTHERS; DESIGN AND
DEVELOPMENT OF MULTI-MEDIA PRODUCTS; DESIGN
OF MULTI-MEDIA OF MULTI-MEDIA PRODUCTS
(U.S. CLS. 100 AND 101).

PAM WILLIS, EXAMINING ATTORNEY

BUSINESSASSURE

THE MARK CONSISTS OF STANDARD CHARACTERS
WITHOUT CLAIM TO ANY PARTICULAR FONT, STYLE,
SIZE, OR COLOR.

CLASS 9—ELECTRICAL AND SCIENTIFIC APPARATUS

FOR COMPUTER SOFTWARE, NAMELY, COMPUTER
SOFTWARE APPLICATIONS FOR USE IN RESPONSE
TIME MEASUREMENT, SERVICE LEVEL REPORTING,
SLA MANAGEMENT, FAULT MANAGEMENT, NETWORK
CONTROL, AUTOMATION AND TELECOMMUNICATIONS
NETWORK MANAGEMENT; AND INSTRUCTIONAL
MANUALS SOLD AS A UNIT THEREWITH (U.S. CLS.
21, 23, 26, 36 AND 38).

CLASS 16—PAPER GOODS AND PRINTED MATTER

FOR PRINTED MATTER, NAMELY, INSTRUCTIONAL
MANUALS, INFORMATIONAL BROCHURES, AND
TEACHING MATERIALS IN THE FIELD OF
COMPUTER SOFTWARE (U.S. CLS. 2, 5, 22, 23, 29,
37, 38 AND 50).

CLASS 42—SCIENTIFIC AND COMPUTER SERVICES

FOR COMPUTER SERVICES, NAMELY, TECHNICAL
SUPPORT SERVICES, NAMELY, TROUBLESHOOTING
OF COMPUTER SOFTWARE PROBLEMS; COMPUTER
SOFTWARE DESIGN FOR OTHERS; INSTALLATION,
UPDATING AND MAINTENANCE OF COMPUTER
SOFTWARE; CONSULTING SERVICES IN THE FIELD
OF COMPUTER SOFTWARE (U.S. CLS. 100 AND 101).

SHAUNIA CARLYLE, EXAMINING ATTORNEY

SN 77-631,739. INTERNATIONAL BUSINESS MACHINES
CORPORATION, ARMONK, NY. FILED 12-12-2008.

SERVICEASSURE

THE MARK CONSISTS OF STANDARD CHARACTERS
WITHOUT CLAIM TO ANY PARTICULAR FONT, STYLE,
SIZE, OR COLOR.

CLASS 9—ELECTRICAL AND SCIENTIFIC APPARATUS

FOR COMPUTER SOFTWARE, NAMELY, COMPUTER
SOFTWARE APPLICATIONS FOR USE IN RESPONSE
TIME MEASUREMENT, SERVICE LEVEL REPORTING,
SLA MANAGEMENT, FAULT MANAGEMENT, NETWORK
CONTROL, AUTOMATION AND TELECOMMUNICATIONS
NETWORK MANAGEMENT; AND INSTRUCTIONAL
MANUALS SOLD AS A UNIT THEREWITH (U.S. CLS.
21, 23, 26, 36 AND 38).

CLASS 16—PAPER GOODS AND PRINTED MATTER

FOR PRINTED MATTER, NAMELY, INSTRUCTIONAL MANUALS, INFORMATIONAL BROCHURES, AND TEACHING MATERIALS IN THE FIELD OF COMPUTER SOFTWARE (U.S. CLS. 2, 5, 22, 23, 29, 37, 38 AND 50).

SN 77-633,897. AMAZON CONSERVATION TEAM, ARLINGTON, VA. FILED 12-16-2008.

CLASS 42—SCIENTIFIC AND COMPUTER SERVICES

FOR COMPUTER SERVICES, NAMELY, TECHNICAL SUPPORT SERVICES, NAMELY, TROUBLESHOOTING OF COMPUTER SOFTWARE PROBLEMS; COMPUTER SOFTWARE DESIGN FOR OTHERS; INSTALLATION, UPDATING AND MAINTENANCE OF COMPUTER SOFTWARE; CONSULTING SERVICES IN THE FIELD OF COMPUTER SOFTWARE (U.S. CLS. 100 AND 101).
SHAUNIA CARLYLE, EXAMINING ATTORNEY

AMAZON CONSERVATION TEAM

THE MARK CONSISTS OF STANDARD CHARACTERS WITHOUT CLAIM TO ANY PARTICULAR FONT, STYLE, SIZE, OR COLOR.
SEC. 2(F).

SN 77-632,240. MOUNTAIN WEST RETIREMENT CORPORATION, SALEM, OR. FILED 12-12-2008.



NO CLAIM IS MADE TO THE EXCLUSIVE RIGHT TO USE "SENIOR LIVING", APART FROM THE MARK AS SHOWN.

THE MARK CONSISTS OF A STYLIZED SILHOUETTE OF A BIRD INSIDE OF A CIRCLE WITH THE WORD "BONAVENTURE" DIRECTLY BELOW; THE WORDS "SENIOR LIVING" APPEAR IN SMALLER STYLIZED FONT UNDER THE "VENTURE" PORTION OF THE WORD "BONAVENTURE".

CLASS 35—ADVERTISING AND BUSINESS

FOR ASSOCIATION SERVICES, NAMELY, PROMOTING THE CONSERVATION OF BIODIVERSITY, HEALTH AND CULTURE OF THE INDIGENOUS PEOPLE OF TROPICAL AMERICA (U.S. CLS. 100, 101 AND 102).
FIRST USE 9-0-1998; IN COMMERCE 9-0-1998.

CLASS 36—INSURANCE AND FINANCIAL

FOR CHARITABLE FUNDRAISING (U.S. CLS. 100, 101 AND 102).
FIRST USE 9-0-1998; IN COMMERCE 9-0-1998.
KELLY BOULTON, EXAMINING ATTORNEY

CLASS 35—ADVERTISING AND BUSINESS

FOR MANAGING THE OPERATIONS OF INDEPENDENT LIVING AND ASSISTED LIVING FACILITIES FOR SENIORS (U.S. CLS. 100, 101 AND 102).

SN 77-633,905. AMAZON CONSERVATION TEAM, ARLINGTON, VA. FILED 12-16-2008.

CLASS 43—HOTEL AND RESTAURANT SERVICES

FOR PROVIDING INDEPENDENT LIVING AND ASSISTED LIVING FACILITIES FOR SENIORS (U.S. CLS. 100 AND 101).

ACT

THE MARK CONSISTS OF STANDARD CHARACTERS WITHOUT CLAIM TO ANY PARTICULAR FONT, STYLE, SIZE, OR COLOR.

CLASS 44—MEDICAL, BEAUTY AND AGRICULTURAL SERVICES

FOR PROVIDING LONG TERM CARE FACILITIES FOR SENIORS (U.S. CLS. 100 AND 101).

CLASS 35—ADVERTISING AND BUSINESS

FOR ASSOCIATION SERVICES, NAMELY, PROMOTING THE CONSERVATION OF BIODIVERSITY, HEALTH AND CULTURE OF THE INDIGENOUS PEOPLE OF TROPICAL AMERICA (U.S. CLS. 100, 101 AND 102).
FIRST USE 10-0-1998; IN COMMERCE 10-0-1998.

CLASS 45—PERSONAL AND LEGAL SERVICES

FOR PROVIDING NON-MEDICAL INDEPENDENT LIVING AND ASSISTED LIVING SERVICES TO SENIORS FOR PERSONAL PURPOSES IN THE NATURE OF SCHEDULING APPOINTMENTS; ANSWERING THE TELEPHONE; CHECKING MESSAGES; MAIL SORTING, HANDLING AND RECEIVING; AND PLANNING, ORGANIZING, COORDINATING, ARRANGING AND ASSISTING INDIVIDUALS TO PERFORM DAILY TASKS (U.S. CLS. 100 AND 101).
G. MAYERSCHOFF, EXAMINING ATTORNEY

CLASS 36—INSURANCE AND FINANCIAL

FOR CHARITABLE FUNDRAISING (U.S. CLS. 100, 101 AND 102).
FIRST USE 10-0-1998; IN COMMERCE 10-0-1998.
KELLY BOULTON, EXAMINING ATTORNEY

SN 77-634,864. THE ENTREPRENEUR'S SOURCE, INC.,
SOUTHBURY, CT. FILED 12-17-2008.

FRANCHISE HARMONY

THE MARK CONSISTS OF STANDARD CHARACTERS WITHOUT CLAIM TO ANY PARTICULAR FONT, STYLE, SIZE, OR COLOR.

NO CLAIM IS MADE TO THE EXCLUSIVE RIGHT TO USE "FRANCHISE", APART FROM THE MARK AS SHOWN.

CLASS 35—ADVERTISING AND BUSINESS

FOR CONSULTING SERVICES, NAMELY, BUSINESS CONSULTING SERVICES IN THE FIELD OF FRANCHISING, MARKETING AND BUSINESS MANAGEMENT; BUSINESS ADVISING SERVICES; ASSISTANCE IN MATCHING FRANCHISEES WITH FRANCHISORS (U.S. CLS. 100, 101 AND 102).

CLASS 41—EDUCATION AND ENTERTAINMENT

FOR PROFESSIONAL COACHING IN THE FIELD OF BUSINESS (U.S. CLS. 100, 101 AND 107).
NAKIA HENRY, EXAMINING ATTORNEY

SN 77-635,115. S. C. JOHNSON & SON, INC., RACINE, WI.
FILED 12-17-2008.

PLEDGE

THE MARK CONSISTS OF STANDARD CHARACTERS WITHOUT CLAIM TO ANY PARTICULAR FONT, STYLE, SIZE, OR COLOR.

OWNER OF U.S. REG. NOS. 668,526, 2,664,435 AND OTHERS.

CLASS 2—PAINTS

FOR PAINTS, VARNISHES, LACQUERS, STAINS AND PAINT STRIPPERS FOR TREATING WOOD FLOORING, MOLDING AND OTHER WOODEN HOUSEHOLD ACCENTS; WOOD FURNITURE TOUCH-UP STICKS CONTAINING STAIN (U.S. CLS. 6, 11 AND 16).

CLASS 3—COSMETICS AND CLEANING PREPARATIONS

FOR CLEANING AND POLISHING PREPARATIONS; DISPOSABLE CLEANING WIPES IMPREGNATED WITH CLEANING CHEMICALS FOR HOUSEHOLD USE; CLEANING, POLISHING AND WAXING PREPARATIONS FOR AUTOMOBILES; COMPRESSED AIR FOR THE CLEANING OF ELECTRONIC EQUIPMENT; WOOD FURNITURE TOUCH-UP STICKS CONTAINING CLEANING PREPARATIONS; FURNITURE POLISH, WOOD FURNITURE TOUCH-UP STICKS CONTAINING FURNITURE POLISH (U.S. CLS. 1, 4, 6, 50, 51 AND 52).

CLASS 7—MACHINERY

FOR ELECTRICAL POWERED FLOOR CLEANING AND TREATMENT MACHINES IN THE NATURE OF VACUUMS, DUSTERS, CLEANERS, BROOMS, SANDERS AND BUFFERS; REPLACEMENT FILTERS AND FRAGRANCERS FOR ELECTRICAL POWERED FLOOR CLEANING AND TREATMENT MACHINES (U.S. CLS. 13, 19, 21, 23, 31, 34 AND 35).

CLASS 11—ENVIRONMENTAL CONTROL APPARATUS

FOR ELECTRICAL AIR PURIFIERS; AIR FILTERS FOR HOUSEHOLD USE (U.S. CLS. 13, 21, 23, 31 AND 34).

CLASS 17—RUBBER GOODS

FOR SEALANTS FOR TREATING WOOD FLOORING, MOLDING AND OTHER WOODEN HOUSEHOLD ACCENTS (U.S. CLS. 1, 5, 12, 13, 35 AND 50).

CLASS 19—NON-METALLIC BUILDING MATERIALS

FOR WOOD FLOORING, WOOD MOLDING AND OTHER HOUSEHOLD ACCENTS MADE OF WOOD, NAMELY, TRIM, PANELING, SIDING AND WINDOW FRAMES (U.S. CLS. 1, 12, 33 AND 50).

CLASS 21—HOUSEWARES AND GLASS

FOR MOPS, BROOMS, BRUSHES, DUSTERS, SQUEEGES, SPONGES AND REPLACEMENT PARTS FOR HOUSEHOLD CLEANING; CLEANING, DUSTING AND POLISHING CLOTHS; SOFT SURFACE LINT REMOVER ROLLER; SHOP CLOTHS FOR CLEANING, DUSTING AND POLISHING; DISPOSABLE AND REUSABLE CLEANING WIPES NOT IMPREGNATED WITH CLEANING CHEMICALS (U.S. CLS. 2, 13, 23, 29, 30, 33, 40 AND 50).

CLASS 37—CONSTRUCTION AND REPAIR

FOR HOUSEHOLD CLEANING SERVICES IN THE NATURE OF HEAT AND AIR DUCT MAINTENANCE, FLOOR TREATMENT SERVICES, NAMELY, APPLICATION OF CHEMICAL PREPARATIONS TO FLOORS TO MAKE THEM SLIP-RESISTANT FOR SAFETY PURPOSES, AND CARPET, UPHOLSTERY, AND DRAPERY CLEANING; HOUSEHOLD EXTERIOR CLEANING SERVICES IN THE NATURE OF SIDING, SHINGLE AND DECK CLEANING (U.S. CLS. 100, 103 AND 106).
JULIE GUTTADAURO, EXAMINING ATTORNEY

SN 77-636,657. EDUCATION SERVICE CENTER REGION XIII, AUSTIN, TX. FILED 12-19-2008.

CSCOPE

THE MARK CONSISTS OF STANDARD CHARACTERS WITHOUT CLAIM TO ANY PARTICULAR FONT, STYLE, SIZE, OR COLOR.

CLASS 35—ADVERTISING AND BUSINESS

FOR EDUCATION PROFESSIONAL CAREER DEVELOPMENT FOR EDUCATORS IN THE FIELD OF K-12 EDUCATION (U.S. CLS. 100, 101 AND 102).
FIRST USE 1-1-2006; IN COMMERCE 1-1-2006.

CLASS 41—EDUCATION AND ENTERTAINMENT

FOR EDUCATIONAL SERVICES, NAMELY, PROVIDING LIVE AND ONLINE TRAINING IN UTILIZING AN EDUCATIONAL CURRICULUM AND CURRICULUM MANAGEMENT, PROVIDING LIVE AND ONLINE EDUCATIONAL ASSESSMENT, TRACKING STUDENT PERFORMANCE, ALL IN THE FIELD OF K-12 EDUCATION (U.S. CLS. 100, 101 AND 107).

FIRST USE 1-1-2006; IN COMMERCE 1-1-2006.
JASON TURNER, EXAMINING ATTORNEY

SN 77-636,739. EBERT, CAROL, DAKOTA, MN. FILED 12-19-2008.

S.M.A.R.T.

THE MARK CONSISTS OF STANDARD CHARACTERS WITHOUT CLAIM TO ANY PARTICULAR FONT, STYLE, SIZE, OR COLOR.

CLASS 16—PAPER GOODS AND PRINTED MATTER

FOR PRINTED TEACHING MATERIALS IN THE FIELD OF METHODS OF REDUCING HEALTH CARE COSTS FOR COMPANIES AND THEIR EMPLOYEES (U.S. CLS. 2, 5, 22, 23, 29, 37, 38 AND 50).

CLASS 41—EDUCATION AND ENTERTAINMENT

FOR EDUCATIONAL SERVICES, NAMELY, DEVELOPING AND CONDUCTING TRAINING COURSES AND DISTRIBUTION OF TRAINING MATERIALS IN THE FIELD OF METHODS OF REDUCING HEALTH CARE COSTS FOR COMPANIES AND THEIR EMPLOYEES (U.S. CLS. 100, 101 AND 107).

AMY C. KEAN, EXAMINING ATTORNEY

SN 77-636,982. KOLALOKA INDUSTRIES, LP, DALLAS, TX. FILED 12-19-2008.

KOLE

THE MARK CONSISTS OF STANDARD CHARACTERS WITHOUT CLAIM TO ANY PARTICULAR FONT, STYLE, SIZE, OR COLOR.

CLASS 1—CHEMICALS

FOR ADHESIVES FOR USE IN INDUSTRY (U.S. CLS. 1, 5, 6, 10, 26 AND 46).

CLASS 16—PAPER GOODS AND PRINTED MATTER

FOR ADHESIVES FOR STATIONERY AND HOUSEHOLD USE; HOUSEHOLD ADHESIVES FOR PAPER, CARDBOARD, PHOTOGRAPHS, CLOTH, POSTERBOARD, AND LABELS (U.S. CLS. 2, 5, 22, 23, 29, 37, 38 AND 50).

WILLIAM BRECKENFELD, EXAMINING ATTORNEY

SN 77-637,129. EDUCATION SERVICE CENTER REGION XIII, AUSTIN, TX. FILED 12-19-2008.



THE MARK CONSISTS OF THE LETTER "C" FOLLOWED BY THE WORD "SCOPE" WITH AN APPLE INSIDE THE LETTER "O".

CLASS 35—ADVERTISING AND BUSINESS

FOR EDUCATION PROFESSIONAL CAREER DEVELOPMENT FOR EDUCATORS IN THE FIELD OF K-12 EDUCATION (U.S. CLS. 100, 101 AND 102).

FIRST USE 1-1-2006; IN COMMERCE 1-1-2006.

CLASS 41—EDUCATION AND ENTERTAINMENT

FOR EDUCATIONAL SERVICES, NAMELY, PROVIDING LIVE AND ONLINE TRAINING IN UTILIZING AN EDUCATIONAL CURRICULUM AND CURRICULUM MANAGEMENT, PROVIDING LIVE AND ONLINE EDUCATIONAL ASSESSMENT, TRACKING STUDENT PERFORMANCE, ALL IN THE FIELD OF K-12 EDUCATION (U.S. CLS. 100, 101 AND 107).

FIRST USE 1-1-2006; IN COMMERCE 1-1-2006.

JASON TURNER, EXAMINING ATTORNEY

SN 77-637,803. THE BOLDT GROUP, INC., APPLETON, WI. FILED 12-22-2008.



OWNER OF U.S. REG. NOS. 1,431,493, 2,819,720 AND OTHERS.

THE COLOR(S) RED AND GREEN IS/ARE CLAIMED AS A FEATURE OF THE MARK.

THE MARK CONSISTS OF THE COLOR RED APPEARING IN THE WORDING "BOLDT" AND THE COLOR GREEN APPEARING IN THE WORDING "RUTHS"; THE LETTER "T" IS SET OFF TO CREATE THE DUAL WORDING OF "BOLDT" AND "TRUTHS".

CLASS 37—CONSTRUCTION AND REPAIR

FOR CONSTRUCTION, REPAIR, AND RENOVATION OF COMMERCIAL, INDUSTRIAL, GOVERNMENTAL, INSTITUTIONAL, EDUCATIONAL, RECREATIONAL, HEALTHCARE, AND RELIGIOUS BUILDINGS AND POWER AND BIOENERGY FACILITIES; AND CONSTRUCTION OF WIND TURBINES; PROVIDE REAL ESTATE DEVELOPMENT, CONSTRUCTION PROJECT PLANNING AND DEVELOPMENT, CONSTRUCTION MANAGEMENT UTILIZING INTEGRATED LEAN PROJECT DELIVERY (ILPD) METHODS, AND GENERAL CONSTRUCTION CONTRACTING SERVICES RELATED TO THE ABOVE-MENTIONED MARKETS (U.S. CLS. 100, 103 AND 106).

FIRST USE 10-1-2008; IN COMMERCE 10-1-2008.

CLASS 42—SCIENTIFIC AND COMPUTER SERVICES

FOR ARCHITECTURAL DESIGN AND ENGINEERING SERVICES; CONCEPTUAL DESIGN OF COMMERCIAL, INDUSTRIAL, GOVERNMENTAL, INSTITUTIONAL, EDUCATIONAL, RECREATIONAL, HEALTHCARE, AND RELIGIOUS BUILDINGS AND POWER AND BIOENERGY FACILITIES AND OTHER BUILDINGS (U.S. CLS. 100 AND 101).

FIRST USE 10-1-2008; IN COMMERCE 10-1-2008.
MATTHEW EINSTEIN, EXAMINING ATTORNEY

SN 77-637,819. THE BOLDT GROUP, INC., APPLETON, WI.
FILED 12-22-2008.

BoldTruths

THE MARK CONSISTS OF STANDARD CHARACTERS WITHOUT CLAIM TO ANY PARTICULAR FONT, STYLE, SIZE, OR COLOR.

OWNER OF U.S. REG. NOS. 1,431,493, 2,819,720 AND OTHERS.

CLASS 37—CONSTRUCTION AND REPAIR

FOR CONSTRUCTION, REPAIR, AND RENOVATION OF COMMERCIAL, INDUSTRIAL, GOVERNMENTAL, INSTITUTIONAL, EDUCATIONAL, RECREATIONAL, HEALTHCARE, AND RELIGIOUS BUILDINGS AND POWER AND BIOENERGY FACILITIES; AND CONSTRUCTION OF WIND TURBINES; PROVIDE REAL ESTATE DEVELOPMENT, CONSTRUCTION PROJECT PLANNING AND DEVELOPMENT, CONSTRUCTION MANAGEMENT UTILIZING INTEGRATED LEAN PROJECT DELIVERY (ILPD) METHODS, AND GENERAL CONSTRUCTION CONTRACTING SERVICES RELATED TO THE ABOVE-MENTIONED MARKETS (U.S. CLS. 100, 103 AND 106).

FIRST USE 10-1-2008; IN COMMERCE 10-1-2008.

CLASS 42—SCIENTIFIC AND COMPUTER SERVICES

FOR ARCHITECTURAL DESIGN AND ENGINEERING SERVICES; CONCEPTUAL DESIGN OF COMMERCIAL, INDUSTRIAL, GOVERNMENTAL, INSTITUTIONAL, EDUCATIONAL, RECREATIONAL, HEALTHCARE, AND RELIGIOUS BUILDINGS AND POWER AND BIOENERGY FACILITIES AND OTHER BUILDINGS (U.S. CLS. 100 AND 101).

FIRST USE 10-1-2008; IN COMMERCE 10-1-2008.
MATTHEW EINSTEIN, EXAMINING ATTORNEY

SN 77-637,890. BAR-B-QSA LLC, SARATOGA SPRINGS, NY.
FILED 12-22-2008.



OWNER OF U.S. REG. NO. 2,007,061.

NO CLAIM IS MADE TO THE EXCLUSIVE RIGHT TO USE "RESTAURANT", APART FROM THE MARK AS SHOWN.

THE MARK CONSISTS OF THE STYLIZED WORDING "BAR-B- QSA RESTAURANT" AND TWO STARS FEATURED ON A DESIGN OF AN INTERSTATE ROAD SIGN, WITH THE SIGN FEATURING A DOUBLE BORDER AND A HORIZONTAL LINE SEPARATING THE WORDING "BAR-B-" FROM THE REMAINING WORDING, WITH THE STARS APPEARING BETWEEN THE LETTERS IN THE WORDING "QSA", AND WITH LIGHT MARKS RANDOMLY SCATTERED OVER THE DESIGN TO SUGGEST THAT THE SIGN IS WEATHERED OR WORN.

CLASS 35—ADVERTISING AND BUSINESS

FOR RESTAURANT FRANCHISING (U.S. CLS. 100, 101 AND 102).

CLASS 43—HOTEL AND RESTAURANT SERVICES

FOR RESTAURANT AND CATERING SERVICES (U.S. CLS. 100 AND 101).

CYNTHIA TRIPI, EXAMINING ATTORNEY

SN 77-637,897. BAR-B-QSA LLC, SARATOGA SPRINGS, NY.
FILED 12-22-2008.



NO CLAIM IS MADE TO THE EXCLUSIVE RIGHT TO USE "RESTAURANT", APART FROM THE MARK AS SHOWN.

THE MARK CONSISTS OF THE STYLIZED WORDING "BAR-B- QSA RESTAURANT A TASTE TOUR OF AMERICAN BARBEQUE" AND DESIGN OF FOUR STARS AND AN INTERSTATE ROAD SIGN, WITH THE WORDING

"BAR-B- QSA RESTAURANT" FEATURED ON THE INTER-STATE ROAD SIGN DESIGN, WITH THE SIGN FEATURING A DOUBLE BORDER AND A HORIZONTAL LINE SEPARATING THE WORDING "BAR-B-" FROM THE WORDING "QSA RESTAURANT", WITH THE STARS APPEARING BETWEEN THE LETTERS IN THE WORDING "QSA", WITH THE WORDING "A TASTE TOUR OF AMERICAN BARBEQUE" APPEARING BENEATH THE INTER-STATE ROAD SIGN DESIGN BETWEEN TWO OF THE STARS, AND WITH LIGHT MARKS RANDOMLY SCATTERED OVER THE WORDING AND DESIGN TO SUGGEST WEATHERING OR WEARING.

CLASS 35—ADVERTISING AND BUSINESS

FOR RESTAURANT FRANCHISING (U.S. CLS. 100, 101 AND 102).

CLASS 43—HOTEL AND RESTAURANT SERVICES

FOR RESTAURANT AND CATERING SERVICES (U.S. CLS. 100 AND 101).
CYNTHIA TRIPI, EXAMINING ATTORNEY

SN 77-638,586. FIRST ADVANTAGE CORPORATION, ST. PETERSBURG, FL. FILED 12-23-2008.

RPP

THE MARK CONSISTS OF STANDARD CHARACTERS WITHOUT CLAIM TO ANY PARTICULAR FONT, STYLE, SIZE, OR COLOR.

CLASS 36—INSURANCE AND FINANCIAL

FOR PRE-RENTING INQUIRY, NAMELY, CREDIT INQUIRY AND CONSULTATION (U.S. CLS. 100, 101 AND 102).
FIRST USE 8-15-2007; IN COMMERCE 8-15-2007.

CLASS 45—PERSONAL AND LEGAL SERVICES

FOR PRE-RENTING BACKGROUND INVESTIGATION, RESEARCH, AND SCREENING SERVICES (U.S. CLS. 100 AND 101).
FIRST USE 8-15-2007; IN COMMERCE 8-15-2007.
SALLY SHIH, EXAMINING ATTORNEY

SN 77-642,151. SYRATECH ACQUISITION CORPORATION, MEFORD, MA. FILED 12-31-2008.

Wallace

THE MARK CONSISTS OF STANDARD CHARACTERS WITHOUT CLAIM TO ANY PARTICULAR FONT, STYLE, SIZE, OR COLOR.
OWNER OF U.S. REG. NOS. 511,794, 1,070,148 AND 2,187,096.
SEC. 2(F).

CLASS 9—ELECTRICAL AND SCIENTIFIC APPARATUS

FOR DIGITAL PHOTO FRAMES FOR DISPLAYING DIGITAL PICTURES, VIDEO CLIPS AND MUSIC (U.S. CLS. 21, 23, 26, 36 AND 38).

CLASS 28—TOYS AND SPORTING GOODS

FOR CHRISTMAS TREE ORNAMENTS AND DECORATIONS (U.S. CLS. 22, 23, 38 AND 50).
CIMMERIAN COLEMAN, EXAMINING ATTORNEY

SN 77-642,364. SHIFTING GEARS CYCLING, LLC, SANTA MONICA, CA. FILED 12-31-2008.



THE MARK CONSISTS OF A HEART DESIGN COMPRISED OF SPIRAL LINES SET AGAINST A BACKGROUND CIRCLE; A SEPARATE SMALL CIRCULAR SHAPE APPEARS DIRECTLY ABOVE THE HEART DESIGN; SURROUNDING THE CENTRAL DESIGN PORTION OF THE MARK IS A PAIR OF CURVED ARCS.

CLASS 25—CLOTHING

FOR ATHLETIC APPAREL, NAMELY, SHIRTS, PANTS, JACKETS, FOOTWEAR, HATS AND CAPS, ATHLETIC UNIFORMS; CYCLISTS' JERSEYS; JERSEYS; KERCHIEFS; POCKET KERCHIEFS; SLEEVELESS JERSEYS; SPORTS JERSEYS; SPORTS JERSEYS AND BREECHES FOR SPORTS; TANK TOPS; TANK-TOPS (U.S. CLS. 22 AND 39).
FIRST USE 5-1-2008; IN COMMERCE 5-1-2008.

CLASS 41—EDUCATION AND ENTERTAINMENT

FOR ENTERTAINMENT SERVICES, NAMELY, PARTICIPATION IN CYCLING EVENTS (U.S. CLS. 100, 101 AND 107).
FIRST USE 5-1-2007; IN COMMERCE 5-1-2007.
JIM RINGLE, EXAMINING ATTORNEY

SN 77-642,369. TIME LINK INTERNATIONAL CORP., PURCHASE, NY. FILED 12-31-2008.

TIMELINK

THE MARK CONSISTS OF STANDARD CHARACTERS WITHOUT CLAIM TO ANY PARTICULAR FONT, STYLE, SIZE, OR COLOR.

CLASS 9—ELECTRICAL AND SCIENTIFIC APPARATUS

FOR COMPUTER HARDWARE; COMPUTER SOFTWARE FOR USE IN WORKFORCE MANAGEMENT (U.S. CLS. 21, 23, 26, 36 AND 38).

FIRST USE 3-0-1998; IN COMMERCE 3-0-1998.

CLASS 35—ADVERTISING AND BUSINESS

FOR BUSINESS CONSULTING SERVICES IN THE FIELD WORKFORCE MANAGEMENT (U.S. CLS. 100, 101 AND 102).

FIRST USE 3-0-1998; IN COMMERCE 3-0-1998. THOMAS MANOR, EXAMINING ATTORNEY

SN 77-642,768. ROLAND-SCHUHE GMBH & CO. HANDELS KG, ESSEN, FED REP GERMANY, FILED 1-2-2009.



OWNER OF FED REP GERMANY REG. NO. 39831797, DATED 6-6-1998, RENEWED AS REG. NO. 39831797, DATED 6-7-2008, EXPIRES 6-7-2018.

THE MARK CONSISTS OF THE WORD "LINEA" SITUATED ABOVE THE WORD "LIBERA", BOTH IN STYLIZED TEXT AND SEPARATED BY CURVED DOUBLE LINES.

THE FOREIGN WORDING IN THE MARK TRANSLATES INTO ENGLISH AS "LINE FREE."

CLASS 18—LEATHER GOODS

FOR LEATHER AND IMITATION LEATHER; LEATHER BAGS, SUITCASES AND WALLETS; LEATHER HANDBAGS; LEATHER KEY CASES; LEATHER PURSES (U.S. CLS. 1, 2, 3, 22 AND 41).

CLASS 25—CLOTHING

FOR FOOTWEAR; HEADGEAR, NAMELY, CAPS, HATS AND VISORS; LEATHER BELTS (U.S. CLS. 22 AND 39).

INGA ERVIN, EXAMINING ATTORNEY

SN 77-642,977. SUBMATERIAL, SEATTLE, WA. FILED 1-4-2009.

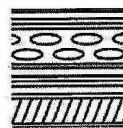

submaterial

THE MARK CONSISTS OF THE WORD "SUBMATERIAL" AND A DESIGN ELEMENT COMPRISING A SQUARE ARRANGEMENT OF LINES AND GEOMETRIC SHAPES SUGGESTING DIFFERING LAYERS OR STRATA.

CLASS 18—LEATHER GOODS

FOR SCULPTURES OF LEATHER (U.S. CLS. 1, 2, 3, 22 AND 41).

FIRST USE 1-4-2008; IN COMMERCE 7-29-2008.

CLASS 20—FURNITURE AND ARTICLES NOT OTHERWISE CLASSIFIED

FOR LEATHER PICTURE FRAMES; PLASTIC SCULPTURES; SCULPTURES OF WOOD OR PLASTIC; SOFT SCULPTURE WALL DECORATIONS; WORKS OF ART OF WOOD, WAX, PLASTER OR PLASTIC (U.S. CLS. 2, 13, 22, 25, 32 AND 50).

FIRST USE 1-4-2008; IN COMMERCE 7-29-2008.

CLASS 24—FABRICS

FOR SCULPTURES OF FELT (U.S. CLS. 42 AND 50).

FIRST USE 1-4-2008; IN COMMERCE 7-29-2008. LAURIE KAUFMAN, EXAMINING ATTORNEY

SN 77-642,762. ROLAND-SCHUHE GMBH & CO. HANDELS KG, ESSEN, FED REP GERMANY, FILED 1-2-2009.



OWNER OF FED REP GERMANY REG. NO. 30663321, DATED 1-23-2007, EXPIRES 1-31-2017.

THE MARK CONSISTS OF THE WORD "LIMELIGHT" IN STYLIZED TEXT.

CLASS 18—LEATHER GOODS

FOR LEATHER AND IMITATION LEATHER BAGS; LEATHER BAGS, SUITCASES AND WALLETS; LEATHER HANDBAGS; LEATHER KEY CASES; LEATHER PURSES (U.S. CLS. 1, 2, 3, 22 AND 41).

CLASS 25—CLOTHING

FOR FOOTWEAR; HEADGEAR, NAMELY, HATS, CAPS AND VISORS; LEATHER BELTS (U.S. CLS. 22 AND 39).

INGA ERVIN, EXAMINING ATTORNEY

SN 77-644,181. MAYBRIDGE LIMITED, CORNWALL, UNITED KINGDOM, FILED 1-6-2009.

SN 77-645,597. SAN FRANCISCO LESBIAN GAY BISEXUAL TRANSGENDER PRIDE CELEBRATION COMMITTEE, INC., SAN FRANCISCO, CA. FILED 1-8-2009.

QUICK2LEAD

THE MARK CONSISTS OF STANDARD CHARACTERS WITHOUT CLAIM TO ANY PARTICULAR FONT, STYLE, SIZE, OR COLOR.

PRIORITY CLAIMED UNDER SEC. 44(D) ON ERP N CMNTY TM OFC APPLICATION NO. 007326754, FILED 10-20-2008, REG. NO. 007326754, DATED 5-20-2009, EXPIRES 10-20-2018.

CLASS 1—CHEMICALS

FOR CHEMICAL REAGENTS FOR NON-MEDICAL PURPOSES; REAGENTS FOR CHEMICAL ANALYSIS, NAMELY, KITS OF TWO OR MORE REACTIVE CHEMICALS FOR SYNTHESIS OF COMPOUNDS TO BE TESTED FOR BIOLOGICAL OR THERAPEUTIC ACTIVITY (U.S. CLS. 1, 5, 6, 10, 26 AND 46).

CLASS 5—PHARMACEUTICALS

FOR CHEMICAL REAGENTS FOR MEDICAL OR VETERINARY PURPOSES (U.S. CLS. 6, 18, 44, 46, 51 AND 52).

KRISTIN DAHLING, EXAMINING ATTORNEY

SN 77-645,253. ROLAND-SCHUHE GMBH & CO. HANDELS KG, ESSEN, FED REP GERMANY, FILED 1-7-2009.



OWNER OF FED REP GERMANY REG. NO. 30752414, DATED 2-8-2008, EXPIRES 2-8-2018.

NO CLAIM IS MADE TO THE EXCLUSIVE RIGHT TO USE "TEEN'S", APART FROM THE MARK AS SHOWN.

THE MARK CONSISTS OF THE WORDS "TEEN'S CLUB" IN STYLIZED TEXT.

CLASS 18—LEATHER GOODS

FOR LEATHER AND IMITATION LEATHER BAGS; LEATHER BAGS, SUITCASES AND WALLETS; LEATHER HANDBAGS; LEATHER KEY CASES; LEATHER PURSES (U.S. CLS. 1, 2, 3, 22 AND 41).

CLASS 25—CLOTHING

FOR FOOTWEAR; HEADGEAR, NAMELY, HATS, CAPS AND VISORS; LEATHER BELTS (U.S. CLS. 22 AND 39).

INGA ERVIN, EXAMINING ATTORNEY

SF PRIDE

THE MARK CONSISTS OF STANDARD CHARACTERS WITHOUT CLAIM TO ANY PARTICULAR FONT, STYLE, SIZE, OR COLOR.

OWNER OF U.S. REG. NOS. 2,619,420, 2,838,789 AND OTHERS.

NO CLAIM IS MADE TO THE EXCLUSIVE RIGHT TO USE "SF", APART FROM THE MARK AS SHOWN.

CLASS 16—PAPER GOODS AND PRINTED MATTER

FOR MAGAZINES, GUIDEBOOKS, POSTCARDS, NEWSLETTERS, NEWSPAPERS, MAPS, DIRECTORIES OF SOCIAL ACTION NETWORKS, AND POSTERS FEATURING NEWS AND COMMENTARY IN THE FIELDS OF CURRENT EVENTS AND ENTERTAINMENT RELATING TO THE GAY, LESBIAN, BISEXUAL AND TRANSGENDER COMMUNITY (U.S. CLS. 2, 5, 22, 23, 29, 37, 38 AND 50).

FIRST USE 5-1-1996; IN COMMERCE 5-1-1996.

CLASS 41—EDUCATION AND ENTERTAINMENT

FOR PROVIDING INFORMATION, NEWS AND COMMENTARY IN THE FIELD OF CURRENT EVENTS AND ENTERTAINMENT RELATING TO THE GAY, LESBIAN, BISEXUAL AND TRANSGENDER COMMUNITY; ORGANIZING AND CONDUCTING COMMUNITY FESTIVALS FEATURING A VARIETY OF ACTIVITIES, NAMELY, ART EXHIBITIONS, PARADES, STREET FAIRS, THEATER PERFORMANCES, MUSIC PERFORMANCES, SEMINARS, PARTIES AND RALLIES (U.S. CLS. 100, 101 AND 107).

FIRST USE 5-1-1996; IN COMMERCE 5-1-1996.

VIVIAN MICZNIK FIRST, EXAMINING ATTORNEY

SN 77-646,462. MURAD, INC., EL SEGUNDO, CA. FILED 1-9-2009.

WHITE BRILLIANCE

THE MARK CONSISTS OF STANDARD CHARACTERS WITHOUT CLAIM TO ANY PARTICULAR FONT, STYLE, SIZE, OR COLOR.

CLASS 3—COSMETICS AND CLEANING PREPARATIONS

FOR NON-MEDICATED SKIN CARE PREPARATIONS, NAMELY, CREAMS, LOTIONS, GELS, TONERS, CLEANSERS AND PEELS (U.S. CLS. 1, 4, 6, 50, 51 AND 52).

CLASS 5—PHARMACEUTICALS

FOR DIETARY FOOD SUPPLEMENTS; VITAMINS (U.S. CLS. 6, 18, 44, 46, 51 AND 52).

APRIL HESIK, EXAMINING ATTORNEY

SN 77-646,761. AMERICAN MEDICAL DIRECTORS ASSOCIATION, INC., COLUMBIA, MD. FILED 1-9-2009.



OWNER OF U.S. REG. NOS. 2,665,710, 3,413,836 AND OTHERS.

THE MARK CONSISTS OF THREE SUPERIMPOSED DIAMONDS, WITH A SOLID DIAMOND IN THE BACKGROUND, A TRANSLUCENT DIAMOND IN THE MIDDLE AND A DIAMOND WITH DIAGONAL LINES IN THE FOREFRONT, THE LETTERS "AMDA" AND THE FIGURE OF A SNAKE WRAPPED AROUND THE VERTICAL PORTION OF THE LETTER "D".

CLASS 9—ELECTRICAL AND SCIENTIFIC APPARATUS

FOR DOWNLOADABLE PUBLICATIONS IN THE NATURE OF JOURNAL ARTICLES, NEWSLETTERS, GUIDELINES, AND EDUCATIONAL TEXT BOOKS IN THE FIELDS OF LONG-TERM CARE MEDICINE AND MEDICAL DIRECTION (U.S. CLS. 21, 23, 26, 36 AND 38).
FIRST USE 1-0-2008; IN COMMERCE 1-0-2008.

CLASS 16—PAPER GOODS AND PRINTED MATTER

FOR EDUCATIONAL PUBLICATIONS, NAMELY, TRAINING MANUALS IN THE FIELD OF MEDICAL DIRECTION AND LONG-TERM CARE MEDICINE; PUBLICATIONS, NAMELY, BROCHURES, NEWSLETTERS, AND JOURNALS IN THE FIELD OF MEDICAL DIRECTION AND LONG-TERM CARE MEDICINE; KITS COMPRISING BOOKS AND ACCOMPANYING CD-ROMS DISTRIBUTED THEREWITH AND SOLD AS A UNIT, IN THE FIELD OF MEDICAL DIRECTION AND LONG-TERM CARE MEDICINE (U.S. CLS. 2, 5, 22, 23, 29, 37, 38 AND 50).
FIRST USE 1-0-2008; IN COMMERCE 1-0-2008.

CLASS 35—ADVERTISING AND BUSINESS

FOR ASSOCIATION SERVICES, NAMELY, PROMOTING THE INTERESTS OF PHYSICIANS WHO PROVIDE LONG-TERM PATIENT HEALTH-CARE; PROVIDING A WEBSITE THAT PROVIDES CONSUMER INFORMATION IN THE FIELD OF MEDICAL DIRECTORS AND PHYSICIANS DEDICATED TO LONG-TERM CARE (U.S. CLS. 100, 101 AND 102).
FIRST USE 1-0-2008; IN COMMERCE 1-0-2008.

CLASS 41—EDUCATION AND ENTERTAINMENT

FOR PROVIDING A WEBSITE THAT FEATURES INFORMATION ABOUT THE PROVISION OF RECOGNITION AND INCENTIVES BY THE WAY OF AWARDS TO DEMONSTRATE EXCELLENCE IN THE FIELD OF MEDICAL DIRECTION AND PHYSICIAN SERVICES IN LONG-TERM CARE; PROVIDING A WEBSITE THAT PROVIDES EDUCATION INFORMATION ABOUT EDUCATIONAL PROGRAMS IN THE FIELD OF MEDICAL DIRECTION AND PHYSICIAN SERVICES FOR LONG-TERM CARE; PROVIDING ONLINE PUBLICATIONS IN THE NATURE OF NEWSLETTERS AND JOURNAL ARTICLES IN THE FIELD OF MEDICAL DIRECTION AND LONG-TERM CARE MEDICINE (U.S. CLS. 100, 101 AND 107).
FIRST USE 1-0-2008; IN COMMERCE 1-0-2008.

CLASS 44—MEDICAL, BEAUTY AND AGRICULTURAL SERVICES

FOR PROVIDING A WEB SITE FEATURING INFORMATION IN THE FIELD OF MEDICAL DIRECTION AND LONG-TERM CARE MEDICINE (U.S. CLS. 100 AND 101).

FIRST USE 1-0-2008; IN COMMERCE 1-0-2008.
STEVEN R. FOSTER, EXAMINING ATTORNEY

SN 77-646,791. AMERICAN MEDICAL DIRECTORS ASSOCIATION, INC., COLUMBIA, MD. FILED 1-9-2009.



OWNER OF U.S. REG. NOS. 2,665,710, 3,413,836 AND OTHERS.

NO CLAIM IS MADE TO THE EXCLUSIVE RIGHT TO USE "DEDICATED TO LONG TERM CARE MEDICINE", APART FROM THE MARK AS SHOWN.

THE MARK CONSISTS OF THREE SUPERIMPOSED DIAMONDS, WITH A SOLID DIAMOND IN THE BACKGROUND, A TRANSLUCENT DIAMOND IN THE MIDDLE AND A DIAMOND WITH DIAGONAL LINES IN THE FOREFRONT, THE LETTERS "AMDA" AND THE FIGURE OF A SNAKE WRAPPED AROUND THE VERTICAL PORTION OF THE LETTER "D" IN "AMDA", AND THE TAG LINE "DEDICATED TO LONG TERM CARE MEDICINE".

CLASS 9—ELECTRICAL AND SCIENTIFIC APPARATUS

FOR DOWNLOADABLE PUBLICATIONS IN THE NATURE OF JOURNAL ARTICLES, NEWSLETTERS, GUIDELINES, AND EDUCATIONAL TEXT BOOKS IN THE FIELDS OF LONG-TERM CARE MEDICINE AND MEDICAL DIRECTION (U.S. CLS. 21, 23, 26, 36 AND 38).
FIRST USE 1-0-2008; IN COMMERCE 1-0-2008.

CLASS 16—PAPER GOODS AND PRINTED MATTER

FOR EDUCATIONAL PUBLICATIONS, NAMELY, TRAINING MANUALS IN THE FIELD OF MEDICAL DIRECTION AND LONG-TERM CARE MEDICINE; PUBLICATIONS, NAMELY, BROCHURES, NEWSLETTERS, AND JOURNALS IN THE FIELD OF MEDICAL DIRECTION AND LONG-TERM CARE MEDICINE; KITS COMPRISING BOOKS AND ACCOMPANYING CD-ROMS DISTRIBUTED THEREWITH AND SOLD AS A UNIT, IN THE FIELD OF MEDICAL DIRECTION AND LONG-TERM CARE MEDICINE (U.S. CLS. 2, 5, 22, 23, 29, 37, 38 AND 50).
FIRST USE 1-0-2008; IN COMMERCE 1-0-2008.

CLASS 35—ADVERTISING AND BUSINESS

FOR ASSOCIATION SERVICES, NAMELY, PROMOTING THE INTERESTS OF PHYSICIANS WHO PROVIDE LONG-TERM PATIENT HEALTH-CARE; PROVIDING A WEBSITE THAT PROVIDES CONSUMER INFORMATION IN THE FIELD OF MEDICAL DIRECTORS AND PHYSICIANS DEDICATED TO LONG-TERM CARE (U.S. CLS. 100, 101 AND 102).
FIRST USE 1-0-2008; IN COMMERCE 1-0-2008.

CLASS 41—EDUCATION AND ENTERTAINMENT

FOR PROVIDING A WEBSITE THAT FEATURES INFORMATION ABOUT THE PROVISION OF RECOGNITION AND INCENTIVES BY THE WAY OF AWARDS TO DEMONSTRATE EXCELLENCE IN THE FIELD OF MEDICAL DIRECTION AND PHYSICIAN SERVICES IN LONG-TERM CARE; PROVIDING A WEBSITE THAT PROVIDES EDUCATION INFORMATION ABOUT EDUCATIONAL PROGRAMS IN THE FIELD OF MEDICAL DIRECTION AND PHYSICIAN SERVICES FOR LONG-TERM CARE; PROVIDING ONLINE PUBLICATIONS IN THE NATURE OF NEWSLETTERS AND JOURNAL ARTICLES IN THE FIELD OF MEDICAL DIRECTION AND LONG-TERM CARE MEDICINE (U.S. CLS. 100, 101 AND 107).

FIRST USE 1-0-2008; IN COMMERCE 1-0-2008.

CLASS 44—MEDICAL, BEAUTY AND AGRICULTURAL SERVICES

FOR PROVIDING A WEB SITE FEATURING INFORMATION IN THE FIELD OF MEDICAL DIRECTION AND LONG-TERM CARE MEDICINE (U.S. CLS. 100 AND 101).

FIRST USE 1-0-2008; IN COMMERCE 1-0-2008.

STEVEN R. FOSTER, EXAMINING ATTORNEY

CLASS 28—TOYS AND SPORTING GOODS

FOR A COMPLETE LINE OF BOWLING PIN AND BALL HANDLING APPARATUS, NAMELY, APPARATUS TO PLACE BOWLING PINS, BALL LIFTS, AND PIN LIFTS; REPLACEMENT PARTS SPECIALLY ADAPTED FOR THE AFOREMENTIONED BOWLING PIN AND BALL HANDLING APPARATUS, NAMELY, BELTS, FUSES, TIMERS, MOLDED REPLACEMENT CASINGS; BOWLING MACHINE PARTS, NAMELY, PINSPOTTERS, PINSETTERS, BALL LIFTS, AND BALL RETURNS, AND BOWLING APPARATUS AND MACHINERY IN THE NATURE OF CASTINGS FOR PINSPOTTERS, PINSETTERS, BALL LIFTS, FOUL LIGHTS, AND BALL RETURNS (U.S. CLS. 22, 23, 38 AND 50).

CLASS 35—ADVERTISING AND BUSINESS

FOR ONLINE RETAIL STORE SERVICES FEATURING A COMPLETE LINE OF BOWLING PIN AND BALL HANDLING APPARATUS AND REPLACEMENT PARTS THEREFOR (U.S. CLS. 100, 101 AND 102).

JUSTINE D. PARKER, EXAMINING ATTORNEY

SN 77-647,665. QUBICAAMF WORLDWIDE, S.A.R.L., LUXEMBOURG, LUXEMBOURG, FILED 1-12-2009.

SN 77-647,684. QUBICAAMF WORLDWIDE, S.A.R.L., LUXEMBOURG, LUXEMBOURG, FILED 1-12-2009.

VANTAGE

VANTAGE BOWLING

THE MARK CONSISTS OF STANDARD CHARACTERS WITHOUT CLAIM TO ANY PARTICULAR FONT, STYLE, SIZE, OR COLOR.

CLASS 7—MACHINERY

FOR MOTORS AND ENGINES EXCEPT FOR LAND VEHICLES AND ELECTRONIC REPLACEMENT COMPONENTS OF SUCH APPARATUS; ENGINE PARTS IN THE NATURE OF SOLENOIDS; ALTERNATORS NOT FOR LAND VEHICLES; INVERTER MOTORS NOT FOR LAND VEHICLES; REGULATORS BEING PARTS OF MACHINES; AC GENERATORS; GEAR REDUCING CONVERTERS FOR MOTORS NOT FOR LAND VEHICLES; MOTOR ADAPTER PLATE GEARBOX CONVERTERS NOT FOR LAND VEHICLES; PNEUMATIC CONTROLS FOR MACHINES; GEAR BOXES OTHER THAN FOR LAND VEHICLES; PNEUMATIC CONTROLS FOR MACHINES, MOTORS AND ENGINES; HYDRAULIC CONTROLS FOR MACHINES, MOTORS AND ENGINES (U.S. CLS. 13, 19, 21, 23, 31, 34 AND 35).

CLASS 9—ELECTRICAL AND SCIENTIFIC APPARATUS

FOR ELECTRONIC CONTROL SYSTEMS FOR MACHINES COMPRISED OF A CENTRAL PROCESSING UNIT, IMBEDDED MICROPROCESSOR AND ELECTRIC RELAY (U.S. CLS. 21, 23, 26, 36 AND 38).

THE MARK CONSISTS OF STANDARD CHARACTERS WITHOUT CLAIM TO ANY PARTICULAR FONT, STYLE, SIZE, OR COLOR.

NO CLAIM IS MADE TO THE EXCLUSIVE RIGHT TO USE "BOWLING", APART FROM THE MARK AS SHOWN.

CLASS 7—MACHINERY

FOR MOTORS AND ENGINES EXCEPT FOR LAND VEHICLES AND ELECTRONIC REPLACEMENT COMPONENTS OF SUCH APPARATUS; ENGINE PARTS IN THE NATURE OF SOLENOIDS; ALTERNATORS NOT FOR LAND VEHICLES; INVERTER MOTORS NOT FOR LAND VEHICLES; REGULATORS BEING PARTS OF MACHINES; AC GENERATORS; GEAR REDUCING CONVERTERS FOR MOTORS NOT FOR LAND VEHICLES; MOTOR ADAPTER PLATE GEARBOX CONVERTERS NOT FOR LAND VEHICLES; PNEUMATIC CONTROLS FOR MACHINES; GEAR BOXES OTHER THAN FOR LAND VEHICLES; PNEUMATIC CONTROLS FOR MACHINES, MOTORS AND ENGINES; HYDRAULIC CONTROLS FOR MACHINES, MOTORS AND ENGINES (U.S. CLS. 13, 19, 21, 23, 31, 34 AND 35).

CLASS 9—ELECTRICAL AND SCIENTIFIC APPARATUS

FOR ELECTRONIC CONTROL SYSTEMS FOR MACHINES COMPRISED OF A CENTRAL PROCESSING UNIT, IMBEDDED MICROPROCESSOR AND ELECTRIC RELAY (U.S. CLS. 21, 23, 26, 36 AND 38).

CLASS 28—TOYS AND SPORTING GOODS

FOR A COMPLETE LINE OF BOWLING PIN AND BALL HANDLING APPARATUS, NAMELY, APPARATUS TO PLACE BOWLING PINS, BALL LIFTS, AND PIN LIFTS; REPLACEMENT PARTS SPECIALLY ADAPTED FOR THE AFOREMENTIONED BOWLING PIN AND BALL HANDLING APPARATUS, NAMELY, BELTS, FUSES, TIMERS, MOLDED REPLACEMENT CASINGS; BOWLING MACHINE PARTS, NAMELY, PINSPOTTERS, PINSETTERS, BALL LIFTS, AND BALL RETURNS, AND BOWLING APPARATUS AND MACHINERY IN THE NATURE OF CASTINGS FOR PINSPOTTERS, PINSETTERS, BALL LIFTS, FOUL LIGHTS, AND BALL RETURNS (U.S. CLS. 22, 23, 38 AND 50).

CLASS 35—ADVERTISING AND BUSINESS

FOR ONLINE RETAIL STORE SERVICES FEATURING A COMPLETE LINE OF BOWLING PIN AND BALL HANDLING APPARATUS AND REPLACEMENT PARTS THEREFOR (U.S. CLS. 100, 101 AND 102).

JUSTINE D. PARKER, EXAMINING ATTORNEY

CLASS 28—TOYS AND SPORTING GOODS

FOR A COMPLETE LINE OF BOWLING PIN AND BALL HANDLING APPARATUS, NAMELY, APPARATUS TO PLACE BOWLING PINS, BALL LIFTS, AND PIN LIFTS; REPLACEMENT PARTS SPECIALLY ADAPTED FOR THE AFOREMENTIONED BOWLING PIN AND BALL HANDLING APPARATUS, NAMELY, BELTS, FUSES, TIMERS, MOLDED REPLACEMENT CASINGS; BOWLING MACHINE PARTS, NAMELY, PINSPOTTERS, PINSETTERS, BALL LIFTS, AND BALL RETURNS, AND BOWLING APPARATUS AND MACHINERY IN THE NATURE OF CASTINGS FOR PINSPOTTERS, PINSETTERS, BALL LIFTS, FOUL LIGHTS, AND BALL RETURNS (U.S. CLS. 22, 23, 38 AND 50).

CLASS 35—ADVERTISING AND BUSINESS

FOR ONLINE RETAIL STORE SERVICES FEATURING A COMPLETE LINE OF BOWLING PIN AND BALL HANDLING APPARATUS AND REPLACEMENT PARTS THEREFOR (U.S. CLS. 100, 101 AND 102).

JUSTINE D. PARKER, EXAMINING ATTORNEY

SN 77-647,706. QUBICAAMF WORLDWIDE, S.A.R.L., LUXEMBOURG, LUXEMBOURG, FILED 1-12-2009.

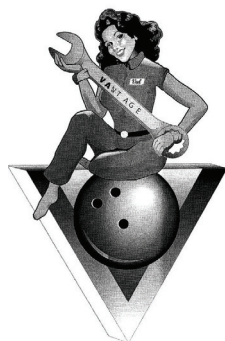

THE STIPPLING IS FOR SHADING PURPOSES ONLY. THE MARK CONSISTS OF A WOMAN HOLDING A WRENCH AND RESTING ON A BOWLING BALL WITHIN THE LETTER "V". THE WORDING "VANTAGE" APPEARS ON THE WRENCH AND THE NAME "VAL" APPEARS ON THE WOMAN'S NAME TAG.

CLASS 7—MACHINERY

FOR MOTORS AND ENGINES EXCEPT FOR LAND VEHICLES AND ELECTRONIC REPLACEMENT COMPONENTS OF SUCH APPARATUS; ENGINE PARTS IN THE NATURE OF SOLENOIDS; ALTERNATORS NOT FOR LAND VEHICLES; INVERTER MOTORS NOT FOR LAND VEHICLES; REGULATORS BEING PARTS OF MACHINES; AC GENERATORS; GEAR REDUCING CONVERTERS FOR MOTORS NOT FOR LAND VEHICLES; MOTOR ADAPTER PLATE GEARBOX CONVERTERS NOT FOR LAND VEHICLES; PNEUMATIC CONTROLS FOR MACHINES; GEAR BOXES OTHER THAN FOR LAND VEHICLES; PNEUMATIC CONTROLS FOR MACHINES, MOTORS AND ENGINES; HYDRAULIC CONTROLS FOR MACHINES, MOTORS AND ENGINES (U.S. CLS. 13, 19, 21, 23, 31, 34 AND 35).

CLASS 9—ELECTRICAL AND SCIENTIFIC APPARATUS

FOR ELECTRONIC CONTROL SYSTEMS FOR MACHINES COMPRISED OF A CENTRAL PROCESSING UNIT, IMBEDDED MICROPROCESSOR AND ELECTRIC RELAY (U.S. CLS. 21, 23, 26, 36 AND 38).

SN 77-649,049. AMERICAN ACADEMY OF OTOLARYNGOLOGY - HEAD AND NECK SURGERY, ALEXANDRIA, VA. FILED 1-14-2009.



**AMERICAN ACADEMY OF
OTOLARYNGOLOGY—
HEAD AND NECK SURGERY**

NO CLAIM IS MADE TO THE EXCLUSIVE RIGHT TO USE "AMERICAN ACADEMY OF OTOLARYNGOLOGY HEAD AND NECK SURGERY", APART FROM THE MARK AS SHOWN.

THE MARK CONSISTS OF AN IMAGE OF A PROFILE OF A HUMAN HEAD FACING TO THE RIGHT WITH ELLIPTICAL LINES EMBEDDED WITHIN. THE TERM "AMERICAN ACADEMY OF OTOLARYNGOLOGY - HEAD AND NECK SURGERY" IS LISTED TO THE RIGHT OF THE PROFILE IMAGE.

CLASS 16—PAPER GOODS AND PRINTED MATTER

FOR PAMPHLETS, BROCHURES, NEWSLETTERS, JOURNALS, MAGAZINES, BOOKS AND MANUALS IN THE FIELD OF OTOLARYNGOLOGY (U.S. CLS. 2, 5, 22, 23, 29, 37, 38 AND 50).

FIRST USE 10-1-2008; IN COMMERCE 10-1-2008.

CLASS 44—MEDICAL, BEAUTY AND AGRICULTURAL SERVICES

FOR PROVIDING EDUCATIONAL INFORMATION IN THE FIELD OF OTOLARYNGOLOGY VIA A GLOBAL COMPUTER NETWORK AND OTHER MEDIA FORMS (U.S. CLS. 100 AND 101).

FIRST USE 10-1-2008; IN COMMERCE 10-1-2008.
NICHOLAS ALTREE, EXAMINING ATTORNEY

SN 77-649,752. AGRIAN INC., FRESNO, CA. FILED 1-14-2009.



THE COLOR(S) GREEN AND BLUE IS/ARE CLAIMED AS A FEATURE OF THE MARK.

THE MARK CONSISTS OF THE WORD "AGRIAN" PRESENTED IN BLUE BLOCK LETTERS PRECEDED BY TWO GREEN LEAVES THAT OPEN TO A BLUE-COLORED, FOUR-PRONGED FORK IN THE CENTER OF THE LEAVES.

THE WORDING "AGRIAN" HAS NO MEANING IN A FOREIGN LANGUAGE.

CLASS 9—ELECTRICAL AND SCIENTIFIC APPARATUS

FOR DATABASE MANAGEMENT SOFTWARE FOR THE AGRICULTURAL AND FARMING INDUSTRY (U.S. CLS. 21, 23, 26, 36 AND 38).

FIRST USE 5-1-2008; IN COMMERCE 5-1-2008.

CLASS 42—SCIENTIFIC AND COMPUTER SERVICES

FOR APPLICATION SERVICE PROVIDER (ASP) FEATURING SOFTWARE FOR USE IN DATABASE MANAGEMENT, NAMELY, PROVIDING, HOSTING, MANAGING, DEVELOPING, RESEARCHING, ANALYZING, REPORTING AND MAINTAINING APPLICATIONS, SOFTWARE, WEB SITES AND DATABASES FOR AGRICULTURE (U.S. CLS. 100 AND 101).

FIRST USE 5-1-2008; IN COMMERCE 5-1-2008.
LESLIE RICHARDS, EXAMINING ATTORNEY

SN 77-650,373. CERTIFY DATA SYSTEMS, INC., SAN JOSE, CA. FILED 1-15-2009.

HEALTHDOCK

THE MARK CONSISTS OF STANDARD CHARACTERS WITHOUT CLAIM TO ANY PARTICULAR FONT, STYLE, SIZE, OR COLOR.

CLASS 9—ELECTRICAL AND SCIENTIFIC APPARATUS

FOR COMPUTER HARDWARE; COMPUTER SOFTWARE FOR USE IN TRANSMISSION OF INFORMATION REGARDING MEDICAL PATIENTS (U.S. CLS. 21, 23, 26, 36 AND 38).

CLASS 42—SCIENTIFIC AND COMPUTER SERVICES

FOR CUSTOMIZATION OF COMPUTER HARDWARE AND SOFTWARE FOR USE IN THE MEDICAL INDUSTRY (U.S. CLS. 100 AND 101).
KATHERINE CONNOLLY, EXAMINING ATTORNEY

SN 77-651,886. HARVEY BALL SMILE LIMITED, SHINAGAWA-KU TOKYO, JAPAN, FILED 1-19-2009.



OWNER OF U.S. REG. NOS. 3,066,172, 3,502,405 AND 3,502,982.

NO CLAIM IS MADE TO THE EXCLUSIVE RIGHT TO USE "DESIGNED BY" AND "USA 1963", APART FROM THE MARK AS SHOWN.

THE NAME, "HARVEY R. BALL" SHOWN IN THE MARK DOES NOT IDENTIFY A PARTICULAR LIVING INDIVIDUAL.

THE MARK CONSISTS OF A SMILEY FACE COMPRISED OF A CIRCLE CONTAINING TWO SMALL SHADED OVALS REPRESENTING EYES AND A WAVY HORIZONTAL LINE REPRESENTING A MOUTH, WITH DEFINED CORNERS, WITH THE WORDING, "DESIGNED BY HARVEY R. BALL USA 1963" PRINTED FROM THE LEFT TO THE RIGHT SIDE, ALONG THE BOTTOM OF THE SMILEY FACE.

CLASS 14—JEWELRY

FOR ALARM CLOCKS; BRACELETS; BRACELETS OF PRECIOUS METAL; BROOCHES (JEWELRY); CHRONOMETERS; CLOCKS; CUFF-LINKS; EARRINGS; FIGURES OF PRECIOUS METAL; FIGURINES OF PRECIOUS METAL; INSIGNIAS OF PRECIOUS METAL; KEY HOLDERS OF PRECIOUS METALS; KEY RINGS OF PRECIOUS METAL; NECKLACES; PRECIOUS GEMSTONES; TIE CLIPS; TIE PINS; WATCH BANDS; WATCHES; WRIST WATCHES (U.S. CLS. 2, 27, 28 AND 50).

CLASS 16—PAPER GOODS AND PRINTED MATTER

FOR A SERIES OF BOOKS AND WRITTEN ARTICLES IN THE FIELD OF CULTURE, ARTISTRY, HISTORY, LITERATURE, LANGUAGES AND GEOGRAPHY; ARTISTS' PASTELS; BOOK BINDINGS; DRAWING RULERS; ENVELOPES; EXERCISE BOOKS; GENERAL PURPOSE PLASTIC BAGS; GIFT CARDS; GLUE FOR STATIONERY OR HOUSEHOLD USE; JOURNALS CONCERNING CULTURE, ARTISTRY, HISTORY, LITERATURE, LANGUAGES AND GEOGRAPHY; MAGAZINES FEATURING CULTURE, ARTISTRY, HISTORY, LITERATURE, LANGUAGES AND GEOGRAPHY; MAGNETIC BOARDS; NEWSPAPERS IN THE FIELD OF CULTURE, ARTISTRY, HISTORY, LITERATURE, LANGUAGES AND GEOGRAPHY; OFFICE HOLE PUNCHERS; PAINT BRUSHES; PAMPHLETS IN THE FIELD OF CULTURE, ARTISTRY, HISTORY, LITERATURE, LANGUAGES AND GEOGRAPHY; PAPER CLIPS; PAPER CUTTERS; PAPER FASTENERS; PAPER RIBBONS; PAPERWEIGHTS; PEN CASES; PENCIL CASES; PENCIL SHARPENERS; PENCILS; PENS; PHOTOGRAPH ALBUMS; PUNCHES; RUBBER ERASERS; SCRATCH PADS; WRITING PAPER (U.S. CLS. 2, 5, 22, 23, 29, 37, 38 AND 50).

CLASS 18—LEATHER GOODS

FOR LEATHER AND IMITATION LEATHER BAGS; LEATHER BAGS AND WALLETS; LEATHER BRIEF-CASES; PARASOLS; TRAVELING BAGS; TRUNKS; UMBRELLAS (U.S. CLS. 1, 2, 3, 22 AND 41).

CLASS 21—HOUSEWARES AND GLASS

FOR BATH SPONGES; COMBS; CUPS; DRINKING GLASSES; HAIR BRUSHES; PET BRUSHES; PLATES; SERVING PLATTERS (U.S. CLS. 2, 13, 23, 29, 30, 33, 40 AND 50).

CLASS 28—TOYS AND SPORTING GOODS

FOR ACTION SKILL GAMES; CHILDREN'S MULTIPLE ACTIVITY TOYS; DOLLS; PARLOR GAMES; PLAY FIGURES; PLAY HOUSES; STUFFED TOYS (U.S. CLS. 22, 23, 38 AND 50).

ODESSA BIBBINS, EXAMINING ATTORNEY

CLASS 16—PAPER GOODS AND PRINTED MATTER

FOR A SERIES OF BOOKS AND WRITTEN ARTICLES IN THE FIELD OF CULTURE, ARTISTRY, HISTORY, LITERATURE, LANGUAGES AND GEOGRAPHY; ARTISTS' PASTELS; BOOKBINDINGS; DRAWING RULERS; ENVELOPES; EXERCISE BOOKS; GENERAL PURPOSE PLASTIC BAGS; GIFT CARDS; GLUE FOR STATIONERY OR HOUSEHOLD USE; JOURNALS CONCERNING CULTURE, ARTISTRY, HISTORY, LITERATURE, LANGUAGES AND GEOGRAPHY; MAGAZINES FEATURING CULTURE, ARTISTRY, HISTORY, LITERATURE, LANGUAGES AND GEOGRAPHY; MAGNETIC BOARDS; NEWSPAPERS IN THE FIELD OF CULTURE, ARTISTRY, HISTORY, LITERATURE, LANGUAGES AND GEOGRAPHY; OFFICE HOLE PUNCHERS; PAINT BRUSHES; PAMPHLETS IN THE FIELD OF CULTURE, ARTISTRY, HISTORY, LITERATURE, LANGUAGES AND GEOGRAPHY; PAPER CLIPS; PAPER CUTTERS; PAPER FASTENERS; PAPER RIBBONS; PAPERWEIGHTS; PEN CASES; PENCIL CASES; PENCIL SHARPENERS; PENCILS; PENS; PHOTOGRAPH ALBUMS; PUNCHES; RUBBER ERASERS; SCRATCH PADS; WRITING PAPER (U.S. CLS. 2, 5, 22, 23, 29, 37, 38 AND 50).

SN 77-652,330. HARVEY BALL SMILE LIMITED, SHINAGAWA-KU TOKYO, JAPAN, FILED 1-20-2009.

CLASS 18—LEATHER GOODS

FOR LEATHER AND IMITATION LEATHER BAGS; LEATHER BAGS AND WALLETS; LEATHER BRIEFCASES; PARASOLS; TRAVELING BAGS; TRUNKS; UMBRELLAS (U.S. CLS. 1, 2, 3, 22 AND 41).

CLASS 21—HOUSEWARES AND GLASS

FOR BATH SPONGES; COMBS; CUPS; DRINKING GLASSES; HAIR BRUSHES; PET BRUSHES; PLATES; SERVING PLATTERS (U.S. CLS. 2, 13, 23, 29, 30, 33, 40 AND 50).

CLASS 28—TOYS AND SPORTING GOODS

FOR ACTION SKILL GAMES; CHILDREN'S MULTIPLE ACTIVITY TOYS; DOLLS; PARLOR GAMES; PLAY FIGURES; PLAY HOUSES; STUFFED TOYS (U.S. CLS. 22, 23, 38 AND 50).

ODESSA BIBBINS, EXAMINING ATTORNEY



OWNER OF U.S. REG. NOS. 3,066,172, 3,502,405 AND 3,502,982.

NO CLAIM IS MADE TO THE EXCLUSIVE RIGHT TO USE "DESIGNED BY" AND "USA 1963", APART FROM THE MARK AS SHOWN.

THE NAME "HARVEY R. BALL" DOES NOT IDENTIFY A LIVING INDIVIDUAL.

THE MARK CONSISTS OF A SMILEY FACE COMPRISED OF A CIRCLE CONTAINING TWO SMALL SHADED OVALS REPRESENTING EYES AND A CURVED LINE REPRESENTING A MOUTH, WITH DEFINED CORNERS, WITH A TONGUE WITH A SHORT LINE ON IT, EXTENDING DOWNWARD FROM THE MOUTH, WITH THE WORDING, "DESIGNED BY HARVEY R. BALL USA 1963" PRINTED FROM THE LEFT TO THE RIGHT SIDE, ALONG THE BOTTOM OF THE SMILEY FACE.

CLASS 14—JEWELRY

FOR ALARM CLOCKS; BRACELETS; BRACELETS OF PRECIOUS METAL; BROOCHES (JEWELRY); CHRONOMETERS; CLOCKS; CUFF-LINKS; EARRINGS; FIGURES OF PRECIOUS METAL; FIGURINES OF PRECIOUS METAL; INSIGNIAS OF PRECIOUS METAL; KEY HOLDERS OF PRECIOUS METALS; KEY RINGS OF PRECIOUS METAL; NECKLACES; PRECIOUS GEMSTONES; TIE CLIPS; TIE PINS; WATCH BANDS; WATCHES; WRIST WATCHES (U.S. CLS. 2, 27, 28 AND 50).

SN 77-652,345. HARVEY BALL SMILE LIMITED, SHINAGAWA-KU TOKYO, JAPAN, FILED 1-20-2009.



OWNER OF U.S. REG. NOS. 3,066,172, 3,502,405 AND 3,502,982.

NO CLAIM IS MADE TO THE EXCLUSIVE RIGHT TO USE "DESIGNED BY" AND "USA 1963", APART FROM THE MARK AS SHOWN.

THE NAME, "HARVEY R. BALL" SHOWN IN THE MARK DOES NOT IDENTIFY A PARTICULAR LIVING INDIVIDUAL.

THE MARK CONSISTS OF A SMILEY FACE COMPRISED OF A CIRCLE CONTAINING ONE EYE, AND AN EYE PATCH AND ITS PARTIAL STRING, REPRESENTING AN EYE, WITH A CURVED LINE REPRESENTING A MOUTH, WITH THE WORDING, "DESIGNED BY HARVEY R. BALL USA 1963" PRINTED FROM THE LEFT TO THE RIGHT SIDE, ALONG THE BOTTOM OF THE SMILEY FACE.

SN 77-652,651. BUNDLE, LLC, BOULDER, CO. FILED 1-20-2009.



CLASS 14—JEWELRY

FOR ALARM CLOCKS; BRACELETS; BRACELETS OF PRECIOUS METAL; BROOCHES(JEWELRY); CHRONOMETERS; CLOCKS; CUFF-LINKS; EARRINGS; FIGURES OF PRECIOUS METAL; FIGURINES OF PRECIOUS METAL; INSIGNIAS OF PRECIOUS METAL; KEY HOLDERS OF PRECIOUS METALS; KEY RINGS OF PRECIOUS METAL; NECKLACES; PRECIOUS GEMSTONES; TIE CLIPS; TIE PINS; WATCH BANDS; WATCHES; WRIST WATCHES (U.S. CLS. 2, 27, 28 AND 50).

CLASS 16—PAPER GOODS AND PRINTED MATTER

FOR A SERIES OF BOOKS AND WRITTEN ARTICLES IN THE FIELD OF CULTURE, ARTISTRY, HISTORY, LITERATURE, LANGUAGES AND GEOGRAPHY; ARTISTS' PASTELS; BOOKBINDINGS; DRAWING RULERS; ENVELOPES; EXERCISE BOOKS; GENERAL PURPOSE PLASTIC BAGS; GIFT CARDS; GLUE FOR STATIONERY OR HOUSEHOLD USE; JOURNALS CONCERNING CULTURE, ARTISTRY, HISTORY, LITERATURE, LANGUAGES AND GEOGRAPHY; MAGAZINES FEATURING CULTURE, ARTISTRY, HISTORY, LITERATURE, LANGUAGES AND GEOGRAPHY; MAGNETIC BOARDS; NEWSPAPERS IN THE FIELD OF CULTURE, ARTISTRY, HISTORY, LITERATURE, LANGUAGES AND GEOGRAPHY; OFFICE HOLE PUNCHERS; PAINT BRUSHES; PAMPHLETS IN THE FIELD OF CULTURE, ARTISTRY, HISTORY, LITERATURE, LANGUAGES AND GEOGRAPHY; PAPER CLIPS; PAPER CUTTERS; PAPER FASTENERS; PAPER RIBBONS; PAPERWEIGHTS; PEN CASES; PENCIL CASES; PENCIL SHARPENERS; PENCILS; PENS; PHOTOGRAPH ALBUMS; PUNCHES; RUBBER ERASERS; SCRATCH PADS; WRITING PAPER (U.S. CLS. 2, 5, 22, 23, 29, 37, 38 AND 50).

CLASS 18—LEATHER GOODS

FOR LEATHER AND IMITATION LEATHER BAGS; LEATHER BAGS AND WALLETS; LEATHER BRIEF-CASES; PARASOLS; TRAVELING BAGS; TRUNKS; UMBRELLAS (U.S. CLS. 1, 2, 3, 22 AND 41).

CLASS 21—HOUSEWARES AND GLASS

FOR BATH SPONGES; COMBS; CUPS; DRINKING GLASSES; HAIR BRUSHES; PET BRUSHES; PLATES; SERVING PLATTERS (U.S. CLS. 2, 13, 23, 29, 30, 33, 40 AND 50).

CLASS 28—TOYS AND SPORTING GOODS

FOR ACTION SKILL GAMES; CHILDREN'S MULTIPLE ACTIVITY TOYS; DOLLS; PARLOR GAMES; PLAY FIGURES; PLAY HOUSES; STUFFED TOYS (U.S. CLS. 22, 23, 38 AND 50).
ODESSA BIBBINS, EXAMINING ATTORNEY

CLASS 35—ADVERTISING AND BUSINESS

FOR RETAIL STORE AND ON-LINE RETAIL STORE FEATURING DIAPERS, DIAPER RELATED PRODUCTS, BABY UTILITY PRODUCTS AND BABY GEAR (U.S. CLS. 100, 101 AND 102).
FIRST USE 9-30-2008; IN COMMERCE 10-3-2008.

CLASS 37—CONSTRUCTION AND REPAIR

FOR LAUNDERING OF BABIES' DIAPERS (U.S. CLS. 100, 103 AND 106).
FIRST USE 9-30-2008; IN COMMERCE 10-3-2008.

CLASS 39—TRANSPORTATION AND STORAGE

FOR PICK UP AND DELIVERY OF BABIES' DIAPERS (U.S. CLS. 100 AND 105).
FIRST USE 9-30-2008; IN COMMERCE 10-3-2008.
JESSICA A. POWERS, EXAMINING ATTORNEY

SN 77-654,560. WASTE CONNECTIONS, INC., FOLSOM, CA. FILED 1-22-2009.

WASTE CONNECTIONS, INC.

THE MARK CONSISTS OF STANDARD CHARACTERS WITHOUT CLAIM TO ANY PARTICULAR FONT, STYLE, SIZE, OR COLOR.

OWNER OF U.S. REG. NO. 2,434,529.
NO CLAIM IS MADE TO THE EXCLUSIVE RIGHT TO USE "WASTE" AND "INC.", APART FROM THE MARK AS SHOWN.

CLASS 37—CONSTRUCTION AND REPAIR

FOR WASTE COLLECTION AND DISPOSAL SERVICES FOR OTHERS; COLLECTION OF WASTE PRODUCTS FOR RECYCLING (U.S. CLS. 100, 103 AND 106).
FIRST USE 3-0-1998; IN COMMERCE 3-0-1998.

CLASS 39—TRANSPORTATION AND STORAGE

FOR WASTE TRANSFER SERVICES FOR OTHERS (U.S. CLS. 100 AND 105).
FIRST USE 3-0-1998; IN COMMERCE 3-0-1998.

CLASS 40—MATERIAL TREATMENT

FOR RECYCLING (U.S. CLS. 100, 103 AND 106).
FIRST USE 3-0-1998; IN COMMERCE 3-0-1998.
TRACY CROSS, EXAMINING ATTORNEY

SN 77-654,580. WASTE CONNECTIONS, INC., FOLSOM, CA. FILED 1-22-2009.



OWNER OF U.S. REG. NO. 2,323,406.
THE MARK CONSISTS OF A DIAMOND PARTIALLY SHADING ANOTHER DIAMOND WITH THE LETTERS "W" AND "C" WITHIN THE TOP DIAMOND AND THE LETTER "C" SET OVER THE LETTER "W".

CLASS 37—CONSTRUCTION AND REPAIR

FOR WASTE COLLECTION AND DISPOSAL SERVICES FOR OTHERS; COLLECTION OF WASTE PRODUCTS FOR RECYCLING (U.S. CLS. 100, 103 AND 106). FIRST USE 3-0-1998; IN COMMERCE 3-0-1998.

CLASS 39—TRANSPORTATION AND STORAGE

FOR WASTE TRANSFER SERVICES FOR OTHERS (U.S. CLS. 100 AND 105). FIRST USE 3-0-1998; IN COMMERCE 3-0-1998.

CLASS 40—MATERIAL TREATMENT

FOR RECYCLING (U.S. CLS. 100, 103 AND 106). FIRST USE 3-0-1998; IN COMMERCE 3-0-1998. TRACY CROSS, EXAMINING ATTORNEY

SN 77-654,839. EVER WELL LLC, MIAMI, FL. FILED 1-22-2009.

Ever Well

THE MARK CONSISTS OF STANDARD CHARACTERS WITHOUT CLAIM TO ANY PARTICULAR FONT, STYLE, SIZE, OR COLOR.

CLASS 7—MACHINERY

FOR AIR CONDITIONER COMPRESSORS; REFRIGERATION COMPRESSORS; AIR CONDITIONER SUPPLIES AND PARTS, NAMELY, ELECTRIC STARTER MOTORS, ELECTRIC TERMINAL MOTOR PROTECTORS, AND VIBRATION ELIMINATORS (U.S. CLS. 13, 19, 21, 23, 31, 34 AND 35).

CLASS 9—ELECTRICAL AND SCIENTIFIC APPARATUS

FOR AIR CONDITIONER SUPPLIES AND PARTS, NAMELY, CAPACITORS, DELAY TIMERS, DEFROST TIMERS, THERMOSTATS, ELECTRICAL PRESSURE SWITCHES, ELECTRICAL COMPONENTS IN THE NATURE OF ELECTRIC CONTACTORS, AND ELECTRICAL RELAYS IN THE NATURE OF POTENTIAL RELAYS, FAN RELAYS, PUSH BUTTON RELAYS, AND SOLID STATE RELAYS (U.S. CLS. 21, 23, 26, 36 AND 38).

CLASS 11—ENVIRONMENTAL CONTROL APPARATUS

FOR AIR CONDITIONERS; FREEZERS; REFRIGERATORS; AIR CONDITIONER SUPPLIES AND PARTS, NAMELY, DEFROST HEATERS (U.S. CLS. 13, 21, 23, 31 AND 34).

JEAN IM, EXAMINING ATTORNEY

SN 77-655,319. BOARDS VIDEO COMPANY, LLC, PORTLAND, OR. FILED 1-23-2009.

VIDEO HQ

THE MARK CONSISTS OF STANDARD CHARACTERS WITHOUT CLAIM TO ANY PARTICULAR FONT, STYLE, SIZE, OR COLOR.

NO CLAIM IS MADE TO THE EXCLUSIVE RIGHT TO USE "VIDEO", APART FROM THE MARK AS SHOWN.

CLASS 35—ADVERTISING AND BUSINESS

FOR RETAIL STORE SERVICES FEATURING AUDIO AND VIDEO RECORDINGS, COMPUTER GAMES, AND VIDEO GAMES; RETAIL STORE SERVICES FEATURING AUDIO AND VIDEO RECORDINGS, COMPUTER GAMES AND VIDEO GAMES FOR TRADE; ONLINE RETAIL STORE SERVICES IN THE FIELD OF AUDIO AND VIDEO RECORDINGS, COMPUTER GAMES AND VIDEO GAMES; ONLINE RETAIL STORE SERVICES FEATURING AUDIO AND VIDEO RECORDINGS, COMPUTER GAMES AND VIDEO GAMES FOR TRADE; ONLINE TRADING SERVICES IN WHICH A SELLER POSTS PRODUCTS TO BE AUCTIONED AND BIDDING IS DONE VIA THE INTERNET IN THE FIELD OF AUDIO AND VIDEO RECORDINGS, COMPUTER GAMES AND VIDEO GAMES (U.S. CLS. 100, 101 AND 102).

CLASS 41—EDUCATION AND ENTERTAINMENT

FOR RENTAL OF AUDIO AND VIDEO RECORDINGS, COMPUTER GAMES AND VIDEO GAMES (U.S. CLS. 100, 101 AND 107).

ERIN FALK, EXAMINING ATTORNEY

SN 77-657,931. ANAPHORE, INC., LA JOLLA, CA. FILED 1-27-2009.

OWNER OF U.S. REG. NO. 3,487,452.

ATRIMER

THE MARK CONSISTS OF STANDARD CHARACTERS WITHOUT CLAIM TO ANY PARTICULAR FONT, STYLE, SIZE, OR COLOR.

THE WORDING "ATRIMER" HAS NO MEANING IN A FOREIGN LANGUAGE.

CLASS 1—CHEMICALS

FOR BIOLOGICAL REAGENTS FOR LABORATORY, CLINICAL MEDICAL AND NON-CLINICAL MEDICAL RESEARCH APPLICATIONS (U.S. CLS. 1, 5, 6, 10, 26 AND 46).

CLASS 5—PHARMACEUTICALS

FOR PHARMACEUTICAL COMPOSITIONS AND PREPARATIONS FOR USE IN THERAPEUTICS FOR HUMAN, ANIMAL AND LIVESTOCK DISEASES, NAMELY, USE FOR CARDIOVASCULAR DISEASE, METABOLIC DISEASE, AUTOIMMUNE DISEASE, DIABETES, OBESITY, INFLAMMATORY DISEASE, VASCULAR DISEASE, DERMATOLOGICAL DISEASE, OCULAR DISEASE, HEMATOLOGICAL DISEASE, NEUROLOGICAL DISEASE, GASTROINTESTINAL DISEASE, RESPIRATORY DISEASE, VIRAL AND INFECTIOUS DISEASE, CANCER, ALLERGIES, ALLOGRAFT REJECTION, GENETIC DISORDERS, DISEASES OF THE MUSCULOSKELETAL AND NERVOUS SYSTEM, ANALGESICS AND WOUND HEALING; PHARMACEUTICAL COMPOSITIONS AND PREPARATIONS FOR THE DIAGNOSIS, PROPHYLAXIS AND TREATMENT OF HUMAN, ANIMAL AND LIVESTOCK DISEASES, NAMELY, CARDIOVASCULAR DISEASE, METABOLIC DISEASE, AUTOIMMUNE DISEASE, DIABETES, OBESITY, INFLAMMATORY DISEASE, VASCULAR DISEASE, DERMATOLOGICAL DISEASE, OCULAR DISEASE, HEMATOLOGICAL DISEASE, NEUROLOGICAL DISEASE, GASTROINTESTINAL DISEASE, RESPIRATORY DISEASE, VIRAL AND INFECTIOUS DISEASE, CANCER, ALLERGIES, ALLOGRAFT REJECTION, GENETIC DISORDERS, DISEASES OF THE MUSCULOSKELETAL AND NERVOUS SYSTEM, ANALGESICS AND WOUND HEALING; VACCINES; PHARMACEUTICAL COMPOSITIONS AND PREPARATIONS IN THE NATURE OF CONTRAST MEDIA FOR USE WITH MEDICAL IMAGING EQUIPMENT; BIOLOGICAL REAGENTS FOR USE IN CLINICAL MEDICAL AND NON-CLINICAL MEDICAL TESTS FOR THE DIAGNOSIS AND MEASUREMENT OF DISEASE PROGRESSION IN HUMAN, ANIMAL AND LIVESTOCK DISEASES; BIOLOGICAL REAGENTS FOR USE IN CLINICAL MEDICAL AND NON-CLINICAL MEDICAL IMAGING (U.S. CLS. 6, 18, 44, 46, 51 AND 52).

COLLEEN KEARNEY, EXAMINING ATTORNEY

SN 77-657,944. SMART IS COOL, LLC, KENNETT SQUARE, PA. FILED 1-27-2009.

SMART IS COOL

THE MARK CONSISTS OF STANDARD CHARACTERS WITHOUT CLAIM TO ANY PARTICULAR FONT, STYLE, SIZE, OR COLOR.

CLASS 16—PAPER GOODS AND PRINTED MATTER

FOR (BASED ON USE IN COMMERCE) A SERIES OF BOOKS, WRITTEN ARTICLES, HANDOUTS AND WORKSHEETS IN THE FIELD OF EDUCATION AND LEADERSHIP (U.S. CLS. 2, 5, 22, 23, 29, 37, 38 AND 50). FIRST USE 1-15-2007; IN COMMERCE 1-15-2007.

CLASS 35—ADVERTISING AND BUSINESS

FOR (BASED ON USE IN COMMERCE) RETAIL STORE AND ON-LINE RETAIL STORE SERVICES FEATURING CLOTHING (BASED ON INTENT TO USE) PROMOTING PUBLIC AWARENESS OF THE IMPORTANCE OF LEADERSHIP (U.S. CLS. 100, 101 AND 102). FIRST USE 10-5-2005; IN COMMERCE 10-5-2005.

CLASS 41—EDUCATION AND ENTERTAINMENT

FOR (BASED ON USE IN COMMERCE) EDUCATIONAL AND ENTERTAINMENT SERVICES, NAMELY, PROVIDING MOTIVATIONAL SPEAKING SERVICES IN THE FIELD OF LEADERSHIP; EDUCATIONAL SERVICES, NAMELY, PROVIDING WORKSHOP CONFERENCES AND IN THE FIELDS OF EDUCATION AND LEADERSHIP (BASED ON INTENT TO USE) EDUCATION SERVICES, NAMELY, PROVIDING EDUCATION WORKSHOPS IN THE FIELD OF EDUCATION AND LEADERSHIP; EDUCATION SERVICES, NAMELY, PROVIDING MENTORING, TUTORING, CLASSES, SEMINARS AND WORKSHOPS IN THE FIELD OF EDUCATION AND LEADERSHIP (U.S. CLS. 100, 101 AND 107).

FIRST USE 1-15-2006; IN COMMERCE 1-15-2006.

MATTHEW EINSTEIN, EXAMINING ATTORNEY

SN 77-658,175. HITACHI CONSULTING CORPORATION, DALLAS, TX. FILED 1-28-2009.

BUILDING THE MARKET RESPONSIVE COMPANY

THE MARK CONSISTS OF STANDARD CHARACTERS WITHOUT CLAIM TO ANY PARTICULAR FONT, STYLE, SIZE, OR COLOR.

CLASS 35—ADVERTISING AND BUSINESS

FOR BUSINESS MANAGEMENT AND CONSULTATION SERVICES (U.S. CLS. 100, 101 AND 102). FIRST USE 2-0-2008; IN COMMERCE 2-0-2008.

CLASS 42—SCIENTIFIC AND COMPUTER SERVICES

FOR COMPUTER CONSULTATION IN THE FIELD OF COMPUTERIZED INFORMATION PROCESSING SYSTEMS (U.S. CLS. 100 AND 101).

FIRST USE 2-0-2008; IN COMMERCE 2-0-2008.

BONNIE LUKEN, EXAMINING ATTORNEY

SN 77-658,507. MITSUI BUSSAN TECHNO PRODUCTS CO., LTD., OSAKA, JAPAN, FILED 1-28-2009.

Fire Protech

THE MARK CONSISTS OF STANDARD CHARACTERS WITHOUT CLAIM TO ANY PARTICULAR FONT, STYLE, SIZE, OR COLOR.

NO CLAIM IS MADE TO THE EXCLUSIVE RIGHT TO USE "FIRE", APART FROM THE MARK AS SHOWN.

CLASS 9—ELECTRICAL AND SCIENTIFIC APPARATUS

FOR PROTECTIVE CLOTHING (U.S. CLS. 21, 23, 26, 36 AND 38).

CLASS 20—FURNITURE AND ARTICLES NOT OTHERWISE CLASSIFIED

FOR BEDS; FURNITURE FOR HOUSE, OFFICE AND GARDEN; MATTRESSES (U.S. CLS. 2, 13, 22, 25, 32 AND 50).

CLASS 24—FABRICS

FOR DRAPERIES; FURNISHING AND UPHOLSTERY FABRICS (U.S. CLS. 42 AND 50).

CLASS 25—CLOTHING

FOR SLEEPWEAR (U.S. CLS. 22 AND 39).

CLASS 27—FLOOR COVERINGS

FOR CARPETS; WALL COVERINGS OF TEXTILE AND NON-WOVEN FABRIC (U.S. CLS. 19, 20, 37, 42 AND 50).

JILL C. ALT, EXAMINING ATTORNEY

SN 77-658,674. CHRIS W. CAMPBELL, SAN JOSE, CA. FILED 1-28-2009.

GUITAR LINK

THE MARK CONSISTS OF STANDARD CHARACTERS WITHOUT CLAIM TO ANY PARTICULAR FONT, STYLE, SIZE, OR COLOR.

NO CLAIM IS MADE TO THE EXCLUSIVE RIGHT TO USE "GUITAR", APART FROM THE MARK AS SHOWN.

CLASS 15—MUSICAL INSTRUMENTS

FOR MUSICAL INSTRUMENTS AND SUPPLIES, NAMELY, STANDS, CASES, STORAGE CASES, GUITAR PEDALS, STRAPS AND STRINGS (U.S. CLS. 2, 21 AND 36).

CLASS 35—ADVERTISING AND BUSINESS

FOR RETAIL STORE SERVICES, ON-LINE RETAIL STORE SERVICES AND MAIL ORDER CATALOG SERVICES FEATURING MUSICAL INSTRUMENTS, ACCESSORIES AND SUPPLIES (U.S. CLS. 100, 101 AND 102).
GIANCARLO CASTRO, EXAMINING ATTORNEY

SN 77-658,983. BOOKBLAST LTD, LONDON, UNITED KINGDOM, FILED 1-29-2009.

BookBlast

THE MARK CONSISTS OF STANDARD CHARACTERS WITHOUT CLAIM TO ANY PARTICULAR FONT, STYLE, SIZE, OR COLOR.

OWNER OF UNITED KINGDOM REG. NO. 2504188, DATED 12-5-2008, EXPIRES 12-5-2018.

CLASS 35—ADVERTISING AND BUSINESS

FOR PROMOTION, MARKETING AND ADVERTISING SERVICES; PUBLIC RELATIONS SERVICES; INFORMATION, ADVISORY AND CONSULTANCY SERVICES RELATING TO THE AFORESAID SERVICES; LITERARY AGENCY SERVICES, WRITERS AGENCY SERVICES (U.S. CLS. 100, 101 AND 102).

CLASS 41—EDUCATION AND ENTERTAINMENT

FOR PUBLISHING SERVICES; TRANSLATION SERVICES; PUBLICATION OF ELECTRONIC BOOKS AND JOURNALS ONLINE; INFORMATION, ADVISORY AND CONSULTANCY SERVICES RELATING THERETO; PROVISION OF INFORMATION IN RELATION TO BOOKS (U.S. CLS. 100, 101 AND 107).

PAUL F. GAST, EXAMINING ATTORNEY

SN 77-659,124. N.V. PERRICONE LLC, MERIDEN, CT. FILED 1-29-2009.

PERRICONE MD SMART BITE

THE MARK CONSISTS OF STANDARD CHARACTERS WITHOUT CLAIM TO ANY PARTICULAR FONT, STYLE, SIZE, OR COLOR.

OWNER OF U.S. REG. NOS. 2,237,822, 3,126,999 AND OTHERS.

NO CLAIM IS MADE TO THE EXCLUSIVE RIGHT TO USE "BITE", APART FROM THE MARK AS SHOWN.

CLASS 5—PHARMACEUTICALS

FOR MEAL REPLACEMENT BARS; NUTRITIONAL ENERGY BARS FOR USE AS A MEAL SUBSTITUTE (U.S. CLS. 6, 18, 44, 46, 51 AND 52).

CLASS 29—MEATS AND PROCESSED FOODS

FOR FRUIT-BASED ORGANIC FOOD BARS; NUT AND SEED-BASED SNACK BARS; PROTEIN BASED, NUTRIENT-DENSE SNACK BARS; SOY-BASED FOOD BARS (U.S. CL. 46).

SN 77-660,582. MOBDUB, LLC, NEW YORK, NY. FILED 1-30-2009.

CLASS 30—STAPLE FOODS

FOR CEREAL BASED ENERGY BARS; CHOCOLATE-BASED READY-TO-EAT FOOD BARS (U.S. CL. 46).
SUSAN RICHARDS, EXAMINING ATTORNEY

VIDEO FOR GENERATION CLICK

SN 77-659,960. PHARMA MARINE AS, SØVIK, NORWAY, FILED 1-30-2009.

CALAMARINE

THE MARK CONSISTS OF STANDARD CHARACTERS WITHOUT CLAIM TO ANY PARTICULAR FONT, STYLE, SIZE, OR COLOR.

THE MARK CONSISTS OF STANDARD CHARACTERS WITHOUT CLAIM TO ANY PARTICULAR FONT, STYLE, SIZE, OR COLOR.

NO CLAIM IS MADE TO THE EXCLUSIVE RIGHT TO USE "VIDEO", APART FROM THE MARK AS SHOWN.

CLASS 1—CHEMICALS

FOR CHEMICALS USED IN INDUSTRY, SCIENCE AND PHOTOGRAPHY, CHEMICAL SUBSTANCES FOR PRESERVING FOODSTUFFS (U.S. CLS. 1, 5, 6, 10, 26 AND 46).

CLASS 9—ELECTRICAL AND SCIENTIFIC APPARATUS

FOR COMPUTER SOFTWARE FOR USE IN VIDEO EDITING ASSOCIATING COMMENTARY AND ANNOTATING, BY MEANS OF SUBTITLING, CAPTIONING AND TELETXT FOR FEATURE FILMS, TELEVISION PROGRAMS, VIDEOS AND DIGITAL MEDIA IN GENERAL; COMPUTER SOFTWARE THAT PROVIDES WEB-BASED ACCESS TO APPLICATIONS AND SERVICES THROUGH A WEB OPERATING SYSTEM OR PORTAL INTERFACE THAT MAY BE DOWNLOADED FROM A GLOBAL COMPUTER NETWORK (U.S. CLS. 21, 23, 26, 36 AND 38).

FIRST USE 11-20-2008; IN COMMERCE 11-20-2008.

CLASS 5—PHARMACEUTICALS

FOR PHARMACEUTICAL PREPARATIONS FOR THE PREVENTION AND TREATMENT OF DISORDERS OF THE BRAIN, THE EYE, THE NERVOUS SYSTEM, THE IMMUNE SYSTEM, THE CARDIO-VASCULAR SYSTEM, THE METABOLIC SYSTEM, THE RESPIRATORY SYSTEM, THE MUSCULO-SKELETAL SYSTEM, AND THE GENITOURINARY SYSTEM (U.S. CLS. 6, 18, 44, 46, 51 AND 52).

CLASS 41—EDUCATION AND ENTERTAINMENT

FOR PROVIDING A WEB SITE FEATURING A SEARCHABLE DATABASE OF INFORMATION RELATED TO VIDEOS, MULTIMEDIA CONTENT AND PHOTOS IN THE FIELD OF ENTERTAINMENT, POP CULTURE, CURRENT EVENTS, EDUCATION AND SPORTS; ENTERTAINMENT, EDUCATION AND NEWS SERVICES, NAMELY, PROVIDING AN ONLINE INTERACTIVE DATABASE OF PHOTOS, MULTIMEDIA CONTENT, AND LINKS AND REFERENCES TO VIDEOS IN THE FIELD OF ENTERTAINMENT, POP CULTURE, CURRENT EVENTS, EDUCATION AND SPORTS (U.S. CLS. 100, 101 AND 107).

FIRST USE 11-20-2008; IN COMMERCE 11-20-2008.

CLASS 29—MEATS AND PROCESSED FOODS

FOR JELLIES, JAMS; FRUIT SAUCES, NAMELY, CRANBERRY SAUCE AND APPLESAUCE; MILK; MILK PRODUCTS EXCLUDING ICE CREAM, ICE MILK AND FROZEN YOGURT; EDIBLE OILS AND FATS; SYRUPS AND PREPARATIONS FOR MAKING MILK BEVERAGES MADE PREDOMINANTLY OF MILK (U.S. CL. 46).

CLASS 42—SCIENTIFIC AND COMPUTER SERVICES

FOR PROVIDING A WEB SITE PROVIDING TEMPORARY USE OF NON-DOWNLOADABLE SOFTWARE ALLOWING USERS TO UPLOAD LINKS TO VIDEOS, AND TO POST, ANNOTATE, PERSIST COMMENTARY ON, EDIT, SUBTITLE, CAPTION, AND DISPLAY ONLINE VIDEOS FOR SHARING WITH OTHERS FOR ENTERTAINMENT, EDUCATION AND NEWS PURPOSES; APPLICATION SERVICE PROVIDER, NAMELY, PROVIDING, HOSTING, MANAGING, DEVELOPING, REPORTING AND MAINTAINING APPLICATIONS AND SOFTWARE FOR VIDEO ANNOTATIONS, METADATA AND COMMENTARY; PROVIDING ON-LINE NON-DOWNLOADABLE COMPUTER SOFTWARE THAT PROVIDES WEB-BASED ACCESS TO APPLICATIONS AND SERVICES THROUGH A WEB OPERATING SYSTEM OR PORTAL INTERFACE (U.S. CLS. 100 AND 101).

FIRST USE 11-20-2008; IN COMMERCE 11-20-2008.
JOHN DWYER, EXAMINING ATTORNEY

CLASS 30—STAPLE FOODS

FOR FRUIT SAUCES EXCLUDING CRANBERRY SAUCE AND APPLESAUCE; MILK PRODUCTS, NAMELY, MILK SHAKES, ICE CREAM, ICE MILK AND FROZEN YOGURT; SYRUPS AND PREPARATIONS FOR MAKING COFFEE-BASED BEVERAGE CONTAINING MILK (U.S. CL. 46).

CLASS 32—LIGHT BEVERAGES

FOR FRUIT DRINKS AND FRUIT JUICES; SYRUPS AND PREPARATIONS FOR MAKING SOFT DRINKS, SPORTS DRINKS, FRUIT DRINKS (U.S. CLS. 45, 46 AND 48).

B. PARADEWELAI, EXAMINING ATTORNEY

SN 77-662,817. SHEA, MICHAEL J, DBA MIKE SHEA'S COFFEEHOUSE TRADITIONALS, RAYNHAM, MA. FILED 2-4-2009.

SN 77-662,924. ANDERSEN CORPORATION, BAYPORT, MN. FILED 2-4-2009.



NO CLAIM IS MADE TO THE EXCLUSIVE RIGHT TO USE "COFFEEHOUSE", APART FROM THE MARK AS SHOWN.

THE NAME(S), PORTRAIT(S), AND/OR SIGNATURE(S) SHOWN IN THE MARK IDENTIFIES MICHAEL SHEA, WHOSE CONSENT(S) TO REGISTER IS MADE OF RECORD.

THE COLOR(S) BLACK AND BROWN IS/ARE CLAIMED AS A FEATURE OF THE MARK.

THE MARK CONSISTS OF THE WORDING "MIKE SHEA'S COFFEEHOUSE TRADITIONALS". THE WORDING "MIKE SHEA'S" IS IN A LIGHT SHADE OF BROWN OVERLYING A RECTANGULAR BOX WITH ROUNDED CORNERS IN A DARK SHADE OF BROWN OUTLINED IN A LIGHT SHADE OF BROWN. THE WORDING "COFFEEHOUSE" IS IN THE COLOR BLACK, BELOW THE WORDING "MIKE SHEA'S". THE WORDING "TRADITIONALS" IS IN THE COLOR BROWN, BELOW THE WORDING "COFFEEHOUSE". ABOVE THE WORDINGS IS A DESIGN ELEMENT OF A ROW OF COFFEE BEANS IN THREE SHADES OF BROWN AND THE COLOR BLACK.

CLASS 30—STAPLE FOODS

FOR BEVERAGES MADE OF COFFEE; CAFFEINE-FREE COFFEE; CHOCOLATE COVERED ROASTED COFFEE BEANS; COFFEE; COFFEE; COFFEE AND ARTIFICIAL COFFEE; COFFEE AND COFFEE SUBSTITUTES; COFFEE AND TEA; COFFEE BASED BEVERAGES; COFFEE BEANS; COFFEE BEVERAGES WITH MILK; COFFEE ESSENCES; COFFEE EXTRACTS; COFFEE FLAVORED SYRUP USED IN MAKING FOOD BEVERAGES; COFFEE PODS; COFFEE SUBSTITUTES; COFFEE-BASED BEVERAGE CONTAINING MILK; COFFEE-BASED BEVERAGES; GREEN COFFEE; GROUND COFFEE BEANS; ICED COFFEE; INSTANT COFFEE; PREPARED COFFEE AND COFFEE-BASED BEVERAGES; ROASTED COFFEE BEANS; SUGAR-COATED COFFEE BEANS; UNROASTED COFFEE (U.S. CL. 46).

CLASS 35—ADVERTISING AND BUSINESS

FOR DRIVE-THROUGH RETAIL STORE SERVICES FEATURING COFFEE AND RELATED GOODS; WHOLESALE STORE, RETAIL STORE, MAIL ORDER, AND ON-LINE ORDERING SERVICES FEATURING COFFEE, TEA, COCOA, HOT CHOCOLATE, FLAVORING SYRUPS AND SAUCES, COFFEE MAKERS, ESPRESSO MACHINES AND TEAPOTS; WHOLESALE FOOD DISTRIBUTORSHIP SERVICES (U.S. CLS. 100, 101 AND 102).

WENDY JUN, EXAMINING ATTORNEY



OWNER OF U.S. REG. NO. 3,592,075.

THE MARK CONSISTS OF THE IMAGE OF A MAN HOLDING A WINDOW WITH IMAGES OF A HOUSE AND TREES IN THE BACKGROUND.

CLASS 19—NON-METALLIC BUILDING MATERIALS

FOR NON-METAL WINDOWS AND COMPONENTS THEREOF (U.S. CLS. 1, 12, 33 AND 50).
FIRST USE 7-0-2007; IN COMMERCE 7-0-2007.

CLASS 35—ADVERTISING AND BUSINESS

FOR RETAIL STORE SERVICES FEATURING DOORS, REPLACEMENT WINDOWS (U.S. CLS. 100, 101 AND 102).
FIRST USE 7-0-2007; IN COMMERCE 7-0-2007.

CLASS 37—CONSTRUCTION AND REPAIR

FOR INSTALLATION OF WINDOWS AND DOORS (U.S. CLS. 100, 103 AND 106).
FIRST USE 7-0-2007; IN COMMERCE 7-0-2007.
HEATHER BIDDULPH, EXAMINING ATTORNEY

SN 77-663,214. WWW VIAJEZ COM, S.A. DE C.V., ESTADO DE MEXICO, MEXICO, FILED 2-4-2009.

VIAJEZ

THE MARK CONSISTS OF STANDARD CHARACTERS WITHOUT CLAIM TO ANY PARTICULAR FONT, STYLE, SIZE, OR COLOR.

THE WORDING "VIAJEZ" DOES NOT HAVE ANY MEANING IN A FOREIGN LANGUAGE.

CLASS 39—TRANSPORTATION AND STORAGE

FOR TRIP ORGANIZATION SERVICES FEATURING BOOKINGS FOR AIRPLANE TRAVEL (U.S. CLS. 100 AND 105).

CLASS 42—SCIENTIFIC AND COMPUTER SERVICES

FOR COMPUTER SOFTWARE DEVELOPMENT AND COMPUTER SOFTWARE DESIGN SERVICES (U.S. CLS. 100 AND 101).

CLASS 43—HOTEL AND RESTAURANT SERVICES

FOR HOTEL RESERVATION SERVICES (U.S. CLS. 100 AND 101).

JAY FLOWERS, EXAMINING ATTORNEY

SN 77-665,873. WEISSEBERGER, SUSANNE, DBA WHITE MOUNTAIN PHOTOGRAPHY, HALF MOON BAY, CA. FILED 2-8-2009.

White Mountain Photography

THE MARK CONSISTS OF STANDARD CHARACTERS WITHOUT CLAIM TO ANY PARTICULAR FONT, STYLE, SIZE, OR COLOR.

NO CLAIM IS MADE TO THE EXCLUSIVE RIGHT TO USE "PHOTOGRAPHY", APART FROM THE MARK AS SHOWN.

CLASS 41—EDUCATION AND ENTERTAINMENT

FOR AERIAL PHOTOGRAPHY; PHOTOGRAPHY; PHOTOGRAPHY SERVICES (U.S. CLS. 100, 101 AND 107).

FIRST USE 7-7-2003; IN COMMERCE 7-7-2003.

CLASS 45—PERSONAL AND LEGAL SERVICES

FOR STOCK PHOTOGRAPHY SERVICES, NAMELY, LEASING REPRODUCTION RIGHTS OF PHOTOGRAPHS AND TRANSPARENCIES TO OTHERS (U.S. CLS. 100 AND 101).

FIRST USE 7-7-2003; IN COMMERCE 7-7-2003.
ODESSA BIBBINS, EXAMINING ATTORNEY

SN 77-665,993. EDIBLE ARRANGEMENTS, LLC, WALLINGFORD, CT. FILED 2-9-2009.

SWEET ANNIVERSARY CELEBRATION

THE MARK CONSISTS OF STANDARD CHARACTERS WITHOUT CLAIM TO ANY PARTICULAR FONT, STYLE, SIZE, OR COLOR.

CLASS 29—MEATS AND PROCESSED FOODS

FOR FRESH FRUIT CUT INTO FLOWER SHAPES AND ARRANGED IN CONTAINERS AS FLORAL DESIGNS; PROCESSED FRUITS; ARRANGEMENTS MADE OF FRESH PROCESSED FRUIT (U.S. CL. 46).

FIRST USE 2-6-2009; IN COMMERCE 2-6-2009.

CLASS 30—STAPLE FOODS

FOR FRESH FRUIT CUT INTO FLOWER SHAPES AND AT LEAST PARTIALLY COATED WITH CHOCOLATE; PROCESSED FRUITS AT LEAST PARTIALLY COATED WITH CHOCOLATE; ARRANGEMENTS MADE OF FRESH PROCESSED FRUIT COATED WITH CHOCOLATE; FRESH FRUIT CUT INTO FLOWER SHAPES AND AT LEAST PARTIALLY COATED WITH CHOCOLATE AND ARRANGED IN CONTAINERS AS FLORAL DESIGNS; ARRANGEMENTS MADE OF FRESH FRUIT AT LEAST PARTIALLY COATED WITH CHOCOLATE (U.S. CL. 46).

FIRST USE 2-6-2009; IN COMMERCE 2-6-2009.
CHARLES L. JENKINS, EXAMINING ATTORNEY

SN 77-667,179. ANDREAS STIHL AG & CO KG, WAIBLINGEN, FED REP GERMANY, FILED 2-10-2009.

MASTER WRENCH SERVICE

THE MARK CONSISTS OF STANDARD CHARACTERS WITHOUT CLAIM TO ANY PARTICULAR FONT, STYLE, SIZE, OR COLOR.

NO CLAIM IS MADE TO THE EXCLUSIVE RIGHT TO USE "WRENCH SERVICE", APART FROM THE MARK AS SHOWN.

CLASS 25—CLOTHING

FOR SHIRTS, T-SHIRTS, HATS, COATS, PULL-OVERS, BELTS, PANTS, UNIFORMS (U.S. CLS. 22 AND 39).

CLASS 26—FANCY GOODS

FOR CLOTH PATCHES FOR CLOTHING (U.S. CLS. 37, 39, 40, 42 AND 50).

CLASS 35—ADVERTISING AND BUSINESS

FOR RETAIL AND WHOLESALE STORE SERVICES FEATURING HAND TOOLS AND POWER TOOLS AND EQUIPMENT (U.S. CLS. 100, 101 AND 102).

CLASS 37—CONSTRUCTION AND REPAIR

FOR REPAIR AND MAINTENANCE SERVICES FOR POWER TOOLS AND EQUIPMENT (U.S. CLS. 100, 103 AND 106).

CLASS 41—EDUCATION AND ENTERTAINMENT

FOR EDUCATIONAL SERVICES, NAMELY, TRAINING PROGRAM FOR THE USE OF POWER TOOLS AND EQUIPMENT (U.S. CLS. 100, 101 AND 107).

MORGAN WYNNE, EXAMINING ATTORNEY

SN 77-667,195. FRAME TAILOR LIMITED, GLASGOW, UNITED KINGDOM, FILED 2-10-2009.

FRAME TAILOR

THE MARK CONSISTS OF STANDARD CHARACTERS WITHOUT CLAIM TO ANY PARTICULAR FONT, STYLE, SIZE, OR COLOR.

PRIORITY CLAIMED UNDER SEC. 44(D) ON ERPN CMNTY TM OFC APPLICATION NO. 007157001, FILED 8-13-2008, REG. NO. 007157001, DATED 5-20-2009, EXPIRES 8-13-2018.

NO CLAIM IS MADE TO THE EXCLUSIVE RIGHT TO USE "FRAME", APART FROM THE MARK AS SHOWN.

CLASS 9—ELECTRICAL AND SCIENTIFIC APPARATUS

FOR SPECTACLES, OPTICAL GLASSES, SUNGLASSES; OPTICAL LENSES; SPECTACLE CASES, CHAINS, FRAMES, HOLDERS AND MOUNTINGS; GLASSES FOR OPTICAL USE OR ADAPTED TO PROTECT THE EYES; EYE GLASSES; EYEWEAR, NAMELY, EYE GLASS SHIELDS AND EYE GLASS RESTRAINING STRAPS; GLASSES CASES AND FRAMES; EYEWEAR, NAMELY, EYE PIECES AND INSTRUMENTS CONTAINING EYE PIECES; MONOCLES; PINCE-NEZ; EYE SHADES IN THE NATURE OF SUNGLASSES AND EYEWEAR; EYE GLASS CASES, CHAINS, CORDS, FRAMES, HOLDERS AND MOUNTINGS; CONTACT LENSES; CONTACT LENS CASES, CONTAINERS AND HOLDERS; REPLACEMENT PARTS AND FITTINGS FOR ALL THE AFORESAID GOODS (U.S. CLS. 21, 23, 26, 36 AND 38).

CLASS 35—ADVERTISING AND BUSINESS

FOR THE BRINGING TOGETHER, FOR THE BENEFIT OF OTHERS, OF A VARIETY OF OPTICAL APPARATUS AND INSTRUMENTS, SPECTACLES, GLASSES, SUNGLASSES, LENSES, CONTACT LENSES, GLASSES CASES AND FRAMES, AND PARTS AND FITTINGS FOR THE AFORESAID, ENABLING CUSTOMERS TO CONVENIENTLY VIEW AND PURCHASE THOSE GOODS FROM DEPARTMENT STORES, TELEVISION SHOPPING CHANNELS, GENERAL MERCHANDISE WEB SITES, GENERAL MAIL ORDER CATALOGUES; THE BRINGING TOGETHER, FOR THE BENEFIT OF OTHERS, OF A VARIETY OF OPTICAL APPARATUS AND INSTRUMENTS, SPECTACLES, GLASSES, SUNGLASSES, LENSES, CONTACT LENSES, GLASSES CASES AND FRAME, AND PARTS AND FITTINGS FOR THE AFORESAID, ENABLING CUSTOMERS TO CONVENIENTLY VIEW AND PURCHASE THOSE GOODS FROM SPECIALIST RETAIL OUTLETS, NAMELY, SPECIALIST STORES, MAIL ORDER CATALOGUES, INTERNET WEB SITES; INFORMATION, ADVISORY AND CONSULTANCY SERVICES RELATING TO ALL THE AFORESAID (U.S. CLS. 100, 101 AND 102).

CLASS 37—CONSTRUCTION AND REPAIR

FOR REPAIR OF OPTICAL APPARATUS AND INSTRUMENTS, SPECTACLES, GLASSES, SUNGLASSES, LENSES, CONTACT LENSES; REPAIR OF FRAMES AND CASES FOR SPECTACLES, GLASSES, SUNGLASSES; INFORMATION, ADVISORY AND CONSULTANCY SERVICES RELATING TO ALL THE AFORESAID (U.S. CLS. 100, 103 AND 106).

CLASS 44—MEDICAL, BEAUTY AND AGRICULTURAL SERVICES

FOR OPTICIAN SERVICES; OPHTHALMIC AND OPTOMETRIST SERVICES; EYECARE SERVICES, NAMELY, OPTOMETRY SERVICES, EYE EXAMINATION SERVICES, ADVISORY SERVICES RELATING TO SELECTION OF SPECTACLES; AFTERCARE SERVICES RELATING TO THE PROVISION OF OPTICAL PRODUCTS, NAMELY, SERVICES RELATING TO THE FITTING AND ADJUSTMENT OF OPTICAL PRODUCTS; EYE GLASS FITTING AND SIGHT TESTING SERVICES; INFORMATION, ADVISORY AND CONSULTANCY SERVICES RELATING TO ALL THE AFORESAID (U.S. CLS. 100 AND 101).

MARK PILARO, EXAMINING ATTORNEY

SN 77-667,558. EYFER DESIGN, LLC, CHANDLER, AZ, FILED 2-10-2009.

AXIA ALLOYS

THE MARK CONSISTS OF STANDARD CHARACTERS WITHOUT CLAIM TO ANY PARTICULAR FONT, STYLE, SIZE, OR COLOR.

NO CLAIM IS MADE TO THE EXCLUSIVE RIGHT TO USE "ALLOYS", APART FROM THE MARK AS SHOWN.

CLASS 12—VEHICLES

FOR PARTS FOR OFFROAD UTILITY VEHICLES, ALL-TERRAIN VEHICLES, AND BOATS, NAMELY, CLAMPS AND/OR CLAMPING SYSTEMS COMPRISED OF CLAMPS FOR USE WITH AFTERMARKE ACCESSORIES (U.S. CLS. 19, 21, 23, 31, 35 AND 44).

FIRST USE 9-1-2007; IN COMMERCE 9-1-2007.

CLASS 35—ADVERTISING AND BUSINESS

FOR ONLINE RETAIL STORE SERVICES FEATURING PARTS AND EQUIPMENT FOR OFFROAD UTILITY VEHICLES, ALL-TERRAIN VEHICLES, AND BOATS; RETAIL STORE SERVICES FEATURING PARTS AND EQUIPMENT FOR OFFROAD UTILITY VEHICLES, ALL-TERRAIN VEHICLES, AND BOATS (U.S. CLS. 100, 101 AND 102).

FIRST USE 9-1-2007; IN COMMERCE 9-1-2007.

MELISSA VALLILLO, EXAMINING ATTORNEY

SN 77-670,374. SOCIETE FRANCAISE D'ASSAINISSEMENT-SFA, 75002 PARIS, FRANCE, FILED 2-13-2009.

SANICUBIC

THE MARK CONSISTS OF STANDARD CHARACTERS WITHOUT CLAIM TO ANY PARTICULAR FONT, STYLE, SIZE, OR COLOR.

OWNER OF ERPN CMNTY TM OFC REG. NO. 002959401, DATED 2-25-2004, EXPIRES 12-4-2012.

CLASS 7—MACHINERY

FOR SHREDDERS FOR WATER CLOSETS; MINI-PUMPING STATIONS, NAMELY, SHREDDER WATER-PUMPS (U.S. CLS. 13, 19, 21, 23, 31, 34 AND 35).

CLASS 11—ENVIRONMENTAL CONTROL APPARATUS

FOR SANITARY INSTALLATIONS, NAMELY, TOILETS AND PARTS THEREFOR, NAMELY, FLUSHING APPARATUS, NAMELY, LEVERS, TOILET BOWLS, FLUSHING HANDLES, WATER TANKS AND TOILET SEATS, AND WASHBASINS, MACERATOR AND UP-FLUSH TOILETS (U.S. CLS. 13, 21, 23, 31 AND 34).
NORA BUCHANAN WILL, EXAMINING ATTORNEY

CLASS 35—ADVERTISING AND BUSINESS

FOR CONSULTING SERVICES IN THE FIELD OF HUMAN RESOURCES DEVELOPMENT AND ORGANIZATION MANAGEMENT, NAMELY, PROMOTION OF EMPLOYEE RETENTION, CAREER GROWTH, AND INCREASED PRODUCTIVITY; CONSULTING SERVICES IN THE FIELD EMPLOYMENT RECRUITING, NAMELY, STRATEGIC EMPLOYMENT RECRUITING, BUSINESS AND UNIVERSITY RELATIONS FOR RECRUITING PURPOSES, INTERNSHIP PROGRAM DEVELOPMENT FOR OTHERS, AND CONTRACTOR RECRUITING PROGRAM DEVELOPMENT FOR OTHERS; BUSINESS CONSULTING SERVICES, NAMELY, START-UP, MERGERS, WIND-DOWN AND DISSOLUTION CONSULTING; RELOCATION SERVICES FOR BUSINESSES; EMPLOYEE AND MANAGEMENT PERFORMANCE EVALUATION SERVICES; CONSULTING SERVICES IN THE FIELD OF EMPLOYEE COMPENSATION AND MANAGEMENT, NAMELY, EMPLOYEE COMPENSATION, EMPLOYEE SCHEDULING, EMPLOYEE PERFORMANCE RECOGNITION, SEVERANCE PAYMENTS; BUSINESS SUCCESSION PLANNING SERVICES; CONSULTING SERVICES IN THE FIELD OF HUMAN RESOURCES, NAMELY, OUT-PLACEMENT AND RELOCATION OF EMPLOYEES (U.S. CLS. 100, 101 AND 102).
FIRST USE 12-0-2008; IN COMMERCE 12-0-2008.

SN 77-670,580. CORYELL, DAREN, LEBANON, MO. FILED 2-13-2009.

Timbertec

THE MARK CONSISTS OF STANDARD CHARACTERS WITHOUT CLAIM TO ANY PARTICULAR FONT, STYLE, SIZE, OR COLOR.

CLASS 41—EDUCATION AND ENTERTAINMENT

FOR PERSONAL LEADERSHIP COACHING; PERSONAL CAREER TRANSITION COACHING; PERSONAL CAREER DEVELOPMENT COACHING; PROVIDING CONTINUING BUSINESS EDUCATION COURSES (U.S. CLS. 100, 101 AND 107).
FIRST USE 12-0-2008; IN COMMERCE 12-0-2008.
ALLISON HOLTZ, EXAMINING ATTORNEY

CLASS 17—RUBBER GOODS

FOR SELF ADHESIVE PLASTIC SHEETS CONTAINING CAMOUFLAGE PATTERN FOR USE ON WOOD, PLASTICS, GLASS, AND METAL (U.S. CLS. 1, 5, 12, 13, 35 AND 50).

SN 77-671,468. NAPLES TOMATO FINE FOODS, LLC, NAPLES, FL. FILED 2-16-2009.

CLASS 24—FABRICS

FOR COTTON FABRIC, WOOL FABRIC, AND SYNTHETIC FIBER FABRICS ALL CONTAINING CAMOUFLAGE PATTERNS (U.S. CLS. 42 AND 50).
DAWN FELDMAN, EXAMINING ATTORNEY

VINE DINING

THE MARK CONSISTS OF STANDARD CHARACTERS WITHOUT CLAIM TO ANY PARTICULAR FONT, STYLE, SIZE, OR COLOR.

SN 77-670,794. FRED DEMERS ASSOCIATES, INC., BALTIMORE, MD. FILED 2-14-2009.

**Right Organization. Right
People. Right Skills.**

CLASS 35—ADVERTISING AND BUSINESS

FOR RESTAURANT FRANCHISING (U.S. CLS. 100, 101 AND 102).

THE MARK CONSISTS OF STANDARD CHARACTERS WITHOUT CLAIM TO ANY PARTICULAR FONT, STYLE, SIZE, OR COLOR.

CLASS 43—HOTEL AND RESTAURANT SERVICES

FOR RESTAURANT; RESTAURANT AND BAR SERVICES (U.S. CLS. 100 AND 101).
FIRST USE 4-0-2007; IN COMMERCE 4-0-2007.
LINDA MICKLEBURGH, EXAMINING ATTORNEY

SN 77-672,897. BOARDS VIDEO COMPANY, LLC, PORTLAND, OR. FILED 2-18-2009.

99¢ VIDEO HQ

THE MARK CONSISTS OF STANDARD CHARACTERS WITHOUT CLAIM TO ANY PARTICULAR FONT, STYLE, SIZE, OR COLOR.

NO CLAIM IS MADE TO THE EXCLUSIVE RIGHT TO USE "99¢ VIDEO", APART FROM THE MARK AS SHOWN.

CLASS 35—ADVERTISING AND BUSINESS

FOR RETAIL STORE SERVICES FEATURING AUDIO AND VIDEO RECORDINGS, COMPUTER GAMES, AND VIDEO GAMES; RETAIL STORE SERVICES FEATURING AUDIO AND VIDEO RECORDINGS, COMPUTER GAMES AND VIDEO GAMES FOR TRADE; ONLINE RETAIL STORE SERVICES IN THE FIELD OF AUDIO AND VIDEO RECORDINGS, COMPUTER GAMES AND VIDEO GAMES; ONLINE RETAIL STORE SERVICES FEATURING AUDIO AND VIDEO RECORDINGS, COMPUTER GAMES AND VIDEO GAMES FOR TRADE; ONLINE TRADING SERVICES IN WHICH A SELLER POSTS PRODUCTS TO BE AUCTIONED AND BIDDING IS DONE VIA THE INTERNET IN THE FIELD OF AUDIO AND VIDEO RECORDINGS, COMPUTER GAMES AND VIDEO GAMES (U.S. CLS. 100, 101 AND 102).

CLASS 41—EDUCATION AND ENTERTAINMENT

FOR RENTAL OF AUDIO AND VIDEO RECORDINGS, COMPUTER GAMES AND VIDEO GAMES (U.S. CLS. 100, 101 AND 107).

ERIN FALK, EXAMINING ATTORNEY

SN 77-674,053. HOCKLANDER, MICHAEL H, DBA CARIBE VIDEO PRODUCERS LLC, FAYETTEVILLE, AR. FILED 2-19-2009.

Adventure Earth

THE MARK CONSISTS OF STANDARD CHARACTERS WITHOUT CLAIM TO ANY PARTICULAR FONT, STYLE, SIZE, OR COLOR.

NO CLAIM IS MADE TO THE EXCLUSIVE RIGHT TO USE "ADVENTURE" FOR CLASSES 9 AND 41, APART FROM THE MARK AS SHOWN.

CLASS 9—ELECTRICAL AND SCIENTIFIC APPARATUS

FOR DOWNLOADABLE FILMS AND TELEVISION PROGRAMS FEATURING REALITY COMPETITION PROVIDED VIA A VIDEO-ON-DEMAND SERVICE; DOWNLOADABLE MOTION PICTURES AND TELEVISION SHOWS ABOUT REALITY COMPETITION (U.S. CLS. 21, 23, 26, 36 AND 38).

CLASS 38—COMMUNICATION

FOR BROADCASTING OF TELEVISION PROGRAMMES; CABLE TELEVISION BROADCASTING; TELEVISION BROADCASTING (U.S. CLS. 100, 101 AND 104).

CLASS 41—EDUCATION AND ENTERTAINMENT

FOR ENTERTAINMENT AND EDUCATION SERVICES IN THE NATURE OF A SERIES OF SHORT SHOWS FEATURING REALITY COMPETITION DISTRIBUTED TO MOBILE HANDSETS, WHICH MAY INCLUDE VIDEO, TEXT, PHOTOS, ILLUSTRATIONS OR HYPERTEXT; ENTERTAINMENT IN THE NATURE OF ON-GOING TELEVISION PROGRAMS IN THE FIELD OF REALITY COMPETITION; ENTERTAINMENT IN THE NATURE OF VISUAL AND AUDIO PERFORMANCES, AND MUSICAL, VARIETY, NEWS AND COMEDY SHOWS; ENTERTAINMENT SERVICES IN THE NATURE OF AN ON-GOING REALITY BASED TELEVISION PROGRAM; ENTERTAINMENT SERVICES, NAMELY, LIVE, TELEVISED AND MOVIE APPEARANCES BY A PROFESSIONAL ENTERTAINER; ENTERTAINMENT SERVICES, NAMELY, PRODUCTION AND DISTRIBUTION OF A GAME SHOW; ENTERTAINMENT SERVICES, NAMELY, PROVIDING A TELEVISION PROGRAM IN THE FIELD OF REALITY COMPETITION VIA A GLOBAL COMPUTER NETWORK; ENTERTAINMENT, NAMELY, A CONTINUING REALITY COMPETITION SHOW BROADCAST OVER TELEVISION, SATELLITE, AUDIO, AND VIDEO MEDIA; ENTERTAINMENT, NAMELY, PRODUCTION OF REALITY COMPETITION; PRODUCTION OF CABLE TELEVISION PROGRAMS; PRODUCTION OF CLOSED CAPTION TELEVISION PROGRAMS; PRODUCTION OF DVDS, VIDEOTAPES AND TELEVISION PROGRAMS FEATURING REALITY COMPETITION; PRODUCTION OF RADIO AND TELEVISION PROGRAMMES; PRODUCTION OF RADIO AND TELEVISION PROGRAMS; PRODUCTION OF RADIO OR TELEVISION PROGRAMS; PRODUCTION OF TELEVISION AND RADIO PROGRAMMES; PRODUCTION OF TELEVISION PROGRAMS; PRODUCTION OF VIDEO AND CREATION OF VISUAL EFFECTS FOR OTHERS FOR USE IN DVDS, TELEVISION PROGRAMS AND ON WEB SITES; PRODUCTION OF VISUAL EFFECTS FOR VIDEOS, DVDS, TELEVISION AND FOR INTERNET WEB SITES; PROVISION OF NON-DOWNLOADABLE FILMS AND TELEVISION PROGRAMMES VIA A VIDEO-ON-DEMAND SERVICE; TELEVISION PRODUCTION; TELEVISION PROGRAM SYNDICATION; TELEVISION SCHEDULING; TELEVISION SHOW PRODUCTION (U.S. CLS. 100, 101 AND 107).

TINA BROWN, EXAMINING ATTORNEY

SN 77-674,344. WCIS MEDIA, LLC, DBA WHOCANISUE.COM, BOCA RATON, FL. FILED 2-20-2009.

whocanisue.com

THE MARK CONSISTS OF STANDARD CHARACTERS WITHOUT CLAIM TO ANY PARTICULAR FONT, STYLE, SIZE, OR COLOR.

NO CLAIM IS MADE TO THE EXCLUSIVE RIGHT TO USE ".COM", APART FROM THE MARK AS SHOWN.

CLASS 35—ADVERTISING AND BUSINESS

FOR PROMOTING THE SERVICES OF OTHERS BY PROVIDING A WEB SITE AT WHICH USERS CAN LINK TO ATTORNEY INFORMATION; PROMOTING THE SERVICES OF OTHERS BY PROVIDING A WEB SITE AT WHICH USERS CAN CONDUCT SEARCHES FOR ATTORNEYS WHO PRACTICE IN SPECIFIED FIELDS OF LAW; PROMOTING THE SERVICES OF OTHERS BY PREPARING AND PLACING ADVERTISEMENTS ON A WEB SITE ACCESSED THROUGH A GLOBAL COMPUTER NETWORK AND THROUGH TELEVISION AND PRINT ADVERTISEMENTS; PROMOTING THE SERVICES OF OTHERS BY MEANS OF OFFERING MEMBERSHIP IN AN ASSOCIATION OF AFFILIATED ATTORNEYS (U.S. CLS. 100, 101 AND 102).

FIRST USE 8-7-2008; IN COMMERCE 8-7-2008.

CLASS 45—PERSONAL AND LEGAL SERVICES

FOR COMPUTER SERVICES PROVIDED THROUGH A GLOBAL COMPUTER NETWORK, NAMELY, PROVIDING ORIGINAL CONTENT AND DATABASE LINKS TO WEB SITES CONTAINING INFORMATION IN THE FIELD OF LAW THROUGH A GLOBAL COMPUTER NETWORK (U.S. CLS. 100 AND 101).

FIRST USE 8-7-2008; IN COMMERCE 8-7-2008.

RICHARD A. STRASER, EXAMINING ATTORNEY

SN 77-674,761. JOSEPH GEKOSKI, BRYN MAWR, PA. FILED 2-20-2009.

ADVANTEXE LEARNING SOLUTIONS

THE MARK CONSISTS OF STANDARD CHARACTERS WITHOUT CLAIM TO ANY PARTICULAR FONT, STYLE, SIZE, OR COLOR.

NO CLAIM IS MADE TO THE EXCLUSIVE RIGHT TO USE "LEARNING SOLUTIONS", APART FROM THE MARK AS SHOWN.

CLASS 35—ADVERTISING AND BUSINESS

FOR BUSINESS CONSULTING SERVICES, NAMELY, DESIGN OF COMPUTER BASED BUSINESS SIMULATIONS AND ANALYSIS FOR BUSINESS PLANNING PURPOSES IN THE FIELDS OF BUSINESS ACUMEN, FINANCE, ACCOUNTING, STRATEGIC PLANNING, MARKETING, STRATEGIC MANAGEMENT, BUSINESS LEADERSHIP, STRATEGIC BUSINESS SELLING, AND PROJECT MANAGEMENT (U.S. CLS. 100, 101 AND 102).

FIRST USE 7-17-2006; IN COMMERCE 7-17-2006.

CLASS 41—EDUCATION AND ENTERTAINMENT

FOR EDUCATION SERVICES, NAMELY, COMPUTER BASED TRAINING IN THE FIELDS OF BUSINESS ACUMEN, FINANCE, ACCOUNTING, STRATEGIC PLANNING, MARKETING, STRATEGIC MANAGEMENT, BUSINESS LEADERSHIP, STRATEGIC BUSINESS SELLING AND PROJECT MANAGEMENT; EDUCATION SERVICES, NAMELY, DEVELOPING CURRICULUM FOR OTHERS IN THE FIELD OF EXECUTIVE EDUCATION AND CONDUCTING SEMINARS IN THE FIELD OF EXECUTIVE EDUCATION (U.S. CLS. 100, 101 AND 107).

FIRST USE 7-17-2006; IN COMMERCE 7-17-2006.

CLASS 42—SCIENTIFIC AND COMPUTER SERVICES

FOR DESIGN AND DEVELOPMENT OF COMPUTER SOFTWARE THAT SIMULATES BUSINESS SCENARIOS IN THE FIELDS OF BUSINESS ACUMEN, FINANCE, ACCOUNTING, STRATEGIC PLANNING, MARKETING, STRATEGIC MANAGEMENT, BUSINESS LEADERSHIP, STRATEGIC BUSINESS SELLING AND PROJECT MANAGEMENT (U.S. CLS. 100 AND 101).

FIRST USE 7-17-2006; IN COMMERCE 7-17-2006.

HEATHER SAPP, EXAMINING ATTORNEY

SN 77-674,978. ANNA LUNNA, LLC, MIAMI, FL. FILED 2-20-2009.

ANNA LUNNA

THE MARK CONSISTS OF STANDARD CHARACTERS WITHOUT CLAIM TO ANY PARTICULAR FONT, STYLE, SIZE, OR COLOR.

THE NAME(S), PORTRAIT(S), AND/OR SIGNATURE(S) SHOWN IN THE MARK IDENTIFIES ANA RITA GONZALEZ, WHOSE CONSENT(S) TO REGISTER IS MADE OF RECORD.

CLASS 18—LEATHER GOODS

FOR PURSES (U.S. CLS. 1, 2, 3, 22 AND 41).

CLASS 25—CLOTHING

FOR BOOTS, SHOES, GLOVES AND HATS (U.S. CLS. 22 AND 39).

DAVID C. REIHNER, EXAMINING ATTORNEY

SN 77-675,703. MITCHELL, ELIZABETH W, JACKSON, MS. FILED 2-23-2009.



NO CLAIM IS MADE TO THE EXCLUSIVE RIGHT TO USE "SPA & LASER CENTER", APART FROM THE MARK AS SHOWN.

THE COLOR(S) TAN, YELLOW, BROWN IS/ARE CLAIMED AS A FEATURE OF THE MARK.

THE MARK CONSISTS OF BROWN WORDS WITH A YELLOW AND TAN STAR OVER THE LETTER "I".

THE ENGLISH TRANSLATION OF THE WORD "MON AMI" IN THE MARK IS MY FRIEND.

CLASS 10—MEDICAL APPARATUS

FOR ELECTRONIC AESTHETIC SKIN TREATMENT DEVICES USING LIGHT EMITTING DIODES, NAMELY, INFRARED, RED, ORANGE, YELLOW, GREEN, AND BLUE WAVELENGTHS FOR GENERATING LIGHT RAYS; LASERS FOR MEDICAL PURPOSES; LASERS FOR THE COSMETIC TREATMENT OF THE FACE AND SKIN (U.S. CLS. 26, 39 AND 44).

CLASS 44—MEDICAL, BEAUTY AND AGRICULTURAL SERVICES

FOR ACUPUNCTURE; ALTERNATIVE MEDICINE SERVICES; BEAUTY SPA SERVICES, NAMELY, COSMETIC BODY CARE; DEPILATORY HAIR REMOVAL SERVICES; FACIAL TREATMENT SERVICES, NAMELY, COSMETIC PEELS; HEALTH SPA SERVICES FOR HEALTH AND WELLNESS OF THE BODY AND SPIRIT; HEALTH SPA SERVICES, NAMELY, COSMETIC BODY CARE SERVICES; HEALTH SPA SERVICES, NAMELY, LASER TREATMENTS FOR ACNE, REJUVENATION, SCARS, TATTOO REMOVAL AND FOR FACIALS AND MASSAGE; MASSAGES; MICRODERMABRASION, NAMELY, A TOPICAL SKIN TREATMENT INVOLVING ABRASION OF THE SKIN WITH A HIGH-PRESSURE FLOW OF CRYSTALS; SKIN TREATMENT, NAMELY, THE INJECTION OF DERMAL FILLERS TO REDUCE THE APPEARANCE OF FACIAL FINE LINES; SKIN TREATMENTS, NAMELY, THE INJECTION OF DERMAL FILLING AGENTS AND NEUROMUSCULAR BLOCKING AGENTS TO REDUCE THE APPEARANCE OF FACIAL LINES AND WRINKLES (U.S. CLS. 100 AND 101).

INGA ERVIN, EXAMINING ATTORNEY

SN 77-680,320. VESTOR LTD., WANCHAI, HONG KONG, FILED 2-27-2009.

KIM DOTCOM

THE MARK CONSISTS OF STANDARD CHARACTERS WITHOUT CLAIM TO ANY PARTICULAR FONT, STYLE, SIZE, OR COLOR.

NO CLAIM IS MADE TO THE EXCLUSIVE RIGHT TO USE "DOTCOM", APART FROM THE MARK AS SHOWN.

CLASS 35—ADVERTISING AND BUSINESS

FOR ADVERTISING AND PUBLICITY SERVICES; DISSEMINATION OF ADVERTISING FOR OTHERS VIA AN ON-LINE COMMUNICATIONS NETWORK ON THE INTERNET; PROVISION OF ADVERTISING SPACE BY ELECTRONIC MEANS AND GLOBAL INFORMATION NETWORKS; ELECTRONIC COMMERCE SERVICES, NAMELY, PROVIDING INFORMATION ABOUT PRODUCTS VIA TELECOMMUNICATION NETWORKS FOR ADVERTISING AND SALES PURPOSES; BUSINESS ADMINISTRATION AND MANAGEMENT; PROVIDING OFFICE FUNCTIONS; COMMERCIAL CONSULTANCY; COMPUTERIZED FILE MANAGEMENT; ON-LINE RETAIL STORE SERVICES FEATURING ELECTRONICS, COMPUTER HARDWARE AND SOFTWARE, HOUSEHOLD ITEMS, BOOKS, MEDIA, SPORTING GOODS, PHOTOGRAPHIC EQUIPMENTS, CLOTHES, SHOES, ACCESSORIES AND FURNITURE; MAIL ORDER CATALOG SERVICES FEATURING ELECTRONICS, COMPUTER HARDWARE AND SOFTWARE, HOUSEHOLD ITEMS, BOOKS, MEDIA, SPORTING GOODS, PHOTOGRAPHIC EQUIPMENTS, CLOTHES, SHOES, ACCESSORIES AND FURNITURE (U.S. CLS. 100, 101 AND 102).

SN 77-679,915. THOMPSON, RICHARD, BATAVIA, OH. AND HASSING, KOOS, 5561 AA RIETHOVEN, NETHERLANDS, FILED 2-27-2009.

VAN TIEKERHOOK

THE MARK CONSISTS OF STANDARD CHARACTERS WITHOUT CLAIM TO ANY PARTICULAR FONT, STYLE, SIZE, OR COLOR.

THE NAME "VAN TIEKERHOOK" DOES NOT IDENTIFY A LIVING INDIVIDUAL.

THE WORDING "VAN TIEKERHOOK" HAS NO MEANING IN A FOREIGN LANGUAGE.

CLASS 35—ADVERTISING AND BUSINESS

FOR RETAIL PET STORE FEATURING CANINE SUPPLIES AND EQUIPMENT (U.S. CLS. 100, 101 AND 102).

CLASS 41—EDUCATION AND ENTERTAINMENT

FOR KENNEL SERVICES, NAMELY, DOG TRAINING (U.S. CLS. 100, 101 AND 107).

CLASS 44—MEDICAL, BEAUTY AND AGRICULTURAL SERVICES

FOR ANIMAL HUSBANDRY AND KENNEL SERVICES, NAMELY, DOG BREEDING (U.S. CLS. 100 AND 101).

ANDREW RHIM, EXAMINING ATTORNEY

CLASS 36—INSURANCE AND FINANCIAL

FOR FINANCIAL SERVICES, NAMELY, INVESTMENT FUND TRANSFER AND TRANSACTION SERVICES; FINANCIAL AND INVESTMENT SERVICES, NAMELY, MANAGEMENT AND BROKERAGE IN THE FIELDS OF STOCKS, BONDS, OPTIONS, COMMODITIES, FUTURES AND OTHER SECURITIES, AND THE INVESTMENT OF FUNDS OF OTHERS; CREDIT CARD AND PAYMENT CARD SERVICES; PROVIDING A WIDE VARIETY OF PAYMENT SERVICES AND PROVIDING FINANCIAL SERVICES, NAMELY, CREDIT CARD PROCESSING AND TRANSMISSION OF BILLS AND PAYMENTS THEREOF, CONDUCTED VIA A GLOBAL COMPUTER NETWORK; FINANCIAL SERVICES, NAMELY, ELECTRONIC FUNDS TRANSFER VIA ELECTRONIC COMMUNICATIONS NETWORKS; CLEARING AND RECONCILING FINANCIAL TRANSACTIONS VIA ELECTRONIC COMMUNICATIONS NETWORKS; FINANCIAL ADVISORY AND CONSULTANCY SERVICES; FINANCIAL ANALYSIS AND RESEARCH SERVICES; PROVIDING FINANCIAL RISK MANAGEMENT SERVICES FOR ELECTRONIC FUNDS TRANSFER, CREDIT AND DEBIT CARD AND ELECTRONIC CHECK TRANSACTIONS VIA A GLOBAL COMPUTER NETWORK; MONETARY STRATEGY CONSULTATION AND RESEARCH; MONETARY EXCHANGE; ACQUISITION AND TRANSFER OF MONETARY CLAIMS; REAL ESTATE CONSULTANCY; REAL ESTATE FINANCING SERVICES; ASSESSMENT AND MANAGEMENT OF REAL ESTATE; INSURANCE AGENCY AND BROKERAGE; INSURANCE INFORMATION AND CONSULTANCY; PROVIDING BILL PAYMENT SERVICES VIA A GLOBAL COMPUTER NETWORK; PROVIDING ELECTRONIC PROCESSING OF ACH AND CREDIT CARD TRANSACTIONS AND ELECTRONIC PAYMENTS VIA A GLOBAL COMPUTER NETWORK (U.S. CLS. 100, 101 AND 102).

CLASS 38—COMMUNICATION

FOR COMMUNICATION SERVICES, NAMELY, TRANSMISSION OF VOICE, AUDIO, VISUAL IMAGES AND DATA BY TELECOMMUNICATIONS NETWORKS, WIRELESS COMMUNICATION NETWORKS, THE INTERNET, INFORMATION SERVICES NETWORKS AND DATA NETWORKS; INTERNET SERVICE PROVIDER (ISP); VOICE OVER INTERNET PROTOCOL (VOIP) SERVICES; MOBILE TELEPHONE SERVICES; WEB-CASTING SERVICES; PROVIDING ACCESS TO INFORMATION AND AUDIO VIA WEBSITES OVER THE INTERNET; ELECTRONIC TRANSMISSION OF DOWNLOADABLE AUDIO FILES VIA COMPUTER AND OTHER COMMUNICATIONS NETWORKS; ELECTRONIC TRANSMISSION OF STREAMED AUDIO FILES VIA COMPUTER AND OTHER COMMUNICATIONS NETWORKS; COMPUTER AIDED TRANSMISSION OF INFORMATION AND IMAGES; PROVIDING ON-LINE FACILITIES FOR REAL TIME INTERACTION WITH OTHER COMPUTER USERS AND PROVIDING ON-LINE FACILITIES FOR TRANSMISSION OF IMAGES AND VIDEOS (U.S. CLS. 100, 101 AND 104).

CLASS 39—TRANSPORTATION AND STORAGE

FOR CHARTERING OF PLANES, YACHTS, BOATS; COORDINATING TRAVEL ARRANGEMENTS FOR INDIVIDUALS AND FOR GROUPS; TRAVEL AGENCY SERVICES, NAMELY, MAKING RESERVATIONS AND BOOKINGS FOR TRANSPORTATION; ELECTRONIC STORAGE OF DIGITAL CONTENT INCLUDING TEXT, PHOTOGRAPHS, IMAGES, VIDEO, AND AUDIO; PROVIDING A WEB SITE FOR THE ELECTRONIC STORAGE OF DIGITAL CONTENT, TEXT, IMAGES, VIDEO, AUDIO, AND OTHER DATA; PROVIDING AN ON-LINE ELECTRONIC STORAGE SERVICE FOR STORAGE OF DIGITAL CONTENT, TEXT, IMAGES, VIDEO, AUDIO, AND OTHER DATA; PACKAGING ARTICLES FOR TRANSPORTATION; TRANSPORT AND STORAGE OF GOODS; ELECTRONIC STORAGE OF FILES AND DOCUMENTS (U.S. CLS. 100 AND 105).

CLASS 41—EDUCATION AND ENTERTAINMENT

FOR ENTERTAINMENT SERVICES, NAMELY, PARTICIPATION IN SPORTS CAR RACES; ENTERTAINMENT SERVICES, NAMELY, CONDUCTING PARTIES FOR THE PURPOSE OF DATING AND SOCIAL INTRODUCTION FOR ADULTS; EDUCATIONAL AND ENTERTAINMENT SERVICES, NAMELY, PROVIDING MOTIVATIONAL SPEAKING SERVICES IN THE FIELD OF ECONOMICS, INFORMATION TECHNOLOGY, COMMUNICATIONS, MOTIVATION SKILLS, BUSINESS, SPORTS, ENTERTAINMENT, WEBSITES AND FINANCIAL MATTERS; ENTERTAINMENT IN THE NATURE OF GOLF TOURNAMENTS; ENTERTAINMENT IN THE NATURE OF TENNIS TOURNAMENTS; ENTERTAINMENT AND EDUCATIONAL SERVICES IN THE NATURE OF ON-LINE COMPETITIONS IN THE FIELD OF ENTERTAINMENT, EDUCATION, CULTURE, SPORTS, AND OTHER NON-BUSINESS AND NON-COMMERCIAL FIELDS; ENTERTAINMENT SERVICES, NAMELY, PROVIDING A WEB SITE FEATURING ADULT-THEMED PHOTOGRAPHS AND VIDEOS; ORGANIZING COMMUNITY SPORTING AND CULTURAL EVENTS; TEACHING AND TRAINING IN BUSINESS, INDUSTRY AND INFORMATION TECHNOLOGY; BUSINESS TRAINING (U.S. CLS. 100, 101 AND 107).

CLASS 42—SCIENTIFIC AND COMPUTER SERVICES

FOR IT CONSULTING SERVICES; COMPUTER CONSULTATION IN THE FIELD OF COMPUTER SECURITY; HOSTING OF DIGITAL CONTENT ON THE INTERNET; DESIGN, CREATION, HOSTING AND MAINTENANCE OF INTERNET SITES FOR THIRD PARTIES; COMPUTER SERVICES, NAMELY, HOSTING AND MAINTAINING AN ON-LINE WEB SITE FOR OTHERS TO UPLOAD AND DOWNLOAD COMPUTER FILES, DIGITAL CONTENT, TEXT, IMAGES, VIDEO, AUDIO, AND OTHER DATA; HOSTING AND MAINTAINING AN ON-LINE WEB SITE FOR STORAGE AND FORWARDING AND THIRD PARTY ACCESS TO DIGITAL CONTENT, TEXT, IMAGES, VIDEO, AUDIO, AND OTHER DATA; PROVIDING TEMPORARY USE OF ON-LINE NON-DOWNLOADABLE SOFTWARE DEVELOPMENT TOOLS FOR WEBSITE CREATION; REMOTE ONLINE BACKUP OF COMPUTER DATA; DESIGN AND DEVELOPMENT OF COMPUTER HARDWARE AND SOFTWARE; SCIENTIFIC AND TECHNOLOGICAL SERVICES AND RESEARCH AND DESIGN IN THE FIELD OF INFORMATION TECHNOLOGY, TELECOMMUNICATIONS, AND CONSUMER ELECTRONICS; RESEARCH SERVICES IN THE FIELD OF INFORMATION AND TELECOMMUNICATIONS TECHNOLOGY; COMPUTER SERVICES, NAMELY, DATA RECOVERY SERVICES; TECHNICAL SUPPORT, NAMELY, PROVIDING BACKUP COMPUTER PROGRAMS AND FACILITIES; PROVIDING SEARCH ENGINES FOR OBTAINING INFORMATION AND RESOURCES ON A GLOBAL COMPUTER NETWORK; APPLICATION SERVICE PROVIDER (ASP), NAMELY, HOSTING COMPUTER SOFTWARE APPLICATIONS OF OTHERS (U.S. CLS. 100 AND 101).

CLASS 45—PERSONAL AND LEGAL SERVICES

FOR SECURITY GUARD SERVICES; BODYGUARD SERVICES; DATING SERVICES; COMPUTER DATING SERVICES; INTERNET-BASED DATING, SOCIAL INTRODUCTION AND SOCIAL NETWORKING SERVICES; WEB SITE SERVICES FEATURING ON-LINE DATING CLUB; ESCORT SERVICES; CONSULTING SERVICES IN THE FIELD OF MAINTAINING THE SECURITY AND INTEGRITY OF DATABASES; SECURITY CONSULTANCY; LEGAL SERVICES; PERSONAL LIFESTYLE CONSULTING SERVICES (U.S. CLS. 100 AND 101).
RICHARD A. STRASER, EXAMINING ATTORNEY

SN 77-681,145. HUMANITY FOR CHILDREN, SEATTLE, WA. FILED 3-2-2009.



NO CLAIM IS MADE TO THE EXCLUSIVE RIGHT TO USE "CHILDREN", APART FROM THE MARK AS SHOWN. THE COLOR(S) WHITE, BROWN, DARK BROWN, ORANGE, PUMPKIN AND PEACH IS/ARE CLAIMED AS A FEATURE OF THE MARK.

THE MARK CONSISTS OF THE WORDING "HUMANITY FOR CHILDREN" IN WHITE SURROUNDED BY A BROWN BANNER, WITH THE DESIGNS OF CHILDREN IN DARK BROWN, BROWN, PUMPKIN, ORANGE AND PEACH.

CLASS 35—ADVERTISING AND BUSINESS

FOR CHARITABLE SERVICES, NAMELY, ORGANIZING VOLUNTEER PROGRAMS AND COMMUNITY SERVICE PROJECTS (U.S. CLS. 100, 101 AND 102).

FIRST USE 10-1-2008; IN COMMERCE 10-1-2008.

CLASS 36—INSURANCE AND FINANCIAL

FOR CHARITABLE FUNDRAISING SERVICES (U.S. CLS. 100, 101 AND 102).
FIRST USE 10-1-2008; IN COMMERCE 10-1-2008.
LEIGH CAROLINE CASE, EXAMINING ATTORNEY

CLASS 32—LIGHT BEVERAGES

FOR NON-ALCOHOLIC HERBAL JUICE BEVERAGES (U.S. CLS. 45, 46 AND 48).
HANNO RITTNER, EXAMINING ATTORNEY

SN 77-681,971. KUMFS BRAND LIMITED, AUCKLAND, NEW ZEALAND, FILED 3-3-2009.

SN 77-682,343. PROTECH, LLC, TAMPA, FL. FILED 3-3-2009.

ZIERA

THE MARK CONSISTS OF STANDARD CHARACTERS WITHOUT CLAIM TO ANY PARTICULAR FONT, STYLE, SIZE, OR COLOR.

PRIORITY CLAIMED UNDER SEC. 44(D) ON NEW ZEALAND APPLICATION NO. 798293, FILED 10-30-2008, REG. NO. 798293, DATED 10-30-2008, EXPIRES 10-30-2018.

CLASS 18—LEATHER GOODS

FOR ALL PURPOSE CARRY BAGS, HAND BAGS, PURSES, LUGGAGE, UMBRELLAS, TRUNKS AND TRAVELLING BAGS (U.S. CLS. 1, 2, 3, 22 AND 41).

CLASS 25—CLOTHING

FOR CLOTHING, NAMELY, TOPS, BOTTOMS, AND JACKETS; SCARVES, FOOTWEAR; BOOTS, SHOES, SLIPPERS, HEADWEAR AND BELTS (U.S. CLS. 22 AND 39).

CLASS 35—ADVERTISING AND BUSINESS

FOR RETAIL AND WHOLESALE STORE SERVICES FEATURING ALL PURPOSE CARRY BAGS, HAND BAGS, PURSES, LUGGAGE, UMBRELLAS, TRUNKS AND TRAVELLING BAGS, CLOTHING, SCARVES, FOOTWEAR, BOOTS, SHOES, SLIPPERS, HEADGEAR AND BELTS, PREPARATIONS FOR THE CARE OF FOOTWEAR, SHOE STORAGE RACKS AND CONTAINERS (U.S. CLS. 100, 101 AND 102).
MARC LEIPZIG, EXAMINING ATTORNEY

SN 77-682,096. GLYKON TECHNOLOGIES GROUP, LLC, LAS VEGAS, NV. FILED 3-3-2009.

LEPTISOL

THE MARK CONSISTS OF STANDARD CHARACTERS WITHOUT CLAIM TO ANY PARTICULAR FONT, STYLE, SIZE, OR COLOR.

CLASS 5—PHARMACEUTICALS

FOR DIETARY SUPPLEMENTS; DIETETIC SUBSTANCES ADAPTED FOR MEDICAL PURPOSES, NAMELY, HERBAL TEAS FOR MEDICINAL PURPOSES (U.S. CLS. 6, 18, 44, 46, 51 AND 52).

NIGHT SLEEP

THE MARK CONSISTS OF STANDARD CHARACTERS WITHOUT CLAIM TO ANY PARTICULAR FONT, STYLE, SIZE, OR COLOR.

NO CLAIM IS MADE TO THE EXCLUSIVE RIGHT TO USE "SLEEP", APART FROM THE MARK AS SHOWN.

CLASS 16—PAPER GOODS AND PRINTED MATTER

FOR PRINTED MATERIALS, NAMELY, BOOKS, MAGAZINES, AND BROCHURES, IN THE FIELD OF SLEEP AND SLEEP PRODUCTS, NAMELY, ADJUSTABLE BEDS, MATTRESSES, BOX SPRINGS, PILLOWS, MATTRESS PADS, MATTRESS COVERS, COMFORTERS, COMFORTER COVERS, DUVETS, DUVET COVERS, BED SHEETS, PILLOW CASES AND BLANKETS (U.S. CLS. 2, 5, 22, 23, 29, 37, 38 AND 50).

CLASS 20—FURNITURE AND ARTICLES NOT OTHERWISE CLASSIFIED

FOR ADJUSTABLE BEDS, MATTRESSES, BOX SPRINGS, AND PILLOWS (U.S. CLS. 2, 13, 22, 25, 32 AND 50).

CLASS 24—FABRICS

FOR MATTRESS PADS, MATTRESS COVERS, COMFORTERS, COMFORTER COVERS, DUVETS, DUVET COVERS, BED SHEETS, PILLOW CASES AND BED BLANKETS (U.S. CLS. 42 AND 50).

JEFF DEFORD, EXAMINING ATTORNEY

SN 77-682,626. PURPOSE PARTIES, INC., NAPLES, FL. FILED 3-3-2009.

EMPOWER PARTIES

THE MARK CONSISTS OF STANDARD CHARACTERS WITHOUT CLAIM TO ANY PARTICULAR FONT, STYLE, SIZE, OR COLOR.

CLASS 16—PAPER GOODS AND PRINTED MATTER

FOR BLANK JOURNALS; EDUCATIONAL PUBLICATIONS, NAMELY, BOOKS, HAND-OUTS, WORKBOOKS, JOURNALS, WORKSHEETS, CARDS IN THE FIELDS OF LIFE COACHING; JOURNALS CONCERNING LIFE COACHING; PRINTED EDUCATIONAL MATERIALS IN THE FIELD OF LIFE COACHING (U.S. CLS. 2, 5, 22, 23, 29, 37, 38 AND 50).

CLASS 41—EDUCATION AND ENTERTAINMENT

FOR LIFE COACHING SERVICES IN THE FIELD OF PERSONAL GROWTH AND PROFESSIONAL GROWTH; PERSONAL COACHING SERVICES IN THE FIELD OF PERSONAL GROWTH; PROVIDING GROUP COACHING AND LEARNING FORUMS IN THE FIELD OF LEADERSHIP DEVELOPMENT (U.S. CLS. 100, 101 AND 107).

ALLISON HALL, EXAMINING ATTORNEY

SN 77-682,742. ARYSTA LIFESCIENCE NORTH AMERICA, LLC, CARY, NC. FILED 3-3-2009.

BASE-PAK

THE MARK CONSISTS OF STANDARD CHARACTERS WITHOUT CLAIM TO ANY PARTICULAR FONT, STYLE, SIZE, OR COLOR.

CLASS 5—PHARMACEUTICALS

FOR PESTICIDES, INSECTICIDES, HERBICIDES, FUNGICIDES ALL FOR USE IN AGRICULTURE, HORTICULTURE AND SILVICULTURE; PREPARATIONS FOR DESTROYING VERMIN; FUMIGANTS (U.S. CLS. 6, 18, 44, 46, 51 AND 52).

CLASS 6—METAL GOODS

FOR CONTAINERS PRINCIPALLY MADE OF METAL FOR STORAGE OF AGRICULTURAL CHEMICALS AND FUMIGANTS FOR COMMERCIAL USE (U.S. CLS. 2, 12, 13, 14, 23, 25 AND 50).

CLASS 20—FURNITURE AND ARTICLES NOT OTHERWISE CLASSIFIED

FOR CONTAINERS PRINCIPALLY MADE OF PLASTIC FOR STORAGE OF AGRICULTURAL CHEMICALS AND FUMIGANTS FOR COMMERCIAL USE (U.S. CLS. 2, 13, 22, 25, 32 AND 50).

ZHALEH DELANEY, EXAMINING ATTORNEY

SN 77-683,713. OREGON STATE BAR, TIGARD, OR. FILED 3-4-2009.



THE MARK CONSISTS OF THE LETTERS "OSB" IN A DARK BOX.

CLASS 9—ELECTRICAL AND SCIENTIFIC APPARATUS

FOR PRE-RECORDED AUDIO, AND VIDEO TAPES, DISCS, AND CASSETTES FEATURING INFORMATION IN THE FIELDS OF LAW, THE LEGAL PROFESSION, LAWYERS' PROFESSIONAL RESPONSIBILITY, LEGAL EDUCATION, AND LAW PRACTICE MANAGEMENT (U.S. CLS. 21, 23, 26, 36 AND 38).

CLASS 16—PAPER GOODS AND PRINTED MATTER

FOR BOOKS, PAMPHLETS, PRINTED EDUCATIONAL MATERIALS, JOURNALS, MANUALS, DIRECTORIES, NEWSLETTERS, BULLETINS, HANDBOOKS, SAMPLE LEGAL FORMS, CASE REPORTERS, AND MAGAZINES IN THE FIELDS OF LAW, THE LEGAL PROFESSION AND THE REGULATION THEREOF, LAWYERS' PROFESSIONAL RESPONSIBILITY, LEGAL EDUCATION, AND LAW PRACTICE MANAGEMENT (U.S. CLS. 2, 5, 22, 23, 29, 37, 38 AND 50).

CLASS 38—COMMUNICATION

FOR STREAMING AUDIO AND VISUAL MATERIAL VIA A GLOBAL COMPUTER NETWORK FEATURING INFORMATION IN THE FIELDS OF LAW, THE LEGAL PROFESSION, LAWYERS' PROFESSIONAL RESPONSIBILITY, LEGAL EDUCATION, AND LAW PRACTICE MANAGEMENT (U.S. CLS. 100, 101 AND 104).

CLASS 41—EDUCATION AND ENTERTAINMENT

FOR ARRANGING AND CONDUCTING EDUCATIONAL SEMINARS, WORKSHOPS, PROGRAMS, CONFERENCES, AND SELF-STUDY ACTIVITIES IN THE FIELDS OF LAW, THE LEGAL PROFESSION, LAWYERS' PROFESSIONAL RESPONSIBILITY, LEGAL EDUCATION, AND LAW PRACTICE MANAGEMENT, AND DISTRIBUTING COURSE MATERIALS IN CONNECTION THEREWITH; DEVELOPMENT AND DISSEMINATION OF EDUCATIONAL MATERIALS IN THE FIELDS OF LAW, THE LEGAL PROFESSION AND THE REGULATION THEREOF, LAWYERS' PROFESSIONAL RESPONSIBILITY, LEGAL EDUCATION, AND LAW PRACTICE MANAGEMENT (U.S. CLS. 100, 101 AND 107).

ALEX KEAM, EXAMINING ATTORNEY

SN 77-684,264. THANE INTERNATIONAL, INC., LA QUINTA, CA. FILED 3-5-2009.

CONTACT BODYBLAST

THE MARK CONSISTS OF STANDARD CHARACTERS WITHOUT CLAIM TO ANY PARTICULAR FONT, STYLE, SIZE, OR COLOR.

NO CLAIM IS MADE TO THE EXCLUSIVE RIGHT TO USE "CONTACT", APART FROM THE MARK AS SHOWN.

CLASS 9—ELECTRICAL AND SCIENTIFIC APPARATUS

FOR PRE-RECORDED DIGITAL VIDEO DISCS FEATURING KICKBOXING WORKOUTS AND TECHNIQUES (U.S. CLS. 21, 23, 26, 36 AND 38).

CLASS 16—PAPER GOODS AND PRINTED MATTER

FOR PRINTED GUIDES FOR 12-DAY KICK START DIET AND 4-WEEK EATING GUIDE (U.S. CLS. 2, 5, 22, 23, 29, 37, 38 AND 50).

CLASS 28—TOYS AND SPORTING GOODS

FOR ATHLETIC SPORTING GOODS, NAMELY, A LIFE-SIZE INFLATABLE DUMMY WITH WATER-FILLED BASE, FOR USE AS TARGET PRACTICE FOR KICKBOXING WORKOUTS (U.S. CLS. 22, 23, 38 AND 50).

RUSS HERMAN, EXAMINING ATTORNEY

SN 77-685,062. ASBURY COMMUNITIES, INC., GERMANTOWN, MD. FILED 3-6-2009.

ASBURY VILLAGE

THE MARK CONSISTS OF STANDARD CHARACTERS WITHOUT CLAIM TO ANY PARTICULAR FONT, STYLE, SIZE, OR COLOR.

OWNER OF U.S. REG. NOS. 3,009,459, 3,339,210 AND OTHERS.

NO CLAIM IS MADE TO THE EXCLUSIVE RIGHT TO USE "VILLAGE", APART FROM THE MARK AS SHOWN.

CLASS 35—ADVERTISING AND BUSINESS

FOR MANAGEMENT OF CONTINUING CARE RETIREMENT COMMUNITIES FOR OTHERS (U.S. CLS. 100, 101 AND 102).

CLASS 43—HOTEL AND RESTAURANT SERVICES

FOR PROVIDING CONTINUING CARE RETIREMENT COMMUNITIES, NAMELY, RESIDENTIAL LIVING FACILITIES, ASSISTED LIVING FACILITIES (U.S. CLS. 100 AND 101).

CLASS 44—MEDICAL, BEAUTY AND AGRICULTURAL SERVICES

FOR PROVIDING CONTINUING CARE RETIREMENT COMMUNITIES, NAMELY, SKILLED NURSING FACILITIES (U.S. CLS. 100 AND 101).

BRENDAN MCCAULEY, EXAMINING ATTORNEY

SN 77-686,417. CENTRIC GROUP, L.L.C., ST. LOUIS, MO. FILED 3-9-2009.

ACCESS CORRECTIONS

THE MARK CONSISTS OF STANDARD CHARACTERS WITHOUT CLAIM TO ANY PARTICULAR FONT, STYLE, SIZE, OR COLOR.

NO CLAIM IS MADE TO THE EXCLUSIVE RIGHT TO USE "CORRECTIONS", APART FROM THE MARK AS SHOWN.

CLASS 36—INSURANCE AND FINANCIAL

FOR ELECTRONIC TRANSFER OF MONEY (U.S. CLS. 100, 101 AND 102).

CLASS 38—COMMUNICATION

FOR ELECTRONIC MAIL SERVICES, NAMELY, TRANSMISSION OF MAIL MESSAGES AND PHOTOS THAT ARE ELECTRONICALLY CARRIED TO A PARTY ON BEHALF OF THE SENDER; PROVIDING ACCESS TO A SECURED-ACCESS NETWORK THAT GIVES USERS THE ABILITY TO RENT, PURCHASE AND DOWNLOAD DIGITAL AUDIO AND VIDEO FILES BY MEANS OF PROPRIETARY HARDWARE (U.S. CLS. 100, 101 AND 104).

CLASS 42—SCIENTIFIC AND COMPUTER SERVICES

FOR PROVIDING A SECURED-ACCESS WEBSITE THAT GIVES USERS THE ABILITY TO RENT, PURCHASE AND DOWNLOAD DIGITAL AUDIO AND VIDEO FILES BY MEANS OF PROPRIETARY HARDWARE (U.S. CLS. 100 AND 101).

MARK PILARO, EXAMINING ATTORNEY

SN 77-686,502. VERISK HEALTH, INC., BOSTON, MA. FILED 3-9-2009.

VERISK HEALTH

THE MARK CONSISTS OF STANDARD CHARACTERS WITHOUT CLAIM TO ANY PARTICULAR FONT, STYLE, SIZE, OR COLOR.

NO CLAIM IS MADE TO THE EXCLUSIVE RIGHT TO USE "HEALTH", APART FROM THE MARK AS SHOWN.

CLASS 9—ELECTRICAL AND SCIENTIFIC APPARATUS

FOR COMPUTER SOFTWARE FOR USE IN DIAGNOSIS-BASED RISK ADJUSTMENT IN THE HEALTHCARE INDUSTRY AND RELATED INSTRUCTIONAL MANUALS SOLD THEREWITH; COMPUTER SOFTWARE FOR RISK ASSESSMENT AND PREDICTIVE MODELING IN THE HEALTHCARE INDUSTRY AND INSTRUCTIONAL MANUALS SOLD TOGETHER THEREWITH (U.S. CLS. 21, 23, 26, 36 AND 38).

CLASS 35—ADVERTISING AND BUSINESS

FOR PROVIDING HEALTH CARE UTILIZATION AND INFORMATION REVIEW SERVICES REGARDING HEALTH CARE COST MANAGEMENT FOR REVENUE RECOVERY OPPORTUNITIES; PROVIDING BUSINESS MARKET SEGMENTATION CONSULTATION TO HEALTHCARE BUSINESSES, HEALTHCARE PROVIDERS AND OTHERS IN THE HEALTHCARE MARKET, NAMELY, COST ANALYSES OF FINANCING, ORGANIZING AND PROVIDING HEALTH SERVICES; PROVIDING COST REDUCTION SERVICES IN THE FIELD OF PREPAID HEALTHCARE INSURANCE BY PERFORMING CLAIMS AUDITING SERVICES OF SUSPECT CLAIMS FOR INSURANCE COMPANIES AND OTHER PAYORS OF HEALTH CARE CLAIMS; DATA ANALYSIS IN THE FIELD OF INSURANCE AND DATA ANALYSIS CONSULTING IN THE FIELD OF INSURANCE (U.S. CLS. 100, 101 AND 102).

CLASS 42—SCIENTIFIC AND COMPUTER SERVICES

FOR PROVIDING TEMPORARY USE OF NON-DOWNLOADABLE SOFTWARE APPLICATIONS FOR ANALYZING, CREATING FINANCIAL MODELS OF, AND CREATING REPORTS ON, HEALTH CARE COSTS, THE FINANCING OF HEALTH CARE COSTS, AND THE DELIVERY OF HEALTH CARE SERVICES, AND FOR TARGETING SPECIFIC BUSINESS PROBLEMS IN THE HEALTH CARE FIELD, NAMELY, IDENTIFYING CHRONIC CONDITIONS FOR CARE MANAGEMENT, ASSESSING HEALTH PLAN RISK SELECTION, DETERMINING RENEWAL RATES FOR HEALTH PLANS, AND EVALUATING PREMIUM EFFICIENCY, OVER A GLOBAL COMPUTER NETWORK; PROVIDING TEMPORARY USE OF ONLINE, NONDOWNLOADABLE SOFTWARE IN THE NATURE OF A DISEASE MANAGEMENT CALCULATOR THAT HELPS CLIENTS UNDERSTAND THEIR POPULATION'S HEALTH CARE NEEDS; PROVIDING ON-LINE NON-DOWNLOADABLE SOFTWARE TO ENABLE OTHERS TO PERFORM INFORMATION AND RESEARCH SERVICES REGARDING THE MEDICARE MARKET, NAMELY, TO IDENTIFY MISSED OR INCORRECT CODING, TO IDENTIFY REVENUE RECOVERY OPPORTUNITIES, AND TO IDENTIFY QUALITY PROBLEMS AND CORRECTIVE ACTION IN HEALTH CARE DATA; PROVIDING ON-LINE NONDOWNLOADABLE SOFTWARE TO HEALTH CARE BUSINESSES, HEALTH CARE PROVIDERS AND OTHERS IN THE HEALTH CARE MARKET, NAMELY, DATA WAREHOUSING SOFTWARE, REPORTING SOFTWARE, BUSINESS INTELLIGENCE SOFTWARE AND PREDICTIVE MODELING SOFTWARE; PROVIDING TEMPORARY USE OF ON-LINE, NONDOWNLOADABLE SOFTWARE FOR PERFORMING COST AND RISK ANALYSIS, COST CONTROL ANALYSIS, AND DATA ANALYSIS, MODELING, REPORTING, AND WAREHOUSING FOR USE IN THE HEALTH CARE INDUSTRY, BY MANAGED CARE PROVIDER GROUPS, SELF-INSURED EMPLOYERS, AND THIRD-PARTY BUSINESS ADMINISTRATORS; PROVIDING TEMPORARY USE OF ON-LINE, NON-DOWNLOADABLE SOFTWARE FOR AMENDING AND PROFILING HEALTHCARE PROVIDER BILLING ACTIVITY IN ORDER TO IDENTIFY AND PREVENT PATTERNS OF FRAUD AND ABUSE, FOR PREVENTING OVERPAYMENTS, RULES VIOLATIONS, AND CLINICAL MISTREATMENT BY ANALYZING HEALTHCARE CLAIM SUBMISSIONS, FOR REDUCING HEALTHCARE FACILITY CLAIM COSTS, DIAGNOSTIC RELATED GROUPINGS AND AMBULATORY PAYMENT CLASSIFICATION EXPENDITURES BY IDENTIFYING FRAUD, ABUSE, AND OVERPAYMENTS TO MAXIMIZE CLAIMS PAYMENT ACCURACY, IDENTIFY FRAUDULENT FACILITIES, AND CLINICALLY VALIDATE CLAIM SUBMISSIONS, FOR REDUCING DENTAL BENEFIT CLAIM COSTS BY IDENTIFYING FRAUD, ABUSE, AND OVERPAYMENT TO MAXIMIZE DENTAL CLAIMS PAYMENT ACCURACY, IDENTIFY FRAUDULENT PROVIDERS, AND CLINICALLY VALIDATE CLAIM SUBMISSIONS, FOR REDUCING PROFESSIONAL CLAIMS COSTS BY IDENTIFYING FRAUD, ABUSE, AND OVERPAYMENTS IN ORDER TO MAXIMIZE CLAIM PAYMENT ACCURACY, IDENTIFY FRAUDULENT PROVIDERS, AND CLINICALLY VALIDATE CLAIM SUBMISSIONS, FOR IDENTIFYING FRAUD AND ABUSE IN THE SUBMISSION OF INSURANCE CLAIMS AND OVERPAYMENT OF INSURANCE CLAIMS AND FOR CREATING PREDICTIVE MODELS OF FUTURE INSURANCE CLAIMS; DEVELOPMENT OF SOFTWARE FOR OTHERS FOR USE IN ANALYZING, COMPILING AND EXPLOITING STATISTICAL HEALTH DATA; PROVIDING DATA CONVERSION OF COMPUTER PROGRAM DATA AND DEVELOPMENT OF DATA REPORTING SOFTWARE IN THE HEALTHCARE AND HEALTH INSURANCE INDUSTRY; PROVIDING CONSULTING SERVICES IN THE FIELD OF DATA CONVERSION OF COMPUTER PROGRAM DATA AND DEVELOPMENT OF DATA REPORTING SOFTWARE IN THE HEALTHCARE AND HEALTH INSURANCE INDUSTRY; PROVIDING QUALITY CONTROL SERVICES FOR HEALTHCARE INFORMATION PARTICULARLY TO IDENTIFY MISSED OR INCORRECT CODING, QUALITY PROBLEMS AND CORRECTIVE ACTION (U.S. CLS. 100 AND 101).

CLASS 45—PERSONAL AND LEGAL SERVICES

FOR COMPILING AND ANALYZING STATISTICAL HEALTH DATA IN ORDER TO UNCOVER AND IDENTIFY HEALTH CARE FRAUD AND CLAIMS ERRORS (U.S. CLS. 100 AND 101).
KIM MONINGHOFF, EXAMINING ATTORNEY

SN 77-686,526. VERISK HEALTH, INC., BOSTON, MA.
FILED 3-9-2009.



NO CLAIM IS MADE TO THE EXCLUSIVE RIGHT TO USE "HEALTH", APART FROM THE MARK AS SHOWN. THE MARK CONSISTS OF A STYLIZED LETTER "V" SUPERIMPOSED ON A CIRCLE BACKGROUND WITH TEN HORIZONTAL LINES TO THE LEFT OF THE WORDS "VERISK HEALTH".

CLASS 9—ELECTRICAL AND SCIENTIFIC APPARATUS

FOR COMPUTER SOFTWARE FOR USE IN DIAGNOSIS-BASED RISK ADJUSTMENT IN THE HEALTHCARE INDUSTRY AND RELATED INSTRUCTIONAL MANUALS SOLD THEREWITH; COMPUTER SOFTWARE FOR RISK ASSESSMENT AND PREDICTIVE MODELING IN THE HEALTHCARE INDUSTRY AND INSTRUCTIONAL MANUALS SOLD TOGETHER THEREWITH (U.S. CLS. 21, 23, 26, 36 AND 38).

CLASS 35—ADVERTISING AND BUSINESS

FOR PROVIDING HEALTH CARE UTILIZATION AND INFORMATION REVIEW SERVICES REGARDING HEALTH CARE COST MANAGEMENT FOR REVENUE RECOVERY OPPORTUNITIES; PROVIDING BUSINESS MARKET SEGMENTATION CONSULTATION TO HEALTHCARE BUSINESSES, HEALTHCARE PROVIDERS AND OTHERS IN THE HEALTHCARE MARKET, NAMELY, COST ANALYSES OF FINANCING, ORGANIZING AND PROVIDING HEALTH SERVICES; PROVIDING COST REDUCTION SERVICES IN THE FIELD OF PREPAID HEALTHCARE INSURANCE BY PERFORMING CLAIMS AUDITING SERVICES OF SUSPECT CLAIMS FOR INSURANCE COMPANIES AND OTHER PAYORS OF HEALTH CARE CLAIMS; DATA ANALYSIS IN THE FIELD OF INSURANCE AND DATA ANALYSIS CONSULTING IN THE FIELD OF INSURANCE (U.S. CLS. 100, 101 AND 102).

CLASS 42—SCIENTIFIC AND COMPUTER SERVICES

FOR PROVIDING TEMPORARY USE OF NON-DOWNLOADABLE SOFTWARE APPLICATIONS FOR ANALYZING, CREATING FINANCIAL MODELS OF, AND CREATING REPORTS ON, HEALTH CARE COSTS, THE FINANCING OF HEALTH CARE COSTS, AND THE DELIVERY OF HEALTH CARE SERVICES, AND FOR TARGETING SPECIFIC BUSINESS PROBLEMS IN THE HEALTH CARE FIELD, NAMELY, IDENTIFYING CHRONIC CONDITIONS FOR CARE MANAGEMENT, ASSESSING HEALTH PLAN RISK SELECTION, DETERMINING RENEWAL RATES FOR HEALTH PLANS, AND EVALUATING PREMIUM EFFICIENCY, OVER A GLOBAL COMPUTER NETWORK; PROVIDING TEMPORARY USE OF ONLINE, NONDOWNLOADABLE SOFTWARE IN THE NATURE OF A DISEASE MANAGEMENT CALCULATOR THAT HELPS CLIENTS UN-

DERSTAND THEIR POPULATION'S HEALTH CARE NEEDS; PROVIDING ON-LINE NON-DOWNLOADABLE SOFTWARE TO ENABLE OTHERS TO PERFORM INFORMATION AND RESEARCH SERVICES REGARDING THE MEDICARE MARKET, NAMELY, TO IDENTIFY MISSED OR INCORRECT CODING, TO IDENTIFY REVENUE RECOVERY OPPORTUNITIES, AND TO IDENTIFY QUALITY PROBLEMS AND CORRECTIVE ACTION IN HEALTH CARE DATA; PROVIDING ON-LINE NONDOWNLOADABLE SOFTWARE TO HEALTH CARE BUSINESSES, HEALTH CARE PROVIDERS AND OTHERS IN THE HEALTH CARE MARKET, NAMELY, DATA WAREHOUSING SOFTWARE, REPORTING SOFTWARE, BUSINESS INTELLIGENCE SOFTWARE AND PREDICTIVE MODELING SOFTWARE; PROVIDING TEMPORARY USE OF ON-LINE, NONDOWNLOADABLE SOFTWARE FOR PERFORMING COST AND RISK ANALYSIS, COST CONTROL ANALYSIS, AND DATA ANALYSIS, MODELING, REPORTING, AND WAREHOUSING FOR USE IN THE HEALTH CARE INDUSTRY, BY MANAGED CARE PROVIDER GROUPS, SELF-INSURED EMPLOYERS, AND THIRD-PARTY BUSINESS ADMINISTRATORS; PROVIDING TEMPORARY USE OF ON-LINE, NON-DOWNLOADABLE SOFTWARE FOR AMENDING AND PROFILING HEALTHCARE PROVIDER BILLING ACTIVITY IN ORDER TO IDENTIFY AND PREVENT PATTERNS OF FRAUD AND ABUSE, FOR PREVENTING OVERPAYMENTS, RULES VIOLATIONS, AND CLINICAL MISTREATMENT BY ANALYZING HEALTHCARE CLAIM SUBMISSIONS, FOR REDUCING HEALTHCARE FACILITY CLAIM COSTS, DIAGNOSTIC RELATED GROUPINGS AND AMBULATORY PAYMENT CLASSIFICATION EXPENDITURES BY IDENTIFYING FRAUD, ABUSE, AND OVERPAYMENTS TO MAXIMIZE CLAIMS PAYMENT ACCURACY, IDENTIFY FRAUDULENT FACILITIES, AND CLINICALLY VALIDATE CLAIM SUBMISSIONS, FOR REDUCING DENTAL BENEFIT CLAIM COSTS BY IDENTIFYING FRAUD, ABUSE, AND OVERPAYMENT TO MAXIMIZE DENTAL CLAIMS PAYMENT ACCURACY, IDENTIFY FRAUDULENT PROVIDERS, AND CLINICALLY VALIDATE CLAIM SUBMISSIONS, FOR REDUCING PROFESSIONAL CLAIMS COSTS BY IDENTIFYING FRAUD, ABUSE, AND OVERPAYMENTS IN ORDER TO MAXIMIZE CLAIM PAYMENT ACCURACY, IDENTIFY FRAUDULENT PROVIDERS, AND CLINICALLY VALIDATE CLAIM SUBMISSIONS, FOR IDENTIFYING FRAUD AND ABUSE IN THE SUBMISSION OF INSURANCE CLAIMS AND OVERPAYMENT OF INSURANCE CLAIMS AND FOR CREATING PREDICTIVE MODELS OF FUTURE INSURANCE CLAIMS; DEVELOPMENT OF SOFTWARE FOR OTHERS FOR USE IN ANALYZING, COMPILING AND EXPLOITING STATISTICAL HEALTH DATA; PROVIDING DATA CONVERSION OF COMPUTER PROGRAM DATA AND DEVELOPMENT OF DATA REPORTING SOFTWARE IN THE HEALTHCARE AND HEALTH INSURANCE INDUSTRY; PROVIDING CONSULTING SERVICES IN THE FIELD OF DATA CONVERSION OF COMPUTER PROGRAM DATA AND DEVELOPMENT OF DATA REPORTING SOFTWARE IN THE HEALTHCARE AND HEALTH INSURANCE INDUSTRY; PROVIDING QUALITY CONTROL SERVICES FOR HEALTHCARE INFORMATION PARTICULARLY TO IDENTIFY MISSED OR INCORRECT CODING, QUALITY PROBLEMS AND CORRECTIVE ACTION (U.S. CLS. 100 AND 101).

CLASS 45—PERSONAL AND LEGAL SERVICES

FOR COMPILING AND ANALYZING STATISTICAL HEALTH DATA IN ORDER TO UNCOVER AND IDENTIFY HEALTH CARE FRAUD AND CLAIMS ERRORS (U.S. CLS. 100 AND 101).
KIM MONINGHOFF, EXAMINING ATTORNEY

SN 77-686,697, CLOUDERA, INC., BURLINGAME, CA.
FILED 3-9-2009.

CLOUDERA

THE MARK CONSISTS OF STANDARD CHARACTERS WITHOUT CLAIM TO ANY PARTICULAR FONT, STYLE, SIZE, OR COLOR.

CLASS 9—ELECTRICAL AND SCIENTIFIC APPARATUS

FOR DOWNLOADABLE COMPUTER SOFTWARE FOR THE COLLECTION, EDITING, ORGANIZING, MODIFYING, BOOK MARKING, TRANSMISSION, STORAGE AND SHARING OF DATA AND INFORMATION (U.S. CLS. 21, 23, 26, 36 AND 38).

FIRST USE 10-15-2008; IN COMMERCE 10-15-2008.

CLASS 42—SCIENTIFIC AND COMPUTER SERVICES

FOR TECHNICAL SUPPORT SERVICES, NAMELY, TECHNICAL SUPPORT SERVICES FOR USERS OF THIRD-PARTY DATA SOFTWARE AND OPEN SOURCE SOFTWARE, NAMELY, COMPUTER SOFTWARE INSTALLATION AND CONFIGURATION AND TROUBLESHOOTING OF COMPUTER SOFTWARE PROBLEMS; COMPUTER CONSULTATION SERVICES IN THE FIELDS OF SELECTION, IMPLEMENTATION, INSTALLATION AND USE OF COMPUTER SOFTWARE SYSTEMS FOR OTHERS; COMPUTER CONSULTATION SERVICES IN THE FIELD OF DESIGN, SELECTION, IMPLEMENTATION AND USE OF COMPUTER SOFTWARE SYSTEMS FOR OTHERS; INFORMATION TECHNOLOGY CONSULTATION; SERVER LEASING SERVICES, NAMELY, RENTAL OF WEB AND COMPUTER SERVERS TO THIRD PARTIES; APPLICATION SERVICE PROVIDER, NAMELY, HOSTING COMPUTER SOFTWARE APPLICATIONS OF OTHERS; COMPUTER SERVICES, NAMELY, ACTING AS AN APPLICATION SERVICE PROVIDER IN THE FIELD OF KNOWLEDGE MANAGEMENT TO HOST COMPUTER APPLICATION SOFTWARE FOR THE COLLECTION, EDITING, ORGANIZING, MODIFYING, BOOK MARKING, TRANSMISSION, STORAGE AND SHARING OF DATA AND INFORMATION (U.S. CLS. 100 AND 101).

FIRST USE 10-15-2008; IN COMMERCE 10-15-2008.
HOWARD SMIGA, EXAMINING ATTORNEY

SN 77-687,191. TOWN & COUNTRY RADIATOR, INC., LUMBERTON, NC. FILED 3-10-2009.

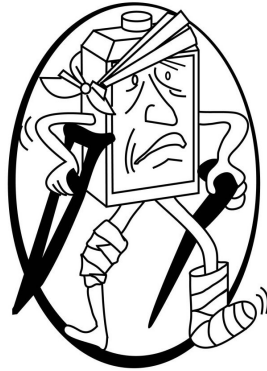

THE MARK CONSISTS OF A RADIATOR WITHIN AN OVAL DEPICTED AS A PERSON WITH A CRUTCH AND A CANE AND BANDAGES ON THE HEAD, KNEE AND FOOT.

CLASS 35—ADVERTISING AND BUSINESS

FOR RETAIL STORE SERVICES FEATURING AUTOMOTIVE RADIATORS AND AIR CONDITIONERS (U.S. CLS. 100, 101 AND 102).
FIRST USE 5-16-1975; IN COMMERCE 5-16-1975.

CLASS 37—CONSTRUCTION AND REPAIR

FOR AUTOMOTIVE RADIATOR AND AIR CONDITIONING REPAIR AND INSTALLATION (U.S. CLS. 100, 103 AND 106).
FIRST USE 5-16-1975; IN COMMERCE 5-16-1975.
MELISSA VALLILLO, EXAMINING ATTORNEY

CLASS 42—SCIENTIFIC AND COMPUTER SERVICES

FOR SURVEYING SERVICES, NAMELY, CADASTRAL LAND SURVEYS AND CONTROL, TOPOGRAPHIC, ROUTE ENGINEERING AND CONSTRUCTION SURVEYS; MAPPING AND CARTOGRAPHIC SERVICES, NAMELY, PHOTOGRAMMETRIC MAPPING, MAPPING USING GEOGRAPHIC INFORMATION SYSTEMS, MAPPING USING REMOTE SENSING; ENGINEERING SERVICES, NAMELY, CIVIL ENGINEERING SERVICES, INFRASTRUCTURE ENGINEERING SERVICES, STRUCTURAL ENGINEERING SERVICES, ENVIRONMENTAL ENGINEERING SERVICES AND CONSULTATION IN CONNECTION THEREWITH (U.S. CLS. 100 AND 101).
FIRST USE 0-0-1976; IN COMMERCE 0-0-1984.
LEIGH CAROLINE CASE, EXAMINING ATTORNEY

SN 77-688,013. ASBURY COMMUNITIES, INC., GERMANTOWN, MD. FILED 3-11-2009.

ALL ABOUT LIVING

SN 77-687,758. THE MCELHANNEY GROUP LTD., VANCOUVER, CANADA, FILED 3-10-2009.

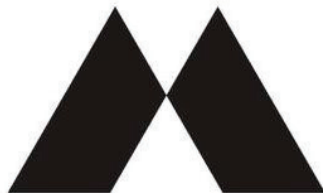

OWNER OF CANADA REG. NO. TMA687653, DATED 5-11-2007, EXPIRES 5-11-2022.
THE MARK CONSISTS OF "M" DESIGN.

CLASS 41—EDUCATION AND ENTERTAINMENT

FOR ORTHOPHOTOGRAPHY SERVICES (U.S. CLS. 100, 101 AND 107).
FIRST USE 0-0-1976; IN COMMERCE 0-0-1984.

THE MARK CONSISTS OF STANDARD CHARACTERS WITHOUT CLAIM TO ANY PARTICULAR FONT, STYLE, SIZE, OR COLOR.

CLASS 35—ADVERTISING AND BUSINESS

FOR MANAGEMENT OF CONTINUING CARE RETIREMENT COMMUNITIES FOR OTHERS (U.S. CLS. 100, 101 AND 102).

CLASS 43—HOTEL AND RESTAURANT SERVICES

FOR PROVIDING CONTINUING CARE RETIREMENT COMMUNITIES, NAMELY, RESIDENTIAL LIVING FACILITIES, ASSISTED LIVING FACILITIES (U.S. CLS. 100 AND 101).

CLASS 44—MEDICAL, BEAUTY AND AGRICULTURAL SERVICES

FOR PROVIDING CONTINUING CARE RETIREMENT COMMUNITIES, NAMELY, SKILLED NURSING FACILITIES (U.S. CLS. 100 AND 101).
BRENDAN MCCAULEY, EXAMINING ATTORNEY

SN 77-688,758. WMK HOLDINGS, INC., WILMINGTON, DE. FILED 3-11-2009.

SN 77-688,769. WMK HOLDINGS, INC., WILMINGTON, DE. FILED 3-11-2009.

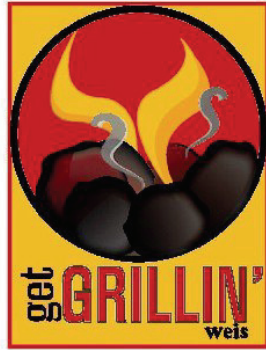

OWNER OF U.S. REG. NOS. 2,426,080, 3,113,678 AND 3,314,554.

THE COLOR(S) RED, ORANGE, YELLOW, GRAY, LIGHT GRAY, DARK GRAY, AND BLACK IS/ARE CLAIMED AS A FEATURE OF THE MARK.

THE MARK CONSISTS OF A BLACK OUTLINED CIRCLE CONTAINING DARK GRAY, GRAY, LIGHT GRAY, RED AND BLACK ROUNDED OBJECTS WITH GRAY AND LIGHT GRAY SWIRLS AND YELLOW AND ORANGE SWIRLS EMANATING VERTICALLY THEREFROM AGAINST A RED BACKGROUND, SURROUNDED BY A YELLOW RECTANGLE WITH A RED OUTLINE AND CONTAINING THE TERMS "GET" AND "WEIS" IN BLACK AND "GRILLIN'" IN RED.

CLASS 21—HOUSEWARES AND GLASS

FOR GROCERY STORE PRODUCTS, NAMELY, SERVINGWARE FOR SERVING FOOD (U.S. CLS. 2, 13, 23, 29, 30, 33, 40 AND 50).

CLASS 29—MEATS AND PROCESSED FOODS

FOR GROCERY STORE PRODUCTS, NAMELY, MEATS (U.S. CL. 46).

CLASS 31—NATURAL AGRICULTURAL PRODUCTS

FOR GROCERY STORE PRODUCTS, NAMELY, FRESH VEGETABLES (U.S. CLS. 1 AND 46).
TINA KUAN, EXAMINING ATTORNEY

OWNER OF U.S. REG. NOS. 2,426,080, 3,113,678 AND 3,314,554.

THE COLOR(S) RED, ORANGE, YELLOW, GRAY, LIGHT GRAY, DARK GRAY, AND BLACK IS/ARE CLAIMED AS A FEATURE OF THE MARK.

THE MARK CONSISTS OF A BLACK OUTLINED PARTIALLY TRUNCATED CIRCLE CONTAINING DARK GRAY, GRAY, LIGHT GRAY, RED AND BLACK ROUNDED OBJECTS WITH GRAY AND LIGHT GRAY SWIRLS AND YELLOW AND ORANGE SWIRLS EMANATING VERTICALLY THEREFROM AGAINST A RED BACKGROUND, SURROUNDED BY A YELLOW TRIANGLE WITH A RED OUTLINE AND CONTAINING THE TERMS "GET" AND "WEIS" IN BLACK AND "GRILLIN'" IN RED.

CLASS 21—HOUSEWARES AND GLASS

FOR GROCERY STORE PRODUCTS, NAMELY, SERVINGWARE FOR SERVING FOOD (U.S. CLS. 2, 13, 23, 29, 30, 33, 40 AND 50).

CLASS 29—MEATS AND PROCESSED FOODS

FOR GROCERY STORE PRODUCTS, NAMELY, MEATS (U.S. CL. 46).

CLASS 31—NATURAL AGRICULTURAL PRODUCTS

FOR GROCERY STORE PRODUCTS, NAMELY, FRESH VEGETABLES (U.S. CLS. 1 AND 46).
TINA KUAN, EXAMINING ATTORNEY

SN 77-689,274. MACE SECURITY INTERNATIONAL, INC., BENNINGTON, VT. FILED 3-12-2009.



OWNER OF U.S. REG. NOS. 888,911, 2,010,600 AND OTHERS.

THE COLOR(S) RED AND WHITE IS/ARE CLAIMED AS A FEATURE OF THE MARK.

THE MARK CONSISTS OF THE STYLIZED WORD "MACE" WITH A BOX AROUND THE "M". THE BOX AND THE LETTERS "A", "C" AND "E" ARE ALL RED AND THE "M" INSIDE THE BOX IS WHITE.

CLASS 6—METAL GOODS

FOR METAL LOCKING DEVICES FOR DOORS AND WINDOWS (U.S. CLS. 2, 12, 13, 14, 23, 25 AND 50).

CLASS 9—ELECTRICAL AND SCIENTIFIC APPARATUS

FOR PERSONAL SECURITY ALARMS, NAMELY, SONIC ALARMS; ELECTRONIC VIDEO SURVEILLANCE PRODUCTS, NAMELY, ELECTRONIC COMPONENTS OF SECURITY SYSTEMS (U.S. CLS. 21, 23, 26, 36 AND 38).

CLASS 13—FIREARMS

FOR PERSONAL DEFENSE SPRAYS; SELF-DEFENSE PRODUCTS, NAMELY, AEROSOL CANISTERS CONTAINING A VOLATILE LIQUID PREPARATION FOR TEMPORARILY INCAPACITATING PERSONS AND ANIMALS (U.S. CLS. 2 AND 9).
KOURTNEE HODGES, EXAMINING ATTORNEY

SN 77-689,884. MARINESYNC CORPORATION, SAN DIEGO, CA. FILED 3-12-2009.

MARINESYNC

THE MARK CONSISTS OF STANDARD CHARACTERS WITHOUT CLAIM TO ANY PARTICULAR FONT, STYLE, SIZE, OR COLOR.

CLASS 9—ELECTRICAL AND SCIENTIFIC APPARATUS

FOR WIRELESS REMOTE MONITORING EQUIPMENT, NAMELY, COMPUTER HARDWARE, MIDDLEWARE AND SOFTWARE FOR REAL-TIME MONITORING, DATA COLLECTION, ALERT NOTIFICATIONS AND USAGE REPORTING FOR MARINE EQUIPMENT AND MARINE VESSELS (U.S. CLS. 21, 23, 26, 36 AND 38).
FIRST USE 4-1-2008; IN COMMERCE 4-1-2008.

CLASS 35—ADVERTISING AND BUSINESS

FOR REAL-TIME MONITORING OF MARITIME VESSELS FOR COMMERCIAL PURPOSES (U.S. CLS. 100, 101 AND 102).
FIRST USE 4-1-2008; IN COMMERCE 4-1-2008.
SUSAN STIGLITZ, EXAMINING ATTORNEY

SN 77-690,553. LADY CAPTIVA INC., DBA BELTSVILLE FASHION GROUP, PLAINVIEW, NY. FILED 3-13-2009.

BFG

THE MARK CONSISTS OF STANDARD CHARACTERS WITHOUT CLAIM TO ANY PARTICULAR FONT, STYLE, SIZE, OR COLOR.

CLASS 18—LEATHER GOODS

FOR PURSES, LEATHER KEYCHAINS, WALLETS; BAGS, NAMELY, HANDBAGS, SHOULDER BAGS, TEXTILE AND LEATHER SHOPPING BAGS, BEACH BAGS, GYM BAGS, SCHOOL BAGS AND KNAPSACKS; PORTFOLIO CASES, NAMELY, BRIEFCASE-TYPE PORTFOLIOS (U.S. CLS. 1, 2, 3, 22 AND 41).

CLASS 25—CLOTHING

FOR BELTS AND WRISTBANDS (U.S. CLS. 22 AND 39).
MARK SHINER, EXAMINING ATTORNEY

SN 77-691,646. MODERNMOM.COM, INC., PACIFIC PALISADES, CA. FILED 3-16-2009.

MODERN MOM

THE MARK CONSISTS OF STANDARD CHARACTERS WITHOUT CLAIM TO ANY PARTICULAR FONT, STYLE, SIZE, OR COLOR.
OWNER OF U.S. REG. NO. 3,483,872.
NO CLAIM IS MADE TO THE EXCLUSIVE RIGHT TO USE "MOM", APART FROM THE MARK AS SHOWN.

CLASS 41—EDUCATION AND ENTERTAINMENT

FOR PROVIDING A WEBSITE FEATURING INFORMATION AND CONTENT IN THE FIELDS OF ENTERTAINMENT, ENTERTAINMENT FOR CHILDREN, EDUCATION, AND PARENTING CONCERNING EDUCATION AND ENTERTAINMENT OF CHILDREN (U.S. CLS. 100, 101 AND 107).
FIRST USE 12-1-2002; IN COMMERCE 11-1-2003.

CLASS 44—MEDICAL, BEAUTY AND AGRICULTURAL SERVICES

FOR PROVIDING A WEBSITE FEATURING INFORMATION AND CONTENT IN THE FIELDS OF HUMAN HEALTH AND CHILDREN'S HEALTH; PROVIDING A WEBSITE FEATURING INFORMATION AND CONTENT IN THE FIELD OF PARENTING CONCERNING THE HEALTH OF CHILDREN (U.S. CLS. 100 AND 101).
FIRST USE 12-1-2002; IN COMMERCE 11-1-2003.

CLASS 45—PERSONAL AND LEGAL SERVICES

FOR PROVIDING A WEBSITE FEATURING INFORMATION AND CONTENT IN THE FIELDS OF PERSONAL RELATIONSHIPS, FASHION, LIFESTYLES, INTRAFAMILY RELATIONSHIPS, AND PARENTING CONCERNING INTRAFAMILY RELATIONSHIPS (U.S. CLS. 100 AND 101).
FIRST USE 12-1-2002; IN COMMERCE 11-1-2003.
KRISTIN CARLSON, EXAMINING ATTORNEY

SN 77-691,652. MODERNMOM.COM, INC., PACIFIC PALISADES, CA. FILED 3-16-2009.



OWNER OF U.S. REG. NO. 3,511,760.
THE PORTRAIT SHOWN IN THE MARK DOES NOT IDENTIFY A PARTICULAR LIVING INDIVIDUAL.
THE MARK CONSISTS OF A SEATED WOMAN WITH MULTIPLE ARMS HOLDING A COMPUTER, WHISK, BARBELL, GLASS, BOOK, CREDIT CARD, CELLPHONE, AND INFANT.

CLASS 41—EDUCATION AND ENTERTAINMENT

FOR PROVIDING A WEBSITE FEATURING INFORMATION AND CONTENT IN THE FIELDS OF ENTERTAINMENT, ENTERTAINMENT FOR CHILDREN, EDUCATION, AND PARENTING CONCERNING EDUCATION AND ENTERTAINMENT OF CHILDREN (U.S. CLS. 100, 101 AND 107).
FIRST USE 12-1-2002; IN COMMERCE 11-1-2003.

CLASS 44—MEDICAL, BEAUTY AND AGRICULTURAL SERVICES

FOR PROVIDING A WEBSITE FEATURING INFORMATION AND CONTENT IN THE FIELDS OF HUMAN HEALTH AND CHILDREN'S HEALTH; PROVIDING A WEBSITE FEATURING INFORMATION AND CONTENT IN THE FIELD OF PARENTING CONCERNING THE HEALTH OF CHILDREN (U.S. CLS. 100 AND 101).
FIRST USE 12-1-2002; IN COMMERCE 11-1-2003.

CLASS 45—PERSONAL AND LEGAL SERVICES

FOR PROVIDING A WEBSITE FEATURING INFORMATION AND CONTENT IN THE FIELDS OF PERSONAL RELATIONSHIPS, FASHION, LIFESTYLES, INTRAFAMILY RELATIONSHIPS, AND PARENTING CONCERNING INTRAFAMILY RELATIONSHIPS (U.S. CLS. 100 AND 101).
FIRST USE 12-1-2002; IN COMMERCE 11-1-2003.
KRISTIN CARLSON, EXAMINING ATTORNEY

SN 77-692,100. RAAB, THORSTEN, SAN FRANCISCO, CA. FILED 3-16-2009.

Hip&Single

THE MARK CONSISTS OF STANDARD CHARACTERS WITHOUT CLAIM TO ANY PARTICULAR FONT, STYLE, SIZE, OR COLOR.

CLASS 25—CLOTHING

FOR CLOTHING, NAMELY, CAPS, HATS AND T-SHIRTS (U.S. CLS. 22 AND 39).

CLASS 45—PERSONAL AND LEGAL SERVICES

FOR COMPUTER SERVICES, NAMELY, MATCHMAKING SERVICES FEATURING MATCHING AND GUIDED COMMUNICATION OF PARTICIPANTS IN CONJUNCTION WITH AN AUTOMATED, ANONYMOUS SCHEDULING SERVICE AMONG REGISTERED USERS; MATCHMAKING SERVICES, NAMELY, PROVIDING AN ONLINE DATABASE OF PERSONAL ADS; INTERNET BASED INTRODUCTION AND SOCIAL NETWORKING SERVICES IN THE FIELD OF PERSONAL RELATIONSHIPS AND SOCIAL INTRODUCTION (U.S. CLS. 100 AND 101).
ASMAT KHAN, EXAMINING ATTORNEY

SN 77-692,114. A3 TECHNOLOGIES, INC., CHARLOTTE, NC. FILED 3-16-2009.



NO CLAIM IS MADE TO THE EXCLUSIVE RIGHT TO USE "TECHNOLOGIES", APART FROM THE MARK AS SHOWN.

THE MARK CONSISTS OF A TRIANGLE BEHIND THREE DIAGONAL LINES, ALL ABOVE THE UNDERLINED PHRASE "A3 TECHNOLOGIES".

CLASS 9—ELECTRICAL AND SCIENTIFIC APPARATUS

FOR COMPUTER SOFTWARE FOR OPERATION OF WIRELESS DATA COLLECTION DEVICES AND BARCODE SCANNERS; COMPUTER SOFTWARE FOR DATABASE MANAGEMENT FOR WIRELESS DATA COLLECTION DEVICES AND BARCODE SCANNERS (U.S. CLS. 21, 23, 26, 36 AND 38).
FIRST USE 11-15-2002; IN COMMERCE 3-16-2003.

CLASS 37—CONSTRUCTION AND REPAIR

FOR INSTALLATION OF MOBILE DATA MANAGEMENT SYSTEMS, BARCODE SCANNING SYSTEMS, AND STAND-ALONE WIRELESS SYSTEMS FOR MOBILE DATA MANAGEMENT AND BARCODE SCANNING (U.S. CLS. 100, 103 AND 106).
FIRST USE 11-15-2002; IN COMMERCE 3-16-2003.
KRISTIN DAHLING, EXAMINING ATTORNEY

SN 77-692,536. JAK & ASSOCIATES, LLC, CHICAGO, IL.
FILED 3-17-2009.

SN 77-692,752. KARAVAN COMPLEX LLC, BROOKLYN,
NY. FILED 3-17-2009.

NTP Wireless

THE MARK CONSISTS OF STANDARD CHARACTERS WITHOUT CLAIM TO ANY PARTICULAR FONT, STYLE, SIZE, OR COLOR.

NO CLAIM IS MADE TO THE EXCLUSIVE RIGHT TO USE "WIRELESS", APART FROM THE MARK AS SHOWN.

CLASS 35—ADVERTISING AND BUSINESS

FOR PROJECT MANAGEMENT FOR OTHERS FOR BUSINESS PURPOSES SPECIFICALLY REGARDING WIRELESS NETWORK INFRASTRUCTURE (U.S. CLS. 100, 101 AND 102).

CLASS 36—INSURANCE AND FINANCIAL

FOR LAND ACQUISITION SERVICES SPECIFICALLY REGARDING WIRELESS NETWORK INFRASTRUCTURE (U.S. CLS. 100, 101 AND 102).

KYLE PEETE, EXAMINING ATTORNEY

SN 77-692,574. JAK & ASSOCIATES, LLC, CHICAGO, IL.
FILED 3-17-2009.



NO CLAIM IS MADE TO THE EXCLUSIVE RIGHT TO USE "WIRELESS", APART FROM THE MARK AS SHOWN. THE COLOR(S) BLUE AND GREEN IS/ARE CLAIMED AS A FEATURE OF THE MARK.

THE MARK CONSISTS OF THE LETTERS "NTP" IN BLUE, THE WORDS "WIRELESS, EVERY SITE, EVERY DAY" IN GREEN, AND AN INVERTED TRIANGLE CONSISTING OF BLUE SQUARES ABOVE THE LETTER "I" IN THE WORD "WIRELESS".

CLASS 35—ADVERTISING AND BUSINESS

FOR PROJECT MANAGEMENT FOR OTHERS FOR BUSINESS PURPOSES SPECIFICALLY REGARDING WIRELESS NETWORK INFRASTRUCTURE (U.S. CLS. 100, 101 AND 102).

CLASS 36—INSURANCE AND FINANCIAL

FOR LAND ACQUISITION SERVICES SPECIFICALLY REGARDING WIRELESS NETWORK INFRASTRUCTURE (U.S. CLS. 100, 101 AND 102).

KYLE PEETE, EXAMINING ATTORNEY



THE COLOR(S) GREEN, BLUE, WHITE, AND BLACK IS/ARE CLAIMED AS A FEATURE OF THE MARK.

THE MARK CONSISTS OF ONE BLUE GLOBE WITH TWO GREEN CONTINENTS, NORTH AMERICA AND SOUTH AMERICA, WITH ONE WHITE WITH BLACK CONTOUR LETTER "K," AND ONE WHITE WITH BLACK CONTOUR REVERSED LETTER "K" ON A BACKGROUND OF A BLUE GLOBE WITH GREEN CONTINENTS.

CLASS 35—ADVERTISING AND BUSINESS

FOR EXPORT AGENCY SERVICES FOR THE GOODS OF OTHERS; EXPORT AND IMPORT AGENCIES; GOODS IMPORT-EXPORT AGENCIES; IMPORT AND EXPORT AGENCIES; VALUE-ADDED RESELLER SERVICES, NAMELY, DISTRIBUTORSHIP SERVICES FEATURING COMPUTER SECURITY AND INFORMATION TECHNOLOGY PRODUCTS (U.S. CLS. 100, 101 AND 102).

CLASS 39—TRANSPORTATION AND STORAGE

FOR ARRANGING AND COORDINATING TRAVEL ARRANGEMENTS FOR INDIVIDUALS AND GROUPS, NAMELY, DESTINATIONS STAYS, HONEYMOONS, FAMILY VACATIONS, AND DESTINATION WEDDINGS; ARRANGING FOR TRAVEL VISAS, PASSPORTS AND TRAVEL DOCUMENTS FOR PERSONS TRAVELING ABROAD; ARRANGING TRAVEL TOURS; ARRANGING TRAVEL TOURS AS A BONUS PROGRAM FOR CREDIT CARDS CUSTOMERS; BOOKING OF SEATS FOR TRAVEL; COORDINATING TRAVEL ARRANGEMENTS FOR INDIVIDUALS AND FOR GROUPS; ESCORTING OF TRAVELLERS; ESCORTING TRAVELLERS; MAKING TRAVEL AND EXCURSION ARRANGEMENTS FOR BANDS AND ORCHESTRAS; ORGANISATION OF TRAVEL; ORGANIZATION OF EXCURSIONS, SIGHTSEEING TOURS, HOLIDAYS, TOURS AND TRAVEL; ORGANIZATION OF TRAVEL AND BOAT TRIPS; PARCEL SHIPPING SERVICES; RESERVATION AND BOOKING OF SEATS FOR TRAVEL; SHIP BROKERAGE; SHIPPING AND DELIVERY SERVICES, NAMELY, PICKUP, TRANSPORTATION, AND DELIVERY OF PACKAGES AND LETTERS BY VARIOUS MODES OF TRANSPORTATION; SHIPPING OF GOODS; TOURIST AGENCY SERVICES; TRANSPORT OF TRAVELLERS; TRAVEL AGENCY SERVICES, NAMELY, MAKING RESERVATIONS AND BOOKINGS FOR TRANSPORTATION; TRAVEL AND TOUR INFORMATION SERVICE; TRAVEL AND TOUR TICKET RESERVATION SERVICE; TRAVEL BOOKING AGENCIES; TRAVEL COURIER AND TRAVEL GUIDE SERVICES; TRAVEL GUIDE AND TRAVEL INFORMATION SERVICES; TRAVEL GUIDE SERVICES; TRAVEL INFORMATION; TRAVEL INFORMATION SERVICES; TRAVEL PLANNING FOR INDIVIDUALS, FAMILIES, AND GROUPS FOR SPECIAL OCCASIONS SUCH AS DESTINATION WEDDINGS AND HONEYMOONS (U.S. CLS. 100 AND 105).

CLASS 43—HOTEL AND RESTAURANT SERVICES

FOR RESERVATION OF HOTEL ROOMS FOR TRAVELLERS; RESERVATION OF ROOMS FOR TRAVELLERS; TRAVEL AGENCY SERVICES, NAMELY, MAKING RESERVATIONS AND BOOKING FOR TEMPORARY LODGING (U.S. CLS. 100 AND 101).

TIMOTHY FINNEGAN, EXAMINING ATTORNEY

SN 77-693,105. DOTFIT, LLC, LAFAYETTE, CA. FILED 3-17-2009.

Exerspy

THE MARK CONSISTS OF STANDARD CHARACTERS WITHOUT CLAIM TO ANY PARTICULAR FONT, STYLE, SIZE, OR COLOR.

CLASS 9—ELECTRICAL AND SCIENTIFIC APPARATUS

FOR ELECTRONIC ACTIVITY TRACKING MONITOR INCORPORATED INTO ARMBANDS FOR WEIGHT MANAGEMENT (U.S. CLS. 21, 23, 26, 36 AND 38).

CLASS 42—SCIENTIFIC AND COMPUTER SERVICES

FOR ON-LINE DOWNLOADABLE SOFTWARE FOR PERSONAL WEIGHT MANAGEMENT (U.S. CLS. 100 AND 101).

BARBARA BROWN, EXAMINING ATTORNEY

SN 77-693,445. NEW IMAGE LABS CORPORATION, WEST PALM BEACH, FL. FILED 3-18-2009.

ACTIV8

THE MARK CONSISTS OF STANDARD CHARACTERS WITHOUT CLAIM TO ANY PARTICULAR FONT, STYLE, SIZE, OR COLOR.

CLASS 3—COSMETICS AND CLEANING PREPARATIONS

FOR HAIR CARE AND HAIR TREATMENT PRODUCTS FOR HAIR LOSS PREVENTION, NAMELY, SHAMPOO, HAIR CONDITIONER, SCALP CLEANSER; HAIR CARE PREPARATIONS FOR HAIR LOSS PREVENTION; NON-MEDICATED HAIR TREATMENT PREPARATIONS FOR HAIR LOSS PREVENTION (U.S. CLS. 1, 4, 6, 50, 51 AND 52).

CLASS 5—PHARMACEUTICALS

FOR HAIR GROWTH STIMULANTS (U.S. CLS. 6, 18, 44, 46, 51 AND 52).

ALYSSA STEEL, EXAMINING ATTORNEY

SN 77-693,475. IBG, D50968 KOLN, FED REP GERMANY, FILED 3-18-2009.

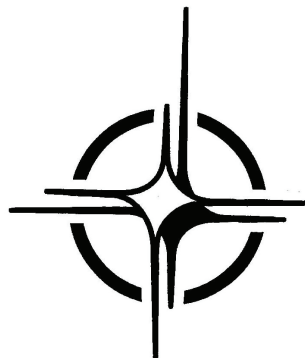

THE MARK CONSISTS OF A DESIGN OF TWO STARS WITH FOUR POINTS CONTAINING RADIATING LINES. THE STARS APPEAR WITHIN A CIRCLE MADE OF BROKEN LINES.

CLASS 6—METAL GOODS

FOR WELDING WIRE MADE OF METAL (U.S. CLS. 2, 12, 13, 14, 23, 25 AND 50).

FIRST USE 1-1-1998; IN COMMERCE 1-1-1998.

CLASS 7—MACHINERY

FOR ELECTRICAL AND GAS-OPERATED WELDING MACHINES AND STRUCTURAL PARTS THEREFOR, NAMELY, GAS NOZZLES, CONTACT TIPS CONNECTIONS FOR WELDING TORCHES, NAMELY, ELECTRICAL CONNECTORS, CABLE ASSEMBLIES FOR WELDING AND CUTTING TORCHES; ELECTRIC PUMPS FOR LIQUIDS, OIL PUMPS FOR USE IN MOTORS AND ENGINES AND POSITIVE DISPLACEMENT PUMPS, WELDING EQUIPMENT FOR ROBOTS, NAMELY, ELECTRICAL WELDING MACHINES (U.S. CLS. 13, 19, 21, 23, 31, 34 AND 35).

FIRST USE 1-1-1998; IN COMMERCE 1-1-1998.

CLASS 9—ELECTRICAL AND SCIENTIFIC APPARATUS

FOR WELDING ELECTRODES, DATA PROCESSORS AND COMPUTERS; COMPUTER SOFTWARE FOR USE IN DATABASE MANAGEMENT, FOR MEASURING WELDING EQUIPMENT (U.S. CLS. 21, 23, 26, 36 AND 38).

FIRST USE 1-1-1998; IN COMMERCE 1-1-1998.

CIMMERIAN COLEMAN, EXAMINING ATTORNEY

SN 77-693,509. ADDIS INTELLECTUAL CAPITAL, LLC, KING OF PRUSSIA, PA. FILED 3-18-2009.

RISK ROVER 365

THE MARK CONSISTS OF STANDARD CHARACTERS WITHOUT CLAIM TO ANY PARTICULAR FONT, STYLE, SIZE, OR COLOR.

NO CLAIM IS MADE TO THE EXCLUSIVE RIGHT TO USE "RISK" AND "365", APART FROM THE MARK AS SHOWN.

CLASS 35—ADVERTISING AND BUSINESS

FOR BUSINESS RISK MANAGEMENT CONSULTING (U.S. CLS. 100, 101 AND 102).

SN 77-695,649, ARYSTA LIFESCIENCE NORTH AMERICA, LLC, CARY, NC. FILED 3-20-2009.

CLASS 36—INSURANCE AND FINANCIAL

FOR INSURANCE CONSULTANCY SERVICES, NAMELY, PROVIDING ADVICE IN THE FIELD OF PROPERTY AND CASUALTY INSURANCE (U.S. CLS. 100, 101 AND 102).

JOHN DALIER, EXAMINING ATTORNEY



THE MARK CONSISTS OF THE WORDS "BASE-PAK" HAVING ABOVE AND BELOW A SHAPE OF TWO SIDES CONVERGING INTO A CORNER.

SN 77-695,398. DAIRY, LLC, PLANO, TX. FILED 3-20-2009.

CLASS 5—PHARMACEUTICALS

FOR PESTICIDES, INSECTICIDES, HERBICIDES, FUNGICIDES ALL FOR USE IN AGRICULTURE, HORTICULTURE AND SILVICULTURE; PREPARATIONS FOR DESTROYING VERMIN; FUMIGANTS (U.S. CLS. 6, 18, 44, 46, 51 AND 52).

CLASS 6—METAL GOODS

FOR CONTAINERS PRINCIPALLY MADE OF METAL FOR STORAGE OF AGRICULTURAL CHEMICALS AND FUMIGANTS FOR COMMERCIAL USE (U.S. CLS. 2, 12, 13, 14, 23, 25 AND 50).

CLASS 20—FURNITURE AND ARTICLES NOT OTHERWISE CLASSIFIED

FOR CONTAINERS PRINCIPALLY MADE OF PLASTIC FOR STORAGE OF AGRICULTURAL CHEMICALS AND FUMIGANTS FOR COMMERCIAL USE (U.S. CLS. 2, 13, 22, 25, 32 AND 50).

ZHALEH DELANEY, EXAMINING ATTORNEY



SN 77-696,073. WORK IN SPORTS, LLC, PHOENIX, AZ. FILED 3-20-2009.

OWNER OF U.S. REG. NOS. 2,626,833 AND 2,676,226. NO CLAIM IS MADE TO THE EXCLUSIVE RIGHT TO USE "DAIRY.COM", APART FROM THE MARK AS SHOWN.

THE MARK CONSISTS OF A COW STANDING ON A WAVED LINE OVER THE WORDS "DAIRY.COM".

MAKE YOUR PASSION YOUR CAREER

CLASS 35—ADVERTISING AND BUSINESS

FOR PROVIDING AN ON-LINE SERVICE WHICH FACILITATES ELECTRONIC COMMERCE BY ENABLING USERS TO LOCATE BUYERS AND SELLERS FOR AGRICULTURAL COMMODITIES (U.S. CLS. 100, 101 AND 102).

FIRST USE 5-0-2001; IN COMMERCE 5-0-2001.

THE MARK CONSISTS OF STANDARD CHARACTERS WITHOUT CLAIM TO ANY PARTICULAR FONT, STYLE, SIZE, OR COLOR.

CLASS 35—ADVERTISING AND BUSINESS

CLASS 36—INSURANCE AND FINANCIAL

FOR ONLINE BROKERAGE SERVICES AND COMMODITY TRADING SERVICES FOR OTHERS IN THE FIELD OF DAIRY PRODUCTS AND OTHER AGRICULTURAL COMMODITIES (U.S. CLS. 100, 101 AND 102).

FIRST USE 5-0-2001; IN COMMERCE 5-0-2001. AMOS T. MATTHEWS, JR., EXAMINING ATTORNEY

FOR PROVIDING ONLINE INFORMATION IN THE FIELD OF EMPLOYMENT IN THE SPORTS INDUSTRY, NAMELY, JOB POSTINGS, RESUME POSTINGS, EMPLOYMENT SEARCHES; PROVIDING ON-LINE INTERACTIVE EMPLOYMENT COUNSELING AND RECRUITING SERVICES FOR THE SPORTS INDUSTRY (U.S. CLS. 100, 101 AND 102).

FIRST USE 7-1-2002; IN COMMERCE 7-1-2002.

CLASS 41—EDUCATION AND ENTERTAINMENT

FOR PROVIDING ONLINE INFORMATION IN THE FIELD OF JOB RESOURCES FOR THE SPORTS INDUSTRY, NAMELY, PROVIDING ON-LINE INFORMATION IN THE FIELD OF EMPLOYMENT TRAINING IN THE SPORTS INDUSTRY (U.S. CLS. 100, 101 AND 107).

FIRST USE 7-1-2002; IN COMMERCE 7-1-2002.
INGRID C. EULIN, EXAMINING ATTORNEY

SN 77-697,353. PAMELA JAMES GROUP, INC., SUMMIT, NJ.
FILED 3-23-2009.

PAMELA JAMES

THE MARK CONSISTS OF STANDARD CHARACTERS WITHOUT CLAIM TO ANY PARTICULAR FONT, STYLE, SIZE, OR COLOR.

"PAMELA JAMES" DOES NOT IDENTIFY A LIVING INDIVIDUAL.

SN 77-696,823. CMC ENERGY SERVICES, INC., BETHESDA, MD. FILED 3-23-2009.

CMC ENERGY SERVICES**CLASS 14—JEWELRY**

FOR JEWELRY; JEWELRY, NAMELY, RINGS, EARRINGS, CUFFS, BANGLES, NECKLACES, PENDANTS (U.S. CLS. 2, 27, 28 AND 50).

FIRST USE 0-0-2005; IN COMMERCE 0-0-2005.

CLASS 18—LEATHER GOODS

FOR HANDBAGS; TOTE BAGS (U.S. CLS. 1, 2, 3, 22 AND 41).

FIRST USE 0-0-2005; IN COMMERCE 0-0-2005.

CLASS 26—FANCY GOODS

FOR BELT BUCKLES (U.S. CLS. 37, 39, 40, 42 AND 50).
FIRST USE 0-0-2005; IN COMMERCE 0-0-2005.

MARK RADEMACHER, EXAMINING ATTORNEY

THE MARK CONSISTS OF STANDARD CHARACTERS WITHOUT CLAIM TO ANY PARTICULAR FONT, STYLE, SIZE, OR COLOR.

OWNER OF U.S. REG. NOS. 2,362,796 AND 3,214,960.

NO CLAIM IS MADE TO THE EXCLUSIVE RIGHT TO USE "ENERGY SERVICES", APART FROM THE MARK AS SHOWN.

SN 77-698,174. BLOWER-DEMPSAY CORPORATION, SANTA ANA, CA. FILED 3-24-2009.

CLASS 9—ELECTRICAL AND SCIENTIFIC APPARATUS

FOR COMPUTER SOFTWARE FOR CONDUCTING INSPECTIONS IN EXISTING HOMES USED TO IDENTIFY IMPROVEMENTS THAT INCREASE THE ENERGY EFFICIENCY OF SUCH HOMES BASED ON INSPECTION DATA, ESTIMATE THE SAVINGS, COSTS, AND PAYBACKS RELATED TO EACH IMPROVEMENT, AND/OR IDENTIFY WHICH IMPROVEMENTS REDUCE ENERGY COSTS MORE THAN THE COSTS OF IMPLEMENTING THE IMPROVEMENTS (U.S. CLS. 21, 23, 26, 36 AND 38).

CLASS 37—CONSTRUCTION AND REPAIR

FOR INSTALLATION OF WEATHERIZATION, LIGHTING, SEALANT, THERMOSTATS, METERING, AND RADIO CONTROLS TO ENHANCE ENERGY EFFICIENCY (U.S. CLS. 100, 103 AND 106).

CLASS 41—EDUCATION AND ENTERTAINMENT

FOR PROVIDING TRAINING IN THE FIELD OF ENERGY EFFICIENCY FOR ENERGY AUDITORS, WEATHERIZATION SPECIALISTS, AND POST-INSTALLATION INSPECTORS, NAMELY, ORGANIZING AND CONDUCTING CLASSES, INSTRUCTING TRAINERS, DISTANCE LEARNING, AND PROVIDING REFRESHER COURSES (U.S. CLS. 100, 101 AND 107).

MELVIN AXILBUND, EXAMINING ATTORNEY

PACIFIC FLEXIBLE SOLUTIONS

THE MARK CONSISTS OF STANDARD CHARACTERS WITHOUT CLAIM TO ANY PARTICULAR FONT, STYLE, SIZE, OR COLOR.

CLASS 35—ADVERTISING AND BUSINESS

FOR DISTRIBUTORSHIP SERVICES IN THE FIELD OF PACKAGING FILMS, PACKAGING CONTAINERS AND PACKAGING EQUIPMENT (U.S. CLS. 100, 101 AND 102).

CLASS 40—MATERIAL TREATMENT

FOR CUSTOM MANUFACTURING SERVICES IN THE FIELD OF PACKAGING FILMS, PACKAGING CONTAINERS AND PACKAGING EQUIPMENT; PRINTING SERVICES IN THE FIELD OF PACKAGING FILMS, PACKAGING CONTAINERS AND PACKAGING EQUIPMENT; CONVERSION SERVICES, NAMELY, CONVERSION OF PAPER AND FILMS INTO CONTAINERS AND FILMS FOR USE IN PACKAGING (U.S. CLS. 100, 103 AND 106).

MARTHA FROMM, EXAMINING ATTORNEY

SN 77-698,432. ALPHA BIO TEC. LTD., PETACH TIKVA, ISRAEL, FILED 3-25-2009.



OWNER OF U.S. REG. NO. 3,407,217.

NO CLAIM IS MADE TO THE EXCLUSIVE RIGHT TO USE "TEC" AND "NANOTEC", APART FROM THE MARK AS SHOWN.

THE COLOR(S) RED, YELLOW, GREEN AND BLACK IS/ ARE CLAIMED AS A FEATURE OF THE MARK.

THE MARK CONSISTS OF A LOGO CONSISTING OF A STYLIZED LOWER CASE "A" AND "B" TOGETHER IN RED, YELLOW AND GREEN, AND THE WORDS "ALPHA-BIO TEC NANOTEC" IN BLACK.

CLASS 10—MEDICAL APPARATUS

FOR ARTIFICIAL LIMBS, DENTAL IMPLANTS, STRUCTURAL PROSTHETIC COMPONENTS FOR DENTAL IMPLANTS, NAMELY, ABUTMENTS, SECONDARY PARTS, TERTIARY PARTS; DENTAL PROSTHESES AND PARTS THEREOF FOR DENTISTRY, ENDO-PROSTHESES FOR HUMAN, DENTAL, AND VETERINARY MEDICINE (U.S. CLS. 26, 39 AND 44).

CLASS 40—MATERIAL TREATMENT

FOR APPLYING COATINGS AND SURFACE TREATMENTS ULTRASONICALLY TO DENTAL IMPLANTS (U.S. CLS. 100, 103 AND 106).

KATHERINE STOIDES, EXAMINING ATTORNEY

SN 77-698,464. CMC ENERGY SERVICES, INC., BETHESDA, MD. FILED 3-25-2009.

HOME ENERGY TUNE-UP

THE MARK CONSISTS OF STANDARD CHARACTERS WITHOUT CLAIM TO ANY PARTICULAR FONT, STYLE, SIZE, OR COLOR.

OWNER OF U.S. REG. NO. 2,858,629.

NO CLAIM IS MADE TO THE EXCLUSIVE RIGHT TO USE "HOME ENERGY", APART FROM THE MARK AS SHOWN.

CLASS 9—ELECTRICAL AND SCIENTIFIC APPARATUS

FOR COMPUTER SOFTWARE FOR CONDUCTING INSPECTIONS IN EXISTING HOMES USED TO IDENTIFY IMPROVEMENTS THAT INCREASE THE ENERGY EFFICIENCY OF SUCH HOMES BASED ON INSPECTION DATA, ESTIMATE THE SAVINGS, COSTS, AND PAYBACKS RELATED TO EACH IMPROVEMENT, AND/OR IDENTIFY WHICH IMPROVEMENTS REDUCE ENERGY COSTS MORE THAN THE COSTS OF IMPLEMENTING THE IMPROVEMENTS (U.S. CLS. 21, 23, 26, 36 AND 38).

CLASS 37—CONSTRUCTION AND REPAIR

FOR INSTALLATION OF WEATHERIZATION, LIGHTING, SEALANT, THERMOSTATS, METERING, AND RADIO CONTROLS TO ENHANCE ENERGY EFFICIENCY (U.S. CLS. 100, 103 AND 106).

CLASS 41—EDUCATION AND ENTERTAINMENT

FOR PROVIDING TRAINING IN THE FIELD OF ENERGY EFFICIENCY FOR ENERGY AUDITORS, WEATHERIZATION SPECIALISTS, AND POST-INSTALLATION INSPECTORS, NAMELY, ORGANIZING AND CONDUCTING CLASSES, INSTRUCTING TRAINERS, DISTANCE LEARNING, AND PROVIDING REFRESHER COURSES (U.S. CLS. 100, 101 AND 107).

MELVIN AXILBUND, EXAMINING ATTORNEY

SN 77-698,499. COMMITTEE ON ACCREDITATION FOR RESPIRATORY CARE, BEDFORD, TX. FILED 3-25-2009.

COARC

THE MARK CONSISTS OF STANDARD CHARACTERS WITHOUT CLAIM TO ANY PARTICULAR FONT, STYLE, SIZE, OR COLOR.

CLASS 9—ELECTRICAL AND SCIENTIFIC APPARATUS

FOR DOWNLOADABLE ELECTRONIC PUBLICATIONS IN THE NATURE OF NEWSLETTERS, PAMPHLETS, BOOKS, AND MANUALS IN THE FIELD OF ACCREDITATION OF CLINICAL RESPIRATORY THERAPY PROGRAMS (U.S. CLS. 21, 23, 26, 36 AND 38).

CLASS 42—SCIENTIFIC AND COMPUTER SERVICES

FOR ACCREDITATION SERVICES, NAMELY, DEVELOPING, EVALUATING, AND TESTING STANDARDS FOR CLINICAL RESPIRATORY THERAPY PROGRAMS FOR THE PURPOSE OF ACCREDITATION, AND EVALUATING RESPIRATORY CLINICS TO DETERMINE WHETHER THE RESPIRATORY CLINICS CONFORM TO ESTABLISHED STANDARDS (U.S. CLS. 100 AND 101).

GINA FINK, EXAMINING ATTORNEY

SN 77-699,670. REVLON CONSUMER PRODUCTS CORPORATION, NEW YORK, NY. FILED 3-26-2009.

MANI-EXPERT

THE MARK CONSISTS OF STANDARD CHARACTERS WITHOUT CLAIM TO ANY PARTICULAR FONT, STYLE, SIZE, OR COLOR.

CLASS 3—COSMETICS AND CLEANING PREPARATIONS

FOR CUTICLE OIL PEN AND NAIL POLISH CORRECTOR (U.S. CLS. 1, 4, 6, 50, 51 AND 52).

CLASS 8—HAND TOOLS

FOR BEAUTY TOOL IMPLEMENTS, NAMELY, NAIL FILES (U.S. CLS. 23, 28 AND 44).

MARK T. MULLEN, EXAMINING ATTORNEY

SN 77-699,772. BIOECHOES, INC., BIRMINGHAM, AL.
FILED 3-26-2009.

GREATER INSIGHT. GREATER
GOOD.

THE MARK CONSISTS OF STANDARD CHARACTERS WITHOUT CLAIM TO ANY PARTICULAR FONT, STYLE, SIZE, OR COLOR.

CLASS 35—ADVERTISING AND BUSINESS

FOR PUBLIC ADVOCACY TO PROMOTE AWARENESS OF ECONOMIC, ENVIRONMENTAL, ETHICAL AND SOCIAL ISSUES IN PRODUCT DESIGN AND DEVELOPMENT (U.S. CLS. 100, 101 AND 102).

CLASS 42—SCIENTIFIC AND COMPUTER SERVICES

FOR ENGINEERING SERVICES AND CONSULTATION IN THE FIELDS OF BIOLOGICAL, MEDICAL, ENVIRONMENTAL AND PHYSICAL SCIENCES; RESEARCH, DEVELOPMENT, ENGINEERING AND TESTING SERVICES IN THE FIELDS OF PRODUCT DESIGN (U.S. CLS. 100 AND 101).

AMY ALFIERI, EXAMINING ATTORNEY

SN 77-700,071. WORKSHOP XI, INC., SAUSALITO, CA.
FILED 3-26-2009.

ARKIV

THE MARK CONSISTS OF STANDARD CHARACTERS WITHOUT CLAIM TO ANY PARTICULAR FONT, STYLE, SIZE, OR COLOR.

THE ENGLISH TRANSLATION OF "ARKIV" IS ARCHIVE.

CLASS 8—HAND TOOLS

FOR HAND TOOLS, NAMELY, SURFBOARD WAX REMOVAL TOOL (U.S. CLS. 23, 28 AND 44).

CLASS 9—ELECTRICAL AND SCIENTIFIC APPARATUS

FOR MESSENGER BAGS SPECIFICALLY DESIGNED FOR HOLDING LAPTOP COMPUTERS; BACKPACKS SPECIFICALLY DESIGNED FOR HOLDING LAPTOP COMPUTERS; CELL PHONE HOLDERS; PROTECTIVE SLEEVES FOR LAPTOPS (U.S. CLS. 21, 23, 26, 36 AND 38).

CLASS 18—LEATHER GOODS

FOR BAGS, NAMELY, ALL PURPOSE CARRYING BAGS, ALL PURPOSE SPORT BAGS; BAGS FOR SPORTS, SHOULDER BAGS, BOOK BAGS, WAIST PACKS, MESSENGER BAGS; BACKPACKS (U.S. CLS. 1, 2, 3, 22 AND 41).

CLASS 28—TOYS AND SPORTING GOODS

FOR SPORTS EQUIPMENT FOR SURFING, NAMELY, BAGS SPECIFICALLY ADAPTED FOR SURFBOARDS, AND RELATED SURFING EQUIPMENT, NAMELY, SURFBOARD LEASHES (U.S. CLS. 22, 23, 38 AND 50).
STEVEN JACKSON, EXAMINING ATTORNEY

SN 77-700,596. INNOVATA BIOMED LIMITED, EDINBURGH, UNITED KINGDOM, FILED 3-27-2009.

DUOHALER

THE MARK CONSISTS OF STANDARD CHARACTERS WITHOUT CLAIM TO ANY PARTICULAR FONT, STYLE, SIZE, OR COLOR.

OWNER OF UNITED KINGDOM REG. NO. 2352496,
DATED 6-11-2004, EXPIRES 1-5-2014.
OWNER OF U.S. REG. NO. 3,187,599.

CLASS 5—PHARMACEUTICALS

FOR PHARMACEUTICAL PREPARATION FOR THE TREATMENT AND/OR ALLEVIATION OF ALLERGIC, PULMONARY, CARDIOVASCULAR, INFLAMMATORY, METABOLIC, NEUROLOGICAL AND ENDOCRINE CONDITIONS AND DISEASES (U.S. CLS. 6, 18, 44, 46, 51 AND 52).

CLASS 10—MEDICAL APPARATUS

FOR SURGICAL AND MEDICAL APPARATUS AND INSTRUMENTS, NAMELY, DELIVERY DEVICES FOR ORAL INHALATION OF PHARMACEUTICAL PREPARATIONS; INHALERS FOR THERAPEUTIC USE; INHALERS FOR MEDICAL PURPOSES, NAMELY, INHALERS FOR USE WITH NEBULIZERS OR FOR USE IN RESPIRATION THERAPY; PARTS AND FITTINGS FOR THE AFORESAID GOODS (U.S. CLS. 26, 39 AND 44).
AMY ALFIERI, EXAMINING ATTORNEY

SN 77-700,657. JEALSA RIANZEIRA, S.A., BOIRO (A CORUNA), SPAIN, FILED 3-27-2009.

HappySalad

THE MARK CONSISTS OF STANDARD CHARACTERS WITHOUT CLAIM TO ANY PARTICULAR FONT, STYLE, SIZE, OR COLOR.

CLASS 29—MEATS AND PROCESSED FOODS

FOR MEAT, FISH (NOT LIVE), POULTRY AND GAME; MEAT EXTRACTS; PRESERVED, FROZEN, DRIED AND COOKED FRUITS AND VEGETABLES; JELLIES, JAMS, COMPOTES; EGGS, MILK AND MILK PRODUCTS EXCLUDING ICE CREAM, ICE MILK AND FROZEN YOGURT; EDIBLE OILS AND FATS FOR FOOD (U.S. CL. 46).

CLASS 31—NATURAL AGRICULTURAL PRODUCTS

FOR AGRICULTURAL GRAINS FOR PLANTING, SEEDS FOR HORTICULTURAL PURPOSES; LIVE ANIMALS; FRESH FRUITS AND VEGETABLES; UNPROCESSED EDIBLE SEEDS, NATURAL PLANTS AND FLOWERS; FOODSTUFFS FOR ANIMALS; MALT FOR BREWING AND DISTILLING (U.S. CLS. 1 AND 46).

RONALD AIKENS, EXAMINING ATTORNEY

CLASS 35—ADVERTISING AND BUSINESS

FOR COMPILATION AND SYSTEMIZATION OF INFORMATION INTO INTERACTIVE COMPUTER DATABASES IN CONNECTION WITH DATA ASCERTAINMENT FROM SUPPLY CHAINS OF PRODUCTS AS TO THEIR CHEMICAL INGREDIENTS; COST PRICE ANALYSIS; BUSINESS INQUIRIES; BUSINESS MANAGEMENT AND ORGANIZATION CONSULTANCY; PROFESSIONAL BUSINESS CONSULTANCY; COMPUTERIZED FILE MANAGEMENT; BUSINESS INVESTIGATIONS; COMPILATION OF STATISTICS; COMMERCIAL INFORMATION AND ADVICE FOR CONSUMERS, IN PARTICULAR IN CONNECTION WITH DATA ASCERTAINMENT FROM SUPPLY CHAINS OF PRODUCTS AS TO THEIR CHEMICAL INGREDIENTS; BUSINESS RESEARCH, NAMELY, DATA SEARCH IN COMPUTER FILES FOR OTHERS; BUSINESS ORGANIZATION CONSULTANCY; OUTSOURCING SERVICES; NEWS CLIPPING SERVICES; BUSINESS MANAGEMENT CONSULTANCY AND BUSINESS ADMINISTRATION; BUSINESS NETWORKING SERVICES, NAMELY, ARRANGING TRADING AND ECONOMIC CONTACTS, ALSO VIA THE INTERNET; COMPILATION OF INFORMATION INTO INTERACTIVE COMPUTER DATABASES IN CONNECTION WITH DATA ASCERTAINMENT FROM SUPPLY CHAINS OF PRODUCTS AS TO THEIR CHEMICAL INGREDIENTS (U.S. CLS. 100, 101 AND 102).

SN 77-701,340. BUREAU VERITAS, REGISTRE INTERNATIONAL DE CLASSIFICATION DE NAVIRES ET D'AERONEFS, COURBEVOIE 92400, FRANCE, FILED 3-27-2009.



OWNER OF U.S. REG. NOS. 2,871,545, 3,425,829 AND OTHERS.

NO CLAIM IS MADE TO THE EXCLUSIVE RIGHT TO USE "BUREAU," "CHEMICAL," AND "COMPLIANCE REGISTER", APART FROM THE MARK AS SHOWN.

THE MARK CONSISTS OF THE WORDS "BUREAU VERITAS COMPLIANCE REGISTER" FORMING A CIRCLE WITHIN TWO CIRCLES WITH THE WORD "CHEMICAL" PLACED HORIZONTALLY ON THE DIAMETER BETWEEN THE WORDS "BUREAU VERITAS" AND "COMPLIANCE REGISTER".

THE ENGLISH TRANSLATION OF "VERITAS" IN THE MARK IS TRUTH.

CLASS 9—ELECTRICAL AND SCIENTIFIC APPARATUS

FOR COMPUTER SOFTWARE FOR CREATING SEARCHABLE DATABASES OF INFORMATION AND DATA FOR DATA ASCERTAINMENT FROM SUPPLY CHAINS OF PRODUCTS AS TO THEIR CHEMICAL INGREDIENTS (U.S. CLS. 21, 23, 26, 36 AND 38).

CLASS 38—COMMUNICATION

FOR PROVIDING USER ACCESS TO PROPRIETARY COLLECTIONS OF INFORMATION BY MEANS OF GLOBAL COMPUTER INFORMATION NETWORKS IN CONNECTION WITH DATA ASCERTAINMENT FROM SUPPLY CHAINS OF PRODUCTS AS TO THEIR CHEMICAL INGREDIENTS; PROVIDING USER ACCESS TO DATABASES IN COMPUTER NETWORKS, IN PARTICULAR IN CONNECTION WITH DATA ASCERTAINMENT FROM SUPPLY CHAINS OF PRODUCTS AS TO THEIR CHEMICAL INGREDIENTS; PROVIDING ACCESS TO INTERACTIVE DATABASES IN CONNECTION WITH DATA ASCERTAINMENT FROM SUPPLY CHAINS OF PRODUCTS AS TO THEIR CHEMICAL INGREDIENTS (U.S. CLS. 100, 101 AND 104).

CLASS 42—SCIENTIFIC AND COMPUTER SERVICES

FOR INDUSTRIAL ANALYSIS AND RESEARCH SERVICES IN THE FIELD OF CHEMICAL SUBSTANCES AND PRODUCT INGREDIENTS; DESIGN AND DEVELOPMENT OF COMPUTER HARDWARE AND COMPUTER SOFTWARE IN CONNECTION WITH DATA ASCERTAINMENT FROM SUPPLY CHAINS OF PRODUCTS AS TO THEIR CHEMICAL INGREDIENTS; CHEMICAL ANALYSIS; CONDUCTING OF TECHNICAL TESTS AND SCIENTIFIC INVESTIGATIONS, NAMELY, CONDUCTING CHEMICAL TESTING OF PRODUCTS AS TO THEIR CHEMICAL INGREDIENTS; TECHNICAL AND SCIENTIFIC SURVEY REPORTS, NAMELY, CHEMICAL SURVEYING OF PRODUCTS TO ASCERTAIN CHEMICAL INGREDIENTS AND PRODUCT SAFETY; RESEARCH IN THE FIELD OF ENVIRONMENTAL PROTECTION; CHEMICAL RESEARCH; TECHNICAL RESEARCH IN THE FIELD OF CHEMICAL SUBSTANCES; MATERIAL TESTING; SEARCHING AND RETRIEVING INFORMATION IN DATABASES AND ON THE INTERNET FOR OTHERS FOR SCIENCE AND RESEARCH PURPOSES; QUALITY CONTROL FOR OTHERS; TECHNICAL CONSULTANCY AND TECHNICAL PROJECT STUDIES IN THE FIELD OF CHEMICAL SUBSTANCES AND PRODUCT INGREDIENTS; ENVIRONMENTAL IMPACT ASSESSMENT; BASIC MATERIAL TESTING; SCIENTIFIC RESEARCH; CERTIFICATIONS, NAMELY, TESTING, ANALYSIS AND EVALUATION OF THE GOODS AND SERVICES OF OTHERS FOR THE PURPOSE OF CERTIFICATION (U.S. CLS. 100 AND 101).

DARRYL SPRULL, EXAMINING ATTORNEY

SN 77-701,568. SCHULTZ, ELAINE, ROSS, CA. FILED 3-28-2009.

Remodel without Remorse

THE MARK CONSISTS OF STANDARD CHARACTERS WITHOUT CLAIM TO ANY PARTICULAR FONT, STYLE, SIZE, OR COLOR.

CLASS 37—CONSTRUCTION AND REPAIR

FOR CONSULTING SERVICES IN THE FIELD OF HOME REMODELING (U.S. CLS. 100, 103 AND 106).
FIRST USE 10-12-2006; IN COMMERCE 10-12-2006.

CLASS 41—EDUCATION AND ENTERTAINMENT

FOR EDUCATIONAL SERVICES, NAMELY, PROVIDING WORKSHOPS, LECTURES, COURSES OF INSTRUCTION, AND SEMINARS IN THE FIELD OF HOME REMODELING (U.S. CLS. 100, 101 AND 107).
FIRST USE 10-12-2006; IN COMMERCE 10-12-2006.
KAREN BRACEY, EXAMINING ATTORNEY

SN 77-702,469. DEXTER FOUNDRY, INC., FAIRFIELD, IA. FILED 3-30-2009.

DURADDEX

THE MARK CONSISTS OF STANDARD CHARACTERS WITHOUT CLAIM TO ANY PARTICULAR FONT, STYLE, SIZE, OR COLOR.

CLASS 6—METAL GOODS

FOR CAST IRON (U.S. CLS. 2, 12, 13, 14, 23, 25 AND 50).

CLASS 40—MATERIAL TREATMENT

FOR MANUFACTURE OF FOUNDRY PRODUCTS TO THE ORDER AND/OR SPECIFICATION OF OTHERS (U.S. CLS. 100, 103 AND 106).
KHANH LE, EXAMINING ATTORNEY

SN 77-702,540. ORGANIC BOUQUET, INC., SAN FRANCISCO, CA. FILED 3-30-2009.

FLOWERS FOR GOOD

THE MARK CONSISTS OF STANDARD CHARACTERS WITHOUT CLAIM TO ANY PARTICULAR FONT, STYLE, SIZE, OR COLOR.

NO CLAIM IS MADE TO THE EXCLUSIVE RIGHT TO USE "FLOWERS", APART FROM THE MARK AS SHOWN.

CLASS 31—NATURAL AGRICULTURAL PRODUCTS

FOR FRESH FLOWERS (U.S. CLS. 1 AND 46).

CLASS 35—ADVERTISING AND BUSINESS

FOR ON-LINE WHOLESALE AND RETAIL STORE SERVICES FEATURING FRESH FLOWERS (U.S. CLS. 100, 101 AND 102).

FIRST USE 2-5-2006; IN COMMERCE 2-5-2006.
SARA THOMAS, EXAMINING ATTORNEY

SN 77-702,837. BOLT BARBERS LLC, LOS ANGELES, CA. FILED 3-31-2009.

BOLT BARBERS

THE MARK CONSISTS OF STANDARD CHARACTERS WITHOUT CLAIM TO ANY PARTICULAR FONT, STYLE, SIZE, OR COLOR.

NO CLAIM IS MADE TO THE EXCLUSIVE RIGHT TO USE "BARBERS", APART FROM THE MARK AS SHOWN.

CLASS 3—COSMETICS AND CLEANING PREPARATIONS

FOR MEN'S HAIR CARE PRODUCTS, NAMELY, HAIR GEL, HAIR WAX, HAIR SPRAY, HAIR POMADE, HAIR GLUE, HAIR PUTTY, HAIR SHAMPOO AND CONDITIONER, HAIR RINSE, HAIR COLOR AND HAIR BLEACH (U.S. CLS. 1, 4, 6, 50, 51 AND 52).

CLASS 44—MEDICAL, BEAUTY AND AGRICULTURAL SERVICES

FOR HAIR CARE SALONS (U.S. CLS. 100 AND 101).
MAYUR VAGHANI, EXAMINING ATTORNEY

SN 77-702,859. YING YEEH ENTERPRISE CO., LTD., TAINAN, TAIWAN, FILED 3-31-2009.

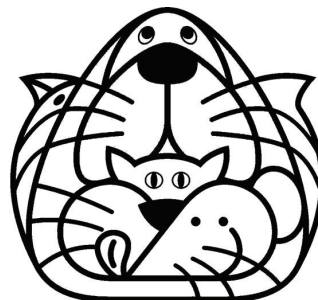

ACEPET

THE MARK CONSISTS OF THE WORD "ACEPET" IN STYLIZED FORM BELOW A STYLIZED DESIGN COMBINING IMAGES OF A DOG, CAT, MOUSE AND BIRD.

CLASS 18—LEATHER GOODS

FOR ANIMAL CARRIERS (U.S. CLS. 1, 2, 3, 22 AND 41).
FIRST USE 12-31-1999; IN COMMERCE 12-31-1999.

CLASS 21—HOUSEWARES AND GLASS

FOR CAT LITTER PANS; SCOOPS FOR THE DISPOSAL OF PET WASTE; DOG FOOD SCOOPS; ANIMAL FOOD SCOOPS; PET FEEDING AND DRINKING BOWLS; ANIMAL FEEDING AND DRINKING BOWLS; ANIMAL ACTIVATED ANIMAL FEEDERS; ANIMAL ACTIVATED LIVESTOCK FEEDERS; ANIMAL ACTIVATED LIVESTOCK WATERERS; BIRD FEEDERS; CAGE FOR PETS; SMALL ANIMAL FEEDERS; RINGS FOR IDENTIFYING BIRDS; CAGES FOR HOUSEHOLD PETS; BIRD CAGES; BIRD CAGES FOR DOMESTIC BIRDS; GRAVEL PAPER FOR BIRD CAGE; INSECT COLLECTING CAGES; PERCHES FOR BIRD CAGES; POULTRY RINGS; MARKING RINGS FOR POULTRY; POULTRY TROUGHES; BIRD HOUSES (U.S. CLS. 2, 13, 23, 29, 30, 33, 40 AND 50).
FIRST USE 12-31-1999; IN COMMERCE 12-31-1999.

CLASS 28—TOYS AND SPORTING GOODS

FOR PET TOYS, MOUSE CAGE ACCESSORIES IN THE NATURE OF TOYS FOR PET MICE (U.S. CLS. 22, 23, 38 AND 50).
FIRST USE 12-31-1999; IN COMMERCE 12-31-1999.
STEVEN PEREZ, EXAMINING ATTORNEY

SN 77-703,128. ECONENMEXICO, LLC, SANTA FE, NM.
FILED 3-31-2009.

eco  **new mexico**

NO CLAIM IS MADE TO THE EXCLUSIVE RIGHT TO USE "ECO" AND "NEW MEXICO", APART FROM THE MARK AS SHOWN.

THE STIPPLING IS A FEATURE OF THE MARK AND DOES NOT INDICATE COLOR.

THE MARK CONSISTS OF THE WORDS "ECO NEW MEXICO" WITH A DESIGN ELEMENT, CONSISTING OF TWO INTERLOCKING SPIRALS THAT ROUGHLY FORM THE SHAPE OF AN EYE, PLACED BETWEEN THE "ECO" AND THE "NEW MEXICO" WORDS.

CLASS 35—ADVERTISING AND BUSINESS

FOR MANAGEMENT AND BUSINESS CONSULTING SERVICES IN THE FIELD OF ECO TOURISM; MANAGEMENT SERVICES, NAMELY, ON-LINE BUSINESS DEVELOPMENT SERVICES, NAMELY, PROVIDING START-UP SUPPORT FOR BUSINESSES OF OTHERS; MARKETING CONSULTATION IN THE FIELD OF ECO TOURISM; NEW BUSINESS VENTURE DEVELOPMENT AND FORMATION CONSULTING SERVICES; ON-LINE ADVERTISING AND MARKETING SERVICES; PROMOTING TOURISM IN NEW MEXICO AREA; PROMOTION AND MARKETING SERVICES AND RELATED CONSULTING; PUBLIC RELATIONS, ADVERTISING AND MARKETING SERVICES FOR THE TOURISM AND CONVENTION INDUSTRY, NAMELY, ORGANIZING AND HOSTING SITE INSPECTIONS AND FAMILIARIZATION TOURS FOR WHOLESALERS, TOUR OPERATORS, TRAVEL AGENTS, MEETING AND INCENTIVE TRAVEL PLANNERS AND TRAVEL MEDIA (U.S. CLS. 100, 101 AND 102).

CLASS 37—CONSTRUCTION AND REPAIR

FOR CONSTRUCTION CONSULTANCY; CONSTRUCTION OF ECO-LODGING (U.S. CLS. 100, 103 AND 106).

CLASS 39—TRANSPORTATION AND STORAGE

FOR ARRANGING TRAVEL TOURS; ORGANIZATION OF EXCURSIONS, SIGHTSEEING TOURS, HOLIDAYS, TOURS AND TRAVEL; ORGANIZATION, BOOKING AND ARRANGEMENT OF EXCURSIONS, DAY TRIPS AND SIGHTSEEING TOURS; PROVIDE A WEBSITE FOR THE ARRANGEMENT AND BOOKING OF ECO-TRAVEL AND ECO-TOURS; TOUR CONDUCTING; TOUR GUIDE SERVICES; TOUR OPERATING AND ORGANIZING (U.S. CLS. 100 AND 105).

CLASS 43—HOTEL AND RESTAURANT SERVICES

FOR PROVIDE A WEBSITE FOR MAKING RESERVATIONS AND BOOKING OF ECO-LODGING; PROVIDING TRAVEL LODGING INFORMATION SERVICES AND TRAVEL LODGING BOOKING AGENCY SERVICES FOR TRAVELERS; RESORT LODGING SERVICES; TRAVEL AGENCY SERVICES, NAMELY, MAKING RESERVATIONS AND BOOKING FOR TEMPORARY LODGING (U.S. CLS. 100 AND 101).
NELSON SNYDER, EXAMINING ATTORNEY

SN 77-704,004. GATEFRONT, LLC, COLLIERVERVILLE, TN.
FILED 4-1-2009.

GateFront

THE MARK CONSISTS OF STANDARD CHARACTERS WITHOUT CLAIM TO ANY PARTICULAR FONT, STYLE, SIZE, OR COLOR.

CLASS 39—TRANSPORTATION AND STORAGE

FOR DISTRIBUTION SERVICES, NAMELY, DELIVERY OF FERTILIZER; WAREHOUSING SERVICES, NAMELY, STORAGE OF FERTILIZER (U.S. CLS. 100 AND 105).

CLASS 40—MATERIAL TREATMENT

FOR CUSTOM BLENDING AND MIXING OF FERTILIZER (U.S. CLS. 100, 103 AND 106).
WARREN L. OLANDRIA, EXAMINING ATTORNEY

SN 77-704,226. RACING POWER COMPANY, CITY OF INDUSTRY, CA. FILED 4-1-2009.



NO CLAIM IS MADE TO THE EXCLUSIVE RIGHT TO USE "RACING" AND "COMPANY", APART FROM THE MARK AS SHOWN.

THE COLOR(S) BLACK, RED AND YELLOW IS/ARE CLAIMED AS A FEATURE OF THE MARK.

THE MARK CONSISTS OF THE COLOR RED FEATURED IN THE LITERAL ELEMENTS OF THE MARK NAMED "RPC RACING POWER COMPANY" OUTLINED IN BLACK AGAINST A YELLOW BACKGROUND, ALL ENCLOSED WITHIN A SEMI-OVAL BLACK RIM.

CLASS 7—MACHINERY

FOR AUTOMOTIVE PARTS AND ACCESSORIES, NAMELY, AUTOMOBILE ENGINE VALVE COVERS, AUTOMOBILE OIL PANS (U.S. CLS. 13, 19, 21, 23, 31, 34 AND 35).

FIRST USE 1-0-2006; IN COMMERCE 1-0-2006.

CLASS 12—VEHICLES

FOR AUTOMOTIVE PARTS AND ACCESSORIES, NAMELY, STRUCTURAL PARTS FOR AUTOMOBILES, AUTOMOBILE TRANSMISSION TOP COVERS AND CASES (U.S. CLS. 19, 21, 23, 31, 35 AND 44).

FIRST USE 1-0-2006; IN COMMERCE 1-0-2006.

Laurie Mayes, Examining Attorney

SN 77-704,413. CHOREO TECHNOLOGY, LLC, CYPRESS, CA. FILED 4-1-2009.

EXPRESS YOUR MOTION

THE MARK CONSISTS OF STANDARD CHARACTERS WITHOUT CLAIM TO ANY PARTICULAR FONT, STYLE, SIZE, OR COLOR.

CLASS 9—ELECTRICAL AND SCIENTIFIC APPARATUS

FOR COMPUTER SOFTWARE FOR ASSISTING CHOREOGRAPHERS WITH THE CREATION, PREVISUALIZATION, COMMUNICATION, EDUCATION, DOCUMENTATION AND REHEARSAL OF DANCE, NAMELY, FOR THE INTEGRATION OF TEXT, AUDIO, GRAPHICS, STILL IMAGES AND MOVING PICTURES INTO AN INTERACTIVE DELIVERY FOR MULTIMEDIA APPLICATIONS THAT MAY BE DOWNLOADED FROM A GLOBAL COMPUTER NETWORK (U.S. CLS. 21, 23, 26, 36 AND 38).

CLASS 25—CLOTHING

FOR CLOTHING FOR MEN, WOMEN AND CHILDREN MADE OF ORGANIC, SYNTHETIC AND MIXED FABRICS INCLUDING CASUAL WEAR, ACTIVE WEAR, DANCEWEAR, AEROBIC WEAR AND KNITWEAR, NAMELY, JACKETS, SHIRTS, VESTS, PANTS, SHORTS, HATS, CAPS, SCARVES, BEANIES, SWEATERS, SWEATSHIRTS, T-SHIRTS, POLO SHIRTS, WARM-UP OUTFITS (U.S. CLS. 22 AND 39).

Renée McCray, Examining Attorney

SN 77-704,749. SPECTRUM DIRECT INSURANCE SERVICES INCORPORATED, MISSION VIEJO, CA. FILED 4-1-2009.

TERMRUNNER

THE MARK CONSISTS OF STANDARD CHARACTERS WITHOUT CLAIM TO ANY PARTICULAR FONT, STYLE, SIZE, OR COLOR.

CLASS 35—ADVERTISING AND BUSINESS

FOR INSURANCE LEAD COLLECTION AND MATCHING SERVICES, NAMELY, MATCHING CONSUMER REQUESTS FOR INSURANCE POLICY QUOTES COLLECTED OVER THE INTERNET TO QUALIFIED INSURANCE COMPANIES, INSURANCE BROKERS AND AGENTS INTERESTED IN THOSE REQUESTS; ONLINE ADVERTISING AND MARKETING SERVICES; ADVERTISING, INCLUDING PROMOTION RELATING TO THE SALE OF SERVICES FOR THIRD PARTIES BY THE TRANSMISSION OF ADVERTISING MATERIAL AND THE DISSEMINATION OF ADVERTISING MESSAGES ON COMPUTER NETWORKS; ADVERTISING AND PUBLICITY SERVICES, NAMELY, PROMOTING THE SALE OF INSURANCE, BRAND IDENTITY AND COMMERCIAL INFORMATION AND NEWS OF THIRD PARTIES THROUGH DIGITAL AND ONLINE MEDIUM (U.S. CLS. 100, 101 AND 102).

FIRST USE 11-10-2008; IN COMMERCE 11-10-2008.

CLASS 36—INSURANCE AND FINANCIAL

FOR FINANCIAL SERVICES, NAMELY, ASSISTING OTHERS WITH THE COMPLETION OF FINANCIAL TRANSACTIONS FOR PURCHASE OF INSURANCE; INSURANCE BROKERAGE SERVICES PROVIDED VIA AN ONLINE ELECTRONIC COMMUNICATIONS NETWORK (U.S. CLS. 100, 101 AND 102).

FIRST USE 11-10-2008; IN COMMERCE 11-10-2008.

David Elton, Examining Attorney

SN 77-705,429. MRS. PINKELMEYER, INC., BOCA RATON, FL. FILED 4-2-2009.

MOOPUS MCGLINDEN

THE MARK CONSISTS OF STANDARD CHARACTERS WITHOUT CLAIM TO ANY PARTICULAR FONT, STYLE, SIZE, OR COLOR.

THE NAME(S), PORTRAIT(S), AND/OR SIGNATURE(S) SHOWN IN THE MARK DOES NOT IDENTIFY A PARTICULAR LIVING INDIVIDUAL.

CLASS 9—ELECTRICAL AND SCIENTIFIC APPARATUS

FOR PRE-RECORDED AUDIO DISCS AND COMPACT DISCS FEATURING MUSIC FOR CHILDREN; COMPUTER GAME PROGRAMS; COMPUTER SOFTWARE FEATURING COMPUTER GAMES AND LEARNING ACTIVITIES FOR CHILDREN; DECORATIVE MAGNETS; DIGITAL CAMERAS; PRE-RECORDED DVDS; DIGITAL VERSATILE DISCS AND DIGITAL VIDEO DISCS FEATURING ENTERTAINMENT FOR CHILDREN, NAMELY, MUSIC, STORIES, COSTUMED CHARACTERS AND ANIMATION CHARACTERS FOR CHILDREN (U.S. CLS. 21, 23, 26, 36 AND 38).

CLASS 16—PAPER GOODS AND PRINTED MATTER

FOR PRINTED MATTER, NAMELY, NOTEPAPER, NOTE CARDS, POSTERS, CALENDARS, DECALS, COLORING BOOKS, PICTURE BOOKS, PEN AND PENCIL BOXES, SERIES OF BOOKS FOR CHILDREN; PAPER PARTY WARE, NAMELY, PLACE MATS, TABLE CLOTHS (U.S. CLS. 2, 5, 22, 23, 29, 37, 38 AND 50).

CLASS 28—TOYS AND SPORTING GOODS

FOR PAPER PARTY HATS; GAMES AND PLAYTHINGS, NAMELY, DOLLS, DOLL CLOTHING, DOLL ACCESSORIES, DOLL PLAY SETS, ACTION FIGURES, PLUSH TOYS, CARD GAMES, BOARD GAMES, PUZZLES, CHRISTMAS TREE DECORATIONS, INFLATABLE TOYS (U.S. CLS. 22, 23, 38 AND 50).

ANDREA BUTLER, EXAMINING ATTORNEY

SN 77-705,432. MRS. PINKELMEYER, INC., BOCA RATON, FL. FILED 4-2-2009.

MRS. PINKELMEYER

THE MARK CONSISTS OF STANDARD CHARACTERS WITHOUT CLAIM TO ANY PARTICULAR FONT, STYLE, SIZE, OR COLOR.

THE NAME "MRS. PINKELMEYER" DOES NOT IDENTIFY A LIVING INDIVIDUAL.

CLASS 9—ELECTRICAL AND SCIENTIFIC APPARATUS

FOR PRE-RECORDED AUDIO DISCS AND COMPACT DISCS FEATURING MUSIC FOR CHILDREN; COMPUTER GAME PROGRAMS; COMPUTER SOFTWARE FEATURING COMPUTER GAMES AND LEARNING ACTIVITIES FOR CHILDREN; DECORATIVE MAGNETS; DIGITAL CAMERAS; PRE-RECORDED DVDS, DIGITAL VERSATILE DISCS AND DIGITAL VIDEO DISCS FEATURING ENTERTAINMENT FOR CHILDREN, NAMELY, MUSIC, STORIES, COSTUMED CHARACTERS AND ANIMATION CHARACTERS FOR CHILDREN (U.S. CLS. 21, 23, 26, 36 AND 38).

CLASS 16—PAPER GOODS AND PRINTED MATTER

FOR PRINTED MATTER, NAMELY, NOTEPAPER, NOTE CARDS, POSTERS, CALENDARS, DECALS, COLORING BOOKS, PICTURE BOOKS, PEN AND PENCIL BOXES, SERIES OF BOOKS FOR CHILDREN; PAPER PARTY WARE, NAMELY, PLACE MATS, TABLE CLOTHS (U.S. CLS. 2, 5, 22, 23, 29, 37, 38 AND 50).

CLASS 28—TOYS AND SPORTING GOODS

FOR PAPER PARTY HATS; GAMES AND PLAYTHINGS, NAMELY, DOLLS, DOLL CLOTHING, DOLL ACCESSORIES, DOLL PLAY SETS, ACTION FIGURES, PLUSH TOYS, CARD GAMES, BOARD GAMES, PUZZLES, CHRISTMAS TREE DECORATIONS, INFLATABLE TOYS (U.S. CLS. 22, 23, 38 AND 50).

ANDREA BUTLER, EXAMINING ATTORNEY

SN 77-705,938. COMPUTER SERVICES, INC., PADUCAH, KY. FILED 4-3-2009.

NUFUND

THE MARK CONSISTS OF STANDARD CHARACTERS WITHOUT CLAIM TO ANY PARTICULAR FONT, STYLE, SIZE, OR COLOR.

CLASS 9—ELECTRICAL AND SCIENTIFIC APPARATUS

FOR COMPUTER SOFTWARE FOR USE IN THE BANKING INDUSTRY BY BANK EMPLOYEES FOR SELECTIVELY INTERFACING CLIENT DATA RESIDING ON ENTERPRISE SYSTEMS (U.S. CLS. 21, 23, 26, 36 AND 38).

CLASS 42—SCIENTIFIC AND COMPUTER SERVICES

FOR PROVIDING TEMPORARY USE OF A WEB-BASED SOFTWARE APPLICATION FOR USE IN THE BANKING INDUSTRY TO OPEN ACCOUNTS THROUGH THE INTERNET (U.S. CLS. 100 AND 101).

MICHAEL WEBSTER, EXAMINING ATTORNEY

SN 77-705,999. KELLOGG NORTH AMERICA COMPANY, BATTLE CREEK, MI. FILED 4-3-2009.

CULINARY EXPRESSIONS

THE MARK CONSISTS OF STANDARD CHARACTERS WITHOUT CLAIM TO ANY PARTICULAR FONT, STYLE, SIZE, OR COLOR.

NO CLAIM IS MADE TO THE EXCLUSIVE RIGHT TO USE "CULINARY", APART FROM THE MARK AS SHOWN.

CLASS 9—ELECTRICAL AND SCIENTIFIC APPARATUS

FOR DOWNLOADABLE RECIPES (U.S. CLS. 21, 23, 26, 36 AND 38).

CLASS 16—PAPER GOODS AND PRINTED MATTER

FOR PRINTED RECIPES (U.S. CLS. 2, 5, 22, 23, 29, 37, 38 AND 50).

CLASS 35—ADVERTISING AND BUSINESS

FOR PROVIDING MARKETING ADVICE AND LOGISTICS MANAGEMENT TO FOODSERVICE OPERATORS WITH RESPECT TO ADVERTISING, PROMOTIONS AND RECIPES FOR USE IN RESTAURANTS, CAFETERIAS AND INSTITUTIONAL FOODSERVICE OPERATIONS (U.S. CLS. 100, 101 AND 102).

CLASS 43—HOTEL AND RESTAURANT SERVICES

FOR PROVIDING AN ONLINE COMPUTER DATABASE TO FOODSERVICE OPERATORS AND THE GENERAL PUBLIC CONCERNING RECIPES, FOOD PRODUCTS, INGREDIENTS AND COOKING INFORMATION (U.S. CLS. 100 AND 101).

CLASS 44—MEDICAL, BEAUTY AND AGRICULTURAL SERVICES

FOR PROVIDED NUTRITIONAL INFORMATION VIA AN ONLINE COMPUTER DATABASE (U.S. CLS. 100 AND 101).

MARK T. MULLEN, EXAMINING ATTORNEY

SN 77-706,201. FINGER PRINCE, INC., MEDIA, PA. FILED 4-3-2009.

PHILADELPHIA POPS

THE MARK CONSISTS OF STANDARD CHARACTERS WITHOUT CLAIM TO ANY PARTICULAR FONT, STYLE, SIZE, OR COLOR.

OWNER OF U.S. REG. NOS. 2,197,233 AND 2,650,910.

NO CLAIM IS MADE TO THE EXCLUSIVE RIGHT TO USE "POPS", APART FROM THE MARK AS SHOWN. SEC. 2(F).

CLASS 9—ELECTRICAL AND SCIENTIFIC APPARATUS

FOR PRE-RECORDED AUDIO AND SOUND RECORDINGS FEATURING MUSIC; DOWNLOADABLE MUSICAL SOUND RECORDINGS (U.S. CLS. 21, 23, 26, 36 AND 38).

CLASS 41—EDUCATION AND ENTERTAINMENT

FOR ENTERTAINMENT IN THE NATURE OF LIVE PERFORMANCES AND SHOWS BY A MUSICAL BAND (U.S. CLS. 100, 101 AND 107).

NICHOLAS COLEMAN, EXAMINING ATTORNEY

SN 77-706,418. VANDIVER GROUP, INC., ST. LOUIS, MO. FILED 4-3-2009.

GROW. LIFE.

THE MARK CONSISTS OF STANDARD CHARACTERS WITHOUT CLAIM TO ANY PARTICULAR FONT, STYLE, SIZE, OR COLOR.

CLASS 35—ADVERTISING AND BUSINESS

FOR PROMOTING PUBLIC AWARENESS OF ISSUES SURROUNDING BIOTECH ACCEPTANCE, NAMELY, COMMUNICATING SAFETY MESSAGES SURROUNDING GENETICALLY MODIFIED FOOD; PROMOTING PUBLIC AWARENESS OF ALTERNATIVE SOLUTIONS TO WORLD HUNGER, NAMELY, COMMUNICATING INFORMATION ON CREATING ENOUGH CROPS TO FEED AN INCREASING WORLD POPULATION; PROMOTING PUBLIC AWARENESS OF THE USE OF BIOTECHNOLOGY, NAMELY, PROMOTING SUSTAINABLE USE OF GLOBAL RESOURCES, NAMELY, PROMOTING LIFE SCIENCES (U.S. CLS. 100, 101 AND 102).

CLASS 38—COMMUNICATION

FOR PROVIDING ON-LINE CHAT ROOMS AND ELECTRONIC BULLETIN BOARDS FOR TRANSMISSION OF MESSAGES AMONG USERS SURROUNDING BIOTECH ACCEPTANCE, NAMELY, COMMUNICATING SAFETY MESSAGES SURROUNDING GENETICALLY MODIFIED FOOD, NAMELY, PROVIDING INFORMATION ON SUSTAINABLE USE OF GLOBAL RESOURCES AND PROMOTING LIFE SCIENCES (U.S. CLS. 100, 101 AND 104).

CLASS 42—SCIENTIFIC AND COMPUTER SERVICES

FOR PROVIDING A MOTIVATIONAL WEBSITE FEATURING INFORMATION ON SCIENTIFIC RESEARCH IN THE FIELDS OF BIOTECHNOLOGY ACCEPTANCE AND THE USE OF BIOTECHNOLOGY AND LIFE SCIENCES TO PROMOTE THE SUSTAINABLE USE OF GLOBAL RESOURCES (U.S. CLS. 100 AND 101).

HEATHER THOMPSON, EXAMINING ATTORNEY

SN 77-706,490. ASBURY COMMUNITIES, INC., GERMANTOWN, MD. FILED 4-3-2009.

FOR ALL LIFE CAN BE

THE MARK CONSISTS OF STANDARD CHARACTERS WITHOUT CLAIM TO ANY PARTICULAR FONT, STYLE, SIZE, OR COLOR.

CLASS 35—ADVERTISING AND BUSINESS

FOR MANAGEMENT OF CONTINUING CARE RETIREMENT COMMUNITIES FOR OTHERS (U.S. CLS. 100, 101 AND 102).

FIRST USE 8-29-2003; IN COMMERCE 8-29-2003.

CLASS 43—HOTEL AND RESTAURANT SERVICES

FOR PROVIDING CONTINUING CARE RETIREMENT COMMUNITIES, NAMELY, RESIDENTIAL LIVING FACILITIES, ASSISTED LIVING FACILITIES (U.S. CLS. 100 AND 101).

FIRST USE 8-29-2003; IN COMMERCE 8-29-2003.

CLASS 44—MEDICAL, BEAUTY AND AGRICULTURAL SERVICES

FOR PROVIDING CONTINUING CARE RETIREMENT COMMUNITIES, NAMELY, SKILLED NURSING FACILITIES (U.S. CLS. 100 AND 101).

FIRST USE 8-29-2003; IN COMMERCE 8-29-2003.

BRENDAN MCCAULEY, EXAMINING ATTORNEY

SN 77-708,256. GATEFRONT, LLC, COLLIERVILLE, TN. FILED 4-7-2009.

SN 77-709,040. MPIRE CORPORATION, SEATTLE, WA. FILED 4-7-2009.



THE MARK CONSISTS OF DESIGN OF A STYLIZED LEAF.

CLASS 39—TRANSPORTATION AND STORAGE

FOR DISTRIBUTION SERVICES, NAMELY, DELIVERY OF FERTILIZER; WAREHOUSING SERVICES, NAMELY, STORAGE OF FERTILIZER (U.S. CLS. 100 AND 105).

CLASS 40—MATERIAL TREATMENT

FOR CUSTOM BLENDING AND MIXING OF FERTILIZER (U.S. CLS. 100, 103 AND 106).
WARREN L. OLANDRIA, EXAMINING ATTORNEY

SN 77-708,391. ARIZONA RACEWAY PARK, LLC, CHANDLER, AZ. FILED 4-7-2009.



NO CLAIM IS MADE TO THE EXCLUSIVE RIGHT TO USE "ARIZONA RACEWAY PARK", APART FROM THE MARK AS SHOWN.

THE MARK CONSISTS OF THE WORD "ARIZONA" IN LARGE CAPITAL LETTERS ABOVE THE WORDS "RACEWAY PARK" IN SMALLER CAPITAL LETTERS WITH A STYLIZED ARROW BEGINNING AT THE MIDDLE OF AND CURVING AROUND THE "A" IN "ARIZONA", UNDERLINING THE WORD "ARIZONA" WITH A POINT AT THE END OF THE ARROW.

CLASS 25—CLOTHING

FOR CLOTHING, NAMELY, T-SHIRTS, TANK TOPS, HATS AND SWEAT SHIRTS (U.S. CLS. 22 AND 39).

CLASS 41—EDUCATION AND ENTERTAINMENT

FOR EDUCATION AND ENTERTAINMENT SERVICES, NAMELY, ENTERTAINMENT SERVICES OF ORGANIZING AND CONDUCTING AUTOMOBILE RACING EVENTS (U.S. CLS. 100, 101 AND 107).
MARK RADEMACHER, EXAMINING ATTORNEY

ADXPOSE

THE MARK CONSISTS OF STANDARD CHARACTERS WITHOUT CLAIM TO ANY PARTICULAR FONT, STYLE, SIZE, OR COLOR.

CLASS 35—ADVERTISING AND BUSINESS

FOR MARKETING SERVICES, NAMELY, CONDUCTING CONSUMER TRACKING BEHAVIOR RESEARCH AND CONSUMER TREND ANALYSIS THROUGH COLLECTING, ORGANIZING, AND SHARING DATA AND INFORMATION RELATING TO USER'S INTERACTION WITH WEBSITES (U.S. CLS. 100, 101 AND 102).

CLASS 42—SCIENTIFIC AND COMPUTER SERVICES

FOR COMPUTER SERVICES, NAMELY, PROVIDING AN INTERACTIVE WEBSITE IN THE FIELD OF KNOWLEDGE MANAGEMENT THAT TRACKS, LOCATES, MONITORS AND LOGS OPERATIONS, AND CREATE INDEXES OF INFORMATION AND OTHER RESOURCES AVAILABLE ON COMPUTER NETWORKS; PROVIDING A SEARCH ENGINE FOR OBTAINING INDEXES OF INFORMATION ON A GLOBAL COMPUTER NETWORK; COMPUTER SERVICES, NAMELY, MONITORING, TESTING, ANALYZING, AND REPORTING ON THE INTERNET TRAFFIC CONTROL AND CONTENT CONTROL OF THE WEB SITES OF OTHERS (U.S. CLS. 100 AND 101).
ROSELLE HERRERA, EXAMINING ATTORNEY

SN 77-709,721. WALKER GROUP HOLDINGS, LLC, NEW LISBON, WI. FILED 4-8-2009.

CONTAINING EXCELLENCE

THE MARK CONSISTS OF STANDARD CHARACTERS WITHOUT CLAIM TO ANY PARTICULAR FONT, STYLE, SIZE, OR COLOR.

CLASS 12—VEHICLES

FOR TANKER TRAILERS AND STRUCTURAL PARTS THEREFOR (U.S. CLS. 19, 21, 23, 31, 35 AND 44).

CLASS 37—CONSTRUCTION AND REPAIR

FOR SERVICING TANKER TRAILERS (U.S. CLS. 100, 103 AND 106).
MICHELE SWAIN, EXAMINING ATTORNEY

SN 77-709,856. WALKER GROUP HOLDINGS, LLC, NEW LISBON, WI. FILED 4-8-2009.

SN 77-710,264. WOZNIAK, MARTIN J., SOUTHPORT, NC. FILED 4-9-2009.

TOGETHER, WE DELIVER

THE MARK CONSISTS OF STANDARD CHARACTERS WITHOUT CLAIM TO ANY PARTICULAR FONT, STYLE, SIZE, OR COLOR.

CLASS 12—VEHICLES

FOR TANKER TRAILERS AND PARTS THEREFOR (U.S. CLS. 19, 21, 23, 31, 35 AND 44).

CLASS 37—CONSTRUCTION AND REPAIR

FOR SERVICING TANKER TRAILERS (U.S. CLS. 100, 103 AND 106).
MICHELE SWAIN, EXAMINING ATTORNEY

SN 77-709,871. COMMITTEE ON ACCREDITATION FOR RESPIRATORY CARE, BEDFORD, TX. FILED 4-8-2009.



NO CLAIM IS MADE TO THE EXCLUSIVE RIGHT TO USE "COMMISSION ON ACCREDITATION FOR RESPIRATORY CARE", APART FROM THE MARK AS SHOWN.

THE MARK CONSISTS OF THE ACRONYM "COARC" WITH THE WORDS "COMMISSION ON ACCREDITATION FOR RESPIRATORY CARE" UNDERNEATH WITH A RUNNING STYLIZED HUMAN FIGURE HOLDING A BOOK IN AN OUTSTRETCHED HAND OVER THE HEAD AND A COMET TAIL EMANATING FROM THE BOOK OVER THE TERM "COARC".

CLASS 9—ELECTRICAL AND SCIENTIFIC APPARATUS

FOR DOWNLOADABLE ELECTRONIC PUBLICATIONS IN THE NATURE OF NEWSLETTERS, BROCHURES, PAMPHLETS, BOOKS, AND MANUALS IN THE FIELD OF ACCREDITATION OF CLINICAL RESPIRATORY THERAPY PROGRAMS (U.S. CLS. 21, 23, 26, 36 AND 38).

CLASS 42—SCIENTIFIC AND COMPUTER SERVICES

FOR ACCREDITATION SERVICES, NAMELY, DEVELOPING, EVALUATING, AND TESTING STANDARDS FOR CLINICAL RESPIRATORY THERAPY PROGRAMS FOR THE PURPOSE OF ACCREDITATION, AND EVALUATING RESPIRATORY CLINICS TO DETERMINE WHETHER THE RESPIRATORY CLINICS CONFORM TO ESTABLISHED STANDARDS (U.S. CLS. 100 AND 101).

GINA FINK, EXAMINING ATTORNEY

BROTHERHOOD OF ARMS

THE MARK CONSISTS OF STANDARD CHARACTERS WITHOUT CLAIM TO ANY PARTICULAR FONT, STYLE, SIZE, OR COLOR.

NO CLAIM IS MADE TO THE EXCLUSIVE RIGHT TO USE "ARMS", APART FROM THE MARK AS SHOWN.

CLASS 35—ADVERTISING AND BUSINESS

FOR RETAIL STORE SERVICES FEATURING CLOTHING, PAPER PRODUCTS, GLASSWARE, AND HOME DECOR ITEMS AND MEMBERSHIP CLUB SERVICES PROVIDING DISCOUNTS AND REWARDS FOR THE SERVICES OF OTHERS (U.S. CLS. 100, 101 AND 102).

CLASS 41—EDUCATION AND ENTERTAINMENT

FOR PROVIDING INTERNET PORTAL SERVICES FEATURING LINKS TO ARTICLES RELATING TO THE SHOOTING OF ARMS (U.S. CLS. 100, 101 AND 107).
DAVID HOFFMAN, EXAMINING ATTORNEY

SN 77-710,357. RECKITT BENCKISER S.A.R.L., L-1840, LUXEMBOURG, FILED 4-9-2009.

RECKITT BENCKISER

THE MARK CONSISTS OF STANDARD CHARACTERS WITHOUT CLAIM TO ANY PARTICULAR FONT, STYLE, SIZE, OR COLOR.

OWNER OF ERPN CMNTY TM OFC REG. NO. 1416056, DATED 2-7-2003, EXPIRES 12-8-2009.

CLASS 1—CHEMICALS

FOR CHEMICALS FOR INDUSTRIAL PURPOSES; DESCALING PREPARATIONS FOR INDUSTRIAL PURPOSES; CHEMICAL WATER SOFTENERS; ALL AFOREMENTIONED GOODS WITH OR WITHOUT A DISINFECTANT COMPONENT (U.S. CLS. 1, 5, 6, 10, 26 AND 46).

CLASS 3—COSMETICS AND CLEANING PREPARATIONS

FOR BLEACHING PREPARATIONS AND LAUNDRY DETERGENT FOR LAUNDRY USE; LAUNDRY ADDITIVES, NAMELY, LAUNDRY STARCH, LAUNDRY BLEACH, LAUNDRY BLUEING, LAUNDRY PRE-SOAK, STAIN REMOVERS AND FABRIC SOFTENERS; LAUNDRY ANTI-STATIC DRYER SHEETS; LAUNDRY PREPARATIONS FOR DRY CLEANING USE, NAMELY, STAIN REMOVING PREPARATIONS AND DRY CLEANING FLUIDS, SOLVENTS AND SPOT REMOVERS; DECALCIFYING AND DESCALING PREPARATIONS FOR HOUSEHOLD USE; SOAPS; DETERGENTS FOR HOUSEHOLD USE; CLEANING, POLISHING, SCOURING AND ABRASIVE CREAMS, LIQUIDS, GELS AND POWDERS; DISHWASHING PREPARATIONS IN THE NATURE OF DETERGENTS IN SOLID, FLUID OR GEL FORM; CARPET CLEANERS; ALL AFOREMENTIONED GOODS WITH OR WITHOUT A DISINFECTIVE COMPONENT; PERFUMERY; ESSENTIAL OILS; PERFUMING PREPARATIONS FOR THE ATMOSPHERE; ROOM PERFUME SPRAYS; COSMETICS; HAIR CARE PREPARATIONS; NON-MEDICATED TOILETRIES; DENTIFRICES, MOUTHWASHES; DEPILATORIES (U.S. CLS. 1, 4, 6, 50, 51 AND 52).

CLASS 5—PHARMACEUTICALS

FOR PHARMACEUTICAL PREPARATIONS FOR THE TREATMENT OF OPIATE, COCAINE AND ALCOHOL ADDICTION; ANALGESICS; PHARMACEUTICAL PREPARATIONS, NAMELY, ANTI-INFLAMMATORY AND ANTI-PYRETIC PREPARATIONS, ANTI-CONVULSANTS, CEREBRAL METABOLIC ACTIVATORS, PREPARATIONS FOR USE IN IMMOBILIZING AND REVIVING ANIMALS, AND MEDICATED PREPARATIONS FOR THE RELIEF OF COUGH AND COLD SYMPTOMS ; GASTRIC REFLUX SUPPRESSANTS; LAXATIVES; ANTACIDS; MEDICATED BEVERAGES AND PREPARATIONS FOR MAKING MEDICATED BEVERAGES, NAMELY, NUTRITIONALLY FORTIFIED BEVERAGES; MEDICATED BEVERAGES AND INGREDIENTS FOR MAKING SUCH BEVERAGES ALL FOR THE USE IN THE TREATMENT OF COLDS, COUGHS, INFLUENZA AND SORE THROATS; PREPARATIONS FOR MAKING MEDICATED BEVERAGES, NAMELY, COLDS, COUGHS, INFLUENZA AND SORE THROAT TREATMENT PREPARATIONS; NATURAL FIBRE BULKING AGENTS, NAMELY, FOR THE RELIEF OF CONSTIPATION AND MAINTENANCE OF BOWEL REGULARITY; HERBAL TEA FOR MEDICINAL PURPOSES; SANITIZING PREPARATIONS FOR HOUSEHOLD AND MEDICAL USE; ALL PURPOSE DISINFECTANTS; ANTISEPTICS; INSECTICIDES AND MITICIDES FOR DOMESTIC USE; INSECT AND MITE REPELLENTS; PREPARATIONS FOR DESTROYING AND REPELLING VERMIN; GERMICIDES; ANTI-BACTERIAL PREPARATIONS; ROOM DEODORANTS AND DEODORIZERS; AIR FRESHENING AND AIR PURIFYING PREPARATIONS (U.S. CLS. 6, 18, 44, 46, 51 AND 52).

CLASS 21—HOUSEWARES AND GLASS

FOR CONTAINERS FOR HOUSEHOLD OR KITCHEN USE; CLEANING SPONGES; WASHING AND SCRUBBING BRUSHES; ARTICLES FOR CLEANING PURPOSES, NAMELY, DUSTERS, CLEANING CLOTHS, STEEL WOOL (U.S. CLS. 2, 13, 23, 29, 30, 33, 40 AND 50).

CLASS 35—ADVERTISING AND BUSINESS

FOR ADVERTISING; BUSINESS MANAGEMENT; BUSINESS ADMINISTRATION; PROVIDING OFFICE FUNCTIONS; MARKETING SERVICES; COMMERCIAL AND INDUSTRIAL MANAGEMENT SERVICES (U.S. CLS. 100, 101 AND 102).

CLASS 42—SCIENTIFIC AND COMPUTER SERVICES

FOR INDUSTRIAL RESEARCH IN THE FIELD OF FOOD, HOME CONSUMER PRODUCTS, AND PERSONAL CARE AND HEALTHCARE CONSUMER PRODUCTS; LABORATORY RESEARCH AND ANALYSIS IN THE FIELD OF IN THE FIELD OF FOOD, HOME CONSUMER PRODUCTS, AND PERSONAL CARE AND HEALTHCARE CONSUMER PRODUCTS; LICENSING OF INTELLECTUAL PROPERTY (U.S. CLS. 100 AND 101).

CLASS 45—PERSONAL AND LEGAL SERVICES

FOR LEGAL SERVICES; EXPLOITATION OF INTELLECTUAL PROPERTY RIGHTS, NAMELY, LICENSING OF INTELLECTUAL PROPERTY (U.S. CLS. 100 AND 101).

KIMBERLY PERRY, EXAMINING ATTORNEY

SN 77-710,578. LIONBRIDGE TECHNOLOGIES, INC., WALTHAM, MA. FILED 4-9-2009.

LIONBRIDGE

THE MARK CONSISTS OF STANDARD CHARACTERS WITHOUT CLAIM TO ANY PARTICULAR FONT, STYLE, SIZE, OR COLOR.

OWNER OF U.S. REG. NOS. 2,243,234 AND 3,108,937.

CLASS 41—EDUCATION AND ENTERTAINMENT

FOR PROVIDING LANGUAGE INTERPRETERS ON-SITE AND VIA TELEPHONE; DEVELOPMENT OF ELECTRONIC EDUCATIONAL MATERIALS FOR OTHERS IN THE FIELDS OF INFORMATION TECHNOLOGY, AVIONICS, AND EDUCATIONAL PUBLISHING (U.S. CLS. 100, 101 AND 107).

FIRST USE 9-1-2005; IN COMMERCE 9-1-2005.

CLASS 42—SCIENTIFIC AND COMPUTER SERVICES

FOR DEVELOPMENT OF TECHNICAL DOCUMENTATION, NAMELY, TECHNICAL WRITING IN THE FIELDS OF INFORMATION TECHNOLOGY, AVIONICS, AND EDUCATIONAL PUBLISHING; TECHNICAL WRITING FOR OTHERS; TESTING SERVICES, NAMELY, TESTING COMPUTER HARDWARE AND SOFTWARE FOR OTHERS (U.S. CLS. 100 AND 101).

FIRST USE 0-0-2000; IN COMMERCE 0-0-2000.
MAUREEN DALL, EXAMINING ATTORNEY

SN 77-710,928. MICHAEL HOLSTEIN, BELLEAIR, FL. FILED 4-9-2009.

GENUINE FIRST AID

THE MARK CONSISTS OF STANDARD CHARACTERS WITHOUT CLAIM TO ANY PARTICULAR FONT, STYLE, SIZE, OR COLOR.

NO CLAIM IS MADE TO THE EXCLUSIVE RIGHT TO USE "FIRST AID", APART FROM THE MARK AS SHOWN.

CLASS 5—PHARMACEUTICALS

FOR ADHESIVE BANDAGES; ADHESIVE FOR BANDAGES FOR SKIN WOUNDS; ADHESIVE TAPES FOR MEDICAL PURPOSES; BANDAGES FOR DRESSINGS; BANDAGES FOR SKIN WOUNDS; BURN DRESSINGS; EYE DROPS; EYE PATCHES FOR MEDICAL PURPOSES; EYE WASHES; FIRST AID KITS; FIRST AID KITS FOR DOMESTIC OR OTHER NON-PROFESSIONAL USE; GAUZE; GAUZE FOR DRESSINGS; IRRIGATING SOLUTIONS FOR EYE USE; MEDICAL ADHESIVE TAPE; MEDICAL AND SURGICAL DRESSINGS; MEDICAL DRESSINGS; MOLE SKIN FOR USE AS A MEDICAL BANDAGE; SALINE WASH FOR MEDICAL PURPOSES; SELF ADHESIVE DRESSINGS; SURGICAL BANDAGES; SURGICAL DRESSINGS; WOUND DRESSINGS; WOUND DRESSINGS, NAMELY, PLEDGETS (U.S. CLS. 6, 18, 44, 46, 51 AND 52).

CLASS 10—MEDICAL APPARATUS

FOR BANDAGES FOR ANATOMICAL JOINTS; CHEMICALLY ACTIVATED HOT AND COLD GEL PACKS FOR MEDICAL PURPOSES; COMPRESSION BANDAGES; CPR (CARDIOPULMONARY RESUSCITATION) MASKS; DRESSING FORCEPS; ELASTIC BANDAGES; EYE DROPPERS; FINGER SPLINTS; FORCEPS FOR MEDICAL USE; GLOVES FOR MEDICAL USE; GLOVES FOR USE IN HOSPITALS; LATEX MEDICAL GLOVES; MEDICAL EXAMINATION GLOVES; MEDICAL GLOVES; NITRILE GLOVES FOR MEDICAL USE; PROTECTIVE GLOVES FOR MEDICAL USE; SLINGS; SPLINTS; SPLINTS; SUPPORT BANDAGES; SUPPORTIVE BANDAGES; SURGICAL GLOVES; THERAPEUTIC APPARATUS, NAMELY, CHEMICALLY ACTIVATED ANTI-CELLULITE WRAPS, ICE PACKS, COMPRESSES, AND COMPRESSION BANDAGES; THERMAL PACKS FOR FIRST AID PURPOSES (U.S. CLS. 26, 39 AND 44).

KHANH LE, EXAMINING ATTORNEY

SN 77-711,058. EMRAD CREATIONS, LTD, CHATSWORTH, CA. FILED 4-9-2009.

Seasonal Sensations

THE MARK CONSISTS OF STANDARD CHARACTERS WITHOUT CLAIM TO ANY PARTICULAR FONT, STYLE, SIZE, OR COLOR.

NO CLAIM IS MADE TO THE EXCLUSIVE RIGHT TO USE "SEASONAL", APART FROM THE MARK AS SHOWN.

CLASS 24—FABRICS

FOR BANNERS AND FLAGS OF TEXTILE; BED AND TABLE LINEN, WALL HANGINGS OF TEXTILE; BED BLANKETS; BLANKET THROWS; BLANKETS FOR OUTDOOR USE; CASHMERE BLANKETS; CHILDREN'S BLANKETS; CURTAINS MADE OF TEXTILE FABRICS; FABRICS FOR TEXTILE USE; FACE TOWELS; FACE TOWELS OF TEXTILES; FELT AND NON-WOVEN TEXTILE FABRICS; GIFT WRAP OF TEXTILE; HAND TOWELS OF TEXTILE; HAND-TOWELS MADE OF TEXTILE FABRICS; HANDKERCHIEFS OF TEXTILE; HANDKERCHIEFS OF TEXTILES; NATURAL AND SYNTHETIC FABRICS AND TEXTILES, NAMELY, COTTON, SILK, POLYESTER AND NYLON FABRICS; NON-WOVEN TEXTILE FABRICS; PET BLANKETS; PLACE MATS OF TEXTILE MATERIAL; QUILTS OF TEXTILE; RECEIVING BLANKETS; SERVIETTES OF TEXTILE; SILK BED BLANKETS; SILK BLANKETS; TABLE LINEN OF TEXTILE; TABLE NAPKINS OF TEXTILE; TABLE-CLOTHS OF TEXTILES; TAPESTRIES OF TEXTILE; TEXTILE FABRICS FOR HOME AND COMMERCIAL INTERIORS; TEXTILE HANDKERCHIEFS; TEXTILE NAPKINS; TEXTILE PLACE MATS; TEXTILE SERVIETTES; TEXTILE TABLECLOTHS; TEXTILE WALL HANGINGS; TEXTILE WALL HANGINGS, NAMELY, CLOTH POSTERS; TOWELS; WALL HANGINGS OF TEXTILE; WOOLLEN BLANKETS (U.S. CLS. 42 AND 50).
FIRST USE 3-1-1997; IN COMMERCE 3-1-1997.

CLASS 28—TOYS AND SPORTING GOODS

FOR ATHLETIC EQUIPMENT, NAMELY, STRIKING BAGS; BAGS FOR SKATEBOARDS; BAGS SPECIALLY ADAPTED FOR SPORTS EQUIPMENT; BALL BEARINGS FOR SKATEBOARDS; BALLS FOR GAMES; BALLS FOR SPORTS; BASKET BALLS; BATH TOYS; BATTERY OPERATED ACTION TOYS; BEACH BALLS; BENDABLE TOYS; CAT TOYS; CHILDREN'S MULTIPLE ACTIVITY TOYS; CHILDREN'S MULTIPLE ACTIVITY TOYS SOLD AS A UNIT WITH PRINTED BOOKS; COLLECTABLE TOY FIGURES; CONSTRUCTION TOYS; DOG TOYS; DRAWING TOYS; ELECTRIC ACTION TOYS; ELECTRIC TOY TRAIN TRANSFORMERS; ELECTRONIC ACTION TOYS; ELECTRONIC LEARNING TOYS; ELECTRONIC TOY VEHICLES; ELECTRONICALLY OPERATED TOY MOTOR VEHICLES; FANTASY CHARACTER TOYS; FOOT BALLS; HARNESSES SPECIALLY ADAPTED FOR CARRYING SNOWBOARDS, SKIS AND SKATEBOARDS; INFLATABLE RIDE-ON TOYS; INFLATABLE TOYS; LEVER ACTION TOYS; MECHANICAL ACTION TOYS; MECHANICAL TOYS; MODEL TOY STEAM ENGINES; MODEL TOY STEAM OPERATED TRACTION ENGINES; MODELED PLASTIC TOY FIGURINES; MOLDED TOY FIGURES; MUSIC BOX TOYS; MUSICAL TOYS; NON-ELECTRONIC TOY VEHICLES; NON-RIDING TRANSPORTATION TOYS; NUTS AND BOLTS FOR SKATEBOARDS; PET TOYS; PLAY BALLS AND PLAY BALLOONS; PLAYGROUND BALLS; PLUSH TOYS; POP UP TOYS; POSITIONABLE THREE DIMENSIONAL TOYS FOR USE IN GAMES; POSITIONABLE TOY FIGURES; POSITIONABLE TWO DIMENSIONAL TOYS FOR USE IN GAMES; PRINTED POSITIONABLE TOYS FOR USE IN CHILDREN'S BOARD GAMES; PROTECTIVE PADDING FOR SKATEBOARDING; PULL TOYS; PUSH TOYS; RADIO CONTROLLED TOY VEHICLES; RUBBER BALLS; SAND TOYS; SANDBOX TOYS; SKATEBOARD DECKS; SKATEBOARD GRIP TAPES; SKATEBOARD RAILS; SKATEBOARD RISER PADS; SKATEBOARD TRUCKS; SKATEBOARD WHEELS; SKATEBOARDS; SKETCHING TOYS; SOCCER BALLS; SOFT SCULPTURE PLUSH TOYS; SOFT SCULPTURE TOYS; SPORT BALLS; SQUEEZABLE SQUEAKING TOYS; SQUEEZE TOYS; STACKING TOYS; STUFFED AND PLUSH TOYS; STUFFED TOY ANIMALS; STUFFED TOY BEARS; STUFFED TOYS; TALKING TOYS; TOY ACTION FIGURES; TOY AIRPLANES; TOY ANIMALS; TOY ANIMALS AND ACCESSORIES THEREFOR; TOY BAKEWARE AND COOKWARE; TOY BALLOONS; TOY BOXES; TOY BUILDING BLOCKS; TOY BUILDING STRUCTURES AND TOY VEHICLE TRACKS; TOY BUILDINGS AND ACCESSORIES THEREFOR; TOY CARS; TOY CHRISTMAS TREES; TOY CLOCKS AND WATCHES; TOY CONSTRUCTION BLOCKS; TOY CONSTRUCTION SETS; TOY FIGURES; TOY HOUSES; TOY MAILBOXES; TOY MODEL CARS; TOY MODEL TRAIN SETS; TOY MODELING DOUGH; TOY MUSIC BOXES;

TOY PUTTY; TOY ROBOTS; TOY ROCKETS; TOY SCOOTERS; TOY SNOW GLOBES; TOY TRAINS AND PARTS AND ACCESSORIES THEREFOR; TOY VEHICLE TRACK SETS AND ROADWAYS AND ACCESSORIES THEREFOR; TOY VEHICLES; TOY VEHICLES AND ACCESSORIES THEREFOR; TOY WATER GLOBES; TOY WHISTLES; TOYS FOR DOMESTIC PETS; TOYS, NAMELY, CHILDREN'S DRESS-UP ACCESSORIES; TWO AND THREE DIMENSIONAL POSITIONABLE TOY FIGURES SOLD AS A UNIT WITH EDUCATIONAL BOOKS; VOLLEY BALLS; WATER SQUIRTING TOYS; WIND-UP TOYS; WIND-UP WALKING TOYS (U.S. CLS. 22, 23, 38 AND 50).

FIRST USE 3-1-1997; IN COMMERCE 3-1-1997.
RONALD MCMORROW, EXAMINING ATTORNEY

SN 77-712,649. GOOD GOSSIP, LLC, DBA WAGGIN TAILZ, LEAGUE CITY, TX. FILED 4-13-2009.

SNAGGLE FOOT

THE MARK CONSISTS OF STANDARD CHARACTERS WITHOUT CLAIM TO ANY PARTICULAR FONT, STYLE, SIZE, OR COLOR.

CLASS 39—TRANSPORTATION AND STORAGE

FOR PET TAXI TRANSPORT SERVICES (U.S. CLS. 100 AND 105).

CLASS 43—HOTEL AND RESTAURANT SERVICES

FOR PET DAY CARE SERVICES; PET BOARDING SERVICES (U.S. CLS. 100 AND 101).

CLASS 44—MEDICAL, BEAUTY AND AGRICULTURAL SERVICES

FOR DOG WALKING SERVICES; PET CARE SERVICES, NAMELY, PET BATHING AND ADMINISTRATION OF MEDICATION TO PETS (U.S. CLS. 100 AND 101).

CLASS 45—PERSONAL AND LEGAL SERVICES

FOR PET SITTING (U.S. CLS. 100 AND 101).
CHRISTINE COOPER, EXAMINING ATTORNEY

SN 77-712,754. RODALE INC., EMMAUS, PA. FILED 4-13-2009.

WOMEN'S RUNNING

THE MARK CONSISTS OF STANDARD CHARACTERS WITHOUT CLAIM TO ANY PARTICULAR FONT, STYLE, SIZE, OR COLOR.

OWNER OF U.S. REG. NOS. 2,643,641 AND 3,064,599.
SEC. 2(F).

CLASS 41—EDUCATION AND ENTERTAINMENT

FOR PROVIDING A WEB SITE FEATURING SPORTING INFORMATION; PROVIDING A WEB SITE FEATURING INFORMATION ON EXERCISE AND FITNESS; PROVIDING INFORMATION IN THE FIELD OF EXERCISE TRAINING; PROVIDING INFORMATION AND INSTRUCTION IN THE FIELD OF ATHLETIC EVENTS; PROVIDING INFORMATION, NEWS AND COMMENTARY IN THE FIELD OF SPORTING AND ATHLETIC EVENTS AND LEISURE ACTIVITIES; PROVIDING INFORMATION ON PHYSICAL EXERCISE; PROVIDING NEWS AND INFORMATION IN THE FIELD OF ATHLETIC EVENTS AND ACTIVITIES, SPORTS AND ATHLETIC EQUIPMENT AND SUPPLIES, EXERCISE AND PHYSICAL FITNESS, AND PHYSICAL FITNESS TRAINING; ENTERTAINMENT SERVICES, NAMELY, PROVIDING VIDEO PODCASTS IN THE FIELD OF ATHLETIC EVENTS AND ACTIVITIES, SPORTS AND ATHLETIC EQUIPMENT AND SUPPLIES, EXERCISE, FITNESS, TRAINING, NUTRITION, WEIGHT LOSS AND MOTIVATION; PROVIDING A WEB SITE FEATURING NON-DOWNLOADABLE INSTRUCTIONAL VIDEOS IN THE FIELD OF ATHLETIC EVENTS AND ACTIVITIES, SPORTS AND ATHLETIC EQUIPMENT AND SUPPLIES, EXERCISE, FITNESS, TRAINING, NUTRITION, WEIGHT LOSS AND MOTIVATION (U.S. CLS. 100, 101 AND 107).

FIRST USE 0-0-1999; IN COMMERCE 0-0-1999.

CLASS 44—MEDICAL, BEAUTY AND AGRICULTURAL SERVICES

FOR PROVIDING A WEB SITE FEATURING INFORMATION ON HEALTH AND NUTRITION; PROVIDING INFORMATION ON MAINTAINING A HEALTHY LIFESTYLE AND LOSING WEIGHT; AND PROVIDING NEWS AND INFORMATION IN THE FIELD OF NUTRITION AND WEIGHT LOSS PROGRAMS (U.S. CLS. 100 AND 101).

FIRST USE 0-0-1999; IN COMMERCE 0-0-1999.
SUSAN RICHARDS, EXAMINING ATTORNEY

SN 77-715,066. NG SPORTS, LLC, PALO ALTO, CA. FILED 4-16-2009.



THE MARK CONSISTS OF A STYLIZED LETTER "Z".

CLASS 9—ELECTRICAL AND SCIENTIFIC APPARATUS

FOR SPORTING GOOD, NAMELY, SWIM FLOATS FOR SAFETY PURPOSES, SWIM GOGGLES, WATER POLO PROTECTIVE CAPS (U.S. CLS. 21, 23, 26, 36 AND 38).

CLASS 25—CLOTHING

FOR CLOTHING AND HEADGEAR, NAMELY, SWIM TRUNKS, SWIMMING CAPS, SWIMWEAR, WATER POLO CAPS (U.S. CLS. 22 AND 39).

CLASS 28—TOYS AND SPORTING GOODS

FOR SPORTING GOODS, NAMELY, SWIM BOARDS FOR RECREATIONAL PURPOSES, SWIM FLOATS FOR RECREATIONAL PURPOSES, SWIM FINS, AND WATER POLO BALLS (U.S. CLS. 22, 23, 38 AND 50).

BRIDGETT SMITH, EXAMINING ATTORNEY

SN 77-715,321. THE CANAL COMPANY, INC., SANTA MONICA, CA. FILED 4-16-2009.

SN 77-715,259. THERMAL SUPPORT, INC., LILBURN, GA. FILED 4-16-2009.



NO CLAIM IS MADE TO THE EXCLUSIVE RIGHT TO USE "THERMALSUPPORT", APART FROM THE MARK AS SHOWN.

THE MARK CONSISTS OF THREE SQUIGGLY STYLIZED LINES WITH THE WORDING "THERMALSUPPORT" TO THE RIGHT OF THE DESIGN

CLASS 35—ADVERTISING AND BUSINESS

FOR WHOLESALE AND RETAIL STORE SERVICES FEATURING LABORATORY THERMAL ANALYSIS CONSUMABLES (U.S. CLS. 100, 101 AND 102).
FIRST USE 3-23-2009; IN COMMERCE 3-23-2009.

CLASS 37—CONSTRUCTION AND REPAIR

FOR INSTALLATION, MAINTENANCE AND REPAIR OF THERMAL ANALYSIS EQUIPMENT IN THE NATURE OF LABORATORY THERMAL ANALYSIS CONSUMABLES (U.S. CLS. 100, 103 AND 106).

FIRST USE 3-23-2009; IN COMMERCE 3-23-2009.
REBECCA SMITH, EXAMINING ATTORNEY

SN 77-715,312. OSRAM SYLVANIA INC., DANVERS, MA. FILED 4-16-2009.

SYLVANIA

THE MARK CONSISTS OF STANDARD CHARACTERS WITHOUT CLAIM TO ANY PARTICULAR FONT, STYLE, SIZE, OR COLOR.

OWNER OF U.S. REG. NOS. 1,325,543, 1,411,188 AND OTHERS.

CLASS 4—LUBRICANTS AND FUELS

FOR FIREPLACE LOGS AND FUEL PELLETS (U.S. CLS. 1, 6 AND 15).

CLASS 11—ENVIRONMENTAL CONTROL APPARATUS

FOR PELLET STOVES (U.S. CLS. 13, 21, 23, 31 AND 34).
ANDREW LEASER, EXAMINING ATTORNEY

HICTIONARY

THE MARK CONSISTS OF STANDARD CHARACTERS WITHOUT CLAIM TO ANY PARTICULAR FONT, STYLE, SIZE, OR COLOR.

CLASS 9—ELECTRICAL AND SCIENTIFIC APPARATUS

FOR MUSICAL SOUND RECORDINGS; MUSICAL VIDEO RECORDINGS; DOWNLOADABLE DIGITAL MUSICAL SOUND RECORDINGS PROVIDED FROM MP3 INTERNET WEBSITES (U.S. CLS. 21, 23, 26, 36 AND 38).

CLASS 41—EDUCATION AND ENTERTAINMENT

FOR MUSIC PUBLISHING SERVICES; BOOK PUBLISHING (U.S. CLS. 100, 101 AND 107).
ANDREW LEASER, EXAMINING ATTORNEY

SN 77-715,765. NONONINA, INC., MENLO PARK, CA. FILED 4-16-2009.

MYALLTOP

THE MARK CONSISTS OF STANDARD CHARACTERS WITHOUT CLAIM TO ANY PARTICULAR FONT, STYLE, SIZE, OR COLOR.

OWNER OF U.S. REG. NO. 3,597,770.

CLASS 41—EDUCATION AND ENTERTAINMENT

FOR PUBLISHING OF ELECTRONIC PUBLICATIONS IN THE NATURE OF NEWS FEEDS AND WEB LOGS (U.S. CLS. 100, 101 AND 107).

FIRST USE 3-17-2009; IN COMMERCE 3-17-2009.

CLASS 42—SCIENTIFIC AND COMPUTER SERVICES

FOR COMPUTER SERVICES, NAMELY, PROVIDING SEARCH ENGINES AND CREATING INDEXES OF INFORMATION, SITES AND OTHER RESOURCES RELATING TO NEWS FEED AND WEB LOGS AVAILABLE ON COMPUTER NETWORKS (U.S. CLS. 100 AND 101).

FIRST USE 3-17-2009; IN COMMERCE 3-17-2009.
WON TEAK OH, EXAMINING ATTORNEY

SN 77-716,239. GREEN MEETUP, DBA GREENMEETUP.-COM, WASHINGTON, DC. FILED 4-17-2009.

Green Meetup

THE MARK CONSISTS OF STANDARD CHARACTERS WITHOUT CLAIM TO ANY PARTICULAR FONT, STYLE, SIZE, OR COLOR.

NO CLAIM IS MADE TO THE EXCLUSIVE RIGHT TO USE "GREEN", APART FROM THE MARK AS SHOWN.

CLASS 35—ADVERTISING AND BUSINESS

FOR PROVIDING CONSUMER PRODUCT INFORMATION VIA THE INTERNET; PROVIDING CONSUMER INFORMATION IN THE FIELD OF GREEN AND/OR ENVIRONMENTALLY FRIENDLY PRODUCTS AND SERVICES (U.S. CLS. 100, 101 AND 102).

CLASS 41—EDUCATION AND ENTERTAINMENT

FOR ARRANGING AND CONDUCTING INDUSTRY SPECIFIC SPECIAL EVENTS (U.S. CLS. 100, 101 AND 107).

ANDREA K. NADELMAN, EXAMINING ATTORNEY

SN 77-716,880. TRANSFORMATION HEART DESIGNS, ELKHORN, NE. FILED 4-18-2009.



THE MARK CONSISTS OF AN OPEN HEART, SHAPED WITH A SLIGHT CURVE TO THE LEFT, A CHAIN LINKS THE HEART TO A CROSS. A SMALL HEART HANGS INSIDE THE OPEN HEART, AND A SMALL HEART IS CENTERED IN THE MIDDLE OF THE CROSS.

CLASS 14—JEWELRY

FOR JEWELRY (U.S. CLS. 2, 27, 28 AND 50).

CLASS 16—PAPER GOODS AND PRINTED MATTER

FOR PAPER GOODS, NAMELY, NOTE CARDS, BLANK JOURNALS, BOOKMARKS, PRINTED WALLET SIZE NOTE CARDS WITH INSPIRATIONAL VERSES, STATIONARY, STICKERS (U.S. CLS. 2, 5, 22, 23, 29, 37, 38 AND 50).

CLASS 25—CLOTHING

FOR CLOTHING, T-SHIRTS, TANKS TOPS, CAPS, HOODED SWEATSHIRTS, POLO SHIRTS, SWEAT PANTS, BLOUSES, SHORTS, SHIRTS, HEADBANDS, DRESSES, JACKETS, PAJAMAS, ROBES, BELTS (U.S. CLS. 22 AND 39).

MARK SHINER, EXAMINING ATTORNEY

SN 77-717,296. AURALOG S.A., MONTIGNY-LE-BRETON-NEUX, FRANCE, FILED 4-20-2009.

TELL ME MORE

THE MARK CONSISTS OF STANDARD CHARACTERS WITHOUT CLAIM TO ANY PARTICULAR FONT, STYLE, SIZE, OR COLOR.

OWNER OF U.S. REG. NO. 2,464,224.

CLASS 9—ELECTRICAL AND SCIENTIFIC APPARATUS

FOR COMPUTER SOFTWARE PLATFORMS FOR TEACHING FOREIGN LANGUAGES; INTERACTIVE MULTIMEDIA COMPUTER PROGRAM FOR TEACHING FOREIGN LANGUAGE (U.S. CLS. 21, 23, 26, 36 AND 38).

FIRST USE 2-28-1998; IN COMMERCE 9-1-1998.

CLASS 41—EDUCATION AND ENTERTAINMENT

FOR EDUCATION SERVICES, NAMELY, PROVIDING TUTORING IN THE FIELD OF FOREIGN LANGUAGES (U.S. CLS. 100, 101 AND 107).

FIRST USE 4-1-2000; IN COMMERCE 6-11-2001.

MATTHEW PAPPAS, EXAMINING ATTORNEY

SN 77-717,884. THE OHIO STATE LOTTERY COMMISSION, DBA OHIO LOTTERY, CLEVELAND, OH. FILED 4-20-2009.

OHIO LOTTERY

THE MARK CONSISTS OF STANDARD CHARACTERS WITHOUT CLAIM TO ANY PARTICULAR FONT, STYLE, SIZE, OR COLOR.

OWNER OF U.S. REG. NO. 3,586,278.

NO CLAIM IS MADE TO THE EXCLUSIVE RIGHT TO USE "LOTTERY", APART FROM THE MARK AS SHOWN. SEC. 2(F).

CLASS 9—ELECTRICAL AND SCIENTIFIC APPARATUS

FOR MACHINES FOR DISPENSING LOTTERY TICKETS (U.S. CLS. 21, 23, 26, 36 AND 38).

FIRST USE 6-0-2000; IN COMMERCE 6-0-2000.

CLASS 28—TOYS AND SPORTING GOODS

FOR LOTTERY TICKETS (U.S. CLS. 22, 23, 38 AND 50).
FIRST USE 5-1-1974; IN COMMERCE 8-22-1974.

CLASS 41—EDUCATION AND ENTERTAINMENT

FOR LOTTERY SERVICES (U.S. CLS. 100, 101 AND 107).
FIRST USE 5-1-1974; IN COMMERCE 8-22-1974.
TINA KUAN, EXAMINING ATTORNEY

SN 77-717,926. EASTSTAR SOLUTIONS, LTD, WEST ALLIS, WI. FILED 4-20-2009.

EastStar

THE MARK CONSISTS OF STANDARD CHARACTERS WITHOUT CLAIM TO ANY PARTICULAR FONT, STYLE, SIZE, OR COLOR.

CLASS 18—LEATHER GOODS

FOR LEATHER CASES FOR KEYS; LEATHER CREDIT CARD CASES; LEATHER KEY CASES; LEATHER POUCHES; PURSES; WALLETS; WALLETS MADE OF LEATHER OR OTHER MATERIALS (U.S. CLS. 1, 2, 3, 22 AND 41).
FIRST USE 4-1-2008; IN COMMERCE 4-1-2008.

CLASS 25—CLOTHING

FOR BELTS MADE OF LEATHER; FOOTWEAR; LEATHER SHOES; WAIST BELTS (U.S. CLS. 22 AND 39).
FIRST USE 4-1-2008; IN COMMERCE 4-1-2008.
GRETCHEN ULRICH, EXAMINING ATTORNEY

SN 77-718,199. SANITEC INDUSTRIES, INC., STUDIO CITY, CA. FILED 4-21-2009.

SANITEC

THE MARK CONSISTS OF STANDARD CHARACTERS WITHOUT CLAIM TO ANY PARTICULAR FONT, STYLE, SIZE, OR COLOR.
OWNER OF U.S. REG. NOS. 2,559,664 AND 3,180,213.

CLASS 11—ENVIRONMENTAL CONTROL APPARATUS

FOR DISINFECTION UNITS FOR THE TREATMENT OF MEDICAL WASTES (U.S. CLS. 13, 21, 23, 31 AND 34).
FIRST USE 11-10-1995; IN COMMERCE 3-22-1996.

CLASS 37—CONSTRUCTION AND REPAIR

FOR DISPOSAL OF WASTE FOR OTHERS; DISINFECTION OF MEDICAL WASTE (U.S. CLS. 100, 103 AND 106).
FIRST USE 10-15-2000; IN COMMERCE 10-15-2000.

CLASS 39—TRANSPORTATION AND STORAGE

FOR TRANSPORTATION BY TRUCK AND RAIL OF MEDICAL WASTE FOR OTHERS (U.S. CLS. 100 AND 105).
FIRST USE 10-15-2000; IN COMMERCE 10-15-2000.

CLASS 40—MATERIAL TREATMENT

FOR TREATMENT OF MEDICAL WASTE; PRODUCTION OF BIO-FUELS; PRODUCTION OF BIO-FUELS FROM MEDICAL WASTE; PRODUCTION OF FUELS FROM MEDICAL WASTE; PRODUCTION OF LUBRICANTS, NAMELY, GREASE; PRODUCTION OF LUBRICANTS FROM MEDICAL WASTE, NAMELY, GREASE (U.S. CLS. 100, 103 AND 106).
FIRST USE 10-15-2000; IN COMMERCE 10-15-2000.
KOURTNEE HODGES, EXAMINING ATTORNEY

SN 77-718,303. SANDLER, TRAVIS & ROSENBERG, P.A., MIAMI, FL. FILED 4-21-2009.



THE MARK CONSISTS OF A 3 DIMENSIONAL GLOBE ON TOP OF A MAZE.

CLASS 41—EDUCATION AND ENTERTAINMENT

FOR EDUCATION SERVICES, NAMELY, PROVIDING LIVE AND ON-LINE SEMINARS, WEBINARS, CLASSES, WORKSHOPS AND TRAINING SESSIONS IN THE FIELD OF INTERNATIONAL TRADE, CUSTOMS AND BUSINESS LAWS, RULES, REGULATIONS AND BEST BUSINESS PRACTICES (U.S. CLS. 100, 101 AND 107).
FIRST USE 4-1-2009; IN COMMERCE 4-1-2009.

CLASS 45—PERSONAL AND LEGAL SERVICES

FOR LEGAL SERVICES (U.S. CLS. 100 AND 101).
AARON BRODSKY, EXAMINING ATTORNEY

SN 77-719,534. SATORI, LAUREL, VENTURA, CA. FILED 4-22-2009.



THE MARK CONSISTS OF THE STYLIZED LETTERS AND WORDS "VAGINA WORTHY VW"; AND AN IMAGE OF A FIGURE IN THE CENTER OF THE STYLIZED LETTERS "VW".

CLASS 16—PAPER GOODS AND PRINTED MATTER

FOR STICKERS, BUMPER STICKERS, DECALS (U.S. CLS. 2, 5, 22, 23, 29, 37, 38 AND 50).

CLASS 25—CLOTHING

FOR TEE-SHIRTS, SHORTS, BRIEFS, BOXERS, SOCKS, JUMPERS, TRACK SUITS, SWIM WEAR (U.S. CLS. 22 AND 39).

RAUL CORDOVA, EXAMINING ATTORNEY

SN 77-719,905. AIRBIQUITY INC., SEATTLE, WA. FILED 4-22-2009.



OWNER OF U.S. REG. NOS. 2,698,331 AND 2,698,332.

THE MARK CONSISTS OF A STYLIZED "A" WITH THREE DOTS APPEARING BEFORE THE TOP OF THE LETTER "A" AND THREE DOTS APPEARING AFTER THE MIDDLE OF THE LETTER "A", ALL CENTERED ABOVE THE WORD "AIRBIQUITY".

CLASS 9—ELECTRICAL AND SCIENTIFIC APPARATUS

FOR WIRELESS TELECOMMUNICATIONS COMPUTER HARDWARE, FIRMWARE, AND SOFTWARE RESIDING IN WIRELESS PHONES, PAGERS, PDAS, COMPUTER NETWORK ROUTERS AND OTHER HAND-HELD WIRELESS DEVICES FOR USE IN PROVIDING USERS, NAMELY, WIRELESS CARRIERS, WIRELESS APPLICATION SERVICE PROVIDERS, COMMERCIAL CALL CENTERS, INTERNET PORTALS, AND VERTICAL MARKETS WITH CONTEMPORANEOUS VOICE AND MOBILE DATA SERVICES OVER WIRELESS NETWORKS TO REMOTE DEVICES (U.S. CLS. 21, 23, 26, 36 AND 38).

FIRST USE 3-1-2009; IN COMMERCE 3-1-2009.

CLASS 38—COMMUNICATION

FOR PROVIDING USERS, NAMELY, WIRELESS APPLICATION SERVICE PROVIDERS, WIRELESS CARRIERS, COMMERCIAL CALL CENTERS, INTERNET PORTALS, AND VERTICAL MARKETS, CONTEMPORANEOUS VOICE AND MOBILE DATA TRANSMISSION CAPABILITY OVER WIRELESS NETWORKS TO REMOTE DEVICES (U.S. CLS. 100, 101 AND 104).

FIRST USE 3-1-2009; IN COMMERCE 3-1-2009.

KATHLEEN LORENZO, EXAMINING ATTORNEY

SN 77-720,263. BREST ACCESS HOLDING SARL, PLOUGASTEL, FRANCE, FILED 4-23-2009.



THE COLOR(S) WHITE, LIGHT RED, DARK RED, LIGHT BLUE, DARK BLUE, YELLOW, LIGHT GREEN AND DARK GREEN IS/ARE CLAIMED AS A FEATURE OF THE MARK.

THE MARKS CONSISTS OF A STYLIZED REPRESENTATION OF THE WORLD IN GREEN AND BLUE COLOURS, ON THE TOP OF WHICH STANDS A FLOWER IN YELLOW AND RED COLORS. THE WORD "NETTY" APPEARS IN WHITE, THE WORD "CARS" APPEARS IN YELLOW AND THE WORDING "WWW" APPEARS IN YELLOW AND THE WORDING "NETTYCARS.COM" APPEARS IN WHITE.

CLASS 3—COSMETICS AND CLEANING PREPARATIONS

FOR PREPARATIONS FOR CLEANING, PROTECTING AND PRESERVING VEHICLE SURFACES (U.S. CLS. 1, 4, 6, 50, 51 AND 52).

CLASS 37—CONSTRUCTION AND REPAIR

FOR AUTOMOBILE CLEANING; AUTOMOBILE CLEANING AND CAR WASHING; CAR CLEANING; VEHICLE CLEANING (U.S. CLS. 100, 103 AND 106).

SAIMA MAKHDOOM, EXAMINING ATTORNEY

SN 77-720,288. JOHN G. WILSON, JOPLIN, MO. FILED 4-23-2009.

Summer Casual

THE MARK CONSISTS OF STANDARD CHARACTERS WITHOUT CLAIM TO ANY PARTICULAR FONT, STYLE, SIZE, OR COLOR.

NO CLAIM IS MADE TO THE EXCLUSIVE RIGHT TO USE "CASUAL", APART FROM THE MARK AS SHOWN.

CLASS 6—METAL GOODS

FOR GAZEBOS PRIMARILY OF METAL; METAL GAZEBOS; PORTABLE GAZEBOS PRIMARILY OF METAL (U.S. CLS. 2, 12, 13, 14, 23, 25 AND 50).

CLASS 11—ENVIRONMENTAL CONTROL APPARATUS

FOR BARBECUE GRILLS; BARBECUES AND GRILLS; CERAMIC BRIQUETTES FOR USE IN BARBECUE GRILLS; CHARCOAL GRILLS; ELECTRIC GRILLS; ELECTRIC INDOOR GRILLS; ELECTRIC OUTDOOR GRILLS; FOLDING PORTABLE CHARCOAL, PROPANE AND GAS FIRED BARBECUES, STOVES, AND GRILLS; GAS GRILLS; GRILL ACCESSORIES, NAMELY, WARMING TRAYS; LAVA ROCK FOR USE IN BARBECUE GRILLS; LIGHTERS PRIMARILY FOR LIGHTING GRILLS, FIREPLACES AND CANDLES; MULTI-PURPOSE, ELECTRIC COUNTERTOP FOOD PREPARATION APPARATUS FOR COOKING, BAKING, BROILING, ROASTING, TOASTING, SEARING, BROWNING, BARBECUING AND GRILLING FOOD; TABLES DESIGNED TO HOLD GAS GRILLS; VENTILATION FAN ACCESSORIES, NAMELY, GRILLES (U.S. CLS. 13, 21, 23, 31 AND 34).

CLASS 18—LEATHER GOODS

FOR BAGS FOR UMBRELLAS; BEACH UMBRELLAS; BEACH UMBRELLAS; FRAMES FOR UMBRELLAS; FRAMES FOR UMBRELLAS OR PARASOLS; GOLF UMBRELLAS; METAL PARTS OF UMBRELLAS; PARASOLS; PATIO UMBRELLAS; TABLE UMBRELLAS; TELESCOPIC UMBRELLAS; UMBRELLA BASES; UMBRELLA COVERS; UMBRELLA FRAMES; UMBRELLA HANDLES; UMBRELLA RINGS; UMBRELLAS; UMBRELLAS AND PARASOLS; UMBRELLAS AND THEIR PARTS; UMBRELLAS FOR CHILDREN (U.S. CLS. 1, 2, 3, 22 AND 41).

CLASS 20—FURNITURE AND ARTICLES NOT OTHERWISE CLASSIFIED

FOR CAMPING FURNITURE; CAST STONE HOUSEHOLD AND GARDEN FURNITURE; CUSHIONS; FURNITURE; FURNITURE FOR CAMPING; FURNITURE FOR HOUSE, OFFICE AND GARDEN; FURNITURE FRAMES; FURNITURE MADE FROM STEEL TUBING; FURNITURE MADE FROM WOOD OR SUBSTITUTES FOR WOOD; FURNITURE MOLDINGS; FURNITURE OF METAL; FURNITURE PARTS; FURNITURE, NAMELY, WALL UNITS; LAWN FURNITURE; METAL FURNITURE; METAL FURNITURE AND FURNITURE FOR CAMPING; OUTDOOR FURNITURE; PET FURNITURE; PLASTIC FURNITURE FOR GARDENS; RESIDENTIAL AND COMMERCIAL FURNITURE; RESIDENTIAL AND COMMERCIAL WROUGHT IRON FURNITURE; SCREENS; SEATING FURNITURE; SEATS; STONE FURNITURE; TABLES; UMBRELLA STANDS (U.S. CLS. 2, 13, 22, 25, 32 AND 50).

SAIMA MAKHDOOM, EXAMINING ATTORNEY

SN 77-720,468. KABUSHIKI KAISHA SQUARE ENIX HOLDINGS, TA SQUARE ENIX HOLDINGS CO., LTD., TOKYO, JAPAN, FILED 4-23-2009.

DRAGON QUEST WARS

THE MARK CONSISTS OF STANDARD CHARACTERS WITHOUT CLAIM TO ANY PARTICULAR FONT, STYLE, SIZE, OR COLOR.

OWNER OF U.S. REG. NOS. 3,060,818, 3,306,797 AND OTHERS.

CLASS 9—ELECTRICAL AND SCIENTIFIC APPARATUS

FOR COMPUTER GAME SOFTWARE; VIDEO GAME SOFTWARE; SOUND RECORDINGS IN THE FORM OF OPTICAL DISCS, MAGNETIC DISCS AND SEMICONDUCTOR ROMS FEATURING MUSIC AND FICTIONAL STORIES; AUDIO VISUAL RECORDINGS IN THE FORM OF OPTICAL DISCS, MAGNETIC DISCS AND SEMICONDUCTOR ROMS FEATURING MUSIC AND ANIMATED FICTIONAL STORIES; PRERECORDED COMPACT DISCS FEATURING MUSIC; PRERECORDED VIDEO DISCS FEATURING MUSIC AND ANIMATED FICTIONAL STORIES; MOUSE PADS; VIDEO GAME CONTROLLERS; DOWNLOADABLE MUSICAL SOUND RECORDINGS; DOWNLOADABLE WALLPAPER GRAPHICS, IMAGES AND PHOTOGRAPHS, ALL OF THE FOREGOING DOWNLOADABLE VIA THE INTERNET AND WIRELESS DEVICES; DOWNLOADABLE ELECTRONIC PUBLICATIONS IN THE NATURE OF MAGAZINES, JOURNALS AND NEWSLETTERS IN THE FIELD OF COMPUTER GAMES AND VIDEO GAMES (U.S. CLS. 21, 23, 26, 36 AND 38).

CLASS 16—PAPER GOODS AND PRINTED MATTER

FOR COMPUTER GAME STRATEGY GUIDEBOOKS; VIDEO GAME STRATEGY GUIDEBOOKS; SONG BOOKS; MUSICAL SCORE BOOKS; COMIC BOOKS; MAGAZINES FEATURING COMPUTER GAMES AND VIDEO GAMES; POSTERS; STICKERS; CALENDARS; POSTCARDS; STATIONERY; COLLECTORS' CARDS; TRADING CARDS; PHOTOGRAPHS (U.S. CLS. 2, 5, 22, 23, 29, 37, 38 AND 50).

ALICIA COLLINS, EXAMINING ATTORNEY

SN 77-720,586. FIN CULTURE, LLC, FORT PIERCE, FL. FILED 4-23-2009.

FIN CULTURE

THE MARK CONSISTS OF STANDARD CHARACTERS WITHOUT CLAIM TO ANY PARTICULAR FONT, STYLE, SIZE, OR COLOR.

CLASS 16—PAPER GOODS AND PRINTED MATTER

FOR BUMPER STICKERS (U.S. CLS. 2, 5, 22, 23, 29, 37, 38 AND 50).

CLASS 25—CLOTHING

FOR CLOTHING IN THE NATURE OF BEACH WEAR AND ACTIVE WEAR, NAMELY, SHIRTS, SHORTS, PANTS, JACKETS, FOOTWEAR, HATS, CAPS, SWIMWEAR, BATHING SUITS AND SWIM TRUNKS (U.S. CLS. 22 AND 39).

BRENDAN REGAN, EXAMINING ATTORNEY

SN 77-720,835. BOGOVICH, MICHAEL S., HAWTHORN WOODS, IL. FILED 4-23-2009.



NO CLAIM IS MADE TO THE EXCLUSIVE RIGHT TO USE "BURN THE BOX", APART FROM THE MARK AS SHOWN.

THE COLOR(S) LIGHT-TAN, MEDIUM-TAN, BROWN, RED, YELLOW, ORANGE, BLACK, WHITE IS/ARE CLAIMED AS A FEATURE OF THE MARK.

THE MARK CONSISTS OF A STYLIZED DRAWING OF A THREE-DIMENSIONAL BOX, IN MEDIUM-TAN COLOR, WITH A BROWN OUTLINE, AND WHITE TAPE ACROSS THE TOP; A LIGHT-TAN STYLIZED DRAWING OF A MATCHSTICK, WITH A RED TIP, AND A YELLOW AND ORANGE FLAME ARE SUPERIMPOSED ON THE BOX; NON-LATIN CHARACTERS, WHICH TRANSLITERATE TO THE LETTERS "VTV", APPEAR AT THE FRONT OF THE DRAWING OF THE BOX IN THE COLOR BLACK AND THE WORDING "BURN THE BOX" APPEAR BELOW THE DRAWING IN THE COLOR BLACK.

THE NON-LATIN CHARACTERS IN THE MARK TRANSLITERATE TO "VTV" AND THIS HAS NO MEANING IN A FOREIGN LANGUAGE.

CLASS 9—ELECTRICAL AND SCIENTIFIC APPARATUS

FOR COMPUTER APPLICATION SOFTWARE FOR MOBILE PHONES (U.S. CLS. 21, 23, 26, 36 AND 38).

CLASS 35—ADVERTISING AND BUSINESS

FOR BUSINESS CONSULTATION (U.S. CLS. 100, 101 AND 102).

AMEEN IMAM, EXAMINING ATTORNEY

SN 77-720,861. NATIONAL ASSOCIATION OF STATE BOARDS OF ACCOUNTANCY, INC., NASHVILLE, TN. FILED 4-23-2009.

CALIBRATE

THE MARK CONSISTS OF STANDARD CHARACTERS WITHOUT CLAIM TO ANY PARTICULAR FONT, STYLE, SIZE, OR COLOR.

CLASS 9—ELECTRICAL AND SCIENTIFIC APPARATUS

FOR DOWNLOADABLE SOFTWARE FOR USE IN MANAGING CONTINUING EDUCATION CREDITS, NAMELY, SOFTWARE USED TO ENTER AND RECORD ACQUIRED CONTINUING EDUCATION CREDITS, COMPARE CREDITS AGAINST DEFINED REGULATORY REQUIREMENTS OF STATE AND FEDERAL AGENCIES AND OTHER ORGANIZATIONS, GENERATE COMPLIANCE REPORTS AND SUBMIT CONTINUING EDUCATION REPORTS VIA E-MAIL TO AGENCIES AND OTHER ORGANIZATIONS, AND PROVIDE LISTINGS OF COURSES FOR CONTINUING EDUCATION CREDITS AND COMPARE AGAINST DEFINED REGULATORY REQUIREMENTS OF STATE AND FEDERAL AGENCIES AND OTHER ORGANIZATIONS (U.S. CLS. 21, 23, 26, 36 AND 38).

CLASS 42—SCIENTIFIC AND COMPUTER SERVICES

FOR APPLICATION SERVICE PROVIDER (ASP) FEATURING SOFTWARE FOR USE IN MANAGING CONTINUING EDUCATION CREDITS, NAMELY, SOFTWARE USED TO ENTER AND RECORD ACQUIRED CONTINUING EDUCATION CREDITS, COMPARE CREDITS AGAINST DEFINED REGULATORY REQUIREMENTS OF STATE AND FEDERAL AGENCIES AND OTHER ORGANIZATIONS, GENERATE COMPLIANCE REPORTS AND SUBMIT CONTINUING EDUCATION REPORTS VIA E-MAIL TO AGENCIES AND OTHER ORGANIZATIONS, AND PROVIDE LISTINGS OF COURSES FOR CONTINUING EDUCATION CREDITS AND COMPARE AGAINST DEFINED REGULATORY REQUIREMENTS OF STATE AND FEDERAL AGENCIES AND OTHER ORGANIZATIONS (U.S. CLS. 100 AND 101).

LAURA KOVALSKY, EXAMINING ATTORNEY

SN 77-721,266. WORLD IMPACT, INC., LOS ANGELES, CA. FILED 4-23-2009.



OWNER OF U.S. REG. NOS. 3,484,996 AND 3,484,997. THE MARK CONSISTS OF A CROSS APPEARING WITHIN A RECTANGLE.

CLASS 41—EDUCATION AND ENTERTAINMENT

FOR RELIGIOUS INSTRUCTION SERVICES IN THE FIELD OF CHRISTIAN DISCIPLESHIP; EDUCATIONAL SERVICES, NAMELY, CONDUCTING CLASSES, CONFERENCES, SEMINARS, WORKSHOPS IN THE FIELD OF CHRISTIAN EDUCATION, BIBLE INSTRUCTION, EVANGELISM AND DISCIPLESHIP AND DISTRIBUTION OF COURSE MATERIALS IN CONNECTION THEREWITH; BASIC VOCATIONAL GUIDANCE; EDUCATIONAL SERVICES, NAMELY, PROVIDING COURSES OF INSTRUCTIONS AT THE PRIMARY LEVEL AND DISTRIBUTION OF COURSE MATERIALS IN CONNECTION THEREWITH; RECREATIONAL CAMPS; RECREATIONAL SERVICES IN THE NATURE OF SPORTS PROGRAMS, ARTS AND CRAFTS PROGRAMS, AND GAMES; CHARITABLE SERVICES, NAMELY, ACADEMIC MENTORING OF SCHOOL-AGE CHILDREN (U.S. CLS. 100, 101 AND 107).

CLASS 43—HOTEL AND RESTAURANT SERVICES

FOR CHARITABLE SERVICES, NAMELY, PROVIDING FOOD AND TEMPORARY HOUSING TO NEEDY PERSONS (U.S. CLS. 100 AND 101).

CLASS 44—MEDICAL, BEAUTY AND AGRICULTURAL SERVICES

FOR CHARITABLE SERVICES, NAMELY, PROVIDING MEDICAL AND DENTAL AND DENTAL HYGIENIST SERVICES TO NEEDY PERSONS (U.S. CLS. 100 AND 101).

CLASS 45—PERSONAL AND LEGAL SERVICES

FOR CHARITABLE SERVICES, NAMELY, PROVIDING CLOTHING TO NEEDY PERSONS; EVANGELISTIC AND MINISTERIAL SERVICES; EVANGELISTIC AND MINISTERIAL SERVICES IN THE NATURE OF EVANGELISTIC CRUSADES AND ESTABLISHMENT OF EVANGELICAL CHURCHES (U.S. CLS. 100 AND 101).
ELIZABETH KAJUBI, EXAMINING ATTORNEY

SN 77-721,267. WORLD IMPACT, INC., LOS ANGELES, CA. FILED 4-23-2009.



OWNER OF U.S. REG. NOS. 3,484,996 AND 3,484,997.
THE MARK CONSISTS OF A CROSS APPEARING WITHIN A RECTANGLE.

CLASS 9—ELECTRICAL AND SCIENTIFIC APPARATUS

FOR PRE-RECORDED CDS, VIDEOTAPES, DVDS, AND CINEMATOGGRAPHIC FILMS FEATURING WORSHIP AND GOSPEL MUSIC AND TOPICS IN THE AREA OF CHRISTIANITY, BIBLE INSTRUCTION, EVANGELISM AND DISCIPLESHIP (U.S. CLS. 21, 23, 26, 36 AND 38).

CLASS 16—PAPER GOODS AND PRINTED MATTER

FOR SERIES OF NON-FICTION BOOKS, BOOKLETS, PAMPHLETS, BROCHURES, NEWSLETTERS, AND CATALOGS IN THE FIELD OF CHRISTIANITY AND BIBLE INSTRUCTION (U.S. CLS. 2, 5, 22, 23, 29, 37, 38 AND 50).
ELIZABETH KAJUBI, EXAMINING ATTORNEY

SN 77-721,428. LUBI ELECTRICALS LIMITED, AHMEDABAD, INDIA, FILED 4-24-2009.

LUBI

THE MARK CONSISTS OF STANDARD CHARACTERS WITHOUT CLAIM TO ANY PARTICULAR FONT, STYLE, SIZE, OR COLOR.

CLASS 6—METAL GOODS

FOR MANUALLY OPERATED METAL VALVES (U.S. CLS. 2, 12, 13, 14, 23, 25 AND 50).

CLASS 7—MACHINERY

FOR CENTRIFUGAL PUMPS; ELECTRIC PUMPS; SUMP PUMPS (U.S. CLS. 13, 19, 21, 23, 31, 34 AND 35).
JOHN SCHUYLER YARD, EXAMINING ATTORNEY

SN 77-721,499. PARI GMBH SPEZIALISTEN FUER EFFEKTIVE INHALATION, STARNBERG, FED REP GERMANY, FILED 4-24-2009.

BRONCHOCLEAR

THE MARK CONSISTS OF STANDARD CHARACTERS WITHOUT CLAIM TO ANY PARTICULAR FONT, STYLE, SIZE, OR COLOR.

CLASS 5—PHARMACEUTICALS

FOR INHALERS FILLED WITH PHARMACEUTICAL PREPARATIONS IN POWDER AND LIQUID FORM FOR THE TREATMENT AND PREVENTION OF RESPIRATORY DISEASES; PHARMACEUTICAL PREPARATIONS, NAMELY, SOLUTIONS FOR TREATMENT AND PREVENTION OF DISEASES OF THE LUNGS AND IRRIGATING NASAL PASSAGES (U.S. CLS. 6, 18, 44, 46, 51 AND 52).

CLASS 10—MEDICAL APPARATUS

FOR INHALERS FOR MEDICAL PURPOSES SOLD EMPTY; NEBULIZERS FOR RESPIRATION THERAPY; NEBULIZER FOR ADMINISTERING MEDICATION IN THE FORM OF A MIST INHALED INTO THE LUNGS, FOR TREATMENT OF RESPIRATORY DISEASES (U.S. CLS. 26, 39 AND 44).

JANICE KIM, EXAMINING ATTORNEY

SN 77-721,653. SF INVESTMENTS, INC., WILMINGTON, DE. FILED 4-24-2009.

HAM IDEAS

SN 77-721,509. BOB MOORE AUTO GROUP LLC, OKLAHOMA CITY, OK. FILED 4-24-2009.



THE MARK CONSISTS OF A FLYING "M".

CLASS 35—ADVERTISING AND BUSINESS

FOR AUTOMOBILE DEALERSHIP (U.S. CLS. 100, 101 AND 102).
FIRST USE 12-31-1999; IN COMMERCE 12-31-1999.

CLASS 37—CONSTRUCTION AND REPAIR

FOR AUTOMOBILE MAINTENANCE AND REPAIR SERVICES (U.S. CLS. 100, 103 AND 106).
FIRST USE 12-31-1999; IN COMMERCE 12-31-1999.
LANA PHAM, EXAMINING ATTORNEY

THE MARK CONSISTS OF STANDARD CHARACTERS WITHOUT CLAIM TO ANY PARTICULAR FONT, STYLE, SIZE, OR COLOR.

NO CLAIM IS MADE TO THE EXCLUSIVE RIGHT TO USE "HAM", APART FROM THE MARK AS SHOWN.

CLASS 29—MEATS AND PROCESSED FOODS

FOR PORK, PORK CUTS, PRE-COOKED PORK, HAM, AND CORNED BEEF (U.S. CL. 46).

CLASS 43—HOTEL AND RESTAURANT SERVICES

FOR PROVIDING INFORMATION IN THE FIELD OF FOOD PREPARATION AND SERVING, NAMELY, PROVIDING INFORMATION ON-LINE AND OFF-LINE, IN THE FIELD OF PORK PRODUCTS, RECIPES, COOKING AND ENTERTAINING (U.S. CLS. 100 AND 101).
KATHERINE E. HALMEN, EXAMINING ATTORNEY

SN 77-721,629. JEFFREY A. NEWMAN, MARBLEHEAD, MA. FILED 4-24-2009.

FUTUREBRINK

THE MARK CONSISTS OF STANDARD CHARACTERS WITHOUT CLAIM TO ANY PARTICULAR FONT, STYLE, SIZE, OR COLOR.

CLASS 41—EDUCATION AND ENTERTAINMENT

FOR MULTIMEDIA PUBLISHING OF BOOKS, MAGAZINES, JOURNALS, SOFTWARE, GAMES, MUSIC, AND ELECTRONIC PUBLICATIONS; PRODUCTION OF VIDEO AND COMPUTER GAME SOFTWARE (U.S. CLS. 100, 101 AND 107).

CLASS 42—SCIENTIFIC AND COMPUTER SERVICES

FOR HOSTING AN ON-LINE WEBSITE FEATURING PREDICTIVE ANALYTICS AND MACHINE LEARNING (U.S. CLS. 100 AND 101).
KATHERINE CONNOLLY, EXAMINING ATTORNEY

SN 77-721,722. SF INVESTMENTS, INC., WILMINGTON, DE. FILED 4-24-2009.

HAMIDEAS.COM

THE MARK CONSISTS OF STANDARD CHARACTERS WITHOUT CLAIM TO ANY PARTICULAR FONT, STYLE, SIZE, OR COLOR.

CLASS 29—MEATS AND PROCESSED FOODS

FOR PORK, PORK CUTS, PRE-COOKED PORK, HAM, AND CORNED BEEF (U.S. CL. 46).

CLASS 43—HOTEL AND RESTAURANT SERVICES

FOR PROVIDING INFORMATION IN THE FIELD OF FOOD PREPARATION AND SERVING, NAMELY, PROVIDING INFORMATION ON-LINE AND OFF-LINE, IN THE FIELD OF PORK PRODUCTS, RECIPES, COOKING AND ENTERTAINING (U.S. CLS. 100 AND 101).
KATHERINE E. HALMEN, EXAMINING ATTORNEY

SN 77-721,931. FAULTLESS STARCH/BON AMI COMPANY,
KANSAS CITY, MO. FILED 4-24-2009.

SN 77-722,174. HARMON AUTOGLASS INTELLECTUAL
PROPERTY, LLC, WACO, TX. FILED 4-24-2009.

TAHITIAN TUBEROSE

THE MARK CONSISTS OF STANDARD CHARACTERS
WITHOUT CLAIM TO ANY PARTICULAR FONT, STYLE,
SIZE, OR COLOR.

NO CLAIM IS MADE TO THE EXCLUSIVE RIGHT TO
USE "TUBEROSE", APART FROM THE MARK AS SHOWN.

CLASS 4—LUBRICANTS AND FUELS

FOR CANDLES (U.S. CLS. 1, 6 AND 15).
FIRST USE 2-3-2009; IN COMMERCE 2-3-2009.

CLASS 11—ENVIRONMENTAL CONTROL AP- PARATUS

FOR ROOM FRAGRANCE DIFFUSERS (U.S. CLS. 13,
21, 23, 31 AND 34).
FIRST USE 2-3-2009; IN COMMERCE 2-3-2009.
KATHERINE E. HALMEN, EXAMINING ATTORNEY

SN 77-721,993. FAULTLESS STARCH/BON AMI COMPANY,
KANSAS CITY, MO. FILED 4-24-2009.

CINNAMON NOIR

THE MARK CONSISTS OF STANDARD CHARACTERS
WITHOUT CLAIM TO ANY PARTICULAR FONT, STYLE,
SIZE, OR COLOR.

NO CLAIM IS MADE TO THE EXCLUSIVE RIGHT TO
USE "CINNAMON", APART FROM THE MARK AS
SHOWN.

THE ENGLISH TRANSLATION OF THE WORD "NOIR"
IN THE MARK IS "BLACK".

CLASS 4—LUBRICANTS AND FUELS

FOR CANDLES (U.S. CLS. 1, 6 AND 15).
FIRST USE 2-3-2009; IN COMMERCE 2-3-2009.

CLASS 11—ENVIRONMENTAL CONTROL AP- PARATUS

FOR ROOM FRAGRANCE DIFFUSERS (U.S. CLS. 13,
21, 23, 31 AND 34).
FIRST USE 2-3-2009; IN COMMERCE 2-3-2009.
KATHERINE E. HALMEN, EXAMINING ATTORNEY

PORTLAND GLASS

THE MARK CONSISTS OF STANDARD CHARACTERS
WITHOUT CLAIM TO ANY PARTICULAR FONT, STYLE,
SIZE, OR COLOR.

OWNER OF U.S. REG. NO. 2,702,428.

NO CLAIM IS MADE TO THE EXCLUSIVE RIGHT TO
USE "GLASS", APART FROM THE MARK AS SHOWN.
SEC. 2(F) AS TO "PORTLAND".

CLASS 35—ADVERTISING AND BUSINESS

FOR RETAIL STORES FEATURING WINDOWS,
SCREENS, GLASS DOORS, GARAGE AND OVERHEAD
DOORS, AUTOMOBILE GLASS AND REPLACEMENT
GLASS FOR COMMERCIAL AND RESIDENTIAL
BUILDINGS (U.S. CLS. 100, 101 AND 102).

FIRST USE 7-5-1988; IN COMMERCE 7-5-1988.

CLASS 37—CONSTRUCTION AND REPAIR

FOR INSTALLATION OF WINDOWS, SCREENS,
GLASS DOORS, GREENHOUSES, GARAGE AND OVER-
HEAD DOORS, PORCH ENCLOSURES, PATIO DOORS,
TUB AND SHOWER ENCLOSURES, AUTOMOBILE
GLASS AND REPLACEMENT GLASS FOR COMMER-
CIAL AND RESIDENTIAL BUILDINGS (U.S. CLS. 100,
103 AND 106).

FIRST USE 7-5-1988; IN COMMERCE 7-5-1988.
ZHALEH DELANEY, EXAMINING ATTORNEY

SN 77-722,436. PROGRESS SOLAR LLC, ORLANDO, FL.
FILED 4-25-2009.



PROGRESS SOLAR

NO CLAIM IS MADE TO THE EXCLUSIVE RIGHT TO
USE "SOLAR", APART FROM THE MARK AS SHOWN.

THE COLOR(S) GREEN, ORANGE AND BLACK IS/ARE
CLAIMED AS A FEATURE OF THE MARK.

THE MARK CONSISTS OF A GRAPHIC DESIGN AT TOP
AND LITERAL ELEMENT AT BOTTOM. THE GRAPHIC
DESIGN CONSISTS OF A SEMI-CIRCLE OUTLINED RE-
PRESENTING THE SUN WITH THREE CURVED BANDS
STARTING AT THE LOWER LEFT CORNER OF THE SEMI-
CIRCLE AND MOVING UP TOWARDS THE UPPER RIGHT
SIDE. THE COLOR ORANGE APPEARS IN THE SEMI-
CIRCLE AND THE COLOR GREEN APPEARS IN THE
CURVED BANDS. THE LITERAL ELEMENT PART CONS-
ISTS OF WORDS "PROGRESS SOLAR" IN BLACK COLOR.

CLASS 9—ELECTRICAL AND SCIENTIFIC APPARATUS

FOR APPARATUS FOR CONVERTING ELECTRONIC RADIATION TO ELECTRICAL ENERGY, NAMELY, PHOTOVOLTAIC SOLAR HYBRID MODULES; APPARATUS FOR CONVERTING ELECTRONIC RADIATION TO ELECTRICAL ENERGY, NAMELY, PHOTOVOLTAIC SOLAR MODULES; PHOTOVOLTAIC CELLS ALSO INCLUDING A SOLAR THERMAL COLLECTOR SOLD AS A UNIT; SOLAR BATTERIES; SOLAR CELLS (U.S. CLS. 21, 23, 26, 36 AND 38).

CLASS 11—ENVIRONMENTAL CONTROL APPARATUS

FOR HEATING SYSTEMS FOR RESIDENTIAL AND COMMERCIAL BUILDINGS COMPRISED OF BOILERS, VALVES, PIPES, MANIFOLDS, SOLAR PANELS, CONTROL PANEL, SWITCHES AND ELECTRICAL WIRE, ALL SOLD AS A UNIT; SOLAR COLLECTORS; SOLAR ENERGY BASED COOLING APPARATUS; SOLAR HEAT COLLECTION PANELS; SOLAR LIGHT FIXTURES, NAMELY, INDOOR AND OUTDOOR SOLAR POWERED LIGHTING UNITS AND FIXTURES; SOLAR THERMAL AIR SYSTEMS FOR HEATING PURPOSES; SOLAR THERMAL INSTALLATIONS, NAMELY, SOLAR THERMAL MODULES; SOLAR WATER HEATERS; SOLAR-POWERED COOLING UNITS (U.S. CLS. 13, 21, 23, 31 AND 34).

KIMBERLY PERRY, EXAMINING ATTORNEY

SN 77-722,549. IRVINE SENSORS CORP., COSTA MESA, CA. FILED 4-26-2009.

TOWHAWK

THE MARK CONSISTS OF STANDARD CHARACTERS WITHOUT CLAIM TO ANY PARTICULAR FONT, STYLE, SIZE, OR COLOR.

CLASS 9—ELECTRICAL AND SCIENTIFIC APPARATUS

FOR ELECTRONIC HARDWARE, NAMELY, SENSOR SYSTEMS COMPRISED OF DAY AND NIGHT VISION AND THERMAL SENSORS, AIRCRAFT AIRSPEED SENSORS AND VEHICLE MOUNTED GPS SENSORS FOR DETERMINING THE RATE OF MOTION FOR VEHICLES, CAMERAS, GROUND CONTROL COMPONENTS IN THE NATURE OF REMOTE CONTROLS FOR UNMANNED AERIAL VEHICLES AND GROUND CONTROL SYSTEMS COMPRISED OF REMOTE CONTROLS FOR UNMANNED AERIAL VEHICLES (U.S. CLS. 21, 23, 26, 36 AND 38).

FIRST USE 5-14-2008; IN COMMERCE 5-14-2008.

CLASS 12—VEHICLES

FOR UNMANNED AERIAL SYSTEMS COMPRISED OF UNMANNED AERIAL VEHICLES (UAVS); UNMANNED AERIAL VEHICLES AND RELATED STRUCTURAL COMPONENT PARTS THEREFOR (U.S. CLS. 19, 21, 23, 31, 35 AND 44).

FIRST USE 5-14-2008; IN COMMERCE 5-14-2008.
DAVID YONTEF, EXAMINING ATTORNEY

SN 77-722,767. CHARLES KOMAR & SONS, INC., NEW YORK, CO. FILED 4-27-2009.

EASY TO BE BEAUTIFUL

THE MARK CONSISTS OF STANDARD CHARACTERS WITHOUT CLAIM TO ANY PARTICULAR FONT, STYLE, SIZE, OR COLOR.

CLASS 3—COSMETICS AND CLEANING PREPARATIONS

FOR AFTER-SUN LOTIONS; BATH BEADS; BATH CREAM; BATH FOAM; BATH MILKS; BEAUTY CREAMS; BEAUTY GELS; BEAUTY LOTIONS; BEAUTY MILKS; BLUSHER; BUBBLE BATH; CLEANSING CREAMS; COLD CREAM; COLOGNE; COSMETICS; ESSENTIAL OILS; ESSENTIAL OILS FOR PERSONAL USE; EYE MAKE-UP; FACE CREAMS; FOUNDATIONS; FRAGRANCES FOR PERSONAL USE; HAIR CARE PREPARATIONS; INCENSE; LIP BALM; LIP CREAM; LIP GLOSS; LIP LINER; LIP POLISHER; LIPSTICK; LOTIONS FOR COSMETIC PURPOSES; MAKE-UP; NAIL CARE PREPARATIONS; NAIL GLITTER; NAIL POLISH; NAIL TIPS; NIGHT CREAM; PERFUME; POTPOURRI; SACHETS; SHAMPOOS; SHAVING PREPARATIONS; SHOWER AND BATH GEL; SKIN LOTION; SKIN MOISTURIZER; SOAPS; SUN SCREEN PREPARATIONS; TEETH WHITENING KIT (U.S. CLS. 1, 4, 6, 50, 51 AND 52).

CLASS 18—LEATHER GOODS

FOR ALL-PURPOSE CARRYING BAGS; ATHLETIC BAGS; BACKPACKS; BEACH BAGS; BEACH UMBRELLAS; BRIEFCASES; BUM BAGS; BUSINESS CARD CASES; CALLING CARD CASES; CARD WALLETS; CARRYALLS; COSMETIC BAGS SOLD EMPTY; EVENING HANDBAGS; FANNY PACKS; HANDBAGS, PURSES AND WALLETS; HIPSACKS; JEWELRY ORGANIZERS FOR TRAVEL; KEY CASES; LUGGAGE; MAKE-UP BAGS SOLD EMPTY; OVERNIGHT BAGS; PURSES; SHAVING BAGS SOLD EMPTY; SPORT BAGS; TOILETRY BAGS SOLD EMPTY; TOTE BAGS; TRAVEL BAGS; UMBRELLAS; WAIST PACKS; WALLETS; WINE CARRYING CASES (U.S. CLS. 1, 2, 3, 22 AND 41).

CLASS 25—CLOTHING

FOR APRONS; BEACHWEAR; BED JACKETS; BLOUSES; BODICES; BOTTOMS; BRAS; BUSTIERS; COATS; COVERALLS; DRESSES; FOOTWEAR; HEAD WEAR; HOODS; HOSIERY; JACKETS; JOGGING OUTFITS; LINGERIE; LOUNGEWEAR; NECKWEAR; NEGLIGENCE; NIGHTWEAR; PAJAMAS; PANTIES; PANTS; RAINWEAR; SCARFS; SHIRTS; SHORTS; SLACKS; SLEEPWEAR; SLIPPERS; SUITS; SWEATBANDS; SWIM WEAR; T-SHIRTS; TANK-TOPS; TIGHTS; TOPS; TROUSERS; UNDER GARMENTS; WRISTBANDS (U.S. CLS. 22 AND 39).

JEFF DEFORD, EXAMINING ATTORNEY

SN 77-722,776. TERRA, DIEGO, MIAMI, FL. FILED 4-27-2009.

SN 77-722,785. CSXT INTELLECTUAL PROPERTIES CORPORATION, JACKSONVILLE, FL. FILED 4-27-2009.

SUITECOMMERCE

THE MARK CONSISTS OF STANDARD CHARACTERS WITHOUT CLAIM TO ANY PARTICULAR FONT, STYLE, SIZE, OR COLOR.

CLASS 35—ADVERTISING AND BUSINESS

FOR ASSISTANCE, ADVISORY SERVICES AND CONSULTANCY WITH REGARD TO BUSINESS PLANNING, BUSINESS ANALYSIS, BUSINESS MANAGEMENT, AND BUSINESS ORGANIZATION; BUSINESS MANAGEMENT; INFORMATION AND DATA COMPILING AND ANALYZING RELATING TO BUSINESS MANAGEMENT; PROFESSIONAL BUSINESS CONSULTATION (U.S. CLS. 100, 101 AND 102).
FIRST USE 8-31-2007; IN COMMERCE 8-31-2007.

CLASS 42—SCIENTIFIC AND COMPUTER SERVICES

FOR COMPUTER NETWORK DESIGN FOR OTHERS; COMPUTER PROGRAMMING AND SOFTWARE DESIGN; COMPUTER SERVICES, NAMELY, DESIGNING AND IMPLEMENTING NETWORK WEB PAGES FOR OTHERS; COMPUTER SOFTWARE DESIGN FOR OTHERS; COMPUTER SOFTWARE DESIGN, COMPUTER PROGRAMMING, OR MAINTENANCE OF COMPUTER SOFTWARE; DESIGN OF HOME PAGES, COMPUTER SOFTWARE AND WEB SITES; DESIGN, DEVELOPMENT AND IMPLEMENTATION OF SOFTWARE (U.S. CLS. 100 AND 101).
FIRST USE 8-31-2007; IN COMMERCE 8-31-2007.
JEFF DEFORD, EXAMINING ATTORNEY



OWNER OF U.S. REG. NOS. 2,475,447, 2,543,728 AND 2,544,010.
THE MARK CONSISTS OF THE OUTLINE OF A RAIL-CAR WITH THE WORDS "CSX HOW TOMORROW MOVES" CONTAINED WITHIN.

CLASS 12—VEHICLES

FOR RAILWAY FREIGHT CARS (U.S. CLS. 19, 21, 23, 31, 35 AND 44).

CLASS 28—TOYS AND SPORTING GOODS

FOR TOY TRAINS (U.S. CLS. 22, 23, 38 AND 50).
MARC LEIPZIG, EXAMINING ATTORNEY

SN 77-722,778. CSXT INTELLECTUAL PROPERTIES CORPORATION, JACKSONVILLE, FL. FILED 4-27-2009.



OWNER OF U.S. REG. NOS. 2,475,447, 2,543,728 AND 2,544,010.
THE MARK CONSISTS OF THE OUTLINE OF A RAIL-CAR WITH THE WORD "CSX" CONTAINED WITHIN.

CLASS 12—VEHICLES

FOR RAILWAY FREIGHT CARS (U.S. CLS. 19, 21, 23, 31, 35 AND 44).

CLASS 28—TOYS AND SPORTING GOODS

FOR TOY TRAINS (U.S. CLS. 22, 23, 38 AND 50).
MARC LEIPZIG, EXAMINING ATTORNEY

SN 77-722,829. MAROLD, VINCENT J., TUCSON, AZ. FILED 4-27-2009.

A Day To Remember

THE MARK CONSISTS OF STANDARD CHARACTERS WITHOUT CLAIM TO ANY PARTICULAR FONT, STYLE, SIZE, OR COLOR.

CLASS 35—ADVERTISING AND BUSINESS

FOR ADVERTISING AND MARKETING; ADVERTISING AND MARKETING SERVICES, NAMELY, PROMOTING THE GOODS AND SERVICES OF OTHERS; ADVERTISING SERVICES, NAMELY, PROMOTING AND MARKETING THE GOODS AND SERVICES OF OTHERS IN THE FIELD OF UPSCALE CHOICES SUCH AS CULTURAL EVENTS, RESTAURANTS, SHOPPING, AND TRAVEL VIA PRINT AND ELECTRONIC MEDIA; ADVERTISING SERVICES, NAMELY, PROMOTING AND MARKETING THE GOODS AND SERVICES OF OTHERS THROUGH ALL PUBLIC COMMUNICATION MEANS; ADVERTISING SERVICES, PUBLIC RELATIONS AND MARKETING SERVICES, NAMELY, PROMOTING AND MARKETING THE GOODS AND SERVICES OF OTHERS THROUGH ALL PUBLIC COMMUNICATION MEANS; ADVERTISING, MARKETING AND PROMOTING THE GOODS AND SERVICES OF OTHERS USING KIOSKS; ADVERTISING, MARKETING AND PROMOTIONAL SERVICES RELATED TO ALL INDUSTRIES FOR THE PURPOSE OF FACILITATING NETWORKING AND SOCIALIZING OPPORTUNITIES FOR BUSINESS PURPOSES; ARRANGING AND CONDUCTING MARKETING PROMOTIONAL EVENTS FOR OTHERS; BRAND CONCEPT AND BRAND DEVELOPMENT SERVICES FOR CORPORATE CLIENTS; DEVELOPING PROMOTIONAL CAMPAIGNS FOR BUSINESS; DEVELOPMENT OF MARKETING STRATEGIES AND CONCEPTS; MARKETING SERVICES IN THE FIELD OF PLANNED-GIVING FOR NON-PROFIT AND CHARITABLE ORGANIZATIONS; ORGANIZATION OF EVENTS, EXHIBITIONS, FAIRS AND SHOWS FOR COMMERCIAL, PROMOTIONAL AND ADVERTISING PURPOSES; PROMOTING PUBLIC AWARENESS OF BRAIN HEALTH; PROVIDING ADVERTISING, MARKETING AND PROMOTIONAL SERVICES, NAMELY, DEVELOPMENT OF ADVERTISING CAMPAIGNS FOR BRAIN HEALTH; SOCIAL MEDIA STRATEGY AND MARKETING CONSULTANCY FOCUSING ON HELPING CLIENTS CREATE AND EXTEND THEIR PRODUCT AND BRAND STRATEGIES BY BUILDING VIRALLY ENGAGING MARKETING SOLUTIONS (U.S. CLS. 100, 101 AND 102).

CLASS 36—INSURANCE AND FINANCIAL

FOR CHARITABLE FUND RAISING SERVICES BY MEANS OF AN ENTERTAINMENT EVENT; FUND RAISING SERVICES, NAMELY, SHARING PROFITS FROM THE SALE OF SOCIALLY RESPONSIBLE PRODUCTS WITH NOT-FOR-PROFIT ORGANIZATIONS, SCHOOLS, AND CIVIC GROUPS; ORGANIZING AND CONDUCTING SPECIAL EVENTS FOR CHARITABLE FUNDRAISING PURPOSES (U.S. CLS. 100, 101 AND 102).

CLASS 41—EDUCATION AND ENTERTAINMENT

FOR ARRANGING AND CONDUCTING SPECIAL EVENTS; ENTERTAINMENT SERVICES, NAMELY, CONTEST AND INCENTIVE AWARD PROGRAMS DESIGNED TO REWARD PROGRAM PARTICIPANTS WHO EXERCISE, MAKE HEALTHY EATING CHOICES, AND ENGAGE IN OTHER HEALTH-PROMOTING ACTIVITIES; ORGANIZING AND CONDUCTING A RUNNING EVENT THE PROCEEDS OF WHICH ARE DONATED TO CHARITY (U.S. CLS. 100, 101 AND 107).

CLASS 44—MEDICAL, BEAUTY AND AGRICULTURAL SERVICES

FOR HEALTH SPA SERVICES FOR HEALTH AND WELLNESS OF THE BODY AND SPIRIT; HEALTH SPA SERVICES FOR HEALTH AND WELLNESS OF THE BODY AND SPIRIT OFFERED AT A HEALTH CLUB FACILITY; HEALTH SPA SERVICES FOR HEALTH AND WELLNESS OF THE BODY AND SPIRIT OFFERED AT A HEALTH RESORT; HEALTH SPA SERVICES FOR HEALTH AND WELLNESS OF THE BODY AND SPIRIT, NAMELY, PROVIDING MASSAGE, FACIAL AND BODY TREATMENT SERVICES, COSMETIC BODY CARE SERVICES; HEALTH SPA SERVICES FOR HEALTH AND WELLNESS OF THE MIND, BODY AND SPIRIT OFFERED IN OR FROM A REMOTE, MOBILE OR TEM-

PORARY ON-SITE LOCATION; HEALTH SPA SERVICES, NAMELY, BODY WRAPS, MUD TREATMENTS, SEAWEED TREATMENTS, HYDROTHERAPY BATHS, AND BODY SCRUBS; HEALTH SPA SERVICES, NAMELY, COSMETIC BODY CARE SERVICES; MENTAL HEALTH SERVICES; PROVIDING A WEB SITE FEATURING INFORMATION IN THE FIELD OF MENTAL HEALTH AND WELLNESS; PROVIDING A WEB SITE FEATURING INFORMATION ON HEALTH AND NUTRITION; PROVIDING A WEBSITE FEATURING INFORMATION CONCERNING ALTERNATIVE HEALTH AND HEALING; PROVIDING AN ON-LINE COMPUTER DATABASE FEATURING INFORMATION REGARDING HEALTH AND NUTRITION; PROVIDING ASSISTANCE, FITNESS EVALUATION AND CONSULTATION TO INDIVIDUALS TO HELP THEM MAKE HEALTH, WELLNESS AND NUTRITIONAL CHANGES IN THEIR DAILY LIVING TO IMPROVE HEALTH; PROVIDING HEALTH INFORMATION (U.S. CLS. 100 AND 101).

ALEX KEAM, EXAMINING ATTORNEY

SN 77-722,876. PURPLE WINE COMPANY, GRATON, CA. FILED 4-27-2009.

Cabernet for the People

THE MARK CONSISTS OF STANDARD CHARACTERS WITHOUT CLAIM TO ANY PARTICULAR FONT, STYLE, SIZE, OR COLOR.

OWNER OF U.S. REG. NO. 2,797,930.

NO CLAIM IS MADE TO THE EXCLUSIVE RIGHT TO USE "CABERNET", APART FROM THE MARK AS SHOWN.

CLASS 16—PAPER GOODS AND PRINTED MATTER

FOR PRINTED VISUALS IN THE NATURE OF PROMOTIONAL MATERIALS (U.S. CLS. 2, 5, 22, 23, 29, 37, 38 AND 50).

CLASS 33—WINES AND SPIRITS

FOR WINE; WINES (U.S. CLS. 47 AND 49).
JAMES LOVELACE, EXAMINING ATTORNEY

SN 77-722,881. EGAN-JONES STRUCTURED PRODUCTS, LLC, NEW YORK, NY. FILED 4-27-2009.

MONEY GOOD

THE MARK CONSISTS OF STANDARD CHARACTERS WITHOUT CLAIM TO ANY PARTICULAR FONT, STYLE, SIZE, OR COLOR.

NO CLAIM IS MADE TO THE EXCLUSIVE RIGHT TO USE "MONEY", APART FROM THE MARK AS SHOWN.

CLASS 35—ADVERTISING AND BUSINESS

FOR ANALYZING AND COMPILING DATA FOR MEASURING THE PERFORMANCE OF FINANCIAL MARKETS; MARKET ANALYSIS; PROVIDING INFORMATION AND ANALYSIS IN THE FIELDS OF ECONOMICS AND BUSINESS (U.S. CLS. 100, 101 AND 102).

CLASS 36—INSURANCE AND FINANCIAL

FOR BUSINESS, STOCK OPTION AND PENSION VALUATION SERVICES; FINANCIAL ADVICE; FINANCIAL ANALYSIS AND RESEARCH SERVICES; FINANCIAL CONSULTING SERVICES, NAMELY, EXPERT ANALYSIS IN FINANCE; FINANCIAL INFORMATION AND ADVISORY SERVICES; FINANCIAL INFORMATION AND EVALUATIONS (U.S. CLS. 100, 101 AND 102).
ALEX KEAM, EXAMINING ATTORNEY

SN 77-722,939. PURPLE WINE COMPANY, GRATON, CA.
FILED 4-27-2009.

Zinfandel for the People

SN 77-722,894. MISSION GROVE OFFICES, LLC, SAN DIEGO, CA. FILED 4-27-2009.

THE CAMPUS AT FASHION VALLEY

THE MARK CONSISTS OF STANDARD CHARACTERS WITHOUT CLAIM TO ANY PARTICULAR FONT, STYLE, SIZE, OR COLOR.

NO CLAIM IS MADE TO THE EXCLUSIVE RIGHT TO USE "CAMPUS", APART FROM THE MARK AS SHOWN.

CLASS 36—INSURANCE AND FINANCIAL

FOR REAL ESTATE SERVICES, NAMELY, RENTAL, BROKERAGE, LEASING AND MANAGEMENT OF COMMERCIAL PROPERTY, OFFICES AND OFFICE SPACE (U.S. CLS. 100, 101 AND 102).

CLASS 37—CONSTRUCTION AND REPAIR

FOR REAL ESTATE DEVELOPMENT (U.S. CLS. 100, 103 AND 106).
ALEX KEAM, EXAMINING ATTORNEY

THE MARK CONSISTS OF STANDARD CHARACTERS WITHOUT CLAIM TO ANY PARTICULAR FONT, STYLE, SIZE, OR COLOR.

OWNER OF U.S. REG. NO. 2,797,930.
NO CLAIM IS MADE TO THE EXCLUSIVE RIGHT TO USE "ZINFANDEL", APART FROM THE MARK AS SHOWN.

CLASS 16—PAPER GOODS AND PRINTED MATTER

FOR PRINTED VISUALS IN THE NATURE OF PROMOTIONAL MATERIALS (U.S. CLS. 2, 5, 22, 23, 29, 37, 38 AND 50).

CLASS 33—WINES AND SPIRITS

FOR WINE; WINES (U.S. CLS. 47 AND 49).
JAMES LOVELACE, EXAMINING ATTORNEY

SN 77-722,914. PURPLE WINE COMPANY, GRATON, CA.
FILED 4-27-2009.

SN 77-722,948. PURPLE WINE COMPANY, GRATON, CA.
FILED 4-27-2009.

Chardonnay for the People**Merlot for the People**

THE MARK CONSISTS OF STANDARD CHARACTERS WITHOUT CLAIM TO ANY PARTICULAR FONT, STYLE, SIZE, OR COLOR.

OWNER OF U.S. REG. NO. 2,797,930.
NO CLAIM IS MADE TO THE EXCLUSIVE RIGHT TO USE "CHARDONNAY", APART FROM THE MARK AS SHOWN.

CLASS 16—PAPER GOODS AND PRINTED MATTER

FOR PRINTED VISUALS IN THE NATURE OF PROMOTIONAL MATERIALS (U.S. CLS. 2, 5, 22, 23, 29, 37, 38 AND 50).

CLASS 33—WINES AND SPIRITS

FOR WINE; WINES (U.S. CLS. 47 AND 49).
JAMES LOVELACE, EXAMINING ATTORNEY

THE MARK CONSISTS OF STANDARD CHARACTERS WITHOUT CLAIM TO ANY PARTICULAR FONT, STYLE, SIZE, OR COLOR.

OWNER OF U.S. REG. NO. 2,797,930.
NO CLAIM IS MADE TO THE EXCLUSIVE RIGHT TO USE "MERLOT", APART FROM THE MARK AS SHOWN.

CLASS 16—PAPER GOODS AND PRINTED MATTER

FOR PRINTED VISUALS IN THE NATURE OF PROMOTIONAL MATERIALS (U.S. CLS. 2, 5, 22, 23, 29, 37, 38 AND 50).

CLASS 33—WINES AND SPIRITS

FOR WINE; WINES (U.S. CLS. 47 AND 49).
JAMES LOVELACE, EXAMINING ATTORNEY

SN 77-722,951. FITNESS BRANDS, INC., AUSTIN, TX. FILED 4-27-2009.

SN 77-723,027. PURPLE WINE COMPANY, GRATON, CA. FILED 4-27-2009.

AB CIRCLE

THE MARK CONSISTS OF STANDARD CHARACTERS WITHOUT CLAIM TO ANY PARTICULAR FONT, STYLE, SIZE, OR COLOR.

OWNER OF U.S. REG. NO. 3,610,057.

NO CLAIM IS MADE TO THE EXCLUSIVE RIGHT TO USE "AB", APART FROM THE MARK AS SHOWN.

CLASS 9—ELECTRICAL AND SCIENTIFIC APPARATUS

FOR PRERECORDED DIGITAL VIDEO DISKS FEATURING INFORMATION ON EXERCISE AND NUTRITION (U.S. CLS. 21, 23, 26, 36 AND 38).

FIRST USE 1-15-2009; IN COMMERCE 1-17-2009.

CLASS 16—PAPER GOODS AND PRINTED MATTER

FOR MANUALS IN THE FIELD OF EXERCISE EQUIPMENT; BOOKLETS IN THE FIELD OF EXERCISE AND NUTRITION (U.S. CLS. 2, 5, 22, 23, 29, 37, 38 AND 50).

FIRST USE 1-15-2009; IN COMMERCE 1-17-2009.

CLASS 28—TOYS AND SPORTING GOODS

FOR MANUALLY-OPERATED EXERCISE EQUIPMENT; EXERCISE EQUIPMENT, NAMELY, ABDOMINAL EXERCISE MACHINES (U.S. CLS. 22, 23, 38 AND 50).

FIRST USE 1-15-2009; IN COMMERCE 1-17-2009. KRISTIN DAHLING, EXAMINING ATTORNEY

SN 77-723,016. PURPLE WINE COMPANY, GRATON, CA. FILED 4-27-2009.

Sauvignon Blanc for the People

THE MARK CONSISTS OF STANDARD CHARACTERS WITHOUT CLAIM TO ANY PARTICULAR FONT, STYLE, SIZE, OR COLOR.

OWNER OF U.S. REG. NO. 2,797,930.

NO CLAIM IS MADE TO THE EXCLUSIVE RIGHT TO USE "SAUVIGNON BLANC", APART FROM THE MARK AS SHOWN.

CLASS 16—PAPER GOODS AND PRINTED MATTER

FOR PRINTED VISUALS IN THE NATURE OF PROMOTIONAL MATERIALS (U.S. CLS. 2, 5, 22, 23, 29, 37, 38 AND 50).

CLASS 33—WINES AND SPIRITS

FOR WINE; WINES (U.S. CLS. 47 AND 49). JAMES LOVELACE, EXAMINING ATTORNEY

Riesling for the People

THE MARK CONSISTS OF STANDARD CHARACTERS WITHOUT CLAIM TO ANY PARTICULAR FONT, STYLE, SIZE, OR COLOR.

OWNER OF U.S. REG. NO. 2,797,930.

NO CLAIM IS MADE TO THE EXCLUSIVE RIGHT TO USE "RIESLING", APART FROM THE MARK AS SHOWN.

CLASS 16—PAPER GOODS AND PRINTED MATTER

FOR PRINTED VISUALS IN THE NATURE OF PROMOTIONAL MATERIALS (U.S. CLS. 2, 5, 22, 23, 29, 37, 38 AND 50).

CLASS 33—WINES AND SPIRITS

FOR WINE; WINES (U.S. CLS. 47 AND 49). JAMES LOVELACE, EXAMINING ATTORNEY

SN 77-723,053. GUARANA ENERGIA, LLC, BOZEMAN, MT. FILED 4-27-2009.

VOKE

THE MARK CONSISTS OF STANDARD CHARACTERS WITHOUT CLAIM TO ANY PARTICULAR FONT, STYLE, SIZE, OR COLOR.

CLASS 5—PHARMACEUTICALS

FOR DIETARY SUPPLEMENTAL DRINKS; DIETARY SUPPLEMENTS (U.S. CLS. 6, 18, 44, 46, 51 AND 52).

CLASS 30—STAPLE FOODS

FOR BROWNIES; CANDY; GRAIN-BASED FOOD BARS; NON-MEDICATED LOZENGES (U.S. CL. 46). BRIAN NEVILLE, EXAMINING ATTORNEY

SN 77-723,218. FITCH, INC., NEW YORK, NY. FILED 4-27-2009.

FITCH SOLUTIONS VALUATIONS SERVICES

THE MARK CONSISTS OF STANDARD CHARACTERS WITHOUT CLAIM TO ANY PARTICULAR FONT, STYLE, SIZE, OR COLOR.

OWNER OF U.S. REG. NOS. 2,494,232, 3,649,570 AND OTHERS.

NO CLAIM IS MADE TO THE EXCLUSIVE RIGHT TO USE "VALUATIONS SERVICES", APART FROM THE MARK AS SHOWN.

SN 77-723,355. ELPIS ENTERTAINMENT NETWORK, INC., KNOXVILLE, TN. FILED 4-27-2009.

CLASS 9—ELECTRICAL AND SCIENTIFIC APPARATUS

FOR COMPUTER SOFTWARE FOR ANALYZING CREDIT DERIVATIVES INFORMATION FOR USE BY COMPANIES TO FACILITATE FINANCIAL ANALYSIS AND RESEARCH (U.S. CLS. 21, 23, 26, 36 AND 38).



NO CLAIM IS MADE TO THE EXCLUSIVE RIGHT TO USE "ENTERTAINMENT NETWORK", APART FROM THE MARK AS SHOWN.

THE MARK CONSISTS OF THE PHRASE "ELPIS ENTERTAINMENT NETWORK" COUPLED WITH A SERIES OF CIRCLES ARRANGED TOGETHER THAT FORM A SOMEWHAT SPHERICAL SHAPE.

CLASS 36—INSURANCE AND FINANCIAL

FOR FINANCIAL SERVICES, NAMELY, PROVIDING FINANCIAL DATA IN THE NATURE OF CREDIT DERIVATIVES INFORMATION TO COMPANIES TO FACILITATE FINANCIAL ANALYSIS AND RESEARCH (U.S. CLS. 100, 101 AND 102).

MICHAEL SOUDERS, EXAMINING ATTORNEY

CLASS 38—COMMUNICATION

FOR TRANSMISSION OF NEWS AND ENTERTAINMENT SEGMENTS BY AN ELECTRONIC COMMUNICATIONS NETWORK, NAMELY, VIA AN INTRANET, THE INTERNET, CLOSED CIRCUIT TELEVISION, OR OTHER SELECTIVE-DISTRIBUTION MEDIUM; TRANSMISSION OF VISUAL AND SOUND RECORDINGS VIA A COMPUTER NETWORK (U.S. CLS. 100, 101 AND 104).

SN 77-723,341. ELPIS ENTERTAINMENT NETWORK, INC., KNOXVILLE, TN. FILED 4-27-2009.

CLASS 41—EDUCATION AND ENTERTAINMENT

FOR PRODUCTION OF AUDIO/VIDEO SEGMENTS OF INTEREST TO TRAVELERS AND SHOPPERS, NAMELY, SEGMENTS PROVIDING NEWS, MUSIC AND ENTERTAINMENT (U.S. CLS. 100, 101 AND 107).

FRANK LATTUCA, EXAMINING ATTORNEY

Elpis Entertainment Network

SN 77-723,430. HULME, ALAN, SAN ANTONIO, TX. FILED 4-27-2009.

THE MARK CONSISTS OF STANDARD CHARACTERS WITHOUT CLAIM TO ANY PARTICULAR FONT, STYLE, SIZE, OR COLOR.

NO CLAIM IS MADE TO THE EXCLUSIVE RIGHT TO USE "ENTERTAINMENT NETWORK", APART FROM THE MARK AS SHOWN.

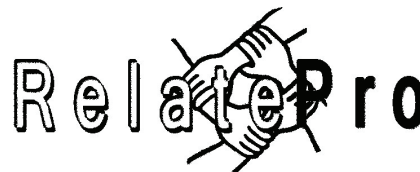

THE MARK CONSISTS OF THE STYLIZED WORDS "RELATEPRO". IN THE BACKGROUND OF THE STYLIZED WORDS IS AN IMAGE OF FOUR HANDS AND ARMS INTERLOCKING, EACH HAND WITH AN ARM IN A CONTINUOUS CIRCULAR FORM.

CLASS 38—COMMUNICATION

FOR TRANSMISSION OF NEWS AND ENTERTAINMENT SEGMENTS BY AN ELECTRONIC COMMUNICATIONS NETWORK, NAMELY, VIA AN INTRANET, THE INTERNET, CLOSED CIRCUIT TELEVISION, OR OTHER SELECTIVE-DISTRIBUTION MEDIUM; TRANSMISSION OF VISUAL AND SOUND RECORDINGS VIA A COMPUTER NETWORK (U.S. CLS. 100, 101 AND 104).

CLASS 9—ELECTRICAL AND SCIENTIFIC APPARATUS

FOR COMPUTER SOFTWARE FOR MANAGING RELATIONSHIPS AND DIGITAL INFORMATION, NAMELY, PERSONAL CONTACT INFORMATION, E-MAIL ADDRESSES, PHONE NUMBERS, AND EMPLOYMENT INFORMATION, AMONGST ORGANIZATIONS, PERSONS, BUSINESSES AND EVENTS (U.S. CLS. 21, 23, 26, 36 AND 38).

CLASS 41—EDUCATION AND ENTERTAINMENT

FOR PRODUCTION OF AUDIO/VIDEO SEGMENTS OF INTEREST TO TRAVELERS AND SHOPPERS, NAMELY, SEGMENTS PROVIDING NEWS, MUSIC AND ENTERTAINMENT (U.S. CLS. 100, 101 AND 107).

FRANK LATTUCA, EXAMINING ATTORNEY

CLASS 42—SCIENTIFIC AND COMPUTER SERVICES

FOR DESIGN AND DEVELOPMENT OF COMPUTER SOFTWARE; APPLICATION SERVICE PROVIDER (ASP) FEATURING SOFTWARE FOR USE IN MANAGING RELATIONSHIPS AND DIGITAL INFORMATION, NAMELY, PERSONAL CONTACT INFORMATION, E-MAIL ADDRESSES, PHONE NUMBERS, AND EMPLOYMENT INFORMATION, AMONGST ORGANIZATIONS, PERSONS, BUSINESSES AND EVENTS; SOFTWARE AS A SERVICE (SAAS) SERVICES FEATURING SOFTWARE FOR USE IN MANAGING RELATIONSHIPS AND DIGITAL INFORMATION, NAMELY, PERSONAL CONTACT INFORMATION, INCLUDING E-MAIL ADDRESSES, PHONE NUMBERS, AND EMPLOYMENT INFORMATION AMONGST ORGANIZATIONS, PERSONS, BUSINESSES AND EVENTS (U.S. CLS. 100 AND 101).
FONG HSU, EXAMINING ATTORNEY

SN 77-723,585. AN TAR, ANDREW S., DBA ELECAR, PROVIDENCE, RI. FILED 4-28-2009.



THE COLOR(S) GREEN AND BLACK IS/ARE CLAIMED AS A FEATURE OF THE MARK.

THE MARK CONSISTS OF THE WORDING "ELECAR ELEVATING THE ELECTRIC CAR" AND A LEAF DESIGN IN THE SHAPE OF THE LETTER "E" WITH TWO CUTOUTS SYMBOLIZING AN ELECTRIC PLUG. THE COLOR GREEN APPEARS ON THE LEAF DESIGN AND THE WORDING "ELEVATING THE ELECTRIC CAR" AND THE COLOR BLACK APPEARS ON THE WORDING "ELECAR".

CLASS 9—ELECTRICAL AND SCIENTIFIC APPARATUS

FOR BATTERIES FOR VEHICLES; BATTERIES, ELECTRIC, FOR VEHICLES; BATTERY CHARGE DEVICES; BATTERY CHARGERS; BATTERY TERMINAL CONNECTOR CLAMPS; CHARGERS FOR ELECTRIC BATTERIES; GRIDS FOR BATTERIES; INTEGRATED BATTERY BACKUP SYSTEMS COMPRISING A BATTERY, AN ELECTRONIC MEASUREMENT APPARATUS FOR USE IN THE MEASUREMENT OF BATTERY HEALTH AND PERFORMANCE, AND A REMOTE COMPUTER SOFTWARE PROGRAM THAT USES THE FOREGOING DATA TO TREND, PREDICT, AND STORE DATA RELATED TO THE HEALTH OF THE BATTERY (U.S. CLS. 21, 23, 26, 36 AND 38).

CLASS 37—CONSTRUCTION AND REPAIR

FOR BATTERY CHARGING SERVICES; CAR REPAIR AND MAINTENANCE; EMERGENCY ROADSIDE ASSISTANCE SERVICES, NAMELY, RESPONDING TO CALLS FOR ROADSIDE ASSISTANCE, FLAT TIRE CHANGING, EMERGENCY FUEL SUPPLYING, AND BATTERY JUMP STARTING (U.S. CLS. 100, 103 AND 106).

NICHOLAS ALTREE, EXAMINING ATTORNEY

SN 77-723,451. WENDY W, RENNER, BOZEMAN, MT. FILED 4-27-2009.



THE COLOR(S) ORANGE, BROWN AND WHITE IS/ARE CLAIMED AS A FEATURE OF THE MARK.

THE MARK CONSISTS OF A SURPRISED FACE IN BROWN, AN ORANGE STAR LOCATED ABOVE THE FACE IN ORANGE AND BROWN OUTLINE, THE NAME OF COMPANY LISTED IN ORANGE ON THE LETTERS "WANTA" AND BROWN LETTERING "REMINDER.COM" LOCATED BELOW THE FACE.

SN 77-723,601. NAME RITE, L.L.C., TEMECULA, CA. FILED 4-28-2009.

YULE RITE

THE MARK CONSISTS OF STANDARD CHARACTERS WITHOUT CLAIM TO ANY PARTICULAR FONT, STYLE, SIZE, OR COLOR.

OWNER OF U.S. REG. NOS. 1,860,176 AND 3,195,974.
NO CLAIM IS MADE TO THE EXCLUSIVE RIGHT TO USE "YULE", APART FROM THE MARK AS SHOWN.

CLASS 41—EDUCATION AND ENTERTAINMENT

FOR PROVIDING ON-LINE RESOURCE GUIDES FOR RELATIVES CONCERNING CHILDREN IN THE FIELDS OF EDUCATION, RECREATION, AND ENTERTAINMENT; PROVISION OF INFORMATION RELATING TO EDUCATIONAL AND ENTERTAINMENT ACTIVITIES AND EVENTS FOR CHILDREN (U.S. CLS. 100, 101 AND 107).

FIRST USE 1-1-2009; IN COMMERCE 4-1-2009.

CLASS 45—PERSONAL AND LEGAL SERVICES

FOR REMINDER SERVICES IN THE AREA OF UPCOMING IMPORTANT DATES AND EVENTS (U.S. CLS. 100 AND 101).

FIRST USE 1-1-2009; IN COMMERCE 4-1-2009.
FRANK LATTUCA, EXAMINING ATTORNEY

CLASS 16—PAPER GOODS AND PRINTED MATTER

FOR CHRISTMAS CARDS; GIFT WRAP PAPER; PAPER GIFT TAGS; STICKERS; GIFT BOXES; PAPER GIFT BAGS; TISSUE PAPER; PAPER GIFT WRAP BOWS; PAPER RIBBONS (U.S. CLS. 2, 5, 22, 23, 29, 37, 38 AND 50).

CLASS 26—FANCY GOODS

FOR RIBBONS FOR WRAPPING; BOWS FOR WRAPPING (U.S. CLS. 37, 39, 40, 42 AND 50).
WILLIAM VERHOSEK, EXAMINING ATTORNEY

SN 77-723,649. STARWOOD ENERGY GROUP GLOBAL, L.L.C., WILMINGTON, DE. FILED 4-28-2009.

STARWOOD SOLAR

THE MARK CONSISTS OF STANDARD CHARACTERS WITHOUT CLAIM TO ANY PARTICULAR FONT, STYLE, SIZE, OR COLOR.

NO CLAIM IS MADE TO THE EXCLUSIVE RIGHT TO USE "SOLAR", APART FROM THE MARK AS SHOWN.

CLASS 35—ADVERTISING AND BUSINESS

FOR BUSINESS MANAGEMENT AND CONSULTING SERVICES, NAMELY, ARRANGING FOR THE CREATION, CONSTRUCTION, MANAGEMENT, PROVISION, ACQUISITION, OPERATION, AND OWNERSHIP OF ENERGY COMMODITIES SUPPLY, GENERATION, TRANSPORTATION, TRANSMISSION AND DISTRIBUTION FACILITIES AND INFRASTRUCTURE; OPERATION AND MANAGEMENT OF ENERGY FACILITIES FOR OTHERS; BUSINESS SERVICES, NAMELY, FACILITIES MANAGEMENT OF TECHNICAL OPERATIONS OF ENERGY FACILITIES FOR OTHERS; BUSINESS ADMINISTRATION AND MANAGEMENT AT ENERGY PROJECTS; TAX CONSULTATION CONCERNING ENERGY COMMODITIES SUPPLY, GENERATION, TRANSPORTATION, TRANSMISSION AND DISTRIBUTION FACILITIES AND INFRASTRUCTURE; CONSULTANCY CONCERNING ECONOMIC CONSEQUENCES AND PROFITABILITY OF ENERGY PROJECTS (U.S. CLS. 100, 101 AND 102).

CLASS 36—INSURANCE AND FINANCIAL

FOR ENERGY BROKERAGE SERVICES; CONSULTING SERVICES IN THE FIELD OF ENERGY BROKERAGE; ENERGY COMMODITY TRADING FOR OTHERS; ARRANGING FOR FINANCING OF ENERGY COMMODITIES; FINANCIAL RISK MANAGEMENT SERVICES IN THE FIELD OF ENERGY; FINANCING OF ENERGY PROJECTS; ARRANGING FOR FINANCING OF ENERGY COMMODITIES SUPPLY, GENERATION, TRANSPORTATION, TRANSMISSION AND DISTRIBUTION FACILITIES AND INFRASTRUCTURE; FINANCIAL RESEARCH, CONSULTING, AND FINANCIAL FORECASTING IN CONNECTION WITH ENERGY COMMODITIES SUPPLY, GENERATION, TRANSPORTATION, TRANSMISSION AND DISTRIBUTION FACILITIES AND INFRASTRUCTURE (U.S. CLS. 100, 101 AND 102).

CLASS 39—TRANSPORTATION AND STORAGE

FOR DELIVERY OF AND MAKING AVAILABLE FOR ACQUISITION POWER AND ITS BY-PRODUCTS FOR AND TO OTHERS, NAMELY, POWER AND ITS BY-PRODUCTS GENERATED FROM SOLAR ENERGY AND RELATED ENERGY SOURCES; DISTRIBUTION OF SOLAR ENERGY AND SOLAR POWER TO AND FROM OTHERS (U.S. CLS. 100 AND 105).

CLASS 40—MATERIAL TREATMENT

FOR GENERATION OF AND PRODUCTION OF ELECTRIC POWER; GENERATION OF AND PRODUCTION OF ENERGY FOR RETAIL AND WHOLESALE CUSTOMERS; ELECTRIC POWER GENERATION FROM CONVENTIONAL, SOLAR, AND ALTERNATIVE ENERGY SOURCES; ELECTRICAL UTILITY SERVICES, NAMELY, THE GENERATION OF ELECTRICITY (U.S. CLS. 100, 103 AND 106).

ROBIN MITTLER, EXAMINING ATTORNEY

SN 77-723,749. SUHP HUR, GYEONGGI-DO, REPUBLIC OF KOREA, FILED 4-28-2009.



THE MARK CONSISTS OF THE LETTER "T" AND THE NUMBER "5" IN THE TILTED OVAL.

CLASS 9—ELECTRICAL AND SCIENTIFIC APPARATUS

FOR ELECTRIC HAIR CURLERS, ELECTRIC HAIR CURLING IRONS, ELECTRIC HAIR ROLLERS, ELECTRIC HAIR STRAIGHTENERS (U.S. CLS. 21, 23, 26, 36 AND 38).

CLASS 11—ENVIRONMENTAL CONTROL APPARATUS

FOR ELECTRIC HAIR DRYERS FOR HOUSEHOLD PURPOSES, ELECTRIC HAIR DRYERS FOR BEAUTY SALON USE (U.S. CLS. 13, 21, 23, 31 AND 34).
JUDITH HELFMAN, EXAMINING ATTORNEY

SN 77-723,793. AVOMEX, INC., FORT WORTH, TX. FILED 4-28-2009.

WHOLLY GUAC DOG

THE MARK CONSISTS OF STANDARD CHARACTERS WITHOUT CLAIM TO ANY PARTICULAR FONT, STYLE, SIZE, OR COLOR.

OWNER OF U.S. REG. NO. 3,641,524.
NO CLAIM IS MADE TO THE EXCLUSIVE RIGHT TO USE "GUAC DOG", APART FROM THE MARK AS SHOWN.

CLASS 29—MEATS AND PROCESSED FOODS

FOR GUACAMOLE (U.S. CL. 46).

CLASS 30—STAPLE FOODS

FOR MEXICAN FOOD SAUCES, NAMELY, CHIPOTLE-BASED SAUCE, PICO DE GALLO SAUCE, RED SALSA AND GREEN SALSA AND GUACAMOLE BASED SAUCES (U.S. CL. 46).

G. MAYERSCHOFF, EXAMINING ATTORNEY

SN 77-724,191. BIG BOOM BRANDS, LLC, WEST PALM BEACH, FL. FILED 4-28-2009.

The Lighter Side

SN 77-723,967. PORTAL PRODUCTIONS, LLC, BOULDER, CO. FILED 4-28-2009.

THE PORTAL

THE MARK CONSISTS OF STANDARD CHARACTERS WITHOUT CLAIM TO ANY PARTICULAR FONT, STYLE, SIZE, OR COLOR.

CLASS 9—ELECTRICAL AND SCIENTIFIC APPARATUS

FOR PRE-RECORDED CD'S FEATURING MUSIC; DVD'S FEATURING MUSIC PRODUCTIONS (U.S. CLS. 21, 23, 26, 36 AND 38).

CLASS 41—EDUCATION AND ENTERTAINMENT

FOR MULTIMEDIA PRODUCTION SERVICES; MUSIC PRODUCTION SERVICES (U.S. CLS. 100, 101 AND 107).
MARGERY A. TIERNEY, EXAMINING ATTORNEY

THE MARK CONSISTS OF STANDARD CHARACTERS WITHOUT CLAIM TO ANY PARTICULAR FONT, STYLE, SIZE, OR COLOR.

CLASS 5—PHARMACEUTICALS

FOR DIETARY AND NUTRITIONAL SUPPLEMENTS (U.S. CLS. 6, 18, 44, 46, 51 AND 52).

CLASS 9—ELECTRICAL AND SCIENTIFIC APPARATUS

FOR DOWNLOADABLE ELECTRONIC PUBLICATIONS IN THE NATURE OF PERIODICALS, BOOKS, E-BOOKS, MAGAZINES, NEWSLETTERS, PAMPHLETS, BROCHURES AND INFORMATIONAL FLYERS IN THE FIELD OF HEALTH, DIETS, DRUGS AND FOOD RECORDED ON COMPUTER MEDIA (U.S. CLS. 21, 23, 26, 36 AND 38).

DAVID YONTEF, EXAMINING ATTORNEY

SN 77-724,114. PRIORITY ENVIRONMENTAL SOLUTIONS, INC., EAGLE, WI. FILED 4-28-2009.

PRO 1 TEK

THE MARK CONSISTS OF STANDARD CHARACTERS WITHOUT CLAIM TO ANY PARTICULAR FONT, STYLE, SIZE, OR COLOR.

CLASS 3—COSMETICS AND CLEANING PREPARATIONS

FOR HOUSEHOLD AND COMMERCIAL CLEANING PRODUCTS, NAMELY, CARPET CLEANERS AND LAUNDRY DETERGENTS, AND COUNTERTOP SURFACE CLEANERS, AND DEODORIZERS FOR PETS (U.S. CLS. 1, 4, 6, 50, 51 AND 52).

CLASS 5—PHARMACEUTICALS

FOR HOUSEHOLD AND COMMERCIAL CLEANING PRODUCTS, NAMELY, HAND SANITIZERS, AIR DEODORIZERS, CARPET DEODORIZERS, MOLD REMEDIATION PRODUCTS, NAMELY, MOLD INHIBITORS FOR TREATING MOLD GROWTH IN AND AROUND BUILDINGS, HYDROGEN SULFIDE NEUTRALIZATION PRODUCTS, NAMELY, ODOR NEUTRALIZING PREPARATION FOR USE ON CARPETS, AND PESTICIDES (U.S. CLS. 6, 18, 44, 46, 51 AND 52).

TEJBIR SINGH, EXAMINING ATTORNEY

SN 77-724,201. WAILEA COMMUNITY ASSOCIATION, KIHAI, HI. FILED 4-28-2009.



THE MARK CONSISTS OF A STYLIZED HEAD OF AN ELEPAIO BIRD IN FRONT OF THE SUN AND PASSING OVER THE SHORE.

CLASS 35—ADVERTISING AND BUSINESS

FOR ADVERTISING AND MARKETING; ASSOCIATION SERVICES, NAMELY, PROMOTING DIVERSITY IN THE RESTAURANT AND HOTEL INDUSTRIES ON BEHALF OF EMPLOYEES, VENDORS, MANAGEMENT, AND OWNERS (U.S. CLS. 100, 101 AND 102).

CLASS 36—INSURANCE AND FINANCIAL

FOR REAL ESTATE SERVICES, NAMELY, PROPERTY MANAGEMENT SERVICES FOR CONDOMINIUM ASSOCIATIONS, HOMEOWNER ASSOCIATIONS AND APARTMENT BUILDINGS (U.S. CLS. 100, 101 AND 102).

NATALIE POLZER, EXAMINING ATTORNEY

SN 77-724,228. PAUL JON BOSCACCI, SAN FRANCISCO, CA.
FILED 4-28-2009.

SN 77-724,242. GENERAL ELECTRIC COMPANY, SCHE-
NECTADY, NY. FILED 4-28-2009.

FORT KNOX

THE MARK CONSISTS OF STANDARD CHARACTERS WITHOUT CLAIM TO ANY PARTICULAR FONT, STYLE, SIZE, OR COLOR.

CLASS 16—PAPER GOODS AND PRINTED MATTER

FOR PRINTED MATTER, NAMELY, COMIC STRIPS (U.S. CLS. 2, 5, 22, 23, 29, 37, 38 AND 50).

CLASS 41—EDUCATION AND ENTERTAINMENT

FOR PROVIDING ON-LINE PUBLICATIONS IN THE NATURE OF A COMIC STRIP (U.S. CLS. 100, 101 AND 107).

JUSTINE D. PARKER, EXAMINING ATTORNEY

SN 77-724,230. DIAMOND LIMITED GROUP, INC., DBA CONTINENTAL COIN AND JEWELRY COMPANY, VAN NUYS, CA. FILED 4-28-2009.



THE MARK CONSISTS OF TWO STYLIZED LETTER "C'S".

CLASS 14—JEWELRY

FOR COLLECTIBLE COINS; COMMEMORATIVE COINS; GOLD; GOLD INGOTS; JEWELRY WATCHES; MONETARY COIN SETS FOR COLLECTING PURPOSES; NON-MONETARY COINS; PRECIOUS METALS, NAMELY, GOLD AND SILVER; SILVER INGOTS; STATUES OF PRECIOUS METAL (U.S. CLS. 2, 27, 28 AND 50).

CLASS 35—ADVERTISING AND BUSINESS

FOR WHOLESALE AND RETAIL STORE SERVICES FEATURING PRECIOUS STONES AND PRECIOUS JEWELRY IN THE NATURE OF NECKLACES, BRACELETS, EARRINGS, RINGS, BROACHES, AND PENDANTS WITH AND WITHOUT DIAMONDS (U.S. CLS. 100, 101 AND 102).

LINDA LAVACHE, EXAMINING ATTORNEY

ACHILLES

THE MARK CONSISTS OF STANDARD CHARACTERS WITHOUT CLAIM TO ANY PARTICULAR FONT, STYLE, SIZE, OR COLOR.

OWNER OF U.S. REG. NO. 2,713,749.

CLASS 9—ELECTRICAL AND SCIENTIFIC APPARATUS

FOR ULTRASONIC BONE DENSITOMETER WITH COMPUTER, PRINTER, AND COMPUTER SOFTWARE FOR USE THEREWITH, SOLD AS A UNIT, FOR SCIENTIFIC USE (U.S. CLS. 21, 23, 26, 36 AND 38).

CLASS 10—MEDICAL APPARATUS

FOR ULTRASONIC BONE DENSITOMETER WITH COMPUTER, PRINTER, AND COMPUTER SOFTWARE FOR USE THEREWITH, SOLD AS A UNIT, FOR MEDICAL DIAGNOSTIC USE (U.S. CLS. 26, 39 AND 44).

ZACHARY BELLO, EXAMINING ATTORNEY

SN 77-724,335. FLEXSTEEL INDUSTRIES, INC., DUBUQUE, IA. FILED 4-28-2009.

KASHMIRA

THE MARK CONSISTS OF STANDARD CHARACTERS WITHOUT CLAIM TO ANY PARTICULAR FONT, STYLE, SIZE, OR COLOR.

CLASS 20—FURNITURE AND ARTICLES NOT OTHERWISE CLASSIFIED

FOR FURNITURE (U.S. CLS. 2, 13, 22, 25, 32 AND 50).
FIRST USE 10-1-2007; IN COMMERCE 10-1-2007.

CLASS 24—FABRICS

FOR FURNISHING AND UPHOLSTERY FABRICS (U.S. CLS. 42 AND 50).

FIRST USE 10-1-2007; IN COMMERCE 10-1-2007.

VIVIAN MICZNIK FIRST, EXAMINING ATTORNEY

SN 77-724,342. SOBBOTA, ANNE, BANDON, OR. FILED 4-28-2009.

DEBRA LEE, EXAMINING ATTORNEY

'Tis Gorse of Course!

THE MARK CONSISTS OF STANDARD CHARACTERS WITHOUT CLAIM TO ANY PARTICULAR FONT, STYLE, SIZE, OR COLOR.

CLASS 14—JEWELRY

FOR JEWELRY (U.S. CLS. 2, 27, 28 AND 50).
FIRST USE 4-28-2009; IN COMMERCE 4-28-2009.

CLASS 16—PAPER GOODS AND PRINTED MATTER

FOR GREETINGS CARDS AND POSTCARDS (U.S. CLS. 2, 5, 22, 23, 29, 37, 38 AND 50).
FIRST USE 4-28-2009; IN COMMERCE 4-28-2009.

CLASS 21—HOUSEWARES AND GLASS

FOR MOSAIC ART TILES MADE OF GLASS AND CERAMIC (U.S. CLS. 2, 13, 23, 29, 30, 33, 40 AND 50).
FIRST USE 4-28-2009; IN COMMERCE 4-28-2009.
LINDA POWELL, EXAMINING ATTORNEY

SN 77-724,383. MARK TIDDENS, DBA DOLPHIN CONSUMER SYSTEMS, SOLANA BEACH, CA. FILED 4-28-2009.

Wave

THE MARK CONSISTS OF STANDARD CHARACTERS WITHOUT CLAIM TO ANY PARTICULAR FONT, STYLE, SIZE, OR COLOR.

CLASS 9—ELECTRICAL AND SCIENTIFIC APPARATUS

FOR COMPUTER HARDWARE; COMPUTER HARDWARE AND COMPUTER PERIPHERAL DEVICES; COMPUTER HARDWARE AND COMPUTER PERIPHERALS; COMPUTER HARDWARE AND PERIPHERAL DEVICES; COMPUTER HARDWARE AND PERIPHERALS; COMPUTER NETWORKING HARDWARE; COMPUTER PERIPHERAL APPARATUS; COMPUTER PERIPHERAL DEVICES; COMPUTER PERIPHERAL EQUIPMENT; COMPUTER PERIPHERALS; COMPUTERS AND COMPUTER HARDWARE; COMPUTERS AND COMPUTER PERIPHERALS; DESKTOP COMPUTERS; ELECTRONIC COMPUTERS; LAPTOP COMPUTERS; NOTEBOOK AND LAPTOP COMPUTERS; NOTEBOOK COMPUTERS; PERSONAL COMPUTERS; TABLET COMPUTER; WIRELESS COMPUTER PERIPHERALS (U.S. CLS. 21, 23, 26, 36 AND 38).

CLASS 42—SCIENTIFIC AND COMPUTER SERVICES

FOR DESIGN OF COMPUTER HARDWARE, INTEGRATED CIRCUITS, COMMUNICATIONS HARDWARE AND COMPUTER NETWORKS FOR OTHERS (U.S. CLS. 100 AND 101).

SN 77-724,449. M.J. CARLYLE AND COMPANY, CULVER CITY, CA. FILED 4-28-2009.

MAKE LOVE NOT TRASH

THE MARK CONSISTS OF STANDARD CHARACTERS WITHOUT CLAIM TO ANY PARTICULAR FONT, STYLE, SIZE, OR COLOR.

CLASS 35—ADVERTISING AND BUSINESS

FOR RETAIL STORE SERVICES AND ON-LINE RETAIL STORE SERVICES IN THE FIELD OF APPAREL, HANDBAGS, TOTE BAGS, CARRYING CASES, WALLET AND ACCESSORIES; PROMOTING PUBLIC AWARENESS OF ENVIRONMENTAL ISSUES, CONSERVATION AND ECOLOGICAL RESPONSIBILITY VIA WEBSITE FEATURING INFORMATION DESIGNED TO ENCOURAGE ENVIRONMENTAL AWARENESS, CONSERVATION AND ECOLOGICAL RESPONSIBILITY (U.S. CLS. 100, 101 AND 102).
FIRST USE 1-21-2008; IN COMMERCE 1-21-2008.

CLASS 36—INSURANCE AND FINANCIAL

FOR CHARITABLE FUNDRAISING SERVICES; CHARITABLE FUNDRAISING SERVICES, NAMELY, FUNDRAISING AND PROVIDING FINANCIAL SUPPORT TO FUND RESEARCH FOR A CURE FOR ALZHEIMER'S DISEASE (U.S. CLS. 100, 101 AND 102).
FIRST USE 1-21-2008; IN COMMERCE 1-21-2008.
COURTNEY MCCORMICK, EXAMINING ATTORNEY

SN 77-724,654. THE PRUDENTIAL INSURANCE COMPANY OF AMERICA, NEWARK, NJ. FILED 4-29-2009.

I-RIC

THE MARK CONSISTS OF STANDARD CHARACTERS WITHOUT CLAIM TO ANY PARTICULAR FONT, STYLE, SIZE, OR COLOR.

CLASS 9—ELECTRICAL AND SCIENTIFIC APPARATUS

FOR DOWNLOADABLE ELECTRONIC PUBLICATIONS IN THE NATURE OF WHITE PAPERS AND PAMPHLETS AND REPORTS WITH RESPECT TO THE PROMOTION OF PUBLIC AWARENESS OF ISSUES RELATING TO RETIREMENT PLANNING, AND LONG-TERM FINANCIAL SECURITY (U.S. CLS. 21, 23, 26, 36 AND 38).

CLASS 35—ADVERTISING AND BUSINESS

FOR PROMOTING PUBLIC AWARENESS OF ISSUES IN RELATION TO RETIREMENT PLANNING, AND LONG-TERM FINANCIAL SECURITY. THINK TANK SERVICES, NAMELY, CONDUCTING BUSINESS AND PUBLIC POLICY RESEARCH DIRECTED TO THE PROMOTION OF PUBLIC AWARENESS OF ISSUES RELATING TO RETIREMENT PLANNING, AND LONG-TERM FINANCIAL SECURITY (U.S. CLS. 100, 101 AND 102).

CLASS 41—EDUCATION AND ENTERTAINMENT

FOR ON-LINE PUBLICATION OF WHITE PAPERS AND PAMPHLETS AND REPORTS IN RELATION TO THE PROMOTION OF PUBLIC AWARENESS OF ISSUES IN RELATION TO RETIREMENT PLANNING, AND LONG-TERM FINANCIAL SECURITY; THINK TANK SERVICES, NAMELY, CONDUCTING MEETINGS, SEMINARS, AND CONFERENCES IN RELATION TO RETIREMENT PLANNING, AND LONG-TERM FINANCIAL SECURITY (U.S. CLS. 100, 101 AND 107).

JANICE KIM, EXAMINING ATTORNEY

SN 77-724,783. EDUFIRE, INC., MENLO PARK, CA. FILED 4-29-2009.

EDUFIRE

THE MARK CONSISTS OF STANDARD CHARACTERS WITHOUT CLAIM TO ANY PARTICULAR FONT, STYLE, SIZE, OR COLOR.

CLASS 38—COMMUNICATION

FOR PROVIDING ONLINE BULLETIN BOARDS AND CHAT ROOMS FOR TRANSMISSION OF MESSAGES AMONG COMPUTER USERS IN THE FIELDS OF LANGUAGE INSTRUCTION, TEST PREPARATION, BUSINESS, EDUCATION, SCIENCE, HISTORY, MATHEMATICS, COMPUTERS, ART, ENTERTAINMENT, MUSIC, GEOLOGY, AND SUBJECTS OF GENERAL INTEREST (U.S. CLS. 100, 101 AND 104).

FIRST USE 1-1-2008; IN COMMERCE 1-1-2008.

CLASS 41—EDUCATION AND ENTERTAINMENT

FOR EDUCATIONAL SERVICES, NAMELY, PROVIDING ONLINE CLASSES AND TUTORING IN THE FIELDS OF LANGUAGE INSTRUCTION, TEST PREPARATION, BUSINESS, EDUCATION, SCIENCE, HISTORY, MATHEMATICS, COMPUTERS, ART, ENTERTAINMENT, MUSIC, GEOLOGY, AND SUBJECTS OF GENERAL INTEREST; ENTERTAINMENT SERVICES, NAMELY, PROVIDING ONLINE COMPUTER GAMES; PROVISION OF INFORMATION RELATING TO EDUCATIONAL SERVICES (U.S. CLS. 100, 101 AND 107).

FIRST USE 1-1-2008; IN COMMERCE 1-1-2008.

TARAH HARDY, EXAMINING ATTORNEY

SN 77-724,668. TENKSOLAR INC., PRIOR LAKE, MN. FILED 4-29-2009.



THE MARK CONSISTS OF A SHADED SQUARE WITH ROUNDED EDGES AND A CURVED BAND THAT STARTS IN THE LOWER LEFT CORNER AND EXTENDS UPWARDS THROUGH THE SQUARE TO THE UPPER RIGHT CORNER.

CLASS 9—ELECTRICAL AND SCIENTIFIC APPARATUS

FOR APPARATUS FOR CONVERTING ELECTRONIC RADIATION TO ELECTRICAL ENERGY, NAMELY, PHOTOVOLTAIC SOLAR MODULES (U.S. CLS. 21, 23, 26, 36 AND 38).

CLASS 11—ENVIRONMENTAL CONTROL APPARATUS

FOR SOLAR COLLECTORS (U.S. CLS. 13, 21, 23, 31 AND 34).

COURTNEY MCCORMICK, EXAMINING ATTORNEY

SN 77-724,848. CONI-SEAL, INC., LAKEWOOD, NJ. FILED 4-29-2009.



THE COLOR(S) BLACK AND YELLOW IS/ARE CLAIMED AS A FEATURE OF THE MARK.

THE MARK CONSISTS OF THE WORD "INTELLIGENTPARTS" HAVING THE "INTELLIGENT" COMPONENT IN BLACK STYLIZED SCRIPT AND THE "PARTS" COMPONENT IN YELLOW STYLIZED SCRIPT ALONG WITH THE OUTLINE OF AN AUTOMOBILE ON THE TOP OF THE LETTER "T", ALL ABOVE THE WORDS "DO A BETTER JOB FASTER" IN BLACK STYLIZED SCRIPT.

CLASS 12—VEHICLES

FOR BRAKE HYDRAULICS, NAMELY, WHEEL CYLINDERS, BRAKE HOSES, WHEEL CYLINDER KITS, BRAKE CALIPER KITS, CLUTCH MASTER CYLINDER KITS, CLUTCH SLAVE CYLINDER KITS, SELF ADJUSTER KITS, BRAKE CYLINDER CUPS, AND MASTER CYLINDERS, ALL FOR USE WITH MOTOR VEHICLES; CHASSIS, NAMELY, TIE ROD ENDS, BALL JOINTS, CENTER LINKS, DRAG LINKS, TRACK BARS, IDLER ARMS, STABILIZER LINK KITS, SWAY BAR KITS, CONTROL ARMS, CONTROL ARM BUSHINGS, STRUT ROD BUSHINGS, RADIUS ARM BUSHINGS, SWAY BAR FRAME BUSHINGS, AND STABILIZER BAR FRAME BUSHINGS, ALL FOR USE WITH MOTOR VEHICLES; HUB BEARING ASSEMBLIES, NAMELY, AXLE BEARINGS; AND FRICTION MATERIALS, NAMELY, BRAKE PADS, ROTORS, AND CALIPERS, ALL FOR USE WITH MOTOR VEHICLES (U.S. CLS. 19, 21, 23, 31, 35 AND 44).

CLASS 35—ADVERTISING AND BUSINESS

FOR RETAIL AUTOMOBILE PARTS AND ACCESSORIES STORES; ON-LINE RETAIL STORE SERVICES FEATURING AUTOMOBILE PARTS AND ACCESSORIES; ADVERTISING, MARKETING AND PROMOTION SERVICES (U.S. CLS. 100, 101 AND 102).
PAM WILLIS, EXAMINING ATTORNEY

SN 77-724,869. FRYE JR., ROBERT E., RIVER EDGE, NJ. FILED 4-29-2009.

NA-NGU-NLF

THE MARK CONSISTS OF STANDARD CHARACTERS WITHOUT CLAIM TO ANY PARTICULAR FONT, STYLE, SIZE, OR COLOR.

CLASS 14—JEWELRY

FOR BRACELETS; JEWELRY (U.S. CLS. 2, 27, 28 AND 50).

CLASS 25—CLOTHING

FOR TEE SHIRTS (U.S. CLS. 22 AND 39).
MELVIN AXILBUND, EXAMINING ATTORNEY

SN 77-724,897. MABRY, ROBERT T., SOUTH WHITLEY, IN. FILED 4-29-2009.

NOBULLSHOT

THE MARK CONSISTS OF STANDARD CHARACTERS WITHOUT CLAIM TO ANY PARTICULAR FONT, STYLE, SIZE, OR COLOR.

CLASS 5—PHARMACEUTICALS

FOR NUTRITIONAL SUPPLEMENT IN THE NATURE OF A NUTRIENT-DENSE, PROTEIN-BASED DRINK MIX (U.S. CLS. 6, 18, 44, 46, 51 AND 52).

CLASS 32—LIGHT BEVERAGES

FOR ENERGY DRINKS (U.S. CLS. 45, 46 AND 48).

CLASS 33—WINES AND SPIRITS

FOR ALCOHOLIC ENERGY DRINKS (U.S. CLS. 47 AND 49).
THEODORE MCBRIDE, EXAMINING ATTORNEY

SN 77-724,902. ILLUMINATE GYM DEVELOPMENT COMPANY, DENVER, CO. FILED 4-29-2009.

illuminate Gym

THE MARK CONSISTS OF STANDARD CHARACTERS WITHOUT CLAIM TO ANY PARTICULAR FONT, STYLE, SIZE, OR COLOR.

NO CLAIM IS MADE TO THE EXCLUSIVE RIGHT TO USE "GYM", APART FROM THE MARK AS SHOWN.

CLASS 35—ADVERTISING AND BUSINESS

FOR FRANCHISING, NAMELY, OFFERING TECHNICAL ASSISTANCE IN THE ESTABLISHMENT AND/OR OPERATION OF A GYM (U.S. CLS. 100, 101 AND 102).
FIRST USE 4-29-2009; IN COMMERCE 4-29-2009.

CLASS 41—EDUCATION AND ENTERTAINMENT

FOR COUNSELING SERVICES IN THE FIELD OF PHYSICAL FITNESS; PERSONAL TRAINER SERVICES; PERSONAL TRAINING SERVICES, NAMELY, STRENGTH AND CONDITIONING TRAINING; PERSONAL TRAINING SERVICES, NAMELY, STRENGTH AND CONDITIONING TRAINING AND SPEED TRAINING; PHYSICAL FITNESS CONSULTATION; PHYSICAL FITNESS INSTRUCTION; PHYSICAL FITNESS TRAINING SERVICES; PROVIDING ASSISTANCE, PERSONAL TRAINING AND PHYSICAL FITNESS CONSULTATION TO INDIVIDUALS TO HELP THEM MAKE PHYSICAL FITNESS, STRENGTH, CONDITIONING, AND EXERCISE IMPROVEMENT IN THEIR DAILY LIVING; PROVIDING FITNESS AND EXERCISE FACILITIES (U.S. CLS. 100, 101 AND 107).

FIRST USE 4-20-2009; IN COMMERCE 4-20-2009.
TRACY WHITTAKER-BROWN, EXAMINING ATTORNEY

SN 77-724,927. MIX BRANDS LLC, WILTON, CT. FILED 4-29-2009.

BLING BAR

THE MARK CONSISTS OF STANDARD CHARACTERS WITHOUT CLAIM TO ANY PARTICULAR FONT, STYLE, SIZE, OR COLOR.

CLASS 3—COSMETICS AND CLEANING PREPARATIONS

FOR COSMETICS (U.S. CLS. 1, 4, 6, 50, 51 AND 52).

SN 77-724,964. N'TAKE, LLC, SOUTHPORT, CT. FILED 4-29-2009.

CLASS 44—MEDICAL, BEAUTY AND AGRICULTURAL SERVICES

FOR PROVIDING INFORMATION ABOUT BEAUTY (U.S. CLS. 100 AND 101).
CAROLINE WOOD, EXAMINING ATTORNEY

WE PUT MORE INTO EVERY BAG

THE MARK CONSISTS OF STANDARD CHARACTERS WITHOUT CLAIM TO ANY PARTICULAR FONT, STYLE, SIZE, OR COLOR.

CLASS 16—PAPER GOODS AND PRINTED MATTER

FOR GROCERY BAGS; MERCHANDISE BAGS; PLASTIC OR PAPER BAGS FOR HOUSEHOLD USE; GENERAL PURPOSE PLASTIC BAGS; CARRYING SOLUTIONS, NAMELY, CARRYING CASES MADE OF PAPER; STORAGE SOLUTIONS, NAMELY, STORAGE CONTAINERS MADE OF PAPER, PLASTIC FOOD STORAGE BAGS FOR HOUSEHOLD USE (U.S. CLS. 2, 5, 22, 23, 29, 37, 38 AND 50).

SN 77-724,934. ILLUMINATE GYM DEVELOPMENT COMPANY, DENVER, CO. FILED 4-29-2009.

**CLASS 18—LEATHER GOODS**

FOR GENERAL PURPOSE BAGS, NAMELY, ALL-PURPOSE CARRYING BAGS; CARRYING SOLUTIONS, NAMELY, ALL-PURPOSE CARRYING BAGS, TOTE BAGS (U.S. CLS. 1, 2, 3, 22 AND 41).
HANNO RITTNER, EXAMINING ATTORNEY

NO CLAIM IS MADE TO THE EXCLUSIVE RIGHT TO USE "GYM", APART FROM THE MARK AS SHOWN.

THE MARK CONSISTS OF A TRIBAL SUN OR A SUN WITH LINES REPRESENTING RADIATING RAYS AND A CENTER CREATED BY A LINE THAT CURVES AROUND ITSELF TO MAKE A CIRCLE. THE WORD "GYM" COVERS THE LOWER RIGHT PORTION OF THE SUN DESIGN.

SN 77-724,972. IMAGIZE LLC, BERKELEY, CA. FILED 4-29-2009.

IMAGIZE

CLASS 35—ADVERTISING AND BUSINESS

FOR FRANCHISING, NAMELY, OFFERING TECHNICAL ASSISTANCE IN THE ESTABLISHMENT AND/OR OPERATION OF A GYM (U.S. CLS. 100, 101 AND 102).
FIRST USE 4-29-2009; IN COMMERCE 4-29-2009.

THE MARK CONSISTS OF STANDARD CHARACTERS WITHOUT CLAIM TO ANY PARTICULAR FONT, STYLE, SIZE, OR COLOR.

CLASS 41—EDUCATION AND ENTERTAINMENT

FOR COUNSELING SERVICES IN THE FIELD OF PHYSICAL FITNESS; PERSONAL TRAINER SERVICES; PERSONAL TRAINING SERVICES, NAMELY, STRENGTH AND CONDITIONING TRAINING; PERSONAL TRAINING SERVICES, NAMELY, STRENGTH AND CONDITIONING TRAINING AND SPEED TRAINING; PHYSICAL FITNESS CONSULTATION; PHYSICAL FITNESS INSTRUCTION; PHYSICAL FITNESS TRAINING SERVICES; PROVIDING ASSISTANCE, PERSONAL TRAINING AND PHYSICAL FITNESS CONSULTATION TO INDIVIDUALS TO HELP THEM MAKE PHYSICAL FITNESS, STRENGTH, CONDITIONING, AND EXERCISE IMPROVEMENT IN THEIR DAILY LIVING; PROVIDING FITNESS AND EXERCISE FACILITIES (U.S. CLS. 100, 101 AND 107).

FIRST USE 1-1-2006; IN COMMERCE 1-1-2006.
TRACY WHITTAKER-BROWN, EXAMINING ATTORNEY

CLASS 9—ELECTRICAL AND SCIENTIFIC APPARATUS

FOR ELECTRONIC CIRCUIT MODULES FOR USE IN DAY AND NIGHT VISION DEVICES (U.S. CLS. 21, 23, 26, 36 AND 38).
FIRST USE 10-23-2000; IN COMMERCE 4-25-2003.

CLASS 42—SCIENTIFIC AND COMPUTER SERVICES

FOR SOFTWARE DESIGN AND DEVELOPMENT FOR ELECTRONIC CIRCUIT DESIGN AND ELECTRONIC CIRCUIT INTERFACE WITH EXTERNAL ELECTRICAL AND OPTICAL DEVICES; ENGINEERING SERVICES, NAMELY, ENGINEERING FOR ELECTRONIC CIRCUIT DESIGN AND ELECTRONIC CIRCUIT INTERFACE WITH EXTERNAL ELECTRICAL AND OPTICAL DEVICES (U.S. CLS. 100 AND 101).

FIRST USE 10-23-2000; IN COMMERCE 4-25-2003.
DAVID MILLER, EXAMINING ATTORNEY

SN 77-724,982. SCOTT L. HUNTER, WELLESLEY HILLS, MA. FILED 4-29-2009.

LESLEY LAMOTHE, EXAMINING ATTORNEY

VEDAVOO

THE MARK CONSISTS OF STANDARD CHARACTERS WITHOUT CLAIM TO ANY PARTICULAR FONT, STYLE, SIZE, OR COLOR.

CLASS 18—LEATHER GOODS

FOR DUFFEL BAGS; MESSENGER BAGS; TOTE BAGS; TRAVEL BAGS; BACKPACKS; SPORTS PACKS; WAIST PACKS (U.S. CLS. 1, 2, 3, 22 AND 41).

CLASS 25—CLOTHING

FOR JACKETS; PARKAS; COATS; RAIN SUITS; PANTS; SHORTS; SHIRTS; SWEATERS; SWEAT PANTS; SWEAT SHIRTS; VESTS; SCARVES; GLOVES; MITTENS; BELTS; SUSPENDERS; THERMAL UNDERWEAR; SOCKS; HEADWEAR; FOOTWEAR (U.S. CLS. 22 AND 39).

JAMES STEIN, EXAMINING ATTORNEY

SN 77-724,985. ZAO PROMYSHLENNAYA GRUPPA "SPEKTR-AVTO", MOSCOW, RUSSIAN FED., FILED 4-29-2009.



THE MARK CONSISTS OF THE WORD "SPECTROL" IN STYLIZED LETTERS.

CLASS 1—CHEMICALS

FOR ANTIFREEZE; BRAKE FLUID; CHEMICAL ADDITIVES FOR FUEL TREATMENT; CHEMICAL PRODUCTS FOR PREVENTING SCALE; DISTILLED WATER; HYDRAULIC FLUID; RADIATOR FLUSH; TRANSMISSION FLUID (U.S. CLS. 1, 5, 6, 10, 26 AND 46).

CLASS 3—COSMETICS AND CLEANING PREPARATIONS

FOR GLASS CLEANERS; RUST REMOVING PREPARATIONS (U.S. CLS. 1, 4, 6, 50, 51 AND 52).

CLASS 4—LUBRICANTS AND FUELS

FOR ALCOHOL AND MIXED ALCOHOL FUEL; ALL PURPOSE LUBRICANTS; BENZENE FUEL; CRUDE OIL; DIESEL FUEL; FUELS; GENERAL PURPOSE GREASES; GUN BARREL OIL; INDUSTRIAL GREASES; INDUSTRIAL OILS; LUBRICATING OIL FOR MOTOR VEHICLE ENGINES; METHYLATED SPIRITS FOR FUEL; MOTOR OIL; NON-CHEMICAL MOTOR OIL ADDITIVES (U.S. CLS. 1, 6 AND 15).

CLASS 35—ADVERTISING AND BUSINESS

FOR RETAIL STORE SERVICES FEATURING AUTOMOTIVE GOODS (U.S. CLS. 100, 101 AND 102).

SN 77-725,005. COHEN, HOWARD E., SHEMAN OAKS, CA. FILED 4-29-2009.

DI PRIMA

THE MARK CONSISTS OF STANDARD CHARACTERS WITHOUT CLAIM TO ANY PARTICULAR FONT, STYLE, SIZE, OR COLOR.

THE NAME(S), PORTRAIT(S), AND/OR SIGNATURE(S) SHOWN IN THE MARK DOES NOT IDENTIFY A PARTICULAR LIVING INDIVIDUAL.

THE ENGLISH TRANSLATION OF DI PRIMA IN THE MARK IS FIRST OR BEFORE.

CLASS 21—HOUSEWARES AND GLASS

FOR HAIR BRUSHES; HAIR COMBS (U.S. CLS. 2, 13, 23, 29, 30, 33, 40 AND 50).

FIRST USE 12-31-1998; IN COMMERCE 12-31-1998.

CLASS 26—FANCY GOODS

FOR HAIR ACCESSORIES, NAMELY, CLAW CLIPS, JAW CLIPS, SNAP CLIPS, AND TWISTERS; HAIR BANDS, BARRETTES, ORNAMENTS, ORNAMENTS IN THE FORM OF COMBS, AND SCRUNCHIES (U.S. CLS. 37, 39, 40, 42 AND 50).

FIRST USE 12-31-1998; IN COMMERCE 12-31-1998.

DAVID C. REIHNER, EXAMINING ATTORNEY

SN 77-725,016. SIEMENS HEALTHCARE DIAGNOSTICS INC., DEERFIELD, IL. FILED 4-29-2009.

VIGILANCE

THE MARK CONSISTS OF STANDARD CHARACTERS WITHOUT CLAIM TO ANY PARTICULAR FONT, STYLE, SIZE, OR COLOR.

CLASS 1—CHEMICALS

FOR ASSAYS AND REAGENTS FOR USE IN GENETIC RESEARCH; DIAGNOSTIC PREPARATIONS FOR SCIENTIFIC OR RESEARCH USE (U.S. CLS. 1, 5, 6, 10, 26 AND 46).

CLASS 5—PHARMACEUTICALS

FOR CLINICAL MEDICAL REAGENTS; MEDICAL DIAGNOSTIC REAGENTS; PREPARATIONS FOR DETECTING GENETIC PREDISPOSITIONS FOR MEDICAL PURPOSES (U.S. CLS. 6, 18, 44, 46, 51 AND 52).

CLASS 9—ELECTRICAL AND SCIENTIFIC APPARATUS

FOR CLINICAL LABORATORY ANALYZERS FOR MEASURING, TESTING AND ANALYZING BLOOD AND OTHER BODILY FLUIDS; MEDICAL SOFTWARE FOR USE WITH CLINICAL LABORATORY ANALYZERS (U.S. CLS. 21, 23, 26, 36 AND 38).

ODESSA BIBBINS, EXAMINING ATTORNEY

SN 77-725,033. LOGICAL IMAGES, INC., ROCHESTER, NY. FILED 4-29-2009.

LearnDerm

THE MARK CONSISTS OF STANDARD CHARACTERS WITHOUT CLAIM TO ANY PARTICULAR FONT, STYLE, SIZE, OR COLOR.

CLASS 16—PAPER GOODS AND PRINTED MATTER

FOR EDUCATIONAL PUBLICATIONS, NAMELY, EDUCATIONAL LEARNING CARDS, FLASH CARDS, ACTIVITY CARDS, WORKBOOKS, TEXTBOOKS, ACTIVITY BOOKS, TEACHER GUIDES, MANUALS, POSTERS AND EDUCATIONAL BOOKLETS IN THE FIELDS OF DERMATOLOGICAL MEDICINE (U.S. CLS. 2, 5, 22, 23, 29, 37, 38 AND 50).

FIRST USE 8-31-2008; IN COMMERCE 8-31-2008.

CLASS 41—EDUCATION AND ENTERTAINMENT

FOR EDUCATION SERVICES, NAMELY, PROVIDING LIVE AND ON-LINE TUTORIALS IN THE FIELD OF DERMATOLOGICAL MEDICINE (U.S. CLS. 100, 101 AND 107).

FIRST USE 11-30-2007; IN COMMERCE 11-30-2007.
RICHARD A. STRASER, EXAMINING ATTORNEY

SN 77-725,039. PROJECT: THINK DIFFERENT, INC., BOSTON, MA. FILED 4-29-2009.

AMPLIFYME

THE MARK CONSISTS OF STANDARD CHARACTERS WITHOUT CLAIM TO ANY PARTICULAR FONT, STYLE, SIZE, OR COLOR.

CLASS 35—ADVERTISING AND BUSINESS

FOR ADVERTISING AND PUBLICITY SERVICES; PROMOTION SERVICES, NAMELY, MARKETING, PROMOTION AND ADVERTISING FOR INDEPENDENT ARTISTS AND ARTISTIC ORGANIZATIONS (U.S. CLS. 100, 101 AND 102).

CLASS 41—EDUCATION AND ENTERTAINMENT

FOR ENTERTAINMENT SERVICES, NAMELY, AUDIO, VIDEOTAPE AND DIGITAL AUDIO, VIDEO AND MULTIMEDIA PRODUCTION; BOOKING OF ENTERTAINMENT HALLS; LIVE PERFORMANCE BOOKING; EDUCATIONAL SERVICES, NAMELY, PROVIDING CLASSES, SEMINARS, WORKSHOPS AND CONFERENCES IN THE FIELD OF ARTS AND MEDIA TO PROMOTE POSITIVE CHANGE; CONSULTING SERVICES IN THE FIELD OF PUBLICATION OF NEWSLETTERS AND REPORTS (U.S. CLS. 100, 101 AND 107).

GEOFFREY FOSDICK, EXAMINING ATTORNEY

SN 77-725,040. CITY OF JACKSONVILLE, FLORIDA, JACKSONVILLE, FL. FILED 4-29-2009.

Cecil Commerce Center

THE MARK CONSISTS OF STANDARD CHARACTERS WITHOUT CLAIM TO ANY PARTICULAR FONT, STYLE, SIZE, OR COLOR.

NO CLAIM IS MADE TO THE EXCLUSIVE RIGHT TO USE "COMMERCE CENTER", APART FROM THE MARK AS SHOWN.

CLASS 35—ADVERTISING AND BUSINESS

FOR CHAMBER OF COMMERCE SERVICES, NAMELY, PROMOTING BUSINESS AND TOURISM IN THE JACKSONVILLE, FLORIDA AREA (U.S. CLS. 100, 101 AND 102).

FIRST USE 4-1-1998; IN COMMERCE 4-1-1999.

CLASS 36—INSURANCE AND FINANCIAL

FOR REAL ESTATE SERVICES, NAMELY, RENTAL, BROKERAGE, LEASING AND MANAGEMENT OF COMMERCIAL PROPERTY, OFFICES AND OFFICE SPACE (U.S. CLS. 100, 101 AND 102).

FIRST USE 4-1-1998; IN COMMERCE 4-1-1999.
GEOFFREY FOSDICK, EXAMINING ATTORNEY

SN 77-725,056. HIGH FIVE FROZEN YOGURT, L.L.C., ST CLOUD, FL. FILED 4-29-2009.



THE COLOR(S) PURPLE, GREEN AND GRAY IS/ARE CLAIMED AS A FEATURE OF THE MARK.

THE MARK CONSISTS OF A PURPLE AND GREEN BERRY WITH A GRAY SWOOSH MARK.

CLASS 16—PAPER GOODS AND PRINTED MATTER

FOR PAPER NAPKINS (U.S. CLS. 2, 5, 22, 23, 29, 37, 38 AND 50).

CLASS 21—HOUSEWARES AND GLASS

FOR PAPER CUPS (U.S. CLS. 2, 13, 23, 29, 30, 33, 40 AND 50).

CLASS 25—CLOTHING

FOR HATS; T-SHIRTS (U.S. CLS. 22 AND 39).
KATHERINE CONNOLLY, EXAMINING ATTORNEY

SN 77-725,059. SHEEHAN, JENNIFER E., DBA SPRINKLE LOVE, DORCHESTER, MA. FILED 4-29-2009.

Sprinkle Love

THE MARK CONSISTS OF STANDARD CHARACTERS WITHOUT CLAIM TO ANY PARTICULAR FONT, STYLE, SIZE, OR COLOR.

CLASS 18—LEATHER GOODS

FOR PET ACCESSORIES, NAMELY, COLLARS AND CHARMS FOR PETS; ALL-PURPOSE CARRYING BAGS FOR ADULTS, BABIES, AND PETS (U.S. CLS. 1, 2, 3, 22 AND 41).

CLASS 25—CLOTHING

FOR APPAREL, NAMELY, BASEBALL CAPS FOR ADULTS AND CHILDREN, SHIRTS FOR ADULTS, CHILDREN, AND INFANTS; CLOTH BIBS (U.S. CLS. 22 AND 39).

HEATHER SAPP, EXAMINING ATTORNEY

SN 77-725,077. HIGH FIVE FROZEN YOGURT, L.L.C., ST. CLOUD, FL. FILED 4-29-2009.

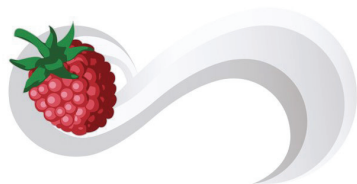

THE COLOR(S) RED, GREEN AND GRAY IS/ARE CLAIMED AS A FEATURE OF THE MARK.
THE MARK CONSISTS OF A RED AND GREEN BERRY WITH A GRAY SWOOSH MARK.

CLASS 16—PAPER GOODS AND PRINTED MATTER

FOR PAPER NAPKINS (U.S. CLS. 2, 5, 22, 23, 29, 37, 38 AND 50).

CLASS 21—HOUSEWARES AND GLASS

FOR PAPER CUPS (U.S. CLS. 2, 13, 23, 29, 30, 33, 40 AND 50).

CLASS 25—CLOTHING

FOR HATS; T-SHIRTS (U.S. CLS. 22 AND 39).
KATHERINE CONNOLLY, EXAMINING ATTORNEY

SN 77-725,129. UGA DIGITAL INC., TAIPEI CITY 115, TAIWAN, FILED 4-29-2009.



THE MARK CONSISTS OF THE STYLIZED WORD "QUICKSTORK" WITH A BIRD LIKE DESIGN FORMING THE TAIL OF THE "Q" WITH THE BIRDLIKE DESIGN WITHIN A CYLINDRICAL CONTOUR FORMED WITHIN THE "Q".

CLASS 9—ELECTRICAL AND SCIENTIFIC APPARATUS

FOR COMPUTER SOFTWARE FOR USE IN DATABASE MANAGEMENT; COMPUTER SOFTWARE FOR UPLOADING, MANIPULATING, AND ENHANCING DIGITAL CONTENT, DOCUMENTS, PHOTOGRAPHS, IMAGES, VIDEO, AND AUDIO; COMPUTER SOFTWARE FOR LINKING METADATA TAGS WITH PHOTOGRAPHIC AND OTHER MEDIA FILES TO ENABLE SEARCH ENGINE RETRIEVAL AND DATABASE SOFTWARE COLLECTIONS OF FILES AND THEIR ON-LINE SHARING, AND FOR LINKING METADATA TAGS WITH WEB PAGES VISITED, TO CREATE LINKS WHICH USERS CAN MAINTAIN FOR THEMSELVES AND SHARE WITH ON-LINE GROUPS AND WEBSITES TAGGING; SOFTWARE TO ENABLE UPLOADING, POSTING, SHOWING, DISPLAYING, TAGGING, BLOGGING, SHARING OR OTHERWISE PROVIDING ELECTRONIC MEDIA OR INFORMATION OVER THE INTERNET OR OTHER COMMUNICATIONS NETWORK; APPLICATION PROGRAMMING INTERFACE (API) FOR THIRD-PARTY SOFTWARE AND ONLINE SERVICES FOR SOCIAL NETWORKING, BUILDING SOCIAL NETWORKING APPLICATIONS AND FOR ALLOWING DATA RETRIEVAL, UPLOAD, ACCESS AND MANAGEMENT; DIGITAL IMAGING SOFTWARE; COMPUTER SOFTWARE FOR PHOTOGRAPHIC AND IMAGE PROCESSING; PORTABLE AND HANDHELD DIGITAL ELECTRONIC DEVICES FOR RECORDING, ORGANIZING, TRANSMITTING, RECEIVING, MANIPULATING, PLAYING AND REVIEWING TEXT, DATA, IMAGE, AUDIO AND VIDEO FILES, NAMELY, PORTABLE COMPUTERS, ULTRA MOBILE PERSONAL COMPUTER (UMPC), SMART PHONES, PERSONAL DIGITAL ASSISTANTS (PDA), DIGITAL PHOTO FRAMES, MOBILE INTERNET DEVICES; COMPUTER SOFTWARE FOR USE IN ORGANIZING, TRANSMITTING, RECEIVING, MANIPULATING, PLAYING AND REVIEWING TEXT, DATA, IMAGE, AUDIO, AND VIDEO FILES ON PORTABLE AND HANDHELD DIGITAL ELECTRONIC DEVICES; COMPUTER APPLICATION SOFTWARE FOR RECORDING AND ORGANIZING CALENDARS AND SCHEDULES, TO-DO LISTS, AND CONTACT INFORMATION; COMPUTER SOFTWARE AND PRERECORDED COMPUTER PROGRAMS FOR PERSONAL INFORMATION MANAGEMENT, DATABASE MANAGEMENT SOFTWARE, ELECTRONIC MAIL AND MESSAGING SOFTWARE; DATABASE SYNCHRONIZATION SOFTWARE, COMPUTER PROGRAMS FOR ACCESSING, BROWSING AND SEARCHING ONLINE DATABASES (U.S. CLS. 21, 23, 26, 36 AND 38).

CLASS 42—SCIENTIFIC AND COMPUTER SERVICES

FOR APPLICATION SERVICE PROVIDER FEATURING SOFTWARE TO ENABLE UPLOADING, POSTING, SHOWING, DISPLAYING, TAGGING, BLOGGING, SHARING OR OTHERWISE PROVIDING ELECTRONIC MEDIA OR INFORMATION OVER THE INTERNET OR OTHER COMMUNICATIONS NETWORK; PROVIDING TEMPORARY USE OF NON-DOWNLOADABLE SOFTWARE APPLICATIONS FEATURING CLASSIFIEDS, AND FOR CREATING VIRTUAL COMMUNITIES, FOR SOCIAL NETWORKING, PHOTO SHARING, VIDEO SHARING, AND TRANSMISSION OF PHOTOGRAPHIC IMAGES; HOSTING OF DIGITAL CONTENT, IMAGES AND VIDEO ON THE INTERNET; COMPUTER SERVICES, NAMELY, HOSTING ONLINE WEB FACILITIES FOR OTHERS FOR ORGANIZING AND CONDUCTING ONLINE MEETINGS, GATHERINGS, AND INTERACTIVE DISCUSSIONS; COMPUTER SERVICES IN THE NATURE OF CUSTOMIZED WEB PAGES FEATURING USER-DEFINED INFORMATION, PERSONAL PROFILES AND INFORMATION (U.S. CLS. 100 AND 101).

CAROLINE WOOD, EXAMINING ATTORNEY

SN 77-725,185. GRACIOUS ELOISE LLC, NEW YORK, NY. FILED 4-29-2009.

GRACIOUS ELOISE

THE MARK CONSISTS OF STANDARD CHARACTERS WITHOUT CLAIM TO ANY PARTICULAR FONT, STYLE, SIZE, OR COLOR.

CLASS 35—ADVERTISING AND BUSINESS

FOR ON-LINE RETAIL STORE SERVICES FEATURING CUSTOM-DESIGNED, PERSONALIZED STATIONERY PRODUCTS (U.S. CLS. 100, 101 AND 102).

CLASS 41—EDUCATION AND ENTERTAINMENT

FOR CUSTOM WRITING SERVICES (U.S. CLS. 100, 101 AND 107).

KATHY DE JONGE, EXAMINING ATTORNEY

SN 77-725,407. BEBE STUDIO, INC., LOS ANGELES, CA. FILED 4-29-2009.

PH8

THE MARK CONSISTS OF STANDARD CHARACTERS WITHOUT CLAIM TO ANY PARTICULAR FONT, STYLE, SIZE, OR COLOR.

CLASS 18—LEATHER GOODS

FOR GYM BAGS; HANDBAGS; LEATHER AND IMITATION LEATHER BAGS; PURSES; SPORTS BAGS; CLUTCH BAGS; SHOULDER BAGS; TOTE BAGS AND BACKPACKS (U.S. CLS. 1, 2, 3, 22 AND 41).

CLASS 25—CLOTHING

FOR ARTICLES OF CLOTHING, NAMELY, SHIRTS, T-SHIRTS, SKIRTS, BLOUSES, PANTS, TROUSERS, SLACKS, JACKETS, COATS, SWEATERS, SUITS, DRESSES, GYM SUITS, JOGGING SUITS, SWEAT PANTS, SWEAT SHIRTS, SWEAT SUITS, TRACK PANTS, TRACK SUITS; ACCESSORIES, NAMELY, BELTS, SCARVES AND HATS; BATHING SUITS; BODY SUITS; FOOTWEAR, NAMELY, ATHLETIC SHOES, LOAFERS, ESPADRILLES, SANDALS, THONGS, MULES AND PUMPS (U.S. CLS. 22 AND 39).

CLASS 35—ADVERTISING AND BUSINESS

FOR ONLINE RETAIL STORE SERVICES FEATURING WOMEN'S CLOTHING AND ACCESSORIES; RETAIL STORE SERVICES FEATURING WOMEN'S CLOTHING AND ACCESSORIES (U.S. CLS. 100, 101 AND 102).

LINDA M. KING, EXAMINING ATTORNEY

SN 77-725,440. EXTELL DEVELOPMENT COMPANY, NEW YORK, NY. FILED 4-29-2009.



THE MARK CONSISTS OF A DIAMOND SHAPE TO REPRESENT THE LETTER "I" FOLLOWED BY THE LETTERS "G" AND "T" AND THE WORDING "FACETED FLAWLESS FOREVER".

CLASS 36—INSURANCE AND FINANCIAL

FOR REAL ESTATE MANAGEMENT AND LEASING SERVICES (U.S. CLS. 100, 101 AND 102).

CLASS 37—CONSTRUCTION AND REPAIR

FOR COMMERCIAL AND RESIDENTIAL REAL ESTATE DEVELOPMENT (U.S. CLS. 100, 103 AND 106).

JIM RINGLE, EXAMINING ATTORNEY

SN 77-725,443. INSURANCE SERVICES OFFICE, INC., JERSEY CITY, NJ. FILED 4-29-2009.

QUICKFILL

THE MARK CONSISTS OF STANDARD CHARACTERS WITHOUT CLAIM TO ANY PARTICULAR FONT, STYLE, SIZE, OR COLOR.

CLASS 35—ADVERTISING AND BUSINESS

FOR SUBSCRIPTIONS TO A COMPUTER SERVICE FOR THE INSURANCE INDUSTRY THAT ELECTRONICALLY PRE-FILLS INSURANCE APPLICATIONS WITH APPLICANT INFORMATION FROM EXISTING DATABASES, AND TO PROVIDE LOSS HISTORY LOSS REPORTS, HAZARD INFORMATION, DRIVER AND VEHICLE INFORMATION, AND PROPERTY TAX VALUATIONS THAT RELATE TO PROPERTY AND AUTOMOBILE INSURANCE (U.S. CLS. 100, 101 AND 102).

CLASS 42—SCIENTIFIC AND COMPUTER SERVICES

FOR PROVIDING TEMPORARY USE OF ON-LINE NON-DOWNLOADABLE SOFTWARE TO THE INSURANCE INDUSTRY TO ELECTRONICALLY PRE-FILL INSURANCE APPLICATIONS WITH APPLICANT INFORMATION FROM EXISTING DATABASES, AND TO PROCESS HISTORY LOSS REPORTS, HAZARD INFORMATION, DRIVER AND VEHICLE INFORMATION, AND PROPERTY TAX VALUATIONS THAT RELATE TO PROPERTY AND AUTOMOBILE INSURANCE (U.S. CLS. 100 AND 101).

DAVID H. STINE, EXAMINING ATTORNEY

SN 77-725,451. NOBLE, LYDIA, CASTLE ROCK, CO. FILED 4-29-2009.

COPING WITH BLUE

THE MARK CONSISTS OF STANDARD CHARACTERS WITHOUT CLAIM TO ANY PARTICULAR FONT, STYLE, SIZE, OR COLOR.

CLASS 16—PAPER GOODS AND PRINTED MATTER

FOR PUBLICATIONS, NAMELY, BOOKS, PRINTED INSTRUCTIONAL AND EDUCATIONAL MATERIAL, AND WORKBOOKS, IN THE FIELDS OF DIVORCE, MARRIAGE, RELATIONSHIPS, AND BEREAVEMENT MANAGEMENT (U.S. CLS. 2, 5, 22, 23, 29, 37, 38 AND 50).

CLASS 41—EDUCATION AND ENTERTAINMENT

FOR EDUCATION SERVICES, NAMELY, PROVIDING CLASSES, SEMINARS, AND WORKSHOPS IN THE FIELDS OF DIVORCE, MARRIAGE, RELATIONSHIPS, AND BEREAVEMENT MANAGEMENT (U.S. CLS. 100, 101 AND 107).

REBECCA SMITH, EXAMINING ATTORNEY

SN 77-725,657. THE PROCTER & GAMBLE COMPANY, CINCINNATI, OH. FILED 4-30-2009.

BURN 100 SAVE 100

THE MARK CONSISTS OF STANDARD CHARACTERS WITHOUT CLAIM TO ANY PARTICULAR FONT, STYLE, SIZE, OR COLOR.

CLASS 5—PHARMACEUTICALS

FOR PROCESSED FOOD ADAPTED FOR MEDICAL PURPOSES (U.S. CLS. 6, 18, 44, 46, 51 AND 52).

CLASS 44—MEDICAL, BEAUTY AND AGRICULTURAL SERVICES

FOR COUNSELING SERVICES IN THE FIELDS OF HEALTH, NUTRITION AND LIFESTYLE WELLNESS SERVICES; HEALTH CARE SERVICES, NAMELY, WELLNESS PROGRAMS; WEIGHT REDUCTION DIET PLANNING; AND PROVIDING WEIGHT LOSS PROGRAM SERVICES (U.S. CLS. 100 AND 101).

MATTHEW PAPPAS, EXAMINING ATTORNEY

SN 77-725,719. TIMEX GROUP B.V., 1017 CA AMSTERDAM, NETHERLANDS, FILED 4-30-2009.

TRAIN SMARTER

THE MARK CONSISTS OF STANDARD CHARACTERS WITHOUT CLAIM TO ANY PARTICULAR FONT, STYLE, SIZE, OR COLOR.

CLASS 10—MEDICAL APPARATUS

FOR HEART RATE MONITORS (U.S. CLS. 26, 39 AND 44).

FIRST USE 10-0-2008; IN COMMERCE 10-0-2008.

CLASS 14—JEWELRY

FOR WATCHES (U.S. CLS. 2, 27, 28 AND 50).

FIRST USE 10-0-2008; IN COMMERCE 10-0-2008.

TEJBIR SINGH, EXAMINING ATTORNEY

SN 77-725,793. QUALITY EDGE, INC., WALKER, MI. FILED 4-30-2009.

DURACRAFT

THE MARK CONSISTS OF STANDARD CHARACTERS WITHOUT CLAIM TO ANY PARTICULAR FONT, STYLE, SIZE, OR COLOR.

CLASS 6—METAL GOODS

FOR METAL SIDING FOR BUILDINGS; METAL FLASHINGS FOR BUILDINGS; METAL SOFFITS FOR BUILDINGS; METAL FASCIAS FOR BUILDINGS; METAL DRIP CAPS FOR BUILDINGS; METAL EXTERIOR TRIM FOR BUILDINGS; METAL WINDOW CASINGS; METAL DOOR CASINGS; METAL STARTER STRIPS FOR BUILDING SIDING; GUTTER GUARDS MADE PRIMARILY OF METAL; METAL GUTTER FITTINGS, HANGERS, STRAPS, MITERS, SPIKES, FERRULES, BANDS, OUTLETS, FUNNELS, SCREWS AND RIVETS; RAINWATER DRAINAGE SYSTEMS FOR DECKS CONSISTING PRIMARILY OF METAL PIPES, METAL PANELS, METAL BRACES AND METAL SUPPORTS (U.S. CLS. 2, 12, 13, 14, 23, 25 AND 50).

CLASS 19—NON-METALLIC BUILDING MATERIALS

FOR NON-METAL SIDING FOR BUILDINGS; NON-METAL STARTERS, CHANNELS AND CORNER POSTS FOR BUILDINGS (U.S. CLS. 1, 12, 33 AND 50).
JAY FLOWERS, EXAMINING ATTORNEY

SN 77-725,805. CROSMAN CORPORATION, EAST BLOOMFIELD, NY. FILED 4-30-2009.

VERDICT

THE MARK CONSISTS OF STANDARD CHARACTERS WITHOUT CLAIM TO ANY PARTICULAR FONT, STYLE, SIZE, OR COLOR.

CLASS 13—FIREARMS

FOR AMMUNITION FOR AIRSOFT GUNS (U.S. CLS. 2 AND 9).

CLASS 28—TOYS AND SPORTING GOODS

FOR PROJECTILES USING COLORANT FOR USE IN AIRSOFT GUNS (U.S. CLS. 22, 23, 38 AND 50).
DOMINICK J. SALEMI, EXAMINING ATTORNEY

SN 77-725,936. GOTO DESIGN LLC, DBA GOTO DESIGN, NEW YORK, NY. FILED 4-30-2009.

PokkeBag

THE MARK CONSISTS OF STANDARD CHARACTERS WITHOUT CLAIM TO ANY PARTICULAR FONT, STYLE, SIZE, OR COLOR.

CLASS 16—PAPER GOODS AND PRINTED MATTER

FOR FABRIC GIFT BAGS; GROCERY BAGS; LUNCH BAGS; LUNCH BAGS MADE OF TEXTILE; MERCHANDISE BAGS; SANDWICH BAGS; TEXTILE GIFT BAGS FOR WINE; TEXTILE WINE GIFT BAGS (U.S. CLS. 2, 5, 22, 23, 29, 37, 38 AND 50).

CLASS 18—LEATHER GOODS

FOR ALL-PURPOSE CARRYING BAGS; ALL-PURPOSE REUSABLE CARRYING BAGS; BACKPACKS, BOOK BAGS, SPORTS BAGS, BUM BAGS, WALLETS AND HANDBAGS; BAGS FOR CARRYING BABIES' ACCESSORIES; BAGS FOR SPORTS; BAGS FOR UMBRELLAS; BOOK BAGS; CANVAS SHOPPING BAGS; CARRY-ALL BAGS; CARRY-ON BAGS; DIAPER BAGS; FLEXIBLE BAGS FOR GARMENTS; FLIGHT BAGS; GENERAL PURPOSE BAGS FOR CARRYING YOGA EQUIPMENT; GENERAL PURPOSE BAGS FOR HOLDING DANCE EQUIPMENT; GYM BAGS; LEATHER AND IMITATION LEATHER BAGS; OVERNIGHT BAGS; REUSABLE SHOPPING BAGS; ROLL BAGS; SCHOOL BAGS; SCHOOL BOOK BAGS; SHOE BAGS FOR TRAVEL; SHOULDER BAGS; SMALL BAGS FOR MEN; SOUVENIR BAGS; SPORT BAGS; SPORTS BAGS; TEXTILE SHOPPING BAGS; TOTE BAGS; TRAVEL BAGS; TRAVELING BAGS; TRAVELLING BAGS; WAIST BAGS; WINE BAGS WITH HANDLES FOR CARRYING OR HOLDING WINE; WRIST MOUNTED CARRYALL BAGS (U.S. CLS. 1, 2, 3, 22 AND 41).

CLASS 22—CORDAGE AND FIBERS

FOR GENERAL UTILITY BAGS FOR COMMERCIAL USE; MULTI-PURPOSE CLOTH BAGS; PACKAGING BAGS OF TEXTILE MATERIAL; SACKS OR BAGS FOR THE TRANSPORTATION OR STORAGE OF MATERIALS IN BULK; SHOE BAGS FOR STORAGE; TEXTILE BAGS FOR MERCHANDISE PACKAGING (U.S. CLS. 1, 2, 7, 19, 22, 42 AND 50).

DEIRDRE ROBERTSON, EXAMINING ATTORNEY

SN 77-725,951. LEARN.COM, INC., SUNRISE, FL. FILED 4-30-2009.

TubeCenter

THE MARK CONSISTS OF STANDARD CHARACTERS WITHOUT CLAIM TO ANY PARTICULAR FONT, STYLE, SIZE, OR COLOR.

CLASS 9—ELECTRICAL AND SCIENTIFIC APPARATUS

FOR COMPUTER SOFTWARE FOR CREATING, MAINTAINING, IMPLEMENTING WEBSITES AND ON-LINE COLLABORATION TOOLS, NAMELY, WEBSITE DEVELOPMENT SOFTWARE AND COMPUTER SOFTWARE DEVELOPMENT TOOLS (U.S. CLS. 21, 23, 26, 36 AND 38).

CLASS 42—SCIENTIFIC AND COMPUTER SERVICES

FOR DESIGN AND DEVELOPMENT OF ON-LINE COMPUTER SOFTWARE SYSTEMS (U.S. CLS. 100 AND 101).

RONALD MCMORROW, EXAMINING ATTORNEY

SN 77-725,956. LEARN.COM, INC., SUNRISE, FL. FILED 4-30-2009.

SN 77-726,104. JB-DM JEWELRY LLC, LOS ANGELES, CA. FILED 4-30-2009.

AlumniCenter

THE MARK CONSISTS OF STANDARD CHARACTERS WITHOUT CLAIM TO ANY PARTICULAR FONT, STYLE, SIZE, OR COLOR.

CLASS 9—ELECTRICAL AND SCIENTIFIC APPARATUS

FOR COMPUTER SOFTWARE FOR CREATING, MAINTAINING, IMPLEMENTING WEBSITES AND ON-LINE COLLABORATION TOOLS, NAMELY, WEBSITE DEVELOPMENT SOFTWARE AND COMPUTER SOFTWARE DEVELOPMENT TOOLS (U.S. CLS. 21, 23, 26, 36 AND 38).

CLASS 42—SCIENTIFIC AND COMPUTER SERVICES

FOR DESIGN AND DEVELOPMENT OF ON-LINE COMPUTER SOFTWARE SYSTEMS (U.S. CLS. 100 AND 101).

RONALD MCMORROW, EXAMINING ATTORNEY

SN 77-726,021. STONEBRIDGE PROMOTIONS LLC, HENDERSON, KY. FILED 4-30-2009.

Barley Legal

THE MARK CONSISTS OF STANDARD CHARACTERS WITHOUT CLAIM TO ANY PARTICULAR FONT, STYLE, SIZE, OR COLOR.

CLASS 21—HOUSEWARES AND GLASS

FOR BEVERAGE GLASSWARE; BOTTLE OPENERS; COASTERS, NOT OF PAPER AND OTHER THAN TABLE LINEN; CUPS AND MUGS; DRINKING GLASSES; GLASS BEVERAGEWARE; GLASS MUGS; INSULATING SLEEVE HOLDERS FOR BEVERAGE CANS; PLASTIC COASTERS; SHOT GLASSES (U.S. CLS. 2, 13, 23, 29, 30, 33, 40 AND 50).

CLASS 25—CLOTHING

FOR CAPS; DRESS SHIRTS; HATS; HEADGEAR, NAMELY, CAPS AND HATS; PANTS; POLO SHIRTS; SHORT-SLEEVED OR LONG-SLEEVED T-SHIRTS; SHORTS; SWEAT SHIRTS; WEARABLE GARMENTS AND CLOTHING, NAMELY, SHIRTS (U.S. CLS. 22 AND 39).

JUSTINE D. PARKER, EXAMINING ATTORNEY



THE MARK CONSISTS OF THE WORDS "CHERRISH STAR" WITH A HEART DESIGN ABOVE THE "I".

CLASS 14—JEWELRY

FOR JEWELRY (U.S. CLS. 2, 27, 28 AND 50).

CLASS 35—ADVERTISING AND BUSINESS

FOR WHOLESALE STORES FEATURING JEWELRY (U.S. CLS. 100, 101 AND 102).

ERIN FALK, EXAMINING ATTORNEY

SN 77-726,167. LEARN.COM, INC., SUNRISE, FL. FILED 4-30-2009.

Prove It or Lose It

THE MARK CONSISTS OF STANDARD CHARACTERS WITHOUT CLAIM TO ANY PARTICULAR FONT, STYLE, SIZE, OR COLOR.

CLASS 9—ELECTRICAL AND SCIENTIFIC APPARATUS

FOR COMPUTER SOFTWARE FOR CREATING, MAINTAINING, IMPLEMENTING WEBSITES AND ON-LINE COLLABORATION TOOLS, NAMELY, WEBSITE DEVELOPMENT SOFTWARE AND COMPUTER SOFTWARE DEVELOPMENT TOOLS (U.S. CLS. 21, 23, 26, 36 AND 38).

CLASS 42—SCIENTIFIC AND COMPUTER SERVICES

FOR DESIGN AND DEVELOPMENT OF ON-LINE COMPUTER SOFTWARE SYSTEMS (U.S. CLS. 100 AND 101).

RONALD MCMORROW, EXAMINING ATTORNEY

SN 77-726,273. BIZEQUITY CORP., SPRING HOUSE, PA. FILED 4-30-2009.



THE COLOR(S) GREY AND GREEN IS/ARE CLAIMED AS A FEATURE OF THE MARK.

THE MARK CONSISTS OF THE "BIZEQUITY" TERM. "BIZ" IS SHOWN IN GREY AN IN A BOLD FONT. THE "Q" IN "EQUITY" IS SHOWN IN GREEN AND IS STYLIZED. THE "E" AND "UITY" IS SHOWN IN GREY AND IN THE SAME FONT AS "BIZ" BUT IS NOT IN A BOLD FONT.

CLASS 36—INSURANCE AND FINANCIAL

FOR BUSINESS VALUATION SERVICES (U.S. CLS. 100, 101 AND 102).
FIRST USE 9-8-2008; IN COMMERCE 9-8-2008.

CLASS 41—EDUCATION AND ENTERTAINMENT

FOR ON-LINE JOURNALS, NAMELY, BLOGS FEATURING INFORMATION IN THE FIELD OF BUSINESS VALUATION (U.S. CLS. 100, 101 AND 107).
FIRST USE 9-8-2008; IN COMMERCE 9-8-2008.
TARAH HARDY, EXAMINING ATTORNEY

CLASS 16—PAPER GOODS AND PRINTED MATTER

FOR DECALS AND STICKERS (U.S. CLS. 2, 5, 22, 23, 29, 37, 38 AND 50).
FIRST USE 10-17-2003; IN COMMERCE 11-17-2003.

CLASS 25—CLOTHING

FOR CLOTHING, NAMELY, SHIRTS, T-SHIRTS, SWEATSHIRTS, SWEATPANTS, HOODED SWEATSHIRTS, JACKETS, HATS, CAPS, BEANIES, SHOES, SOCKS, PANTS, SHORTS, JERSEYS AND TIES (U.S. CLS. 22 AND 39).
FIRST USE 10-17-2003; IN COMMERCE 11-17-2003.
MARGERY A. TIERNEY, EXAMINING ATTORNEY

SN 77-726,382. WRIGHT, JED D., ROY, UT. FILED 4-30-2009.

SN 77-726,339. EHLERT PUBLISHING GROUP, INC., MAPLE GROVE, MN. FILED 4-30-2009.



The logo for WaterCraft WORLD features the word "WaterCraft" in a large, bold, italicized sans-serif font. Below it, the word "WORLD" is written in a smaller, bold, all-caps sans-serif font. A horizontal line runs under "WaterCraft", and a vertical line runs down from the end of this horizontal line to the "W" in "WORLD".

OWNER OF U.S. REG. NO. 1,988,841.
NO CLAIM IS MADE TO THE EXCLUSIVE RIGHT TO USE WATERCRAFT, APART FROM THE MARK AS SHOWN.

THE MARK CONSISTS OF THE STYLIZED WORDING "WATERCRAFT WORLD" WITH A HORIZONTAL LINE UNDER THE LETTERS "WATERCR" THAT CURVES DOWN TO FORM A SHORT VERTICAL LINE NEXT TO THE WORD "WORLD".

CLASS 16—PAPER GOODS AND PRINTED MATTER

FOR MAGAZINES IN THE FIELD OF PERSONAL WATER VEHICLES (U.S. CLS. 2, 5, 22, 23, 29, 37, 38 AND 50).
FIRST USE 1-30-2005; IN COMMERCE 1-30-2005.

CLASS 41—EDUCATION AND ENTERTAINMENT

FOR PROVIDING ON-LINE MAGAZINES IN THE FIELD OF PERSONAL WATER VEHICLES (U.S. CLS. 100, 101 AND 107).
FIRST USE 1-30-2005; IN COMMERCE 1-30-2005.
CYNTHIA TRIPI, EXAMINING ATTORNEY

SN 77-726,343. WRIGHT, JED D., ROY, UT. FILED 4-30-2009.

IRATE

THE MARK CONSISTS OF STANDARD CHARACTERS WITHOUT CLAIM TO ANY PARTICULAR FONT, STYLE, SIZE, OR COLOR.

I'LL RIDE ALWAYS TILL THE END

THE MARK CONSISTS OF STANDARD CHARACTERS WITHOUT CLAIM TO ANY PARTICULAR FONT, STYLE, SIZE, OR COLOR.

CLASS 16—PAPER GOODS AND PRINTED MATTER

FOR DECALS AND STICKERS (U.S. CLS. 2, 5, 22, 23, 29, 37, 38 AND 50).
FIRST USE 10-17-2003; IN COMMERCE 11-17-2003.

CLASS 25—CLOTHING

FOR CLOTHING, NAMELY, SHIRTS, T-SHIRTS, SWEATSHIRTS, SWEATPANTS, HOODED SWEATSHIRTS, JACKETS, HATS, CAPS, BEANIES, SHOES, PANTS, SHORTS, JERSEYS AND TIES (U.S. CLS. 22 AND 39).
FIRST USE 10-17-2003; IN COMMERCE 11-17-2003.
MARGERY A. TIERNEY, EXAMINING ATTORNEY

SN 77-726,400. TRI-POWER GROUP, INC., LIVERMORE, CA. FILED 4-30-2009.

BETWEEN THE WALLS

THE MARK CONSISTS OF STANDARD CHARACTERS WITHOUT CLAIM TO ANY PARTICULAR FONT, STYLE, SIZE, OR COLOR.

CLASS 16—PAPER GOODS AND PRINTED MATTER

FOR PRINTED MATERIALS, NAMELY, EDUCATIONAL MATERIALS IN THE FIELD OF IN-BUILDING TELECOMMUNICATIONS SERVICES, AND PUBLIC SAFETY RELATED TELECOMMUNICATIONS ORDINANCES AND CODES (U.S. CLS. 2, 5, 22, 23, 29, 37, 38 AND 50).

CLASS 41—EDUCATION AND ENTERTAINMENT

FOR EDUCATION SERVICES, NAMELY, PROVIDING CLASSES, SEMINARS, WORKSHOPS, AND PRESENTATIONS IN THE FIELD OF IN-BUILDING TELECOMMUNICATIONS SERVICES, AND PUBLIC SAFETY RELATED TELECOMMUNICATIONS ORDINANCES AND CODES (U.S. CLS. 100, 101 AND 107).
TASNEEM HUSSAIN, EXAMINING ATTORNEY

CLASS 44—MEDICAL, BEAUTY AND AGRICULTURAL SERVICES

FOR BEAUTY SPA SERVICES, NAMELY, COSMETIC BODY CARE; DAY SPA SERVICES, NAMELY, NAIL CARE, MANICURES, PEDICURES AND NAIL ENHANCEMENTS; HEALTH SPA SERVICES FOR HEALTH AND WELLNESS OF THE BODY AND SPIRIT; HEALTH SPA SERVICES FOR HEALTH AND WELLNESS OF THE BODY AND SPIRIT OFFERED AT A HEALTH CLUB FACILITY; HEALTH SPA SERVICES FOR HEALTH AND WELLNESS OF THE BODY AND SPIRIT OFFERED AT A HEALTH RESORT; HEALTH SPA SERVICES FOR HEALTH AND WELLNESS OF THE BODY AND SPIRIT, NAMELY, PROVIDING MASSAGE, FACIAL AND BODY TREATMENT SERVICES, COSMETIC BODY CARE SERVICES; HEALTH SPA SERVICES FOR HEALTH AND WELLNESS OF THE MIND, BODY AND SPIRIT OFFERED IN OR FROM A REMOTE, MOBILE OR TEMPORARY ON-SITE LOCATION; HEALTH SPA SERVICES, NAMELY, BODY WRAPS, MUD TREATMENTS, SEAWEED TREATMENTS, HYDROTHERAPY BATHS, AND BODY SCRUBS; HEALTH SPA SERVICES, NAMELY, COSMETIC BODY CARE SERVICES; HEALTH SPA SERVICES, NAMELY, LASER TREATMENTS FOR ACNE, REJUVENATION, SCARS, TATTOO REMOVAL AND FOR FACIALS AND MASSAGE; MAKING RESERVATIONS AND BOOKINGS FOR OTHERS FOR PHYSICAL AND BEAUTY TREATMENTS AT HEALTH SPAS (U.S. CLS. 100 AND 101).
RENEE SERVANCE, EXAMINING ATTORNEY

SN 77-726,405. MICHELLE BARTOK, ENCINITAS, CA. FILED 4-30-2009.

SN 77-726,428. SELF-ENHANCEMENT, INC., PORTLAND, OR. FILED 4-30-2009.

OceanZen Wellness Spa

THE MARK CONSISTS OF STANDARD CHARACTERS WITHOUT CLAIM TO ANY PARTICULAR FONT, STYLE, SIZE, OR COLOR.

NO CLAIM IS MADE TO THE EXCLUSIVE RIGHT TO USE "WELLNESS SPA", APART FROM THE MARK AS SHOWN.

CLASS 42—SCIENTIFIC AND COMPUTER SERVICES

FOR INTERIOR DESIGN SERVICES IN THE NATURE OF AROMA CONSULTING SERVICES IN THE SELECTION AND USE OF AROMAS FOR HOTELS, CASINOS, RESORTS, CONFERENCE FACILITIES, RETAIL STORES, SPORTS AND FITNESS CENTERS, SPAS, HEALTH CARE FACILITIES, RESIDENTIAL BUILDINGS AND PRIVATE RESIDENCES (U.S. CLS. 100 AND 101).

CLASS 43—HOTEL AND RESTAURANT SERVICES

FOR MAKING RESERVATIONS AND BOOKINGS FOR OTHERS FOR ACCOMMODATIONS AND MEALS AT HEALTH SPAS; SPA SERVICES, NAMELY, PROVIDING TEMPORARY ACCOMMODATIONS AND MEALS TO CLIENTS OF A HEALTH OR BEAUTY SPA (U.S. CLS. 100 AND 101).



SELF ENHANCEMENT, INC.

NO CLAIM IS MADE TO THE EXCLUSIVE RIGHT TO USE "INC.", APART FROM THE MARK AS SHOWN.

THE MARK CONSISTS OF A STYLIZED DRAWING OF A CHILD RAISING HIS OR HER HAND AS IF AT A DESK, OVER A RECTANGULAR DESIGN CONTAINING THE LETTERS "SEI" IN LARGE TYPE AND THE WORDS "YOUTH POTENTIAL REALIZED" IN SMALLER TYPE AT THE BOTTOM OF THE DESIGN. THE WORDS "SELF ENHANCEMENT, INC." ARE WRITTEN TO THE RIGHT OF THE RECTANGULAR DESIGN.

CLASS 36—INSURANCE AND FINANCIAL

FOR CHARITABLE FUNDRAISING SERVICES; ORGANIZING AND CONDUCTING SPECIAL EVENTS FOR CHARITABLE FUNDRAISING PURPOSES (U.S. CLS. 100, 101 AND 102).

FIRST USE 0-0-2002; IN COMMERCE 0-0-2002.

CLASS 41—EDUCATION AND ENTERTAINMENT

FOR CHARITABLE SERVICES, NAMELY, ACADEMIC MENTORING OF SCHOOL AGE CHILDREN; EDUCATION SERVICES, NAMELY, PROVIDING MENTORING, TUTORING, CLASSES, SEMINARS AND WORKSHOPS IN THE FIELD OF ACADEMICS, ARTS, AND ATHLETICS; EDUCATIONAL SERVICES IN THE NATURE OF CHARTER SCHOOLS; INFORMATION IN THE FIELD OF PARENTING CONCERNING EDUCATION OF CHILDREN; PROVIDING AFTER SCHOOL EDUCATIONAL PROGRAMS FOR CHILDREN IN GRADES 2-12 AND BEYOND (U.S. CLS. 100, 101 AND 107).

FIRST USE 0-0-2002; IN COMMERCE 0-0-2002.
KIMBERLY FRYE, EXAMINING ATTORNEY

SN 77-726,605. S & M BIKES, INC., SANTA ANA, CA. FILED 4-30-2009.

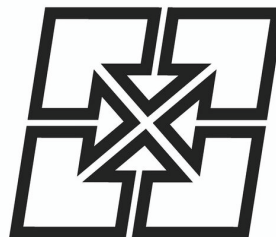

SN 77-726,582. S & M BIKES, INC., SANTA ANA, CA. FILED 4-30-2009.



NO CLAIM IS MADE TO THE EXCLUSIVE RIGHT TO USE "BICYCLE CO.", APART FROM THE MARK AS SHOWN.

THE COLOR(S) RED, WHITE, GOLD IS/ARE CLAIMED AS A FEATURE OF THE MARK.

THE MARK CONSISTS OF THE SHIELD DESIGN OUTLINED IN RED, WITH THE WORDS "AMERICAN BICYCLE CO." WRITTEN IN WHITE LETTERS WITHIN THE RED OUTLINE; THE INTERIOR BODY OF THE SHIELD IS DIVIDED IN HALF DIAGONALLY WITH THE BACKGROUND OF THE UPPER HALF BEING WHITE AND THE LOWER HALF BEING GOLD IN COLOR; THE LETTERS "S & M" ARE SUPERIMPOSED IN RED.

SEC. 2(F) AS TO "AMERICAN BICYCLE CO."

CLASS 12—VEHICLES

FOR BICYCLES AND BICYCLE COMPONENTS, NAMELY, FRAMES, FORKS, HANDLEBAR STEMS, HANDLEBARS, HANDLE GRIPS, HANDLEBAR ENDS, BOTTOM BRACKET SETS, HEADSETS, CRANKS, SPROCKETS, PEDALS, SEATS, SEAT GUTS, SEAT POSTS, SEAT CLAMPS, TIRES, RIMS (U.S. CLS. 19, 21, 23, 31, 35 AND 44).

FIRST USE 11-0-1986; IN COMMERCE 7-0-1987.

CLASS 25—CLOTHING

FOR CLOTHING, NAMELY, T-SHIRTS, SHORT SLEEVED T-SHIRTS, LONG SLEEVED T-SHIRTS, SWEATSHIRTS, HOODED SWEATSHIRTS, RACING JERSEYS, JACKETS, APRONS, HATS, SHOES (U.S. CLS. 22 AND 39).

FIRST USE 11-0-1986; IN COMMERCE 7-0-1987.
VIVIAN MICZNIK FIRST, EXAMINING ATTORNEY

THE MARK CONSISTS OF A GRAPHIC DESIGN OF INTERLOCKING SQUARES AND INTERSECTING ARROWS.

CLASS 12—VEHICLES

FOR BICYCLES AND BICYCLE COMPONENTS, NAMELY, FRAMES, FORKS, HANDLEBAR STEMS, HANDLEBARS, HANDLE GRIPS, HANDLEBAR ENDS, BOTTOM BRACKET SETS, HEADSETS, CRANKS, SPROCKETS, PEDALS, SEATS, SEAT GUTS, SEAT POSTS, SEAT CLAMPS, TIRES, RIMS (U.S. CLS. 19, 21, 23, 31, 35 AND 44).

FIRST USE 9-0-1999; IN COMMERCE 9-0-1999.

CLASS 25—CLOTHING

FOR CLOTHING, NAMELY, T-SHIRTS, SHORT SLEEVED T-SHIRTS, LONG-SLEEVED T-SHIRTS, JERSEYS, JACKETS, SWEATSHIRTS, HOODED SWEATSHIRTS, APRONS, HATS, SHOES (U.S. CLS. 22 AND 39).

FIRST USE 9-0-1999; IN COMMERCE 9-0-1999.
VIVIAN MICZNIK FIRST, EXAMINING ATTORNEY

SN 77-726,675. PRETZEL-HUT, INC., ORANGE, CT. FILED 5-1-2009.

Million Snacks

THE MARK CONSISTS OF STANDARD CHARACTERS WITHOUT CLAIM TO ANY PARTICULAR FONT, STYLE, SIZE, OR COLOR.

NO CLAIM IS MADE TO THE EXCLUSIVE RIGHT TO USE "SNACKS", APART FROM THE MARK AS SHOWN.

CLASS 29—MEATS AND PROCESSED FOODS

FOR CANDIED FRUIT SNACKS; DAIRY-BASED SNACK FOODS EXCLUDING ICE CREAM, ICE MILK AND FROZEN YOGURT; DEHYDRATED FRUIT SNACKS; DRIED FRUIT-BASED SNACKS; FRUIT AND SOY BASED SNACK FOOD; FRUIT-BASED SNACK FOOD; MEAT-BASED SNACK FOODS; NUT AND SEED-BASED SNACK BARS; NUT-BASED SNACK FOODS; NUT-BASED SNACK FOODS, NAMELY, NUT CLUSTERS; NUT-BASED SNACK FOODS, NAMELY, NUT CRISPS; ORGANIC NUT AND SEED-BASED SNACK BARS; POTATO-BASED SNACK FOODS; PROTEIN BASED, NUTRIENT-DENSE SNACK BARS; SNACK FOOD DIPS; SNACK MIX CONSISTING OF DEHYDRATED FRUIT AND PROCESSED NUTS; SNACK MIX CONSISTING OF PRIMARILY OF PROCESSED NUTS AND SALTED SQUASH SEEDS AND ALSO INCLUDING TOASTED CORN; SNACK MIX CONSISTING OF PRIMARILY OF PROCESSED NUTS, SEEDS, DRIED FRUIT AND ALSO INCLUDING CHOCOLATE; SNACK MIX CONSISTING OF WASABI PEAS, PROCESSED NUTS, DEHYDRATED FRUIT AND/OR RAISINS; SNACK MIX CONSISTING PRIMARILY OF DEHYDRATED FRUITS, PROCESSED NUTS AND ALSO INCLUDING SESAME STICKS; SNACK MIX CONSISTING PRIMARILY OF PROCESSED FRUITS, PROCESSED NUTS AND/OR RAISINS; SOY-BASED SNACK FOODS; VEGETABLE-BASED SNACK FOODS (U.S. CL. 46).

CLASS 35—ADVERTISING AND BUSINESS

FOR ASSISTANCE IN BUSINESS MANAGEMENT AND PRODUCT COMMERCIALIZATION, WITHIN THE FRAMEWORK OF A FRANCHISE CONTRACT; FRANCHISE SERVICES, NAMELY, OFFERING BUSINESS MANAGEMENT ASSISTANCE IN THE ESTABLISHMENT AND OPERATION OF SNACKS BARS, SNACK STATIONS, OR SNACK RETAIL FACILITIES; FRANCHISING, NAMELY, CONSULTATION AND ASSISTANCE IN BUSINESS MANAGEMENT, ORGANIZATION AND PROMOTION; RESTAURANT FRANCHISING (U.S. CLS. 100, 101 AND 102).

JASON BLAIR, EXAMINING ATTORNEY

CLASS 29—MEATS AND PROCESSED FOODS

FOR CANDIED FRUIT SNACKS; DAIRY-BASED SNACK FOODS EXCLUDING ICE CREAM, ICE MILK AND FROZEN YOGURT; DEHYDRATED FRUIT SNACKS; DRIED FRUIT-BASED SNACKS; FRUIT AND SOY BASED SNACK FOOD; FRUIT-BASED SNACK FOOD; MEAT-BASED SNACK FOODS; NUT AND SEED-BASED SNACK BARS; NUT-BASED SNACK FOODS; NUT-BASED SNACK FOODS, NAMELY, NUT CLUSTERS; NUT-BASED SNACK FOODS, NAMELY, NUT CRISPS; ORGANIC NUT AND SEED-BASED SNACK BARS; POTATO-BASED SNACK FOODS; PROTEIN BASED, NUTRIENT-DENSE SNACK BARS; SNACK FOOD DIPS; SNACK MIX CONSISTING OF DEHYDRATED FRUIT AND PROCESSED NUTS; SNACK MIX CONSISTING OF PRIMARILY OF PROCESSED NUTS AND SALTED SQUASH SEEDS AND ALSO INCLUDING TOASTED CORN; SNACK MIX CONSISTING OF PRIMARILY OF PROCESSED NUTS, SEEDS, DRIED FRUIT AND ALSO INCLUDING CHOCOLATE; SNACK MIX CONSISTING OF WASABI PEAS, PROCESSED NUTS, DEHYDRATED FRUIT AND/OR RAISINS; SNACK MIX CONSISTING PRIMARILY OF DEHYDRATED FRUITS, PROCESSED NUTS AND ALSO INCLUDING SESAME STICKS; SNACK MIX CONSISTING PRIMARILY OF PROCESSED FRUITS, PROCESSED NUTS AND/OR RAISINS; SOY-BASED SNACK FOODS; VEGETABLE-BASED SNACK FOODS (U.S. CL. 46).

CLASS 35—ADVERTISING AND BUSINESS

FOR ASSISTANCE IN BUSINESS MANAGEMENT AND PRODUCT COMMERCIALIZATION, WITHIN THE FRAMEWORK OF A FRANCHISE CONTRACT; FRANCHISE SERVICES, NAMELY, OFFERING BUSINESS MANAGEMENT ASSISTANCE IN THE ESTABLISHMENT AND OPERATION OF SNACKS BARS, SNACK STATIONS, OR SNACK RETAIL FACILITIES; FRANCHISING, NAMELY, CONSULTATION AND ASSISTANCE IN BUSINESS MANAGEMENT, ORGANIZATION AND PROMOTION; RESTAURANT FRANCHISING (U.S. CLS. 100, 101 AND 102).

JASON BLAIR, EXAMINING ATTORNEY

SN 77-726,718. KRISTIN MITCHELL FOUNDATION, BALA CYNWYD, PA. FILED 5-1-2009.

KRISTIN'S KRUSADE

THE MARK CONSISTS OF STANDARD CHARACTERS WITHOUT CLAIM TO ANY PARTICULAR FONT, STYLE, SIZE, OR COLOR.

CLASS 35—ADVERTISING AND BUSINESS

FOR PROMOTING AWARENESS AMONG COLLEGE STUDENTS AND THE PUBLIC REGARDING VIOLENCE AGAINST WOMEN, DOMESTIC VIOLENCE AND UNHEALTHY DATING RELATIONSHIPS (U.S. CLS. 100, 101 AND 102).

FIRST USE 9-0-2006; IN COMMERCE 9-0-2006.

CLASS 36—INSURANCE AND FINANCIAL

FOR CHARITABLE FOUNDATION SERVICES, NAMELY, FUNDRAISING ACTIVITIES TO SUPPORT EDUCATION AND RAISING AWARENESS AMONG COLLEGE STUDENTS AND THE PUBLIC ABOUT VIOLENCE AGAINST WOMEN, DOMESTIC VIOLENCE AND UNHEALTHY DATING RELATIONSHIPS (U.S. CLS. 100, 101 AND 102).

FIRST USE 9-0-2006; IN COMMERCE 9-0-2006.
HELENE LIWINSKI, EXAMINING ATTORNEY

SN 77-726,679. PRETZEL-HUT, INC., ORANGE, CT. FILED 5-1-2009.

MillionSnaxs

THE MARK CONSISTS OF STANDARD CHARACTERS WITHOUT CLAIM TO ANY PARTICULAR FONT, STYLE, SIZE, OR COLOR.

SN 77-726,724. KRISTIN MITCHELL FOUNDATION, BALA CYNWYD, PA. FILED 5-1-2009.

SN 77-726,818. MUMBOJUMBO LLC, DALLAS, TX. FILED 5-1-2009.

RUN LIFE YOUR WAY

THE MARK CONSISTS OF STANDARD CHARACTERS WITHOUT CLAIM TO ANY PARTICULAR FONT, STYLE, SIZE, OR COLOR.

CLASS 35—ADVERTISING AND BUSINESS

FOR PROMOTING AWARENESS AMONG COLLEGE STUDENTS AND THE PUBLIC REGARDING VIOLENCE AGAINST WOMEN, DOMESTIC VIOLENCE AND UNHEALTHY DATING RELATIONSHIPS (U.S. CLS. 100, 101 AND 102).

FIRST USE 9-0-2007; IN COMMERCE 9-0-2007.

CLASS 36—INSURANCE AND FINANCIAL

FOR CHARITABLE FOUNDATION SERVICES, NAMELY, FUNDRAISING ACTIVITIES TO SUPPORT EDUCATION AND RAISING AWARENESS AMONG COLLEGE STUDENTS AND THE PUBLIC ABOUT VIOLENCE AGAINST WOMEN, DOMESTIC VIOLENCE AND UNHEALTHY DATING RELATIONSHIPS (U.S. CLS. 100, 101 AND 102).

FIRST USE 9-0-2007; IN COMMERCE 9-0-2007.
HELENE LIWINSKI, EXAMINING ATTORNEY

SN 77-726,794. PINKBERRY, INC., LOS ANGELES, CA. FILED 5-1-2009.

GOODNESS EVERY DAY

THE MARK CONSISTS OF STANDARD CHARACTERS WITHOUT CLAIM TO ANY PARTICULAR FONT, STYLE, SIZE, OR COLOR.

CLASS 29—MEATS AND PROCESSED FOODS

FOR YOGURT-BASED BEVERAGES (U.S. CL. 46).

CLASS 30—STAPLE FOODS

FOR FROZEN YOGURT AND FROZEN YOGURT BASED DESSERTS (U.S. CL. 46).

CLASS 32—LIGHT BEVERAGES

FOR SMOOTHIES (U.S. CLS. 45, 46 AND 48).

CLASS 43—HOTEL AND RESTAURANT SERVICES

FOR RESTAURANT SERVICES; RESTAURANTS; TAKE-OUT RESTAURANT SERVICES; CAFE-RESTAURANTS; FAST-FOOD RESTAURANTS (U.S. CLS. 100 AND 101).

HENRY S. ZAK, EXAMINING ATTORNEY

Midnight Mysteries

THE MARK CONSISTS OF STANDARD CHARACTERS WITHOUT CLAIM TO ANY PARTICULAR FONT, STYLE, SIZE, OR COLOR.

CLASS 9—ELECTRICAL AND SCIENTIFIC APPARATUS

FOR COMPUTER GAME SOFTWARE FOR PERSONAL COMPUTERS AND HOME VIDEO GAME CONSOLES (U.S. CLS. 21, 23, 26, 36 AND 38).

CLASS 41—EDUCATION AND ENTERTAINMENT

FOR ENTERTAINMENT SERVICES, NAMELY, PROVIDING ON-LINE COMPUTER GAMES (U.S. CLS. 100, 101 AND 107).

GISELLE AGOSTO, EXAMINING ATTORNEY

SN 77-726,905. CHINA SHIPBUILDING CORPORATION, TAIPEI CITY, TAIWAN, FILED 5-1-2009.

CSBC

THE MARK CONSISTS OF STANDARD CHARACTERS WITHOUT CLAIM TO ANY PARTICULAR FONT, STYLE, SIZE, OR COLOR.

CLASS 12—VEHICLES

FOR BOATS AND THEIR PARTS AND FITTINGS, NAMELY, CARGO BOATS, PASSENGER BOATS, POWER BOATS, MOTORBOATS, JET BOATS, YACHTS, LAUNCHES, SAILBOATS, BOAT HULLS, BOAT HOOKS, STEERING GEARS FOR SHIPS, PROPELLERS FOR BOATS, SPARS FOR BOATS (U.S. CLS. 19, 21, 23, 31, 35 AND 44).

CLASS 37—CONSTRUCTION AND REPAIR

FOR SHIPBUILDING AND SHIP REPAIR SERVICES (U.S. CLS. 100, 103 AND 106).

COURTNEY MCCORMICK, EXAMINING ATTORNEY

SN 77-727,018. KOHBURG HOLDINGS LIMITED, SHATIN, NEWTERRITORIES, HONG KONG, FILED 5-1-2009.



THE MARK CONSISTS OF THE STYLIZED WORD "KOHBURG" WITH INTERLOCKING CIRCLES IN THE BACKGROUND.

CLASS 16—PAPER GOODS AND PRINTED MATTER

FOR COLOR PENCILS; EDUCATIONAL AND LEARNING PUBLICATIONS, NAMELY, BOOKLETS AND FLASH CARDS ON A VARIETY OF EDUCATIONAL DISCIPLINES IN PRE-SCHOOL THROUGH EIGHTH GRADE; EDUCATIONAL PUBLICATIONS, NAMELY, EDUCATIONAL LEARNING CARDS, FLASH CARDS, ACTIVITY CARDS, WORKBOOKS, TEXTBOOKS, ACTIVITY BOOKS, STORY BOOKS, PUZZLE BOOKS, PRINTED PUZZLES, TEACHER GUIDES, MANUALS, POSTERS AND EDUCATIONAL BOOKLETS IN THE FIELD OF EDUCATIONAL LEARNING TOYS; MARKERS; PACKAGED KITS COMPRISING PRINTED INSTRUCTIONAL, EDUCATIONAL, AND TEACHING MATERIALS FOR EDUCATIONAL ACTIVITIES IN THE FIELD OF MATHEMATICS AND GEOGRAPHY; PENCILS; PENCILS FOR PAINTING AND DRAWING; PRINTED EDUCATIONAL MATERIAL, NAMELY, TEACHING TILES; PRINTED INSTRUCTIONAL, EDUCATIONAL, AND TEACHING MATERIALS IN THE FIELD OF MATHEMATICS AND GEOGRAPHY; STATIONERY; STATIONERY WRITING PAPER AND ENVELOPES (U.S. CLS. 2, 5, 22, 23, 29, 37, 38 AND 50).
FIRST USE 5-1-2009; IN COMMERCE 5-1-2009.

CLASS 20—FURNITURE AND ARTICLES NOT OTHERWISE CLASSIFIED

FOR CABINETS; FURNITURE; FURNITURE MADE FROM WOOD OR SUBSTITUTES FOR WOOD; OFFICE FURNITURE; SCHOOL FURNITURE; SEATING FURNITURE; SEATS; TABLES (U.S. CLS. 2, 13, 22, 25, 32 AND 50).

FIRST USE 5-1-2009; IN COMMERCE 5-1-2009.

CLASS 28—TOYS AND SPORTING GOODS

FOR CHILDREN'S MULTIPLE ACTIVITY TOYS; CHILDREN'S MULTIPLE ACTIVITY TOYS SOLD AS A UNIT WITH PRINTED BOOKS; CONSTRUCTION TOYS; DRAWING TOYS; EDUCATIONAL TOYS FOR TEACHING MATH PRINCIPLES TO CHILDREN, NAMELY, MANIPULATIVE BLOCKS FOR DISPLAYING PATTERNS AND GROUPINGS; EDUCATIONAL TOYS IN THE NATURE OF AN ILLUSTRATED WALL MAP; INFANT DEVELOPMENT TOYS; INFANT TOYS; MUSICAL TOYS; STACKING TOYS; TOY BOATS; TOY BOXES; TOY BUILDING BLOCKS; TOY CARS; TOY FIGURES; TOY FURNITURE; TOY NOISEMAKERS; TOY PIANOS; WIND-UP TOYS (U.S. CLS. 22, 23, 38 AND 50).

FIRST USE 5-1-2009; IN COMMERCE 5-1-2009.
JAMES A. RAUEN, EXAMINING ATTORNEY

SN 77-727,172. PRIORITY ENVIRONMENTAL SOLUTIONS, INC., EAGLE, WI. FILED 5-1-2009.



THE COLOR(S) NAVY BLUE, LIGHT BLUE, SILVER, GRAY, WHITE, AND BLACK IS/ARE CLAIMED AS A FEATURE OF THE MARK.

THE MARK CONSISTS OF THE WORDS "PRO" AND "TEK" IN NAVY BLUE, WITH THE NUMERAL "1" IN WHITE AND OUTLINED IN BLACK LOCATED IN BETWEEN THE WORDS "PRO" AND "TEK", WITH A SHIELD LOCATED BEHIND THIS LITERAL ELEMENT. THE SHIELD HAS A BORDER THAT IS A GRADIENT FROM WHITE TO SILVER TO GRAY, WITH AN INTERIOR NAVY BLUE BORDER. THE INSIDE OF THE UPPER THIRD OF THE SHIELD IS A NAVY BLUE GRADIENT, AND THE LOWER TWO-THIRDS OF THE SHIELD IS A LIGHT BLUE GRADIENT.

CLASS 3—COSMETICS AND CLEANING PREPARATIONS

FOR HOUSEHOLD AND COMMERCIAL CLEANING PRODUCTS, NAMELY, CARPET CLEANERS AND LAUNDRY DETERGENTS, AND COUNTERTOP SURFACE CLEANERS, AND DEODORIZERS FOR PETS (U.S. CLS. 1, 4, 6, 50, 51 AND 52).

CLASS 5—PHARMACEUTICALS

FOR HOUSEHOLD AND COMMERCIAL CLEANING PRODUCTS, NAMELY, HAND SANITIZERS, AIR DEODORIZERS, CARPET DEODORIZERS, MOLD REMEDIATION PRODUCTS, NAMELY, MOLD INHIBITORS FOR TREATING MOLD GROWTH IN AND AROUND BUILDINGS, HYDROGEN SULFIDE NEUTRALIZATION PRODUCTS, NAMELY, ODOR NEUTRALIZING PREPARATION FOR USE ON CARPETS, AND PESTICIDES (U.S. CLS. 6, 18, 44, 46, 51 AND 52).

TEJBIR SINGH, EXAMINING ATTORNEY

SN 77-727,212. AVOMEX, INC., HOUSTON, TX. FILED 5-1-2009.

WHOLLY GUAC YOUR DOG

THE MARK CONSISTS OF STANDARD CHARACTERS WITHOUT CLAIM TO ANY PARTICULAR FONT, STYLE, SIZE, OR COLOR.

CLASS 29—MEATS AND PROCESSED FOODS

FOR GUACAMOLE (U.S. CL. 46).

CLASS 30—STAPLE FOODS

FOR MEXICAN FOOD SAUCES, NAMELY, CHIPOTLE-BASED SAUCE, PICO DE GALLO SAUCE, RED SALSA AND GREEN SALSA AND GUACAMOLE BASED SAUCES (U.S. CL. 46).

G. MAYERSCHOFF, EXAMINING ATTORNEY

SN 77-727,223. AVOMEX, INC., FORT WORTH, TX. FILED 5-1-2009.

WHOLLY GUAC YOUR BURGER

THE MARK CONSISTS OF STANDARD CHARACTERS WITHOUT CLAIM TO ANY PARTICULAR FONT, STYLE, SIZE, OR COLOR.

CLASS 29—MEATS AND PROCESSED FOODS

FOR GUACAMOLE (U.S. CL. 46).

CLASS 30—STAPLE FOODS

FOR MEXICAN FOOD SAUCES, NAMELY, CHIPOTLE-BASED SAUCE, PICO DE GALLO SAUCE, RED SALSA AND GREEN SALSA AND GUACAMOLE BASED SAUCES (U.S. CL. 46).

G. MAYERSCHOFF, EXAMINING ATTORNEY

SN 77-727,240. AVOMEX, INC., FORT WORTH, TX. FILED 5-1-2009.

WHOLLY GUAC YOUR SANDWICH

THE MARK CONSISTS OF STANDARD CHARACTERS WITHOUT CLAIM TO ANY PARTICULAR FONT, STYLE, SIZE, OR COLOR.

CLASS 29—MEATS AND PROCESSED FOODS

FOR GUACAMOLE (U.S. CL. 46).

CLASS 30—STAPLE FOODS

FOR MEXICAN FOOD SAUCES, NAMELY, CHIPOTLE-BASED SAUCE, PICO DE GALLO SAUCE, RED SALSA AND GREEN SALSA AND GUACAMOLE BASED SAUCES (U.S. CL. 46).

G. MAYERSCHOFF, EXAMINING ATTORNEY

SN 77-727,275. AVOMEX, INC., FORT WORTH, TX. FILED 5-1-2009.

WHOLLY GUAC YOUR FAJITA

THE MARK CONSISTS OF STANDARD CHARACTERS WITHOUT CLAIM TO ANY PARTICULAR FONT, STYLE, SIZE, OR COLOR.

CLASS 29—MEATS AND PROCESSED FOODS

FOR GUACAMOLE (U.S. CL. 46).

CLASS 30—STAPLE FOODS

FOR MEXICAN FOOD SAUCES, NAMELY, CHIPOTLE-BASED SAUCE, PICO DE GALLO SAUCE, RED SALSA AND GREEN SALSA AND GUACAMOLE BASED SAUCES (U.S. CL. 46).

G. MAYERSCHOFF, EXAMINING ATTORNEY

SN 77-727,289. AVOMEX, INC., FORT WORTH, TX. FILED 5-1-2009.

WHOLLY GUAC YOUR SALAD

THE MARK CONSISTS OF STANDARD CHARACTERS WITHOUT CLAIM TO ANY PARTICULAR FONT, STYLE, SIZE, OR COLOR.

CLASS 29—MEATS AND PROCESSED FOODS

FOR GUACAMOLE (U.S. CL. 46).

CLASS 30—STAPLE FOODS

FOR MEXICAN FOOD SAUCES, NAMELY, CHIPOTLE-BASED SAUCE, PICO DE GALLO SAUCE, RED SALSA AND GREEN SALSA AND GUACAMOLE BASED SAUCES (U.S. CL. 46).

G. MAYERSCHOFF, EXAMINING ATTORNEY

SN 77-727,308. AVOMEX, INC., FORT WORTH, TX. FILED 5-1-2009.

WHOLLY GUAC SANDWICH

THE MARK CONSISTS OF STANDARD CHARACTERS WITHOUT CLAIM TO ANY PARTICULAR FONT, STYLE, SIZE, OR COLOR.

OWNER OF U.S. REG. NO. 3,641,524.

NO CLAIM IS MADE TO THE EXCLUSIVE RIGHT TO USE "GUAC SANDWICH", APART FROM THE MARK AS SHOWN.

CLASS 29—MEATS AND PROCESSED FOODS

FOR GUACAMOLE (U.S. CL. 46).

CLASS 30—STAPLE FOODS

FOR MEXICAN FOOD SAUCES, NAMELY, CHIPOTLE-BASED SAUCE, PICO DE GALLO SAUCE, RED SALSA AND GREEN SALSA AND GUACAMOLE BASED SAUCES (U.S. CL. 46).

G. MAYERSCHOFF, EXAMINING ATTORNEY

SN 77-727,326. AVOMEX, INC., FORT WORTH, TX. FILED 5-1-2009.

SN 77-727,352. WELLBORN CABINET, INC., ASHLAND, AL. FILED 5-1-2009.

WHOLLY GUAC FAJITA

THE MARK CONSISTS OF STANDARD CHARACTERS WITHOUT CLAIM TO ANY PARTICULAR FONT, STYLE, SIZE, OR COLOR.
 OWNER OF U.S. REG. NO. 3,641,524.
 NO CLAIM IS MADE TO THE EXCLUSIVE RIGHT TO USE "GUAC FAJITA", APART FROM THE MARK AS SHOWN.

CLASS 29—MEATS AND PROCESSED FOODS
 FOR GUACAMOLE (U.S. CL. 46).

CLASS 30—STAPLE FOODS
 FOR MEXICAN FOOD SAUCES, NAMELY, CHIPOTLE-BASED SAUCE, PICO DE GALLO SAUCE, RED SALSA AND GREEN SALSA AND GUACAMOLE BASED SAUCES (U.S. CL. 46).
 G. MAYERSCHOFF, EXAMINING ATTORNEY

SN 77-727,342. AVOMEX, INC., FORT WORTH, TX. FILED 5-1-2009.

WHOLLY GUAC SALAD

THE MARK CONSISTS OF STANDARD CHARACTERS WITHOUT CLAIM TO ANY PARTICULAR FONT, STYLE, SIZE, OR COLOR.
 OWNER OF U.S. REG. NO. 3,641,524.
 NO CLAIM IS MADE TO THE EXCLUSIVE RIGHT TO USE "GUAC SALAD", APART FROM THE MARK AS SHOWN.

CLASS 29—MEATS AND PROCESSED FOODS
 FOR GUACAMOLE (U.S. CL. 46).

CLASS 30—STAPLE FOODS
 FOR MEXICAN FOOD SAUCES, NAMELY, CHIPOTLE-BASED SAUCE, PICO DE GALLO SAUCE, RED SALSA AND GREEN SALSA AND GUACAMOLE BASED SAUCES (U.S. CL. 46).
 G. MAYERSCHOFF, EXAMINING ATTORNEY



THE MARK CONSISTS OF STYLIZED "YOU" OVER "NIQUE" AND THE WORDS "FOR YOU" IN A BOX UNDER THE WORD "NIQUE".

CLASS 40—MATERIAL TREATMENT
 FOR CUSTOM MANUFACTURE OF FURNITURE (U.S. CLS. 100, 103 AND 106).
 FIRST USE 2-20-2009; IN COMMERCE 2-20-2009.

CLASS 42—SCIENTIFIC AND COMPUTER SERVICES
 FOR CUSTOM DESIGN OF FURNITURE FOR OTHERS (U.S. CLS. 100 AND 101).
 FIRST USE 2-20-2009; IN COMMERCE 2-20-2009.
 KATINA MISTER, EXAMINING ATTORNEY

SN 77-727,407. KOBRIN, MINDY B., AKA MEALS ON HEELS, NEW YORK, NY. FILED 5-1-2009.

Meals on Heels

THE MARK CONSISTS OF STANDARD CHARACTERS WITHOUT CLAIM TO ANY PARTICULAR FONT, STYLE, SIZE, OR COLOR.

CLASS 16—PAPER GOODS AND PRINTED MATTER
 FOR BOOKS IN THE FIELD OF HOME ENTERTAINING, HOSPITALITY, COOKING, MIXOLOGY, SOCIALIZING, HOSTING, DINNER PARTIES (U.S. CLS. 2, 5, 22, 23, 29, 37, 38 AND 50).

CLASS 28—TOYS AND SPORTING GOODS
 FOR PARLOR GAMES (U.S. CLS. 22, 23, 38 AND 50).

CLASS 41—EDUCATION AND ENTERTAINMENT
 FOR EDUCATIONAL SERVICES, NAMELY, CONDUCTING PROGRAMS IN THE FIELD OF HOME ENTERTAINING, SOCIALIZING, HOSPITALITY, COOKING, MIXOLOGY, HOSTING, DINNER PARTIES (U.S. CLS. 100, 101 AND 107).

CLASS 43—HOTEL AND RESTAURANT SERVICES
 FOR SERVING FOOD AND DRINKS (U.S. CLS. 100 AND 101).
 DANNEAN HETZEL, EXAMINING ATTORNEY

SN 77-727,414. GAT, LLC, DBA GREAT AMERICAN TAXI, FIRESTONE, CO. FILED 5-1-2009.

Great American Taxi

THE MARK CONSISTS OF STANDARD CHARACTERS WITHOUT CLAIM TO ANY PARTICULAR FONT, STYLE, SIZE, OR COLOR.

NO CLAIM IS MADE TO THE EXCLUSIVE RIGHT TO USE "AMERICAN", APART FROM THE MARK AS SHOWN.

CLASS 9—ELECTRICAL AND SCIENTIFIC APPARATUS

FOR AUDIO AND VIDEO RECORDINGS FEATURING MUSIC; DIGITAL MEDIA, NAMELY, PRE-RECORDED VIDEO CASSETTES, DIGITAL VIDEO DISCS, DIGITAL VERSATILE DISCS, DOWNLOADABLE AUDIO AND VIDEO RECORDINGS, DVDS, AND HIGH DEFINITION DIGITAL DISCS FEATURING MUSIC; DOWNLOADABLE MP3 FILES AND MP3 RECORDINGS FEATURING MUSIC; PRE-RECORDED CDS, VIDEO TAPES, LASER DISKS AND DVDS FEATURING MUSIC (U.S. CLS. 21, 23, 26, 36 AND 38).

FIRST USE 3-10-2005; IN COMMERCE 3-10-2005.

CLASS 41—EDUCATION AND ENTERTAINMENT

FOR ENTERTAINMENT IN THE NATURE OF LIVE PERFORMANCES BY MUSICAL GROUP OR ROCK BAND; ENTERTAINMENT SERVICES IN THE NATURE OF LIVE MUSICAL PERFORMANCES; ENTERTAINMENT, NAMELY, LIVE PERFORMANCES BY A MUSICAL BAND (U.S. CLS. 100, 101 AND 107).

FIRST USE 3-10-2005; IN COMMERCE 3-10-2005.
KATHERINE E. HALMEN, EXAMINING ATTORNEY

SN 77-727,432. KOBRIN, MINDY B., AKA MINDY'S MEALS ON HEELS, NEW YORK, NY. FILED 5-1-2009.

Mindy's Meals on Heels

THE MARK CONSISTS OF STANDARD CHARACTERS WITHOUT CLAIM TO ANY PARTICULAR FONT, STYLE, SIZE, OR COLOR.

CLASS 16—PAPER GOODS AND PRINTED MATTER

FOR A SERIES OF BOOKS AND WRITTEN ARTICLES IN THE FIELD OF HOME ENTERTAINING, HOSPITALITY, COOKING, MIXOLOGY, SOCIALIZING, HOSTING, DINNER PARTIES (U.S. CLS. 2, 5, 22, 23, 29, 37, 38 AND 50).

CLASS 28—TOYS AND SPORTING GOODS

FOR PARLOR GAMES (U.S. CLS. 22, 23, 38 AND 50).

CLASS 41—EDUCATION AND ENTERTAINMENT

FOR EDUCATIONAL SERVICES, NAMELY, CONDUCTING PROGRAMS IN THE FIELD OF HOME ENTERTAINING, HOSPITALITY, COOKING, MIXOLOGY, SOCIALIZING, HOSTING, DINNER PARTIES (U.S. CLS. 100, 101 AND 107).

CLASS 43—HOTEL AND RESTAURANT SERVICES

FOR SERVING FOOD AND DRINKS (U.S. CLS. 100 AND 101).
DANNEAN HETZEL, EXAMINING ATTORNEY

SN 77-727,448. WRIGHT, JED D., ROY, UT. FILED 5-1-2009.

IRATE INCORPORATED

THE MARK CONSISTS OF STANDARD CHARACTERS WITHOUT CLAIM TO ANY PARTICULAR FONT, STYLE, SIZE, OR COLOR.

NO CLAIM IS MADE TO THE EXCLUSIVE RIGHT TO USE "INCORPORATED", APART FROM THE MARK AS SHOWN.

CLASS 16—PAPER GOODS AND PRINTED MATTER

FOR DECALS AND STICKERS (U.S. CLS. 2, 5, 22, 23, 29, 37, 38 AND 50).
FIRST USE 10-17-2003; IN COMMERCE 11-17-2003.

CLASS 25—CLOTHING

FOR CLOTHING, NAMELY, SHIRTS, T-SHIRTS, SWEATSHIRTS, SWEATPANTS, HOODED SWEATSHIRTS, JACKETS, HATS, CAPS, BEANIES, SHOES, SOCKS, PANTS, SHORTS, JERSEYS AND TIES (U.S. CLS. 22 AND 39).

FIRST USE 10-17-2003; IN COMMERCE 11-17-2003.
MARGERY A. TIERNEY, EXAMINING ATTORNEY

SN 77-727,458. LIBERTY LEAGUE INTERNATIONAL, L.L.C., SCOTTSDALE, AZ. FILED 5-1-2009.

LIBERTY LEAGUE INTERNATIONAL

THE MARK CONSISTS OF STANDARD CHARACTERS WITHOUT CLAIM TO ANY PARTICULAR FONT, STYLE, SIZE, OR COLOR.

OWNER OF U.S. REG. NO. 2,836,342.

NO CLAIM IS MADE TO THE EXCLUSIVE RIGHT TO USE "LEAGUE INTERNATIONAL", APART FROM THE MARK AS SHOWN.

CLASS 9—ELECTRICAL AND SCIENTIFIC APPARATUS

FOR EDUCATIONAL MATERIALS, NAMELY, CD ROMS AND DVDS FEATURING EDUCATIONAL MATERIALS IN THE FIELDS OF PERSONAL DEVELOPMENT, SELF-HELP, AND GENERAL BUSINESS DEVELOPMENT (U.S. CLS. 21, 23, 26, 36 AND 38).

FIRST USE 7-1-2001; IN COMMERCE 7-1-2001.

CLASS 16—PAPER GOODS AND PRINTED MATTER

FOR PRINTED EDUCATIONAL MATERIALS IN THE FIELDS OF PERSONAL DEVELOPMENT, SELF-HELP, AND GENERAL BUSINESS DEVELOPMENT (U.S. CLS. 2, 5, 22, 23, 29, 37, 38 AND 50).

FIRST USE 7-1-2001; IN COMMERCE 7-1-2001.

CLASS 41—EDUCATION AND ENTERTAINMENT

FOR DEVELOPMENT AND DISSEMINATION OF EDUCATIONAL MATERIALS OF OTHERS, NAMELY, CD ROMS, DVDS, AND OTHER DIGITAL AND/OR ELECTRONIC MEDIA, AND PRINTED EDUCATIONAL MATERIALS IN THE FIELDS OF PERSONAL DEVELOPMENT, SELF-HELP, AND GENERAL BUSINESS DEVELOPMENT; AND EDUCATIONAL SERVICES, NAMELY, ARRANGING AND CONDUCTING SEMINARS FEATURING LIVE LECTURES IN THE FIELDS OF PERSONAL DEVELOPMENT, SELF-HELP AND GENERAL BUSINESS DEVELOPMENT, AND DISTRIBUTION OF COURSE MATERIALS IN CONNECTION THEREWITH (U.S. CLS. 100, 101 AND 107).

FIRST USE 7-1-2001; IN COMMERCE 7-1-2001.

RICHARD A. STRASER, EXAMINING ATTORNEY

SN 77-727,470. LIBERTY LEAGUE INTERNATIONAL, L.L.C., SCOTTSDALE, AZ. FILED 5-1-2009.

LIBERTY LEAGUE

THE MARK CONSISTS OF STANDARD CHARACTERS WITHOUT CLAIM TO ANY PARTICULAR FONT, STYLE, SIZE, OR COLOR.

OWNER OF U.S. REG. NO. 2,836,342.

NO CLAIM IS MADE TO THE EXCLUSIVE RIGHT TO USE "LEAGUE", APART FROM THE MARK AS SHOWN.

CLASS 9—ELECTRICAL AND SCIENTIFIC APPARATUS

FOR EDUCATIONAL MATERIALS, NAMELY, CD ROMS AND DVDS FEATURING EDUCATIONAL MATERIALS IN THE FIELDS OF PERSONAL DEVELOPMENT, SELF-HELP, AND GENERAL BUSINESS DEVELOPMENT (U.S. CLS. 21, 23, 26, 36 AND 38).

FIRST USE 7-1-2001; IN COMMERCE 7-1-2001.

CLASS 16—PAPER GOODS AND PRINTED MATTER

FOR PRINTED EDUCATIONAL MATERIALS IN THE FIELDS OF PERSONAL DEVELOPMENT, SELF-HELP, AND GENERAL BUSINESS DEVELOPMENT (U.S. CLS. 2, 5, 22, 23, 29, 37, 38 AND 50).

FIRST USE 7-1-2001; IN COMMERCE 7-1-2001.

CLASS 41—EDUCATION AND ENTERTAINMENT

FOR DEVELOPMENT AND DISSEMINATION OF EDUCATIONAL MATERIALS OF OTHERS, NAMELY, CD ROMS, DVDS, AND OTHER DIGITAL AND/OR ELECTRONIC MEDIA, AND PRINTED EDUCATIONAL MATERIALS IN THE FIELDS OF PERSONAL DEVELOPMENT, SELF-HELP, AND GENERAL BUSINESS DEVELOPMENT; AND EDUCATIONAL SERVICES, NAMELY, ARRANGING AND CONDUCTING SEMINARS FEATURING LIVE LECTURES IN THE FIELDS OF PERSONAL DEVELOPMENT, SELF-HELP AND GENERAL BUSINESS DEVELOPMENT, AND DISTRIBUTION OF COURSE MATERIALS IN CONNECTION THEREWITH (U.S. CLS. 100, 101 AND 107).

FIRST USE 7-1-2001; IN COMMERCE 7-1-2001.

RICHARD A. STRASER, EXAMINING ATTORNEY

SN 77-727,534. AOA GEOPHYSICS INC., HOUSTON, TX. FILED 5-1-2009.

Axis

THE MARK CONSISTS OF STANDARD CHARACTERS WITHOUT CLAIM TO ANY PARTICULAR FONT, STYLE, SIZE, OR COLOR.

CLASS 9—ELECTRICAL AND SCIENTIFIC APPARATUS

FOR SEISMIC EXPLORATION MACHINES AND APPARATUS (U.S. CLS. 21, 23, 26, 36 AND 38).

CLASS 42—SCIENTIFIC AND COMPUTER SERVICES

FOR GEOPHYSICAL PROSPECTING SERVICE (U.S. CLS. 100 AND 101).

ANDREA K. NADELMAN, EXAMINING ATTORNEY

SN 77-727,623. NARRELL, BRANDAN R, DBA ANCHORED MUSIC, DENTON, TX. FILED 5-2-2009.

Anchored

THE MARK CONSISTS OF STANDARD CHARACTERS WITHOUT CLAIM TO ANY PARTICULAR FONT, STYLE, SIZE, OR COLOR.

CLASS 9—ELECTRICAL AND SCIENTIFIC APPARATUS

FOR MUSICAL SOUND RECORDINGS (U.S. CLS. 21, 23, 26, 36 AND 38).

CLASS 25—CLOTHING

FOR WEARABLE GARMENTS AND CLOTHING, NAMELY, SHIRTS (U.S. CLS. 22 AND 39).

CLASS 41—EDUCATION AND ENTERTAINMENT

FOR ENTERTAINMENT SERVICES IN THE NATURE OF LIVE MUSICAL PERFORMANCES (U.S. CLS. 100, 101 AND 107).

SANDRA MANIOS, EXAMINING ATTORNEY

SN 77-727,695. GIRLS FROM SAVOY, L.L.C., BLACKWOOD, NJ. FILED 5-2-2009.

Girls from Savoy

THE MARK CONSISTS OF STANDARD CHARACTERS WITHOUT CLAIM TO ANY PARTICULAR FONT, STYLE, SIZE, OR COLOR.

CLASS 42—SCIENTIFIC AND COMPUTER SERVICES

FOR FASHION DESIGN CONSULTING SERVICES (U.S. CLS. 100 AND 101).

CLASS 45—PERSONAL AND LEGAL SERVICES

FOR FASHION CONSULTING SERVICES (U.S. CLS. 100 AND 101).

CAROLINE WOOD, EXAMINING ATTORNEY

SN 77-727,730. MARINO, MATTHEW S, CONCORD, MA. FILED 5-2-2009.

BuyBorg

THE MARK CONSISTS OF STANDARD CHARACTERS WITHOUT CLAIM TO ANY PARTICULAR FONT, STYLE, SIZE, OR COLOR.

CLASS 35—ADVERTISING AND BUSINESS

FOR INTERNET ADVERTISING SERVICES; PROMOTING THE GOODS AND SERVICES OF OTHERS BY PROVIDING A WEB SITE FEATURING COUPONS, REBATES, PRICE-COMPARISON INFORMATION, PRODUCT REVIEWS, LINKS TO THE RETAIL WEB SITES OF OTHERS, AND DISCOUNT INFORMATION; PROVISION OF SPACE ON WEBSITES FOR ADVERTISING GOODS AND SERVICES (U.S. CLS. 100, 101 AND 102).

CLASS 38—COMMUNICATION

FOR STREAMING OF AUDIO MATERIAL ON THE INTERNET; STREAMING OF AUDIO, VISUAL AND AUDIOVISUAL MATERIAL VIA A GLOBAL COMPUTER NETWORK; STREAMING OF VIDEO MATERIAL ON THE INTERNET (U.S. CLS. 100, 101 AND 104).

CLASS 42—SCIENTIFIC AND COMPUTER SERVICES

FOR PROVIDING A WEB SITE FEATURING TEMPORARY USE OF NON-DOWNLOADABLE SOFTWARE ALLOWING WEB SITE USERS TO UPLOAD, POST AND DISPLAY ONLINE VIDEOS FOR SHARING WITH OTHERS FOR ENTERTAINMENT PURPOSES; PROVIDING A WEBSITE THAT GIVES USERS THE ABILITY TO CREATE CUSTOMIZED WEB PAGES FEATURING USER-DEFINED INFORMATION; PROVIDING A WEBSITE THAT GIVES USERS THE ABILITY TO CREATE CUSTOMIZED WEB PAGES FEATURING USER-DEFINED PROFILES (U.S. CLS. 100 AND 101).

CLASS 45—PERSONAL AND LEGAL SERVICES

FOR PROVIDING A SOCIAL NETWORKING WEBSITE FOR ENTERTAINMENT PURPOSES (U.S. CLS. 100 AND 101).

BARBARA BROWN, EXAMINING ATTORNEY

SN 77-727,765. 930185 ONTARIO LTD., DBA TECHS4BIZ, TORONTO, ONTARIO, CANADA, FILED 5-3-2009.

Pervidi

THE MARK CONSISTS OF STANDARD CHARACTERS WITHOUT CLAIM TO ANY PARTICULAR FONT, STYLE, SIZE, OR COLOR.

CLASS 9—ELECTRICAL AND SCIENTIFIC APPARATUS

FOR COMPUTER SOFTWARE FOR USE IN CUSTOMER RELATIONSHIP MANAGEMENT (CRM); COMPUTER SOFTWARE FOR COLLECTING DATA, ANALYZING DATA, AND PROVIDING REPORTS TO AUTOMATE THE PROCESS OF ELECTRONICALLY RECORDING INSPECTIONS AND WORK ORDER INFORMATION; COMPUTER SOFTWARE, NAMELY, AN APPLICATION ALLOWING SALES AND FIELD SERVICE EMPLOYEES TO UPDATE AND RECEIVE DATA STORED IN AN ENTERPRISE'S COMPUTER DATABASES IN REAL TIME, USING A MOBILE DEVICE, WITH FULL TELEPHONY INTEGRATION WITH THE TELEPHONE AND/OR SOFTWARE FEATURES OF THE MOBILE DEVICE (U.S. CLS. 21, 23, 26, 36 AND 38).

FIRST USE 1-1-2001; IN COMMERCE 1-1-2001.

CLASS 42—SCIENTIFIC AND COMPUTER SERVICES

FOR APPLICATION SERVICE PROVIDER (ASP) FEATURING SOFTWARE FOR USE FOR PROVIDING AN ON-LINE DATABASE IN THE FIELD OF TRANSACTION PROCESSING TO UPLOAD TRANSACTIONAL DATA, PROVIDE STATISTICAL ANALYSIS, AND PRODUCE NOTIFICATIONS AND REPORTS; DATA AUTOMATION AND COLLECTION SERVICE USING PROPRIETARY SOFTWARE TO EVALUATE, ANALYZE AND COLLECT SERVICE DATA (U.S. CLS. 100 AND 101).

FIRST USE 1-1-2001; IN COMMERCE 1-1-2001.
DAVID COLLIER, EXAMINING ATTORNEY

SN 77-728,320. THE ROCHESTER GROUP, INC., ROCHESTER, NY. FILED 5-4-2009.

SN 77-728,520. EPIGRAPHICS SOFTWARE, INC., HILLSIDE, IL. FILED 5-4-2009.

AVITRAK

THE MARK CONSISTS OF STANDARD CHARACTERS WITHOUT CLAIM TO ANY PARTICULAR FONT, STYLE, SIZE, OR COLOR.

CLASS 9—ELECTRICAL AND SCIENTIFIC APPARATUS

FOR COMPUTER SOFTWARE FOR VIEWING AND ANALYZING BUSINESS DATA (U.S. CLS. 21, 23, 26, 36 AND 38).

CLASS 35—ADVERTISING AND BUSINESS

FOR CONSULTING SERVICES IN THE FIELD OF BUSINESS DATA AND BUSINESS MODELING (U.S. CLS. 100, 101 AND 102).

CLASS 42—SCIENTIFIC AND COMPUTER SERVICES

FOR APPLICATION SERVICE PROVIDER, NAMELY, PROVIDING HOSTING, MANAGING, DEVELOPING, RESEARCHING, ANALYZING, REPORTING AND MAINTAINING APPLICATIONS, SOFTWARE, WEB SITES AND DATABASES FOR OTHERS IN THE FIELDS OF BUSINESS DATA AND BUSINESS MODELING (U.S. CLS. 100 AND 101).

MATTHEW KLINE, EXAMINING ATTORNEY

SN 77-728,332. PV NEXT CORPORATION, 30351, TAIWAN, FILED 5-4-2009.

PVNEXT

THE MARK CONSISTS OF STANDARD CHARACTERS WITHOUT CLAIM TO ANY PARTICULAR FONT, STYLE, SIZE, OR COLOR.

CLASS 9—ELECTRICAL AND SCIENTIFIC APPARATUS

FOR SOLAR BATTERIES; SOLAR CELLS (U.S. CLS. 21, 23, 26, 36 AND 38).

CLASS 40—MATERIAL TREATMENT

FOR CUSTOM MANUFACTURE OF SOLAR CELLS AND SOLAR BATTERIES FOR OTHERS (U.S. CLS. 100, 103 AND 106).

WARREN L. OLANDRIA, EXAMINING ATTORNEY

Phrasaurus

THE MARK CONSISTS OF STANDARD CHARACTERS WITHOUT CLAIM TO ANY PARTICULAR FONT, STYLE, SIZE, OR COLOR.

CLASS 9—ELECTRICAL AND SCIENTIFIC APPARATUS

FOR COMPUTER PROGRAMS FOR ASSISTING INDIVIDUALS IN THE FIELD OF WRITING AND ADVERTISING (U.S. CLS. 21, 23, 26, 36 AND 38).

FIRST USE 1-1-2006; IN COMMERCE 1-1-2006.

CLASS 16—PAPER GOODS AND PRINTED MATTER

FOR REFERENCE BOOKS IN THE FIELD OF WRITING AND ADVERTISING; RESOURCE BOOKS IN THE FIELD OF WRITING AND ADVERTISING (U.S. CLS. 2, 5, 22, 23, 29, 37, 38 AND 50).

FIRST USE 1-1-2006; IN COMMERCE 1-1-2006.

TOBY BULLOFF, EXAMINING ATTORNEY

SN 77-728,633. LIVING HARVEST FOODS, INC., PORTLAND, OR. FILED 5-4-2009.

LIVING HARVEST

THE MARK CONSISTS OF STANDARD CHARACTERS WITHOUT CLAIM TO ANY PARTICULAR FONT, STYLE, SIZE, OR COLOR.

OWNER OF U.S. REG. NOS. 3,261,810 AND 3,391,657.

CLASS 29—MEATS AND PROCESSED FOODS

FOR HEMP-BASED PRODUCTS, NAMELY, YOGURT, DRINKING YOGURT AND YOGURT-BASED BEVERAGES (U.S. CL. 46).

CLASS 30—STAPLE FOODS

FOR HEMP-BASED PRODUCTS, NAMELY, FROZEN YOGURT AND FROZEN YOGURT CONFECTIONS (U.S. CL. 46).

TRACY FLETCHER, EXAMINING ATTORNEY

SN 77-728,654. MODERN MUSE, INC., SEATTLE, WA. FILED
5-4-2009.



THE MARK CONSISTS OF A STYLIZED LETTER "M".

CLASS 9—ELECTRICAL AND SCIENTIFIC APPARATUS

FOR DECORATIVE MAGNETS; SPORTS HELMETS; MOTORCYCLE HELMETS; CASES FOR MOBILE PHONES; CASES FOR PORTABLE MUSIC PLAYERS; DECORATIVE ORNAMENTS FOR CELL PHONES; EYEGLASS CASES; EYEGLASS FRAMES; DECORATIVE SWITCH PLATE COVERS (U.S. CLS. 21, 23, 26, 36 AND 38).

CLASS 14—JEWELRY

FOR JEWELRY; CLOCKS; WATCHES; WATCH BANDS AND STRAPS; TIMEPIECES; MEDALS; CUFF LINKS AND TIE CLIPS; CHARMS AS PERSONAL JEWELRY; JEWELRY BOXES (U.S. CLS. 2, 27, 28 AND 50).

CLASS 18—LEATHER GOODS

FOR LUGGAGE; BACKPACKS; HANDBAGS; WALLETS; COIN PURSES; BAGS FOR SPORTS; BOOK BAGS; ALL-PURPOSE CARRYING BAGS; BELT BAGS AND HIP BAGS; HARNESSES AND SADDLERY; COLLARS FOR ANIMALS; ANIMAL LEASHES; CLOTHING FOR ANIMALS; ANIMAL CARRIERS (U.S. CLS. 1, 2, 3, 22 AND 41).

CLASS 20—FURNITURE AND ARTICLES NOT OTHERWISE CLASSIFIED

FOR FURNITURE; BULLETIN BOARDS; DISPLAY UNITS; PILLOWS; WINDOW SHADES; NON-METAL KEY FOBS; HAND-HELD MIRRORS; PHOTO STANDS; PICTURE FRAMES; DECORATIVE MOBILES (U.S. CLS. 2, 13, 22, 25, 32 AND 50).

CLASS 21—HOUSEWARES AND GLASS

FOR DISHWARE; MUGS; BEVERAGE GLASSWARE; CANDLE HOLDERS; NAPKIN RINGS; TEAPOTS; CONTAINERS FOR HOUSEHOLD USE; VASES; GARBAGE CANS; LUNCHBOXES; SERVING TRAYS (U.S. CLS. 2, 13, 23, 29, 30, 33, 40 AND 50).

CLASS 25—CLOTHING

FOR CLOTHING, NAMELY, COATS, JACKETS, BELTS, PANTS, TOPS, SKIRTS, SOCKS AND STOCKINGS, SWIMWEAR, NECKWEAR, HEADWEAR, FOOTWEAR, GLOVES (U.S. CLS. 22 AND 39).

CLASS 26—FANCY GOODS

FOR BUTTONS; RIVET BUTTONS; SNAP FASTENERS; HAT ORNAMENTS NOT OF PRECIOUS METAL; SMALL NON-PRECIOUS METAL DECORATIONS IN THE NATURE OF ORNAMENTS FOR ATTACHMENT TO SHOES, CLOTHING, BAGS, AND PERSONAL ITEMS; HAIR ORNAMENTS; BELT BUCKLES (U.S. CLS. 37, 39, 40, 42 AND 50).

HEATHER SAPP, EXAMINING ATTORNEY

SN 77-728,714. PHARMAVITE LLC, MISSION HILLS, CA.
FILED 5-4-2009.

PACKED WITH SOY. BAKED IN
HISTORY

THE MARK CONSISTS OF STANDARD CHARACTERS WITHOUT CLAIM TO ANY PARTICULAR FONT, STYLE, SIZE, OR COLOR.

NO CLAIM IS MADE TO THE EXCLUSIVE RIGHT TO USE "PACKED WITH SOY", APART FROM THE MARK AS SHOWN.

CLASS 5—PHARMACEUTICALS

FOR VITAMIN AND/OR MINERAL-CONTAINING NUTRITION BARS, NAMELY, MEAL REPLACEMENT BARS AND NUTRITIONAL ENERGY BARS FOR USE AS A MEAL SUBSTITUTE (U.S. CLS. 6, 18, 44, 46, 51 AND 52).

CLASS 29—MEATS AND PROCESSED FOODS

FOR SOY-BASED NUTRITIONAL SNACK BARS (U.S. CL. 46).
JENNY PARK, EXAMINING ATTORNEY

SN 77-728,718. ORIGINAL PRODUCTIONS LLC, BURBANK,
CA. FILED 5-4-2009.

MGMC

THE MARK CONSISTS OF STANDARD CHARACTERS WITHOUT CLAIM TO ANY PARTICULAR FONT, STYLE, SIZE, OR COLOR.

CLASS 16—PAPER GOODS AND PRINTED MATTER

FOR PUBLICATIONS, NAMELY, BOOKS IN THE FIELDS OF CARS (U.S. CLS. 2, 5, 22, 23, 29, 37, 38 AND 50).

CLASS 25—CLOTHING

FOR HATS; SHORT-SLEEVED OR LONG-SLEEVED T-SHIRTS (U.S. CLS. 22 AND 39).

CLASS 41—EDUCATION AND ENTERTAINMENT

FOR ENTERTAINMENT SERVICES IN THE NATURE OF AN ON-GOING REALITY BASED TELEVISION PROGRAM (U.S. CLS. 100, 101 AND 107).
EMILY CARLSEN, EXAMINING ATTORNEY

SN 77-728,727. IMAGING TECHNOLOGIES DIRECT LLC, LOS ANGELES, CA. FILED 5-4-2009.

RHINOTEK

THE MARK CONSISTS OF STANDARD CHARACTERS WITHOUT CLAIM TO ANY PARTICULAR FONT, STYLE, SIZE, OR COLOR.

CLASS 2—PAINTS

FOR INK JET CARTRIDGES; TONER CARTRIDGES (U.S. CLS. 6, 11 AND 16).
FIRST USE 8-1-1997; IN COMMERCE 8-1-1997.

CLASS 9—ELECTRICAL AND SCIENTIFIC APPARATUS

FOR BLANK MAGNETIC COMPUTER TAPES (U.S. CLS. 21, 23, 26, 36 AND 38).
FIRST USE 8-1-1997; IN COMMERCE 8-1-1997.

CLASS 16—PAPER GOODS AND PRINTED MATTER

FOR COMPUTER PRINTER RIBBONS (U.S. CLS. 2, 5, 22, 23, 29, 37, 38 AND 50).
FIRST USE 8-1-1997; IN COMMERCE 8-1-1997.

CLASS 35—ADVERTISING AND BUSINESS

FOR WHOLESALE AND RETAIL STORE SERVICES FEATURING INK JET CARTRIDGES, TONER CARTRIDGES, AND OTHER COMPUTER AND PRINTER PRODUCTS (U.S. CLS. 100, 101 AND 102).
FIRST USE 8-1-1997; IN COMMERCE 8-1-1997.
DAVID H. STINE, EXAMINING ATTORNEY

SN 77-729,029. BAYER AKTIENGESELLSCHAFT, LEVERKUSEN, FED REP GERMANY, FILED 5-5-2009.

BETAPOCKET

THE MARK CONSISTS OF STANDARD CHARACTERS WITHOUT CLAIM TO ANY PARTICULAR FONT, STYLE, SIZE, OR COLOR.

CLASS 9—ELECTRICAL AND SCIENTIFIC APPARATUS

FOR DATA PROCESSING EQUIPMENT AND COMPUTERS FOR USE IN THE FIELD OF MEDICINE (U.S. CLS. 21, 23, 26, 36 AND 38).

CLASS 10—MEDICAL APPARATUS

FOR MEDICAL INSTRUMENTS IN THE FIELD OF TREATMENT OF MULTIPLE SCLEROSIS (U.S. CLS. 26, 39 AND 44).

CLASS 44—MEDICAL, BEAUTY AND AGRICULTURAL SERVICES

FOR MEDICAL SERVICES IN THE FIELD OF TREATMENT OF MULTIPLE SCLEROSIS (U.S. CLS. 100 AND 101).
EDWARD NELSON, EXAMINING ATTORNEY

SN 77-729,551. FIRST NATIONAL OF NEBRASKA, INC., OMAHA, NE. FILED 5-5-2009.

GIMMERWARDS

THE MARK CONSISTS OF STANDARD CHARACTERS WITHOUT CLAIM TO ANY PARTICULAR FONT, STYLE, SIZE, OR COLOR.

CLASS 35—ADVERTISING AND BUSINESS

FOR PROMOTING THE SALE OF CREDIT CARD ACCOUNTS THROUGH THE ADMINISTRATION OF INCENTIVE AWARD PROGRAMS (U.S. CLS. 100, 101 AND 102).

CLASS 36—INSURANCE AND FINANCIAL

FOR CREDIT CARD SERVICES (U.S. CLS. 100, 101 AND 102).
ALICE BENMAMAN, EXAMINING ATTORNEY

SN 77-732,850. HOSPIRA, INC., LAKE FOREST, IL. FILED 5-8-2009.

PROTECOL

THE MARK CONSISTS OF STANDARD CHARACTERS WITHOUT CLAIM TO ANY PARTICULAR FONT, STYLE, SIZE, OR COLOR.

CLASS 40—MATERIAL TREATMENT

FOR MANUFACTURING SERVICES IN THE FIELD OF PROTEINS AND PEPTIDES (U.S. CLS. 100, 103 AND 106).
FIRST USE 12-31-2005; IN COMMERCE 12-31-2005.

CLASS 42—SCIENTIFIC AND COMPUTER SERVICES

FOR RESEARCH AND DEVELOPMENT SERVICES IN THE FIELD OF PROTEINS AND PEPTIDES (U.S. CLS. 100 AND 101).
FIRST USE 12-31-2005; IN COMMERCE 12-31-2005.
CHRIS WELLS, EXAMINING ATTORNEY

SN 77-733,674. REED ELSEVIER PROPERTIES INC., WILMINGTON, DE. FILED 5-11-2009.

SN 77-736,624. CONRAD FAFARD, INC., AGAWAM, MA. FILED 5-14-2009.



NO CLAIM IS MADE TO THE EXCLUSIVE RIGHT TO USE "ENGINEERING", APART FROM THE MARK AS SHOWN.

THE MARK CONSISTS OF THE LETTERS "EZ" PARTIALLY OVERLAPPING A CIRCLE DESIGN WITH AN ARROW NEXT TO THE LETTER "Z". THE STACKED WORDING "ENGINEERING ZONE" APPEARS TO THE RIGHT OF THE DESIGN WITH A LINE RUNNING BETWEEN THE WORDS.

CLASS 16—PAPER GOODS AND PRINTED MATTER

FOR MAGAZINE IN THE FIELD OF ENGINEERING, SCIENTIFIC AND TECHNOLOGICAL DEVELOPMENT (U.S. CLS. 2, 5, 22, 23, 29, 37, 38 AND 50).

CLASS 42—SCIENTIFIC AND COMPUTER SERVICES

FOR PROVIDING ONLINE INFORMATION IN THE FIELDS OF ENGINEERING, SCIENTIFIC, AND TECHNOLOGICAL DEVELOPMENT (U.S. CLS. 100 AND 101). JAMES LOVELACE, EXAMINING ATTORNEY

SN 77-735,821. POLYCOM, INC., PLEASANTON, CA. FILED 5-13-2009.

E2BCONNECT

THE MARK CONSISTS OF STANDARD CHARACTERS WITHOUT CLAIM TO ANY PARTICULAR FONT, STYLE, SIZE, OR COLOR.

CLASS 35—ADVERTISING AND BUSINESS

FOR BUSINESS NETWORKING; ON-LINE BUSINESS NETWORKING SERVICES (U.S. CLS. 100, 101 AND 102).

CLASS 42—SCIENTIFIC AND COMPUTER SERVICES

FOR COMPUTER SERVICES, NAMELY, CREATING AN ON-LINE COMMUNITY FOR REGISTERED USERS TO PARTICIPATE IN DISCUSSIONS, GET FEEDBACK FROM THEIR PEERS, FORM VIRTUAL COMMUNITIES, AND ENGAGE IN SOCIAL NETWORKING (U.S. CLS. 100 AND 101).

CLASS 45—PERSONAL AND LEGAL SERVICES

FOR ON-LINE SOCIAL NETWORKING SERVICES (U.S. CLS. 100 AND 101). MIDGE BUTLER, EXAMINING ATTORNEY

Science Behind The Art

THE MARK CONSISTS OF STANDARD CHARACTERS WITHOUT CLAIM TO ANY PARTICULAR FONT, STYLE, SIZE, OR COLOR.

CLASS 1—CHEMICALS

FOR PEAT HUMUS, MANURES, COMPOSTS, SOIL AMENDMENTS, PLANT FOOD, SOIL CONDITIONERS, AND POTTING SOIL (U.S. CLS. 1, 5, 6, 10, 26 AND 46).

CLASS 31—NATURAL AGRICULTURAL PRODUCTS

FOR PEAT MOSS (U.S. CLS. 1 AND 46). JASON BLAIR, EXAMINING ATTORNEY

SN 77-737,199. TARGET BRANDS, INC., MINNEAPOLIS, MN. FILED 5-14-2009.

MARKET PANTRY

THE MARK CONSISTS OF STANDARD CHARACTERS WITHOUT CLAIM TO ANY PARTICULAR FONT, STYLE, SIZE, OR COLOR.

OWNER OF U.S. REG. NOS. 2,562,603, 2,564,715 AND 2,768,080.

CLASS 29—MEATS AND PROCESSED FOODS

FOR POTATO BASED SNACK FOODS; FRUIT BASED SNACK FOODS; SNACK MIX CONSISTING PRIMARILY OF PROCESSED FRUITS, PROCESSED NUTS AND/OR RAISINS; DRIED FRUITS; PROCESSED, PREPARED AND ROASTED NUTS; JERKY; DEHYDRATED FRUITS; PROCESSED LUNCHEON MEATS; MEAT; FISH; POULTRY; SEAFOOD; SAUSAGES; PEANUT BUTTER; FRUIT PRESERVES; JELLIES; CANNED OR PROCESSED OLIVES; PICKLES; INSTANT POTATOES; FLAKED COCONUT; SOUP MIXES; DRIED BEANS; CANNED BEANS WITH OR WITHOUT MEAT; CANNED VEGETABLES; CANNED SOUPS; CANNED OR BOTTLED FRUITS; COOKING OR VEGETABLE OILS; CHEESE; SHORTENING, NONDAIRY CREAMER; DIPS, EXCLUDING SALSA AND OTHER SAUCES USED AS DIPS; MILK; HALF AND HALF, MILK AND CREAM MIXTURE; WHIPPED CREAM; CONDENSED AND EVAPORATED MILK; EGGS; SOUR CREAM; COTTAGE CHEESE; BUTTER; MARGARINE; CREAM CHEESE; FROZEN VEGETABLES; PREPARED AND OR PROCESSED POTATOES; FROZEN APPETIZERS CONSISTING PRIMARILY OF MEAT, CHICKEN, SEAFOOD, CHEESE, AND/OR VEGETABLES; FROZEN APPETIZERS CONSISTING PRIMARILY OF JALAPENO PEPPERS; NON-DAIRY WHIPPED TOPPING; FROZEN FRUIT; BAGGED GARDEN SALADS; POTATO SALAD; APPLESAUCE; FROZEN ENTREES CONSISTING PRIMARILY OF MEAT, FISH, POULTRY AND/OR VEGETABLES; FRUIT BASED PIE FILLING FOR CAKES AND PIES (U.S. CL. 46). FIRST USE 7-31-2001; IN COMMERCE 7-31-2001.

CLASS 30—STAPLE FOODS

FOR CANDY; COOKIES; GRANOLA-BASED SNACK FOODS; GRANOLA; READY-TO-EAT CEREAL DERIVED FOOD BARS; PUDDINGS; PASTRIES; CAKE MIXES; CAKES; CUPCAKES; PIES; DONUTS; MUFFINS; BAGELS; DANISHES; BREAKFAST CEREALS; OATMEAL; PANCAKE MIXES; BAKERY MIXES; CONES FOR ICE CREAM; BISCUITS; CINNAMON ROLLS; SANDWICHES; WAFFLES; MARSHMALLOWS; CONFECTIONERY CHIPS FOR BAKING; FRUIT BASED PIE FILLING FOR CAKES AND PIES; BAKING POWDER; SPICES; VANILLA; CORN SYRUP; PANCAKE SYRUP; BAKING SODA; SALT; SUGAR AND SUGAR SUBSTITUTES; POWDERED SUGAR; BROWN SUGAR; FLOUR; RICE; FLAVORED NOODLE AND RICE MIXES; FLAVORED AND SWEETENED GELATINS; FLAVORING SYRUPS; TEA BAGS; COFFEE; COCOA MIXES; TEA; ICE CREAM; FROZEN CONFECTIONS; FROZEN CONFECTIONS, NAMELY, FREEZER POPS; SHERBET; TORTILLA CHIPS; PRETZELS; CORN CHIPS; CHEESE FLAVORED PUFFED CORN SNACKS; MICROWAVE POPCORN; CRACKERS; BREADS AND BUNS; STUFFING MIXES CONTAINING BREAD; NOODLES OR SAUCE MIXES OR SEASONING COMBINED IN UNITARY PACKAGES; MACARONI AND CHEESE; PIZZA CRUST; TORTILLAS; TACO SHELLS; RICE; RICE AND SEASONING MIX COMBINED IN UNITARY PACKAGES; PASTA AND NOODLES; PIE CRUST; BREAD STICKS; TEA BASED BEVERAGES WITH FRUIT FLAVORING; ICED TEA; FLAVORED ICES; MINCED GARLIC; HONEY; KETCHUP; MUSTARD; MARIANADES; SAUCES; MAYONNAISE; SALAD DRESSINGS; VINEGAR; GRAVY; CANNED SPAGHETTI AND MEATBALLS; CANNED SPAGHETTI SAUCE WITH PASTA; SALSA; TACO SEASONING; SOY SAUCE; PASTA SAUCE; RAVIOLI; PIZZA; MACARONI SALAD; PASTA SALAD; MACARONI AND CHEESE DINNERS (U.S. CL. 46).

FIRST USE 6-30-2001; IN COMMERCE 6-30-2001.

CLASS 31—NATURAL AGRICULTURAL PRODUCTS

FOR FRESH FRUITS AND VEGETABLES; RAW FRUITS AND VEGETABLES; UNPROCESSED FRUITS AND VEGETABLES (U.S. CLS. 1 AND 46).

FIRST USE 0-0-2003; IN COMMERCE 0-0-2003.

CLASS 32—LIGHT BEVERAGES

FOR FLAVORED AND NON-FLAVORED BOTTLED WATERS; SPARKLING WATERS; FRUIT JUICES; VEGETABLE JUICES; FRUIT FLAVORED DRINKS AND JUICES; SELTZER WATER; SMOOTHIES; SOFT DRINKS; FRUIT JUICE CONCENTRATES (U.S. CLS. 45, 46 AND 48).

FIRST USE 6-30-2001; IN COMMERCE 6-30-2001.
JESSICA FATHY, EXAMINING ATTORNEY

SN 77-737,904. FLUOR CORPORATION, IRVING, TX. FILED 5-15-2009.

FLUOR

Complex Challenges. Easy Choice.

THE MARK CONSISTS OF THE WORD "FLUOR" WITH THE WORDS "COMPLEX CHALLENGES. EASY CHOICE." BELOW IT IN A SMALLER FONT.

CLASS 37—CONSTRUCTION AND REPAIR

FOR CONSTRUCTION, MAINTENANCE AND/OR REPAIR SERVICES ON A CUSTOM BASIS FOR BUILDINGS, PLANTS, STRUCTURES, OPERATING AND PROCESSING FACILITIES, WELLS, LABORATORIES, PILOT PLANTS AND EQUIPMENT FOR THE AEROSPACE, AUTOMOTIVE, BIOTECHNOLOGY, CHEMICAL, ELECTRICAL POWER GENERATING, ELECTRONICS, ENVIRONMENTAL, GENERAL COMMERCIAL, MANUFACTURING, MATERIAL PROCESSING, METALLURGICAL MINING, NATURAL GAS, NUCLEAR ENERGY, OFFSHORE PETROLEUM, PETROCHEMICAL, PETROLEUM, PHARMACEUTICAL, PLASTICS, PULP/PAPER TELECOMMUNICATION, THERMAL ENERGY AND TRANSPORTATION INDUSTRIES; CONSULTATION SERVICES ON A CUSTOM BASIS RELATING TO CLEANING-UP ISSUES, NAMELY, THE ABATEMENT, CONTROL AND DISPOSAL OF HAZARDOUS WASTES AND ENVIRONMENTAL POLLUTANTS (U.S. CLS. 100, 103 AND 106).

CLASS 40—MATERIAL TREATMENT

FOR CONSULTATION SERVICES ON A CUSTOM BASIS RELATING TO TREATMENT ISSUES, NAMELY, THE ABATEMENT, CONTROL AND DISPOSAL OF HAZARDOUS WASTES AND ENVIRONMENTAL POLLUTANTS (U.S. CLS. 100, 103 AND 106).

CLASS 42—SCIENTIFIC AND COMPUTER SERVICES

FOR ARCHITECTURAL AND ENGINEERING SERVICES ON A CUSTOM BASIS FOR THE DESIGN OF BUILDINGS, PLANTS, STRUCTURES, OPERATING AND PROCESSING FACILITIES, WELLS, LABORATORIES, PILOT PLANTS AND EQUIPMENT, AND RELATED STRUCTURES FOR AEROSPACE, AUTOMOTIVE, BIOTECHNOLOGY, CHEMICAL, ELECTRICAL POWER GENERATING, ELECTRONICS, ENVIRONMENTAL, GENERAL COMMERCIAL, MANUFACTURING, MATERIAL PROCESSING, METALLURGICAL MINING, NATURAL GAS, NUCLEAR ENERGY, OFFSHORE PETROLEUM, PETROCHEMICAL, PETROLEUM, PHARMACEUTICAL, PLASTICS, PULP/PAPER, TELECOMMUNICATION, THERMAL ENERGY AND TRANSPORTATION INDUSTRIES; SCIENTIFIC CONSULTATION SERVICES ON A CUSTOM BASIS RELATING TO THE ABATEMENT, CONTROL AND DISPOSAL OF HAZARDOUS WASTES AND ENVIRONMENTAL POLLUTANTS (U.S. CLS. 100 AND 101).

KARANENDRA S. CHHINA, EXAMINING ATTORNEY

SN 77-737,940. FLUOR CORPORATION, IRVING, TX. FILED 5-15-2009.

FLUOR. COMPLEX CHALLENGES.
EASY CHOICE.

THE MARK CONSISTS OF STANDARD CHARACTERS WITHOUT CLAIM TO ANY PARTICULAR FONT, STYLE, SIZE, OR COLOR.

CLASS 37—CONSTRUCTION AND REPAIR

FOR CONSTRUCTION, MAINTENANCE AND/OR REPAIR SERVICES ON A CUSTOM BASIS FOR BUILDINGS, PLANTS, STRUCTURES, OPERATING AND PROCESSING FACILITIES, WELLS, LABORATORIES, PILOT PLANTS AND EQUIPMENT FOR THE AEROSPACE, AUTOMOTIVE, BIOTECHNOLOGY, CHEMICAL, ELECTRICAL POWER GENERATING, ELECTRONICS, ENVIRONMENTAL, GENERAL COMMERCIAL, MANUFACTURING, MATERIAL PROCESSING, METALLURGICAL MINING, NATURAL GAS, NUCLEAR ENERGY, OFFSHORE PETROLEUM, PETROCHEMICAL, PETROLEUM, PHARMACEUTICAL, PLASTICS, PULP/PAPER TELECOMMUNICATION, THERMAL ENERGY AND TRANSPORTATION INDUSTRIES; CONSULTATION SERVICES ON A CUSTOM BASIS RELATING TO CLEANING-UP ISSUES, NAMELY, THE ABATEMENT, CONTROL AND DISPOSAL OF HAZARDOUS WASTES AND ENVIRONMENTAL POLLUTANTS (U.S. CLS. 100, 103 AND 106).

CLASS 40—MATERIAL TREATMENT

FOR CONSULTATION SERVICES ON A CUSTOM BASIS RELATING TO TREATMENT ISSUES, NAMELY, THE ABATEMENT, CONTROL AND DISPOSAL OF HAZARDOUS WASTES AND ENVIRONMENTAL POLLUTANTS (U.S. CLS. 100, 103 AND 106).

CLASS 42—SCIENTIFIC AND COMPUTER SERVICES

FOR ARCHITECTURAL AND ENGINEERING SERVICES ON A CUSTOM BASIS FOR THE DESIGN OF BUILDINGS, PLANTS, STRUCTURES, OPERATING AND PROCESSING FACILITIES, WELLS, LABORATORIES, PILOT PLANTS AND EQUIPMENT, AND RELATED STRUCTURES FOR AEROSPACE, AUTOMOTIVE, BIOTECHNOLOGY, CHEMICAL, ELECTRICAL POWER GENERATING, ELECTRONICS, ENVIRONMENTAL, GENERAL COMMERCIAL, MANUFACTURING, MATERIAL PROCESSING, METALLURGICAL MINING, NATURAL GAS, NUCLEAR ENERGY, OFFSHORE PETROLEUM, PETROCHEMICAL, PETROLEUM, PHARMACEUTICAL, PLASTICS, PULP/PAPER, TELECOMMUNICATION, THERMAL ENERGY AND TRANSPORTATION INDUSTRIES; SCIENTIFIC CONSULTATION SERVICES ON A CUSTOM BASIS RELATING TO THE ABATEMENT, CONTROL AND DISPOSAL OF HAZARDOUS WASTES AND ENVIRONMENTAL POLLUTANTS (U.S. CLS. 100 AND 101).
KARANENDRA S. CHHINA, EXAMINING ATTORNEY

SN 77-739,725. CHICAGO TRIBUNE COMPANY, CHICAGO, IL. FILED 5-18-2009.

HAWKEY TOWN

THE MARK CONSISTS OF STANDARD CHARACTERS WITHOUT CLAIM TO ANY PARTICULAR FONT, STYLE, SIZE, OR COLOR.

CLASS 16—PAPER GOODS AND PRINTED MATTER

FOR NEWSPAPERS (U.S. CLS. 2, 5, 22, 23, 29, 37, 38 AND 50).

CLASS 35—ADVERTISING AND BUSINESS

FOR ADVERTISING, MARKETING AND PROMOTION SERVICES (U.S. CLS. 100, 101 AND 102).

CLASS 41—EDUCATION AND ENTERTAINMENT

FOR ENTERTAINMENT SERVICES, NAMELY, PROVIDING A WEB SITE FEATURING PHOTOGRAPHIC, VIDEO AND PROSE PRESENTATIONS FEATURING SPORTS (U.S. CLS. 100, 101 AND 107).
JAMES A. RAUEN, EXAMINING ATTORNEY

SN 77-740,156. MEADWESTVACO CORPORATION, GLEN ALLEN, VA. FILED 5-19-2009.

MED-EASY

THE MARK CONSISTS OF STANDARD CHARACTERS WITHOUT CLAIM TO ANY PARTICULAR FONT, STYLE, SIZE, OR COLOR.

OWNER OF ERPN CMNTY TM OFC REG. NO. 005794011, DATED 2-18-2008, EXPIRES 3-28-2017.

CLASS 16—PAPER GOODS AND PRINTED MATTER

FOR PAPERBOARD PACKAGING CONTAINERS FOR PHARMACEUTICALS AND DRUGS (U.S. CLS. 2, 5, 22, 23, 29, 37, 38 AND 50).

CLASS 20—FURNITURE AND ARTICLES NOT OTHERWISE CLASSIFIED

FOR PACKAGING CONTAINERS OF PLASTIC FOR PHARMACEUTICALS AND DRUGS (U.S. CLS. 2, 13, 22, 25, 32 AND 50).

JILL PRATER, EXAMINING ATTORNEY

SN 77-741,794. EGAN-JONES STRUCTURED PRODUCTS, LLC, NEW YORK, NY. FILED 5-21-2009.

MONEYGOOD

THE MARK CONSISTS OF STANDARD CHARACTERS WITHOUT CLAIM TO ANY PARTICULAR FONT, STYLE, SIZE, OR COLOR.

CLASS 35—ADVERTISING AND BUSINESS

FOR ANALYZING AND COMPILING DATA FOR MEASURING THE PERFORMANCE OF FINANCIAL MARKETS; MARKET ANALYSIS; PROVIDING INFORMATION AND ANALYSIS IN THE FIELDS OF ECONOMICS AND BUSINESS (U.S. CLS. 100, 101 AND 102).

CLASS 36—INSURANCE AND FINANCIAL

FOR BUSINESS, STOCK OPTION AND PENSION VALUATION SERVICES; FINANCIAL ADVICE; FINANCIAL ANALYSIS AND RESEARCH SERVICES; FINANCIAL CONSULTING SERVICES, NAMELY, EXPERT ANALYSIS IN FINANCE; FINANCIAL INFORMATION AND ADVISORY SERVICES; FINANCIAL INFORMATION AND EVALUATIONS (U.S. CLS. 100, 101 AND 102).
ALEX KEAM, EXAMINING ATTORNEY

SN 77-743,160. AMERICAN EXPRESS MARKETING & DEVELOPMENT CORP., NEW YORK, NY. FILED 5-22-2009.

MAXVANTAGE

THE MARK CONSISTS OF STANDARD CHARACTERS WITHOUT CLAIM TO ANY PARTICULAR FONT, STYLE, SIZE, OR COLOR.

CLASS 35—ADVERTISING AND BUSINESS

FOR CORPORATE EVENT MANAGEMENT SERVICES; BUSINESS MEETING PLANNING; BUSINESS ASSISTANCE AND ADVISORY SERVICES IN THE FIELDS OF BUDGETING, BOOKKEEPING AND BILL PAYING FOR CORPORATE MEETINGS (U.S. CLS. 100, 101 AND 102).

CLASS 39—TRANSPORTATION AND STORAGE

FOR COORDINATING TRAVEL ARRANGEMENTS FOR INDIVIDUALS AND GROUPS (U.S. CLS. 100 AND 105).

CLASS 41—EDUCATION AND ENTERTAINMENT

FOR MEETING AND SEMINAR ARRANGING (U.S. CLS. 100, 101 AND 107).

CLASS 43—HOTEL AND RESTAURANT SERVICES

FOR MAKING HOTEL RESERVATIONS FOR OTHERS (U.S. CLS. 100 AND 101).
BERYL GARDNER, EXAMINING ATTORNEY

SN 77-747,808. 200 KELSEY ASSOCIATES, LLC, NEW ROCHELLE, NY. FILED 5-29-2009.



NO CLAIM IS MADE TO THE EXCLUSIVE RIGHT TO USE "AMERICAN BRANDS", APART FROM THE MARK AS SHOWN.

THE COLOR(S) RED AND BLUE IS/ARE CLAIMED AS A FEATURE OF THE MARK.

THE MARK CONSISTS OF THE WORDS "AMERICAN BRANDS" APPEARING IN RED AND "MADE BY AMERICAN HANDS" APPEARING IN BLUE.

CLASS 12—VEHICLES

FOR AUTOMOBILES AND STRUCTURAL PARTS THEREFOR (U.S. CLS. 19, 21, 23, 31, 35 AND 44).

CLASS 35—ADVERTISING AND BUSINESS

FOR RETAIL STORE AND ON-LINE RETAIL STORE SERVICES FEATURING GENERAL MERCHANDISE (U.S. CLS. 100, 101 AND 102).
CAROLINE WOOD, EXAMINING ATTORNEY

SN 77-750,461. TIBCO SOFTWARE INC., PALO ALTO, CA. FILED 6-2-2009.

TIBBR

THE MARK CONSISTS OF STANDARD CHARACTERS WITHOUT CLAIM TO ANY PARTICULAR FONT, STYLE, SIZE, OR COLOR.

CLASS 38—COMMUNICATION

FOR TELECOMMUNICATIONS SERVICES, NAMELY, PROVIDING DATA TRANSFER SERVICES BY ONLINE AND TELECOMMUNICATION MEANS TO FACILITATE REAL-TIME INTERACTION BETWEEN AND AMONG USERS OF COMPUTERS, MOBILE AND HANDHELD COMPUTERS, AND WIRED AND WIRELESS COMMUNICATION DEVICES, ENABLING INDIVIDUALS TO SEND AND RECEIVE TEXT, WEBLINKS, IMAGES, AUDIO AND VIDEO CONTENT IN THE FIELDS OF BUSINESS AND GENERAL INTEREST AND PROVIDING ON-LINE CHAT ROOMS AND ELECTRONIC BULLETIN BOARDS FOR TRANSMISSION OF MESSAGES AMONG USERS IN THE FIELDS OF BUSINESS AND GENERAL INTEREST. ALL THE FOREGOING FOR PUBLIC AND CORPORATE USE (U.S. CLS. 100, 101 AND 104).

CLASS 42—SCIENTIFIC AND COMPUTER SERVICES

FOR COMPUTER SERVICES, NAMELY, PROVIDING AN ON-LINE COMMUNITY FOR REGISTERED USERS TO PARTICIPATE IN DISCUSSIONS, GET FEEDBACK FROM THEIR PEERS AND CO-WORKERS, FORM VIRTUAL COMMUNITIES, AND ENGAGE IN SOCIAL AND BUSINESS NETWORKING, ALL FOR PUBLIC AND CORPORATE USE (U.S. CLS. 100 AND 101).
YAT SYE, LEE, EXAMINING ATTORNEY

SN 77-751,110. TRUJILLO & SONS, INC., MIAMI, FL. FILED 6-3-2009.

DON LUCAS

THE MARK CONSISTS OF STANDARD CHARACTERS WITHOUT CLAIM TO ANY PARTICULAR FONT, STYLE, SIZE, OR COLOR.

THE NAME "DON LUCAS" IDENTIFIES THE PSEUDONYM OF "LUCAS" TRUJILLO, JR., A LIVING PERSON WHOSE CONSENT IS OF RECORD.

CLASS 3—COSMETICS AND CLEANING PREPARATIONS

FOR LAUNDRY BLEACH (U.S. CLS. 1, 4, 6, 50, 51 AND 52).
FIRST USE 0-0-1978; IN COMMERCE 0-0-1978.

CLASS 30—STAPLE FOODS

FOR FLOUR (U.S. CL. 46).
FIRST USE 0-0-1978; IN COMMERCE 0-0-1978.
MARY CRAWFORD, EXAMINING ATTORNEY

SN 77-751,280. WESTERN HOLDINGS, LLC, CARSON CITY, NV. FILED 6-3-2009.

QUICKSTART RAPID WEIGHT
LOSS SYSTEM

THE MARK CONSISTS OF STANDARD CHARACTERS WITHOUT CLAIM TO ANY PARTICULAR FONT, STYLE, SIZE, OR COLOR.

NO CLAIM IS MADE TO THE EXCLUSIVE RIGHT TO USE "RAPID WEIGHT LOSS SYSTEM", APART FROM THE MARK AS SHOWN.

CLASS 3—COSMETICS AND CLEANING PREPARATIONS

FOR COSMETICS (U.S. CLS. 1, 4, 6, 50, 51 AND 52).

CLASS 5—PHARMACEUTICALS

FOR DIETARY SUPPLEMENTS (U.S. CLS. 6, 18, 44, 46, 51 AND 52).
JENNIFER VASQUEZ, EXAMINING ATTORNEY

SN 77-754,985. L'OREAL, PARIS, FRANCE, FILED 6-9-2009.

INTRA-CYLANE

THE MARK CONSISTS OF STANDARD CHARACTERS WITHOUT CLAIM TO ANY PARTICULAR FONT, STYLE, SIZE, OR COLOR.

PRIORITY CLAIMED UNDER SEC. 44(D) ON FRANCE APPLICATION NO. 083618777, FILED 12-15-2008, REG. NO. 083618777, DATED 12-15-2008, EXPIRES 12-15-2018.

CLASS 1—CHEMICALS

FOR CHEMICALS USED IN THE COMPOSITION OF HAIR PRODUCTS (U.S. CLS. 1, 5, 6, 10, 26 AND 46).

CLASS 3—COSMETICS AND CLEANING PREPARATIONS

FOR SHAMPOOS; PRODUCTS FOR HAIR STYLING AND HAIR CARE, NAMELY, GELS, MOUSSES, BALMS, CREAM, WAX, SERUMS AND LOTIONS; HAIR LACQUERS; HAIR COLOURING AND HAIR DECOLORANT PREPARATIONS; PERMANENT WAVING AND CURLING PREPARATIONS; ESSENTIAL OILS FOR PERSONAL USE (U.S. CLS. 1, 4, 6, 50, 51 AND 52).
JENNIFER HETU, EXAMINING ATTORNEY

SN 77-758,760. SOLAZYME, INC., SOUTH SAN FRANCISCO, CA. FILED 6-12-2009.



THE MARK CONSISTS OF CIRCLES OF VARYING DIAMETERS ARRANGED IN STRAIGHT AND ARCULATE LINES TO FORM A SQUARE SHAPE.

CLASS 4—LUBRICANTS AND FUELS

FOR FOSSIL FUEL SUBSTITUTES, NAMELY, BIO-FUELS (U.S. CLS. 1, 6 AND 15).

CLASS 42—SCIENTIFIC AND COMPUTER SERVICES

FOR SCIENTIFIC RESEARCH AND DEVELOPMENT IN THE FIELD OF FOSSIL FUEL SUBSTITUTES, NAMELY, BIO-FUELS (U.S. CLS. 100 AND 101).
DAVON HATCHETT, EXAMINING ATTORNEY

SN 77-760,054. MOOMAH LLC, NEW YORK, NY. FILED 6-15-2009.

CREATIVE ARTS CAFE

THE MARK CONSISTS OF STANDARD CHARACTERS WITHOUT CLAIM TO ANY PARTICULAR FONT, STYLE, SIZE, OR COLOR.

NO CLAIM IS MADE TO THE EXCLUSIVE RIGHT TO USE "ARTS CAFE", APART FROM THE MARK AS SHOWN.

CLASS 35—ADVERTISING AND BUSINESS

FOR RETAIL STORE SERVICES FEATURING DINERWARE, FLATWARE, PILLOWS, TABLE AND BED LINENS, STATIONERY, STICKERS, WRITING INSTRUMENTS, GREETING CARDS, BABY BOOKS, CHILDREN'S BOOKS, COLORING BOOKS, MEMORY BOOKS, BLANK JOURNAL BOOKS, BOOKS IN THE FIELDS OF PARENTING, COOKING, HEALTH AND FITNESS, CLOTHING, NAMELY, TOPS, BOTTOMS, CLOTH DIAPERS, HATS, SOCKS, BODYSUITS, SCARVES, JACKETS, SHOES, HEADBANDS, AND CLOTH SLINGS, TOYS, ART, PAINTINGS, GROCERY, PREPARED FOODS, AND CRAFT KITS (U.S. CLS. 101 AND 102).

CLASS 41—EDUCATION AND ENTERTAINMENT

FOR EDUCATIONAL SERVICES, NAMELY, PROVIDING CLASSES, WORKSHOPS, AND SEMINARS IN THE FIELDS OF EXERCISE, MUSIC, LANGUAGE, PAINTING, COOKING, AND PARENTING (U.S. CLS. 100, 101 AND 107).

CLASS 43—HOTEL AND RESTAURANT SERVICES

FOR RESTAURANT SERVICES (U.S. CLS. 100 AND 101).
THEODORE MCBRIDE, EXAMINING ATTORNEY

SN 77-762,435. TENKSOLAR INC., BLOOMINGTON, MN. FILED 6-17-2009.



THE MARK CONSISTS OF VARIOUS LINES FORMING AT LEAST A PORTION OF A REPRESENTATION OF A SUN.

CLASS 9—ELECTRICAL AND SCIENTIFIC APPARATUS

FOR APPARATUS FOR CONVERTING ELECTRONIC RADIATION TO ELECTRICAL ENERGY, NAMELY, PHOTOVOLTAIC SOLAR MODULES (U.S. CLS. 21, 23, 26, 36 AND 38).

CLASS 11—ENVIRONMENTAL CONTROL APPARATUS

FOR LIGHT REFLECTORS; SOLAR COLLECTORS (U.S. CLS. 13, 21, 23, 31 AND 34).
COURTNEY MCCORMICK, EXAMINING ATTORNEY

SN 77-762,445. TENKSOLAR INC., BLOOMINGTON, MN. FILED 6-17-2009.



THE MARK CONSISTS OF VARIOUS LINES FORMING AT LEAST A PORTION OF A REPRESENTATION OF A SUN TO THE LEFT OF THE WORDING "TENKSOLAR" WHICH APPEARS IN STYLIZED LETTERS.

CLASS 9—ELECTRICAL AND SCIENTIFIC APPARATUS

FOR APPARATUS FOR CONVERTING ELECTRONIC RADIATION TO ELECTRICAL ENERGY, NAMELY, PHOTOVOLTAIC SOLAR MODULES (U.S. CLS. 21, 23, 26, 36 AND 38).

CLASS 11—ENVIRONMENTAL CONTROL APPARATUS

FOR LIGHT REFLECTORS; SOLAR COLLECTORS (U.S. CLS. 13, 21, 23, 31 AND 34).
COURTNEY MCCORMICK, EXAMINING ATTORNEY

SN 77-763,267. GENERAL ELECTRIC COMPANY, SCHECTADY, NY. FILED 6-18-2009.

MYENGINES

THE MARK CONSISTS OF STANDARD CHARACTERS WITHOUT CLAIM TO ANY PARTICULAR FONT, STYLE, SIZE, OR COLOR.

CLASS 9—ELECTRICAL AND SCIENTIFIC APPARATUS

FOR COMPUTER SOFTWARE FOR CONNECTING USERS OF A GLOBAL ONLINE NETWORK IN ORDER TO SHARE DATA RELATING TO ENGINES; NAMELY, ALERTS, STATUS UPDATES, WORKFLOW REQUESTS, CONFIGURATIONS, OPERATIONAL AND MAINTENANCE HISTORY (U.S. CLS. 21, 23, 26, 36 AND 38).

CLASS 42—SCIENTIFIC AND COMPUTER SERVICES

FOR PROVIDING AN ONLINE NETWORK SERVICE THAT ENABLES USERS TO SHARE DATA IN THE FIELD OF ENGINES; NAMELY, ALERTS, STATUS UPDATES, WORKFLOW REQUESTS, CONFIGURATIONS, OPERATIONAL AND MAINTENANCE HISTORY; PROVIDING ON-LINE NON-DOWNLOADABLE SOFTWARE FOR USERS TO SHARE DATA RELATING TO ENGINES; NAMELY, ALERTS, STATUS UPDATES, WORKFLOW REQUESTS, CONFIGURATIONS, OPERATIONAL AND MAINTENANCE HISTORY (U.S. CLS. 100 AND 101).

ZACHARY BELLO, EXAMINING ATTORNEY

SN 77-763,519. NAVAJO TIMES PUBLISHING COMPANY, INC., A TRIBAL CORPORATION WHOLLY OWNED BY THE NAVAJO NATION, WINDOW ROCK, AZ. FILED 6-18-2009.

SN 77-766,473. MODERN MUSE, INC., SEATTLE, WA. FILED 6-23-2009.

NAVAJO TIMES

NEWSPAPER OF THE NAVAJO PEOPLE

THE COLOR(S) RED AND BLACK IS/ARE CLAIMED AS A FEATURE OF THE MARK.

THE MARK CONSISTS OF THE WORDS "NAVAJO TIMES NEWSPAPER OF THE NAVAJO PEOPLE" IN SMALL CAPS ELIZA FONT AND BLACK COLOR, AND THE LINE BELOW THESE WORDS IN RED COLOR.

SEC. 2(F) AS TO "NAVAJO TIMES NEWSPAPER OF THE NAVAJO PEOPLE".

CLASS 16—PAPER GOODS AND PRINTED MATTER

FOR NEWSPAPERS IN THE FIELD OF NAVAJO AND NATIONAL NATIVE AMERICAN NEWS (U.S. CLS. 2, 5, 22, 23, 29, 37, 38 AND 50).

FIRST USE 8-4-1960; IN COMMERCE 8-4-1960.

CLASS 35—ADVERTISING AND BUSINESS

FOR PROVIDING ADVERTISING SPACE IN PERIODICALS, NEWSPAPERS AND MAGAZINES (U.S. CLS. 100, 101 AND 102).

FIRST USE 8-4-1960; IN COMMERCE 8-4-1960.

CLASS 41—EDUCATION AND ENTERTAINMENT

FOR PUBLICATION OF ELECTRONIC NEWSPAPERS ACCESSIBLE VIA A GLOBAL COMPUTER NETWORK (U.S. CLS. 100, 101 AND 107).

FIRST USE 8-1-1998; IN COMMERCE 8-1-1998.

KATHY DE JONGE, EXAMINING ATTORNEY

SN 77-764,530. ROCLAND WINE IMPORTS, SAN FRANCISCO, CA. FILED 6-20-2009.

SWEET JESUS

THE MARK CONSISTS OF STANDARD CHARACTERS WITHOUT CLAIM TO ANY PARTICULAR FONT, STYLE, SIZE, OR COLOR.

CLASS 32—LIGHT BEVERAGES

FOR BEER (U.S. CLS. 45, 46 AND 48).

CLASS 33—WINES AND SPIRITS

FOR WINE (U.S. CLS. 47 AND 49).

SUE LAWRENCE, EXAMINING ATTORNEY

WE JUST CLICK!

THE MARK CONSISTS OF STANDARD CHARACTERS WITHOUT CLAIM TO ANY PARTICULAR FONT, STYLE, SIZE, OR COLOR.

CLASS 9—ELECTRICAL AND SCIENTIFIC APPARATUS

FOR DECORATIVE MAGNETS; SPORTS HELMETS; MOTORCYCLE HELMETS; CASES FOR MOBILE PHONES; CASES FOR PORTABLE MUSIC PLAYERS; DECORATIVE ORNAMENTS FOR CELL PHONES; EYEGLASS CASES; EYEGLASS FRAMES; DECORATIVE SWITCH PLATE COVERS (U.S. CLS. 21, 23, 26, 36 AND 38).

CLASS 14—JEWELRY

FOR JEWELRY; CLOCKS; WATCHES; WATCH BANDS AND STRAPS; TIMEPIECES; MEDALS; CUFF LINKS AND TIE CLIPS; CHARMS AS PERSONAL JEWELRY; JEWELRY BOXES (U.S. CLS. 2, 27, 28 AND 50).

HEATHER SAPP, EXAMINING ATTORNEY

SN 77-769,929. DOCUSIGN, INC., SEATTLE, WA. FILED 6-29-2009.



THE MARK CONSISTS OF THE TERM "PAPER" WITH A PROHIBITION SYMBOL.

CLASS 38—COMMUNICATION

FOR ON-LINE DOCUMENT DELIVERY VIA A GLOBAL COMPUTER NETWORK; DELIVERY OF MESSAGES BY ELECTRONIC TRANSMISSION (U.S. CLS. 100, 101 AND 104).

FIRST USE 3-18-2009; IN COMMERCE 3-18-2009.

CLASS 42—SCIENTIFIC AND COMPUTER SERVICES

FOR PROVIDING ON-LINE NON-DOWNLOADABLE SOFTWARE FOR USE WITH ELECTRONIC DATA VERIFICATION, NAMELY, TO FACILITATE ASSIGNMENT OF A LEGALLY BINDING ELECTRONIC SIGNATURE TO A DOCUMENT OR FILE FOR COMMUNICATION VIA A GLOBAL COMPUTER NETWORK; PROVIDING A WEBSITE THAT ALLOWS USERS TO UPLOAD AND ATTACH A LEGALLY BINDING ELECTRONIC SIGNATURE TO A DOCUMENT OR FILE FOR COMMUNICATION VIA A GLOBAL COMPUTER NETWORK (U.S. CLS. 100 AND 101).

FIRST USE 3-18-2009; IN COMMERCE 3-18-2009.

CLASS 45—PERSONAL AND LEGAL SERVICES

FOR PROVIDING USER AUTHENTICATION SERVICES RELATED TO ELECTRONIC SIGNATURE IN E-COMMERCE TRANSACTIONS (U.S. CLS. 100 AND 101).

FIRST USE 3-18-2009; IN COMMERCE 3-18-2009.
JENNIFER HETU, EXAMINING ATTORNEY

SN 77-977,299. HERBALSCIENCE, INC., NAPLES, FL. FILED 12-21-2007.

RHINOLOC

THE MARK CONSISTS OF STANDARD CHARACTERS WITHOUT CLAIM TO ANY PARTICULAR FONT, STYLE, SIZE, OR COLOR.

CLASS 1—CHEMICALS

FOR BOTANICAL EXTRACTS FOR USE IN THE MANUFACTURE OF NUTRACEUTICALS AND PHARMACEUTICALS; CHEMICAL EXTRACTS AND ACTIVE PRINCIPALS EXTRACTED FROM MEDICINAL PLANTS FOR USE IN THE MANUFACTURE OF PHARMACEUTICALS; AND BOTANICAL EXTRACTS IN THE MANUFACTURE OF PHARMACEUTICAL PREPARATIONS IN THE FORM OF LOTIONS, CREAMS, AND TOPICAL ANALGESICS AND ANESTHETICS, TABLETS, CAPSULES, PILLS, TINCTURE, SUPPOSITORIES AND AMPULE FOR INJECTION (U.S. CLS. 1, 5, 6, 10, 26 AND 46).

CLASS 3—COSMETICS AND CLEANING PREPARATIONS

FOR HERBAL EXTRACTS SOLD AS AN INTEGRAL INGREDIENT IN COSMETICS; PRE-MOISTENED NON-MEDICATED PERSONAL HYGIENE WIPES, NAMELY, HERPES RELIEF WIPES (U.S. CLS. 1, 4, 6, 50, 51 AND 52).

CLASS 5—PHARMACEUTICALS

FOR NUTRITIONAL SUPPLEMENTS; HERBAL PRODUCTS, NAMELY, MEDICATED SKIN AND LIP BALMS; HERBAL PRODUCTS FOR MEDICAL USE, NAMELY, MEDICATED OINTMENTS, MEDICATED OILS, MEDICINAL DRINKS, MEDICATED SYRUPS CONTAINING HERBAL EXTRACTS; BACTERIAL POISONS FOR MEDICAL PURPOSES, AND TINCTURES ALL FOR USE IN THE TREATMENT OF STROKES, INFARCTS AND OTHER CARDIOVASCULAR AND CEREBRUM DISEASES; HERBAL PRODUCTS FOR MEDICINAL PURPOSES, NAMELY, HERBAL EXTRACTS FOR USE AS NUTRITIONAL AND DIETARY SUPPLEMENTS; HERBAL PRODUCTS FOR MEDICINAL PURPOSES, NAMELY, MEDICINAL HERBAL EXTRACTS AND MEDICATED SYRUPS CONTAINING

HERBAL EXTRACTS; MEDICINAL HERB EXTRACTS; MEDICINAL HERBAL EXTRACTS FOR MEDICAL PURPOSES; PLANT EXTRACTS FOR MEDICAL OR PHARMACEUTICAL PURPOSES; YEAST EXTRACTS FOR MEDICAL OR PHARMACEUTICAL PURPOSES; MEDICINAL BOTANICAL EXTRACTS USED AS COMPONENT INGREDIENTS OF PHARMACEUTICAL PREPARATIONS IN THE FORM OF LOTIONS, CREAMS, AND TOPICAL ANALGESICS AND ANESTHETICS, TABLETS, CAPSULES, PILLS, TINCTURES, SUPPOSITORIES AND FILLED AMPULE FOR INJECTION USED TO TREAT SKIN AILMENTS, FOR INFECTION, DEGENERATIVE, MUSCULAR, PULMONARY, SKELETAL, ENDOCRINE, IMMUNE, NEUROLOGICAL, CARDIOVASCULAR, METABOLIC, INFLAMMATORY, CANCER AND RELATED CONDITIONS; HERBAL PRODUCTS, NAMELY, HERBAL POWDERS BEING NUTRITIONAL SUPPLEMENTS; HERBAL PRODUCTS, NAMELY, HERBAL POWDERS IN NUTRITIONAL SUPPLEMENT DRINK MIXES FOR NUTRITIONAL PURPOSES; HERBAL PRODUCTS, NAMELY, HERBAL MEAL REPLACEMENT POWDERS FOR DIETARY AND NUTRITIONAL PURPOSES; HERBAL PRODUCTS, NAMELY, AROMATHERAPY PACKS CONTAINING HERBS USED FOR RELIEF FROM HEADACHES, INSOMNIA AND SINUS DISCOMFORT; ORAL PREPARATIONS CONTAINING HERBS OR HERBAL EXTRACTS USED TO MAINTAIN HEALTH AND FOR A WIDE VARIETY OF PHYSICAL CONDITIONS; VITAMIN AND MINERAL PREPARATIONS INTENDED FOR USE AS DIETARY SUPPLEMENTS; VITAMINS; FOOD SUPPLEMENTS; PHARMACEUTICALS AND NUTRACEUTICALS, NAMELY, VITAMINS AND FOOD SUPPLEMENTS; PHARMACEUTICAL PREPARATIONS, NAMELY, APPETITE SUPPRESSANTS AND LIPID LOWERING AGENTS; FOOD FOR MEDICALLY RESTRICTED DIETS; FOOD SUPPLEMENTS, NAMELY, ANTI-OXIDANTS; FOOD FOR DIABETICS, INFANTS AND ENTERAL FEEDING; BOTANICAL EXTRACTS FOR NUTRITIONAL USE, NAMELY, FOR USE AS NUTRITIONAL SUPPLEMENTS; BOTANICAL EXTRACTS SOLD AS AN INTEGRAL INGREDIENT IN NUTRACEUTICALS AND PHARMACEUTICALS FOR THE TREATMENT OF, OR RELIEF OF SYMPTOMS IN, INFECTIOUS DISEASES AND ADVERSE HUMAN HEALTH CONDITIONS, NAMELY, INFECTION, DEGENERATIVE, MUSCULAR, PULMONARY, SKELETAL, ENDOCRINE, IMMUNE, NEUROLOGICAL, CARDIOVASCULAR, METABOLIC, AND/OR INFLAMMATORY DISORDERS AND DISEASES, CANCER AND RELATED CONDITIONS; ANTI-COUGH DROPS; COUGH DROPS; COUGH EXPECTORANTS; COUGH LOZENGES; COUGH SYRUPS; COUGH TREATMENT PREPARATIONS; COLD SORE TREATMENT PREPARATIONS; PHARMACEUTICAL ANTITUSSIVE-COLD PREPARATIONS; PREPARATIONS FOR TREATING COLDS; ANALGESIC PREPARATIONS; ANALGESICS; ANTIPIRETTIC ANALGESICS; IBUPROFEN FOR USE AS AN ORAL ANALGESIC; MULTIPURPOSE MEDICATED ANTIBIOTIC CREAM, ANALGESIC BALM AND MENTHOLATED SALVE; ORAL ANALGESICS; TOPICAL ANALGESICS; PHARMACEUTICAL PREPARATIONS FOR THE TREATMENT AND PREVENTION OF HERPES; VACCINES FOR THE TREATMENT AND PREVENTION OF HERPES; BIOLOGICAL PREPARATIONS FOR THE TREATMENT AND PREVENTION OF HERPES; PHARMACEUTICAL PREPARATIONS FOR THE TREATMENT OF HERPES SIMPLEX INFECTION; PHARMACEUTICAL CAPSULES FOR THE TREATMENT OF HERPES SIMPLEX INFECTION; HOMEOPATHIC PREPARATIONS FOR THE TREATMENT OF HERPES AND COLD SORES; PHARMACEUTICAL PREPARATIONS FOR THE TREATMENT OF HERPES VIRUSES; MEDICATED TOPICAL CLEAR FLUORIDE GEL FOR THE TREATMENT OF HERPES VIRUS DURING THE PHYSICAL MANIFESTATION OF THE VIRUS; PHARMACEUTICAL PREPARATIONS FOR THE TREATMENT OF HERPES SIMPLEX VIRUS TYPE I OR TYPE II OR HERPES ZOSTER VIRUS, NOT IN INTRAVENOUS FORM; PLANT BASED ANTIVIRALS; OVER-THE-COUNTER TOPICAL ANTIVIRALS; PHARMACEUTICAL PREPARATION WITH ANTIVIRAL OR ANTIMICROBIAL PROPERTIES, OR BOTH, FOR USE IN THE TREATMENT OF HERPETIC KERATITIS, CONJUNCTIVITIS, HIV RETINOPATHY, VIRAL INFLUENZA "FLU", HERPES SIMPLEX VIRUS 1, HERPES SIMPLEX VIRUS 2, VARICELLA ZOSTER VIRUS "HERPES ZOSTER" "SHINGLES", CYTOMEGALOVIRUS, VIRAL PARAINFLUENZA, ADENOVIRUS, VIRAL ENCEPHALITIS, VIR-

AL MENINGITIS, ARBOVIRUS, ARENAVIRUS, PICORNAVIRUS, CORONAVIRUS, SYNTIALVIRUS, VIRAL INFECTIONS, COMMON COLDS CAUSED BY VIRUSES, COLD SORES, HUMAN IMMUNE DEFICIENCY VIRUS "HIV", ROSEOLA INFANTUM, HUMAN HERPES IV; PHARMACEUTICAL PREPARATIONS FOR THE TREATMENT OF VIRAL DISEASES AND DISORDERS, NAMELY, HERPES; PHARMACEUTICAL PREPARATIONS FOR TREATING IMMUNE DISEASES INDUCED BY VIRUS, NAMELY, HERPES ZOSTER AND AIDS (U.S. CLS. 6, 18, 44, 46, 51 AND 52).

LYDIA BELZER, EXAMINING ATTORNEY

SN 77-977,300. HERBALSCIENCE, INC., NAPLES, FL. FILED 12-21-2007.

RHINOBLOCK

THE MARK CONSISTS OF STANDARD CHARACTERS WITHOUT CLAIM TO ANY PARTICULAR FONT, STYLE, SIZE, OR COLOR.

CLASS 1—CHEMICALS

FOR BOTANICAL EXTRACTS FOR USE IN THE MANUFACTURE OF NUTRACEUTICALS AND PHARMACEUTICALS; CHEMICAL EXTRACTS AND ACTIVE PRINCIPALS EXTRACTED FROM MEDICINAL PLANTS FOR USE IN THE MANUFACTURE OF PHARMACEUTICALS; AND BOTANICAL EXTRACTS IN THE MANUFACTURE OF PHARMACEUTICAL PREPARATIONS IN THE FORM OF LOTIONS, CREAMS, AND TOPICAL ANALGESICS AND ANESTHETICS, TABLETS, CAPSULES, PILLS, TINCTURE, SUPPOSITORIES AND AMPULE FOR INJECTION (U.S. CLS. 1, 5, 6, 10, 26 AND 46).

CLASS 3—COSMETICS AND CLEANING PREPARATIONS

FOR HERBAL EXTRACTS SOLD AS AN INTEGRAL INGREDIENT IN COSMETICS; PRE-MOISTENED NON-MEDICATED PERSONAL HYGIENE WIPES, NAMELY, HERPES RELIEF WIPES (U.S. CLS. 1, 4, 6, 50, 51 AND 52).

CLASS 5—PHARMACEUTICALS

FOR NUTRITIONAL SUPPLEMENTS; HERBAL PRODUCTS, NAMELY, MEDICATED SKIN AND LIP BALMS; HERBAL PRODUCTS FOR MEDICAL USE, NAMELY, MEDICATED OINTMENTS, MEDICATED OILS, MEDICINAL DRINKS, MEDICATED SYRUPS CONTAINING HERBAL EXTRACTS, BACTERIAL POISONS FOR MEDICAL PURPOSES, AND TINCTURES ALL FOR USE IN THE TREATMENT OF STROKES, INFARCTS AND OTHER CARDIOVASCULAR AND CEREBRUM DISEASES; HERBAL PRODUCTS FOR MEDICINAL PURPOSES, NAMELY, HERBAL EXTRACTS FOR USE AS NUTRITIONAL AND DIETARY SUPPLEMENTS; HERBAL PRODUCTS FOR MEDICINAL PURPOSES, NAMELY, MEDICINAL HERBAL EXTRACTS AND MEDICATED SYRUPS CONTAINING HERBAL EXTRACTS; MEDICINAL HERB EXTRACTS; MEDICINAL HERBAL EXTRACTS FOR MEDICAL PURPOSES; PLANT EXTRACTS FOR MEDICAL OR PHARMACEUTICAL PURPOSES; YEAST EXTRACTS FOR MEDICAL OR PHARMACEUTICAL PURPOSES; MEDICINAL BOTANICAL EXTRACTS USED AS COMPONENT INGREDIENTS OF PHARMACEUTICAL PREPARATIONS IN THE FORM OF LOTIONS, CREAMS, AND TOPICAL ANALGESICS AND ANESTHETICS, TABLETS, CAPSULES, PILLS, TINCTURES, SUPPOSITORIES AND FILLED AMPULE FOR INJECTION USED TO TREAT SKIN AILMENTS, FOR INFECTION, DEGENERATIVE, MUSCULAR, PULMONARY,

SKELETAL, ENDOCRINE, IMMUNE, NEUROLOGICAL, CARDIOVASCULAR, METABOLIC, INFLAMMATORY, CANCER AND RELATED CONDITIONS; HERBAL PRODUCTS, NAMELY, HERBAL POWDERS BEING NUTRITIONAL SUPPLEMENTS; HERBAL PRODUCTS, NAMELY, HERBAL POWDERS IN NUTRITIONAL SUPPLEMENT DRINK MIXES FOR NUTRITIONAL PURPOSES; HERBAL PRODUCTS, NAMELY, HERBAL MEAL REPLACEMENT POWDERS FOR DIETARY AND NUTRITIONAL PURPOSES; HERBAL PRODUCTS, NAMELY, AROMATHERAPY PACKS CONTAINING HERBS USED FOR RELIEF FROM HEADACHES, INSOMNIA AND SINUS DISCOMFORT; ORAL PREPARATIONS CONTAINING HERBS OR HERBAL EXTRACTS USED TO MAINTAIN HEALTH AND FOR A WIDE VARIETY OF PHYSICAL CONDITIONS; VITAMIN AND MINERAL PREPARATIONS INTENDED FOR USE AS DIETARY SUPPLEMENTS; VITAMINS; FOOD SUPPLEMENTS; PHARMACEUTICALS AND NUTRACEUTICALS, NAMELY, VITAMINS AND FOOD SUPPLEMENTS; PHARMACEUTICAL PREPARATIONS, NAMELY, APPETITE SUPPRESSANTS AND LIPID LOWERING AGENTS; FOOD FOR MEDICALLY RESTRICTED DIETS; FOOD SUPPLEMENTS, NAMELY, ANTI-OXIDANTS; FOOD FOR DIABETICS, INFANTS AND ENTERAL FEEDING; BOTANICAL EXTRACTS FOR NUTRITIONAL USE, NAMELY, FOR USE AS NUTRITIONAL SUPPLEMENTS; BOTANICAL EXTRACTS SOLD AS AN INTEGRAL INGREDIENT IN NUTRACEUTICALS AND PHARMACEUTICALS FOR THE TREATMENT OF, OR RELIEF OF SYMPTOMS IN, INFECTIOUS DISEASES AND ADVERSE HUMAN HEALTH CONDITIONS, NAMELY, INFECTION, DEGENERATIVE, MUSCULAR, PULMONARY, SKELETAL, ENDOCRINE, IMMUNE, NEUROLOGICAL, CARDIOVASCULAR, METABOLIC, AND/OR INFLAMMATORY DISORDERS AND DISEASES, CANCER AND RELATED CONDITIONS; ANTI-COUGH DROPS; COUGH DROPS; COUGH EXPECTORANTS; COUGH LOZENGES; COUGH SYRUPS; COUGH TREATMENT PREPARATIONS; COLD SORE TREATMENT PREPARATIONS; PHARMACEUTICAL ANTITUSSIVE-COLD PREPARATIONS; PREPARATIONS FOR TREATING COLDS; ANALGESIC PREPARATIONS; ANALGESICS; ANTIPIRETTIC ANALGESICS; IBUPROFEN FOR USE AS AN ORAL ANALGESIC; MULTIPURPOSE MEDICATED ANTIBIOTIC CREAM, ANALGESIC BALM AND MENTHOLATED SALVE; ORAL ANALGESICS; TOPICAL ANALGESICS; PHARMACEUTICAL PREPARATIONS FOR THE TREATMENT AND PREVENTION OF HERPES; VACCINES FOR THE TREATMENT AND PREVENTION OF HERPES; BIOLOGICAL PREPARATIONS FOR THE TREATMENT AND PREVENTION OF HERPES; PHARMACEUTICAL PREPARATIONS FOR THE TREATMENT OF HERPES SIMPLEX INFECTION; PHARMACEUTICAL CAPSULES FOR THE TREATMENT OF HERPES SIMPLEX INFECTION; HOMEOPATHIC PREPARATIONS FOR THE TREATMENT OF HERPES AND COLD SORES; PHARMACEUTICAL PREPARATIONS FOR THE TREATMENT OF HERPES VIRUSES; MEDICATED TOPICAL CLEAR FLUORIDE GEL FOR THE TREATMENT OF HERPES VIRUS DURING THE PHYSICAL MANIFESTATION OF THE VIRUS; PHARMACEUTICAL PREPARATIONS FOR THE TREATMENT OF HERPES SIMPLEX VIRUS TYPE I OR TYPE II OR HERPES ZOSTER VIRUS, NOT IN INTRAVENOUS FORM; PLANT BASED ANTIVIRALS; OVER-THE-COUNTER TOPICAL ANTIVIRALS; PHARMACEUTICAL PREPARATION WITH ANTIVIRAL OR ANTIMICROBIAL PROPERTIES, OR BOTH, FOR USE IN THE TREATMENT OF HERPETIC KERATITIS, CONJUNCTIVITIS, HIV RETINOPATHY, VIRAL INFLUENZA "FLU", HERPES SIMPLEX VIRUS 1, HERPES SIMPLEX VIRUS 2, VARICELLA ZOSTER VIRUS "HERPES ZOSTER" "SHINGLES", CYTOMEGALOVIRUS, VIRAL PARAINFLUENZA, ADENOVIRUS, VIRAL ENCEPHALITIS, VIRAL MENINGITIS, ARBOVIRUS, ARENAVIRUS, PICORNAVIRUS, CORONAVIRUS, SYNTIALVIRUS, VIRAL INFECTIONS, COMMON COLDS CAUSED BY VIRUSES, COLD SORES, HUMAN IMMUNE DEFICIENCY VIRUS "HIV", ROSEOLA INFANTUM, HUMAN HERPES IV; PHARMACEUTICAL PREPARATIONS FOR THE TREATMENT OF VIRAL DISEASES AND DISORDERS, NAMELY, HERPES; PHARMACEUTICAL PREPARATIONS FOR TREATING IMMUNE DISEASES INDUCED BY VIRUS, NAMELY, HERPES ZOSTER AND AIDS (U.S. CLS. 6, 18, 44, 46, 51 AND 52).

LYDIA BELZER, EXAMINING ATTORNEY

SN 77-977,485. NARRAGANSETT BAY INSURANCE COMPANY, PAWTUCKET, RI. FILED 9-15-2008.

NARRAGANSETT BAY INSURANCE

THE MARK CONSISTS OF STANDARD CHARACTERS WITHOUT CLAIM TO ANY PARTICULAR FONT, STYLE, SIZE, OR COLOR.

NO CLAIM IS MADE TO THE EXCLUSIVE RIGHT TO USE "INSURANCE", APART FROM THE MARK AS SHOWN.
SEC. 2(F).

CLASS 35—ADVERTISING AND BUSINESS

FOR DATA COMPILING AND ANALYZING IN THE FIELD OF INSURANCE, PROVIDING INSURANCE AGENT REFERRALS; BUSINESS RISK MANAGEMENT CONSULTATION (U.S. CLS. 100, 101 AND 102).
FIRST USE 0-0-1981; IN COMMERCE 0-0-1981.

CLASS 36—INSURANCE AND FINANCIAL

FOR FINANCIAL VALUATION OF PERSONAL PROPERTY AND REAL ESTATE; INSURANCE ADMINISTRATION, INSURANCE UNDERWRITING IN THE FIELD OF REAL ESTATE AND PERSONAL PROPERTY; INSURANCE INFORMATION AND CONSULTANCY; INSURANCE SERVICES, NAMELY, UNDERWRITING PERSONAL PROPERTY AND REAL ESTATE INSURANCE, PROVIDING INFORMATION IN THE FIELD OF REAL ESTATE AND PERSONAL PROPERTY INSURANCE (U.S. CLS. 100, 101 AND 102).

FIRST USE 0-0-1981; IN COMMERCE 0-0-1981.
KIMBERLY PERRY, EXAMINING ATTORNEY

SN 78-322,776. EFALOCK PROFESSIONAL TOOLS GMBH, BAD KISSINGEN, FED REP GERMANY, FILED 11-4-2003.

EFALOCK

THE MARK CONSISTS OF STANDARD CHARACTERS WITHOUT CLAIM TO ANY PARTICULAR FONT, STYLE, SIZE, OR COLOR.

OWNER OF FED REP GERMANY REG. NO. 1001843, DATED 5-12-1980, EXPIRES 5-12-2010.

OWNER OF U.S. REG. NO. 1,252,191.

THE FOREIGN WORDING IN THE MARK TRANSLATES INTO ENGLISH AS HAVING NO MEANING. "EFALOCK". THE MARK IS A COMBINATION OF "EFA" WHICH IS ROUGHLY EQUIVALENT TO EVE IN ENGLISH AND LOCK WHICH IS THE FIRST SYLLABLE OF THE GERMAN WORD LOCKE WHICH TRANSLATES IN ENGLISH AS CURL.

CLASS 8—HAND TOOLS

FOR CUTTING, MANICURE AND PEDICURE TOOLS, NAMELY, SCISSORS AND KNIVES, RAZORS AND RAZOR-BLADES, SAFETY-RAZORS, CUTICLE FORCEPS, NAIL CLIPPERS, TWEEZERS, NAIL FILES, NAIL BUFFERS, CORN REMOVERS AND CORN GRATERS, NAIL CUTICLE KNIVES, AND ELECTRIC MINI HAIR TRIMMERS (U.S. CLS. 23, 28 AND 44).

CLASS 11—ENVIRONMENTAL CONTROL APPARATUS

FOR ELECTRICAL APPLIANCES FOR THE HAIRDRESSERS' TRADE, NAMELY, DRYER HOODS FIXEDLY MOUNTED OR MOUNTED UPON A MOVEABLE TRIPOD FOR THE DRYING OF CLIENTS' HAIR, HAIR DRYERS WITH HOLDERS, HAIR TRIMMERS, ELECTRIC HEATED HAIR STYLERS FOR THE STYLING OF CLIENTS' HAIR, AND HOT-AIR DRYERS WITH ATTACHED BRUSH (U.S. CLS. 13, 21, 23, 31 AND 34).

CLASS 16—PAPER GOODS AND PRINTED MATTER

FOR PRINTED EDUCATIONAL AND TEACHING MATERIALS FOR THE TRAINING OF HAIRDRESSERS, HAIR-STYLE BOOKS, PRINTED NOTEPADS MADE OF PAPER, PLASTIC BAGS, ALL USED IN THE HAIRDRESSING BUSINESS (U.S. CLS. 2, 5, 22, 23, 29, 37, 38 AND 50).

CLASS 20—FURNITURE AND ARTICLES NOT OTHERWISE CLASSIFIED

FOR HAIR AND COSMETIC SALON FURNITURE AND THEIR PARTS, NAMELY, ROLLER STOOLS, SALON CARTS WITH CASTORS, COSMETIC BEDS, BARBER CHAIRS, KIDS CHAIRS, HEAD AND FOOT RESTS, MIRRORS, WALL-PROTECTION PLATES MADE OF PLASTIC AND PLACED BEHIND CHAIR FOOTRESTS TO PROTECT THE WALLS IN A HAIRDRESSER STORE, TRAINING MANNEQUIN HEAD STANDS AND TABLE-HOLDERS AND THEIR PARTS, TOUPEE STANDS MADE OF METAL OR PLASTIC, NECK PILLOWS, AND HAND MIRRORS, REUSABLE PLASTIC NECK PROTECTOR TRAYS TO PROTECT AGAINST HAIR CLIPPINGS, REUSABLE PLASTIC HAIR CUTTING COLLARS TO PROTECT AGAINST HAIR CLIPPINGS, PLASTIC PRICE BOARDS, AND PLASTIC EQUIPMENT BOXES AND PLASTIC ROLL OFF BOXES FOR USE IN THE HAIRDRESSING INDUSTRY (U.S. CLS. 2, 13, 22, 25, 32 AND 50).

CLASS 21—HOUSEWARES AND GLASS

FOR EMPTY CONTAINERS FOR THE HAIRDRESSING TRADE, NAMELY, SPRAY AND APPLICATION BOTTLES, BOWLS, SOAP AND TINT BOWLS, SOAP DISHES, RINSING BOXES MADE OF PLASTICS FOR THE CLEANING OF PERM RODS, SHAVING-SOAP BOWLS, TUBE SQUEEZERS, BRISTLE TOOLS FOR THE HAIRDRESSERS TRADE, NAMELY, HAIR BRUSHES, CLOTHES-BRUSHES, SALON BROOMS, POWDER AND SHAVING BRUSHES, NECK BRUSHES AND DUSTERS, HAIR TINT BRUSHES, TOOLS FOR HAIR AND BODY CARE, NAMELY, COMBS MADE OF METAL AND PLASTIC, AND APPLICATION AND FIXING SPONGES (U.S. CLS. 2, 13, 23, 29, 30, 33, 40 AND 50).

CLASS 24—FABRICS

FOR HAND AND EYE TOWELS MADE OF TEXTILE (U.S. CLS. 42 AND 50).

CLASS 25—CLOTHING

FOR HAIRDRESSERS' CLOTHING, NAMELY, CAPES, APRONS, AND HAIRDRESSING CAPES MADE OF FABRIC OR PLASTIC (U.S. CLS. 22 AND 39).

CLASS 26—FANCY GOODS

FOR PERM RODS, PERM CLAMS, PERM CLIPS, AND PERM STICKS (U.S. CLS. 37, 39, 40, 42 AND 50).
LINDA MICKLEBURGH, EXAMINING ATTORNEY

SN 78-332,694. UNIMET GMBH, RIEDEN, FED REP GERMANY, FILED 11-25-2003.

SN 78-363,725. NIKON CORPORATION, TOKYO, JAPAN, FILED 2-6-2004.

Unimet

PictureProject

THE MARK CONSISTS OF STANDARD CHARACTERS WITHOUT CLAIM TO ANY PARTICULAR FONT, STYLE, SIZE, OR COLOR.

CLASS 6—METAL GOODS

FOR STRUCTURED METAL FOILS FOR CATALYZERS (U.S. CLS. 2, 12, 13, 14, 23, 25 AND 50).
FIRST USE 0-0-1970; IN COMMERCE 8-8-1998.

CLASS 7—MACHINERY

FOR MOTOR DRIVEN PRODUCTION TOOLS FOR PRODUCING AND PROCESSING OF CONTACT PARTS, NAMELY, PUNCHING PRESSES, METAL FOLDING MACHINES; METAL PUNCHING AND FOLDING MACHINERY FOR PRODUCTION OF ELECTRIC CONTACT PARTS; POWER OPERATED PROGRESSIVE PUNCHING AND FOLDING TOOLS FOR THE PRODUCTION OF ELECTRIC CONTACT PARTS, NAMELY, PUNCHING PRESSES AND DIES FOR USE WITH MACHINE TOOLS, BENDING TOOLS, FOLDING TOOLS (U.S. CLS. 13, 19, 21, 23, 31, 34 AND 35).
FIRST USE 0-0-1970; IN COMMERCE 8-8-1998.

CLASS 9—ELECTRICAL AND SCIENTIFIC APPARATUS

FOR ELECTRIC CONTACTS FOR ELECTRIC AND ELECTRONIC PLUGS; ELECTRIC AND ELECTRONIC CONDUITS AND CONNECTORS, NAMELY, COMPUTER PLUGS, TELEPHONE PLUGS, ANTI-SKID-SYSTEM-PLUGS FOR AUTOMOTIVE CONNECTIONS (U.S. CLS. 21, 23, 26, 36 AND 38).
FIRST USE 0-0-1970; IN COMMERCE 8-8-1998.

CLASS 40—MATERIAL TREATMENT

FOR (BASED ON INTENT TO USE) METAL TREATING FOR OTHERS, NAMELY, METAL PLATING, PUNCHING, FOLDING, WELDING, MACHINING; MANUFACTURE OF STRUCTURED METAL FOILS FOR CATALYZERS TO THE ORDER AND SPECIFICATION OF OTHERS; MANUFACTURE OF ELECTRIC AND ELECTRONIC CONDUITS TO THE ORDER AND SPECIFICATION OF OTHERS, NAMELY, STAMPING, BENDING, AND PLATING OF ELECTRIC CONTACTS; MANUFACTURE OF CONTACTS FOR ELECTRIC AND ELECTRONIC PURPOSES TO THE ORDER AND/OR SPECIFICATION OF OTHERS, NAMELY, ASSEMBLING COMPOUND ELECTRIC CONTACT PARTS, ASSEMBLING PARTS TO ELECTRIC CONTACTS, AND ASSEMBLING ELECTRIC PLUGS (U.S. CLS. 100, 103 AND 106).
BRIAN PINO, EXAMINING ATTORNEY

THE MARK CONSISTS OF STANDARD CHARACTERS WITHOUT CLAIM TO ANY PARTICULAR FONT, STYLE, SIZE, OR COLOR.

PRIORITY CLAIMED UNDER SEC. 44(D) ON JAPAN APPLICATION NO. 2003-103307, FILED 11-20-2003, REG. NO. 4811312, DATED 10-22-2004, EXPIRES 10-22-2014.

PRIORITY CLAIMED UNDER SEC. 44(D) ON JAPAN APPLICATION NO. 2003-114430, FILED 12-24-2003, REG. NO. 4897753, DATED 9-30-2005, EXPIRES 9-30-2015.

CLASS 9—ELECTRICAL AND SCIENTIFIC APPARATUS

FOR COMPUTER SOFTWARE AND DOWNLOADABLE COMPUTER SOFTWARE FOR DIGITIZING, ENHANCING, MANIPULATING, EDITING, PRINTING, STORING, INDEXING AND TRANSMITTING IMAGES, FOR ORDERING OF PHOTOGRAPHIC PRINTS AND ALBUMS OVER GLOBAL COMPUTER NETWORKS, AND FOR ORDERING AND CENTRAL STORAGE OF ONLINE PHOTOGRAPH ALBUMS; COMPUTER SOFTWARE AND DOWNLOADABLE COMPUTER SOFTWARE FOR DIGITIZING, ENHANCING, MANIPULATING, EDITING, PRINTING, INDEXING AND TRANSMITTING IMAGES, FOR ORDERING OF PHOTOGRAPHIC PRINTS AND ALBUMS OVER GLOBAL COMPUTER NETWORKS, AND FOR ORDERING AND CENTRAL STORAGE OF ONLINE PHOTOGRAPH ALBUMS (U.S. CLS. 21, 23, 26, 36 AND 38).

CLASS 39—TRANSPORTATION AND STORAGE

FOR ONLINE STORAGE OF DIGITAL PHOTOGRAPH ALBUMS AND DIGITAL PHOTO ARCHIVING SERVICES (U.S. CLS. 100 AND 105).

CLASS 40—MATERIAL TREATMENT

FOR ELECTRONIC IMAGING, SCANNING, DIGITIZING, ALTERATION, RESTORATION AND RETOUCHING OF PHOTOGRAPHIC AND DIGITAL IMAGES; PROVIDING ONLINE ENHANCEMENT AND MANIPULATION OF DOWNLOADED DIGITAL PICTURES; DIGITAL IMAGING SERVICES; PHOTOGRAPHIC REPRODUCTION AND PRINTING SERVICES, NAMELY, DIGITAL ON-DEMAND PRINTING OF PHOTOGRAPHS; BINDING, COLLATING, MOUNTING, FINISHING AND/OR LAMINATING OF PHOTOGRAPHS; PREPARING AND BINDING PHOTOGRAPH ALBUMS FOR OTHERS (U.S. CLS. 100, 103 AND 106).

CLASS 42—SCIENTIFIC AND COMPUTER SERVICES

FOR PROVIDING TEMPORARY USE OF ONLINE NON-DOWNLOADABLE SOFTWARE FOR DIGITIZING, ENHANCING, MANIPULATING, EDITING, PRINTING, STORING, INDEXING AND TRANSMITTING IMAGES, FOR ORDERING OF PHOTOGRAPHIC PRINTS AND ALBUMS OVER GLOBAL COMPUTER NETWORKS, AND FOR ORDERING AND CENTRAL STORAGE OF ONLINE PHOTOGRAPH ALBUMS; UPDATING OF COMPUTER SOFTWARE FOR OTHERS (U.S. CLS. 100 AND 101).

KATHERINE STOIDES, EXAMINING ATTORNEY

SN 78-397,140. SONY NETSERVICES GMBH, ANIF, AUSTRIA, FILED 4-6-2004.

PERSONAL MEDIA ASSISTANT

THE MARK CONSISTS OF STANDARD CHARACTERS WITHOUT CLAIM TO ANY PARTICULAR FONT, STYLE, SIZE, OR COLOR.

PRIORITY CLAIMED UNDER SEC. 44(D) ON ERPNCMNTY TM OFC APPLICATION NO. 003387057, FILED 10-6-2003, REG. NO. 003387057, DATED 3-31-2005, EXPIRES 10-6-2013.

NO CLAIM IS MADE TO THE EXCLUSIVE RIGHT TO USE "PERSONAL MEDIA", APART FROM THE MARK AS SHOWN.

CLASS 9—ELECTRICAL AND SCIENTIFIC APPARATUS

FOR APPARATUS FOR RECORDING, TRANSMISSION OR REPRODUCTION OF SOUND OR IMAGES, NAMELY, COMPUTERS AND OTHER MEMORY BASED PLAYER DEVICES, NAMELY, MP3 PLAYERS, PERSONAL DIGITAL ASSISTANTS, ELECTRONIC ORGANIZERS, DATA PROCESSING DEVICES, TELEPHONES, CELLULAR TELEPHONES, VIDEO GAMING DEVICES, SET TOP BOXES, RADIOS, DIGITAL RADIOS, ANALOG AND/OR DIGITAL RECEIVERS, DIGITAL CAMERAS AND DIGITAL VIDEO CAMERAS; DATA PROCESSING EQUIPMENT, NAMELY, SET TOP BOXES AND HANDHELD DEVICES FOR PROVIDING ACCESS TO AUDIO AND VIDEO CONTENT, GAMES AND INFORMATION AND FOR THE CREATION AND MANAGEMENT OF PERSONAL AND BUSINESS INFORMATION AND MULTIMEDIA CONTENT; COMPUTER HARDWARE AND COMPUTER SOFTWARE FOR PROVIDING ACCESS TO AUDIO AND VIDEO CONTENT, GAMES AND INFORMATION AND FOR THE CREATION AND MANAGEMENT OF PERSONAL AND BUSINESS INFORMATION AND MULTIMEDIA CONTENT (U.S. CLS. 21, 23, 26, 36 AND 38).

CLASS 16—PAPER GOODS AND PRINTED MATTER

FOR PAPER, CARDBOARDS AND GOODS MADE FROM THESE MATERIALS, NAMELY, BOXES, TAGS, STICKERS, BAGS, POUCHES, SLEEVES, COVERS, WRAPPERS; PRINTED MATTER, NAMELY, FORMS, PAMPHLETS, GUIDES, BROCHURES, PAPER LABELS, MANUALS, TABLES, BOOKLETS, MAGAZINES, ALL RELATED TO ENTERTAINMENT, FILM, SPORT, MUSIC, GAMES, COMPUTERS, MEDIA AND/OR LIFESTYLE (U.S. CLS. 2, 5, 22, 23, 29, 37, 38 AND 50).

CLASS 41—EDUCATION AND ENTERTAINMENT

FOR ENTERTAINMENT SERVICES, NAMELY, PROVIDING MUSIC, PICTURE, VIDEO, GAMES, AND NEWS FEEDS AND INFORMATION RELATING TO ENTERTAINMENT, MUSIC, PICTURES, VIDEO, MOVIES, TELEVISION, GAMES, CELEBRITIES AND CURRENT EVENTS; PROVIDING INFORMATION IN THE FIELD OF ENTERTAINMENT RELATING SPECIFICALLY, TO MUSIC, MOVIES, TELEVISION, GAMES, CELEBRITIES AND NEWS (U.S. CLS. 100, 101 AND 107).

CLASS 42—SCIENTIFIC AND COMPUTER SERVICES

FOR SCIENTIFIC AND TECHNOLOGICAL SERVICES, NAMELY, RESEARCH AND DEVELOPMENT FOR NEW PRODUCTS AND/OR SERVICES; TECHNICAL CONSULTING AND RESEARCH IN THE FIELD OF NETWORK DESIGN, NAMELY, WIRELESS, PRODUCTS AND/OR SERVICES; DESIGN AND TESTING OF NEW PRODUCTS AND/OR SERVICES (U.S. CLS. 100 AND 101).

MICHAEL ENGEL, EXAMINING ATTORNEY

SN 78-433,887. POWER IGNITION CONTROLS LTD., EDMONTON, CANADA, FILED 6-11-2004.



Power Ignition and Controls

a division of Spartan Controls

OWNER OF CANADA REG. NO. TMA641016, DATED 6-1-2005, EXPIRES 6-1-2020.

NO CLAIM IS MADE TO THE EXCLUSIVE RIGHT TO USE "POWER IGNITION AND CONTROLS A DIVISION OF", APART FROM THE MARK AS SHOWN.

THE COLOR(S) RED AND BLACK IS/ARE CLAIMED AS A FEATURE OF THE MARK.

THE MARK CONSISTS OF THE WORDING "PIC" IN THE COLOR RED INSIDE A BLACK OVAL AND THE WORDING "POWER IGNITION AND CONTROLS A DIVISION OF SPARTAN CONTROLS" IN BLACK.

CLASS 7—MACHINERY

FOR NATURAL GAS RECIPROCATING ENGINES AND PARTS THEREFOR, NAMELY, IGNITION HARNESS RECORES, IGNITION HARNESSSES, TRIGGER DISKS, AND RELUCTOR PINS (U.S. CLS. 13, 19, 21, 23, 31, 34 AND 35).

CLASS 9—ELECTRICAL AND SCIENTIFIC APPARATUS

FOR NATURAL GAS RECIPROCATING ENGINE PARTS, NAMELY, DUAL OUTPUT HALL EFFECT SENSORS; PRIMARY SHIELD LEADS IN THE NATURE OF A SHIELDED CABLE THAT PROVIDES ELECTRICAL CONNECTION FROM A JUNCTION BOX ON THE IGNITION HARNESS TO THE PRIMARY SIDE OF AN IGNITION COIL; SECONDARY SHIELD LEAD, WHICH PROVIDES A SHIELDED EXPLOSION PROOF ELECTRICAL CONNECTION FROM THE SECONDARY SIDE OF AN IGNITION COIL TO THE SPARK PLUG; BATTERY BOXES (U.S. CLS. 21, 23, 26, 36 AND 38).

CLASS 35—ADVERTISING AND BUSINESS

FOR WHOLESALE DISTRIBUTORSHIPS AND RETAIL SUPPLY SERVICES FEATURING NATURAL GAS RECIPROCATING ENGINE PARTS (U.S. CLS. 100, 101 AND 102).

CLASS 37—CONSTRUCTION AND REPAIR

FOR MAINTENANCE AND REPAIR OF NATURAL GAS RECIPROCATING ENGINES AND COMPONENTS THEREOF; IGNITION SYSTEM INSTALLATION; TECHNICAL SUPPORT SERVICES, NAMELY, PROVIDING TECHNICAL ADVICE IN THE FIELD OF INSTALLING AND REPAIRING IGNITION SYSTEMS (U.S. CLS. 100, 103 AND 106).

CLASS 42—SCIENTIFIC AND COMPUTER SERVICES

FOR ENGINE EMISSION TESTING AND REPORTING (U.S. CLS. 100 AND 101).
KEVON CHISOLM, EXAMINING ATTORNEY

SN 78-454,920. MERCENARY INDUSTRIES, INC., FOXBORO, MA. FILED 7-22-2004.

MERCENARY

THE MARK CONSISTS OF STANDARD CHARACTERS WITHOUT CLAIM TO ANY PARTICULAR FONT, STYLE, SIZE, OR COLOR.

OWNER OF U.S. REG. NOS. 1,780,581 AND 2,445,851.

CLASS 9—ELECTRICAL AND SCIENTIFIC APPARATUS

FOR APPARATUS FOR RECORDING, TRANSMITTING, REPRODUCING, EDITING AND MODIFYING OF SOUND AND IMAGES; ANALOG-TO-DIGITAL AND DIGITAL-TO-ANALOG CONVERTERS; COMPUTER SOFTWARE USED EXCLUSIVELY IN AUDIO PRODUCTION, NAMELY, MIXING CONSOLE FUNCTIONALITY FOR RECORDING, EDITING AND MIXING AUDIO MATERIAL, AUDIO EFFECTS PROCESSING, IN THE NATURE OF REVERBS, EQUALIZATION, AND COMPRESSION, ANALOG TO DIGITAL AUDIO CONVERSION, DIGITAL TO ANALOG AUDIO CONVERSION, AND AUDIO FILE FORMAT CONVERSION FOR USE IN RECORDING STUDIOS; ELECTRONIC APPARATUS AND COMPONENTS FOR RECORDING STUDIOS FOR USE IN AUDIO RECORDING AND PRODUCTION AND LIVE SOUND REPRODUCTION, NAMELY, COMPRESSORS, LIMITERS, EQUALIZERS, DIGITAL DELAYS, DIGITAL AND ANALOG CONVERTERS, MIXERS, RECORDING CONSOLES, MICROPHONE PRE AMPLIFIERS, AUDIO EFFECT PROCESSORS, AUDIO DIRECT INPUT INTERFACES, AUDIO FILTERS, AUDIO SPLITTERS, ROUTERS AND FORMAT CONVERTERS AND MICROPHONES; AMPLIFIERS; AUDIO SPEAKERS (U.S. CLS. 21, 23, 26, 36 AND 38).

CLASS 15—MUSICAL INSTRUMENTS

FOR MUSICAL INSTRUMENTS (U.S. CLS. 2, 21 AND 36).

CLASS 25—CLOTHING

FOR CLOTHING, NAMELY, T-SHIRTS, SLEEVELESS SHIRTS, SWEATSHIRTS, JACKETS, PANTS, BANDANAS, FOOTWEAR, HEADGEAR, NAMELY, HATS AND CAPS (U.S. CLS. 22 AND 39).

CLASS 35—ADVERTISING AND BUSINESS

FOR RETAIL STORE SERVICES FEATURING MUSICAL INSTRUMENTS, CLOTHING, ELECTRONIC APPARATUS FOR USE IN RECORDING, PUBLISHING, TRANSMITTING AND REPRODUCING SOUND IMAGES, ON-LINE RETAIL SERVICES FEATURING MUSICAL INSTRUMENTS, CLOTHING AND ELECTRONIC APPARATUS FOR USE IN RECORDING, PUBLISHING, TRANSMITTING AND REPRODUCING SOUND IMAGES, ARTIST AGENCY SERVICES, NAMELY MANAGEMENT AND PUBLICITY OF PERFORMING ARTISTS; MARKETING SERVICES FOR OTHERS, NAMELY, PRODUCT BRANDING AND IDENTITY DEVELOPMENT, PUBLICITY AND PROMOTIONS STRATEGIC PLANNING AND IMPLEMENTATION, AND LOGO DEVELOPMENT (U.S. CLS. 100, 101 AND 102).

CLASS 41—EDUCATION AND ENTERTAINMENT

FOR MUSIC PUBLISHING; ARRANGING OF LIVE MUSIC PERFORMANCES (U.S. CLS. 100, 101 AND 107).
ALICIA COLLINS, EXAMINING ATTORNEY

SN 78-517,252. SUBHUB LTD., WHEATHAMPSTEAD, UNITED KINGDOM, FILED 11-15-2004.

SubHub

THE MARK CONSISTS OF STANDARD CHARACTERS WITHOUT CLAIM TO ANY PARTICULAR FONT, STYLE, SIZE, OR COLOR.

CLASS 35—ADVERTISING AND BUSINESS

FOR FACILITATING THE EXCHANGE OF NEEDED INFORMATION FOR FINANCIAL COMPENSATION VIA THE INTERNET FOR THE PURPOSE OF ALLOWING THE WEBSITE OWNER TO CHARGE FOR ACCESS TO WEBSITE CONTENT BY GIVING THE OWNER THE ABILITY TO USE THE SUBSCRIPTION PAYMENT METHOD (U.S. CLS. 100, 101 AND 102).

CLASS 42—SCIENTIFIC AND COMPUTER SERVICES

FOR DESIGN, CREATION, HOSTING AND MAINTENANCE OF INTERNET SITES TO ASSIST THIRD PARTIES IN THE CREATION OF REVENUE GENERATING INTERNET SITES BY ALLOWING THE SUBSCRIPTION METHOD OF PAYMENT (U.S. CLS. 100 AND 101).
KATHLEEN M. VANSTON, EXAMINING ATTORNEY

SN 78-575,391. PUZZLER MEDIA GROUP LIMITED, RED-HILL, SURREY, UNITED KINGDOM, FILED 2-25-2005.

SN 78-614,774. MARRIOTT INTERNATIONAL, INC., BETHESDA, MD. FILED 4-22-2005.



PRIORITY CLAIMED UNDER SEC. 44(D) ON ERPN CMNTY TM OFC APPLICATION NO. 4000642, FILED 8-25-2004, REG. NO. 4000642, DATED 3-28-2008, EXPIRES 8-25-2014.

CLASS 9—ELECTRICAL AND SCIENTIFIC APPARATUS

FOR COMPUTER SOFTWARE FOR GAMES; ELECTRONIC GAMES SOFTWARE FOR HAND-HELD ELECTRONIC DEVICES; COMPUTER GAME PROGRAMS; COMPUTER GAME DISCS; VIDEO GAMES ON CD-ROM; COMPUTER GAMES SOFTWARE; VIDEO GAMES SOFTWARE; ELECTRONIC GAMES SOFTWARE; VIDEO GAME SOFTWARE FOR VIDEO GAME MACHINES USED WITH TELEVISION; VIDEO GAME SOFTWARE FOR VIDEO GAMES PLAYED WITH COMPUTERS; COMPUTER GAME CARTRIDGES; ELECTRONIC GAME CONTROLLERS FOR USE WITH ELECTRONIC VIDEO GAMES; VIDEO OUTPUT GAME MACHINES FOR USE WITH TELEVISION AND COMPUTER; INTERACTIVE MULTIMEDIA COMPUTER GAME PROGRAMS; GAMES SUPPLIED IN THE FORM OF PRE-RECORDED CARTRIDGES, TAPES, CASSETTES, RECORDS, DISCS, CDS, DVDS, AND COMPUTER GAME CARTRIDGES AND INSTRUCTIONAL MANUALS SOLD AS A UNIT; PARTS AND FITTINGS FOR ALL THE AFORESAID GOODS; DOWNLOADABLE ELECTRONIC PUBLICATIONS IN THE NATURE OF BOOKS, PAMPHLETS, MAGAZINES, NEWSPAPERS, NEWSPAPER FEATURE COLUMNS, NEWSLETTERS, INSTRUCTIONAL AND TEACHING MATERIAL, INSTRUCTION MANUALS IN THE FIELD OF WORD GAMES, LOGIC GAMES, SUDOKU GAMES, CODE CRACKING GAMES AND QUIZZES (U.S. CLS. 21, 23, 26, 36 AND 38).

CLASS 28—TOYS AND SPORTING GOODS

FOR GAMES, TOYS AND PLAYTHINGS, NAMELY, BOARD GAMES AND HANDHELD GAMES, NAMELY, CHECKERS, CHESS AND DOMINOES GAMES AND PUZZLE GAMES, NAMELY, WORD GAMES, LOGIC GAMES, SUDOKU GAMES, CODE CRACKING GAMES AND QUIZZES, NOT INCLUDING WORD GAMES AND PUZZLE GAMES IN CLASS 16, ELECTRONIC GAMES AND PLAYTHINGS, OTHER THAN THOSE ADAPTED FOR USE WITH TELEVISION RECEIVERS, NAMELY, WORD GAMES, LOGIC GAMES, SUDOKU GAMES, CODE CRACKING GAMES AND QUIZZES; ARCADE-TYPE ELECTRONIC VIDEO GAMES; HAND-HELD UNIT FOR PLAYING ELECTRONIC GAMES; HAND-HELD COMPUTER GAMES, NAMELY, BATTERY POWERED COMPUTER GAMES WITH LCD SCREENS THAT FEATURE ANIMATION AND SOUND EFFECTS; AMUSEMENT GAME MACHINES; COIN-OPERATED AMUSEMENT MACHINES; PARTS AND FITTINGS FOR ALL THE AFORESAID GOODS (U.S. CLS. 22, 23, 38 AND 50).

CLASS 41—EDUCATION AND ENTERTAINMENT

FOR ENTERTAINMENT SERVICES, NAMELY, PROVIDING ON-LINE COMPUTER GAMES AND GAMES BROADCAST VIA TELEVISION, CABLE, TELEPHONE, CELLULAR TELEPHONE BROADCAST OR VIA THE INTERNET; PROVIDING ELECTRONIC PUBLICATIONS, NAMELY, ON-LINE BROCHURES, ARTICLES, MAGAZINES, AND MANUALS IN THE FIELD OF COMPUTER GAMES (U.S. CLS. 100, 101 AND 107).
BENJAMIN OKEKE, EXAMINING ATTORNEY

MARRIOTT RESORTS

THE MARK CONSISTS OF STANDARD CHARACTERS WITHOUT CLAIM TO ANY PARTICULAR FONT, STYLE, SIZE, OR COLOR.

OWNER OF U.S. REG. NOS. 899,900, 3,638,115 AND OTHERS.

NO CLAIM IS MADE TO THE EXCLUSIVE RIGHT TO USE "RESORTS", APART FROM THE MARK AS SHOWN. SEC. 2(F) AS TO "MARRIOTT".

CLASS 41—EDUCATION AND ENTERTAINMENT

FOR HEALTH CLUB SERVICES, NAMELY, PROVIDING INSTRUCTION AND CONSULTATION IN THE FIELD OF PHYSICAL EXERCISE; PROVIDING USE OF EXERCISE EQUIPMENT; PROVIDING FITNESS AND EXERCISE FACILITIES; GOLF CLUB, GOLF COURSE AND GOLF INSTRUCTION SERVICES (U.S. CLS. 100, 101 AND 107).

FIRST USE 11-4-2004; IN COMMERCE 11-4-2004.

CLASS 43—HOTEL AND RESTAURANT SERVICES

FOR HOTEL SERVICES; RESTAURANT, CATERING, BAR AND COCKTAIL LOUNGE SERVICES; RESORT LODGING SERVICES; PROVISION OF GENERAL PURPOSE FACILITIES FOR MEETINGS, CONFERENCES AND EXHIBITIONS; PROVISION OF BANQUET AND SOCIAL FUNCTION FACILITIES FOR SPECIAL OCCASIONS; AND RESERVATION SERVICES FOR HOTEL ACCOMMODATIONS FOR OTHERS (U.S. CLS. 100 AND 101).

FIRST USE 11-4-2004; IN COMMERCE 11-4-2004.

CLASS 44—MEDICAL, BEAUTY AND AGRICULTURAL SERVICES

FOR HEALTH SPA SERVICES, NAMELY, PROVIDING FACIAL, HAIR, SKIN AND BODY TREATMENTS, MANICURE AND PEDICURE SERVICES, MASSAGE SERVICES, BODY WAXING SERVICES AND BEAUTY SALON SERVICES (U.S. CLS. 100 AND 101).

FIRST USE 11-4-2004; IN COMMERCE 11-4-2004.

GENE MACIOL, EXAMINING ATTORNEY

SN 78-727,131. HAEMEDIC AB, TYRESO, SWEDEN, FILED 10-5-2005.

PROLANCE

THE MARK CONSISTS OF STANDARD CHARACTERS WITHOUT CLAIM TO ANY PARTICULAR FONT, STYLE, SIZE, OR COLOR.

OWNER OF ERPN CMNTY TM OFC REG. NO. 004289542, DATED 2-1-2006, EXPIRES 2-15-2015.

CLASS 10—MEDICAL APPARATUS

FOR SURGICAL, MEDICAL, DENTAL AND VETERINARY APPARATUS AND INSTRUMENTS, NAMELY, ACUPUNCTURE NEEDLES, BLOOD ANALYSIS APPARATUS, NAMELY, HEMATOLOGY ANALYZERS, BLOOD GLUCOSE MONITORS, BLOOD PRESSURE MEASURING APPARATUS, SURGICAL NEEDLES, ELECTRO-ACUPUNCTURE APPARATUS, ELECTRO-CARDIOGRAPHS, PACEMAKERS, INFUSION APPARATUS, NAMELY, SYRINGES, INJECTION NEEDLES, LANCETS FOR OBTAINING BLOOD SAMPLES, CATHETERS FOR INSERTION INTO BLOOD VESSELS, PUMPS FOR METERING MEDICATIONS, INFUSION SETS, DEVICES FOR FLUSHING BODY CAVITIES, DENTAL DRILLS, DENTAL MIRRORS; ORTHOPEDIC APPLIANCES, NAMELY, ARTIFICIAL LIMBS, EYES AND TEETH; ORTHOPEDIC ARTICLES, NAMELY, PATIENT HOISTS, BATH LIFTERS, NECK SUPPORTS, BACK SUPPORTS, KNEE SUPPORTS, ANKLE SUPPORTS, PATIENT TRANSPORT SYSTEMS, NAMELY, STRETCHERS, MEDICAL PATIENT TREATMENT CHAIRS, PATIENT EXAMINATION TABLES, PATIENT TREATMENT TABLES, TOILETS ADAPTED FOR MEDICAL PATIENTS, AND HOSPITAL GURNEYS (U.S. CLS. 26, 39 AND 44).

CLASS 12—VEHICLES

FOR WHEELCHAIRS (U.S. CLS. 19, 21, 23, 31, 35 AND 44).

CLASS 16—PAPER GOODS AND PRINTED MATTER

FOR PACKAGING MADE OF PAPER, CARDBOARD AND PLASTIC, NAMELY, PAPER BAGS FOR PACKAGING, PLASTIC BAGS FOR PACKAGING, PLASTIC WRAPPING FILMS, PLASTIC BUBBLE PACKS FOR WRAPPING, BOXES OF PAPER OR CARDBOARD (U.S. CLS. 2, 5, 22, 23, 29, 37, 38 AND 50).

CLASS 20—FURNITURE AND ARTICLES NOT OTHERWISE CLASSIFIED

FOR PLASTIC BOXES FOR PACKAGING; NON-METAL RIGID AND FOLDABLE BOXES FOR SURGICAL, MEDICAL, DENTAL AND VETERINARY APPARATUS AND INSTRUMENTS INCLUDING SURGICAL, MEDICAL, DENTAL AND VETERINARY TOOLS, FOR ARTIFICIAL LIMBS, EYES AND TEETH, AND FOR ORTHOPEDIC ARTICLES INCLUDING ORTHOPEDIC TOOLS; HOSPITAL BEDS FOR USE BY PATIENTS (U.S. CLS. 2, 13, 22, 25, 32 AND 50).

CLASS 42—SCIENTIFIC AND COMPUTER SERVICES

FOR ENGINEERING SERVICES IN THE FIELD OF DEVELOPMENT AND CONSULTANCY IN CONNECTION WITH MEDICAL INSTRUMENTS, APPARATUS AND ARTICLES; ENGINEERING IN THE FIELD OF TECHNICAL MEDICAL INSTRUMENTS, APPARATUS AND ARTICLES (U.S. CLS. 100 AND 101).

ANGELA M. MICHELI, EXAMINING ATTORNEY

SN 78-741,859. INTERNATIONAL PAPER COMPANY, STAMFORD, CT. FILED 10-27-2005.

REDD EXPRESS

THE MARK CONSISTS OF STANDARD CHARACTERS WITHOUT CLAIM TO ANY PARTICULAR FONT, STYLE, SIZE, OR COLOR.

NO CLAIM IS MADE TO THE EXCLUSIVE RIGHT TO USE "EXPRESS", APART FROM THE MARK AS SHOWN.

CLASS 35—ADVERTISING AND BUSINESS

FOR INFORMATION MANAGEMENT SERVICES, NAMELY, SHIPMENT PROCESSING, PREPARING SHIPMENT DOCUMENTS AND INVOICES, TRACKING DOCUMENTS, PACKAGES AND FREIGHT OVER COMPUTER NETWORKS, INTRANETS AND INTERNETS (U.S. CLS. 100, 101 AND 102).

CLASS 39—TRANSPORTATION AND STORAGE

FOR TRANSPORTATION AND DELIVERY SERVICES FOR PAPER AND PACKAGING PRODUCTS OF OTHERS BY ROAD; WAREHOUSING SERVICES, NAMELY, STORAGE AND DISTRIBUTION OF PAPER AND PACKAGING PRODUCTS FOR OTHERS (U.S. CLS. 100 AND 105).

PAULA MAHONEY, EXAMINING ATTORNEY

SN 78-742,867. GAMZE LTD, KOWLOON, HONG KONG, FILED 10-28-2005.



PRIORITY CLAIMED UNDER SEC. 44(D) ON ERPNTY TM OFC APPLICATION NO. 4626586, FILED 9-29-2005.

NO CLAIM IS MADE TO THE EXCLUSIVE RIGHT TO USE "MANGA" AND "GAMES", APART FROM THE MARK AS SHOWN.

THE LINING IS A FEATURE OF THE MARK AND DOES NOT INDICATE COLOR.

THE ENGLISH TRANSLATION OF THE WORD "MANGA" IN THE MARK IS COMIC OR COMIC BOOK.

CLASS 9—ELECTRICAL AND SCIENTIFIC APPARATUS

FOR INTERACTIVE VIDEO GAME PROGRAMS THAT ARE PLAYED ON HAND-HELD UNITS THAT COMMUNICATE WITH ONE ANOTHER OVER A GLOBAL COMPUTER NETWORK (U.S. CLS. 21, 23, 26, 36 AND 38).

CLASS 28—TOYS AND SPORTING GOODS

FOR HAND-HELD UNIT FOR PLAYING ELECTRONIC GAMES; HAND-HELD UNIT FOR PLAYING VIDEO GAMES; HAND-HELD UNIT FOR PLAYING VIDEO GAMES THAT MAY BE CONNECTED DIRECTLY TO A LIKE UNIT OR COMMUNICATE WITH LIKE UNITS OVER A GLOBAL COMPUTER NETWORK FOR HEAD-TO-HEAD PLAY; HAND-HELD GAMES WITH LIQUID CRYSTAL DISPLAYS; LCD GAME MACHINES (U.S. CLS. 22, 23, 38 AND 50).

DAVID YONTEF, EXAMINING ATTORNEY

SN 78-752,106. DERTTY ENTERTAINMENT, LLC, OVERLAND, MO. FILED 11-11-2005.

DERTTY ENTERTAINMENT

THE MARK CONSISTS OF STANDARD CHARACTERS WITHOUT CLAIM TO ANY PARTICULAR FONT, STYLE, SIZE, OR COLOR.

NO CLAIM IS MADE TO THE EXCLUSIVE RIGHT TO USE "ENTERTAINMENT", APART FROM THE MARK AS SHOWN.

CLASS 9—ELECTRICAL AND SCIENTIFIC APPARATUS

FOR PRERECORDED TAPES, RECORDS, VIDEO TAPES, AND COMPACT DISCS CONTAINING MUSIC AND MUSIC VIDEOS (U.S. CLS. 21, 23, 26, 36 AND 38).

CLASS 41—EDUCATION AND ENTERTAINMENT

FOR MUSIC AND MUSIC VIDEO RECORDING AND PRODUCTION; RECORD EDITING AND PRODUCTION, AND OPERATION OF AUDIO AND VIDEO RECORDING STUDIOS FOR MUSIC AND MUSIC VIDEOS (U.S. CLS. 100, 101 AND 107).

DAVID MILLER, EXAMINING ATTORNEY

SN 78-755,283. SAG GMBH, LANGEN, FED REP GERMANY, FILED 11-16-2005.



PRIORITY CLAIMED UNDER SEC. 44(D) ON ERPNCMNTY TM OFC APPLICATION NO. 004663076, FILED 9-30-2005, REG. NO. 4663076, DATED 7-25-2008, EXPIRES 9-30-2015.

THE COLORS BLUE AND ORANGE ARE CLAIMED AS A FEATURE OF THE MARK.

THE COLOR BLUE APPEARS IN THE LETTERS "SAG" AND IN TWO CIRCLES. THE COLOR ORANGE APPEARS IN A THIRD CIRCLE IN THE MARK.

CLASS 6—METAL GOODS

FOR BUILDING MATERIALS OF METAL, NAMELY, METAL BUILDING FLASHING, SOFFITS AND FASCIA; METAL POLES; POLES OF METAL FOR ELECTRIC POWER LINES; METAL POWER LINE TOWERS IN THE NATURE OF METAL UTILITY POLES (U.S. CLS. 2, 12, 13, 14, 23, 25 AND 50).

CLASS 7—MACHINERY

FOR ELECTRIC MOTORS FOR MACHINES, ELECTRIC GENERATORS, ELECTRIC POWER GENERATORS, TURBINES NOT FOR LAND VEHICLES, ELECTRIC COMPRESSORS, AIR COMPRESSORS; AIR CONDENSERS AND TURBO ELECTRIC COMPRESSORS (U.S. CLS. 13, 19, 21, 23, 31, 34 AND 35).

CLASS 9—ELECTRICAL AND SCIENTIFIC APPARATUS

FOR CONDENSERS, NAMELY, CAPACITORS; APPARATUS AND INSTRUMENTS FOR HEAVY CURRENT ENGINEERING AND LINES TRANSMISSION, CONVERSION, STORAGE, REGULATION AND CONTROL, NAMELY, CURRENT CONVERTERS, CURRENT RECTIFIERS, COMPUTERS, AND CIRCUITS FOR HEAVY ELECTRICAL CURRENT; ELECTRIC CABLES, ELECTRIC WIRES, ELECTRICAL CONDUCTORS AND PARTS THEREFORE, NAMELY, ELECTRIC CABLE AND WIRE CONNECTION FITTINGS; ELECTRIC SWITCHES; ELECTRICAL DISTRIBUTION BOXES; ELECTRICAL FUSES; ELECTRICAL TRANSFORMERS; ELECTRICAL RELAYS; ELECTRIC MEASURING INSTRUMENTS; ELECTRICAL INDICATING EQUIPMENT, NAMELY, ELECTRICAL METERS, CURRENT METERS, VOLTAGE METERS, AND COMPUTERS FOR MONITORING ELECTRICAL CURRENT; ELECTRICAL SWITCHING DEVICES AND ELECTRICAL SWITCHGEAR, NAMELY, SWITCHGEARS, POWER SWITCHES, SWITCH BOXES, AND VOLTAGE BOOSTING DEVICES FOR ELECTRIC POWER LINES; COUNTERS AND METERS, NAMELY, VOLTAGE TESTERS; POWER RECTIFIERS (U.S. CLS. 21, 23, 26, 36 AND 38).

CLASS 35—ADVERTISING AND BUSINESS

FOR COMMERCIAL BUSINESS AND BUSINESS ORGANIZATIONAL CONSULTING REGARDING THE PREPARATION FOR, ERECTION AND CONSTRUCTION OF, AND THE OPERATION OF ENERGY SUPPLY FACILITIES, ENERGY GENERATION FACILITIES, POWER ENGINEERING INSTALLATIONS AND SYSTEMS, ELECTRICAL SYSTEMS, SUPPLY AND DISTRIBUTION SYSTEMS FOR POWER, GAS, WATER AND HEAT, WASTE DISPOSAL SYSTEMS, PARTICULARLY FOR WASTE WATER, TELECOMMUNICATIONS EQUIPMENT, LIGHTING EQUIPMENT, TRAFFIC SIGNAL EQUIPMENT AND OVERHEAD TRACTION EQUIPMENT; COMMERCIAL BUSINESS PLANNING AND BUSINESS ORGANIZATIONAL PLANNING OF CONSTRUCTION PROJECTS; BUSINESS MANAGEMENT CONSULTING, BUSINESS MANAGEMENT AND ADMINISTRATION; PERSONNEL MANAGEMENT, NAMELY, TEMPORARY TRANSFER OF PERSONNEL FOR OTHERS (U.S. CLS. 100, 101 AND 102).

CLASS 36—INSURANCE AND FINANCIAL

FOR FINANCIAL CONSULTING AND FINANCING FOR OTHERS OF THE CONSTRUCTION AND THE OPERATION OF ENERGY SUPPLY FACILITIES, ENERGY GENERATION FACILITIES, POWER ENGINEERING INSTALLATIONS AND SYSTEMS, ELECTRICAL SYSTEMS, SUPPLY AND DISTRIBUTION SYSTEMS FOR POWER, GAS, WATER AND HEAT, WASTE WATER DISPOSAL SYSTEMS, TELECOMMUNICATIONS EQUIPMENT, LIGHTING EQUIPMENT, TRAFFIC SIGNAL EQUIPMENT AND OVERHEAD TRACTION EQUIPMENT; FINANCIAL PLANNING FOR CONSTRUCTION PROJECTS; INVESTMENT SERVICES, NAMELY, ASSETS MANAGEMENT IN CONNECTION WITH CONSTRUCTION PROJECTS (U.S. CLS. 100, 101 AND 102).

CLASS 37—CONSTRUCTION AND REPAIR

FOR COMMERCIAL CONSTRUCTION AND CONSTRUCTION ORGANIZATIONAL CONSULTING REGARDING BUILDING AND CONSTRUCTION OF ENERGY SUPPLY FACILITIES, ENERGY GENERATION FACILITIES, POWER ENGINEERING INSTALLATIONS AND SYSTEMS, ELECTRICAL SYSTEMS, SUPPLY AND DISTRIBUTION SYSTEMS FOR POWER, GAS, WATER AND HEAT, WASTE DISPOSAL SYSTEMS, PARTICULARLY FOR WASTE WATER, TELECOMMUNICATIONS EQUIPMENT, LIGHTING EQUIPMENT, TRAFFIC SIGNAL EQUIPMENT AND OVERHEAD TRACTION EQUIPMENT; SERVICES OF AN ELECTRICIAN, NAMELY, ELECTRICAL CONTRACTING SERVICES; CONSTRUCTION OF BUILDINGS; CONSTRUCTION OF ENERGY SUPPLY FACILITIES AND ENERGY GENERATION FACILITIES, POWER

ENGINEERING INSTALLATIONS AND SYSTEMS, ELECTRICAL SYSTEMS, SUPPLY AND DISTRIBUTION SYSTEMS FOR POWER, GAS, WATER AND HEAT, DISPOSAL SYSTEMS, PARTICULARLY FOR WASTE WATER; INSTALLATION, MAINTENANCE AND REPAIR OF TELECOMMUNICATIONS EQUIPMENT, LIGHTING EQUIPMENT, TRAFFIC SIGNAL EQUIPMENT AND OVERHEAD TRACTION EQUIPMENT; ELECTRICAL INSTALLATIONS OF ELECTRICAL SYSTEMS; REPAIR AND MAINTENANCE OF TOWERS FOR POWER DISTRIBUTION AND FOR TELECOMMUNICATIONS (U.S. CLS. 100, 103 AND 106).

CLASS 38—COMMUNICATION

FOR TELECOMMUNICATIONS, NAMELY, PROVIDING ELECTRONIC TELECOMMUNICATION CONNECTIONS; TELECOMMUNICATION SERVICES, NAMELY, TRANSMISSION OF VOICE, DATA AND DOCUMENTS; RENTAL OF TELECOMMUNICATIONS EQUIPMENT (U.S. CLS. 100, 101 AND 104).

CLASS 39—TRANSPORTATION AND STORAGE

FOR DISTRIBUTION OF POWER, GAS, WATER AND HEAT (U.S. CLS. 100 AND 105).

CLASS 41—EDUCATION AND ENTERTAINMENT

FOR PROVIDING TRAINING AND SEMINARS IN THE FIELD OF ENGINEERING, CONSTRUCTION, ELECTRICAL SYSTEMS, ENERGY GENERATION, ENERGY SUPPLY, ENERGY DISTRIBUTION AND TELECOMMUNICATIONS (U.S. CLS. 100, 101 AND 107).

CLASS 42—SCIENTIFIC AND COMPUTER SERVICES

FOR TECHNICAL ENGINEERING CONSULTATION FOR THE ERECTION, CONSTRUCTION AND OPERATION OF ENERGY SUPPLY FACILITIES, ENERGY GENERATION FACILITIES, POWER ENGINEERING INSTALLATIONS AND SYSTEMS, ELECTRICAL SYSTEMS, SUPPLY AND DISTRIBUTION SYSTEMS FOR POWER, GAS, WATER AND HEAT, DISPOSAL SYSTEMS, PARTICULARLY FOR WASTE WATER, TELECOMMUNICATIONS EQUIPMENT, LIGHTING EQUIPMENT, TRAFFIC SIGNAL EQUIPMENT AND OVERHEAD TRACTION EQUIPMENT; SERVICES OF AN ENGINEER, NAMELY, ENGINEERING; SERVICES OF A PHYSICIST, NAMELY, CONSULTATION AND RESEARCH IN THE FIELD OF PHYSICS; SERVICES OF A CHEMIST, NAMELY, CHEMIST SERVICES (U.S. CLS. 100 AND 101).

BRENDAN MCCAULEY, EXAMINING ATTORNEY

SN 78-764,834. MOBIDIA TECHNOLOGY, INC., RICHMOND, CANADA, FILED 12-1-2005.

WAVE

THE MARK CONSISTS OF STANDARD CHARACTERS WITHOUT CLAIM TO ANY PARTICULAR FONT, STYLE, SIZE, OR COLOR.

CLASS 9—ELECTRICAL AND SCIENTIFIC APPARATUS

FOR COMPUTER SOFTWARE FOR USE IN COMMUNICATIONS NETWORKS, NAMELY, COMPUTER SOFTWARE FOR USE IN ENABLING MOBILE DEVICES TO COMMUNICATE WITH WIRELESS NETWORKS AND PROVIDING MIX DATA TRAFFIC DATABASE MANAGEMENT OVER SINGLE OR MIX DATA NETWORK TYPES (U.S. CLS. 21, 23, 26, 36 AND 38).

CLASS 42—SCIENTIFIC AND COMPUTER SERVICES

FOR DESIGN, DEVELOPMENT AND IMPLEMENTATION OF COMPUTER SOFTWARE FOR OTHERS RELATING TO ENABLING MOBILE DEVICES TO COMMUNICATE WITH WIRELESS NETWORKS AND PROVIDING MIX DATA TRAFFIC DATABASE MANAGEMENT OVER SINGLE OR MIX DATA NETWORK TYPES (U.S. CLS. 100 AND 101).

HOWARD SMIGA, EXAMINING ATTORNEY

SN 78-779,389. BLAZE EUROPE LIMITED, DONCASTER, UNITED KINGDOM, FILED 12-22-2005.

XPLODER

THE MARK CONSISTS OF STANDARD CHARACTERS WITHOUT CLAIM TO ANY PARTICULAR FONT, STYLE, SIZE, OR COLOR.

OWNER OF UNITED KINGDOM REG. NO. 2423242, DATED 10-26-2007, EXPIRES 5-31-2016.

CLASS 9—ELECTRICAL AND SCIENTIFIC APPARATUS

FOR VIDEO GAMES ENHANCERS IN THE NATURE OF COMPUTER SOFTWARE; COMPACT DISCS AND DVDS FEATURING VIDEO GAMES CHEAT CODES, ALL FOR USE OR BEING ADAPTED FOR USE WITH COMPUTER GAMES, ELECTRONIC GAMES AND VIDEO GAMES APPARATUS, CONSOLES AND/OR OTHER AMUSEMENT APPARATUS AND/OR ALL FOR USE OR BEING ADAPTED FOR USE WITH HANDHELD COMPUTER GAMES, ELECTRONIC GAMES, VIDEO GAMES AND OTHER HANDHELD AMUSEMENT APPARATUS; VIDEO GAME SOFTWARE CONTAINING CODES FOR USE IN PLAYING COMPUTER GAMES, ELECTRONIC GAMES AND/OR VIDEO GAMES; AND DOWNLOADABLE VIDEO GAME SOFTWARE CONTAINING CODES FOR USE IN PLAYING COMPUTER GAMES, ELECTRONIC GAMES AND/OR VIDEO GAMES DOWNLOADABLE FROM AN ONLINE COMPUTER DATABASE AND/OR VIA THE WORLDWIDE WEB OR INTERNET (U.S. CLS. 21, 23, 26, 36 AND 38).

CLASS 41—EDUCATION AND ENTERTAINMENT

FOR ENTERTAINMENT SERVICES, NAMELY, PROVIDING CHEAT CODES, INFORMATION AND INSTRUCTIONAL TIPS FOR USE IN PLAYING COMPUTER GAMES, ELECTRONIC GAMES AND VIDEO GAMES. (U.S. CLS. 100, 101 AND 107).

KEVIN DINALLO, EXAMINING ATTORNEY

SN 78-788,154. SA SA OVERSEAS LIMITED, TORTOLA, BR. VIRGIN ISLANDS, FILED 1-10-2006.

莎莎

OWNER OF HONG KONG REG. NO. 301090467, DATED 5-2-1998, EXPIRES 5-2-2015.

OWNER OF U.S. REG. NOS. 2,446,341, 2,857,114 AND 3,039,350.

THE ENGLISH TRANSLATION OF "SHA SHA" IS SPECIES OF SEDGE. "SA SA" HAS NO MEANING IN ENGLISH. THE NON-LATIN CHARACTERS IN THE MARK TRANSLITERATE TO "SA SA" IN CANTONESE AND "SHA SHA" IN MANDARIN.

CLASS 3—COSMETICS AND CLEANING PREPARATIONS

FOR MAKE-UP, NAMELY, LIPSTICKS, LIPLINERS, LIP PENCILS, LIP CONDITIONERS, FACIAL POWDER, COMPACT CASES FILLED WITH FACIAL POWDER, LOOSE POWDER, FOUNDATION MAKE-UP, POWDER FOUNDATION MAKE-UP, LIQUID FOUNDATION MAKE-UP, BLUSH, POWDER EYESHADOW, CREAM EYESHADOW, EYELINER, EYEBROW PENCIL, MASCARA, WATERPROOF MASCARA, EYE PENCIL, EYE MAKEUP REMOVER, NAIL POLISH, BASE COAT POLISH FOR NAILS, NAIL POLISH REMOVER, NAIL CARE, NAMELY, ENVIRONMENTAL PROTECTIVE NAIL CREAM; NAIL HARDENER, CONCEALER; SKIN CARE PREPARATIONS, NAMELY, CLEANSING GEL, CLEANSING CREAM, CLEANSING LOTION, CLEANSING WATER, FOAMING CLEANSER, CLEANSING BAR, MOISTURIZING LOTION, MOISTURIZING CREAM, DAY CREAM, NIGHT CREAM, FIRING CREAM, BUST CREAM, BUST LOTION, SLIMMING CREAM, SLIMMING GEL, SLIMMING LOTION, ANTI-WRINKLE LOTION, FIRING WRINKLE CREAM, HAND CREAM, HAND LOTION, MAKEUP REMOVER, NECK CREAM, THROAT CREAM, EYE CREAM, WHITENING CREAM, WHITENING TONER, WHITENING LOTION, WHITENING ESSENCE, BODY AND FACIAL EMULSIONS, BODY MASKS LOTION AND CREAMS, PURIFYING MASK, RELAXING MASK, CLEANSING MASK, SKIN TONER, STIMULATING TONER, NAMELY, SKIN SOOTHING LOTION, ANTI-AGING CREAM, ANTI-AGING LOTION; SKIN CARE IN THE NATURE OF A CERAMIDE, NAMELY, SKIN CARE INGREDIENT TO PREVENT MOISTURE LOSS TO FACE AND EYE AREAS; SKIN CARE IN THE NATURE OF A FRUITION, NAMELY, AN INGREDIENT TO INCREASE SKIN CLARITY; SKIN CARE IN THE NATURE OF A SERUM, NAMELY, AN IMMEDIATE ACTION FLUID GEL FOR SOFTENING AND HYDRATING SKIN, NAMELY, THE FACE AND EYE AREAS; SKIN CARE PREPARATIONS, NAMELY, NON-MEDICATED EXFOLIATING CREAM AND GEL, SKIN LOTION, SUN BLOCK CREAM, SUN BLOCK LOTION, UV DEFENSE CREAM, UV DEFENSE GEL, AFTER SUN BODY CREAM, AFTER SUN BODY LOTION, AFTER SUN MILK, HYDRATION CREAM, HYDRATION LOTION, SELF TANNING MILK, SELF TANNING BODY GEL; HAIR CARE PREPARATIONS, NAMELY, SHAMPOO, RINSE, NOURISHING CLEANSER, CONDITIONER, HAIR TREATMENT, REVITALIZER, BOOSTER, NAMELY, A PRODUCT WHICH INCREASES PROTEIN IN HAIR, STYLING AND FINISHING LOTION, FIXING GEL, FIXING/STYLING SPRAY, FINISHING SPRITZ, MOUSSE, SHAPING MIST,

STYLING WHIP, SHAPING LOTION; FRAGRANCES, NAMELY, PERFUME, EAU DE TOILETTE, EAU DE PARFUM, EAU DE COLOGNE, FRAGRANCES FOR PERSONAL USE IN MINIBOTTLES; MINIATURE SETS, NAMELY, FRAGRANCES FOR PERSONAL USE IN A SET OF MINIBOTTLES; FRAGRANCES FOR PERSONAL USE IN A LARGE BOTTLE; SHOWER GEL, BODY LOTION, BODY OIL, DUSTING POWDER, SKIN SOAP, BODY CREAM, BODY MILK, PERSONAL DEODORANT, AFTER SHAVE CREAM, AFTER SHAVE FOAM; ACCESSORIES, NAMELY, COTTON FOR COSMETIC PURPOSES; GEL EYE MASKS, BLUSHERS; PUMICE STONES FOR PERSONAL USE; SPRAY WATER, NAMELY, MINERAL WATER IN ATOMIZED CONTAINERS FOR SKIN FRESHENING AND MOISTURIZING (U.S. CLS. 1, 4, 6, 50, 51 AND 52).

CLASS 20—FURNITURE AND ARTICLES NOT OTHERWISE CLASSIFIED

FOR PERSONAL COMPACT MIRRORS (U.S. CLS. 2, 13, 22, 25, 32 AND 50).

CLASS 21—HOUSEWARES AND GLASS

FOR COSMETIC BRUSHES, NAMELY, FACE BRUSHES, LIP BRUSHES, EYESHADOW BRUSHES, HAIR BRUSHES, HAIR COMB, SPONGES FOR APPLYING BODY POWDER, DISPOSABLE FOAM APPLICATOR STICKS FOR APPLYING COSMETICS NOT CONTAINING COSMETICS, BOTTLES, NAMELY, EMPTY COSMETIC BOTTLES FOR THE PURPOSE OF FILLING THE BOTTLES WITH VARIOUS COSMETIC PRODUCTS AS DESIRED BY THE INDIVIDUAL CONSUMER (U.S. CLS. 2, 13, 23, 29, 30, 33, 40 AND 50).

CLASS 44—MEDICAL, BEAUTY AND AGRICULTURAL SERVICES

FOR PHYSICAL THERAPY SERVICES; BEAUTY SALON SERVICES; SKIN CARE SALONS; WEIGHT REDUCTION DIET PLANNING AND SUPERVISION; MASSAGE SERVICES; PROVIDING PUBLIC BATH FACILITIES; BEAUTY CONSULTATION SERVICES, NAMELY, ADVISING INDIVIDUALS ON THE SPECIFIC SELECTION OF COSMETICS; PROVISION OF INFORMATION AND ADVISORY AND CONSULTANCY SERVICES RELATING TO THE USE OF SKIN CARE, BEAUTY TREATMENT, COSMETIC PRODUCTS, PHARMACEUTICAL AND MEDICAL SERVICES VIA THE INTERNET, BY TELECOMMUNICATIONS DEVICES OR OTHER ELECTRONIC MEANS; OPERATION OF SAUNA FACILITIES; OPERATING SOLARIUMS AND SUN DECK FACILITIES; WEIGHT REDUCTION DIET PLANNING AND SUPERVISION SERVICES; HEALTH CARE SERVICES (U.S. CLS. 100 AND 101).

KATHERINE STOIDES, EXAMINING ATTORNEY

SN 78-788,380. FONDATION ONE DROP, MONTREAL, QUEBEC, CANADA, FILED 1-10-2006.

ONE DROP

THE MARK CONSISTS OF STANDARD CHARACTERS WITHOUT CLAIM TO ANY PARTICULAR FONT, STYLE, SIZE, OR COLOR.

PRIORITY CLAIMED UNDER SEC. 44(D) ON CANADA APPLICATION NO. 1284497, FILED 12-23-2005, REG. NO. TMA740,894, DATED 5-27-2009, EXPIRES 5-27-2024.

CLASS 35—ADVERTISING AND BUSINESS

FOR BUSINESS MANAGEMENT, PLANNING, AND DEVELOPMENT OF HUMANITARIAN PROJECTS FOR IMPROVING QUALITY OF LIFE AND LIVING CONDITIONS OF UNDERPRIVILEGED POPULATIONS (U.S. CLS. 100, 101 AND 102).

CLASS 36—INSURANCE AND FINANCIAL

FOR CHARITABLE FUND RAISING; FINANCING OF HUMANITARIAN PROJECTS FOR IMPROVING QUALITY OF LIFE AND LIVING CONDITIONS OF UNDERPRIVILEGED POPULATIONS (U.S. CLS. 100, 101 AND 102).

DOMINIC J. FERRAIUOLO, EXAMINING ATTORNEY

SN 78-863,520. A. DAIGGER AND COMPANY, THROUGH ITS ETA/CUISENAIRE DIVISION, VERNON HILLS, IL. FILED 4-18-2006.

CPW

THE MARK CONSISTS OF STANDARD CHARACTERS WITHOUT CLAIM TO ANY PARTICULAR FONT, STYLE, SIZE, OR COLOR.

CLASS 9—ELECTRICAL AND SCIENTIFIC APPARATUS

FOR SCIENTIFIC APPARATUS FOR EDUCATIONAL PURPOSES, NAMELY, ALTIMETERS, ANEMOMETERS, GRADUATED RULERS, BAROMETERS, SCALES, COMPASSES, CALIPERS, CLINOMETERS, THERMOMETERS, THERMOMETER RACKS, APPARATUS TO MEASURE LIQUID VOLUME, MEASURING CUPS, MEASURING SPOONS, MEASURING JARS, PROTRACTORS, MEASURING PITCHERS, RAIN GAUGES, ELECTRIC TIMERS, SPECTROSCOPES, TAPE MEASURES, ELECTRONIC TIMERS, AND FOLDING RULERS IN THE NATURE OF YARD STICKS; LAB SUPPLIES FOR EDUCATIONAL PURPOSES, NAMELY, BATTERIES, BATTERY HOLDERS, BEAKERS, BINOCULARS, LABORATORY GLASSWARE, NAMELY, BEAKERS, GOGGLES, SAFETY GLASSES, LABORATORY GLASSWARE IN THE NATURE OF CALIBRATED CYLINDERS, LABORATORY EQUIPMENT IN THE NATURE OF WEIGHTS, MICROSCOPES, LABORATORY GLASSWARE IN THE NATURE OF PREPARED MICROSCOPE SLIDES, PETRI DISHES, PIPETTES, POWER SUPPLIES, TELESCOPES, TEST TUBES AND TEST TUBE RACKS; CALCULATORS; PRE-RECORDED CDS FEATURING EDUCATIONAL MATERIAL FOR TEACHING MATHEMATICS, SCIENCE, READING AND LANGUAGE ARTS; PRE-RECORDED VIDEOS FEATURING EDUCATIONAL MATERIAL FOR TEACHING MATHEMATICS, SCIENCE, READING AND LANGUAGE ARTS; AND EDUCATIONAL SOFTWARE FOR TEACHING MATHEMATICS, SCIENCE, READING AND LANGUAGE ARTS (U.S. CLS. 21, 23, 26, 36 AND 38).

CLASS 16—PAPER GOODS AND PRINTED MATTER

FOR TEMPLATES FOR DRAWING AND DRAFTING; CHILDREN'S BOOKS, STUDENT WORKBOOKS AND TEACHER RESOURCE BOOKS FOR TEACHING MATHEMATICS, SCIENCE, READING AND LANGUAGE ARTS; AND PRINTED TEACHING MATERIALS FOR TEACHING MATHEMATICS, SCIENCE, READING AND LANGUAGE ARTS (U.S. CLS. 2, 5, 22, 23, 29, 37, 38 AND 50).

CLASS 28—TOYS AND SPORTING GOODS

FOR EDUCATIONAL TOYS, GAMES AND MANIPULATIVES FOR TEACHING MATHEMATICS, SCIENCE, READING AND LANGUAGE ARTS, NAMELY, BOARD GAMES, CARD GAMES, PUZZLES, MANIPULATIVE TOYS, MANIPULATIVE GAMES, EDUCATIONAL ACTIVITY GAME MATS AND ELECTRONIC EDUCATIONAL GAME MACHINES FOR CHILDREN; CHILDREN'S EDUCATIONAL KITS FOR TEACHING MATHEMATICS AND LIFE, PHYSICAL AND EARTH SCIENCES COMPRISED OF MANIPULATIVE TOYS AND ONE OR MORE OF THE FOLLOWING: WORKBOOKS, ACTIVITY CARDS, OR TEACHER GUIDES (U.S. CLS. 22, 23, 38 AND 50).

CLASS 35—ADVERTISING AND BUSINESS

FOR MAIL ORDER AND COMPUTERIZED ONLINE ORDERING SERVICES FEATURING EDUCATIONAL MATERIAL AND EQUIPMENT (U.S. CLS. 100, 101 AND 102).

COLLEEN KEARNEY, EXAMINING ATTORNEY

SN 78-869,985. MOLECULAR LIGHT TECHNOLOGY RESEARCH LIMITED, CARDIFF, UNITED KINGDOM, FILED 4-26-2006.

HYDRUS

THE MARK CONSISTS OF STANDARD CHARACTERS WITHOUT CLAIM TO ANY PARTICULAR FONT, STYLE, SIZE, OR COLOR.

OWNER OF ERPN CMNTY TM OFC REG. NO. 004590501, DATED 8-22-2006, EXPIRES 8-12-2015.

CLASS 1—CHEMICALS

FOR CHEMICAL AND BIOCHEMICAL REAGENTS FOR SCIENTIFIC OR RESEARCH USE, NAMELY, FOR TESTING AND ANALYZING WATER AND OTHER FLUIDS FOR MICROBIOLOGICAL CONTAMINATION, AND FOR ENVIRONMENTAL TESTING AND ANALYSIS; KITS COMPRISED PRIMARILY OF THE AFORESAID REAGENTS (U.S. CLS. 1, 5, 6, 10, 26 AND 46).

CLASS 5—PHARMACEUTICALS

FOR CHEMICAL AND BIOCHEMICAL DIAGNOSTIC REAGENTS FOR MEDICAL USE, NAMELY, FOR TESTING AND ANALYZING WATER AND OTHER FLUIDS FOR MICROBIOLOGICAL CONTAMINATION; KITS COMPRISED PRIMARILY OF THE AFORESAID DIAGNOSTIC REAGENTS (U.S. CLS. 6, 18, 44, 46, 51 AND 52).

CLASS 9—ELECTRICAL AND SCIENTIFIC APPARATUS

FOR COMPUTER SOFTWARE FOR THE ORGANIZATION AND ANALYSIS OF ENVIRONMENTAL WATER AND MICROBIOLOGICAL TEST DATA, AND DOWNLOADABLE ELECTRONIC PUBLICATIONS IN THE NATURE OF INSTRUCTION MANUALS, USER GUIDES, TECHNICAL SPECIFICATIONS AND INFORMATION SHEETS, ALL IN THE FIELD OF ENVIRONMENTAL TESTING, WATER TESTING OR MICROBIOLOGICAL CONTAMINATION (U.S. CLS. 21, 23, 26, 36 AND 38).

CURTIS FRENCH, EXAMINING ATTORNEY

SN 78-872,098. GS DEVELOPMENT AB, MALMO, SWEDEN,
FILED 4-28-2006.

BIOSPRING

THE MARK CONSISTS OF STANDARD CHARACTERS WITHOUT CLAIM TO ANY PARTICULAR FONT, STYLE, SIZE, OR COLOR.

PRIORITY CLAIMED UNDER SEC. 44(D) ON SWEDEN APPLICATION NO. 2005/08119, FILED 10-31-2005, REG. NO. 378913, DATED 2-24-2006, EXPIRES 2-24-2016.

CLASS 10—MEDICAL APPARATUS

FOR ARTIFICIAL LIMBS AND JOINTS; ORTHOPEDIC ARTICLES, NAMELY, ORTHOPEDIC APPARATUS FOR TALIPES, ORTHOPEDIC BELTS, ORTHOPEDIC BRACES, ORTHOPEDIC FOOTWEAR, ORTHOPEDIC JOINT IMPLANTS, ORTHOPEDIC SOLES, ORTHOPEDIC SUPPORT BANDAGES, ORTHOPEDIC SUPPORTS, SPLINTS, TEMPLATES FOR ORTHOPEDIC PURPOSES, VERTEBRAL ORTHOPEDIC APPARATUS (U.S. CLS. 26, 39 AND 44).

CLASS 44—MEDICAL, BEAUTY AND AGRICULTURAL SERVICES

FOR MEDICAL SERVICES; MEDICAL CLINICS; PLASTIC SURGERY; PHYSICAL THERAPY; MEDICAL ASSISTANCE; INFORMATION AND ADVICE REGARDING ARTIFICIAL LIMBS AND JOINTS; SURGERY IN THE FIELD OF ORTHOPAEDICS AND ARTIFICIAL LIMBS AND JOINTS; ADVICE CONCERNING PHARMACY AND MEDICAL TECHNOLOGY, NAMELY, ADVICE REGARDING THE OPERATION OF MEDICAL APPARATUS IN THE NATURE OF ARTIFICIAL LIMBS AND JOINTS; ORTHOPEDIC ARTICLES, NAMELY, ORTHOPEDIC APPARATUS FOR TALIPES, ORTHOPEDIC BELTS, ORTHOPEDIC BRACES, ORTHOPEDIC FOOTWEAR, ORTHOPEDIC JOINT IMPLANTS, ORTHOPEDIC SOLES, ORTHOPEDIC SUPPORT BANDAGES, ORTHOPEDIC SUPPORTS, SPLINTS, TEMPLATES FOR ORTHOPEDIC PURPOSES, VERTEBRAL ORTHOPEDIC APPARATUS (U.S. CLS. 100 AND 101).

SUSAN STIGLITZ, EXAMINING ATTORNEY

SN 78-874,441. FRANCE, JOHN, MR., WESTLAKE, OH.
FILED 5-2-2006.

CELLATEL

THE MARK CONSISTS OF STANDARD CHARACTERS WITHOUT CLAIM TO ANY PARTICULAR FONT, STYLE, SIZE, OR COLOR.

CLASS 9—ELECTRICAL AND SCIENTIFIC APPARATUS

FOR MOBILE TELEPHONES, TELEPHONES AND MODEMS, AND ACCESSORIES AND EQUIPMENT THEREFOR, NAMELY, BATTERIES, BATTERY CHARGERS, CIGARETTE LIGHTER ADAPTERS, CARRYING CASES, HANDS FREE DEVICES, AND BELT AND CARRYING CLIPS, SOLD AS UNITS OR IN COMBINATION WITH MOBILE TELEPHONES (U.S. CLS. 21, 23, 26 AND 38).

CLASS 35—ADVERTISING AND BUSINESS

FOR RETAIL STORE SERVICES FEATURING MOBILE TELEPHONES, TELEPHONE AND MODEMS, AND ACCESSORIES AND EQUIPMENT THEREFOR, NAMELY, BATTERIES, BATTERY CHARGERS, CIGARETTE LIGHTER ADAPTERS, CARRYING CASES, HANDS FREE DEVICES, AND BELT AND CARRYING CLIPS, SOLD AS UNITS OR IN COMBINATION WITH MOBILE TELEPHONES (U.S. CLS. 100, 101 AND 102).

CLASS 38—COMMUNICATION

FOR TELECOMMUNICATIONS SERVICES, NAMELY, THE TRANSMISSION OF VOICE, DATA, IMAGES, AUDIO, VIDEO, AND INFORMATION VIA TELEPHONE OR THE INTERNET; SATELLITE COMMUNICATION SERVICES VIA GLOBAL COMPUTER NETWORK; PERSONAL COMMUNICATIONS SERVICES; PAGING SERVICES; WIRELESS TELEPHONE ROAMING COMMUNICATION SERVICES; LEASING TELECOMMUNICATIONS EQUIPMENT, COMPONENTS, SYSTEMS AND SUPPLIES; ELECTRONIC MAIL SERVICES; VOICE MESSAGING SERVICES; PROVIDING MULTIPLE-USER ACCESS TO GLOBAL COMPUTER NETWORKS TO TRANSMIT, RECEIVE AND OTHERWISE ACCESS AND USE INFORMATION OF GENERAL INTEREST TO CONSUMERS (U.S. CLS. 100, 101 AND 104).

JULIE WATSON, EXAMINING ATTORNEY

SN 78-903,197. COUGAR CLUB FILMS, LLC, BEVERLY HILLS, CA. FILED 6-7-2006.



THE COLOR(S) BLACK AND ORANGE IS/ARE CLAIMED AS A FEATURE OF THE MARK.

THE MARK CONSISTS OF ORANGE COUGAR PAW PRINT IN THE MIDDLE OF A BLACK CIRCLE, CIRCUMSCRIBED BY 2 BLACK ARCHES WHICH RESEMBLE A LETTER "C" ON THE LEFT-HAND SIDE WITH ITS MIRROR IMAGE FACING IT, OVER THE WORDS "COUGARCLUB" IN ALL LOWER CASE LETTERS, WITH "COUGAR" IN BLACK AND "CLUB" IN ORANGE.

CLASS 9—ELECTRICAL AND SCIENTIFIC APPARATUS

FOR MOTION PICTURE FILMS ABOUT OLDER WOMEN SEDUCING YOUNGER MEN (U.S. CLS. 21, 23, 26, 36 AND 38).

CLASS 25—CLOTHING

FOR HATS, SHIRTS, AND LOUNGEWEAR (U.S. CLS. 22 AND 39).

SHARON MEIER, EXAMINING ATTORNEY

SN 78-912,656. OASIS EDMONTON INC., EDMONTON, CANADA, FILED 6-20-2006.

OASIS EDMONTON COLLEGE OF
INTEGRATED PHILOSOPHY

THE MARK CONSISTS OF STANDARD CHARACTERS WITHOUT CLAIM TO ANY PARTICULAR FONT, STYLE, SIZE, OR COLOR.

OWNER OF CANADA REG. NO. 732659, DATED 1-19-2009, EXPIRES 1-19-2024.

NO CLAIM IS MADE TO THE EXCLUSIVE RIGHT TO USE "EDMONTON COLLEGE OF INTEGRATED PHILOSOPHY", APART FROM THE MARK AS SHOWN.

CLASS 9—ELECTRICAL AND SCIENTIFIC APPARATUS

FOR PRE-RECORDED AUDIO CASSETTES, PRE-RECORDED VIDEO CASSETTES, PRE-RECORDED DIGITAL VIDEO DISCS, PRE-RECORDED AUDIO COMPACT DISCS, PRE-RECORDED DIGITAL AUDIO DISCS FEATURING INSTRUCTIONAL, EDUCATIONAL, INSPIRATIONAL AND MOTIVATIONAL TEACHINGS, PHILOSOPHY AND INFORMATION RELATING TO PERSONAL, MENTAL, EMOTIONAL AND PHYSICAL IMPROVEMENT AND WELL-BEING; SOUND RECORDINGS, NAMELY, PRE-RECORDED AUDIO TAPES AND COMPACT DISCS FEATURING INSTRUCTIONAL, EDUCATIONAL, INSPIRATIONAL AND MOTIVATIONAL TEACHINGS, PHILOSOPHY AND INFORMATION RELATING TO PERSONAL, MENTAL, EMOTIONAL AND PHYSICAL IMPROVEMENT AND WELL-BEING (U.S. CLS. 21, 23, 26, 36 AND 38).

CLASS 16—PAPER GOODS AND PRINTED MATTER

FOR BOOKS FEATURING INSTRUCTIONAL, EDUCATIONAL, INSPIRATIONAL AND MOTIVATIONAL TEACHINGS, PHILOSOPHY AND INFORMATION RELATING TO PERSONAL, MENTAL, EMOTIONAL AND PHYSICAL IMPROVEMENT AND WELL-BEING (U.S. CLS. 2, 5, 22, 23, 29, 37, 38 AND 50).

CLASS 35—ADVERTISING AND BUSINESS

FOR ONLINE RETAIL STORE SERVICES FEATURING BOOKS, MAGAZINES, PRE-RECORDED AUDIO CASSETTES, PRE-RECORDED VIDEO CASSETTES, PRE-RECORDED DIGITAL VIDEO DISCS, PRE-RECORDED AUDIO COMPACT DISCS, PRE-RECORDED DIGITAL AUDIO DISCS IN THE FIELD OF PHILOSOPHY, SELF-AWARENESS, SELF-MOTIVATION AND SELF-IMPROVEMENT (U.S. CLS. 100, 101 AND 102).

CLASS 41—EDUCATION AND ENTERTAINMENT

FOR PUBLICATION OF EDUCATIONAL BOOKS, PAMPHLETS, NEWSLETTERS, BROCHURES, WRITTEN ARTICLES AND MAGAZINES CONTAINING INSTRUCTIONAL, EDUCATIONAL, INSPIRATIONAL AND MOTIVATIONAL TEACHINGS IN THE FIELD OF PHILOSOPHY AND INFORMATION RELATING TO PERSONAL, MENTAL, EMOTIONAL AND PHYSICAL IMPROVEMENT AND WELL-BEING; EDUCATIONAL SERVICES, NAMELY, EDUCATING AT A UNIVERSITY OR COLLEGE; PROVIDING CLASSES AND TRAINING SERVICES IN THE FIELD OF PHILOSOPHY, SELF-AWARENESS, SELF-MOTIVATION, AND SELF-IMPROVEMENT; EDUCATION IN THE FIELD OF PHILOSOPHY, SELF-AWARENESS, SELF-MOTIVATION, AND SELF-IMPROVEMENT, RENDERED THROUGH CORRESPONDENCE COURSES; ARRANGING AND CONDUCTING SEMINARS, SPEECHES, PRESENTATIONS, WORKSHOPS AND EDUCATIONAL RETREATS IN THE FIELD OF PHILOSOPHY, SELF-AWARENESS, SELF-MOTIVATION, AND SELF-IMPROVEMENT (U.S. CLS. 100, 101 AND 107).

CLASS 44—MEDICAL, BEAUTY AND AGRICULTURAL SERVICES

FOR CONSULTING SERVICES IN THE FIELD OF MENTAL FITNESS (U.S. CLS. 100 AND 101).

CLASS 45—PERSONAL AND LEGAL SERVICES

FOR PERSONAL GROWTH AND MOTIVATION CONSULTING SERVICES; PERSONAL LIFESTYLE CONSULTING SERVICES; PROVIDING AN INTERACTIVE ELECTRONIC DATABASE IN THE FIELD OF PERSONAL GROWTH AND MOTIVATION (U.S. CLS. 100 AND 101).

MARK SPARACINO, EXAMINING ATTORNEY

SN 78-920,247. MED-ENG SYSTEMS INC., OTTAWA, CANADA, FILED 6-29-2006.

CHAMELEON

THE MARK CONSISTS OF STANDARD CHARACTERS WITHOUT CLAIM TO ANY PARTICULAR FONT, STYLE, SIZE, OR COLOR.

PRIORITY CLAIMED UNDER SEC. 44(D) ON CANADA APPLICATION NO. 1303864, FILED 6-2-2006, REG. NO. TMA730349, DATED 12-8-2008, EXPIRES 12-8-2023.

CLASS 9—ELECTRICAL AND SCIENTIFIC APPARATUS

FOR ELECTRONIC COUNTERMEASURE DEVICES, NAMELY, ELECTRONIC TRANSMITTERS FOR JAMMING SIGNALS THAT TRIGGER EXPLOSIVE DEVICES; COMPUTER OPERATING SOFTWARE FOR USE WITH ELECTRONIC COUNTERMEASURE DEVICES (U.S. CLS. 21, 23, 26, 36 AND 38).

FIRST USE 11-7-2005; IN COMMERCE 11-7-2005.

CLASS 41—EDUCATION AND ENTERTAINMENT

FOR END USER TRAINING IN THE USE OF ELECTRONIC COUNTERMEASURE DEVICES (U.S. CLS. 100, 101 AND 107).

FIRST USE 11-7-2005; IN COMMERCE 11-7-2005.
IRA J. GOODSARD, EXAMINING ATTORNEY

SN 78-938,179. JOUETS PAINTIVITY INC./PAINTIVITY TOYS INC., DORVAL, CANADA, FILED 7-26-2006.

SN 79-029,750. CR MEDIA PTE LTD, SINGAPORE, FILED 7-19-2006.

PAINTIVITY

THE MARK CONSISTS OF STANDARD CHARACTERS WITHOUT CLAIM TO ANY PARTICULAR FONT, STYLE, SIZE, OR COLOR.

PRIORITY CLAIMED UNDER SEC. 44(D) ON CANADA APPLICATION NO. 1307412, FILED 6-29-2006, REG. NO. TMA714842, DATED 5-22-2008, EXPIRES 5-22-2023.

CLASS 16—PAPER GOODS AND PRINTED MATTER

FOR PRINTED MATTER AND STATIONERY PRODUCTS OF PAPER AND CARDBOARD, NAMELY, WRITING AND SKETCHING PAPER, ORIGAMI AND KIRIGAMI PAPER; ARTISTS SUPPLIES, NAMELY, ARTISTS' PAINT SETS AND PAINT APPLICATORS, NAMELY, BRUSHES AND ROLLERS, PAINT-BY-NUMBER PAINTING SETS; PAINTING KITS, PAINTING SETS; AND INSTRUCTIONAL AND TEACHING MATERIALS IN THE FIELD OF PAINTING (U.S. CLS. 2, 5, 22, 23, 29, 37, 38 AND 50).

CLASS 28—TOYS AND SPORTING GOODS

FOR TOYS, NAMELY, PLAYTHINGS AND GAMES IN THE NATURE OF BOARD GAMES, CARD GAMES, DICE GAMES; PLAYING CARDS (U.S. CLS. 22, 23, 38 AND 50).

HEATHER THOMPSON, EXAMINING ATTORNEY

SN 78-978,208. THE TRUSTEE OF THE REUBEN B. KLAMER LIVING TRUST, A CALIFORNIA TRUST, THE SOLE TRUSTEE COMPRISING REUBEN B. KLAMER, A UNITED STATES CITIZEN, SAN DIEGO, CA. FILED 4-18-2006.

SPIN TO WIN

THE MARK CONSISTS OF STANDARD CHARACTERS WITHOUT CLAIM TO ANY PARTICULAR FONT, STYLE, SIZE, OR COLOR.

CLASS 9—ELECTRICAL AND SCIENTIFIC APPARATUS

FOR VIDEO GAME SOFTWARE, HAND-HELD UNITS FOR PLAYING ELECTRONIC GAMES FOR USE WITH EXTERNAL DISPLAY SCREEN OR MONITOR, COMPUTER GAME SOFTWARE, MULTIMEDIA SOFTWARE RECORDED ON CD-ROM FEATURING GAMES, DOWNLOADABLE COMPUTER GAMES VIA THE INTERNET AND WIRELESS DEVICES; SLOT MACHINES (U.S. CLS. 21, 23, 26, 36 AND 38).

CLASS 28—TOYS AND SPORTING GOODS

FOR GAMES, NAMELY, BOARD GAMES AND HAND-HELD UNITS FOR PLAYING ELECTRONIC GAMES (U.S. CLS. 22, 23, 38 AND 50).

TIMOTHY FINNEGAN, EXAMINING ATTORNEY

PRESTIGE

PRIORITY DATE OF 7-19-2006 IS CLAIMED.
OWNER OF INTERNATIONAL REGISTRATION 0900243
DATED 7-19-2006, EXPIRES 7-19-2016.
OWNER OF U.S. REG. NO. 3,211,663.

CLASS 35—ADVERTISING AND BUSINESS

FOR ADVERTISING, BUSINESS, MARKETING, PROMOTIONAL AND PUBLICITY SERVICES, NAMELY, ADVERTISING, BUSINESS, MARKETING, PROMOTIONAL AND PUBLICITY SERVICES RELATING TO UPMARKET SOCIAL LIFESTYLE PUBLICATIONS; DIRECT MAIL ADVERTISING; DISSEMINATION OF ADVERTISING MATTER, DISTRIBUTION OF SAMPLES; DOCUMENT REPRODUCTION; ARRANGING NEWSPAPER SUBSCRIPTION SERVICES FOR THIRD PARTIES; RENTAL OF ADVERTISING SPACE, INCLUDING RENTAL OF SPACE IN UPMARKET SOCIAL LIFESTYLE PUBLICATIONS; BUSINESS CONSULTANCY, BUSINESS INFORMATION OR INQUIRIES; ON-LINE ADVERTISING ON A COMPUTER NETWORK; ORGANIZATION OF EXHIBITIONS FOR COMMERCIAL OR ADVERTISING PURPOSES; ORGANIZING AND CONDUCTING CHARITY AUCTIONS FOR CHARITABLE FUND RAISING PURPOSES; ON-LINE AUCTION SERVICES (U.S. CLS. 100, 101 AND 102).

CLASS 41—EDUCATION AND ENTERTAINMENT

FOR EDUCATION AND TRAINING IN THE FIELDS OF FASHION AND AESTHETICISM RENDERED THROUGH CLASSES, SEMINARS, AND ONLINE INSTRUCTION; ENTERTAINMENT SERVICES, NAMELY, TELEVISION PROGRAMS AND A WEBSITE FEATURING INFORMATION ON UPMARKET SOCIAL LIFESTYLES, ENTERTAINMENT ASPECTS OF FASHION AND AESTHETICISM; ORGANIZATION OF SPORTING AND CULTURAL ACTIVITIES; PUBLICATION OF BOOKS, MAGAZINES, NEWSPAPERS; SPECIAL EVENT PLANNING, NAMELY, ORGANIZATION OF BALLS; ORGANIZATION OF COMPETITIONS IN THE FIELDS OF FASHION AND AESTHETICISM; ORGANIZATION OF EXHIBITIONS AND EVENTS FOR CULTURAL OR EDUCATIONAL PURPOSES; SPECIAL EVENT PLANNING, NAMELY, ORGANIZATION OF EVENTS RELATING TO FASHION AND AESTHETICISM; ARRANGING AND CONDUCTING OF COLLOQUIUMS, CONFERENCES AND CONGRESSES ON THE TOPICS OF UPMARKET SOCIAL LIFESTYLES, FASHION AND AESTHETICISM; BOOKING OF SEATS FOR SHOWS; ENTERTAINMENT SERVICES, NAMELY, PROVIDING ONLINE COMPUTER GAMES AND PROVIDING GAME INFORMATION ONLINE; ONLINE PUBLICATION OF A MAGAZINE ON THE SUBJECTS OF UPMARKET SOCIAL LIFESTYLES, FASHION AND AESTHETICISM; ELECTRONIC DESKTOP PUBLISHING; SPORTING AND CULTURAL ACTIVITIES, NAMELY, GOLF TOURNAMENTS, JEWELRY FESTIVALS AND CHARITY SHOWS IN THE NATURE OF FASHION SHOWS FOR ENTERTAINMENT PURPOSES AND ENTERTAINMENT VARIETY SHOWS, THE PROCEEDS OF WHICH ARE DONATED TO CHARITY; ORGANIZATION OF SPORTS COMPETITIONS; PROVIDING ENTERTAINMENT INFORMATION, NAMELY, PROVIDING INFORMATION RELATING TO UPMARKET SOCIAL LIFESTYLES, ENTERTAINMENT ASPECTS OF FASHION AND AESTHETICISM; FAN CLUB SERVICES; EDITING OF WRITTEN TEXT; NEWS REPORTERS SERVICES; NEWS REPORTERS SERVICES PROVIDED BY MEANS OF THE INTERNET (U.S. CLS. 100, 101 AND 107).

NORA BUCHANAN WILL, EXAMINING ATTORNEY

SN 79-035.625. ZETA AG BIOPROCESS SYSTEMS, WANGEN SZ, SWITZERLAND, FILED 10-3-2006.

 FreezeContainer

PRIORITY DATE OF 4-13-2006 IS CLAIMED.
OWNER OF INTERNATIONAL REGISTRATION 0916607
DATED 10-3-2006, EXPIRES 10-3-2016.

NO CLAIM IS MADE TO THE EXCLUSIVE RIGHT TO USE "FREEZE CONTAINER", APART FROM THE MARK AS SHOWN.

CLASS 7—MACHINERY

FOR MACHINES AND MACHINE TOOLS, IN PARTICULAR FOR THE CHEMICAL, PHARMACEUTICAL, BIOCHEMICAL AND BIOTECHNOLOGICAL INDUSTRIES AND THE FOOD INDUSTRY, NAMELY, MACHINES FOR PROCESSING BACTERIA, ANIMAL CELLS AND PLANT CELLS FOR THE MANUFACTURE OF BIOLOGICAL PRODUCTS IN THE NATURE OF VACCINES AND THERAPEUTIC AND DIAGNOSTIC PREPARATIONS AND PROTEINS AND COMPONENT PARTS THEREOF (U.S. CLS. 13, 19, 21, 23, 31, 34 AND 35).

CLASS 9—ELECTRICAL AND SCIENTIFIC APPARATUS

FOR APPARATUS, INSTALLATIONS, EQUIPMENT AND DISPOSABLE APPARATUS, DISPOSABLE INSTALLATIONS AND DISPOSABLE EQUIPMENT FOR CELL CULTURE AND BIOLOGICAL PROCEDURES, NAMELY, LABORATORY PLASTIC BAGS AND HOSES, LABORATORY PLASTIC WARE, NAMELY, INCUBATORS, TEST TUBES, BEAKERS AND FLASKS; LABORATORY EQUIPMENT, NAMELY, PROTECTIVE VATS FOR BAGS FOR CELL CULTURE AND BIOLOGICAL PROCEDURES; LABORATORY EQUIPMENT, NAMELY, SMALL BAGS AND RECEPTACLES FOR CELL CULTURES, AND BIOTECHNOLOGICAL PROCEDURES; APPARATUS AND FERMENTORS FOR CELL CULTURES AND BACTERIAL CULTURES, NAMELY, LABORATORY EQUIPMENT IN THE NATURE OF BIOREACTORS AND DISPOSABLE BIOREACTORS COMPRISED OF PLASTIC, STAINLESS STEEL AND GLASS VESSELS; RESERVOIRS, CONTAINERS AND CLOSURES FOR CONTAINERS AS PARTS OF THE AFOREMENTIONED GOODS IN THIS CLASS, ALL THE AFOREMENTIONED GOODS BEING FOR THE CHEMICAL, BIO-CHEMICAL AND BIOTECHNOLOGICAL INDUSTRIES AND THE FOOD INDUSTRY; ELECTRIC DOUBLE JACKETS BIOREACTORS, NAMELY, ELECTRIC DOUBLE JACKETS FOR BIOREACTORS FOR CELL CULTURING COMPRISED OF PLASTIC, STAINLESS STEEL AND GLASS VESSELS (U.S. CLS. 21, 23, 26, 36 AND 38).

CLASS 11—ENVIRONMENTAL CONTROL APPARATUS

FOR STERILIZERS; COOLING INSTALLATIONS IN THE NATURE OF FREEZERS FOR CRYOPRESERVATION AND FOR COOLING SOLUTIONS, DISPERSIONS AND EMULSIONS COMPRISING BACTERIA, ANIMAL CELLS AND PLANT CELLS; REFRIGERATING CONTAINERS, NAMELY, REFRIGERATED STORING AND SHIPPING CONTAINERS; ALL THE AFOREMENTIONED GOODS OF METAL AND OR PLASTICS (U.S. CLS. 13, 21, 23, 31 AND 34).

CLASS 42—SCIENTIFIC AND COMPUTER SERVICES

FOR SCIENTIFIC RESEARCH AND PROFESSIONAL SCIENTIFIC CONSULTING IN THE FIELDS OF CHEMISTRY, PHARMACEUTICAL RESEARCH AND DEVELOPMENT, BIOCHEMISTRY, BIOTECHNOLOGY, STERILE FACILITY CONSTRUCTION, AND LABORATORY RESEARCH IN THE NATURE OF PROCEDURAL AND LABORATORY APPARATUS PRODUCTION TECHNIQUES; DATABASE DEVELOPMENT SERVICES, NAMELY, PROCEDURAL ANALYSIS AND DEVELOPMENT OF ONLINE DATABASES; COPYRIGHT MANAGEMENT AND LICENSING OF INTELLECTUAL PROPERTY (U.S. CLS. 100 AND 101).

DAYNA BROWNE, EXAMINING ATTORNEY

SN 79-036.821. UPM-KYMMENE CORPORATION, HELSINKI, FINLAND, FILED 2-22-2007.



THE MARK CONSISTS OF STANDARD CHARACTERS WITHOUT CLAIM TO ANY PARTICULAR FONT, STYLE, SIZE, OR COLOR.

OWNER OF INTERNATIONAL REGISTRATION 0919811
DATED 2-22-2007, EXPIRES 2-22-2017.

OWNER OF U.S. REG. NOS. 2,715,351, 2,874,389 AND OTHERS.

THE WORDING "UPM PROFI" HAS NO MEANING OTHER THAN TRADEMARK SIGNIFICANCE.

CLASS 16—PAPER GOODS AND PRINTED MATTER

FOR SELF-ADHESIVE LABEL MATERIALS MADE OF PAPER, NAMELY, ADHESIVE LABELS, BAR CODE LABELS, BLANK PAPER LABELS, PLASTIC FILM NOT FOR COMMERCIAL OR INDUSTRIAL PURPOSES, AND THEIR PRODUCTION WASTE, NAMELY, PAPER REMNANTS OF ADHESIVE LABELS USED FOR MANUFACTURING PAPER AND PLASTIC ADHESIVE LABELS (U.S. CLS. 2, 5, 22, 23, 29, 37, 38 AND 50).

CLASS 17—RUBBER GOODS

FOR PLASTICS IN EXTRUDED FORM FOR USE IN MANUFACTURE; PLASTIC COMPOSITE PANELS HAVING INSULATING PROPERTIES FOR USE AS HEAT AND INSULATING SHIELD FOR DECKING OF PATIOS, PLAYGROUNDS, GARDEN BUILDINGS, JETTIES, MARINAS, BOARDWALKS AND PALLETS FOR TRANSPORTATION; PLASTIC COMPOSITE MATERIAL IN THE FORM OF PROFILES, BOARDS AND SHEETS, NAMELY, INJECTION MOULDED ITEMS FOR THE MANUFACTURE OF PLASTIC COMPOSITE TRANSPORTATION PALLETS, PLASTIC COMPOSITE INJECTION MOULDED BOWLS, PLASTIC COMPOSITE GARDEN TILES, PLASTIC COMPOSITE DECORATIONS AND AUXILIARIES TO GARDEN BUILDINGS (U.S. CLS. 1, 5, 12, 13, 35 AND 50).

CLASS 19—NON-METALLIC BUILDING MATERIALS

FOR TIMBER, NAMELY, SAWN TIMBER AND MACHINED TIMBER; PLYWOOD; WOOD VENEERS; COMPOSITE DOORS AND WINDOWS; DOOR AND WINDOW FRAMES, NOT OF METAL; SEMI-FINISHED PRODUCTS AND COMPONENTS FOR CONSTRUCTION, NAMELY, WOODEN MOULDINGS, NON-METAL MOULDINGS FOR CORNICES, NON-METAL MOULDINGS FOR BUILDING; BUILDING PAPERS, NAMELY, TARRED ROOFING PAPER; ROOF COVERING UNDERLAY, NAMELY, LINING LAMINATES MADE OF COMBINATIONS OF PAPER, PLASTIC AND ALUMINUM FOIL TO BE USED AS WATER VAPOR BARRIER IN LINING OF MINERAL WOOL AND BUILDING LAMINATES FOR HUMIDITY BARRIER AND WIND SHIELD PURPOSES AS UNDERLAY LAMINATES UNDER ROOFING MATERIALS; PANELS, NAMELY, NON-METAL COMPOSITE PANELS IN WOOD PANELING, FLOOR PANELS, FENCE PANELS, NON-METAL FLOOR PANELS AND NON-METAL CEILING PANELS; CHIPBOARD, FIBREBOARD FOR MECHANICAL WOODWORKING; NON-METALLIC LAMINATED PLYWOOD AND WOOD BOARDS; NON-METALLIC COMPOSITE MATERIALS FOR PAVING OF SURFACES, NAMELY, BUILDING MATERIALS IN THE NATURE OF DECKING BOARDS COMPRISED OF PLASTIC COMPOSITE MATERIALS (U.S. CLS. 1, 12, 33 AND 50).

TINA BROWN, EXAMINING ATTORNEY

CLASS 14—JEWELRY

FOR HOROLOGICAL AND CHRONOMETRIC INSTRUMENTS AND THEIR PARTS; WATCHES, WRIST WATCHES, WATCH STRAPS, STOPWATCHES, WATCH MOVEMENTS, WATCHBANDS, WATCH GLASSES, CHRONOMETERS, CHRONOGRAPHS FOR USE AS WATCHES, CLOCKS, ELECTRONIC CLOCKS, MECHANICAL CLOCKS, QUARTZ CLOCKS, ALARM CLOCKS, CLOCK CASES, WATCH CASES, NEEDLES OF PRECIOUS METAL, CLOCKS INCORPORATING RADIOS, CUFFLINKS, TIE CLIPS, PINS, CHARMS, PRECIOUS STONES, JEWELS BEING JEWELRY, KEYRINGS OF PRECIOUS METAL, PENDANTS OF PRECIOUS METAL, EARRINGS, BRACELETS, NECKLACES; PICTURE FRAMES, PENHOLDERS, PILL BOXES AND PAPERWEIGHTS AND TRAYS ALL OF PRECIOUS METALS; POCKET WATCHES, WALL CLOCKS, TABLE CLOCKS, ELECTRIC TIMEPIECES, ELECTRONIC TIMEPIECES, ATOMIC TIMEPIECES, MEASURING WATCHES IN THE NATURE OF TIMEPIECES, ORNAMENTAL PINS, TIE PINS, DIGITAL ALARM CLOCKS (U.S. CLS. 2, 27, 28 AND 50).

CLASS 16—PAPER GOODS AND PRINTED MATTER

FOR BROCHURES, PERIODICALS, MAGAZINES, BOOKS AND BOOKLETS ON THE SUBJECTS OF AUTOMOBILES, AUTOMOBILE MAINTENANCE AND REPAIR, AUTOMOBILE RACING AND AUTOMOBILE COMPETITIONS AND THE HISTORY OF FERRARI S.P.A. AND ITS PARTICIPATION IN AUTOMOBILE RACING AND COMPETITIONS; CAR MANUALS, DECALS, PICTURES, PHOTOGRAPHS, POSTCARDS, POSTERS, PRINTS, STICKERS, IRON-ON TRANSFERS BEING DECALCOMANIAS, PLASTIC TRANSFERS BEING DECALCOMANIAS; PROMOTIONAL MATERIAL BEING GOODS IN TRADE, NAMELY, BROCHURES AND LEAFLETS FEATURING INFORMATION ABOUT AUTOMOBILES AND AUTOMOTIVE PRODUCTS; EVENT PROGRAMS; PAPER BANNERS, PAPER FLAGS; CATALOGS IN THE FIELD OF AUTOMOBILES AND AUTOMOTIVE PRODUCTS AND SHOWING FERRARI S.P.A.'S OFFICIAL MERCHANDISE; PAPER TICKET HOLDERS; STATIONERY ITEMS, NAMELY FOUNTAIN PENS, ROLLING PENS, FELT PENS, WRITING PENS, PENCIL SHARPENERS, DIARIES, NOTEBOOKS AND EXERCISE BOOKS, NOTEPAPERS, PHOTO ALBUMS, GREETING CARDS, WRAPPING PAPERS, NOTE PADS FOR COLLECTORS, ALBUMS FOR DRAWINGS, PENHOLDERS NOT OF PRECIOUS METAL, PAPER CUTTERS, DOCUMENT FOLDERS FOR CARDS AND DOCUMENTS, SMALL BLACKBOARDS, STAPLERS; ERASERS, AGENDAS, STAMPS FOR COLLECTORS, RUBBER STAMPS, NON-MAGNETICALLY ENCODED PASSES OR IDENTIFICATION CARDS MADE OF PAPER FOR ACCESS TO A RESTRICTED AREA, ENVELOPES, BUSINESS CARDS, UTO A RESTRICTED AREA, ENVELOPES, BUSINESS CARDS (U.S. CLS. 2, 5, 22, 23, 29, 37, 38 AND 50).

SN 79-040,161. FERRARI S.P.A., ITALY, FILED 9-14-2006.



PRIORITY DATE OF 6-21-2006 IS CLAIMED.

OWNER OF INTERNATIONAL REGISTRATION 0928584 DATED 9-14-2006, EXPIRES 9-14-2016.

OWNER OF U.S. REG. NOS. 2,531,201, 2,895,631 AND OTHERS.

NO CLAIM IS MADE TO THE EXCLUSIVE RIGHT TO USE "CLUB", APART FROM THE MARK AS SHOWN.

THE MARK CONSISTS OF THE WORDS "SCUDERIA FERRARI CLUB" IN STYLIZED FONT WITHIN A RECTANGULAR BACKGROUND WHICH EXTENDS TO THE RIGHT AND ENDS WITH A CHECKERBOARD PATTERN, OVERLAPPING THIS BACKGROUND BETWEEN THE WORDING AND CHECKERBOARD IS A RECTANGULAR BOX WITH DOUBLE BORDER CONTAINING A SHIELD DESIGN BEARING A PRANCING HORSE AND THE LETTERS "SF" IN STYLIZED FONT.

THE ENGLISH TRANSLATION OF THE WORD "SCUDERIA" IN THE MARK IS STABLE OR TEAM.

CLASS 6—METAL GOODS

FOR METAL KEY RINGS, METAL KEY CASES AND METAL PILL BOXES, METAL NAME BADGES, METAL IDENTIFICATION TAGS TO BE USED ON AUTOMOBILES, AND TABLE TROPHIES, ALL MADE OF COMMON METAL (U.S. CLS. 2, 12, 13, 14, 23, 25 AND 50).

CLASS 25—CLOTHING

FOR AUTOMOBILE RACING SUITS NOT IN THE NATURE OF PROTECTIVE CLOTHING; T-SHIRTS, SWEAT SHIRTS, POLO SHIRTS, TIES, CAPS, OVERALLS, WIND RESISTANT JACKETS, WATERPROOF JACKETS, BLAZERS, BERMUDA SHORTS, PULL-OVERS, COATS, ROBES, SCARVES, SHOES, BOOTS, SWEATERS, SHIRTS, TROUSERS, BELTS, RAINCOATS, TRACK SUITS, SHORTS, GLOVES, PAJAMAS, SLIPPERS, SWIMMING COSTUMES (U.S. CLS. 22 AND 39).

CLASS 41—EDUCATION AND ENTERTAINMENT

FOR EDUCATION SERVICES, NAMELY, PROVIDING SEMINARS, WORKSHOPS IN THE FIELD OF SPORT AND SAFE DRIVING; PROVIDING OF PERSONAL TRAINING SERVICES IN THE FIELD OF AUTOMOTIVE REPAIR, SPORT AND SAFE DRIVING; ENTERTAINMENT IN THE NATURE OF AUTOMOBILE RACES; SPORTING AND CULTURAL ACTIVITIES, NAMELY, PRODUCTION OF VIDEOS IN THE FIELD OF DRIVING COMPETITIONS AND ON THE HISTORY OF FERRARI S.P.A. AND ITS RACE CAR DRIVERS; ARRANGING FOR TICKET RESERVATIONS FOR RACING COMPETITIONS; ORGANIZING ENTERTAINMENT CLUBS FOR OWNERS OF AUTOMOBILES MANUFACTURED BY FERRARI S.P.A., NAMELY, CLUBS WHICH ORGANIZE AUTOMOBILE RACES, SPORTS CAR COMPETITIONS, AND MEETINGS OF ENTHUSIASTS OF AUTOMOBILE RACING AND SPORTS CAR COMPETITIONS FOR OWNERS AND ENTHUSIASTS OF AUTOMOBILES MANUFACTURED BY FERRARI S.P.A.; PROVIDING INFORMATION ABOUT AUTOMOBILE RACES AND RACING TEAMS AND SPORT COMPETITIONS; ORGANIZING AUTOMOBILE RACING EXHIBITIONS AND COMPETITIONS FOR SPORTING PURPOSES, ORGANIZING WORKSHOPS IN THE FIELD OF AUTOMOBILES FOR AUTOMOTIVE CLUB MEMBERS AND OWNERS OF AUTOMOBILES; ENTERTAINMENT IN THE NATURE OF ON-GOING TELEVISION PROGRAMS IN THE FIELD OF AUTOMOBILES AND AUTOMOBILE RACES; PROVIDING INFORMATION IN THE FIELD OF SPORTS, PROVIDING SPORTS INFORMATION IN THE FIELD OF AUTOMOBILE RACING AND ABOUT AUTOMOTIVE RACES SPONSORED OR ATTENDED BY FERRARI S.P.A.; SPORTS TRAINING SERVICES IN THE FIELD OF DRIVING AUTOMOBILES, SPORT AUTOMOBILES AND RACING AUTOMOBILES (U.S. CLS. 100, 101 AND 107).

STEVEN PEREZ, EXAMINING ATTORNEY

SN 79-045,163, LINDAL DISPENSER GMBH, FED REP GERMANY, FILED 10-10-2007.



OWNER OF INTERNATIONAL REGISTRATION 0940773 DATED 10-10-2007, EXPIRES 10-10-2017.

THE MARK CONSISTS OF THE LETTERS "L" AND "I", STYLIZED IN A TRIANGULAR SHAPE AND INSIDE OF A CIRCULAR BORDER. THE DOT OF THE LETTER "I" APPEARS OVER BOTH OF THE LETTERS "L" AND "I" IN THE MARK.

SN 79-041,510, K2 SKI SPORT + MODE GMBH, FED REP GERMANY, FILED 5-25-2007.

LINE

PRIORITY DATE OF 12-22-2006 IS CLAIMED.

OWNER OF INTERNATIONAL REGISTRATION 0931893 DATED 5-25-2007, EXPIRES 5-25-2017.

THE MARK CONSISTS OF THE WORD "LINE" IN STYLIZED BLOCK LETTERS.

CLASS 18—LEATHER GOODS

FOR SPORTS PACKS, ALL-PURPOSE SPORTS BAGS, KNAPSACKS, BACKPACKS (U.S. CLS. 1, 2, 3, 22 AND 41).

CLASS 25—CLOTHING

FOR CLOTHING FOR MEN, WOMEN AND CHILDREN, NAMELY, T-SHIRTS, HOODED SWEATSHIRTS; HEADGEAR, NAMELY, CAPS, BEANIES, BANDANAS AND HATS; FOOTWEAR (U.S. CLS. 22 AND 39).

CLASS 28—TOYS AND SPORTING GOODS

FOR SPORTING GOODS, NAMELY, SKIS, SKI POLES AND SKI BAGS (U.S. CLS. 22, 23, 38 AND 50).
DAWN FELDMAN, EXAMINING ATTORNEY

CLASS 7—MACHINERY

FOR VALVES ALL BEING PARTS OF MACHINES, NAMELY, PUMP CONTROL VALVES, FEMALE AEROSOL VALVES, STEM VALVES, VALVES FOR DISPENSING PU-FOAMS, THREADED VALVES, VARIABLE VALVES, AND BALL VALVES; PNEUMATIC VALVE ACTUATORS ALL FOR SPRAY NOZZLES, HYDRAULIC VALVES, PNEUMATIC VALVES, MECHANICAL VALVES, METERING VALVES, FEMALE AEROSOL VALVES, STEM VALVES, VALVES FOR DISPENSING PU-FOAMS, BAG-ON-VALVES, THREADED VALVES, VARIABLE VALVES AND FOR BALL VALVES; PARTS AND ATTACHMENTS FOR ALL THE AFORESAID GOODS ALL SOLD AS A UNIT THEREWITH, NAMELY, MOUNTING CUPS, OUTER GASKETS, INNER GASKETS, VALVE STEMS, VALVE SEATS, SPRINGS, HOUSINGS, DIPTUBES, METERING CHAMBERS, AND WELDED BAGS (U.S. CLS. 13, 19, 21, 23, 31, 34 AND 35).

CLASS 20—FURNITURE AND ARTICLES NOT OTHERWISE CLASSIFIED

FOR VALVES, NAMELY, NON-METAL VALVES FOR CONTAINERS, VALVES OF PLASTIC BEING OTHER THAN MACHINE PARTS; ACTUATORS FOR NON-METAL VALVES FOR CONTAINERS, VALVES OF PLASTIC BEING OTHER THAN MACHINE PARTS; NON-METAL PARTS AND ATTACHMENTS ALL SOLD AS A UNIT WITH THE AFORESAID GOODS, NAMELY, MOUNTING CUP, OUTER GASKET, INNER GASKETS, VALVE STEMS, VALVE SEATS, SPRINGS, HOUSINGS, DIPTUBES, METERING CHAMBERS, WELDED BAGS, AND NON-METAL CASKS (U.S. CLS. 2, 13, 22, 25, 32 AND 50).

CLASS 21—HOUSEWARES AND GLASS

FOR HOUSEHOLD OR KITCHEN UTENSILS AND CONTAINERS NOT OF PRECIOUS METAL NOR COATED THEREWITH, NAMELY, BOTTLES SOLD EMPTY, CANS IN THE NATURE OF AEROSOL CANS THAT ARE NON-METAL, SOLD EMPTY AND NOT FOR MEDICAL USE AND BEVERAGE GLASSWARE; AEROSOL DISPENSERS NOT FOR MEDICAL USE; SOAP DISPENSERS NOT FOR MEDICAL USE; AEROSOL VALVES SOLD AS A UNIT WITH AEROSOL DISPENSERS NOT FOR MEDICAL USE; ACTUATORS FOR AEROSOL VALVES SOLD AS A UNIT WITH AEROSOL DISPENSERS NOT FOR MEDICAL USE; SPRAYER NOZZLES FOR GARDEN HOSES SOLD AS A UNIT WITH SPRAY CAPS BEING CAP AND SPRAY NOZZLES IN ONE, SPRAY CANS, AND AEROSOL CANS; SPRAY HEADS, NAMELY, PLASTIC ACTUATORS WITH SPRAY NOZZLES FOR GARDEN HOSES; PARTS AND FITTINGS ALL SOLD AS A UNIT WITH THE AFORESAID GOODS, NAMELY, MOUNTING CUPS, OUTER GASKETS, INNER GASKETS, VALVE STEMS, VALVE SEATS, SPRINGS, HOUSINGS, DIPTUBES, METERING CHAMBERS, AND WELDED BAGS (U.S. CLS. 2, 13, 23, 29, 30, 33, 40 AND 50).

Laurie Kaufman, Examining Attorney

SN 79-045,277. VOITH PATENT GMBH, FED REP GERMANY, FILED 10-1-2007.

SensoTop

OWNER OF INTERNATIONAL REGISTRATION 0941123 DATED 10-1-2007, EXPIRES 10-1-2017.

CLASS 7—MACHINERY

FOR GEAR BOXES, OTHER THAN FOR LAND VEHICLES; DRIVING MOTORS, OTHER THAN FOR LAND VEHICLES; CLUTCHES, OTHER THAN FOR LAND VEHICLES, NAMELY, CLUTCHES FOR MACHINES (U.S. CLS. 13, 19, 21, 23, 31, 34 AND 35).

CLASS 9—ELECTRICAL AND SCIENTIFIC APPARATUS

FOR COMPUTER SOFTWARE, NAMELY, GEAR-CHANGE COMPUTER PROGRAMS FOR INITIATING OR TIMING THE CHANGE OF GEAR; ELECTRIC COUPLINGS (U.S. CLS. 21, 23, 26, 36 AND 38).

CLASS 12—VEHICLES

FOR GEAR BOXES FOR LAND VEHICLES, DRIVING MOTORS FOR LAND VEHICLES, CLUTCHES FOR LAND VEHICLES (U.S. CLS. 19, 21, 23, 31, 35 AND 44).

Colleen Dombrow, Examining Attorney

SN 79-045,487. THE BRITISH BROADCASTING CORPORATION, UNITED KINGDOM, FILED 7-18-2007.



PRIORITY DATE OF 6-7-2007 IS CLAIMED.

OWNER OF INTERNATIONAL REGISTRATION 0941761 DATED 7-18-2007, EXPIRES 7-18-2017.

CLASS 9—ELECTRICAL AND SCIENTIFIC APPARATUS

FOR AUDIO, VIDEO, STILL, AND MOVING IMAGES AND DATA RECORDINGS IN COMPRESSED AND UNCOMPRESSED FORM, NAMELY, PRE-RECORDED AUDIO AND VIDEO TAPES, CASSETTES, CD ROMS, CDS, TAPES, CARTRIDGES, DIGITAL AUDIO AND VIDEO COMPRESSION FILES, MP3 FILES, AND FILMS ALL PERTAINING TO OR FEATURING A WIDE RANGE OF CULTURAL, EDUCATIONAL, NEWS, AND ENTERTAINMENT TOPICS; COMPUTER GAME AND VIDEO GAME EQUIPMENT, NAMELY, COMPUTER GAME PROGRAMS, SOFTWARE, CASSETTES, DISCS AND TAPES; COMPUTER SOFTWARE FOR ACCESSING, REVIEWING, INTERACTING WITH AND RETRIEVING ON-LINE INFORMATION, ENTERTAINMENT AND EDUCATION FROM THE INTERNET; DOWNLOADABLE PUBLICATIONS IN THE NATURE OF MAGAZINES FEATURING A WIDE RANGE OF CULTURAL, EDUCATIONAL, NEWS, AND ENTERTAINMENT TOPICS (U.S. CLS. 21, 23, 26, 36 AND 38).

CLASS 16—PAPER GOODS AND PRINTED MATTER

FOR PRINTED PUBLICATIONS, NAMELY, BOOKS, PAMPHLETS, PRINTED GUIDES, CATALOGUES AND PRINTED PROGRAMS PROVIDING INSTRUCTION, ENTERTAINMENT, AND EDUCATION RELATING TO ENVIRONMENTAL ISSUES; MAGAZINES FEATURING ENTERTAINMENT, INSTRUCTION, AND EDUCATION IN THE FIELDS OF ENVIRONMENTAL ISSUES, SPORT, AND NEWS; PHOTOGRAPHS; STATIONERY; PAINT BRUSHES; PRINTED INSTRUCTIONAL AND TEACHING MATERIAL FOR CHILDREN IN THE FIELD OF ENVIRONMENTAL ISSUES; PLASTIC MATERIAL FOR PACKAGING, NAMELY, BAGS AND BUBBLE PACKS; PRINTING BLOCKS; POSTERS; POSTCARDS; GREETINGS CARDS; TRADING CARDS; PRINTED INVITATIONS; DIARIES; CALENDARS; PHOTOGRAPH ALBUMS; ART PRINTS; PAPER BAGS AND GENERAL PURPOSE PLASTIC BAGS; GIFT BOXES; NOTEPADS; WRITING INSTRUMENTS AND CRAYONS; COASTERS MADE OF PAPER; GIFT TAGS OF PAPER AND LUGGAGE TAGS; ORNAMENTS OF PAPER, CARDBOARD AND PAPER-MACHE; STICKERS; IRON ON AND PLASTIC TRANSFERS; RUBBER STAMPS; PERSONAL ORGANIZERS; ADDRESS BOOKS; AND PENCIL HOLDERS; DESK PADS; EMBROIDERY, SEWING AND KNITTING PATTERNS; POSTAGE STAMPS, NAMELY, COMMEMORATIVE STAMP SHEETS, AND PAPER AND PLASTIC GIFT WRAP; CROSSWORD PUZZLES (U.S. CLS. 2, 5, 22, 23, 29, 37, 38 AND 50).

CLASS 18—LEATHER GOODS

FOR ALL-PURPOSE CARRYING BAGS; BACKPACKS RUCKSACKS (U.S. CLS. 1, 2, 3, 22 AND 41).

CLASS 25—CLOTHING

FOR CLOTHING, NAMELY, SHIRTS, T-SHIRTS, BLOUSES, VESTS, PANTS, JEANS, SWEAT PANTS, OVERALLS, SHORTS, SKIRTS, DRESSES, SWIMSUITS, JACKETS, COATS, SWEATERS, SWEATSHIRTS, ROBES, TIES, BELTS, GLOVES, MITTENS, PAJAMAS, UNDERWEAR, FOOTWEAR, AND HEADWEAR (U.S. CLS. 22 AND 39).

CLASS 28—TOYS AND SPORTING GOODS

FOR TOYS, GAMES AND PLAYTHINGS, NAMELY, PLUSH TOYS, PUPPETS, BATH TOYS, FANCY DRESS COSTUMES BEING CHILDREN'S DRESS ACCESSORIES AND TOY COSTUME MASKS, TOY MUSICAL BOXES, TOY MUSICAL INSTRUMENTS, TOY MODEL HOBBY-CRAFT KITS, JIGSAW PUZZLES, BOARD GAMES; GYMNASIAC AND SPORTING ARTICLES, NAMELY, BASEBALL GLOVES, HANDBALL GLOVES, SKATEBOARDS, ROLLER SKATES, IN-LINE SKATES, BASEBALL BATS, TENNIS AND SQUASH RACKETS; CHRISTMAS CRACKERS; KITES; PLAY BALLS AND PLAY BALLOONS; FLIPPERS FOR SWIMMING; SWIM FLOATS AND INFLATABLE TOYS FOR PLAY PURPOSES; ELECTRONIC AND VIDEO GAME APPARATUS, NAMELY, HANDHELD UNITS FOR PLAYING ELECTRONIC AND VIDEO GAMES; PLAYING CARDS (U.S. CLS. 22, 23, 38 AND 50).

CLASS 35—ADVERTISING AND BUSINESS

FOR MAIL ORDER CATALOG AND ON-LINE RETAIL STORE SERVICES FEATURING CLOTHING, EDUCATIONAL AND LANGUAGE TEACHING MATERIALS, SOUND AND VIDEO RECORDINGS, BOOKS, MAGAZINES, GAMES AND TOYS, AND MERCHANDISE RELATED TO RADIO AND TELEVISION PROGRAMS (U.S. CLS. 100, 101 AND 102).

CLASS 38—COMMUNICATION

FOR TELEVISION AND RADIO BROADCASTING; AUDIO AND VIDEO BROADCASTING; BROADCASTING PROGRAMS VIA THE INTERNET; STREAMING OF AUDIO AND VIDEO MATERIAL ACROSS BROAD BAND NETWORKS AND THE INTERNET; AUDIO AND VIDEO BROADCASTING SERVICES RENDERED THROUGH TERRESTRIAL BROADCASTING, SATELLITES, WEBCASTING, AND TRANSMISSION TO WIRELESS COMMUNICATIONS DEVICES, HANDHELD COMPUTERS, PERSONAL DIGITAL ASSISTANTS, AND MOBILE AND CELLULAR PHONES; ELECTRONIC TRANSMISSION OF DATA, DOCUMENTS, MESSAGES, TEXT, SOUND, IMAGES, GRAPHICS, ENTERTAINMENT, AND EDUCATION VIA A GLOBAL COMPUTER NETWORK; VIDEO-ON-DEMAND TRANSMISSION SERVICES; MOBILE MEDIA AND ENTERTAINMENT SERVICES IN THE NATURE OF ELECTRONIC TRANSMISSION OF ENTERTAINMENT MEDIA CONTENT; PROVIDING ONLINE ELECTRONIC BULLETIN BOARDS AND CHATROOMS FOR TRANSMISSION OF MESSAGES AMONG COMPUTER USERS CONCERNING TOPICS OF GENERAL INTEREST (U.S. CLS. 100, 101 AND 104).

CLASS 41—EDUCATION AND ENTERTAINMENT

FOR ENTERTAINMENT SERVICES, NAMELY, PRODUCTION OF RADIO AND TELEVISION ENTERTAINMENT AND AUDIO AND VIDEO RECORDINGS; PROVISION OF ONGOING RADIO AND TELEVISION ENTERTAINMENT, ONLINE ENTERTAINMENT AND ONLINE INTERACTIVE ENTERTAINMENT IN THE NATURE OF A WEBSITE FEATURING ON-LINE GAMES HAVING ENVIRONMENTAL THEMES, AND FILMS FEATURING A WIDE RANGE OF CULTURAL, NEWS, AND ENTERTAINMENT TOPICS AND FEATURING EDUCATIONAL TOPICS, NAMELY, ENVIRONMENTAL ISSUES; ORGANIZING EXHIBITIONS FOR ENTERTAINMENT, EDUCATIONAL, CULTURAL, AND SPORTING PURPOSES RELATING TO OR FEATURING QUIZZES AND GAMES DESIGNED TO TEST GENERAL KNOWLEDGE AND RELATING TO MUSIC, DRAMA, FILM, ART, COMEDY, GENERAL KNOWLEDGE, GAMES, INFORMATION, NEWS, TELEVISION AND RADIO PROGRAMS INCLUDING CHILDREN'S RADIO AND TELEVISION PROGRAMS, EVENTS, SPORT, DOCUMENTARIES, HISTORY, FICTION, NON-FICTION TOPICS, SCIENCE AND TECHNOLOGY; RENTAL OF MOTION PICTURE FILMS, PRERECORDED RADIO AND TELEVISION PROGRAMS, AND SOUND RECORDINGS AND VIDEOTAPES; PUBLICATION OF BOOKS; DISTRIBUTION OF TELEVISION PROGRAMMING FOR OTHERS TO CABLE, TERRESTRIAL OR SATELLITE

TELEVISION SYSTEMS; PROVISION OF ENTERTAINMENT IN THE NATURE OF A TV SERIES RELATED TO THE ENVIRONMENT AND RADIO AND TELEVISION PROGRAMS FOR ACCESSING VIA COMMUNICATION AND COMPUTER NETWORKS; EDUCATIONAL SERVICES, NAMELY, PROVIDING COURSES OF INSTRUCTION IN THE FIELD OF ENVIRONMENTAL ISSUES FOR ACCESSING VIA COMMUNICATION AND COMPUTER NETWORKS INCLUDING THE GLOBAL COMPUTER NETWORK; NEWS SYNDICATION FOR THE BROADCASTING INDUSTRY; INTERNET PORTAL SERVICES, NAMELY, PROVIDING A WEBSITE FEATURING VIDEOS, MOTION PICTURE CLIPS, AND OTHER MULTIMEDIA MATERIALS RELATED TO ENVIRONMENTAL EDUCATION AND ENTERTAINMENT; AND PROVIDING A WEBSITE FEATURING EDUCATION AND ENTERTAINMENT FOR CHILDREN AND ADULTS RELATING TO CONSERVATION OF THE ENVIRONMENT VIA THE INTERNET; RENTAL OF RADIO PROGRAMS, TELEVISION PROGRAMS, AND FILMS (U.S. CLS. 100, 101 AND 107).

DEBRA LEE, EXAMINING ATTORNEY

SN 79-046,115. BEAUTYSANE HOLDING SA, LUXEMBOURG, FILED 6-11-2007.

BEAUTYSANE

THE MARK CONSISTS OF STANDARD CHARACTERS WITHOUT CLAIM TO ANY PARTICULAR FONT, STYLE, SIZE, OR COLOR.

PRIORITY DATE OF 12-12-2006 IS CLAIMED.

OWNER OF INTERNATIONAL REGISTRATION 0943235 DATED 6-11-2007, EXPIRES 6-11-2017.

CLASS 3—COSMETICS AND CLEANING PREPARATIONS

FOR SOAPS, PERFUMERY, PERFUMERY PRODUCTS, NAMELY, SCENTED BATH SALTS FOR NON-MEDICINAL PURPOSES; SACHETS FOR PERFUMING LINEN; BASE SCENTS FOR FLOWER PERFUMES, COLOGNE WATER, LAVENDER WATER, PERFUMES, TOILET WATER, EAU DE PARFUM, SCENTED WATER FOR CLOTHES AND BED LINEN, DEODORANTS FOR PERSONAL USE, ESSENTIAL OILS, OILS FOR COSMETIC PURPOSES, COSMETICS, COSMETIC PREPARATIONS FOR SKIN CARE, COSMETIC CREAMS, COSMETIC LOTIONS, LOTIONS FOR COSMETIC PURPOSES, COSMETIC POWDER FOR THE BODY, COSMETIC PREPARATIONS FOR SLIMMING PURPOSES, TISSUES IMPREGNATED WITH COSMETIC LOTIONS, COSMETICS SUN-TANNING PREPARATIONS, MAKE-UP AND MAKE-UP REMOVING PRODUCTS, NAMELY, MAKE-UP REMOVER, BEAUTY CREAMS, CLEANSING MILKS, BEAUTY MASKS, CREAMS AND LOTIONS FOR THE FACE AND BODY, NON-MEDICATED COSMETIC BATH PREPARATIONS, BATH SALTS, NOT FOR MEDICAL PURPOSES, OILS FOR COSMETIC PURPOSES, SHAMPOOS, HAIR LOTIONS, AFTER-SHAVE LOTIONS, SHAVING PRODUCTS, NAMELY, SHAVING CREAM, SHAVING SOAP, MAKE-UP, MAKE-UP POWDER, LIPSTICK, COSMETIC PRODUCTS FOR LIPS, NAMELY, LIP BALM, LIP PRIMER, BEAUTY MASK FOR LIPS, MASCARA, COSMETIC PENCILS, NUTRITIONAL OILS FOR COSMETIC PURPOSES (U.S. CLS. 1, 4, 6, 50, 51 AND 52).

CLASS 5—PHARMACEUTICALS

FOR SANITARY PREPARATIONS FOR MEDICAL PURPOSES, DIETETIC SUBSTANCES ADAPTED FOR MEDICAL USE, NAMELY, SUGARS, NUTRITIONAL ADDITIVES FOR MEDICAL PURPOSES FOR USE IN FOODS FOR HUMAN CONSUMPTION COMPRISING PLANTS, VITAMINS, AND MINERALS, DIETETIC BEVERAGES ADAPTED FOR MEDICAL PURPOSES AND MEDICINAL INFUSIONS IN THE NATURE OF DIETETIC BEVERAGES ADAPTED FOR MEDICAL PURPOSES AND MEDICINAL INFUSIONS; DIETETIC BEVERAGES ADAPTED FOR MEDICAL PURPOSES AND MEDICINAL INFUSIONS IN THE NATURE OF DIETETIC HERBAL INFUSIONS ADAPTED FOR MEDICAL USE AND DIETETIC PLANT INFUSIONS ADAPTED FOR EATING DISORDERS, SLIMMING PURPOSES AND SLEEPING DISORDERS, DIETETIC FOODS ADAPTED FOR MEDICAL PURPOSES, BIOLOGICAL PREPARATIONS FOR MEDICAL PURPOSES, DIETETIC BEVERAGES ADAPTED FOR MEDICAL PURPOSES, MEDICATED CONFECTIONERY, CHEMICAL-PHARMACEUTICAL PREPARATIONS FOR THE TREATMENT OF EATING DISORDERS, SLIMMING PURPOSES, AND SLEEPING DISORDERS, CHEMICAL PREPARATIONS FOR MEDICAL PURPOSES FOR THE TREATMENT OF EATING DISORDERS, SLIMMING PURPOSES, AND SLEEPING DISORDERS, NUTRITIONAL SUPPLEMENTS AND SUBSTITUTES FOR MEDICAL USE, NAMELY, DIETETIC NUTRITIONAL ENERGY BARS FOR USE AS A MEAL SUBSTITUTE, DIETETIC FOOD SUPPLEMENTS IN THE FORM OF LIQUID, POWDER, CAPSULES, JELLIES AND TABLETS FOR USE AS A MEAL SUBSTITUTE, DECOCTIONS FOR PHARMACEUTICAL PURPOSES FOR THE TREATMENT OF EATING DISORDERS, SLIMMING PURPOSES, AND SLEEPING DISORDERS, ELIXIRS, NAMELY, PHARMACEUTICAL PREPARATIONS FOR THE TREATMENT OF EATING DISORDERS, SLIMMING PURPOSES, AND SLEEPING DISORDERS, ESSENCES, NAMELY, DILL OIL FOR MEDICAL PURPOSES, OIL OF TURPENTINE FOR PHARMACEUTICAL PURPOSES, EDIBLE PLANT FIBRES, NAMELY, PLANT EXTRACTS FOR MEDICAL, VETERINARY AND PHARMACEUTICAL PURPOSES, SMOKING HERBS FOR MEDICAL PURPOSES, CHEWING GUM FOR MEDICAL PURPOSES, GUM FOR MEDICAL PURPOSES, MEDICINAL HERBS, NUTRITIONAL OILS FOR MEDICAL USE AND MEDICINAL INFUSIONS BEING PHARMACEUTICALS, ALL FOR THE TREATMENT OF EATING DISORDERS, SLIMMING PURPOSES, AND SLEEPING DISORDERS, MEDICATED LOTIONS FOR PHARMACEUTICAL PURPOSES FOR THE TREATMENT OF EATING DISORDERS, SLIMMING PURPOSES, AND SLEEPING DISORDERS, MEDICINES FOR HUMAN PURPOSES FOR THE TREATMENT OF EATING DISORDERS, SLIMMING PURPOSES, AND SLEEPING DISORDERS, NUTRITIONALLY FORTIFIED MINERAL WATERS BEING PHARMACEUTICALS FOR MEDICAL PURPOSES FOR THE TREATMENT OF EATING DISORDERS, SLIMMING PURPOSES, AND SLEEPING DISORDERS, SYNTHEIC NARCOTICS, PHARMACEUTICAL PREPARATIONS OF TRACE ELEMENTS FOR HUMAN CONSUMPTION FOR THE TREATMENT OF EATING DISORDERS, SLIMMING PURPOSES, AND SLEEPING DISORDERS, OINTMENTS FOR PHARMACEUTICAL PURPOSES FOR THE TREATMENT OF EATING DISORDERS, SLIMMING PURPOSES, AND SLEEPING DISORDERS, MEDICINAL ROOTS BEING HERBAL MEDICAL PREPARATIONS FOR THE TREATMENT OF EATING DISORDERS, SLIMMING PURPOSES, AND SLEEPING DISORDERS, TONICS BEING PHARMACEUTICALS FOR THE TREATMENT OF EATING DISORDERS, SLIMMING PURPOSES, AND SLEEPING DISORDERS, MEDICINES FOR HUMAN PURPOSES, NAMELY, SEDATIVES, ANTITOXIC SERA, SYRUPS FOR PHARMACEUTICAL PURPOSES FOR THE TREATMENT OF EATING DISORDERS, SLIMMING PURPOSES, AND SLEEPING DISORDERS, SOPORIFICS BEING PHARMACEUTICALS FOR INDUCING SLEEP, SUGAR REPLACEMENT FOR MEDICINAL OR THERAPEUTIC PURPOSES, MINERAL FOOD SUPPLEMENTS, MEDICINAL TEA, HERB TEAS FOR MEDICINAL PURPOSES,

VITAMIN AND MINERAL PREPARATIONS FOR MEDICAL USE, GLYCERINE FOR MEDICAL PURPOSES; FOOD SUPPLEMENTS FOR NON-MEDICAL USE MADE WITH RAISINS, SALTED MEATS, SAUSAGE, TOFU AND YOGURT (U.S. CLS. 6, 18, 44, 46, 51 AND 52).

CLASS 29—MEATS AND PROCESSED FOODS

FOR MEAT, FISH, POULTRY AND GAME, MEAT EXTRACTS, PRESERVED, DRIED AND COOKED FRUITS AND VEGETABLES, FRUIT, VEGETABLE AND PLANT EXTRACTS FOR USE IN JAMS, SOUP AND JUICE, JELLIES, JAMS, COMPOTES, EGGS, MILK AND MILK PRODUCTS EXCLUDING ICE CREAM, ICE MILK AND FROZEN YOGURT, EDIBLE OILS AND FATS, PREPARED WEED EXTRACTS FOR FOOD, NAMELY, FOR SOUPS; DRIED WEED EXTRACTS FOR FOOD, NAMELY, FOR SOUPS; GROUND ALMONDS, PROCESSED PEANUTS, BUTTER, MILK BEVERAGES WITH HIGH MILK CONTENT, BOUILLONS, PREPARATIONS FOR MAKING BOUILLONS, PROCESSED MUSHROOMS, DESICCATED COCONUT, BOUILLON CONCENTRATES, CRYSTALLIZED FRUITS, CONSOMMÉS, CREAM, FROSTED FRUITS, FRUIT PEEL, PROCESSED BEANS, CHEESES, UNFLAVORED AND UNSWEETENED GELATIN FOR FOOD, PRESERVED GARDEN HERBS, VEGETABLE JUICES FOR COOKING, WHEY, MARGARINE, MARMALADES, PROCESSED NUTS, NUT OILS, PRESERVED OLIVES, FISH PRODUCTS, NAMELY, FISHES, SALTED FISH AND PRESERVED FISH, PICKLES, PROCESSED BEE POLLEN PREPARED AS FOOD, PROTEIN BEING FOODSTUFFS FOR HUMAN CONSUMPTION, PROCESSED VEGETABLE FIBRES FOR HUMAN CONSUMPTION, RAISINS, SALTED MEATS, SAUSAGES, TOFU, YOGHURT, PREPARED MEALS MADE FROM MEAT, FISH, POULTRY, FRUIT, VEGETABLES, EGGS, MILK AND MILK PRODUCTS, PREPARED DISHES AND DIETETIC DISHES FOR NON-MEDICAL USE MADE WITH MEAT, FISH, POULTRY, FRUITS, VEGETABLES, EGGS, MILK AND MILK PRODUCTS, CANNED FRUITS, CANNED VEGETABLES, CANNED FISH, CANNED MEAT AND THICK SOUPS (U.S. CL. 46).

CLASS 30—STAPLE FOODS

FOR FLOUR AND CEREAL BASED PREPARATIONS, NAMELY, SNACK FOODS AND CHIPS, BREAKFAST CEREALS, SALT, VINEGAR, SPICES, WEEDS, NAMELY, PROCESSED GARDEN HERBS, EDIBLE ICES, PASTA, ALMOND CONFECTIONERY, NAMELY, CANDY, ALMOND PASTE, SUGARED ALMOND; ALMOND PASTES, EDIBLE FOOD STARCH; SNACK FOODS, NAMELY, CORN CHIPS, CEREAL BASED CEREAL BARS, ENERGY BARS; MAIZE, WHEAT FLOUR, RICE, FLAVOURINGS OTHER THAN ESSENTIAL OILS, FLAVOURINGS, OTHER THAN ESSENTIAL OILS, FOR CAKES, AROMATIC PREPARATIONS FOR FOOD, NAMELY, SEASONINGS, CONDIMENTS, NAMELY, MUSTARD, SPICES, TAPIOCA, FLOUR, AND SALT; SEASONINGS, OAT-BASED FOOD, NAMELY, BREAD, CRUSHED ROLLED OATS, OATMEAL, HUSKED OAT, OAT FLAKES, STICKS OF LIQUORICE, BEVERAGE FLAVOURINGS, OTHER THAN ESSENTIAL OILS, COCOA PRODUCTS, NAMELY, COCOA BASED BEVERAGES, CHOCOLATE BASED BEVERAGES NOT BEING DAIRY BASED, CHOCOLATE, CHOCOLATE CONFECTIONERY, COFFEE, COFFEE FLAVOURINGS, VEGETABLE PREPARATIONS FOR USE AS COFFEE SUBSTITUTES, UNROASTED COFFEE, DRIED CEREAL FLAKES FOR USE IN BREAD, BREAKFAST CEREAL, SNACKS, CHICORY BASED COFFEE SUBSTITUTE, COCOA, CONDIMENTS, NAMELY, PEPPER SAUCE, CHILI SAUCE, MAYONNAISE, SUGAR CONFECTIONERY, NAMELY, CANDY, FRUIT JELLIES, ALMOND PASTE, PASTILLES, COUSCOUS, ICE-CREAMS, NATURAL SWEETENERS, THICKENING AGENTS FOR COOKING FOODSTUFFS, ESSENCES FOR FOODSTUFFS, NAMELY, FLAVOURINGS OF MINT, LEMON, ORANGE AND BLACKBERRY, EXCEPT ETHERIC ESSENCES AND ESSENTIAL OILS, MALT EXTRACT FOR FOOD, STARCH FOR FOOD, FERMENTS FOR PÂTES, NAMELY, LEAVEN, YEAST, BEAN FLOURS, WHEAT FLOUR, FARINACEOUS FOOD PASTE FOR HUMAN CONSUMPTION, CORN FLAKES, ROYAL JELLY FOR HUMAN CONSUMPTION, GLUCOSE FOR FOOD, SWEETS, CHEWING GUM FOR NON-MEDICAL PURPOSES,

POSES, CONFECTIONERY, NAMELY, PASTILLES, FRUIT JELLIES, GRUEL WITH A MILK BASE FOR FOOD, PUDDINGS, GLUTEN FOR FOOD, PROCESSED GROATS, NAMELY, GRAINS FOR HUMAN FOOD, LEAVEN, NAMELY, YEAST, YEAST IN PILL FORM NOT FOR MEDICAL USE, YEAST FOR BREAD, YEAST, CORN FLOUR, GRILLED MAIZE, POPCORN, MALT FOR FOOD, MAYONNAISE, MOLASSES FOR FOOD, TREACLE, HERBAL INFUSIONS, NAMELY, VERBENA, CHAMOMILE, LIME BLOSSOM TEA, FENNEL, HONEY, BREAD, UNLEAVENED BREAD, GINGERBREAD, CRACKERS, FLOUR-MILLING PRODUCTS, NAMELY, FLOUR, FARINEOUS FOODS, MUSTARD, NOODLES, BARLEY FLOUR MEAL, FOR USE WITH FOOD AND BREAD, MAIZE FLAKES FOR USE WITH BREAD, HOMINY GRITS, HOMINY, PEPPER, POTATO FLOUR FOR FOOD, CAKE POWDER, PRALINES, PROPOLIS FOR HUMAN CONSUMPTION, LIQUORICE, RICE, SAUCES, PROCESSED SEMOLINA, SOYA FLOUR, SORBETS, SUGAR, CANDY SUGAR FOR FOOD, TAPIOCA, TAPIOCA FLOUR FOR FOOD, TEA, FROZEN YOGHURT, DIETETIC FOOD PRODUCTS AND FOOD SUPPLEMENTS FOR NON-MEDICAL USE MADE WITH THE ABOVE PRODUCTS, BEVERAGES AND DIETETIC BEVERAGES NOT ADAPTED FOR MEDICAL PURPOSES MADE FROM COCOA, COFFEE AND CHOCOLATE, RUSKS AND DIETETIC RUSKS NOT ADAPTED FOR MEDICAL USE, BISCUITS AND DIETETIC BISCUITS NOT ADAPTED FOR MEDICAL USE (U.S. CL. 46).

CLASS 32—LIGHT BEVERAGES

FOR BEERS, MINERAL AND AERATED WATERS AND OTHER NON-ALCOHOLIC BEVERAGES, NAMELY, HONEY BASED BEVERAGES, SODA WATERS, NON-ALCOHOLIC COCKTAILS, FRUIT DRINKS AND FRUIT JUICES, SYRUPS AND OTHER PREPARATIONS FOR MAKING BEVERAGES, NAMELY, FRUIT JUICES, ISOTONIC BEVERAGES; NON-ALCOHOLIC APERITIFS, ESSENCES FOR MAKING BEVERAGES, NAMELY, SOFT DRINKS AND ISOTONIC BEVERAGES, PASTILLES FOR EFFERVESCING BEVERAGES, NAMELY, SOFT DRINKS AND ISOTONIC BEVERAGES, POWDERS FOR EFFERVESCING BEVERAGES, NAMELY, ISOTONIC BEVERAGES, SYRUPS FOR BEVERAGES, NON-ALCOHOLIC COCKTAILS, TABLE WATERS, PREPARATIONS FOR MAKING AERATED WATER, NON-ALCOHOLIC FRUIT EXTRACT VEGETABLE JUICES, SODA WATER, SORBETS IN THE FORM OF BEVERAGES AND DIETETIC BEVERAGES NOT ADAPTED FOR MEDICAL USE, NAMELY, ISOTONIC BEVERAGES (U.S. CLS. 45, 46 AND 48).

CLASS 35—ADVERTISING AND BUSINESS

FOR ADVERTISING SERVICES, BUSINESS MANAGEMENT, BUSINESS ADMINISTRATION, IMPORT-EXPORT AGENCIES, DISSEMINATION OF ADVERTISEMENTS, SUPPLY CHAIN MANAGEMENT SERVICES FOR THIRD PARTIES FOR THE PURCHASE OF GOODS AND SERVICES FOR OTHER COMPANIES, DIRECT MAIL ADVERTISING, DEMONSTRATION OF GOODS, DISTRIBUTION OF SAMPLES, DISSEMINATION OF ADVERTISING MATERIAL IN THE NATURE OF LEAFLETS, PROSPECTUSES, PRINTED MATTER AND SAMPLES, RENTAL OF VENDING MACHINES, UPDATING OF ADVERTISING MATERIAL, COMPILATION OF DATA IN DATABASES, SYSTEMIZATION OF INFORMATION INTO COMPUTER DATABASES, COMPUTER FILE MANAGEMENT, RENTAL OF ADVERTISING SPACE, MARKET STUDIES, MARKET RESEARCH, ORGANIZATION OF TRADE FAIRS FOR BUSINESS OR ADVERTISING PURPOSES, SALES PROMOTION FOR THIRD PARTIES, ONLINE ADVERTISING ON A COMPUTER NETWORK, ADVERTISING BY POST, ADMINISTRATIVE SERVICES IN THE CONTEXT OF PLACING AND RECEIVING ORDERS FOR GENERAL MERCHANDISE ON THE INTERNET, ORGANIZING PROMOTIONAL EVENTS FOR OTHERS, ALONG WITH CUSTOMER LOYALTY PROGRAMMES, RETAIL STORE SERVICES AND ONLINE RETAIL STORE SERVICES FEATURING SOAPS, PERFUMERY, PERFUMERY PRODUCTS, PERFUMES, TOILET WATER, EAU DE PARFUM, SCENTED WATER, DEODORANTS FOR PERSONAL USE, ESSENTIAL OILS, OILS FOR TOILET

PURPOSES, COSMETICS, COSMETIC SETS, COSMETIC PREPARATIONS FOR SKIN CARE, COSMETIC CREAMS, COSMETIC LOTIONS, LOTIONS FOR COSMETIC PURPOSES, COSMETIC POWDER, COSMETIC PREPARATIONS FOR SLIMMING PURPOSES, TISSUES IMPREGNATED WITH COSMETIC LOTIONS, COSMETICS FOR TANNING, MAKE-UP AND MAKE-UP REMOVING PRODUCTS, BEAUTY CREAMS, CLEANSING MILKS, BEAUTY MASKS, CREAMS AND LOTIONS FOR THE FACE AND BODY, COSMETIC BATH PREPARATIONS, BATH SALTS, NOT FOR MEDICAL PURPOSES, OILS FOR COSMETIC PURPOSES, SHAMPOOS, HAIR LOTIONS, LOTIONS FOR COSMETIC PURPOSES, AFTER-SHAVE LOTIONS, SHAVING PRODUCTS, SHAVING SOAP, MAKE-UP, MAKE-UP POWDER, LIPSTICK, COSMETIC PRODUCTS FOR LIPS, MASCARA, COSMETIC PENCILS, FOOD SUPPLEMENTS FOR COSMETIC PURPOSES, SANITARY PREPARATIONS, DIETETIC SUBSTANCES FOR MEDICAL USE, DIETETIC FOODS ADAPTED FOR MEDICAL PURPOSES, BIOLOGICAL PREPARATIONS FOR MEDICAL PURPOSES, DIETETIC BEVERAGES ADAPTED FOR MEDICAL PURPOSES, MEDICATED CONFECTIONERY, CHEMICAL-PHARMACEUTICAL PREPARATIONS, CHEMICAL PREPARATIONS FOR MEDICAL PURPOSES, CHEMICAL PREPARATIONS FOR PHARMACEUTICAL PURPOSES, NUTRITIONAL SUPPLEMENTS AND SUBSTITUTES FOR MEDICAL USE, DECOCTIONS FOR PHARMACEUTICAL PURPOSES, ELIXIRS, ESSENCES FOR MEDICAL PURPOSES, EDIBLE PLANT FIBRES, SMOKING HERBS FOR MEDICAL PURPOSES, CHEWING GUMS FOR MEDICAL PURPOSES, GUM FOR MEDICAL PURPOSES, MEDICINAL HERBS, OILS FOR MEDICAL USE, MEDICINAL INFUSIONS, LOTIONS FOR PHARMACEUTICAL PURPOSES, MEDICINES FOR HUMAN PURPOSES, MINERAL WATERS FOR MEDICAL PURPOSES, NARCOTICS, PREPARATIONS OF TRACE ELEMENTS FOR HUMAN CONSUMPTION, OINTMENTS FOR PHARMACEUTICAL PURPOSES, MEDICINAL DRINKS, TONICS, REMEDIES FOR HUMAN MEDICINE, SEDATIVES, SERA, SYRUPS FOR PHARMACEUTICAL PURPOSES, SOPORIFICS, SUGAR FOR MEDICAL PURPOSES, MINERAL FOOD SUPPLEMENTS, MEDICINAL TEA, HERB TEAS, VITAMIN AND MINERAL PREPARATIONS, GLYCERINE FOR MEDICAL PURPOSES, MEAT, FISH, POULTRY AND GAME, MEAT EXTRACTS, PRESERVED, DRIED AND COOKED FRUITS AND VEGETABLES, FRUIT, VEGETABLE AND PLANT EXTRACTS FOR HUMAN CONSUMPTION, JELLIES, JAMS, COMPOTES, EGGS, MILK AND MILK PRODUCTS, EDIBLE OILS AND FATS, WEED EXTRACTS FOR FOOD, GROUND ALMONDS, PROCESSED PEANUTS, BUTTER, MILK BEVERAGES WITH MILK PREDOMINATING, BOUILLONS, PREPARATIONS FOR MAKING BOUILLON, PRESERVED MUSHROOMS, DESICCATED COCONUT, BOUILLON CONCENTRATES, CRYSTALLIZED FRUITS, CONSOMMÉS, CREAM, FROSTED FRUITS, FRUIT PEEL, PRESERVED BEANS, CHEESES, GELATINE FOR FOOD, FRUIT JELLIES, FRUIT PULP, EDIBLE JELLIES, PRESERVED SOYA BEANS FOR CONSUMPTION, PRESERVED GARDEN HERBS, VEGETABLE JUICES FOR KITCHEN USE, WHEY, MARGARINE, MARMALADES, PREPARED NUTS, NUT OILS, PRESERVED OLIVES, FISH PRODUCTS, PICKLES, POLLEN PREPARED AS FOOD, PROTEIN FOR HUMAN CONSUMPTION, VEGETABLE FIBRES FOR HUMAN CONSUMPTION, RAISINS, SALTED MEATS, SAUSAGES, TOFU, YOGHURT, DIETETIC FOOD PRODUCTS AND FOOD SUPPLEMENTS FOR NON-MEDICAL USE MADE WITH THE ABOVE PRODUCTS, COOKED DISHES AND DISHES MADE WITH MEAT, FISH, POULTRY, FRUIT, VEGETABLES, EGGS, MILK AND MILK PRODUCTS, COOKED DISHES AND DIETETIC DISHES FOR NON-MEDICAL USE MADE WITH MEAT, FISH, POULTRY, FRUITS, VEGETABLES, EGGS, MILK AND MILK PRODUCTS, TINNED FRUITS, TINNED VEGETABLES, TINNED FISH, TINNED MEAT AND THICK SOUPS, FLOURS AND CEREAL PREPARATIONS, SALT, VINEGAR, SPICES, WEEDS, EDIBLE ICES, PASTA, ALMOND CONFECTIONERY, ALMOND PASTES, EDIBLE STARCH, STARCH PRODUCTS FOR FOOD, PEANUT CONFECTIONERY, FLAVOURINGS OTHER THAN ESSENTIAL OILS, FLAVOURINGS, OTHER THAN ESSENTIAL OILS, FOR CAKES, AROMATIC PREPARATIONS FOR FOOD, SEASONINGS, OAT-BASED FOOD, OAT FLAKES, STICKS OF LIQUORICE, FLAVORINGS, OTHER THAN ESSENTIAL OILS, FOR BEVERAGES, COCOA PRODUCTS, COFFEE, COF-

FEE FLAVOURINGS, VEGETAL PREPARATIONS FOR USE AS COFFEE SUBSTITUTES, COFFEE, UNROASTED COFFEE, DRIED CEREAL FLAKES, CHICORY, COCOA, CHOCOLATE, CONDIMENTS, SUGAR CONFECTIONERY, COUSCOUS, ICE-CREAMS, NATURAL SWEETENERS, THICKENING AGENTS FOR COOKING FOODSTUFFS, ESSENCES FOR FOODSTUFFS, STARCH FOR FOOD, FERMENTS FOR PASTES, BEAN FLOURS, WHEAT FLOUR, FARINACEOUS FOODS, CORN FLAKES, ROYAL JELLY FOR HUMAN CONSUMPTION, GLUCOSE FOR FOOD, SWEETS, CHEWING GUM NOT FOR MEDICAL PURPOSES, PASTILLES, FRUIT JELIES, MILK-BASED GRUEL FOR FOOD, PUDDINGS, GLUTEN FOR FOOD, GROATS FOR HUMAN FOOD, LEAVEN, YEAST, CORN FLOUR, POPCORN, MALT EXTRACT FOR FOOD, MALT FOR FOOD, MAYONNAISE, MOLASSES FOR FOOD, TREACLE, NON-MEDICINAL INFUSIONS, HONEY, BREAD, UNLEAVENED BREAD, GINGERBREAD, CRACKERS, FLOUR-MILLING PRODUCTS, MUSTARD, NOODLES, BARLEY MEAL, MAIZE FLAKES, PEPPER, POTATO FLOUR FOR FOOD, CAKE POWDER, PRALINES, PROPOLIS FOR HUMAN CONSUMPTION, LIQUORICE, RICE, SAUCES, SEMOLINA, SOYA FLOUR, SORBETS, SUGAR, CANDY SUGAR FOR FOOD, TAPIOCA, TAPIOCA FLOUR FOR FOOD, TEA, FROZEN YOGHURT, DIETETIC FOOD PRODUCTS AND FOOD SUPPLEMENTS FOR NON-MEDICAL USE MADE WITH THE ABOVE PRODUCTS, BEVERAGES AND DIETETIC BEVERAGES NOT ADAPTED FOR MEDICAL PURPOSES MADE WITH COCOA, COFFEE AND CHOCOLATE, RUSKS AND DIETETIC RUSKS NOT ADAPTED FOR MEDICAL USE, BISCUITS AND DIETETIC BISCUITS FOR NON-MEDICAL PURPOSES, BEERS, MINERAL AND AERATED WATERS AND OTHER NON-ALCOHOLIC BEVERAGES, FRUIT DRINKS AND FRUIT JUICES, SYRUPS AND OTHER PREPARATIONS FOR MAKING BEVERAGES, NON-ALCOHOLIC APERITIFS, ESSENCES FOR MAKING BEVERAGES, PASTILLES FOR EFFERVESCING BEVERAGES, BEVERAGE POWDERS, ISOTONIC BEVERAGES, SYRUPS FOR BEVERAGES, NON-ALCOHOLIC COCKTAILS, TABLE WATERS, PREPARATIONS FOR MAKING AERATED WATER, NON-ALCOHOLIC FRUIT EXTRACTS, VEGETABLE JUICES, SODA WATER, SORBETS, DIETETIC BEVERAGES NOT ADAPTED FOR MEDICAL PURPOSES (U.S. CLS. 100, 101 AND 102).

CLASS 38—COMMUNICATION

FOR TELECOMMUNICATIONS, NAMELY, COMMUNICATIONS BY COMPUTER TERMINALS, ELECTRONIC MESSAGE SENDING, COMPUTER AIDED TRANSMISSION OF MESSAGES AND IMAGES (U.S. CLS. 100, 101 AND 104).

CLASS 42—SCIENTIFIC AND COMPUTER SERVICES

FOR SCIENTIFIC AND TECHNOLOGICAL SERVICES AND RELATED RESEARCH AND DESIGN SERVICES IN THE FIELD OF DIETETIC FOOD PRODUCTS AND FOOD SUPPLEMENTS FOR NON-MEDICAL USE, COSMETIC PURPOSES, MEDICAL USE AND HEALTH; INDUSTRIAL ANALYSIS AND RESEARCH SERVICES IN THE FIELD OF DIETETIC FOOD PRODUCTS AND FOOD SUPPLEMENTS FOR NON-MEDICAL USE, COSMETIC PURPOSES, MEDICAL USE AND HEALTH; DESIGN AND DEVELOPMENT OF COMPUTERS AND SOFTWARE; DESIGN OF COMPUTER SYSTEMS; QUALITY CONTROL FOR OTHERS, CONVERSION OF DATA OR DOCUMENTS FROM PHYSICAL TO ELECTRONIC MEDIA, COSMETIC SCIENCE RESEARCH, PACKAGING DESIGN SERVICES, COMPUTER PROGRAMMING, RESEARCH AND DEVELOPMENT OF NEW PRODUCTS FOR THIRD PARTIES (U.S. CLS. 100 AND 101).

CLASS 44—MEDICAL, BEAUTY AND AGRICULTURAL SERVICES

FOR MEDICAL SERVICES, HYGIENE AND BEAUTY CARE FOR HUMAN BEINGS, BEAUTY SALONS, HEALTH CARE (U.S. CLS. 100 AND 101).

CLASS 45—PERSONAL AND LEGAL SERVICES

FOR LEGAL SERVICES; COPYRIGHT MANAGEMENT; LICENSING OF INTELLECTUAL PROPERTY LICENCES (U.S. CLS. 100 AND 101).
DAVID HOFFMAN, EXAMINING ATTORNEY

SN 79-046,298. THE FOOTBALL ASSOCIATION PREMIER LEAGUE LIMITED, LONDON W1U 8PL, UNITED KINGDOM, FILED 6-13-2007.



OWNER OF INTERNATIONAL REGISTRATION 0943634 DATED 6-13-2007, EXPIRES 6-13-2017.

OWNER OF U.S. REG. NO. 3,003,148.
NO CLAIM IS MADE TO THE EXCLUSIVE RIGHT TO USE "LEAGUE", APART FROM THE MARK AS SHOWN.

CLASS 9—ELECTRICAL AND SCIENTIFIC APPARATUS

FOR SURVEYING, SCIENTIFIC, NAUTICAL, PHOTOGRAPHIC, CINEMATOGRAPHIC, OPTICAL, WEIGHING, MEASURING, SIGNALING, CHECKING, LIFE-SAVING AND TEACHING APPARATUS AND INSTRUMENTS, NAMELY, CAMERAS, VIDEO CAMERAS, SLIDE PROJECTORS, OPTICAL LENSES, EYEGASSES, SUNGLASSES, BINOCULARS, TIME RECORDING APPARATUS, DISTANCE MEASURING APPARATUS, GOGGLES FOR SPORT; APPARATUS AND INSTRUMENTS FOR TRANSFORMING, REGULATING OR CONTROLLING ELECTRICITY; APPARATUS FOR RECORDING, TRANSMISSION OR REPRODUCTION OF SOUND OR IMAGES; BLANK MAGNETIC DATA CARRIERS, PRERECORDED MAGNETIC DATA CARRIERS RELATED TO SPORT; BLANK RECORD DISCS; AUTOMATIC VENDING MACHINES AND MECHANISMS FOR COIN OPERATED APPARATUS; CASH REGISTERS; CALCULATING MACHINES, DATA PROCESSING EQUIPMENT AND COMPUTERS; FIRE-EXTINGUISHING APPARATUS; MAGNETIC CARDS; MAGNETICALLY ENCODED CREDIT, DEBIT, CASH AND IDENTITY CARDS; MAGNETICALLY ENCODED CARDS FOR PROVIDING ACCESS TO BUILDINGS, ELECTRONICALLY STORED DATA OR COMPUTER NETWORKS; BLANK SMART CARDS; ENCODED SMART CARDS CONTAINING PROGRAMMING USED TO STORE FINANCIAL INFORMATION OR INFORMATION RELATED TO SPORT; PREPAID TELEPHONE CALLING CARDS, MAGNETICALLY ENCODED; ELECTRONIC MACHINES FOR READING CREDIT CARDS AND RECORDING FINANCIAL TRANSACTIONS IN THE NATURE OF APPARATUS FOR PROCESSING CARD TRANSACTIONS AND DATA RELATING THERETO AND FOR PAYMENT PROCESSING; APPARATUS IN THE NATURE OF READERS FOR VERIFYING DATA ON MAGNETICALLY ENCODED CARDS; SOUND AND VIDEO RECORDINGS IN THE FIELD OF SPORT; BLANK AUDIO AND VIDEO TAPES; BLANK AUDIO AND VIDEO CASSETTES; PRERECORDED AUDIO AND VIDEO TAPES, PRERECORDED AUDIO AND VIDEO CASSETTES, PRERECORDED AUDIO AND VIDEO COMPACT DISCS, ALL RELATED TO SPORT;

EXPOSED CAMERA FILMS; CINEMATOGRAPHIC FILMS RELATED TO SPORT; PHOTOGRAPHIC SLIDES; VIDEO RECORDERS; BLANK VIDEO CASSETTES; BLANK VIDEO DISCS; BLANK DVDS; PRERECORDED VIDEO CASSETTES, PRERECORDED VIDEO DISCS, PRERECORDED DVDS, ALL RELATED TO SPORT; GAMES ADAPTED FOR USE WITH TELEVISION RECEIVERS; COMPUTER GAME CARTRIDGES AND DISCS; COMPUTER GAME SOFTWARE; COMPUTER SOFTWARE IN THE NATURE OF PROGRAMS HAVING INFORMATION, STATISTICS AND TRIVIA RELATED TO SPORT; COMPUTER SCREEN SAVER SOFTWARE; DOWNLOADABLE ELECTRONIC PUBLICATIONS IN THE NATURE OF ARTICLES, NEWSLETTERS, MAGAZINES, BROCHURES AND CATALOGUES, ALL IN THE FIELD OF SPORT; DOWNLOADABLE ELECTRONIC PUBLICATIONS IN THE NATURE OF ARTICLES, NEWSLETTERS, MAGAZINES, BROCHURES, CATALOGUES PROVIDING INFORMATION RELATING TO GAME INFORMATION AND GAME SCHEDULES AND RESULTS, ALL IN THE FIELD OF SPORT; DATA PROCESSING EQUIPMENT; ELECTRIC AND ELECTRONIC SCOREBOARDS; TELECOMMUNICATIONS APPARATUS, EQUIPMENT AND ACCESSORIES, NAMELY, PHONES, CELL PHONES AND CELL PHONE ACCESSORIES, NAMELY, CARRYING CASES FOR CELL PHONES, COVERS ADAPTED FOR CELL PHONES; PROTECTIVE CLOTHING AND PROTECTIVE FOOTWEAR, NAMELY, INDUSTRIAL SHOES (U.S. CLS. 21, 23, 26, 36 AND 38).

CLASS 16—PAPER GOODS AND PRINTED MATTER

FOR PAPER AND CARDBOARD; PRINTED MATTER, NAMELY, PUBLICATIONS IN THE NATURE OF BOOKS, ARTICLES, NEWSLETTERS, MAGAZINES, BROCHURES, CATALOGUES AND JOURNALS RELATING TO SPORT; BOOK BINDING MATERIAL; PHOTOGRAPHS; STATIONERY; ADHESIVES FOR STATIONERY OR HOUSEHOLD PURPOSES; ARTISTS' MATERIALS, NAMELY, PAINT BRUSHES, PAINTING CANVAS, PAINTING PALETTES, ARTISTS' PRINTING BLOCKS, DRAWING PENS, DRAWING INK, PASTELS, CRAYONS AND EASELS; TYPEWRITERS; PRINTED INSTRUCTIONAL AND TEACHING MATERIAL IN THE FIELD OF SPORT; PLASTIC MATERIALS FOR PACKAGING IN THE NATURE OF BUBBLE WRAP, PLASTICS FILM, NOT FOR COMMERCIAL OR INDUSTRIAL USE; PLASTIC BAGS; PRINTERS' TYPE; PRINTING BLOCKS; BLANK TRAVELERS' CHECKS; BANKING CARDS, NOT MAGNETICALLY ENCODED, GREETING CARDS, GIFT CARDS, BUSINESS CARDS, POSTCARDS, DISCOUNT CARDS THAT ARE NOT MAGNETICALLY ENCODED, IDENTITY CARDS THAT ARE NOT MAGNETICALLY ENCODED, MEMBERSHIP CARDS THAT ARE NOT MAGNETICALLY ENCODED, TRADING CARDS AND TELEPHONE CALLING CARDS, NOT MAGNETICALLY ENCODED, ALL OF CARDBOARD OR PLASTIC; MONEY ORDER FORMS; BLANK CHECKS; BOOKLETS IN THE FIELD OF SPORT; POSTERS; BOOKMARKS; PAPER FLAGS; PAPER BANNERS; HEAT TRANSFER PAPER; DECALCOMANIAS; ADHESIVE LABELS; WRAPPING AND PACKAGING MATERIALS, NAMELY, GIFT WRAPPING PAPER AND PAPER FOR PACKAGING; PRINTED PERIODICAL PUBLICATIONS IN THE FIELD OF SPORT; NEWSPAPERS; BOOKS IN THE FIELD OF SPORT; PHOTOGRAPHS; ALBUMS FOR COINS, PHOTOGRAPHS AND STAMPS; PENS, PENCILS, DRAWING RULERS, PENCIL CASES AND WRITING PAPER; STICKERS; VEHICLE STICKERS; WRITING AND DRAWING INSTRUMENTS; PRINTED INSTRUCTIONAL AND TEACHING MATERIAL IN THE FIELD OF SPORT; CALENDARS; DIARIES; ADDRESS BOOKS; FOLDERS; DOCUMENT FILES; WRITING INSTRUMENTS OF PRECIOUS METAL; CHECK BOOK HOLDERS (U.S. CLS. 2, 5, 22, 23, 29, 37, 38 AND 50).

CLASS 25—CLOTHING

FOR CLOTHING, NAMELY, T-SHIRTS, SHIRTS, SPORTS JERSEYS, POLO SHIRTS, SWEATERS, CARDIGANS, SINGLETS, SUITS, VESTS, WARM-UP TOPS, WARM-UP SUITS, PANTS, TROUSERS, SHORTS, SKIRTS, WARM-UP PANTS, DRESSES, UNIFORMS, JACKETS, PARKAS, COATS, PAJAMAS, NIGHT SHIRTS, BATH ROBES, DRESSING GOWNS, UNDERGARMENTS, BOXER SHORTS, HOSIERY, SOCKS, GLOVES, MITTENS, SCARVES, SHAWLS, BELTS, TIES, WRIST BANDS, APRONS, SWIM WEAR, BATHING SUITS, BIKINIS, SWIM TRUNKS, BOARD SHORTS, WET SUITS AND BEACH COVER-UPS; FOOTWEAR; HEADGEAR, NAMELY, HATS, CAPS, BEANIES, VISORS, EAR MUFFS, BANDANAS, HEAD BANDS, SWIM CAPS AND BATHING CAPS (U.S. CLS. 22 AND 39).

CLASS 28—TOYS AND SPORTING GOODS

FOR GAMES AND PLAYTHINGS, NAMELY, SPORT TABLE TOP GAMES, BOARD GAMES, HAND-HELD GAMES WITH LIQUID CRYSTAL DISPLAYS NOT ADAPTED FOR USE WITH EXTERNAL DISPLAY SCREENS OR MONITORS, ACTION SKILL GAMES, ADULT'S AND CHILDREN'S PARTY GAMES, TRIVIA INFORMATION GAMES PLAYED WITH CARDS AND GAME COMPONENTS, ELECTRONIC VIDEO ARCADE GAME MACHINES, BENDABLE TOY FIGURINES; MODEL TOYS, NAMELY, MODEL CARS, TRAINS, BOATS AND PLANES; DOLLS, DECORATIVE DOLLS, COLLECTABLE DOLLS, TOY ACTION FIGURES, STUFFED TOYS, NOVELTY PLUSH TOYS WITH WIGS, JIGSAW PUZZLES, TOY VEHICLES IN THE NATURE OF CARS, TRUCKS, TRAINS AND VANS, TOY TROPHIES, BATH TOYS, PLAYING CARDS, CARD GAMES, BEACH TOYS, NAMELY, BEACH BALLS, INFLATABLE SPORT BALLS, TOY PAILS, TOY SHOVELS, SAND TOYS, SAND BOX TOYS, WATER-SQUIRTING TOYS, BEACH AND POOL ACCESSORIES, NAMELY, SWIM FLOATS FOR RECREATIONAL USE, POOL SWIM FLOATS FOR RECREATIONAL USE, FOAM FLOATS FOR RECREATIONAL USE, SWIMMING AIDS IN THE NATURE OF POOL RINGS, SWIMMING AIDS IN THE NATURE OF FOAM POOL RINGS, BODY BOARDS, SURF BOARDS, SWIM FINS, SURF FINS, SWIMMING AIDS IN THE NATURE OF ARM FLOATS FOR RECREATIONAL USE AND WATER WING SWIM AIDS FOR RECREATIONAL USE, INFLATABLE TOYS, PLAYGROUND APPARATUS IN THE NATURE OF SWINGS, SLIDES AND CLIMBING UNITS, BALLS, NAMELY, BALLS FOR GAMES, PLUSH PLAY BALLS AND PLASTIC PLAY BALLS, BALLOONS, DART BOARDS, PLAY COSTUMES FOR DOLLS; GYMNASIAC AND SPORTING GOODS, NAMELY, FOOTBALLS, SPORT BALLS, PUMPS FOR INFLATING SPORT BALLS, NEEDLES FOR PUMPS FOR INFLATING SPORT BALLS, SHIN, HIP, LEG, KNEE, WRIST AND CHEST GUARDS FOR ATHLETIC USE; SOCCER BALL GOALS, SOCCER BALL GOAL NETS, TARGETS FOR SPORTING USE, SOCCER GLOVES, BATTING GLOVES, GOLF GLOVES, CRICKET BATS, BASEBALL BATS, TENNIS RACKETS, BADMINTON RACKETS, SQUASH RACKETS AND GYMNASIAC APPARATUS; BAGS ADAPTED FOR CARRYING SPORTING ARTICLES AND APPARATUS, NAMELY, BAGS FOR SOCCER BALLS (U.S. CLS. 22, 23, 38 AND 50).

CLASS 41—EDUCATION AND ENTERTAINMENT

FOR EDUCATION SERVICES, NAMELY, PROVIDING CLASSES, SEMINARS, WORKSHOPS AND LECTURES IN THE FIELD OF SPORT; PROVIDING OF TRAINING IN THE FIELD OF SPORT; CONDUCTING AND ARRANGING SPORTS CLINICS AND CAMPS; ENTERTAINMENT, NAMELY, ENTERTAINMENT IN THE NATURE OF SOCCER MATCHES, PRODUCTION AND DISTRIBUTION OF RADIO AND TELEVISION PROGRAMS RELATING TO SPORT, LIVE MUSIC CONCERTS; SPORTING AND CULTURAL ACTIVITIES IN THE NATURE OF SOCCER GAMES AND COMPETITIONS; FAN CLUB SERVICES; INFORMATION RELATING TO SPORTING EVENTS PROVIDED ONLINE FROM A COMPUTER DATABASE OR THE INTERNET; PROVIDING ONLINE COMPUTER SPORTS GAMES VIA THE INTERNET; ORGANIZATION OF SPORTS COMPE-

TITIONS AND SPORTING EVENTS IN THE NATURE OF SPECIAL EVENTS FEATURING SPORT; ARRANGING AND CONDUCTING SEMINARS, EDUCATIONAL CONFERENCES IN THE FIELD OF SPORT; ORGANIZATION OF EXHIBITIONS FOR EDUCATIONAL PURPOSES; CONDUCTING EDUCATIONAL SYMPOSIA RELATING TO SOCCER AND OTHER SPORTING ACTIVITIES; OFFICIATING AT SPORTS CONTESTS; PROVISION OF SPORTS FACILITIES; PRODUCTION OF RADIO AND TELEVISION PROGRAMS, AND PRODUCTION OF VIDEOTAPES; PROVISION OF ONLINE ELECTRONIC PUBLICATIONS, IN THE NATURE OF ARTICLES, NEWSLETTERS, MAGAZINES, BROCHURES AND CATALOGUES RELATED TO SPORT; PROVISION OF ONLINE ELECTRONIC PUBLICATIONS IN THE NATURE OF ARTICLES, NEWSLETTERS, MAGAZINES, BROCHURES, AND CATALOGUES PROVIDING INFORMATION RELATED TO GAME INFORMATION AND GAME SCHEDULES AND RESULTS RELATED TO SPORT; PUBLICATION OF ELECTRONIC BOOKS AND JOURNALS; ENTERTAINMENT SERVICES, NAMELY, NON-DOWNLOADABLE RINGTONES, PRE-RECORDED MUSIC, VIDEO AND GRAPHICS PRESENTED TO MOBILE COMMUNICATIONS DEVICES VIA A GLOBAL COMPUTER NETWORK AND WIRELESS NETWORKS; ARCHIVE LIBRARY SERVICES (U.S. CLS. 100, 101 AND 107).

Laura Hammel, Examining Attorney

SN 79-046,618, GENETEIN CO., LTD., TOKYO, JAPAN,
FILED 10-16-2007.

Genetein

THE MARK CONSISTS OF STANDARD CHARACTERS WITHOUT CLAIM TO ANY PARTICULAR FONT, STYLE, SIZE, OR COLOR.

PRIORITY DATE OF 10-5-2007 IS CLAIMED.
OWNER OF INTERNATIONAL REGISTRATION 0944501
DATED 10-16-2007, EXPIRES 10-16-2017.

THE WORDING IN THE MARK HAS NO MEANING IN A FOREIGN LANGUAGE.

CLASS 1—CHEMICALS

FOR CHEMICALS FOR USE IN BIOCHEMICAL INDUSTRY, NAMELY, CHEMICALS AND REAGENTS FOR SEPARATING, EXTRACTING, PURIFYING, SYNTHESIZING, PRODUCING AND AMPLIFYING FOR CELLS, BACTERIA, VIRUS, DNA, RNA, OLIGONUCLEOTIDE, PROTEINS, CARBOHYDRATES, SUGAR CHAIN, PEPTIDE AND OTHER BIOCHEMICAL OR BIOLOGICAL SUBSTANCES, NOT FOR MEDICAL AND VETERINARY USE; CHEMICAL CARRIERS, NAMELY, CHEMICALS FOR USE IN THE BIOTECHNOLOGY INDUSTRY HAVING BIOCHEMICAL AND BIOLOGICAL SUBSTANCES BONDED THEREWITH FOR ANALYSIS OF BIOCHEMICAL AND BIOLOGICAL SUBSTANCES SUCH AS DNA, RNA, OLIGONUCLEOTIDES, PROTEINS, CARBOHYDRATES, SUGAR CHAIN, PEPTIDES, NOT FOR MEDICAL OR VETERINARY USE; KIT COMPRISED OF CHEMICAL CARRIERS, NAMELY, CHEMICALS FOR USE IN THE BIOTECHNOLOGY INDUSTRY HAVING BIOCHEMICAL AND BIOLOGICAL SUBSTANCES BONDED HEREWITH FOR ANALYSIS OF BIOCHEMICAL AND BIOLOGICAL SUBSTANCES SUCH AS DNA, RNA, OLIGONUCLEOTIDES, PROTEINS, CARBOHYDRATES, SUGAR CHAIN, PEPTIDES, NOT FOR MEDICAL OR VETERINARY USE; PLANT GROWTH REGULATING PREPARATIONS; CHEMICALS FOR USE IN AGRICULTURE, EXCEPT FUNGICIDES, WEEDKILLERS, HERBICIDES, INSECTICIDES AND PARASITICIDS, NAMELY, CHEMICALS FOR SEPARATING, EXTRACTING, PURIFYING, SYNTHESIZING, PRODUCING AND AMPLIFYING CELLS, BACTERIA, VIRUS, DNA, RNA, OLIGONUCLEOTIDE, PROTEINS, CARBOHYDRATES, SUGAR CHAIN, PEPTIDE AND OTHER BIOCHEMICAL OR BIOLOGICAL SUBSTANCES; FERTILIZERS; ARTIFICIAL SWEETENERS (U.S. CLS. 1, 5, 6, 10, 26 AND 46).

CLASS 5—PHARMACEUTICALS

FOR PHARMACEUTICAL, VETERINARY AND SANITARY PREPARATIONS FOR DIAGNOSTICS AND ANALYSIS, NAMELY, REAGENTS FOR PHARMACEUTICAL DIAGNOSTICS BY USE OF DNA, RNA, OLIGONUCLEOTIDE, PROTEINS, CARBOHYDRATES, SUGAR CHAIN, PEPTIDE, OR OTHER BIOCHEMICAL OR BIOLOGICAL SUBSTANCES; CHEMICAL CARRIERS, NAMELY, CHEMICAL REAGENTS FOR MEDICAL DIAGNOSTIC PURPOSES HAVING BIOCHEMICAL AND BIOLOGICAL SUBSTANCES BONDED THEREWITH FOR ANALYSIS OF BIOCHEMICAL AND BIOLOGICAL SUBSTANCES SUCH AS DNA, RNA, OLIGONUCLEOTIDES, PROTEINS, CARBOHYDRATES, SUGAR CHAIN, PEPTIDE, IN CLINICAL MEDICINE AND CLINICAL MEDICAL PROCEDURES; KIT COMPRISED OF CHEMICAL CARRIERS, NAMELY, CHEMICAL REAGENTS FOR MEDICAL PURPOSES HAVING BIOCHEMICAL AND BIOLOGICAL SUBSTANCES BONDED THEREWITH FOR ANALYSIS OF BIOCHEMICAL AND BIOLOGICAL SUBSTANCES, IN CLINICAL MEDICINE AND CLINICAL MEDICAL PROCEDURES (U.S. CLS. 6, 18, 44, 46, 51 AND 52).

CLASS 9—ELECTRICAL AND SCIENTIFIC APPARATUS

FOR PIPETTE FOR LABORATORY USE; PIPETTE TIPS FOR LABORATORY USE; CAPILLARY TUBES FOR LABORATORY USE; TEST TUBES FOR LABORATORY USE; MICROTUBES, NAMELY, MICRO TEST TUBES FOR LABORATORY USE; PETRI DISHES FOR LABORATORY USE; VIALS FOR LABORATORY USE; CULTURE BOTTLES AND TRAYS FOR LABORATORY USE; LABORATORY GLASSWARE, NAMELY, FLASKS AND FLASK HOLDERS; SEALS, NAMELY, LABORATORY EQUIPMENT IN THE NATURE OF SEALS FOR LABORATORY BOTTLES; REAGENT RESERVOIRS FOR DISPENSING REAGENTS FOR LABORATORY USE; SYRINGES, NAMELY, LABORATORY SYRINGES; GRADUATED DISPENSERS, NAMELY, GRADUATED DISPENSERS TO DISPENSE FLUIDS FOR LABORATORY USE; AND SOLID AND LIQUID WASTE RECEPTACLES, ALL FOR USE IN THE ANALYSIS, TESTING, AND RESEARCH OF BIOCHEMICAL AND BIOLOGICAL SUBSTANCES SUCH AS DNA, RNA, OLIGONUCLEOTIDES, PROTEINS, SUGAR CHAIN, CARBOHYDRATES, PEPTIDES; MEASURING AND

TESTING MACHINES AND INSTRUMENTS FOR ANALYSIS OF BIOCHEMICAL AND BIOLOGICAL SUBSTANCES, NAMELY, GENETIC ANALYZERS, FRAGMENT ANALYZERS, ELECTROPHORESIS MACHINES NOT FOR MEDICAL PURPOSES, LINKAGE ANALYZERS, NAMELY, GENETIC LINKAGE ANALYSIS INSTRUMENTS AND SOFTWARE SOLD AS A UNIT FOR MOLECULAR DIAGNOSTIC PURPOSES, GENETIC MAPPERS, ORGANIC AND INORGANIC SYNTHESIZERS, NAMELY, SYNTHESIZERS FOR USE IN SCREENING AND OPTIMIZING CHEMICAL REACTIONS FOR LABORATORY PURPOSES, SPECTROPHOTOMETERS, METERS FOR MEASURING LUMINESCENCE ABSORBENCY, FLUORESCENCE, AND TIME-RESOLVED FLUORESCENCE, NAMELY, MICROPLATE READERS, FLUORESCENT SCANNERS, THERMOMETERS, NOT FOR MEDICAL USE, CHRONOGRAPHS FOR USE AS SPECIALIZED TIME RECORDING APPARATUS, ROBOTIC WORKSTATIONS COMPRISED OF LABORATORY ROBOTS, COMPUTERS, AND COMPUTER MONITORS, INCUBATORS, IMMUNOASSAY ANALYZERS, NAMELY, AUTOMATED IMMUNOASSAY ANALYZERS; AND SAMPLE PREPARATION AND SCREENING WORKSTATIONS COMPRISED OF CONTAINERS FOR BIOLOGICAL SUBSTANCES AND LIQUID MAGNETIC PARTICLE SUSPENSIONS FOR USE IN PURIFYING PROTEINS, AND DISTRIBUTORS FOR APPLYING AND REMOVING MAGNETIC BEADS BOUND TO PROTEINS; ELECTRONIC MACHINES, APPARATUS, AND THEIR PARTS, NAMELY, CENTRAL PROCESSING UNITS, COMPUTER HARDWARE, AND COMPUTER SOFTWARE, ALL USED IN THE TESTING, ANALYSIS, AND EXAMINATION OF DNA, RNA, OLIGO-NUCLEOTIDES, PROTEINS, SUGAR CHAIN, CARBOHYDRATES, AND PEPTIDES; ELECTROLYSERS; AND ELECTROLYTIC CELLS (U.S. CLS. 21, 23, 26, 36 AND 38).

CLASS 10—MEDICAL APPARATUS

FOR MEDICAL MACHINES AND APPARATUS FOR EXAMINING AND STUDYING BIOCHEMICAL AND BIOLOGICAL SUBSTANCES EXTRACTED FROM PATIENTS, NAMELY, URINE TESTING DEVICES, NAMELY, PROTEIN TESTING DEVICES, SALIVA TESTING DEVICES, STOOL TESTING DEVICES, IMMUNE SUBSTANCES ANALYZERS, DNA DIAGNOSIS DEVICES, ELECTROPHORESIS, DOPING TEST DEVICES (U.S. CLS. 26, 39 AND 44).

CLASS 42—SCIENTIFIC AND COMPUTER SERVICES

FOR TESTING, INSPECTION OR RESEARCH OF PHARMACEUTICALS, COSMETICS OR FOODSTUFF; TESTING OR RESEARCH ON MACHINES, APPARATUS AND INSTRUMENTS (U.S. CLS. 100 AND 101).
JAMES STEIN, EXAMINING ATTORNEY

SN 79-046,808. FIAT GROUP MARKETING & CORPORATE COMMUNICATION S.P.A., TORINO, ITALY, FILED 11-6-2007.

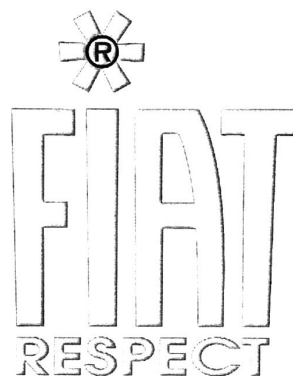

PRIORITY DATE OF 10-15-2007 IS CLAIMED.
OWNER OF INTERNATIONAL REGISTRATION 0944968 DATED 11-6-2007, EXPIRES 11-6-2017.
OWNER OF U.S. REG. NOS. 2,697,187, 2,924,679 AND 3,352,555.

THE MARK CONSISTS OF IN PART, OF THE LETTER "R" IN A CIRCLE THAT IS NOT REPRESENTATIVE OF THE REGISTRATION SYMBOL.

CLASS 12—VEHICLES

FOR LAND VEHICLES; APPARATUS FOR LOCOMOTION BY LAND, AIR OR WATER, NAMELY, AUTOMOBILES, AIRPLANES, BOATS (U.S. CLS. 19, 21, 23, 31, 35 AND 44).

CLASS 35—ADVERTISING AND BUSINESS

FOR ADVERTISING; BUSINESS MANAGEMENT; BUSINESS ADMINISTRATION; OFFICE FUNCTIONS (U.S. CLS. 100, 101 AND 102).

CLASS 41—EDUCATION AND ENTERTAINMENT

FOR EDUCATION SERVICES, NAMELY, CONDUCTING SEMINARS, LECTURES, WORKSHOPS IN THE FIELD OF AUTOMOBILE MANUFACTURING; TRAINING IN THE FIELD OF AUTOMOBILE MANUFACTURING; ENTERTAINMENT, NAMELY, ORGANIZING COMMUNITY SPORTING AND CULTURAL ACTIVITIES (U.S. CLS. 100, 101 AND 107).

WILLIAM VERHOSEK, EXAMINING ATTORNEY

SN 79-047,031. SMS SIEMAG AKTIENGESELLSCHAFT, FED REP GERMANY, FILED 9-7-2007.

The logo consists of the text "X-Pro" in a large, bold, black, sans-serif font. The "X" and "P" are significantly larger than the "o".

THE MARK CONSISTS OF STANDARD CHARACTERS WITHOUT CLAIM TO ANY PARTICULAR FONT, STYLE, SIZE, OR COLOR.

PRIORITY DATE OF 3-22-2007 IS CLAIMED.
OWNER OF INTERNATIONAL REGISTRATION 0945571 DATED 9-7-2007, EXPIRES 9-7-2017.
OWNER OF U.S. REG. NOS. 2,807,958, 3,216,061 AND 3,294,183.

CLASS 7—MACHINERY

FOR MACHINES FOR THE METALLURGICAL INDUSTRY, MACHINES FOR THE STEEL MILL INDUSTRY, MACHINES AND LINES COMPOSED THEREOF FOR CONTINUOUS AND DISCONTINUOUS STRIP PROCESSING LINES FOR FLAT METALLIC SUBSTRATES, NAMELY, PICKLING LINES, GALVANIZING MACHINES, HOT DIP GALVANIZING LINES, HOT DIP ALUMINIZING LINES, CONTINUOUS ANNEALING LINES, STRIP COATING LINES, ELECTROLYTIC GALVANIZING LINES, TINNING LINES, DEGREASING LINES, ANNEALING AND PICKLING LINES FOR STAINLESS STEEL, ANNEALING AND PICKLING LINES FOR SILICON STEEL, BRIGHT ANNEALING LINES, SLITTING AND CROSS CUTTING LINES, SHEARING LINES, STRIP PROCESSING LINES FOR NON FERROUS METALS, WELDING MACHINES FOR STRIP WELDING, ACID REGENERATION PLANTS, FLATTENING AND LEVELING LINES, RECOILING LINES, STRUCTURAL PARTS OF THE FOREGOING MACHINES (U.S. CLS. 13, 19, 21, 23, 31, 34 AND 35).

CLASS 9—ELECTRICAL AND SCIENTIFIC APPARATUS

FOR INSTRUMENTATION AND CONTROL DEVICES, NAMELY, ELECTRIC CONTROL PANELS, FOR MACHINES FOR THE METALLURGICAL INDUSTRY, FOR MACHINES FOR THE STEEL MILL INDUSTRY AND FOR MACHINES AND LINES COMPOSED THEREOF FOR THE CONTINUOUS AND DISCONTINUOUS STRIP PROCESSING LINES FOR FLAT METALLIC SUBSTRATES, NAMELY, PICKLING LINES, GALVANIZING MACHINES, HOT DIP GALVANIZING LINES, HOT DIP ALUMINIZING LINES, CONTINUOUS ANNEALING LINES, STRIP COATING LINES, ELECTROLYTIC GALVANIZING LINES, TINNING LINES, DEGREASING LINES, ANNEALING AND PICKLING LINES FOR STAINLESS STEEL, ANNEALING AND PICKLING LINES FOR SILICON STEEL, BRIGHT ANNEALING LINES, SLITTING AND CROSS CUTTING LINES, SHEARING LINES, STRIP PROCESSING LINES FOR NON FERROUS METALS, WELDING MACHINES FOR STRIP WELDING, ACID REGENERATION PLANTS, FLATTENING AND LEVELING LINES, RECOILING LINES (U.S. CLS. 21, 23, 26, 36 AND 38).

CLASS 11—ENVIRONMENTAL CONTROL APPARATUS

FOR FURNACES FOR METALLURGICAL PLANTS, FOR STEEL MILLS, FOR CONTINUOUS CASTING PLANTS, FOR ROLLING MILLS, AND FOR FORGING AND PRESS SYSTEMS, ALL FOR CONTINUOUSLY AND DISCONTINUOUSLY STRIP PROCESSING MACHINE LINES FOR FLAT METALLIC SUBSTRATES; WATER, OIL OR AIR COOLING APPARATUS FOR USE WITH CONTINUOUSLY AND DISCONTINUOUSLY STRIP PROCESSING MACHINES AND MACHINE LINES FOR FLAT METALLIC SUBSTRATES, NAMELY, PICKLING LINES, GALVANIZING MACHINES, HOT DIP GALVANIZING LINES, HOT DIP ALUMINIZING LINES, CONTINUOUS ANNEALING LINES, STRIP COATING LINES, ELECTROLYTIC GALVANIZING LINES, TINNING LINES, DEGREASING LINES, ANNEALING AND PICKLING LINES FOR STAINLESS STEEL, ANNEALING AND PICKLING LINES FOR SILICON STEEL, BRIGHT ANNEALING LINES, SLITTING AND CROSS CUTTING LINES, SHEARING LINES, STRIP PROCESSING LINES FOR NON FERROUS METALS, WELDING MACHINES FOR STRIP WELDING, ACID REGENERATION PLANTS, FLATTENING AND LEVELING LINES, AND RECOILING LINES (U.S. CLS. 13, 21, 23, 31 AND 34).

CLASS 37—CONSTRUCTION AND REPAIR

FOR CONSULTANCY IN THE FIELDS OF BUILDING CONSTRUCTION AND CONSTRUCTION (U.S. CLS. 100, 103 AND 106).

CLASS 42—SCIENTIFIC AND COMPUTER SERVICES

FOR BUILDING AND CONSTRUCTION PLANNING, NAMELY, PLANNING OF BUILDINGS, PLANTS AND INFRASTRUCTURE SYSTEMS FOR BUILDINGS AND PLANTS; ENGINEERING SERVICES; DESIGN AND DEVELOPMENT OF COMPUTER SOFTWARE; TECHNICAL CONSULTATION RELATING TO RESEARCH AND DEVELOPMENT OF METALLURGICAL PRODUCTION PROCESSES AND PRODUCTS, AND PREPARATION OF TECHNICAL EXPERT OPINION RELATING TO RESEARCH AND DEVELOPMENT IN THE FIELD OF CONTINUOUSLY AND DISCONTINUOUSLY STRIP PROCESSING MACHINES AND MACHINE LINES FOR FLAT METALLIC SUBSTRATES, NAMELY, PICKLING LINES, GALVANIZING MACHINES, HOT DIP GALVANIZING LINES, HOT DIP ALUMINIZING LINES, CONTINUOUS ANNEALING LINES, STRIP COATING LINES, ELECTROLYTIC GALVANIZING LINES, TINNING LINES, DEGREASING LINES, ANNEALING AND PICKLING LINES FOR STAINLESS STEEL, ANNEALING AND PICKLING LINES FOR SILICON STEEL, BRIGHT ANNEALING LINES, SLITTING AND CROSS CUTTING LINES, SHEARING LINES, STRIP PROCESSING LINES FOR NON FERROUS METALS, WELDING MACHINES FOR STRIP WELDING, ACID REGENERATION PLANTS, FLATTENING AND LEVELING LINES, RECOILING LINES (U.S. CLS. 100 AND 101).

LYDIA BELZER, EXAMINING ATTORNEY

SN 79-047,911, HOOGENDOORN GROEP B.V., NL-3131 HX
VLAARDINGEN, NETHERLANDS, FILED 11-16-2007.



PRIORITY DATE OF 11-13-2007 IS CLAIMED.
OWNER OF INTERNATIONAL REGISTRATION 0947937
DATED 11-16-2007, EXPIRES 11-16-2017.
THE MARK CONSISTS OF A STYLIZED LETTER "H".

CLASS 7—MACHINERY

FOR MACHINES AND MACHINE TOOLS IN THE FIELD OF AGRICULTURE AND HORTICULTURE, NAMELY, LEAF VACUUMS FOR PIPE RAIL, FLOWER BINDING MACHINES, INDUSTRIAL BUNDLING AUTOMATONS, BUNDLING MACHINES, BUFFER BELTS AS PARTS OF POWER OPERATED BUFFERS, BUCKET FILLING MACHINES, FLOWER PACKING MACHINES, MILLING MACHINES, SOIL ELEVATORS, POTTING MACHINES, SEALING MACHINES, CRATE FILLING MACHINES, CRATE WASHING MACHINES, AUTOMATIC INDUSTRIAL LABELING MACHINES FOR APPLYING LABELS TO CONTAINERS AND BOTTLES, INDUSTRIAL PLACING ROBOTS, DEFOLIATING MACHINES, DE-BULBING MACHINES, DE-NESTING MACHINES; HARVESTING SYSTEMS COMPRISED OF HARVESTERS, PLANT HARVESTING MACHINES; HARVESTING MACHINES, POTTING MACHINES, CLEARING MACHINES, MATERIAL HANDLING MACHINES IN THE NATURE OF PALLETIZERS, PAPER POT PACKING MACHINES, PLANTING MACHINES, SOIL BLOCKING MACHINES, SORTING MACHINES, SPRAY CARTS AS COMPONENTS OF SPRAYING MACHINES; POWER OPERATED LAWN AND GARDEN STRING TRIMMERS; STRING WINDING MACHINES, CONVEYOR BELTS, CONVEYORS; CONVEYOR SYSTEMS COMPRISED OF CONVEYOR BELTS, CONVEYOR CARS, AND CONVEYORS; FRAY FILLING MACHINES, VIBRATING MACHINES, SWEEPING MACHINES, SHREDDING MACHINES, AGRICULTURAL TRANS-PLANTING MACHINES; AGRICULTURAL AND HORTICULTURAL WASHING, DRYING, AND BRUSHING MACHINES; WATER CONVEYORS, PACKAGING MACHINES FEATURING A WEIGHING FUNCTION, AGRICULTURAL SEED SOWING MACHINES; POWER OPERATED AGRICULTURAL SEED SOWING APPARATUS; POWER OPERATED AGRICULTURAL AND HORTICULTURAL IMPLEMENTS, NAMELY, TAKING FORKS, BINDERS, MILLING CUTTERS, BUCKET FILERS, AUTOMATIC INDUSTRIAL LABELING MACHINES FOR APPLYING LABELS TO CONTAINERS AND BOTTLES, ELECTRIC SEALING MACHINES, LENGTH SORTERS; POWER-OPERATED LIFTING AND MOVING EQUIPMENT, NAMELY, FORK LIFTS; PICKING CARTS AS A COMPONENT OF A PICKING MACHINES; POWER OPERATED HOSE REELS (U.S. CLS. 13, 19, 21, 23, 31, 34 AND 35).

CLASS 9—ELECTRICAL AND SCIENTIFIC APPARATUS

FOR PORTABLE METERS TO MEASURE TEMPERATURE, HUMIDITY, CARBON DIOXIDE AND RADIATION; REGULATORS FOR TEMPERATURE, GAS AND HUMIDITY; SENSORS FOR TEMPERATURE, HUMIDITY, GAS, LIGHT AND SUN RADIATION; DATA PROCESSORS IN THE NATURE OF DATA LOGGERS; INDICATORS TO DISPLAY GREENHOUSE PARAMETERS; OPTICAL SCANNERS AND READERS OF AIR FLOW, SCALES; MEASURING SYSTEMS FOR GREENHOUSE PARAMETERS COMPRISED OF THERMOMETERS, CARBON DIOXIDE DETECTORS, HUMIDITY DETECTORS, SUN RADIATION DETECTORS, SUNLIGHT DETECTORS, GROW LIGHT DETECTORS, WIND SPEED DETECTORS, WIND DIRECTION DETECTORS, RAIN DETECTORS, ACIDITY DETECTORS, ELECTRICAL-CONDUCTIVITY DETECTORS IN WATER, WINDOW POSITION DETECTORS, LEAF THICKNESS DETECTORS, LEAF TEMPERATURE DETECTORS, STALK THICKNESS DETECTORS, LIGHT ABSORPTION DETECTORS; DISPENSING SYSTEMS COMPRISED OF NON-REFRIGERATED AND NON-HEATED ELECTRICAL LIQUID DISPENSERS; BOXES SPECIFICALLY ADAPTED TO HOLD MEASURING INSTRUMENTATION FOR GREENHOUSES; APPARATUS FOR RECORDING, TRANSMISSION OR REPRODUCTION OF SOUND OR IMAGES; INDUSTRIAL CAMERAS; BLANK MAGNETIC DATA CATTERS; PRERECORDED MAGNETIC DATA CATTERS FEATURING AGRICULTURAL AND HORTICULTURAL INFORMATION; DATA PROCESSORS AND COMPUTERS; COMPUTER HARDWARE; COMPUTER SOFTWARE FOR CLIMATE CONTROL, PLANT WATERING AND ENERGY CONTROL IN GREENHOUSES, REGISTRATION AND COMPARISON OF GROWING AND CROP PARAMETERS IN GREENHOUSES, GROWTH AND CROP PREDICTION IN GREENHOUSES; COMPUTER SOFTWARE FOR

VIEWING DIGITAL IMAGES AND PHOTOGRAPHS; COMPUTER SOFTWARE FOR THE CONTROL OF LARGE PRODUCTION MACHINES; PROCESS CONTROL SOFTWARE FOR INDUSTRIAL PRODUCTION PLANTS; COMPUTER SOFTWARE FOR VISUAL CONTROLS IN PRODUCTION ENVIRONMENTS, NAMELY, QUALITY CONTROL, SORTING AND POSITIONING; COMPUTER SOFTWARE FOR THE REGULATION OF TEMPERATURE, HUMIDITY, CARBON DIOXIDE, LIGHT, GAS AND ELECTRICITY, WATER FLOW, AND FERTILIZER DISPENSING IN GREENHOUSES; COMPUTER SOFTWARE FOR CONTROLLING MACHINE MOVEMENTS, ROOT ARMS LIQUID FLOW, LEVEL, AND TEMPERATURE; THE FOREGOING SOFTWARE FEATURING VERIFICATION OF EVERY PARAMETER THAT IS MEASURED BY THE COMPUTER (U.S. CLS. 21, 23, 26, 36 AND 38).

CLASS 37—CONSTRUCTION AND REPAIR

FOR INSTALLATION OF MACHINERY FOR AGRICULTURE AND HORTICULTURE (U.S. CLS. 100, 103 AND 106).

CLASS 41—EDUCATION AND ENTERTAINMENT

FOR EDUCATIONAL SERVICES, NAMELY, PROVIDING WORKSHOPS, COURSES, TRAINING EXERCISES, MEETINGS, PRACTICAL LESSONS, AND USER DAYS IN THE FIELD OF CLIMATE, ENERGY, CULTIVATION, HEATING, VENTILATION, SCREENS, AIR CIRCULATION, PLANT PHYSIOLOGY, USE OF CLIMATE COMPUTERS, USE OF SENSORS, AND ANALYSIS OF CULTIVATION AND MANAGEMENT DATA; PROVIDING TRAINING IN THE FIELD OF CLIMATE, ENERGY, CULTIVATION, HEATING, VENTILATION, SCREENS, AIR CIRCULATION, PLANT PHYSIOLOGY, USE OF CLIMATE COMPUTERS, USE OF SENSORS, AND ANALYSIS OF CULTIVATION AND MANAGEMENT DATA (U.S. CLS. 100, 101 AND 107).

ELI HELLMAN, EXAMINING ATTORNEY

SN 79-049,093. SUEZ, FRANCE, FILED 4-27-2007.

YOU ARE GOING TO LOVE THE FUTURE

THE MARK CONSISTS OF STANDARD CHARACTERS WITHOUT CLAIM TO ANY PARTICULAR FONT, STYLE, SIZE, OR COLOR.

PRIORITY DATE OF 4-26-2007 IS CLAIMED.

OWNER OF INTERNATIONAL REGISTRATION 0951210 DATED 4-27-2007, EXPIRES 4-27-2017.

CLASS 1—CHEMICALS

FOR UNPROCESSED ARTIFICIAL RESINS, UNPROCESSED PLASTICS; SOIL FERTILIZERS; FIRE EXTINGUISHING COMPOSITIONS; TEMPERING AND SOLDERING PREPARATIONS; CHEMICAL SUBSTANCES FOR PRESERVING FOODSTUFFS; ADHESIVES FOR INDUSTRIAL USE (U.S. CLS. 1, 5, 6, 10, 26 AND 46).

CLASS 9—ELECTRICAL AND SCIENTIFIC APPARATUS

FOR AUTOMATIC VENDING MACHINES AND MECHANISMS FOR COIN-OPERATED APPARATUS; CASH REGISTERS; CALCULATING MACHINES; COMPUTERS; FIRE EXTINGUISHERS; COMPACT DISKS, TELEPHONE RECEIVERS, TELEPHONE WIRES, TELEPHONE TRANSMITTERS (U.S. CLS. 21, 23, 26, 36 AND 38).

CLASS 11—ENVIRONMENTAL CONTROL APPARATUS

FOR APPARATUS FOR FILTERING WATER; WATER SOFTENING APPARATUS AND INSTALLATIONS; WATER PURIFICATION APPARATUS; COOLING INSTALLATIONS FOR WATER; WATER HEATERS; WATER STERILIZERS; WATER FILTERS; WATER TANKS (U.S. CLS. 13, 21, 23, 31 AND 34).

CLASS 35—ADVERTISING AND BUSINESS

FOR ORGANIZATION OF EXHIBITIONS FOR COMMERCIAL OR ADVERTISING PURPOSES; TELEPHONE ANSWERING SERVICES; DISSEMINATION OF ADVERTISEMENTS, NEWSPAPER SUBSCRIPTIONS; BUSINESS MANAGEMENT ASSISTANCE; DISSEMINATION OF ADVERTISING MATTER; RENTAL OF ADVERTISING MATERIAL; PUBLIC RELATIONS (U.S. CLS. 100, 101 AND 102).

CLASS 37—CONSTRUCTION AND REPAIR

FOR PUBLIC WORKS, NAMELY, CONSTRUCTION OF STRUCTURES FOR WATER AND POWER STORAGE, TREATMENT AND SUPPLY, CONSTRUCTION OF STRUCTURES FOR WASTE STORAGE, TREATMENT AND ELIMINATION, CONSTRUCTION OF INFRASTRUCTURES FOR TELECOMMUNICATION; CONSTRUCTION, SUPERVISION OF CONSTRUCTION WORKS, DEMOLITION OF BUILDINGS; BUILDING OF FACTORIES AND BRIDGES; ROAD PAVING, INSTALLATION AND REPAIR OF HEATING SYSTEMS, AIR CONDITIONING APPLIANCES, ELECTRICAL APPLIANCES, OVENS, REFRIGERATING DEVICES; SERVICES OF CONSTRUCTION OF WATER TREATMENT PLANTS (U.S. CLS. 100, 103 AND 106).

CLASS 39—TRANSPORTATION AND STORAGE

FOR STORAGE OF GOODS; TRAVEL ORGANIZATION; WATER SUPPLY AND DISTRIBUTION SERVICES; TRANSPORT OF WATER; AIR TRANSPORT, TRANSPORT BROKERAGE, TRANSPORT INFORMATION (U.S. CLS. 100 AND 105).

CLASS 40—MATERIAL TREATMENT

FOR TREATMENT OF MATERIALS, NAMELY, TREATMENT OF WATER, TREATMENT OF HYDROCARBONS, WASTE TREATMENT; WATER TREATMENT AND WATER PURIFYING; DESTRUCTION OF WASTE, AIR DEODORIZING, PURIFYING AND FRESHENING; PRODUCTION OF ENERGY; INFORMATION ON TREATMENT OF MATERIALS; INCINERATION OF WASTE, RECYCLING OF WASTE AND TRASH; WATER AND DRINKING WATER TREATMENT SERVICES, WATER PURIFICATION SERVICES; SORTING OF WASTE AND RECYCLABLE MATERIAL; PRINTING (U.S. CLS. 100, 103 AND 106).

CLASS 41—EDUCATION AND ENTERTAINMENT

FOR FILM PRODUCTION, EDITING OF VIDEOTAPES, EDITING OF RADIO AND TELEVISION PROGRAMMES; RENTAL OF EXHIBITION SPACE; PHOTOGRAPHIC REPORTING (U.S. CLS. 100, 101 AND 107).

CLASS 42—SCIENTIFIC AND COMPUTER SERVICES

FOR CHEMICAL AND BACTERIOLOGICAL RESEARCH, CHEMICAL ANALYSIS; DRAWING UP OF CONSTRUCTION PLANS; MECHANICAL ENGINEERING RESEARCH; DESIGN AND DEVELOPMENT OF SOFTWARE; COMPUTER CONSULTING, DESIGN OF SERVER CENTRES, DESIGN AND DEVELOPMENT OF COMPUTER COMMUNICATION APPLICATIONS USING ALL DIGITAL MEDIA IN ALL STORAGE FORMS AND USING ALL TYPES OF NETWORK COMMUNICATION, DESIGN OF COMPUTER NETWORKS; UPDATING AND CREATING INTERNET SITES; DESIGN OF WATER TREATMENT PLANTS (U.S. CLS. 100 AND 101).

SUE LAWRENCE, EXAMINING ATTORNEY

SN 79-049,455. ANTON DREESMANN, BELGIUM, FILED 9-25-2007.

MIDW3

THE MARK CONSISTS OF STANDARD CHARACTERS WITHOUT CLAIM TO ANY PARTICULAR FONT, STYLE, SIZE, OR COLOR.

PRIORITY DATE OF 5-2-2007 IS CLAIMED.

OWNER OF INTERNATIONAL REGISTRATION 0952248 DATED 9-25-2007, EXPIRES 9-25-2017.

CLASS 9—ELECTRICAL AND SCIENTIFIC APPARATUS

FOR SOFTWARE, MAGNETIC CARDS, MEMORY CARDS AND COMPUTER HARDWARE FOR IDENTIFICATION, AUTHENTICATION, VERIFICATION AND/OR ACCESS TO DATA, TO PROGRAMMING, TO WEBSITES, TO DATABANKS AND/OR TO NETWORKS; SOFTWARE AND ELECTRONIC EQUIPMENT IN THE NATURE OF COMPUTER HARDWARE FOR PROCESSING, HANDLING AND COMPARISON OF DATA; SOFTWARE AND ELECTRONIC EQUIPMENT IN THE NATURE OF COMPUTER HARDWARE FOR IDENTIFICATION AND VERIFICATION OF INDIVIDUALS BY MEANS OF ELECTRONIC DATA IN THE USE OF ACCESS CONTROL SYSTEMS BY ELECTRONIC MEANS AND MORE SPECIFICALLY VIA THE INTERNET; APPARATUS AND SYSTEMS FOR IDENTIFICATION, MONITORING, PROTECTION AND SECURITY, NOT INCLUDED IN OTHER CLASSES, NAMELY, ACCESS CONTROL AND ALARM MONITORING SYSTEMS; MOBILE OR WIRELESS ACCESS CONTROL SYSTEMS, NAMELY, COMPUTER PROGRAMS FOR THE ENABLING OF ACCESS OR ENTRANCE CONTROL; SOFTWARE FOR SECURING THE ACCESS TO WEBSITES BY VERIFYING THE THE IDENTITY OF THE PERSON WHO WANTS ACCESS TO THE WEBSITE, AND LEGAL AUTHENTICATION OF DATA BY COMPUTERS; SOFTWARE FOR REMOTE ACCESS CONTROL TO COMPUTER AND TELECOMMUNICATION NETWORKS (U.S. CLS. 21, 23, 26, 36 AND 38).

CLASS 42—SCIENTIFIC AND COMPUTER SERVICES

FOR DESIGN, ESTABLISHMENT AND COMMISSIONING OF ELECTRONIC APPARATUS AND SOFTWARE FOR IDENTIFYING INDIVIDUALS, NAMELY, PRODUCT DEVELOPMENT; DESIGN, DEVELOPMENT AND MAINTENANCE OF SOFTWARE; SERVICES RENDERED BY INFORMATION TECHNOLOGY SPECIALISTS IN THE FIELD OF SECURITY AND AUTHENTICATION IN THE TELECOMMUNICATIONS FIELD, NAMELY, INFORMATION TECHNOLOGY CONSULTATION (U.S. CLS. 100 AND 101).

CLASS 45—PERSONAL AND LEGAL SERVICES

FOR SECURITY SERVICES FOR THE PROTECTION OF PROPERTY AND INDIVIDUALS, TOGETHER WITH THE USE OF ELECTRONICS, INCLUDING IDENTIFICATION, ACCESS CONTROL AND SURVEILLANCE SERVICES, NAMELY, SECURITY GUARD SERVICES; PROVIDING ADVICE, INFORMATION AND INTELLIGENCE ON THE USE AND APPLICATION OF APPARATUS AND SYSTEMS FOR SECURITY, MONITORING, IDENTIFICATION AND CONTROL AND MORE PARTICULARLY WITH REGARD TO APPARATUS, INSTRUMENTS, SOFTWARE, MAGNETIC CARDS, MEMORY CARDS OR OTHER COMPUTER HARDWARE FOR IDENTIFICATION, AUTHENTICATION, VERIFICATION AND ACCESS TO DATA, TO PROGRAMMING, TO WEBSITES, TO DATA BANKS AND TO NETWORKS, NAMELY, SECURITY CONSULTANCY (U.S. CLS. 100 AND 101).

ROBERT STRUCK, EXAMINING ATTORNEY

CLASS 4—LUBRICANTS AND FUELS

FOR INDUSTRIAL OILS AND GREASES; LUBRICANTS, NAMELY, ALL PURPOSE LUBRICANT, AUTOMOTIVE LUBRICANT; DUST ABSORBING, WETTING AND BINDING COMPOSITIONS FOR USE IN WOOD INDUSTRY; FUELS; ILLUMINANTS, NAMELY, CANDLES, LAMP OIL; CANDLES AND WICKS FOR LIGHTING, NAMELY, WICKS FOR CANDLES, WICKS FOR OIL LAMPS (U.S. CLS. 1, 6 AND 15).

CLASS 5—PHARMACEUTICALS

FOR PHARMACEUTICAL AND VETERINARY PREPARATIONS FOR DESTROYING VERMIN; FUNGICIDES, HERBICIDES (U.S. CLS. 6, 18, 44, 46, 51 AND 52).

SN 79-049,582. UPM-KYMMENE CORPORATION, FINLAND, FILED 1-10-2008.



OWNER OF INTERNATIONAL REGISTRATION 0952587 DATED 1-10-2008, EXPIRES 1-10-2018.

OWNER OF U.S. REG. NOS. 1,799,287, 3,223,380 AND OTHERS.

CLASS 1—CHEMICALS

FOR CHEMICALS USED IN INDUSTRY, SCIENCE AND PHOTOGRAPHY; CHEMICALS FOR AGRICULTURAL, HORTICULTURAL AND FORESTRY USE, EXCEPT FUNGICIDES, HERBICIDES, INSECTICIDES AND PARASITICIDES; UNPROCESSED ARTIFICIAL RESINS, UNPROCESSED PLASTICS; MANURES; FIRE EXTINGUISHING COMPOSITIONS; TEMPERING AND SOLDERING PREPARATIONS, NAMELY, TEMPERING CHEMICALS, SOLDERING FLUX; CHEMICAL SUBSTANCES FOR PRESERVING FOODSTUFFS; TANNING SUBSTANCES, NAMELY, TANNING AGENTS FOR USE IN THE MANUFACTURE OF LEATHER; ADHESIVES USED IN INDUSTRY (U.S. CLS. 1, 5, 6, 10, 26 AND 46).

CLASS 2—PAINTS

FOR PAINTS, VARNISHES, LACQUERS; PRESERVATIVES AGAINST RUST AND AGAINST DETERIORATION OF WOOD, NAMELY, COATINGS; COLORANTS; MORDANTS, NAMELY, MORDANT DYES; RAW NATURAL RESINS; METALS IN FOIL AND POWDER FORM FOR PAINTERS, DECORATORS, PRINTERS AND ARTISTS (U.S. CLS. 6, 11 AND 16).

CLASS 16—PAPER GOODS AND PRINTED MATTER

FOR PAPER, CARDBOARD AND GOODS MADE FROM PAPER AND CARDBOARD, NAMELY, PAPER WRAPPINGS FOR MEDICAL INSTRUMENTS, PACKAGING PAPER, WRAPPING PAPER, ENVELOPE PAPER, PRINTING PAPERS; RELEASE AND FACE PAPER TO PRODUCE SELF-ADHESIVE LABELS; BOXBOARD, NAMELY, CARDBOARD; CARTONS, NAMELY, PAPERBOARD CARTONS, CARDBOARD CARTONS; CORRUGATED BOARD, NAMELY, CORRUGATED BOARD BOXES FOR TRANSPORT PACKAGING IN THE NATURE OF CORRUGATED CARDBOARD BOXES; MOULDED PULP PRODUCTS, NAMELY, PREFORMED PAPERBOARD MOLDS FOR PACKAGING PURPOSES; PAPER PACKAGING MATERIALS FOR FOOD, ELECTRONICS AND OTHER INDUSTRIES, NAMELY, PACKAGING CONTAINERS OF PAPER; PLASTIC BUBBLE PACKS FOR WRAPPING OR PACKAGING; PAPER POUCHES FOR PACKAGING, PACKAGING CONTAINERS OF PAPER; PAPER WRAPPINGS FOR INDUSTRY, NAMELY, PRINTED FOOD PACKAGING FILMS AND LAMINATES COMPOSED OF CARDBOARD; PAPER AND PLASTIC SACKS FOR HOUSEHOLD USE, NAMELY, PAPER AND PLASTIC BAGS FOR HOUSEHOLD USE; PLASTIC BAGS AND CARRIER BAGS FOR RETAILERS, NAMELY, SHOPPING BAGS OF PLASTIC AND PAPER; PAPER FOR WRAPPING AND PACKAGING; FOOD WRAPPING PLASTIC FILM FOR HOUSEHOLD USE; VACUUM POUCHES IN THE NATURE OF PLASTIC FOOD STORAGE BAGS FOR HOUSEHOLD USE; PAPER POUCHES FOR FOODSTUFFS PACKAGING; CELLULAR PLASTICS FOR PACKAGING MADE OF PLASTIC SUPPORTS, NAMELY, PLASTIC BUBBLE PACKS FOR WRAPPING OR PACKAGING; PLASTIC FILM VACUUM POUCHES FOR FOODSTUFFS PACKAGING, NAMELY, PLASTIC FILM FOOD STORAGE VACUUM POUCHES FOR HOUSEHOLD USE; PAPER SACKS AND BAGS; REEL WRAPPINGS OF PAPER AND REEL-END DISCS OF CARDBOARD FOR THE PAPER AND PACKAGING INDUSTRY; ASEPTIC LIQUID PACKAGES OF CARDBOARD, NAMELY, ASEPTIC CARDBOARD CANS FOR LIQUIDS; SELF-ADHESIVE PAPER LAMINATES, NAMELY, LAMINATES IN THE NATURE OF ADHESIVE LABELS; DRY-FORMED PAPER FOR USE IN THE MANUFACTURE OF HYGIENE PRODUCTS, PAPER TABLE SETTINGS AND INDUSTRIAL CELLULOSE WIPES; STATIONERY PRODUCTS OF PAPER, NAMELY, ENVELOPES, NOTEBOOKS, NOTEPADS, EXERCISE BOOKS; PADS FOR SKETCHING, DRAWING AND WATERCOLOR PAINTING; PAPER TAGS AND CARDBOARD TAGS SUPPLIED IN REELS WITH ADHESIVE OR SILICONE LINER (U.S. CLS. 2, 5, 22, 23, 29, 37, 38 AND 50).

CLASS 19—NON-METALLIC BUILDING MATERIALS

FOR NON-METALLIC BUILDING MATERIALS, NAMELY, BUILDING MATERIALS OF WOOD, PLYWOOD AND WOOD PLASTIC COMPOSITES IN THE NATURE OF PLYWOOD BOARDS, WOOD SIDING, WOOD AND PLASTIC COMPOSITE WALLBOARDS, WOOD AND PLASTIC COMPOSITE FLOORINGS, WOOD AND PLASTIC COMPOSITE PANELS, WOOD AND PLASTIC COMPOSITE LAMINATES IN THE NATURE OF DRYWALL AND FLOORING, WOOD AND PLASTIC COMPOSITE SHINGLES; NON-METALLIC RIGID PIPES FOR BUILDING; NON-METALLIC TRANSPORTABLE BUILDINGS (U.S. CLS. 1, 12, 33 AND 50).

CLASS 29—MEATS AND PROCESSED FOODS

FOR MEAT, FISH, POULTRY AND GAME; MEAT EXTRACTS; PRESERVED, FROZEN, DRIED AND COOKED FRUITS AND VEGETABLES; JELLIES, JAMS, COMPOTES; EGGS; EDIBLE OILS AND FATS (U.S. CL. 46).

CLASS 30—STAPLE FOODS

FOR COFFEE, TEA, COCOA, SUGAR, RICE, TAPIOCA, SAGO, ARTIFICIAL COFFEE; FLOUR; BREAD, PASTRY; HONEY, TREACLE; YEAST, BAKING-POWDER; SALT, MUSTARD; VINEGAR, CONDIMENT SAUCES; SPICES; ICE (U.S. CL. 46).

APRIL ROACH, EXAMINING ATTORNEY

CLASS 4—LUBRICANTS AND FUELS

FOR INDUSTRIAL OILS AND GREASES; LUBRICANTS, NAMELY, ALL PURPOSE LUBRICANT, AUTOMOTIVE LUBRICANT; DUST ABSORBING, WETTING AND BINDING COMPOSITIONS FOR USE IN WOOD INDUSTRY; FUELS; ILLUMINANTS, NAMELY, CANDLES, LAMP OIL; CANDLES AND WICKS FOR LIGHTING, NAMELY, WICKS FOR CANDLES, WICKS FOR OIL LAMPS (U.S. CLS. 1, 6 AND 15).

CLASS 5—PHARMACEUTICALS

FOR PHARMACEUTICAL AND VETERINARY PREPARATIONS FOR DESTROYING VERMIN; FUNGICIDES, HERBICIDES (U.S. CLS. 6, 18, 44, 46, 51 AND 52).

CLASS 16—PAPER GOODS AND PRINTED MATTER

FOR PAPER, CARDBOARD AND GOODS MADE FROM PAPER AND CARDBOARD, NAMELY, PAPER WRAPPINGS FOR MEDICAL INSTRUMENTS, PACKAGING PAPER, WRAPPING PAPER, ENVELOPE PAPER, PRINTING PAPERS; RELEASE AND FACE PAPER TO PRODUCE SELF-ADHESIVE LABELS; BOXBOARD, NAMELY, CARDBOARD; CARTONS, NAMELY, PAPERBOARD CARTONS, CARDBOARD CARTONS; CORRUGATED BOARD, NAMELY, CORRUGATED BOARD BOXES FOR TRANSPORT PACKAGING IN THE NATURE OF CORRUGATED CARDBOARD BOXES; MOULDED PULP PRODUCTS, NAMELY, PREFORMED PAPERBOARD MOLDS FOR PACKAGING PURPOSES; PAPER PACKAGING MATERIALS FOR FOOD, ELECTRONICS AND OTHER INDUSTRIES, NAMELY, PACKAGING CONTAINERS OF PAPER; PLASTIC BUBBLE PACKS FOR WRAPPING OR PACKAGING; PAPER POUCHES FOR PACKAGING, PACKAGING CONTAINERS OF PAPER; PAPER WRAPPINGS FOR INDUSTRY, NAMELY, PRINTED FOOD PACKAGING FILMS AND LAMINATES COMPOSED OF CARDBOARD; PAPER AND PLASTIC SACKS FOR HOUSEHOLD USE, NAMELY, PAPER AND PLASTIC BAGS FOR HOUSEHOLD USE; PLASTIC BAGS AND CARRIER BAGS FOR RETAILERS, NAMELY, SHOPPING BAGS OF PLASTIC AND PAPER; PAPER FOR WRAPPING AND PACKAGING; FOOD WRAPPING PLASTIC FILM FOR HOUSEHOLD USE; VACUUM POUCHES IN THE NATURE OF PLASTIC FOOD STORAGE BAGS FOR HOUSEHOLD USE; PAPER POUCHES FOR FOODSTUFFS PACKAGING; CELLULAR PLASTICS FOR PACKAGING MADE OF PLASTIC SUPPORTS, NAMELY, PLASTIC BUBBLE PACKS FOR WRAPPING OR PACKAGING; PLASTIC FILM VACUUM POUCHES FOR FOODSTUFFS PACKAGING, NAMELY, PLASTIC FILM FOOD STORAGE VACUUM POUCHES FOR HOUSEHOLD USE; PAPER SACKS AND BAGS; REEL WRAPPINGS OF PAPER AND REEL-END DISCS OF CARDBOARD FOR THE PAPER AND PACKAGING INDUSTRY; ASEPTIC LIQUID PACKAGES OF CARDBOARD, NAMELY, ASEPTIC CARDBOARD CANS FOR LIQUIDS; SELF-ADHESIVE PAPER LAMINATES, NAMELY, LAMINATES IN THE NATURE OF ADHESIVE LABELS; DRY-FORMED PAPER FOR USE IN THE MANUFACTURE OF HYGIENE PRODUCTS, PAPER TABLE SETTINGS AND INDUSTRIAL CELLULOSE WIPES; STATIONERY PRODUCTS OF PAPER, NAMELY, ENVELOPES, NOTEBOOKS, NOTEPADS, EXERCISE BOOKS; PADS FOR SKETCHING, DRAWING AND WATERCOLOR PAINTING; PAPER TAGS AND CARDBOARD TAGS SUPPLIED IN REELS WITH ADHESIVE OR SILICONE LINER (U.S. CLS. 2, 5, 22, 23, 29, 37, 38 AND 50).

SN 79-050,351. UPM-KYMMENE CORPORATION, HELSINKI, FINLAND, FILED 1-10-2008.

UPM-Kymmene

THE MARK CONSISTS OF STANDARD CHARACTERS WITHOUT CLAIM TO ANY PARTICULAR FONT, STYLE, SIZE, OR COLOR.

OWNER OF INTERNATIONAL REGISTRATION 0954539 DATED 1-10-2008, EXPIRES 1-10-2018.

OWNER OF U.S. REG. NOS. 2,360,479, 3,223,380 AND OTHERS.

THE ENGLISH TRANSLATION OF "KYMMENE" IN THE MARK IS TEN.

CLASS 1—CHEMICALS

FOR CHEMICALS FOR AGRICULTURAL, HORTICULTURAL AND FORESTRY, EXCEPT FUNGICIDES, HERBICIDES, INSECTICIDES AND PARASITICIDES; MANURES; FIRE EXTINGUISHING COMPOSITIONS; TEMPERING AND SOLDERING PREPARATIONS, NAMELY, TEMPERING CHEMICALS, SOLDERING FLUX; CHEMICAL SUBSTANCES FOR PRESERVING FOODSTUFFS; TANNING SUBSTANCES, NAMELY, TANNING AGENTS FOR USE IN THE MANUFACTURE OF LEATHER (U.S. CLS. 1, 5, 6, 10, 26 AND 46).

CLASS 2—PAINTS

FOR PAINTS, VARNISHES; COLORANTS; METALS IN FOIL AND POWDER FORM FOR PAINTERS, DECORATORS, PRINTERS AND ARTISTS (U.S. CLS. 6, 11 AND 16).

CLASS 19—NON-METALLIC BUILDING MATERIALS

FOR NON-METALLIC BUILDING MATERIALS, NAMELY, BUILDING MATERIALS OF WOOD, PLYWOOD AND WOOD PLASTIC COMPOSITES IN THE NATURE OF PLYWOOD BOARDS, WOOD SIDING, WOOD AND PLASTIC COMPOSITE WALLBOARDS, WOOD AND PLASTIC COMPOSITE FLOORINGS, WOOD AND PLASTIC COMPOSITE PANELS, WOOD AND PLASTIC COMPOSITE LAMINATES IN THE NATURE OF DRYWALL AND FLOORING, WOOD AND PLASTIC COMPOSITE SHINGLES; NON-METALLIC RIGID PIPES FOR BUILDING; NON-METALLIC TRANSPORTABLE BUILDINGS (U.S. CLS. 1, 12, 33 AND 50).

CLASS 29—MEATS AND PROCESSED FOODS

FOR MEAT, FISH, POULTRY AND GAME; MEAT EXTRACTS; PRESERVED, FROZEN, DRIED AND COOKED FRUITS AND VEGETABLES; JELLIES, JAMS, COMPOTES; EGGS; EDIBLE OILS AND FATS (U.S. CL. 46).

CLASS 30—STAPLE FOODS

FOR COFFEE, TEA, COCOA, SUGAR, RICE, TAPIOCA, SAGO, ARTIFICIAL COFFEE; FLOUR; BREAD, PASTRY; HONEY, TREACLE; YEAST, BAKING-POWDER; SALT, MUSTARD; VINEGAR, CONDIMENT SAUCES; SPICES; ICE (U.S. CL. 46).

APRIL ROACH, EXAMINING ATTORNEY

CLASS 9—ELECTRICAL AND SCIENTIFIC APPARATUS

FOR BROWSERS, NAMELY, SOFTWARE FOR NAVIGATING AND INTERACTING WITH DATA ON THE GLOBAL COMPUTER NETWORK AND ON SECURE PRIVATE NETWORKS; SOFTWARE DESIGNED FOR CONNECTING COMPUTERS TO THE GLOBAL COMPUTER NETWORK AND TO SECURE PRIVATE NETWORKS; COMPUTERS; COMPUTER PERIPHERAL DEVICES; APPARATUS FOR SENDING, RECORDING, TRANSMITTING OR REPRODUCING SOUND, IMAGES OR DATA; DATA PROCESSORS, COMPUTER MEMORIES, MODEMS, INTERFACES FOR COMPUTERS; INTERFACE APPLICATION SOFTWARE FOR COMPUTERS, BLANK MAGNETIC TAPES, BLANK ELECTRONIC STORAGE MEDIA, NAMELY, OPTICAL, TELEMATIC OR MAGNETIC; TELECOMMUNICATION TRANSMITTERS; COMPUTER SOFTWARE FOR FINDING, DISCOVERING OR SHARING ANY KIND OF CONTENT, NAMELY, PHOTOS, VIDEOS, BOOKMARKS, WEBSITES, COMMENTS, PRODUCTS OR FOR COMMUNICATION PURPOSES BETWEEN USERS, NAMELY, INSTANT MESSAGING SYSTEMS, BLOGS OR FORUMS PLATFORMS, ANY COMPUTER SOFTWARE FOR MATCHING PEOPLE SHARING THE SAME INTERESTS; COMPUTER SOFTWARE PACKAGES FOR FINDING, DISCOVERING OR SHARING ANY KIND OF CONTENT, NAMELY, PHOTOS, VIDEOS, BOOKMARKS, WEBSITES, COMMENTS, PRODUCTS OR FOR COMMUNICATION PURPOSES BETWEEN USERS, NAMELY, INSTANT MESSAGING SYSTEMS, BLOGS OR FORUMS PLATFORMS, ANY COMPUTER SOFTWARE FOR MATCHING PEOPLE SHARING THE SAME INTERESTS; TELEPHONE APPARATUS; TELECOMMUNICATION APPARATUS, NAMELY, TELEPHONES, COMPUTERS; BLANK DIGITAL STORAGE MEDIA FOR RECORDING AND REPRODUCING SOUNDS, IMAGES, SIGNALS AND DATA, SOFTWARE FOR SEARCHING FOR, COMPILING, INDEXING AND ORGANIZING INFORMATION ON COMPUTER NETWORKS; SOFTWARE FOR CREATING, MANAGING UPDATING AND USING DATABASES, INTERNET PORTAL CREATION SOFTWARE; COMPUTER PROGRAMS FOR CONNECTING REMOTELY TO COMPUTERS OR COMPUTER NETWORKS; COMPUTER PROGRAMS FOR SEARCHING REMOTELY FOR CONTENT ON COMPUTERS AND COMPUTER NETWORKS; COMPUTER PROGRAMS FOR REMOTELY TRANSMITTING AND RECEIVING DATA AND FILES TO AND FROM REMOTE COMPUTERS AND COMPUTER NETWORKS; COMPUTER PROGRAMS AIDING THE USER TO NAVIGATE ACROSS COMPUTER NETWORKS, INCLUDING GLOBAL COMMUNICATIONS NETWORKS (U.S. CLS. 21, 23, 26, 36 AND 38).

SN 79-050,527. YOONO, FRANCE, FILED 4-17-2007.

CLASS 35—ADVERTISING AND BUSINESS

FOR COMPUTER FILE MANAGEMENT; INPUTTING AND PROCESSING OF DATA, SIGNALS AND INFORMATION PROCESSED BY COMPUTERS OR BY TELECOMMUNICATIONS APPLIANCES AND INSTRUMENTS, NAMELY, UPDATE, CAPTURE, COMPILATION AND SYSTEMATIZATION OF DATA, SIGNALS AND INFORMATION PROCESSED BY COMPUTERS OR BY TELECOMMUNICATIONS APPARATUS AND INSTRUMENTS; COMPILATION AND SYSTEMATIZATION OF INFORMATION INTO COMPUTER DATABASES; SEARCH, DISCOVERY AND RECOVERY SERVICES FOR COMPUTERIZED BUSINESS DATA; ADMINISTRATIVE MANAGEMENT OF COMPUTERIZED DATABASES; SEARCHING FOR COMMERCIAL INFORMATION IN A DATABASE FOR THIRD PARTIES; ADVERTISING AND COMMERCIAL INFORMATION SERVICES PROVIDED ON THE INTERNET, VIA TELEPHONE NETWORKS OR VIA DATA COMMUNICATIONS; PROVIDING ONLINE COMMERCIAL INFORMATION DIRECTORIES AND COMMERCIAL WEB SITE DIRECTORIES ON THE INTERNET; ARRANGING SUBSCRIPTIONS TO TELECOMMUNICATION SERVICES AND PUBLICATIONS FOR OTHERS, NAMELY, DATA COMMUNICATION SUBSCRIPTIONS, OF SUBSCRIPTIONS TO A DATABASE, OF SUBSCRIPTIONS TO A DATABASE SERVER, OF SUBSCRIPTIONS TO ELECTRONIC NEWSPAPERS, OF SUBSCRIPTIONS TO A TELECOMMUNICATION SERVICE; ADVERTISING AND PROMOTIONAL SERVICES, NAMELY, PRESENTATION OF GOODS, PEOPLE AND SERVICES ON A

YOONO

THE MARK CONSISTS OF STANDARD CHARACTERS WITHOUT CLAIM TO ANY PARTICULAR FONT, STYLE, SIZE, OR COLOR.

PRIORITY DATE OF 10-18-2006 IS CLAIMED.
OWNER OF INTERNATIONAL REGISTRATION 0955087
DATED 4-17-2007, EXPIRES 4-17-2017.

COMPUTER SITE ACCESSIBLE VIA COMPUTER, MOBILE DEVICES, TELEMATIC AND ELECTRONIC NETWORKS OF INTERCONNECTED COMPUTERS; RENTAL OF ADVERTISING SPACE ON COMPUTER, DATA COMMUNICATION AND ELECTRONIC NETWORKS; ARRANGING AND CONDUCTING OF AUCTION SALES; PROVIDING COMMERCIAL OR ADVERTISING INFORMATION BY MEANS OF A SEARCH ENGINE ON THE INTERNET; ADVERTISING; ADVERTISING ON TELECOMMUNICATION NETWORKS; OUTDOOR ADVERTISING; ADVERTISING AGENCY SERVICES; BUSINESS MANAGEMENT FOR ADVERTISEMENT PURPOSES; BUSINESS MANAGEMENT; BUSINESS ADMINISTRATION; PROVIDING OFFICE FUNCTIONS; PROMOTING THE GOODS AND SERVICES OF OTHERS BY ARRANGING FOR SPONSORS TO AFFILIATE THEIR GOODS AND SERVICES WITH AN AWARDS PROGRAM, A SPORTS COMPETITION AND SPORTING ACTIVITIES; BUSINESS MANAGEMENT ASSISTANCE AND CONSULTING; ADVICE RELATING TO THE ORGANIZATION AND MANAGEMENT OF BUSINESS; BUSINESS MANAGEMENT CONSULTANCY; BUSINESS INFORMATION AND ENQUIRIES; BUSINESS MANAGEMENT ASSISTANCE; BUSINESS AUDITING; PROFESSIONAL BUSINESS CONSULTING; ACCOUNTING; ADVERTISING SERVICES, NAMELY, PREPARING MAILING LISTS, DEMONSTRATION OF GOODS, DISTRIBUTION OF SAMPLES, UPDATING OF ADVERTISING MATERIAL, AND RENTAL OF ADVERTISING SPACE, DOCUMENT REPRODUCTION; DISSEMINATION OF ADVERTISEMENTS; DISTRIBUTION OF ADVERTISING MATTER IN THE NATURE OF TRACTS, PROSPECTUSES, SAMPLES AND PRINTED MATTER; ORGANIZATION OF EXHIBITIONS FOR COMMERCIAL OR ADVERTISING PURPOSES; RENTAL OF ADVERTISING TIME BY COMMUNICATION MEANS, NAMELY, RADIO, TELEVISION AND MAIL ADVERTISING; EDITING AND PUBLICATION OF ADVERTISING TEXTS; ADVERTISING AND COMMERCIAL INFORMATION SERVICES ONLINE ON A COMPUTER NETWORK; MARKET RESEARCH AND RESEARCH FOR BUSINESS PURPOSES; ADVERTISING AND MARKETING; MARKET STUDY AND RESEARCH, EFFICIENCY EXPERTS; BUSINESS APPRAISALS; NEWSPAPER SUBSCRIPTION SERVICES FOR THIRD PARTIES; RENTAL OF COMPUTERIZED DATABASES; MANAGEMENT, UPDATING AND MAINTENANCE OF COMPUTER DATABASES, ADVERTISING, INCLUDING PROMOTION RELATING TO THE SALE OF ARTICLES AND SERVICES FOR THIRD PARTIES BY THE TRANSMISSION OF ADVERTISING MATERIAL AND THE DISSEMINATION OF ADVERTISING MESSAGES ON COMPUTER NETWORKS (U.S. CLS. 100, 101 AND 102).

CLASS 38—COMMUNICATION

FOR TELECOMMUNICATIONS SERVICES, NAMELY, ELECTRONIC DATA TRANSMISSION AND MOBILE TELEPHONE SERVICES; TRANSMISSION OF IMAGES, SOUNDS, INFORMATION AND DATA BY TELEPHONE, TELEMATICS AND COMPUTER; COMMUNICATION BY COMPUTER TERMINALS; COMMUNICATION VIA FIBRE-OPTIC NETWORKS; TRANSMISSION OF COMMERCIAL AND/OR ADVERTISING DATA VIA INTERNET NETWORKS; INTERNET-BASED TRANSMISSION OF INFORMATION VIA ELECTRONIC CATALOGUES; PRESS AND INFORMATION AGENCIES, NAMELY, THE TRANSMISSION OF NEWS ITEMS TO NEWS REPORTING ORGANIZATIONS; PROVIDING ACCESS TO DATABASES; TELEPHONE AND RADIO COMMUNICATIONS; TELEMATIC SENDING OF INFORMATION; COMPUTER AIDED TRANSMISSION OF MESSAGES AND IMAGES; MOBILE RADIO COMMUNICATION; SATELLITE TRANSMISSION SERVICES; TRANSMISSION OF INFORMATION VIA A COMPUTER NETWORK SUCH AS THE INTERNET; EXCHANGE OF COMPUTERIZED DOCUMENTS, NAMELY, TRANSMISSION OF DOCUMENTS BY MEANS OF COMPUTER NETWORKS; ELECTRONIC INFORMATION EXCHANGE BY TELECOMMUNICATIONS APPARATUS, FACSIMILE MACHINES AND DATABASES ACCESSIBLE VIA TELECOMMUNICATION NETWORKS; TRANSMISSION OF INFORMATION HELD IN DATA BANKS VIA TELECOMMUNICATIONS NETWORKS; PROVISION OF ACCESS TO A GLOBAL COMPUTER NETWORK; TELECOMMUNICATIONS AND ELECTRONIC MAIL SERVICES VIA A GLOBAL WORLD COM-

MUNICATION NETWORK OR VIA A LOCAL NETWORK; ELECTRONIC MAIL SERVICES; PROVIDING ACCESS TO ELECTRONIC COMMUNICATIONS NETWORKS AND TO THE INTERNET; PROVIDING ACCESS TO A TELECOMMUNICATIONS NETWORK PORTAL; PROVIDING ACCESS TO A TELECOMMUNICATION NETWORK SEARCH ENGINE; PROVIDING ACCESS TO A DATABASE SERVER CENTRE; PROVIDING ACCESS TO ELECTRONIC COMMUNICATION NETWORKS AND TO THE INTERNET; RENTAL OF TELECOMMUNICATION APPARATUS AND INSTALLATIONS; DATA COMMUNICATIONS MANAGEMENT CONSULTING; CONSULTING IN TELECOMMUNICATION NETWORKS; TELECOMMUNICATION CONSULTATION IN THE NATURE OF TECHNICAL CONSULTING IN THE FIELD OF AUDIO, TEXT AND VISUAL DATA TRANSMISSION AND COMMUNICATION (U.S. CLS. 100, 101 AND 104).

CLASS 41—EDUCATION AND ENTERTAINMENT

FOR EDUCATION SERVICES, NAMELY, PROVIDING TRAININGS, SEMINARS, WORKSHOPS, TUTORIALS, PROGRAMS, INTERNSHIPS IN THE FIELD OF INTERNET SERVICES, MOBILE SERVICES FOR INSTANCE SOCIAL NETWORKS, SOCIAL MEDIA, DISCOVERY SERVICES, SEARCH ENGINES, SHARING TOOLS AND SERVICES; COMPUTING AND DATA COMMUNICATIONS INSTRUCTION SERVICES; TRAINING AND FURTHER TRAINING IN THE FIELD OF DATA COMMUNICATION, COMPUTING AND TELECOMMUNICATIONS; ARRANGING OF COURSES IN THE FIELD OF DATA COMMUNICATIONS, COMPUTING AND TELECOMMUNICATIONS; EDITING AND PUBLISHING OF WRITTEN TEXTS, EXCLUDING ADVERTISING TEXTS; SOFTWARE PUBLISHING; EDITING OF COMPUTER DATA FOR USE ON COMPUTER NETWORKS; EDUCATIONAL SERVICES, NAMELY, ARRANGING AND CONDUCTING OF COLLOQUIUMS, CONFERENCES, CONVENTIONS, SEMINARS, SYMPOSIUMS, SHOWS AND EXHIBITIONS IN THE FIELD OF DATA COMMUNICATION, COMPUTING AND TELECOMMUNICATIONS, ADVERTISING, MEDIA, INTERNET, MOBILE; TRAINING IN THE USE OF SOFTWARE TOOLS; SERVICES FOR PUBLISHING SOFTWARE AND ELECTRONIC DATA INTENDED TO BE MADE AVAILABLE TO THE PUBLIC ON COMPUTER OR ELECTRONIC NETWORKS, ESPECIALLY THE INTERNET, VIA SEARCH ENGINES; PUBLICATION OF MULTIMEDIA INFORMATION, NAMELY, ELECTRONIC PUBLISHING OF BOOKS AND PERIODICALS ONLINE (U.S. CLS. 100, 101 AND 107).

CLASS 42—SCIENTIFIC AND COMPUTER SERVICES

FOR CONDUCTING TECHNICAL PROJECT STUDIES IN THE FIELD OF COMPUTING; SOFTWARE DESIGN AND DEVELOPMENT SERVICES; SCIENTIFIC AND INDUSTRIAL RESEARCH IN THE FIELD OF COMPUTING, NAMELY, TECHNICAL RESEARCH; ENGINEERING SERVICES; CONDUCTING ENGINEERING SURVEYS; RESEARCH AND DEVELOPMENT OF NEW PRODUCTS FOR THIRD PARTIES REGARDING INFORMATION TECHNOLOGY; DEVELOPMENT, DESIGN, INSTALLATION, UPDATING AND MAINTENANCE OF SOFTWARE; RENTAL OF COMPUTER SOFTWARE AND HARDWARE; ADVICE AND CONSULTANCY CONCERNING COMPUTING; TECHNICAL COMPUTER CONSULTING; DESIGN OF COMPUTER PROGRAMS AND SYSTEMS; COMPUTER PROGRAMMING, DESIGN AND MAINTENANCE OF WEBSITES ON THE INTERNET FOR OTHERS; HOSTING OF INTERNET WEBSITES; DESIGN, CREATION, HOSTING, MAINTENANCE OF WEB SITES FOR OTHERS; TECHNOLOGICAL OR COMPUTER ANALYSIS FOR THE INSTALLATION OF COMPUTER SYSTEMS; COMPUTER RENTAL; DUPLICATION OF COMPUTER PROGRAMS; COMPUTER SECURITY SERVICES FOR PREVENTING PIRACY AND INFORMATION DEGRADATION, NAMELY, RESTRICTING ACCESS TO AND BY COMPUTER NETWORKS TO AND OF UNDESIRE WEB SITES, MEDIA AND INDIVIDUALS AND FACILITIES; COMPUTING SERVICES, NAMELY, ESTIMATES, ANALYSES, TESTS AND EVALUATIONS OF COMPUTER EQUIPMENT

PERFORMANCE; DATABASE RECONSTRUCTION SERVICES; RESEARCH, DEVELOPMENT AND DESIGN OF COMPUTER EQUIPMENT, SOFTWARE AND TELECOMMUNICATION NETWORKS, AND TECHNICAL CONSULTING RELATING THERETO; COMPUTER HARDWARE AND SOFTWARE CONSULTING SERVICES; COMPUTER PROGRAMMING, COMPUTER HARDWARE AND SOFTWARE DEVELOPMENT, AND ENGINEERING SERVICES IN THE FIELD OF COMPUTING; TECHNICAL SUPPORT FOR PROJECT IMPLEMENTATION AND FOLLOW-UP IN THE COMPUTING FIELD, NAMELY, TROUBLESHOOTING OF COMPUTER HARDWARE AND SOFTWARE PROBLEMS; CREATING, INSTALLING, MANAGING, UPDATING AND MAINTAINING SOFTWARE; DESIGN, DEVELOPMENT AND INSTALLATION OF COMPUTER DATABASES; TECHNICAL CONSULTING, CONDUCTING TECHNICAL STUDIES, TECHNICAL ANALYSES AND TECHNICAL DIAGNOSTICS IN THE FIELD OF COMPUTING; TECHNICAL CONSULTING, PERFORMANCE EVALUATION AND DIAGNOSTIC SERVICES IN THE FIELD OF COMPUTING; TECHNICAL SUPPORT SERVICES IN THE FIELD OF COMPUTING, NAMELY, TROUBLESHOOTING OF COMPUTER HARDWARE AND SOFTWARE PROBLEMS; DESIGN AND DEVELOPMENT OF WEB SITE SEARCH ENGINES, AND COMPUTER PROGRAMMING RELATING THERETO; COMPUTER PROJECT MANAGEMENT CONSULTANCY, AUDITING OF COMPUTERS SYSTEMS FOR SHARING INFORMATION AND COMMUNICATION FACILITIES; INSTALLATION, MAINTENANCE AND REPAIR OF COMPUTER SOFTWARE AND SOFTWARE PACKAGES; DATA CONVERSION OF COMPUTER PROGRAM DATA OR INFORMATION (U.S. CLS. 100 AND 101).

ELI HELLMAN, EXAMINING ATTORNEY

CLASS 16—PAPER GOODS AND PRINTED MATTER

FOR BROCHURES, PERIODICALS, MAGAZINES, BOOKS AND BOOKLETS ON THE SUBJECTS OF AUTOMOBILES, AUTOMOBILE MAINTENANCE AND REPAIR, AUTOMOBILE RACING AND AUTOMOBILE COMPETITIONS AND THE HISTORY OF FERRARI S.P.A. AND ITS PARTICIPATION IN AUTOMOBILE RACING AND COMPETITIONS; CAR MANUALS, DECALS, PICTURES, PHOTOGRAPHS, POSTCARDS, POSTERS, PRINTS, STICKERS, IRON-ON TRANSFERS BEING DECALCOMANIAS, PLASTIC TRANSFERS BEING DECALCOMANIAS; PROMOTIONAL MATERIAL BEING GOODS IN TRADE, NAMELY, BROCHURES AND LEAFLETS FEATURING INFORMATION ABOUT AUTOMOBILES AND AUTOMOTIVE PRODUCTS; EVENT PROGRAMS; PAPER BANNERS, PAPER FLAGS; CATALOGS IN THE FIELD OF AUTOMOBILES AND AUTOMOTIVE PRODUCTS AND SHOWING FERRARI S.P.A.'S OFFICIAL MERCHANDISE; PAPER TICKET HOLDERS; STATIONERY ITEMS, NAMELY, FOUNTAIN PENS, ROLLING PENS, FELT PENS, WRITING PENS, PENCIL SHARPENERS, DIARIES, NOTEBOOKS AND EXERCISE BOOKS, NOTEPAPERS, PHOTO ALBUMS, GREETING CARDS, WRAPPING PAPERS, NOTE PADS FOR COLLECTORS, ALBUMS FOR DRAWINGS, PEN-HOLDERS NOT OF PRECIOUS METAL, PAPER CUTTERS, DOCUMENT FOLDERS FOR CARDS AND DOCUMENTS, SMALL BLACKBOARDS, STAPLERS; ERASERS, AGENDAS, STAMPS FOR COLLECTORS, RUBBER STAMPS, NON-MAGNETICALLY ENCODED PASSES OR IDENTIFICATION CARDS MADE OF PAPER FOR ACCESS TO A RESTRICTED AREA, ENVELOPES, BUSINESS CARDS (U.S. CLS. 2, 5, 22, 23, 29, 37, 38 AND 50).

CLASS 25—CLOTHING

FOR AUTOMOBILE RACING SUITS NOT IN THE NATURE OF PROTECTIVE CLOTHING, T-SHIRTS, SWEAT SHIRTS, POLO SHIRTS, TIES, CAPS, OVERALLS, WIND RESISTANT JACKETS, WATERPROOF JACKETS, BLAZERS, BERMUDA SHORTS, PULL-OVERS, FLEECE PULLOVERS, FLEECE JACKETS, FLEECE SHORTS, FLEECE VESTS, COATS, ROBES, SCARVES, SHOES, BOOTS, SKI BOOTS, SWEATERS, SHIRTS, TROUSERS, BELTS, RAINCOATS, TRACK SUITS, SHORTS, GLOVES, PAJAMAS, SLIPPERS, SWIMMING COSTUMES (U.S. CLS. 22 AND 39).

CLASS 41—EDUCATION AND ENTERTAINMENT

FOR EDUCATION SERVICES, NAMELY, PROVIDING SEMINARS, WORKSHOPS IN THE FIELD OF SPORT AND SAFE DRIVING; PROVIDING OF PERSONAL TRAINING SERVICES IN THE FIELD OF AUTOMOTIVE REPAIR, SPORT AND SAFE DRIVING; ENTERTAINMENT IN THE NATURE OF AUTOMOBILE RACES; SPORTING AND CULTURAL ACTIVITIES, NAMELY, PRODUCTION OF VIDEOS IN THE FIELD OF DRIVING COMPETITIONS AND ON THE HISTORY OF FERRARI S.P.A. AND ITS F1 DRIVERS; ARRANGING FOR TICKET RESERVATIONS FOR RACING COMPETITIONS; ORGANIZING ENTERTAINMENT CLUBS FOR OWNERS OF AUTOMOBILES MANUFACTURED BY FERRARI S.P.A., NAMELY, CLUBS WHICH ORGANIZE AUTOMOBILE RACES, SPORTS CAR COMPETITIONS, AND MEETINGS OF ENTHUSIASTS OF AUTOMOBILES RACING AND SPORTS CAR COMPETITIONS FOR OWNERS AND ENTHUSIASTS OF AUTOMOBILES MANUFACTURED BY FERRARI S.P.A.; PROVIDING INFORMATION ABOUT AUTOMOBILE RACES AND RACING TEAMS AND SPORT COMPETITIONS; ORGANIZING AUTOMOBILE RACING EXHIBITIONS AND COMPETITIONS FOR SPORTING PURPOSES, ORGA-

SN 79-051,488. FERRARI S.P.A., ITALY, FILED 2-6-2008.

FERRARI CLUB

THE MARK CONSISTS OF STANDARD CHARACTERS WITHOUT CLAIM TO ANY PARTICULAR FONT, STYLE, SIZE, OR COLOR.

PRIORITY DATE OF 1-2-2008 IS CLAIMED.

OWNER OF INTERNATIONAL REGISTRATION 0957689 DATED 2-6-2008, EXPIRES 2-6-2018.

OWNER OF U.S. REG. NOS. 862,632, 3,000,743 AND OTHERS.

NO CLAIM IS MADE TO THE EXCLUSIVE RIGHT TO USE "CLUB", APART FROM THE MARK AS SHOWN.

NIZING WORKSHOPS IN THE FIELD OF AUTOMOBILES FOR AUTOMOTIVE CLUB MEMBERS AND OWNERS OF AUTOMOBILES; ENTERTAINMENT IN THE NATURE OF ON-GOING TELEVISION PROGRAMS IN THE FIELD OF AUTOMOBILES AND AUTOMOBILE RACES; PROVIDING INFORMATION IN THE FIELD OF SPORTS, PROVIDING INFORMATION IN THE FIELD OF CARS, AND ABOUT RACES SPONSORED OR ATTENDED BY FERRARI S.P.A.; SPORTS TRAINING SERVICES IN THE FIELD OF DRIVING AUTOMOBILES, SPORT AUTOMOBILES AND RACING AUTOMOBILES (U.S. CLS. 100, 101 AND 107).

ALLISON HOLTZ, EXAMINING ATTORNEY

SN 79-051,644. INOUTIC / DECEUNINCK GMBH, BOGEN, FED REP GERMANY, FILED 7-27-2007.

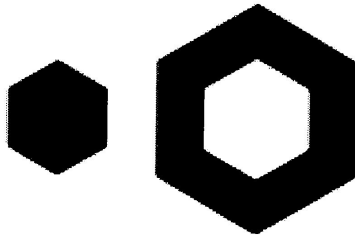

PRIORITY DATE OF 1-30-2007 IS CLAIMED.
OWNER OF INTERNATIONAL REGISTRATION 0958104
DATED 7-27-2007, EXPIRES 7-27-2017.

THE MARK CONSISTS OF A HEXAGONAL DEVICE WITH A DARK THICK OUTLINE; TO THE LEFT OF THE HEXAGONAL DEVICE IS ANOTHER FULLY SHAPED SMALLER HEXAGONAL DEVICE.

CLASS 1—CHEMICALS

FOR ADHESIVES FOR GENERAL INDUSTRIAL USE, NAMELY, SPRAY ADHESIVE, HOT-MELT ADHESIVE, FUSION ADHESIVE, REACTIVE ADHESIVE, DISPERSION ADHESIVE, CONSTRUCTION ADHESIVE, INSTANT VERY STRONG ADHESIVE, CONDUCTIVE ADHESIVE, SINGLE OR MULTIPLE COMPONENT ADHESIVES, ADHESIVE FOR SOLVENTS, PURE NON-METALLIC SILICON SOLD IN GEL, INGOTS OR SLICES, SILICON, SPRAY AND CONSTRUCTION ADHESIVES, ESPECIALLY FOR FITTING WINDOWS AND DOORS (U.S. CLS. 1, 5, 6, 10, 26 AND 46).

CLASS 6—METAL GOODS

FOR COMMON METALS AND THEIR ALLOYS; METAL BUILDING MATERIALS AND ACCESSORIES, NAMELY, ALLOYED IRON, ALLOYED ALUMINUM; CAST IRON FOR USE IN HYDRAULICS, SANITATION AND BUILDINGS, METAL FASTENERS AND FITTINGS, NAMELY, BOLTS, NAILS, RIVETS, SCREWS; METAL HINGES, REINFORCING MATERIALS OF METAL FOR BUILDING PURPOSES IN THE NATURE OF METAL REINFORCEMENT SECTIONS FOR HOLLOW PLASTIC SECTIONS; LOCKSMITH'S GOODS AND IRONMONGERY, NAMELY, METAL LOCKS, METAL LOCKING MECHANISM, METAL LOCKERS, NON-ELECTRIC METAL CABLES AND WIRES, WALL PANELS OF METAL, METAL ROOFING PANELS, METAL FENCE PANELS, METAL CEILING PANELS, DOOR PANELS OF METAL, CLADDING OF METAL FOR CONSTRUCTION AND BUILDING, METAL FLOORS, METAL ROOFING FOR CONSERVATORIES, FRAMES OF METAL FOR BUILDING GLASS, NAMELY, METAL WINDOW FRAMES, STAIRS OF METAL, METAL WINDOW LATCHES, NON-ELECTRIC WINDOW AND DOOR OPENERS AND CLOSERS, NAMELY, FASTENERS, NAMELY, METAL BARS AND CHAINS, METAL HANDLES FOR DOORS AND WINDOWS, METAL WINDOWS, METAL DOORS, METAL GATES, METAL SHUTTERS AND METAL EXTERIOR ROLLER BLINDS; METAL VENTILATION DUCTS AS PARTS FOR WINDOWS, DOORS, ROLLER BLINDS, SHUTTERS AND CONSERVATORIES; METAL BUILDING MATERIALS, NAMELY, PIPE JOINT CONNECTORS FOR SECTIONS AND END CAPS FOR TUBING ENDS; NON-ELECTRIC METAL LOCKS, METAL SECURITY LOCK CYLINDERS; METAL VENTILATION AND FILTER ELEMENTS, NAMELY, VENTILATING DUCTS OF METAL, METAL ROOF VENTS FOR HEATING, COOLING, VENTILATION IN RESIDENTIAL AND COMMERCIAL BUILDINGS; DOOR FITTINGS OF METAL; METAL WINDOW FITTINGS, NAMELY, WINDOW CASEMENTS OF METAL, METAL WINDOW TRIM, METAL WINDOW SILLS, METAL WINDOW PULLEYS; CLOSURE MECHANISMS, NAMELY, METAL CLOSURES FOR DOORS AND WINDOWS; METAL LOCKS (U.S. CLS. 2, 12, 13, 14, 23, 25 AND 50).

CLASS 7—MACHINERY

FOR MACHINES FOR METAL AND PLASTIC PROCESSING, NAMELY, BENDING MACHINES, BORING MACHINES, CUTTING MACHINES, LAPPING MACHINES, INJECTION PLASTIC MOLDING MACHINES; MOTORS OTHER THAN FOR LAND VEHICLES AND AGRICULTURAL VEHICLES; PNEUMATIC OR HYDRAULIC TOOLS FOR MACHINES, NAMELY, METAL WORKING MACHINE TOOLS, THREAD MILLING CUTTERS, CHASERS, AND BROACHES (U.S. CLS. 13, 19, 21, 23, 31, 34 AND 35).

CLASS 9—ELECTRICAL AND SCIENTIFIC APPARATUS

FOR MEASURING, SIGNALING, CONTROL AND RESCUE APPARATUS AND INSTRUMENTS, NAMELY, DISTANCE MEASURING APPARATUS, TRANSMITTERS OF ELECTRONIC SIGNALS, ELECTRICAL CONTROLLERS, ELECTRIC CONTROL PANELS; HYGROMETERS, BAROMETERS AND THERMOMETERS; APPARATUS AND INSTRUMENTS FOR THE CONDUCTION, DISTRIBUTION, CONVERSION, STORAGE, MODULATION OR CONTROL OF ELECTRIC CURRENT, NAMELY, ELECTRIC CONDUCTORS, ELECTRICAL DISTRIBUTION BOXES, DISTRIBUTION TRANSFORMERS, ELECTRIC CONVERTERS, ELECTRIC STORAGE BATTERIES, ELECTRIC CONTROL PANELS; ELECTRIC SWITCHES, NAMELY, ELECTRIC CONTACT SWITCHES, ELECTRIC TOUCH SWITCHES; ELECTRONIC APPARATUS, NAMELY, MOTION DETECTORS; ELECTRONICALLY OPERATED WINDOW LATCHES; ELECTRICAL WINDOW AND DOOR OPENERS AND CLOSERS; ELECTRICAL CONTROLLING DEVICES FOR OPENING AND CLOSING WINDOWS, SHUTTERS, ROLLER BLINDS, GATES AND DOORS; ELECTRICAL CONTROLLING DEVICES FOR ROLLER BLINDS AND SHUTTERS AND TO DRIVE GATES AND DOORS; ELECTRIC AND ELECTRONIC LOCKS; INSTRUMENTS AND MEDIA FOR RECORDING, REPRO-

DUCEING, PHOTOGRAPHING, STORAGE, PROCESSING, EDITING, TRANSMITTING, BROADCASTING AND RETRIEVING PUBLICATIONS, TEXTS, SIGNALS, SOFTWARE, INFORMATION, DATA, CODES, SOUND AND IMAGE, NAMELY, COMPUTER TOUCH SCREENS; ELECTRIC DISTRIBUTION CONSOLES IN THE NATURE OF DISTRIBUTION BOARDS AND ELECTRICAL DISTRIBUTION BOXES FOR LIGHTING SYSTEMS; CONTROL DEVICES AND INSTRUMENTS FOR LIGHTING SYSTEMS, NAMELY, LIGHTING CONTROL PANELS, ELECTRIC BUILDING BUS SYSTEMS, NAMELY, LON (LOCAL OPERATING NETWORK) OR EIB (EUROPEAN INSTALLATION BUS) SYSTEMS; COMPUTER SOFTWARE FOR DEVELOPING AND CONTROLLING ELECTRICAL DEVICES IN INDUSTRIAL OR PRIVATE AREAS; COMPUTER HARDWARE AND COMPUTER PERIPHERAL DEVICES FOR USE WITH COMPUTER HARDWARE; DEVICES FOR SOUND OUTPUT, NAMELY, LOUDSPEAKERS, FLAT LOUDSPEAKERS; LUMINOUS ADVERTISING AND INFORMATION SIGNS FOR WINDOWS, DOORS AND FACADES (U.S. CLS. 21, 23, 26, 36 AND 38).

CLASS 11—ENVIRONMENTAL CONTROL APPARATUS

FOR HEATING, STEAM AND COOLING, DRYING, AND VENTILATION DEVICES, NAMELY, STEAM GENERATORS, AIR COOLING APPARATUS, CLOTHES DRYERS, VENTILATION HOODS; ILLUMINATION DEVICES AND THEIR COMPONENTS, NAMELY, INFRARED ILLUMINATORS; ILLUMINATING LIGHTS, NAMELY, ELECTRIC LIGHTING FIXTURES; ELECTRIC LIGHTING FIXTURES IN THE NATURE OF MARKER LIGHTS FOR WINDOWS, DOORS AND FACADES (U.S. CLS. 13, 21, 23, 31 AND 34).

CLASS 17—RUBBER GOODS

FOR PLASTIC COMMODITIES IN THE NATURE OF SEMI-FINISHED PRODUCTS MADE OF PLASTICS, NAMELY, PLASTIC SHEETS FOR CONSTRUCTION AND GENERAL USE IN THE NATURE OF PLASTIC SECTIONS AND PANELS FOR WINDOWS, DOORS, CONSERVATORIES, PILLARS, ROOFS, FENCES AND WINDOW SILLS; HEAT AND SOUND INSULATING MATERIALS; NATURAL RUBBER, RUBBER AND COMMODITIES MADE THEREOF, NAMELY, NATURAL RUBBER, RUBBER, RUBBER SHEETS, RUBBER THREAD, STUFFING OF RUBBER; SEALING MATERIAL FOR INDUSTRIAL USE, NAMELY, SEALING COMPOUNDS, SEALING AGENTS, SEALING STRIPS, SEALING RINGS, SEALING TAPES, INSULATING MATERIAL (U.S. CLS. 1, 5, 12, 13, 35 AND 50).

CLASS 19—NON-METALLIC BUILDING MATERIALS

FOR BUILDING MATERIALS, NAMELY, SEMI-WORKED WOODS, PLASTIC PIPE SUPPORTS, LOGS, STONE, CAST STONE, MARBLE; NON-METAL WINDOWS, NON-METAL WINDOW FRAMES; STRUCTURAL BUILDING GLASS; NON-METAL SKYLIGHTS; NON-METAL LINTELS; NON METAL EXTERIOR BLINDS, NAMELY, NON METAL AND NON TEXTILE ROLLER BLINDS; NON METAL SHUTTERS, NAMELY, INTERIOR OR EXTERIOR WINDOW AND DOOR SHUTTERS, NON-METAL ROLL SHUTTERS; NON METAL CASINGS, NAMELY, ROLLER BLIND CASINGS FOR BUILDING; NON METALLIC TRANSPORTABLE BUILDINGS IN THE NATURE OF CONSERVATORIES; RIGID PIPES OF POLYPROPYLENE FOR THE SUPPLY OF DRINKING WATER AND HEATING AND AIR CONDITIONING SYSTEMS IN HOUSES, OFFICE BUILDINGS AND INDUSTRIAL BUILDINGS, NON-METAL ROOFING PANELS, NON-METAL CEILING PANELS, NON-METAL DOOR PANELS, NON-METAL FLOOR PANELS, FOR BUILDING PURPOSES, NON-METAL; BUILDING MATERIALS, NAMELY, NON METAL DOORS, NON METAL GATES, NON METAL STAIRS, NON METAL CLADDING FOR BUILDING, CONCRETE WALLS, NON METAL FLOORS, NON-METAL CEILING PANELS, NON-METAL ROOFING, NON-METAL EXTERIOR ROLLER BLINDS, NON-METAL ROLLER BLIND CASINGS FOR BUILDING, NON-METAL WINDOW FRAMES, NON-METAL DOOR FRAMES,

NON-METAL CLADDING FOR CONSTRUCTION AND BUILDING, NAMELY, NON-METAL CLADDING FOR DOORS AND WINDOWS; NON-METALLIC BUILDING MATERIALS IN THE NATURE OF JOINT CONNECTORS FOR SECTIONS AND END CAPS, NAMELY, NON METALLIC EXPANSION JOINTS FOR FLOORS AND WALLS; ACCESSORIES FOR WINDOWS AND DOORS, NAMELY, NON-METAL WINDOW SILLS, NON-METAL WINDOW SHUTTERS; NON-METAL MOSQUITO SCREENS; NON-METAL VENTILATION ELEMENTS FOR WINDOWS, DOORS, GATES, NAMELY, NON-METAL VENTILATING DUCTS; NON METAL FENCES; PRE-FABRICATED NONMETAL ARCHITECTURAL COLUMNS IN THE NATURE OF PILLARS; ALL AFOREMENTIONED COMMODITIES BEING NON-METALLIC AND FOR BUILDING PURPOSES (U.S. CLS. 1, 12, 33 AND 50).

CLASS 20—FURNITURE AND ARTICLES NOT OTHERWISE CLASSIFIED

FOR NON-METAL WINDOW FITTINGS; INDOOR INTERNAL BLINDS FOR WINDOWS; INDOOR SUNSCREENS FOR DOORS AND WINDOWS, NAMELY, WINDOWS SHADES; OPENING AND CLOSING DEVICES FOR WINDOWS, DOORS, GATES, SHELVES, SHUTTERS, NAMELY, NON-METAL LATCHES, NON-METAL HANDLES FOR WINDOWS, DOORS, GATES, SHELVES AND SHUTTERS; NON METAL LOCKS FOR WINDOWS, DOORS, GATES, SHELVES, AND SHUTTERS; NON METAL WINDOWS FITTINGS; NON-METAL DOOR FITTINGS, NAMELY, NON-METAL DOOR BOLTS, NON-METAL DOOR TRIMS, NON-METAL DOOR VIEWERS (U.S. CLS. 2, 13, 22, 25, 32 AND 50).

CLASS 35—ADVERTISING AND BUSINESS

FOR PLANNING AND CONDUCTING TRADE FAIRS AND EXHIBITIONS FOR ECONOMIC AND ADVERTISING PURPOSES; MARKETING AND ADVERTISING; PERFORMING OF MARKETING RESEARCH STUDIES; MARKET RESEARCH; PROVISION OF BUSINESS AND MARKETING INFORMATION (U.S. CLS. 100, 101 AND 102).

CLASS 37—CONSTRUCTION AND REPAIR

FOR BUILDING CONSTRUCTION SERVICES; REPAIR SERVICES, NAMELY, REPAIR OF BUILDINGS AND BUILDING COMPONENTS, NAMELY, ROOFS, CONSERVATORIES, GLASS FRAMES, STAIRS, WINDOWS, DOORS, GATES, ROLLER BLINDS, ROLLER BLIND CASINGS, WINDOW AND DOOR FRAMES, WINDOW SILLS, AWNING SUBSTRUCTURES, SUNSCREENS, AS WELL AS ILLUMINATING, HEATING, STEAM GENERATING, COOLING, DRYING, VENTILATION AND WATER CONDUIT DEVICES, AS WELL AS SANITARY INSTALLATIONS; INSTALLATION, MAINTENANCE AND REPAIR OF COMPUTER HARDWARE; INSTALLATION WORK, NAMELY, INSTALLATION OF ELECTRICAL SYSTEMS, APPLIANCES, WINDOWS, DOORS, GATES, SHUTTERS, ROLLER BLINDS (U.S. CLS. 100, 103 AND 106).

CLASS 41—EDUCATION AND ENTERTAINMENT

FOR TRAINING AND ADVANCED TRAINING SERVICES IN THE FIELD OF PLANNING, CONSTRUCTING AND USING WINDOWS, DOORS, GATES, SHUTTERS AND OTHER BUILDING MATERIALS; PROVIDING INFORMATION IN THE FIELD OF EDUCATION, TRAINING AND PUBLICATION IN THE FIELD OF BUILDING AND WINDOW CONSTRUCTION; EDUCATION SERVICES, NAMELY, PROVIDING TRAINING AND ADVANCED TRAINING IN THE NATURE OF SEMINARS AND WORKSHOPS, SERIES OF LECTURES, AND SYMPOSIA IN THE FIELD OF PLANNING, USING AND CONSTRUCTING WINDOWS, DOORS, GATES, SHUTTERS AND OTHER BUILDING MATERIALS; TECHNICAL INSTRUCTION IN THE FIELD OF USING WINDOWS, DOORS, GATES, SHUTTERS AND OTHER BUILDING MATERIALS; TRAINING SERVICES IN THE FIELD OF SALES IN THE FIELD OF PLANNING, USING AND CONSTRUCTING WINDOWS, DOORS, GATES, SHUTTERS AND OTHER BUILDING MATERIALS (U.S. CLS. 100, 101 AND 107).

CLASS 42—SCIENTIFIC AND COMPUTER SERVICES

FOR RESEARCH, SCIENTIFIC AND TECHNOLOGY SERVICES, NAMELY, SCIENTIFIC RESEARCH, TECHNOLOGY CONSULTATION AND RESEARCH IN THE FIELD OF USING AND CONSTRUCTING WINDOWS, DOORS, GATES, SHUTTERS AND OTHER BUILDING MATERIALS; RESEARCH, TECHNICAL DEVELOPMENT AND DESIGNER SERVICES IN THE FIELD OF BUILDING AND WINDOW CONSTRUCTION, NAMELY, RESEARCH ON BUILDING CONSTRUCTION RESIDENTIAL BUILDING DESIGN, DESIGN FOR WINDOWS, DOORS, SHUTTERS AND OTHER BUILDING MATERIALS; NEW PRODUCT DESIGN AND DEVELOPMENT FOR OTHERS; DESIGN FOR OTHERS IN THE FIELD OF ENGINEERING; CONSTRUCTION AND STRUCTURAL PLANNING, NAMELY, PLANNING OF BUILDINGS AND INFRASTRUCTURE SYSTEMS FOR BUILDINGS; ARCHITECTURAL CONSULTATION; CONSULTATION SERVICES IN THE FIELD OF PRODUCT DEVELOPMENT IN THE FIELD ELECTRICAL INSTALLATIONS AND HEATING TECHNOLOGY; TECHNICAL CONSULTATION IN THE FIELD OF ENGINEERING (U.S. CLS. 100 AND 101).

KATHERINE E. HALMEN, EXAMINING ATTORNEY

SN 79-051.645. INOUTIC / DECEUNINCK GMBH, BOGEN, FED REP GERMANY, FILED 7-27-2007.



PRIORITY DATE OF 1-30-2007 IS CLAIMED.
OWNER OF INTERNATIONAL REGISTRATION 0958105 DATED 7-27-2007, EXPIRES 7-27-2017.

THE MARK CONSISTS OF A HEXAGONAL DEVICE WITH A DARK THICK OUTLINE; TO THE LEFT OF THE HEXAGONAL DEVICE IS ANOTHER FULLY SHAPED SMALLER HEXAGONAL DEVICE; TO THE RIGHT THERE IS A LETTER COMBINATION OF TWO LETTERS "IC" ALSO IN THICK OUTLINES.

CLASS 1—CHEMICALS

FOR ADHESIVES FOR GENERAL INDUSTRIAL USE, NAMELY, SPRAY ADHESIVE, HOT-MELT ADHESIVE, FUSION ADHESIVE, REACTIVE ADHESIVE, DISPERSION ADHESIVE, CONSTRUCTION ADHESIVE, INSTANT VERY STRONG ADHESIVE, CONDUCTIVE ADHESIVE, SINGLE OR MULTIPLE COMPONENT ADHESIVES, ADHESIVE FOR SOLVENTS, PURE NON-METALLIC SILICON SOLD IN GEL, INGOTS OR SLICES, SILICON, SPRAY AND CONSTRUCTION ADHESIVES, ESPECIALLY FOR FITTING WINDOWS AND DOORS (U.S. CLS. 1, 5, 6, 10, 26 AND 46).

CLASS 6—METAL GOODS

FOR COMMON METALS AND THEIR ALLOYS; METAL BUILDING MATERIALS AND ACCESSORIES, NAMELY, ALLOYED IRON, ALLOYED ALUMINUM; CAST IRON FOR USE IN HYDRAULICS, SANITATION AND BUILDINGS, METAL FASTENERS AND FITTINGS, NAMELY, BOLTS, NAILS, RIVETS, SCREWS; METAL HINGES, REINFORCING MATERIALS OF METAL FOR BUILDING PURPOSES IN THE NATURE OF METAL REINFORCEMENT SECTIONS FOR HOLLOW PLASTIC SECTIONS; LOCKSMITH'S GOODS AND IRONMONGERY, NAMELY, METAL LOCKS, METAL LOCKING MECHANISM, METAL LOCKERS, NON-ELECTRIC METAL CABLES AND WIRES, WALL PANELS OF METAL, METAL ROOFING PANELS, METAL FENCE PANELS, METAL CEILING PANELS, DOOR PANELS OF METAL, CLADDING OF METAL FOR CONSTRUCTION AND BUILDING, METAL FLOORS, METAL ROOFING FOR CONSERVATORIES, FRAMES OF METAL FOR BUILDING GLASS, NAMELY, METAL WINDOW FRAMES, STAIRS OF METAL, METAL WINDOW LATCHES, NON-ELECTRIC WINDOW AND DOOR OPENERS AND CLOSERS, NAMELY, FASTENERS, NAMELY, METAL BARS AND CHAINS, METAL HANDLES FOR DOORS AND WINDOWS, METAL WINDOWS, METAL DOORS, METAL GATES, METAL SHUTTERS AND METAL EXTERIOR ROLLER BLINDS; METAL VENTILATION DUCTS AS PARTS FOR WINDOWS, DOORS, ROLLER BLINDS, SHUTTERS AND CONSERVATORIES; METAL BUILDING MATERIALS, NAMELY, PIPE JOINT CONNECTORS FOR SECTIONS AND END CAPS FOR TUBING ENDS; NON-ELECTRIC METAL LOCKS, METAL SECURITY LOCK CYLINDERS; METAL VENTILATION AND FILTER ELEMENTS, NAMELY, VENTILATING DUCTS OF METAL, METAL ROOF VENTS FOR HEATING, COOLING, VENTILATION IN RESIDENTIAL AND COMMERCIAL BUILDINGS; DOOR FITTINGS OF METAL; METAL WINDOW FITTINGS, NAMELY, WINDOW CASEMENTS OF METAL, METAL WINDOW TRIM, METAL WINDOW SILLS, METAL WINDOW PULLEYS; CLOSURE MECHANISMS, NAMELY, METAL CLOSURES FOR DOORS AND WINDOWS; METAL LOCKS (U.S. CLS. 2, 12, 13, 14, 23, 25 AND 50).

CLASS 7—MACHINERY

FOR MACHINES FOR METAL AND PLASTIC PROCESSING, NAMELY, BENDING MACHINES, BORING MACHINES, CUTTING MACHINES, LAPPING MACHINES, INJECTION PLASTIC MOLDING MACHINES; MOTORS OTHER THAN FOR LAND VEHICLES AND AGRICULTURAL VEHICLES; PNEUMATIC OR HYDRAULIC TOOLS FOR MACHINES, NAMELY, METAL WORKING MACHINE TOOLS, THREAD MILLING CUTTERS, CHASERS, AND BROACHES (U.S. CLS. 13, 19, 21, 23, 31, 34 AND 35).

CLASS 9—ELECTRICAL AND SCIENTIFIC APPARATUS

FOR MEASURING, SIGNALING, CONTROL AND RESCUE APPARATUS AND INSTRUMENTS, NAMELY, DISTANCE MEASURING APPARATUS, TRANSMITTERS OF ELECTRONIC SIGNALS, ELECTRICAL CONTROLLERS, ELECTRIC CONTROL PANELS; HYGROMETERS, BAROMETERS AND THERMOMETERS; APPARATUS AND INSTRUMENTS FOR THE CONDUCTION, DISTRIBUTION, CONVERSION, STORAGE, MODULATION OR CONTROL OF ELECTRIC CURRENT, NAMELY, ELECTRIC CONDUCTORS, ELECTRICAL DISTRIBUTION BOXES, DISTRIBUTION TRANSFORMERS, ELECTRIC CONVERTERS, ELECTRIC STORAGE BATTERIES, ELECTRIC CONTROL PANELS; ELECTRIC SWITCHES, NAMELY, ELECTRIC CONTACT SWITCHES, ELECTRIC TOUCH SWITCHES; ELECTRONIC APPARATUS, NAMELY, MOTION DETECTORS; ELECTRONICALLY OPERATED WINDOW LATCHES; ELECTRICAL WINDOW AND DOOR OPENERS AND CLOSERS; ELECTRICAL CONTROLLING DEVICES FOR OPENING AND CLOSING WINDOWS, SHUTTERS, ROLLER BLINDS, GATES AND DOORS; ELECTRICAL CONTROLLING DEVICES FOR ROLLER BLINDS AND SHUTTERS AND TO DRIVE GATES AND DOORS; ELECTRIC AND ELECTRONIC LOCKS; INSTRUMENTS AND MEDIA FOR RECORDING, REPRODUCING, PHOTOGRAPHING, STORAGE, PROCESSING, EDITING, TRANSMITTING, BROADCASTING AND RETRIEVING PUBLICATIONS, TEXTS, SIGNALS, SOFTWARE, INFORMATION, DATA, CODES, SOUND AND IMAGE, NAMELY, COMPUTER TOUCH SCREENS; ELECTRIC DISTRIBUTION CONSOLES IN THE NATURE OF DISTRIBUTION BOARDS AND ELECTRICAL DISTRIBUTION BOXES FOR LIGHTING SYSTEMS; CONTROL DEVICES AND INSTRUMENTS FOR LIGHTING SYSTEMS, NAMELY, LIGHTING CONTROL PANELS, ELECTRIC BUILDING BUS SYSTEMS, NAMELY, LON (LOCAL OPERATING NETWORK) OR EIB (EUROPEAN INSTALLATION BUS) SYSTEMS; COMPUTER SOFTWARE FOR DEVELOPING AND CONTROLLING ELECTRICAL DEVICES IN INDUSTRIAL OR PRIVATE AREAS; COMPUTER HARDWARE AND COMPUTER PERIPHERAL DEVICES FOR USE WITH COMPUTER HARDWARE; DEVICES FOR SOUND OUTPUT, NAMELY, LOUDSPEAKERS, FLAT LOUDSPEAKERS; LUMINOUS ADVERTISING AND INFORMATION SIGNS FOR WINDOWS, DOORS AND FACADES (U.S. CLS. 21, 23, 26, 36 AND 38).

CLASS 11—ENVIRONMENTAL CONTROL APPARATUS

FOR COOLING, DRYING, AND VENTILATION DEVICES, NAMELY, STEAM GENERATORS, AIR COOLING APPARATUS, CLOTHES DRYERS, VENTILATION HOODS; ILLUMINATION DEVICES AND THEIR COMPONENTS, NAMELY, INFRARED ILLUMINATORS; ILLUMINATING LIGHTS, NAMELY, ELECTRIC LIGHTING FIXTURES; ELECTRIC LIGHTING FIXTURES IN THE NATURE OF MARKER LIGHTS FOR WINDOWS, DOORS AND FACADES (U.S. CLS. 13, 21, 23, 31 AND 34).

CLASS 17—RUBBER GOODS

FOR PLASTIC COMMODITIES IN THE NATURE OF SEMI-FINISHED PRODUCTS MADE OF PLASTICS, NAMELY, PLASTIC SHEETS FOR CONSTRUCTION AND GENERAL USE IN THE NATURE OF PLASTIC SECTIONS AND PANELS FOR WINDOWS, DOORS, CONSERVATORIES, PILLARS, ROOFS, FENCES AND WINDOW SILLS; HEAT AND SOUND INSULATING MATERIALS; NATURAL RUBBER, RUBBER AND COMMODITIES MADE THEREOF, NAMELY, NATURAL RUBBER, RUBBER, RUBBER SHEETS, RUBBER THREAD, STUFFING OF RUBBER; SEALING MATERIAL FOR INDUSTRIAL USE, NAMELY, SEALING COMPOUNDS, SEALING AGENTS, SEALING STRIPS, SEALING RINGS, SEALING TAPES, INSULATING MATERIAL (U.S. CLS. 1, 5, 12, 13, 35 AND 50).

CLASS 19—NON-METALLIC BUILDING MATERIALS

FOR BUILDING MATERIALS, NAMELY, SEMI-WORKED WOODS, PLASTIC PIPE SUPPORTS, LOGS, STONE, CAST STONE, MARBLE; NON-METAL WINDOWS, NON-METAL WINDOW FRAMES; STRUCTURAL BUILDING GLASS; NON-METAL SKYLIGHTS; NON-METAL LINTELS; NON METAL EXTERIOR BLINDS, NAMELY, NON METAL AND NON TEXTILE ROLLER BLINDS; NON METAL SHUTTERS, NAMELY, INTERIOR OR EXTERIOR WINDOW AND DOOR SHUTTERS, NON-METAL ROLL SHUTTERS; NON METAL CASINGS, NAMELY, ROLLER BLIND CASINGS FOR BUILDING; NON METALLIC TRANSPORTABLE BUILDINGS IN THE NATURE OF CONSERVATORIES; RIGID PIPES OF POLYPROPYLENE FOR THE SUPPLY OF DRINKING WATER AND HEATING AND AIR CONDITIONING SYSTEMS IN HOUSES, OFFICE BUILDINGS AND INDUSTRIAL BUILDINGS, NON-METAL ROOFING PANELS, NON-METAL CEILING PANELS, NON-METAL DOOR PANELS, NON-METAL FLOOR PANELS, FOR BUILDING PURPOSES, NON-METAL; BUILDING MATERIALS, NAMELY, NON METAL DOORS, NON METAL GATES, NON METAL STAIRS, NON METAL CLADDING FOR BUILDING, CONCRETE WALLS, NON METAL FLOORS, NON-METAL CEILING PANELS, NON-METAL ROOFING, NON-METAL EXTERIOR ROLLER BLINDS, NON-METAL ROLLER BLIND CASINGS FOR BUILDING, NON-METAL WINDOW FRAMES, NON-METAL DOOR FRAMES, NON-METAL CLADDING FOR CONSTRUCTION AND BUILDING, NAMELY, NON-METAL CLADDING FOR DOORS AND WINDOWS; NON-METALLIC BUILDING MATERIALS IN THE NATURE OF JOINT CONNECTORS FOR SECTIONS AND END CAPS, NAMELY, NON METALLIC EXPANSION JOINTS FOR FLOORS AND WALLS; ACCESSORIES FOR WINDOWS AND DOORS, NAMELY, NON-METAL WINDOW SILLS, NON-METAL WINDOW SHUTTERS; NON-METAL MOSQUITO SCREENS; NON-METAL VENTILATION ELEMENTS FOR WINDOWS, DOORS, GATES, NAMELY, NON-METAL VENTILATING DUCTS; NON METAL FENCES; PRE-FABRICATED NONMETAL ARCHITECTURAL COLUMNS IN THE NATURE OF PILLARS; ALL AFOREMENTIONED COMMODITIES BEING NON-METALLIC AND FOR BUILDING PURPOSES (U.S. CLS. 1, 12, 33 AND 50).

CLASS 20—FURNITURE AND ARTICLES NOT OTHERWISE CLASSIFIED

FOR NON-METAL WINDOW FITTINGS; INDOOR INTERNAL BLINDS FOR WINDOWS; INDOOR SUNSCREENS FOR DOORS AND WINDOWS, NAMELY, WINDOWS SHADES; OPENING AND CLOSING DEVICES FOR WINDOWS, DOORS, GATES, SHELVES, SHUTTERS, NAMELY, NON-METAL LATCHES, NON-METAL HANDLES FOR WINDOWS, DOORS, GATES, SHELVES AND SHUTTERS; NON METAL LOCKS FOR WINDOWS, DOORS, GATES, SHELVES, AND SHUTTERS; NON METAL WINDOWS FITTINGS; NON-METAL DOOR FITTINGS, NAMELY, NON-METAL DOOR BOLTS, NON-METAL DOOR TRIMS, NON-METAL DOOR VIEWERS (U.S. CLS. 2, 13, 22, 25, 32 AND 50).

CLASS 35—ADVERTISING AND BUSINESS

FOR PLANNING AND CONDUCTING TRADE FAIRS AND EXHIBITIONS FOR ECONOMIC AND ADVERTISING PURPOSES; MARKETING AND ADVERTISING; PERFORMING OF MARKETING RESEARCH STUDIES; MARKET RESEARCH; PROVISION OF BUSINESS AND MARKETING INFORMATION (U.S. CLS. 100, 101 AND 102).

CLASS 37—CONSTRUCTION AND REPAIR

FOR BUILDING CONSTRUCTION SERVICES; REPAIR SERVICES, NAMELY, REPAIR OF BUILDINGS AND BUILDING COMPONENTS, NAMELY, ROOFS, CONSERVATORIES, GLASS FRAMES, STAIRS, WINDOWS, DOORS, GATES, ROLLER BLINDS, ROLLER BLIND CASINGS, WINDOW AND DOOR FRAMES, WINDOW SILLS, AWNING SUBSTRUCTURES, SUNSCREENS, AS WELL AS ILLUMINATING, HEATING, STEAM GENERATING, COOLING, DRYING, VENTILATION AND WATER CONDUIT DEVICES, AS WELL AS SANITARY INSTALLATIONS; INSTALLATION, MAINTENANCE AND REPAIR OF COMPUTER HARDWARE; INSTALLATION WORK, NAMELY, INSTALLATION OF ELECTRICAL SYSTEMS, APPLIANCES, WINDOWS, DOORS, GATES, SHUTTERS, ROLLER BLINDS (U.S. CLS. 100, 103 AND 106).

CLASS 41—EDUCATION AND ENTERTAINMENT

FOR TRAINING AND ADVANCED TRAINING SERVICES IN THE FIELD OF PLANNING, CONSTRUCTING AND USING WINDOWS, DOORS, GATES, SHUTTERS AND OTHER BUILDING MATERIALS; PROVIDING INFORMATION IN THE FIELD OF EDUCATION, TRAINING AND PUBLICATION IN THE FIELD OF BUILDING AND WINDOW CONSTRUCTION; EDUCATION SERVICES, NAMELY, PROVIDING TRAINING AND ADVANCED TRAINING IN THE NATURE OF SEMINARS AND WORKSHOPS, SERIES OF LECTURES, AND SYMPOSIA IN THE FIELD OF PLANNING, USING AND CONSTRUCTING WINDOWS, DOORS, GATES, SHUTTERS AND OTHER BUILDING MATERIALS; TECHNICAL INSTRUCTION IN THE FIELD OF USING WINDOWS, DOORS, GATES, SHUTTERS AND OTHER BUILDING MATERIALS; TRAINING SERVICES IN THE FIELD OF SALES IN THE FIELD OF PLANNING, USING AND CONSTRUCTING WINDOWS, DOORS, GATES, SHUTTERS AND OTHER BUILDING MATERIALS (U.S. CLS. 100, 101 AND 107).

CLASS 42—SCIENTIFIC AND COMPUTER SERVICES

FOR RESEARCH, SCIENTIFIC AND TECHNOLOGY SERVICES, NAMELY, SCIENTIFIC RESEARCH, TECHNOLOGY CONSULTATION AND RESEARCH IN THE FIELD OF USING AND CONSTRUCTING WINDOWS, DOORS, GATES, SHUTTERS AND OTHER BUILDING MATERIALS; RESEARCH, TECHNICAL DEVELOPMENT AND DESIGNER SERVICES IN THE FIELD OF BUILDING AND WINDOW CONSTRUCTION, NAMELY, RESEARCH ON BUILDING CONSTRUCTION, RESIDENTIAL BUILDING DESIGN, DESIGN FOR WINDOWS, DOORS, SHUTTERS AND OTHER BUILDING MATERIALS; NEW PRODUCT DESIGN AND DEVELOPMENT FOR OTHERS; DESIGN FOR OTHERS IN THE FIELD OF ENGINEERING; CONSTRUCTION AND STRUCTURAL PLANNING, NAMELY, PLANNING OF BUILDINGS AND INFRASTRUCTURE SYSTEMS FOR BUILDINGS; ARCHITECTURAL CONSULTATION; CONSULTATION SERVICES IN THE FIELD OF PRODUCT DEVELOPMENT IN THE FIELD ELECTRICAL INSTALLATIONS AND HEATING TECHNOLOGY; TECHNICAL CONSULTATION IN THE FIELD OF ENGINEERING (U.S. CLS. 100 AND 101).

KATHERINE E. HALMEN, EXAMINING ATTORNEY

SN 79-051,700. GENETHIA PHRIMA S.R.L., ITALY, FILED 2-6-2008.

GENETHIA

THE MARK CONSISTS OF STANDARD CHARACTERS WITHOUT CLAIM TO ANY PARTICULAR FONT, STYLE, SIZE, OR COLOR.

PRIORITY DATE OF 12-13-2007 IS CLAIMED.

OWNER OF INTERNATIONAL REGISTRATION 0958263 DATED 2-6-2008, EXPIRES 2-6-2018.

CLASS 3—COSMETICS AND CLEANING PREPARATIONS

FOR SOAPS, PERFUMERY, ESSENTIAL OILS, COSMETICS, HAIR LOTIONS (U.S. CLS. 1, 4, 6, 50, 51 AND 52).

CLASS 5—PHARMACEUTICALS

FOR MEDICATED PHARMACEUTICAL PRODUCTS, NAMELY, ALL PREPARATIONS IN THE FORM OF LOTIONS, GELS, BALMS, CREAMS, AND GUMS FOR USE IN COMBATING PERSPIRATION, MOISTURIZING SKIN, SKIN AGING AND ELASTICITY PROBLEMS, BURNS AND ITCHES; MEDICINAL PREPARATIONS FOR THE MOUTH TO BE APPLIED IN THE FORM OF TABLETS, GELATIN CAPSULES AND POWDERS FOR USE IN COMBATING PERSPIRATION, SKIN MOISTURIZING, SKIN AGING AND ELASTICITY PROBLEMS AND CELLULITE REDUCTION TREATMENTS, AND FOR USE IN PLASTIC SURGERY, SANITARY PREPARATIONS FOR MEDICAL PURPOSES, DIETETIC SUBSTANCES, NAMELY, FUNCTIONAL DIETARY SUPPLEMENTS SUITABLE FOR MEDICAL USE, MEDICAL PLASTERS, DRESSING FOR WOUNDS, BURNS AND SURGERY, NAMELY, MEDICAL PLASTERS IN THE FORM OF SKIN HEALING MEMBRANES AND MOIST WOUND DRESSINGS, CREAMS, GELS, LOTIONS, GAUZES, AND BANDAGES (U.S. CLS. 6, 18, 44, 46, 51 AND 52).

CLASS 10—MEDICAL APPARATUS

FOR MEDICAL APPARATUS AND INSTRUMENTS TO BE USED IN PLASTIC SURGERY AND AESTHETIC MEDICINE, BREAST IMPLANTS AND SURGICAL IMPLANTS COMPRISING ARTIFICIAL MATERIAL (U.S. CLS. 26, 39 AND 44).

BARBARA BROWN, EXAMINING ATTORNEY

SN 79-052,509. DONGPENG EUROPE S.P.A., VERONA, ITALY, FILED 2-21-2008.

DPE

THE MARK CONSISTS OF STANDARD CHARACTERS WITHOUT CLAIM TO ANY PARTICULAR FONT, STYLE, SIZE, OR COLOR.

PRIORITY DATE OF 8-27-2007 IS CLAIMED.

OWNER OF INTERNATIONAL REGISTRATION 0960533 DATED 2-21-2008, EXPIRES 2-21-2018.

CLASS 11—ENVIRONMENTAL CONTROL APPARATUS

FOR APPARATUS FOR WATER SUPPLY AND SANITARY PURPOSES, NAMELY, SHOWER ENCLOSURES, SHOWER TRAYS, SHOWER PANELS AND SHOWER MIXER, BODY-HYDROMASSAGING SHOWER HEADS, SAUNAS, BATH TUBS AND HYDROMASSAGE BATH TUBS, FAUCETS AND MIXER FAUCETS, BASINS, NAMELY, SINKS, BIDET AND TOILETS (U.S. CLS. 13, 21, 23, 31 AND 34).

CLASS 19—NON-METALLIC BUILDING MATERIALS

FOR NON-METALLIC BUILDING MATERIALS, NAMELY, COMPOSITE PANELS OF NON-METALLIC MATERIAL, CERAMIC AND RUBBER TILES, BUILDING DECORATIVE GLASS, WOODEN FLOOR BOARDING AND WOOD PANELING, PARQUET FLOORING (U.S. CLS. 1, 12, 33 AND 50).

CLASS 27—FLOOR COVERINGS

FOR FLOORS COVERINGS (U.S. CLS. 19, 20, 37, 42 AND 50).

CHARISMA HAMPTON, EXAMINING ATTORNEY

SN 79-052,874. AC SERENDIP LTD., BREMEN HRB, FED REP GERMANY, FILED 1-25-2008.

Serendip

PRIORITY DATE OF 7-27-2007 IS CLAIMED.
OWNER OF INTERNATIONAL REGISTRATION 0961611
DATED 1-25-2008, EXPIRES 1-25-2018.

CLASS 7—MACHINERY

FOR FILLING MACHINES; ELECTROMECHANICAL MACHINES FOR THE CHEMICAL AND MANUFACTURING INDUSTRIES, NAMELY, MIXING AND EMULSIFYING MACHINES FOR CHEMICAL PROCESSING; PROCESS MACHINERY, NAMELY, MACHINES FOR MIXING, DISSOLVING, EXTRACTING, HOMOGENIZING, DISRUPTING, AND ENCAPSULATION IN THE FIELD OF CHEMICAL PROCESSING; FILTER MACHINES AND INSERTS THEREFORE, NAMELY, FILTERS FOR CHEMICAL PROCESSING MACHINES; CONVEYORS; MOLDING MACHINES, NAMELY, INJECTION PLASTIC MOLDING MACHINES; CRUSHING UNITS AND MACHINES, NAMELY, ELECTRIC CRUSHERS FOR CHEMICAL PROCESSING FOR CRUSHING SEMI-SOLID, EMULSION, AND LIQUID MATERIALS; PRESSES, NAMELY, MECHANICAL PRESSES FOR CHEMICAL PROCESSING; PUMPS, NAMELY, ROTARY PUMPS AND MONO PUMPS IN THE NATURE OF HYDRAULIC PUMPS; CLEANING APPARATUS AND MACHINES, NAMELY, STEAM AND LIQUID MECHANICAL CLEANING MACHINES; VIBRATORS FOR INDUSTRIAL PURPOSES, NAMELY, ELECTRICAL VIBRATORS FOR CHEMICAL PROCESSING; ATOMISERS IN THE NATURE OF MACHINES, NAMELY, FLUID AND POWDER SPRAYERS; MIXING MACHINES FOR HOMOGENIZING SUBSTANCES; CHEMICAL PROCESSING MACHINES FOR MIXING, STIRRING, KNEADING, AND CONVEYING SUBSTANCES; DISPERSION, EMULSIFYING AND SUSPENSION MACHINES FOR CHEMICAL PROCESSING; CONTINUOUS MIXER MACHINES; CONVEYOR CHAINS FOR USE IN SUPPLY SYSTEMS (U.S. CLS. 13, 19, 21, 23, 31, 34 AND 35).

CLASS 42—SCIENTIFIC AND COMPUTER SERVICES

FOR SCIENTIFIC, TECHNOLOGICAL AND RESEARCH SERVICES, NAMELY, DEVELOPING AND TESTING OF TECHNIQUES, TECHNOLOGIES, AND PROCESSES TO ENABLE AND IMPROVE HOMOGENIZING, MIXING, KNEADING, STIRRING, DISPERSING, AND CONVEYING SUBSTANCES IN THE FIELD OF CHEMICAL PROCESSING; INDUSTRIAL ANALYSIS AND RESEARCH SERVICES, NAMELY, ANALYSIS REGARDING CONCENTRATION MEASURING, PARTICLE SIZE DISTRIBUTION, VISCOSITY, TEMPERATURE, DENSITY, AND INTERFACIAL TENSION, AND, NAMELY, RESEARCH REGARDING PROCESS UNIT

CHARACTERIZATION VIA FLOW RATES, ENERGY CONSUMPTION, AND PRODUCTIVITY, ALL IN THE FIELD OF CHEMICAL PROCESSING; DESIGN AND DEVELOPMENT OF COMPUTER HARDWARE AND SOFTWARE; RESEARCH IN THE FIELD OF CHEMISTRY, PHYSICS AND ENGINEERING; SERVICES IN THE FIELD OF CHEMICAL PROCESSING, NAMELY, DEVELOPING AND IMPROVING THE PERFORMANCE AND EFFICIENCY OF PROCESSES; ENGINEERING SERVICES; AND MECHANICAL ENGINEERING SERVICES; ENGINEERING; RESEARCH AND DEVELOPMENT OF NEW PRODUCTS FOR OTHERS; RESEARCH IN THE FIELD OF TECHNOLOGY IN THE NATURE OF CHEMICAL PROCESSING AND MECHANICAL ENGINEERING; PROVIDING OF TECHNICAL AND TECHNOLOGICAL EXPERTISE, NAMELY, CONSULTING IN THE FIELD OF CHEMICAL PROCESSING AND MECHANICAL ENGINEERING; CONSTRUCTION DRAFTING; TECHNICAL PLANNING SERVICES FOR CHEMICAL PROCESSING PLANTS; DEVELOPMENT OF PROCESSES AND METHODS FOR MANUFACTURING EMULSIONS, SUSPENSIONS AND DISPERSION SYSTEMS; SERVICES FOR THE DEVELOPMENT OF PARTS, PRODUCTS AND PROCESSES, NAMELY, DEVELOPMENT OF NEW TECHNOLOGY FOR OTHERS IN THE FIELD OF PHARMACY, BIOTECHNOLOGY, CHEMICAL PROCESSING, DEVELOPMENT AND TESTING OF CHEMICAL PRODUCTION METHODS (U.S. CLS. 100 AND 101).

APRIL ROACH, EXAMINING ATTORNEY

SN 79-053,112. CULLINAN ANSTALT, FL-9490 VADUZ, LIECHTENSTEIN, FILED 2-11-2008.

C U L L I N A N  D I A M O N D S

OWNER OF INTERNATIONAL REGISTRATION 0962295
DATED 2-11-2008, EXPIRES 2-11-2018.

OWNER OF U.S. REG. NOS. 2,887,901, 2,953,825 AND 2,996,925.

NO CLAIM IS MADE TO THE EXCLUSIVE RIGHT TO USE "DIAMONDS", APART FROM THE MARK AS SHOWN.

THE MARK CONSISTS OF THE WORDING "CULLINAN DIAMONDS" AND A DESIGN OF A LOTUS FLOWER SEPARATING THE TWO WORDS.

CLASS 14—JEWELRY

FOR DIAMONDS; PRECIOUS METALS AND THEIR ALLOYS MADE WHOLLY OR SUBSTANTIALLY OF DIAMONDS; PRODUCTS MADE OR COATED WITH PRECIOUS METALS AND THEIR ALLOYS, NAMELY, NECKLACES, JEWELLERY, BRACELETS, CHARMS, RINGS AND EARRINGS MADE WHOLLY OR SUBSTANTIALLY OF DIAMONDS; JEWELLERY MADE WHOLLY OR SUBSTANTIALLY OF DIAMONDS, PRECIOUS STONES MADE WHOLLY OR SUBSTANTIALLY OF DIAMONDS; HOROLOGICAL AND CHROMOMETRIC INSTRUMENTS MADE WHOLLY OR SUBSTANTIALLY OF DIAMONDS (U.S. CLS. 2, 27, 28 AND 50).

CLASS 40—MATERIAL TREATMENT

FOR TREATMENT OF MATERIALS, NAMELY, DIAMOND CUTTING, EMBOSsing WORDS, DESIGNS OR IMAGES ON JEWELLERY, ENGRAVING, METAL STAMPING; CONSULTING SERVICES RELATING TO ALL THE AFORESAID SERVICES, NAMELY, PROVIDING MATERIAL TREATMENT INFORMATION (U.S. CLS. 100, 103 AND 106).

CLASS 42—SCIENTIFIC AND COMPUTER SERVICES

FOR DESIGN SERVICES, NAMELY, DESIGNING OF JEWELLERY AND DIAMOND; SERVICES OF A GEOLOGIST, NAMELY, PROVIDING GEOLOGICAL ESTIMATIONS AND RESEARCH, GEOLOGICAL PROSPECTING, GEOLOGICAL SURVEYING, GEOLOGICAL SURVEYS OR RESEARCH (U.S. CLS. 100 AND 101).

CHARISMA HAMPTON, EXAMINING ATTORNEY

SN 79-053,839. INFRARED INTEGRATED; SYSTEMS LIMITED, UNITED KINGDOM, FILED 1-29-2008.



PRIORITY DATE OF 12-21-2007 IS CLAIMED.
OWNER OF INTERNATIONAL REGISTRATION 0964322 DATED 1-29-2008, EXPIRES 1-29-2018.
OWNER OF U.S. REG. NOS. 2,562,393 AND 2,867,010.

CLASS 9—ELECTRICAL AND SCIENTIFIC APPARATUS

FOR ELECTRONIC DETECTION, MONITORING, COUNTING, TRACKING, STEERING, AND LOCATING COMPONENTS, APPARATUS, AND INSTRUMENTS, FOR DETECTING AND INTERPRETING HEAT CHANGE, HEAT DISTRIBUTION, AND MOVEMENT OF PEOPLE, ANIMALS, VEHICLES, AND MACHINERY, FOR USE IN SAFETY SYSTEMS, SECURITY SYSTEMS, FIRE DETECTION SYSTEMS, MANUFACTURING PROCESS CONTROL SYSTEMS, LABORATORY MEASUREMENT SYSTEMS, QUEUE MONITORING, AND AUTOMATIC ELECTRIC DOOR CONTROLLERS; ANTI-INTRUSION, BURGLAR, AND FIRE ALARMS; ELECTRONIC APPARATUS AND INSTRUMENTS USING ARRAYS OF INFRARED DETECTORS FOR DETECTING THE PRESENCE OF INFRARED LASER BEAMS, NAMELY, LASER SPOT AND OTHER BEAM DETECTORS; ELECTRONIC APPARATUS AND INSTRUMENTS USING ARRAYS OF INFRARED DETECTORS FOR DETECTION AND ANALYSIS OF GAS, FOR USE IN SAFETY SYSTEMS, SECURITY SYSTEMS, FIRE DETECTION SYSTEMS, MANUFACTURING PROCESS CONTROL SYSTEMS, AND LABORATORY MEASUREMENT SYSTEMS; ELECTRONIC APPARATUS AND INSTRUMENTS USING ARRAYS OF INFRARED DETECTORS FOR DETECTION AND INTERPRETATION OF CHEMICAL AND BIOLOGICAL ACTIVITY, FOR USE IN SAFETY SYSTEMS, SECURITY SYSTEMS, FIRE DETECTION SYSTEMS, MANUFACTURING PROCESS CONTROL SYSTEMS, AND LABORATORY MEASUREMENT SYSTEMS; THERMAL IMAGING APPARATUS AND INSTRUMENTS USED TO MEASURE TEMPERATURE; FACILITIES MANAGEMENT DEVICES FOR CONTROLLING BUILDING ENVIRONMENTAL, SECURITY, ACCESS, AND ELEVATOR FUNCTIONS, NAMELY, ELECTRONIC MOVEMENT, PRESENCE, AND TEMPERATURE FLOW DETECTORS CONNECTED TO CONTROL DEVICES THAT ANALYZE OUTPUT FROM THE DETECTORS AND PROVIDE STATUS AND CONTROL INFORMATION; HEALTHCARE MONITORING SYSTEMS, NAMELY, ELECTRONIC DEVICES COMPRISING DETECTORS BASED ON ARRAYS OF INFRARED DETECTORS CONNECTED TO A CONTROL DEVICE THAT ANALYZES OUTPUT FROM THE DETECTORS AND PROVIDING INFORMATION REGARDING THE PRESENCE, MOVEMENT, LOCATION, AND ACTIVITY OF OLD, INFIRM, INCAPACITATED, OR VULNERABLE PEOPLE; AUTOMATIC ELECTRICAL DOOR CONTROLLERS; ELECTRONIC DEVICES FOR TRACKING AND COUNTING VEHICLES ON ROADS AND IN PARKING LOTS, COMPRISING ONE OR MORE ELECTRONIC VEHICLE DETECTORS

USING DETECTOR ARRAYS CONNECTED TO A PROCESSOR WITH TRACKING, COUNTING, AND OUTPUT SIGNALLING CAPABILITY; AND PARTS THEREFOR (U.S. CLS. 21, 23, 26, 36 AND 38).

CLASS 12—VEHICLES

FOR ELECTRONIC COLLISION AVOIDANCE SYSTEM MOUNTED ON A VEHICLE, FOR DETECTING AND TRACKING OBJECTS IN THE VICINITY OF THE VEHICLE, COMPRISING ONE OR MORE ELECTRONIC VEHICLE DETECTORS, AT LEAST ONE USING DETECTOR ARRAYS, CONNECTED TO A PROCESSOR WITH TRACKING AND OUTPUT SIGNALLING CAPABILITY; ANTI-THEFT ALARMS AND ANTI-THEFT ALARM SYSTEMS FOR VEHICLES; OCCUPANT DETECTORS AND MONITORS FOR THE PURPOSE OF CONTROLLING THE DEPLOYMENT OF AIR BAGS IN VEHICLES; AND PARTS THEREFOR (U.S. CLS. 19, 21, 23, 31, 35 AND 44).

APRIL ROACH, EXAMINING ATTORNEY

SN 79-054,488. DR. BERNARD HUBER, FED REP GERMANY, FILED 1-17-2008.

The logo for ORYX consists of the word "ORYX" in a large, bold, black, serif font. The letters are closely spaced and have a slightly distressed or textured appearance.

THE MARK CONSISTS OF STANDARD CHARACTERS WITHOUT CLAIM TO ANY PARTICULAR FONT, STYLE, SIZE, OR COLOR.

PRIORITY DATE OF 7-19-2007 IS CLAIMED.
OWNER OF INTERNATIONAL REGISTRATION 0965982 DATED 1-17-2008, EXPIRES 1-17-2018.

THE WORDING "ORYX" HAS NO MEANING IN A FOREIGN LANGUAGE.

CLASS 36—INSURANCE AND FINANCIAL

FOR CAPITAL INVESTMENT, NAMELY, CAPITAL INVESTMENT IN SCIENTIFIC RESEARCH PROJECTS; FINANCIAL SPONSORSHIP OF SCIENTIFIC RESEARCH (U.S. CLS. 100, 101 AND 102).

CLASS 42—SCIENTIFIC AND COMPUTER SERVICES

FOR SCIENTIFIC AND TECHNOLOGICAL SERVICES AND RESEARCH AND DESIGN RELATING THERETO, NAMELY, SCIENTIFIC RESEARCH (U.S. CLS. 100 AND 101).

CLASS 45—PERSONAL AND LEGAL SERVICES

FOR INTELLECTUAL PROPERTY WATCH SERVICES; LICENSING OF INTELLECTUAL PROPERTY RIGHTS AND COPYRIGHTS; DEVELOPMENT OF CONCEPTS FOR THE EXPLOITATION OF INTELLECTUAL PROPERTY, NAMELY, INTELLECTUAL PROPERTY CONSULTATION; DEVELOPMENT OF CONCEPTS FOR THE EXPLOITATION OF INTELLECTUAL PROPERTY RIGHTS, NAMELY, PROVIDING INFORMATION ABOUT INTELLECTUAL AND INDUSTRIAL PROPERTY RIGHTS (U.S. CLS. 100 AND 101).

ROBERT STRUCK, EXAMINING ATTORNEY

SN 79-054,664. W. NEUDORFF GMBH KG, FED REP GERMANY, FILED 5-5-2008.

Ferrox

THE MARK CONSISTS OF STANDARD CHARACTERS WITHOUT CLAIM TO ANY PARTICULAR FONT, STYLE, SIZE, OR COLOR.

PRIORITY DATE OF 11-15-2007 IS CLAIMED.

OWNER OF INTERNATIONAL REGISTRATION 0966595 DATED 5-5-2008, EXPIRES 5-5-2018.

CLASS 1—CHEMICALS

FOR CHEMICALS FOR USE IN AGRICULTURE, EXCEPT FUNGICIDES, HERBICIDES, INSECTICIDES AND PARASITICIDES; CHEMICALS FOR USE IN HORTICULTURE, EXCEPT FUNGICIDES, HERBICIDES, INSECTICIDES AND PARASITICIDES; CHEMICALS FOR USE IN FORESTRY, EXCEPT FUNGICIDES, HERBICIDES, INSECTICIDES AND PARASITICIDES (U.S. CLS. 1, 5, 6, 10, 26 AND 46).

CLASS 5—PHARMACEUTICALS

FOR PREPARATIONS FOR DESTROYING VERMIN; FUNGICIDES; HERBICIDES; ALL PURPOSE DISINFECTANTS (U.S. CLS. 6, 18, 44, 46, 51 AND 52).

KIM SAITO, EXAMINING ATTORNEY

SN 79-054,902. POTASSE ET PRODUITS CHIMIQUES, THANN, FRANCE, FILED 4-30-2008.



PRIORITY DATE OF 10-30-2007 IS CLAIMED.

OWNER OF INTERNATIONAL REGISTRATION 0967355 DATED 4-30-2008, EXPIRES 4-30-2018.

NO CLAIM IS MADE TO THE EXCLUSIVE RIGHT TO USE "POTASSE ET PRODUITS CHIMIQUES", APART FROM THE MARK AS SHOWN.

THE COLOR(S) BLUE AND GREY IS/ARE CLAIMED AS A FEATURE OF THE MARK.

THE MARK CONSISTS OF THE PHRASE "PPC POTASSE ET PRODUITS CHIMIQUES" WITH A CURVED BAND DESIGN; THE COLOR BLUE APPEARS IN THE TERM "PPC" AND IN THE UPPER LEFT AND LOWER RIGHT CURVED BANDS THAT FORM THE INCOMPLETE OVAL; THE COLOR GREY APPEARS IN THE PHRASE "POTASSE ET PRODUITS CHIMIQUES" AND IN THE LOWER LEFT AND UPPER RIGHT CURVED BANDS THAT FORM THE INCOMPLETE OVAL.

THE ENGLISH TRANSLATION OF "POTASSE ET PRODUITS CHIMIQUES" IN THE MARK IS POTASSIUM AND CHEMICAL PRODUCTS.

CLASS 1—CHEMICALS

FOR POTASSIUM-CONTAINING CHEMICAL PRODUCTS, NAMELY, POTASSIUM CARBONATE, POTASSIUM HYDROXIDE ALL FOR USE IN INDUSTRY, SCIENCE, PHOTOGRAPHY, AS WELL AS AGRICULTURE, HORTICULTURE AND FORESTRY; CHLORINE-CONTAINING CHEMICAL PRODUCTS, NAMELY, BLEACH BEING CHEMICALS AND NOT FOR HAIR OR LAUNDRY PURPOSES, CHLORINE BLEACH BEING CHEMICALS AND NOT FOR HAIR OR LAUNDRY PURPOSES, SODIUM HYPOCHLORITE, HYDROCHLORIC ACID ALL FOR USE IN INDUSTRY, SCIENCE, PHOTOGRAPHY, AS WELL AS AGRICULTURE, HORTICULTURE AND FORESTRY; BROMINE-CONTAINING CHEMICAL PRODUCTS, NAMELY, BROMINATED ORGANIC COMPOUNDS, NAMELY, BROMINATED HYDROCARBONS, BROMINATED AROMATIC HYDROCARBONS, BROMINATED PHENOLS, BROMINATED ALKANES, BROMINATED CARBOXYLIC ACIDS, BROMINATED CARBOXYLIC ACID ESTERS, BROMINATED CARBOXYLIC ACID AMIDES AND IMIDES, HYDROBROMIC ACID, ANHYDROUS HYDROBROMIC ACID, SODIUM BROMIDE, AMMONIUM BROMIDE, TETRABUTYLAMMONIUM BROMIDE, ALL FOR USE IN INDUSTRY, SCIENCE PHOTOGRAPHY, AS WELL AS AGRICULTURE, HORTICULTURE AND FORESTRY; UNPROCESSED ARTIFICIAL RESINS, UNPROCESSED PLASTICS; FERTILIZERS; FIRE EXTINGUISHING COMPOSITIONS; TEMPERING AND SOLDERING PREPARATIONS, NAMELY, CHEMICALS FOR USE IN METALWORKING; CHEMICAL PRESERVATIVES FOR PRESERVING FOODSTUFFS; ADHESIVES USED IN INDUSTRY (U.S. CLS. 1, 5, 6, 10, 26 AND 46).

CLASS 5—PHARMACEUTICALS

FOR CHEMICAL PRODUCTS FOR MEDICAL SCIENCE, PHARMACEUTICAL AND VETERINARY PREPARATIONS, NAMELY, CHEMICAL REAGENTS FOR MEDICAL OR VETERINARY USE, CHEMICAL PREPARATIONS FOR SANITARY PURPOSES; SANITARY PREPARATIONS FOR MEDICAL PURPOSES; DISINFECTANTS, NAMELY, DISINFECTANTS FOR HYGIENIC PURPOSES; PREPARATIONS FOR DESTROYING VERMIN; FUNGICIDES, HERBICIDES (U.S. CLS. 6, 18, 44, 46, 51 AND 52).

CLASS 40—MATERIAL TREATMENT

FOR MATERIALS TREATMENT SERVICES, NAMELY, CUSTOM PROCESSING OF SPECIALTY CHEMICALS FOR OTHERS, NAMELY, CUSTOM MANUFACTURE AND CUSTOM BLENDING OF POTASSIUM-CONTAINING CHEMICAL PRODUCTS, SPECIALTY CHLORINE-CONTAINING CHEMICAL PRODUCTS AND SPECIALTY BROMINE-CONTAINING CHEMICAL PRODUCTS (U.S. CLS. 100, 103 AND 106).

CLASS 42—SCIENTIFIC AND COMPUTER SERVICES

FOR SCIENTIFIC AND TECHNOLOGICAL SERVICES, NAMELY, RESEARCH AND DEVELOPMENT SERVICES IN THE FIELDS OF PHARMACOLOGY, AGRICULTURAL CHEMISTRY, BIOTECHNOLOGY, CHEMICALS USED IN ELECTRONICS AND PHOTOGRAPHY AND IN THE FIELD OF THE POLYMERS, DETERGENTS AND GLASS INDUSTRY; SCIENTIFIC AND TECHNOLOGICAL SERVICES, NAMELY, ANALYSIS AND DEVELOPMENT SERVICES FOR THE SYNTHESIS OF BROMINATED ORGANIC COMPOUNDS AND PRODUCTS DERIVED FROM POTASH (U.S. CLS. 100 AND 101).

MYRIAH HABEEB, EXAMINING ATTORNEY

SN 79-055.011, ZAO "HOLDING COMPANY INTERROS",
RUSSIAN FED., FILED 1-17-2008.



PRIORITY DATE OF 11-14-2007 IS CLAIMED.
OWNER OF INTERNATIONAL REGISTRATION 0967567
DATED 1-17-2008, EXPIRES 1-17-2018.

THE COLOR(S) BLUE-GREEN (PANTONE 316) AND
WHITE IS/ARE CLAIMED AS A FEATURE OF THE MARK.

THE MARK CONSISTS OF THE TERM INTERROS AND
THE INVENTED GRAPHIC DESIGNATION, CONSISTING
OF SIX DIFFERENT LENGTH LINES OF HYPERBOLIC
FORM AND ONE HORIZONTAL PLACED CURVE, VI-
SUALLY PERCEIVED AS A FANCY FIGURE OF A TRIAN-
GLE SHAPE. THE COLOR BLUE-GREEN (PANTONE 316)
APPEARS IN THE BACKGROUND AND THE COLOR
WHITE APPEARS IN THE FANCY FIGURE OF A TRIAN-
GLE AND IN THE TERM INTERROS

THE WORDING INTERROS HAS NO MEANING IN A
FOREIGN LANGUAGE

CLASS 9—ELECTRICAL AND SCIENTIFIC APPARATUS

FOR PRERECORDED VIDEO DISKS, VIDEO TAPES,
AND DVDS, FEATURING ANIMATED CARTOONS;
ENCODED CARDS, MAGNETIC; AUDIO VIDEO COM-
PACT DISCS, NAMELY, BLANK CD-ROMS FOR SOUND
OR VIDEO RECORDING, PRERECORDED CDS FEAT-
URING MUSIC OR MOTION PICTURES; READ ONLY
MEMORY COMPACT DISCS, NAMELY, PRERE-
CORDED CDS FEATURING MUSIC OR MOTION PICT-
URES; COMPUTER GAME PROGRAMS; COMPUTER
PROGRAMS, NAMELY, DOWNLOADABLE SOFTWARE
FOR USE AS BIOS (BASIC INPUT OUTPUT SYSTEM),
FOR DATABASE MANAGEMENT, FOR USE AS
SPREADSHEETS, FOR WORD PROCESSING, FOR USE
AS COMPUTER OPERATING SYSTEM, FOR DOCU-
MENT MANAGEMENT, FOR EDITING IMAGES, FOR
USING THE INTERNET AND THE WORLD WIDE WEB,
FOR SENDING AND RECEIVING E-MAIL, FOR CREAT-
ING PRESENTATION SLIDES, FOR COMPILATION OF
CREDIT REPORTING DATA, FOR THE ENABLING OF
ACCESS OR ENTRANCE CONTROL, FOR USE IN
CONSTRUCTION AND AUTOMATED MANUFACTUR-
ING FOR OPERATING AUTOMATED MANUFACTUR-
ING MACHINERY, FOR OPERATING ELECTRONIC
CASH REGISTER SYSTEM, FOR USE IN LANGUAGE
LOCALIZATION BY MEANS OF LANGUAGE TRANSLA-
TION, SUBTITLING, DUBBING, CLOSED CAPTION-
ING AND TELETXT FOR FEATURE FILMS,
TELEVISION PROGRAMS, VIDEOS AND DIGITAL
MEDIA IN GENERAL, FOR CHILDREN'S EDUCATION,
FOR TAX MANAGEMENT, FOR USE AS ANTI-SPY-
WARE SOFTWARE, FOR USE AS ANTI-VIRUS SOFT-
WARE, FOR PROCESSING DIGITAL MUSIC FILES, FOR
USE AS A SEARCH ENGINE, FOR CREATION OF
FIREWALLS, FOR ENCRYPTION AND DECRYPTION
OF DATA, FOR PLAYING MUSIC, FOR WATCHING
VIDEOS, OR FOR COMPRESSION OF DATA FILES;
MAGNETIC DATA MEDIA, NAMELY, BLANK MAG-
NETIC DATA CARRIERS AND DATA DISKS; OPTICAL
DATA MEDIA, NAMELY, BLANK OPTICAL DATA
CARRIERS AND DATA DISKS; DOWNLOADABLE
ELECTRONIC PUBLICATIONS IN THE NATURE OF
BOOKS OR MAGAZINES FEATURING INFORMATION
IN THE FIELDS OF ACCOUNTING, ART, COMPUTER,
MOTOR VEHICLES, DAILY NEWS, ECONOMICS, EN-

GINEERING, SCIENCE, MEDICINE, MUSIC, TRAVEL,
LAW, MATHEMATICS, A SERIES OF FICTION NOVELS,
AND NON-FICTION AUTOBIOGRAPHIES AND BIO-
GRAPHIES; FLOPPY DISKS, NAMELY, BLANK FLOPPY
DISKS, PRERECORDED FLOPPY DISKS FEATURING
COMPUTER PROGRAMS FOR USE AS BIOS (BASIC
INPUT OUTPUT SYSTEM), FOR DATABASE MANAGE-
MENT, FOR USE AS SPREADSHEETS, FOR WORD
PROCESSING, FOR USE AS COMPUTER OPERATING
SYSTEM, FOR DOCUMENT MANAGEMENT, FOR
EDITING IMAGES, FOR USING THE INTERNET AND
THE WORLD WIDE WEB, FOR SENDING AND RECEIV-
ING E-MAIL, FOR CREATING PRESENTATION SLIDES,
FOR COMPILATION OF CREDIT REPORTING DATA,
FOR THE ENABLING OF ACCESS OR ENTRANCE
CONTROL, FOR USE IN CONSTRUCTION AND AUTO-
MATED MANUFACTURING FOR OPERATING AUTO-
MATED MANUFACTURING MACHINERY, FOR
OPERATING ELECTRONIC CASH REGISTER SYSTEM,
FOR USE IN LANGUAGE LOCALIZATION BY MEANS
OF LANGUAGE TRANSLATION, SUBTITLING, DUB-
BING, CLOSED CAPTIONING AND TELETXT FOR
FEATURE FILMS, TELEVISION PROGRAMS, VIDEOS
AND DIGITAL MEDIA IN GENERAL, FOR CHIL-
DREN'S EDUCATION, FOR TAX MANAGEMENT, FOR
USE AS ANTI-SPYWARE SOFTWARE, FOR USE AS
ANTI-VIRUS SOFTWARE, FOR PROCESSING DIGITAL
MUSIC FILES, FOR USE AS A SEARCH ENGINE, FOR
CREATION OF FIREWALLS, FOR ENCRYPTION AND
DECRYPTION OF DATA, FOR PLAYING MUSIC, FOR
WATCHING VIDEOS, OR FOR COMPRESSION OF
DATA FILES; HOLOGRAM APPARATUS; INTERFACES
FOR COMPUTERS; MAGNETS; DECORATIVE MAG-
NETS; MOUSE PADS; RECORDED COMPUTER OPER-
ATING PROGRAMS; PHOTOGRAPHY SLIDES; SOUND
RECORDING CARRIERS, NAMELY, BLANK CD-ROMS,
TAPES AND MICROCHIPS FOR SOUND RECORDING,
PRERECORDED CD-ROMS, TAPES AND MICROCHIPS
FEATURING MUSIC; SOUND RECORDING DISCS,
NAMELY, BLANK CD-ROMS FOR SOUND RECORD-
ING, PRERECORDED CD-ROMS FEATURING MUSIC
(U.S. CLS. 21, 23, 26, 36 AND 38).

CLASS 16—PAPER GOODS AND PRINTED MATTER

FOR ADHESIVE TAPES FOR STATIONERY OR
HOUSEHOLD PURPOSES; ALBUMS FOR COINS,
PHOTOGRAPHS, OR STAMPS; ALMANACS; AN-
NOUNCEMENT CARDS BEING STATIONERY; CONI-
CAL PAPER BAGS; BAGS IN THE FORM OF
ENVELOPES OR POUCHES MADE OF PAPER OR
PLASTICS, FOR MERCHANDISE PACKAGING; LOOSE-
LEAF BINDERS; BOOKBINDING MATERIAL; BOOK-
BINDINGS; BOOKLETS IN THE FIELD OF
ACCOUNTING, ART, ECONOMICS, ENGINEERING,
LAW, MATHEMATICS, MEDICINE, MUSIC, OR
SCIENCE; BOOKMARKERS; BOOKS, NAMELY, AD-
DRESS BOOKS, ACCOUNT BOOKS, A SERIES OF
NOVELS OR NON-FICTION BOOKS IN THE FIELD OF
AUTOBIOGRAPHIES AND BIOGRAPHIES, COMIC
BOOKS, TELEPHONE BOOKS, DICTIONARIES, TEXT-
BOOKS IN THE FIELD OF ACCOUNTING, ART, ECO-
NOMICS, ENGINEERING, LAW, MATHEMATICS,
MEDICINE, MUSIC, OR SCIENCE, TEXTBOOKS FOR
USE IN CHILDREN'S EDUCATION IN THE FIELD OF
MATHEMATICS, READING COMPREHENSION, WRIT-
ING, GRAMMAR, SPELLING, PHYSICAL EDUCATION,
MUSIC, ART, HISTORY, GEOGRAPHY, SCIENCE, OR
SOCIAL STUDIES; BOTTLE ENVELOPES BEING BOT-
TLE WRAPPERS OF CARDBOARD OR PAPER; BOTTLE
WRAPPERS OF CARDBOARD OR PAPER; BOXES FOR
PENS; BOXES OF CARDBOARD OR PAPER; CALEN-
DARS; CARDBOARD; CARDBOARD ARTICLES,
NAMELY, CARDBOARD, CARDBOARD PACKAGING,
CARDBOARD BANNERS, CARDBOARD FLAGS, CARDBOARD
HANG TAGS, CARDBOARD PRINTED MATERI-
ALS, NAMELY, PRINTED INSTRUCTIONAL
MATERIALS IN THE FIELD OF TELECOMMUNICA-
TIONS, CARDBOARD STATIONERIES; CARDBOARD
TUBES; CARDS, NAMELY, BLANK CARDS, BASEBALL
CARDS, GREETING CARDS, BUSINESS CARDS,
PHOTOGRAPH CARDS, NAMELY, GREETING CARDS
FEATURING PHOTOGRAPHS, POSTCARDS FEATUR-
ING PHOTOGRAPHS, IDENTIFICATION CARDS,
NAMELY, NOVELTY IDENTIFICATION CARDS, PAPER
IDENTIFICATION CARDS, CHRISTMAS CARDS, INVI-
TATION CARDS, FLASH CARDS, POST CARDS,

SCRATCH CARDS, HOLIDAY CARDS, NOTE CARDS, SCORE CARDS, TRADING CARDS, VISITING CARDS; CATALOGUES IN THE FIELD OF CLOTHING, FURNITURE, FOOD, COMPUTER, GAME, BOOK, STATIONERY, OR JEWELRY; CHARCOAL PENCILS; COMIC BOOKS; COPYING PAPER BEING STATIONERY; COVERS BEING STATIONERY, NAMELY, BOOK COVERS, DOCUMENT COVERS; CREDIT CARD IMPRINTERS, NON ELECTRIC, FOR OFFICE USE; DECALCOMANIAS; DRAWING PADS; ENGRAVINGS; ENVELOPES BEING STATIONERY; ETCHINGS; FLAGS OF PAPER; FOLDERS FOR PAPERS; FORMS, PRINTED; FOUNTAIN PENS; GRAPHIC PRINTS; GRAPHIC REPRESENTATIONS; GRAPHIC REPRODUCTIONS, NAMELY, GRAPHIC REPRESENTATIONS; GREETING CARDS; LABELS, NOT OF TEXTILE, NAMELY, PAPER LABELS, PLASTIC LABELS; LUMINOUS PAPER; MAGAZINES BEING PERIODICALS FEATURING ACCOUNTING, ART, ECONOMICS, ENGINEERING, LAW, MATHEMATICS, MEDICINE, MUSIC, OR SCIENCE; MUSICAL GREETING CARDS; NEWSLETTERS IN THE FIELD OF ACCOUNTING, ART, ECONOMICS, ENGINEERING, LAW, MATHEMATICS, MEDICINE, MUSIC, OR SCIENCE; NEWSPAPERS; NOTE BOOKS; STATIONERY PADS; PAINTINGS BEING PICTURES, FRAMED OR UNFRAMED; PRINTED PAMPHLETS FEATURING INFORMATION IN THE FIELDS OF OR ABOUT REAL ESTATE SALES, SELLING GOODS TO OTHERS, THEATER, CONCERTS, MUSEUMS, RELIGION, TRAVEL, SIGHTSEEING, OR HOTEL SERVICES, PRINTED PAMPHLETS FEATURING INFORMATION ABOUT BUSINESSES OR POLITICAL OPINION; PAPER; PAPER RIBBONS; PAPER SHEETS BEING STATIONERY; PARCHMENT PAPER; PENCIL LEAD HOLDERS; PENCILS; PHOTOENGRAVINGS; PHOTOGRAPHS; PICTURES; PAPER POSTAGE STAMPS; POSTCARDS; POSTERS; PRINTED MATTER, NAMELY, VINYL STATIC CLING SHEETS ON WHICH PRAYERS ARE PRINTED FOR AFFIXATION IN WINDOWS AND WINDSHIELDS; PRINTED TIMETABLES; PRINTS BEING ENGRAVINGS; PRINTED PROSPECTUSES FEATURING INFORMATION ABOUT MOTION PICTURE FILMS, COMPANIES, SCHOOLS, OR STOCKS; SEALING COMPOUNDS FOR STATIONERY PURPOSES, NAMELY, SEALING WAX, GLUES, ADHESIVES; SEALING STAMPS; SEALS BEING STAMPS; SIGNBOARDS OF PAPER OR CARDBOARD; SILVER PAPER; STENCIL PLATES; STICKERS BEING STATIONERY; TEAR-OFF CALENDARS; PRINTED TICKETS; TRACING CLOTH IN THE NATURE OF TRANSPARENT CLOTH FOR TRACING, NAMELY, TRACING PAPER; TRACING PAPER; TRACING PATTERNS, NAMELY, PRINTED PAPER TRACING PATTERNS, PRINTED IRON-ON TRACING PATTERNS, PRINTED PLASTIC TRACING PATTERNS; WOOD PULP BOARD BEING STATIONERY, NAMELY, PAPER; WOOD PULP PAPER; WRAPPING PAPER; WRITING PAPER (U.S. CLS. 2, 5, 22, 23, 29, 37, 38 AND 50).

CLASS 18—LEATHER GOODS

FOR BACKPACKS; LEATHER OR LEATHER BOARD BOXES; BRIEFCASES; CARD CASES BEING NOTE-CASES, NAMELY, NAME CARD CASES, BUSINESS CARD CASES; CHAMOIS LEATHER, OTHER THAN FOR CLEANING PURPOSES; HAVERSACKS; IMITATION LEATHER; LEATHER, UNWORKED OR SEMIWORKED; LEATHERBOARD, NAMELY, IMITATION LEATHER; PARASOLS; POCKET WALLETS; PURSES; TRAVELLING SETS, NAMELY, TRAVELLING BAGS BEING LEATHERWARE; UMBRELLAS; UNFITTED VANITY CASES (U.S. CLS. 1, 2, 3, 22 AND 41).

CLASS 20—FURNITURE AND ARTICLES NOT OTHERWISE CLASSIFIED

FOR WORKS OF ART OF WOOD, WAX, PLASTER OR PLASTIC; BOOK RESTS BEING FURNITURE; CABINET WORK, NAMELY, WOODEN CABINET BEING FURNITURE; DISPLAY STANDS; MAGAZINE RACKS; MIRRORS BEING LOOKING GLASSES; MOBILES BEING DECORATION; NEWSPAPER DISPLAY STANDS; PLACARDS OF WOOD OR PLASTICS; SIGNBOARDS OF WOOD OR PLASTICS; WICKERWORK IN THE NATURE OF FURNITURE (U.S. CLS. 2, 13, 22, 25, 32 AND 50).

CLASS 21—HOUSEWARES AND GLASS

FOR CERAMICS FOR HOUSEHOLD PURPOSES, NAMELY, CERAMIC BOWLS, CERAMIC CUPS, CERAMIC FIGURINES, CERAMIC PLATES, CERAMIC VASES; ENAMELLED GLASS; GLASS INCORPORATING FINE ELECTRICAL CONDUCTORS; OPAL GLASS; GLASS, UNWORKED OR SEMIWORKED, EXCEPT BUILDING GLASS; MAJOLICA, NAMELY, EARTHENWARE IN THE FORM OF BOWLS, CUPS, FIGURINES, PLATES, OR VASES; MOSAICS OF GLASS, NOT FOR BUILDING; FITTED PICNIC BASKETS; FITTED PICNIC BASKETS CONTAINING DISHES; SIGNBOARDS OF PORCELAIN OR GLASS; TOILET CASES, NAMELY, CONTAINERS FOR TOILETRY, NAMELY, FITTED VANITY CASES; WORKS OF ART, OF PORCELAIN, TERRACOTTA OR GLASS (U.S. CLS. 2, 13, 23, 29, 30, 33, 40 AND 50).

CLASS 24—FABRICS

FOR TEXTILE BANNERS; TEXTILE FLAGS, NOT OF PAPER; LABELS OF CLOTH; SILK BEING CLOTH (U.S. CLS. 42 AND 50).

CLASS 25—CLOTHING

FOR BANDANAS BEING NECKERCHIEFS; BELTS BEING CLOTHING; BRACES FOR CLOTHING BEING SUSPENDERS; COLLAR PROTECTORS; HOSIERY; NECKTIES; SASHES FOR WEAR; SCARVES; SINGLETTS; TEE SHIRTS; TOP HATS; UNIFORMS (U.S. CLS. 22 AND 39).

CLASS 26—FANCY GOODS

FOR BADGES FOR WEAR, NOT OF PRECIOUS METAL, NAMELY, BADGES FOR CLOTHING, NAMELY, ORNAMENTAL NOVELTY BADGES; FANCY GOODS, NAMELY, EMBROIDERY; RIBBONS BEING HABERDASHERY; TRIMMINGS FOR CLOTHING, NAMELY, BORDER DECORATION FOR CLOTHING (U.S. CLS. 37, 39, 40, 42 AND 50).

CLASS 28—TOYS AND SPORTING GOODS

FOR BELLS FOR CHRISTMAS TREES; BOARD GAMES; CHESS GAMES; ORNAMENTS FOR CHRISTMAS TREES, EXCEPT ILLUMINATION ARTICLES AND CONFECTIONERY; GAMES, NAMELY, ACTION SKILL GAMES, ACTION TARGET GAMES, ACTION-TYPE TARGET GAMES, AERO-DYNAMIC DISK CATCHING GAMES, ARCADE GAMES, ARCADE-TYPE ELECTRONIC EDUCATION VIDEO GAMES, ARCADE-TYPE ELECTRONIC VIDEO GAMES, BACKGAMMON GAMES, BADMINTON BOARD GAMES, BASKETBALL BOARD GAMES, BASKETBALL TABLE TOP GAMES, BILLIARD BOARD GAMES, BINGO BOARD GAMES, BOARD GAMES, BUILDING GAMES, CARD GAMES, CARD GAME FOR BUSINESS TRAINING, CHESS GAMES, COIN-OPERATED VIDEO GAMES, BOARD GAMES FOR PLAYING CRAPS, DART GAMES, DICE GAMES, EDUCATIONAL CARD GAMES, ELECTRONIC DART GAMES, ELECTRONIC GAMES OTHER THAN THOSE ADAPTED FOR USE WITH TELEVISION RECEIVERS ONLY, GAMES OF CHANCE, NAMELY, BOARD GAMES FOR PLAYING CRAPS, GO GAMES, HAND-HELD GAMES WITH LIQUID CRYSTAL DISPLAYS, HORSESHOE GAMES, HUNTING BOARD GAMES, JAPANESE CHESS GAMES, JAPANESE DICE GAMES, JAPANESE CARD GAMES, LOTTERY BOARD GAMES, MAH JONG GAMES, MANIPULATIVE GAMES, MARBLE GAMES, MEMORY GAMES, PADDLE BALL GAMES, PARLOR GAMES, PARTY GAMES, PINBALL GAMES, PINBALL-TYPE GAMES, PUZZLE GAMES, RING GAMES, ROLE PLAYING GAMES, TABLETOP GAMES, TARGET GAMES, TIBETAN DICE GAMES, TRADING CARD GAMES, TREASURE HUNT BOARD GAMES, TRIVIA BOARD GAMES, TRIVIA GAMES PLAYED WITH CARDS AND GAME COMPONENTS, VERTICAL HOOP TARGET GAMES, VIDEO GAMES, NAMELY, COIN-OPERATED VIDEO GAMES, VOLLEYBALL BOARD GAMES; JIGSAW PUZZLES; THEATRICAL MASKS; TOY MASKS; NOVELTIES FOR PARTIES AND DANCES BEING PARTY FAVORS AND DANCE FAVORS, NAMELY, FAKE TEETH, NOVELTY TOY ITEM IN THE NATURE OF A DISPENSER OF STREAM

MATERIAL; TOYS, NAMELY, BABY MULTIPLE ACTIVITY TOYS, BATH TOYS, BATHTUB TOYS, BATTERY OPERATED ACTION TOYS, BENDABLE TOYS, CAT TOYS, CHILDREN'S MULTIPLE ACTIVITY TOYS, CHILDREN'S WIRE CONSTRUCTION AND ART ACTIVITY TOYS, CLOCKWORK TOYS OF METAL OR PLASTIC, CONSTRUCTION TOYS, CRIB TOYS, DISC TOSS TOYS, DOG TOYS, DRAWING TOYS, EDUCATIONAL TOY FOR THE PURPOSE OF THE DEMONSTRATION OF ALTERNATIVE ENERGY SOURCES, EDUCATIONAL TOYS FOR TEACHING MATH PRINCIPLES TO CHILDREN, NAMELY, MANIPULATIVE BLOCKS FOR DISPLAYING PATTERNS AND GROUPINGS, EDUCATIONAL TOYS FOR TEACHING AND TESTING KNOWLEDGE RELATING TO THE POLITICS, POLITICAL PROCESS, AND POLITICAL HISTORY OF THE UNITED STATES, EDUCATIONAL TOYS IN THE NATURE OF AN ILLUSTRATED WALL MAP, ELECTRIC ACTION TOYS, ELECTRIC EDUCATIONAL TOY USED TO DEMONSTRATE ALTERNATIVE ENERGY SOURCES, ELECTRONIC ACTION TOYS, ELECTRONIC NOVELTY TOYS, NAMELY, TOYS THAT ELECTRONICALLY RECORD, PLAY BACK, AND DISTORT OR MANIPULATE VOICES AND SOUNDS, ELECTRONIC TOY VEHICLES, ELECTRONICALLY OPERATED TOY MOTOR VEHICLES, FANTASY CHARACTER TOYS, FLYING TOYS USING ELECTROSTATIC LEVITATION, HAND-POWERED NON-MECHANICAL FLYING TOYS, INFANT ACTION CRIB TOYS, INFANT DEVELOPMENT TOYS, INFANT TOYS, INFLATABLE BATH TOYS, INFLATABLE RIDE-ON TOYS, INFLATABLE THIN RUBBER TOYS, INFLATABLE TOYS, INFLATABLE TOYS SHOWING DECORATIVE PICTURES, LEVER ACTION TOYS, MECHANICAL ACTION TOYS, MECHANICAL TOYS, MINIATURE TOY HELMETS, MODEL TOY STEAM ENGINES, MODEL TOY STEAM OPERATED TRACTION ENGINES, MODELED PLASTIC TOY FIGURINES, MOLDED TOY FIGURES, MUSIC BOX TOYS, MUSICAL TOYS, NON-ELECTRONIC TOY VEHICLES, NON-RIDING TRANSPORTATION TOYS, PET TOYS, PET TOYS CONTAINING CATNIP, PET TOYS MADE OF ROPE, PLASTIC CHARACTER TOYS, PLASTIC TOY HOOPS, PLUSH TOYS, POP UP TOYS, POSITIONABLE PRINTED TOY FIGURES FOR USE IN GAMES, POSITIONABLE PRINTED TOY FIGURES FOR USE IN PUZZLES, POSITIONABLE THREE DIMENSIONAL TOYS FOR USE IN GAMES, POSITIONABLE TOY FIGURES, POSITIONABLE TWO DIMENSIONAL TOYS FOR USE IN GAMES, PRINTED POSITIONABLE TOYS FOR USE IN CHILDREN'S BOARD GAMES, PRINTING TOYS, PULL TOYS, PUNCHING TOYS, PUSH TOYS, RADIO CONTROLLED TOY VEHICLES, REMOTE CONTROL TOY CARS, REMOTE CONTROL TOY RACE CARS, REMOTE CONTROL TOY AIRPLANES, REMOTE CONTROL TOY BOATS, RIDE-ON TOYS, RUBBER CHARACTER TOYS, SAND TOYS, SANDBOX TOYS, SKETCHING TOYS, SOFT SCULPTURE PLUSH TOYS, SOFT SCULPTURE TOYS, SQUEEZABLE SQUEAKING TOYS, SQUEEZE TOYS, STACKING TOYS, STUFFED AND PLUSH TOYS, STUFFED TOY ANIMALS, STUFFED TOY BEARS, STUFFED TOYS, TALKING ELECTRONIC PRESS-DOWN TOYS, TALKING TOYS, TESSELATION TOYS, TOSSING DISC TOYS, TOY ACTION FIGURES, TOY ACTION FIGURES AND ACCESSORIES THEREFOR, TOY AIRPLANES, TOY AND NOVELTY FACE MASKS, TOY ANIMALS, TOY ANIMALS AND ACCESSORIES THEREFOR, TOY ARMOR, TOY ARTIFICIAL FINGERNAILS, TOY BAKEWARE AND COOKWARE, TOY BALLOONS, TOY BANKS, TOY BOATS, TOY BOWS AND ARROWS, TOY BOXES, TOY BUILDING BLOCKS, TOY BUILDING BLOCKS CAPABLE OF INTERCONNECTION, TOY BUILDING STRUCTURES AND TOY VEHICLE TRACKS, TOY BUILDINGS AND ACCESSORIES THEREFOR, TOY BUTTERFLY NETS, TOY CAP PISTOLS, TOY CARS, TOY CHRISTMAS TREES, TOY CLOCKS AND WATCHES, TOY CONSTRUCTION BLOCKS, TOY CONSTRUCTION SETS, TOY FIGURES, TOY FILM CARTRIDGES AND VIEWERS, TOY FOAM NOVELTY ITEMS, NAMELY, FOAM FINGERS AND HANDS, TOY FURNITURE, TOY GLIDERS, TOY GLOCKENSPIELS, TOY GUNS, TOY HARMONICAS, TOY HOLSTERS, TOY HOOP SETS, TOY HOUSES, TOY MAILBOXES, TOY MASKS, TOY MOBILES, TOY MODEL CARS, TOY MODEL GUITARS, TOY MODEL HOBBYCRAFT KITS, TOY MODEL KIT CARS, TOY MODEL TRAIN SETS, TOY MODEL VEHICLES AND RELATED ACCESSORIES SOLD AS UNITS, TOY MODELING DOUGH, TOY MUSIC BOXES, TOY NOISEMAKERS, TOY PIANOS,

TOY PIANOS, SOLD AS A UNIT WITH PRINTED BOOKS IN THE FIELD OF MUSIC EDUCATION, TOY PISTOLS, TOY PRISM GLASSES, TOY PUTTY, TOY RECORD PLAYERS, TOY ROBOTS, TOY ROCKETS, TOY SCOOTERS, TOY SETS OF CARPENTERS' TOOLS, TOY SLING PLANES, TOY SNOW GLOBES, TOY STAMPS, TOY SWORDS, TOY TOOLS, TOY TRAINS AND PARTS AND ACCESSORIES THEREFOR, TOY VEHICLE TRACK SETS AND ROADWAYS AND ACCESSORIES THEREFOR, TOY VEHICLES, TOY VEHICLES AND ACCESSORIES THEREFOR, TOY VEHICLES WITH TRANSFORMING PARTS, TOY WATCHES, TOY WATER GLOBES, TOY WEAPONS, TOY WHISTLES, TOY WIND SOCKS, TOY XYLOPHONES, TOY ZIP GUNS, TOY, NAMELY, BATTERY-POWERED COMPUTER GAME WITH LCD SCREEN WHICH FEATURES ANIMATION AND SOUND EFFECTS, TOYS DESIGNED TO BE ATTACHED TO CAR SEATS, TOYS DESIGNED TO BE ATTACHED TO STROLLERS, TOYS DESIGNED TO BE ATTACHED TO CRIBS, TOYS DESIGNED TO BE ATTACHED TO HIGH CHAIRS, TOYS FOR DOMESTIC PETS, TOYS, NAMELY, A DISK TO TOSS IN PLAYING A GAME WHEREIN OTHER DISKS ARE FLIPPED AND COLLECTED, TOYS, NAMELY, CHILDREN'S DRESS-UP ACCESSORIES, TRANSFORMING ROBOTIC TOY VEHICLES, TRANSFORMING ROBOTIC TOYS, TWO AND THREE DIMENSIONAL POSITIONABLE TOY FIGURES SOLD AS A UNIT WITH OTHER TOYS, WATER SQUIRTING TOYS, WIND-UP TOYS, WIND-UP WALKING TOYS (U.S. CLS. 22, 23, 38 AND 50).

CLASS 34—SMOKERS' ARTICLES

FOR MATCH BOXES; SNUFF BOXES (U.S. CLS. 2, 8, 9 AND 17).

CLASS 35—ADVERTISING AND BUSINESS

FOR ADVERTISING SERVICES; ADVERTISING AGENCIES; ADVERTISING BY MAIL ORDER, NAMELY, DIRECT MAIL ADVERTISING; UPDATING OF ADVERTISING MATERIAL; RENTAL OF ADVERTISING SPACE; ARRANGING NEWSPAPER SUBSCRIPTIONS FOR OTHERS; BUSINESS MANAGEMENT OF PERFORMING ARTISTS; DIRECT MAIL ADVERTISING; ORGANIZATION OF EXHIBITIONS FOR COMMERCIAL OR ADVERTISING PURPOSES; NEWS CLIPPING SERVICES; ONLINE ADVERTISING ON A COMPUTER NETWORK; ORGANIZATION OF TRADE FAIRS FOR COMMERCIAL OR ADVERTISING PURPOSES; PHOTOCOPYING; WORD PROCESSING; PUBLIC RELATIONS; PUBLICATION OF PUBLICITY TEXTS; RADIO ADVERTISING SERVICES; TELEVISION ADVERTISING; TRANSCRIPTION, NAMELY, COPYING OF DOCUMENTS FOR OTHERS (U.S. CLS. 100, 101 AND 102).

CLASS 38—COMMUNICATION

FOR ELECTRONIC BULLETIN BOARD SERVICES BEING TELECOMMUNICATIONS SERVICES, NAMELY, PROVIDING ON-LINE ELECTRONIC BULLETIN BOARDS FOR TRANSMISSION OF MESSAGES AMONG COMPUTER USERS CONCERNING ACCOUNTING, ART, BOOKS, COMPUTER, DAILY NEWS, ECONOMICS, EDUCATION, ENGINEERING, GAME, GENERAL INTEREST, LAW, MATHEMATICS, MEDICINE, MOVIE, MUSIC, POLITICAL OPINION, RELIGION, SCIENCE, OR SPORT (U.S. CLS. 100, 101 AND 104).

CLASS 40—MATERIAL TREATMENT

FOR BOOKBINDING; COLOUR SEPARATION SERVICES; EMBROIDERY; ENGRAVING; FRAMING OF WORKS OF ART; OFFSET PRINTING; PATTERN PRINTING; PHOTOGRAPHIC PRINTING; PHOTOGRAPHY; PRINTING; SILKSCREEN PRINTING (U.S. CLS. 100, 103 AND 106).

CLASS 41—EDUCATION AND ENTERTAINMENT

FOR ARRANGING AND CONDUCTING OF EDUCATIONAL CONFERENCES; ARRANGING OF SEMINARS; ARRANGING AND CONDUCTING OF ATHLETIC COMPETITIONS; ARRANGING PROFESSIONAL WORKSHOP AND TRAINING COURSES; ORGANIZATION OF EXHIBITIONS FOR CULTURAL OR EDUCATIONAL PURPOSES; ORGANIZING LIVE EXHIBITIONS AND CONFERENCES IN THE FIELDS OF EDUCATION, CULTURE, SPORTS AND ENTERTAINMENT FOR NON-BUSINESS AND NON-COMMERCIAL PURPOSES; ARRANGING AND CONDUCTING OF EDUCATIONAL, TRAINING, OR CULTURAL CONGRESSES IN THE FIELD OF ACCOUNTING, ART, ECONOMICS, ENGINEERING, LAW, MATHEMATICS, MEDICINE, MUSIC, OR SCIENCE; ARRANGING AND CONDUCTING OF SEMINARS IN THE FIELD OF ACCOUNTING, ART, ECONOMICS, ENGINEERING, LAW, MATHEMATICS, MEDICINE, MUSIC, OR SCIENCE; ARRANGING AND CONDUCTING OF EDUCATIONAL, TRAINING OR CULTURAL SYMPOSIUMS IN THE FIELD OF ACCOUNTING, ART, ECONOMICS, ENGINEERING, LAW, MATHEMATICS, MEDICINE, OR SCIENCE; ARRANGING AND CONDUCTING OF TRAINING WORKSHOPS IN THE FIELD OF ACCOUNTING, ART, ECONOMICS, ENGINEERING, LAW, MATHEMATICS, MEDICINE, MUSIC, OR SCIENCE; PUBLICATION OF BOOKS; ORGANIZATION OF COMPETITIONS FOR EDUCATION OR ENTERTAINMENT, NAMELY, ORGANIZATION OF SPORTS COMPETITIONS AND SPORT FISHING COMPETITIONS; VIDEOTAPE EDITING; ORGANIZATION OF EXHIBITIONS FOR CULTURAL OR EDUCATIONAL PURPOSES; MICROFILMING FOR OTHERS; PHOTOGRAPHIC REPORTING; PHOTOGRAPHY; VIDEOTAPE FILM PRODUCTION; PUBLISHING ELECTRONIC BOOKS AND JOURNALS FOR OTHERS; WRITING OF TEXTS OTHER THAN PUBLICITY TEXTS; VIDEOTAPING (U.S. CLS. 100, 101 AND 107).

CLASS 42—SCIENTIFIC AND COMPUTER SERVICES

FOR DESIGN OF INTERIOR DECOR; GRAPHIC ARTS DESIGNING (U.S. CLS. 100 AND 101).
MYRIAH HABEEB, EXAMINING ATTORNEY

SN 79-055,012. ZAO "HOLDING COMPANY INTERROS", RUSSIAN FED., FILED 1-17-2008.



PRIORITY DATE OF 11-14-2007 IS CLAIMED.
OWNER OF INTERNATIONAL REGISTRATION 0967568 DATED 1-17-2008, EXPIRES 1-17-2018.
THE COLOR(S) BLUE-GREEN (PANTONE 316) AND WHITE IS/ARE CLAIMED AS A FEATURE OF THE MARK.
THE MARK CONSISTS OF THE CYRILLIC CHARAC-

TERS WHICH TRANSLITERATE TO INTERROS AND THE INVENTED GRAPHIC DESIGNATION, CONSISTING OF SIX DIFFERENT LENGTH LINES OF HYPERBOLIC FORM AND ONE HORIZONTAL PLACED CURVE, VISUALLY PERCEIVED AS A FANCY FIGURE OF A TRIANGLE SHAPE. THE COLOR BLUE-GREEN (PANTONE 316) APPEARS IN THE BACKGROUND AND THE COLOR WHITE APPEARS IN THE FANCY FIGURE OF A TRIANGLE AND IN THE CYRILLIC CHARACTERS WHICH TRANSLITERATE TO INTERROS

THE TRANSLITERATION OF THE NON-LATIN CHARACTERS IN THE MARK IS INTERROS AND THIS HAS NO MEANING IN ENGLISH.

CLASS 9—ELECTRICAL AND SCIENTIFIC APPARATUS

FOR PRERECORDED VIDEO DISKS, VIDEO TAPES, AND DVDS, FEATURING ANIMATED CARTOONS; ENCODED CARDS, MAGNETIC; AUDIO VIDEO COMPACT DISCS, NAMELY, BLANK CD-ROMS FOR SOUND OR VIDEO RECORDING, PRERECORDED CDS FEATURING MUSIC OR MOTION PICTURES; READ ONLY MEMORY COMPACT DISCS, NAMELY, PRERECORDED CDS FEATURING MUSIC OR MOTION PICTURES; COMPUTER GAME PROGRAMS; COMPUTER PROGRAMS, NAMELY, DOWNLOADABLE SOFTWARE FOR USE AS BIOS (BASIC INPUT OUTPUT SYSTEM), FOR DATABASE MANAGEMENT, FOR USE AS SPREADSHEETS, FOR WORD PROCESSING, FOR USE AS COMPUTER OPERATING SYSTEM, FOR DOCUMENT MANAGEMENT, FOR EDITING IMAGES, FOR USING THE INTERNET AND THE WORLD WIDE WEB, FOR SENDING AND RECEIVING E-MAIL, FOR CREATING PRESENTATION SLIDES, FOR COMPILATION OF CREDIT REPORTING DATA, FOR THE ENABLING OF ACCESS OR ENTRANCE CONTROL, FOR USE IN CONSTRUCTION AND AUTOMATED MANUFACTURING FOR OPERATING AUTOMATED MANUFACTURING MACHINERY, FOR OPERATING ELECTRONIC CASH REGISTER SYSTEM, FOR USE IN LANGUAGE LOCALIZATION BY MEANS OF LANGUAGE TRANSLATION, SUBTITLING, DUBBING, CLOSED CAPTIONING AND TELETEXT FOR FEATURE FILMS, TELEVISION PROGRAMS, VIDEOS AND DIGITAL MEDIA IN GENERAL, FOR CHILDREN'S EDUCATION, FOR TAX MANAGEMENT, FOR USE AS ANTI-SPYWARE SOFTWARE, FOR USE AS ANTI-VIRUS SOFTWARE, FOR PROCESSING DIGITAL MUSIC FILES, FOR USE AS A SEARCH ENGINE, FOR CREATION OF FIREWALLS, FOR ENCRYPTION AND DECRYPTION OF DATA, FOR PLAYING MUSIC, FOR WATCHING VIDEOS, OR FOR COMPRESSION OF DATA FILES; MAGNETIC DATA MEDIA, NAMELY, BLANK MAGNETIC DATA CARRIERS AND DATA DISKS; OPTICAL DATA MEDIA, NAMELY, BLANK OPTICAL DATA CARRIERS AND DATA DISKS; DOWNLOADABLE ELECTRONIC PUBLICATIONS IN THE NATURE OF BOOKS OR MAGAZINES FEATURING INFORMATION IN THE FIELDS OF ACCOUNTING, ART, COMPUTER, MOTOR VEHICLES, DAILY NEWS, ECONOMICS, ENGINEERING, SCIENCE, MEDICINE, MUSIC, TRAVEL, LAW, MATHEMATICS, A SERIES OF FICTION NOVELS, AND NON-FICTION AUTOBIOGRAPHIES AND BIOGRAPHIES; FLOPPY DISKS, NAMELY, BLANK FLOPPY DISKS, PRERECORDED FLOPPY DISKS FEATURING COMPUTER PROGRAMS FOR USE AS BIOS (BASIC INPUT OUTPUT SYSTEM), FOR DATABASE MANAGEMENT, FOR USE AS SPREADSHEETS, FOR WORD PROCESSING, FOR USE AS COMPUTER OPERATING SYSTEM, FOR DOCUMENT MANAGEMENT, FOR EDITING IMAGES, FOR USING THE INTERNET AND THE WORLD WIDE WEB, FOR SENDING AND RECEIVING E-MAIL, FOR CREATING PRESENTATION SLIDES, FOR COMPILATION OF CREDIT REPORTING DATA, FOR THE ENABLING OF ACCESS OR ENTRANCE CONTROL, FOR USE IN CONSTRUCTION AND AUTOMATED MANUFACTURING FOR OPERATING AUTOMATED MANUFACTURING MACHINERY, FOR OPERATING ELECTRONIC CASH REGISTER SYSTEM, FOR USE IN LANGUAGE LOCALIZATION BY MEANS OF LANGUAGE TRANSLATION, SUBTITLING, DUBBING, CLOSED CAPTIONING AND TELETEXT FOR FEATURE FILMS, TELEVISION PROGRAMS, VIDEOS AND DIGITAL MEDIA IN GENERAL, FOR CHILDREN'S EDUCATION, FOR TAX MANAGEMENT, FOR USE AS ANTI-SPYWARE SOFTWARE, FOR USE AS ANTI-VIRUS SOFTWARE, FOR PROCESSING DIGITAL

MUSIC FILES, FOR USE AS A SEARCH ENGINE, FOR CREATION OF FIREWALLS, FOR ENCRYPTION AND DECRYPTION OF DATA, FOR PLAYING MUSIC, FOR WATCHING VIDEOS, OR FOR COMPRESSION OF DATA FILES; HOLOGRAM APPARATUS; INTERFACES FOR COMPUTERS; MAGNETS; DECORATIVE MAGNETS; MOUSE PADS; RECORDED COMPUTER OPERATING PROGRAMS; PHOTOGRAPHY SLIDES; SOUND RECORDING CARRIERS, NAMELY, BLANK CD-ROMS, TAPES AND MICROCHIPS FOR SOUND RECORDING, PRERECORDED CD-ROMS, TAPES AND MICROCHIPS FEATURING MUSIC; SOUND RECORDING DISCS, NAMELY, BLANK CD-ROMS FOR SOUND RECORDING, PRERECORDED CD-ROMS FEATURING MUSIC (U.S. CLS. 21, 23, 26, 36 AND 38).

CLASS 16—PAPER GOODS AND PRINTED MATTER

FOR ADHESIVE TAPES FOR STATIONERY OR HOUSEHOLD PURPOSES; ALBUMS FOR COINS, PHOTOGRAPHS, OR STAMPS; ALMANACS; ANNOUNCEMENT CARDS BEING STATIONERY; CONICAL PAPER BAGS; BAGS IN THE FORM OF ENVELOPES OR POUCHES MADE OF PAPER OR PLASTICS, FOR MERCHANDISE PACKAGING; LOOSE-LEAF BINDERS; BOOKBINDING MATERIAL; BOOKBINDINGS; BOOKLETS IN THE FIELD OF ACCOUNTING, ART, ECONOMICS, ENGINEERING, LAW, MATHEMATICS, MEDICINE, MUSIC, OR SCIENCE; BOOKMARKERS; BOOKS, NAMELY, ADDRESS BOOKS, ACCOUNT BOOKS, A SERIES OF NOVELS OR NON-FICTION BOOKS IN THE FIELD OF AUTOBIOGRAPHIES AND BIOGRAPHIES, COMIC BOOKS, TELEPHONE BOOKS, DICTIONARIES, TEXTBOOKS IN THE FIELD OF ACCOUNTING, ART, ECONOMICS, ENGINEERING, LAW, MATHEMATICS, MEDICINE, MUSIC, OR SCIENCE, TEXTBOOKS FOR USE IN CHILDREN'S EDUCATION IN THE FIELD OF MATHEMATICS, READING COMPREHENSION, WRITING, GRAMMAR, SPELLING, PHYSICAL EDUCATION, MUSIC, ART, HISTORY, GEOGRAPHY, SCIENCE, OR SOCIAL STUDIES; BOTTLE ENVELOPES BEING BOTTLE WRAPPERS OF CARDBOARD OR PAPER; BOTTLE WRAPPERS OF CARDBOARD OR PAPER; BOXES FOR PENS; BOXES OF CARDBOARD OR PAPER; CALENDARS; CARDBOARD; CARDBOARD ARTICLES, NAMELY, CARDBOARD, CARDBOARD PACKAGING, CARDBOARD BANNERS, CARDBOARD FLAGS, CARDBOARD HANG TAGS, CARDBOARD PRINTED MATERIALS, NAMELY, PRINTED INSTRUCTIONAL MATERIALS IN THE FIELD OF TELECOMMUNICATIONS, CARDBOARD STATIONERIES; CARDBOARD TUBES; CARDS, NAMELY, BLANK CARDS, BASEBALL CARDS, GREETING CARDS, BUSINESS CARDS, PHOTOGRAPH CARDS, NAMELY, GREETING CARDS FEATURING PHOTOGRAPHS, POSTCARDS FEATURING PHOTOGRAPHS, IDENTIFICATION CARDS, NAMELY, NOVELTY IDENTIFICATION CARDS, PAPER IDENTIFICATION CARDS, CHRISTMAS CARDS, INVITATION CARDS, FLASH CARDS, POST CARDS, SCRATCH CARDS, HOLIDAY CARDS, NOTE CARDS, SCORE CARDS, TRADING CARDS, VISITING CARDS; CATALOGUES IN THE FIELD OF CLOTHING, FURNITURE, FOOD, COMPUTER, GAME, BOOK, STATIONERY, OR JEWELRY; CHARCOAL PENCILS; COMIC BOOKS; COPYING PAPER BEING STATIONERY; COVERS BEING STATIONERY, NAMELY, BOOK COVERS, DOCUMENT COVERS; CREDIT CARD IMPRINTERS, NON ELECTRIC, FOR OFFICE USE; DECALCOMANIAS; DRAWING PADS; ENGRAVINGS; ENVELOPES BEING STATIONERY; ETCHINGS; FLAGS OF PAPER; FOLDERS FOR PAPERS; FORMS, PRINTED; FOUNTAIN PENS; GRAPHIC PRINTS; GRAPHIC REPRESENTATIONS; GRAPHIC REPRODUCTIONS, NAMELY, GRAPHIC REPRESENTATIONS; GREETING CARDS; LABELS, NOT OF TEXTILE, NAMELY, PAPER LABELS, PLASTIC LABELS; LUMINOUS PAPER; MAGAZINES BEING PERIODICALS FEATURING ACCOUNTING, ART, ECONOMICS, ENGINEERING, LAW, MATHEMATICS, MEDICINE, MUSIC, OR SCIENCE; MUSICAL GREETING CARDS; NEWSLETTERS IN THE FIELD OF ACCOUNTING, ART, ECONOMICS, ENGINEERING, LAW, MATHEMATICS, MEDICINE, MUSIC, OR SCIENCE; NEWSPAPERS; NOTE BOOKS; STATIONERY PADS; PAINTINGS BEING PICTURES, FRAMED OR UNFRAMED; PRINTED PAMPHLETS FEATURING INFORMATION IN THE FIELDS OF OR ABOUT REAL

ESTATE SALES, SELLING GOODS TO OTHERS, THEATER, CONCERTS, MUSEUMS, RELIGION, TRAVEL, SIGHTSEEING, OR HOTEL SERVICES, PRINTED PAMPHLETS FEATURING INFORMATION ABOUT BUSINESSES OR POLITICAL OPINION; PAPER; PAPER RIBBONS; PAPER SHEETS BEING STATIONERY; PARCHMENT PAPER; PENCIL LEAD HOLDERS; PENCILS; PHOTOENGRAVINGS; PHOTOGRAPHS; PICTURES; PAPER POSTAGE STAMPS; POSTCARDS; POSTERS; PRINTED MATTER, NAMELY, VINYL STATIC CLING SHEETS ON WHICH PRAYERS ARE PRINTED FOR AFFIXATION IN WINDOWS AND WINDSHIELDS; PRINTED TIMETABLES; PRINTS BEING ENGRAVINGS; PRINTED PROSPECTUSES FEATURING INFORMATION ABOUT MOTION PICTURE FILMS, COMPANIES, SCHOOLS, OR STOCKS; SEALING COMPOUNDS FOR STATIONERY PURPOSES, NAMELY, SEALING WAX, GLUES, ADHESIVES; SEALING STAMPS; SEALS BEING STAMPS; SIGNBOARDS OF PAPER OR CARDBOARD; SILVER PAPER; STENCIL PLATES; STICKERS BEING STATIONERY; TEAR-OFF CALENDARS; PRINTED TICKETS; TRACING CLOTH IN THE NATURE OF TRANSPARENT CLOTH FOR TRACING, NAMELY, TRACING PAPER; TRACING PAPER; TRACING PATTERNS, NAMELY, PRINTED PAPER TRACING PATTERNS, PRINTED IRON-ON TRACING PATTERNS, PRINTED PLASTIC TRACING PATTERNS; WOOD PULP BOARD BEING STATIONERY, NAMELY, PAPER; WOOD PULP PAPER; WRAPPING PAPER; WRITING PAPER (U.S. CLS. 2, 5, 22, 23, 29, 37, 38 AND 50).

CLASS 18—LEATHER GOODS

FOR BACKPACKS; LEATHER OR LEATHER BOARD BOXES; BRIEFCASES; CARD CASES BEING NOTE-CASES, NAMELY, NAME CARD CASES, BUSINESS CARD CASES; CHAMOIS LEATHER, OTHER THAN FOR CLEANING PURPOSES; HAVERSACKS; IMITATION LEATHER; LEATHER, UNWORKED OR SEMIWORKED; LEATHERBOARD, NAMELY, IMITATION LEATHER; PARASOLS; POCKET WALLETS; PURSES; TRAVELLING SETS, NAMELY, TRAVELLING BAGS BEING LEATHERWARE; UMBRELLAS; UNFITTED VANITY CASES (U.S. CLS. 1, 2, 3, 22 AND 41).

CLASS 20—FURNITURE AND ARTICLES NOT OTHERWISE CLASSIFIED

FOR WORKS OF ART OF WOOD, WAX, PLASTER OR PLASTIC; BOOK RESTS BEING FURNITURE; CABINET WORK, NAMELY, WOODEN CABINET BEING FURNITURE; DISPLAY STANDS; MAGAZINE RACKS; MIRRORS BEING LOOKING GLASSES; MOBILES BEING DECORATION; NEWSPAPER DISPLAY STANDS; PLACARDS OF WOOD OR PLASTICS; SIGNBOARDS OF WOOD OR PLASTICS; WICKERWORK IN THE NATURE OF FURNITURE (U.S. CLS. 2, 13, 22, 25, 32 AND 50).

CLASS 21—HOUSEWARES AND GLASS

FOR CERAMICS FOR HOUSEHOLD PURPOSES, NAMELY, CERAMIC BOWLS, CERAMIC CUPS, CERAMIC FIGURINES, CERAMIC PLATES, CERAMIC VASES; ENAMELLED GLASS; GLASS INCORPORATING FINE ELECTRICAL CONDUCTORS; OPAL GLASS; GLASS, UNWORKED OR SEMIWORKED, EXCEPT BUILDING GLASS; MAJOLICA, NAMELY, EARTHENWARE IN THE FORM OF BOWLS, CUPS, FIGURINES, PLATES, OR VASES; MOSAICS OF GLASS, NOT FOR BUILDING; FITTED PICNIC BASKETS; FITTED PICNIC BASKETS CONTAINING DISHES; SIGNBOARDS OF PORCELAIN OR GLASS; TOILET CASES, NAMELY, CONTAINERS FOR TOILETRY, NAMELY, FITTED VANITY CASES; WORKS OF ART, OF PORCELAIN, TERRACOTTA OR GLASS (U.S. CLS. 2, 13, 23, 29, 30, 33, 40 AND 50).

CLASS 24—FABRICS

FOR TEXTILE BANNERS; TEXTILE FLAGS, NOT OF PAPER; LABELS OF CLOTH; SILK BEING CLOTH (U.S. CLS. 42 AND 50).

CLASS 25—CLOTHING

FOR BANDANAS BEING NECKERCHIEFS; BELTS BEING CLOTHING; BRACES FOR CLOTHING BEING SUSPENDERS; COLLAR PROTECTORS; HOSIERY; NECKTIES; SASHES FOR WEAR; SCARVES; SINGLETS; TEE SHIRTS; TOP HATS; UNIFORMS (U.S. CLS. 22 AND 39).

CLASS 26—FANCY GOODS

FOR BADGES FOR WEAR, NOT OF PRECIOUS METAL, NAMELY, BADGES FOR CLOTHING, NAMELY, ORNAMENTAL NOVELTY BADGES; FANCY GOODS, NAMELY, EMBROIDERY; RIBBONS BEING HABERDASHERY; TRIMMINGS FOR CLOTHING, NAMELY, BORDER DECORATION FOR CLOTHING (U.S. CLS. 37, 39, 40, 42 AND 50).

CLASS 28—TOYS AND SPORTING GOODS

FOR BELLS FOR CHRISTMAS TREES; BOARD GAMES; CHESS GAMES; ORNAMENTS FOR CHRISTMAS TREES, EXCEPT ILLUMINATION ARTICLES AND CONFECTIONERY; GAMES, NAMELY, ACTION SKILL GAMES, ACTION TARGET GAMES, ACTION-TYPE TARGET GAMES, AERO-DYNAMIC DISK CATCHING GAMES, ARCADE GAMES, ARCADE-TYPE ELECTRONIC EDUCATION VIDEO GAMES, ARCADE-TYPE ELECTRONIC VIDEO GAMES, BACKGAMMON GAMES, BADMINTON BOARD GAMES, BASKETBALL BOARD GAMES, BASKETBALL TABLE TOP GAMES, BILLIARD BOARD GAMES, BINGO BOARD GAMES, BOARD GAMES, BUILDING GAMES, CARD GAMES, CARD GAME FOR BUSINESS TRAINING, CHESS GAMES, COIN-OPERATED VIDEO GAMES, BOARD GAMES FOR PLAYING CRAPS, DART GAMES, DICE GAMES, EDUCATIONAL CARD GAMES, ELECTRONIC DART GAMES, ELECTRONIC GAMES OTHER THAN THOSE ADAPTED FOR USE WITH TELEVISION RECEIVERS ONLY, GAMES OF CHANCE, NAMELY, BOARD GAMES FOR PLAYING CRAPS, GO GAMES, HAND-HELD GAMES WITH LIQUID CRYSTAL DISPLAYS, HORSESHOE GAMES, HUNTING BOARD GAMES, JAPANESE CHESS GAMES, JAPANESE DICE GAMES, JAPANESE CARD GAMES, LOTTERY BOARD GAMES, MAH JONG GAMES, MANIPULATIVE GAMES, MARBLE GAMES, MEMORY GAMES, PADDLE BALL GAMES, PARLOR GAMES, PARTY GAMES, PINBALL GAMES, PINBALL-TYPE GAMES, PUZZLE GAMES, RING GAMES, ROLE PLAYING GAMES, TABLETOP GAMES, TARGET GAMES, TIBETAN DICE GAMES, TRADING CARD GAMES, TREASURE HUNT BOARD GAMES, TRIVIA BOARD GAMES, TRIVIA GAMES PLAYED WITH CARDS AND GAME COMPONENTS, VERTICAL HOOP TARGET GAMES, VIDEO GAMES, NAMELY, COIN-OPERATED VIDEO GAMES, VOLLEYBALL BOARD GAMES; JIGSAW PUZZLES; THEATRICAL MASKS; TOY MASKS; NOVELTIES FOR PARTIES AND DANCES BEING PARTY FAVORS AND DANCE FAVORS, NAMELY, FAKE TEETH, NOVELTY TOY ITEM IN THE NATURE OF A DISPENSER OF STREAM MATERIAL; TOYS, NAMELY, BABY MULTIPLE ACTIVITY TOYS, BATH TOYS, BATHTUB TOYS, BATTERY OPERATED ACTION TOYS, BENDABLE TOYS, CAT TOYS, CHILDREN'S MULTIPLE ACTIVITY TOYS, CHILDREN'S WIRE CONSTRUCTION AND ART ACTIVITY TOYS, CLOCKWORK TOYS OF METAL OR PLASTIC, CONSTRUCTION TOYS, CRIB TOYS, DISC TOSS TOYS, DOG TOYS, DRAWING TOYS, EDUCATIONAL TOY FOR THE PURPOSE OF THE DEMONSTRATION OF ALTERNATIVE ENERGY SOURCES, EDUCATIONAL TOYS FOR TEACHING MATH PRINCIPLES TO CHILDREN, NAMELY, MANIPULATIVE BLOCKS FOR DISPLAYING PATTERNS AND GROUPINGS, EDUCATIONAL TOYS FOR TEACHING AND TESTING KNOWLEDGE RELATING TO THE POLITICS, POLITICAL PROCESS, AND POLITICAL HISTORY OF THE UNITED STATES, EDUCATIONAL TOYS IN THE NATURE OF AN ILLUSTRATED WALL MAP, ELECTRIC ACTION TOYS, ELECTRIC EDUCATIONAL TOY USED TO DEMONSTRATE ALTERNATIVE ENERGY SOURCES, ELECTRONIC ACTION TOYS, ELECTRONIC NOVELTY TOYS, NAMELY, TOYS THAT ELECTRONICALLY RECORD, PLAY BACK, AND DISTORT OR MANIPULATE VOICES AND SOUNDS, ELECTRONIC TOY VEHICLES, ELECTRONICALLY OPERATED TOY MOTOR VEHICLES, FANTASY CHARACTER TOYS,

FLYING TOYS USING ELECTROSTATIC LEVITATION, HAND-POWERED NON-MECHANICAL FLYING TOYS, INFANT ACTION CRIB TOYS, INFANT DEVELOPMENT TOYS, INFANT TOYS, INFLATABLE BATH TOYS, INFLATABLE RIDE-ON TOYS, INFLATABLE THIN RUBBER TOYS, INFLATABLE TOYS, INFLATABLE TOYS SHOWING DECORATIVE PICTURES, LEVER ACTION TOYS, MECHANICAL ACTION TOYS, MECHANICAL TOYS, MINIATURE TOY HELMETS, MODEL TOY STEAM ENGINES, MODEL TOY STEAM OPERATED TRACTION ENGINES, MODELED PLASTIC TOY FIGURINES, MOLDED TOY FIGURES, MUSIC BOX TOYS, MUSICAL TOYS, NON-ELECTRONIC TOY VEHICLES, NON-RIDING TRANSPORTATION TOYS, PET TOYS, PET TOYS CONTAINING CATNIP, PET TOYS MADE OF ROPE, PLASTIC CHARACTER TOYS, PLASTIC TOY HOOPS, PLUSH TOYS, POP UP TOYS, POSITIONABLE PRINTED TOY FIGURES FOR USE IN GAMES, POSITIONABLE PRINTED TOY FIGURES FOR USE IN PUZZLES, POSITIONABLE THREE DIMENSIONAL TOYS FOR USE IN GAMES, POSITIONABLE TOY FIGURES, POSITIONABLE TWO DIMENSIONAL TOYS FOR USE IN GAMES, PRINTED POSITIONABLE TOYS FOR USE IN CHILDREN'S BOARD GAMES, PRINTING TOYS, PULL TOYS, PUNCHING TOYS, PUSH TOYS, RADIO CONTROLLED TOY VEHICLES, REMOTE CONTROL TOY CARS, REMOTE CONTROL TOY RACE CARS, REMOTE CONTROL TOY AIRPLANES, REMOTE CONTROL TOY BOATS, RIDE-ON TOYS, RUBBER CHARACTER TOYS, SAND TOYS, SANDBOX TOYS, SKETCHING TOYS, SOFT SCULPTURE PLUSH TOYS, SOFT SCULPTURE TOYS, SQUEEZABLE SQUEAKING TOYS, SQUEEZE TOYS, STACKING TOYS, STUFFED AND PLUSH TOYS, STUFFED TOY ANIMALS, STUFFED TOY BEARS, STUFFED TOYS, TALKING ELECTRONIC PRESS-DOWN TOYS, TALKING TOYS, TESSELATION TOYS, TOSSING DISC TOYS, TOY ACTION FIGURES, TOY ACTION FIGURES AND ACCESSORIES THEREFOR, TOY AIRPLANES, TOY AND NOVELTY FACE MASKS, TOY ANIMALS, TOY ANIMALS AND ACCESSORIES THEREFOR, TOY ARMOR, TOY ARTIFICIAL FINGERNAILS, TOY BAKEWARE AND COOKWARE, TOY BALLOONS, TOY BANKS, TOY BOATS, TOY BOWS AND ARROWS, TOY BOXES, TOY BUILDING BLOCKS, TOY BUILDING BLOCKS CAPABLE OF INTERCONNECTION, TOY BUILDING STRUCTURES AND TOY VEHICLE TRACKS, TOY BUILDINGS AND ACCESSORIES THEREFOR, TOY BUTTERFLY NETS, TOY CAP PISTOLS, TOY CARS, TOY CHRISTMAS TREES, TOY CLOCKS AND WATCHES, TOY CONSTRUCTION BLOCKS, TOY CONSTRUCTION SETS, TOY FIGURES, TOY FILM CARTRIDGES AND VIEWERS, TOY FOAM NOVELTY ITEMS, NAMELY, FOAM FINGERS AND HANDS, TOY FURNITURE, TOY GLIDERS, TOY GLOCKENSPIELS, TOY GUNS, TOY HARMONICAS, TOY HOLSTERS, TOY HOOP SETS, TOY HOUSES, TOY MAILBOXES, TOY MASKS, TOY MOBILES, TOY MODEL CARS, TOY MODEL GUITARS, TOY MODEL HOBBY-CRAFT KITS, TOY MODEL KIT CARS, TOY MODEL TRAIN SETS, TOY MODEL VEHICLES AND RELATED ACCESSORIES SOLD AS UNITS, TOY MODELING DOUGH, TOY MUSIC BOXES, TOY NOISEMAKERS, TOY PIANOS, TOY PIANOS, SOLD AS A UNIT WITH PRINTED BOOKS IN THE FIELD OF MUSIC EDUCATION, TOY PISTOLS, TOY PRISM GLASSES, TOY PUTTY, TOY RECORD PLAYERS, TOY ROBOTS, TOY ROCKETS, TOY SCOOTERS, TOY SETS OF CARPENTERS' TOOLS, TOY SLING PLANES, TOY SNOW GLOBES, TOY STAMPS, TOY SWORDS, TOY TOOLS, TOY TRAINS AND PARTS AND ACCESSORIES THEREFOR, TOY VEHICLE TRACK SETS AND ROADWAYS AND ACCESSORIES THEREFOR, TOY VEHICLES, TOY VEHICLES AND ACCESSORIES THEREFOR, TOY VEHICLES WITH TRANSFORMING PARTS, TOY WATCHES, TOY WATER GLOBES, TOY WEAPONS, TOY WHISTLES, TOY WIND SOCKS, TOY XYLOPHONES, TOY ZIP GUNS, TOY, NAMELY, BATTERY-POWERED COMPUTER GAME WITH LCD SCREEN WHICH FEATURES ANIMATION AND SOUND EFFECTS, TOYS DESIGNED TO BE ATTACHED TO CAR SEATS, TOYS DESIGNED TO BE ATTACHED TO STROLLERS, TOYS DESIGNED TO BE ATTACHED TO CRIBS, TOYS DESIGNED TO BE ATTACHED TO HIGH CHAIRS, TOYS FOR DOMESTIC PETS, TOYS, NAMELY, A DISK TO TOSS IN PLAYING A GAME WHEREIN OTHER DISKS ARE FLIPPED AND COLLECTED, TOYS, NAMELY, CHILDREN'S DRESS-UP ACCESSORIES, TRANSFORMING ROBOTIC TOY VEHICLES, TRANSFORMING ROBOTIC TOYS, TWO AND

THREE DIMENSIONAL POSITIONABLE TOY FIGURES SOLD AS A UNIT WITH OTHER TOYS, WATER SQUIRTING TOYS, WIND-UP TOYS, WIND-UP WALKING TOYS (U.S. CLS. 22, 23, 38 AND 50).

CLASS 34—SMOKERS' ARTICLES

FOR MATCH BOXES; SNUFF BOXES (U.S. CLS. 2, 8, 9 AND 17).

CLASS 35—ADVERTISING AND BUSINESS

FOR ADVERTISING SERVICES; ADVERTISING AGENCIES; ADVERTISING BY MAIL ORDER, NAMELY, DIRECT MAIL ADVERTISING; UPDATING OF ADVERTISING MATERIAL; RENTAL OF ADVERTISING SPACE; ARRANGING NEWSPAPER SUBSCRIPTIONS FOR OTHERS; BUSINESS MANAGEMENT OF PERFORMING ARTISTS; DIRECT MAIL ADVERTISING; ORGANIZATION OF EXHIBITIONS FOR COMMERCIAL OR ADVERTISING PURPOSES; NEWS CLIPPING SERVICES; ONLINE ADVERTISING ON A COMPUTER NETWORK; ORGANIZATION OF TRADE FAIRS FOR COMMERCIAL OR ADVERTISING PURPOSES; PHOTOCOPYING; WORD PROCESSING; PUBLIC RELATIONS; PUBLICATION OF PUBLICITY TEXTS; RADIO ADVERTISING SERVICES; TELEVISION ADVERTISING; TRANSCRIPTION, NAMELY, COPYING OF DOCUMENTS FOR OTHERS (U.S. CLS. 100, 101 AND 102).

CLASS 38—COMMUNICATION

FOR ELECTRONIC BULLETIN BOARD SERVICES BEING TELECOMMUNICATIONS SERVICES, NAMELY, PROVIDING ON-LINE ELECTRONIC BULLETIN BOARDS FOR TRANSMISSION OF MESSAGES AMONG COMPUTER USERS CONCERNING ACCOUNTING, ART, BOOKS, COMPUTER, DAILY NEWS, ECONOMICS, EDUCATION, ENGINEERING, GAME, GENERAL INTEREST, LAW, MATHEMATICS, MEDICINE, MOVIE, MUSIC, POLITICAL OPINION, RELIGION, SCIENCE, OR SPORT (U.S. CLS. 100, 101 AND 104).

CLASS 40—MATERIAL TREATMENT

FOR BOOKBINDING; COLOUR SEPARATION SERVICES; EMBROIDERY; ENGRAVING; FRAMING OF WORKS OF ART; OFFSET PRINTING; PATTERN PRINTING; PHOTOGRAPHIC PRINTING; PHOTOGRAPHY; PRINTING; SILKSCREEN PRINTING (U.S. CLS. 100, 103 AND 106).

CLASS 41—EDUCATION AND ENTERTAINMENT

FOR ARRANGING AND CONDUCTING OF EDUCATIONAL CONFERENCES; ARRANGING OF SEMINARS; ARRANGING AND CONDUCTING OF ATHLETIC COMPETITIONS; ARRANGING PROFESSIONAL WORKSHOP AND TRAINING COURSES; ORGANIZATION OF EXHIBITIONS FOR CULTURAL OR EDUCATIONAL PURPOSES; ORGANIZING LIVE EXHIBITIONS AND CONFERENCES IN THE FIELDS OF EDUCATION, CULTURE, SPORTS AND ENTERTAINMENT FOR NON-BUSINESS AND NON-COMMERCIAL PURPOSES; ARRANGING AND CONDUCTING OF EDUCATIONAL, TRAINING, OR CULTURAL CONGRESSES IN THE FIELD OF ACCOUNTING, ART, ECONOMICS, ENGINEERING, LAW, MATHEMATICS, MEDICINE, MUSIC, OR SCIENCE; ARRANGING AND CONDUCTING OF SEMINARS IN THE FIELD OF ACCOUNTING, ART, ECONOMICS, ENGINEERING, LAW, MATHEMATICS, MEDICINE, MUSIC, OR SCIENCE; ARRANGING AND CONDUCTING OF EDUCATIONAL, TRAINING OR CULTURAL SYMPOSIUMS IN THE FIELD OF ACCOUNTING, ART, ECONOMICS, ENGINEERING, LAW, MATHEMATICS, MEDICINE, OR SCIENCE; ARRANGING AND CONDUCTING OF TRAINING WORKSHOPS IN THE FIELD OF ACCOUNTING, ART, ECONOMICS, ENGINEERING, LAW, MATHEMATICS,

MEDICINE, MUSIC, OR SCIENCE; PUBLICATION OF BOOKS; ORGANIZATION OF COMPETITIONS FOR EDUCATION OR ENTERTAINMENT, NAMELY, ORGANIZATION OF SPORTS COMPETITIONS AND SPORT FISHING COMPETITIONS; VIDEOTAPE EDITING; ORGANIZATION OF EXHIBITIONS FOR CULTURAL OR EDUCATIONAL PURPOSES; MICROFILMING FOR OTHERS; PHOTOGRAPHIC REPORTING; PHOTOGRAPHY; VIDEOTAPE FILM PRODUCTION; PUBLISHING ELECTRONIC BOOKS AND JOURNALS FOR OTHERS; WRITING OF TEXTS OTHER THAN PUBLICITY TEXTS; VIDEOTAPING (U.S. CLS. 100, 101 AND 107).

CLASS 42—SCIENTIFIC AND COMPUTER SERVICES

FOR DESIGN OF INTERIOR DECOR; GRAPHIC ARTS DESIGNING (U.S. CLS. 100 AND 101).
MYRIAH HABEEB, EXAMINING ATTORNEY

SN 79-055,013. ZAO "HOLDING COMPANY INTERROS", RUSSIAN FED., FILED 1-17-2008.



PRIORITY DATE OF 11-14-2007 IS CLAIMED.
OWNER OF INTERNATIONAL REGISTRATION 0967569 DATED 1-17-2008, EXPIRES 1-17-2018.

THE COLOR(S) BLUE-GREEN (PANTONE 316) IS/ARE CLAIMED AS A FEATURE OF THE MARK.

THE MARK CONSISTS OF THE CYRILLIC CHARACTERS WHICH TRANSLITERATE TO INTERROS AND THE INVENTED GRAPHIC DESIGNATION, CONSISTING OF SIX DIFFERENT LENGTH LINES OF HYPERBOLIC FORM AND ONE HORIZONTAL PLACED CURVE, VISUALLY PERCEIVED AS A FANCY FIGURE OF A TRIANGLE SHAPE. THE COLOR BLUE-GREEN (PANTONE 316) APPEARS IN THE FANCY FIGURE OF A TRIANGLE AND IN THE CYRILLIC CHARACTERS WHICH TRANSLITERATE TO INTERROS

THE TRANSLITERATION OF THE NON-LATIN CHARACTERS IN THE MARK IS INTERROS AND THIS HAS NO MEANING IN ENGLISH.

CLASS 9—ELECTRICAL AND SCIENTIFIC APPARATUS

FOR PRERECORDED VIDEO DISKS, VIDEO TAPES, AND DVDS, FEATURING ANIMATED CARTOONS; ENCODED CARDS, MAGNETIC; AUDIO VIDEO COMPACT DISCS, NAMELY, BLANK CD-ROMS FOR SOUND OR VIDEO RECORDING, PRERECORDED CDS FEATURING MUSIC OR MOTION PICTURES; READ ONLY MEMORY COMPACT DISCS, NAMELY, PRERECORDED CDS FEATURING MUSIC OR MOTION PICTURES; COMPUTER GAME PROGRAMS; COMPUTER PROGRAMS, NAMELY, DOWNLOADABLE SOFTWARE FOR USE AS BIOS (BASIC INPUT OUTPUT SYSTEM), FOR DATABASE MANAGEMENT, FOR USE AS SPREADSHEETS, FOR WORD PROCESSING, FOR USE AS COMPUTER OPERATING SYSTEM, FOR DOCUMENT MANAGEMENT, FOR EDITING IMAGES, FOR USING THE INTERNET AND THE WORLD WIDE WEB, FOR SENDING AND RECEIVING E-MAIL, FOR CREATING PRESENTATION SLIDES, FOR COMPILATION OF CREDIT REPORTING DATA, FOR THE ENABLING OF

ACCESS OR ENTRANCE CONTROL, FOR USE IN CONSTRUCTION AND AUTOMATED MANUFACTURING FOR OPERATING AUTOMATED MANUFACTURING MACHINERY, FOR OPERATING ELECTRONIC CASH REGISTER SYSTEM, FOR USE IN LANGUAGE LOCALIZATION BY MEANS OF LANGUAGE TRANSLATION, SUBTITLING, DUBBING, CLOSED CAPTIONING AND TELETEXT FOR FEATURE FILMS, TELEVISION PROGRAMS, VIDEOS AND DIGITAL MEDIA IN GENERAL, FOR CHILDREN'S EDUCATION, FOR TAX MANAGEMENT, FOR USE AS ANTI-SPYWARE SOFTWARE, FOR USE AS ANTI-VIRUS SOFTWARE, FOR PROCESSING DIGITAL MUSIC FILES, FOR USE AS A SEARCH ENGINE, FOR CREATION OF FIREWALLS, FOR ENCRYPTION AND DECRYPTION OF DATA, FOR PLAYING MUSIC, FOR WATCHING VIDEOS, OR FOR COMPRESSION OF DATA FILES; MAGNETIC DATA MEDIA, NAMELY, BLANK MAGNETIC DATA CARRIERS AND DATA DISKS; OPTICAL DATA MEDIA, NAMELY, BLANK OPTICAL DATA CARRIERS AND DATA DISKS; DOWNLOADABLE ELECTRONIC PUBLICATIONS IN THE NATURE OF BOOKS OR MAGAZINES FEATURING INFORMATION IN THE FIELDS OF ACCOUNTING, ART, COMPUTER, MOTOR VEHICLES, DAILY NEWS, ECONOMICS, ENGINEERING, SCIENCE, MEDICINE, MUSIC, TRAVEL, LAW, MATHEMATICS, A SERIES OF FICTION NOVELS, AND NON-FICTION AUTOBIOGRAPHIES AND BIOGRAPHIES; FLOPPY DISKS, NAMELY, BLANK FLOPPY DISKS, PRERECORDED FLOPPY DISKS FEATURING COMPUTER PROGRAMS FOR USE AS BIOS (BASIC INPUT OUTPUT SYSTEM), FOR DATABASE MANAGEMENT, FOR USE AS SPREADSHEETS, FOR WORD PROCESSING, FOR USE AS COMPUTER OPERATING SYSTEM, FOR DOCUMENT MANAGEMENT, FOR EDITING IMAGES, FOR USING THE INTERNET AND THE WORLD WIDE WEB, FOR SENDING AND RECEIVING E-MAIL, FOR CREATING PRESENTATION SLIDES, FOR COMPILATION OF CREDIT REPORTING DATA, FOR THE ENABLING OF ACCESS OR ENTRANCE CONTROL, FOR USE IN CONSTRUCTION AND AUTOMATED MANUFACTURING FOR OPERATING AUTOMATED MANUFACTURING MACHINERY, FOR OPERATING ELECTRONIC CASH REGISTER SYSTEM, FOR USE IN LANGUAGE LOCALIZATION BY MEANS OF LANGUAGE TRANSLATION, SUBTITLING, DUBBING, CLOSED CAPTIONING AND TELETEXT FOR FEATURE FILMS, TELEVISION PROGRAMS, VIDEOS AND DIGITAL MEDIA IN GENERAL, FOR CHILDREN'S EDUCATION, FOR TAX MANAGEMENT, FOR USE AS ANTI-SPYWARE SOFTWARE, FOR USE AS ANTI-VIRUS SOFTWARE, FOR PROCESSING DIGITAL MUSIC FILES, FOR USE AS A SEARCH ENGINE, FOR CREATION OF FIREWALLS, FOR ENCRYPTION AND DECRYPTION OF DATA, FOR PLAYING MUSIC, FOR WATCHING VIDEOS, OR FOR COMPRESSION OF DATA FILES; HOLOGRAM APPARATUS; INTERFACES FOR COMPUTERS; MAGNETS; DECORATIVE MAGNETS; MOUSE PADS; RECORDED COMPUTER OPERATING PROGRAMS; PHOTOGRAPHY SLIDES; SOUND RECORDING CARRIERS, NAMELY, BLANK CD-ROMS, TAPES AND MICROCHIPS FOR SOUND RECORDING, PRERECORDED CD-ROMS, TAPES AND MICROCHIPS FEATURING MUSIC; SOUND RECORDING DISCS, NAMELY, BLANK CD-ROMS FOR SOUND RECORDING, PRERECORDED CD-ROMS FEATURING MUSIC (U.S. CLS. 21, 23, 26, 36 AND 38).

CLASS 16—PAPER GOODS AND PRINTED MATTER

FOR ADHESIVE TAPES FOR STATIONERY OR HOUSEHOLD PURPOSES; ALBUMS FOR COINS, PHOTOGRAPHS, OR STAMPS; ALMANACS; ANNOUNCEMENT CARDS BEING STATIONERY; CONICAL PAPER BAGS; BAGS IN THE FORM OF ENVELOPES OR POUCHES MADE OF PAPER OR PLASTIC, FOR MERCHANDISE PACKAGING; LOOSE-LEAF BINDERS; BOOKBINDING MATERIAL; BOOKBINDINGS; BOOKLETS IN THE FIELD OF ACCOUNTING, ART, ECONOMICS, ENGINEERING, LAW, MATHEMATICS, MEDICINE, MUSIC, OR SCIENCE; BOOKMARKERS; BOOKS, NAMELY, ADDRESS BOOKS, ACCOUNT BOOKS, A SERIES OF NOVELS OR NON-FICTION BOOKS IN THE FIELD OF AUTOBIOGRAPHIES AND BIOGRAPHIES, COMIC BOOKS, TELEPHONE BOOKS, DICTIONARIES, TEXTBOOKS IN THE FIELD OF ACCOUNTING, ART, ECO-

NOMICS, ENGINEERING, LAW, MATHEMATICS, MEDICINE, MUSIC, OR SCIENCE, TEXTBOOKS FOR USE IN CHILDREN'S EDUCATION IN THE FIELD OF MATHEMATICS, READING COMPREHENSION, WRITING, GRAMMAR, SPELLING, PHYSICAL EDUCATION, MUSIC, ART, HISTORY, GEOGRAPHY, SCIENCE, OR SOCIAL STUDIES; BOTTLE ENVELOPES BEING BOTTLE WRAPPERS OF CARDBOARD OR PAPER; BOTTLE WRAPPERS OF CARDBOARD OR PAPER; BOXES FOR PENS; BOXES OF CARDBOARD OR PAPER; CALENDARS; CARDBOARD; CARDBOARD ARTICLES, NAMELY, CARDBOARD, CARDBOARD PACKAGING, CARDBOARD BANNERS, CARDBOARD FLAGS, CARDBOARD HANG TAGS, CARDBOARD PRINTED MATERIALS, NAMELY, PRINTED INSTRUCTIONAL MATERIALS IN THE FIELD OF TELECOMMUNICATIONS, CARDBOARD STATIONERIES; CARDBOARD TUBES; CARDS, NAMELY, BLANK CARDS, BASEBALL CARDS, GREETING CARDS, BUSINESS CARDS, PHOTOGRAPH CARDS, NAMELY, GREETING CARDS FEATURING PHOTOGRAPHS, POSTCARDS FEATURING PHOTOGRAPHS, IDENTIFICATION CARDS, NAMELY, NOVELTY IDENTIFICATION CARDS, PAPER IDENTIFICATION CARDS, CHRISTMAS CARDS, INVITATION CARDS, FLASH CARDS, POST CARDS, SCRATCH CARDS, HOLIDAY CARDS, NOTE CARDS, SCORE CARDS, TRADING CARDS, VISITING CARDS; CATALOGUES IN THE FIELD OF CLOTHING, FURNITURE, FOOD, COMPUTER, GAME, BOOK, STATIONERY, OR JEWELRY; CHARCOAL PENCILS; COMIC BOOKS; COPYING PAPER BEING STATIONERY; COVERS BEING STATIONERY, NAMELY, BOOK COVERS, DOCUMENT COVERS; CREDIT CARD IMPRINTERS; NON ELECTRIC, FOR OFFICE USE; DECALCOMANIAS; DRAWING PADS; ENGRAVINGS; ENVELOPES BEING STATIONERY; ETCHINGS; FLAGS OF PAPER; FOLDERS FOR PAPERS; FORMS, PRINTED; FOUNTAIN PENS; GRAPHIC PRINTS; GRAPHIC REPRESENTATIONS; GRAPHIC REPRODUCTIONS, NAMELY, GRAPHIC REPRESENTATIONS; GREETING CARDS; LABELS, NOT OF TEXTILE, NAMELY, PAPER LABELS, PLASTIC LABELS; LUMINOUS PAPER; MAGAZINES BEING PERIODICALS FEATURING ACCOUNTING, ART, ECONOMICS, ENGINEERING, LAW, MATHEMATICS, MEDICINE, MUSIC, OR SCIENCE; MUSICAL GREETING CARDS; NEWSLETTERS IN THE FIELD OF ACCOUNTING, ART, ECONOMICS, ENGINEERING, LAW, MATHEMATICS, MEDICINE, MUSIC, OR SCIENCE; NEWSPAPERS; NOTE BOOKS; STATIONERY PADS; PAINTINGS BEING PICTURES, FRAMED OR UNFRAMED; PRINTED PAMPHLETS FEATURING INFORMATION IN THE FIELDS OF OR ABOUT REAL ESTATE SALES, SELLING GOODS TO OTHERS, THEATER, CONCERTS, MUSEUMS, RELIGION, TRAVEL, SIGHTSEEING, OR HOTEL SERVICES, PRINTED PAMPHLETS FEATURING INFORMATION ABOUT BUSINESSES OR POLITICAL OPINION; PAPER; PAPER RIBBONS; PAPER SHEETS BEING STATIONERY; PARCHMENT PAPER; PENCIL LEAD HOLDERS; PENCILS; PHOTOENGRAVINGS; PHOTOGRAPHS; PICTURES; PAPER POSTAGE STAMPS; POSTCARDS; POSTERS; PRINTED MATTER, NAMELY, VINYL STATIC CLING SHEETS ON WHICH PRAYERS ARE PRINTED FOR AFFIXATION IN WINDOWS AND WINDSHIELDS; PRINTED TIMETABLES; PRINTS BEING ENGRAVINGS; PRINTED PROSPECTUSES FEATURING INFORMATION ABOUT MOTION PICTURE FILMS, COMPANIES, SCHOOLS, OR STOCKS; SEALING COMPOUNDS FOR STATIONERY PURPOSES, NAMELY, SEALING WAX, GLUES, ADHESIVES; SEALING STAMPS; SEALS BEING STAMPS; SIGNBOARDS OF PAPER OR CARDBOARD; SILVER PAPER; STENCIL PLATES; STICKERS BEING STATIONERY; TEAR-OFF CALENDARS; PRINTED TICKETS; TRACING CLOTH IN THE NATURE OF TRANSPARENT CLOTH FOR TRACING, NAMELY, TRACING PAPER; TRACING PAPER; TRACING PATTERNS, NAMELY, PRINTED PAPER TRACING PATTERNS, PRINTED IRON-ON TRACING PATTERNS, PRINTED PLASTIC TRACING PATTERNS; WOOD PULP BOARD BEING STATIONERY, NAMELY, PAPER; WOOD PULP PAPER; WRAPPING PAPER; WRITING PAPER (U.S. CLS. 2, 5, 22, 23, 29, 37, 38 AND 50).

CLASS 18—LEATHER GOODS

FOR BACKPACKS; LEATHER OR LEATHER BOARD BOXES; BRIEFCASES; CARD CASES BEING NOTE-CASES, NAMELY, NAME CARD CASES, BUSINESS CARD CASES; CHAMOIS LEATHER, OTHER THAN FOR CLEANING PURPOSES; HAVERSACKS; IMITATION LEATHER; LEATHER, UNWORKED OR SEMI-WORKED; LEATHERBOARD, NAMELY, IMITATION LEATHER; PARASOLS; POCKET WALLETS; PURSES; TRAVELLING SETS, NAMELY, TRAVELLING BAGS BEING LEATHERWARE; UMBRELLAS; UNFITTED VANITY CASES (U.S. CLS. 1, 2, 3, 22 AND 41).

CLASS 20—FURNITURE AND ARTICLES NOT OTHERWISE CLASSIFIED

FOR WORKS OF ART OF WOOD, WAX, PLASTER OR PLASTIC; BOOK RESTS BEING FURNITURE; CABINET WORK, NAMELY, WOODEN CABINET BEING FURNITURE; DISPLAY STANDS; MAGAZINE RACKS; MIRRORS BEING LOOKING GLASSES; MOBILES BEING DECORATION; NEWSPAPER DISPLAY STANDS; PLACARDS OF WOOD OR PLASTICS; SIGNBOARDS OF WOOD OR PLASTICS; WICKERWORK IN THE NATURE OF FURNITURE (U.S. CLS. 2, 13, 22, 25, 32 AND 50).

CLASS 21—HOUSEWARES AND GLASS

FOR CERAMICS FOR HOUSEHOLD PURPOSES, NAMELY, CERAMIC BOWLS, CERAMIC CUPS, CERAMIC FIGURINES, CERAMIC PLATES, CERAMIC VASES; ENAMELLED GLASS; GLASS INCORPORATING FINE ELECTRICAL CONDUCTORS; OPAL GLASS; GLASS, UNWORKED OR SEMIWORKED, EXCEPT BUILDING GLASS; MAJOLICA, NAMELY, EARTHENWARE IN THE FORM OF BOWLS, CUPS, FIGURINES, PLATES, OR VASES; MOSAICS OF GLASS, NOT FOR BUILDING; FITTED PICNIC BASKETS; FITTED PICNIC BASKETS CONTAINING DISHES; SIGNBOARDS OF PORCELAIN OR GLASS; TOILET CASES, NAMELY, CONTAINERS FOR TOILETRY, NAMELY, FITTED VANITY CASES; WORKS OF ART, OF PORCELAIN, TERRACOTTA OR GLASS (U.S. CLS. 2, 13, 23, 29, 30, 33, 40 AND 50).

CLASS 24—FABRICS

FOR TEXTILE BANNERS; TEXTILE FLAGS, NOT OF PAPER; LABELS OF CLOTH; SILK BEING CLOTH (U.S. CLS. 42 AND 50).

CLASS 25—CLOTHING

FOR BANDANAS BEING NECKERCHIEFS; BELTS BEING CLOTHING; BRACES FOR CLOTHING BEING SUSPENDERS; COLLAR PROTECTORS; HOSIERY; NECKTIES; SASHES FOR WEAR; SCARVES; SINGLET; TEE SHIRTS; TOP HATS; UNIFORMS (U.S. CLS. 22 AND 39).

CLASS 26—FANCY GOODS

FOR BADGES FOR WEAR, NOT OF PRECIOUS METAL, NAMELY, BADGES FOR CLOTHING, NAMELY, ORNAMENTAL NOVELTY BADGES; FANCY GOODS, NAMELY, EMBROIDERY; RIBBONS BEING HABERDASHERY; TRIMMINGS FOR CLOTHING, NAMELY, BORDER DECORATION FOR CLOTHING (U.S. CLS. 37, 39, 40, 42 AND 50).

CLASS 28—TOYS AND SPORTING GOODS

FOR BELLS FOR CHRISTMAS TREES; BOARD GAMES; CHESS GAMES; ORNAMENTS FOR CHRISTMAS TREES, EXCEPT ILLUMINATION ARTICLES AND CONFECTIONERY; GAMES, NAMELY, ACTION SKILL GAMES, ACTION TARGET GAMES, ACTION-TYPE TARGET GAMES, AERO-DYNAMIC DISK CATCHING GAMES, ARCADE GAMES, ARCADE-TYPE ELECTRONIC EDUCATION VIDEO GAMES, ARCADE-TYPE ELECTRONIC VIDEO GAMES, BACKGAMMON GAMES, BADMINTON BOARD GAMES, BASKETBALL BOARD GAMES, BASKETBALL TABLE TOP GAMES, BILLIARD BOARD GAMES, BINGO BOARD GAMES,

BOARD GAMES, BUILDING GAMES, CARD GAMES, CARD GAME FOR BUSINESS TRAINING, CHESS GAMES, COIN-OPERATED VIDEO GAMES, BOARD GAMES FOR PLAYING CRAPS, DART GAMES, DICE GAMES, EDUCATIONAL CARD GAMES, ELECTRONIC DART GAMES, ELECTRONIC GAMES OTHER THAN THOSE ADAPTED FOR USE WITH TELEVISION RECEIVERS ONLY, GAMES OF CHANCE, NAMELY, BOARD GAMES FOR PLAYING CRAPS, GO GAMES, HAND-HELD GAMES WITH LIQUID CRYSTAL DISPLAYS, HORSESHOE GAMES, HUNTING BOARD GAMES, JAPANESE CHESS GAMES, JAPANESE DICE GAMES, JAPANESE CARD GAMES, LOTTERY BOARD GAMES, MAH JONG GAMES, MANIPULATIVE GAMES, MARBLE GAMES, MEMORY GAMES, PADDLE BALL GAMES, PARLOR GAMES, PARTY GAMES, PINBALL GAMES, PINBALL-TYPE GAMES, PUZZLE GAMES, RING GAMES, ROLE PLAYING GAMES, TABLETOP GAMES, TARGET GAMES, TIBETAN DICE GAMES, TRADING CARD GAMES, TREASURE HUNT BOARD GAMES, TRIVIA BOARD GAMES, TRIVIA GAMES PLAYED WITH CARDS AND GAME COMPONENTS, VERTICAL HOOP TARGET GAMES, VIDEO GAMES, NAMELY, COIN-OPERATED VIDEO GAMES, VOLLEYBALL BOARD GAMES; JIGSAW PUZZLES; THEATRICAL MASKS; TOY MASKS; NOVELTIES FOR PARTIES AND DANCES BEING PARTY FAVORS AND DANCE FAVORS, NAMELY, FAKE TEETH, NOVELTY TOY ITEM IN THE NATURE OF A DISPENSER OF STREAM MATERIAL; TOYS, NAMELY, BABY MULTIPLE ACTIVITY TOYS, BATH TOYS, BATHTUB TOYS, BATTERY OPERATED ACTION TOYS, BENDABLE TOYS, CAT TOYS, CHILDREN'S MULTIPLE ACTIVITY TOYS, CHILDREN'S WIRE CONSTRUCTION AND ART ACTIVITY TOYS, CLOCKWORK TOYS OF METAL OR PLASTIC, CONSTRUCTION TOYS, CRIB TOYS, DISC TOSS TOYS, DOG TOYS, DRAWING TOYS, EDUCATIONAL TOY FOR THE PURPOSE OF THE DEMONSTRATION OF ALTERNATIVE ENERGY SOURCES, EDUCATIONAL TOYS FOR TEACHING MATH PRINCIPLES TO CHILDREN, NAMELY, MANIPULATIVE BLOCKS FOR DISPLAYING PATTERNS AND GROUPINGS, EDUCATIONAL TOYS FOR TEACHING AND TESTING KNOWLEDGE RELATING TO THE POLITICS, POLITICAL PROCESS, AND POLITICAL HISTORY OF THE UNITED STATES, EDUCATIONAL TOYS IN THE NATURE OF AN ILLUSTRATED WALL MAP, ELECTRIC ACTION TOYS, ELECTRIC EDUCATIONAL TOY USED TO DEMONSTRATE ALTERNATIVE ENERGY SOURCES, ELECTRONIC ACTION TOYS, ELECTRONIC NOVELTY TOYS, NAMELY, TOYS THAT ELECTRONICALLY RECORD, PLAY BACK, AND DISTORT OR MANIPULATE VOICES AND SOUNDS, ELECTRONIC TOY VEHICLES, ELECTRONICALLY OPERATED TOY MOTOR VEHICLES, FANTASY CHARACTER TOYS, FLYING TOYS USING ELECTROSTATIC LEVITATION, HAND-POWERED NON-MECHANICAL FLYING TOYS, INFANT ACTION CRIB TOYS, INFANT DEVELOPMENT TOYS, INFANT TOYS, INFLATABLE BATH TOYS, INFLATABLE RIDE-ON TOYS, INFLATABLE THIN RUBBER TOYS, INFLATABLE TOYS, INFLATABLE TOYS SHOWING DECORATIVE PICTURES, LEVER ACTION TOYS, MECHANICAL ACTION TOYS, MECHANICAL TOYS, MINIATURE TOY HELMETS, MODEL TOY STEAM ENGINES, MODEL TOY STEAM OPERATED TRACTION ENGINES, MODELED PLASTIC TOY FIGURINES, MOLDED TOY FIGURES, MUSIC BOX TOYS, MUSICAL TOYS, NON-ELECTRONIC TOY VEHICLES, NON-RIDING TRANSPORTATION TOYS, PET TOYS, PET TOYS CONTAINING CATNIP, PET TOYS MADE OF ROPE, PLASTIC CHARACTER TOYS, PLASTIC TOY HOOPS, PLUSH TOYS, POP UP TOYS, POSITIONABLE PRINTED TOY FIGURES FOR USE IN GAMES, POSITIONABLE PRINTED TOY FIGURES FOR USE IN PUZZLES, POSITIONABLE THREE DIMENSIONAL TOYS FOR USE IN GAMES, POSITIONABLE TOY FIGURES, POSITIONABLE TWO DIMENSIONAL TOYS FOR USE IN GAMES, PRINTED POSITIONABLE TOYS FOR USE IN CHILDREN'S BOARD GAMES, PRINTING TOYS, PULL TOYS, PUNCHING TOYS, PUSH TOYS, RADIO CONTROLLED TOY VEHICLES, REMOTE CONTROL TOY CARS, REMOTE CONTROL TOY RACE CARS, REMOTE CONTROL TOY AIRPLANES, REMOTE CONTROL TOY BOATS, RIDE-ON TOYS, RUBBER CHARACTER TOYS, SAND TOYS, SANDBOX TOYS, SKETCHING TOYS, SOFT SCULPTURE PLUSH TOYS, SOFT SCULPTURE TOYS, SQUEEZABLE SQUEAKING TOYS, SQUEEZE TOYS, STACKING TOYS, STUFFED AND PLUSH TOYS, STUFFED TOY ANIMALS,

STUFFED TOY BEARS, STUFFED TOYS, TALKING ELECTRONIC PRESS-DOWN TOYS, TALKING TOYS, TESSELATION TOYS, TOSSING DISC TOYS, TOY ACTION FIGURES, TOY ACTION FIGURES AND ACCESSORIES THEREFOR, TOY AIRPLANES, TOY AND NOVELTY FACE MASKS, TOY ANIMALS, TOY ANIMALS AND ACCESSORIES THEREFOR, TOY ARMOR, TOY ARTIFICIAL FINGERNAILS, TOY BAKEWARE AND COOKWARE, TOY BALLOONS, TOY BANKS, TOY BOATS, TOY BOWS AND ARROWS, TOY BOXES, TOY BUILDING BLOCKS, TOY BUILDING BLOCKS CAPABLE OF INTERCONNECTION, TOY BUILDING STRUCTURES AND TOY VEHICLE TRACKS, TOY BUILDINGS AND ACCESSORIES THEREFOR, TOY BUTTERFLY NETS, TOY CAP PISTOLS, TOY CARS, TOY CHRISTMAS TREES, TOY CLOCKS AND WATCHES, TOY CONSTRUCTION BLOCKS, TOY CONSTRUCTION SETS, TOY FIGURES, TOY FILM CARTRIDGES AND VIEWERS, TOY FOAM NOVELTY ITEMS, NAMELY, FOAM FINGERS AND HANDS, TOY FURNITURE, TOY GLIDERS, TOY GLOCKENSPIELS, TOY GUNS, TOY HARMONICAS, TOY HOLSTERS, TOY HOOP SETS, TOY HOUSES, TOY MAILBOXES, TOY MASKS, TOY MOBILES, TOY MODEL CARS, TOY MODEL GUITARS, TOY MODEL HOBBYCRAFT KITS, TOY MODEL KIT CARS, TOY MODEL TRAIN SETS, TOY MODEL VEHICLES AND RELATED ACCESSORIES SOLD AS UNITS, TOY MODELING DOUGH, TOY MUSIC BOXES, TOY NOISEMAKERS, TOY PIANOS, TOY PIANOS, SOLD AS A UNIT WITH PRINTED BOOKS IN THE FIELD OF MUSIC EDUCATION, TOY PISTOLS, TOY PRISM GLASSES, TOY PUTTY, TOY RECORD PLAYERS, TOY ROBOTS, TOY ROCKETS, TOY SCOOTERS, TOY SETS OF CARPENTERS' TOOLS, TOY SLING PLANES, TOY SNOW GLOBES, TOY STAMPS, TOY SWORDS, TOY TOOLS, TOY TRAINS AND PARTS AND ACCESSORIES THEREFOR, TOY VEHICLE TRACK SETS AND ROADWAYS AND ACCESSORIES THEREFOR, TOY VEHICLES, TOY VEHICLES AND ACCESSORIES THEREFOR, TOY VEHICLES WITH TRANSFORMING PARTS, TOY WATCHES, TOY WATER GLOBES, TOY WEAPONS, TOY WHISTLES, TOY WIND SOCKS, TOY XYLOPHONES, TOY ZIP GUNS, TOY, NAMELY, BATTERY-POWERED COMPUTER GAME WITH LCD SCREEN WHICH FEATURES ANIMATION AND SOUND EFFECTS, TOYS DESIGNED TO BE ATTACHED TO CAR SEATS, TOYS DESIGNED TO BE ATTACHED TO STROLLERS, TOYS DESIGNED TO BE ATTACHED TO CRIBS, TOYS DESIGNED TO BE ATTACHED TO HIGH CHAIRS, TOYS FOR DOMESTIC PETS, TOYS, NAMELY, A DISK TO TOSS IN PLAYING A GAME WHEREIN OTHER DISKS ARE FLIPPED AND COLLECTED, TOYS, NAMELY, CHILDREN'S DRESS-UP ACCESSORIES, TRANSFORMING ROBOTIC TOY VEHICLES, TRANSFORMING ROBOTIC TOYS, TWO AND THREE DIMENSIONAL POSITIONABLE TOY FIGURES SOLD AS A UNIT WITH OTHER TOYS, WATER SQUIRTING TOYS, WIND-UP TOYS, WIND-UP WALKING TOYS (U.S. CLS. 22, 23, 38 AND 50).

CLASS 34—SMOKERS' ARTICLES

FOR MATCH BOXES; SNUFF BOXES (U.S. CLS. 2, 8, 9 AND 17).

CLASS 35—ADVERTISING AND BUSINESS

FOR ADVERTISING SERVICES; ADVERTISING AGENCIES; ADVERTISING BY MAIL ORDER, NAMELY, DIRECT MAIL ADVERTISING; UPDATING OF ADVERTISING MATERIAL; RENTAL OF ADVERTISING SPACE; ARRANGING NEWSPAPER SUBSCRIPTIONS FOR OTHERS; BUSINESS MANAGEMENT OF PERFORMING ARTISTS; DIRECT MAIL ADVERTISING; ORGANIZATION OF EXHIBITIONS FOR COMMERCIAL OR ADVERTISING PURPOSES; NEWS CLIPPING SERVICES; ONLINE ADVERTISING ON A COMPUTER NETWORK; ORGANIZATION OF TRADE FAIRS FOR COMMERCIAL OR ADVERTISING PURPOSES; PHOTOCOPYING; WORD PROCESSING; PUBLIC RELATIONS; PUBLICATION OF PUBLICITY TEXTS; RADIO ADVERTISING SERVICES; TELEVISION ADVERTISING; TRANSCRIPTION, NAMELY, COPYING OF DOCUMENTS FOR OTHERS (U.S. CLS. 100, 101 AND 102).

CLASS 38—COMMUNICATION

FOR ELECTRONIC BULLETIN BOARD SERVICES BEING TELECOMMUNICATIONS SERVICES, NAMELY, PROVIDING ON-LINE ELECTRONIC BULLETIN BOARDS FOR TRANSMISSION OF MESSAGES AMONG COMPUTER USERS CONCERNING ACCOUNTING, ART, BOOKS, COMPUTER, DAILY NEWS, ECONOMICS, EDUCATION, ENGINEERING, GAME, GENERAL INTEREST, LAW, MATHEMATICS, MEDICINE, MOVIE, MUSIC, POLITICAL OPINION, RELIGION, SCIENCE, OR SPORT (U.S. CLS. 100, 101 AND 104).

CLASS 40—MATERIAL TREATMENT

FOR BOOKBINDING; COLOUR SEPARATION SERVICES; EMBROIDERY; ENGRAVING; FRAMING OF WORKS OF ART; OFFSET PRINTING; PATTERN PRINTING; PHOTOGRAPHIC PRINTING; PHOTOGRAPHY; PRINTING; SILKSCREEN PRINTING (U.S. CLS. 100, 103 AND 106).

CLASS 41—EDUCATION AND ENTERTAINMENT

FOR ARRANGING AND CONDUCTING OF EDUCATIONAL CONFERENCES; ARRANGING OF SEMINARS; ARRANGING AND CONDUCTING OF ATHLETIC COMPETITIONS; ARRANGING PROFESSIONAL WORKSHOP AND TRAINING COURSES; ORGANIZATION OF EXHIBITIONS FOR CULTURAL OR EDUCATIONAL PURPOSES; ORGANIZING LIVE EXHIBITIONS AND CONFERENCES IN THE FIELDS OF EDUCATION, CULTURE, SPORTS AND ENTERTAINMENT FOR NON-BUSINESS AND NON-COMMERCIAL PURPOSES; ARRANGING AND CONDUCTING OF EDUCATIONAL, TRAINING, OR CULTURAL CONGRESSES IN THE FIELD OF ACCOUNTING, ART, ECONOMICS, ENGINEERING, LAW, MATHEMATICS, MEDICINE, MUSIC, OR SCIENCE; ARRANGING AND CONDUCTING OF SEMINARS IN THE FIELD OF ACCOUNTING, ART, ECONOMICS, ENGINEERING, LAW, MATHEMATICS, MEDICINE, MUSIC, OR SCIENCE; ARRANGING AND CONDUCTING OF EDUCATIONAL, TRAINING OR CULTURAL SYMPOSIUMS IN THE FIELD OF ACCOUNTING, ART, ECONOMICS, ENGINEERING, LAW, MATHEMATICS, MEDICINE, OR SCIENCE; ARRANGING AND CONDUCTING OF TRAINING WORKSHOPS IN THE FIELD OF ACCOUNTING, ART, ECONOMICS, ENGINEERING, LAW, MATHEMATICS, MEDICINE, MUSIC, OR SCIENCE; PUBLICATION OF BOOKS; ORGANIZATION OF COMPETITIONS FOR EDUCATION OR ENTERTAINMENT, NAMELY, ORGANIZATION OF SPORTS COMPETITIONS AND SPORT FISHING COMPETITIONS; VIDEOTAPE EDITING; ORGANIZATION OF EXHIBITIONS FOR CULTURAL OR EDUCATIONAL PURPOSES; MICROFILMING FOR OTHERS; PHOTOGRAPHIC REPORTING; PHOTOGRAPHY; VIDEOTAPE FILM PRODUCTION; PUBLISHING ELECTRONIC BOOKS AND JOURNALS FOR OTHERS; WRITING OF TEXTS OTHER THAN PUBLICITY TEXTS; VIDEOTAPING (U.S. CLS. 100, 101 AND 107).

CLASS 42—SCIENTIFIC AND COMPUTER SERVICES

FOR DESIGN OF INTERIOR DECOR; GRAPHIC ARTS DESIGNING (U.S. CLS. 100 AND 101).
MYRIAH HABEEB, EXAMINING ATTORNEY

SN 79-055,410. PAION DEUTSCHLAND GMBH, 52062 AACHEN, FED REP GERMANY, FILED 10-10-2007.

New hope in stroke

PRIORITY DATE OF 4-11-2007 IS CLAIMED.
OWNER OF INTERNATIONAL REGISTRATION 0968562
DATED 10-10-2007, EXPIRES 10-10-2017.

CLASS 1—CHEMICALS

FOR BIOCHEMICAL PREPARATIONS FOR SCIENTIFIC PURPOSES; REAGENTS FOR RESEARCH PURPOSES AND NOT FOR MEDICAL OR VETERINARY PURPOSES (U.S. CLS. 1, 5, 6, 10, 26 AND 46).

CLASS 5—PHARMACEUTICALS

FOR PHARMACEUTICAL, BIOCHEMICAL, BIOTECHNOLOGICAL PREPARATIONS FOR THE TREATMENT AND DIAGNOSIS OF BLOOD DISORDERS AND BLOOD FORMING ORGANS, THROMBOTIC DISEASES, DISORDERS OF HAEMOSTASIS, NEURONAL DISEASES, NEURODEGENERATIVE DISORDERS, HEART DISEASES INCLUDING HEART FAILURE, CIRCULATION DISORDERS, SPINAL CORD INJURY, PAIN; PREPARATIONS FOR HEALTH CARE, NAMELY, SANITARY PREPARATIONS FOR MEDICAL AND PERSONAL HYGIENIC PURPOSES; DRUGS FOR MEDICAL PURPOSES, NAMELY, PHARMACEUTICAL PREPARATIONS FOR THE TREATMENT AND DIAGNOSIS OF BLOOD DISORDERS AND BLOOD FORMING ORGANS, THROMBOTIC DISEASES, DISORDERS OF HAEMOSTASIS, NEURONAL DISEASES, NEURODEGENERATIVE DISORDERS, HEART DISEASES INCLUDING HEART FAILURE, CIRCULATION DISORDERS, SPINAL CORD INJURY, PAIN; PREPARATIONS FOR HEALTH CARE, NAMELY, SANITARY PREPARATIONS FOR MEDICAL AND PERSONAL HYGIENIC PURPOSES; DIAGNOSTIC PREPARATIONS FOR MEDICAL PURPOSES; DIAGNOSTIC REAGENTS FOR MEDICAL PURPOSES; MEDICINES FOR HUMAN AND VETERINARY PURPOSES, NAMELY, PHARMACEUTICAL PREPARATIONS FOR THE TREATMENT OF AND DIAGNOSIS OF BLOOD DISORDERS AND BLOOD FORMING ORGANS, THROMBOTIC DISEASES, DISORDERS OF HAEMOSTASIS, NEURONAL DISEASES, NEURODEGENERATIVE DISORDERS, HEART DISEASES INCLUDING HEART FAILURE, CIRCULATION DISORDERS, SPINAL CORD INJURY, PAIN (U.S. CLS. 6, 18, 44, 46, 51 AND 52).

CLASS 10—MEDICAL APPARATUS

FOR LABORATORY AND ANALYSIS DEVICES FOR MEDICAL, LABORATORY MEDICAL AND PHARMACEUTICAL INVESTIGATIONS, NAMELY, APPARATUS FOR BLOOD ANALYSIS AND FILTRATION, FILTERS FOR DIALYSIS, HAEMOFILTRATION; MEDICAL INSTRUMENTS AND APPARATUS, NAMELY, BIOPSY INSTRUMENTS, CATHETERS, MEDICAL STENTS, MEDICAL SYRINGES, SURGICAL IMPLANTS COMPRISING ARTIFICIAL MATERIAL, AND SURGICAL NEEDLES (U.S. CLS. 26, 39 AND 44).

CLASS 41—EDUCATION AND ENTERTAINMENT

FOR CONDUCTING OF SEMINARS AND ORGANIZATION OF EDUCATIONAL EXHIBITIONS IN THE FIELDS OF HEALTH CARE, PHARMACOLOGY AND DRUG RESEARCH AND DEVELOPMENT (U.S. CLS. 100, 101 AND 107).

CLASS 42—SCIENTIFIC AND COMPUTER SERVICES

FOR SERVICES OF A BIOCHEMIST, NAMELY, CHEMICAL, BIOCHEMICAL, BIOLOGICAL AND BACTERIOLOGICAL RESEARCH AND ANALYSIS; SCIENTIFIC RESEARCH AND DEVELOPMENT IN THE FIELDS OF DIAGNOSTIC AND PHARMACEUTICS; BIOCHEMICAL AND BIOTECHNOLOGICAL RESEARCH AND DEVELOPMENT, NAMELY, SCIENTIFIC RESEARCH AND DEVELOPMENT; SCIENTIFIC ANALYSIS IN THE FIELDS OF DIAGNOSTICS AND DRUG RESEARCH, NAMELY, SCIENTIFIC RESEARCH; CREATION OF DATA BASES AND COMPUTER PROGRAMS AS WELL AS PERFORMANCE OF CHEMICAL, BIOLOGICAL AND BIOTECHNOLOGICAL ANALYSES, NAMELY, DATA-BASE DEVELOPMENT SERVICES; TECHNICAL CONSULTING IN THE FIELDS OF BIOTECHNOLOGY, NAMELY, CONSULTANCY PERTAINING TO PHARMACOLOGY, CHEMISTRY AND BIOLOGY; SERVICES OF A BIOTECHNOLOGICAL LABORATORY, BIOLOGICAL RESEARCH; PREPARATION OF BIOTECHNOLOGICAL EXPERT OPINIONS, NAMELY, BIOLOGICAL RESEARCH CONSULTATION (U.S. CLS. 100 AND 101).

ROBERT STRUCK, EXAMINING ATTORNEY

SN 79-055,514. ZIEHM IMAGING GMBH, FED REP GERMANY, FILED 2-6-2008.



OWNER OF INTERNATIONAL REGISTRATION 0968896 DATED 2-6-2008, EXPIRES 2-6-2018.

OWNER OF U.S. REG. NO. 3,458,687.

NO CLAIM IS MADE TO THE EXCLUSIVE RIGHT TO USE "IMAGING", APART FROM THE MARK AS SHOWN. THE COLOR(S) TURQUOISE AND GREEN IS/ARE CLAIMED AS A FEATURE OF THE MARK.

THE MARK CONSISTS OF THE COLOR TURQUOISE APPEARING IN THE DESIGN OF A GLOBE WITH A SILHOUETTE OF A MAN UNDERNEATH THREE SWIRL LINES AND IN THE WORDING "ZIEHM". THE COLOR GREEN APPEARS IN THE WORDING "IMAGING".

CLASS 9—ELECTRICAL AND SCIENTIFIC APPARATUS

FOR SCIENTIFIC, SURVEYING, PHOTOGRAPHIC, CINEMATOGRAPHIC, OPTICAL, MEASURING, SIGNALING, CHECKING APPARATUS AND INSTRUMENTS, NAMELY, AMORPHOUS SILICON FLAT PANEL X-RAY DETECTORS, NOT FOR MEDICAL PURPOSES, X-RAY IMAGE INTENSIFIERS OTHER THAN FOR MEDICAL PURPOSES, IMAGE INTENSIFIERS BEING NIGHT VISION GOGGLES, X-RAY TUBES OTHER THAN FOR MEDICAL PURPOSES; APPARATUS AND INSTRUMENTS FOR CONDUCTING, SWITCHING, TRANSFORMING, ACCUMULATING, REGULATING OR CONTROLLING ELECTRICITY, NAMELY, ELECTRIC SWITCHES; APPARATUS FOR RECORDING, TRANSMISSION OR REPRODUCTION OF SOUND OR IMAGES, NAMELY, MEMORIES FOR USE WITH COMPUTERS; DATA PROCESSORS; AND COMPUTERS (U.S. CLS. 21, 23, 26, 36 AND 38).

CLASS 10—MEDICAL APPARATUS

FOR SURGICAL, MEDICAL, DENTAL AND VETERINARY APPARATUS AND INSTRUMENTS, NAMELY, X-RAY DIAGNOSTIC APPARATUS, ULTRASONIC MEDICAL DIAGNOSTIC APPARATUS AND INFRARED MEDICAL DIAGNOSTIC APPARATUS (U.S. CLS. 26, 39 AND 44).

CLASS 42—SCIENTIFIC AND COMPUTER SERVICES

FOR SCIENTIFIC AND INDUSTRIAL RESEARCH RELATING TO ASSISTANCE SYSTEMS, NAMELY, NAVIGATION SYSTEMS FOR MEDICAL PURPOSES, PASSIVE AND ACTIVE ROBOTIC SYSTEMS, INJECTOR SYSTEMS FOR MEDICAL PURPOSES, MEDICAL APPARATUS FOR USE IN COMPUTER ASSISTED SURGERY, PERIPHERY SYSTEMS FOR MEDICAL DIAGNOSTIC AND THERAPEUTIC TREATMENT, VISUALIZATION APPARATUS FOR MEDICAL PURPOSES, X-RAY MEDICAL IMAGING AND MEDICAL APPARATUS; DESIGN AND DEVELOPMENT OF COMPUTER SOFTWARE (U.S. CLS. 100 AND 101).

CLASS 44—MEDICAL, BEAUTY AND AGRICULTURAL SERVICES

FOR MEDICAL SERVICES; VETERINARY SERVICES (U.S. CLS. 100 AND 101).
SCOTT BIBB, EXAMINING ATTORNEY

SN 79-056,368. FIONA LYALL, UNITED KINGDOM, FILED 4-11-2008.

THE FROOTLINGS

THE MARK CONSISTS OF STANDARD CHARACTERS WITHOUT CLAIM TO ANY PARTICULAR FONT, STYLE, SIZE, OR COLOR.

PRIORITY DATE OF 10-11-2007 IS CLAIMED.
OWNER OF INTERNATIONAL REGISTRATION 0970968 DATED 4-11-2008, EXPIRES 4-11-2018.

CLASS 9—ELECTRICAL AND SCIENTIFIC APPARATUS

FOR DOWNLOADABLE PUBLICATIONS IN THE NATURE OF BOOKS, MAGAZINES AND POSTERS IN THE FIELD OF FILM, TELEVISION, GAMES, GAME SHOWS AND ENTERTAINMENT IN ELECTRONIC FORM SUPPLIED ON-LINE FROM DATABASES OR FROM FACILITIES PROVIDED ON THE INTERNET INCLUDING WEBSITES; BOOKS, NAMELY, DOWNLOADABLE AUDIO AND ELECTRONIC NOVELS AND BOOKS IN THE FIELD OF FILM, TELEVISION, GAMES, GAME SHOWS AND ENTERTAINMENT IN ELECTRONIC FORM SUPPLIED ON-LINE; COMPUTER GAMES, NAMELY, COMPUTER GAMES SOFTWARE; COMPUTER CONSOLES, NAMELY, COMPUTER GAMES FOR USE WITH AN EXTERNAL DISPLAY SCREEN OR MONITOR; COMPUTER GAMES FOR USE WITH TELEVISION RECEIVERS; PRE-RECORDED AUDIO RECORDS FEATURING AUDIO BOOKS AND MUSIC; PRE-RECORDED DVDS FEATURING MOVIES, MUSIC AND TELEVISION PROGRAMS; RADIOS; ELECTRONIC PERSONAL ORGANIZERS AND PERSONAL STEREOs; APPARATUS FOR RECORDING, TRANSMISSION, STORAGE OR REPRODUCTION OF SOUND, DATA OR IMAGES, NAMELY, PRE-RECORDED COMPACT DISCS FEATURING AUDIO BOOK AND MUSIC; DIGITAL AUDIO PLAYERS AND MP3 PLAYERS; COVERS AND CASES FOR MOBILE PHONES; ACCESSORIES SPECIALLY ADAPTED FOR USE WITH MOBILE PHONES, NAMELY, EAR PHONES, BELT CLIPS, TELEPHONE HEAD SETS, HANDS FREE EQUIPMENT, NAMELY, DEVICES FOR HANDS-FREE USE OF MOBILE PHONES AND MOBILE PHONE CHARGERS; SUNGLASSES AND CASES FOR SUNGLASSES; COMPUTER MOUSE MATS; COMPUTER MOUSE; COMPUTER SOFTWARE, NAMELY, COMPUTER SOFTWARE FOR THE PRODUCTION OF FILM INCLUDING COMPUTER ANIMATION, COMPUTER SOFTWARE AND COMPUTER GRAPHICS SOFTWARE FOR THE PRODUCTION OF SPECIAL EFFECTS (U.S. CLS. 21, 23, 26, 36 AND 38).

CLASS 16—PAPER GOODS AND PRINTED MATTER

FOR PRINTED MATTER, NAMELY, BOOKS, MAGAZINES, NEWSLETTERS, POSTERS, CATALOGUES, LEAFLETS AND BROCHURES IN THE FIELD OF FILM, TELEVISION, GAMES, GAME SHOWS AND ENTERTAINMENT; BOOKS, NAMELY, SERIES OF FICTIONAL BOOKS AND NON-FICTIONAL BOOKS IN THE FIELD OF FILM, TELEVISION, GAMES, GAME SHOWS AND ENTERTAINMENT; STATIONERY, NAMELY, PENS, PENCILS, ERASERS, FELT TIP PENS, CRAYONS, COLORING PENCILS; PHOTOGRAPHS; WRAPPING PAPER; PUBLICATIONS, NAMELY, PRINTED PERIODICALS IN THE FIELD OF FILM, TELEVISION, GAMES, GAME SHOWS AND ENTERTAINMENT, CALENDARS; GREETINGS CARDS; CHRISTMAS CARDS; POSTCARDS; DIARIES AND ADDRESS BOOKS; NEWSLETTERS IN THE FIELD OF FILM, TELEVISION, GAMES, GAME SHOWS AND ENTERTAINMENT; MAGAZINES IN THE FIELD OF FILM, TELEVISION, GAMES, GAME SHOWS AND ENTERTAINMENT; PAPERCLIPS, BOOKS MARKERS, STENCILS, CHECK BOOK AND PASSPORT HOLDERS; TABLE LINEN, NAMELY, PAPER TABLE CLOTHS; TABLEMATS AND TABLE NAPKINS OF PAPER; DECALCOMANIAS (U.S. CLS. 2, 5, 22, 23, 29, 37, 38 AND 50).

CLASS 41—EDUCATION AND ENTERTAINMENT

FOR ENTERTAINMENT SERVICES, NAMELY, THE PRESENTATION OF FILMS, TELEVISION AND RADIO PROGRAMS, GAMES, GAME SHOWS AND LIVE ENTERTAINMENT EVENTS, NAMELY, PLANNING AND CONDUCTING A SERIES OF FILM FESTIVALS, ENTERTAINMENT IN THE NATURE OF ON-GOING CHILDREN'S TELEVISION SHOWS; ONLINE ELECTRONIC PUBLISHING OF BOOKS, MAGAZINES AND REVIEWS; PUBLISHING OF BOOKS, MAGAZINES AND REVIEWS; PROVISION OF NON-DOWNLOADABLE BOOKS ON-LINE, NAMELY, PROVIDING ELECTRONIC LIBRARY SERVICES THAT FEATURE BOOKS VIA AN ONLINE COMPUTER NETWORK; ARRANGING AND CONDUCTING OF SEMINARS, EDUCATIONAL CONFERENCES AND EDUCATIONAL EXHIBITIONS IN THE FIELD OF FILM, TELEVISION, GAMES, GAME SHOWS AND ENTERTAINMENT; BOOK CLUB SERVICES, NAMELY, CONDUCTING SOCIAL BOOK CLUBS FOR EDUCATIONAL AND ENTERTAINMENT PURPOSES; ELECTRONIC GAMES SERVICES, NAMELY, PROVISION OF COMPUTER GAMES ON-LINE; PROVISION OF COMPUTER GAMES SERVICES ON-LINE; FILM PRODUCTION SERVICES; PRODUCTION OF FILMS, TELEVISION AND RADIO PROGRAMS (U.S. CLS. 100, 101 AND 107).

MYRIAH HABEEB, EXAMINING ATTORNEY

SN 79-056,489. CAIRN HOLDINGS (UK) LIMITED, UNITED KINGDOM, FILED 5-8-2008.

GEO-FIX

THE MARK CONSISTS OF STANDARD CHARACTERS WITHOUT CLAIM TO ANY PARTICULAR FONT, STYLE, SIZE, OR COLOR.

OWNER OF INTERNATIONAL REGISTRATION 0971313 DATED 5-8-2008, EXPIRES 5-8-2018.

CLASS 1—CHEMICALS

FOR CHEMICAL BINDING AGENTS IN LIQUID OR SEMI-LIQUID FORM IN THE NATURE OF ADHESIVES FOR USE IN BINDING AND LAYING PAVING, PAVING BLOCKS, PAVING SLABS, COBBLES, SETTS, KERB STONES, TILES (U.S. CLS. 1, 5, 6, 10, 26 AND 46).

CLASS 19—NON-METALLIC BUILDING MATERIALS

FOR PARTICULATE COMPOSITIONS IN THE NATURE OF SAND FOR USE IN LAYING PAVING; PAVING BLOCKS, PAVING SLABS OF CEMENT, CONCRETE, CLAY, SLATE, COBBLES, SETTS, KERBSTONES, PAVING TILES (U.S. CLS. 1, 12, 33 AND 50).

MATTHEW KLINE, EXAMINING ATTORNEY

PRINTED INSTRUCTIONAL, EDUCATIONAL, AND TEACHING MATERIAL IN THE FIELD OF SPORTS; PLASTIC MATERIALS FOR PACKAGING, NAMELY, PLASTIC BAGS FOR PACKAGING, PLASTIC BUBBLE PACKS FOR WRAPPING OR PACKAGING, PLASTIC BAGS IN THE FORM OF ENVELOPES AND POUCHES FOR MERCHANDISE PACKAGING, PLASTIC WRAP FOR USE IN PACKAGING; PRINTERS' TYPE; PRINTING BLOCKS (U.S. CLS. 2, 5, 22, 23, 29, 37, 38 AND 50).

CLASS 18—LEATHER GOODS

FOR LEATHER AND IMITATIONS OF LEATHER; GOODS MADE OF THESE MATERIALS, NAMELY, LEATHER HANDBAGS, LEATHER KEY CASES, LEATHER WALLETS, LEATHER SOLD IN BULK, LEATHER AND IMITATION LEATHER BAGS, LEATHER CASES; POCKET WALLETS; BEACH BAGS; SHOPPING BAGS, NAMELY, LEATHER SHOPPING BAGS, REUSABLE SHOPPING BAGS, MESH SHOPPING BAGS, CANVAS SHOPPING BAGS, TEXTILE SHOPPING BAGS, WHEELED SHOPPING BAGS; PURSES; HANDBAGS; SUITCASES; UNFITTED VANITY CASES; TRAVELING BAGS; TRAVELING TRUNKS; RUCKSACKS; SCHOOL BAGS; BAGS FOR SPORTS; ANIMAL SKINS AND HIDES; TRUNKS, NAMELY, TRAVELING TRUNKS MADE OF LEATHER, LUGGAGE TRUNKS, KORI WICKER TRUNKS; TRAVELING BAGS; UMBRELLAS, PARASOLS; WALKING STICKS; WHIPS, HARNESSSES; SADDLERY (U.S. CLS. 1, 2, 3, 22 AND 41).

CLASS 21—HOUSEWARES AND GLASS

FOR HOUSEHOLD OR KITCHEN UTENSILS, NAMELY, STRAINERS, SPATULAS, NON-ELECTRIC EGG BEATERS, HOUSEHOLD CONTAINERS FOR FOODS, ALL PURPOSE PORTABLE HOUSEHOLD CONTAINERS, COOKING SIFTERS, FRYING PANS; BASTING SPOONS, FOR KITCHEN USE, NON ELECTRIC BLENDERS FOR HOUSEHOLD PURPOSES, HAND-OPERATED MILLS FOR DOMESTIC PURPOSES, NON-ELECTRIC FRUIT PRESSES FOR HOUSEHOLD PURPOSES; HEAT-INSULATED CONTAINERS, NAMELY, THERMAL INSULATED CONTAINERS FOR FOOD OR BEVERAGE, THERMAL INSULATED BAGS FOR FOOD OR BEVERAGES, INSULATED CONTAINERS FOR BEVERAGE CANS FOR DOMESTIC USE, INSULATED CONTAINERS FOR FOOD OR BEVERAGE FOR DOMESTIC USE; NON-ELECTRIC COFFEE FILTERS, NAMELY, COFFEE FILTERS NOT OF PAPER BEING PART OF NON-ELECTRIC COFFEE MAKERS; NON ELECTRIC COFFEEPOTS, HAND-OPERATED COFFEE GRINDERS, CAULDRONS, NON-ELECTRIC KETTLES; BINS AND BASKETS FOR THE DOMESTIC USE, NAMELY, BREAD BINS, DUST BINS, REFUSE BINS, LAUNDRY BINS FOR DOMESTIC OR HOUSEHOLD USE, BREAD BASKETS FOR DOMESTIC USE, STEAMER BASKETS, LAUNDRY BASKETS, WASTEPAPER BASKETS, FLOWER BASKETS; NON-ELECTRIC BEATERS, NAMELY, NON-ELECTRIC EGG BEATERS, CARPET BEATERS NOT BEING MACHINES; MIXING SPOONS; VESSELS OF METAL FOR MAKING ICE AND ICED DRINKS, NAMELY, ICE CUBE MOLDS FOR REFRIGERATORS, DRINKING VESSELS, DEWAR VESSELS; TRAYS FOR DOMESTIC PURPOSES, NON-ELECTRIC WHISKS FOR HOUSEHOLD PURPOSES, NON-ELECTRIC PRESSURE COOKERS, BREAD BOARDS; CONTAINERS FOR HOUSEHOLD OR KITCHEN USE NOT OF PRECIOUS METAL OR COATED THEREWITH; COMBS; SPONGES, NAMELY, BATH SPONGES, SCOURING SPONGES, LOOFAH SPONGES, BODY SPONGES, SPONGES FOR HOUSEHOLD PURPOSES; BRUSHES, NAMELY, HAIR BRUSHES, TOOTHBRUSHES, DUSTING BRUSHES, FLOOR BRUSHES, LINT BRUSHES, TOILET BRUSHES; IRONING BOARDS; FLOWER POTS; BRUSH-MAKING MATERIALS, NAMELY, FILAMENTS FOR MAKING BRUSHES, MATERIAL FOR BRUSH-MAKING, SYNTHETIC FIBERS FOR USE IN BRUSH-MAKING; ARTICLES FOR CLEANING PURPOSES, NAMELY, BROOMS, MOPS, DUST PANS, DUSTERS, NON-ELECTRIC CARPET SWEEPERS; STEEL WOOL; UNWORKED OR SEMI-WORKED GLASS NOT FOR USE IN BUILDING; GLASSWARE, NAMELY, BEVERAGE GLASSWARE, GLASS TABLEWARE, NAMELY, GLASS SAUCERS; GLASS MUGS, GLASS CUPS, GLASS PLATES, GLASS BOTTLES SOLD EMPTY, GLASS STORAGE CONTAINERS FOR HOUSEHOLD OR DOMESTIC USE, PILSNER DRINK-

SN 79-056,775. JAN BIRCK, FED REP GERMANY, FILED 4-22-2008.



PRIORITY DATE OF 11-21-2007 IS CLAIMED.

OWNER OF INTERNATIONAL REGISTRATION 0972022 DATED 4-22-2008, EXPIRES 4-22-2018.

THE MARK CONSISTS OF A STYLIZED ARROWHEAD WITH TWO EYES; THE RIGHT EYE IS COVERED BY AN EYE PATCH ATTACHED TO A DIAGONAL STRAP. THE STYLIZED ARROWHEAD ALSO CONTAINS SEVERAL VERTICAL BANDS.

CLASS 16—PAPER GOODS AND PRINTED MATTER

FOR PAPER, CARDBOARD AND GOODS MADE FROM THESE MATERIALS, NOT INCLUDED IN OTHER CLASSES, NAMELY, ART PAPER, LASER PRINTING PAPER, COPY PAPER, DRAWING PAPER, CARDBOARD HANG TAGS, CARDBOARD BOXES, CARDBOARD CONTAINERS, PAPER BAGS, PAPER BANNERS, PAPER BOXES, PAPER DIAPERS, PAPER EGG CARTONS, PLACARDS OF PAPER OR CARDBOARD, MATS, NAMELY, PAPER PLACE MATS, PAPER MATS, PAPER TABLE MATS, COIN MATS, PAPER FLOOR MATS, TABLE MATS OF PAPER; PRINTED MATTER, NAMELY, PRINTED BOOKS, MAGAZINES, GUIDES, NEWSPAPERS, PERIODICALS, JOURNALS AND PAMPHLETS IN THE FIELD OF SPORT AND CHILDREN'S ENTERTAINMENT; SERIES OF FICTION WORKS, NAMELY, NOVELS AND BOOKS; ADDRESS BOOKS; CALENDARS; PLASTIC ENVELOPES FOR NOTEBOOKS AND BOOKLETS, NAMELY, PROTECTIVE PLASTIC COVERS FOR BOOKS; PLASTIC BOOK OR NOTEBOOK COVERS, PLASTIC BOOKLET COVERS; PAPER SCHEDULES, NAMELY, DATE BOOKS, PRINTED TIMETABLES; POETRY BOOKS; BOOKBINDING MATERIAL, NAMELY, BOOKBINDING WIRE, BOOKBINDING TAPE, CLOTH FOR BOOKBINDING, BOOKBINDINGS; PHOTOGRAPHS; STATIONERY; WRITING INSTRUMENTS; PEN CASES; ADHESIVES FOR STATIONERY OR HOUSEHOLD PURPOSES; ARTISTS' MATERIALS, NAMELY, ARTISTS' BRUSHES, ARTISTS' PASTELS, ARTISTS' PENCILS, ARTISTS' PENS, CANVAS PANELS FOR ARTISTS; PAINT BRUSHES; TYPEWRITERS; OFFICE REQUISITES NOT INCLUDING FURNITURE, NAMELY, BINDERS FOR OFFICE USE, COLLATORS FOR OFFICE USE, CORRECTING FLUID FOR TYPE, OFFICE HOLE PUNCHERS, ENVELOPE SEALING MACHINES, OFFICE LABELING MACHINES, RUBBER BANDS, STAPLERS, PAPER SHREDDERS, PAPER EMBOSSERS; INSTRUCTIONAL AND TEACHING MATERIAL, NAMELY,

ING GLASSES, DRINKING GLASSES, GLASS DRINKING VESSELS, GLASS BOWLS, GLASS VASES, GLASS JUGS, GLASS DECANTERS; PORCELAIN AND EARTHENWARE, NAMELY, PORCELAIN TABLEWARE, NAMELY, PORCELAIN SAUCERS, PORCELAIN CUPS, PORCELAIN PLATES, PORCELAIN BOTTLES SOLD EMPTY, PORCELAIN STORAGE CONTAINERS FOR HOUSEHOLD OR DOMESTIC USE, PORCELAIN DRINKING VESSELS, PORCELAIN BOWLS, PORCELAIN VASES, PORCELAIN JUGS, PORCELAIN DECANTERS, PORCELAIN MUGS, PORCELAIN OR EARTHENWARE DOORKNOBS, FIGURINES AND STATUETTES MADE OF PORCELAIN OR EARTHENWARE, EARTHENWARE MUGS, EARTHENWARE CUPS, EARTHENWARE BOTTLES SOLD EMPTY, EARTHENWARE TABLEWARE, NAMELY, EARTHENWARE SAUCERS, EARTHENWARE CUPS, EARTHENWARE PLATES, EARTHENWARE STORAGE CONTAINERS FOR HOUSEHOLD OR DOMESTIC USE, EARTHENWARE BOWLS, EARTHENWARE VASES, EARTHENWARE JUGS, EARTHENWARE DECANTERS, EARTHENWARE DRINKING VESSELS, EARTHENWARE BASINS, EARTHENWARE DINNER PLATES, EARTHENWARE BOTTLES SOLD EMPTY; PAPER PLATES; PAPER CUPS; CUPS OF PLASTIC; EGG CUPS; BEER MUGS; DISPOSABLE TABLE PLATES; GLASS JARS; BUCKETS; CHOPSTICKS; FLASKS; BOTTLE OPENER; COOKING POT SETS; BOXES OF GLASS; CHEESE-DISH COVERS, COOKIE JARS; CANDLESTICKS; GARLIC PRESSES; COOKING POTS, CORK-SCREWS; PEPPER POTS; SALT CELLARS; SOAP DISPENSERS; NAPKIN RINGS; COCKTAIL SHAKERS; POTS; NON-ELECTRIC TEAPOTS; TRIVETS; SUGAR BOWLS (U.S. CLS. 2, 13, 23, 29, 30, 33, 40 AND 50).

CLASS 24—FABRICS

FOR TEXTILES AND TEXTILE GOODS NOT INCLUDED IN OTHER CLASSES, NAMELY, TEXTILE NAPKINS, TEXTILE TABLECLOTHS, TEXTILE TAPETRIES, TEXTILE QUILTS, TEXTILE FABRICS FOR THE MANUFACTURE OF CLOTHING, TEXTILE USED AS LINING FOR CLOTHING, WAVY FIBER TEXTILES, TEXTILE FABRICS FOR HOME AND COMMERCIAL INTERIORS, PLACE MATS, NAMELY, VINYL PLACE MATS, TEXTILE PLACE MATS, PLASTIC PLACE MATS; CURTAINS, TOWELS OF TEXTILE, HOUSEHOLD LINEN, CUSHION COVERS, KITCHEN LINENS, KNITTED FABRICS, SHOWER CURTAINS, LINGERIE FABRIC, BED BLANKETS, COVERS FOR FURNITURE, NAMELY, UNFITTED FABRIC FURNITURE COVERS; UPHOLSTERY FABRICS, TRAVELING RUGS, TABLE NAPKINS OF TEXTILE, LABELS OF CLOTH, TEXTILE HANDKERCHIEFS, TABLE LINEN, SHEETS OF TEXTILE, NAMELY, TEXTILE BED SHEETS; SERVIETTES OF TEXTILE, NON-WOVEN TEXTILE FABRICS; BED COVERS, NAMELY, BED BLANKETS, BED LINEN, BED SHEETS, CONTOURED MATTRESS COVERS, PILLOW COVERS, MATTRESS COVERS, DUVET COVERS; TABLE COVERS, NAMELY, TABLE MATS NOT OF PAPER, TABLE LINEN, FABRIC TABLE TOPPERS, FABRIC TABLE RUNNERS, TABLE CLOTHS NOT OF PAPER; SAIL CLOTH (U.S. CLS. 42 AND 50).

CLASS 25—CLOTHING

FOR CLOTHING, NAMELY, PANTS, SHIRTS, HATS, SOCKS, SHORTS, SPORTS BRAS, SPORT SHIRTS, JACKETS, COATS, JERSEYS, SUITS, NECKTIES, DRESSING GOWNS, OVERALLS, PULLOVERS, SKIRTS, DRESSES; WATERPROOF CLOTHING, NAMELY, WATERPROOF JACKETS, PANTS, SHIRTS, HATS, SOCKS, SHORTS, COATS, JERSEYS, SUITS, OVERALLS AND PULLOVERS; COLLAR PROTECTORS, PAJAMAS, BATHING SUITS, BATHING TRUNKS, BATH ROBES, BRASIERES, SCARVES, T-SHIRTS, VESTS, OVERALLS, ARM WARMERS, HAND-WARMERS, KNEE WARMERS; CLOTHING FOR SPORTS, NAMELY, SURF WEAR, KITE SURF WEAR, WATER SKI WEAR, NAMELY, WET SUITS FOR WATER-SKIING, WET SUIT GLOVES, DIVING WEAR, NAMELY, WET SUITS FOR SUB-AQUA, WET-SUITS, WET SUIT GLOVES, SAILING WEAR, NAMELY, SHORTS, HATS, SHIRTS, PANTS, JACKETS, SOCKS, COATS, JERSEYS, SUITS, OVERALLS, PULLOVERS AND DECK-SHOES, SNOWBOARDING WEAR, NAMELY, SNOWBOARDING SUITS, SNOWBOARD GLOVES, SNOWBOARD MITTENS, SNOWBOARD

PANTS, SNOWBOARD PARKAS, SKIWEAR, SWIMMING WEAR, NAMELY, SWIMWEAR, BATHING SUITS, SWIMMING CAPS, FOOTBALL WEAR, NAMELY, FOOTBALL PANTS, FOOTBALL JERSEYS, FOOTBALL SHOES, FOOTBALL SOCKS, SOCCER WEAR, NAMELY, SOCCER JERSEYS, SOCCER SHOES, SOCCER SOCKS, SOCCER SHORTS, SOCCER BOOTS, BEACH SOCCER WEAR, NAMELY, BEACH SOCCER JERSEYS, BEACH SOCCER SHOES, BEACH SOCCER SOCKS, BEACH SOCCER SHORTS, BEACH SOCCER BOOTS, AND WATER POLO WEAR, NAMELY, BATHING SUITS, SWIMMING CAPS, SWIMMING COSTUMES, SWIMMING TRUNKS, SKI JACKETS, SKI MASKS, SKI PANTS, SKI SUITS, SKI TROUSERS, WET SUITS FOR WATER-SKIING, WINDSURFING AND KITE SURFING, SNOWBOARD PANTS; CORSETRY, NAMELY, CORSETS; UNDERWEAR; CHILDREN'S CLOTHING, NAMELY, PANTS, SHIRTS, HATS, SOCKS, SHORTS, JACKETS, COATS, JERSEYS; CLOTHES FOR NEWBORN BABIES, NAMELY, BABY BODYSUITS, BABY BUNTING, BABY BOTTOMS, INFANTWEAR, PANTS, SHIRTS, HATS, SOCKS, SHORTS, JACKETS, COATS, JERSEYS; PLAYSUITS, NAMELY, BABY BODYSUITS; FOOTWEAR; BOOTS; SHOES, NAMELY, SURF SHOES; KITE SURF SHOES, WATER SKIING SHOES, DIVING SHOES, NAMELY, SHOES SPECIALLY DESIGNED TO BE WORN WITH WETSUITS, SAILING SHOES, NAMELY, DECK-SHOES, SNOWBOARD BOOTS AND SHOES, LEATHER SHOES, SKIING SHOES, SOCCER SHOES, BEACH SOCCER SHOES, FOOTBALL SHOES, SWIMMING SHOES, TRAINING SHOES, THONGS, FLIP FLOPS, BEACH FOOTWEAR; BELTS; STOCKINGS; TIGHTS; SOCKS; NECKTIES, NAMELY, TIES; GLOVES; HEADGEAR, NAMELY, HEADBANDS, SWEATBANDS, BASEBALL CAPS, VISORS, BANDANNAS, HATS, WOOLLEN HATS, CAPS, BATHING CAPS, SWIMMING CAPS, SNOWBOARD GLOVES, WET SUIT GLOVES, SKI GLOVES, SKI BOOT BAGS (U.S. CLS. 22 AND 39).

CLASS 28—TOYS AND SPORTING GOODS

FOR GAMES AND PLAYTHINGS, NAMELY, ARCADE GAMES, BOARD GAMES, PINBALL GAMES, DOLLS, DOLLS' CLOTHES, DOLLS' HOUSES, DOLLS' BEDS, JIGSAW PUZZLES, BACKGAMMON GAMES, STUFFED TOYS, PLAY HOUSES, ELECTRONIC EDUCATIONAL GAME MACHINES FOR CHILDREN, TABLETOP UNITS FOR PLAYING ELECTRONIC GAMES OTHER THAN IN CONJUNCTION WITH A TELEVISION OR COMPUTER, VIDEO, COMPUTER AND ELECTRONIC GAMES OTHER THAN THOSE ADAPTED FOR USE WITH TELEVISION RECEIVERS ONLY, NAMELY, ELECTRONIC GAMES OTHER THAN THOSE ADAPTED FOR USE WITH TELEVISION RECEIVERS ONLY, FLOOR-STANDING UNITS FOR PLAYING ELECTRONIC GAMES OTHER THAN IN CONJUNCTION WITH A TELEVISION OR COMPUTER, COIN-OPERATED VIDEO GAMES, ARCADE-TYPE ELECTRONIC VIDEO GAMES, STAND ALONE VIDEO GAME MACHINES; TOYS, NAMELY, BATTERY-POWERED COMPUTER GAME WITH LCD SCREEN WHICH FEATURES ANIMATION AND SOUND EFFECTS, APPARATUS FOR ELECTRONIC GAMES OTHER THAN THOSE ADAPTED FOR USE WITH AN EXTERNAL DISPLAY SCREEN OR MONITOR, HAND HELD UNIT FOR PLAYING VIDEO AND ELECTRONIC GAMES, CARD GAMES, CONFETTI, DICE, TEDDY BEARS, JOKE ARTICLES, NAMELY, FAKE TEETH, MAGIC TRICKS, TOY MASKS, PLAYING BALLS, NAMELY, PLAYGROUND BALLS, BILLIARD BALLS, BASKET BALLS, BEACH BALLS, BOWLING BALLS, EXERCISE BALLS, GOLF BALLS, HAND BALLS, SOFT TENNIS BALLS, SQUASH BALLS, TENNIS BALLS, VOLLEY BALLS, RACKET BALLS, RUGBY BALLS, NET BALLS, PADDLE BALLS; TOY ANIMALS, BUILDING BLOCKS, CUPS FOR DICE, DOMINOES, TOY PISTOLS, PLUSH TOYS, TOY MASKS, THEATRICAL MASKS, SCALE MODEL VEHICLES, CHESS GAMES, CHESSBOARDS, DARTS, MARBLES FOR GAMES, PARLOUR GAMES, MECHANICAL, ELECTRONIC AND ELECTRIC ACTION TOYS, PET TOYS, MUSICAL TOYS, MECHANICAL TOYS, PRINTING TOYS, TOY BOXES, BATH TOYS, COLLECTABLE TOY FIGURES, TOY ROBOTS, TOY FIGURES, TOY ANIMALS, TOY WEAPONS, TOY WATCHES, TOY WHISTLES, ELECTRONIC TOY VEHICLES, INFANT TOYS; GYMNASIUM AND SPORTING ARTICLES AND SPORTING APPARATUS, NAMELY, GYMNASIUM PARALLEL BARS, SWINGS, GYMNASIUM VAULTING HORSES,

CHEST PROTECTORS FOR SPORTS, GOLF CLUBS, DUMB-BELLS, HOCKEY STICKS, KNEE GUARDS FOR ATHLETIC USE, BALLS FOR GAMES, SHIN GUARDS FOR ATHLETIC USE, TENNIS NETS, BODY BUILDING APPARATUS, ELBOW GUARDS FOR ATHLETIC USE, BALLS FOR SPORTS, STORAGE RACKS FOR SKI AND SPORTS EQUIPMENT, ICE SKATES, SNOWSHOES, SURFBOARDS, KITE BOARDS, KITES, WATER SKIS, LEASHES USED IN CONJUNCTION WITH SURFING AND KITE SURFING, PORTABLE SKI CARRIERS, SKI BINDINGS, SKI CASES, SKI COVERS, SURF SKIS, SKI POLES, SNOWBOARDS, BODY PROTECTORS FOR FOOTBALL, SKIING, SNOWBOARDING, AND KITE SURFING; JACKETS WITH BACK PROTECTORS AND SPINAL PROTECTORS, NAMELY, JACKETS IN THE NATURE OF CHEST PROTECTORS FOR SPORTS; VESTS WITH BACK PROTECTORS AND SPINAL PROTECTORS, NAMELY, VESTS IN THE NATURE OF CHEST PROTECTORS FOR SPORTS; KNEE GUARDS AND PROTECTORS, NAMELY, KNEE PADS FOR ATHLETIC USE, SOCCER KNEE PADS; FOOTBALL CHEST PADS, FOOTBALL ELBOW PADS, FOOTBALL KNEE PADS, FOOTBALL LEG PADS, FOOTBALL SHOULDER PADS, FOOTBALLS, TABLES FOR TABLE FOOTBALL, SWIMMING BOARDS, POOL RINGS, SAIL BOARDS, SKATEBOARDS, BAGS FOR SKIS AND SURFBOARDS, GOLF BAGS, PUNCHING BAGS, PLAYGROUND EQUIPMENT, NAMELY, SLIDES, ROLLER SKATES, BASEBALL GLOVES, BOXING GLOVES, GOLF GLOVES, GOLF BAGS, SPORT BALLS, SOCCER BALLS, BEACH SOCCER BALLS, BASEBALLS, SKIS, APPLIANCES FOR GYMNASTICS, GYMNASTIC APPARATUS, BASEBALL AND CRICKET BATS, TENNIS RACKETS, BALLS FOR WATER POLO, FLIPPERS FOR SWIMMING, SURF SKIS, SURF PADDLES, SURF FINS, DIVING GLOVES, FOOTBALL GLOVES, SOCCER GLOVES, SWIMMING GLOVES, WATER-SKI GLOVES, WINDSURFING GLOVES; CHRISTMAS TREE DECORATIONS NOT INCLUDING CONFECTIONERY OR ILLUMINATION ARTICLES, SNOW SHOES (U.S. CLS. 22, 23, 38 AND 50).

CLASS 41—EDUCATION AND ENTERTAINMENT

FOR EDUCATION, PROVIDING OF TRAINING, ENTERTAINMENT AND SPORTING AND CULTURAL ACTIVITIES, NAMELY, PUBLICATION AND WRITTEN TEXT EDITING OF BOOKS, MAGAZINES, TEXTS, GUIDES, NEWSPAPERS, PERIODICALS, JOURNALS, ADDRESS BOOKS AND CALENDARS FOR OTHERS; PUBLISHING OF ELECTRONIC PUBLICATIONS, MULTIMEDIA PUBLISHING OF BOOKS, MAGAZINES, JOURNALS, SOFTWARE, GAMES, MUSIC, AND ELECTRONIC PUBLICATIONS; CONCEPTION, ORGANIZATION AND PERFORMANCE OF EXHIBITIONS, EVENTS, CONFERENCES, CONGRESSES, SYMPOSIA, LECTURES, COURSES, WORKSHOPS, SEMINARS AND TRAINING IN THE FIELD OF CULTURE, ENTERTAINMENT, EDUCATION AND TRAINING, NAMELY, CONDUCTING WORKSHOPS, COURSES, SYMPOSIA, LECTURES, COURSES, CONFERENCES, AND SEMINARS IN FIELD OF CULTURE AND EDUCATION, CONDUCTING ENTERTAINMENT EXHIBITIONS IN THE NATURE OF MAGIC SHOWS AND WINE FESTIVALS, CONDUCTING EDUCATIONAL EXHIBITIONS IN THE NATURE OF SCIENCE FAIRS AND ART EXHIBITIONS; EDUCATIONAL SERVICES, NAMELY, CONDUCTING CONFERENCES, SYMPOSIA, LECTURES, COURSES, WORKSHOPS, AND SEMINARS IN THE FIELD OF LAW, ART, HISTORY, MEDICINE, SCIENCE, CHILDREN'S EDUCATION, SOCIOLOGY, ECONOMICS, FINANCE, AND MATH AND DISTRIBUTION OF COURSE MATERIAL IN CONNECTION THEREWITH; EDUCATIONAL SERVICES, NAMELY, DEVELOPING, ARRANGING, AND CONDUCTING EDUCATIONAL CONFERENCES AND PROGRAMS AND PROVIDING COURSES OF INSTRUCTION IN THE FIELD OF IN THE FIELD OF LAW, ART, HISTORY, MEDICINE, SCIENCE, CHILDREN'S EDUCATION, SOCIOLOGY, ECONOMICS, FINANCE, AND MATH; EDUCATIONAL SERVICES, NAMELY, DEVELOPING AND CONDUCTING TRAINING COURSES AND DISTRIBUTION OF TRAINING MATERIAL IN CONNECTION THEREWITH FOR SUBJECT MATTERS AS REQUESTED BY CUSTOMERS; ARRANGING AND CONDUCTING EDUCATIONAL CONFERENCES, ENTERTAINMENT SERVICES, NAMELY, CONDUCTING CONTESTS, PARTIES, AND FAIRS NOT FOR COMMERCIAL PURPOSES; PLAN-

NING AND CONDUCTING A SERIES OF FILM FESTIVALS; ORGANISATION OF SPORTS COMPETITIONS, ORGANISATION OF GAMES, ORGANISATION OF EXHIBITIONS FOR CULTURAL OR EDUCATIONAL PURPOSES, ORGANISATION OF FASHION SHOWS AND DANCING EVENTS, ORGANIZING, CONDUCTING, AND PERFORMING ENTERTAINMENT EVENTS IN THE NATURE OF SOCCER COMPETITIONS, ATHLETIC COMPETITIONS, CONCERTS, THEATRICAL SHOWS, MUSICAL CONCERTS, ARRANGING AND CONDUCTING NIGHTCLUB ENTERTAINMENT EVENTS AND SPECIAL EVENTS; FILM PRODUCTION AND FILM DISTRIBUTION FOR TELEVISION AND CINEMA, NAMELY, DISTRIBUTION OF TELEVISION PROGRAMS FOR OTHERS, PRODUCTION OF TELEVISION PROGRAMS, FILM PRODUCTION, FILM DISTRIBUTION; VIDEOTAPE FILM PRODUCTION, CINEMA PRESENTATIONS, NAMELY, CINEMA THEATERS; RENTAL OF CINE-FILMS AND VIDEOTAPES; PRODUCTION OF TELEVISION PROGRAMS AND SHOWS, SCRIPTWRITING SERVICES, ORGANIZATION OF EXHIBITIONS FOR CULTURAL OR EDUCATIONAL PURPOSES, PROVIDING NEWS AND INFORMATION IN THE FIELDS OF SPORT, ORGANIZATION OF GAMES AND SPORTS COMPETITIONS, ORGANIZING EXHIBITIONS AND CONFERENCES IN THE FIELDS OF SPORTS FOR NON-BUSINESS AND NON-COMMERCIAL PURPOSES, ORGANIZATION AND PROVIDING OF SPORTS ACTIVITIES AND SPORTS EVENTS, NAMELY, ORGANISATION OF SPORTS COMPETITIONS IN THE FIELDS OF WINDSURFING, KITE SURFING, WATER SKIING, DIVING, SAILING, WATER POLO, AND SWIMMING; ORGANISATION OF SPORTS COMPETITIONS IN THE FIELDS OF SOCCER, BEACH SOCCER, FOOTBALL, SNOWBOARDING AND SKIING (U.S. CLS. 100, 101 AND 107).

CLASS 42—SCIENTIFIC AND COMPUTER SERVICES

FOR DESIGN AND DEVELOPMENT OF COMPUTER HARDWARE AND SOFTWARE FOR OTHERS; COMPUTER SOFTWARE DEVELOPMENT FOR OTHERS IN THE FIELDS OF MULTIMEDIA, INTERACTIVE TELEVISION AND PAY TELEVISION; TECHNICAL CONSULTANCY IN THE FIELD OF MULTIMEDIA, INTERACTIVE TELEVISION AND PAY TV, NAMELY, TECHNICAL CONSULTING AND ASSISTANCE WITH COMPUTER-BASED INFORMATION SYSTEMS AND COMPONENTS FOR OPERATING INTERACTIVE TELEVISION AND PAY TELEVISION SYSTEMS, COMPUTER PROGRAMMING FOR OTHERS (U.S. CLS. 100 AND 101).

CLASS 45—PERSONAL AND LEGAL SERVICES

FOR ISSUING, NEGOTIATING, RENTAL AND OTHER EXPLOITATION OF RIGHTS TO FILMS, TELEVISION AND VIDEO PRODUCTIONS AND OTHER IMAGE AND SOUND PROGRAMS, NAMELY, PROVIDING INFORMATION ABOUT INTELLECTUAL AND INDUSTRIAL PROPERTY RIGHTS, LEASING REPRODUCTION RIGHTS OF PHOTOGRAPHS AND TRANSPARENCIES TO OTHERS, COPYRIGHT MANAGEMENT, COPYRIGHT MANAGEMENT CONSULTATION, INTELLECTUAL PROPERTY CONSULTATION, LICENSING OF INTELLECTUAL PROPERTY, LICENSING OF ADVERTISING SLOGANS AND CARTOON CHARACTERS, LICENSING OF COMPUTER SOFTWARE, LICENSING OF RIGHTS TO FILMS, TELEVISION AND VIDEO PRODUCTIONS AND OTHER IMAGE AND SOUND PROGRAMS; MANAGEMENT AND EXPLOITATION OF COPYRIGHT AND INDUSTRIAL PROPERTY RIGHTS BY LICENSING FOR OTHERS, NAMELY, LICENSING OF COPYRIGHTS AND INTELLECTUAL PROPERTY RIGHTS TO OTHERS; EXPLOITATION OF FILM AND TELEVISION ANCILLARY RIGHTS IN THE FIELD OF MERCHANDISING BY LICENSING FOR OTHERS, NAMELY, LICENSING OF FILM AND TELEVISION ANCILLARY RIGHTS FOR MERCHANDISING PRODUCTS (U.S. CLS. 100 AND 101).

MICHAEL TANNER, EXAMINING ATTORNEY

SN 79-056,777. JAN BIRCK, FED REP GERMANY, FILED 4-22-2008.

MOONSURFER

THE MARK CONSISTS OF STANDARD CHARACTERS WITHOUT CLAIM TO ANY PARTICULAR FONT, STYLE, SIZE, OR COLOR.

PRIORITY DATE OF 11-21-2007 IS CLAIMED.
OWNER OF INTERNATIONAL REGISTRATION 0972024 DATED 4-22-2008, EXPIRES 4-22-2018.

CLASS 16—PAPER GOODS AND PRINTED MATTER

FOR PAPER, CARDBOARD AND GOODS MADE FROM THESE MATERIALS, NOT INCLUDED IN OTHER CLASSES, NAMELY, ART PAPER, LASER PRINTING PAPER, COPY PAPER, DRAWING PAPER, CARDBOARD HANG TAGS, CARDBOARD BOXES, CARDBOARD CONTAINERS, PAPER BAGS, PAPER BANNERS, PAPER BOXES, PAPER DIAPERS, PAPER EGG CARTONS, PLACARDS OF PAPER OR CARDBOARD, MATS, NAMELY, PAPER PLACE MATS, PAPER MATS, PAPER TABLE MATS, COIN MATS, PAPER FLOOR MATS, TABLE MATS OF PAPER; PRINTED MATTER, NAMELY, PRINTED BOOKS, MAGAZINES, GUIDES, NEWSPAPERS, PERIODICALS, JOURNALS AND PAMPHLETS IN THE FIELD OF SPORT AND CHILDREN'S ENTERTAINMENT; SERIES OF FICTION WORKS, NAMELY, NOVELS AND BOOKS; ADDRESS BOOKS; CALENDARS; PLASTIC ENVELOPES FOR NOTEBOOKS AND BOOKLETS, NAMELY, PROTECTIVE PLASTIC COVERS FOR BOOKS; PLASTIC BOOK OR NOTEBOOK COVERS, PLASTIC BOOKLET COVERS; PAPER SCHEDULES, NAMELY, DATE BOOKS, PRINTED TIMETABLES; POETRY BOOKS; BOOKBINDING MATERIAL, NAMELY, BOOKBINDING WIRE, BOOKBINDING TAPE, CLOTH FOR BOOKBINDING, BOOKBINDINGS; PHOTOGRAPHS; STATIONERY; WRITING INSTRUMENTS; PEN CASES; ADHESIVES FOR STATIONERY OR HOUSEHOLD PURPOSES; ARTISTS' MATERIALS, NAMELY, ARTISTS' BRUSHES, ARTISTS' PASTELS, ARTISTS' PENCILS, ARTISTS' PENS, CANVAS PANELS FOR ARTISTS; PAINT BRUSHES; TYPEWRITERS; OFFICE REQUISITES NOT INCLUDING FURNITURE, NAMELY, BINDERS FOR OFFICE USE, COLLATORS FOR OFFICE USE, CORRECTING FLUID FOR TYPE, OFFICE HOLE PUNCHERS, ENVELOPE SEALING MACHINES, OFFICE LABELING MACHINES, RUBBER BANDS, STAPLERS, PAPER SHREDDERS, PAPER EMBOSSERS; INSTRUCTIONAL AND TEACHING MATERIAL, NAMELY, PRINTED INSTRUCTIONAL, EDUCATIONAL, AND TEACHING MATERIAL IN THE FIELD OF SPORTS; PLASTIC MATERIALS FOR PACKAGING, NAMELY, PLASTIC BAGS FOR PACKAGING, PLASTIC BUBBLE PACKS FOR WRAPPING OR PACKAGING, PLASTIC BAGS IN THE FORM OF ENVELOPES AND POUCHES FOR MERCHANDISE PACKAGING, PLASTIC WRAP FOR USE IN PACKAGING; PRINTERS' TYPE; PRINTING BLOCKS (U.S. CLS. 2, 5, 22, 23, 29, 37, 38 AND 50).

CLASS 18—LEATHER GOODS

FOR LEATHER AND IMITATIONS OF LEATHER; GOODS MADE OF THESE MATERIALS, NAMELY, LEATHER HANDBAGS, LEATHER KEY CASES, LEATHER WALLETS, LEATHER SOLD IN BULK, LEATHER AND IMITATION LEATHER BAGS, LEATHER CASES; POCKET WALLETS; BEACH BAGS; SHOPPING BAGS, NAMELY, LEATHER SHOPPING BAGS, REUSABLE SHOPPING BAGS, MESH SHOPPING BAGS, CANVAS SHOPPING BAGS, TEXTILE SHOPPING BAGS, WHEELED SHOPPING BAGS; PURSES; HANDBAGS; SUITCASES; UNFITTED VANITY CASES; TRAVELING BAGS; TRAVELING TRUNKS; RUCKSACKS; SCHOOL BAGS; BAGS FOR SPORTS; ANIMAL SKINS AND HIDES; TRUNKS, NAMELY, TRAVELING TRUNKS MADE OF LEATHER, LUGGAGE TRUNKS, KORI WICKER TRUNKS; TRAVELING BAGS; UMBRELLAS, PARASOLS; WALKING STICKS; WHIPS, HARNESSSES; SADDLERY (U.S. CLS. 1, 2, 3, 22 AND 41).

CLASS 21—HOUSEWARES AND GLASS

FOR HOUSEHOLD OR KITCHEN UTENSILS, NAMELY, STRAINERS, SPATULAS, NON-ELECTRIC EGG BEATERS, HOUSEHOLD CONTAINERS FOR FOODS, ALL PURPOSE PORTABLE HOUSEHOLD CONTAINERS, COOKING SIFTERS, FRYING PANS; BASTING SPOONS, FOR KITCHEN USE, NON ELECTRIC BLENDERS FOR HOUSEHOLD PURPOSES, HAND-OPERATED MILLS FOR DOMESTIC PURPOSES, NON-ELECTRIC FRUIT PRESSES FOR HOUSEHOLD PURPOSES; HEAT-INSULATED CONTAINERS, NAMELY, THERMAL INSULATED CONTAINERS FOR FOOD OR BEVERAGE, THERMAL INSULATED BAGS FOR FOOD OR BEVERAGES, INSULATED CONTAINERS FOR BEVERAGE CANS FOR DOMESTIC USE, INSULATED CONTAINERS FOR FOOD OR BEVERAGE FOR DOMESTIC USE; NON-ELECTRIC COFFEE FILTERS, NAMELY, COFFEE FILTERS NOT OF PAPER BEING PART OF NON-ELECTRIC COFFEE MAKERS; NON ELECTRIC COFFEEPOTS, HAND-OPERATED COFFEE GRINDERS, CAULDRONS, NON-ELECTRIC KETTLES; BINS AND BASKETS FOR THE DOMESTIC USE, NAMELY, BREAD BINS, DUST BINS, REFUSE BINS, LAUNDRY BINS FOR DOMESTIC OR HOUSEHOLD USE, BREAD BASKETS FOR DOMESTIC USE, STEAMER BASKETS, LAUNDRY BASKETS, WASTEPAPER BASKETS, FLOWER BASKETS; NON-ELECTRIC BEATERS, NAMELY, NON-ELECTRIC EGG BEATERS, CARPET BEATERS NOT BEING MACHINES; MIXING SPOONS; VESSELS OF METAL FOR MAKING ICE AND ICED DRINKS, NAMELY, ICE CUBE MOLDS FOR REFRIGERATORS, DRINKING VESSELS, DEWAR VESSELS; TRAYS FOR DOMESTIC PURPOSES, NON-ELECTRIC WHISKS FOR HOUSEHOLD PURPOSES, NON-ELECTRIC PRESSURE COOKERS, BREAD BOARDS; CONTAINERS FOR HOUSEHOLD OR KITCHEN USE NOT OF PRECIOUS METAL OR COATED THEREWITH; COMBS; SPONGES, NAMELY, BATH SPONGES, SCOURING SPONGES, LOOFAH SPONGES, BODY SPONGES, SPONGES FOR HOUSEHOLD PURPOSES; BRUSHES, NAMELY, HAIR BRUSHES, TOOTHBRUSHES, DUSTING BRUSHES, FLOOR BRUSHES, LINT BRUSHES, TOILET BRUSHES; IRONING BOARDS; FLOWER POTS; BRUSH-MAKING MATERIALS, NAMELY, FILAMENTS FOR MAKING BRUSHES, MATERIAL FOR BRUSH-MAKING, SYNTHETIC FIBERS FOR USE IN BRUSH MAKING; ARTICLES FOR CLEANING PURPOSES, NAMELY, BROOMS, MOPS, DUST PANS, DUSTERS, NON-ELECTRIC CARPET SWEEPERS; STEEL WOOL; UNWORKED OR SEMI-WORKED GLASS NOT FOR USE IN BUILDING; GLASSWARE, NAMELY, BEVERAGE GLASSWARE, GLASS TABLEWARE, NAMELY, GLASS SAUCERS, GLASS MUGS, GLASS CUPS, GLASS PLATES, GLASS BOTTLES SOLD EMPTY, GLASS STORAGE CONTAINERS FOR HOUSEHOLD OR DOMESTIC USE, PILSNER DRINKING GLASSES, DRINKING GLASSES, GLASS DRINKING VESSELS, GLASS BOWLS, GLASS VASES, GLASS JUGS, GLASS DECANTERS; PORCELAIN AND EARTHENWARE, NAMELY, PORCELAIN TABLEWARE, NAMELY, PORCELAIN SAUCERS, PORCELAIN CUPS, PORCELAIN PLATES, PORCELAIN BOTTLES SOLD EMPTY, PORCELAIN STORAGE CONTAINERS FOR HOUSEHOLD OR DOMESTIC USE, PORCELAIN DRINKING VESSELS, PORCELAIN BOWLS, PORCELAIN VASES, PORCELAIN JUGS, PORCELAIN DECANTERS, PORCELAIN MUGS, PORCELAIN OR EARTHENWARE DOORKNOBS, FIGURINES AND STATUETTES MADE OF PORCELAIN OR EARTHENWARE, EARTHENWARE MUGS, EARTHENWARE CUPS, EARTHENWARE BOTTLES SOLD EMPTY, EARTHENWARE TABLEWARE, NAMELY, EARTHENWARE SAUCERS, EARTHENWARE CUPS, EARTHENWARE PLATES, EARTHENWARE STORAGE CONTAINERS FOR HOUSEHOLD OR DOMESTIC USE, EARTHENWARE BOWLS, EARTHENWARE VASES, EARTHENWARE JUGS, EARTHENWARE DECANTERS, EARTHENWARE DRINKING VESSELS, EARTHENWARE BASINS, EARTHENWARE DINNER PLATES, EARTHENWARE BOTTLES SOLD EMPTY; PAPER PLATES; PAPER CUPS; CUPS OF PLASTIC; EGG CUPS; BEER MUGS; DISPOSABLE TABLE PLATES; GLASS JARS; BUCKETS; CHOPSTICKS; FLASKS; BOTTLE OPENER; COOKING POT SETS; BOXES OF GLASS; CHEESE-DISH COVERS, COOKIE JARS; CANDLESTICKS; GARLIC PRESSES; COOKING POTS, CORK-SCREWS; PEPPER POTS; SALT CELLARS; SOAP

DISPENSERS; NAPKIN RINGS; COCKTAIL SHAKERS; POTS; NON-ELECTRIC TEAPOTS; TRIVETS; SUGAR BOWLS (U.S. CLS. 2, 13, 23, 29, 30, 33, 40 AND 50).

CLASS 24—FABRICS

FOR TEXTILES AND TEXTILE GOODS NOT INCLUDED IN OTHER CLASSES, NAMELY, TEXTILE NAPKINS, TEXTILE TABLECLOTHS, TEXTILE TAPESTRIES, TEXTILE QUILTS, TEXTILE FABRICS FOR THE MANUFACTURE OF CLOTHING, TEXTILE USED AS LINING FOR CLOTHING, WAVY FIBER TEXTILES, TEXTILE FABRICS FOR HOME AND COMMERCIAL INTERIORS, PLACE MATS, NAMELY, VINYL PLACE MATS, TEXTILE PLACE MATS, PLASTIC PLACE MATS; CURTAINS, TOWELS OF TEXTILE, HOUSEHOLD LINEN, CUSHION COVERS, KITCHEN LINENS, KNITTED FABRICS, SHOWER CURTAINS, LINGERIE FABRIC, BED BLANKETS, COVERS FOR FURNITURE, NAMELY, UNFITTED FABRIC FURNITURE COVERS; UPHOLSTERY FABRICS, TRAVELING RUGS, TABLE NAPKINS OF TEXTILE, LABELS OF CLOTH, TEXTILE HANDKERCHIEFS, TABLE LINEN, SHEETS OF TEXTILE, NAMELY, TEXTILE BED SHEETS; SERVIETTES OF TEXTILE, NON-WOVEN TEXTILE FABRICS; BED COVERS, NAMELY, BED BLANKETS, BED LINEN, BED SHEETS, CONTOURED MATTRESS COVERS, PILLOW COVERS, MATTRESS COVERS, DUVET COVERS; TABLE COVERS, NAMELY, TABLE MATS NOT OF PAPER, TABLE LINEN, FABRIC TABLE TOPPERS, FABRIC TABLE RUNNERS, TABLE CLOTHS NOT OF PAPER; SAIL CLOTH (U.S. CLS. 42 AND 50).

CLASS 25—CLOTHING

FOR CLOTHING, NAMELY, PANTS, SHIRTS, HATS, SOCKS, SHORTS, SPORTS BRAS, SPORT SHIRTS, JACKETS, COATS, JERSEYS, SUITS, NECKTIES, DRESSING GOWNS, OVERALLS, PULLOVERS, SKIRTS, DRESSES; WATERPROOF CLOTHING, NAMELY, WATERPROOF JACKETS, PANTS, SHIRTS, HATS, SOCKS, SHORTS, COATS, JERSEYS, SUITS, OVERALLS AND PULLOVERS; COLLAR PROTECTORS, PAJAMAS, BATHING SUITS, BATHING TRUNKS, BATH ROBES, BRASIERES, SCARVES, T-SHIRTS, VESTS, OVERALLS, ARM WARMERS, HAND-WARMERS, KNEE WARMERS; CLOTHING FOR SPORTS, NAMELY, SURF WEAR, KITE SURF WEAR, WATER SKI WEAR, NAMELY, WET SUITS FOR WATER-SKIING, WET SUIT GLOVES, DIVING WEAR, NAMELY, WET SUITS FOR SUB-AQUA, WET-SUITS, WET SUIT GLOVES, SAILING WEAR, NAMELY, SHORTS, HATS, SHIRTS, PANTS, JACKETS, SOCKS, COATS, JERSEYS, SUITS, OVERALLS, PULLOVERS AND DECK-SHOES, SNOWBOARDING WEAR, NAMELY, SNOWBOARDING SUITS, SNOWBOARD GLOVES, SNOWBOARD MITTENS, SNOWBOARD PANTS, SNOWBOARD PARKAS, SKIWEAR, SWIMMING WEAR, NAMELY, SWIMWEAR, BATHING SUITS, SWIMMING CAPS, FOOTBALL WEAR, NAMELY, FOOTBALL PANTS, FOOTBALL JERSEYS, FOOTBALL SHOES, FOOTBALL SOCKS, SOCCER WEAR, NAMELY, SOCCER JERSEYS, SOCCER SHOES, SOCCER SOCKS, SOCCER SHORTS, SOCCER BOOTS, BEACH SOCCER WEAR, NAMELY, BEACH SOCCER JERSEYS, BEACH SOCCER SHOES, BEACH SOCCER SOCKS, BEACH SOCCER SHORTS, BEACH SOCCER BOOTS, AND WATER POLO WEAR, NAMELY, BATHING SUITS, SWIMMING CAPS, SWIMMING COSTUMES, SWIMMING TRUNKS, SKI JACKETS, SKI MASKS, SKI PANTS, SKI SUITS, SKI TROUSERS, WET SUITS FOR WATER-SKIING, WINDSURFING AND KITE SURFING, SNOWBOARD PANTS; CORSETRY, NAMELY, CORSETS; UNDERWEAR; CHILDREN'S CLOTHING, NAMELY, PANTS, SHIRTS, HATS, SOCKS, SHORTS, JACKETS, COATS, JERSEYS; CLOTHES FOR NEWBORN BABIES, NAMELY, BABY BODYSUITS, BABY BUNTING, BABY BOTTOMS, INFANTWEAR, PANTS, SHIRTS, HATS, SOCKS, SHORTS, JACKETS, COATS, JERSEYS; PLAYSUITS, NAMELY, BABY BODYSUITS; FOOTWEAR; BOOTS; SHOES, NAMELY, SURF SHOES; KITE SURF SHOES, WATER SKIING SHOES, DIVING SHOES, NAMELY, SHOES SPECIALLY DESIGNED TO BE WORN WITH WETSUITS, SAILING SHOES, NAMELY, DECK-SHOES, SNOWBOARD BOOTS AND SHOES, LEATHER SHOES, SKIING SHOES, SOCCER SHOES, BEACH SOCCER SHOES, FOOTBALL SHOES, SWIMMING SHOES, TRAINING SHOES, THONGS, FLIP FLOPS, BEACH

FOOTWEAR; BELTS; STOCKINGS; TIGHTS; SOCKS; NECKTIES, NAMELY, TIES; GLOVES; HEADGEAR, NAMELY, HEADBANDS, SWEATBANDS, BASEBALL CAPS, VISORS, BANDANNAS, HATS, WOOLLEN HATS, CAPS, BATHING CAPS, SWIMMING CAPS, SNOWBOARD GLOVES, WET SUIT GLOVES, SKI GLOVES, SKI BOOT BAGS (U.S. CLS. 22 AND 39).

CLASS 28—TOYS AND SPORTING GOODS

FOR GAMES AND PLAYTHINGS, NAMELY, ARCADE GAMES, BOARD GAMES, PINBALL GAMES, DOLLS, DOLLS' CLOTHES, DOLLS' HOUSES, DOLLS' BEDS, JIGSAW PUZZLES, BACKGAMMON GAMES, STUFFED TOYS, PLAY HOUSES, ELECTRONIC EDUCATIONAL GAME MACHINES FOR CHILDREN, TABLETOP UNITS FOR PLAYING ELECTRONIC GAMES OTHER THAN IN CONJUNCTION WITH A TELEVISION OR COMPUTER, VIDEO, COMPUTER AND ELECTRONIC GAMES OTHER THAN THOSE ADAPTED FOR USE WITH TELEVISION RECEIVERS ONLY, NAMELY, ELECTRONIC GAMES OTHER THAN THOSE ADAPTED FOR USE WITH TELEVISION RECEIVERS ONLY, FLOOR-STANDING UNITS FOR PLAYING ELECTRONIC GAMES OTHER THAN IN CONJUNCTION WITH A TELEVISION OR COMPUTER, COIN-OPERATED VIDEO GAMES, ARCADE-TYPE ELECTRONIC VIDEO GAMES, STAND ALONE VIDEO GAME MACHINES; TOYS, NAMELY, BATTERY-POWERED COMPUTER GAME WITH LCD SCREEN WHICH FEATURES ANIMATION AND SOUND EFFECTS, APPARATUS FOR ELECTRONIC GAMES OTHER THAN THOSE ADAPTED FOR USE WITH AN EXTERNAL DISPLAY SCREEN OR MONITOR, HAND HELD UNIT FOR PLAYING VIDEO AND ELECTRONIC GAMES, CARD GAMES, CONFETTI, DICE, TEDDY BEARS, JOKE ARTICLES, NAMELY, FAKE TEETH, MAGIC TRICKS, TOY MASKS, PLAYING BALLS, NAMELY, PLAYGROUND BALLS, BILLIARD BALLS, BASKET BALLS, BEACH BALLS, BOWLING BALLS, EXERCISE BALLS, GOLF BALLS, HAND BALLS, SOFT TENNIS BALLS, SQUASH BALLS, TENNIS BALLS, VOLLEY BALLS, RACKET BALLS, RUGBY BALLS, NET BALLS, PADDLE BALLS; TOY ANIMALS, BUILDING BLOCKS, CUPS FOR DICE, DOMINOES, TOY PISTOLS, PLUSH TOYS, TOY MASKS, THEATRICAL MASKS, SCALE MODEL VEHICLES, CHESS GAMES, CHESSBOARDS, DARTS, MARBLES FOR GAMES, PARLOUR GAMES, MECHANICAL, ELECTRONIC AND ELECTRIC ACTION TOYS, PET TOYS, MUSICAL TOYS, MECHANICAL TOYS, PRINTING TOYS, TOY BOXES, BATH TOYS, COLLECTABLE TOY FIGURES, TOY ROBOTS, TOY FIGURES, TOY ANIMALS, TOY WEAPONS, TOY WATCHES, TOY WHISTLES, ELECTRONIC TOY VEHICLES, INFANT TOYS; GYMNASIUM AND SPORTING ARTICLES AND SPORTING APPARATUS, NAMELY, GYMNASIUM PARALLEL BARS, SWINGS, GYMNASIUM VAULTING HORSES, CHEST PROTECTORS FOR SPORTS, GOLF CLUBS, DUMB-BELLS, HOCKEY STICKS, KNEE GUARDS FOR ATHLETIC USE, BALLS FOR GAMES, SHIN GUARDS FOR ATHLETIC USE, TENNIS NETS, BODY BUILDING APPARATUS, ELBOW GUARDS FOR ATHLETIC USE, BALLS FOR SPORTS, STORAGE RACKS FOR SKI AND SPORTS EQUIPMENT, ICE SKATES, SNOWSHOES, SURFBOARDS, KITE BOARDS, KITES, WATER SKIS, LEASHES USED IN CONJUNCTION WITH SURFING AND KITE SURFING, PORTABLE SKI CARRIERS, SKI BINDINGS, SKI CASES, SKI COVERS, SURF SKIS, SKI POLES, SNOWBOARDS, BODY PROTECTORS FOR FOOTBALL, SKIING, SNOWBOARDING, AND KITE SURFING; JACKETS WITH BACK PROTECTORS AND SPINAL PROTECTORS, NAMELY, JACKETS IN THE NATURE OF CHEST PROTECTORS FOR SPORTS; VESTS WITH BACK PROTECTORS AND SPINAL PROTECTORS, NAMELY, VESTS IN THE NATURE OF CHEST PROTECTORS FOR SPORTS; KNEE GUARDS AND PROTECTORS, NAMELY, KNEE PADS FOR ATHLETIC USE, SOCCER KNEE PADS; FOOTBALL CHEST PADS, FOOTBALL ELBOW PADS, FOOTBALL KNEE PADS, FOOTBALL LEG PADS, FOOTBALL SHOULDER PADS, FOOTBALLS, TABLES FOR TABLE FOOTBALL, SWIMMING BOARDS, POOL RINGS, SAIL BOARDS, SKATEBOARDS, BAGS FOR SKIS AND SURFBOARDS, GOLF BAGS, PUNCHING BAGS, PLAYGROUND EQUIPMENT, NAMELY, SLIDES, ROLLER SKATES, BASEBALL GLOVES, BOXING GLOVES, GOLF GLOVES, GOLF BAGS, SPORT BALLS, SOCCER BALLS, BEACH SOCCER BALLS, BASEBALLS, SKIS, APPLIANCES FOR

GYMNASTICS, GYMNASTIC APPARATUS, BASEBALL AND CRICKET BATS, TENNIS RACKETS, BALLS FOR WATER POLO, FLIPPERS FOR SWIMMING, SURF SKIS, SURF PADDLES, SURF FINS, DIVING GLOVES, FOOTBALL GLOVES, SOCCER GLOVES, SWIMMING GLOVES, WATER-SKI GLOVES, WINDSURFING GLOVES; CHRISTMAS TREE DECORATIONS NOT INCLUDING CONFECTIONERY OR ILLUMINATION ARTICLES, SNOW SHOES (U.S. CLS. 22, 23, 38 AND 50).

CLASS 41—EDUCATION AND ENTERTAINMENT

FOR EDUCATION, PROVIDING OF TRAINING, ENTERTAINMENT AND SPORTING AND CULTURAL ACTIVITIES, NAMELY, PUBLICATION AND WRITTEN TEXT EDITING OF BOOKS, MAGAZINES, TEXTS, GUIDES, NEWSPAPERS, PERIODICALS, JOURNALS, ADDRESS BOOKS AND CALENDARS FOR OTHERS; PUBLISHING OF ELECTRONIC PUBLICATIONS, MULTIMEDIA PUBLISHING OF BOOKS, MAGAZINES, JOURNALS, SOFTWARE, GAMES, MUSIC, AND ELECTRONIC PUBLICATIONS; CONCEPTION, ORGANIZATION AND PERFORMANCE OF EXHIBITIONS, EVENTS, CONFERENCES, CONGRESSES, SYMPOSIA, LECTURES, COURSES, WORKSHOPS, SEMINARS AND TRAINING IN THE FIELD OF CULTURE, ENTERTAINMENT, EDUCATION AND TRAINING, NAMELY, CONDUCTING WORKSHOPS, COURSES, SYMPOSIA, LECTURES, COURSES, CONFERENCES, AND SEMINARS IN FIELD OF CULTURE AND EDUCATION, CONDUCTING ENTERTAINMENT EXHIBITIONS IN THE NATURE OF MAGIC SHOWS AND WINE FESTIVALS, CONDUCTING EDUCATIONAL EXHIBITIONS IN THE NATURE OF SCIENCE FAIRS AND ART EXHIBITIONS; EDUCATIONAL SERVICES, NAMELY, CONDUCTING CONFERENCES, SYMPOSIA, LECTURES, COURSES, WORKSHOPS, AND SEMINARS IN THE FIELD OF LAW, ART, HISTORY, MEDICINE, SCIENCE, CHILDREN'S EDUCATION, SOCIOLOGY, ECONOMICS, FINANCE, AND MATH AND DISTRIBUTION OF COURSE MATERIAL IN CONNECTION THEREWITH; EDUCATIONAL SERVICES, NAMELY, DEVELOPING, ARRANGING, AND CONDUCTING EDUCATIONAL CONFERENCES AND PROGRAMS AND PROVIDING COURSES OF INSTRUCTION IN THE FIELD OF IN THE FIELD OF LAW, ART, HISTORY, MEDICINE, SCIENCE, CHILDREN'S EDUCATION, SOCIOLOGY, ECONOMICS, FINANCE, AND MATH; EDUCATIONAL SERVICES, NAMELY, DEVELOPING AND CONDUCTING TRAINING COURSES AND DISTRIBUTION OF TRAINING MATERIAL IN CONNECTION THEREWITH FOR SUBJECT MATTERS AS REQUESTED BY CUSTOMERS; ARRANGING AND CONDUCTING EDUCATIONAL CONFERENCES, ENTERTAINMENT SERVICES, NAMELY, CONDUCTING CONTESTS, PARTIES, AND FAIRS NOT FOR COMMERCIAL PURPOSES; PLANNING AND CONDUCTING A SERIES OF FILM FESTIVALS; ORGANISATION OF SPORTS COMPETITIONS, ORGANISATION OF GAMES, ORGANISATION OF EXHIBITIONS FOR CULTURAL OR EDUCATIONAL PURPOSES, ORGANISATION OF FASHION SHOWS AND DANCING EVENTS, ORGANIZING, CONDUCTING, AND PERFORMING ENTERTAINMENT EVENTS IN THE NATURE OF SOCCER COMPETITIONS, ATHLETIC COMPETITIONS, CONCERTS, THEATRICAL SHOWS, MUSICAL CONCERTS, ARRANGING AND CONDUCTING NIGHTCLUB ENTERTAINMENT EVENTS AND SPECIAL EVENTS; FILM PRODUCTION AND FILM DISTRIBUTION FOR TELEVISION AND CINEMA, NAMELY, DISTRIBUTION OF TELEVISION PROGRAMS FOR OTHERS, PRODUCTION OF TELEVISION PROGRAMS, FILM PRODUCTION, FILM DISTRIBUTION; VIDEOTAPE FILM PRODUCTION, CINEMA PRESENTATIONS, NAMELY, CINEMA THEATERS; RENTAL OF CINE-FILMS AND VIDEOTAPES, PRODUCTION OF TELEVISION PROGRAMS AND SHOWS, SCRIPTWRITING SERVICES, ORGANIZATION OF EXHIBITIONS FOR CULTURAL OR EDUCATIONAL PURPOSES, PROVIDING NEWS AND INFORMATION IN THE FIELDS OF SPORT, ORGANIZATION OF GAMES AND SPORTS COMPETITIONS, ORGANIZING EXHIBITIONS AND CONFERENCES IN THE FIELDS OF SPORTS FOR NON-BUSINESS AND NON-COMMERCIAL PURPOSES, ORGANIZATION AND PROVIDING OF SPORTS ACTIVITIES AND SPORTS EVENTS, NAMELY, ORGANISATION OF SPORTS COMPETITIONS IN THE FIELDS OF WINDSURFING, KITE

SURFING, WATER SKIING, DIVING, SAILING, WATER POLO, AND SWIMMING; ORGANISATION OF SPORTS COMPETITIONS IN THE FIELDS OF SOCCER, BEACH SOCCER, FOOTBALL, SNOWBOARDING AND SKIING (U.S. CLS. 100, 101 AND 107).

CLASS 42—SCIENTIFIC AND COMPUTER SERVICES

FOR DESIGN AND DEVELOPMENT OF COMPUTER HARDWARE AND SOFTWARE FOR OTHERS; COMPUTER SOFTWARE DEVELOPMENT FOR OTHERS IN THE FIELDS OF MULTIMEDIA, INTERACTIVE TELEVISION AND PAY TELEVISION; TECHNICAL CONSULTANCY IN THE FIELD OF MULTIMEDIA, INTERACTIVE TELEVISION AND PAY TV, NAMELY, TECHNICAL CONSULTING AND ASSISTANCE WITH COMPUTER-BASED INFORMATION SYSTEMS AND COMPONENTS FOR OPERATING INTERACTIVE TELEVISION AND PAY TELEVISION SYSTEMS, COMPUTER PROGRAMMING FOR OTHERS (U.S. CLS. 100 AND 101).

CLASS 45—PERSONAL AND LEGAL SERVICES

FOR ISSUING, NEGOTIATING, RENTAL AND OTHER EXPLOITATION OF RIGHTS TO FILMS, TELEVISION AND VIDEO PRODUCTIONS AND OTHER IMAGE AND SOUND PROGRAMS, NAMELY, PROVIDING INFORMATION ABOUT INTELLECTUAL AND INDUSTRIAL PROPERTY RIGHTS, LEASING REPRODUCTION RIGHTS OF PHOTOGRAPHS AND TRANSPARENCIES TO OTHERS, COPYRIGHT MANAGEMENT, COPYRIGHT MANAGEMENT CONSULTATION, INTELLECTUAL PROPERTY CONSULTATION, LICENSING OF INTELLECTUAL PROPERTY, LICENSING OF ADVERTISING SLOGANS AND CARTOON CHARACTERS, LICENSING OF COMPUTER SOFTWARE, LICENSING OF RIGHTS TO FILMS, TELEVISION AND VIDEO PRODUCTIONS AND OTHER IMAGE AND SOUND PROGRAMS; MANAGEMENT AND EXPLOITATION OF COPYRIGHT AND INDUSTRIAL PROPERTY RIGHTS BY LICENSING FOR OTHERS, NAMELY, LICENSING OF COPYRIGHTS AND INTELLECTUAL PROPERTY RIGHTS TO OTHERS; EXPLOITATION OF FILM AND TELEVISION ANCILLARY RIGHTS IN THE FIELD OF MERCHANDISING BY LICENSING FOR OTHERS, NAMELY, LICENSING OF FILM AND TELEVISION ANCILLARY RIGHTS FOR MERCHANDISING PRODUCTS (U.S. CLS. 100 AND 101).

MICHAEL TANNER, EXAMINING ATTORNEY

SN 79-057,075. GENO, NORWAY, FILED 4-1-2008.



PRIORITY DATE OF 10-17-2007 IS CLAIMED.
OWNER OF INTERNATIONAL REGISTRATION 0972773
DATED 4-1-2008, EXPIRES 4-1-2018.
OWNER OF U.S. REG. NOS. 2,442,090 AND 3,454,060.

CLASS 5—PHARMACEUTICALS

FOR PHARMACEUTICAL PREPARATIONS AND VETERINARY PREPARATIONS, NAMELY, SPERM FOR ARTIFICIAL INSEMINATION; IMPREGNATED EGGS FOR IMPLANTING IN CATTLE, SHEEP AND GOATS (U.S. CLS. 6, 18, 44, 46, 51 AND 52).

CLASS 31—NATURAL AGRICULTURAL PRODUCTS

FOR LIVE ANIMALS; FOODSTUFFS FOR ANIMALS; ANIMAL FOOD; FOODSTUFFS FOR DOMESTIC ANIMALS AND PETS (U.S. CLS. 1 AND 46).

CLASS 42—SCIENTIFIC AND COMPUTER SERVICES

FOR RESEARCH AND DEVELOPMENT OF NEW PRODUCTS IN THE FIELD OF CATTLE, SHEEP AND GOATS; VETERINARY SERVICES (U.S. CLS. 100 AND 101).

CLASS 44—MEDICAL, BEAUTY AND AGRICULTURAL SERVICES

FOR BREEDING OF ANIMALS; PROFESSIONAL CONSULTANCY IN THE FIELD OF ANIMAL MEDICAL CARE; VETERINARY SERVICES (U.S. CLS. 100 AND 101).

WILLIAM ROSSMAN, EXAMINING ATTORNEY

SN 79-057,101. WRH WALTER REIST HOLDING AG, CH-8272 ERMATINGEN, SWITZERLAND, FILED 7-15-2008.

DENIROLL

THE MARK CONSISTS OF STANDARD CHARACTERS WITHOUT CLAIM TO ANY PARTICULAR FONT, STYLE, SIZE, OR COLOR.

PRIORITY DATE OF 2-18-2008 IS CLAIMED.

OWNER OF INTERNATIONAL REGISTRATION 0972838 DATED 7-15-2008, EXPIRES 7-15-2018.

CLASS 7—MACHINERY

FOR CONVEYING MACHINERY; CONVEYING MACHINERY COMPONENTS, NAMELY, ROLLER ELEMENTS FOR CONVEYOR BELTS, ROLLER CONVEYOR BELTS AND CHAIN CONVEYOR BELTS, NAMELY, MACHINE COMPONENTS AND STRUCTURAL PARTS CONTAINING ROLLS FOR ROLLER CONVEYORS AND FOR CONVEYOR BELTS AND FOR DRIVES FOR CONVEYOR INSTALLATIONS, IN THE NATURE OF ROLLS, ROLLERS, ROLLER BEARINGS AND ROLLER CONVEYORS; CONVEYING MACHINERY COMPONENTS, NAMELY, DEFLECTION ELEMENTS AND DEFLECTION DEVICES FOR CONVEYOR BELTS AND CHAIN CONVEYOR BELTS, NAMELY, DEFLECTORS, GUIDE TRACKS, CONSTRUCTION ELEMENTS AND MACHINE PARTS FOR DEFLECTING GOODS AND FOR DEFLECTING CONVEYORS AND CONVEYOR ELEMENTS, IN THE NATURE OF ROLLS, ROLLERS, ROLLER BEARINGS, DEFLECTORS, RECIRCULATING ROLLER BEARINGS, AND ROLLER CONVEYORS; CONVEYING MACHINERY COMPONENTS, NAMELY, GUIDING DEVICES FOR ROLLERS IN ROLLER ELEMENTS, NAMELY, GUIDE TRACKS, GUARD RAILS, CHAIN GUIDES, CARRIERS, NAMELY, CARRIER BELTS AND CARRIER ROLLERS, GUIDE ROLLS, GUIDES, BAR GUIDES, BELT GUIDES; CONVEYING MACHINERY COMPONENTS, NAMELY, ROLLER ELEMENTS FOR MECHANICAL STORING, CONVEYING AND DEFLECTION OF MOVED OR TO BE MOVED OBJECTS, NAMELY, MACHINE COMPONENTS AND STRUCTURAL PARTS CONTAINING ROLLS FOR ROLLER CONVEYORS AND FOR CONVEYOR BELTS AND FOR DRIVES FOR CONVEYOR INSTALLATIONS, ROLLS AND ROLLERS; DRIVES FOR CONVEYOR INSTALLATIONS WITH ROLLER ELEMENTS (U.S. CLS. 13, 19, 21, 23, 31, 34 AND 35).

CLASS 9—ELECTRICAL AND SCIENTIFIC APPARATUS

FOR ELECTRONIC APPARATUS FOR OPERATING CONVEYOR INSTALLATIONS AND CONVEYOR EQUIPMENT, FOR MEASURING AND CONTROLLING THE QUANTITY AND QUALITY OF GOODS TO BE CONVEYED; COMPUTERS AND ELECTRONIC CONTROL DEVICES FOR CONTROLLING THE HANDLING PROCESSES OF GOODS TO BE CONVEYED; ELECTRICAL CONTROLLERS FOR CONVEYOR INSTALLATIONS, COMPUTER SOFTWARE FOR CONTROLLING CONVEYOR INSTALLATIONS (U.S. CLS. 21, 23, 26, 36 AND 38).

CLASS 12—VEHICLES

FOR GROUND VEHICLES, NAMELY, LAND VEHICLES, ALL-TERRAIN VEHICLES, ARMORED VEHICLES; LAND, ALL-TERRAIN, ARMORED VEHICLES FOR CONVEYING AND MANIPULATING OBJECTS, IN PARTICULAR PRINTED PRODUCTS; ALL AFOREMENTIONED VEHICLES IN PARTICULAR WITH AN UNDERCARRIAGE INCLUDING ROLLER ELEMENTS (U.S. CLS. 19, 21, 23, 31, 35 AND 44).

CLASS 42—SCIENTIFIC AND COMPUTER SERVICES

FOR TECHNICAL CONSULTANCY FOR THE DESIGN OF CONVEYOR INSTALLATIONS AND OF PROCESSING CONVEYOR INSTALLATIONS; DEVELOPMENT AND DESIGN OF CONVEYOR INSTALLATIONS AND OF PROCESSING CONVEYOR INSTALLATIONS; DEVELOPMENT AND DESIGN OF COMPONENTS FOR CONVEYOR INSTALLATIONS AND PROCESSING CONVEYOR INSTALLATIONS (U.S. CLS. 100 AND 101).

SARA THOMAS, EXAMINING ATTORNEY

SN 79-057,595. GIMAEX INTERNATIONAL, FRANCE, FILED 4-1-2008.

PRIORITY DATE OF 10-9-2007 IS CLAIMED.

OWNER OF INTERNATIONAL REGISTRATION 0973849 DATED 4-1-2008, EXPIRES 4-1-2018.

THE COLOR(S) GREY AND RED IS/ARE CLAIMED AS A FEATURE OF THE MARK.

THE MARK CONSISTS OF THE COLOR(S) GREY AND RED, WITH THE COLOR GREY APPEARING IN THE OUTLINE OF THE WORD "GIMAEX", AND THE COLOR RED APPEARING IN THE SPACE BETWEEN THE LETTERS "E" AND "X". THE COLOR WHITE CONSTITUTES BACKGROUND, OUTLINING, SHADING OR TRANSPARENT AREAS AND IS NOT PART OF THE MARK.

THE WORDING "GIMAEX" HAS NO MEANING IN A FOREIGN LANGUAGE.

CLASS 9—ELECTRICAL AND SCIENTIFIC APPARATUS

FOR FIRE EXTINGUISHERS; FIRE-FIGHTING VEHICLES, NAMELY, FIRE TRUCKS AND FIRE BOATS; SPECIAL FIRE-FIGHTING VEHICLES, NAMELY, FIRE VANS, FIRE CARS, FIRE HELICOPTERS, AND FIRE PLANES, ALL HAVING MEANS TO PROJECT WATER OR FOAM, NAMELY, PUMPS AND NOZZLES FOR EXTINGUISHING FIRES; APPLIANCES FOR PREPARING, EMITTING OR DISTRIBUTING EXTINGUISHANTS, NAMELY, FIRE EXTINGUISHING APPARATUS; FIRE-FIGHTERS' HOSE NOZZLES; FIRE ALARMS; PROTECTIVE CLOTHING IN CASE OF FIRE AND DISASTER; PROTECTIVE HELMETS AGAINST FIRE AND DISASTER; PROTECTIVE GLOVES AGAINST FIRE AND DISASTER, NAMELY, FIRE RESISTANT GLOVES; BREATHING APPARATUS, NAMELY, SELF-RESCUE APPARATUS IN THE NATURE OF OXYGEN BREATHING UNITS; BREATHING APPARATUS, NAMELY, SELF-RESCUE APPARATUS IN THE NATURE OF OXYGEN BREATHING UNITS, AND PROTECTIVE MASKS; FILTERS FOR RESPIRATORY MASKS; HAND APPLIANCES FOR FIRE-FIGHTING, NAMELY, FIRE EXTINGUISHING APPARATUS; PROTECTIVE SHEETS AND BLANKETS IN CASE OF FIRE, NAMELY, FIRE SHEETS, FIRE BLANKETS; LIFE SAVING APPARATUS AND DEVICES, NAMELY, SAFETY TARPAULINS, LIFE BELTS, LIFE JACKETS, LIFE PRESERVERS, SAFETY NETS; FIRE-FIGHTER CONTROL EQUIPMENT, NAMELY, ELECTRONIC CONTROL APPARATUS FOR DIGITAL DISPLAY TIMERS, LARGE SCREEN DISPLAY APPARATUS, MOVEMENT DETECTORS; COMMUNICATION APPARATUS FOR FIRE-FIGHTERS, NAMELY, DISPATCH RADIOS, CELLULAR TELEPHONES, CALL BOXES, FAX MACHINES; MEASURING AND ANALYSIS APPARATUS FOR FIRE PROTECTION, PROTECTION IN CASE OF DISASTER, AND ENVIRONMENTAL PROTECTION, NAMELY, TEMPERATURE GAUGES, AIR ANALYSIS APPARATUS, AND ENVIRONMENTAL MONITORING SYSTEM COMPRISED OF METERS AND SENSORS THAT MEASURE PRESSURE, HUMIDITY, TEMPERATURE AND INCLUDES ALARM AND REPORTING FUNCTIONS; FIRE-FIGHTING EQUIPMENT, NAMELY, LADDERS FOR FIRE-FIGHTERS MADE OF HEAT RESISTANT MATERIALS (U.S. CLS. 21, 23, 26, 36 AND 38).

CLASS 12—VEHICLES

FOR APPARATUS FOR LOCOMOTION BY LAND, AIR OR WATER, NAMELY, AIR-CUSHION VEHICLES, TRUCKS, VANS, CARS, HELICOPTER, BOATS, AND PLANES; VEHICLES FOR PROTECTION IN CASE OF DISASTER, NAMELY, ARMORED TRUCKS, ARMORED VANS, ARMORED CARS, ARMORED HELICOPTERS, ARMORED BOATS, AND ARMORED PLANES; FIRE ENGINES; FIRE ENGINES FITTED WITH MEANS OF ELEVATION, SUCH AS CABINS; MOBILE FIRE RESPONSE CENTRES FOR FIRE-FIGHTING, PROTECTION IN CASE OF DISASTER, ENVIRONMENTAL PROTECTION AND RESCUE IN THE FORM OF FIRE ENGINES; SPECIAL VEHICLES FOR ENVIRONMENTAL PROTECTION, RESCUE, AND PROTECTION IN CASE OF DISASTER, NAMELY, FIRE AND RESCUE VEHICLE IN THE NATURE OF TRUCKS, VANS, CARS, HELICOPTERS, BOATS, AND PLANES FOR CARRYING AN ON-BOARD ELECTRICAL GENERATOR; MEASUREMENT VEHICLES, NAMELY, LAND VEHICLES FOR CARRYING HAZARDOUS MATERIAL TEST EQUIPMENT; LAND VEHICLES; AIRCRAFT, AIR-CUSHION VEHICLES, HELICOPTERS, AND BOATS, ALL CONTAINING MEANS FOR CARRYING OUT ANALYSES AND TESTS; FIRE AND RESCUE VEHICLE IN THE NATURE OF TRUCKS, VANS, CARS, HELICOPTERS, BOATS, AND PLANES FOR CARRYING AN ON-BOARD ELECTRICAL GENERATOR; MOBILE STORAGE CARTS FOR COMMERCIAL USE, NAMELY, ROLLTAINERS (U.S. CLS. 19, 21, 23, 31, 35 AND 44).

LIEF MARTIN, EXAMINING ATTORNEY

SN 79-057,738. RASCHIG GMBH, FED REP GERMANY, FILED 11-16-2007.

RASCHIG

THE MARK CONSISTS OF STANDARD CHARACTERS WITHOUT CLAIM TO ANY PARTICULAR FONT, STYLE, SIZE, OR COLOR.

PRIORITY DATE OF 6-1-2007 IS CLAIMED.

OWNER OF INTERNATIONAL REGISTRATION 0974324 DATED 11-16-2007, EXPIRES 11-16-2017.

CLASS 1—CHEMICALS

FOR CHEMICAL PRODUCTS FOR INDUSTRIAL AND SCIENTIFIC PURPOSES, NAMELY, CHEMICALS FOR USE IN SYNTHESIS, FOR ANALYSIS, QUALITY CONTROL, SAMPLE PREPARATION, SAMPLE DIGESTION AND EXTRACTION; CHEMICALS FOR THE USE IN CHEMICAL INDUSTRY, SYNTHETIC REFINERY, IN WATER PURIFICATION, IN BIOCHEMICAL AND PHARMACEUTICAL INDUSTRY; SYNTHETIC RESIN IN THE UNPROCESSED STATE, PLASTICS IN THE UNPROCESSED STATE FOR THE PRODUCTION OF PACKING ELEMENTS FOR DISTILLATION, ABSORPTION, DESORPTION, EXTRACTION AND HEAT TRANSFER (U.S. CLS. 1, 5, 6, 10, 26 AND 46).

CLASS 11—ENVIRONMENTAL CONTROL APPARATUS

FOR APPARATUS FOR EXCHANGING HEAT AND ENERGY, NAMELY, PACKING ELEMENTS MADE OF METAL, PLASTICS, GLASS, CERAMICS OR OF A COMPOSITE OF AT LEAST TWO OF THE AFOREMENTIONED MATERIALS, FOR PROCESS ENGINEERING, NAMELY, FOR DISTILLATION, ABSORPTION, DESORPTION, EXTRACTION AND HEAT TRANSFER; APPARATUS FOR EXCHANGING HEAT AND ENERGY, NAMELY, COLUMNS AND TOWERS FOR THE AFOREMENTIONED PACKING ELEMENTS, NAMELY, FOR DISTILLATION, ABSORPTION, DESORPTION, EXTRACTION AND HEAT TRANSFER; APPARATUS FOR EXCHANGING HEAT AND ENERGY, NAMELY, MASS AND HEAT EXCHANGE COLUMNS AND MASS AND HEAT EXCHANGE TOWERS FOR THE AFOREMENTIONED PACKING ELEMENTS (U.S. CLS. 13, 21, 23, 31 AND 34).

CLASS 17—RUBBER GOODS

FOR SEMI-FINISHED GOODS MADE OF PLASTICS FOR THE MANUFACTURE OF PLASTIC ARTICLES USED IN PROCESS ENGINEERING, NAMELY, FOR DISTILLATION, ABSORPTION, DESORPTION, EXTRACTION, AND HEAT TRANSFER (U.S. CLS. 1, 5, 12, 13, 35 AND 50).

CLASS 42—SCIENTIFIC AND COMPUTER SERVICES

FOR SCIENTIFIC AND TECHNOLOGICAL SERVICES AND RESEARCH WORK IN THE FIELD OF CHEMICAL SYNTHESIS, PROCESS ENGINEERING, NAMELY, FOR DISTILLATION, ABSORPTION, DESORPTION, EXTRACTION AND HEAT TRANSFER; INDUSTRIAL ANALYSIS SERVICES AND RESEARCH SERVICES IN THE FIELD OF CHEMICAL SYNTHESIS, PROCESS ENGINEERING, NAMELY, FOR DISTILLATION, ABSORPTION, DESORPTION, EXTRACTION AND HEAT TRANSFER; PROCESS DEVELOPMENT FOR CHEMICAL SYNTHESIS FOR THIRD PARTIES (U.S. CLS. 100 AND 101).

KRISTINA MORRIS, EXAMINING ATTORNEY

SN 79-057,822. VILLEROY & BOCH AG, FED REP GERMANY, FILED 5-30-2008.

SN 79-058,073. FIGLEAVES GLOBAL TRADING LTD., UNITED KINGDOM, FILED 6-30-2008.

vivo
 VILLEROY & BOCH

PRIORITY DATE OF 2-8-2008 IS CLAIMED.
 OWNER OF INTERNATIONAL REGISTRATION 0974558 DATED 5-30-2008, EXPIRES 5-30-2018.
 OWNER OF U.S. REG. NOS. 1,339,086, 1,946,247 AND OTHERS.
 THE ENGLISH TRANSLATION OF VIVO IN THE MARK IS LIVING.

CLASS 11—ENVIRONMENTAL CONTROL APPARATUS

FOR APPARATUS FOR WATER SUPPLY, NAMELY, WATER FOUNTAINS; SANITARY APPARATUS AND INSTALLATIONS, NAMELY, SINKS, BATH TUBS, WATER CLOSETS, LAVATORIES, SHOWER ENCLOSURES, SINKS, BIDETS AND URINALS; FITTINGS FOR SINKS, FITTINGS FOR BATH TUBS, FITTINGS FOR SHOWERS; BATH TUBS, NAMELY, BIBS, COCKS, TRAPS AND VALVES; BATH INSTALLATIONS, NAMELY, BATH TUBS; BATH FITTINGS, NAMELY, FAUCETS AND SHOWER HEADS; WASH-HAND BASINS AS PARTS OF SANITARY INSTALLATIONS SOLD AS A UNIT; BIDETS; SHOWERS; SHOWER CUBICLES AND ENCLOSURES; SHOWER TUBS; TAPS, FAUCETS; TAPS FOR PIPES; SPA BATHS; MANUALLY CONTROLLABLE VALVES AND MIXING VALVES FOR SANITARY WATER SUPPLY; REGULATING ACCESSORIES FOR WATER APPARATUS AND PIPES FOR PLUMBING PURPOSES, NAMELY, TUB CONTROL VALVES, SHOWER CONTROL VALVES AND METERED VALVES; SAUNA BATH INSTALLATIONS, NAMELY, SAUNAS; PLUMBING FITTINGS, NAMELY, SIPHON TRAPS; SIT BATHS; SINKS; TOILETS; TOILET BOWLS; TOILET SEATS; WATER FLUSHING INSTALLATIONS, NAMELY, FLUSH LEVERS; FLUSHING TANKS, NAMELY, TOILET TANKS; STRUCTURAL COVERS FOR URINALS; MIXER TAPS FAUCETS FOR WATER PIPES; WATER SUPPLY INSTALLATIONS, NAMELY, SINKS; WATER DISTRIBUTION INSTALLATIONS, NAMELY, WATER PURIFICATION TANKS; WHIRLPOOL-JET APPARATUS; PARTS AND COMPONENTS FOR ALL AFORESAID GOODS, INCLUDED IN THIS CLASS, NAMELY, FLEXIBLE PIPES BEING PART OF SINK, SHOWER AND BATH PLUMBING; APPARATUS FOR LIGHTING, NAMELY, LIGHTING APPARATUS FOR WHIRLPOOL JET APPARATUS AND BATH TUBS; LIGHT FIXTURES, NAMELY, INDOOR SOLAR POWERED LIGHT FIXTURES, LED AND HID LIGHT FIXTURES; ELECTRIC LAMPS; LAMPS (U.S. CLS. 13, 21, 23, 31 AND 34).

CLASS 24—FABRICS

FOR TEXTILES AND TEXTILE GOODS, NAMELY, BED AND PLASTIC TABLE COVERS; BATH LINEN; BED BLANKETS; BED LINEN; COVERS FOR CUSHIONS; SHOWER CURTAINS OF TEXTILE OR PLASTIC; CURTAINS OF TEXTILE OR PLASTIC; CURTAIN HOLDERS OF TEXTILE MATERIAL, NAMELY, CURTAIN LOOPS OF TEXTILE MATERIAL; HOUSEHOLD LINEN; TABLE LINEN, NAMELY, COASTERS; MATTRESS COVERS; PLACE MATS, NOT OF PAPER, NAMELY, TEXTILE AND PLASTIC MATS; TRAVELING RUGS; BED COVERS; TEXTILE TABLE NAPKINS, TABLE NAPKINS OF TEXTILE; HANDKERCHIEFS OF TEXTILE; TOWELS OF TEXTILE; TABLECLOTHS, NOT OF PAPER; TABLE LINEN, NOT OF PAPER, NAMELY, TABLE LINEN OF TEXTILE; FABRIC TABLE RUNNERS; FITTED TOILET LID COVERS OF FABRIC, NOT OF PAPER (U.S. CLS. 42 AND 50).
 NAPOLEON SHARMA, EXAMINING ATTORNEY

SCARLET ROSE

THE MARK CONSISTS OF STANDARD CHARACTERS WITHOUT CLAIM TO ANY PARTICULAR FONT, STYLE, SIZE, OR COLOR.

PRIORITY DATE OF 6-25-2008 IS CLAIMED.
 OWNER OF INTERNATIONAL REGISTRATION 0975267 DATED 6-30-2008, EXPIRES 6-30-2018.
 THE NAME "SCARLET ROSE" DOES NOT IDENTIFY A LIVING INDIVIDUAL.

CLASS 3—COSMETICS AND CLEANING PREPARATIONS

FOR BLEACHING PREPARATIONS AND OTHER SUBSTANCES FOR LAUNDRY USE, NAMELY, LAUNDRY DETERGENT, FABRIC SOFTENER FOR LAUNDRY USE, STAIN REMOVER FOR LAUNDRY USE, LAUNDRY FRESHENER SPRAY, LAUNDRY CREASE-REMOVING SPRAY; CLEANING, POLISHING, SCOURING AND ABRASIVE PREPARATIONS; SOAPS; PERFUMERY, ESSENTIAL OILS, COSMETICS, HAIR LOTIONS; DENTIFRICES; EYE MAKE-UP, EYE SHADOWS, EYE POWDERS, EYE CREAMS, MASCARAS, EYE LINERS, EYE PENCILS, EYEBROW PENCILS, FACE MAKE-UP, FOUNDATIONS, CONCEALERS, FACE POWDERS, PRESSED FACE POWDERS, LOOSE FACE POWDERS, BLUSHERS, BRONZERS; NAIL VARNISH, NAIL POLISH; COSMETICS IN THE NATURE OF HIGHLIGHTERS, FACE GLITTER, MAKE-UP FOR LIPS, LIP STICKS, LIP GLOSSES, LIP LINERS, LIP BALMS; EAU-DE-COLOGNE, TOILET WATER, MASSAGE OILS, AROMATHERAPY OILS; PRE-SHAVE AND AFTER-SHAVE PREPARATIONS; SHAVING CREAMS; DEPILATORIES; DEODORANTS AND ANTI-PERSPIRANTS FOR PERSONAL USE; NON-MEDICATED TOILETRIES; NON-MEDICATED TOILET PREPARATIONS, NAMELY, BATH FOAMS, BATH GELS, BATH OILS, BATH SALTS, BATH BEADS; SKINCARE PRODUCTS, NAMELY, MOISTURIZERS, SKIN CREAMS AND LOTIONS, SKIN EXFOLIATING PREPARATIONS, BABY OILS, BABY POWDERS; FACECARE PRODUCTS, NAMELY, ANTI-AGEING CREAMS, ANTI-FRECKLE CREAMS, ANTI-WRINKLE CREAMS, FACIAL SOAPS, FACIAL CLEANSERS, MAKE-UP REMOVERS, FACIAL TONERS; HAIRCARE PRODUCTS, NAMELY, SHAMPOO, HAIR CONDITIONER, HAIR TREATMENT MASKS, HAIR SERUMS, LEAVE-IN CONDITIONER, BABY SHAMPOOS AND CONDITIONERS; NAILCARE PRODUCTS, NAMELY, CUTICLE SOFTENING CREAMS, NAIL HARDENING LACQUERS; HANDCARE PRODUCTS, NAMELY, HAND CREAMS AND LOTIONS; SKIN TONERS, SKIN CLEANSERS, FACIAL MASKS, FACE PACKS IN THE NATURE OF CLAY-BASED, OAT-MEAL-BASED OR BRAN-BASED MASKS; NON-MEDICATED HAIRCARE AND SKINCARE SERUMS, HAIR CONDITIONING MASKS, HAIR SPRAYS, HAIR GELS, HAIR MOUSSES; PREPARATIONS, CREAMS, LOTIONS, SPRAYS AND MOUSSES FOR TANNING AND/OR FOR PROTECTION AGAINST THE SUN; AFTER-SUN LOTIONS, CREAMS AND SPRAYS; COTTON WOOL FOR COSMETIC PURPOSES; TALCUM POWDER; POT-POURRI; JOSS STICKS; BATH BOMBS, BATH SALTS; TOOTH-PASTE, MOUTHWASH; FALSE EYELASHES, FALSE NAILS; TISSUES IMPREGNATED WITH COSMETIC LOTIONS; TEETH WHITENING PREPARATIONS (U.S. CLS. 1, 4, 6, 50, 51 AND 52).

CLASS 9—ELECTRICAL AND SCIENTIFIC APPARATUS

FOR SUNGLASSES; SPECTACLE GLASSES; SPECTACLE FRAMES; SPECTACLE CASES; PROTECTIVE EYEWEAR; GOGGLES FOR SKIING, NIGHT VISION, SCUBA DIVING; CLEAR, TINTED, POLARIZING AND PRESCRIPTION LENSES FOR SUNGLASSES AND SPECTACLES; CONTACT LENSES (U.S. CLS. 21, 23, 26, 36 AND 38).

CLASS 14—JEWELRY

FOR PRECIOUS METALS AND THEIR ALLOYS; GOODS IN PRECIOUS METALS OR COATED THEREWITH, NAMELY, NECKLACES, BRACELETS, RINGS FOR FINGERS AND TOES, EARRINGS, PENDANTS, CHARMS FOR CHARM BRACELETS, CHAINS, LAPEL PINS, BROOCHES, BADGES OF PRECIOUS METALS; JEWELLERY, PRECIOUS STONES; HOROLOGICAL AND CHRONOMETRIC INSTRUMENTS; COSTUME JEWELLERY; IMITATION JEWELLERY; CASES, BOXES AND CASKETS FOR JEWELLERY AND WATCHES; CHAINS, BANDS, BRACELETS AND STRAPS FOR WATCHES; PARTS FOR WATCHES AND CLOCKS; CUFFLINKS; TIECLIPS; JEWELRY PINS FOR USE ON HATS; KEY RINGS OF PRECIOUS METAL; TRINKETS IN THE NATURE OF WATCH FOBS (U.S. CLS. 2, 27, 28 AND 50).

CLASS 16—PAPER GOODS AND PRINTED MATTER

FOR PRINTED MATTER, NAMELY, CALENDARS, DIARIES, ADDRESS BOOKS, VISITORS BOOKS, NOTE-CARDS AND ENVELOPES, GREETINGS CARDS; PRINTED PUBLICATIONS, NAMELY, BOOKS, MAGAZINES, CATALOGUES AND NEWSLETTERS IN THE FIELD OF FASHION, CLOTHING, UNDERWEAR, SHOPPING, ENTERTAINMENT, TELEVISION, MOVIES AND THEATRE, HEALTHCARE, EXERCISE, SPORT, COSMETICS, BEAUTY AND SKINCARE, PREGNANCY, BABIES AND CHILDREARING, HOME FURNISHINGS AND INTERIOR DECORATING, GARDENING, ARTS AND CRAFTS, COOKING AND FOOD, ENVIRONMENTAL ISSUES, FEMINISM, MONEY AND INVESTMENTS, TRAVEL AND HOLIDAYS, SCIENCE AND TECHNOLOGY, GEOGRAPHY, HISTORY, POLITICS, CURRENT AFFAIRS; RETAIL CATALOGS FEATURING A WIDE VARIETY OF CONSUMER GOODS; PAPER, CARDBOARD AND GOODS MADE FROM THESE MATERIALS, NAMELY, BAGS, STICKERS, SCENTED DRAWER LINERS; PHOTOGRAPHS; STATIONERY; PENS, PENCILS, WRITING IMPLEMENTS; ALBUMS FOR PHOTOGRAPHS; WRAPPING PAPER; POSTCARDS; ADHESIVES FOR STATIONERY OR HOUSEHOLD PURPOSES; ARTISTS' MATERIALS, NAMELY, ARTISTS' PENCILS, ARTISTS' CHALKS, ARTISTS' BRUSHES, CANVAS PANELS; PAINT BRUSHES; CHEQUE BOOK HOLDERS; PASSPORT HOLDERS (U.S. CLS. 2, 5, 22, 23, 29, 37, 38 AND 50).

CLASS 18—LEATHER GOODS

FOR LEATHER AND IMITATIONS OF LEATHER; GOODS MADE OF LEATHER AND IMITATION LEATHER, NAMELY, HANDBAGS, PURSES, WALLETS, TRAVELLING BAGS, LUGGAGE, SLINGS FOR INFANTS, BABY CARRYING BAGS, PET COLLARS; ANIMAL SKINS, HIDES; TRUNKS AND TRAVELLING BAGS; UMBRELLAS, PARASOLS AND WALKING STICKS; WHIPS, HARNESS AND SADDLERY; BAGS, NAMELY, LEATHER BAGS, SPORTS BAGS, ATHLETIC BAGS, GENERAL PURPOSE SPORTS BAGS FOR SWIMMING AND YOGA, SHOE BAGS FOR TRAVEL; HANDBAGS; CLUTCH BAGS; TOTE BAGS; BACKPACKS; SHOPPING BAGS OF LEATHER, IMITATION LEATHER OR CANVAS; EVENING BAGS; PURSES AND WALLETS; LUGGAGE; SUITCASES; UNFITTED VANITY CASES; FLIGHT BAGS (U.S. CLS. 1, 2, 3, 22 AND 41).

CLASS 25—CLOTHING

FOR CLOTHING, NAMELY, WOMEN'S, MEN'S, CHILDREN'S AND BABIES' T-SHIRTS, VESTS, BLOUSES, SHIRTS, WAISTCOATS, JACKETS, SUITS, CARDIGANS, JUMPERS, PULLOVERS, SWEATERS, TROUSERS, SKIRTS, SHORTS, JEANS, DRESSES, CORSETS, GLOVES, SCARVES, SHAWLS, STOLEES, JOGGING PANTS, YOGA PANTS, COATS, RAINCOATS, BLAZERS, WEDDING DRESSES, WEDDING VEILS, BRIDESMAID DRESSES, TIES, CRAVATS, DRESS SUITS, DINNER JACKETS, TUXEDOS, BRACES IN THE NATURE OF SUSPENDERS, SARONGS, BIKINIS, SWIMSUITS, KAPTANS, BEACHWEAR, SWIMMING TRUNKS, SWIMMING SHORTS, MATERNITYWEAR, NAMELY, SHIRTS AND PANTS; SOCKS; FOOTWEAR, NAMELY, SANDALS, FORMAL SHOES, BOOTS, TRAINERS IN THE NATURE OF ATHLETIC SHOES AND RUNNING SHOES, SLIPPERS, SKI BOOTS, BALLET SLIPPERS, BEACH FOOTWEAR; HEADGEAR, NAMELY, HATS, CAPS, VISORS, WOOL HATS, SKI HATS; LINGERIE; UNDERWEAR; HOSIERY; SLEEPWEAR; SWIMWEAR; CLOTHING BELTS; SPORTSWEAR, NAMELY, SKI-SUITS, SKI PANTS, SKI JACKETS, YOGA PANTS, TRACKSUITS (U.S. CLS. 22 AND 39).

CLASS 35—ADVERTISING AND BUSINESS

FOR RETAIL STORE, MAIL ORDER, AND ONLINE RETAIL STORE SERVICES FEATURING CLOTHING, FOOTWEAR, HEADGEAR, LINGERIE, UNDERWEAR, HOSIERY, SLEEPWEAR, SWIMWEAR, BELTS, SPORTSWEAR, BLEACHING PREPARATIONS AND OTHER SUBSTANCES FOR LAUNDRY USE, CLEANING, POLISHING, SCOURING AND ABRASIVE PREPARATIONS, SOAPS, PERFUMERY, ESSENTIAL OILS, COSMETICS, HAIR LOTIONS, DENTIFRICES, COSMETICS, EYE MAKE-UP, EYE SHADOWS, EYE POWDERS, EYE CREAMS, MASCARAS, EYE LINERS, EYE PENCILS, EYEBROW PENCILS, FACE MAKE-UP, FOUNDATIONS, CONCEALERS, POWDERS, PRESSED POWDERS, LOOSE POWDERS, BLUSHERS, BRONZERS, NAIL VARNISH, NAIL POLISH, HIGHLIGHTERS, FACE GLITTER, MAKE-UP FOR LIPS, LIP STICKS, LIP GLOSSES, LIP LINERS, LIP BALMS, SOAPS, PERFUMERY, EAU-DE-COLOGNE, TOILET WATER, ESSENTIAL OILS, MASSAGE OILS, AROMATHERAPY OILS, PRE-SHAVE AND AFTERSHAVE PREPARATIONS, SHAVING CREAMS, DEPILATORIES, DEODORANTS, ANTI-PERSPIRANTS, TOILETRIES, NON-MEDICATED TOILET PREPARATIONS, SKINCARE PRODUCTS, FACECARE PRODUCTS, HAIRCARE PRODUCTS, NAILCARE PRODUCTS, HANDCARE PRODUCTS, MOISTURISERS, TONERS, CLEANSERS, MAKE-UP REMOVERS, FACE MASKS, FACE PACKS, PREPARATIONS, CREAMS, LOTIONS FOR THE HAIR, FACE AND SKIN, HAIR LOTIONS, SHAMPOOS, CONDITIONERS, SERUMS, HAIR CONDITIONING MASKS, HAIR SPRAYS, HAIR GELS, HAIR MOUSSES, PREPARATIONS, CREAMS, LOTIONS, SPRAYS AND MOUSSES FOR TANNING AND/OR FOR PROTECTION AGAINST THE SUN, AFTER-SUN LOTIONS, CREAMS AND SPRAYS, COTTON WOOL, TALCUM POWDER, POT-POURRI, JOSS STICKS, BATH BOMBS, BATH SALTS, TOOTHPASTE, MOUTHWASH, EMERY BOARDS, NAIL FILES, FALSE EYELASHES, FALSE HAIR, FALSE NAILS, TISSUES IMPREGNATED WITH COSMETIC LOTIONS, TEETH WHITENING PREPARATIONS, CANDLES, SCENTED CANDLES, SUNGLASSES, SPECTACLE GLASSES, SPECTACLE FRAMES, SPECTACLE CASES, PROTECTIVE EYEWEAR, GOGGLES, LENSES, CONTACT LENSES, PRECIOUS METALS AND THEIR ALLOYS AND GOODS IN PRECIOUS METALS OR COATED THEREWITH, JEWELLERY, PRECIOUS STONES, HOROLOGICAL AND CHRONOMETRIC INSTRUMENTS, COSTUME JEWELLERY, IMITATION JEWELLERY, CASES, BOXES AND CASKETS FOR JEWELLERY AND WATCHES, CHAINS, BANDS, BRACELETS AND STRAPS FOR WATCHES, PARTS AND FITTINGS FOR WATCHES AND CLOCKS, CUFFLINKS, TIECLIPS, HATPINS, KEY RINGS, PRINTED MATTER, PRINTED PUBLICATIONS, BOOKS, MAGAZINES, CATALOGUES, NEWSLETTERS, PAPER, CARDBOARD AND GOODS MADE FROM THESE MATERIALS, PHOTOGRAPHS, STATIONERY, PENS, PENCILS, WRITING IMPLEMENTS, ALBUMS, CALENDARS, GREETINGS CARDS, WRAPPING PAPER, POSTCARDS, ADHESIVES FOR STATIONERY OR HOUSEHOLD PURPOSES, ARTISTS' MATERIALS,

PAINT BRUSHES, TYPEWRITERS AND OFFICE REQUISITES, INSTRUCTIONAL AND TEACHING MATERIAL, PACKAGING MATERIALS, PRINTERS' TYPE, PRINTING BLOCKS, CHEQUE BOOK HOLDERS, PASSPORT HOLDERS, LEATHER AND IMITATIONS OF LEATHER, AND GOODS MADE OF THESE MATERIALS, ANIMAL SKINS, HIDES, TRUNKS AND TRAVELLING BAGS, UMBRELLAS, PARASOLS AND WALKING STICKS, WHIPS, HARNESS AND SADDLERY, BAGS, HANDBAGS, CLUTCH BAGS, TOTE BAGS, BACKPACKS, SHOPPING BAGS, EVENING BAGS, PURSES AND WALLETS, LUGGAGE, SUITCASES, VANITY CASES, FLIGHT BAGS, FURNITURE, MIRRORS, PICTURE FRAMES, GOODS OF WOOD, CORK, REED, CANE, WICKER, HORN, BONE, IVORY, WHALEBONE, SHELL, AMBER, MOTHER-OF-PEARL, MEERSCHAUM AND SUBSTITUTES FOR ALL THESE MATERIALS, OR OF PLASTICS, HOUSEHOLD OR KITCHEN UTENSILS AND CONTAINERS, COMBS AND SPONGES, BRUSHES, BRUSH-MAKING MATERIALS, ARTICLES FOR CLEANING PURPOSES, STEELWOOL, UNWORKED OR SEMI-WORKED GLASS, GLASSWARE, PORCELAIN AND EARTHENWARE, CERAMICS FOR HOUSEHOLD PURPOSES, TEXTILES AND TEXTILE GOODS, BED AND TABLE COVERS, BED LINEN, CUSHIONS AND PILLOWS, DUVETS, BATH LINEN, TOWELS AND FACECLOTHS; ADVERTISING; BUSINESS MANAGEMENT; BUSINESS ADMINISTRATION; OFFICE FUNCTIONS (U.S. CLS. 100, 101 AND 102).

KELLY CHOE, EXAMINING ATTORNEY

SN 79-058,169. JULIAN AGNÈS, FRANCE, FILED 7-25-2008.

Technilum

OWNER OF INTERNATIONAL REGISTRATION 0975600 DATED 7-25-2008, EXPIRES 7-25-2018.

THE WORDING "TECHNILUM" HAS NO MEANING IN A FOREIGN LANGUAGE.

CLASS 6—METAL GOODS

FOR COMMON SEMI-WORKED METALS AND STEEL ALLOYS, FOR FURTHER MANUFACTURE; ROLLED AND CAST CONSTRUCTION MATERIALS OF METAL FOR URBAN AND ROAD LIGHTENING FURNITURE; LOCKSMITHS' GOODS, NAMELY, METAL LOCKS; METAL PIPES AND TUBES; CONSTRUCTION MATERIAL MADE OF METAL, NAMELY, URBAN AND ROAD FURNITURE; METAL MASTS AND POLES, METAL DISPLAY BOLLARDS, NON-LUMINOUS NON-MECHANICAL ADVERTISEMENT COLUMN SIGNS OF METAL, NON-LUMINOUS NON-MECHANICAL SIGN OF METAL; ALL OF THE AFORESAID GOODS IN THE STYLE OF URBAN AND ROAD FURNITURE (U.S. CLS. 2, 12, 13, 14, 23, 25 AND 50).

CLASS 11—ENVIRONMENTAL CONTROL APPARATUS

FOR PUBLIC ELECTRIC LIGHTING FIXTURES; STREET LAMPS IN THE STYLE OF URBAN AND ROAD FURNITURE AND NON-METAL UTILITY LIGHT POLES SOLD AS A UNIT; LIGHTING APPLIANCES, NAMELY, ELECTRIC TORCHES FOR LIGHTING, LIGHTING PROJECTORS, NAMELY, STREET LAMPS AND ROAD LAMPS USED FOR STREET ROAD AND PUBLIC LIGHTING, LIGHTING FIXTURES, LIGHTING TUBES, TOWER LIGHTS, ELECTRICALLY LIGHTED SIGNALLING FIXTURES ATTACHABLE TO URBAN AND ROAD FURNITURE (U.S. CLS. 13, 21, 23, 31 AND 34).

CLASS 19—NON-METALLIC BUILDING MATERIALS

FOR NON-METAL UTILITY POLES, NON-METAL CONCRETE BOLLARDS, NON-METALLIC ADVERTISEMENT COLUMNS, NON-LUMINOUS NON-MECHANICAL SIGNS NOT OF METAL; ALL THE AFORESAID GOODS IN THE STYLE OF URBAN AND ROAD FURNITURE (U.S. CLS. 1, 12, 33 AND 50).

CLASS 40—MATERIAL TREATMENT

FOR HEAT COATING OF THE SURFACE OF URBAN AND ROAD FURNITURE BY THERMOLACQUERING AND ANODIZATION; TREATMENT OF MATERIALS OCCURRING IN THE COURSE OF THE MANUFACTURING PROCESS FOR ANY PRODUCT, OTHER THAN AN EDIFICE, NAMELY, METAL CUTTING FOR URBAN AND ROAD FURNITURE, GLASS AND METAL POLISHING FOR URBAN AND ROAD FURNITURE, METAL COATING FOR URBAN AND ROAD FURNITURE (U.S. CLS. 100, 103 AND 106).

CLASS 42—SCIENTIFIC AND COMPUTER SERVICES

FOR EVALUATING INSTALLED URBAN AND ROAD FURNITURE OF OTHERS FOR THE PURPOSE OF CERTIFICATION; MAINTENANCE ASSESSMENTS OF THE PERFORMANCE OF INSTALLED URBAN AND ROAD FURNITURE; RESEARCH FOR THE INSTALLATION OF URBAN AND ROAD FURNITURE, IN THE FIELDS OF SCIENCE AND TECHNOLOGY PROVIDED BY ENGINEERS; TECHNICAL PROJECT RESEARCH STUDIES IN THE FIELD OF URBAN AND ROAD FURNITURE (U.S. CLS. 100 AND 101).

SIMON TENG, EXAMINING ATTORNEY

SN 79-058,246. THE NETWIZZY COMPANY, S.L., SPAIN, FILED 5-16-2008.

OUR.COM

PRIORITY DATE OF 1-13-2008 IS CLAIMED.
OWNER OF INTERNATIONAL REGISTRATION 0975751 DATED 5-16-2008, EXPIRES 5-16-2018.

THE COLOR(S) PINK IS/ARE CLAIMED AS A FEATURE OF THE MARK.

THE MARK CONSISTS OF THE WORDING "OUR.COM" IN STYLIZED, PINK FONT.

CLASS 9—ELECTRICAL AND SCIENTIFIC APPARATUS

FOR SURVEYING, CINEMATOGRAPHIC, AND WEIGHING APPARATUS AND INSTRUMENTS; SCIENTIFIC, NAUTICAL, PHOTOGRAPHIC, OPTICAL, MEASURING, SIGNALING, CHECKING AND SUPERVISION, LIFE-SAVING AND TEACHING APPARATUS AND INSTRUMENTS, NAMELY, CAMERAS AND FIRE EXTINGUISHERS; APPARATUS AND INSTRUMENTS FOR CONDUCTING, SWITCHING, TRANSFORMING, ACCUMULATING, REGULATING OR CONTROLLING ELECTRICITY, NAMELY, ELECTRICAL CONDUCTORS, SWITCHES AND TRANSFORMERS; APPARATUS FOR RECORDING, TRANSMITTING, REPRODUCING SOUNDS OR IMAGES; BLANK MAGNETIC RECORDING MEDIA, NAMELY, MAGNETIC DATA CARRIERS AND DISCS; BLANK OPTICAL DISCS FOR RECORDING SOUND; AUTOMATIC VENDING MACHINES AND MECHANISMS FOR COIN-OPERATED APPARATUS; CASH REGISTERS, CALCULATING MACHINES, DATA PROCESSING EQUIPMENT AND COMPUTERS; COMPUTER GAME PROGRAMS; RECORDED COMPUTER OPERATING PROGRAMS; ELECTRONICALLY DOWNLOADABLE COMPUTER PROGRAMS AND SOFTWARE FOR USE IN DATABASE MANAGEMENT, USE AS A SPREADSHEET; DOWNLOADABLE ELECTRONIC PUBLICATIONS IN THE NATURE OF NEWSLETTERS AND MAGAZINES IN THE FIELD OF ELECTRONIC GAMES (U.S. CLS. 21, 23, 26, 36 AND 38).

CLASS 38—COMMUNICATION

FOR TELECOMMUNICATIONS SERVICES, NAMELY, PROVIDING ACCESS TO TELECOMMUNICATIONS NETWORKS AND TRANSMISSION OF VOICE, DATA, ELECTRONIC GAMES, GRAPHICS AND VIDEO BY MEANS OF BROADBAND, OPTICAL OR WIRELESS NETWORKS (U.S. CLS. 100, 101 AND 104).

CLASS 41—EDUCATION AND ENTERTAINMENT

FOR EDUCATION SERVICES, NAMELY, PROVIDING CLASSES, LECTURES AND SEMINARS IN THE FIELD OF ELECTRONIC GAMES; TRAINING IN THE USE OF COMPUTERS AND ELECTRONIC GAMES; ENTERTAINMENT, NAMELY, PROVIDING A WEBSITE FEATURING NEWS AND INFORMATION IN THE FIELD OF ELECTRONIC GAMES; SPORTS, NAMELY, ELECTRONIC GAMES COMPETITIONS; CULTURAL AND LEISURE ACTIVITIES, NAMELY, ORGANIZATION OF EXHIBITIONS FOR CULTURAL PURPOSES; ORGANIZATION OF FASHION SHOWS; PRODUCTION OF RADIO AND TELEVISION PROGRAMS; PRODUCTION AND RENTAL OF CINEMATOGRAPHIC FILMS; SERVICES FOR THE ORGANIZATION OF EDUCATIONAL COMPETITIONS; SERVICES FOR THE ORGANIZATION OF ENTERTAINMENT COMPETITIONS, NAMELY, ELECTRONIC GAMES; PUBLISHING OF NON ADVERTISING TEXTS (U.S. CLS. 100, 101 AND 107).

AMEETA JORDAN, EXAMINING ATTORNEY

CLASS 9—ELECTRICAL AND SCIENTIFIC APPARATUS

FOR APPARATUS FOR RECORDING, TRANSMISSION OR REPRODUCTION OF SOUND OR IMAGES; BATTERIES; BATTERY PACKS; SOUND RECORDINGS FEATURING MUSIC; VIDEO RECORDINGS FEATURING ANIMATED CARTOONS, AND DRAMA, ACTION AND ADVENTURE FILMS; RECORDINGS OF IMAGES ON CD-ROMS AND DVD-ROMS FEATURING ANIMATED CARTOONS, AND DRAMA, ACTION AND ADVENTURE FILMS; RECORDING DISCS IN THE NATURE OF CD-ROMS AND DVD-ROMS FEATURING ANIMATED CARTOONS, AND DRAMA, ACTION AND ADVENTURE FILMS; PRERECORDED MAGNETIC DATA CARRIERS FEATURING ANIMATED CARTOONS, AND DRAMA, ACTION AND ADVENTURE FILMS; COMPUTER DISCS FEATURING ANIMATED CARTOONS, AND DRAMA, ACTION AND ADVENTURE FILMS; COMPACT DISCS FEATURING MUSIC; DIGITAL VERSATILE DISCS FEATURING ANIMATED CARTOONS, AND DRAMA, ACTION AND ADVENTURE FILMS; CD-ROMS AND DVD-ROMS FEATURING ANIMATED CARTOONS, AND DRAMA, ACTION AND ADVENTURE FILMS; CINEMATOGRAPHIC FILMS FEATURING ANIMATED CARTOONS, AND DRAMA, ACTION AND ADVENTURE FILMS, VIDEO FILMS FEATURING ANIMATION, DRAMA, ACTION AND ADVENTURE, DVD FILMS FEATURING ANIMATION, DRAMA, ACTION AND ADVENTURE; BOOKS PRERECORDED ON AUDIO TAPES AND CDS IN THE NATURE OF TALKING BOOKS FEATURING DRAMA, ACTION AND ADVENTURE; ELECTRONIC AMUSEMENT APPARATUS AND GAME MACHINES FOR USE WITH AN EXTERNAL DISPLAY SCREEN OR MONITOR; ELECTRONIC GAMES CONSOLES FOR USE WITH AN EXTERNAL DISPLAY SCREEN OR MONITOR; COMPUTER AND VIDEO GAMES APPARATUS, NAMELY, COMPUTER GAME EQUIPMENT CONTAINING MEMORY DEVICES, NAMELY, DISCS, COMPUTER GAME JOYSTICKS, VIDEO AND COMPUTER GAME PROGRAMS, VIDEO GAME INTERACTIVE HAND HELD REMOTE CONTROLS FOR PLAYING ELECTRONIC GAMES, VIDEO GAME MACHINES FOR USE WITH TELEVISIONS; COMPUTER GAMES SOFTWARE; VIDEO GAME DISCS; INTERACTIVE COMPUTER SOFTWARE FOR GAMES; INTERACTIVE COMPUTER DISCS FOR GAMES; INTERACTIVE COMPUTER GAMES SOFTWARE; ELECTRONIC PUBLICATIONS, NAMELY, ELECTRONIC MAGAZINES FEATURING ANIMATED CHARACTERS RECORDED ON COMPUTER MEDIA; DOWNLOADABLE INSTRUCTIONAL MANUALS FOR VIDEO AND COMPUTER GAMES, ELECTRONIC ACTION TOYS, TOYS AND GAMES; DOWNLOADABLE AUDIO FILES, MULTIMEDIA FILES, TEXT FILES, VIDEO FILES AND GAMES FEATURING FICTIONAL CHARACTERS AND ANIMATED CHARACTERS FOR ENTERTAINMENT; COMPUTER SOFTWARE FEATURING DIGITAL BOOKS, STORIES AND IMAGES DOWNLOADABLE FROM COMPUTER NETWORKS OR THE INTERNET IN THE FIELD OF FICTIONAL CHARACTERS AND ANIMATED CHARACTERS FOR ENTERTAINMENT; SOFTWARE FOR PRODUCING BACKGROUNDS, ICONS, IMAGES, SCREEN SAVERS AND WALLPAPERS FOR COMPUTER SCREENS, MOBILE TELEPHONES AND OTHER ELECTRONIC DISPLAYS; DOWNLOADABLE RING TONES FOR MOBILE TELEPHONES; MOBILE TELEPHONE ACCESSORIES, NAMELY, COVERS, CASES, FASCIAS, CHARMS; MOUSE PADS; SUNGLASSES; VISORS; NIGHT VISION GOGGLES; NEON SIGNS (U.S. CLS. 21, 23, 26, 36 AND 38).

SN 79-058,379. ARMOURON LIMITED, UNITED KINGDOM, FILED 10-16-2007.

ARMOURON

PRIORITY DATE OF 8-1-2007 IS CLAIMED.
OWNER OF INTERNATIONAL REGISTRATION 0976071
DATED 10-16-2007, EXPIRES 10-16-2017.

CLASS 16—PAPER GOODS AND PRINTED MATTER

FOR PAPER, BLANK CARDS AND CARDBOARD AND GOODS MADE FROM THESE MATERIALS, NAMELY, NOTEBOOKS, CARRYING CASES, CAKE DECORATIONS, PARTY DECORATIONS, PARTY FAVORS, POSTERS; PRINTED MATTER, NAMELY, BOOKS AND MAGAZINES FEATURING COMIC MATERIAL AND FICTIONAL CHARACTERS, A SERIES OF BOOKS OF FICTION; CHILDREN'S BOOKS, CHILDREN'S ACTIVITY BOOKS, COLORING BOOKS, STICKER BOOKS; STATIONERY; PRINTED PUBLICATIONS, NAMELY, BOOKS AND MAGAZINES FEATURING COMIC MATERIAL AND FICTIONAL CHARACTERS; ANNUALS,

BOOKS, BOOKLETS, COMICS, MAGAZINES, JOURNALS FEATURING COMIC MATERIAL AND FICTIONAL CHARACTERS; GREETING CARDS; POSTCARDS; PHOTOGRAPHS; POSTERS; PICTURES; CALENDARS; WRAPPING AND PACKAGING MATERIALS, NAMELY, PAPER GIFT WRAP, GIFT BAGS, GIFT BOXES, PAPER GIFT BOWS; PLASTIC MATERIALS FOR PACKAGING, NAMELY, GIFT WRAP, GIFT BAGS, GIFT BOXES; BOOK BINDING MATERIAL; ADHESIVES FOR STATIONERY OR HOUSEHOLD PURPOSES; PAINT BRUSHES; WRITING INSTRUMENTS; DRAWING INSTRUMENTS; COLORING PENCILS; CRAYONS; TYPEWRITERS; PENCILS, PENCIL SHARPENERS, PEN, ERASERS; COMPUTER AND VIDEO GAME INSTRUCTION MANUALS; INSTRUCTION SHEETS FOR TOYS, GAMES AND PLAYTHINGS, NAMELY, ELECTRONIC ACTION TOYS, CONSTRUCTION TOYS, DRAWING TOYS, ELECTRONIC TOY VEHICLES, FANTASY CHARACTER TOYS, MECHANICAL ACTION TOYS, NON-ELECTRONIC TOY VEHICLES, PLUSH TOYS, TOSSING DISC TOYS, MODEL HOBBY CRAFT KITS, TOY SWORDS, TOY WEAPONS, CHILDREN'S DRESS-UP ACCESSORIES, BOARD GAMES, AND CARD GAMES; PRINTING TYPE; PRINTING BLOCKS; DECALS, IRON ON TRANSFERS, STICKERS; PENCIL CASES; WRITING INSTRUMENTS CASES; TRADING CARDS; TRADING DISCS AND TOKENS MADE OF PAPER, CARDBOARD OR OF PLASTIC MATERIALS; PAPER PARTY DECORATIONS (U.S. CLS. 2, 5, 22, 23, 29, 37, 38 AND 50).

SN 79-058,454. BEADS4U, S.R.O., CZECH REPUBLIC, FILED 12-7-2007.



OWNER OF INTERNATIONAL REGISTRATION 0976219 DATED 12-7-2007, EXPIRES 12-7-2017.

NO CLAIM IS MADE TO THE EXCLUSIVE RIGHT TO USE "ON THIS PRODUCT PARTICIPATED HANDICAPPED PEOPLE" AND "THANK YOU FOR YOUR HELP", APART FROM THE MARK AS SHOWN.

CLASS 25—CLOTHING

FOR CLOTHING FOR CHILDREN, NAMELY, SHIRTS, T-SHIRTS, PAJAMAS, SWEATSHIRTS, JACKETS AND HEADWEAR; COSTUMES FOR USE IN ROLE-PLAYING GAMES; COSTUMES FOR USE IN CHILDREN'S DRESS UP PLAY (U.S. CLS. 22 AND 39).

CLASS 14—JEWELRY

FOR PRECIOUS METALS AND ITS ALLOYS AND GOODS IN PRECIOUS METALS OR COATED THEREWITH, NOT INCLUDED IN OTHER CLASSES, NAMELY, AMULETS, BROOCHES, HAT ORNAMENTS, BELT ORNAMENTS, KEY CHAINS; JEWELS, NAMELY, PRECIOUS STONES; JEWELLERY, PRECIOUS STONES; CLOCKS AND WATCHES, CHRONOMETRIC INSTRUMENTS, NAMELY, CHRONOMETERS (U.S. CLS. 2, 27, 28 AND 50).

CLASS 28—TOYS AND SPORTING GOODS

FOR TOYS, GAMES AND PLAYTHINGS, NAMELY, ELECTRONIC ACTION TOYS, CONSTRUCTION TOYS, DRAWING TOYS, ELECTRONIC TOY VEHICLES, FANTASY CHARACTER TOYS, MECHANICAL ACTION TOYS, NON-ELECTRONIC TOY VEHICLES, PLUSH TOYS, TOSSING DISC TOYS, MODEL HOBBY CRAFT KITS, TOY SWORDS, TOY WEAPONS, CHILDREN'S DRESS-UP ACCESSORIES, BOARD GAMES, AND CARD GAMES; TOY ARMOR AND HELMETS; TOY MODEL ARMOR, PLAYSUITS, WEAPONS, AND SHIELDS AND RELATED ACCESSORIES SOLD AS UNITS; TOY CONSTRUCTION SETS; TOY SETS FOR THE CONSTRUCTION OF CHARACTERS, MODELS AND PLAYSUITS OF ARMOR; TOY SUITS OF ARMOR; TOY PLAYSUITS, ELECTRONIC LEARNING TOYS; HAND HELD UNIT FOR PLAYING ELECTRONIC GAMES; HAND-HELD COMPUTER, ELECTRONIC AND VIDEO GAME UNITS, NAMELY, HAND-HELD UNITS FOR PLAYING ELECTRONIC AND VIDEO GAMES; HAND-HELD COMPUTER, ELECTRONIC AND VIDEO GAMES WITH LIQUID CRYSTAL DISPLAYS, NAMELY, HAND-HELD UNITS FOR PLAYING ELECTRONIC AND VIDEO GAMES; ACTION FIGURES, TOY MODEL FIGURES, TOY FIGURES; PLAYING CARDS; PLAY TOKENS; TOY MEDALS, DISCS AND MEDALLIONS BEING COLLECTABLE CHILDREN'S PLAY THINGS INCLUDED IN THIS CLASS; TOY WEAPONS AND SHIELDS; FLYING DISCS; THROWING DISCS, LANCES AND SPEARS FOR USE AS TOYS; FOAM SHOOTING TOYS; TOY AIR GUNS; TOY AIR PISTOLS; TOY LASER GUNS; TOY WATER BOMBS; TOY WATER GUNS; TOY WATER PISTOLS; CHRISTMAS TREE ORNAMENTS AND DECORATIONS; PARTY FAVORS, NAMELY, SMALL TOYS, NOISEMAKERS, BLOWOUTS, AND PARTY HATS; BODY ARMOR AS PLAYTHINGS (U.S. CLS. 22, 23, 38 AND 50).

SUE LAWRENCE, EXAMINING ATTORNEY

CLASS 20—FURNITURE AND ARTICLES NOT OTHERWISE CLASSIFIED

FOR FURNITURE, MIRRORS, PICTURE FRAMES, GOODS NOT INCLUDED IN OTHER CLASSES OF WOOD, CORK, CANE, WICKER, HORN, BONE, IVORY, WHALE BONE, TORTOISESHELL, MOTHER-OF-PEARL AND SUBSTITUTES FOR ALL THESE MATERIALS AND OF PLASTICS, NAMELY, WOODEN BOXES, WOVEN TIMBER BLINDS, CORK STOPPERS, ART OF WOOD, WOODEN CURTAINS OF BAMBOO FOR DECORATION (U.S. CLS. 2, 13, 22, 25, 32 AND 50).

CLASS 26—FANCY GOODS

FOR LACES AND EMBROIDERIES, RIBBONS AND SHOE LACES, BUTTONS FOR CLOTHING, CLOTHING HOOKS, EYELETS AND SNAP FASTENERS BEING HABERSDASHERY; HAT PINS AND NEEDLES; ARTIFICIAL FLOWERS (U.S. CLS. 37, 39, 40, 42 AND 50).

CLASS 35—ADVERTISING AND BUSINESS

FOR BUSINESS MANAGEMENT ASSISTANCE, BUSINESS ADMINISTRATION, PROVIDING OFFICE FUNCTIONS, PUBLICATION OF PUBLICITY TEXTS, BUSINESS INFORMATION IN THE FIELD OF ADVERTISING AND BUSINESS; ORGANIZATION OF EXHIBITIONS FOR COMMERCIAL OF ADVERTISING PURPOSES (U.S. CLS. 100, 101 AND 102).

CLASS 39—TRANSPORTATION AND STORAGE

FOR TRANSPORT AND STORAGE OF GOODS; PACKAGING ARTICLES FOR TRANSPORTATION; ARRANGING OF TRAVEL TOURS (U.S. CLS. 100 AND 105).

CLASS 40—MATERIAL TREATMENT

FOR TREATMENT OF MATERIALS, NAMELY, GLASS ABRASION, ELECTROPLATING, FIRING POTTERY, CLOTH DYEING, CLOTHING ALTERATION, GLASS PLATING, GOLD-PLATING (U.S. CLS. 100, 103 AND 106).

MELISSA VALLILLO, EXAMINING ATTORNEY

SN 79-058,467. HANSATON AKUSTIK GMBH, FED REP GERMANY, FILED 5-23-2008.

Style Pro

THE MARK CONSISTS OF STANDARD CHARACTERS WITHOUT CLAIM TO ANY PARTICULAR FONT, STYLE, SIZE, OR COLOR.

OWNER OF INTERNATIONAL REGISTRATION 0976252 DATED 5-23-2008, EXPIRES 5-23-2018.

CLASS 9—ELECTRICAL AND SCIENTIFIC APPARATUS

FOR SOUND AND DATA MEDIA, NAMELY, CDS FEATURING AUDIO TONES AND DVDS FEATURING AUDIO TONES AND VISUAL DEPICTION OF AUDIO TONES, FOR USE IN THE FIELD OF AUDIOLOGICAL MEDICINE; SOFTWARE USED FOR ADJUSTING VOLUME LEVELS AND TONES, FOR HEARING SYSTEMS; APPARATUS FOR PRODUCTION OF SOUND AND TONES FOR TESTING THE HEARING (U.S. CLS. 21, 23, 26, 36 AND 38).

CLASS 10—MEDICAL APPARATUS

FOR MEDICAL AND ELECTROMEDICAL APPARATUS AND INSTRUMENTS, NAMELY, APPARATUS AND INSTRUMENTS FOR USE BY PERSONS WITH A HEARING IMPEDIMENT AND INSTRUMENTS FOR TESTING THE HEARING; HEARING AIDS, AS WELL AS STRUCTURAL PARTS FOR THE AFOREMENTIONED GOODS (U.S. CLS. 26, 39 AND 44).

LAURA HAMMEL, EXAMINING ATTORNEY

SN 79-058,468. HANSATON AKUSTIK GMBH, FED REP GERMANY, FILED 5-23-2008.

Style Exclusive

THE MARK CONSISTS OF STANDARD CHARACTERS WITHOUT CLAIM TO ANY PARTICULAR FONT, STYLE, SIZE, OR COLOR.

OWNER OF INTERNATIONAL REGISTRATION 0976253 DATED 5-23-2008, EXPIRES 5-23-2018.

NO CLAIM IS MADE TO THE EXCLUSIVE RIGHT TO USE "EXCLUSIVE", APART FROM THE MARK AS SHOWN.

CLASS 9—ELECTRICAL AND SCIENTIFIC APPARATUS

FOR SOUND AND DATA MEDIA, NAMELY, CDS, DVDS FEATURING AUDIO TONES FOR USE IN THE FIELD OF AUDIOLOGICAL MEDICINE; SOFTWARE USED FOR ADJUSTING VOLUME LEVELS AND OTHER FITTING PARAMETERS, FOR HEARING SYSTEMS; APPARATUS FOR PRODUCTION OF SOUND AND TONES FOR TESTING THE HEARING (U.S. CLS. 21, 23, 26, 36 AND 38).

CLASS 10—MEDICAL APPARATUS

FOR MEDICAL AND ELECTROMEDICAL APPARATUS AND INSTRUMENTS, NAMELY, APPARATUS AND INSTRUMENTS FOR USE BY PERSONS WITH A HEARING IMPEDIMENT AND INSTRUMENTS FOR TESTING THE HEARING; HEARING AIDS, AS WELL AS STRUCTURAL PARTS FOR THE AFOREMENTIONED GOODS (U.S. CLS. 26, 39 AND 44).

ALLISON SCHRODY, EXAMINING ATTORNEY

SN 79-058,470. HANSATON AKUSTIK GMBH, FED REP GERMANY, FILED 5-23-2008.

Media Pro

THE MARK CONSISTS OF STANDARD CHARACTERS WITHOUT CLAIM TO ANY PARTICULAR FONT, STYLE, SIZE, OR COLOR.

OWNER OF INTERNATIONAL REGISTRATION 0976255 DATED 5-23-2008, EXPIRES 5-23-2018.

NO CLAIM IS MADE TO THE EXCLUSIVE RIGHT TO USE "MEDIA", APART FROM THE MARK AS SHOWN.

CLASS 9—ELECTRICAL AND SCIENTIFIC APPARATUS

FOR SOUND AND DATA MEDIA FOR USE IN THE FIELD OF AUDIOLOGICAL MEDICINE, NAMELY, DIGITAL MEDIA STREAMING DEVICES; FOR USE IN ADJUSTING VOLUME AND TONE IN HEARING SYSTEMS; APPARATUS FOR PRODUCTION AND REPRODUCTION OF SOUND AND TONES FOR TESTING THE HEARING (U.S. CLS. 21, 23, 26, 36 AND 38).

CLASS 10—MEDICAL APPARATUS

FOR MEDICAL AND ELECTROMEDICAL APPARATUS AND INSTRUMENTS, IN PARTICULAR FOR USE BY PERSONS WITH A HEARING IMPEDIMENT; HEARING AIDS; AND PARTS OF THE AFOREMENTIONED GOODS, NAMELY, PARTS OF MEDICAL HEARING INSTRUMENTS (U.S. CLS. 26, 39 AND 44).

LAURA HAMMEL, EXAMINING ATTORNEY

SN 79-058,471. HANSATON AKUSTIK GMBH, FED REP GERMANY, FILED 5-23-2008.

Style Premium

THE MARK CONSISTS OF STANDARD CHARACTERS WITHOUT CLAIM TO ANY PARTICULAR FONT, STYLE, SIZE, OR COLOR.

OWNER OF INTERNATIONAL REGISTRATION 0976256 DATED 5-23-2008, EXPIRES 5-23-2018.

NO CLAIM IS MADE TO THE EXCLUSIVE RIGHT TO USE "PREMIUM", APART FROM THE MARK AS SHOWN.

CLASS 9—ELECTRICAL AND SCIENTIFIC APPARATUS

FOR SOUND AND DATA MEDIA, NAMELY, CDS, DVDS FEATURING AUDIO TONES FOR USE IN THE FIELD OF AUDIOLOGICAL MEDICINE; SOFTWARE USED FOR ADJUSTING VOLUME LEVELS AND OTHER FITTING PARAMETERS, FOR HEARING SYSTEMS; APPARATUS FOR PRODUCTION OF SOUND AND TONES FOR TESTING THE HEARING (U.S. CLS. 21, 23, 26, 36 AND 38).

CLASS 10—MEDICAL APPARATUS

FOR MEDICAL AND ELECTROMEDICAL APPARATUS AND INSTRUMENTS, NAMELY, APPARATUS AND INSTRUMENTS FOR USE BY PERSONS WITH A HEARING IMPEDIMENT AND INSTRUMENTS FOR TESTING THE HEARING; HEARING AIDS, AS WELL AS STRUCTURAL PARTS FOR THE AFOREMENTIONED GOODS (U.S. CLS. 26, 39 AND 44).
ALLISON SCHRODY, EXAMINING ATTORNEY

SN 79-058,743. APETITO AKTIENGESSELLSCHAFT, FED REP GERMANY, FILED 9-3-2008.



THE MARK CONSISTS OF STANDARD CHARACTERS WITHOUT CLAIM TO ANY PARTICULAR FONT, STYLE, SIZE, OR COLOR.

OWNER OF INTERNATIONAL REGISTRATION 0920727 DATED 10-24-2006, EXPIRES 10-24-2016.

THE ENGLISH TRANSLATION OF "APETITO" IN THE MARK IS "APPETITE".

CLASS 5—PHARMACEUTICALS

FOR DIETETIC FOODS ADAPTED FOR MEDICAL USE (U.S. CLS. 6, 18, 44, 46, 51 AND 52).

CLASS 11—ENVIRONMENTAL CONTROL APPARATUS

FOR COOKING APPARATUS, NAMELY, COOK AND HOLD OVENS, INDUSTRIAL COOKING OVENS; REFRIGERATING APPARATUS, NAMELY, REFRIGERATING MACHINES; FREEZING APPARATUS, NAMELY, FREEZERS; AND DEFROSTING APPARATUS FOR FOODS (U.S. CLS. 13, 21, 23, 31 AND 34).

CLASS 21—HOUSEWARES AND GLASS

FOR CONTAINERS FOR KITCHEN USE AND HOUSEHOLD HEAT-INSULATED CONTAINERS FOR FOOD OR BEVERAGE (U.S. CLS. 2, 13, 23, 29, 30, 33, 40 AND 50).

CLASS 30—STAPLE FOODS

FOR NON-ALCOHOLIC COFFEE, TEA, COCOA AND CHOCOLATE DRINKS (U.S. CL. 46).

CLASS 39—TRANSPORTATION AND STORAGE

FOR MOBILE FOOD DELIVERY SERVICES, NAMELY, THE DELIVERY OF MEALS AND ROUTE PLANNING FOR MOBILE FOOD DELIVERY SERVICES (U.S. CLS. 100 AND 105).

CLASS 42—SCIENTIFIC AND COMPUTER SERVICES

FOR TECHNICAL AND ORGANIZATIONAL PLANNING, NAMELY, INTERIOR DESIGN SERVICES FOR KITCHEN EQUIPMENT FOR PROVIDING FOOD AND DRINK TO THE PUBLIC; COMPUTER PROGRAMMING FOR CUSTOMER AND CONSUMER FILES AND ORDER LIST ACCOUNTS (U.S. CLS. 100 AND 101).

CLASS 43—HOTEL AND RESTAURANT SERVICES

FOR PROVIDING OF FOOD AND DRINK TO THE PUBLIC, NAMELY, COOKING, HEATING OR SERVING MEALS AND CONSULTANCY SERVICES IN THE FIELD OF MENU PLANNING FOR OTHERS (U.S. CLS. 100 AND 101).

CLASS 44—MEDICAL, BEAUTY AND AGRICULTURAL SERVICES

FOR NUTRITIONAL CONSULTANCY FOR INDIVIDUALS AND GROUPS, NUTRITIONAL CONSULTANCY FOR MANAGEMENT AND EMPLOYEES OF SERVICES PROVIDING FOOD AND DRINK TO THE PUBLIC (U.S. CLS. 100 AND 101).
TASNEEM HUSSAIN, EXAMINING ATTORNEY

SN 79-058,897. AIAI CO., LTD., KYOTO-SHI, KYOTO 600-8310, JAPAN, FILED 5-2-2008.



PRIORITY DATE OF 3-25-2008 IS CLAIMED.
OWNER OF INTERNATIONAL REGISTRATION 0977350 DATED 5-2-2008, EXPIRES 5-2-2018.

CLASS 14—JEWELRY

FOR PRECIOUS METALS; KEY RINGS OF PRECIOUS METAL; JEWEL CASES OF PRECIOUS METAL; PERSONAL ORNAMENTS OF PRECIOUS METAL; JEWELRY; SHOE ORNAMENTS OF PRECIOUS METAL; CLOCKS AND WATCHES (U.S. CLS. 2, 27, 28 AND 50).

CLASS 24—FABRICS

FOR PERSONAL ARTICLES OF WOVEN TEXTILE, NAMELY, TOWELS, HANDKERCHIEFS, JAPANESE COTTON TOWELS TENUGUI, JAPANESE CEREMONIAL WRAPPING CLOTH FUKUSA, JAPANESE GENERAL WRAPPING CLOTH FUROSHIKI, HOUSEHOLD LINEN; BEDSHEETS; FUTON COVERS, NAMELY, QUILTS; QUILTS; PILLOWCASES; BED BLANKETS; WOVEN FABRICS; TOILET SEAT COVERS OF TEXTILE (U.S. CLS. 42 AND 50).

CLASS 25—CLOTHING

FOR CLOTHING, NAMELY, COATS, JACKETS, SWEATERS, SHIRTS, NIGHTWEAR, UNDERWEAR, SWIM WEAR, SWIMMING CAPS, APRONS, COLLAR PROTECTORS, SOCKS AND STOCKINGS; FUR STOLE; SHAWLS; SCARVES, GLOVES AND MITTENS, BABIES' DIAPERS OF TEXTILE; NECKTIES; NECKERCHIEVES; BANDANAS, THERMAL UNDERWEAR, MUFFLERS, EAR MUFFS, NIGHTCAPS, THERMAL HEADWEAR, HEADWEAR, GARTERS, SOCK SUSPENDERS, SUSPENDERS, WAISTBANDS, BELTS FOR CLOTHING, SPORTS SHIRTS, SPORTS JACKETS, SPORTS PANTS, BOOTS FOR SPORTS, SLEEP MASKS, FOOTWEAR (U.S. CLS. 22 AND 39).

CLASS 27—FLOOR COVERINGS

FOR BATH MATS FOR WASH PLACES; FLOOR COVERINGS; GYMNASIUM MATS; WALLPAPER (U.S. CLS. 19, 20, 37, 42 AND 50).

CHRISIE B. KING, EXAMINING ATTORNEY

SN 79-059,086. LIDL STIFTUNG & CO. KG, 74167 NECK-ARSULM, FED REP GERMANY, FILED 4-18-2008.



PRIORITY DATE OF 2-1-2008 IS CLAIMED.

OWNER OF INTERNATIONAL REGISTRATION 0977865 DATED 4-18-2008, EXPIRES 4-18-2018.

THE COLOR(S) GREEN AND YELLOW IS/ARE CLAIMED AS A FEATURE OF THE MARK.

THE COLOR YELLOW APPEARS IN SIDE THE OVAL DESIGN WITH A GREEN OUTLINE AND THE WORDING "FLORA BEST" APPEARING IN THE COLOR GREEN.

CLASS 7—MACHINERY

FOR PUMPS, NAMELY, SUBMERSIBLE PUMPS, NAMELY, SUBMERSIBLE PUMPS AND RAIN BUTT PUMPS; MOTOR-DRIVEN GRASS CUTTING MOWER; ELECTRICALLY OPERATED GARDEN TOOLS, NAMELY, CHIPPERS, SHREDDERS, EDGERS AND CULTIVATORS; GRASS CUTTING MOWER, POWER OPERATED AND ELECTRIC HEDGE TRIMMERS, CHAIN SAWS AND MACHINE SAWS, NAMELY, POWER-OPERATED SAWS (U.S. CLS. 13, 19, 21, 23, 31, 34 AND 35).

CLASS 8—HAND TOOLS

FOR HAND-OPERATED IMPLEMENTS FOR SOIL CULTIVATION, NAMELY, CULTIVATORS; HAND-OPERATED GRASS CUTTING MOWER, NAMELY, HAND OPERATED LAWN EDGERS; HAND-OPERATED SHEARS; HEDGE TRIMMERS, NAMELY, HAND OPERATED HEDGE TRIMMERS; PRUNING SHEARS, SECTEURS, NAMELY, SMALL PRUNING SHEARS CONTAINING A SPRING THAT HOLDS THE HANDLES OPEN AND A SINGLE BLADE THAT CLOSSES AGAINST A FLAT SURFACE; HAND-OPERATED GRASS CLIPPERS (U.S. CLS. 23, 28 AND 44).

CLASS 17—RUBBER GOODS

FOR WATERING HOSES; STRUCTURAL FITTINGS AND NON-METAL SEALS AS WELL AS CONNECTING PIECES, NAMELY, CYLINDER JOININGS AND NON-METAL FLANGES FOR WATERING HOSES (U.S. CLS. 1, 5, 12, 13, 35 AND 50).

CLASS 20—FURNITURE AND ARTICLES NOT OTHERWISE CLASSIFIED

FOR GARDEN DECORATIONS OF WOOD OR PLASTIC, NAMELY, STATUES, AND GARDEN STAKES; GARDEN FURNITURE, NAMELY, PLASTIC GARDEN PINWHEELS FOR DECORATION; NON-METALLIC AND NON-MECHANICAL HOSE SUPPORTS, NAMELY, HOSE CARRIERS, NAMELY, HAND OPERATED NON-METAL GARDEN HOSE REELS, AND HOSE CARRIERS, NAMELY, NON-METAL HOSE HANGERS (U.S. CLS. 2, 13, 22, 25, 32 AND 50).

CLASS 21—HOUSEWARES AND GLASS

FOR DECORATIVE ARTICLES OF GLASS FOR THE GARDEN, NAMELY, MIRROR BALLS, AND OTHER DECORATIVE GLASS NOT FOR BUILDING; IRRIGATION APPARATUS FOR WATERING FLOWERS AND PLANTS, FOR GARDEN USE ONLY, NAMELY, WATERING CANS AND WATERING POTS; LAWN SPRINKLERS, GARDEN HOSE SPRAYERS; WASHING BRUSHES; PLANT POTS, FLOWER POTS (U.S. CLS. 2, 13, 23, 29, 30, 33, 40 AND 50).

WILLIAM ROSSMAN, EXAMINING ATTORNEY

SN 79-059,567. OBSHCHESTVO S OGRANICHENNOI; OT-VETSTVENNOSTIY "SPLAT-KOSMETIKA", RUSSIAN FED., FILED 3-26-2008.

SNOW-HOW

PRIORITY DATE OF 10-19-2007 IS CLAIMED.

OWNER OF INTERNATIONAL REGISTRATION 0978995 DATED 3-26-2008, EXPIRES 3-26-2018.

CLASS 3—COSMETICS AND CLEANING PREPARATIONS

FOR ABRASIVE PAPER; ABRASIVES, NAMELY, ABRASIVE PASTE; ADHESIVES FOR AFFIXING FALSE HAIR; ADHESIVES FOR COSMETIC PURPOSES; AFTER-SHAVE LOTIONS; CANNED PRESSURIZED AIR FOR CLEANING AND DUSTING PURPOSES; ALMOND MILK FOR COSMETIC PURPOSES; ALMOND BODY OIL; ALMOND SOAP; ALUM POLISHING STONES; ANTIPERSPIRANT SOAP; AROMATICS, NAMELY, ESSENTIAL OILS; ASTRINGENTS FOR COSMETIC PURPOSES; BATH SALTS, NOT FOR MEDICAL PURPOSES; COSMETIC PREPARATIONS FOR BATHS; BEAUTY MASKS; BERGAMOT OIL; FLAVORINGS FOR BEVERAGES, NAMELY, ESSENTIAL OILS; BLEACHING PREPARATIONS FOR COSMETIC PURPOSES; BLEACHING SALTS; BREATH FRESHENER IN THE NATURE OF FRESHENING SPRAYS; PREPARATIONS FOR CLEANING DENTURES; CLEANSING MILK FOR TOILET PURPOSES; COSMETICS; COTTON STICKS FOR COSMETIC PURPOSES; COTTON WOOL FOR COSMETIC PURPOSES; COSMETIC CREAMS; CREAMS FOR LEATHER; SKIN WHITENING CREAMS; DENTAL BLEACHING GELS; DENTIFRICES; DENTURE POLISHES, NAMELY, CLEANERS; DEODORANT SOAP; DEODORANTS FOR PERSONAL USE; DEPILATORIES; DEPILATORY PREPARATIONS; DISINFECTANT SOAP; EAU DE COLOGNE; ESSENTIAL OILS; EXTRACTS OF FLOWERS, NAMELY, PERFUMES; EYEBROW COSMETICS; EYEBROW PENCILS; FALSE EYELASHES; FALSE NAILS; PERFUMED EXTRACTS OF FLOWERS FOR PERFUMES; SOAP FOR FOOT PERSPIRATION; GREASES FOR COSMETIC PURPOSES; HAIR COLORANTS; HAIR LOTIONS; HAIR SPRAY; HAIR WAVING PREPARATIONS; HYDROGEN PEROXIDE FOR COSMETIC PURPOSES, NAMELY, FOR USE ON THE HAIR; JEWELLERS' ROUGE; JOSS STICKS; LACQUER-REMOVING PREPARATIONS; LAVENDER OIL; MAKE-UP; MAKE-UP PREPARATIONS; MAKE-UP REMOVING PREPARATIONS; MASCARA; MOUTH WASHES, NOT FOR MEDICAL PURPOSES; OILS FOR PERFUMES; COSMETIC PENCILS; PERFUMERY; PERFUMES; POMADES FOR COSMETIC PURPOSES, NAMELY, FOR

LIPS; ROSE OIL FOR COSMETIC PURPOSES; SHAMPOOS; SHAVING PREPARATIONS; SHAVING SOAP; COSMETIC PREPARATIONS FOR SKIN CARE; SOAP; SUN-TANNING PREPARATIONS AS COSMETICS; TOILET WATER; TOOTHPASTES (U.S. CLS. 1, 4, 6, 50, 51 AND 52).

CLASS 5—PHARMACEUTICALS

FOR DENTAL ABRASIVES; ADHESIVE MEDICAL PLASTER; ADHESIVES FOR DENTURES; AIR FRESHENING PREPARATIONS; DENTAL AMALGAMS; ANTI-BIOTICS; ANTISEPTIC COTTON AS BALLS, STICKS, WOUND DRESSING, FOR MEDICAL PURPOSES; BACTERIAL PREPARATIONS FOR MEDICAL USE; BACTERIOLOGICAL PREPARATIONS FOR MEDICAL USE; BALMS FOR MEDICAL PURPOSES; BATH PREPARATIONS, MEDICATED; BATH SALTS FOR MEDICAL PURPOSES; THERAPEUTIC MEDICATED PREPARATIONS FOR THE BATH; MEDICATED SALTS FOR MINERAL WATER BATHS; BIOLOGICAL PREPARATIONS FOR MEDICAL PURPOSES; MEDICATED CANDY FOR MEDICAL PURPOSES; MEDICATED CHEWING GUM FOR MEDICAL PURPOSES; CHEMICAL CONTRACEPTIVES; DENTAL CEMENTS; DENTAL IMPRESSION MATERIALS; DENTAL CONDUCTIVE LACQUER; CHEMICAL PREPARATIONS FOR DIAGNOSIS OF PREGNANCY, NAMELY, CHEMICAL REAGENT FOR THE IN VITRO DIAGNOSIS OF PREGNANCY IN A FEMALE MAMMAL; DIAGNOSTIC PREPARATIONS FOR MEDICAL PURPOSES; DIETETIC BEVERAGES ADAPTED FOR MEDICAL PURPOSES; DIETETIC FOODS ADAPTED FOR MEDICAL PURPOSES; DISINFECTANTS FOR HYGIENE PURPOSES; MEDICINAL DRINKS; FIRST-AID BOXES, NAMELY, KITS, FILLED; FOOD FOR BABIES; DIETETIC FOOD PREPARATIONS ADAPTED FOR MEDICAL PURPOSES; MEDICINAL HERBS; SKIN LOTIONS FOR PHARMACEUTICAL PURPOSES, NAMELY, MEDICATED LOTIONS FOR THE SKIN; MENSTRUATION PADS; MENSTRUATION TAMPONS; TEETH FILLING MATERIAL; VITAMIN PREPARATIONS, NAMELY, VITAMIN PILLS (U.S. CLS. 6, 18, 44, 46, 51 AND 52).

LAURA HAMMEL, EXAMINING ATTORNEY

CLASS 9—ELECTRICAL AND SCIENTIFIC APPARATUS

FOR ELECTRIC APPARATUS, ESPECIALLY APPARATUS FOR RECORDING, TRANSMITTING AND REPRODUCING SOUND AND IMAGES; RECORD TURNTABLES; COMPACT DISC PLAYERS; AMPLIFIERS; LOUD-SPEAKERS; POWER AMPLIFIERS; PRE-AMPLIFIERS, AMPLIFIER HEADS; CABINETS FOR LOUDSPEAKERS; HEADPHONES; CABLE JUMP LEADS, AUDIO CABLES; CABLE CONNECTORS; ELECTRONIC SOUND PICK-UPS FOR GUITARS AND BASSES; MICROPHONES; MULTI-EFFECT SOUND CARDS; SOUND CARDS; ELECTRICAL CONNECTORS; DIGITAL EFFECT APPLIANCES, NAMELY, ELECTRONIC EFFECT PEDALS FOR USE WITH SOUND AMPLIFIERS; SOUND EQUALIZERS; RADIO TRANSMITTERS; LOUDSPEAKER UNITS; STAGE MONITOR SPEAKERS; COMPUTER HARDWARE AND SOFTWARE FOR PROCESSING SOUND; MICROPHONES; GUITAR EFFECT PROCESSORS (U.S. CLS. 21, 23, 26, 36 AND 38).

CLASS 11—ENVIRONMENTAL CONTROL APPARATUS

FOR LIGHT PROJECTORS (U.S. CLS. 13, 21, 23, 31 AND 34).

CLASS 15—MUSICAL INSTRUMENTS

FOR MUSICAL INSTRUMENTS, NAMELY, ELECTRIC GUITARS AND BASS GUITARS; ELECTRONIC MUSICAL INSTRUMENTS; MUSIC SYNTHESIZERS; SOUND EFFECT PEDALS FOR MUSICAL INSTRUMENTS; KEYBOARDS FOR MUSICAL INSTRUMENTS; PLECTRUMS; MUSIC STRINGS FOR MUSICAL INSTRUMENTS; MUSICAL INSTRUMENT STANDS, CASES FOR MUSICAL INSTRUMENTS; COVERS FOR MUSICAL INSTRUMENTS (U.S. CLS. 2, 21 AND 36).

PATRICIA EVANKO, EXAMINING ATTORNEY

SN 79-059,821. ALGAM, RUE DE MILAN; F-44470 THOUARE SUR LOIRE, FRANCE, FILED 9-2-2008.

LAG

THE MARK CONSISTS OF STANDARD CHARACTERS WITHOUT CLAIM TO ANY PARTICULAR FONT, STYLE, SIZE, OR COLOR.

OWNER OF INTERNATIONAL REGISTRATION 0908175 DATED 5-12-2006, EXPIRES 5-12-2016.
OWNER OF U.S. REG. NO. 2,720,241.

SN 79-059,907. P.M. ESSER HOLDING BV, NETHERLANDS, FILED 9-1-2008.

VANEESCH

THE MARK CONSISTS OF STANDARD CHARACTERS WITHOUT CLAIM TO ANY PARTICULAR FONT, STYLE, SIZE, OR COLOR.

PRIORITY DATE OF 8-26-2008 IS CLAIMED.
OWNER OF INTERNATIONAL REGISTRATION 0979715 DATED 9-1-2008, EXPIRES 9-1-2018.

CLASS 35—ADVERTISING AND BUSINESS

FOR ADVERTISING, BUSINESS MANAGEMENT, BUSINESS ADMINISTRATION, OFFICE FUNCTIONS, BUSINESS MEDITATION, NAMELY, MEDITATION OF AGREEMENTS REGARDING THE SALE AND PURCHASE OF APPARATUS FOR LOCOMOTION BY WATER (U.S. CLS. 100, 101 AND 102).

CLASS 42—SCIENTIFIC AND COMPUTER SERVICES

FOR ARCHITECTURE, NAMELY, SHIP DESIGN (U.S. CLS. 100 AND 101).
KATHRYN COWARD, EXAMINING ATTORNEY

SN 79-060,239. MOBILITY GENOSSENSCHAFT, SWITZERLAND, FILED 9-30-2008.

Mobility CarSharing

THE MARK CONSISTS OF STANDARD CHARACTERS WITHOUT CLAIM TO ANY PARTICULAR FONT, STYLE, SIZE, OR COLOR.

OWNER OF INTERNATIONAL REGISTRATION 0924823 DATED 2-27-2007, EXPIRES 2-27-2017.

NO CLAIM IS MADE TO THE EXCLUSIVE RIGHT TO USE "CARSHARING", APART FROM THE MARK AS SHOWN.

CLASS 38—COMMUNICATION

FOR TELECOMMUNICATIONS USING TELEMATIC MEANS, NAMELY, INFORMATION TRANSMISSION BY TELEMATIC CODES (U.S. CLS. 100, 101 AND 104).

CLASS 39—TRANSPORTATION AND STORAGE

FOR TRANSPORT SERVICES, NAMELY, CAR TRANSPORT; RENTAL OF MOTOR CARS, GARAGES AND PARKING SPACES; TRANSPORT OF PASSENGERS; CHAUFFEUR SERVICES; POSTAL SERVICES, NAMELY, COURIER SERVICES; ARRANGING OF TOURS; BOOKING OF SEATS FOR TRAVEL PURPOSES; TRAVEL AND TOUR TICKET RESERVATION SERVICES (U.S. CLS. 100 AND 105).

ZHALEH DELANEY, EXAMINING ATTORNEY

SN 79-060,399. BRIDGESTONE CORPORATION, TOKYO 104-8340, JAPAN, FILED 8-29-2008.

BRIDGESTONE
GOLF

PRIORITY DATE OF 7-17-2008 IS CLAIMED.
OWNER OF INTERNATIONAL REGISTRATION 0980861 DATED 8-29-2008, EXPIRES 8-29-2018.

NO CLAIM IS MADE TO THE EXCLUSIVE RIGHT TO USE "GOLF", APART FROM THE MARK AS SHOWN.

CLASS 18—LEATHER GOODS

FOR SHOULDER BAGS, BOSTON BAGS, BACKPACKS, POUCHES, WALLETS, KEY CASES, BUSINESS CARD HOLDERS, UMBRELLAS AND THEIR PARTS (U.S. CLS. 1, 2, 3, 22 AND 41).

CLASS 24—FABRICS

FOR TOWELS OF TEXTILE; HANDKERCHIEFS (U.S. CLS. 42 AND 50).

CLASS 25—CLOTHING

FOR HEADWEAR, NAMELY, HATS, CAPS, VISORS; FOOTWEAR, NAMELY, TRAINING SHOES, SANDALS, BOOTS, GOLF SHOES, GOLF SPIKES; BELTS FOR CLOTHING; CLOTHING, NAMELY, JACKETS, JOGGING PANTS, SWEATPANTS, TROUSERS, OVERCOATS, RAINCOATS, SWEATERS, SPORT SHIRTS, CAMISOLES, UNDERSHIRTS, UNDERPANTS, VESTS, OPEN-NECKED SHIRTS, COLLAR PROTECTORS, SOCKS, SCARVES, GLOVES, NECKERCHIEFS, MUFFLERS, EARMUFFS; POLO SHIRTS; WIND JACKETS, WRISTBANDS; GOLF CAPS, GOLF SHIRTS, GOLF PANTS, GOLF SKIRTS, GOLF TROUSERS (U.S. CLS. 22 AND 39).

CLASS 28—TOYS AND SPORTING GOODS

FOR GOLF BALLS, GOLF CLUBS, GOLF CLUB BAGS, TROLLEY BAGS FOR GOLF EQUIPMENT, GOLF GLOVES, GOLF TEES, GOLF BALL MARKERS; PUTTING PRACTICE MATS (U.S. CLS. 22, 23, 38 AND 50).
JILL C. ALT, EXAMINING ATTORNEY

SN 79-060,770. ALSTOM TECHNOLOGY LTD., SWITZERLAND, FILED 9-15-2008.



PRIORITY DATE OF 4-18-2008 IS CLAIMED.
OWNER OF INTERNATIONAL REGISTRATION 0981762 DATED 9-15-2008, EXPIRES 9-15-2018.

THE MARK CONSISTS OF THE STYLIZED WORDING "P20" WITHIN AN INCOMPLETE STRIPED CIRCLE DESIGN WITH THE TOP RIGHT OF THE INCOMPLETE CIRCLE CONTINUING IN AN ARROW.

CLASS 37—CONSTRUCTION AND REPAIR

FOR SERVICING, MAINTENANCE, REPAIR AND CONVERSION OF POWER STATIONS, COMPONENTS OF POWER STATIONS AND INSTALLATIONS, NAMELY, POWER PLANTS, GAS POWER PLANTS, COAL POWER PLANTS, INDUSTRIAL POWER PLANTS, REFINERIES, CHEMICAL PLANTS, TURBINES, GAS TURBINES, STEAM TURBINES, AND POWER GENERATORS FOR SUPPLYING ENERGY (U.S. CLS. 100, 103 AND 106).

CLASS 41—EDUCATION AND ENTERTAINMENT

FOR PROVIDING TRAINING IN THE FORM OF CLASSES, COURSES, SEMINARS, WORKSHOPS REGARDING THE SERVICING, MAINTENANCE, REPAIR AND CONVERSION OF POWER STATIONS, OF COMPONENTS FOR POWER STATIONS AND INSTALLATIONS FOR SUPPLYING ENERGY; EDUCATIONAL SERVICES, NAMELY, PROVIDING FURTHER TRAINING IN THE FORM OF CLASSES, COURSES, SEMINARS, WORKSHOPS REGARDING THE SERVICING, MAINTENANCE, REPAIR AND CONVERSION OF POWER STATIONS, OF COMPONENTS FOR POWER PLANTS AND INSTALLATIONS FOR SUPPLYING ENERGY; ARRANGING AND CONDUCTING MEETINGS AND SEMINARS REGARDING THE SERVICING, MAINTENANCE, REPAIR AND CONVERSION OF POWER STATIONS, OF COMPONENTS FOR POWER PLANTS AND INSTALLATIONS FOR SUPPLYING ENERGY; AND ENGINEERING (U.S. CLS. 100, 101 AND 107).

CLASS 42—SCIENTIFIC AND COMPUTER SERVICES

FOR SCIENTIFIC AND TECHNOLOGICAL SERVICES, NAMELY, CONSULTING IN THE FIELD OF SERVICING, MAINTENANCE, REPAIR AND CONVERSION OF POWER STATIONS, OF COMPONENTS FOR POWER PLANTS AND INSTALLATIONS FOR SUPPLYING ENERGY; SCIENTIFIC AND TECHNOLOGICAL SERVICES, NAMELY, SERVICING, MAINTENANCE, REPAIR AND CONVERSION OF POWER STATIONS, OF COMPONENTS FOR POWER PLANTS AND INSTALLATIONS FOR SUPPLYING ENERGY (U.S. CLS. 100 AND 101).
JULIE VEPPUMTHARA, EXAMINING ATTORNEY

CLASS 41—EDUCATION AND ENTERTAINMENT

FOR PROVIDING TRAINING IN THE FORM OF CLASSES, COURSES, SEMINARS, WORKSHOPS REGARDING THE SERVICING, MAINTENANCE, REPAIR AND CONVERSION OF POWER STATIONS, OF COMPONENTS FOR POWER STATIONS AND INSTALLATIONS FOR SUPPLYING ENERGY; EDUCATIONAL SERVICES, NAMELY, PROVIDING FURTHER TRAINING IN THE FORM OF CLASSES, COURSES, SEMINARS, WORKSHOPS REGARDING THE SERVICING, MAINTENANCE, REPAIR AND CONVERSION OF POWER STATIONS, OF COMPONENTS FOR POWER PLANTS AND INSTALLATIONS FOR SUPPLYING ENERGY; ARRANGING AND CONDUCTING MEETINGS AND SEMINARS REGARDING THE SERVICING, MAINTENANCE, REPAIR AND CONVERSION OF POWER STATIONS, OF COMPONENTS FOR POWER PLANTS AND INSTALLATIONS FOR SUPPLYING ENERGY; AND ENGINEERING (U.S. CLS. 100, 101 AND 107).

CLASS 42—SCIENTIFIC AND COMPUTER SERVICES

FOR SCIENTIFIC AND TECHNOLOGICAL SERVICES, NAMELY, CONSULTING IN THE FIELD OF SERVICING, MAINTENANCE, REPAIR AND CONVERSION OF POWER STATIONS, OF COMPONENTS FOR POWER PLANTS AND INSTALLATIONS FOR SUPPLYING ENERGY; SCIENTIFIC AND TECHNOLOGICAL SERVICES, NAMELY, SERVICING, MAINTENANCE, REPAIR AND CONVERSION OF POWER STATIONS, OF COMPONENTS FOR POWER PLANTS AND INSTALLATIONS FOR SUPPLYING ENERGY (U.S. CLS. 100 AND 101).
JULIE VEPPUMTHARA, EXAMINING ATTORNEY

SN 79-060,771. ALSTOM TECHNOLOGY LTD., SWITZERLAND, FILED 9-15-2008.



PRIORITY DATE OF 4-18-2008 IS CLAIMED.
OWNER OF INTERNATIONAL REGISTRATION 0981763 DATED 9-15-2008, EXPIRES 9-15-2018.
THE MARK CONSISTS OF THE STYLIZED WORDING SPPPO WITHIN AN INCOMPLETE STRIPED CIRCLE DESIGN WITH THE TOP RIGHT OF THE INCOMPLETE CIRCLE CONTINUING IN AN ARROW.

CLASS 37—CONSTRUCTION AND REPAIR

FOR SERVICING, MAINTENANCE, REPAIR AND CONVERSION OF POWER STATIONS, COMPONENTS OF POWER STATIONS AND INSTALLATIONS, NAMELY, POWER PLANTS, GAS POWER PLANTS, COAL POWER PLANTS, INDUSTRIAL POWER PLANTS, REFINERIES, CHEMICAL PLANTS, TURBINES, GAS TURBINES, STEAM TURBINES, AND POWER GENERATORS FOR SUPPLYING ENERGY (U.S. CLS. 100, 103 AND 106).

SN 79-060,796. DEVELOPMENT BANK OF JAPAN, TOKYO, JAPAN, FILED 5-2-2008.



PRIORITY DATE OF 3-31-2008 IS CLAIMED.
OWNER OF INTERNATIONAL REGISTRATION 0981828 DATED 5-2-2008, EXPIRES 5-2-2018.
OWNER OF U.S. REG. NO. 2,791,701.

THE COLOR(S) BLUE, LIGHT BLUE, GREEN, LIGHT GREEN, ORANGE, AND YELLOW IS/ARE CLAIMED AS A FEATURE OF THE MARK.

THE MARK CONSISTS OF A CIRCLE DESIGN TO THE LEFT OF THE LETTERS "DBJ". THE CIRCLE IS DIVIDED INTO FOUR AREAS: THE TWO UPPER PORTIONS ARE DIVIDED FROM THE LOWER PORTIONS BY A HORIZONTAL DIAMETER, AND THE LEFT PORTIONS ARE DIVIDED FROM THE RIGHT PORTIONS BY A VERTICAL LINE THAT FORMS A RIGHT ANGLE WITH THE HORIZONTAL DIAMETER AT A POINT ONE-HALF THE RADIUS TO THE LEFT OF THE CENTER OF THE CIRCLE. THE COLORS ORANGE AND YELLOW APPEAR IN THE TOP LEFT PORTION OF THE CIRCLE DESIGN. THE COLOR LIGHT BLUE APPEARS IN THE TOP RIGHT PORTION OF THE CIRCLE DESIGN. THE COLORS GREEN AND LIGHT GREEN APPEAR IN THE BOTTOM LEFT PORTION OF THE CIRCLE DESIGN. THE COLOR BLUE APPEARS IN THE BOTTOM RIGHT PORTION OF THE CIRCLE DESIGN. THE COLOR BLUE APPEARS IN THE LETTERS "DBJ".

CLASS 35—ADVERTISING AND BUSINESS

FOR BUSINESS MANAGEMENT CONSULTANCY AND ADVISORY SERVICES; MARKETING SERVICES, NAMELY, INDUSTRIAL MARKETING RESEARCH; ECONOMIC RESEARCH AND ANALYSIS; BUSINESS MANAGEMENT CONSULTANCY AND ADVISORY SERVICES ON MERGER AND ACQUISITION ACTIVITY; PROVIDING BUSINESS INFORMATION RELATING TO COMMODITY SALES, NAMELY, PROVIDING LEADS AND REFERRALS AND OPPORTUNITIES FOR BUSINESS COLLABORATION IN THE FIELD OF COMMODITY SALES; BUSINESS MANAGEMENT OF HOTELS FOR OTHERS; DRAWING UP OF STATEMENTS OF ACCOUNTS; EMPLOYMENT AGENCIES; AUCTIONEERING; INTERNET ADVERTISING SERVICES; ADVERTISING BY OTHER MEDIA, NAMELY, ADVERTISING THROUGH ALL PUBLIC COMMUNICATION MEANS; GOODS IMPORT-EXPORT AGENCIES; PROVIDING INFORMATION RELATING TO EMPLOYMENT RECRUITMENT, NAMELY, EMPLOYMENT RECRUITING CONSULTANCY (U.S. CLS. 100, 101 AND 102).

CLASS 36—INSURANCE AND FINANCIAL

FOR FINANCING SERVICES AND PROVIDING FINANCIAL LIABILITY GUARANTEES; ELECTRONIC FUNDS TRANSFER; COLLECTION AGENCIES, NAMELY, AGENCIES FOR COLLECTING PAYMENTS FOR GOODS AND SERVICES; ISSUANCE OF CREDIT CARDS; DEBIT CARD SERVICES, NAMELY, ISSUANCE OF DEBIT CARDS; ADMINISTRATION OF MUTUAL FUNDS; MUTUAL FUNDS BROKERAGE AND DISTRIBUTION; FINANCIAL ASSET MANAGEMENT, NAMELY, MANAGEMENT OF ASSETS HELD IN TRUST; SECURITIES BROKERAGE, NAMELY, PAYMENT OF DIVIDENDS AND REDEMPTION PROCEEDS OF SECURITIES INVESTMENT TRUSTS; INVESTMENT ADVISORY AND CONSULTANCY SERVICES, NAMELY, CONSULTATION REGARDING INVESTMENT ADVISORY CONTRACTS; INVESTMENT SERVICES FOR OTHERS, NAMELY, FUNDS INVESTMENT, MUTUAL FUND INVESTMENT, REAL ESTATE INVESTMENT, PRIVATE EQUITY FUND INVESTMENT, DERIVATIVE SECURITIES INVESTMENT, AND SECURITIES INVESTMENT SERVICES UNDER INVESTMENT DISCRETION CONTRACTS; PROVISION OF FINANCIAL INFORMATION; SECURITIES BROKERAGE OR AGENCIES SERVICES, NAMELY, ACQUISITION, DISPOSITION AND TRANSFER OF SECURITIES FOR OTHERS AND FUND SETTLEMENT SERVICES IN SECURITIES TRANSACTIONS; FIDUCIARY REPRESENTATIVE SERVICES, NAMELY, REGISTERING NAME CHANGES ON SECURITIES; FINANCIAL SERVICES IN THE NATURE OF LOAN SERVICING, NAMELY, COLLECTION OF PRINCIPAL AND INTEREST FOR DEPOSIT ASSETS; FIDUCIARY REPRESENTATIVE SERVICES, NAMELY, VOTING OF DEPOSIT SECURITIES BY PROXY; FIDUCIARY REPRESENTATIVE SERVICES, NAMELY, EXERCISING SHARE WARRANTS AND WARRANT-LINKED BONDS BY PROXY; DEBT COLLECTION AGENCIES; SAFE DEPOSIT BOX SERVICES; ACCEPTANCE OF DEPOSITS, NAMELY, SUBSTITUTE BOND ISSUANCE AND ACCEPTANCE OF FIXED INTERVAL INSTALLMENT DEPOSITS; LOANS AND DISCOUNT OF BILLS; DOMESTIC EXCHANGE SETTLEMENT FOR OTHERS; FINANCIAL GUARANTEES, NAMELY, LIABILITY GUARANTEES; BANKING SERVICES; BANKING SERVICES, NAMELY, ACCEPTANCE OF BILLS; SECURITIES LENDING, NAMELY, LENDING OF BONDS AND STOCKS; MONETARY AFFAIRS, NAMELY, ACQUISITION AND TRANSFER OF MONETARY CLAIMS; SAFE DEPOSIT BOX SERVICES, NAMELY, SAFEKEEPING OF VALUABLES INCLUDING SECURITIES AND PRECIOUS METALS; MONEY EXCHANGE SERVICES; TRUSTEESHIP OF FINANCIAL FUTURES CONTRACTS; TRUSTEESHIP OF MONEY, SECURITIES, MONETARY CLAIMS, PERSONAL PROPERTY, LAND, RIGHTS ON LAND FIXTURES, SURFACE RIGHTS OR LAND LEASING RIGHTS; BROKERAGE IN THE FIELD OF SUBSCRIPTION BONDS; FOREIGN EXCHANGE TRANSACTIONS; PROVIDING LETTER-OF-CREDIT SERVICES FOR OTHERS; BROKERAGE IN THE FIELD OF LOANS AND FINANCING; AGENCIES OR BROKERAGE FOR TRADING OF SECURITIES, SECURITIES INDEX FUTURES, SECURITIES OPTIONS, AND OVERSEAS MARKET SECURITIES FUTURES;

AGENCIES OR BROKERAGE FOR ENTRUSTING AGENTS WITH ON-COMMISSION TRADING IN DOMESTIC MARKETS OF SECURITIES, SECURITIES INDEX FUTURES AND SECURITIES OPTIONS; AGENCIES OR BROKERAGE FOR ENTRUSTING AGENTS WITH ON-COMMISSION TRADING IN OVERSEAS MARKETS OF SECURITIES, AND SECURITIES INDEX FUTURES; SECURITIES UNDERWRITING; SECURITIES TRADING SERVICES FOR OTHERS; FINANCIAL TRANSACTION SERVICES, NAMELY, ASSISTING OTHERS WITH THE COMPLETION OF FINANCIAL TRANSACTIONS FOR SECURITIES SUBSCRIPTION OR TRADING; PROVIDING STOCK MARKET INFORMATION; AGENCIES FOR COMMODITY FUTURES TRADING; LIFE INSURANCE BROKERAGE; LIFE INSURANCE UNDERWRITING; AGENCIES FOR NON-LIFE INSURANCE; CLAIM ADJUSTMENT FOR NON-LIFE INSURANCE; NON-LIFE INSURANCE UNDERWRITING; INSURANCE PREMIUM RATE COMPUTING; REAL ESTATE MANAGEMENT; AGENCIES OR BROKERAGE FOR LEASING OR RENTING OF BUILDINGS; LEASING OR RENTING OF BUILDINGS; REAL ESTATE BROKERAGE, NAMELY, PURCHASE AND SALE OF BUILDINGS; AGENCIES OR BROKERAGE FOR PURCHASE AND SALE OF BUILDINGS FOR OTHERS; REAL ESTATE APPRAISAL; REAL ESTATE MANAGEMENT SERVICES RELATING TO LAND; AGENCIES OR BROKERAGE FOR LEASING OR RENTING OF LAND; LEASING OF LAND; PURCHASE AND SALE OF LAND; AGENCIES OR BROKERAGE FOR PURCHASE OR SALES OF LAND; COMPANY CREDIT INVESTIGATION; CREDIT RATING SERVICES, NAMELY, REPORTING AND PROVIDING INFORMATION ON CORPORATE CREDIT RATINGS; RENTAL OF PAPER MONEY AND COIN COUNTING OR PROCESSING MACHINES; RENTAL OF CASH DISPENSERS OR AUTOMATED-TELLER MACHINES; PROVIDING INFORMATION IN THE FIELD OF REAL ESTATE, NAMELY, PROVIDING REAL ESTATE INFORMATION IN RELATION TO BUILDINGS OR LAND; ANTIQUE APPRAISAL; ART APPRAISAL; PRECIOUS STONE APPRAISAL; USED AUTOMOBILES APPRAISAL; CHARITABLE FUND RAISING (U.S. CLS. 100, 101 AND 102).

CLASS 41—EDUCATION AND ENTERTAINMENT

FOR ORGANIZATION, MANAGEMENT OR ARRANGEMENT OF SEMINARS; EDUCATIONAL AND INSTRUCTION SERVICES, NAMELY, INSTRUCTION IN THE FIELD OF ARTS AND CRAFTS; INSTRUCTION IN THE SPORTS OF BASEBALL, BASKETBALL, SOCCER, VOLLEYBALL, SWIMMING, MARATHON, 100-METER SPRINTS, SUMO, AND RUGBY; EDUCATIONAL SERVICES, NAMELY, PROVIDING CLASSES, SEMINARS, WORKSHOPS, OR CONFERENCES IN THE FIELD OF ECONOMICS AND FINANCE; PRODUCTION OF BOOKS AND JOURNALS, NAMELY, PUBLICATION OF BOOKS AND JOURNALS; PRODUCTION OF RADIO OR TELEVISION PROGRAMS; PRODUCTION OF VIDEO TAPE FILM IN THE FIELDS OF EDUCATION, CULTURE, ENTERTAINMENT OR SPORTS; PROVIDING SPORTS FACILITIES; LANGUAGE INTERPRETATION; TRANSLATION (U.S. CLS. 100, 101 AND 107).

PAUL MORENO, EXAMINING ATTORNEY

SN 79-060,933. VIVANCO GRUPPE AG, AHRENSBURG, FED REP GERMANY, FILED 7-30-2008.



THE MARK CONSISTS OF STANDARD CHARACTERS WITHOUT CLAIM TO ANY PARTICULAR FONT, STYLE, SIZE, OR COLOR.

OWNER OF INTERNATIONAL REGISTRATION 0982169 DATED 7-30-2008, EXPIRES 7-30-2018.

CLASS 2—PAINTS

FOR FILLED INK CARTRIDGES FOR PRINTERS; FILLED PRINT HEAD INK CARTRIDGES; FILLED TONER CARTRIDGES (U.S. CLS. 6, 11 AND 16).

CLASS 9—ELECTRICAL AND SCIENTIFIC APPARATUS

FOR OPTICAL, ELECTROTECHNICAL AND ELECTRONIC APPARATUS AND INSTRUMENTS, NAMELY, OPTICAL TRANSMITTERS, OPTICAL RECEIVERS, DIGITAL TRANSMITTERS, AND OPTICAL CHARACTER READERS; APPARATUS FOR THE RECORDING, TRANSMISSION, STORAGE, PROCESSING AND OUTPUT OF DATA, IMAGES AND SOUND; TELECOMMUNICATIONS EQUIPMENT AND APPARATUS, DATA-PROCESSING EQUIPMENT AND COMPUTERS AND PERIPHERAL DEVICES THEREFOR, NAMELY, DATA-GUIDING APPARATUS, COMPUTER INTERFACE APPARATUS IN THE NATURE OF BOARDS, CONNECTING APPARATUS IN THE NATURE OF PARALLEL AND SERIAL PORTS, ADAPTERS, INPUT, OUTPUT AND READING APPARATUS FOR DATA-PROCESSING EQUIPMENT, KEYBOARDS, SCREENS, PRINTERS, DRIVES, MEMORY DEVICES, JOYSTICKS, COMPUTER MICE, CONTROLLERS, PHOTO MEMORY CARDS, ELECTRONIC INPUT PENS, GRAPHICS CARDS AND NETWORK CARDS, MODEMS, INTERFACES, AND PARTS FOR ALL THE AFORESAID GOODS; DRIVER SOFTWARE AND COMPILER, ANTI-VIRUS, ANTI-SPYWARE SOFTWARE; MACHINE-READABLE DATA CARRIERS, NAMELY, BLANK MAGNETIC AND ELECTRONIC STORAGE MEDIA, BLANK FLOPPY DISCS, BLANK CASSETTES AND TAPES, BLANK SOUND AND IMAGE DISCS, BLANK DVDS, BLANK CDS, MEMORY CARDS; CABLES, FIBRES, AND ACCESSORIES FOR THE TRANSMISSION OF SOUNDS AND IMAGES, NAMELY, ELECTRIC CABLES, ADAPTERS, WIRING, CONNECTION BLOCKS, PLUGS AND BUSHINGS, ELECTRIC CABLES WITH CONNECTORS, CABLE CLIPS AND FIXINGS FOR ELECTRIC CABLES; ACCESSORIES FOR THE AFORESAID APPARATUS AND EQUIPMENT IN THE FORM OF CONTRAST FILTERS FOR SCREENS, COMPUTER STANDS, MOUSE HOLDERS, MOUSE PADS, HAND REST PADS; CABLE CLIPS AND CABLE TUBES FOR ELECTRIC WIRES; PRINTER AND FAX STANDS, MONITOR ARMS, PRINT HEADS; UNFILLED INK CARTRIDGES, UNFILLED PRINT HEAD INK CARTRIDGES, UNFILLED TONER CARTRIDGES; LASER PRINTERS, LASER FAX APPARATUS AND LASER PRINTING APPARATUS; ALARM AND MONITORING APPARATUS, ELECTRIC AND ELECTRONIC MEASURING APPARATUS, NAMELY, VOLTAGE MEASURING APPARATUS; ANTENNAE, COMBINERS, AERIAL AMPLIFIERS, SPREADERS, SOCKETS FOR AERIALS, ELECTRICAL CURRENT REGULATING AND MEASURING APPARATUS; INFRARED-CONTROLLED DETECTOR APPARATUS AND CONTROL APPARATUS THEREFOR AND ELECTRONIC APPARATUS USING SOLAR ENERGY SOURCES; COMPASSES; ELECTRIC CONTROL CONSOLES, DISTRIBUTION CONSOLES AND MIXING DESKS, AUDIO AND VIDEO DISTRIBUTION CONSOLES AND MIXING DESKS; VIDEO CAMERAS AND TELEVISION CAMERAS, VIDEO MONITORS, ELECTRIC REMOTE CONTROLS FOR DISTRIBUTION CONSOLES AND MIXING DESKS, AND FOR VIDEO CAMERAS, DIGITAL CAMERAS AND PARTS FOR THE AFORESAID GOODS; MICROPHONES, EARPHONES AND HEADPHONES, ELECTRIC VOLUME CONTROLS, OPTICAL CABLES; REMOTE CONTROL DEVICES; BATTERIES, ACCUMULATORS, ACCUMULATOR CHARGERS; INTERCOMMUNICATION SYSTEMS IN THE NATURE OF INTERCOMS; MONITORING DEVICES IN THE NATURE OF ELECTRIC AND ELECTRONIC VIDEO AND AUDIO SURVEILLANCE INSTALLATIONS; STATIONARY TELEPHONES AND MOBILE TELEPHONES, RADIO-TELEPHONY SETS AND ACCESSORIES THEREFOR IN THE NATURE OF ANTENNAE, DEVICES FOR HANDS-FREE USE OF MOBILE PHONES AND STATIONARY TELEPHONE HAND SETS AND CHARGERS THEREFOR, CASES; SPECIAL CONTAINERS, BAGS AND COVERS ADAPTED FOR THE AFORESAID APPARATUS AND GOODS, NAMELY, EQUIPMENT BAGS FOR OPTICAL AND ELECTRONIC APPARATUS, COVERS, MOUSE HOLDERS, CONTAINERS FOR DATA

CARRIERS, ELECTRONIC MEDIA BOXES, DISPATCH CASES, PROTECTIVE BAGS, LAPTOP BAGS, CAMERA BAGS, STORAGE CONTAINERS FOR FLOPPY DISCS AND OPTICAL, MAGNETIC, OPTOMAGNETIC, ELECTRONIC AND STORAGE MEDIA; ALL THE AFORESAID GOODS OTHER THAN LOUDSPEAKERS AND AUDIO EQUIPMENT (U.S. CLS. 21, 23, 26, 36 AND 38).

CLASS 16—PAPER GOODS AND PRINTED MATTER

FOR INKING RIBBONS; PAPER HOLDERS; DOCUMENT HOLDERS (U.S. CLS. 2, 5, 22, 23, 29, 37, 38 AND 50).

DOMINICK J. SALEMI, EXAMINING ATTORNEY

SN 79-060,950. CHANDRA ENTERPRISES LTD., LONDON, UNITED KINGDOM, FILED 8-6-2008.



PRIORITY DATE OF 7-15-2008 IS CLAIMED.
OWNER OF INTERNATIONAL REGISTRATION 0982231 DATED 8-6-2008, EXPIRES 8-6-2018.

NO CLAIM IS MADE TO THE EXCLUSIVE RIGHT TO USE "PRINT & MAIL", APART FROM THE MARK AS SHOWN.

THE COLOR(S) YELLOW AND BLUE IS/ARE CLAIMED AS A FEATURE OF THE MARK.

THE MARK CONSISTS OF HALF OPEN CIRCLE, OPEN TO THE LEFT, WHICH BEING IN THE COLORS YELLOW IN THE UPPER HALF OF THE HALF OPEN CIRCLE AND BLUE IN THE LOWER HALF OF THE HALF OPEN CIRCLE AND THE LITERAL ELEMENT "PRINT&MAIL" WITH THE LITERAL ELEMENT "PRINT" BEING IN THE COLOR YELLOW AND THE REMAINING VERBAL ELEMENT "&MAIL" BEING IN THE COLOR BLUE.

CLASS 16—PAPER GOODS AND PRINTED MATTER

FOR ADDRESS LABELS; ADDRESS PLATES FOR ADDRESSING MACHINES; ADDRESSING MACHINES; CABINETS FOR STATIONERY; USER AND INSTRUCTION MANUALS FOR COMPUTERS, COMPUTER HARD- AND SOFTWARE; STENCILS; PRINTED MATTER, NAMELY, BUSINESS LETTERS, MARKETING LETTERS AND SALES LETTERS, FLYERS, MARKETING AND SALES BOOKLETS AND BROCHURES; PRINTERS' TYPE; BUSINESS FORMS; STAPLING PRESSES; ENVELOPING MACHINES FOR OFFICE USE; PUNCHES FOR OFFICE USE; PAPER AND CARDBOARD; PAPER LABELS; PAPER STAPLERS; MACHINES FOR SEALING ENVELOPES; PAPER CUTTERS; STATIONERY, WRITING PAPER AND ENVELOPES; ROTARY DUPLICATORS (U.S. CLS. 2, 5, 22, 23, 29, 37, 38 AND 50).

CLASS 35—ADVERTISING AND BUSINESS

FOR PAYROLL PREPARATION; UPDATING OF ADVERTISING MATERIAL; COST PRICE ANALYSIS; DISSEMINATION OF ADVERTISING MATTER; PREPARING AUDIOVISUAL PRESENTATIONS FOR USE IN ADVERTISING; BUSINESS INQUIRIES; ADMINISTRATIVE PROCESSING OF ORDERS; PROFESSIONAL BUSINESS CONSULTANCY; BUSINESS ORGANIZATION CONSULTANCY; ADVICE ON THE CONCLUSION OF COMMERCIAL TRANSACTIONS; BUSINESS ORGANIZATION AND MANAGEMENT CONSULTANCY; BUSINESS MARKETING CONSULTANCY; BUSINESS MANAGEMENT CONSULTANCY; OFFICE MACHINES AND EQUIPMENT RENTAL; SECRETARIAL AND CLERICAL SERVICES; COMPUTER-AIDED DATABASE MANAGEMENT; COMPUTERIZED FILE MANAGEMENT; SYSTEMATIC ORDERING OF DATA IN COMPUTER DATABASES; DATABASE ADMINISTRATION; DATA PROCESSING; DIRECT ADVERTISING; DOCUMENT REPRODUCTION; PROVISION OF BUSINESS EXPERTISE; STATISTICS; PREPARING MAILING LISTS; PREPARING ADVERTISEMENTS FOR OTHERS; INVOICING; MARKETING STUDIES; PHOTOCOPYING; BUSINESS CONSULTANCY; BUSINESS PLANNING; COMMERCIAL MANAGEMENT OF LICENSING OF GOODS AND SERVICES, FOR OTHERS; COPYING OF DOCUMENTS; LAYOUT DESIGN FOR ADVERTISING PURPOSES; MARKETING AND ADVERTISING; MARKET ANALYSIS; PUBLIC RELATIONS; ONLINE ADVERTISING ON A COMPUTER NETWORK; OUTSOURCING SERVICES; REPRODUCTION OF DOCUMENTS; WORD PROCESSING; SECRETARIAL SERVICES; MONITORING OF BUSINESS; UPDATING AND DISSEMINATION OF ADVERTISING MATERIAL AND DIRECT MAIL ADVERTISING; COMPILATION AND PROVISION OF INFORMATION ON FREIGHT FORWARDING, COURIER AND POSTAL SERVICES (U.S. CLS. 100, 101 AND 102).

CLASS 38—COMMUNICATION

FOR ESTABLISHING AND PROVIDING OF COMMUNICATIONS PROTOCOLS TO FACILITATE DATA EXCHANGE OR DATA TRANSMISSION BETWEEN TWO OR MORE COMMUNICATIONS PARTNERS; TELECOMMUNICATIONS CONSULTANCY; CONSULTANCY AND INFORMATION IN THE FIELD OF TELECOMMUNICATIONS; PROVIDING ACCESS TO A GLOBAL COMPUTER NETWORK; PROVIDING MULTIPLE USER ACCESS TO A GLOBAL COMPUTER INFORMATION NETWORK; PROVIDING MULTIPLE USER ACCESS TO ELECTRONIC COMMUNICATIONS NETWORKS, INCLUDING THE INTERNET; PROVIDING ACCESS TO A COMPUTER SERVER VIA TELEPHONE LINES, CABLES, NETWORK CONNECTIONS AND THE INTERNET; PROVIDING ACCESS TO AN ELECTRONIC NETWORK FOR ONLINE INFORMATION SEARCHES; PROVIDING AN ELECTRONIC MAILBOX; PROVIDING A TELECOMMUNICATIONS CENTRE FOR OTHERS; PROVIDING E-MAIL SERVICES; PROVIDING TELECOMMUNICATIONS CONNECTIONS TO A GLOBAL COMPUTER NETWORK OR DATABASES; INTERNET PROVIDER SERVICES; E-MAIL, FACSIMILE, TELEX AND TELEPHONE SERVICES; E-MAIL FORWARDING SERVICES; E-MAIL AND MAILBOX SERVICES; ELECTRONIC DATA TRANSMISSION VIA COMPUTER AND COMMUNICATIONS NETWORKS AND VIA THE INTERNET; ELECTRONIC ORDER ROUTING; ELECTRONIC MAILBOXES; ELECTRONIC TRANSMISSION OF MESSAGES, DATA AND DOCUMENTS; ELECTRONIC TRANSMISSION OF INSTRUCTIONS; ELECTRONIC TRANSMISSION OF FAXES AND DATA WITH DATA ENCRYPTION AND DECRYPTION; ELECTRONIC TRANSMISSION OF CARDS, LETTERS, POST AND MESSAGES; ELECTRONIC MAIL SERVICES AND ELECTRONIC TEXT TRANSMISSION; FACSIMILE SERVICES; INFORMATION AND CONSULTANCY WITH REGARD TO TELECOMMUNICATIONS SERVICES; HIRING AND RENTAL OF TELECOMMUNICATIONS APPARATUS, INSTALLATIONS AND INSTRUMENTS; HIRING AND RENTAL OF COMMUNICATIONS APPARATUS; MOBILE PHONE SERVICES; DIRECT ELECTRONIC TRANSMISSION OF MESSAGES; RENTAL OF APPARATUS FOR TELECOMMUNICATIONS AND FOR SENDING AND RETRIEVING DATA AND MESSAGES;

PROVIDING ACCESS TO DATABASES; FORWARDING OF MESSAGES OF ALL KINDS TO INTERNET ADDRESSES (U.S. CLS. 100, 101 AND 104).

CLASS 39—TRANSPORTATION AND STORAGE

FOR COLLECTION, STORAGE AND DELIVERY OF PACKAGES, PARCELS, FREIGHT, GOODS AND LOADS; TRANSPORT BROKERAGE; STORAGE OF GOODS; GATHERING, STORAGE AND DELIVERY OF PACKAGES, PARCELS, LETTERS, FREIGHT AND GOODS; FRANKING OF MAIL; FREIGHT FORWARDING SERVICES; TRANSPORTATION INFORMATION; COURIER SERVICES; STORAGE OF ELECTRONICALLY RECORDED DATA AND DOCUMENTS; STORAGE, DELIVERY AND DISTRIBUTION OF GOODS; RENTAL OF WAREHOUSES; MESSAGE DELIVERY; ORGANIZING AND CONDUCTING THE DELIVERY OF MAIL-ORDER GOODS; DELIVERY OF PACKAGES; TRANSPORT RESERVATION; FREIGHT FORWARDING; HAULAGE SERVICES; TRANSPORT OF PACKAGES, GOODS AND VALUABLES; ARRANGING STORAGE AND PACKAGING OF GOODS; PACKAGING OF GOODS (U.S. CLS. 100 AND 105).

CLASS 42—SCIENTIFIC AND COMPUTER SERVICES

FOR UPDATING OF COMPUTER SOFTWARE AND MEMORY DATABASES OF COMPUTERS AND COMPUTER SYSTEMS; UPDATING AND ADAPTING OF COMPUTER PROGRAMS ACCORDING TO USER REQUIREMENTS; UPDATING AND MAINTENANCE OF COMPUTER SOFTWARE AND COMPUTER PROGRAMS; DATA WAREHOUSING; CONSTRUCTING AN INTERNET PLATFORM FOR ELECTRONIC COMMERCE; CONSULTANCY IN THE FIELD OF COMPUTER HARDWARE AND COMPUTER SOFTWARE AS WELL AS INFORMATION TECHNOLOGY; CONSULTANCY WITH REGARD TO COMPUTER NETWORKS WITH DIFFERENT SOFTWARE ENVIRONMENTS; CONSULTANCY WITH REGARD TO THE CREATION, DEVELOPMENT, MAINTENANCE AND USE OF WEBSITES; PROVIDING ONLINE SUPPORT FOR USERS OF COMPUTER PROGRAMS; PROVIDING SECURITY SERVICES FOR COMPUTER NETWORKS, COMPUTER ACCESS AND COMPUTER-BASED TRANSACTIONS; PROVIDING SEARCH ENGINES FOR THE INTERNET; COMPUTER TIMESHARING SERVICES; RECOVERY OF COMPUTER DATA; INSTALLING, COPYING AND MAINTENANCE OF COMPUTER PROGRAMS; COMPUTER RENTAL; BACKUP OF COMPUTER DATA; COMPUTER PROGRAMMING; DATA ENCRYPTION; DESIGN OF COMPUTER SITES; ENGINEERING; SERVICES OF AN APPLICATION SERVICE PROVIDER, NAMELY, HOSTING OF COMPUTER SOFTWARE APPLICATIONS FOR OTHERS; DATA ENCRYPTION AND DECRYPTION SERVICES; PRODUCT DESIGN SERVICES; DEVELOPMENT AND TESTING OF ELECTRONIC COMMUNICATIONS, WORD PROCESSING AND INFORMATION PROCESSING SYSTEMS; DATABASE DEVELOPMENT SERVICES; DESIGN AND DEVELOPMENT OF COMPUTER HARDWARE AND SOFTWARE; DESIGN OF COMPUTER NETWORKS FOR OTHERS; DESIGN, DEVELOPMENT AND MAINTENANCE OF INTRANETS; DESIGN, DEVELOPMENT AND UPDATING OF A SEARCH ENGINE FOR TELECOMMUNICATIONS NETWORKS; DESIGN AND MAINTENANCE OF WEBSITES FOR OTHERS; ENGINEERING CONSULTANCY IN THE FIELDS OF COMPUTER SOFTWARE, COMPUTER HARDWARE AND TELECOMMUNICATIONS; INSTALLATION AND CUSTOMIZATION OF APPLICATION SOFTWARE FOR COMPUTERS; INSTALLATION AND MAINTENANCE OF COMPUTER SOFTWARE, INTEGRATION OF COMPUTER SOFTWARE, COMPUTER SYSTEMS AND COMPUTER NETWORKS; CONFIGURATION OF COMPUTER SYSTEMS AND NETWORKS; CONSTRUCTION DRAFTING; CONVERSION OF DATA OR DOCUMENTS FROM PHYSICAL TO ELECTRONIC MEDIA; COPYING OF COMPUTER PROGRAMS; MANAGEMENT OF COMPUTER PROJECTS; COMPUTER DISASTER RECOVERY PLANNING; QUALITY CONTROL FOR OTHERS; QUALITY TESTING; SOFTWARE DESIGN; SOFTWARE ENGINEERING; SOFTWARE DEVELOPMENT SERVICES; ASSUMING OF HOST FUNCTIONS FOR WEBSITES; RENTAL OF COM-

PUTER SOFTWARE, DATA PROCESSING EQUIPMENT AND COMPUTER PERIPHERAL DEVICES (U.S. CLS. 100 AND 101).

CLASS 45—PERSONAL AND LEGAL SERVICES

FOR LICENSING OF COMPUTER SOFTWARE LEGAL SERVICES; LICENSING OF INTELLECTUAL PROPERTY; COPYRIGHT MANAGEMENT (U.S. CLS. 100 AND 101).

DOMINICK J. SALEMI, EXAMINING ATTORNEY

SN 79-061,120. URENCO LIMITED, UNITED KINGDOM, FILED 9-25-2008.

ENRICHING THE FUTURE

THE MARK CONSISTS OF STANDARD CHARACTERS WITHOUT CLAIM TO ANY PARTICULAR FONT, STYLE, SIZE, OR COLOR.

PRIORITY DATE OF 4-11-2008 IS CLAIMED.

OWNER OF INTERNATIONAL REGISTRATION 0982700 DATED 9-25-2008, EXPIRES 9-25-2018.

CLASS 1—CHEMICALS

FOR ISOTOPES FOR INDUSTRIAL USE; NON-RADIOACTIVE ISOTOPES FOR INDUSTRIAL USE; URANIUM; NATURAL AND PROCESSED URANIUM; ENRICHED URANIUM; HYDROFLUORIC ACID AND URANIUM OXIDE (U.S. CLS. 1, 5, 6, 10, 26 AND 46).

CLASS 40—MATERIAL TREATMENT

FOR TREATMENT OF MATERIALS BY URANIUM ENRICHMENT; TREATMENT OF MATERIALS, NAMELY, ENRICHMENT OF URANIUM; TREATMENT OF MATERIALS, NAMELY, SERVICES FOR THE ENRICHMENT OF URANIUM AND URANIUM ISOTOPE 235; TRANSFORMATION AND CONVERSION OF URANIUM HEXAFLUORIDE TO URANIUM OXIDE THROUGH TREATMENT OF THE URANIUM; CHEMICAL DECONTAMINATION OF URANIUM ENRICHMENT PLANTS AND NUCLEAR PLANT; DECONTAMINATION OF NUCLEAR WASTE; GENERATING ELECTRICITY; REPROCESSING OF NUCLEAR FUELS; PROVIDING INFORMATION IN THE FIELD OF THE AFORESAID SERVICES AND CONSULTATION SERVICES IN THE FIELD OF THE AFORESAID (U.S. CLS. 100, 103 AND 106).

JASON TURNER, EXAMINING ATTORNEY

SN 79-061,195. KBA-GIORI SA, SWITZERLAND, FILED 10-22-2008.



PRIORITY DATE OF 4-24-2008 IS CLAIMED. OWNER OF INTERNATIONAL REGISTRATION 0982872 DATED 10-22-2008, EXPIRES 10-22-2018.

THE MARK CONSISTS OF THE WORDING "2D IRIS" OVER A RECTANGLE DESIGN.

CLASS 7—MACHINERY

FOR MECHANICALLY-OPERATED MACHINES FOR MAKING AND PACKING BANK-NOTES; MECHANICALLY-OPERATED MACHINES USED FOR PRINTING BANK-NOTES; MACHINES FOR APPLYING SECURITY FEATURES TO PAPER SECURITIES, IN PARTICULAR TO BANK-NOTES AND SECURITY PAPER; MECHANICALLY-OPERATED MACHINES FOR MANUFACTURING SECURITY DOCUMENTS AND PAPER SECURITIES WITH BIOMETRIC DATA (U.S. CLS. 13, 19, 21, 23, 31, 34 AND 35).

CLASS 9—ELECTRICAL AND SCIENTIFIC APPARATUS

FOR ELECTRONIC APPARATUS AND MACHINES FOR CONTROLLING THE PRINT QUALITY OF PRINTED DOCUMENTS, ESPECIALLY OF BANK-NOTES AND SECURITY PAPER; ELECTRONIC APPARATUS AND MACHINES FOR SORTING BANK-NOTES; ELECTRONIC MACHINES FOR MEASURING AND CHECKING BIOMETRIC DATA (U.S. CLS. 21, 23, 26, 36 AND 38).

JAMES STEIN, EXAMINING ATTORNEY

SN 79-061,239. CHRYSAL INTERNATIONAL B.V., NETHERLANDS, FILED 10-15-2008.

BOOSTIE

THE MARK CONSISTS OF STANDARD CHARACTERS WITHOUT CLAIM TO ANY PARTICULAR FONT, STYLE, SIZE, OR COLOR.

PRIORITY DATE OF 4-25-2008 IS CLAIMED.

OWNER OF INTERNATIONAL REGISTRATION 0982964 DATED 10-15-2008, EXPIRES 10-15-2018.

CLASS 1—CHEMICALS

FOR CHEMICALS USED IN AGRICULTURE, HORTICULTURE, FORESTRY AND FLORICULTURE, EXCEPT OF FUNGICIDES, HERBICIDES AND INSECTICIDES; NATURAL AND ARTIFICIAL FERTILIZERS; POTTING SOIL; COMPOST; PRESERVATIVES FOR FLOWERS; NUTRIENTS FOR NATURAL PLANTS, FLOWERS AND CUT FLOWERS (U.S. CLS. 1, 5, 6, 10, 26 AND 46).

CLASS 3—COSMETICS AND CLEANING PREPARATIONS

FOR PREPARATIONS TO MAKE THE LEAVES OF PLANTS SHINY (U.S. CLS. 1, 4, 6, 50, 51 AND 52).

CLASS 5—PHARMACEUTICALS

FOR DISINFECTANTS; INSECTICIDES, FUNGICIDES, HERBICIDES (U.S. CLS. 6, 18, 44, 46, 51 AND 52).

SCOTT BIBB, EXAMINING ATTORNEY

SN 79-061,412. BP BATTIONI E PAGANI S.P.A., ITALY, FILED 9-1-2008.



PRIORITY DATE OF 7-29-2008 IS CLAIMED.
OWNER OF INTERNATIONAL REGISTRATION 0983310 DATED 9-1-2008, EXPIRES 9-1-2018.
THE TRADEMARK COMPRISES THE SIGN "BP" REPRODUCED IN STYLIZED CHARACTERS AND INSERTED IN AN OVAL FRAME.

CLASS 12—VEHICLES

FOR FORK LIFT TRUCKS (U.S. CLS. 19, 21, 23, 31, 35 AND 44).

CLASS 37—CONSTRUCTION AND REPAIR

FOR MAINTENANCE, INSTALLATION AND REPAIR SERVICES FOR FORK LIFT TRUCKS AND LIFTING DEVICES (U.S. CLS. 100, 103 AND 106).
RON FAIRBANKS, EXAMINING ATTORNEY

SN 79-061,503. ORGANIZATION TO PROMOTE JAPANESE; RESTAURANTS ABROAD, JAPAN, FILED 10-2-2008.

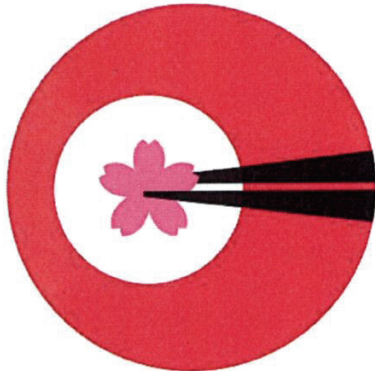

OWNER OF INTERNATIONAL REGISTRATION 0983518 DATED 10-2-2008, EXPIRES 10-2-2018.
THE COLOR(S) RED, WHITE, PINK AND BLACK IS/ARE CLAIMED AS A FEATURE OF THE MARK.
THE MARK CONSISTS OF CHOPSTICKS PICKING UP FROM OR PLACING ON A SMALL PLATE ON TOP OF A LARGER PLATE, A FLOWER.

CLASS 16—PAPER GOODS AND PRINTED MATTER

FOR PRINTED MATTER, NAMELY, GUIDES, BOOKS, CATALOGUES, NEWSLETTERS, BROCHURES AND MAGAZINES IN THE FIELD OF JAPANESE RESTAURANTS, JAPANESE COOKING AND JAPANESE FOOD CULTURE; JOURNALS CONCERNING JAPANESE RESTAURANTS AND JAPANESE COOKING; PRINTED EDUCATIONAL MATERIALS IN THE FIELD OF JAPANESE RESTAURANTS AND JAPANESE COOKING; CATALOGUES IN THE FIELD OF JAPANESE FOOD AND/OR CUISINE, FOOD INGREDIENTS, COOKWARE, COOKING LESSONS AND SEMINARS; MAGAZINES IN THE FIELD OF JAPANESE RESTAURANTS, JAPANESE COOKING AND JAPANESE FOOD CULTURE; BOOKS IN THE FIELD OF JAPANESE COOKING, JAPANESE RESTAURANTS AND JAPANESE FOOD CULTURE; NEWSLETTERS IN THE FIELD OF JAPANESE COOKING, JAPANESE RESTAURANTS AND JAPANESE FOOD CULTURE; BROCHURES ABOUT JAPANESE FOOD AND/OR CUISINE, FOOD INGREDIENTS, COOKWARE, COOKING LESSONS AND SEMINARS (U.S. CLS. 2, 5, 22, 23, 29, 37, 38 AND 50).

CLASS 41—EDUCATION AND ENTERTAINMENT

FOR EDUCATIONAL SERVICES, NAMELY, CLASSES, LECTURES AND SEMINARS IN THE FIELD OF JAPANESE FOOD AND/OR CUISINE, COOKING UTILIZING TRADITIONAL JAPANESE FOODSTUFF AND JAPANESE RESTAURANTS; EDUCATIONAL SERVICES, NAMELY, CLASSES, LECTURES AND SEMINARS IN THE FIELD OF JAPANESE COOKING; EDUCATIONAL SERVICES, NAMELY, OFFERING CLASSES, LECTURES AND SEMINARS IN THE FIELD OF COOKING; ARRANGING, CONDUCTING AND ORGANIZING SEMINARS IN THE FIELD OF COOKING TECHNIQUES, HYGIENE CONTROL, STORING FOODSTUFF AND JAPANESE FOOD CULTURE; ARRANGING, CONDUCTING AND ORGANIZING SEMINARS IN THE FIELD OF COOKING TECHNIQUES, HYGIENE CONTROL, INSTALLING KITCHEN DEVICES, STORING FOODSTUFF WHICH ARE USED IN A CENTRAL KITCHEN; ORGANIZING AND ARRANGING WORKSHOPS RELATING TO HUMAN RESOURCES DEVELOPMENT (U.S. CLS. 100, 101 AND 107).
SHARON MEIER, EXAMINING ATTORNEY

SN 79-061,540. HYPER BARRE LTD, UNITED KINGDOM, AND HYPER BARRE LTD, SWITZERLAND, FILED 9-23-2008.

Fenuslim

THE MARK CONSISTS OF STANDARD CHARACTERS WITHOUT CLAIM TO ANY PARTICULAR FONT, STYLE, SIZE, OR COLOR.
PRIORITY DATE OF 8-11-2008 IS CLAIMED.
OWNER OF INTERNATIONAL REGISTRATION 0983619 DATED 9-23-2008, EXPIRES 9-23-2018.

CLASS 3—COSMETICS AND CLEANING PREPARATIONS

FOR BLEACHING PREPARATIONS FOR LAUNDRY USE; CLEANING, POLISHING, SCOURING AND ABRASIVE PREPARATIONS; SOAPS; PERFUMERY, ESSENTIAL OILS, COSMETICS, HAIR LOTIONS; DENTIFRICES (U.S. CLS. 1, 4, 6, 50, 51 AND 52).

CLASS 5—PHARMACEUTICALS

FOR SANITARY PREPARATIONS FOR MEDICAL PURPOSES; FOOD FOR BABIES; MATERIAL FOR STOPPING TEETH, DENTAL WAX; PREPARATIONS FOR DESTROYING VERMIN; FUNGICIDES, HERBICIDES (U.S. CLS. 6, 18, 44, 46, 51 AND 52).

CLASS 32—LIGHT BEVERAGES

FOR BEERS; MINERAL AND AERATED WATERS; FRUIT DRINKS AND FRUIT JUICES; SYRUPS FOR MAKING BEVERAGES (U.S. CLS. 45, 46 AND 48).
DOUGLAS LEE, EXAMINING ATTORNEY

SN 79-061,549. BEAU-RIVAGE NEUCHÂTEL SA, SWITZERLAND, FILED 10-6-2008.



PRIORITY DATE OF 4-21-2008 IS CLAIMED.
OWNER OF INTERNATIONAL REGISTRATION 0983644 DATED 10-6-2008, EXPIRES 10-6-2018.
THE MARK CONSISTS OF THE LETTERS "YGP" IN STYLIZED FONT.

SN 79-061,541. GENE SIGNAL INTERNATIONAL S.A., EPALINGES, SWITZERLAND, FILED 10-22-2008.



THE MARK CONSISTS OF STANDARD CHARACTERS WITHOUT CLAIM TO ANY PARTICULAR FONT, STYLE, SIZE, OR COLOR.

PRIORITY DATE OF 4-23-2008 IS CLAIMED.
OWNER OF INTERNATIONAL REGISTRATION 0983621 DATED 10-22-2008, EXPIRES 10-22-2018.

CLASS 3—COSMETICS AND CLEANING PREPARATIONS

FOR PERFUMES (U.S. CLS. 1, 4, 6, 50, 51 AND 52).

CLASS 9—ELECTRICAL AND SCIENTIFIC APPARATUS

FOR SPECTACLES (U.S. CLS. 21, 23, 26, 36 AND 38).

CLASS 25—CLOTHING

FOR CLOTHING, NAMELY, SHIRTS, T-SHIRTS, SINGLETs, TIES, SCARVES, JACKETS, ESPECIALLY FOR RIDERS (U.S. CLS. 22 AND 39).

CLASS 30—STAPLE FOODS

FOR CHOCOLATE (U.S. CL. 46).
JOHN GARTNER, EXAMINING ATTORNEY

CLASS 1—CHEMICALS

FOR CHEMICAL OR BIOCHEMICAL PRODUCTS AND PREPARATIONS FOR SCIENTIFIC APPLICATIONS, NAMELY, CHEMICALS AND BIOCHEMICAL PRODUCTS FOR USE IN BIOTECHNOLOGICAL PRODUCT DEVELOPMENT, CHEMICAL AND BIOCHEMICAL PREPARATIONS FOR SCIENTIFIC PURPOSES (U.S. CLS. 1, 5, 6, 10, 26 AND 46).

SN 79-061,657. FONDATION IMAGINE, FRANCE, FILED 9-24-2008.

CLASS 5—PHARMACEUTICALS

FOR CHEMICAL, PHARMACEUTICAL AND BIOTECHNOLOGICAL PRODUCTS FOR MEDICAL AND PHARMACEUTICAL PURPOSES, NAMELY, PHARMACEUTICAL PREPARATIONS FOR INHIBITION OF PATHOLOGICAL ANGIOGENESIS, PARTICULARLY CORNEAL NEOVASCULARIZATION; PHARMACEUTICAL PREPARATIONS FOR INHIBITION OF CORNEAL NEOVASCULARIZATION AND PREVENTION OF CORNEAL GRAFT REJECTION; THERAPEUTIC PRODUCTS AND PREPARATIONS DESIGNED FOR PATHOLOGIES LINKED TO ANGIOGENESIS, NAMELY, EYE DROPS AND EYE OINTMENTS DESIGNED FOR PATHOLOGIES LINKED TO ANGIOGENESIS (U.S. CLS. 6, 18, 44, 46, 51 AND 52).



PRIORITY DATE OF 4-3-2008 IS CLAIMED.
OWNER OF INTERNATIONAL REGISTRATION 0983916 DATED 9-24-2008, EXPIRES 9-24-2018.

NO CLAIM IS MADE TO THE EXCLUSIVE RIGHT TO USE "FONDATION" OR "INSTITUT DES MALADIES GÉNÉTIQUES", APART FROM THE MARK AS SHOWN.

THE COLOR(S) PINK AND VIOLET IS/ARE CLAIMED AS A FEATURE OF THE MARK.

THE MARK CONSISTS OF THE STYLIZED WORDING PINK "IMAGINE" CONSISTING OF LETTERS WITH MISSING PARTS, WITH THE PINK WORDING "FONDATION" ABOVE THE RIGHT HAND SIDE OF "IMAGINE", AND THE VIOLET WORDING "INSTITUT DES MALADIES GÉNÉTIQUES" APPEARING UNDERNEATH THE WORDING "IMAGINE".

THE ENGLISH TRANSLATION OF THE WORD "FONDATION" IN THE MARK IS FOUNDATION.

THE ENGLISH TRANSLATION OF THE WORD "INSTITUT DES MALADIES GÉNÉTIQUES" IN THE MARK IS INSTITUTE OF GENETIC MALADIES.

CLASS 42—SCIENTIFIC AND COMPUTER SERVICES

FOR SCIENTIFIC RESEARCH FOR MEDICAL PURPOSES; RESEARCH AND ENGINEERING IN THE MEDICAL, PHARMACEUTICAL, CHEMICAL AND BIOTECHNOLOGY FIELDS; RESEARCH AND DEVELOPMENT FOR OTHERS OF THERAPEUTIC PRODUCTS AND PREPARATIONS DESIGNED FOR PATHOLOGIES LINKED, INTER ALIA, TO ANGIOGENESIS (U.S. CLS. 100 AND 101).

JAMES STEIN, EXAMINING ATTORNEY

CLASS 36—INSURANCE AND FINANCIAL

FOR CHARITABLE FUNDRAISING AND MANAGEMENT OF A CAPITAL INVESTMENT FUND FOR A FOUNDATION IN THE FIELDS OF MEDICAL AND SCIENTIFIC RESEARCH (U.S. CLS. 100, 101 AND 102).

CLASS 41—EDUCATION AND ENTERTAINMENT

FOR ORGANIZATION OF EXHIBITIONS FOR EDUCATIONAL PURPOSES IN THE FIELDS OF MEDICINE AND RESEARCH INTO HUMAN HEALTH; ARRANGING AND CONDUCTING CONVENTIONS, SEMINARS, COLLOQUIUMS AND SYMPOSIUMS, ALL FOR EDUCATIONAL PURPOSES, IN THE FIELDS OF MEDICINE AND RESEARCH INTO HUMAN HEALTH; ORGANIZATION OF CULTURAL EXHIBITIONS IN THE FIELDS OF MEDICINE AND RESEARCH INTO HUMAN HEALTH; PUBLICATION OF TEXTS, PERIODICAL REVIEWS, BOOKS, AND THESES IN THE FIELDS OF MEDICINE AND RESEARCH INTO HUMAN HEALTH (U.S. CLS. 100, 101 AND 107).

CLASS 42—SCIENTIFIC AND COMPUTER SERVICES

FOR SCIENTIFIC, BIOLOGICAL, MEDICAL AND HEALTH-RELATED RESEARCH; MEASUREMENT EVALUATIONS IN THE FIELDS OF TECHNIQUES AND PROCESSES OF BIOLOGICAL TESTING, THERAPEUTIC INVESTIGATIONS, AND MEDICAL DIAGNOSES (U.S. CLS. 100 AND 101).

MEGHAN REINHART, EXAMINING ATTORNEY

SN 79-061.688. OTTO BOCK HEALTHCARE GMBH, FED REP GERMANY, FILED 10-9-2008.



PRIORITY DATE OF 5-13-2008 IS CLAIMED.

OWNER OF INTERNATIONAL REGISTRATION 0984000 DATED 10-9-2008, EXPIRES 10-9-2018.

NO CLAIM IS MADE TO THE EXCLUSIVE RIGHT TO USE "TECHNOLOGY", APART FROM THE MARK AS SHOWN.

THE COLOR(S) BLUE AND GREY IS/ARE CLAIMED AS A FEATURE OF THE MARK.

THE MARK CONSISTS OF THREE CIRCLES, TWO BEING IN BLUE AND ONE IN GREY WITH A GREY CURVED BAND AND THE WORDING "SKINGUARD" IN BLUE AND "TECHNOLOGY" IN BLUE WITH A THIN GREY LINE ABOVE THE WORD "TECHNOLOGY".

CLASS 1—CHEMICALS

FOR CHEMICALS USED IN INDUSTRY; UNPROCESSED ARTIFICIAL RESINS, UNPROCESSED PLASTICS (U.S. CLS. 1, 5, 6, 10, 26 AND 46).

CLASS 10—MEDICAL APPARATUS

FOR ORTHOPEDIC ARTICLES, NAMELY, PROSTHESES, SOCKETS FOR PROSTHESES, COSMETIC CASINGS FOR PROSTHESES, STOCKINGS, LINER FOR ORTHOPAEDIC USE MADE OF SILICON, POLYURETHANE AND COPOLYMER, BANDAGES, ORTHOSES, BELTS FOR PROSTHESES AND ORTHOSES, ORTHOPAEDIC SEATINGS; ARTIFICIAL LIMBS (U.S. CLS. 26, 39 AND 44).

CLASS 17—RUBBER GOODS

FOR RUBBER, GUTTA-PERCHA, GUM, ASBESTOS, MICA AND GOODS MADE FROM THESE MATERIALS INCLUDED IN THIS CLASS, NAMELY, PADDING MATERIALS AND PLASTICS WITH ANTIBACTERIAL CHARACTERISTICS FOR THE MANUFACTURE OF PROSTHETIC SOCKETS, LINER AND FOR THE MANUFACTURE OF ORTHOSES AND THEIR PARTS; PLASTICS IN EXTRUDED FORM FOR USE IN MANUFACTURE (U.S. CLS. 1, 5, 12, 13, 35 AND 50).

JACLYN KIDWELL, EXAMINING ATTORNEY

SN 79-061.692. CP MEDIEN AG, FED REP GERMANY, FILED 10-28-2008.



OWNER OF INTERNATIONAL REGISTRATION 0984009 DATED 10-28-2008, EXPIRES 10-28-2018.

THE MARK CONSISTS OF THE WORDING "CAPELLA" APPEARING BELOW THE DESIGN OF A CHARIOTEER ABOARD A CHARIOT BEING DRAWN BY FOUR HORSES; THE AFOREMENTIONED WORDING AND THE DESIGN ARE SEPARATED BY A SINGLE HORIZONTAL LINE.

CLASS 40—MATERIAL TREATMENT

FOR PROCESSING OF CINEMATOGRAPHIC FILMS (U.S. CLS. 100, 103 AND 106).

CLASS 41—EDUCATION AND ENTERTAINMENT

FOR FILM PRODUCTION, FILM RENTAL, MICROFILMING FOR OTHERS; RENTAL OF MOVIE PROJECTORS AND ACCESSORIES; VIDEOTAPE FILM PRODUCTION; TELEVISION ENTERTAINMENT, NAMELY, ENTERTAINMENT IN THE NATURE OF TELEVISION NEWS SHOWS, TELEVISION PRODUCTION; PRODUCTION OF TELEVISION FEATURES, NAMELY, TELEVISION SHOW PRODUCTION, PRODUCTION OF CABLE TELEVISION PROGRAMS (U.S. CLS. 100, 101 AND 107).

CLASS 45—PERSONAL AND LEGAL SERVICES

FOR LICENSING OF FILMS, TELEVISION PROGRAMS, AND VIDEO RECORDINGS; COPYRIGHT MANAGEMENT; INDUSTRIAL PROPERTY RIGHTS MANAGEMENT, NAMELY, LICENSING OF INDUSTRIAL PROPERTY RIGHTS; LICENSING OF COPYRIGHT AND INTELLECTUAL PROPERTY RIGHTS (U.S. CLS. 100 AND 101).

KEVIN CORWIN, EXAMINING ATTORNEY

SN 79-061,724. ADVANCED MEDICAL TECHNOLOGIES
AG, FED REP GERMANY, FILED 9-29-2008.

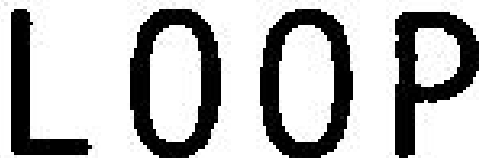

THE MARK CONSISTS OF STANDARD CHARACTERS
WITHOUT CLAIM TO ANY PARTICULAR FONT, STYLE,
SIZE, OR COLOR.

OWNER OF INTERNATIONAL REGISTRATION 0975461
DATED 7-23-2008, EXPIRES 7-23-2018.

CLASS 10—MEDICAL APPARATUS

FOR SURGICAL IMPLANTS COMPRISING ARTIFI-
CIAL MATERIALS (U.S. CLS. 26, 39 AND 44).

CLASS 42—SCIENTIFIC AND COMPUTER SERVICES

FOR DEVELOPMENT SERVICES CONCERNING NEW
PRODUCTS FOR OTHERS IN THE FIELD OF MEDICAL
TECHNOLOGY (U.S. CLS. 100 AND 101).

CLASS 44—MEDICAL, BEAUTY AND AGRI- CULTURAL SERVICES

FOR MEDICAL SERVICES (U.S. CLS. 100 AND 101).
ROBIN CHOSID, EXAMINING ATTORNEY

SN 79-061,909. OPERA WIRELESS, S.L., SPAIN, FILED 3-7-
2008.



OWNER OF INTERNATIONAL REGISTRATION 0984505
DATED 3-7-2008, EXPIRES 3-7-2018.

THE COLOR(S) RED, GRAY, WHITE AND BLACK IS/
ARE CLAIMED AS A FEATURE OF THE MARK.

THE MARK CONSISTS OF THE COLORS RED, GRAY,
WHITE AND BLACK WITH THE COLOR RED APPEARING
IN WORDING "3D" AND IN THE GEOMETRIC DESIGN
ELEMENT MADE UP OF LINES AND SQUARES, VARYING
FROM LIGHT RED ON THE LEFT PORTION OF THE
DESIGN TO DARK RED ON THE RIGHT SIDE OF THE
DESIGN. THE COLOR BLACK APPEARS IN THE WORD-
ING "PHOTONAV", AND THE BACKGROUND IS WHITE
WITH GRAY DOTS.

CLASS 9—ELECTRICAL AND SCIENTIFIC APPARATUS

FOR COMPUTER PROGRAMS FOR TURN-BY-TURN
NAVIGATION USING VECTOR DATA, ORTHOGONAL
AND OBLIQUE REAL IMAGERY, SHOWING ALSO
REAL BUILDING FACADES FOR USE IN PERSONAL
NAVIGATION DEVICES, PERSONAL DIGITAL ASSIS-
TANTS, MOBILE PHONES, SMART PHONES, PERSONAL
MEDIA PLAYERS AND COMPUTERS (U.S. CLS. 21,
23, 26, 36 AND 38).

CLASS 38—COMMUNICATION

FOR TELECOMMUNICATIONS, MESSAGE, NEWS,
TRAFFIC INFORMATION, COMMUNICATIONS, AND
INFORMATION TRANSMISSION SERVICES BY ELEC-
TRONIC MEANS, NAMELY, COMMUNICATIONS VIA
GLOBAL COMPUTER NETWORKS, NAMELY, TELE-
COMMUNICATION SERVICES, NAMELY, TRANSMIS-
SION OF DATA, GRAPHICS AND IMAGES BY MEANS
OF TELECOMMUNICATIONS NETWORKS, WIRELESS
COMMUNICATION NETWORKS, AND THE INTERNET
(U.S. CLS. 100, 101 AND 104).

CLASS 42—SCIENTIFIC AND COMPUTER SERVICES

FOR COMPUTER PROGRAMMING, COMPUTING,
NAMELY, PROVIDING SOFTWARE LIBRARIES FOR
SOFTWARE INTEGRATORS, NAMELY, PROVIDING
ORTHOGONAL AND OBLIQUE REAL IMAGERY TO
BE USED IN THEIR OWN COMPUTER PROGRAMS,
SOFTWARE DESIGN AND TECHNICAL PROJECT SER-
VICES, NAMELY, CUSTOMIZED SOFTWARE USING
ORTHOGONAL AND OBLIQUE REAL IMAGERY,
SHOWING ALSO REAL BUILDING FACADES ALL IN
THE FIELD OF ELECTRONIC DATA PROCESSING (U.S.
CLS. 100 AND 101).

SCOTT BIBB, EXAMINING ATTORNEY

SN 79-061,939. MYDENTY SWEDEN AB, SWEDEN, FILED
10-17-2008.



PRIORITY DATE OF 5-7-2008 IS CLAIMED.
OWNER OF INTERNATIONAL REGISTRATION 0984578
DATED 10-17-2008, EXPIRES 10-17-2018.

CLASS 10—MEDICAL APPARATUS

FOR FEEDING BOTTLES; FEEDING BOTTLE
VALVES; FEEDING BOTTLE TEATS; TEETHING
RINGS; BABIES PACIFIERS (TEATS); HOLDERS FOR
BABIES PACIFIERS (TEATS) (U.S. CLS. 26, 39 AND 44).

CLASS 21—HOUSEWARES AND GLASS

FOR MUGS; TABLE PLATES (U.S. CLS. 2, 13, 23, 29, 30,
33, 40 AND 50).
LINDA MICKLEBURGH, EXAMINING ATTORNEY

SN 79-061,975. MICH. WEYERMANN GMBH & CO. KG,
96052 BAMBERG, FED REP GERMANY, FILED 7-30-2008.



PRIORITY DATE OF 2-4-2008 IS CLAIMED.

OWNER OF INTERNATIONAL REGISTRATION 0984665 DATED 7-30-2008, EXPIRES 7-30-2018.

OWNER OF U.S. REG. NO. 3,398,692.

THE MARK CONSISTS OF THE WORDING "WEYER-MANN" IN AN ARCH OVER A CIRCLE DESIGN CONTAINING A STYLIZED "W" AND "M".

SN 79-062,022. MONTANA AIR, S.L., SPAIN, FILED 9-26-2008.

CLASS 2—PAINTS

FOR MALT COLORANTS, CARAMEL MALT FOR USE AS A COLORANT IN THE MANUFACTURE OF FOOD AND BEVERAGES, BEER COLORANTS (U.S. CLS. 6, 11 AND 16).



CLASS 30—STAPLE FOODS

FOR MALT FOR FOOD PURPOSES, MALT BISCUITS, MALT EXTRACT FOR FLAVORING FOOD, SUGAR, NAMELY, MALTOSE; PREPARATIONS OF MALT, NAMELY, MALT COFFEE, BARLEY COFFEE; FLAVORINGS OTHER THAN ESSENTIAL OILS; YEAST; MALT BEVERAGES WITH MILK NOT FOR MEDICAL PURPOSES, PROCESSED CEREALS, BREAKFAST CEREALS IN THE NATURE OF GRAIN FLAKES, FOOD ON THE BASIS OF MALT AND BARLEY, NAMELY, COOKIES, SHORTCAKES; FLOUR MILL PRODUCTS, NAMELY, WHEAT GERM NOT FOR USE AS A DIETARY SUPPLEMENT; NON-MEDICATED MALT LOZENGES (U.S. CL. 46).

PRIORITY DATE OF 5-22-2008 IS CLAIMED.
OWNER OF INTERNATIONAL REGISTRATION 0984808 DATED 9-26-2008, EXPIRES 9-26-2018.

CLASS 2—PAINTS

FOR PAINTS; PAINTS IN AEROSOL AND SPRAY FORM; COLORANTS; VARNISHES AND LACQUERS; PRESERVATIVES AGAINST RUST IN THE NATURE OF A COATING; PRESERVATIVES AGAINST THE DETERIORATION OF WOOD; DYESTUFFS; MORDANTS FOR USE IN THE MANUFACTURE OF PAINT; RAW NATURAL RESINS; METALS IN FOIL AND POWDER FORM FOR PAINTERS, DECORATORS, PRINTERS AND ARTISTS (U.S. CLS. 6, 11 AND 16).

CLASS 31—NATURAL AGRICULTURAL PRODUCTS

FOR MALT FOR BREWERIES AND DISTILLERIES, FOODSTUFFS FOR ANIMALS, FODDER ADDITIVES NOT FOR MEDICAL PURPOSES (U.S. CLS. 1 AND 46).

CLASS 16—PAPER GOODS AND PRINTED MATTER

FOR WATERCOLOURS; ETCHINGS; ENGRAVED WORKS OF ART MADE FROM CUSTOM MANUFACTURED PAPER; LITHOGRAPHIC WORKS OF ART; DRAWING PADS; CHARCOAL PENCILS; POSTERS; INK STICKS; INDIAN INKS; FRAMED OR UNFRAMED PAINTINGS; DRAWING ARTICLES AND INSTRUMENTS, NAMELY, PANTOGRAPHS, BRUSHES, COMPASSES, CURVES AND TRIANGLES; DRAWING SETS COMPRISED OF PADS, PAPER, PENCILS, RULERS AND SQUARES; PAINTING SETS FOR CHILDREN; ENGRAVINGS; ENGRAVED WORKS OF ART; PALTTES FOR PAINTERS; DRAWING INSTRUMENTS, NAMELY, PANTOGRAPHS; PAINTBOXES; DRAWING PENS; PEN CASES; DRAWING BOARDS; CANVAS FOR PAINTING; INK, NAMELY, INK FOR WRITING INSTRUMENTS, DUPLICATING INK AND CORRECTING INK; ARTISTS' MATERIALS, NAMELY, MOLDS FOR MODELING CLAYS (U.S. CLS. 2, 5, 22, 23, 29, 37, 38 AND 50).

CLASS 32—LIGHT BEVERAGES

FOR MALT BEER, MALT WORT, BEER, BEER WORT, ROASTED MALT BEER, EXTRACTS OF MALTS AND HOPS FOR BEER PRODUCTION, BEER, MINERAL WATER, CARBONATED WATER; OTHER NON ALCOHOLIC BEVERAGES IN THE NATURE OF SOFT DRINKS, FRUIT BEVERAGES AND FRUIT JUICE, SYRUPS FOR BEVERAGES; MALT EXTRACTS FOR FOOD (U.S. CLS. 45, 46 AND 48).

CLASS 41—EDUCATION AND ENTERTAINMENT

FOR ORGANIZATION OF ART EXHIBITIONS FEATURING DRAWINGS AND PAINTINGS; EDUCATION COURSES RELATING TO DRAWING AND PAINTING; ENTERTAINMENT IN THE NATURE OF COMPETITIONS IN THE FIELD OF ART FEATURING DRAWING AND PAINTING; PUBLISHING OF BOOKS AND MAGAZINES ON DRAWING AND PAINTING; ORGANIZATION OF RECREATIONAL AND CULTURAL ACTIVITIES FEATURING THE CONNECTION OF DRAWING AND PAINTING IN THE NATURE OF RECREATIONAL ART CAMPS AND ART EXHIBITIONS FOR CULTURAL PURPOSES; EDUCATION AND TRAINING SERVICES, NAMELY, PROVIDING CLASSES, SEMINARS, AND WORKSHOPS IN THE FIELDS OF ART; ENTERTAINMENT AND CULTURAL SERVICES, NAMELY, ORGANIZING EXHIBITIONS FOR ART EDUCATION AND ORGANIZATION OF ART EXHIBITIONS FOR CULTURAL PURPOSES (U.S. CLS. 100, 101 AND 107).

CLASS 42—SCIENTIFIC AND COMPUTER SERVICES

FOR TECHNOLOGICAL CONSULTING REGARDING THE CHEMISTRY OF MALT AND BEER PRODUCTION, PROVIDING OF CHEMICAL LABORATORY SERVICES, CONDUCTING OF CHEMICAL TESTS (U.S. CLS. 100 AND 101).

AMY C. KEAN, EXAMINING ATTORNEY

CLASS 43—HOTEL AND RESTAURANT SERVICES

FOR CATERING; PROVIDING TEMPORARY ACCOMMODATIONS (U.S. CLS. 100 AND 101).
FRED CARL, EXAMINING ATTORNEY

SN 79-062,024. MONTANA AIR, S.L., SPAIN, FILED 10-22-2008.

SN 79-062,042. SIEMENS SCHWEIZ AG, CH-8047 ZÜRICH, SWITZERLAND, FILED 11-7-2008.



PRIORITY DATE OF 5-30-2008 IS CLAIMED.
OWNER OF INTERNATIONAL REGISTRATION 0984810 DATED 10-22-2008, EXPIRES 10-22-2018.
THE COLOR(S) BLACK AND GRAY IS/ARE CLAIMED AS A FEATURE OF THE MARK.

THE MARK CONSISTS OF THE COLORS BLACK AND GRAY, WITH THE COLOR BLACK APPEARING IN THE LETTERING FOR THE WORDING "MTN 94" AND THE COLOR GRAY APPEARING AS THE BACKGROUND COLOR BEHIND THE WORDING.

CLASS 2—PAINTS

FOR PAINTS; PAINTS IN AEROSOL AND SPRAY FORM; COLORANTS; VARNISHES AND LACQUERS; PRESERVATIVES AGAINST RUST IN THE NATURE OF A COATING; PRESERVATIVES AGAINST THE DETERIORATION OF WOOD; DYESTUFFS; MORDANTS FOR USE IN THE MANUFACTURE OF PAINT; RAW NATURAL RESINS; METALS IN FOIL AND POWDER FORM FOR PAINTERS; DECORATORS, PRINTERS AND ARTISTS (U.S. CLS. 6, 11 AND 16).

CLASS 16—PAPER GOODS AND PRINTED MATTER

FOR BALL-POINT PENS; WATERCOLORS; ETCHINGS; ENGRAVED WORKS OF ART MADE FROM CUSTOM MANUFACTURED PAPER; LITHOGRAPHIC WORKS OF ART; DRAWING PADS; CHARCOAL PENCILS; POSTERS; INK STICKS; INDIAN INKS; FRAMED OR UNFRAMED PAINTINGS; DRAWING ARTICLES AND INSTRUMENTS, NAMELY, PANTOGRAPHES, BRUSHES, COMPASSES, CURVES AND TRIANGLES; DRAWING SETS COMPRISED OF PADS, PAPER, PENCILS AND RULERS, SQUARES; PAINTING SETS FOR CHILDREN; ENGRAVINGS; ENGRAVED WORKS OF ART, PALETTES FOR PAINTERS; DRAWING INSTRUMENTS, NAMELY, PANTOGRAPHES; PAINTBOXES; DRAWING PENS; PEN CASES; DRAWING BOARDS; CANVAS FOR PAINTING; INK FOR WRITING INSTRUMENTS, DUPLICATING INK AND CORRECTING INK; ARTISTS' MATERIALS, NAMELY, MOLDS FOR MODELING CLAYS (U.S. CLS. 2, 5, 22, 23, 29, 37, 38 AND 50).

CLASS 25—CLOTHING

FOR TEE SHIRTS, SWEATERS, TROUSERS, JACKETS AND CAPS (U.S. CLS. 22 AND 39).
AMY C. KEAN, EXAMINING ATTORNEY

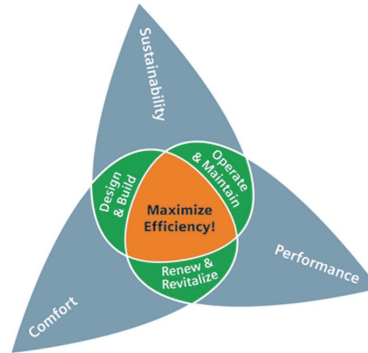

PRIORITY DATE OF 9-17-2008 IS CLAIMED.
OWNER OF INTERNATIONAL REGISTRATION 0984871 DATED 11-7-2008, EXPIRES 11-7-2018.

NO CLAIM IS MADE TO THE EXCLUSIVE RIGHT TO USE "SUSTAINABILITY," "PERFORMANCE," "COMFORT," "OPERATE & MAINTAIN," "RENEW & REVITALIZE," "DESIGN & BUILD" AND "MAXIMIZE EFFICIENCY", APART FROM THE MARK AS SHOWN.

THE COLOR(S) GREEN, ORANGE, BLUE-GREY, WHITE AND BLACK IS/ARE CLAIMED AS A FEATURE OF THE MARK.

THE MARK CONSISTS OF A FLOWER IN WHICH THE COLOR BLUE-GREY APPEARS ON THE BIG PARTS OF THE LEAVES, THE COLOR GREEN APPEARS IN THE SMALL PARTS OF THE LEAVES CLOSE TO THE CENTRE OF THE FLOWER, THE COLOR ORANGE APPEARS IN THE CENTRE OF THE FLOWER, THE COLOR WHITE APPEARS IN THE WORDING "SUSTAINABILITY PERFORMANCE COMFORT OPERATE & MAINTAIN RENEW & REVITALIZE DESIGN & BUILD", AND THE COLOR BLACK APPEARS IN THE WORDING "MAXIMIZE EFFICIENCY!".

CLASS 35—ADVERTISING AND BUSINESS

FOR BUSINESS MANAGEMENT CONSULTATION (U.S. CLS. 100, 101 AND 102).

CLASS 42—SCIENTIFIC AND COMPUTER SERVICES

FOR TECHNICAL SUPPORT SERVICES, NAMELY, PROVIDING TECHNICAL ADVICE CONCERNING BUILDING ENGINEERING AND BUILDING SAFETY (U.S. CLS. 100 AND 101).

MICHELE SWAIN, EXAMINING ATTORNEY

SN 79-062,047. TOKYO OHKA KOGYO CO., LTD., KANAGAWA, JAPAN, FILED 3-7-2008.

E P L U S

THE MARK CONSISTS OF STANDARD CHARACTERS WITHOUT CLAIM TO ANY PARTICULAR FONT, STYLE, SIZE, OR COLOR.

PRIORITY DATE OF 11-9-2007 IS CLAIMED.
OWNER OF INTERNATIONAL REGISTRATION 0984886 DATED 3-7-2008, EXPIRES 3-7-2018.

CLASS 1—CHEMICALS

FOR CHEMICALS FOR USE IN THE MANUFACTURE OF SOLAR CELLS, NAMELY, DIFFUSION CHEMICALS, MASKING CHEMICALS, PHOTORESISTS; CHEMICAL PASTES FOR FORMING ELECTRODES, NAMELY, ANODE PASTE AND CATHODE PASTE; CHEMICAL SOLUTIONS FOR FORMING ELECTRODES, NAMELY, PLATING SOLUTIONS; CHEMICALS FOR USE IN THE PRODUCTION OF SEMI-CONDUCTORS, NAMELY, DIFFUSION CHEMICALS, ETCHING CHEMICALS, MASKING CHEMICALS, PHOTORESISTS; INDUSTRIAL CHEMICALS; CHEMICAL PREPARATIONS FOR SCIENTIFIC PURPOSES; PHOTOGRAPHIC CHEMICALS (U.S. CLS. 1, 5, 6, 10, 26 AND 46).

CLASS 17—RUBBER GOODS

FOR PASTES FOR FORMING INSULATING LAYERS, NAMELY, INSULATING PLASTER; ELECTRICAL INSULATING MATERIALS, NAMELY, ELECTRICAL INSULATING PASTES, ELECTRICAL INSULATING TAPES, ELECTRICAL INSULATING PAINTS (U.S. CLS. 1, 5, 12, 13, 35 AND 50).

SCOTT BIBB, EXAMINING ATTORNEY

THE WORDING "ADVANCO" HAS NO MEANING IN A FOREIGN LANGUAGE.

CLASS 9—ELECTRICAL AND SCIENTIFIC APPARATUS

FOR COMPUTER PROGRAMS AND SOFTWARE IN THE FIELD OF INTEGRATION OF SOLUTIONS INVOLVING AUTOMATIC IDENTIFICATION AND INTELLIGENT DATA PROCESSING (U.S. CLS. 21, 23, 26, 36 AND 38).

CLASS 42—SCIENTIFIC AND COMPUTER SERVICES

FOR COMPUTER PROGRAM AND SOFTWARE DESIGN; COMPUTER PROGRAM AND SOFTWARE IMPLEMENTATION AND INTEGRATION; COMPUTER CONSULTATION (U.S. CLS. 100 AND 101).

LINDA MICKLEBURGH, EXAMINING ATTORNEY

SN 79-062,082. CITRUS SENSATION PTY LTD, AUSTRALIA, FILED 9-26-2008.

FLAVOTEC

THE MARK CONSISTS OF STANDARD CHARACTERS WITHOUT CLAIM TO ANY PARTICULAR FONT, STYLE, SIZE, OR COLOR.

OWNER OF INTERNATIONAL REGISTRATION 0984963 DATED 9-26-2008, EXPIRES 9-26-2018.

CLASS 29—MEATS AND PROCESSED FOODS

FOR FRESH CUT FRUITS AND VEGETABLES (U.S. CL. 46).

CLASS 32—LIGHT BEVERAGES

FOR FRUIT JUICES AND VEGETABLE JUICES (U.S. CLS. 45, 46 AND 48).

AMY C. KEAN, EXAMINING ATTORNEY

SN 79-062,156. JERSEY LOMELLINA S.P.A., ITALY, FILED 10-15-2008.



OWNER OF INTERNATIONAL REGISTRATION 0760558 DATED 1-8-2001, EXPIRES 1-8-2011.

OWNER OF U.S. REG. NOS. 2,634,289 AND 2,781,093.

THE MARK CONSISTS OF THE STYLIZED LETTER "JL" UPON WHICH IS SUPERIMPOSED ANOTHER STYLIZED VERSION OF THE LETTERS "JL" AS WELL AS THE WORDS "INTENSIVE" IN STYLIZED WRITING. ALL THE WORDING IN THE MARK IS SURROUNDED BY A RECTANGLE.

CLASS 24—FABRICS

FOR CLOTH FABRICS, NAMELY, FELT CLOTH, WOOLEN CLOTH, TEXTILE FABRICS FOR THE MANUFACTURE OF CLOTHING, WATERPROOF FABRIC FOR MANUFACTURING CLOTHING; JERSEY FABRICS FOR CLOTHING, ELASTIC FABRICS FOR CLOTHING (U.S. CLS. 42 AND 50).

CLASS 25—CLOTHING

FOR KNITTED CLOTHING ARTICLES, NAMELY, KNITTED SHIRTS, CAPS, GLOVES, SCARVES, SWEATERS, SKIRTS, SOCKS AND KNITTED UNDERWEAR (U.S. CLS. 22 AND 39).

MICHAEL TANNER, EXAMINING ATTORNEY

SN 79-062,144. ADVANCO, SOCIÉTÉ ANONYME, B-1130 BRUXELLES, BELGIUM, FILED 10-17-2008.



PRIORITY DATE OF 4-21-2008 IS CLAIMED.

OWNER OF INTERNATIONAL REGISTRATION 0985092 DATED 10-17-2008, EXPIRES 10-17-2018.

THE COLOR(S) BLUE AND BLACK IS/ARE CLAIMED AS A FEATURE OF THE MARK.

THE MARK CONSISTS OF "ADVANCO" IN BLACK FONT BELOW THREE INTERSECTING BLUE CIRCLES IN A TRIANGULAR FORM. EACH CIRCLE HAS A DARK BLUE OUTLINE WITH THE TOP CIRCLE BEING THE palest inside and the bottom two being darker blue; WHERE THE CIRCLES INTERSECT ARE VARYING SHADES OF BLUE.

SN 79-062,191. FEDERACIÓN ESPAÑOLA DE EMPRESAS;
DE LA CONFECCIÓN (FEDECON), SPAIN, FILED 4-4-
2008.



PRIORITY DATE OF 11-8-2007 IS CLAIMED.
OWNER OF INTERNATIONAL REGISTRATION 0985152
DATED 4-4-2008, EXPIRES 4-4-2018.

NO CLAIM IS MADE TO THE EXCLUSIVE RIGHT TO
USE "MODA ESPAÑA", APART FROM THE MARK AS
SHOWN.

THE COLOR(S) HOT PINK IS/ARE CLAIMED AS A
FEATURE OF THE MARK.

THE MARK CONSIST OF THE WORDING "M MODAE-
SPAÑA" IN STYLIZED HOT PINK FONT A CURVED LINE
APPEARS OVER THE "M" ALSO IN HOT PINK COLOR.

THE ENGLISH TRANSLATION OF THE WORD "MODA
ESPAÑA" IN THE MARK IS FASHION SPAIN.

CLASS 25—CLOTHING

FOR CLOTHING OF SPAIN, NAMELY, SHIRTS,
BLOUSES, SCARVES, JACKETS, SUITS, WOMEN
DRESSES, NIGHT GOWNS; SKIRTS, TROUSERS,
JEANS, SHORTS, PANTIES, SOCKS; FOOTWEAR, EX-
CEPT ORTHOPEDIC FOOTWEAR; HEADWEAR (U.S.
CLS. 22 AND 39).

CLASS 35—ADVERTISING AND BUSINESS

FOR ADVERTISING SERVICES; PUBLISHING OF
ADVERTISING TEXTS; IMPORT-EXPORT; BUSINESS
ENQUIRIES; BUSINESS EXPERT REPORTS; CONSULT-
ING FOR BUSINESS ORGANIZATION AND MANAGE-
MENT; BUSINESS MANAGEMENT; BUSINESS
ADMINISTRATION; OFFICE FUNCTIONS; ORGANIZA-
TION OF FAIRS AND EXHIBITIONS FOR COMMER-
CIAL OR ADVERTISING PURPOSES; FRANCHISE
SERVICES, NAMELY, OFFERING ASSISTANCE CON-
CERNING BUSINESS OPERATION AND MANAGE-
MENT; RETAILING IN STORES AND ONLINE RETAIL
STORE SERVICES OFFERED VIA GLOBAL COMPUTER
NETWORKS OF CLOTHING, FOOTWEAR AND HEAD-
GEAR; SUPPLY SERVICES FOR OTHERS IN THE
NATURE OF PROCUREMENT SERVICES, NAMELY,
PURCHASING CLOTHING DESIGN SERVICES, AND
CLOTHING PRODUCTION SERVICES; MARKET STU-
DIES; MODELING FOR ADVERTISING OR SALES
PROMOTION; DISTRIBUTION OF SAMPLES; DEMON-
STRATION OF GOODS; SALES PROMOTION FOR
OTHERS (U.S. CLS. 100, 101 AND 102).

FRED MANDIR, EXAMINING ATTORNEY

SN 79-062,272. INDUSTRIE EMILIANA PARATI S.P.A.,
ITALY, FILED 10-2-2008.



THE MARK CONSISTS OF STANDARD CHARACTERS
WITHOUT CLAIM TO ANY PARTICULAR FONT, STYLE,
SIZE, OR COLOR.

PRIORITY DATE OF 5-26-2008 IS CLAIMED.

OWNER OF INTERNATIONAL REGISTRATION 0985351
DATED 10-2-2008, EXPIRES 10-2-2018.

CLASS 24—FABRICS

FOR TEXTILES AND TEXTILE GOODS, NAMELY,
TEXTILE WALL HANGINGS, CLOTH POSTERS, TEX-
TILE OR PLASTIC CURTAINS; PLASTIC BED AND
TABLE COVERS (U.S. CLS. 42 AND 50).

CLASS 27—FLOOR COVERINGS

FOR CARPETS, RUGS, MATS AND MATTING, LINO-
LEUM FOR COVERING EXISTING FLOORS; NON-
TEXTILE WALL HANGINGS (U.S. CLS. 19, 20, 37, 42
AND 50).

PAM WILLIS, EXAMINING ATTORNEY

SN 79-062,295. EROTIC FROM IBIZA, S.L., E-07800 IBIZA,
SPAIN, FILED 6-27-2008.



PRIORITY DATE OF 1-2-2008 IS CLAIMED.

OWNER OF INTERNATIONAL REGISTRATION 0985414
DATED 6-27-2008, EXPIRES 6-27-2018.

NO CLAIM IS MADE TO THE EXCLUSIVE RIGHT TO
USE "EROTIC FROM IBIZA", APART FROM THE MARK
AS SHOWN.

THE MARK COMPRISES THE NAME "EROTIC FROM
IBIZA" WRITTEN ON TWO LINES WITHIN A FANCY
SHAPE FORMED BY TWO HEARTS, ONE OF WHICH IS
PLACED OVER THE OTHER, WITH THE LATTER IN-
VERTED WITH RESPECT TO THE FIRST AND WITH ITS
TIP HIDDEN.

CLASS 16—PAPER GOODS AND PRINTED MATTER

FOR PAPER, CARDBOARD AND GOODS MADE
FROM PAPER AND CARDBOARD, NAMELY, PAPER
BAGS AND PAPER BAGS FOR PACKAGING, PAPER
BOARD, PAPER ENVELOPES FOR PACKAGING, PAPER
SHOPPING BAGS, PAPER HANDTOWELS, GREETING
CARDS; BOOKBINDING MATERIAL; PHOTOGRAPHS;
STATIONERY; OFFICE REQUISITES EXCEPT FURNI-
TURE, NAMELY, PENS, NOTEBOOKS, ENVELOPES,
PAPER SHEETS FOR NOTE TAKING; INSTRUCTIONAL
AND TEACHING MATERIAL, EXCEPT APPARATUS,
NAMELY, BROCHURES, BOOKS, BOOKLETS AND
TEACHING MATERIALS IN THE FIELD OF EROTI-
CISM; PLASTIC MATERIALS FOR PACKAGING,
NAMELY, PLASTIC BAGS FOR PACKAGING, PLASTIC
BUBBLE PACKS FOR PACKAGING (U.S. CLS. 2, 5, 22,
23, 29, 37, 38 AND 50).

CLASS 20—FURNITURE AND ARTICLES NOT OTHERWISE CLASSIFIED

FOR FURNITURE, NAMELY, MIRRORS AND PIC-
TURE FRAMES MADE OF WOOD OR PLASTIC, BED
MATTRESSES, BED PILLOWS (U.S. CLS. 2, 13, 22, 25, 32
AND 50).

CLASS 25—CLOTHING

FOR CLOTHING, NAMELY, COATS, SHIRTS, T-SHIRTS, UNDERSHIRTS, STOCKINGS, BRAS, JACKETS, JERSEYS, PANTS, PANTIES; FOULARDS; HEADGEAR, NAMELY, CAPS (U.S. CLS. 22 AND 39).

CLASS 28—TOYS AND SPORTING GOODS

FOR GAMES, NAMELY, PUZZLES, BOARD GAMES, CARD GAMES AND TARGET GAMES, DICE, DICE GAMES; TOYS, NAMELY, TOY BALLOONS, DOLLS, TALKING TOYS, TOY CLOCKS AND TOY WATCHES, TOY FIGURES, TOY FURNITURE, YO-YOS, BATH TOYS; GYMNASIAC AND SPORTING ARTICLES, NAMELY, YOGA MATS, PLAY BALLOONS, BAGS SPECIALLY ADAPTED FOR SPORTS EQUIPMENT; DECORATIONS FOR CHRISTMAS TREES (U.S. CLS. 22, 23, 38 AND 50).

CLASS 35—ADVERTISING AND BUSINESS

FOR RETAILING, NAMELY, RETAIL STORE SERVICES AND ONLINE RETAIL STORE SERVICES VIA THE GLOBAL COMMUNICATIONS NETWORK OF ALL KINDS OF EROTIC ARTICLES AND GOODS, NAMELY, EROTIC TOYS, CLOTHING, ADULT BOOKS, EROTIC PRODUCTS AND SEXUAL AIDS, VIBRATORS (U.S. CLS. 100, 101 AND 102).

CLASS 41—EDUCATION AND ENTERTAINMENT

FOR PUBLICATION OF TEXTS OTHER THAN PUBLICITY TEXTS; ARRANGING AND CONDUCTING OF CONFERENCES, COLLOQUIUMS AND SYMPOSIUMS RELATING TO EROTICISM, NAMELY, ON THE SUBJECTS OF SEXUALITY, ADULT-ORIENTED MATERIALS, EROTICA (U.S. CLS. 100, 101 AND 107).
CARYN GLASSER, EXAMINING ATTORNEY

SN 79-062,351. SAVOUR CLUB SELECTION, FRANCE, FILED 9-22-2008.

LES CHAIS DU SAVOUR

THE MARK CONSISTS OF STANDARD CHARACTERS WITHOUT CLAIM TO ANY PARTICULAR FONT, STYLE, SIZE, OR COLOR.

PRIORITY DATE OF 9-18-2008 IS CLAIMED.
OWNER OF INTERNATIONAL REGISTRATION 0985549 DATED 9-22-2008, EXPIRES 9-22-2018.

OWNER OF U.S. REG. NO. 2,786,251.
NO CLAIM IS MADE TO THE EXCLUSIVE RIGHT TO USE "CHAI", APART FROM THE MARK AS SHOWN.

THE ENGLISH TRANSLATION OF "LE CHAIS DU SAVOUR" IN THE MARK IS "WINE STOREHOUSES OF THE SAVOUR."

CLASS 32—LIGHT BEVERAGES

FOR BEERS (U.S. CLS. 45, 46 AND 48).

CLASS 33—WINES AND SPIRITS

FOR ALCOHOLIC BEVERAGES, NAMELY, ARMAGNAC, LIQUEURS, KIR, CALVADOS, EAUX-DE-VIE AND CRÈME-LIQUEURS, ALCOHOLIC EXTRACTS, ALCOHOLIC PUNCH, RUM, WHISKY, VODKA, ALCOHOLIC BITTERS, COGNAC, BRANDY, PASTIS, OZUO, ANIS FLAVORED LIQUEURS, GINS, JUNIPER FLAVORED LIQUEURS, AQUAVIT, VERMOUTH; WINE; SPIRITS (U.S. CLS. 47 AND 49).

CLASS 35—ADVERTISING AND BUSINESS

FOR RETAIL STORE SERVICES FEATURING BEERS, ALCOHOLIC BEVERAGES, WINE AND SPIRITS (U.S. CLS. 100, 101 AND 102).
WENDY GOODMAN, EXAMINING ATTORNEY

SN 79-062,504. ALLIBAL, INC., PANAMÁ, PANAMA, FILED 8-5-2008.

CISITALIA

THE MARK CONSISTS OF STANDARD CHARACTERS WITHOUT CLAIM TO ANY PARTICULAR FONT, STYLE, SIZE, OR COLOR.

OWNER OF INTERNATIONAL REGISTRATION 0985988 DATED 8-5-2008, EXPIRES 8-5-2018.

THE WORDING "CISITALIA" HAS NO MEANING IN A FOREIGN LANGUAGE.

CLASS 3—COSMETICS AND CLEANING PREPARATIONS

FOR PERFUMERY, ESSENTIAL OILS, COSMETICS, HAIR LOTIONS (U.S. CLS. 1, 4, 6, 50, 51 AND 52).

CLASS 9—ELECTRICAL AND SCIENTIFIC APPARATUS

FOR NAUTICAL APPARATUS, NAMELY, COMPASSES, MAGNIFYING GLASSES, BINOCULARS; CAMERAS; BAGS FOR CAMERAS AND PHOTOGRAPHIC EQUIPMENT; OPTICAL GLASSES, SPORTS GLASSES, SUNGLASSES, EYEGLASS CASES; MEASURING APPARATUS AND INSTRUMENTS, NAMELY, SPEED INDICATORS, AUTOMATIC INDICATORS OF LOW PRESSURE IN VEHICLE TIRES; HELMETS, NAMELY, PROTECTIVE HELMETS FOR SPORTS, MOTORCYCLE HELMETS; BAGS SPECIALLY ADAPTED FOR PROTECTIVE HELMETS; APPARATUS FOR RECORDING, TRANSMISSION OR REPRODUCTION OF SOUND OR IMAGES, NAMELY, ELECTRONIC ORGANIZERS, AUDIO AND VIDEO CASSETTE RECORDERS, DIGITAL VIDEO RECORDERS, PORTABLE VIDEO CAMERAS WITH BUILT-IN VIDEOCASSETTE RECORDERS, VIDEO CAMERAS, HEADPHONES (U.S. CLS. 21, 23, 26, 36 AND 38).

CLASS 14—JEWELRY

FOR JEWELRY; HOROLOGICAL AND CHRONOMETRIC INSTRUMENTS, NAMELY, ALARM CLOCKS AND WRISTWATCHES (U.S. CLS. 2, 27, 28 AND 50).

CLASS 25—CLOTHING

FOR CLOTHING, NAMELY, SHIRTS, T-SHIRTS, BLOUSES, SWEATSHIRTS, PARKAS, JACKETS, PANTS, GLOVES, SOCKS, PAJAMAS, SHAWLS, COATS, SCARVES, DRESSES, NECKTIES, BELTS, SUSPENDERS, SWIMSUITS, BEACH WRAPS, BATHROBES, WARM UP SUITS, JERSEYS, ANORAKS, JUMP SUITS, RAINWEAR, SUITS; FOOTWEAR; HEADGEAR, NAMELY, HATS AND CAPS (U.S. CLS. 22 AND 39).
LIEF MARTIN, EXAMINING ATTORNEY

SN 79-062,535. STIFTUNG ZUR FÖRDERUNG; DER INTERNATIONALEN ARBEIT; DER RELIGIÖSEN GEMEINSCHAFT; LECTORIUM ROSICRUCIANUM, SWITZERLAND, FILED 10-29-2008.

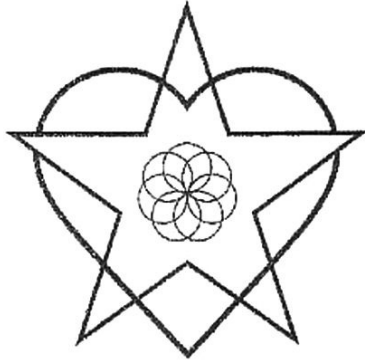

OWNER OF INTERNATIONAL REGISTRATION 0986114 DATED 10-29-2008, EXPIRES 10-29-2018.

THE MARK CONSISTS OF A DESIGN OF A HEART AND STAR CONTAINING THE STYLIZED REPRESENTATION OF A ROSE.

CLASS 16—PAPER GOODS AND PRINTED MATTER

FOR PAPER, CARDBOARD AND GOODS MADE OF THESE MATERIALS, NAMELY, PRINTED INSTRUCTIONAL AND TEACHING MATERIALS FOR USE IN THE FIELD OF GNOSTIC CHRISTIANITY; BOOKBINDING MATERIALS; PHOTOGRAPHS; STATIONERY; ADHESIVES FOR STATIONERY OR HOUSEHOLD PURPOSES (U.S. CLS. 2, 5, 22, 23, 29, 37, 38 AND 50).

CLASS 35—ADVERTISING AND BUSINESS

FOR ADVERTISING; BUSINESS MANAGEMENT; BUSINESS ADMINISTRATION; OFFICE FUNCTIONS (U.S. CLS. 100, 101 AND 102).

CLASS 41—EDUCATION AND ENTERTAINMENT

FOR EDUCATIONAL SERVICES, NAMELY, PROVIDING CLASSES, SEMINARS AND WORKSHOPS IN THE FIELD OF GNOSTIC CHRISTIANITY (U.S. CLS. 100, 101 AND 107).

Laura Hammel, Examining Attorney

SN 79-062,666. ENERTAG (SOCIÉTÉ PAR ACTIONS SIMPLIFIÉE), FRANCE, FILED 11-6-2008.



PRIORITY DATE OF 5-26-2008 IS CLAIMED. OWNER OF INTERNATIONAL REGISTRATION 0986363 DATED 11-6-2008, EXPIRES 11-6-2018.

OWNER OF U.S. REG. NO. 3,527,791. THE COLOR(S) BLACK, YELLOW, AND WHITE IS/ARE CLAIMED AS A FEATURE OF THE MARK.

THE MARK CONSISTS OF THE WORDING "ENERTAG" APPEARING IN THE COLOR YELLOW. THERE IS A CIRCLE IN PLACE OF THE LOWER PORTION OF THE LETTER "T" WHICH APPEARS IN THE COLOR WHITE. ALL THE WORDING IS ENCLOSED IN A BLACK RECTANGLE.

CLASS 9—ELECTRICAL AND SCIENTIFIC APPARATUS

FOR ELECTRONIC SYSTEMS FOR UNDERSEA OR AIRBORNE IDENTIFICATION, TRACKING AND LOCATION EMPLOYING RADIOFREQUENCY TECHNOLOGY APPLICABLE TO DIFFERENT ENERGIES COMPRISED OF RADIO FREQUENCY IDENTIFICATION TAGS, RADIO FREQUENCY IDENTIFICATION CREDENTIALS, NAMELY, CARDS AND TAGS, AND READERS FOR RADIO FREQUENCY IDENTIFICATION CREDENTIALS; SYSTEMS FOR IDENTIFYING UNDERSEA PIPELINE SEGMENTS COMPRISED OF RADIO FREQUENCY IDENTIFICATION TAGS, RADIO FREQUENCY IDENTIFICATION CREDENTIALS, NAMELY, CARDS AND TAGS, AND READERS FOR RADIO FREQUENCY IDENTIFICATION CREDENTIALS; COMPUTER SOFTWARE RECORDED ON CD-ROM FOR ELECTRONIC SYSTEMS OF IDENTIFICATION, TRACKING, LOCATION, MANAGEMENT AND MAINTENANCE, USING RADIO-FREQUENCY TECHNOLOGIES APPLICABLE TO DIFFERENT ENERGIES; ELECTRIC COILS; ELECTRONIC CHIPS FOR THE MANUFACTURER OF INTEGRATED CIRCUITS; CHIP CARD READERS; TRANSPONDERS; SUBMERSIBLE ELECTRONIC HOUSING COMPRISED OF ELECTRONIC CIRCUITS; BLANK MAGNETIC DATA CARRIERS; ELECTRONIC CARDS FOR PROCESSING IMAGES, NAMELY, ELECTRONIC CARDS FOR VIEWING PIPELINE SEGMENTS; SECURE, ENCRYPTED DATABASE MANAGEMENT SOFTWARE FOR READING AND RECORDING INFORMATION ON UNDERSEA PIPELINES (U.S. CLS. 21, 23, 26, 36 AND 38).

CLASS 42—SCIENTIFIC AND COMPUTER SERVICES

FOR DESIGN, DEVELOPMENT AND UPDATING OF SOFTWARE FOR ELECTRONIC SYSTEMS FOR UNDERSEA OR AIRBORNE IDENTIFICATION, TRACKING, LOCATION, MANAGEMENT AND MAINTENANCE, EMPLOYING RADIOFREQUENCY TECHNOLOGY APPLICABLE TO DIFFERENT ENERGIES; TECHNICAL PROJECT STUDIES, NAMELY, TECHNICAL RESEARCH IN THE FIELD OF ENERGIES, OIL PROSPECTING; ENGINEER'S SERVICES IN THE FIELD OF ENERGIES; INDUSTRIAL ANALYSIS AND RESEARCH, NAMELY, TECHNICAL RESEARCH IN THE FIELD OF ENERGIES; OIL EXPLORATION; OILWELL AND OIL PIPELINE TESTING; ANALYSIS FOR OIL-FIELD EXPLOITATION; OIL-FIELD SURVEYS; DEVELOPMENT AND UPDATING OF DATABASES FOR IDENTIFYING UNDERSEA PIPELINE SEGMENTS (U.S. CLS. 100 AND 101).

Courtney McCormick, Examining Attorney

SN 79-062,692. VENTA LUFTWÄSCHER AG, SWITZERLAND, FILED 9-12-2008.



THE MARK CONSISTS OF STANDARD CHARACTERS WITHOUT CLAIM TO ANY PARTICULAR FONT, STYLE, SIZE, OR COLOR.

PRIORITY DATE OF 3-14-2008 IS CLAIMED. OWNER OF INTERNATIONAL REGISTRATION 0986447 DATED 9-12-2008, EXPIRES 9-12-2018.

OWNER OF U.S. REG. NOS. 2,195,526, 3,021,368 AND 3,245,498. THE ENGLISH TRANSLATION OF "VENTA" IN THE MARK IS SALE.

CLASS 3—COSMETICS AND CLEANING PREPARATIONS

FOR DETERGENTS AND WHITENERS FOR USE IN HOUSEHOLDS ESPECIALLY FOR CLEANING FURNITURE AND APPARATUS AND FOR BLEACHING TEXTILES; HOUSEHOLD PREPARATIONS, IN PARTICULAR CLEANING AND HYGIENE PREPARATIONS FOR CLEANING CLOTHES; POLISHING AND GREASE REMOVAL PREPARATIONS FOR HOUSEHOLD PURPOSES AND SANDING PRODUCTS, NAMELY, SANDING APPARATUS IN THE FORM OF A GLOVE OR A CLOTH; DEODORANT SOAP; INDUSTRIAL SOAP; PERFUMERY PREPARATIONS; ESSENTIAL OILS, PERFUMED ESSENCES IN PARTICULAR FOR USE IN AERATION SYSTEMS, AIR HUMIDIFIERS AND PURIFIERS, EAU DE PARFUM, BEAUTY AND BODY CARE COSMETICS, HAIR LOTIONS; DENTAL HYGIENE PRODUCTS, NAMELY, TOOTHPASTE AND TOOTH WHITENING KITS (U.S. CLS. 1, 4, 6, 50, 51 AND 52).

SN 79-062,763. ALTAY HOLDING S.P.A., ITALY, FILED 7-24-2008.



PRIORITY DATE OF 6-13-2008 IS CLAIMED.
OWNER OF INTERNATIONAL REGISTRATION 0986675
DATED 7-24-2008, EXPIRES 7-24-2018.

CLASS 9—ELECTRICAL AND SCIENTIFIC APPARATUS

FOR APPARATUS, DEVICES AND INSTRUMENTS FOR MEASURING, SIGNALLING AND MONITORING, IN PARTICULAR THERMOMETERS FOR NON-MEDICAL PURPOSES AND HYGROMETERS FOR MEASURING HUMIDITY AND APPARATUS THAT IS A COMBINATION OF A THERMOMETER AND A HYGROMETER (U.S. CLS. 21, 23, 26, 36 AND 38).

CLASS 9—ELECTRICAL AND SCIENTIFIC APPARATUS

FOR SCIENTIFIC APPARATUS, INSTRUMENTS AND MODELS AS TEACHING AIDS IN THE FIELD OF PHYSICS, BIOLOGY, CHEMISTRY, AND EARTH SCIENCES, NAMELY, DYNAMOMETERS, PULLEYS IN THE NATURE OF TOOLS FOR THE MEASUREMENT AND MONITORING OF MOTION, VARIGNON FORCE TABLES, INCLINED PLANES, LINEAR AIR TRACKS AND ACCESSORIES FOR USE AS LABORATORY EQUIPMENT AND/OR TEACHING APPARATUS FOR THE MEASUREMENT AND MONITORING OF MOTION, ELECTRIC LAUNCHERS IN THE NATURE OF TOOLS FOR THE MEASUREMENT AND MONITORING OF PROJECTILE MOTION, PHOTOGATES, NAMELY, TIMING DEVICES, MAGNETIC BLACKBOARDS FOR MECHANICS EXPERIMENTS, ATWOOD'S MACHINES IN THE NATURE OF A TOOL USED TO MEASURE ELEMENTS OF PHYSICS, TORSION PENDULUMS, HOOKE'S LAW APPARATUS IN THE NATURE OF A TOOL USED TO MEASURE ELEMENTS OF PHYSICS, PRESSURE STRINGS WITH PRESSURE GAUGE MEASURING THE DEPENDENCE OF PITCH ON THE LENGTH, TENSION AND THICKNESS OF A VIBRATING STRING, SPOUTING JARS FOR DEMONSTRATING THE LAWS GOVERNING PRESSURE IN FLUIDS, PASCAL'S APPARATUS IN THE NATURE OF A TOOL USED TO DEMONSTRATE THE PRINCIPLES OF FLUID PRESSURE, COMMUNICATING VESSELS IN THE NATURE OF A TOOL USED TO DEMONSTRATE THE PRINCIPLES OF FLUID DYNAMICS, INSTRUMENTS FOR VERIFYING ARCHIMEDE'S LAW IN THE NATURE OF TOOLS USED TO DEMONSTRATE THE PRINCIPLES OF BUOYANCY, APPARATUS FOR VERIFYING CAPILLARITY IN THE NATURE OF A SET OF FIVE INTERCONNECTING GLASS TUBES OF DIFFERENT DIAMETER THAT DISPLAYS THE PHENOMENA OF CAPILLARITY AND SURFACE TENSION, BOYLE LAW APPARATUS IN THE NATURE OF A TOOL USED TO DEMONSTRATE THE RELATIONSHIP BETWEEN PRESSURE AND VOLUME, GUNTHER EXPANSION APPARATUS IN THE NATURE OF A TOOL USED TO DETERMINE THE COEFFICIENT OF LINEAR EXPANSION OF A SOLID, BALLS AND RINGS APPARATUS IN THE NATURE OF A TOOL USED TO DEMONSTRATE THE EXPANSION OF MATERIALS, BAR BREAKING APPARATUS IN THE NATURE OF A TOOL USED TO DEMONSTRATE THE FORCE OF CONTRACTION OR EXPANSION, THERMAL EXPANSION APPARATUS IN THE NATURE OF A TOOL USED TO DEMONSTRATE THE EXPANSION OF METALS WITH INCREASING TEMPERATURE, JOULE'S CALORIMETERS, CONVECTION APPARATUS IN THE NATURE OF TOOLS USED TO DEMONSTRATE THE PRINCIPLES OF THERMODYNAMICS, CONDUCTIVITY APPARATUS IN THE NATURE OF TOOLS USED TO DEMONSTRATE THE PRINCIPLES OF ELECTROCHEMISTRY, THERMODYNAMICS AND TO TEST FOR TOTAL DISSOLVED SOLIDS, CONDUCTIVITY, OR SALINITY IN WATER

CLASS 11—ENVIRONMENTAL CONTROL APPARATUS

FOR STEAM GENERATORS; HUMIDIFIERS; REFRIGERATING MACHINES; HEATING APPARATUS, NAMELY, GAS WATER HEATERS, ELECTRIC SPACE HEATERS, ELECTRIC RADIANT HEATERS, PORTABLE ELECTRIC HEATERS, SOLAR WATER HEATERS, DRYING APPARATUS, NAMELY, CLOTHES DRYERS, HAIR DRYERS, ELECTRIC HOT AIR HAND DRYERS; VENTILATORS FOR HUMIDIFIERS, ELECTRIC HEATERS, REFRIGERATING MACHINES; AIR HUMIDIFIERS, DRIERS, PURIFIERS, IN PARTICULAR AIR HUMIDIFIERS AND DRYERS OR PURIFIERS FOR USE IN LIVING ROOMS, OFFICES, HOTEL ROOMS AND OTHER PRIVATE, BUSINESS AND INDUSTRIAL PREMISES, IN PARTICULAR APPLIANCES FOR MOISTENING AND FILTERING AIR THAT CONSISTS OF PLATES THAT ROTATE THROUGH A LIQUID LIKE A PADDLE-WHEEL, WHEREIN THE AIR CIRCULATES AROUND THE PLATE; SPARE PARTS AND ACCESSORIES FOR THESE PRODUCTS, NOT INCLUDED IN OTHER CLASSES, NAMELY, FOR HUMIDIFIERS, HEATING APPARATUS, AIR FILTERS FOR DOMESTIC AND INDUSTRIAL USE (U.S. CLS. 13, 21, 23, 31 AND 34).
MARILYN IZZI, EXAMINING ATTORNEY

SAMPLES, RIPPLE TANKS IN THE NATURE OF A TOOLS USED TO DEMONSTRATE THE PRINCIPLES OF WAVE MECHANICS, THREE-WIRE SONOMETERS, TUNING FORKS WITH RESONANCE BOXES, KUNDT'S TUBES FOR DEMONSTRATING THE PHENOMENON OF STANDING WAVES, TUNING FORKS ON RESONANCE BOXES, OPTICAL BENCHES IN THE NATURE OF TOOLS USED TO INVESTIGATE OPTICAL PHENOMENA, NAMELY, REFLECTION, LENS THEORY, POLARIZATION, INTERFERENCE, DIFFRACTION AND OPTICAL INSTRUMENTS, CONCAVE MIRRORS, OPTICAL DISKS IN THE NATURE OF OPTICAL LENSES, NEWTON COLOR DISKS FOR DEMONSTRATING THE RELATIONSHIP BETWEEN COLORS, SPECTROMETERS, VAN DE GRAAF GENERATORS IN THE NATURE OF A TOOL USED TO PRODUCE STATIC ELECTRICITY, WIMSHURST MACHINES IN THE NATURE OF A TOOLS USED TO PRODUCT STATIC ELECTRICITY, KIT TO COVER ALL THE CLASSIC EXPERIMENTS OF ELECTROSTATICS PRIMARILY IN THE NATURE OF RODS OF DIFFERENT MATERIALS, ELECTROSCOPES, FARADAY WELL IN THE NATURE OF A TOOL USED TO GENERATE AN ELECTROMAGNETIC CHARGE, CONE, SPHERE, AND CYLINDER CONDUCTORS FOR DEMONSTRATING THE PRINCIPLES OF ELECTROMAGNETICS, PAIR OF CONDENSER PLATES FOR DEMONSTRATING CHARGE ACCUMULATION, MODELS OF VOLTAIC CELL WITH DIFFERENT ELECTRODES, MAGNETIC FIELD DEMONSTRATION APPARATUS IN THE NATURE OF A TOOL USED TO MEASURE MAGNETIC FIELDS, GALVANOSCOPES IN THE NATURE OF A TOOL USED TO DETECT THE PRESENCE OF AN ELECTRIC CURRENT AND DETERMINE ITS DIRECTION, GALVANOMETERS, RESISTANCE BOXES FOR TESTING CIRCUITS WITH DIFFERENT RESISTANCES, DECADE CAPACITANCE BOXES FOR TESTING CAPACITORS, DEMOUNTABLE TRANSFORMERS, COILS FOR DEMOUNTABLE TRANSFORMERS, INDUCTION COILS, HOFFMANN VOLTMETERS, WIRE BRIDGES FOR TRANSFORMING ALTERNATE CURRENT IN DIRECT CURRENT, CROOKE'S RADIOMETERS, EXTERNAL COMBUSTION ENGINE MODEL, DC POWER SUPPLIES, LOW TENSION POWER SUPPLIES AC/DC, TRANSFORMERS, HIGH TENSION POWER SUPPLIES, WATTMETERS, MULTIMETERS FOR MEASURING VOLTAGE AND RESISTANCE, OSCILLOSCOPES, FUNCTION GENERATORS FOR TESTING CIRCUITS, KITS TO COVER THE MAIN CLASSIC EXPERIMENTS ON STATICS AND DYNAMICS, FEATURING APPARATUS USED TO DEMONSTRATE BALANCE, LEVERS, INCLINED PLANE, PARALLELOGRAM OF FORCES, NEWTON'S LAWS, MOMENTUM, KITS TO COVER MAIN CLASSIC EXPERIMENTS ON ELECTROMAGNETISM FEATURING FLOATING MAGNETS, EDDY CURRENTS, EARTH'S MODEL, KITS FOR ELECTRONICS AND ELECTRICITY FEATURING PRIMARILY RESISTORS, CAPACITORS, POTENTIOMETERS, SWITCHES, PNP, NPN, PTC, NPC, LEDS, TRIAC, KIT TO PERFORM EXPERIMENTS ON ELECTROCHEMISTRY FEATURING HOFFMANN APPARATUS, ELECTRODES, KITS WITH APPARATUS TO PERFORM CLASSIC EXPERIMENTS ON OPTICS FEATURING PRIMARILY LENSES, MIRRORS, POLARIZING FILTERS, PROJECTORS, LASERS, ELECTRONIC TUBES USED TO DEMONSTRATE THE EFFECT OF GAS EXCITATION AND VISIBLE LIGHT EMISSION, PHYSICS SENSORS AND DATA LOGGERS FOR DATA COMPILATION; PROJECTORS, NAMELY, OVERHEAD PROJECTORS, OPTICAL MICROSCOPES, STEREOMICROSCOPES, DIGITAL MICROSCOPES, INVERTED MICROSCOPES, METALLURGY MICROSCOPES, HAND MICROTOMES FOR CUTTING BIOLOGICAL SPECIMENS INTO TRANSPARENT THIN SECTIONS FOR MICROSCOPIC EXAMINATION, DISSECTING DISH WITH LID; TEACHING APPARATUS, NAMELY, HUMAN ANATOMY PLASTIC MODELS AND PLANT PLASTIC MODELS; TEACHING APPARATUS, NAMELY, ANIMAL SKELETONS FOR SCIENTIFIC, INSTRUCTIONAL, AND EDUCATIONAL PURPOSES; LABORATORY GLASSWARE, PREPARED MICROSCOPE SLIDES, CLEANED MICROSCOPE SLIDES, MICROSCOPE SLIDES COVERS, GLASS STAINING JARS; TEACHING APPARATUS, NAMELY, FORMALIN-PRESERVED SPECIMEN OF ANIMALS, PLANTS, FUNGI; PLASTOMOUNTS IN THE NATURE OF A DISPLAY CASE FOR SCIENTIFIC SPECIMENS, POTOMETERS IN THE NATURE OF A TOOL USED TO MEASURE THE RATE OF WATER UPTAKE OF A LEAFY SHOOT, RESPIROMETERS IN THE NATURE

OF A TOOL USED TO MEASURE THE RATE OF RESPIRATION OF A LIVING ORGANISM, OSMOMETERS IN THE NATURE OF A TOOL USED TO MEASURE OSMOTIC PRESSURE, SENSORS AND DATA LOGGERS FOR MEASURING BIOLOGICAL DATA; SCIENTIFIC LABORATORY EQUIPMENT IN THE NATURE OF AUTOCLAVES, WEIGHING BALANCES, WATER THERMOSTATIC BATHS, OIL THERMOSTATIC BATHS, SAND THERMOSTATIC BATHS, HISTOLOGY BATHS, BUNSEN BURNERS, CENTRIFUGES, PAPER AND THIN LAYER CHROMATOGRAPHY APPARATUS IN THE NATURE OF TOOLS USED TO SEPARATE AND IDENTIFY MIXTURES THAT IS OR CAN BE COLORED, COLORIMETERS IN THE NATURE OF A TOOL USED TO STUDY COLOR PERCEPTION, ELECTROPHORESIS TANKS AND EQUIPMENT IN THE NATURE OF A TOOL USED TO MEASURE ELECTROKINETICS, LABORATORY FURNACES, FILTERING UNITS FOR LABORATORY USE, HOT PLATES FOR LABORATORY EXPERIMENTS, MUFFLES, NAMELY, A FURNACE USED FOR SCIENTIFIC EXPERIMENTS, INCUBATORS, VISCOMETERS, PHMETERS, PHOTOMETERS, FLUORIMETERS, GLASSWARE, JOINTED GLASSWARE, MAGNETIC STIRRERS, REFRACTOMETERS, SPECTROPHOTOMETERS, DISTILLATORS; TEACHING APPARATUS, NAMELY, SET OF METAMORPHIC, SEDIMENTARY, IGNEOUS ROCKS, SET OF ANIMAL AND PLANTS FOSSILS, SET OF REPRESENTATIVE MINERALS, THIN LAYER SECTIONS, GEOLOGY MODELS FOR FOLDS, FAULTS, AND TECTONICS IN THE NATURE OF TOOLS USED IN THE FIELD OF GEOLOGICAL STUDIES; HYGROMETERS, AND WEATHER STATIONS IN THE NATURE OF TOOLS USED IN THE FIELD OF STUDIES OF THE WEATHER; COMPASSES, BINOCULARS (U.S. CLS. 21, 23, 26, 36 AND 38).

CLASS 10—MEDICAL APPARATUS

FOR ELECTROCARDIOGRAPHS; STETHOSCOPES; PARTS AND FITTINGS FOR THE AFORESAID GOODS (U.S. CLS. 26, 39 AND 44).

CLASS 16—PAPER GOODS AND PRINTED MATTER

FOR PRINTED TEACHING MATERIALS IN THE FIELD OF SCIENCE; PLANETARIA; GEOGRAPHIC AND POLITICAL GLOBES (U.S. CLS. 2, 5, 22, 23, 29, 37, 38 AND 50).

CLASS 20—FURNITURE AND ARTICLES NOT OTHERWISE CLASSIFIED

FOR FURNITURE USED FOR TEACHING, NAMELY, TEACHERS' BENCHES, STUDENT BENCHES, WALL BENCHES, CUPBOARDS, WOODEN DISSECTION BOARDS; LABORATORY FURNITURE, NAMELY, LABORATORY CENTRAL BENCHES, BALANCE TABLES, STORAGE CUPBOARDS FOR INFLAMMABLE AND NON-INFLAMMABLE REAGENTS AND CHEMICALS, ALKALI AND ACID STORAGE CUPBOARDS (U.S. CLS. 2, 13, 22, 25, 32 AND 50).

ANN E. SAPPENFIELD, EXAMINING ATTORNEY

SN 79-062,965. HENKEL; KOMMANDITGESELLSCHAFT AUF AKTIEN, DÜSSELDORF, FED REP GERMANY, FILED 8-1-2008.

No-Sort-Formula

THE MARK CONSISTS OF STANDARD CHARACTERS WITHOUT CLAIM TO ANY PARTICULAR FONT, STYLE, SIZE, OR COLOR.

OWNER OF INTERNATIONAL REGISTRATION 0987132 DATED 8-1-2008, EXPIRES 8-1-2018.

CLASS 3—COSMETICS AND CLEANING PREPARATIONS

FOR BLEACHING PREPARATIONS AND OTHER SUBSTANCES FOR LAUNDRY USE, NAMELY, LAUNDRY DETERGENT, LAUNDRY SOAP, LAUNDRY PRE-SOAK; PREPARATIONS FOR WASHING DISHES AND LAUNDRY, NAMELY, DISH AND LAUNDRY DETERGENTS, FABRIC SOFTENER FOR LAUNDRY USE, STAIN REMOVING PREPARATIONS, LAUNDRY STARCH; CLEANING, POLISHING, SCOURING AND ABRASIVE PREPARATIONS; CLEANING PREPARATIONS FOR METAL, WOOD, STONE, PORCELAIN, GLASS, PLASTIC AND TEXTILES; SOAPS FOR HOUSEHOLD USE; PERFUMERY; ESSENTIAL OILS, COSMETICS, HAIR LOTIONS; DENTIFRICES (U.S. CLS. 1, 4, 6, 50, 51 AND 52).

CLASS 5—PHARMACEUTICALS

FOR ALL-PURPOSE DISINFECTANTS (U.S. CLS. 6, 18, 44, 46, 51 AND 52).
TIMOTHY FINNEGAN, EXAMINING ATTORNEY

SN 79-063,102. ABB TURBO SYSTEMS AG, BADEN, SWITZERLAND, FILED 10-20-2008.

CPEX

THE MARK CONSISTS OF STANDARD CHARACTERS WITHOUT CLAIM TO ANY PARTICULAR FONT, STYLE, SIZE, OR COLOR.

PRIORITY DATE OF 7-16-2008 IS CLAIMED.
OWNER OF INTERNATIONAL REGISTRATION 0987519 DATED 10-20-2008, EXPIRES 10-20-2018.

CLASS 7—MACHINERY

FOR TURBO COMPRESSORS FOR INTERNAL COMBUSTION ENGINES, IN PARTICULAR DIESEL ENGINES AND GAS ENGINES, PREFERABLY FOR POWERING STATIONARY GENERATORS AND LOCOMOTIVES; STRUCTURAL PARTS AND ACCESSORIES FOR TURBO COMPRESSORS, NAMELY, GAS TURBINES NOT FOR LAND VEHICLES; COMPRESSORS FOR AIR AND AIR-GAS MIXTURES; BEARINGS BEING MACHINE PARTS; LUBRICATION PUMPS; GAS AND AIR CHAMBERS; AIR FILTERS FOR MECHANICAL PURPOSES AND COUPLINGS FOR MACHINES (U.S. CLS. 13, 19, 21, 23, 31, 34 AND 35).

CLASS 37—CONSTRUCTION AND REPAIR

FOR MAINTENANCE OF TURBO COMPRESSORS, CORRECTIVE MAINTENANCE OF TURBO COMPRESSORS, SERVICING OF TURBO COMPRESSORS, REPAIR OF TURBO COMPRESSORS AND INSTALLATIONS CONTAINING TURBOCOMPRESSORS, INSTALLATION SERVICES OF TURBO COMPRESSORS (U.S. CLS. 100, 103 AND 106).

DOMINIC FATHY, EXAMINING ATTORNEY

SN 79-063,118. LAUTSPRECHER TEUFEL GMBH, FED REP GERMANY, FILED 10-14-2008.

Cinebar

THE MARK CONSISTS OF STANDARD CHARACTERS WITHOUT CLAIM TO ANY PARTICULAR FONT, STYLE, SIZE, OR COLOR.

PRIORITY DATE OF 5-14-2008 IS CLAIMED.
OWNER OF INTERNATIONAL REGISTRATION 0987562 DATED 10-14-2008, EXPIRES 10-14-2018.

CLASS 9—ELECTRICAL AND SCIENTIFIC APPARATUS

FOR APPARATUS FOR RECORDING, TRANSMISSION OR REPRODUCTION OF SOUND OR IMAGES; LOUDSPEAKERS (U.S. CLS. 21, 23, 26, 36 AND 38).

CLASS 35—ADVERTISING AND BUSINESS

FOR ADVERTISING (U.S. CLS. 100, 101 AND 102).

CLASS 41—EDUCATION AND ENTERTAINMENT

FOR ENTERTAINMENT AND CULTURAL ACTIVITIES, NAMELY, ORGANIZING EXHIBITIONS FOR CULTURAL AND ENTERTAINMENT PURPOSES (U.S. CLS. 100, 101 AND 107).

MATTHEW KLINE, EXAMINING ATTORNEY

SN 79-063,126. KOR LANDA CORPORATION, PHILIPPINES, FILED 10-24-2008.



MATIÈRES À EXPLORER

PRIORITY DATE OF 5-20-2008 IS CLAIMED.
OWNER OF INTERNATIONAL REGISTRATION 0987575 DATED 10-24-2008, EXPIRES 10-24-2018.

NO CLAIM IS MADE TO THE EXCLUSIVE RIGHT TO USE "MATIERES", APART FROM THE MARK AS SHOWN. THE COLOR(S) TAN AND WHITE IS/ARE CLAIMED AS A FEATURE OF THE MARK.

THE MARK CONSISTS OF THE TERM "KOR LANDA" IN WHITE, SET AGAINST A TAN BACKGROUND; BELOW THIS APPEARS THE TERM "MATIERES A EXPLORER" IN TAN. THE OVERALL BACKGROUND OF THE ENTIRE MARK IS WHITE.

THE ENGLISH TRANSLATION OF "MATIERES A EXPLORER" IN THE MARK IS MATERIALS TO EXPLORE. THE WORDING "KOR LANDA" HAS NO MEANING IN A FOREIGN LANGUAGE.

CLASS 3—COSMETICS AND CLEANING PREPARATIONS

FOR BLEACHING PREPARATIONS FOR LAUNDRY USE, POLISHING, SCOURING AND ABRASIVE PREPARATIONS; SOAPS; PERFUMERY, ESSENTIAL OILS, COSMETICS, HAIR LOTIONS; DENTIFRICES (U.S. CLS. 1, 4, 6, 50, 51 AND 52).

CLASS 14—JEWELRY

FOR PRECIOUS METALS AND THEIR ALLOYS; JEWELRY, PRECIOUS STONES; TIMEPIECES AND CHRONOMETRIC INSTRUMENTS (U.S. CLS. 2, 27, 28 AND 50).

CLASS 35—ADVERTISING AND BUSINESS

FOR ADVERTISING; RETAIL STORE SERVICES FEATURING JEWELRY, COSMETIC AND PERFUMERY PRODUCTS (U.S. CLS. 100, 101 AND 102).

CLASS 42—SCIENTIFIC AND COMPUTER SERVICES

FOR GRAPHIC ARTS DESIGN SERVICES; INDUSTRIAL DESIGN SERVICES; DESIGN OF JEWELRY FOR OTHERS (U.S. CLS. 100 AND 101).
JIM RINGLE, EXAMINING ATTORNEY

SN 79-063,254. IMCELLA INTERNATIONAL AS, NORWAY, FILED 9-15-2008.

IMCELLA

THE MARK CONSISTS OF STANDARD CHARACTERS WITHOUT CLAIM TO ANY PARTICULAR FONT, STYLE, SIZE, OR COLOR.

PRIORITY DATE OF 9-2-2008 IS CLAIMED.
OWNER OF INTERNATIONAL REGISTRATION 0987886 DATED 9-15-2008, EXPIRES 9-15-2018.

THE WORDING "IMCELLA" HAS NO MEANING IN A FOREIGN LANGUAGE.

CLASS 10—MEDICAL APPARATUS

FOR MEDICAL APPARATUS AND INSTRUMENTS, NAMELY, PHOTOTHERAPY LASERS FOR MEDICAL PURPOSES (U.S. CLS. 26, 39 AND 44).

CLASS 42—SCIENTIFIC AND COMPUTER SERVICES

FOR TECHNICAL AND TECHNOLOGICAL RESEARCH RELATING TO MEDICAL APPARATUS (U.S. CLS. 100 AND 101).

CLASS 44—MEDICAL, BEAUTY AND AGRICULTURAL SERVICES

FOR MEDICAL LASER TREATMENT, NAMELY, PROVIDING LASER PHOTOTHERAPY FOR TREATING MEDICAL CONDITIONS (U.S. CLS. 100 AND 101).
MYRIAH HABEEB, EXAMINING ATTORNEY

SN 79-063,259. RITTAL GMBH & CO. KG, FED REP GERMANY, FILED 10-24-2008.

TopPult

THE MARK CONSISTS OF STANDARD CHARACTERS WITHOUT CLAIM TO ANY PARTICULAR FONT, STYLE, SIZE, OR COLOR.

OWNER OF INTERNATIONAL REGISTRATION 0987903 DATED 10-24-2008, EXPIRES 10-24-2018.

CLASS 6—METAL GOODS

FOR PORTABLE BUILDINGS OF METAL; COMPONENTS OF METAL FOR SWITCH CUPBOARDS, NAMELY, RACK PANELS, METAL PROFILES FOR ARRANGING DEVICES ON AND IN WALLS, CEILINGS AND OTHER SURFACES, MOUNTING PLATES, METAL RAILS FOR BUILDINGS, NAMELY, GUIDE RAILS AND MOUNTING RAILS, CONTAINERS OF METAL FOR BURGLARPROOF AND FIREPROOF STORAGE AND PROTECTION OF ELECTRONIC DATA PROCESSING HARDWARE COMPONENTS, METAL CONTAINERS FOR TRANSPORT AND STORAGE; FACINGS OF SHEET METAL, NAMELY, DOORS, WALL PANELS; CLOSING DEVICES OF METAL, NAMELY, DOOR LOCKS; POSITIONING AND MOVEMENT DEVICES OF METAL, NAMELY, COVE BASES AND ROLLERS FOR MOVING CABINETS AND COMPARTMENTS; MOUNTING DEVICES AND AUXILIARY MOUNTING DEVICES, FIXED OR MOVEABLE, OF METAL, NAMELY, MOUNTING PLATES, SWIVEL ARMS, SHELVES; FASTENING DEVICES OF METAL, NAMELY, BEARING ANGLES IN THE NATURE OF ANGLE IRONS (U.S. CLS. 2, 12, 13, 14, 23, 25 AND 50).

CLASS 9—ELECTRICAL AND SCIENTIFIC APPARATUS

FOR ELECTRICAL SWITCH CABINETS OF METAL AND/OR PLASTIC, AND RACKS AND HOUSINGS THEREFOR, MAINLY FOR USE IN INDUSTRY, INSTALLATION, ELECTRONICS, TELECOMMUNICATIONS, DATA PROCESSING, INTERACTIVE TERMINAL SYSTEMS AND DATA TRANSMISSION, INCLUDING THE AFORESAID GOODS IN CONNECTION WITH BRACKET SYSTEMS AND/OR EARTHQUAKE AND/OR VANDAL AND/OR EXPLOSION PROOF; COMPONENTS OF ELECTRICAL SWITCH CABINETS, NAMELY, SUBRACKS FOR PLUG-IN UNITS WITH ELECTRONIC CIRCUITS; SIGNALLING DEVICES FOR MONITORING AND SECURING SWITCH CUPBOARDS, NAMELY, OPTICAL AND ACOUSTIC SIGNAL EMITTERS; CURRENT DISTRIBUTION COMPONENTS, NAMELY, ADAPTORS FOR CONNECTORS AND DEVICES, AND LOAD-BREAKERS; MODULES AND SYSTEM COMPONENTS FOR ENERGY SUBDISTRIBUTION, AND POWER SUPPLIES, NAMELY, POWER SUPPLY UNITS, ELECTRIC ACCUMULATORS; POWER-SUPPLYING APPARATUS, NAMELY, UNINTERRUPTIBLE POWER SUPPLIES, IN MODULAR FORM AND NON-MODULAR FORM; DC/AC POWER CONVERTERS AND POWER INVERTERS; CABLE DUCTS FOR ELECTRIC PURPOSES; OVERLOAD PROTECTION DEVICES FOR SENSITIVE ELECTRONIC APPARATUS AND COMPUTERS, NAMELY, FUSES AND MONITORING UNITS; ELECTRIC AND ELECTRONIC CONTROL APPARATUS AND INSTALLATIONS CONSTRUCTED THEREFROM, AND ELECTRIC AND ELECTRONIC APPARATUS AND INSTRUMENTS, NAMELY, CONTROLLERS FOR CONTROL STATIONS, CONTROL ROOMS, CONSOLE WORKSTATIONS; CONFIGURATION AND MONITORING SOFTWARE FOR SECURITY AREAS FOR INFORMATION TECHNOLOGY; AUXILIARY CABLING DEVICES FOR ELECTRIC PURPOSES, OF METAL OR PLASTIC, NAMELY, CABLE MANAGEMENT MODULES CONSISTING OF CABLE GUIDE CHANNELS, CABLE REROUTING CHANNELS, CABLE FASTENERS FOR

ELECTRIC CABLES IN THE NATURE OF CABLE SUPPORT RAILS OF PLASTIC OR METAL, AND CABLE ENTRIES; PLUG-IN UNITS FOR SUB-RACKS, NAMELY, PLUG-IN CARDS, BUS BOARDS, CASSETTES, PIN AND SOCKET CONNECTORS; AND STRUCTURAL PARTS FOR ALL THE AFORESAID GOODS (U.S. CLS. 21, 23, 26, 36 AND 38).

CLASS 11—ENVIRONMENTAL CONTROL APPARATUS

FOR APPARATUS FOR AIR-CONDITIONING, IN PARTICULAR COOLING APPARATUS, HEAT EXCHANGERS, AIR FILTERS, HEATING APPARATUS, AND LIQUID COOLING APPARATUS, IN PARTICULAR FOR SWITCH CABINETS; AIR-CONDITIONING APPARATUS AND AIR-CONDITIONING EQUIPMENT CONSTRUCTED THEREFROM, NAMELY, ROOM AIR CONDITIONERS; INSTALLATION ACCESSORIES, NAMELY, SWITCH CABINET LIGHTS (U.S. CLS. 13, 21, 23, 31 AND 34).

CLASS 19—NON-METALLIC BUILDING MATERIALS

FOR FACINGS OF GLASS OR PLASTIC, NAMELY, DOORS AND WALL PANELS (U.S. CLS. 1, 12, 33 AND 50).

VIVIAN MICZNIK FIRST, EXAMINING ATTORNEY

SN 79-063,273. KBA-GIORI S.A., SWITZERLAND, FILED 11-24-2008.

NotaMesh

THE MARK CONSISTS OF STANDARD CHARACTERS WITHOUT CLAIM TO ANY PARTICULAR FONT, STYLE, SIZE, OR COLOR.

PRIORITY DATE OF 6-13-2008 IS CLAIMED.

OWNER OF INTERNATIONAL REGISTRATION 0987940 DATED 11-24-2008, EXPIRES 11-24-2018.

OWNER OF U.S. REG. NOS. 2,009,490, 3,271,703 AND OTHERS.

CLASS 7—MACHINERY

FOR MECHANICALLY-OPERATED MACHINES FOR MAKING AND PACKING BANK-NOTES; MECHANICALLY-OPERATED MACHINES USED FOR PRINTING BANK-NOTES; MACHINES FOR APPLYING SECURITY FEATURES TO PAPER SECURITIES, IN PARTICULAR TO BANK-NOTES AND SECURITY PAPER; MECHANICALLY-OPERATED MACHINES FOR MANUFACTURING SECURITY DOCUMENTS AND PAPER SECURITIES WITH BIOMETRIC DATA (U.S. CLS. 13, 19, 21, 23, 31, 34 AND 35).

CLASS 9—ELECTRICAL AND SCIENTIFIC APPARATUS

FOR ELECTRONIC APPARATUS AND MACHINES FOR CONTROLLING THE PRINT QUALITY OF PRINTED DOCUMENTS, ESPECIALLY OF BANK-NOTES AND SECURITY PAPER; ELECTRONIC APPARATUS AND MACHINES FOR SORTING BANK-NOTES; ELECTRONIC MACHINES FOR MEASURING AND CHECKING BIOMETRIC DATA (U.S. CLS. 21, 23, 26, 36 AND 38).

CLASS 37—CONSTRUCTION AND REPAIR

FOR REPAIR SERVICES FOR MECHANICALLY-OPERATED OR ELECTRONIC MACHINES USED FOR MAKING AND/OR PRINTING AND/OR CHECKING AND/OR NUMBERING BANK NOTES AND SECURITY PAPERS (U.S. CLS. 100, 103 AND 106).

JAMES STEIN, EXAMINING ATTORNEY

SN 79-063,329. INTERKAT KATALYSATOREN GMBH, FED REP GERMANY, FILED 7-9-2008.

INTERKAT

THE MARK CONSISTS OF STANDARD CHARACTERS WITHOUT CLAIM TO ANY PARTICULAR FONT, STYLE, SIZE, OR COLOR.

OWNER OF INTERNATIONAL REGISTRATION 0988072 DATED 7-9-2008, EXPIRES 7-9-2018.

CLASS 7—MACHINERY

FOR MOTORS AND ENGINES (EXCEPT FOR LAND VEHICLES); PARTS OF MOTORS AND ENGINES AND CARBURETORS, IN PARTICULAR FOR EXHAUST RETROFITTING AND CATALYTIC CONVERTERS; CATALYTIC CONVERTERS; FILTERS BEING PARTS OF MACHINES OR ENGINES (U.S. CLS. 13, 19, 21, 23, 31, 34 AND 35).

CLASS 12—VEHICLES

FOR VEHICLES, NAMELY, AUTOMOBILES, ALL-TERRAIN VEHICLES, BUSES, CARS, MOTORCYCLES, BICYCLES, TRUCKS, SUV'S, PICK-UP TRUCKS, VANS, BOATS, AIRPLANES, AND TRAILERS; MOTORS AND ENGINES FOR LAND VEHICLES AND REPLACEMENT COMPONENTS THEREOF (U.S. CLS. 19, 21, 23, 31, 35 AND 44).

CLASS 37—CONSTRUCTION AND REPAIR

FOR REPAIR INFORMATION IN CONNECTION WITH LAND VEHICLES; VEHICLE MAINTENANCE; VEHICLE SERVICE STATIONS; INSTALLATION, MAINTENANCE AND REPAIR OF MACHINES IN CONNECTION WITH EXHAUST GAS REDUCTION SYSTEMS AND/OR CATALYTIC CONVERTERS; RECONDITIONING MACHINES, MOTORS AND ENGINES THAT HAVE BEEN WORN OR PARTIALLY DESTROYED; REPAIR AND MAINTENANCE OF MOTORS (U.S. CLS. 100, 103 AND 106).

CLASS 40—MATERIAL TREATMENT

FOR TREATMENT OF MATERIALS, NAMELY, COATING OF MOTOR AND ENGINE PARTS FOR LAND, AIR OR WATER VEHICLES, FOR AGRICULTURAL, FORESTRY AND INDUSTRIAL MACHINERY, FOR POWER TOOLS, AND FOR GENERATORS FOR REDUCING WASTE GAS EMISSIONS; COATING OF CATALYTIC CONVERTER BEARING ELEMENTS AND/OR FILTERS FOR THE AUTOMOBILE INDUSTRY; PROVIDING INFORMATION REGARDING MATERIAL TREATMENT IN THE FIELD OF COATING OF MOTOR AND ENGINE PARTS FOR LAND, AIR OR WATER VEHICLES, FOR AGRICULTURAL, FORESTRY AND INDUSTRIAL MACHINERY, FOR POWER TOOLS, AND FOR GENERATORS FOR REDUCING WASTE GAS EMISSIONS; CUSTOM ASSEMBLING FOR OTHERS, NAMELY, ASSEMBLING OF MOTORS AND ENGINES AND MOTOR AND ENGINE PARTS FOR LAND, AIR AND WATER VEHICLES, FOR AGRICULTURAL, FORESTRY AND INDUSTRIAL MACHINERY, FOR POWER TOOLS, FOR GENERATORS (U.S. CLS. 100, 103 AND 106).

CLASS 42—SCIENTIFIC AND COMPUTER SERVICES

FOR SCIENTIFIC RESEARCH SERVICES AND INDUSTRIAL ANALYSIS SERVICES IN THE FIELD OF WASTE GAS EMISSION REDUCTION TECHNOLOGY FOR MOTORS AND ENGINES; DESIGN SERVICES IN THE FIELD OF WASTE GAS EMISSION REDUCTION TECHNOLOGY FOR MOTORS AND ENGINES; ENGINEERING SERVICES IN THE FIELD OF WASTE GAS EMISSION REDUCTION TECHNOLOGY FOR MOTORS AND ENGINES; TECHNICAL CONSULTING SERVICES RELATING TO WASTE GAS EMISSION REDUCTION TECHNOLOGY FOR MOTORS AND ENGINES; TECHNICAL CONSULTANCY, NAMELY, IN THE FIELD OF SOOT AND EXHAUST EMISSIONS REDUCTION AND CATALYTIC CONVERTERS FOR LAND VEHICLES (U.S. CLS. 100 AND 101).

THOMAS MANOR, EXAMINING ATTORNEY

SN 79-063,340. ENDEKA CERAMICS HOLDING S.L., SPAIN, FILED 10-2-2008.

ENDEKA

THE MARK CONSISTS OF STANDARD CHARACTERS WITHOUT CLAIM TO ANY PARTICULAR FONT, STYLE, SIZE, OR COLOR.

PRIORITY DATE OF 6-12-2008 IS CLAIMED.

OWNER OF INTERNATIONAL REGISTRATION 0988108 DATED 10-2-2008, EXPIRES 10-2-2018.

THE ENGLISH TRANSLATION OF "ENDEKA" IN THE MARK IS ELEVEN.

CLASS 1—CHEMICALS

FOR CHEMICAL ZIRCONIUM CONNECTORS FOR INDUSTRIAL PURPOSES, NAMELY, GROUND ZIRCONIUM SILICATES USE IN THE MANUFACTURE OF HEAT RESILIENT MATERIALS AS WELL AS CASTINGS AND CERAMIC INDUSTRY; CHEMICALS FOR INDUSTRIAL PURPOSES; ZIRCONIUM ORE FOR INDUSTRIAL PURPOSES, NAMELY, FOR USE IN MANUFACTURE OF TILES, SANITARY WARE, TABLEWARE, ELECTROPORCELAIN, REFRACTORIES FOR GLASS FURNACES, INVESTMENT CASTINGS, FOUNDRY POWDERS, FLAT GLASS, DENTAL POWDERS; SILICIC ACID ZIRCONIUM; GRINDING SILICIC ACID ZIRCONIUM; CHEMICAL COMPOUNDS OF ZIRCONIUM FOR USE IN INDUSTRY; ZIRCONIUM SILICATES; ZIRCONIUM SILICATES FOR USE AS THERMOSETTING PLASTIC REFRACTORY MATERIAL AND AS OPACIFIERS; ZIRCONIUM SILICATES FOR USE IN MANUFACTURING BUILDING MATERIALS IN THE NATURE OF GLASS, CERAMICS, POTTERY, EARTHENWARE AND PORCELAIN; ZIRCONIUM SILICATES FOR USE AS GLAZE OPACIFIERS; ZIRCONIUM SILICATES FOR USE IN MANUFACTURING CERAMIC GLAZES, OPTICAL GLASS AND HEAT-RESISTANT PORCELAIN; CHEMICALS FOR USE AS FLAME RETARDANTS; FIRE- EXTINGUISHING COMPOSITIONS; CHEMICALS CONTAINING ANTIMONY, ZIRCONIUM OR ZINC OR COMPOUNDS OF ANTIMONY, ZIRCONIUM OR ZINC, OR COMBINATIONS THEREOF, ALL FOR USE IN INDUSTRY AND SCIENCE; UNPROCESSED ACRYLIC RESINS; ADHESIVES FOR INDUSTRIAL PURPOSES; ADHESIVES FOR WALL TILES; AGGLUTINANTS FOR CONCRETE, NAMELY, ADHESIVES FOR CEMENT MANUFACTURED PRODUCTS; ALKALINE IODIDES FOR INDUSTRIAL PURPOSES; ALUMINA; ALUMINUM CHLORIDE; ALUMINUM IODIDE; ALUMINUM SILICATE; COLOR BRIGHTENING CHEMICALS FOR INDUSTRIAL PURPOSES; CERAMIC GRANULES AND POWDER COMPOSITIONS USED IN MANUFACTURING BY SINTERING; CERAMIC GLAZINGS; COMPOSITIONS, NAMELY, CERAMIC COMPOSITIONS, INORGANIC POLYMERIC COMPOSITIONS FOR THE MANUFACTURE OF TECHNICAL CERAMICS; COBALT OXIDE FOR INDUSTRIAL PURPOSES; CHE-

MICALS, NAMELY, DECOLORANTS FOR INDUSTRIAL PURPOSES; CHEMICAL PREPARATIONS, EXCEPT PIGMENTS, NAMELY, ALCOHOL, CHEMICAL VEHICLES, WETTING AGENTS FOR THE MANUFACTURE OF ENAMEL; CHEMICALS FOR THE MANUFACTURE OF ENAMEL, NAMELY, OPACIFIERS FOR ENAMEL; CHEMICAL PRODUCTS FOR THE PREPARATION OF ENAMEL-STAINS; OPACIFIERS FOR GLASS, NAMELY, CHEMICALS USED TO REGULATE TRANSPARENCY IN GLASS PRODUCTION; GLASS-FROSTING CHEMICALS, NAMELY, ETCHING GELS AND SOLUTIONS; CHEMICAL PREPARATIONS, NAMELY, WETTING AGENTS, CHEMICAL VEHICLES FOR USE IN THE MANUFACTURE OF PAINTS; PRESERVATIVES FOR TILES, EXCEPT PAINTS AND OILS; SILICON; SILICATES FOR INDUSTRIAL AND SCIENTIFIC USE; SODIUM; SOLVENTS FOR VARNISHES, NAMELY, WETTING AGENTS FOR USE IN THE MANUFACTURE OF VARNISHES; ANTIMONY (U.S. CLS. 1, 5, 6, 10, 26 AND 46).

CLASS 2—PAINTS

FOR NON-TRANSPARENT GLAZES INCLUDING SILICIC ACID ZIRCONIUM USED FOR CERAMIC PRODUCTS, POTTERY, CROCKERY AND PORCELAIN; NON-TRANSPARENT COATING INCLUDING SILICIC ACID ZIRCONIUM USED FOR CERAMIC PRODUCTS, POTTERY, CROCKERY AND PORCELAIN; DYEING PREPARATION INCLUDING SILICIC ACID ZIRCONIUM USED FOR CERAMIC PRODUCTS, GLAZES, POTTERY, CROCKERY AND PORCELAIN; BINDING PREPARATIONS FOR PAINTS; BRIGHT GOLD AND BRIGHT PLATINUM COLORANTS FOR USE IN THE MANUFACTURE OF CERAMICS; CERAMIC PAINTS; COATINGS, NAMELY, COATING COMPOSITION IN THE NATURE OF PAINT FOR INDUSTRIAL APPLICATIONS; ENAMELS FOR PAINTING; ENAMEL VARNISHES; GLAZES, NAMELY, PAINTS AND LACQUERS; GLAZES, NAMELY, PAINTS AND LACQUERS FOR USE IN SANITARY WARE, TABLEWARE AND ELECTRICAL PORCELAIN MARKETS; LACQUERS; PIGMENTS, NAMELY, ZINC OXIDE (U.S. CLS. 6, 11 AND 16).

CLASS 19—NON-METALLIC BUILDING MATERIALS

FOR CERAMIC TILES; FLOOR BRICKS; NON-METAL REFRACTORY MATERIALS, NAMELY, FIRED REFRACTORY MATERIALS, CERAMIC SHAPES, REFRACTORY FURNACE LININGS FOR USE IN LINING FURNACES OR OVENS AND NON-METAL REFRACTORY BRICKS; TILES, NOT OF METAL, FOR BUILDINGS; WALL TILES, NOT OF METAL; FLOOR TILES, NOT OF METAL; WAINSCOTTING, NOT OF METAL; NON-METAL COVERINGS FOR BUILDING, NAMELY, ROOF COVERINGS; TILE FLOORINGS, NOT OF METAL; GLASS MOSAICS FOR BUILDING; NON-METAL MOSAIC TILES FOR BUILDING; BUILDING PANELS NOT OF METAL, NAMELY, DOOR PANELS, CEILING PANELS, FLOOR PANELS; PAVING BLOCKS, NOT OF METAL; STONE FOR BUILDING AND CONSTRUCTION; ARTIFICIAL STONE; BUILDING STONES; FIRE BURRS, NAMELY, FIREPLACE BRICKS; CABANAS NOT OF METAL FLOORS, NOT OF METAL; NON-METAL CABANAS, NAMELY, PREFABRICATED NON-METAL BUILDINGS (U.S. CLS. 1, 12, 33 AND 50).

HEATHER BIDDULPH, EXAMINING ATTORNEY

SN 79-063,683. MAXI MILIAAN B.V., NETHERLANDS, FILED 11-25-2008.

URBAN IQ

THE MARK CONSISTS OF STANDARD CHARACTERS WITHOUT CLAIM TO ANY PARTICULAR FONT, STYLE, SIZE, OR COLOR.

PRIORITY DATE OF 10-17-2008 IS CLAIMED.

OWNER OF INTERNATIONAL REGISTRATION 0988848
DATED 11-25-2008, EXPIRES 11-25-2018.

CLASS 12—VEHICLES

FOR BABY CARRIAGES, NAMELY, PUSHCHAIRS, BUGGIES, AND PRAMS, AND STRUCTURAL PARTS THEREFOR, SAFETY SEATS FOR CHILDREN AND BABIES FOR VEHICLES FOR TRANSPORT BY LAND, AIR AND WATER, AND PARTS THEREFOR SOLD AS A UNIT WITH THE GOODS, SAFETY BELTS FOR VEHICLE SEATS FOR CHILDREN AND ADULTS, WHEELED SUPPORTS FOR CAR SEATS FOR CAR SEATS FOR CHILDREN AND BABIES FOR USE AS A STROLLER, FITTED COVERS AND INSERTS ADAPTED TO CAR SEATS (U.S. CLS. 19, 21, 23, 31, 35 AND 44).

CLASS 18—LEATHER GOODS

FOR LEATHER AND IMITATIONS OF LEATHER, ANIMAL SKINS, ANIMAL HIDES, TRUNKS AND TRAVELING BAGS, UMBRELLAS, PARASOLS AND WALKING STICKS, WHIPS, HARNESS AND SADDLERY; CARRIER BAGS AND BELLY CARRIERS FOR BABIES AND CHILDREN (U.S. CLS. 1, 2, 3, 22 AND 41).
LESLIE RICHARDS, EXAMINING ATTORNEY

SN 79-063,688. MAXI MILIAAN B.V., NETHERLANDS,
FILED 11-25-2008.



PRIORITY DATE OF 10-17-2008 IS CLAIMED.
OWNER OF INTERNATIONAL REGISTRATION 0988876
DATED 11-25-2008, EXPIRES 11-25-2018.

CLASS 12—VEHICLES

FOR BABY CARRIAGES, NAMELY, PUSHCHAIRS, BUGGIES, AND PRAMS, AND STRUCTURAL PARTS THEREFOR, SAFETY SEATS FOR CHILDREN AND BABIES FOR VEHICLES FOR TRANSPORT BY LAND, AIR AND WATER, AND PARTS THEREFOR SOLD AS A UNIT WITH THE GOODS, SAFETY BELTS FOR VEHICLE SEATS FOR CHILDREN AND ADULTS, WHEELED SUPPORTS FOR CAR SEATS FOR CAR SEATS FOR CHILDREN AND BABIES FOR USE AS A STROLLER, FITTED COVERS AND INSERTS ADAPTED TO CAR SEATS (U.S. CLS. 19, 21, 23, 31, 35 AND 44).

CLASS 18—LEATHER GOODS

FOR LEATHER AND IMITATIONS OF LEATHER, ANIMAL SKINS, ANIMAL HIDES, TRUNKS AND TRAVELING BAGS, UMBRELLAS, PARASOLS AND WALKING STICKS, WHIPS, HARNESS AND SADDLERY; CARRIER BAGS AND BELLY CARRIERS FOR BABIES AND CHILDREN (U.S. CLS. 1, 2, 3, 22 AND 41).
LESLIE RICHARDS, EXAMINING ATTORNEY

SN 79-063,693. RITTAL GMBH & CO. KG, FED REP
GERMANY, FILED 10-24-2008.

TopPultSystem

THE MARK CONSISTS OF STANDARD CHARACTERS WITHOUT CLAIM TO ANY PARTICULAR FONT, STYLE, SIZE, OR COLOR.

OWNER OF INTERNATIONAL REGISTRATION 0988897
DATED 10-24-2008, EXPIRES 10-24-2018.

CLASS 6—METAL GOODS

FOR PORTABLE BUILDINGS OF METAL; COMPONENTS OF METAL FOR SWITCH CUPBOARDS, NAMELY, RACK PANELS, METAL PROFILES FOR ARRANGING DEVICES ON AND IN WALLS, CEILINGS AND OTHER SURFACES, MOUNTING PLATES, METAL RAILS FOR BUILDINGS, NAMELY, GUIDE RAILS AND MOUNTING RAILS, CONTAINERS OF METAL FOR BURGLARPROOF AND FIREPROOF STORAGE AND PROTECTION OF ELECTRONIC DATA PROCESSING HARDWARE COMPONENTS, METAL CONTAINERS FOR TRANSPORT AND STORAGE; FACINGS OF SHEET METAL, NAMELY, DOORS, WALL PANELS; CLOSING DEVICES OF METAL, NAMELY, DOOR LOCKS; POSITIONING AND MOVEMENT DEVICES OF METAL, NAMELY, COVE BASES AND ROLLERS FOR MOVING CABINETS AND COMPARTMENTS; MOUNTING DEVICES AND AUXILIARY MOUNTING DEVICES, FIXED OR MOVEABLE, OF METAL, NAMELY, MOUNTING PLATES, SWIVEL ARMS, SHELVES; FASTENING DEVICES OF METAL, NAMELY, BEARING ANGLES IN THE NATURE OF ANGLE IRONS (U.S. CLS. 2, 12, 13, 14, 23, 25 AND 50).

CLASS 9—ELECTRICAL AND SCIENTIFIC APPARATUS

FOR ELECTRICAL SWITCH CABINETS OF METAL AND/OR PLASTIC, AND RACKS AND HOUSINGS THEREFOR, MAINLY FOR USE IN INDUSTRY, INSTALLATION, ELECTRONICS, TELECOMMUNICATIONS, DATA PROCESSING, INTERACTIVE TERMINAL SYSTEMS AND DATA TRANSMISSION, INCLUDING THE AFORESAID GOODS IN CONNECTION WITH BRACKET SYSTEMS AND/OR EARTHQUAKE AND/OR VANDAL AND/OR EXPLOSION PROOF; COMPONENTS OF ELECTRICAL SWITCH CABINETS, NAMELY, SUBRACKS FOR PLUG-IN UNITS WITH ELECTRONIC CIRCUITS; SIGNALLING DEVICES FOR MONITORING AND SECURING SWITCH CUPBOARDS, NAMELY, OPTICAL AND ACOUSTIC SIGNAL EMITTERS; CURRENT DISTRIBUTION COMPONENTS, NAMELY, ADAPTORS FOR CONNECTORS AND DEVICES, AND LOAD-BREAKERS; MODULES AND SYSTEM COMPONENTS FOR ENERGY SUBDISTRIBUTION, AND POWER SUPPLIES, NAMELY, POWER SUPPLY UNITS, ELECTRIC ACCUMULATORS; POWER-SUPPLYING APPARATUS, NAMELY, UNINTERRUPTIBLE POWER SUPPLIES, IN MODULAR FORM AND NON-MODULAR FORM; DC/AC POWER CONVERTERS AND POWER INVERTERS; CABLE DUCTS FOR ELECTRIC PURPOSES; OVERLOAD PROTECTION DEVICES FOR SENSITIVE ELECTRONIC APPARATUS AND COMPUTERS, NAMELY, FUSES AND MONITORING UNITS; ELECTRIC AND ELECTRONIC CONTROL APPARATUS AND INSTALLATIONS CONSTRUCTED THEREFROM, AND ELECTRIC AND ELECTRONIC APPARATUS AND INSTRUMENTS, NAMELY, CONTROLLERS FOR CONTROL STATIONS, CONTROL ROOMS, CONSOLE WORKSTATIONS; CONFIGURATION AND MONITORING SOFTWARE FOR SECURITY AREAS FOR INFORMATION TECHNOLOGY; AUXILIARY CABLING DEVICES FOR ELECTRIC PURPOSES, OF METAL OR PLASTIC, NAMELY, CABLE MANAGEMENT MODULES CONSISTING OF CABLE GUIDE CHANNELS, CABLE REROUTING CHANNELS, CABLE FASTENERS FOR ELECTRIC CABLES IN THE NATURE OF CABLE SUPPORT RAILS OF PLASTIC OR METAL, AND CABLE ENTRIES; PLUG-IN UNITS FOR SUB-RACKS, NAMELY, PLUG-IN CARDS, BUS BOARDS, CASSETTES, PIN AND

SOCKET CONNECTORS; AND STRUCTURAL PARTS FOR ALL THE AFORESAID GOODS (U.S. CLS. 21, 23, 26, 36 AND 38).

CLASS 11—ENVIRONMENTAL CONTROL APPARATUS

FOR APPARATUS FOR AIR-CONDITIONING, IN PARTICULAR COOLING APPARATUS, HEAT EXCHANGERS, AIR FILTERS, HEATING APPARATUS, AND LIQUID COOLING APPARATUS, IN PARTICULAR FOR SWITCH CABINETS; AIR-CONDITIONING APPARATUS AND AIR-CONDITIONING EQUIPMENT CONSTRUCTED THEREFROM, NAMELY, ROOM AIR CONDITIONERS; INSTALLATION ACCESSORIES, NAMELY, SWITCH CABINET LIGHTS (U.S. CLS. 13, 21, 23, 31 AND 34).

CLASS 19—NON-METALLIC BUILDING MATERIALS

FOR POSITIONING AND MOVEMENT DEVICES OF PLASTIC, NAMELY, COVE BASES; FACINGS OF GLASS OR PLASTIC, NAMELY, DOORS AND WALL PANELS (U.S. CLS. 1, 12, 33 AND 50).

VIVIAN MICZNIK FIRST, EXAMINING ATTORNEY

SN 79-063,790. FLOS S.P.A., ITALY, FILED 10-15-2008.



OWNER OF INTERNATIONAL REGISTRATION 0989201 DATED 10-15-2008, EXPIRES 10-15-2018.

OWNER OF U.S. REG. NOS. 920,102 AND 3,348,799.

THE MARK CONSISTS OF THE WORDING "FLOS" WITHIN A SQUARE DESIGN NEXT TO THE WORD "CUBO". A FINGERPRINT DESIGN APPEARS IN THE UPPER RIGHT CORNER.

THE ENGLISH TRANSLATION OF THE WORD "FLOS" IN THE MARK IS FLOWER. THE ENGLISH TRANSLATION OF THE WORD "CUBO" IN THE MARK IS CUBE.

CLASS 9—ELECTRICAL AND SCIENTIFIC APPARATUS

FOR REMOTE CONTROL DEVICE FOR HOUSEHOLD LIGHTING APPARATUS (U.S. CLS. 21, 23, 26, 36 AND 38).

CLASS 11—ENVIRONMENTAL CONTROL APPARATUS

FOR HOUSEHOLD LIGHTING APPARATUS, NAMELY, LIGHTING FIXTURES, CHANDELIERS, LAMPS, LIGHTS, NAMELY, PEN LIGHTS, BOOK LIGHTS, ELECTRIC HOLIDAY LIGHTS, ELECTRIC NIGHT LIGHTS, WALL LIGHTS, DESK LAMPS, TABLE LAMPS, FLOOR LAMPS, ELECTRIC CANDLES, CEILING LIGHTS, NAMELY, LIGHT FIXTURES FOR ATTACHMENT TO THE CEILING, ELECTRIC TRACK LIGHTING UNITS, TASK LIGHTING, NAMELY, TASK LIGHTING FIXTURES, FLEXIBLE DESK LAMPS, LASER LIGHT PROJECTORS, RECESSED LIGHTING, NAMELY, LIGHTING FIXTURES FOR RECESSED INSTALLATION IN WALLS AND CEILINGS, OUTDOOR LIGHTING, NAMELY, LAMPS FOR OUTDOOR USE, PAVER LIGHTS, OUTDOOR SOLAR POWERED LIGHTING UNITS AND FIXTURES, LIGHTING FIXTURES FOR USE WITH SIGNS OR PICTURES, WALL SCONCE LIGHTING FIXTURES AND LAMP SHADES (U.S. CLS. 13, 21, 23, 31 AND 34).

BERNICE MIDDLETON, EXAMINING ATTORNEY

SN 79-063,853. AB7 INDUSTRIES, FRANCE, FILED 8-11-2008.

Dr. ReChell

OWNER OF INTERNATIONAL REGISTRATION 0989430 DATED 8-11-2008, EXPIRES 8-11-2018.

THE NAME(S), PORTRAIT(S), AND/OR SIGNATURE(S) SHOWN IN THE MARK DOES NOT IDENTIFY A PARTICULAR LIVING INDIVIDUAL.

THE MARK CONSISTS OF STANDARD CHARACTERS WITHOUT CLAIM TO ANY PARTICULAR FONT, STYLE, SIZE, OR COLOR.

CLASS 3—COSMETICS AND CLEANING PREPARATIONS

FOR SOAPS; PERFUMES, ESSENTIAL OILS, COSMETIC HAIR LOTIONS; DENTIFRICES, DEPILATORIES, MAKE-UP REMOVING PREPARATIONS, LIPSTICK, BEAUTY MASKS, SHAVING PRODUCTS, NAMELY, SHAVING FOAM, SHAVING CREAM, SHAVING SOAP (U.S. CLS. 1, 4, 6, 50, 51 AND 52).

CLASS 5—PHARMACEUTICALS

FOR PHARMACEUTICAL PREPARATIONS AND VETERINARY PREPARATIONS FOR THE TREATMENT OF SKIN DISEASES, PHARMACEUTICAL AND VETERINARY PREPARATIONS FOR THE TREATMENT OF STRESS SYNDROMES AND FOR THE TREATMENT OF TIREDNESS, PHARMACEUTICAL PREPARATION FOR THE TREATMENT OF PERSPIRATION; SANITARY PREPARATIONS FOR MEDICAL PURPOSES; DIETETIC FOODS ADAPTED FOR MEDICAL PURPOSES; DISINFECTANTS FOR SANITARY PURPOSES; MEDICINAL HERBS, PARASITICIDES; ALL THE AFORESAID PRODUCTS ARE PREPARED AND/OR TESTED BY A VETERINARY DOCTOR AND A PHARMACEUTICAL DOCTOR; MEDICATED BATH PREPARATIONS; SANITARY PADS AND TOWELS; CHEMICAL PREPARATIONS FOR SANITARY PURPOSES (U.S. CLS. 6, 18, 44, 46, 51 AND 52).

CLASS 10—MEDICAL APPARATUS

FOR SURGICAL AND MEDICAL APPARATUS AND INSTRUMENTS FOR USE IN ORTHOPEDIC SURGERY; MEDICAL APPARATUS, NAMELY, ELECTRIC VAPORIZER FOR UPPER RESPIRATORY CONDITIONS; ARTIFICIAL LIMBS, EYE AND TEETH; ORTHOPAEDIC ARTICLES, NAMELY, ORTHOPAEDIC SOLES, ORTHOPAEDIC DEVICE TO STRETCH AND EXERCISE THE TOES AND FEET; SUTURE MATERIALS; MEDICAL COMPRESSION STOCKINGS, NAMELY, STOCKINGS FOR VARICOSE VEINS; BABY BOTTLES; FEEDING BOTTLE NIPPLES; CLOTHING ESPECIALLY FOR OPERATING ROOMS, NAMELY, SURGICAL SCRUB SUITS; MASSAGE APPARATUS, ESTHETIC MASSAGE APPARATUS; SURGICAL IMPLANTS COMPRISING ARTIFICIAL MATERIAL; ARMCHAIRS FOR MEDICAL OR DENTAL PURPOSES, NAMELY, MEDICAL PATIENT TREATMENT CHAIRS AND DENTIST'S CHAIRS; SURGICAL DRAPES; BED PANS FOR MEDICAL USE; SURGICAL CUTLERY, ORTHOPAEDIC FOOTWEAR (U.S. CLS. 26, 39 AND 44).

CLASS 23—YARNS AND THREADS

FOR YARNS AND THREADS FOR TEXTILE USE; ELASTIC YARNS AND THREADS FOR TEXTILE USE; RUBBER THREAD FOR TEXTILE USE; FIBERGLASS THREAD FOR TEXTILE USE; SPUN WOOL; SPUN SILK (U.S. CL. 43).

CLASS 24—FABRICS

FOR TEXTILES, NAMELY, TEXTILE FABRICS FOR THE MANUFACTURE OF CLOTHING, FOR LINGERIE, FOR HOME; BED COVERS AND TABLE COVERS OF LINEN; FABRIC FOR TEXTILE USE; ELASTIC FABRICS FOR CLOTHING; VELVET; BED LINEN; HOUSEHOLD LINEN; TABLE LINEN NOT OF PAPER; BATH LINEN (U.S. CLS. 42 AND 50).

CLASS 25—CLOTHING

FOR CLOTHING, NAMELY, SUITS, JACKETS, COATS, VESTS, BLOUSES, OVERCOATS, RAINCOATS, TROUSERS, PANTS, SHORTS, SWEATERS, SHIRTS, T-SHIRTS, BATHING SUITS, UNDERSHIRTS; FOOTWEAR, HEADGEAR, NAMELY, HATS, CAPS; LEATHER OR IMITATION LEATHER CLOTHING, NAMELY, LEATHER COATS AND JACKETS, TROUSERS OF LEATHER; BELTS; FURS, NAMELY, FURS COATS AND JACKETS; GLOVES; SCARVES, TIES; HOSIERY; SOCKS; SLIPPERS; BEACH SHOES; SKI AND SPORTS FOOTWEAR, NAMELY, SKI AND SNOWBOARD SHOES AND PARTS THEREOF, AFTER SKI BOOTS; BABIES' NAPKINS OF TEXTILE, NAMELY, TEXTILE NAPPIES; UNDERWEAR (U.S. CLS. 22 AND 39).

SCOTT BIBB, EXAMINING ATTORNEY

SN 79-063,906. BEIJING ZEHUA; CHEMICAL ENGINEERING CO., LTD., CHINA, FILED 12-1-2008.

EDV

THE MARK CONSISTS OF STANDARD CHARACTERS WITHOUT CLAIM TO ANY PARTICULAR FONT, STYLE, SIZE, OR COLOR.

OWNER OF INTERNATIONAL REGISTRATION 0989610 DATED 12-1-2008, EXPIRES 12-1-2018.

CLASS 7—MACHINERY

FOR MACHINES AND APPARATUS FOR THE PETROCHEMICAL INDUSTRY, NAMELY, GAS AND LIQUID SEPARATORS; GAS SEPARATING MACHINES FOR OIL REFINEMENT; OIL AND STEAM SEPARATORS (U.S. CLS. 13, 19, 21, 23, 31, 34 AND 35).

CLASS 11—ENVIRONMENTAL CONTROL APPARATUS

FOR DISTILLING UNITS, NAMELY, VALVES AND VALVE TRAYS USED IN OIL REFINEMENT; DISTILLING UNITS, NAMELY, FRACTIONATION TRAYS IN DISTILLATION TOWERS IN THE CHEMICAL AND PETROCHEMICAL INDUSTRY; REFINING TOWERS FOR DISTILLERS (U.S. CLS. 13, 21, 23, 31 AND 34).

WILLIAM BRECKENFELD, EXAMINING ATTORNEY

SN 79-064,001. LIDL STIFTUNG & CO. KG, FED REP GERMANY, FILED 11-6-2008.

EL TEQUITO

THE MARK CONSISTS OF STANDARD CHARACTERS WITHOUT CLAIM TO ANY PARTICULAR FONT, STYLE, SIZE, OR COLOR.

OWNER OF INTERNATIONAL REGISTRATION 0676552 DATED 6-19-1997, EXPIRES 6-19-2017.

OWNER OF U.S. REG. NO. 3,369,690.

THE WORDING "EL TEQUITO" HAS NO MEANING IN A FOREIGN LANGUAGE.

CLASS 29—MEATS AND PROCESSED FOODS

FOR POTATO BASED SNACK FOODS (U.S. CL. 46).

CLASS 30—STAPLE FOODS

FOR WHEAT, RICE AND CORN BASED SNACKS; PASTRY, NAMELY, SALTED PASTRY; SAUCES BEING CONDIMENTS, NAMELY, KETCHUP, MUSTARD, PEPPER SAUCE, SALSA, CHILI SAUCE, HOT SAUCE, PICO DE GALLO SAUCE; SPICE MIXES IN THE NATURE OF SPICE BLENDS (U.S. CL. 46).

KEVIN CORWIN, EXAMINING ATTORNEY

SN 79-064,013. KNORR-NÄHRMITTEL AKTIENGESELLSCHAFT, THAYNGEN, SWITZERLAND, FILED 7-29-2008.

VIE

THE MARK CONSISTS OF STANDARD CHARACTERS WITHOUT CLAIM TO ANY PARTICULAR FONT, STYLE, SIZE, OR COLOR.

OWNER OF INTERNATIONAL REGISTRATION 0791042 DATED 10-18-2002, EXPIRES 10-18-2012.

OWNER OF U.S. REG. NO. 3,449,676.

THE ENGLISH TRANSLATION OF "VIE" IN THE MARK IS LIFE.

CLASS 29—MEATS AND PROCESSED FOODS

FOR PRESERVED, DRIED AND COOKED FRUITS AND VEGETABLES; FOOD ADDITIVES, NAMELY, FRUIT EXTRACTS AND VEGETABLES EXTRACTS; PROCESSED FRUITS, PROCESSED VEGETABLES (U.S. CL. 46).

CLASS 32—LIGHT BEVERAGES

FOR FRUIT DRINKS AND FRUIT JUICES; VEGETABLES JUICES AND VEGETABLE JUICE BASED DRINKS; FRUIT AND VEGETABLES DRINKS; FRUIT AND VEGETABLES JUICES (U.S. CLS. 45, 46 AND 48).

TINA L. SNAPP, EXAMINING ATTORNEY

SN 79-064,133. LIDL STIFTUNG & CO. KG, FED REP GERMANY, FILED 12-9-2008.

BENTOL

THE MARK CONSISTS OF STANDARD CHARACTERS WITHOUT CLAIM TO ANY PARTICULAR FONT, STYLE, SIZE, OR COLOR.

PRIORITY DATE OF 9-17-2008 IS CLAIMED.

OWNER OF INTERNATIONAL REGISTRATION 0990132 DATED 12-9-2008, EXPIRES 12-9-2018.
THE WORDING "BENTOL" HAS NO MEANING IN A FOREIGN LANGUAGE.

CLASS 5—PHARMACEUTICALS

FOR DIETETIC FOODS ADAPTED FOR MEDICAL USE, NAMELY, LIQUORICE AND LIQUORICE CANDIES IN THE NATURE OF LIQUORICE PASTELS TO TREAT THE COMMON COLD, BACTERIAL AND VIRAL INFECTIONS, ASTHMA, ARTHRITIS, AND TO LOWER CHOLESTEROL LEVELS (U.S. CLS. 6, 18, 44, 46, 51 AND 52).

CLASS 30—STAPLE FOODS

FOR LIQUORICE GOODS, NAMELY, LIQUORICE, LIQUORICE CANDY AND LIQUORICE CANDY IN THE NATURE OF LIQUORICE PASTELS, ALL THE AFORESAID GOODS NOT FOR MEDICAL PURPOSES (U.S. CL. 46).

KEVIN CORWIN, EXAMINING ATTORNEY

SN 79-064,317. KARL-HEINZ MAIER, FED REP GERMANY, FILED 9-26-2008.

Pac-Ice

THE MARK CONSISTS OF STANDARD CHARACTERS WITHOUT CLAIM TO ANY PARTICULAR FONT, STYLE, SIZE, OR COLOR.

PRIORITY DATE OF 4-3-2008 IS CLAIMED.
OWNER OF INTERNATIONAL REGISTRATION 0990598 DATED 9-26-2008, EXPIRES 9-26-2018.

CLASS 29—MEATS AND PROCESSED FOODS

FOR MEAT, FISH, POULTRY AND GAME, MEAT EXTRACTS, BOUILLON AND BOUILLON CONCENTRATES, CONSOMME, SOUP AND SOUP PREPARATIONS; FRUIT CREAMS, CONSISTING OF STEWED FRUIT WITH FULL-CREAM MILK, CREAM, YOGHURT OR SOYA-MILK; MEAT, FRUIT AND VEGETABLE JELLIES; MILK AND MILK PRODUCTS, ESPECIALLY YOGHURT, CREAM AND MILK SHAKES; SOYA MILK; EDIBLE OILS; MOUSSES OR FARCES FOR PIES ESSENTIALLY CONSISTING OF MEAT OR FISH AND CREAM; VEGETABLE CONCENTRATES FOR SOUPS AND SAUCES; ALL THE AFORESAID GOODS ALSO DEEP-FROZEN; PRESERVED, DRIED, COOKED AND/OR DEEP-FROZEN FRUITS AND VEGETABLES (U.S. CL. 46).

CLASS 30—STAPLE FOODS

FOR ICES; ICE CREAM AND SORBETS; ICE, NATURAL OR ARTIFICIAL; CONDIMENTS IN THE NATURE OF SAUCES AND SPICES; SEASONINGS IN THE NATURE OF PRESERVED GARDEN HERBS; HERB CONCENTRATES FOR SOUPS AND SAUCES; ALL THE AFORESAID GOODS ALSO DEEP-FROZEN (U.S. CL. 46).

CLASS 39—TRANSPORTATION AND STORAGE

FOR DELIVERY OF FOOD, ESPECIALLY DESSERTS, FOR IMMEDIATE CONSUMPTION (U.S. CLS. 100 AND 105).

CLASS 43—HOTEL AND RESTAURANT SERVICES

FOR FOOD AND DRINK CATERING (U.S. CLS. 100 AND 101).
HENRY S. ZAK, EXAMINING ATTORNEY

SN 79-064,374. THE TRUSTEES OF THE GODSBREATH UNIT TRUST, GREENBANK QLD 4124, AUSTRALIA, FILED 6-19-2008.

ENOVEE

THE MARK CONSISTS OF STANDARD CHARACTERS WITHOUT CLAIM TO ANY PARTICULAR FONT, STYLE, SIZE, OR COLOR.

PRIORITY DATE OF 1-29-2008 IS CLAIMED.
OWNER OF INTERNATIONAL REGISTRATION 0990785 DATED 6-19-2008, EXPIRES 6-19-2018.

THE WORDING "ENOVEE" HAS NO MEANING IN A FOREIGN LANGUAGE.

CLASS 11—ENVIRONMENTAL CONTROL APPARATUS

FOR APPARATUS FOR WATER SUPPLY, NAMELY, TAPS; WATER FILTERING APPARATUS AND REGULATING ACCESSORIES FOR WATER SUPPLY, NAMELY, SPECIALIZED PIPE FITTINGS IN THE NATURE OF WATER FILTERS TO COLLECT AND DIVERT RAINWATER AND MOISTURE (U.S. CLS. 13, 21, 23, 31 AND 34).

CLASS 19—NON-METALLIC BUILDING MATERIALS

FOR NON-METALLIC BUILDING MATERIALS, NAMELY, GUTTER PIPES, WATER PIPES, DOWN SPOUTS, AND NON-METALLIC BUILDING MATERIALS, NAMELY, NON-METALLIC GUTTER GUARDS THAT ARE PLACED IN GUTTERS OF BUILDINGS TO PREVENT POLLUTANTS FROM ENTERING DRAIN PIPES; NON-METALLIC RIGID PIPES (U.S. CLS. 1, 12, 33 AND 50).

LEIGH LOWRY, EXAMINING ATTORNEY

SN 79-065,010. OTTO BOCK HEALTHCARE GMBH, FED REP GERMANY, FILED 11-11-2008.

SKINGUARD

THE MARK CONSISTS OF STANDARD CHARACTERS WITHOUT CLAIM TO ANY PARTICULAR FONT, STYLE, SIZE, OR COLOR.

PRIORITY DATE OF 5-13-2008 IS CLAIMED.
OWNER OF INTERNATIONAL REGISTRATION 0991906 DATED 11-11-2008, EXPIRES 11-11-2018.

CLASS 1—CHEMICALS

FOR CHEMICALS USED IN INDUSTRY; UNPROCESSED ARTIFICIAL RESINS, UNPROCESSED PLASTICS (U.S. CLS. 1, 5, 6, 10, 26 AND 46).

CLASS 10—MEDICAL APPARATUS

FOR ORTHOPEDIC ARTICLES, NAMELY, PROSTHESES, SOCKETS FOR PROSTHESES, COSMETIC CASINGS FOR PROSTHESES, STOCKINGS, LINER FOR ORTHOPAEDIC USE MADE OF SILICON, POLYURETHANE AND COPOLYMER, BANDAGES, ORTHOSSES, BELTS FOR PROSTHESES AND ORTHOSSES, ORTHOPAEDIC SEATINGS; ARTIFICIAL LIMBS (U.S. CLS. 26, 39 AND 44).

CLASS 17—RUBBER GOODS

FOR RUBBER, GUTTA-PERCHA, GUM, ASBESTOS, MICA AND GOODS MADE FROM THESE MATERIALS INCLUDED IN THIS CLASS, NAMELY, PADDING MATERIALS AND PLASTICS WITH ANTIBACTERIAL CHARACTERISTICS FOR THE MANUFACTURE OF PROSTHETIC SOCKETS, LINER AND FOR THE MANUFACTURE OF ORTHOSSES AND THEIR PARTS; PLASTICS IN EXTRUDED FORM FOR USE IN MANUFACTURE (U.S. CLS. 1, 5, 12, 13, 35 AND 50).
MIDGE BUTLER, EXAMINING ATTORNEY

SN 79-065,114. UPCOMING TM S.A., LUXEMBOURG, FILED 1-13-2009.



OWNER OF INTERNATIONAL REGISTRATION 0992708 DATED 1-13-2009, EXPIRES 1-13-2019.

THE MARK CONSISTS OF A HAND WITH THE WORD "SIXTY" IN THE PALM OF THE HAND AND THE LETTERS OF THE WORD "FRIENDS", LOCATED ON THE FIVE FINGERS.

CLASS 18—LEATHER GOODS

FOR LEATHER AND IMITATION OF LEATHER, HANDBAGS, BAGS, NAMELY, RUCK SACKS, BEACH BAGS, BAGS FOR SPORT, WALLETS, SHOULDER BAGS, BRIEF CASES, LUGGAGE TRUNKS, TRAVELING BAGS, SUITCASES, ANIMAL SKINS AND HIDES, UMBRELLAS, PARASOLS AND WALKING STICKS, WHIPS, HARNESS AND SADDLERY (U.S. CLS. 1, 2, 3, 22 AND 41).

CLASS 25—CLOTHING

FOR CLOTHING, NAMELY, BELTS, DRESSES, COATS, TROUSERS, SHORTS, SCARVES, JEANS, BLOUSES, JUMPERS, SHIRTS, SWEATS, NAMELY, SWEAT PANTS, SWEAT JACKETS, OVERCOATS, JACKETS, BLAZERS, SWEATERS, T-SHIRTS, SOCKS, SHOES, BOOTS, SLIPPERS, SANDALS, FOOTWEAR, HEADGEAR, NAMELY, HATS, CAPS, VISORS (U.S. CLS. 22 AND 39).

CLASS 35—ADVERTISING AND BUSINESS

FOR ADVERTISING; BUSINESS MANAGEMENT; BUSINESS ADMINISTRATION; PROVIDING OFFICE FUNCTIONS; SALES PROMOTION SERVICES FOR OTHERS; THE BRINGING TOGETHER, FOR THE BENEFIT OF OTHERS, OF LEATHER AND IMITATIONS OF LEATHER, ANIMAL SKINS, ANIMAL HIDES, TRUNKS AND TRAVELLING BAGS, UMBRELLAS, PARASOLS AND WALKING STICKS, WHIPS, HARNESS, SADDLERY, CLOTHING, FOOTWEAR, HEADGEAR, ENABLING CUSTOMERS TO CONVENIENTLY VIEW AND PURCHASE THOSE GOODS IN A RETAIL CLOTHES STORE (U.S. CLS. 100, 101 AND 102).
NAKIA HENRY, EXAMINING ATTORNEY

SN 79-065,450. MINEARC SYSTEMS PTY LTD, SUBIACO WA 6008, AUSTRALIA, FILED 1-30-2009.

COAL-SAFE

THE MARK CONSISTS OF STANDARD CHARACTERS WITHOUT CLAIM TO ANY PARTICULAR FONT, STYLE, SIZE, OR COLOR.

PRIORITY DATE OF 8-1-2008 IS CLAIMED.
OWNER OF INTERNATIONAL REGISTRATION 0993674 DATED 1-30-2009, EXPIRES 1-30-2019.

CLASS 6—METAL GOODS

FOR REFUGE CHAMBERS IN THE NATURE OF METAL SHELTERS FOR PROVIDING TEMPORARY LIFE SUPPORTING CLOSED ENVIRONMENTS; AND PARTS AND FITTINGS THEREFOR (U.S. CLS. 2, 12, 13, 14, 23, 25 AND 50).

CLASS 11—ENVIRONMENTAL CONTROL APPARATUS

FOR AIR PURIFYING APPARATUS FOR SUPPLYING BREATHABLE AIR FOR REFUGE CHAMBERS; GAS SCRUBBING APPARATUS INCLUDING CO SCRUBBERS AND CO2 SCRUBBERS; AIR PURIFYING APPARATUS AND MACHINES; AND PARTS AND FITTINGS FOR THE AFORESAID GOODS (U.S. CLS. 13, 21, 23, 31 AND 34).
SHARON MEIER, EXAMINING ATTORNEY

SN 79-065,677. CONTEXTVISION AB, SWEDEN, FILED 12-16-2008.

GOPICE

THE MARK CONSISTS OF STANDARD CHARACTERS WITHOUT CLAIM TO ANY PARTICULAR FONT, STYLE, SIZE, OR COLOR.

PRIORITY DATE OF 6-18-2008 IS CLAIMED.
OWNER OF INTERNATIONAL REGISTRATION 0994358 DATED 12-16-2008, EXPIRES 12-16-2018.

OWNER OF U.S. REG. NOS. 2,277,528 AND 3,557,756.
THE WORDING "GOPICE" HAS NO MEANING IN A FOREIGN LANGUAGE.

CLASS 9—ELECTRICAL AND SCIENTIFIC APPARATUS

FOR COMPUTER SOFTWARE FOR ELECTRONIC IMAGE TREATMENT; COMPUTER SOFTWARE FOR IMAGE DIAGNOSTIC (U.S. CLS. 21, 23, 26, 36 AND 38).

CLASS 42—SCIENTIFIC AND COMPUTER SERVICES

FOR DESIGN AND DEVELOPMENT OF COMPUTER SOFTWARE, NAMELY, COMPUTER SOFTWARE FOR ELECTRONIC PICTURE TREATMENT AND COMPUTER SOFTWARE FOR IMAGE DIAGNOSTIC; RENTAL OF COMPUTER SOFTWARE, NAMELY, COMPUTER SOFTWARE FOR ELECTRONIC IMAGE TREATMENT AND COMPUTER SOFTWARE FOR IMAGE DIAGNOSTIC (U.S. CLS. 100 AND 101).

MYRIAH HABEEB, EXAMINING ATTORNEY

SN 79-066,589. AIGNER, GEORG, FED REP GERMANY, FILED 11-15-2008.

Vectrafix

SN 79-066,455. ACANFORA, GIOVANNI, ITALY, FILED 11-25-2008.

GIVOVA

THE MARK CONSISTS OF STANDARD CHARACTERS WITHOUT CLAIM TO ANY PARTICULAR FONT, STYLE, SIZE, OR COLOR.

PRIORITY DATE OF 5-28-2008 IS CLAIMED.

OWNER OF INTERNATIONAL REGISTRATION 0996587 DATED 11-25-2008, EXPIRES 11-25-2018.

CLASS 18—LEATHER GOODS

FOR LEATHER AND IMITATION LEATHER AND GOODS MADE OF THESE MATERIALS, NAMELY, BAGS, HANDBAGS, BRIEFCASES, SUITCASES, WALLET, DOCUMENT CASES, LEATHER KEY CASES, PURSES, TRUNKS AND TRAVELING BAGS; ANIMAL SKINS AND HIDES, UMBRELLAS, PARASOLS AND WALKING STICKS; WHIPS, HARNESSSES AND SADDLERY (U.S. CLS. 1, 2, 3, 22 AND 41).

CLASS 25—CLOTHING

FOR CLOTHING, NAMELY, JACKETS, HATS, CAPS, SHIRTS, TIES, TROUSERS, COATS, SWEATERS, SKIRTS, PULLOVERS, TIES, SOCKS, STOCKINGS, TIGHTS, GLOVES, BELTS, SCARVES, JEANS, UNDERWEAR, TRACKSUITS, SWIMSUITS, FOOTWEAR, SHOES, SLIPPERS (U.S. CLS. 22 AND 39).

CLASS 28—TOYS AND SPORTING GOODS

FOR GYMNASTIC AND SPORTING ARTICLES, NAMELY, SPORT BALLS, GOLF CLUBS, HOCKEY STICKS, FISHING RODS, BASEBALL BATS, ROLLER SKATES, ICE SKATES, BOXING GLOVES, SWIMMING FLIPPERS, TABLE TENNIS PADDLES, SNOWSHOES, SKI POLES, TENNIS RACKETS, SKIS, SKATEBOARDS, SLEDGES, NAMELY, SNOW SLEDS FOR RECREATIONAL USE, SNOWBOARDS, SAIL BOARDS, SURFBOARDS, WEIGHT LIFTING MACHINES, BODY BUILDING APPARATUS, KNEE GUARDS FOR ATHLETIC USE, GLOVES FOR GAMES, NAMELY, GLOVES FOR PLAYING GOLF, BOXING, FENCING, FOOTBALL, BASEBALL AND BODYBUILDING, BAGS SPECIALLY ADAPTED FOR SPORTS EQUIPMENT (U.S. CLS. 22, 23, 38 AND 50).

MATTHEW EINSTEIN, EXAMINING ATTORNEY

THE MARK CONSISTS OF STANDARD CHARACTERS WITHOUT CLAIM TO ANY PARTICULAR FONT, STYLE, SIZE, OR COLOR.

PRIORITY DATE OF 10-15-2008 IS CLAIMED.

OWNER OF INTERNATIONAL REGISTRATION 0996878 DATED 11-15-2008, EXPIRES 11-15-2018.

CLASS 7—MACHINERY

FOR MACHINES AND MACHINE TOOLS FOR THE CUTTING AND FORMING OF MATERIALS; MACHINE PARTS, NAMELY, FITTINGS FOR CONNECTING CLAMPING PLATES TO FENCE SUPPORTS FOR TABLE SAWS, AND FITTINGS WITH CLAMPING PLATES FOR CONNECTING CATCH SYSTEMS COMPOSED OF GUIDE FENCES AND PUSH ARMS TO FENCE SUPPORTS FOR TABLE SAWS (U.S. CLS. 13, 19, 21, 23, 31, 34 AND 35).

CLASS 8—HAND TOOLS

FOR HAND OPERATED GUIDE AND FEED APPARATUS FOR MACHINE TOOLS, WOOD WORKING MACHINES AND SAWING MACHINES, NAMELY, HAND-OPERATED CLAMPS (U.S. CLS. 23, 28 AND 44).

MATTHEW EINSTEIN, EXAMINING ATTORNEY

SN 79-066,602. TROPICAL ISLAND MANAGEMENT GMBH, FED REP GERMANY, FILED 1-13-2009.

Tropical Island

THE MARK CONSISTS OF STANDARD CHARACTERS WITHOUT CLAIM TO ANY PARTICULAR FONT, STYLE, SIZE, OR COLOR.

OWNER OF INTERNATIONAL REGISTRATION 0996913 DATED 1-13-2009, EXPIRES 1-13-2019.

CLASS 3—COSMETICS AND CLEANING PREPARATIONS

FOR SOAPS; PERFUMERY, ESSENTIAL OILS, COSMETICS, HAIR LOTIONS; DENTIFRICES (U.S. CLS. 1, 4, 6, 50, 51 AND 52).

CLASS 25—CLOTHING

FOR CLOTHING FOR MEN, WOMEN AND CHILDREN, NAMELY, COATS, RAINCOATS, ANORAKS, PARKAS, BLAZERS, JACKETS, CARDIGANS, BOLEROS, SPORT COATS, WIND-RESISTANT JACKETS, SUITS, TUXEDOS, VESTS, DRESSES, EVENING GOWNS, JUMPERS, SKIRTS, PANTS, SLACKS, TROUSERS, JEANS, DUNGAREES, JUMPSUITS, OVERALLS, COVERALLS, FLIGHT SUITS, GYM SUITS, JOGGING SUITS, SWEAT PANTS, THERMAL UNDERWEAR, SHORTS, SKORTS, ROMPERS, CULOTTES, SHORTALLS, SHIRTS, SWEATERS, JERSEYS, BLOUSES, TUNICS, SWEATSHIRTS, T-SHIRTS, HALTER TOPS, TANK TOPS, BODYSUITS, UNITARDS, CAMISOLES, CHEMISES, UNDERSHIRTS, SLIPS, FOUNDATION GARMENTS, BODY SHAPERS, BRASSIERES, BUSTIERS, GARTER BELTS, BRIEFS, BOXER SHORTS, BLOOMERS, UNDERPANTS, PANTIES, LINGERIE, LOUNGEWEAR, NIGHTGOWNS, NIGHT SHIRTS, NEGLIGEEES, ROBES, PAJAMAS, HOSIERY, PANTYHOSE, TIGHTS, KNEE HIGHS, LEG WARMERS, LEGGINGS, SOCKS, HEADWEAR, HATS, CAPS, HOODS, HEADBANDS, NECKTIES, BOW TIES, ASCOTS, POCKET SQUARES, SCARVES, SHAWLS, NECKERCHIEFS, GLOVES, MITTENS, BELTS, SASHES, CUMMERBUNDS, SHOES, FOOTWEAR, BOOTS, ATHLETIC SHOES, ATHLETIC FOOTWEAR, GALOSHES, SWIMWEAR, BATHING SUITS, BATHING TRUNKS, BEACHWEAR, BEACH COVERUPS, SARONGS, SKIWEAR, SKI SUITS, SKI PANTS, SKI GLOVES, THERMAL SOCKS, INFANT WEAR, BIBS, BOOTIES, BABY BUNTING, PLAYSUITS (U.S. CLS. 22 AND 39).

CLASS 33—WINES AND SPIRITS

FOR ALCOHOLIC BEVERAGES EXCEPT BEERS (U.S. CLS. 47 AND 49).
ALICE SUE CARRUTHERS, EXAMINING ATTORNEY

SN 79-067,423. GUANGZHOU BILIHUA SHOES CO., LTD., GUANGZHOU CITY, GUANGDONG PROVINC, CHINA, FILED 11-4-2008.

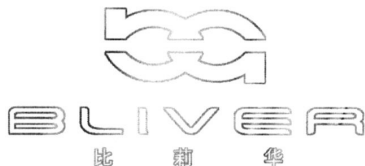

OWNER OF INTERNATIONAL REGISTRATION 0999149 DATED 11-4-2008, EXPIRES 11-4-2018.

THE MARK CONSISTS OF THE LETTERS "BG" ABOVE THE WORDING "BLIVER" ABOVE THREE CHINESE CHARACTERS.

THE WORDING "BLIVER" IN THE MARK HAS NO MEANING IN A FOREIGN LANGUAGE.

THE NON-LATIN CHARACTERS IN THE MARK TRANSLITERATE TO "BI" "LI" AND "HUA," AND TRANSLATE TO "COMPARING," "JASMINE" AND "MAGNIFICENT". THE COMBINATION OF THE NON-LATIN CHARACTERS HAS NO MEANING IN A FOREIGN LANGUAGE.

CLASS 18—LEATHER GOODS

FOR IMITATION LEATHER; PURSES; BACKPACKS; TRAVELLING BAGS; POCKET WALLETS; WALKING STICKS; LEATHER BEDSHEETS; LEATHER STRAPS; UMBRELLAS; TRIMMINGS OF LEATHER FOR FURNITURE (U.S. CLS. 1, 2, 3, 22 AND 41).

CLASS 25—CLOTHING

FOR CLOTHING, NAMELY, SHIRTS; UNDERWEAR; DOWN JACKETS; LAYETTES; SHOES; HATS; HOSIERY; GLOVES; NECKTIES; BELTS (U.S. CLS. 22 AND 39).
DOMINIC FATHY, EXAMINING ATTORNEY

SN 79-067,543. COGNIS IP MANAGEMENT GMBH, FED REP GERMANY, FILED 12-15-2008.

SOYTENSOR

THE MARK CONSISTS OF STANDARD CHARACTERS WITHOUT CLAIM TO ANY PARTICULAR FONT, STYLE, SIZE, OR COLOR.

PRIORITY DATE OF 8-26-2008 IS CLAIMED.
OWNER OF INTERNATIONAL REGISTRATION 0999559 DATED 12-15-2008, EXPIRES 12-15-2018.

CLASS 1—CHEMICALS

FOR CHEMICAL PREPARATIONS FOR INDUSTRIAL USE, NAMELY, EXTRACTS OF NATURAL, VEGETAL, MARINE, SYNTHETIC OR BIOTECHNOLOGICAL ORIGIN, INTENDED FOR THE MANUFACTURE OF COSMETIC PRODUCTS AND SANITARY PREPARATIONS FOR COSMETIC BODY, HAIR AND FACE CARE (U.S. CLS. 1, 5, 6, 10, 26 AND 46).

CLASS 3—COSMETICS AND CLEANING PREPARATIONS

FOR COSMETIC PREPARATIONS FOR SKIN AND BODY CARE, NAMELY, SKIN EMULSIONS, SHAVING GELS AND HAND LOTIONS, SKIN CREAMS, BODY LOTIONS, AND DEPILATORIES; HAIR CARE PRODUCTS, NAMELY, SHAMPOOS, HAIR COLORING EMULSIONS, HAIR LOTIONS, HAIR STYLING FOAMS, AND HAIR SETTING GELS; COSMETICS, NAMELY, MAKE-UP PREPARATIONS, MAKE-UP POWDERS, COLORING CREAMS FOR COSMETIC PURPOSES, BLUSHERS, LIPSTICK, MASCARA, EYE PENCILS, EYE SHADOWS, AND MAKE-UP REMOVING PREPARATIONS; TANNING CREAMS AND LOTIONS; PERFUMES; ESSENTIAL OILS FOR PERSONAL USE; OILS FOR COSMETIC PURPOSES (U.S. CLS. 1, 4, 6, 50, 51 AND 52).

FRED CARL, EXAMINING ATTORNEY

SN 79-067,565. KÜHNLE KUTSCHENMANUFAKTUR GMBH & CO. KG, FED REP GERMANY, FILED 3-2-2009.



PRIORITY DATE OF 9-3-2008 IS CLAIMED.

OWNER OF INTERNATIONAL REGISTRATION 0999640 DATED 3-2-2009, EXPIRES 3-2-2019.

THE MARK CONSISTS OF A STYLIZED LETTER "K" WITHIN A CIRCLE.

CLASS 11—ENVIRONMENTAL CONTROL APPARATUS

FOR ACCESSORIES FOR LAND VEHICLES, NAMELY, LAMPS FOR HORSE-DRAWN CARRIAGES (U.S. CLS. 13, 21, 23, 31 AND 34).

CLASS 12—VEHICLES

FOR LAND VEHICLES, NAMELY, HORSE-DRAWN CARRIAGES, MOTOR COACHES, HORSE CARTS, AND SLEIGHS; ACCESSORIES FOR LAND VEHICLES, NAMELY, CANOPIES FOR HORSE-DRAWN CARRIAGES, SINGLE AND DOUBLE SHAFTS FOR HORSE-DRAWN CARRIAGES, CARRIAGE SPRINGS, WOODEN WHEELS FOR CARRIAGES, WHIP MOUNTS FOR CARRIAGES AND SLEIGH BELLS (U.S. CLS. 19, 21, 23, 31, 35 AND 44).

KYLE PEETE, EXAMINING ATTORNEY

SN 79-067,603. RETINALYZE A/S; C/O SANKT LUKAS, HELLERUP, DENMARK, FILED 2-16-2009.

RETINALYZE

THE MARK CONSISTS OF STANDARD CHARACTERS WITHOUT CLAIM TO ANY PARTICULAR FONT, STYLE, SIZE, OR COLOR.

OWNER OF INTERNATIONAL REGISTRATION 0753317 DATED 2-21-2001, EXPIRES 2-21-2011.

CLASS 9—ELECTRICAL AND SCIENTIFIC APPARATUS

FOR DATA PROCESSING EQUIPMENT AND COMPUTERS; COMPUTER SOFTWARE, NAMELY, COMPUTER SOFTWARE FOR DIAGNOSING AND CONTROLLING DIABETIC RETINOPATHY (U.S. CLS. 21, 23, 26, 36 AND 38).

CLASS 42—SCIENTIFIC AND COMPUTER SERVICES

FOR SCIENTIFIC AND INDUSTRIAL RESEARCH REGARDING DIAGNOSIS AND CONTROL OF DIABETIC RETINOPATHY; PROGRAMMING OF COMPUTERS, NAMELY, DEVELOPMENT AND MAINTENANCE OF SOFTWARE FOR THE DIAGNOSIS AND CONTROL OF DIABETIC RETINOPATHY (U.S. CLS. 100 AND 101).

DOUGLAS LEE, EXAMINING ATTORNEY

SN 79-067,649. GIULIANI S.P.A., ITALY, FILED 12-2-2008.

CHRONOBIOGENINA

THE MARK CONSISTS OF STANDARD CHARACTERS WITHOUT CLAIM TO ANY PARTICULAR FONT, STYLE, SIZE, OR COLOR.

PRIORITY DATE OF 10-24-2008 IS CLAIMED.

OWNER OF INTERNATIONAL REGISTRATION 0999772 DATED 12-2-2008, EXPIRES 12-2-2018.

THE WORDING "CHRONOBIOGENINA" HAS NO MEANING IN A FOREIGN LANGUAGE.

CLASS 1—CHEMICALS

FOR CHEMICAL SUBSTANCES, NAMELY, BIOGENIC AMMINES ALONE OR COMBINED WITH OTHER SUBSTANCES FOR USE IN THE MANUFACTURE OF COSMETICS AND IN THE MANUFACTURE OF HAIR PRODUCTS (U.S. CLS. 1, 5, 6, 10, 26 AND 46).

CLASS 3—COSMETICS AND CLEANING PREPARATIONS

FOR PRODUCTS FOR THE CARE, THE BEAUTY AND THE TREATMENT OF HAIR, SKIN AND NAILS, NAMELY, HAIR CARE PREPARATIONS, NON-MEDICATED SKIN CARE PREPARATIONS, AND NAIL CARE PREPARATIONS (U.S. CLS. 1, 4, 6, 50, 51 AND 52).

CLASS 5—PHARMACEUTICALS

FOR VITAMIN, MINERAL AND DIETARY SUPPLEMENTS; PRODUCTS FOR THE HEALTH OF SKIN, SKIN APPENDAGES AND HAIR, FOR MEDICAL USE, NAMELY, MEDICATED HAIR CARE PREPARATIONS, MEDICATED SKIN CARE PREPARATIONS, AND NAIL SANITIZING PREPARATIONS (U.S. CLS. 6, 18, 44, 46, 51 AND 52).

ROBERT STRUCK, EXAMINING ATTORNEY

SN 79-068,187. ARCHEA S.A.S. DI CHIARA ENRICO & C., ITALY, FILED 12-4-2008.

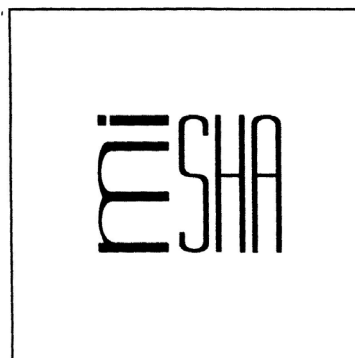

PRIORITY DATE OF 9-18-2008 IS CLAIMED.
OWNER OF INTERNATIONAL REGISTRATION 1001100 DATED 12-4-2008, EXPIRES 12-4-2018.

THE "MISHA" MARK IS DEPICTED BY A LOGO NOT IN COLOR WITH THE NAME "MISHA" CONTAINED IN A SQUARE WITH THE LETTERS "MI" WRITTEN HORIZONTALLY AND THE LETTERS "SHA" WRITTEN VERTICALLY.

CLASS 20—FURNITURE AND ARTICLES NOT OTHERWISE CLASSIFIED

FOR TABLES, BED-SIDE TABLES, DESKS, SCREENS, CUPBOARDS, BEDS (U.S. CLS. 2, 13, 22, 25, 32 AND 50).

CLASS 24—FABRICS

FOR CURTAINS AND DRAPERIES (U.S. CLS. 42 AND 50).

CLASS 27—FLOOR COVERINGS

FOR WALLPAPER (U.S. CLS. 19, 20, 37, 42 AND 50).
JAMES STEIN, EXAMINING ATTORNEY

SN 79-069,150. ELEPHANT BAMBUSPRODUKTE GMBH, FED REP GERMANY, FILED 4-27-2009.

Cobam

THE MARK CONSISTS OF STANDARD CHARACTERS WITHOUT CLAIM TO ANY PARTICULAR FONT, STYLE, SIZE, OR COLOR.

PRIORITY DATE OF 2-19-2009 IS CLAIMED.
OWNER OF INTERNATIONAL REGISTRATION 1003570 DATED 4-27-2009, EXPIRES 4-27-2019.

CLASS 19—NON-METALLIC BUILDING MATERIALS

FOR BUILDING MATERIALS MADE OF BAMBOO, IN PARTICULAR FLOORS AND SKIRTING AND FLOOR BOARDS FOR TERRACES, ALL MADE OF BAMBOO (U.S. CLS. 1, 12, 33 AND 50).

CLASS 20—FURNITURE AND ARTICLES NOT OTHERWISE CLASSIFIED

FOR FURNITURE MADE OF BAMBOO (U.S. CLS. 2, 13, 22, 25, 32 AND 50).
JACLYN KIDWELL, EXAMINING ATTORNEY

SN 79-069,798. NOVO NORDISK A/S, DENMARK, FILED 1-13-2009.

FlexLife

THE MARK CONSISTS OF STANDARD CHARACTERS WITHOUT CLAIM TO ANY PARTICULAR FONT, STYLE, SIZE, OR COLOR.

PRIORITY DATE OF 12-3-2008 IS CLAIMED.
OWNER OF INTERNATIONAL REGISTRATION 1004993 DATED 1-13-2009, EXPIRES 1-13-2019.

CLASS 5—PHARMACEUTICALS

FOR PHARMACEUTICAL PREPARATIONS CONTAINED IN PREFILLED HYPODERMIC DISPOSABLE SYRINGES FILLED WITH PREPARATIONS FOR THE TREATMENT OF DIABETES OR GROWTH HORMONE DEFICIENCIES (U.S. CLS. 6, 18, 44, 46, 51 AND 52).

CLASS 10—MEDICAL APPARATUS

FOR MEDICAL APPARATUS AND INSTRUMENTS, NAMELY, HYPODERMIC SYRINGES (U.S. CLS. 26, 39 AND 44).
DEBRA LEE, EXAMINING ATTORNEY

SN 79-069,799. NOVO NORDISK A/S, DENMARK, FILED 1-13-2009.

FlexFriend

THE MARK CONSISTS OF STANDARD CHARACTERS WITHOUT CLAIM TO ANY PARTICULAR FONT, STYLE, SIZE, OR COLOR.

PRIORITY DATE OF 12-3-2008 IS CLAIMED.
OWNER OF INTERNATIONAL REGISTRATION 1004994 DATED 1-13-2009, EXPIRES 1-13-2019.

CLASS 5—PHARMACEUTICALS

FOR PHARMACEUTICAL PREPARATIONS CONTAINED IN PREFILLED HYPODERMIC DISPOSABLE SYRINGES FILLED WITH PREPARATIONS FOR THE TREATMENT OF DIABETES OR GROWTH HORMONE DEFICIENCIES (U.S. CLS. 6, 18, 44, 46, 51 AND 52).

CLASS 10—MEDICAL APPARATUS

FOR MEDICAL APPARATUS AND INSTRUMENTS, NAMELY, HYPODERMIC SYRINGES (U.S. CLS. 26, 39 AND 44).
DEBRA LEE, EXAMINING ATTORNEY

SN 79-069,967. PIERRE FABRE DERMO-COSMETIQUE, F-92100 BOULOGNE, FRANCE, FILED 9-12-2008.

DENSEAL

THE MARK CONSISTS OF STANDARD CHARACTERS WITHOUT CLAIM TO ANY PARTICULAR FONT, STYLE, SIZE, OR COLOR.

PRIORITY DATE OF 4-4-2008 IS CLAIMED.
OWNER OF INTERNATIONAL REGISTRATION 1005484 DATED 9-12-2008, EXPIRES 9-12-2018.

CLASS 3—COSMETICS AND CLEANING PREPARATIONS

FOR COSMETICS, NAMELY, SKIN CREAMS, SKIN OILS, SKIN GELS, SKIN LOTIONS, SKIN MILKS AND EMULSIONS FOR THE SKIN; COSMETIC HAIR CARE PRODUCTS, NAMELY, CREAMS, GELS, MILKS AND LOTIONS, SHAMPOOS, MEDICINAL SHAMPOOS FOR USE ON HAIR (U.S. CLS. 1, 4, 6, 50, 51 AND 52).

CLASS 5—PHARMACEUTICALS

FOR PHARMACEUTICAL PREPARATIONS, NAMELY, DERMATOLOGICAL PRODUCTS IN THE FORM OF CREAMS, GELS, LOTIONS, MILKS, EMULSIONS, BALMS, TABLETS, CAPSULES OF VARIOUS TYPES AND PILLS; PRODUCTS FOR SKIN CARE, NAMELY, MEDICINAL CREAMS FOR SKIN CARE, MEDICATED CLEANSING MILKS FOR THE SKIN, MEDICATED EMULSIONS FOR SKIN CARE, MEDICINAL LOTIONS FOR SKIN CARE, MEDICATED GELS FOR SKIN CARE, MEDICATED BALMS FOR THE SKIN; HAIR CARE AND TREATMENT PRODUCTS, NAMELY, MEDICINAL CREAMS FOR HAIR CARE, MEDICATED MILKS FOR HAIR, MEDICATED EMULSIONS FOR HAIR, MEDICINAL LOTIONS FOR HAIR, MEDICATED GELS FOR HAIR, BALMS (U.S. CLS. 6, 18, 44, 46, 51 AND 52).

MIDGE BUTLER, EXAMINING ATTORNEY

SEPT. 8, 2009

U.S. PATENT AND TRADEMARK OFFICE

TM 369

SN 79-070,256. NOVO NORDISK A/S, DENMARK, FILED 4-8-2009.

NordiPro

THE MARK CONSISTS OF STANDARD CHARACTERS WITHOUT CLAIM TO ANY PARTICULAR FONT, STYLE, SIZE, OR COLOR.

PRIORITY DATE OF 4-6-2009 IS CLAIMED.

OWNER OF INTERNATIONAL REGISTRATION 1006189 DATED 4-8-2009, EXPIRES 4-8-2019.

CLASS 5—PHARMACEUTICALS

FOR PHARMACEUTICAL PREPARATIONS, NAMELY, HYPODERMIC DISPOSABLE SYRINGES FILLED WITH PREPARATIONS FOR THE TREATMENT OF GROWTH HORMONE DEFICIENCIES (U.S. CLS. 6, 18, 44, 46, 51 AND 52).

CLASS 10—MEDICAL APPARATUS

FOR MEDICAL APPARATUS AND INSTRUMENTS, NAMELY, HYPODERMIC SYRINGES (U.S. CLS. 26, 39 AND 44).

FRANK LATTUCA, EXAMINING ATTORNEY

* * * * *

SECTION 2.— INTERNATIONAL CLASSIFICATION

The short titles associated below with the international class numbers are terms designed merely for quick identification and are not an official part of the international classification. The full names of international classes are given in section 6.1 of the trademark rules of practice.

The designation "U.S. Cl." appearing in this section refers to the U.S. class in effect prior to Sep. 1, 1973 rather than the international class which applies to applications filed on or after that date. For adoption of international classification see notice in the OFFICIAL GAZETTE of Jun. 26, 1973 (911 O.G. TM 210).

Application in one class

CLASS 1—CHEMICALS

SN 77-317,864. PERSTORP SPECIALTY CHEMICALS AB, PERSTORP, SWEDEN, FILED 10-31-2007.

PERIMIDE

THE MARK CONSISTS OF STANDARD CHARACTERS WITHOUT CLAIM TO ANY PARTICULAR FONT, STYLE, SIZE, OR COLOR.

OWNER OF ERPN CMNTY TM OFC REG. NO. 006856967, DATED 10-20-2008, EXPIRES 4-15-2018.

FOR CHEMICALS USED IN INDUSTRY AND SCIENCE; SYNTHETIC MONOMERS FOR USE IN THE MANUFACTURE OF POLYMERS; UNPROCESSED ARTIFICIAL RESINS; UNPROCESSED PLASTICS; MACHINABLE UNPROCESSED PLASTICS; ADHESIVES USED IN INDUSTRY (U.S. CLS. 1, 5, 6, 10, 26 AND 46).
JEAN IM, EXAMINING ATTORNEY

SN 77-318,577. MAPEI CORPORATION U.S.A., DEERFIELD BEACH, FL. FILED 10-31-2007.

NORTH AMERICAN ADHESIVES

THE MARK CONSISTS OF STANDARD CHARACTERS WITHOUT CLAIM TO ANY PARTICULAR FONT, STYLE, SIZE, OR COLOR.

NO CLAIM IS MADE TO THE EXCLUSIVE RIGHT TO USE "ADHESIVES", APART FROM THE MARK AS SHOWN. SEC. 2(F).

FOR COUNTER-TOP, FLOOR AND WALL COVERING ADHESIVES, NAMELY, CERAMIC FLOOR AND WALL TILE ADHESIVE, CERAMIC WALL TILE ADHESIVE; CONSTRUCTION INDUSTRY ADHESIVES, NAMELY, WALL CARPET ADHESIVE, MULTI-PURPOSE ADHESIVE, ACRYLIC COVE BASE ADHESIVE, CLEAR THIN SPREAD ADHESIVE, CARPET ADHESIVE, PRESSURE SENSITIVE ADHESIVE, PREMIUM NON-STAINING MULTIPURPOSE ADHESIVE, WOOD FLOOR ADHESIVE (U.S. CLS. 1, 5, 6, 10, 26 AND 46).

FIRST USE 5-0-1990; IN COMMERCE 5-0-1990.

MARK RADEMACHER, EXAMINING ATTORNEY

CLASS 1—(Continued).

SN 77-353,981. NISSAN CHEMICAL INDUSTRIES, LTD., CHIYODA-KU, TOKYO, JAPAN, FILED 12-17-2007.

HYPERTech

THE MARK CONSISTS OF STANDARD CHARACTERS WITHOUT CLAIM TO ANY PARTICULAR FONT, STYLE, SIZE, OR COLOR.

PRIORITY CLAIMED UNDER SEC. 44(D) ON JAPAN APPLICATION NO. 2007-120471, FILED 12-3-2007.

OWNER OF JAPAN REG. NO. 5147861, DATED 7-4-2008, EXPIRES 7-4-2018.

FOR UNPROCESSED PLASTICS, NAMELY, UNPROCESSED ACRYLIC RESIN AND POLYSTYRENE RESINS WITH ANTI-BACTERIAL PROPERTIES OR USED AS A CARRIER FOR ANTI-BACTERIAL AGENTS FOR USE IN THE MANUFACTURE OF ELECTRIC APPARATUS AND EQUIPMENT FOR HOUSEHOLD USE, NAMELY, REFRIGERATORS, MICROWAVE OVENS, DISH DRYERS, HOT WATER SUPPLY THERMAL POTS, HUMIDIFIERS, WATER PURIFICATION APPARATUS, TOILET SEATS WITH WASHING AND DRYING FUNCTIONS, DAILY USE PRODUCTS, NAMELY, CUTTING BOARDS, GLOVES, SPONGES, TOWELS, APRONS, TOOTH BRUSHES, HAIR BRUSHES, STATIONERY, NAMELY, WRITING MATERIALS, PAPERS AND FILES, TEXTILE ARTICLES, NAMELY, UNIFORM FOR MEDICAL USE, SHEETS, PILLOW CASES, CURTAINS AND MOPS, MATERIALS FOR BUILDING, NAMELY, MATERIALS FOR FLOORS, CARPETS, PAINTS FOR COVERING FLOORS, WALL PAPERS, PAINTS AND KITCHEN SINKS, SHAVERS, BATHROOM SCALES, CALCULATORS, TOYS, STROLLERS AND BAGS; UNPROCESSED ACRYLIC RESINS AND POLYSTYRENE RESINS FOR USE IN THE MANUFACTURE OF ADHESION ENHANCEMENT AGENT BETWEEN POLYMER FILM AND METALLIC SUBSTRATE; UNPROCESSED ACRYLIC RESINS AND POLYSTYRENE RESINS FOR USE IN THE MANUFACTURE OF CROSSLINK DENSITY ENHANCEMENT AGENT; UNPROCESSED ACRYLIC RESINS AND POLYSTYRENE RESINS FOR USE IN THE MANUFACTURE OF HYDROPHOBILIZING AGENT ON THE SURFACE OF POLYMER FILM; UNPROCESSED ACRYLIC RESINS AND POLYSTYRENE RESINS FOR USE IN THE MANUFACTURE OF ENHANCER OF HYDROPHILICITY ON THE SURFACE OF POLYMER FILM; UNPROCESSED ACRYLIC RESINS AND POLYSTYRENE RESINS FOR USE IN THE MANUFACTURE OF DISPERSANT FOR METALLIC NANOPARTICLES, METALLIC OXIDE NANOPARTICLES, AND SEMICONDUCTOR NANOPARTICLES; AND UNPROCESSED ACRYLIC RESINS AND POLYSTYRENE RESINS FOR USE IN THE MANUFACTURE OF DISPERSANT FOR DYE, AND PIGMENT (U.S. CLS. 1, 5, 6, 10, 26 AND 46).

HOWARD B. LEVINE, EXAMINING ATTORNEY

CLASS 1—(Continued).

SN 77-459,951. BUTTRESS B.V., 3532 AD UTRECHT, NETHERLANDS, FILED 4-28-2008.

NATREEN

THE MARK CONSISTS OF STANDARD CHARACTERS WITHOUT CLAIM TO ANY PARTICULAR FONT, STYLE, SIZE, OR COLOR.

OWNER OF BENELUX REG. NO. 655080, DATED 6-25-1999, EXPIRES 6-25-2019.

THE WORDING "NATREEN" HAS NO MEANING IN A FOREIGN LANGUAGE.

FOR ARTIFICIAL SWEETENERS (U.S. CLS. 1, 5, 6, 10, 26 AND 46).

MARTHA FROMM, EXAMINING ATTORNEY

CLASS 1—(Continued).

SN 77-562,088. ENZO BIOCHEM, NEW YORK, NY. FILED 9-4-2008.

RED SEEKER

THE MARK CONSISTS OF STANDARD CHARACTERS WITHOUT CLAIM TO ANY PARTICULAR FONT, STYLE, SIZE, OR COLOR.

NO CLAIM IS MADE TO THE EXCLUSIVE RIGHT TO USE "RED", APART FROM THE MARK AS SHOWN.

FOR ASSAYS AND REAGENTS FOR GENOMIC, CELLULAR AND DIAGNOSTIC APPLICATIONS FOR CLINICAL OR MEDICAL LABORATORY USE (U.S. CLS. 1, 5, 6, 10, 26 AND 46).

TIMOTHY FINNEGAN, EXAMINING ATTORNEY

SN 77-562,100. ENZO BIOCHEM, NEW YORK, NY. FILED 9-4-2008.

GREEN SEEKER

THE MARK CONSISTS OF STANDARD CHARACTERS WITHOUT CLAIM TO ANY PARTICULAR FONT, STYLE, SIZE, OR COLOR.

NO CLAIM IS MADE TO THE EXCLUSIVE RIGHT TO USE "GREEN", APART FROM THE MARK AS SHOWN.

FOR ASSAYS AND REAGENTS FOR GENOMIC, CELLULAR AND DIAGNOSTIC APPLICATIONS FOR CLINICAL OR MEDICAL LABORATORY USE (U.S. CLS. 1, 5, 6, 10, 26 AND 46).

TIMOTHY FINNEGAN, EXAMINING ATTORNEY

SN 77-562,117. ENZO BIOCHEM, NEW YORK, NY. FILED 9-4-2008.

BLUE SEEKER

THE MARK CONSISTS OF STANDARD CHARACTERS WITHOUT CLAIM TO ANY PARTICULAR FONT, STYLE, SIZE, OR COLOR.

NO CLAIM IS MADE TO THE EXCLUSIVE RIGHT TO USE "BLUE", APART FROM THE MARK AS SHOWN.

FOR ASSAYS AND REAGENTS FOR GENOMIC, CELLULAR AND DIAGNOSTIC APPLICATIONS FOR CLINICAL OR MEDICAL LABORATORY USE (U.S. CLS. 1, 5, 6, 10, 26 AND 46).

TIMOTHY FINNEGAN, EXAMINING ATTORNEY

SN 77-470,736. WOLF MOUNTAIN PRODUCTS, LLC, LINDON, UT. FILED 5-9-2008.



Designer Soils

NO CLAIM IS MADE TO THE EXCLUSIVE RIGHT TO USE "SOILS", APART FROM THE MARK AS SHOWN.

THE COLOR(S) BROWN IS/ARE CLAIMED AS A FEATURE OF THE MARK.

THE MARK CONSISTS OF TWO HANDPRINTS AND THE WORDS "DESIGNER SOILS".

FOR FERTILIZER AND SOIL CONDITIONERS FOR AGRICULTURAL, HORTICULTURAL, AND GOLF COURSE USE; POTTING MIX COMPOSED PRIMARILY OF POTTING SOILS, FOREST HUMUS, AND FERTILIZERS, BUT ALSO INCLUDING AGED WOOD CHIPS AND PEAT MOSS, ALL SOLD AS A UNIT; POTTING AND NURSERY GREENHOUSE MIXES COMPOSED PRIMARILY OF POTTING SOILS, FOREST HUMUS, AND FERTILIZERS, BUT ALSO INCLUDING AGED WOOD CHIPS AND PEAT MOSS, ALL SOLD AS A UNIT; COMPOST MIX; HUMUS, COMPOSED PRIMARILY OF HUMUS, BUT ALSO INCLUDING AGED WOOD CHIPS AND BARK, ALL SOLD AS A UNIT (U.S. CLS. 1, 5, 6, 10, 26 AND 46).

APRIL HESIK, EXAMINING ATTORNEY

CLASS 1—(Continued).

SN 77-562,134. ENZO BIOCHEM, NEW YORK, NY. FILED 9-4-2008.

ORANGE SEEKER

THE MARK CONSISTS OF STANDARD CHARACTERS WITHOUT CLAIM TO ANY PARTICULAR FONT, STYLE, SIZE, OR COLOR.

NO CLAIM IS MADE TO THE EXCLUSIVE RIGHT TO USE "ORANGE", APART FROM THE MARK AS SHOWN.

FOR ASSAYS AND REAGENTS FOR GENOMIC, CELLULAR AND DIAGNOSTIC APPLICATIONS FOR CLINICAL OR MEDICAL LABORATORY USE (U.S. CLS. 1, 5, 6, 10, 26 AND 46).

TIMOTHY FINNEGAN, EXAMINING ATTORNEY

SN 77-576,153. BORO-PHARM, INC., FORMERLY BORO-PHARM LLC, NOVI, MI. FILED 9-22-2008.

Your Bridge to Discovery

THE MARK CONSISTS OF STANDARD CHARACTERS WITHOUT CLAIM TO ANY PARTICULAR FONT, STYLE, SIZE, OR COLOR.

FOR ACTIVE CHEMICAL INGREDIENTS AND SOLVENTS FOR USE IN THE MANUFACTURE OF INSECTICIDES; CATALYSTS FOR USE IN THE MANUFACTURE OF INDUSTRIAL CHEMICALS; CHEMICALS FOR INDUSTRIAL PURPOSES; CHEMICALS FOR USE IN THE MANUFACTURE OF AGRICULTURAL FUNGICIDES, HERBICIDES, INSECTICIDES AND PARASITICIDES; CHEMICALS FOR USE IN BIOTECHNOLOGICAL MANUFACTURING PROCESSES; CHEMICALS FOR USE IN BIOTECHNOLOGICAL PRODUCT DEVELOPMENT; CHEMICALS FOR USE IN INDUSTRY; CHEMICALS FOR USE IN INDUSTRY AND SCIENCE; CHEMICALS FOR USE IN THE BIOCHEMICAL AND CHEMICAL INDUSTRY; CHEMICALS FOR USE IN THE PURIFICATION OF PROTEINS FOR IN VITRO USE; CHEMICALS USED IN INDUSTRY; INDUSTRIAL CHEMICALS; SPECIALTY CHEMICALS, NAMELY, CHEMICAL ADDITIVES FOR GENERAL INDUSTRIAL USE IN THE MANUFACTURE OF A WIDE VARIETY OF GOODS (U.S. CLS. 1, 5, 6, 10, 26 AND 46).

FIRST USE 8-28-2007; IN COMMERCE 9-8-2007.

JASON TURNER, EXAMINING ATTORNEY

CLASS 1—(Continued).

SN 77-577,356. XCEIVE CORP., SANTA CLARA, CA. FILED 9-24-2008.

XDDI

THE MARK CONSISTS OF STANDARD CHARACTERS WITHOUT CLAIM TO ANY PARTICULAR FONT, STYLE, SIZE, OR COLOR.

FOR SILICON AND NON-SILICON TELEVISION TUNERS; DEMODULATORS AND ELECTRONIC CIRCUITS (U.S. CLS. 1, 5, 6, 10, 26 AND 46).

JEAN IM, EXAMINING ATTORNEY

SN 77-579,819. DAINICHISEIKA COLOR & CHEMICALS MFG. CO., LTD., TOKYO 108-8383, JAPAN, FILED 9-26-2008.

NONSOLBOND

THE MARK CONSISTS OF STANDARD CHARACTERS WITHOUT CLAIM TO ANY PARTICULAR FONT, STYLE, SIZE, OR COLOR.

FOR ADHESIVES FOR INDUSTRIAL PURPOSES; ADHESIVES FOR PAPERHANGING; ADHESIVES FOR WALL TILES; ADHESIVES FOR LAMINATING PLASTIC FILMS; ADHESIVES FOR USE IN MANUFACTURING TEXTILES; ADHESIVES FOR USE IN THE MANUFACTURE OF CORRUGATED PAPER; ADHESIVES PREPARATIONS FOR USE IN MANUFACTURING SURGICAL BANDAGES; ADHESIVES FOR LAMINATING METAL SHEETS; INDUSTRIAL CHEMICALS; CHEMICAL PREPARATIONS FOR SCIENTIFIC PURPOSES OTHER THAN FOR MEDICAL OR VETERINARY USE (U.S. CLS. 1, 5, 6, 10, 26 AND 46).

HEATHER THOMPSON, EXAMINING ATTORNEY

SN 77-580,027. CORAL CHEMICAL COMPANY, ZION, IL. FILED 9-26-2008.

GREEN & YELLOW GONE

THE MARK CONSISTS OF STANDARD CHARACTERS WITHOUT CLAIM TO ANY PARTICULAR FONT, STYLE, SIZE, OR COLOR.

OWNER OF U.S. REG. NO. 2,400,641.

NO CLAIM IS MADE TO THE EXCLUSIVE RIGHT TO USE "GREEN & YELLOW", APART FROM THE MARK AS SHOWN.

FOR CLEANING ADDITIVES IN THE NATURE OF WATER TREATMENT AND/OR WATER PURIFYING CHEMICALS FOR SWIMMING POOLS (U.S. CLS. 1, 5, 6, 10, 26 AND 46).

HOWARD SMIGA, EXAMINING ATTORNEY

CLASS 1—(Continued).

SN 77-598,682. ASHLAND LICENSING AND INTELLECTUAL PROPERTY LLC, DUBLIN, OH. FILED 10-23-2008.

MULTI-LIFE

THE MARK CONSISTS OF STANDARD CHARACTERS WITHOUT CLAIM TO ANY PARTICULAR FONT, STYLE, SIZE, OR COLOR.
FOR CHEMICAL MOTOR OIL ADDITIVES (U.S. CLS. 1, 5, 6, 10, 26 AND 46).
BILL DAWE, EXAMINING ATTORNEY

SN 77-610,259. SOCIETE D'EXPLOITATION DE PRODUITS POUR LES INDUSTRIES CHIMIQUES SEPPIC - SOCIÉTÉ ANONYME À DIRECTOIRE ET CONSEIL DE SURVEILLANCE, PARIS, FRANCE, FILED 11-7-2008.

SURVICODE

THE MARK CONSISTS OF STANDARD CHARACTERS WITHOUT CLAIM TO ANY PARTICULAR FONT, STYLE, SIZE, OR COLOR.
PRIORITY CLAIMED UNDER SEC. 44(D) ON FRANCE APPLICATION NO. 083.578.949, FILED 5-30-2008, REG. NO. 083.578.949, DATED 5-30-2008, EXPIRES 5-30-2018.
FOR CHEMICALS USED AS RAW MATERIAL FOR THE MANUFACTURING OF COSMETIC, PHARMACEUTICAL, OR VETERINARY PRODUCTS (U.S. CLS. 1, 5, 6, 10, 26 AND 46).
DOUGLAS LEE, EXAMINING ATTORNEY

SN 77-612,275. MANNCO FERTILIZER CO., INC., CONWAY, AR. FILED 11-11-2008.

Top Choice Organic

THE MARK CONSISTS OF STANDARD CHARACTERS WITHOUT CLAIM TO ANY PARTICULAR FONT, STYLE, SIZE, OR COLOR.
NO CLAIM IS MADE TO THE EXCLUSIVE RIGHT TO USE "ORGANIC", APART FROM THE MARK AS SHOWN.
FOR ORGANIC FERTILIZER HAVING ORGANIC COMPONENTS GATHERED FROM WASTE TREATMENT FACILITIES AND SOLD TO AGRICULTURAL OPERATIONS OR COMMERCIAL TURF MANAGEMENT OPERATIONS (U.S. CLS. 1, 5, 6, 10, 26 AND 46).
FIRST USE 6-30-2004; IN COMMERCE 6-30-2004.
DAWN FELDMAN, EXAMINING ATTORNEY

CLASS 1—(Continued).

SN 77-613,444. AJINOMOTO CO., INC., CHUO-KU, TOKYO, JAPAN, FILED 11-13-2008.

CORYNEX

THE MARK CONSISTS OF STANDARD CHARACTERS WITHOUT CLAIM TO ANY PARTICULAR FONT, STYLE, SIZE, OR COLOR.
OWNER OF U.S. REG. NO. 3,556,696.
FOR CHEMICALS USED IN INDUSTRY AND SCIENCE, NAMELY, PROTEIN, PEPTIDES, PROTEIN PREPARATIONS AND PEPTIDE PREPARATIONS; PROTEIN PREPARATION AND PEPTIDE PREPARATIONS FOR SCIENTIFIC AND MEDICAL RESEARCH; PROTEINS, PEPTIDES OR REAGENTS FOR CLINICAL LABORATORY, MEDICAL, CHEMICAL, BIOCHEMICAL OR INDUSTRIAL RESEARCH USE; DIAGNOSTIC CULTURAL MEDIA FOR CLINICAL LABORATORY AND MEDICAL, CHEMICAL, BIOCHEMICAL OR INDUSTRIAL RESEARCH USE (U.S. CLS. 1, 5, 6, 10, 26 AND 46).
VIVIAN MICZNIK FIRST, EXAMINING ATTORNEY

SN 77-615,975. FRANKLIN INTERNATIONAL, INC., COLUMBUS, OH. FILED 11-17-2008.

TITAN

THE MARK CONSISTS OF STANDARD CHARACTERS WITHOUT CLAIM TO ANY PARTICULAR FONT, STYLE, SIZE, OR COLOR.
FOR CONSTRUCTION INDUSTRY ADHESIVES; ADHESIVES FOR USE IN CONSTRUCTION, NAMELY, ADHESIVE MASTICS FOR BUILDING, BONDING, REPAIR, RESTORATION, AND SURFACING PURPOSES (U.S. CLS. 1, 5, 6, 10, 26 AND 46).
JAY BESCH, EXAMINING ATTORNEY

CLASS 1—(Continued).

SN 77-617,989. UWIZ TECHNOLOGY CO., LTD., TAOYUAN COUNTY 32063, TAIWAN, FILED 11-19-2008.

SuperNova

THE MARK CONSISTS OF THE STYLIZED WORDS "SUPERNOVA".

FOR CHEMICAL SLURRY FOR USE IN SEMICONDUCTOR WAFER POLISHING; CHEMICAL DEVELOPERS AND SENSITIZERS FOR USE ON SEMICONDUCTOR WAFERS; CHEMICALS FOR INDUSTRIAL USES; PHOTORESISTS; PHOTORESISTS FOR SEMICONDUCTOR DEVICES; CHEMICAL ETCHING INHIBITORS ADAPTED FOR MANUFACTURING INTEGRATED CIRCUITS; CHEMICAL SOLVENTS ADAPTED FOR MANUFACTURING ELECTRONIC PARTS; CHEMICALS FOR SCIENTIFIC USES (U.S. CLS. 1, 5, 6, 10, 26 AND 46).

JEFFREY LOOK, EXAMINING ATTORNEY

SN 77-628,774. KEMIRA CHEMICALS, INC., KENNESAW, GA. FILED 12-8-2008.

OMNISOFT

THE MARK CONSISTS OF STANDARD CHARACTERS WITHOUT CLAIM TO ANY PARTICULAR FONT, STYLE, SIZE, OR COLOR.

PRIORITY CLAIMED UNDER SEC. 44(D) ON FINLAND APPLICATION NO. T200802086, FILED 6-6-2008.

FOR CHEMICALS USED IN THE MANUFACTURE OF PAPER (U.S. CLS. 1, 5, 6, 10, 26 AND 46).

FIRST USE 12-0-1996; IN COMMERCE 12-0-1996.
G. MAYERSCHOFF, EXAMINING ATTORNEY

SN 77-665,917. APPLIED BIOSYSTEMS, LLC., FOSTER CITY, CA. FILED 2-9-2009.

TED

THE MARK CONSISTS OF STANDARD CHARACTERS WITHOUT CLAIM TO ANY PARTICULAR FONT, STYLE, SIZE, OR COLOR.

FOR FLUORESCENT DYE FOR SCIENTIFIC OR RESEARCH USE (U.S. CLS. 1, 5, 6, 10, 26 AND 46).

LINDA E. BLOHM, EXAMINING ATTORNEY

CLASS 1—(Continued).

SN 77-687,409. BECTON, DICKINSON AND COMPANY, FRANKLIN LAKES, NJ. FILED 3-10-2009.



OWNER OF U.S. REG. NOS. 2,510,232, 2,791,440 AND OTHERS.

THE MARK CONSISTS OF A SHADED CIRCLE CONTAINING A SUNBURST DESIGN AND A PARTIAL ARC DESIGN; NEXT TO THE SHADED CIRCLE ARE THE LETTERS "BD" AND WORD "ULTRAPOL".

FOR BIOLOGICALS, NAMELY, HUMAN LIVER MICROSOME FOR SCIENTIFIC AND MEDICAL RESEARCH USE (U.S. CLS. 1, 5, 6, 10, 26 AND 46).

JENNIFER MARTIN, EXAMINING ATTORNEY

SN 77-702,483. TURFGRASS MANAGEMENT, INC., DBA GRIGG BROS., ALBION, ID. FILED 3-30-2009.

E3 TECHNOLOGY

THE MARK CONSISTS OF STANDARD CHARACTERS WITHOUT CLAIM TO ANY PARTICULAR FONT, STYLE, SIZE, OR COLOR.

NO CLAIM IS MADE TO THE EXCLUSIVE RIGHT TO USE "TECHNOLOGY", APART FROM THE MARK AS SHOWN.

FOR FERTILIZER (U.S. CLS. 1, 5, 6, 10, 26 AND 46).

FIRST USE 2-27-2009; IN COMMERCE 2-27-2009.
JAMES A. RAUEN, EXAMINING ATTORNEY

SN 77-704,047. A.V.W. INC., DBA MAX PROFESSIONAL, FT LAUDERDALE, FL. FILED 4-1-2009.

Fire Fight

THE MARK CONSISTS OF STANDARD CHARACTERS WITHOUT CLAIM TO ANY PARTICULAR FONT, STYLE, SIZE, OR COLOR.

FOR FIRE-EXTINGUISHING COMPOSITIONS (U.S. CLS. 1, 5, 6, 10, 26 AND 46).

FIRST USE 10-25-2007; IN COMMERCE 10-21-2008.
JENNIFER VASQUEZ, EXAMINING ATTORNEY

CLASS 1—(Continued).

SN 77-705,293. COOK COMPOSITES AND POLYMERS COMPANY, KANSAS CITY, MO. FILED 4-2-2009.

EPOVIA

THE MARK CONSISTS OF STANDARD CHARACTERS WITHOUT CLAIM TO ANY PARTICULAR FONT, STYLE, SIZE, OR COLOR.

THE WORDING "EPOVIA" HAS NO MEANING IN A FOREIGN LANGUAGE.

FOR VINYL ESTER RESIN FOR USE ON INDUSTRIAL EQUIPMENT (U.S. CLS. 1, 5, 6, 10, 26 AND 46).

FIRST USE 8-29-2007; IN COMMERCE 8-29-2007.
NAKIA HENRY, EXAMINING ATTORNEY

CLASS 1—(Continued).

SN 77-716,267. SOCIETE D'EXPLOITATION DE PRODUITS POUR LES INDUSTRIES CHIMIQUES SEPPIC - SOCIÉTÉ ANONYME À DIRECTOIRE ET CONSEIL DE SURVEILLANCE, PARIS CEDEX 07, FRANCE, FILED 4-17-2009.

SIMULQUAT

THE MARK CONSISTS OF STANDARD CHARACTERS WITHOUT CLAIM TO ANY PARTICULAR FONT, STYLE, SIZE, OR COLOR.

PRIORITY CLAIMED UNDER SEC. 44(D) ON FRANCE APPLICATION NO. 083606143, FILED 10-21-2008, REG. NO. 083606143, DATED 10-21-2008, EXPIRES 10-21-2018.

FOR CHEMICALS, NAMELY, THICKENER POLYMERS TO BE USED IN THE COMPOSITION OF HAIR-CARE PRODUCTS (U.S. CLS. 1, 5, 6, 10, 26 AND 46).

GRETTA YAO, EXAMINING ATTORNEY

SN 77-718,818. WTI, INC., JEFFERSON, GA. FILED 4-21-2009.

MYOSOL

THE MARK CONSISTS OF STANDARD CHARACTERS WITHOUT CLAIM TO ANY PARTICULAR FONT, STYLE, SIZE, OR COLOR.

FOR FOOD ADDITIVES USED IN MEATS, NAMELY, COMPOSITIONS FOR MAINTAINING COLOR AND ENHANCING LIQUID RETENTION CAPACITY OF MEAT PRODUCTS (U.S. CLS. 1, 5, 6, 10, 26 AND 46).

FIRST USE 7-13-1984; IN COMMERCE 7-13-1984.
RON FAIRBANKS, EXAMINING ATTORNEY

SN 77-710,286. BAR'S PRODUCTS, INC., HOLLY, MI. FILED 4-9-2009.



OWNER OF U.S. REG. NOS. 1,872,144, 2,556,976 AND OTHERS.

NO CLAIM IS MADE TO THE EXCLUSIVE RIGHT TO USE "LEAKS" AND "BLOCK SEAL" AND "PERMANENT HEAD GASKET FIX", APART FROM THE MARK AS SHOWN.

THE MARK CONSISTS OF AN OVAL WITH "BAR'S" IN TOP HALF, "LEAKS" IN BOTTOM HALF; "BLOCK SEAL" IN OVAL WITH STRAIGHT EDGE ON LEFT SIDE; "PERMANENT" WITH THE "P" CAPITALIZED AND "HEAD GASKET FIX" IN ALL CAPS.

FOR AUTOMOBILE INTERNAL COMBUSTION ENGINES COOLING SYSTEM LEAK SEALANT (U.S. CLS. 1, 5, 6, 10, 26 AND 46).

FIRST USE 0-0-2000; IN COMMERCE 0-0-2000.
GINA FINK, EXAMINING ATTORNEY

SN 77-719,369. AQUALBELLA ORGANIC SOLUTIONS LLC, SEBASTOPOL, CA. FILED 4-22-2009.

TERRABELLA

THE MARK CONSISTS OF STANDARD CHARACTERS WITHOUT CLAIM TO ANY PARTICULAR FONT, STYLE, SIZE, OR COLOR.

THE ENGLISH TRANSLATION OF "TERRABELLA" IS BEAUTIFUL EARTH.

FOR HORTICULTURAL PRODUCTS, NAMELY, SOIL AMENDMENTS THAT ARE INCORPORATED INTO OR ONTO A TURF, LAWN OR SOIL PROFILE FOR CREATING A HEALTH MEDIUM FOR INCREASED ROOT GROWTH AND/OR A SMOOTHER TURF OR LAWN SURFACE CUT OR APPEARANCE (U.S. CLS. 1, 5, 6, 10, 26 AND 46).

MARIAM MAHMOUDI, EXAMINING ATTORNEY

CLASS 1—(Continued).

SN 77-724,223. INTERCAT, INC., MANASQUAN, NJ. FILED 4-28-2009.

SOXCUTTER

THE MARK CONSISTS OF STANDARD CHARACTERS WITHOUT CLAIM TO ANY PARTICULAR FONT, STYLE, SIZE, OR COLOR.

OWNER OF U.S. REG. NOS. 2,738,783 AND 3,034,510. FOR CHEMICAL PREPARATIONS FOR CATALYTIC CRACKING IN THE PETROLEUM INDUSTRY (U.S. CLS. 1, 5, 6, 10, 26 AND 46).
ANDREA BUTLER, EXAMINING ATTORNEY

SN 77-724,253. ADVANCED MINERALS CORPORATION, SANTA BARBARA, CA. FILED 4-28-2009.

ECOFLAT

THE MARK CONSISTS OF STANDARD CHARACTERS WITHOUT CLAIM TO ANY PARTICULAR FONT, STYLE, SIZE, OR COLOR.

FOR SILICA FOR USE IN PAINT AND INDUSTRIAL COATINGS (U.S. CLS. 1, 5, 6, 10, 26 AND 46).
SOPHIA S. KIM, EXAMINING ATTORNEY

SN 77-724,745. ADVANCED REFINING TECHNOLOGIES, LLC, COLUMBIA, MD. FILED 4-29-2009.

HSLs

THE MARK CONSISTS OF STANDARD CHARACTERS WITHOUT CLAIM TO ANY PARTICULAR FONT, STYLE, SIZE, OR COLOR.

FOR CHEMICAL CATALYSTS USED IN THE PETROLEUM AND REFINING INDUSTRIES AND MORE SPECIFICALLY, FOR HYDROPROCESSING AND HYDROTREATING CATALYSTS (U.S. CLS. 1, 5, 6, 10, 26 AND 46).
JENNIFER DIXON, EXAMINING ATTORNEY

CLASS 1—(Continued).

SN 77-725,262. KELTNER, KENNETH E., DALLAS, TX. FILED 4-29-2009.

WIND-FALL

THE MARK CONSISTS OF STANDARD CHARACTERS WITHOUT CLAIM TO ANY PARTICULAR FONT, STYLE, SIZE, OR COLOR.

FOR DRIFT CONTROL AGENT FOR USE IN AIR SPRAYING OF HERBICIDES, FUNGICIDES AND INSECTICIDES (U.S. CLS. 1, 5, 6, 10, 26 AND 46).
SUE LAWRENCE, EXAMINING ATTORNEY

SN 77-725,858. NUGEN TECHNOLOGIES, INC., SAN CARLOS, CA. FILED 4-30-2009.

ENCORE

THE MARK CONSISTS OF STANDARD CHARACTERS WITHOUT CLAIM TO ANY PARTICULAR FONT, STYLE, SIZE, OR COLOR.

FOR CHEMICALS, CHEMICAL ASSAYS, REAGENT ASSAYS, AND SAMPLE PREPARATION REAGENTS FOR THE ANALYSIS OF NUCLEIC ACIDS, PROTEINS AND ANTIBODIES, NUCLEIC ACID SEQUENCE AMPLIFICATION, SEQUENCING, SEQUENCE ANALYSIS AND DETECTION, OLIGONUCLEOTIDES, CDNA AND RNA LIBRARIES, AND MICROARRAYS, ALL FOR SCIENTIFIC AND RESEARCH USE (U.S. CLS. 1, 5, 6, 10, 26 AND 46).
PATRICIA EVANKO, EXAMINING ATTORNEY

SN 77-725,862. NUGEN TECHNOLOGIES, INC., SAN CARLOS, CA. FILED 4-30-2009.

PRELUDE

THE MARK CONSISTS OF STANDARD CHARACTERS WITHOUT CLAIM TO ANY PARTICULAR FONT, STYLE, SIZE, OR COLOR.

FOR CHEMICALS, CHEMICAL ASSAYS, REAGENT ASSAYS, AND SAMPLE PREPARATION REAGENTS FOR THE ANALYSIS OF NUCLEIC ACIDS, PROTEINS AND ANTIBODIES, NUCLEIC ACID SEQUENCE AMPLIFICATION, SEQUENCING, SEQUENCE ANALYSIS AND DETECTION, OLIGONUCLEOTIDES, CDNA AND RNA LIBRARIES, AND MICROARRAYS, ALL FOR SCIENTIFIC AND RESEARCH USE (U.S. CLS. 1, 5, 6, 10, 26 AND 46).
PATRICIA EVANKO, EXAMINING ATTORNEY

CLASS 1—(Continued).

SN 77-726,555. GRUPO BIOQUIMICO MEXICANO, S.A. DE C.V., SALTILLO, COAHUILA, MEXICO, FILED 4-30-2009.



OWNER OF U.S. REG. NO. 3,530,889.
THE MARK CONSISTS OF THE WORD "RAIZAL" UNDERLINED AND HAVING ON THE RIGHT SIDE OF THE WORD A SUPERSCRIPT ASTERISK AND SUBSCRIPT LEAF.
FOR FERTILIZERS FOR AGRICULTURAL USE (U.S. CLS. 1, 5, 6, 10, 26 AND 46).
GEORGE LORENZO, EXAMINING ATTORNEY

SN 77-726,570. LOVELAND PRODUCTS, INC., GREELEY, CO. FILED 4-30-2009.

EARLY HARVEST

THE MARK CONSISTS OF STANDARD CHARACTERS WITHOUT CLAIM TO ANY PARTICULAR FONT, STYLE, SIZE, OR COLOR.
FOR DEFOLIANTS (U.S. CLS. 1, 5, 6, 10, 26 AND 46).
JUDITH HELFMAN, EXAMINING ATTORNEY

SN 77-726,727. PHELPS, ROBERT S., TRENTON, ME. FILED 5-1-2009.

XenoQ

THE MARK CONSISTS OF STANDARD CHARACTERS WITHOUT CLAIM TO ANY PARTICULAR FONT, STYLE, SIZE, OR COLOR.
FOR ASSAYS AND REAGENTS FOR USE IN GENETIC RESEARCH (U.S. CLS. 1, 5, 6, 10, 26 AND 46).
JOHN GARTNER, EXAMINING ATTORNEY

CLASS 1—(Continued).

SN 77-727,491. CHRYSO, INC., CHARLESTOWN, IN. FILED 5-1-2009.

PoreTite

THE MARK CONSISTS OF STANDARD CHARACTERS WITHOUT CLAIM TO ANY PARTICULAR FONT, STYLE, SIZE, OR COLOR.
FOR CONCRETE ADMIXTURES (U.S. CLS. 1, 5, 6, 10, 26 AND 46).
FIRST USE 9-26-2006; IN COMMERCE 9-26-2006.
ZACHARY BELLO, EXAMINING ATTORNEY

SN 77-727,576. AQUA TRI, IRVINE, CA. FILED 5-1-2009.

FRESH & CLEAN

THE MARK CONSISTS OF STANDARD CHARACTERS WITHOUT CLAIM TO ANY PARTICULAR FONT, STYLE, SIZE, OR COLOR.
OWNER OF U.S. REG. NO. 3,626,017.
FOR WATER TREATMENT CHEMICALS FOR USE IN SWIMMING POOLS AND SPAS, EXCLUDING NON-CHLORINE BASED WATER SHOCK PRODUCTS USING THE CHEMICALS POTASSIUM MONOPERSULFATE, ALSO KNOWN AS POTASSIUM PEROXYMONOPERSULFATE, AND SODIUM MONOPERSULFATE (U.S. CLS. 1, 5, 6, 10, 26 AND 46).
FIRST USE 11-20-1990; IN COMMERCE 4-1-1992.
DAVID H. STINE, EXAMINING ATTORNEY

SN 77-728,507. SUN CHEMICAL CORPORATION, PARSIPPANY, NJ. FILED 5-4-2009.

MAGNITEK

THE MARK CONSISTS OF STANDARD CHARACTERS WITHOUT CLAIM TO ANY PARTICULAR FONT, STYLE, SIZE, OR COLOR.
FOR PRINTING PRESSROOM CHEMICALS, NAMELY, BLANKET CLEANERS AND ROLLER CLEANERS (U.S. CLS. 1, 5, 6, 10, 26 AND 46).
FIRST USE 3-31-2006; IN COMMERCE 3-31-2006.
MARK T. MULLEN, EXAMINING ATTORNEY

CLASS 1—(Continued).

SN 77-729,001. MERCEDES MEDICAL, INC., SARASOTA, FL. FILED 5-5-2009.

CLEAR-X

THE MARK CONSISTS OF STANDARD CHARACTERS WITHOUT CLAIM TO ANY PARTICULAR FONT, STYLE, SIZE, OR COLOR.

FOR XYLENE SUBSTITUTE FOR CLINICAL LABORATORY OR MEDICAL LABORATORY USE; CHEMICAL REAGENT FOR USE IN HISTOLOGY APPLICATIONS TO PREPARE TISSUE FOR STAINING IN CLINICAL LABORATORY SITUATIONS (U.S. CLS. 1, 5, 6, 10, 26 AND 46).

BRIAN NEVILLE, EXAMINING ATTORNEY

SN 77-748,978. CHR. HANSEN A/S, MILWAUKEE, WI. FILED 6-1-2009.

MANEUVER

THE MARK CONSISTS OF STANDARD CHARACTERS WITHOUT CLAIM TO ANY PARTICULAR FONT, STYLE, SIZE, OR COLOR.

FOR GRANULATED COMPOSITIONS CONTAINING MICROORGANISMS AND/OR ENZYMES USED FOR BREAKING DOWN MANURE AND CONTROLLING ODOR (U.S. CLS. 1, 5, 6, 10, 26 AND 46).

FIRST USE 8-21-1996; IN COMMERCE 8-21-1996.
GINA FINK, EXAMINING ATTORNEY

SN 77-753,610. LOVELAND PRODUCTS, INC., GREELEY, CO. FILED 6-5-2009.

UPGRADE

THE MARK CONSISTS OF STANDARD CHARACTERS WITHOUT CLAIM TO ANY PARTICULAR FONT, STYLE, SIZE, OR COLOR.

FOR ADJUVANT USED WITH PESTICIDES (U.S. CLS. 1, 5, 6, 10, 26 AND 46).

JUDITH HELFMAN, EXAMINING ATTORNEY

CLASS 1—(Continued).

SN 77-754,090. KAO KABUSHIKI KAISHA, TA KAO CORPORATION, CHUO-KU, TOKYO, JAPAN, FILED 6-8-2009.

WONDERFOAM

THE MARK CONSISTS OF STANDARD CHARACTERS WITHOUT CLAIM TO ANY PARTICULAR FONT, STYLE, SIZE, OR COLOR.

FOR SURFACTANTS FOR USE AS A FOAM BOOSTER FOR SHAMPOOS (U.S. CLS. 1, 5, 6, 10, 26 AND 46).
DAVID H. STINE, EXAMINING ATTORNEY

SN 79-060,221. DANSTAR FERMENT AG.; SOCIÉTÉ DE DROIT SUISSE, SWITZERLAND, FILED 9-19-2008.

VITILEVURES

OWNER OF INTERNATIONAL REGISTRATION 0542472 DATED 7-31-1989, EXPIRES 7-31-2009.

THE WORDING "VITILEVURES" HAS NO MEANING IN A FOREIGN LANGUAGE.

FOR WINE PRODUCT USED IN THE WINE-MAKING PROCESS, NAMELY, ENZYME PREPARATIONS FOR FERMENTING WINE (U.S. CLS. 1, 5, 6, 10, 26 AND 46).
ALLISON HALL, EXAMINING ATTORNEY

SN 79-060,535. NOVOZYMES A/S, DENMARK, FILED 10-8-2008.

IZYME

THE MARK CONSISTS OF STANDARD CHARACTERS WITHOUT CLAIM TO ANY PARTICULAR FONT, STYLE, SIZE, OR COLOR.

PRIORITY DATE OF 6-4-2008 IS CLAIMED.
OWNER OF INTERNATIONAL REGISTRATION 0981207 DATED 10-8-2008, EXPIRES 10-8-2018.

OWNER OF U.S. REG. NOS. 2,531,502, 2,958,900 AND OTHERS.

THE WORDING "IZYME" HAS NO MEANING IN A FOREIGN LANGUAGE

FOR ENZYME PREPARATIONS FOR USE IN THE FOOD AND NUTRITION INDUSTRY (U.S. CLS. 1, 5, 6, 10, 26 AND 46).

WILLIAM ROSSMAN, EXAMINING ATTORNEY

CLASS 1—(Continued).

SN 79-063,638. POLIMERI EUROPA S.P.A., ITALY, FILED 10-14-2008.

PBE-2

THE MARK CONSISTS OF STANDARD CHARACTERS WITHOUT CLAIM TO ANY PARTICULAR FONT, STYLE, SIZE, OR COLOR.

PRIORITY DATE OF 9-22-2008 IS CLAIMED.
OWNER OF INTERNATIONAL REGISTRATION 0988641 DATED 10-14-2008, EXPIRES 10-14-2018.

FOR CHEMICALS USED IN CHEMICAL AND PETROCHEMICAL INDUSTRY; CATALYSTS USED IN CHEMICAL PROCESSES AND FOR USE IN THE MANUFACTURE OF INDUSTRIAL CHEMICALS; SILICALITES, NAMELY, ALUMINUM SILICATE; ZEOLITES IN THE NATURE OF ALUMINUM SILICATE; INORGANIC MATERIALS IN THE NATURE OF INDUSTRIAL CHEMICALS USED IN CHEMICAL AND PETROCHEMICAL INDUSTRY (U.S. CLS. 1, 5, 6, 10, 26 AND 46).
LAURA HAMMEL, EXAMINING ATTORNEY

SN 79-063,639. POLIMERI EUROPA S.P.A., ITALY, FILED 10-14-2008.

PBE-1

THE MARK CONSISTS OF STANDARD CHARACTERS WITHOUT CLAIM TO ANY PARTICULAR FONT, STYLE, SIZE, OR COLOR.

PRIORITY DATE OF 9-22-2008 IS CLAIMED.
OWNER OF INTERNATIONAL REGISTRATION 0988642 DATED 10-14-2008, EXPIRES 10-14-2018.

FOR CHEMICALS USED IN CHEMICAL AND PETROCHEMICAL INDUSTRY; CATALYSTS USED IN CHEMICAL PROCESSES AND FOR USE IN THE MANUFACTURE OF INDUSTRIAL CHEMICALS; SILICALITES, NAMELY, ALUMINUM SILICATE; ZEOLITES IN THE NATURE OF ALUMINUM SILICATE; INORGANIC MATERIALS IN THE NATURE OF INDUSTRIAL CHEMICALS USED IN CHEMICAL AND PETROCHEMICAL INDUSTRIES (U.S. CLS. 1, 5, 6, 10, 26 AND 46).
LAURA HAMMEL, EXAMINING ATTORNEY

CLASS 1—(Continued).

SN 79-068,514. KEMIRA CHEMSOLUTIONS B.V., NETHERLANDS, FILED 4-27-2009.

PROVIAN

THE MARK CONSISTS OF STANDARD CHARACTERS WITHOUT CLAIM TO ANY PARTICULAR FONT, STYLE, SIZE, OR COLOR.

PRIORITY DATE OF 1-9-2009 IS CLAIMED.
OWNER OF INTERNATIONAL REGISTRATION 1001919 DATED 4-27-2009, EXPIRES 4-27-2019.

FOR CHEMICALS USED IN INDUSTRY, NAMELY, CHEMICALS USED FOR PRESERVATION OF FOOD STUFFS (U.S. CLS. 1, 5, 6, 10, 26 AND 46).
HAI-LY LAM, EXAMINING ATTORNEY

CLASS 2—PAINTS

SN 76-697,236. DOW CORNING CORPORATION, MIDLAND, MI. FILED 5-5-2009.

|XIAMETER|

OWNER OF U.S. REG. NOS. 2,768,964, 2,768,965 AND 2,835,042.

THE MARK IS CHARACTERIZED BY THE WORD "XIAMETER" PRINTED IN A SANS SERIF ALL CAPITAL TYPEFACE IN BETWEEN A PAIR OF VERTICAL ELEMENTS SUGGESTIVE OF A GATE.

THE WORDING "XIAMETER" HAS NO MEANING IN A FOREIGN LANGUAGE.

FOR COATING GOODS SOLD TO MANUFACTURES OF HOUSEHOLD CARE PRODUCTS AND INDUSTRIAL PRODUCTS, NAMELY, PAINTS FOR EXTERIOR AND INTERIOR USE, VARNISHES, LACQUERS FOR USE AS A COATING; RUST PREVENTATIVES IN THE NATURE OF A COATING, WOOD PRESERVATIVES AGAINST DETERIORATION OF WOOD; COLORING MATERIALS IN THE NATURE OF COLOR PIGMENTS, COLORANTS FOR USE IN THE MANUFACTURE OF PRINTING INK, PAINT, PAPER; DYE-STUFFS FOR USE IN THE MANUFACTURE OF SEALANTS; MORDANTS FOR USE IN THE PAINT INDUSTRY AND CONSTRUCTION INDUSTRY; NATURAL RESINS FOR USE IN THE MANUFACTURE OF ADHESIVES; HEAT RESISTANT EXTERIOR AND INTERIOR HOUSE PAINTS, WEATHER RESISTANT EXTERIOR AND INTERIOR HOUSE PAINTS, VARNISH, ELECTRICAL VARNISHES, EXTERIOR AND INTERIOR HOUSE PAINTS AND NATURAL RESINS FOR USE IN THE MANUFACTURE OF SEALANTS ALL FOR USE AS A COATING, PREPARATIONS FOR COATING CONCRETE, METAL AND MASONRY IN THE NATURE OF EXTERIOR AND INTERIOR PAINTS (U.S. CLS. 6, 11 AND 16).

FIRST USE 1-7-2002; IN COMMERCE 1-7-2002.
B. PARADEWELAI, EXAMINING ATTORNEY

CLASS 2—(Continued).

SN 76-697,238. DOW CORNING CORPORATION, MIDLAND, MI. FILED 5-5-2009.

 The logo for XIAMETER features the word "XIAMETER" in a bold, orange, sans-serif font. The letters are contained within a white rectangular frame that has vertical bars on the left and right sides, resembling a gate or a stylized 'X' shape.

OWNER OF U.S. REG. NOS. 2,768,964, 2,768,965 AND 2,835,042.

THE COLOR(S) ORANGE IS/ARE CLAIMED AS A FEATURE OF THE MARK.

THE MARK IS CHARACTERIZED BY THE WORD "XIAMETER" PRINTED IN A SANS SERIF ALL CAPITAL TYPEFACE IN BETWEEN A PAIR OF VERTICAL ELEMENTS SUGGESTIVE OF A GATE AND PRINTED IN AN ORANGE COLOR (PANTONE 151 C).

THE WORDING "XIAMETER" HAS NO MEANING IN A FOREIGN LANGUAGE.

FOR COATING GOODS SOLD TO MANUFACTURES OF HOUSEHOLD CARE PRODUCTS AND INDUSTRIAL PRODUCTS, NAMELY, PAINTS FOR EXTERIOR AND INTERIOR USE, VARNISHES, LACQUERS FOR USE AS A COATING; RUST PREVENTATIVES IN THE NATURE OF A COATING, WOOD PRESERVATIVES AGAINST DETERIORATION OF WOOD; COLORING MATERIALS IN THE NATURE OF COLOR PIGMENTS, COLORANTS FOR USE IN THE MANUFACTURE OF PRINTING INK, PAINT, PAPER; DYE-STUFFS FOR USE IN THE MANUFACTURE OF SEALANTS; MORDANTS FOR USE IN THE PAINT INDUSTRY AND CONSTRUCTION INDUSTRY; NATURAL RESINS FOR USE IN THE MANUFACTURE OF ADHESIVES; HEAT RESISTANT EXTERIOR AND INTERIOR HOUSE PAINTS; WEATHER RESISTANT EXTERIOR AND INTERIOR HOUSE PAINTS, VARNISH, ELECTRICAL VARNISHES, EXTERIOR AND INTERIOR HOUSE PAINTS AND NATURAL RESINS FOR USE IN THE MANUFACTURE OF SEALANTS ALL FOR USE AS A COATING, PREPARATIONS FOR COATING CONCRETE, METAL AND MASONRY IN THE NATURE OF EXTERIOR AND INTERIOR PAINTS (U.S. CLS. 6, 11 AND 16).

FIRST USE 1-7-2002; IN COMMERCE 1-7-2002.

B. PARADEWELAI, EXAMINING ATTORNEY

SN 77-022,323. CONSOLIDATED COATINGS CORPORATION, DELTA, CANADA, FILED 10-16-2006.

CEMENTPAL

THE MARK CONSISTS OF STANDARD CHARACTERS WITHOUT CLAIM TO ANY PARTICULAR FONT, STYLE, SIZE, OR COLOR.

PRIORITY CLAIMED UNDER SEC. 44(D) ON CANADA APPLICATION NO. 1,298,471, FILED 4-20-2006, REG. NO. TMA715,424, DATED 5-29-2008, EXPIRES 5-29-2023.

OWNER OF U.S. REG. NO. 2,194,049.

FOR PAINTS, NAMELY, HOUSE PAINTS, INKS AND DYES; COATINGS, NAMELY, ACRYLIC COATINGS AND ALKYD COATINGS; WOOD STAINS; WOOD SEALERS; VARNISHES; AND LACQUERS (U.S. CLS. 6, 11 AND 16).

DAVID MILLER, EXAMINING ATTORNEY

CLASS 2—(Continued).

SN 77-546,633. FARROW & BALL HOLDINGS LIMITED, WIMBORNE DORSET, UNITED KINGDOM, FILED 8-13-2008.

CAT'S PAW

THE MARK CONSISTS OF STANDARD CHARACTERS WITHOUT CLAIM TO ANY PARTICULAR FONT, STYLE, SIZE, OR COLOR.

PRIORITY CLAIMED UNDER SEC. 44(D) ON ERPNTY TM OFC APPLICATION NO. 006679302, FILED 2-19-2008, REG. NO. 006679302, DATED 1-20-2009, EXPIRES 2-19-2018.

FOR INTERIOR AND EXTERIOR PAINTS (U.S. CLS. 6, 11 AND 16).

JAMES A. RAUEN, EXAMINING ATTORNEY

SN 77-596,312. ERGON ASPHALT & EMULSIONS, INC., JACKSON, MS. FILED 10-20-2008.

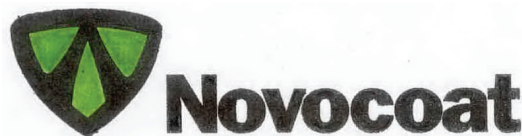
 The logo for Novocoat features a stylized green triangle with a black outline, containing three smaller green triangles. To the right of the triangle is the word "Novocoat" in a bold, black, sans-serif font.

OWNER OF U.S. REG. NO. 2,064,537.

THE COLOR(S) GREEN AND BLACK IS/ARE CLAIMED AS A FEATURE OF THE MARK.

THE MARK CONSISTS OF A TRIANGULAR SHAPED DESIGN WITH THREE INTERIOR AREAS TO THE LEFT OF THE WORDING "NOVOCOAT". THE MARK CONSISTS OF THE FOLLOWING: A TRIANGULAR DESIGN THAT HAS THREE INTERIOR AREAS DEPICTED IN THE COLOR GREEN OUTLINED IN BLACK. ADDITIONALLY THE WORDING IN THE MARK IS DEPICTED IN THE COLOR BLACK.

FOR INDUSTRIAL EPOXY AND ACRYLIC COATINGS FOR NON-RECREATIONAL USE ON ROOFS, PAVEMENT, CONCRETE AND METAL STRUCTURES, AND PIPES (U.S. CLS. 6, 11 AND 16).

BRIDGETT SMITH, EXAMINING ATTORNEY

SN 77-597,982. T-INK, LLC, NEW YORK, NY. FILED 10-22-2008.

AKLIMATE

THE MARK CONSISTS OF STANDARD CHARACTERS WITHOUT CLAIM TO ANY PARTICULAR FONT, STYLE, SIZE, OR COLOR.

FOR INK BASED ELECTRICALLY CONDUCTIVE COMPOSITIONS FOR USE IN MANUFACTURE, WHICH ARE USED TO CONDUCT HEAT (U.S. CLS. 6, 11 AND 16).

SAIMA MAKHDOOM, EXAMINING ATTORNEY

CLASS 2—(Continued).

SN 77-598,593. SUN CHEMICAL CORPORATION, PARSIP-
PANY, NJ. FILED 10-22-2008.

CLASS 2—(Continued).

SN 77-707,506. TOPPS PRODUCTS, INC., STILWELL, KS.
FILED 4-6-2009.

SBVELOCITY

Topps

THE MARK CONSISTS OF STANDARD CHARACTERS
WITHOUT CLAIM TO ANY PARTICULAR FONT, STYLE,
SIZE, OR COLOR.
FOR PRINTING INKS (U.S. CLS. 6, 11 AND 16).
BILL DAWE, EXAMINING ATTORNEY

THE MARK CONSISTS OF STANDARD CHARACTERS
WITHOUT CLAIM TO ANY PARTICULAR FONT, STYLE,
SIZE, OR COLOR.
OWNER OF U.S. REG. NO. 1,911,421.
FOR ELASTOMERIC-BASED COATINGS FOR USE ON
ROOFS, WALLS AND BUILDING FOUNDATIONS (U.S.
CLS. 6, 11 AND 16).
FIRST USE 9-29-1993; IN COMMERCE 9-29-1993.
BRIAN PINO, EXAMINING ATTORNEY

SN 77-602,812. COLOR RESOLUTIONS INTERNATIONAL
LLC, FAIRFIELD, OH. FILED 10-29-2008.

SN 77-723,069. SHAMIR INSIGHT, INC., SAN DIEGO, CA.
FILED 4-27-2009.

PACESETTER

GLACIER

THE MARK CONSISTS OF STANDARD CHARACTERS
WITHOUT CLAIM TO ANY PARTICULAR FONT, STYLE,
SIZE, OR COLOR.
FOR FLEXOGRAPHIC PRINTING INK (U.S. CLS. 6, 11
AND 16).
FIRST USE 9-28-2008; IN COMMERCE 9-28-2008.
SETH A. RAPPAPORT, EXAMINING ATTORNEY

THE MARK CONSISTS OF STANDARD CHARACTERS
WITHOUT CLAIM TO ANY PARTICULAR FONT, STYLE,
SIZE, OR COLOR.
FOR OPTICAL LENS COATINGS (U.S. CLS. 6, 11 AND
16).
AMY KERTGATE, EXAMINING ATTORNEY

SN 77-616,916. POLYMERIC IMAGING, INC., NORTH KAN-
SAS CITY, MO. FILED 11-18-2008.

SN 77-724,056. HAYWOOD HOLDINGS, INC., LEEDS, AL.
FILED 4-28-2009.

BIOSPHERE

INDUROLINE

THE MARK CONSISTS OF STANDARD CHARACTERS
WITHOUT CLAIM TO ANY PARTICULAR FONT, STYLE,
SIZE, OR COLOR.
FOR SCREEN PRINTING INK (U.S. CLS. 6, 11 AND
16).
NAPOLEON SHARMA, EXAMINING ATTORNEY

THE MARK CONSISTS OF STANDARD CHARACTERS
WITHOUT CLAIM TO ANY PARTICULAR FONT, STYLE,
SIZE, OR COLOR.
OWNER OF U.S. REG. NOS. 1,674,723 AND 3,287,095.
FOR PROTECTIVE COATING IN THE NATURE OF
PAINT FOR LINING DUCTILE IRON PIPE AND FIT-
TINGS (U.S. CLS. 6, 11 AND 16).
G. MAYERSCHOFF, EXAMINING ATTORNEY

CLASS 2—(Continued).

SN 77-724,493. TWO TREE INK, LLC, CINCINNATI, OH.
FILED 4-28-2009.



NO CLAIM IS MADE TO THE EXCLUSIVE RIGHT TO USE "INK", APART FROM THE MARK AS SHOWN.

THE MARK CONSISTS OF THE WORDS INK-IT ENCLOSED WITHIN A RECTANGULAR PANEL HAVING ROUNDED ENDS, AND A CIRCLE ON THE UPPER EDGE OF THE RECTANGULAR PANEL SURROUNDING THREE CIRCULARLY ARRANGED DROPS.

FOR REFILLED INK CARTRIDGES FOR INKJET PRINTERS AND REFILLED TONER CARTRIDGES FOR LASER PRINTERS (U.S. CLS. 6, 11 AND 16).

GINA HAYES, EXAMINING ATTORNEY

SN 77-724,940. BENJAMIN MOORE & CO., MONTVALE, NJ.
FILED 4-29-2009.

ECOCOLOR

THE MARK CONSISTS OF STANDARD CHARACTERS WITHOUT CLAIM TO ANY PARTICULAR FONT, STYLE, SIZE, OR COLOR.

FOR COLORANTS FOR USE IN THE MANUFACTURE OF PAINT (U.S. CLS. 6, 11 AND 16).

MAYUR VAGHANI, EXAMINING ATTORNEY

SN 77-751,909. GRAFFITI SOLUTIONS, INC., NORTH ST.
PAUL, MN. FILED 6-4-2009.

MAX ALL

THE MARK CONSISTS OF STANDARD CHARACTERS WITHOUT CLAIM TO ANY PARTICULAR FONT, STYLE, SIZE, OR COLOR.

FOR EXTERIOR SURFACE PROTECTIVE COATINGS (U.S. CLS. 6, 11 AND 16).

FIRST USE 7-0-2001; IN COMMERCE 7-0-2001.

MATTHEW EINSTEIN, EXAMINING ATTORNEY

CLASS 2—(Continued).

SN 77-751,910. GRAFFITI SOLUTIONS, INC., NORTH ST.
PAUL, MN. FILED 6-4-2009.

SHIELD MAX

THE MARK CONSISTS OF STANDARD CHARACTERS WITHOUT CLAIM TO ANY PARTICULAR FONT, STYLE, SIZE, OR COLOR.

FOR EXTERIOR SURFACE PROTECTIVE COATINGS (U.S. CLS. 6, 11 AND 16).

FIRST USE 6-0-2007; IN COMMERCE 6-0-2007.

MATTHEW EINSTEIN, EXAMINING ATTORNEY

SN 77-756,710. SUNNYSIDE CORPORATION, WHEELING,
IL. FILED 6-10-2009.

PAV LOCK

THE MARK CONSISTS OF STANDARD CHARACTERS WITHOUT CLAIM TO ANY PARTICULAR FONT, STYLE, SIZE, OR COLOR.

FOR PROTECTIVE TREATMENTS AND COATINGS, NAMELY, SEALERS AND COATINGS IN THE NATURE OF INDUSTRIAL SEALANTS FOR WATERPROOFING AND SURFACE HARDENING; STAINS AND CLEAR FINISHES FOR EXTERIOR AND INTERIOR USE ON A VARIETY OF SUBSTRATES FOR USE IN PAVEMENT, FLOORING, BLOCK PAVING, AND BUILDING MATERIALS (U.S. CLS. 6, 11 AND 16).

ANDREW RHIM, EXAMINING ATTORNEY

CLASS 3—COSMETICS AND CLEANING PREPARATIONS

SN 76-627,445. MONSTER CABLE PRODUCTS, INC., BRISBANE, CA. FILED 1-10-2005.

ICLEAN

THE MARK CONSISTS OF STANDARD CHARACTERS WITHOUT CLAIM TO ANY PARTICULAR FONT, STYLE, SIZE, OR COLOR.

FOR CLEANING SOLUTION, NAMELY, AN ALCOHOL-FREE, AMMONIA-FREE ELECTRONIC DISPLAY SCREEN CLEANING SOLUTION (U.S. CLS. 1, 4, 6, 50, 51 AND 52).

FIRST USE 7-0-2002; IN COMMERCE 9-0-2002.

JULIE GUTTADAURO, EXAMINING ATTORNEY

CLASS 3—(Continued).

SN 76-693,031. GREEK ISLAND LABS, LLC, SCOTTSDALE, AZ. FILED 9-22-2008.

ADONIA LEGTONE

THE MARK CONSISTS OF STANDARD CHARACTERS WITHOUT CLAIM TO ANY PARTICULAR FONT, STYLE, SIZE, OR COLOR.

FOR COSMETIC SKIN CARE PREPARATIONS, NAMELY, SKIN CREAMS AND LOTIONS (U.S. CLS. 1, 4, 6, 50, 51 AND 52).

FIRST USE 7-29-2008; IN COMMERCE 7-29-2008.
MARY ROSSMAN, EXAMINING ATTORNEY

SN 77-236,388. AMINOGENESIS, LLC, NEWPORT BEACH, CA. FILED 7-23-2007.

Dermascyne

THE MARK CONSISTS OF STANDARD CHARACTERS WITHOUT CLAIM TO ANY PARTICULAR FONT, STYLE, SIZE, OR COLOR.

FOR BODY AND BEAUTY CARE COSMETICS; COSMETIC CREAMS FOR SKIN CARE; BEAUTY SERUMS; FACIAL CREAM; FACIAL LOTION; SKIN CARE PRODUCTS, NAMELY, NON-MEDICATED SKIN SERUM; FACIAL CREAMS; FACIAL EMULSIONS; MOISTURIZING CREAMS; SKIN MOISTURIZER; ANTI-AGING CREAM (U.S. CLS. 1, 4, 6, 50, 51 AND 52).

FIRST USE 7-16-2007; IN COMMERCE 7-16-2007.
BARNEY CHARLON, EXAMINING ATTORNEY

CLASS 3—(Continued).

SN 77-322,824. TARTE, INC., NEW YORK, NY. FILED 11-6-2007.



NO CLAIM IS MADE TO THE EXCLUSIVE RIGHT TO USE "FRUIT COMPLEX", APART FROM THE MARK AS SHOWN.

THE COLOR(S) LAVENDER AND DARK PURPLE IS/ARE CLAIMED AS A FEATURE OF THE MARK.

THE MARK CONSISTS OF A STYLIZED LETTER "T" AND A STYLIZED NUMBER "5", IN WHICH THE TOP OF THE "5" IS PART OF THE RIGHT SIDE OF THE CROSSBAR IN THE LETTER "T", ALL SHOWN AGAINST A SHADED CIRCLE, WITH THE WORDS "SUPER FRUIT COMPLEX" SHOWN INSIDE THE EDGE OF THE LOWER HALF OF THE CIRCLE. THE COLOR LAVENDER APPEARS IN THE BACKGROUND OF THE CIRCLE, AND THE COLOR DARK PURPLE APPEARS IN THE WORDING "T5 SUPER FRUIT COMPLEX".

FOR COSMETICS CONTAINING FRUIT EXTRACTS (U.S. CLS. 1, 4, 6, 50, 51 AND 52).

FIRST USE 10-1-2007; IN COMMERCE 10-1-2007.
ESTHER BELENKER, EXAMINING ATTORNEY

SN 77-334,963. ASAM, MARCUS, MUNCHEN, 81669, FED REP GERMANY, AND ASAM, MIRIAM, MUNCHEN, 81669, FED REP GERMANY, FILED 11-21-2007.

AQUAINTENSE

THE MARK CONSISTS OF STANDARD CHARACTERS WITHOUT CLAIM TO ANY PARTICULAR FONT, STYLE, SIZE, OR COLOR.

PRIORITY CLAIMED UNDER SEC. 44(D) ON ERPN CMNTY TM OFC APPLICATION NO. 005987623, FILED 6-1-2007, REG. NO. 005987623, DATED 4-16-2008, EXPIRES 6-1-2017.

FOR GENERAL PURPOSE CLEANING, POLISHING AND ABRASIVE LIQUIDS AND POWDERS; BLEACHING PREPARATIONS FOR LAUNDRY USE; CLEANING, POLISHING, SCOURING PREPARATIONS; GENERAL PURPOSE ABRASIVE LIQUIDS AND POWDERS; SKIN SOAPS; PERFUMERY, ESSENTIAL OILS, COSMETICS, HAIR LOTIONS; DENTIFRICES (U.S. CLS. 1, 4, 6, 50, 51 AND 52).

CHERYL CLAYTON, EXAMINING ATTORNEY

CLASS 3—(Continued).

SN 77-410,733. MCBRIDE,COLEEN,M, DBA BODY SCENT-SATIONS, VENTURA, CA. FILED 3-2-2008.

BODY SCENTSATIONS

THE MARK CONSISTS OF STANDARD CHARACTERS WITHOUT CLAIM TO ANY PARTICULAR FONT, STYLE, SIZE, OR COLOR.

NO CLAIM IS MADE TO THE EXCLUSIVE RIGHT TO USE "BODY", APART FROM THE MARK AS SHOWN.

SEC. 2(F).
FOR NON-MEDICATED TOILETRIES (U.S. CLS. 1, 4, 6, 50, 51 AND 52).

FIRST USE 7-24-2002; IN COMMERCE 7-24-2002.
SUSAN LESLIE DUBOIS, EXAMINING ATTORNEY

SN 77-427,738. AMAZON BEAUTY, INC., NEW YORK, NY. FILED 3-20-2008.

SYMBIOTIC

THE MARK CONSISTS OF STANDARD CHARACTERS WITHOUT CLAIM TO ANY PARTICULAR FONT, STYLE, SIZE, OR COLOR.

FOR ADHESIVES FOR ATTACHING ARTIFICIAL FINGERNAILS AND/OR EYELASHES; ADHESIVES FOR COSMETIC USE; AFTER SUN CREAMS; AFTER-SHAVE; AFTER-SHAVE BALMS; AFTER-SHAVE CREAMS; AFTER-SHAVE EMULSIONS; AFTER-SHAVE GEL; AFTER-SHAVE LOTIONS; AFTER-SUN LOTIONS; AGE RETARDANT GEL; AGE RETARDANT LOTION; AGE SPOT REDUCING CREAMS; ANTI-AGING CREAM; ANTI-FRECKLE CREAMS; ANTI-WRINKLE CREAM; ANTIBACTERIAL SKIN SOAPS; ANTIBACTERIAL SOAP; ANTIPERSPIRANTS; AROMATHERAPY CREAMS; AROMATHERAPY LOTIONS; AROMATHERAPY OILS; AROMATHERAPY PILLOWS COMPRISING POTPOURRI IN FABRIC CONTAINERS; ARTIFICIAL EYELASHES; ARTIFICIAL FINGERNAILS; ASTRINGENTS FOR COSMETIC PURPOSES; BABY LOTION; BABY OIL; BABY OILS; BABY POWDER; BATH BEADS; BATH CRYSTALS; BATH FOAM; BATH FOAMS; BATH GELS; BATH LOTION; BATH MILKS; BATH OIL; BATH PEARLS; BATH POWDER; BATH SALTS; BATHING LOTIONS; BEAUTY CREAMS; BEAUTY GELS; BEAUTY LOTIONS; BEAUTY MASKS; BEAUTY MILKS; BEAUTY SERUMS; BLUSH; BLUSH PENCILS; BODY AND BEAUTY CARE COSMETICS; BODY CREAMS; BODY EMULSIONS; BODY LOTIONS; BODY MASK POWDER; BODY MASKS; BODY MILKS; BODY OILS; BODY POWDER; BODY SCRUB; BODY SPRAYS; BUBBLE BATH; CHALK FOR COSMETIC USE; CLEANSING CREAMS; CLEANSING MILK; COCOA BUTTER FOR COSMETIC PURPOSES; COLD CREAMS; COLD WAVING SOLUTIONS; COLOGNE; COLORING PREPARATIONS FOR COSMETIC PURPOSES; COMPACTS CONTAINING MAKE-UP; CONCEALERS; CONDITIONERS; COSMETIC BALLS; COSMETIC CREAMS; COSMETIC CREAMS FOR SKIN CARE; COSMETIC FACIAL BLOTTER PAPERS; COSMETIC MILKS; COSMETIC OILS; COSMETIC PADS; COSMETIC PENCILS; COSMETIC PREPARATIONS; COSMETIC PREPARATIONS AGAINST SUNBURN; COSMETIC PREPARATIONS FOR BODY CARE; COSMETIC PREPARATIONS FOR EYE LASHES; COSMETIC PREPARATIONS FOR SKIN RENEWAL; COSMETIC PREPARATIONS FOR THE CARE OF MOUTH AND TEETH; COSMETIC

CLASS 3—(Continued).

PRODUCTS IN THE FORM OF AEROSOLS FOR SKIN CARE; COSMETIC ROUGES; COSMETIC SOAPS; COSMETIC SUN-PROTECTING PREPARATIONS; COSMETIC SUN-TANNING PREPARATIONS; COSMETICS; COSMETICS AND COSMETIC PREPARATIONS; COSMETICS AND MAKE-UP; COTTON BALLS FOR COSMETIC PURPOSES; CREAMY ROUGES; CUTICLE CONDITIONERS; CUTICLE CREAM; CUTICLE REMOVING PREPARATIONS; COSMETICS, NAMELY, COMPACTS; COTTON FOR COSMETIC PURPOSES; COTTON SWABS FOR COSMETIC PURPOSES; CREAMS FOR CELLULITE REDUCTION; CREAMY FACE POWDER; CREAMY FOUNDATION; DEODORANT SOAP; DEODORANTS AND ANTIPERSPIRANTS; DEPILATORIES; EMERY BOARDS; EPILATORY STRIPS; ESSENTIAL OILS; EXFOLIANT CREAMS; EYE COMPRESSES FOR COSMETIC PURPOSES; EYE CREAM; EYE GELS; EYE LINER; EYE LOTIONS; EYE MAKE-UP; EYE MAKE-UP REMOVER; EYE PENCILS; EYE SHADOW; EYEBROW COLORS; EYEBROW COSMETICS; EYELINER PENCILS; EYES MAKE-UP; EYES PENCILS; FACE AND BODY CREAMS; FACE AND BODY LOTIONS; FACE AND BODY MILK; FACE CREAMS; FACE CREAMS FOR COSMETIC USE; FACE MILK AND LOTIONS; FACE POWDER; FACIAL BEAUTY MASKS; FACIAL CLEANSERS; FACIAL CONCEALER; FACIAL CREAM; FACIAL SCRUBS; FAIR COMPLEXION CREAM; FEMININE DEODORANT SPRAYS; FEMININE DEODORANT SUPPOSITORIES; FOAM BATH; FOAMS CONTAINING COSMETICS AND SUNSCREENS; FOOT DEODORANT SPRAY; FOOT POWDER; FOUNDATION; FRAGRANCE EMITTING WICKS FOR ROOM FRAGRANCE; FRAGRANCES FOR PERSONAL USE; GEL EYE MASKS; GAUZE FOR COSMETIC PURPOSES; HAIR BALSAM; HAIR BLEACHING PREPARATIONS; HAIR CARE LOTIONS; HAIR CARE PREPARATIONS; HAIR CLEANING PREPARATIONS; HAIR COLOR; HAIR COLOR REMOVERS; HAIR COLORANTS; HAIR COLORING PREPARATIONS; HAIR CONDITIONER; HAIR CREAMS; HAIR EMOLLIENTS; HAIR FIXERS; HAIR GEL; HAIR LACQUERS; HAIR LIGHTENERS; HAIR LOTION; HAIR MASCARA; HAIR MOUSSE; HAIR NOURISHERS; HAIR OILS; HAIR POMADES; HAIR RELAXERS; HAIR REMOVING CREAM; HAIR RINSES; HAIR SHAMPOO; HAIR SPRAY; HAIR STRAIGHTENING PREPARATIONS; HAIR STYLING PREPARATIONS; HAIR TONIC; HAIR WAVING LOTION; HAND CLEANING PREPARATIONS; HAND CREAM; HAND LOTIONS; HAND SOAPS; HENNA FOR COSMETIC PURPOSES; HYDROGEN PEROXIDE FOR USE ON THE HAIR; INCENSE; INCENSE STICKS; LAVENDER OIL; LIP BALM; LIP CREAM; LIP GLOSS; LIP LINER; LIP POLISHER; LIPSTICK; LIPSTICK CASES; LIPSTICK HOLDERS; LIQUID BATH SOAPS; LIQUID SOAP; LOTIONS FOR BEARDS; LOTIONS FOR CELLULITE REDUCTION; LOTIONS FOR FACE AND BODY CARE; LOTIONS FOR STRENGTHENING THE NAILS; MASCARA; MASSAGE CREAMS; MASSAGE OIL; MEDICATED SOAP; MOISTURIZING CREAMS; MOISTURIZING MILKS; MOUTHWASH; MUSK; MUSTACHE WAX; NAIL BUFFING PREPARATIONS; NAIL CARE PREPARATIONS; NAIL CREAM; NAIL ENAMEL; NAIL GLITTER; NAIL GROOMING PRODUCTS, NAMELY, TIPS, GLUE, LACQUER AND GLITTER; NAIL POLISH; NAIL POLISH REMOVER; NAIL STENCILS; NAIL VARNISH; NIGHT CREAM; NON-MEDICATED BATH PREPARATIONS; NON-MEDICATED BODY SOAKS; NON-MEDICATED FOOT CREAM; NON-MEDICATED SCALP TREATMENT CREAM; NUTRITIONAL OILS FOR COSMETIC PURPOSES; OIL BATHS FOR HAIR CARE; OILS FOR COSMETIC PURPOSES; OILS FOR HAIR CONDITIONING; OILS FOR TOILETRY PURPOSES; PENCILS FOR COSMETIC PURPOSES; PERFUME; PETROLEUM JELLY FOR COSMETIC PURPOSES; POMADES; POTPOURRI; PRE-MOISTENED COSMETIC TISSUES; PRE-MOISTENED COSMETIC TOWELETTES; PRE-MOISTENED COSMETIC WIPES; PRE-SHAVE CREAMS; PUMICE STONES FOR PERSONAL USE; ROOM FRAGRANCES; ROUGES; SACHET-LIKE EYE PILLOWS CONTAINING FRAGRANCES; SCENTED BODY SPRAY; SCENTED CERAMIC STONES; SCENTED LINEN SPRAYS; SCENTED LINEN WATER; SCENTED OILS USED TO PRODUCE AROMAS WHEN HEATED; SHAMPOO-CONDITIONERS; SHAMPOOS; SHAVING BALM; SHAVING CREAM; SHAVING CREAMS; SHAVING FOAM; SHAVING GEL; SHAVING LOTION; SHAVING MOUSSE;

CLASS 3—(Continued).

SHAVING PREPARATIONS; SHAVING SOAP; SHOWER AND BATH FOAM; SHOWER AND BATH GEL; SKIN CLARIFIERS; SKIN CLEANSERS; SKIN CREAM; SKIN EMOLLIENTS; SKIN GELS FOR ACCELERATING, ENHANCING OR EXTENDING TANS; SKIN LIGHTENERS; SKIN MASKS; SKIN MOISTURIZER; SKIN SOAP; SKIN TEXTURIZERS; SKIN TONERS; SOAPS FOR PERSONAL USE; SUN BLOCK PREPARATIONS; SUN CARE LOTIONS; SUN CREAMS; SUN TAN GEL; SUN TAN OIL; SUN-TANNING PREPARATIONS; TALCUM POWDER; TONERS; TOPICAL HERBAL CREAM FOR FIRING AND ENHANCING BREASTS; TOPICAL SKIN SPRAYS FOR COSMETIC PURPOSES; UNDER-EYE ENHANCERS; WRINKLE REMOVING SKIN CARE PREPARATIONS; WRINKLE RESISTANT CREAM (U.S. CLS. 1, 4, 6, 50, 51 AND 52).

ALICIA COLLINS, EXAMINING ATTORNEY

CLASS 3—(Continued).

SN 77-435,786. OJON CORPORATION, NEW YORK, NY. FILED 3-31-2008.



OWNER OF U.S. REG. NOS. 3,164,351, 3,219,485 AND OTHERS.

THE MARK CONSISTS OF A CIRCLE DEVICE WITH THE MARK "OJON" IN STYLIZED LETTERING APPEARING BELOW.

SEC. 2(F) AS TO "OJON".

FOR HAIR CARE PREPARATIONS; NON-MEDICATED SKIN CARE PREPARATIONS; BODY AND BEAUTY CARE COSMETICS (U.S. CLS. 1, 4, 6, 50, 51 AND 52).

FIRST USE 12-31-2003; IN COMMERCE 12-31-2003.

BARNEY CHARLON, EXAMINING ATTORNEY

SN 77-431,001. OJON CORPORATION, NEW YORK, NY. FILED 3-25-2008.

OJON

SN 77-504,682. DANYA COSMETICS LTD., 42377 NETANYA, ISRAEL, FILED 6-20-2008.



THE MARK CONSISTS OF STANDARD CHARACTERS WITHOUT CLAIM TO ANY PARTICULAR FONT, STYLE, SIZE, OR COLOR.

OWNER OF U.S. REG. NOS. 3,164,351, 3,219,485 AND OTHERS.

SEC. 2(F).

FOR COSMETIC INGREDIENT SOLD AS A COMPONENT IN HAIR CARE PREPARATIONS, NON-MEDICATED SKIN CARE PREPARATIONS AND BODY AND BEAUTY CARE COSMETICS (U.S. CLS. 1, 4, 6, 50, 51 AND 52).

FIRST USE 12-31-2003; IN COMMERCE 12-31-2003.

BARNEY CHARLON, EXAMINING ATTORNEY

PRIORITY CLAIMED UNDER SEC. 44(D) ON ISRAEL APPLICATION NO. 209610, FILED 3-10-2008.

OWNER OF ISRAEL REG. NO. 209610, DATED 6-9-2009, EXPIRES 3-10-2018.

THE MARK CONSISTS OF THE WORDING "JA-DE" IN STYLIZED FORM WITH A CHECK MARK OVER THE LETTER "E" AND A FLOWER ABOVE THE CHECK MARK. THE WORDING IS ENCASED IN A BACKGROUND IN THE SHAPE OF AN OPEN RECTANGLE.

FOR COSMETICS; HAIR LOTIONS; PERFUMERY; SOAPS FOR PERSONAL USE (U.S. CLS. 1, 4, 6, 50, 51 AND 52).

EDWARD FENNESSY, EXAMINING ATTORNEY

CLASS 3—(Continued).

SN 77-515,979. BELLAH BRANDS INCORPORATED, LOS ANGELES, CA. FILED 7-7-2008.

REVEAL BY HALLE BERRY

THE MARK CONSISTS OF STANDARD CHARACTERS WITHOUT CLAIM TO ANY PARTICULAR FONT, STYLE, SIZE, OR COLOR.

THE NAME(S), PORTRAIT(S), AND/OR SIGNATURE(S) SHOWN IN THE MARK IDENTIFIES "HALLE BERRY", WHOSE CONSENT(S) TO REGISTER IS MADE OF RECORD.

FOR PERFUMERY, EAU DE TOILETTE, COLOGNE, DEODORANT AND ANTIPERSPIRANTS FOR PERSONAL USE, AFTER-SHAVE, SCENTED SOAPS, BEAUTY CARE PREPARATIONS, NAMELY, SKIN AND BODY CREAMS, SKIN LOTIONS, SKIN CLEANSERS, SKIN TONERS AND SKIN MOISTURIZERS, BODY WASH, SHOWER GEL, BUBBLE BATH, ESSENTIAL OILS AND COSMETICS (U.S. CLS. 1, 4, 6, 50, 51 AND 52).

MAYUR VAGHANI, EXAMINING ATTORNEY

SN 77-529,332. OCEAN SPRAY CRANBERRIES, INC., LAKEVILLE-MIDDLEBORO, MA. FILED 7-23-2008.

CRANESSENCE

THE MARK CONSISTS OF STANDARD CHARACTERS WITHOUT CLAIM TO ANY PARTICULAR FONT, STYLE, SIZE, OR COLOR.

OWNER OF U.S. REG. NO. 3,419,838.

FOR MOUTHWASH, TOOTHPASTE AND ORAL CARE RINSES, NAMELY, NON-MEDICATED MOUTH RINSE (U.S. CLS. 1, 4, 6, 50, 51 AND 52).

ROBERT STRUCK, EXAMINING ATTORNEY

SN 77-541,360. CLINIQUE LABORATORIES LLC, NEW YORK, NY. FILED 8-7-2008.

SKIN CALMING

THE MARK CONSISTS OF STANDARD CHARACTERS WITHOUT CLAIM TO ANY PARTICULAR FONT, STYLE, SIZE, OR COLOR.

OWNER OF U.S. REG. NO. 2,141,372.

NO CLAIM IS MADE TO THE EXCLUSIVE RIGHT TO USE "SKIN", APART FROM THE MARK AS SHOWN.

FOR COSMETICS; NON-MEDICATED SKIN CARE PREPARATIONS (U.S. CLS. 1, 4, 6, 50, 51 AND 52).

MARY CRAWFORD, EXAMINING ATTORNEY

CLASS 3—(Continued).

SN 77-580,886. SHISEIDO COMPANY LTD., TOKYO, JAPAN, FILED 9-29-2008.

FUTURE SOLUTION LX

THE MARK CONSISTS OF STANDARD CHARACTERS WITHOUT CLAIM TO ANY PARTICULAR FONT, STYLE, SIZE, OR COLOR.

OWNER OF U.S. REG. NO. 2,744,598.

FOR SOAPS, PERFUMERIES, AND COSMETICS, NAMELY, SKIN CARE PREPARATIONS, HAIR CARE PREPARATIONS, BODY CARE PREPARATIONS, AND MAKE-UP PREPARATIONS (U.S. CLS. 1, 4, 6, 50, 51 AND 52).

GRETTA YAO, EXAMINING ATTORNEY

SN 77-581,828. L'OREAL, PARIS, FRANCE, FILED 9-30-2008.

FRAME WAX

THE MARK CONSISTS OF STANDARD CHARACTERS WITHOUT CLAIM TO ANY PARTICULAR FONT, STYLE, SIZE, OR COLOR.

PRIORITY CLAIMED UNDER SEC. 44(D) ON FRANCE APPLICATION NO. 083565960, FILED 3-31-2008, REG. NO. 083565960, DATED 3-31-2008, EXPIRES 3-31-2018.

NO CLAIM IS MADE TO THE EXCLUSIVE RIGHT TO USE "WAX", APART FROM THE MARK AS SHOWN.

FOR SHAMPOOS; GELS, SPRAYS, MOUSSES, BALMS, CREAM, SERUMS AND WAX FOR THE HAIR STYLING AND HAIR CARE; HAIR LACQUERS; HAIR COLOURING AND HAIR DECOLORANT PREPARATIONS; PERMANENT WAVING PREPARATIONS AND CURLING PREPARATIONS, NAMELY, HAIR WAX; ESSENTIAL OILS FOR PERSONAL USE (U.S. CLS. 1, 4, 6, 50, 51 AND 52).

NAKIA HENRY, EXAMINING ATTORNEY

SN 77-582,973. TEMPTU MARKETING, INC., NEW YORK, NY. FILED 10-1-2008.

TEMPTU

THE MARK CONSISTS OF STANDARD CHARACTERS WITHOUT CLAIM TO ANY PARTICULAR FONT, STYLE, SIZE, OR COLOR.

OWNER OF U.S. REG. NO. 2,314,001.

FOR COSMETICS (U.S. CLS. 1, 4, 6, 50, 51 AND 52). FIRST USE 8-25-1999; IN COMMERCE 8-25-1999.

SKYE YOUNG, EXAMINING ATTORNEY

CLASS 3—(Continued).

SN 77-585,958. PACO RABANNE PARFUMS, NEUILLY SUR SEINE, PARIS, FRANCE, FILED 10-6-2008.



OWNER OF ERPN CMNTY TM OFC REG. NO. 006826556, DATED 1-19-2009, EXPIRES 4-11-2018.

NO CLAIM IS MADE TO THE EXCLUSIVE RIGHT TO USE THE SHAPE OF A RECTANGULAR BOX, APART FROM THE MARK AS SHOWN.

THE COLOR(S) GOLD AND BLACK IS/ARE CLAIMED AS A FEATURE OF THE MARK.

THE MARK CONSISTS OF THREE DIMENSIONAL RECTANGULAR PRODUCT PACKAGING IN GOLD WITH "1 MILLION" AND A FANCIFUL DESIGN FEATURE APPEARING IN BLACK ON THE FRONT PANEL OF THE THREE DIMENSIONAL RECTANGULAR PRODUCT PACKAGING.

FOR SOAPS, PERFUMES, ESSENTIAL OILS, COSMETIC MILKS, COSMETIC CREAMS, LOTIONS FOR COSMETIC PURPOSES, FOR THE FACE AND THE BODY; NON-MEDICATED BATH AND SHOWER GELS, AFTER SHAVE LOTIONS AND CREAMS, HAIR LOTIONS, DEODORANTS FOR PERSONAL USE (U.S. CLS. 1, 4, 6, 50, 51 AND 52).

ROBERT STRUCK, EXAMINING ATTORNEY

SN 77-586,456. THANE INTERNATIONAL, INC., LA QUINTA, CA. FILED 10-6-2008.

CALIFORNIA BEAUTY

THE MARK CONSISTS OF STANDARD CHARACTERS WITHOUT CLAIM TO ANY PARTICULAR FONT, STYLE, SIZE, OR COLOR.

OWNER OF U.S. REG. NOS. 2,282,132, 2,796,043 AND 2,871,939.

SEC. 2(F).

FOR (BASED ON USE IN COMMERCE) ANTI-WRINKLE CREAMS; WRINKLE REMOVING SKIN CARE PREPARATIONS(BASED ON INTENT TO USE) BATH SOAPS; BODY CREAMS; BODY LOTIONS; BODY SCRUB; BODY WASHES; COSMETIC SOAPS; DISINFECTANT SOAPS; FACIAL CLEANSERS; FACIAL SCRUBS; HAIR CARE CREAMS; HAIR CARE PREPARATIONS; HAIR COLOR; HAIR COLOURING PREPARATIONS; HAIR CONDITIONERS; HAIR LOTIONS; HAIR SHAMPOO; HAIR SPRAYS; HAIR STRAIGHTENING PREPARATIONS; HAIR STYLING PREPARATIONS; MAKE-UP REMOVER; SKIN CLEANSERS; SKIN SOAP; SOAPS FOR BODY CARE; SOAPS FOR PERSONAL USE (U.S. CLS. 1, 4, 6, 50, 51 AND 52).

FIRST USE 6-13-2003; IN COMMERCE 6-13-2003.

AMY ALFIERI, EXAMINING ATTORNEY

CLASS 3—(Continued).

SN 77-592,349. HS TM, LLC, NEWARK, DE. FILED 10-14-2008.

ACCLEAN

THE MARK CONSISTS OF STANDARD CHARACTERS WITHOUT CLAIM TO ANY PARTICULAR FONT, STYLE, SIZE, OR COLOR.

OWNER OF U.S. REG. NOS. 2,090,717, 3,377,673 AND OTHERS.

FOR DENTIFRICES, NAMELY, PROPHY PASTES AND PROPHY POWDER FOR CLEANING TEETH; NON-MEDICATED ORAL MOUTH RINSES, NAMELY, MOUTH WASHES, NON-MEDICATED ORAL MOUTH RINSES AND NON-MEDICATED ORAL MOUTH WASHES (U.S. CLS. 1, 4, 6, 50, 51 AND 52).

THOMAS MANOR, EXAMINING ATTORNEY

SN 77-594,380. PACIFIC TRADE INTERNATIONAL, INC., ROCKVILLE, MD. FILED 10-16-2008.

MODERN LIGHT

THE MARK CONSISTS OF STANDARD CHARACTERS WITHOUT CLAIM TO ANY PARTICULAR FONT, STYLE, SIZE, OR COLOR.

FOR SCENTED OILS USED TO PRODUCE AROMAS WHEN HEATED; SCENTED ROOM SPRAYS AND ROOM FRAGRANCES (U.S. CLS. 1, 4, 6, 50, 51 AND 52).

FIRST USE 7-12-2009; IN COMMERCE 7-12-2009.

SANI KHOURI, EXAMINING ATTORNEY

SN 77-594,755. ASTRAL HEALTH & BEAUTY, INC., ATLANTA, GA. FILED 10-17-2008.

RESULTS RX

THE MARK CONSISTS OF STANDARD CHARACTERS WITHOUT CLAIM TO ANY PARTICULAR FONT, STYLE, SIZE, OR COLOR.

OWNER OF U.S. REG. NO. 3,510,721.

NO CLAIM IS MADE TO THE EXCLUSIVE RIGHT TO USE "RX", APART FROM THE MARK AS SHOWN.

FOR SKIN CARE PREPARATIONS AND TREATMENTS, NAMELY, CLEANSERS, CHEMICAL PEELS, SKIN BRIGHTENERS AND EXFOLIANTS (U.S. CLS. 1, 4, 6, 50, 51 AND 52).

FIRST USE 5-3-2007; IN COMMERCE 5-3-2007.

JEFFREY LOOK, EXAMINING ATTORNEY

CLASS 3—(Continued).

SN 77-599,080. COURREGES PARFUMS, PARIS, FRANCE, FILED 10-23-2008.

empreinte

THE MARK CONSISTS OF THE WORD "EMPREINTE" IN STYLIZED LETTERING.

THE FOREIGN WORDING IN THE MARK TRANSLATES INTO ENGLISH AS "SEAL", "STAMP" OR "PRINT".

FOR COSMETIC AND BEAUTY PREPARATIONS, NAMELY, PERFUMES, COLOGNES, TOILET WATERS, TOILET SOAPS, SOAPS IN GEL FORM, AFTERSHAVE LOTION AND PERSONAL DEODORANTS, COSMETIC OILS AND LOTIONS; HAIR RINSE AND SHAMPOO, HAIR TONIC AND SETTING LOTIONS (U.S. CLS. 1, 4, 6, 50, 51 AND 52).

G. MAYERSCHOFF, EXAMINING ATTORNEY

SN 77-599,981. MT MANUFACTURING, INC., SOLON, OH. FILED 10-24-2008.

VersaSpa

OWNER OF U.S. REG. NO. 3,383,341.

THE MARK CONSISTS OF THE WORDING "VERSASPA". THE "V" IN THE MARK IS LARGER THAN THE OTHER LETTERS AND HAS WHITE PORTIONS, IN THE NATURE OF SMALL LINES, IN THE UPPER ARMS OF THE "V"

FOR COSMETIC PREPARATIONS, NAMELY, INDOOR TANNING ACCELERATOR LOTIONS, EXFOLIATOR LOTIONS, MOISTURIZER LOTIONS, AND BODY WASHES; UV-FREE INDOOR TANNING SOLUTIONS (U.S. CLS. 1, 4, 6, 50, 51 AND 52).

FIRST USE 6-1-2008; IN COMMERCE 6-1-2008.
MATTHEW KLINE, EXAMINING ATTORNEY

SN 77-604,088. VYSER INC., BRAMPTON, CANADA, FILED 10-30-2008.

TARIKA

THE MARK CONSISTS OF STANDARD CHARACTERS WITHOUT CLAIM TO ANY PARTICULAR FONT, STYLE, SIZE, OR COLOR.

THE ENGLISH TRANSLATION OF "TARIKA" IN THE MARK IS STAR.

FOR NON-MEDICAL HERBAL COSMETIC PRODUCTS, NAMELY, FACIAL MASKS, MESSAGE OILS, BODY SCRUBS (U.S. CLS. 1, 4, 6, 50, 51 AND 52).

STEVEN JACKSON, EXAMINING ATTORNEY

CLASS 3—(Continued).

SN 77-607,734. BARE ESSENTUALS BEAUTY, INC., SAN FRANCISCO, CA. FILED 11-5-2008.

SIREN OF THE SEA

THE MARK CONSISTS OF STANDARD CHARACTERS WITHOUT CLAIM TO ANY PARTICULAR FONT, STYLE, SIZE, OR COLOR.

FOR COSMETICS; COSMETIC KITS COMPRISED OF POWDERS FOR THE FACE, LIP GLOSS, LIPSTICK, POWDERS FOR THE EYES, AND MAKEUP BRUSHES (U.S. CLS. 1, 4, 6, 50, 51 AND 52).

JILL PRATER, EXAMINING ATTORNEY

SN 77-611,444. WHITER IMAGE, LLC, ATLANTA, GA. FILED 11-10-2008.

WHITE BLITZ TOGO WHITENING PEN

THE MARK CONSISTS OF STANDARD CHARACTERS WITHOUT CLAIM TO ANY PARTICULAR FONT, STYLE, SIZE, OR COLOR.

NO CLAIM IS MADE TO THE EXCLUSIVE RIGHT TO USE "WHITE" OR "WHITENING PEN", APART FROM THE MARK AS SHOWN.

FOR TEETH WHITENING PEN CONTAINING TEETH WHITENING PREPARATIONS (U.S. CLS. 1, 4, 6, 50, 51 AND 52).

FRED MANDIR, EXAMINING ATTORNEY

SN 77-612,182. FORD MODELS, INC., NEW YORK, NY. FILED 11-11-2008.

FORD MODELS SUPERMODEL OF THE WORLD

THE MARK CONSISTS OF STANDARD CHARACTERS WITHOUT CLAIM TO ANY PARTICULAR FONT, STYLE, SIZE, OR COLOR.

OWNER OF U.S. REG. NOS. 1,296,761 AND 2,481,166.
NO CLAIM IS MADE TO THE EXCLUSIVE RIGHT TO USE "MODELS", APART FROM THE MARK AS SHOWN.

FOR BLUSH; BODY CREAMS; BODY LOTIONS; BODY POWDER; BODY SCRUB; CONCEALERS; COSMETIC PENCILS; COSMETICS; EYELINER; EYESHADOW; FACE POWDER; FACIAL MASKS; FACIAL SCRUBS; FOUNDATION MAKE-UP; HAIR CONDITIONER; LIPSTICKS; MASCARA; PERFUMES AND COLOGNES; ROUGE; SHAMPOOS; SKIN MOISTURIZER; SOAPS (U.S. CLS. 1, 4, 6, 50, 51 AND 52).

ANDREW LEASER, EXAMINING ATTORNEY

CLASS 3—(Continued).

SN 77-612,588. ARIMINO CO., LTD., TOKYO, JAPAN, FILED 11-12-2008.



THE MARK CONSISTS OF THE DESIGN OF A HEART FORMED BY THE WORD "PEACE".
FOR SHAMPOO; HAIR CARE PREPARATIONS; HAIR STYLING PREPARATIONS (U.S. CLS. 1, 4, 6, 50, 51 AND 52).

DAVID C. REIHNER, EXAMINING ATTORNEY

SN 77-612,621. ARIMINO CO., LTD., TOKYO, JAPAN, FILED 11-12-2008.

ARIMINO
BOTANICAL
GARDEN

NO CLAIM IS MADE TO THE EXCLUSIVE RIGHT TO USE "BOTANICAL", APART FROM THE MARK AS SHOWN.

THE MARK CONSISTS OF THE TERM "ARIMINO" OVER TWO HORIZONTAL LINES AND WORDING "BOTANICAL GARDEN".

FOR SHAMPOO; HAIR CARE PREPARATIONS (U.S. CLS. 1, 4, 6, 50, 51 AND 52).

DAVID C. REIHNER, EXAMINING ATTORNEY

CLASS 3—(Continued).

SN 77-618,530. EZ NAILS, INC., GARDEN GROVE, CA. FILED 11-20-2008.



THE COLOR(S) BLACK AND BLUE IS/ARE CLAIMED AS A FEATURE OF THE MARK.

THE MARK CONSISTS OF A BLUE BOX CONTAINING AN UPPER CASE LETTER "E" IN BLACK ABOVE THE WORDING "EZNAILS" IN BLACK.

FOR NAIL CARE PREPARATIONS FOR HUMAN USE (U.S. CLS. 1, 4, 6, 50, 51 AND 52).

FIRST USE 10-1-1997; IN COMMERCE 10-1-1997.

CHRISTINE COOPER, EXAMINING ATTORNEY

SN 77-619,477. SCHERING-PLOUGH HEALTHCARE PRODUCTS, INC., MEMPHIS, TN. FILED 11-21-2008.

BLISTERDEFENSE

THE MARK CONSISTS OF STANDARD CHARACTERS WITHOUT CLAIM TO ANY PARTICULAR FONT, STYLE, SIZE, OR COLOR.

FOR NON-MEDICATED SKIN CARE PREPARATIONS FOR USE ON THE FOOT TO PROTECT SKIN FROM IRRITATION AND RUBBING, AND TO PREVENT BLISTERS (U.S. CLS. 1, 4, 6, 50, 51 AND 52).

CURTIS FRENCH, EXAMINING ATTORNEY

SN 77-623,753. ASTRAL HEALTH & BEAUTY, INC., ATLANTA, GA. FILED 12-1-2008.

pürminerals

OWNER OF U.S. REG. NO. 3,274,226.

THE MARK CONSISTS OF A STYLIZED VERSION OF THE WORD "PÜRMINERALS".

THE ENGLISH TRANSLATION OF "PUR" IN THE MARK IS "PURE".

FOR FACIAL AND BODY LOTIONS; COSMETIC AND TOILETRY PREPARATIONS, NAMELY, FACIAL CLEANSERS, SKIN CLEANSERS, BODY CREAMS, BATH GEL, BODY SOAPS AND SCRUBS, BODY SPRAYS, AND COSMETICS, NAMELY, FOUNDATION, BLUSHES, LIPSTICKS, EYE SHADOWS, EYELINERS, MASCARA, AND EYE PENCILS (U.S. CLS. 1, 4, 6, 50, 51 AND 52).

FIRST USE 6-1-2001; IN COMMERCE 6-1-2001.

JEFFREY LOOK, EXAMINING ATTORNEY

CLASS 3—(Continued).

SN 77-628,177. DAMPNEY, JOANNE, MAYFIELD, AUSTRALIA, FILED 12-8-2008.

SKIN JUICE

NO CLAIM IS MADE TO THE EXCLUSIVE RIGHT TO USE "SKIN", APART FROM THE MARK AS SHOWN.

FOR NON-MEDICATED SKIN CARE PREPARATIONS; NON-MEDICATED SKIN CARE PREPARATIONS, NAMELY, CREAMS, LOTIONS, GELS, TONERS, CLEANSERS AND PEELS; NON-MEDICATED SKIN CREAMS; NON-MEDICATED STIMULATING LOTIONS FOR THE SKIN; SKIN AND BODY TOPICAL LOTIONS, CREAMS AND OILS FOR COSMETIC USE; SKIN CLEANSERS; SKIN MASKS; SKIN MOISTURIZER; SKIN MOISTURIZER MASKS; SKIN TONERS (U.S. CLS. 1, 4, 6, 50, 51 AND 52).

TINA L. SNAPP, EXAMINING ATTORNEY

SN 77-637,018. EXPRESS, LLC, COLUMBUS, OH. FILED 12-19-2008.

EXPRESS BLACK LUXE

THE MARK CONSISTS OF STANDARD CHARACTERS WITHOUT CLAIM TO ANY PARTICULAR FONT, STYLE, SIZE, OR COLOR.

NO CLAIM IS MADE TO THE EXCLUSIVE RIGHT TO USE "BLACK", APART FROM THE MARK AS SHOWN.

FOR PERSONAL CARE PRODUCTS, NAMELY, AFTERSHAVE PREPARATIONS, NAMELY, GELS AND LOTIONS, ANTIPERSPIRANTS, COSMETIC ASTRINGENT FOR THE FACE, COSMETIC ASTRINGENT FOR THE SKIN, BATH BEADS, BATH CREAM, BATH CRYSTALS, BATH FIZZIES, BATH FOAM, BATH GELS, BATH HERBS, BATH LOTION, BATH MILKS, BATH OIL, BATH SALTS, BLUSH, SKIN CARE PREPARATIONS, NAMELY, BODY BALM, BODY CREAM, BODY GLITTER, BODY MIST, BODY OIL, BODY POLISH, BODY POWDER, SOAPS FOR BODY CARE, BODY SCRUB, BODY WASHES, BUBBLE BATH, COLOGNE, DEODORANTS FOR PERSONAL USE, ESSENTIAL OILS FOR PERSONAL USE, EXFOLIANTS FOR THE SKIN, EYE CREAM, EYE GELS, EYELINER, EYELINER PENCILS, GEL EYE MASKS, EYE SHADOW, FACE CREAM, FACE PAINT, FACIAL BEAUTY MASKS, FACE POWDER, FACE SOAP, FACIAL SCRUB, NON-MEDICATED FOOT SOAKS, SKIN TONERS, FOOT POWDER, FOOT SCRUBS, FOUNDATION, BODY SPLASH, BODY MIST, HAIR CONDITIONER, HAIR POMADE, HAIR RINSES, HAIR REMOVING CREAMS, HAIR SHAMPOO, HAIR SPRAY, HAIR STRAIGHTENING PREPARATIONS, HAIR STYLING GEL, HAIR STYLING MOUSSE, HAND CREAM, HAND SOAP, LOTION FOR THE BODY, LOTION FOR THE FACE, NON-MEDICATED LOTION FOR THE FEET, LOTION FOR THE HANDS, LIP BALM, LIP GLOSS, LIP LINER, LIP MAKEUP PENCILS, LIPSTICK, MAKEUP FOR THE BODY, MAKEUP FOR THE FACE, MAKEUP REMOVER, MASCARA, MASSAGE CREAM, MASSAGE OIL, BODY LOTION, NAMELY,

CLASS 3—(Continued).

MASSAGE LOTION, NAIL POLISH, NAIL POLISH REMOVER, NON-MEDICATED COSMETIC MAKEUP PENCILS FOR BLEMISHES, NON-MEDICATED CLEANSER FOR THE FACE, NON-MEDICATED FOOT CREAM, NON-MEDICATED LIP BALM, COSMETIC FACIAL BLOTTERING PAPERS, PERFUME, NON-MEDICATED BATH SALT FOR THE SKIN, SHAVING CREAM, SHAVING GELS, SHEA BUTTER FOR COSMETIC PURPOSES, SHOWER CREAM, SHOWER GEL, SKIN BRONZING CREAM; SKIN CARE PREPARATION, NAMELY, NON-MEDICATED BODY POLISH AND BODY BALM, SKIN TONERS, SUN BLOCK FOR THE BODY, SUN BLOCK FOR THE FACE, SUNTAN LOTION FOR THE BODY, SUNTAN LOTION FOR THE FACE, INDOOR TANNING LOTION FOR THE BODY, SELF-TANNING SUNTAN CREAMS FOR THE FACE, SUNTAN LOTION FOR THE BODY, PRE-SUNNING SUNTAN LOTION FOR THE FACE, POST-SUNNING SUNTAN LOTION FOR THE BODY, POST-SUNTAN LOTION FOR THE FACE, TALCUM POWDER, WRINKLE REMOVING SKIN CARE PREPARATIONS (U.S. CLS. 1, 4, 6, 50, 51 AND 52).

TIMOTHY FINNEGAN, EXAMINING ATTORNEY

SN 77-652,316. ENGLISH, NANCY L, KANSAS CITY, MO. FILED 1-19-2009.

Lash Advance

THE MARK CONSISTS OF STANDARD CHARACTERS WITHOUT CLAIM TO ANY PARTICULAR FONT, STYLE, SIZE, OR COLOR.

NO CLAIM IS MADE TO THE EXCLUSIVE RIGHT TO USE "LASH", APART FROM THE MARK AS SHOWN.

FOR BEAUTY GELS; BEAUTY SERUMS (U.S. CLS. 1, 4, 6, 50, 51 AND 52).

JENNIFER MARTIN, EXAMINING ATTORNEY

SN 77-653,192. PHOENIX BRANDS LLC, STAMFORD, CT. FILED 1-21-2009.

CRISP MORNING AIR

THE MARK CONSISTS OF STANDARD CHARACTERS WITHOUT CLAIM TO ANY PARTICULAR FONT, STYLE, SIZE, OR COLOR.

FOR LAUNDRY DETERGENT (U.S. CLS. 1, 4, 6, 50, 51 AND 52).

AMY ALFIERI, EXAMINING ATTORNEY

CLASS 3—(Continued).

SN 77-654,117. EXPRESS, LLC, COLUMBUS, OH. FILED 1-22-2009.

EXPRESS RESERVE

THE MARK CONSISTS OF STANDARD CHARACTERS WITHOUT CLAIM TO ANY PARTICULAR FONT, STYLE, SIZE, OR COLOR.

OWNER OF U.S. REG. NOS. 1,120,073, 3,222,813 AND OTHERS.

FOR PERSONAL CARE PRODUCTS, NAMELY, AFTERSHAVE PREPARATIONS, NAMELY, GELS AND LOTIONS, ANTIPERSPIRANTS, COSMETIC ASTRINGENT FOR THE FACE, COSMETIC ASTRINGENT FOR THE SKIN, BATH BEADS, BATH CREAM, BATH CRYSTALS, BATH FIZZIES, BATH FOAM, BATH GELS, BATH HERBS, BATH LOTION, BATH MILKS, BATH OIL, BATH SALTS, BLUSH, SKIN CARE PREPARATIONS, NAMELY, BODY BALM, BODY CREAM, BODY GLITTER, BODY MIST, BODY OIL, BODY POLISH, BODY POWDER, SOAPS FOR BODY CARE, BODY SCRUB, BODY WASHES, BUBBLE BATH, COLOGNE, DEODORANTS FOR PERSONAL USE, ESSENTIAL OILS FOR PERSONAL USE, EXFOLIANTS FOR THE SKIN, EYE CREAM, EYE GELS, EYELINER, EYELINER PENCILS, GEL EYE MASKS, EYE SHADOW, FACE CREAM, FACE PAINT, FACIAL BEAUTY MASKS, FACE POWDER, FACE SOAP, FACIAL SCRUB, NON-MEDICATED FOOT SOAKS, SKIN TONERS, FOOT POWDER, FOOT SCRUBS, FOUNDATION, BODY SPLASH, BODY MIST, HAIR CONDITIONER, HAIR POMADE, HAIR RINSES, HAIR REMOVING CREAMS, HAIR SHAMPOO, HAIR SPRAY, HAIR STRAIGHTENING PREPARATIONS, HAIR STYLING GEL, HAIR STYLING MOUSSE, HAND CREAM, HAND SOAP, LOTION FOR THE BODY, LOTION FOR THE FACE, NON-MEDICATED LOTION FOR THE FEET, LOTION FOR THE HANDS, LIP BALM, LIP GLOSS, LIP LINER, LIP MAKEUP PENCILS, LIPSTICK, MAKEUP FOR THE BODY, MAKEUP FOR THE FACE, MAKEUP REMOVER, MASCARA, MASSAGE CREAM, MASSAGE OIL, BODY LOTION, NAMELY, MASSAGE LOTION, NAIL POLISH, NAIL POLISH REMOVER, NON-MEDICATED COSMETIC MAKEUP PENCILS FOR BLEMISHES, NON-MEDICATED CLEANSER FOR THE FACE, NON-MEDICATED FOOT CREAM, NON-MEDICATED LIP BALM, COSMETIC FACIAL BLOTTERING PAPERS, PERFUME, NON-MEDICATED BATH SALT FOR THE SKIN, SHAVING CREAM, SHAVING GELS, SHEA BUTTER FOR COSMETIC PURPOSES, SHOWER CREAM, SHOWER GEL, SKIN BRONZING CREAM; SKIN CARE PREPARATION, NAMELY, NON-MEDICATED BODY POLISH AND BODY BALM, SKIN TONERS, SUN BLOCK FOR THE BODY, SUN BLOCK FOR THE FACE, SUNTAN LOTION FOR THE BODY, SUNTAN LOTION FOR THE FACE, INDOOR TANNING LOTION FOR THE BODY, SELF-TANNING SUNTAN CREAMS FOR THE FACE, SUNTAN LOTION FOR THE BODY, PRE-SUNNING SUNTAN LOTION FOR THE FACE, POST-SUNNING SUNTAN LOTION FOR THE BODY, POST-SUNTAN LOTION FOR THE FACE, TALCUM POWDER, WRINKLE REMOVING SKIN CARE PREPARATIONS (U.S. CLS. 1, 4, 6, 50, 51 AND 52).

TIMOTHY FINNEGAN, EXAMINING ATTORNEY

CLASS 3—(Continued).

SN 77-657,611. ZERRAN INTERNATIONAL CORPORATION, PACOIMA, CA. FILED 1-27-2009.

Oil Drillers

THE MARK CONSISTS OF STANDARD CHARACTERS WITHOUT CLAIM TO ANY PARTICULAR FONT, STYLE, SIZE, OR COLOR.

FOR HAND LOTIONS; HAND SCRUBS (U.S. CLS. 1, 4, 6, 50, 51 AND 52).

LINDA E. BLOHM, EXAMINING ATTORNEY

SN 77-666,966. CORSO, KERRY, A., PALATINE, IL. FILED 2-10-2009.

Nature's Butter

THE MARK CONSISTS OF STANDARD CHARACTERS WITHOUT CLAIM TO ANY PARTICULAR FONT, STYLE, SIZE, OR COLOR.

NO CLAIM IS MADE TO THE EXCLUSIVE RIGHT TO USE "BUTTER", APART FROM THE MARK AS SHOWN.

FOR NON-MEDICATED ORGANIC BUTTERS WITH NATURAL AND ESSENTIAL OILS MADE INTO SALVES FOR REPAIRING AND PREVENTING STRETCH MARKS, WRINKLES, ECZEMA, PSORIASIS, BURNS, CELLULITE, SCARS, RASHES, AND DRY AND ITCHY SKIN, FOR USE ON BODY, HANDS, FEET, FACE, EYES AND NECK (U.S. CLS. 1, 4, 6, 50, 51 AND 52).

FIRST USE 1-1-2002. THE MARK WAS FIRST USED ANYWHERE IN A DIFFERENT FORM OTHER THAN THAT SOUGHT TO BE REGISTERED AT LEAST AS EARLY AS 01/01/2002.; IN COMMERCE 1-1-2003, THE MARK WAS FIRST USED IN COMMERCE IN A DIFFERENT FORM OTHER THAN THAT SOUGHT TO BE REGISTERED AT LEAST AS EARLY AS 01/01/2003..

PRISCILLA MILTON, EXAMINING ATTORNEY

SN 77-670,588. FLYNN, RANEE, WENHAM, MA. FILED 2-13-2009.

Still Life Skin

THE MARK CONSISTS OF STANDARD CHARACTERS WITHOUT CLAIM TO ANY PARTICULAR FONT, STYLE, SIZE, OR COLOR.

NO CLAIM IS MADE TO THE EXCLUSIVE RIGHT TO USE "SKIN", APART FROM THE MARK AS SHOWN.

FOR SKINCARE PRODUCTS, NAMELY, CLEANSERS, MOISTURIZERS, SOAP, TONICS, SERUMS, BATH AND BODY FRAGRANCE (U.S. CLS. 1, 4, 6, 50, 51 AND 52).

LESLIE RICHARDS, EXAMINING ATTORNEY

CLASS 3—(Continued).

SN 77-680,340. HALCROMB, DENISE, HIGHLAND, CA. AND HALCROMB, BRIAN L., HIGHLAND, CA. FILED 2-27-2009.

Face 2 Face Beauty

THE MARK CONSISTS OF STANDARD CHARACTERS WITHOUT CLAIM TO ANY PARTICULAR FONT, STYLE, SIZE, OR COLOR.

NO CLAIM IS MADE TO THE EXCLUSIVE RIGHT TO USE "BEAUTY", APART FROM THE MARK AS SHOWN.

FOR COSMETICS AND MAKE-UP; FACE AND BODY LOTIONS; HAIR SHAMPOOS AND CONDITIONERS; LOTIONS FOR FACE AND BODY CARE; NATURAL ESSENTIAL OILS; NATURAL MINERAL MAKE-UP; OILS FOR PERFUMES AND SCENTS; SOAPS FOR BODY CARE (U.S. CLS. 1, 4, 6, 50, 51 AND 52).

LINDA MICKLEBURGH, EXAMINING ATTORNEY

SN 77-683,947. KMC EXIM CORP., PORT WASHINGTON, NY. FILED 3-5-2009.

DRAMA QUEEN

THE MARK CONSISTS OF STANDARD CHARACTERS WITHOUT CLAIM TO ANY PARTICULAR FONT, STYLE, SIZE, OR COLOR.

FOR NAIL CARE PREPARATIONS, ARTIFICIAL NAILS AND NAIL POLISH (U.S. CLS. 1, 4, 6, 50, 51 AND 52).

FIRST USE 4-9-2009; IN COMMERCE 4-9-2009.

MICHAEL ENGEL, EXAMINING ATTORNEY

SN 77-683,953. KMC EXIM CORP., PORT WASHINGTON, NY. FILED 3-5-2009.

NEON GIRL

THE MARK CONSISTS OF STANDARD CHARACTERS WITHOUT CLAIM TO ANY PARTICULAR FONT, STYLE, SIZE, OR COLOR.

FOR NAIL CARE PREPARATIONS, ARTIFICIAL NAILS AND NAIL POLISH (U.S. CLS. 1, 4, 6, 50, 51 AND 52).

FIRST USE 4-9-2009; IN COMMERCE 4-9-2009.

MICHAEL ENGEL, EXAMINING ATTORNEY

CLASS 3—(Continued).

SN 77-687,240. KNIGHT DISTRIBUTING COMPANY, INC., LAWRENCEVILLE, GA. FILED 3-10-2009.

MY SECRET CORRECTIVES

THE MARK CONSISTS OF STANDARD CHARACTERS WITHOUT CLAIM TO ANY PARTICULAR FONT, STYLE, SIZE, OR COLOR.

NO CLAIM IS MADE TO THE EXCLUSIVE RIGHT TO USE "CORRECTIVES", APART FROM THE MARK AS SHOWN.

FOR CORRECTIVE COSMETICS (U.S. CLS. 1, 4, 6, 50, 51 AND 52).

BRIAN NEVILLE, EXAMINING ATTORNEY

SN 77-689,719. KMC EXIM CORP., PORT WASHINGTON, NY. FILED 3-12-2009.

GELIFE

THE MARK CONSISTS OF STANDARD CHARACTERS WITHOUT CLAIM TO ANY PARTICULAR FONT, STYLE, SIZE, OR COLOR.

FOR NAIL CARE PREPARATIONS, ARTIFICIAL FINGERNAILS AND NAIL POLISH (U.S. CLS. 1, 4, 6, 50, 51 AND 52).

FIRST USE 1-23-2009; IN COMMERCE 1-23-2009.

MICHAEL ENGEL, EXAMINING ATTORNEY

SN 77-690,321. BOUGIE INC., DBA BOUGIE INC, CLAWSON, MI. FILED 3-13-2009.

Sabrina

THE MARK CONSISTS OF STANDARD CHARACTERS WITHOUT CLAIM TO ANY PARTICULAR FONT, STYLE, SIZE, OR COLOR.

FOR COSMETICS AND MAKE-UP (U.S. CLS. 1, 4, 6, 50, 51 AND 52).

TIMOTHY FINNEGAN, EXAMINING ATTORNEY

CLASS 3—(Continued).

SN 77-691,636. DELTA PERFUME HOUSE, INC., BROOKLYN, NY. FILED 3-16-2009.

CLIPSAL

THE MARK CONSISTS OF STANDARD CHARACTERS WITHOUT CLAIM TO ANY PARTICULAR FONT, STYLE, SIZE, OR COLOR.
 FOR PERFUME (U.S. CLS. 1, 4, 6, 50, 51 AND 52).
 TARA PATE, EXAMINING ATTORNEY

SN 77-691,660. DELTA PERFUME HOUSE, INC., BROOKLYN, NY. FILED 3-16-2009.

EVERIO

THE MARK CONSISTS OF STANDARD CHARACTERS WITHOUT CLAIM TO ANY PARTICULAR FONT, STYLE, SIZE, OR COLOR.
 FOR PERFUME (U.S. CLS. 1, 4, 6, 50, 51 AND 52).
 TARA PATE, EXAMINING ATTORNEY

SN 77-701,473. SBE ENTERTAINMENT GROUP, LOS ANGELES, CA. FILED 3-27-2009.



NO CLAIM IS MADE TO THE EXCLUSIVE RIGHT TO USE "CONDITIONER", APART FROM THE MARK AS SHOWN.
 THE MARK CONSISTS OF A GLASS CONTAINER WITH AN ETCHING DESIGN INCLUDING CIRCULAR SHAPES AND THE WORD "CONDITIONER." THE MARK ITSELF IS NOT A CONFIGURATION OF THE GOOD BUT IT IS SUPERIMPOSED ON THE PACKAGING OF THE GOOD.
 FOR HAIR CONDITIONER (U.S. CLS. 1, 4, 6, 50, 51 AND 52).
 FIRST USE 11-1-2008; IN COMMERCE 11-1-2008.
 ZACHARY BELLO, EXAMINING ATTORNEY

CLASS 3—(Continued).

SN 77-702,694. CHRISTAL, DEAN V., SANTA BARBARA, CA. FILED 3-30-2009.

nano-organics

THE MARK CONSISTS OF STANDARD CHARACTERS WITHOUT CLAIM TO ANY PARTICULAR FONT, STYLE, SIZE, OR COLOR.
 FOR ORGANIC HAIR CARE PREPARATIONS, ORGANIC COLOR TREATMENT PRODUCTS, NAMELY, SHAMPOOS, CONDITIONERS, HAIR GELS, HAIR SPRAYS, ORGANIC NON-MEDICATED SKIN CARE PREPARATIONS, NAMELY, SKIN LOTION; ORGANIC COSMETICS, NAMELY, MAKE-UP REMOVER, LIP BALM, BODY LOTION, BATH SOAP, BATH OILS, PERFUME, LIQUID SOAPS FOR HANDS, FACE AND BODY (U.S. CLS. 1, 4, 6, 50, 51 AND 52).
 SOPHIA S. KIM, EXAMINING ATTORNEY

SN 77-708,401. SMITHKLINE BEECHAM CORPORATION, PHILADELPHIA, PA. FILED 4-7-2009.

LP3

THE MARK CONSISTS OF STANDARD CHARACTERS WITHOUT CLAIM TO ANY PARTICULAR FONT, STYLE, SIZE, OR COLOR.
 FOR TOOTHPASTES AND MOUTHWASH (U.S. CLS. 1, 4, 6, 50, 51 AND 52).
 ANDREW RHIM, EXAMINING ATTORNEY

SN 77-711,953. GOTHE, AXEL, NEW YORK, NY. FILED 4-10-2009.



THE MARK CONSISTS OF THE WORDING "BLUEBU", WITH THE LETTER "E" AND "B" STYLIZED AND INTERTWINED.
 THE WORDING "BLUEBU" HAS NO MEANING IN A FOREIGN LANGUAGE.
 FOR COSMETICS AND FRAGRANCES, NAMELY, BODY AND MOISTURIZING LOTIONS, BATH AND SHOWER GEL, SHAVING CREAM, HAIR CONDITIONER AND SHAMPOO, LIPSTICK, NAIL POLISH AND NAIL POLISH REMOVER, PERFUMES, COLOGNES, ESSENTIAL OILS FOR PERSONAL USE (U.S. CLS. 1, 4, 6, 50, 51 AND 52).
 AMY KERTGATE, EXAMINING ATTORNEY

CLASS 3—(Continued).

SN 77-712,475. URBAN DECAY COSMETICS LLC, NEW-PORT BEACH, CA. FILED 4-13-2009.

APOCALYPTIC NAIL KIT

THE MARK CONSISTS OF STANDARD CHARACTERS WITHOUT CLAIM TO ANY PARTICULAR FONT, STYLE, SIZE, OR COLOR.

NO CLAIM IS MADE TO THE EXCLUSIVE RIGHT TO USE "NAIL KIT", APART FROM THE MARK AS SHOWN. FOR COSMETICS (U.S. CLS. 1, 4, 6, 50, 51 AND 52). KYLE PEETE, EXAMINING ATTORNEY

SN 77-716,297. EIRAM, LLC, WEST CHESTER, PA. FILED 4-17-2009.



THE COLOR(S) BLACK, WHITE, BROWN, ORANGE, FUCHSIA, PINK IS/ARE CLAIMED AS A FEATURE OF THE MARK.

THE MARK CONSISTS OF THE NAME "EIRAM" IN COLORS RANGING FROM LIGHT TO DARK ORANGE FROM THE TOP OF THE LETTERING TO THE BOTTOM. A FACIAL OUTLINE COMET TRAIL COMPRISING FOUR LINES APPEARS IN THE BACKGROUND PROTRUDING FROM RIGHT TO LEFT IN THE COLORS BLACK, BROWN, PINK, WHITE, ORANGE. UNDERNEATH THE NAME "EIRAM" IS A MIRRORING EFFECT OF THE NAME "EIRAM" IN WHITE, FOLLOWED BY THE FORMULA "E" IN WHITE LETTERING, "*" IN FUCHSIA, A FACIAL OUTLINE IN BLACK, BROWN, PINK, WHITE, AND ORANGE, "=" IN ORANGE, THE WORDING "INNER BEAUTY" IN WHITE, AND THE WORD "REVEALED" IN ORANGE. THE MARK BACKGROUND IS BLACK AND OUTLINED IN ORANGE.

FOR LUXURY BRAND COSMETICS FOR SALONS, RETAIL STORES, AND INTERNET RETAILERS; COSMETIC ACCESSORIES FOR SALONS, RETAIL STORES, AND INTERNET RETAILERS, NAMELY, COSMETIC LIP PENCILS, EYE PENCILS, AND COSMETIC BRUSH CLEANERS (U.S. CLS. 1, 4, 6, 50, 51 AND 52). AARON BRODSKY, EXAMINING ATTORNEY

CLASS 3—(Continued).

SN 77-716,860. SUSANNE LANG FRAGRANCE INC., DBA SULA BEAUTY, TORONTO, CANADA, FILED 4-18-2009.

LASTING LOVE PEELABLE POLISH

THE MARK CONSISTS OF STANDARD CHARACTERS WITHOUT CLAIM TO ANY PARTICULAR FONT, STYLE, SIZE, OR COLOR.

NO CLAIM IS MADE TO THE EXCLUSIVE RIGHT TO USE "PEELABLE POLISH", APART FROM THE MARK AS SHOWN.

FOR NAIL POLISH; NAIL POLISH BASE COAT; NAIL POLISH TOP COAT (U.S. CLS. 1, 4, 6, 50, 51 AND 52). MATTHEW KLINE, EXAMINING ATTORNEY

SN 77-716,871. LAM, TONY, KAILUA, HI. FILED 4-18-2009.



La Caviar usa

NO CLAIM IS MADE TO THE EXCLUSIVE RIGHT TO USE "CAVIAR" AND "USA", APART FROM THE MARK AS SHOWN.

THE COLOR(S) GOLD AND GREEN IS/ARE CLAIMED AS A FEATURE OF THE MARK.

THE MARK CONSISTS OF A SQUARE OUTLINED IN GREEN WITH A GOLD LEAF -SHAPED LETTER "L" OUTLINED IN GREEN AND WITH GREEN VEINS IN THE CENTER. TO THE BOTTOM RIGHT OF THE SQUARE IS THE GREEN WORDING "USA". UNDERNEATH THE SQUARE ARE THE WORDS "LA CAVIAR USA" IN GREEN. THE WHITE IN THE MARK IS BACKGROUND AREA WHICH IS NOT A PART OF THE MARK.

FOR COSMETIC CREAMS FOR SKIN CARE (U.S. CLS. 1, 4, 6, 50, 51 AND 52).

REBECCA GILBERT, EXAMINING ATTORNEY

SN 77-719,319. KISS NAIL PRODUCTS, INC., PORT WASHINGTON, NY. FILED 4-22-2009.

FAST FRENCH DIVINE

THE MARK CONSISTS OF STANDARD CHARACTERS WITHOUT CLAIM TO ANY PARTICULAR FONT, STYLE, SIZE, OR COLOR.

OWNER OF U.S. REG. NO. 2,613,297.

NO CLAIM IS MADE TO THE EXCLUSIVE RIGHT TO USE "FRENCH", APART FROM THE MARK AS SHOWN.

FOR ARTIFICIAL NAILS; ARTIFICIAL FINGERNAIL KITS COMPRISING ARTIFICIAL FINGERNAILS (U.S. CLS. 1, 4, 6, 50, 51 AND 52).

MARK SHINER, EXAMINING ATTORNEY

CLASS 3—(Continued).

SN 77-719,704. BMD MANAGEMENT, LLC, LAS VEGAS, NV.
FILED 4-22-2009.

DIVA BEAUTY

THE MARK CONSISTS OF STANDARD CHARACTERS WITHOUT CLAIM TO ANY PARTICULAR FONT, STYLE, SIZE, OR COLOR.

NO CLAIM IS MADE TO THE EXCLUSIVE RIGHT TO USE "BEAUTY", APART FROM THE MARK AS SHOWN.

FOR NON-MEDICATED TOILETRIES, COSMETICS, FRAGRANCES, BEAUTY PREPARATIONS, NAMELY, EYELINER, MAKEUP KITS COMPRISING BROW GROOMING GEL, BROW BRUSH, NOURISHING BROW OIL AND BROW TWEEZERS; COSMETIC FACIAL BLOTTERING PAPER, LIPLINER, LIPSTICK, NAIL POLISH, PRESSED POWDER, BLUSH, MASCARA, EYE SHADOW, EYEBROW PENCIL, FACIAL AND SKIN CLEANSER, FACIAL AND SKIN MOISTURIZER, SKIN CREAM, NIGHT CREAM, EYE CREAM, HAND CREAM, BODY CREAM, LIQUID MAKEUP, FACE CREAM, PERFUMES, COLOGNE, MASSAGE LOTIONS, MASSAGE OILS, FOUNDATION MAKEUP, FACE POWDER AND LIP GLOSS (U.S. CLS. 1, 4, 6, 50, 51 AND 52).

ALEX KEAM, EXAMINING ATTORNEY

CLASS 3—(Continued).

SN 77-721,386. DEA COSMETICS, INC., MINATO-KU, TOKYO, JAPAN, FILED 4-24-2009.

Anuheala

THE MARK CONSISTS OF STANDARD CHARACTERS WITHOUT CLAIM TO ANY PARTICULAR FONT, STYLE, SIZE, OR COLOR.

THE ENGLISH TRANSLATION OF "ANUHEALA" IN THE MARK IS ANUHEA=FRAGRANCE OF THE MOUNTAIN FORESTS, COOL AND SWEET. LA= SUN.

FOR AFTER-SUN GELS; AFTER-SUN MILKS; AFTER-SUN OILS; ALOE VERA GEL FOR COSMETIC PURPOSES; ANTIBACTERIAL SKIN SOAPS; AQUEOUS AROMATIC ADDITIVES FOR USE IN THE MANUFACTURE OF ROOM FRESHENERS AND COSMETICS; AROMATHERAPY BODY CARE PRODUCTS, NAMELY, BODY LOTION, SHOWER GEL, CUTICLE CREAM, SHAMPOO, CONDITIONER, NON-MEDICATED LIP BALM, SOAP, BODY POLISH, BODY AND FOOT SCRUB AND NON-MEDICATED FOOT CREAM; ASTRINGENTS FOR COSMETIC PURPOSES; BATH OILS FOR COSMETIC PURPOSES; BATH POWDER; BEAUTY CREAMS FOR BODY CARE; BODY AND BEAUTY CARE COSMETICS; BODY SPRAY USED AS A PERSONAL DEODORANT AND AS FRAGRANCE; CLEANSING CREAMS; COLOGNES, PERFUMES AND COSMETICS; COLORING PREPARATIONS FOR COSMETIC PURPOSES; CONCEALERS; CONDITIONERS; COSMETIC CREAMS; COSMETIC CREAMS FOR SKIN CARE; COSMETIC HAIR DRESSING PREPARATIONS; COSMETIC MILKS; COSMETIC OILS; COSMETIC OLIVE OIL FOR THE FACE AND BODY; COSMETIC PREPARATIONS; COSMETIC PREPARATIONS AGAINST SUNBURN; COSMETIC PREPARATIONS FOR BODY CARE; COSMETIC PREPARATIONS FOR SKIN RENEWAL; COSMETIC PREPARATIONS FOR SLIMMING PURPOSES; COSMETIC PREPARATIONS FOR THE HAIR AND SCALP; COSMETIC PRODUCTS IN THE FORM OF AEROSOLS FOR SKIN CARE; COSMETIC PRODUCTS IN THE FORM OF AEROSOLS FOR SKINCARE; COSMETIC SOAPS; COSMETIC SUN-PROTECTING PREPARATIONS; COSMETIC SUN-TANNING PREPARATIONS; COSMETIC SUNTAN LOTIONS; COSMETIC SUNTAN PREPARATIONS; COSMETICS; COSMETICS AND COSMETIC PREPARATIONS; COSMETICS AND MAKE-UP; COSMETICS IN GENERAL, INCLUDING PERFUMES; COSMETICS, NAMELY, COMPACTS; COSMETICS, NAMELY, LIP REPAIRERS; DEODORANTS FOR BODY CARE; EXFOLIANTS FOR SKIN CARE PRODUCTS; FACE CREAMS AND CLEANSERS CONTAINING BENZOYL PEROXIDE FOR COSMETIC PURPOSES; FACE CREAMS FOR COSMETIC USE; FOAMS CONTAINING COSMETICS AND SUNSCREENS; FRAGRANCE EMITTING WICKS FOR ROOM FRAGRANCE; FRAGRANCE SACHETS; FRAGRANCES; FRAGRANCES AND PERFUMERY; FRAGRANCES FOR PERSONAL USE; GLITTER FOR COSMETIC PURPOSES; GRAPE SEED OIL FOR COSMETIC USE; HAIR CARE CREAMS; HAIR CARE KITS COMPRISING NON-MEDICATED HAIR CARE PREPARATIONS, NAMELY, HAIR TREATMENT GEL; HAIR CARE LOTIONS; HAIR CARE PREPARATIONS; HAIR CARE PREPARATIONS CONSISTING OF ORGANIC COCONUT VIRGIN OIL AND COCONUT VIRGIN OIL; HENNA FOR COSMETIC PURPOSES; LOTIONS FOR COSMETIC PURPOSES; LOTIONS FOR FACE AND BODY CARE; LOTIONS FOR AFTER SUN; MILK FOR COSMETIC PURPOSES; MINERAL POWDER FOR USE IN COSMETIC BODY WRAP APPLICATIONS; MOUSSE FOR HAIR TREATMENT; NON-MEDICATED COSMETIC SKIN CARE PREPARATIONS CONSISTING OF ORGANIC COCONUT VIRGIN OIL AND COCONUT VIRGIN OIL; NON-MEDICATED HAIR TREATMENT PREPARATIONS FOR COSMETIC PURPOSES; NON-MEDICATED LIP CARE PREPARATIONS; NON-MEDICATED PREPARATIONS ALL FOR THE CARE OF SKIN, HAIR AND SCALP; NON-MEDICATED SKIN CARE PREPARATION, NAMELY, BODY MIST; NON-MEDICATED SKIN CARE PREPARATIONS; NON-MEDI-

SN 77-720,469. ANSON & HIGGINS PLASTIC SURGERY ASSOCIATES, LLP, LAS VEGAS, NV. FILED 4-23-2009.

**Anson & Higgins
Environmental Solar Defense**

THE MARK CONSISTS OF STANDARD CHARACTERS WITHOUT CLAIM TO ANY PARTICULAR FONT, STYLE, SIZE, OR COLOR.

OWNER OF U.S. REG. NO. 3,566,560.

NO CLAIM IS MADE TO THE EXCLUSIVE RIGHT TO USE "SOLAR DEFENSE", APART FROM THE MARK AS SHOWN.

THE NAME(S), PORTRAIT(S), AND/OR SIGNATURE(S) SHOWN IN THE MARK DOES NOT IDENTIFY A PARTICULAR LIVING INDIVIDUAL.

FOR SUNSCREEN CREAM (U.S. CLS. 1, 4, 6, 50, 51 AND 52).

HOWARD FRIEDMAN, EXAMINING ATTORNEY

CLASS 3—(Continued).

CATED SKIN CARE PREPARATIONS, NAMELY, CREAMS, LOTIONS, GELS, TONERS, CLEANERS AND PEELS; NON-MEDICATED SKIN CREAMS; NON-MEDICATED STIMULATING LOTIONS FOR THE SKIN; NON-MEDICATED SUN CARE PREPARATIONS; NUTRITIONAL OILS FOR COSMETIC PURPOSES; OIL BATHS FOR HAIR CARE; OILS FOR COSMETIC PURPOSES; PARAFFIN WAX FOR COSMETIC PURPOSES; PERFUME OILS FOR THE MANUFACTURE OF COSMETIC PREPARATIONS; PRE-SCENTED STRIPS AND CARDS FOR SAMPLING FRAGRANCES; PRIVATE LABEL COSMETICS; RETINOL CREAM FOR COSMETIC PURPOSES; ROOM FRAGRANCE REFILLS FOR NON-ELECTRIC ROOM FRAGRANCE DISPENSERS; ROOM FRAGRANCES; ROOM FRAGRANCING PREPARATIONS; ROSE OIL FOR COSMETIC PURPOSES; SACHET-LIKE EYE PILLOWS CONTAINING FRAGRANCES; SELF-TANNING PREPARATIONS; SHEA BUTTER FOR COSMETIC PURPOSES; SKIN ABRASIVE PREPARATIONS; SKIN AND BODY TOPICAL LOTIONS, CREAMS AND OILS FOR COSMETIC USE; SKIN BRONZER; SKIN BRONZING CREAMS; SKIN CARE PREPARATION, NAMELY, BODY POLISH; SKIN CARE PREPARATIONS, NAMELY, BODY BALM; SKIN CARE PREPARATIONS, NAMELY, CHEMICAL PEELS FOR SKIN; SKIN CARE PREPARATIONS, NAMELY, FRUIT ACID PEELS FOR SKIN; SKIN CARE PREPARATIONS, NAMELY, SKIN PEELS; SKIN CARE PRODUCTS, NAMELY, NON-MEDICATED SKIN SERUM; SKIN CLARIFIERS; SKIN CLEANSERS; SKIN CLEANSING CREAM; SKIN CLEANSING LOTION; SKIN CONDITIONERS; SKIN CONDITIONING CREAMS FOR COSMETIC PURPOSES; SKIN CREAM; SKIN CREAMS; SKIN CREAMS IN LIQUID AND IN SOLID FORM; SKIN CREAMS IN LIQUID AND SOLID; SKIN CREAMS IN LIQUID AND SOLID FORM; SKIN EMOLLIENTS; SKIN FRESHENERS; SKIN GELS FOR ACCELERATING, ENHANCING OR EXTENDING TANS; SKIN LIGHTENERS; SKIN LIGHTENING CREAMS; SKIN LOTION; SKIN LOTIONS; SKIN MASKS; SKIN MOISTURIZER; SKIN MOISTURIZER MASKS; SKIN POLISHING RICE BRAN (ARAI-NUKA); SKIN SOAP; SKIN TEXTURIZERS; SKIN TONERS; SKIN WHITENING CREAMS; SKIN WHITENING PREPARATIONS; SOAPS; SOAPS FOR BODY CARE; SOLID POWDER FOR COMPACTS; SUN CARE LOTIONS; SUNTAN OILS FOR COSMETIC PURPOSES; TANNING AND AFTER-SUN MILKS, GELS AND OILS; TANNING GELS; TANNING MILKS; TANNING OILS; TONERS; TOPICAL SKIN SPRAYS FOR COSMETIC PURPOSES; WRINKLE REMOVING SKIN CARE PREPARATIONS; WRINKLE-MINIMIZING COSMETIC PREPARATIONS FOR TOPICAL FACIAL USE (U.S. CLS. 1, 4, 6, 50, 51 AND 52).

GIANCARLO CASTRO, EXAMINING ATTORNEY

CLASS 3—(Continued).

SN 77-721,828. SCHERING-PLOUGH HEALTHCARE PRODUCTS, INC., MEMPHIS, TN. FILED 4-24-2009.



OWNER OF U.S. REG. NOS. 512,484, 1,257,297 AND OTHERS.

NO CLAIM IS MADE TO THE EXCLUSIVE RIGHT TO USE "ODOR" AND "SYSTEM", APART FROM THE MARK AS SHOWN.

THE NAME(S), PORTRAIT(S), AND/OR SIGNATURE(S) SHOWN IN THE MARK DOES NOT IDENTIFY A PARTICULAR LIVING INDIVIDUAL.

THE COLOR(S) GREEN, LIGHT GREEN, DARK GREEN, BLUE, DARK BLUE, YELLOW, SILVER, AND WHITE IS/ARE CLAIMED AS A FEATURE OF THE MARK.

THE MARK CONSISTS OF DIAGONAL WAVY BANDS OF GREEN, SILVER, YELLOW, SILVER, AND GREEN STARTING FROM THE TOP LEFT TO THE BOTTOM RIGHT, OF WHICH THE GREEN WAVY BANDS EACH CONSISTS OF A LIGHT GREEN AND DARK GREEN CIRCLE-SHAPED PATTERN; AND CONTAINED ON TOP OF THE WAVY BANDS, "DR. SCHOLL'S" IN WHITE STYLIZED LETTERING OUTLINED IN SILVER WITH A YELLOW PERIOD IN THE FORM OF A SHADED SQUARE UNDER THE LETTER "R" IN "DR." IN A COMPLETELY DARK BLUE SHADED OVAL WITHIN A SILVER OVAL WITH A WHITE STARBURST DESIGN ON THE BOTTOM RIGHT OF THE SILVER OVAL; UNDER WHICH THE TERM "ODOR DESTROYERS" IN DARK BLUE LETTERING OUTLINED IN WHITE, UNDER WHICH A BLUE RECTANGLE-SHAPED BAND, UNDER WHICH A BLUE RECTANGLE-SHAPED BAND CONTAINING THE TERM "WITH 3X" IN WHITE LETTERING OUTLINED IN DARK BLUE WITH A WHITE BAND UNDERLINING "WITH," AND AFTER "3X", THE WORDS "TRIPLE ACTION SYSTEM" IN BLUE LETTERING INSIDE A WHITE ARROW-LIKE DESIGN OUTLINED IN DARK BLUE, WITH THREE DARK BLUE VERTICAL LINES WITH WHITE BACKGROUND, AND UNDER WHICH ON THE LEFT SIDE A BLUE VERTICAL LINE WITH THREE BLUE BOXES EACH CONTAINING WHITE "X" MARKS.

FOR NON-MEDICATED DEODORANT FOOT POWDER (U.S. CLS. 1, 4, 6, 50, 51 AND 52).

MELISSA VALLILLO, EXAMINING ATTORNEY

CLASS 3—(Continued).

SN 77-721,850. JL CORP OF SARASOTA, INC, SARASOTA, FL. FILED 4-24-2009.

Purple Haze

THE MARK CONSISTS OF STANDARD CHARACTERS WITHOUT CLAIM TO ANY PARTICULAR FONT, STYLE, SIZE, OR COLOR.

FOR AUTOMOBILE WAX (U.S. CLS. 1, 4, 6, 50, 51 AND 52).

MARIAM MAHMOUDI, EXAMINING ATTORNEY

SN 77-721,880. TRIUMPH PHARMACEUTICALS INC., ST. LOUIS, MO. FILED 4-24-2009.

12 HOUR POWER

THE MARK CONSISTS OF STANDARD CHARACTERS WITHOUT CLAIM TO ANY PARTICULAR FONT, STYLE, SIZE, OR COLOR.

NO CLAIM IS MADE TO THE EXCLUSIVE RIGHT TO USE "12 HOUR", APART FROM THE MARK AS SHOWN.

FOR NON-MEDICATED MOUTH RINSE (U.S. CLS. 1, 4, 6, 50, 51 AND 52).

LINDA M. KING, EXAMINING ATTORNEY

SN 77-722,214. MIX BRANDS LLC, WILTON, CT. FILED 4-24-2009.

BLINGTONE

THE MARK CONSISTS OF STANDARD CHARACTERS WITHOUT CLAIM TO ANY PARTICULAR FONT, STYLE, SIZE, OR COLOR.

FOR COSMETICS (U.S. CLS. 1, 4, 6, 50, 51 AND 52).
CAROLINE WOOD, EXAMINING ATTORNEY

CLASS 3—(Continued).

SN 77-722,223. MIX BRANDS LLC, WILTON, CT. FILED 4-24-2009.

ONE HIT WONDERS

THE MARK CONSISTS OF STANDARD CHARACTERS WITHOUT CLAIM TO ANY PARTICULAR FONT, STYLE, SIZE, OR COLOR.

FOR COSMETICS (U.S. CLS. 1, 4, 6, 50, 51 AND 52).
CAROLINE WOOD, EXAMINING ATTORNEY

SN 77-722,470. Z-DISTRIBUTION INC., DBA Z-DISTRIBUTION OPTIMIZED VISION, SAN JOSE, CA. FILED 4-26-2009.

Healing Springs

THE MARK CONSISTS OF STANDARD CHARACTERS WITHOUT CLAIM TO ANY PARTICULAR FONT, STYLE, SIZE, OR COLOR.

FOR 3-IN-1 HAIR CONDITIONERS; 3-IN-1 HAIR SHAMPOOS; ABRASIVE PAPER; ABRASIVE PASTE; ABRASIVE SAND; ABRASIVE STRIPS; ADHESIVE REMOVERS; ADHESIVES FOR AFFIXING FALSE EYELASHES; ADHESIVES FOR AFFIXING FALSE HAIR; ADHESIVES FOR ARTIFICIAL NAILS; ADHESIVES FOR ATTACHING ARTIFICIAL FINGERNAILS AND/OR EYELASHES; ADHESIVES FOR COSMETIC USE; ADHESIVES FOR FALSE EYELASHES, HAIR AND NAILS; AEROSOL SPRAY FOR CLEANING CONDENSER COILS OF AIR FILTERS FOR AIR CONDITIONING, HEATING AND AIR FILTRATION UNITS; AFTER SHAVE LOTIONS; AFTER SUN CREAMS; AFTER-SHAVE; AFTER-SHAVE BALMS; AFTER-SHAVE CREAMS; AFTER-SHAVE EMULSIONS; AFTER-SHAVE GEL; AFTER-SHAVE LOTIONS; AFTER-SUN GELS; AFTER-SUN LOTIONS; AFTER-SUN MILKS; AFTER-SUN OILS; AFTER-SHAVE; AFTERSHAVE COLOGNE; AFTERSHAVE PREPARATIONS; AGE RETARDANT GEL; AGE RETARDANT LOTION; AGE SPOT REDUCING CREAMS; ALCOHOL FOR CLEANING PURPOSES; ALL PURPOSE CLEANING PREPARATIONS; ALL PURPOSE COTTON SWABS FOR PERSONAL USE; ALL-PURPOSE CLEANERS; ALMOND SOAPS; ALOE VERA GEL FOR COSMETIC PURPOSES; AMMONIA FOR CLEANING PURPOSES; ANTI-AGING CLEANSER; ANTI-AGING CREAM; ANTI-AGING CREAMS; ANTI-AGING MOISTURIZER; ANTI-AGING TONER; ANTI-FRECKLE CREAMS; ANTI-PERSPIRANTS; ANTI-STATIC DRYER SHEETS; ANTI-STATIC PREPARATIONS FOR HOUSEHOLD PURPOSES; ANTI-STATIC SPRAY FOR CLOTHING; ANTI-WRINKLE CREAM; ANTI-WRINKLE CREAMS; ANTIBACTERIAL SKIN SOAPS; ANTIBACTERIAL SOAP; ANTIPERSPIRANTS; ANTIPERSPIRANTS AND DEODORANTS FOR PERSONAL USE; ANTIPERSPIRANTS FOR PERSONAL USE; AQUEOUS AROMATIC ADDITIVES FOR USE IN THE MANUFACTURE OF ROOM FRESHENERS AND COSMETICS; AROMATHERAPY BODY CARE PRODUCTS, NAMELY, BODY LOTION, SHOWER GEL, CUTICLE CREAM, SHAMPOO, CONDITIONER, NON-MEDICATED LIP BALM, SOAP, BODY POLISH, BODY AND FOOT SCRUB AND NON-MEDICATED FOOT CREAM; AROMATHERAPY CREAMS; AROMATHERAPY EVAPORATING SHOWER BALLS; AROMATHERAPY INHALER SOLD FILLED WITH AROMATHERAPY ESSENTIAL OILS; AROMATHERAPY LOTIONS; AROMATHERAPY OIL;

CLASS 3—(Continued).

AROMATHERAPY OILS; AROMATHERAPY PILLOWS COMPRISING POTPOURRI IN FABRIC CONTAINERS; AROMATHERAPY PILLOWS THAT MAY BE USED TO FRESHEN CLOTHING OR LAY OVER THE EYES; AROMATHERAPY SPRAYS; ARTIFICIAL EYELASHES; ARTIFICIAL FINGERNAILS; ARTIFICIAL FINGERNAILS NOT OF PRECIOUS METAL; ARTIFICIAL FINGERNAILS OF PRECIOUS METAL; ASTRINGENTS FOR COSMETIC PURPOSES; BABY HAIR CONDITIONER; BABY LOTION; BABY OIL; BABY OILS; BABY POWDER; BABY POWDERS; BABY SHAMPOO; BABY WIPES; BAR SOAP; BATH AND SHOWER GELS AND SALTS NOT FOR MEDICAL PURPOSES; BATH BEADS; BATH CREAM; BATH CRYSTALS; BATH FIZZIES; BATH FLAKES; BATH FOAM; BATH FOAMS; BATH GEL; BATH GELS; BATH HERBS; BATH LOTION; BATH MILKS; BATH OIL; BATH OILS; BATH OILS AND BATH SALTS; BATH OILS FOR COSMETIC PURPOSES; BATH PEARLS; BATH POWDER; BATH SALTS; BATH SOAPS; BATH SOAPS IN LIQUID, SOLID OR GEL FORM; BATHING LOTIONS; BEAUTY CREAMS; BEAUTY CREAMS FOR BODY CARE; BEAUTY GELS; BEAUTY LOTIONS; BEAUTY MASKS; BEAUTY MILKS; BEAUTY SERUMS; BIOTECHNOLOGICAL CHEMICAL AND SPRAY CLEANERS FOR INDUSTRIAL AND HOUSEHOLD APPLICATIONS SUCH AS STAIN REMOVAL, ODOR ELIMINATION, AND BIOREMEDIATION OF MANY TYPES OF ORGANIC AND HYDROCARBON-BASED MATERIALS; BIOTECHNOLOGICAL CLEANING SOLUTION FOR ELIMINATING ODORS, BREAKING DOWN ORGANICS, AND REMOVING STAINS; BLEACHING PREPARATIONS FOR COSMETIC PURPOSES; BLUSH; BLUSH PENCILS; BLUSHER; BODY AND BEAUTY CARE COSMETICS; BODY ART PENS; BODY BUTTER; BODY CRAYONS; BODY CREAM; BODY CREAM SOAP; BODY CREAMS; BODY DEODORANT IN PILL FORM; BODY DEODORANTS; BODY EMULSIONS; BODY GLITTER; BODY LOTION; BODY LOTIONS; BODY MASK CREAM; BODY MASK LOTION; BODY MASK POWDER; BODY MASKS; BODY MILK; BODY MILKS; BODY OIL; BODY OILS; BODY POWDER; BODY SCRUB; BODY SPLASH; BODY SPRAY USED AS A PERSONAL DEODORANT AND AS FRAGRANCE; BODY SPRAYS; BODY SPRAYS, NAMELY, WATER IN ATOMIZED CONTAINERS USED TO PRODUCE A COOLING EFFECT; BODY WASHES; BOOT CREAM; BOOT POLISH; BREATH FRESHENER; BREATH FRESHENING CONFECTIONARY, NAMELY, DISSOLVABLE BREATH STRIPS, BREATH MINTS, CANDY AND GUM; BREATH MINTS FOR USE AS A BREATH FRESHENER; BRILLIANTINE; BUBBLE BATH; CAKES OF TOILET SOAP; CANNED PRESSURIZED AIR FOR DUSTING AND CLEANING PURPOSES; CANNED PRESSURIZED GASES FOR DUSTING AND CLEANING PURPOSES; CARBURETOR AND CHOKE CLEANING PREPARATIONS; CARNAUBA WAX FOR AUTOMOTIVE USE; CHALK FOR COSMETIC USE; CHALK FOR MAKE-UP; CLEANER FOR COSMETIC BRUSHES; CLEANING AGENTS AND PREPARATIONS; CLEANING AND POLISHING PAPER; CLEANING AND POLISHING PREPARATIONS; CLEANING AND SHINING PREPARATIONS FOR PLANT LEAVES; CLEANING AND WASHING PREPARATIONS; CLEANING PREPARATIONS; CLEANING PREPARATIONS CONTAINING MICROBIAL ENZYMES, USED TO PRESERVE DRAIN SYSTEMS AND WATERWAYS; CLEANING PREPARATIONS CONTAINING VITAMINS, MINERALS, PLANT EXTRACTS AND/OR BOTANICALS, USED TO PRESERVE HARD SURFACES BY RENDERING THE SURFACES FREE OF AGING AGENTS; CLEANING PREPARATIONS FOR CLEANING SURFACES; CLEANING PREPARATIONS FOR CLEANSING DRAINS; CLEANING PREPARATIONS THAT ELIMINATE BACTERIA THAT CAUSE PRODUCTS TO AGE OR PRODUCE FOUL ODORS; CLEANSING CREAMS; CLEANSING MILK; CLEANSING MILK FOR TOILET PURPOSES; CLOTHS OR TISSUES IMPREGNATED WITH A SKIN CLEANSER; COCOA BUTTER FOR COSMETIC PURPOSES; COLD CREAM; COLD CREAMS; COLD WAVYING SOLUTIONS; COLOGNE; COLOGNE WATER; COLOGNES, PERFUMES AND COSMETICS; COLORING PREPARATIONS FOR COSMETIC PURPOSES; COMBINATION CLEANER AND DEODORIZER FOR LITTER BOXES; COMPACTS CONTAINING MAKE-UP; CONCEALERS; CONDITIONERS; COSMETIC BALLS; COSMETIC CREAMS; COSMETIC CREAMS FOR SKIN CARE; COSMETIC FACIAL BLOTTING

CLASS 3—(Continued).

PAPERS; COSMETIC HAIR DRESSING PREPARATIONS; COSMETIC HAIR REGROWTH INHIBITING PREPARATIONS; COSMETIC MILKS; COSMETIC OILS; COSMETIC OILS FOR THE EPIDERMIS; COSMETIC OLIVE OIL FOR THE FACE AND BODY; COSMETIC PADS; COSMETIC PENCILS; COSMETIC PREPARATIONS; COSMETIC PREPARATIONS AGAINST SUNBURN; COSMETIC PREPARATIONS FOR BODY CARE; COSMETIC PREPARATIONS FOR EYE LASHES; COSMETIC PREPARATIONS FOR SKIN RENEWAL; COSMETIC PREPARATIONS FOR SLIMMING PURPOSES; COSMETIC PREPARATIONS FOR THE CARE OF MOUTH AND TEETH; COSMETIC PREPARATIONS FOR THE HAIR AND SCALP; COSMETIC PRODUCTS IN THE FORM OF AEROSOLS FOR SKIN CARE; COSMETIC PRODUCTS IN THE FORM OF AEROSOLS FOR SKINCARE; COSMETIC PRODUCTS TAKEN ORALLY, NAMELY, PILLS THAT INDUCE BRONZING OF THE SKIN; COSMETIC ROUGES; COSMETIC SOAPS; COSMETIC SUN-PROTECTING PREPARATIONS; COSMETIC SUN-TANNING PREPARATIONS; COSMETIC SUNTAN LOTIONS; COSMETIC SUNTAN PREPARATIONS; COSMETICS; COSMETICS AND COSMETIC PREPARATIONS; COSMETICS AND MAKE-UP; COSMETICS FOR ANIMALS; COSMETICS IN GENERAL, INCLUDING PERFUMES; COSMETICS, NAMELY, COMPACTS; COSMETICS, NAMELY, LIP PRIMER; COSMETICS, NAMELY, LIP REPAIRERS; COTTON BALLS FOR COSMETIC PURPOSES; COTTON BUDS FOR COSMETIC PURPOSES; COTTON FOR COSMETIC PURPOSES; COTTON PUFFS FOR COSMETIC PURPOSES; COTTON STICKS FOR COSMETIC PURPOSES; COTTON SWABS FOR COSMETIC PURPOSES; COTTON WOOL AND COTTON STICKS FOR COSMETIC PURPOSES; COTTON WOOL FOR COSMETIC PURPOSES; CREAM SOAPS; CREAMS FOR CELLULITE REDUCTION; CREAMS FOR LEATHER; CREAMY FACE POWDER; CREAMY FOUNDATION; CREAMY ROUGES; CUTICLE CONDITIONERS; CUTICLE CREAM; CUTICLE REMOVING PREPARATIONS; DECORATIVE TRANSFERS AND SKIN JEWELS FOR COSMETIC PURPOSES; DENTAL BLEACHING GEL; DENTIFRICE; DENTIFRICES; DENTIFRICES AND MOUTHWASHES; DENTIFRICES IN THE FORM OF CHEWING GUM; DENTURE CLEANERS; DENTURE CLEANING PREPARATIONS; DEODORANT FOR PERSONAL USE; DEODORANT SOAP; DEODORANTS AND ANTIPERSPIRANTS; DEODORANTS AND ANTIPERSPIRANTS FOR PERSONAL USE; DEODORANTS FOR ANIMALS; DEODORANTS FOR BODY CARE; DEODORANTS FOR PERSONAL USE; DEODORIZERS FOR PETS; DEPILATORIES; DEPILATORY CREAMS; DEPILATORY PREPARATIONS; DEPILATORY PREPARATIONS AND SUBSTANCES; DEPILATORY WAX; DETERGENT SOAP; DETERGENTS FOR AUTOMOBILES; DETERGENTS FOR HOUSEHOLD USE; DETERGENTS FOR MACHINE DISHWASHING; DETERGENTS PREPARED FROM PETROLEUM; DISINFECTANT SOAPS; DISINFECTING PERFUMED SOAPS; EAU DE COLOGNE; EAU DE COLOGNES; EAU DE PARFUM; EAU DE PERFUME; EAU DE TOILETTE; EAU DE TOILETTE AND EAU DE COLOGNE; EAU-DE-COLOGNE; EAU-DE-TOILETTE; EAUX DE COLOGNE; EAUX DE TOILETTE; EMERY BOARDS; EMERY PAPER; EPILATORY STRIPS; ESSENTIAL OILS; ESSENTIAL OILS AS PERFUME FOR LAUNDRY PURPOSES; ESSENTIAL OILS FOR FLAVORING BEVERAGES; ESSENTIAL OILS FOR FOOD FLAVORINGS; ESSENTIAL OILS FOR PERSONAL USE; ESSENTIAL OILS FOR USE IN THE MANUFACTURE OF SCENTED PRODUCTS; ETHEREAL OILS; EXFOLIANT CREAMS; EYE COMPRESSES FOR COSMETIC PURPOSES; EYE CREAM; EYE GELS; EYE LINER; EYE LOTIONS; EYE MAKE-UP; EYE MAKE-UP REMOVER; EYE PENCILS; EYE SHADOW; EYE SHADOWS; EYE-SHADOW; EYEBROW COLORS; EYEBROW COSMETICS; EYEBROW PENCILS; EYEGLOSS LENS CLEANING SOLUTIONS; EYELINER; EYELINER PENCILS; EYELINERS; EYES MAKE-UP; EYES PENCILS; EYESHADOW; EYESHADOWS; EYEWEAR CLEANING KITS COMPRISED OF CLEANING FLUID AND A CLEANING CLOTH; FACE AND BODY BEAUTY CREAMS; FACE AND BODY CREAMS; FACE AND BODY GLITTER; FACE AND BODY LOTIONS; FACE AND BODY MILK; FACE CREAMS; FACE CREAMS AND CLEANSERS CONTAINING BENZOYL PEROXIDE FOR COSMETIC PURPOSES; FACE CREAMS FOR COSMETIC USE; FACE GLITTER; FACE MILK AND LOTIONS; FACE PAINT; FACE

CLASS 3—(Continued).

PAINTING KITS; FACE POWDER; FACE POWDER PASTE; FACE-POWDER ON PAPER; FACIAL BEAUTY MASKS; FACIAL CLEANSERS; FACIAL CLEANSING GRAINS; FACIAL CLEANSING MILK; FACIAL CONCEALER; FACIAL CREAM; FACIAL CREAMS; FACIAL EMULSIONS; FACIAL LOTION; FACIAL MAKE-UP; FACIAL MASKS; FACIAL SCRUBS; FACIAL WASHES; FAIR COMPLEXION CREAM; FALSE EYELASHES; FALSE NAILS; FEMININE DEODORANT SPRAYS; FEMININE DEODORANT SUPPOSITORIES; FEMININE HYGIENE CLEANSING TOWELETTES; FINGERNAIL DECALS; FINGERNAIL SCULPTURING OVERLAYS; FLEXIBLE ABRASIVES; FOAM BATH; FOAM CLEANING PREPARATIONS; FOAM CLEANSERS FOR PERSONAL USE; FOAMS CONTAINING COSMETICS AND SUNSCREENS; FOOT DEODORANT SPRAY; FOOT POWDER; FOOT SCRUBS; FOOT SMOOTHING STONES; FOUNDATION; FOUNDATION MAKE-UP; FOUNDATIONS; FRAGRANCE EMITTING WICKS FOR ROOM FRAGRANCE; FRAGRANCE SACHETS; FRAGRANCES; FRAGRANCES AND PERFUMERY; FRAGRANCES FOR PERSONAL USE; GAUZE FOR COSMETIC PURPOSES; GEL EYE MASKS; GLITTER FOR COSMETIC PURPOSES; GRAPE SEED OIL FOR COSMETIC USE; GREASES FOR COSMETIC PURPOSES; HAIR BALSAM; HAIR BLEACH; HAIR BLEACHES; HAIR BLEACHING PREPARATIONS; HAIR CARE CREAMS; HAIR CARE LOTIONS; HAIR CARE PREPARATIONS; HAIR CARE PREPARATIONS CONSISTING OF ORGANIC COCONUT VIRGIN OIL AND COCONUT VIRGIN OIL; HAIR CLEANING PREPARATIONS; HAIR COLOR; HAIR COLOR REMOVERS; HAIR COLORANTS; HAIR COLORING PREPARATIONS; HAIR COLOURANTS; HAIR COLOURING; HAIR COLOURING AND DYES; HAIR COLOURING PREPARATIONS; HAIR CONDITIONER; HAIR CONDITIONERS; HAIR CONDITIONERS FOR BABIES; HAIR CREAMS; HAIR CURLING PREPARATIONS; HAIR DECOLORANTS; HAIR DRESSINGS FOR MEN; HAIR DRESSINGS FOR WOMEN; HAIR DYE; HAIR DYES; HAIR EMOLLIENTS; HAIR FIXERS; HAIR FROSTS; HAIR GEL; HAIR GEL AND HAIR MOUSSE; HAIR GELS; HAIR GLAZE; HAIR LACQUERS; HAIR LIGHTENERS; HAIR LOTION; HAIR LOTIONS; HAIR MASCARA; HAIR MOUSSE; HAIR MOUSSES; HAIR NOURISHERS; HAIR OILS; HAIR PIECE BONDING GLUE; HAIR POMADES; HAIR PRODUCTS, NAMELY, THICKENING CONTROL CREAMS; HAIR RELAXERS; HAIR RELAXING PREPARATIONS; HAIR REMOVING CREAM; HAIR RINSES; HAIR SHAMPOO; HAIR SHAMPOOS AND CONDITIONERS; HAIR SPRAY; HAIR SPRAYS; HAIR SPRAYS AND HAIR GELS; HAIR STRAIGHTENING PREPARATIONS; HAIR STYLING FIXATIVE IN THE NATURE OF HAIR WAX; HAIR STYLING GEL; HAIR STYLING PREPARATIONS; HAIR STYLING SPRAY; HAIR TONIC; HAIR TONICS; HAIR WAVING LOTION; HAIR WAVING PREPARATIONS; HAIR WAX; HAIR-WASHING POWDER; HAIRSPRAY; HAND CLEANERS; HAND CLEANING PREPARATIONS; HAND CREAM; HAND CREAMS; HAND LOTIONS; HAND SCRUBS; HAND SOAPS; HENNA FOR COSMETIC PURPOSES; INDOOR SUN TANNING PREPARATIONS; JAPANESE HAIR FIXING OIL (BINT-SUKE-ABURA); JASMINE OIL FOR PERSONAL USE; JOSS STICKS; LAVENDER OIL; LIP BALM; LIP CREAM; LIP GLOSS; LIP GLOSS PALATTE; LIP LINER; LIP POLISHER; LIPSTICK; LIPSTICK CASES; LIPSTICK HOLDERS; LIPSTICKS; LIQUID BATH SOAPS; LIQUID FOUNDATION (MIZU-OSHIROI); LIQUID PERFUMES; LIQUID SOAP; LIQUID SOAP USED IN FOOT BATH; LIQUID SOAPS; LIQUID SOAPS FOR HANDS AND FACE; LIQUID SOAPS FOR HANDS, FACE AND BODY; LOOFAH SOAPS; LOOSE FACE POWDER; LOTIONS FOR BEARDS; LOTIONS FOR CELLULITE REDUCTION; LOTIONS FOR COSMETIC PURPOSES; LOTIONS FOR FACE AND BODY CARE; LOTIONS FOR STRENGTHENING THE NAILS; MAKE UP FOUNDATIONS; MAKE UP REMOVING PREPARATIONS; MAKE-UP; MAKE-UP FOR THE FACE AND BODY; MAKE-UP FOUNDATIONS; MAKE-UP PENCILS; MAKE-UP POWDER; MAKE-UP PREPARATIONS; MAKE-UP REMOVER; MAKE-UP REMOVING LOTIONS; MAKE-UP REMOVING MILK, GEL, LOTIONS AND CREAMS; MAKE-UP REMOVING MILKS; MAKE-UP REMOVING PREPARATIONS; MASCARA; MASCARAS; MASSAGE CREAMS; MASSAGE OIL; MASSAGE OILS; MEDICATED SOAP; MEDICATED SOAPS; MILK FOR COSMETIC PURPOSES; MINERAL POWDER FOR USE IN

CLASS 3—(Continued).

COSMETIC BODY WRAP APPLICATIONS; MINERAL SALT IN THE NATURE OF BATH SALTS NOT FOR MEDICAL PURPOSES; MOISTENED TOOTH POWDER; MOISTURIZING CREAMS; MOISTURIZING MILKS; MOUTH WASHES; MOUTHWASH; MOUTHWASHES; MUSK; MUSTACHE WAX; NAIL BUFFING PREPARATIONS; NAIL CARE PREPARATIONS; NAIL CARE PREPARATIONS, NAMELY, NAIL SOFTENERS; NAIL CREAM; NAIL ENAMEL; NAIL ENAMEL REMOVERS; NAIL ENAMELS; NAIL GLITTER; NAIL GROOMING PRODUCTS, NAMELY, TIPS, GLUE, LACQUER AND GLITTER; NAIL HARDENERS; NAIL POLISH; NAIL POLISH BASE COAT; NAIL POLISH REMOVER; NAIL POLISH REMOVERS; NAIL POLISH TOP COAT; NAIL STENCILS; NAIL STRENGTHENERS; NAIL TIPS; NAIL VARNISH; NAIL VARNISH FOR COSMETIC PURPOSES; NAIL VARNISHES; NAIL-POLISH REMOVERS; NATURAL ESSENTIAL OILS; NATURAL MINERAL MAKE-UP; NIGHT CREAM; NON-MEDICATED ACNE TREATMENT PREPARATIONS; NON-MEDICATED ANTI-AGING SERUM; NON-MEDICATED BATH PREPARATIONS; NON-MEDICATED BATH SALTS; NON-MEDICATED BODY SOAKS; NON-MEDICATED BREATH FRESHENING STRIPS; NON-MEDICATED BUBBLE BATH PREPARATIONS; NON-MEDICATED COSMETIC SKIN CARE PREPARATIONS CONSISTING OF ORGANIC COCONUT VIRGIN OIL AND COCONUT VIRGIN OIL; NON-MEDICATED DENTAL RINSE; NON-MEDICATED DIAPER RASH OINTMENTS AND LOTIONS; NON-MEDICATED DOUCHES; NON-MEDICATED FEMININE HYGIENE WASH; NON-MEDICATED FOOT CREAM; NON-MEDICATED FOOT LOTIONS; NON-MEDICATED FOOT SOAKS; NON-MEDICATED HAIR RESTORATION LOTIONS; NON-MEDICATED HAIR TREATMENT PREPARATIONS FOR COSMETIC PURPOSES; NON-MEDICATED LIP BALM THAT DOES NOT CONTAIN BEESWAX; NON-MEDICATED LIP CARE PREPARATIONS; NON-MEDICATED LIP PROTECTORS; NON-MEDICATED MOUTH RINSE; NON-MEDICATED MOUTH WASH AND RINSE; NON-MEDICATED MOUTH WASHES; NON-MEDICATED MOUTHWASH AND GARGLE; NON-MEDICATED MOUTHWASHES; NON-MEDICATED OINTMENTS FOR THE PREVENTION AND TREATMENT OF SUNBURN; NON-MEDICATED PREPARATIONS ALL FOR THE CARE OF SKIN, HAIR AND SCALP; NON-MEDICATED SCALP TREATMENT CREAM; NON-MEDICATED SKIN CARE PREPARATION, NAMELY, BODY MIST; NON-MEDICATED SKIN CARE PREPARATIONS; NON-MEDICATED SKIN CARE PREPARATIONS, NAMELY, CREAMS, LOTIONS, GELS, TONERS, CLEANERS AND PEELS; NON-MEDICATED SKIN CREAMS; NON-MEDICATED STIMULATING LOTIONS FOR THE SKIN; NON-MEDICATED SUN CARE PREPARATIONS; NON-MEDICATED TOILETRIES; NON-SLIPPING LIQUIDS FOR FLOORS; NON-SLIPPING WAX FOR FLOORS; NUTRITIONAL OILS FOR COSMETIC PURPOSES; OIL BATHS FOR HAIR CARE; OILS FOR CLEANING PURPOSES; OILS FOR COSMETIC PURPOSES; OILS FOR HAIR CONDITIONING; OILS FOR PERFUMES AND SCENTS; OILS FOR TOILETRY PURPOSES; PATCHES CONTAINING SUN SCREEN AND SUN BLOCK FOR USE ON THE SKIN; PENCILS FOR COSMETIC PURPOSES; PEPPERMINT OIL; PERFUME; PERFUME OILS; PERFUME OILS FOR THE MANUFACTURE OF COSMETIC PREPARATIONS; PERFUMED CREAMS; PERFUMED EXTRACTS FOR TISSUES AND PERFUMES; PERFUMED PASTE; PERFUMED POWDER; PERFUMED POWDERS; PERFUMED SOAP; PERFUMED SOAPS; PERFUMED TALCUM POWDER; PERFUMERIES; PERFUMERY; PERFUMES; PERFUMES AND COLOGNES; PERFUMES AND TOILET WATERS; PERFUMES FOR INDUSTRIAL PURPOSES; PERFUMES, AFTERSHAVES AND COLOGNES; PERFUMES, EAU DE COLOGNE AND AFTERSHAVES; PERFUMES, EAUX DE COLOGNE AND AFTERSHAVES; PERFUMING SACHETS; PERMANENT WAVE PREPARATIONS; PERMANENT WAVING LOTIONS; PERSONAL DEODORANTS; PETROLEUM JELLY FOR COSMETIC PURPOSES; POMADES; POMANDERS; POT POURRI; POTPOURRI; PRE-MOISTENED COSMETIC TISSUES; PRE-MOISTENED COSMETIC TOWELETTES; PRE-MOISTENED COSMETIC WIPES; PRE-MOISTENED TOWELETTES IMPREGNATED WITH DISHWASHING DETERGENT; PRE-SCENTED STRIPS AND CARDS FOR SAMPLING FRAGRANCES; PRE-SHAVE CREAMS; PREPARATIONS FOR PERMANENT HAIR WAVES; PREPARATIONS FOR SETTING HAIR; PRESSED FACE

CLASS 3—(Continued).

POWDER; PRIVATE LABEL COSMETICS; PUMICE STONES FOR PERSONAL USE; RETINOL CREAM FOR COSMETIC PURPOSES; ROOM FRAGRANCE REFILLS FOR NON-ELECTRIC ROOM FRAGRANCE DISPENSERS; ROSE OIL FOR COSMETIC PURPOSES; ROUGE; ROUGES; SACHET-LIKE EYE PILLOWS CONTAINING FRAGRANCES; SACHETS; SADDLE SOAP; SAND FOR USE AS ABRASIVE IN SANDBLASTING; SANDING APPARATUS IN THE FORM OF A GLOVE; SANDPAPER; SCENTED BODY LOTIONS AND CREAMS; SCENTED BODY SPRAY; SCULPTING GEL; SELF-TANNING PREPARATIONS; SHAMPOO-CONDITIONERS; SHAMPOOS; SHAMPOOS FOR BABIES; SHAVING BALM; SHAVING CREAM; SHAVING CREAMS; SHAVING FOAM; SHAVING GEL; SHAVING GELS; SHAVING LOTION; SHAVING LOTIONS; SHAVING MOUSSE; SHAVING PREPARATIONS; SHAVING SOAP; SHAVING SOAPS; SHAVING SPRITZ IN THE NATURE OF A MOISTURIZING SOLUTION FOR SHAVING; SHEA BUTTER FOR COSMETIC PURPOSES; SHINING PREPARATIONS; SHOWER AND BATH FOAM; SHOWER AND BATH GEL; SHOWER CREAMS; SHOWER GEL; SHOWER GELS; SKIN ABRASIVE PREPARATIONS; SKIN AND BODY TOPICAL LOTIONS, CREAMS AND OILS FOR COSMETIC USE; SKIN BRONZER; SKIN BRONZING CREAMS; SKIN CARE PREPARATION, NAMELY, BODY POLISH; SKIN CARE PREPARATIONS, NAMELY, BODY BALM; SKIN CARE PREPARATIONS, NAMELY, CHEMICAL PEELS FOR SKIN; SKIN CARE PREPARATIONS, NAMELY, FRUIT ACID PEELS FOR SKIN; SKIN CARE PREPARATIONS, NAMELY, SKIN PEELS; SKIN CARE PRODUCTS, NAMELY, NON-MEDICATED SKIN SERUM; SKIN CLARIFIERS; SKIN CLEANSERS; SKIN CLEANSING CREAM; SKIN CLEANSING LOTION; SKIN CONDITIONERS; SKIN CONDITIONING CREAMS FOR COSMETIC PURPOSES; SKIN CREAM; SKIN CREAMS; SKIN CREAMS IN LIQUID AND IN SOLID FORM; SKIN CREAMS IN LIQUID AND SOLID; SKIN CREAMS IN LIQUID AND SOLID FORM; SKIN EMOLLIENTS; SKIN FRESHENERS; SKIN GELS FOR ACCELERATING, ENHANCING OR EXTENDING TANS; SKIN LIGHTENERS; SKIN LIGHTENING CREAMS; SKIN LOTION; SKIN LOTIONS; SKIN MASKS; SKIN MOISTURIZER; SKIN MOISTURIZER MASKS; SKIN POLISHING RICE BRAN (ARAI-NUKA); SKIN SOAP; SKIN TEXTURIZERS; SKIN TONERS; SKIN WHITENING CREAMS; SKIN WHITENING PREPARATIONS; SOAP POWDER; SOAPS; SOAPS AND DETERGENTS; SOAPS FOR BODY CARE; SOAPS FOR HOUSEHOLD USE; SOAPS FOR PERSONAL USE; SOAPS FOR TOILET PURPOSES; SOLID POWDER FOR COMPACTS; SPF SUNBLOCK TOWELETTES; SPOT REMOVER; STAIN REMOVERS; STICK POMADE; STYLING CLAY FOR HAIR; STYLING FOAM FOR HAIR; STYLING GELS; STYLING LOTIONS; STYLING MOUSSE; STYLING PASTE FOR HAIR; SUN BLOCK; SUN BLOCK PREPARATIONS; SUN CARE LOTIONS; SUN CREAMS; SUN SCREEN; SUN SCREEN PREPARATIONS; SUN TAN GEL; SUN TAN LOTION; SUN TAN OIL; SUN-BLOCK LOTIONS; SUN-TANNING OILS; SUN-TANNING OILS AND LOTIONS; SUN-TANNING PREPARATIONS; SUNSCREEN CREAM; SUNSCREEN CREAMS; SUNTAN CREAMS; SUNTAN OILS FOR COSMETIC PURPOSES; SUNTANNING PREPARATIONS; SYNTHETIC PERFUMERY; TALCUM POWDER; TALCUM POWDERS; TANNING AND AFTER-SUN MILKS, GELS AND OILS; TANNING CREAMS; TANNING GELS; TANNING MILKS; TANNING OILS; TEETH CLEANING LOTIONS; TEETH WHITENING KIT; TEETH WHITENING STRIPS IMPREGNATED WITH TEETH WHITENING PREPARATIONS; TEMPORARY TATTOO SPRAYS AND STENCILS THEREFOR SOLD AS A UNIT; THEATRICAL MAKE-UP; TISSUES IMPREGNATED WITH COSMETIC LOTIONS; TOILET SOAP; TOILET SOAPS; TOILET WATER; TOILET WATER CONTAINING SNAKE OIL; TOILET WATERS; TONERS; TONING LOTION, FOR THE FACE, BODY AND HANDS; TOOTH BLEACHING PREPARATIONS; TOOTH CLEANING PREPARATIONS; TOOTH GEL; TOOTH PASTE; TOOTH PASTE IN SOFT CAKE; TOOTH POLISH; TOOTH POWDER; TOOTH POWDERS; TOOTH WHITENING CREAMS; TOOTH WHITENING GELS; TOOTH WHITENING PASTES; TOOTH WHITENING

CLASS 3—(Continued).

PREPARATIONS; TOOTHPASTE; TOOTHPASTE AND MOUTHWASHES; TOOTHPASTES; TOPICAL HERBAL CREAM FOR FIRING AND ENHANCING BREASTS; TOPICAL SKIN SPRAYS FOR COSMETIC PURPOSES; UNDER-EYE ENHANCERS; VANISHING CREAM; VARNISH REMOVERS; WATERLESS SOAP; WAX FOR REMOVING BODY HAIR; WAX STRIPPING PREPARATIONS; WAX STRIPS FOR REMOVING BODY HAIR; WRINKLE REMOVING SKIN CARE PREPARATIONS; WRINKLE RESISTANT CREAM; WRINKLE-MINIMIZING COSMETIC PREPARATIONS FOR TOPICAL FACIAL USE (U.S. CLS. 1, 4, 6, 50, 51 AND 52).
ANDREW LEASER, EXAMINING ATTORNEY

SN 77-722,847. ARGYRIADIS, ELEYTHERIOS, PALMETTO, FL. FILED 4-27-2009.

Crown

THE MARK CONSISTS OF STANDARD CHARACTERS WITHOUT CLAIM TO ANY PARTICULAR FONT, STYLE, SIZE, OR COLOR.

FOR BREATH FRESHENING CONFECTIONARY, NAMELY, DISSOLVABLE BREATH STRIPS, BREATH MINTS, CANDY AND GUM; DENTIFRICES IN THE FORM OF CHEWING GUM; HOME DENTAL CARE PRODUCTS FOR DOGS AND CATS, NAMELY, TOOTHPASTE; TEETH WHITENING KIT; TEETH WHITENING STRIPS IMPREGNATED WITH TEETH WHITENING PREPARATIONS; TOOTH WHITENING CREAMS; TOOTH WHITENING GELS; TOOTH WHITENING PASTES; TOOTH WHITENING PREPARATIONS; TOOTHPASTE; TOOTHPASTE AND MOUTHWASHES; TOOTHPASTES (U.S. CLS. 1, 4, 6, 50, 51 AND 52).
TIMOTHY FINNEGAN, EXAMINING ATTORNEY

SN 77-723,173. HINSON, PAUL, SAN DIEGO, CA. FILED 4-27-2009.

THE MARK CONSISTS OF THE WORDS "QWIK 6" WITH THE WORD "SIX" SUPERIMPOSED OVER THE NUMBER "6".

FOR CARPET CLEANER AND STAIN REMOVER (U.S. CLS. 1, 4, 6, 50, 51 AND 52).
FIRST USE 10-1-2008; IN COMMERCE 10-1-2008.
ALLISON HOLTZ, EXAMINING ATTORNEY

CLASS 3—(Continued).

SN 77-723,295. CARICASI INC., HACIENDA HEIGHTS, CA. FILED 4-27-2009.

CARICASI

THE MARK CONSISTS OF STANDARD CHARACTERS WITHOUT CLAIM TO ANY PARTICULAR FONT, STYLE, SIZE, OR COLOR.

FOR COSMETIC PREPARATIONS; COSMETICS; LIP GLOSS; NAIL CARE PREPARATIONS; NAIL POLISH; NAIL-POLISH REMOVERS (U.S. CLS. 1, 4, 6, 50, 51 AND 52).

FONG HSU, EXAMINING ATTORNEY

SN 77-723,611. PINT SIZE PALS, LLC, RAYNHAM, MA. FILED 4-28-2009.



THE MARK CONSISTS OF CARTOON DRAWING OF CAT, DOG AND BIRD ON A PERCH SURROUNDED BY THE WORDS "PINT SIZE PALS".

FOR PET ODOR REMOVERS; PET SHAMPOO (U.S. CLS. 1, 4, 6, 50, 51 AND 52).

FIRST USE 8-21-2006; IN COMMERCE 8-21-2006. JENNIFER MARTIN, EXAMINING ATTORNEY

SN 77-723,698. L'OREAL, PARIS, FRANCE, FILED 4-28-2009.

HIP STUDIO SECRETS

THE MARK CONSISTS OF STANDARD CHARACTERS WITHOUT CLAIM TO ANY PARTICULAR FONT, STYLE, SIZE, OR COLOR.

OWNER OF U.S. REG. NO. 3,326,078. FOR COSMETICS (U.S. CLS. 1, 4, 6, 50, 51 AND 52). JENNIFER HETU, EXAMINING ATTORNEY

CLASS 3—(Continued).

SN 77-723,704. CARLINO, CRISTINA M., PARADISE VALLEY, AZ. FILED 4-28-2009.

ART OF GRACE

THE MARK CONSISTS OF STANDARD CHARACTERS WITHOUT CLAIM TO ANY PARTICULAR FONT, STYLE, SIZE, OR COLOR.

OWNER OF U.S. REG. NO. 3,581,660.

FOR BABY LOTION; BABY POWDER; BABY SHAMPOO; BAR SOAP; BODY POWDER; BODY SCRUB; BODY SPRAYS; COSMETIC FACIAL BLOTTING PAPERS; COSMETIC PADS; COSMETIC PENCILS; COSMETIC PREPARATIONS FOR THE CARE OF MOUTH AND TEETH; COSMETICS; DEPILATORIES; FACIAL CLEANSERS; FACIAL SCRUBS; FRAGRANCES; HAIR CARE PREPARATIONS; HOUSEHOLD CLEANING PREPARATIONS; NAIL CARE PREPARATIONS; NON-MEDICATED BATH PREPARATIONS; NON-MEDICATED LIP CARE PREPARATIONS; NON-MEDICATED SKIN CARE PREPARATIONS; NON-MEDICATED SUN CARE PREPARATIONS; NON-MEDICATED TOILETRIES; PERSONAL DEODORANTS; SCENTED ROOM SPRAYS; SHAVING PREPARATIONS; SHOWER AND BATH GEL (U.S. CLS. 1, 4, 6, 50, 51 AND 52).

JUDITH HELFMAN, EXAMINING ATTORNEY

SN 77-723,708. REVLON CONSUMER PRODUCTS CORPORATION, NEW YORK, NY. FILED 4-28-2009.

ELASTICOLOR

THE MARK CONSISTS OF STANDARD CHARACTERS WITHOUT CLAIM TO ANY PARTICULAR FONT, STYLE, SIZE, OR COLOR.

FOR COSMETICS AND MAKEUP; NAIL CARE PRODUCTS (U.S. CLS. 1, 4, 6, 50, 51 AND 52).

ODESSA BIBBINS, EXAMINING ATTORNEY

SN 77-723,727. GARCOA, INC., CALABASAS, CA. FILED 4-28-2009.

FLUID OF BEAUTY

THE MARK CONSISTS OF STANDARD CHARACTERS WITHOUT CLAIM TO ANY PARTICULAR FONT, STYLE, SIZE, OR COLOR.

NO CLAIM IS MADE TO THE EXCLUSIVE RIGHT TO USE "BEAUTY", APART FROM THE MARK AS SHOWN.

FOR NON-MEDICATED SKIN CARE PREPARATIONS, NAMELY, CREAMS, LOTIONS, GELS, TONERS, CLEANSERS AND PEELS (U.S. CLS. 1, 4, 6, 50, 51 AND 52).

FIRST USE 10-0-1984; IN COMMERCE 10-0-1984. JOHN WILKE, EXAMINING ATTORNEY

CLASS 3—(Continued).

SN 77-723,818. MISSION PRODUCT HOLDINGS, INC., NEW YORK, NY. FILED 4-28-2009.

PROTECT LIKE THE PROS

THE MARK CONSISTS OF STANDARD CHARACTERS WITHOUT CLAIM TO ANY PARTICULAR FONT, STYLE, SIZE, OR COLOR.

FOR COSMETIC CREAMS FOR SKIN CARE; DEODORANT FOR PERSONAL USE; DEODORANTS AND ANTIPERSPIRANTS; DEODORANTS FOR BODY CARE; LOTIONS FOR SKIN; NON-MEDICATED FOOT CREAM; NON-MEDICATED SKIN CARE PREPARATIONS; SKIN CLEANSERS; SKIN MOISTURIZER; SUN BLOCK PREPARATIONS; SUN SCREEN; SUN SCREEN PREPARATIONS; SUN-BLOCK LOTIONS (U.S. CLS. 1, 4, 6, 50, 51 AND 52).

LAURA HAMMEL, EXAMINING ATTORNEY

SN 77-723,926. PIPEDREAM PRODUCTS, INC., CHATSWORTH, CA. FILED 4-28-2009.

PURE SEX

THE MARK CONSISTS OF STANDARD CHARACTERS WITHOUT CLAIM TO ANY PARTICULAR FONT, STYLE, SIZE, OR COLOR.

FOR FRAGRANCES; FRAGRANCES FOR PERSONAL USE (U.S. CLS. 1, 4, 6, 50, 51 AND 52).

FIRST USE 3-25-2009; IN COMMERCE 3-25-2009.
SALLY SHIH, EXAMINING ATTORNEY

SN 77-723,940. ANTHONY FOR MEN, LLC, NEW YORK, NY. FILED 4-28-2009.

ANTHONY FOR LITTLE WOMEN

THE MARK CONSISTS OF STANDARD CHARACTERS WITHOUT CLAIM TO ANY PARTICULAR FONT, STYLE, SIZE, OR COLOR.

OWNER OF U.S. REG. NOS. 3,032,890 AND 3,085,440. FOR BABY SHAMPOO (U.S. CLS. 1, 4, 6, 50, 51 AND 52).

GEORGE LORENZO, EXAMINING ATTORNEY

CLASS 3—(Continued).

SN 77-723,983. I.B.S. BEAUTY, INC., SANTA FE SPRINGS, CA. FILED 4-28-2009.

innosys
BEAUTYCARE IBS

NO CLAIM IS MADE TO THE EXCLUSIVE RIGHT TO USE "BEAUTYCARE", APART FROM THE MARK AS SHOWN.

THE MARK CONSISTS OF STYLIZED WORDS OF "INNOSYS BEAUTYCARE IBS" WITH TWO HORIZONTAL LINES, ONE ON TOP AND THE OTHER ON BOTTOM OF THE LETTERS "INNOSYS".

FOR HAIR CARE CREAMS; HAIR CARE LOTIONS; HAIR CARE PREPARATIONS; NON-MEDICATED HAIR RESTORATION LOTIONS; NON-MEDICATED HAIR TREATMENT PREPARATIONS FOR COSMETIC PURPOSES; NON-MEDICATED PREPARATIONS ALL FOR THE CARE OF SKIN, HAIR AND SCALP (U.S. CLS. 1, 4, 6, 50, 51 AND 52).

CORY BOONE, EXAMINING ATTORNEY

SN 77-724,010. INDULSCENTS, LLC, OSHKOSH, WI. FILED 4-28-2009.

INDULSCENTS

THE MARK CONSISTS OF STANDARD CHARACTERS WITHOUT CLAIM TO ANY PARTICULAR FONT, STYLE, SIZE, OR COLOR.

FOR BODY LOTIONS; FACE AND BODY CREAMS; MASSAGE OILS (U.S. CLS. 1, 4, 6, 50, 51 AND 52).

FIRST USE 4-18-2006; IN COMMERCE 4-18-2006.
LOURDES AYALA, EXAMINING ATTORNEY

CLASS 3—(Continued).

SN 77-724,166. AYCAYIA, LLC, TAMPA, FL. FILED 4-28-2009.



THE MARK CONSISTS OF SIX MERMAIDS IN A CIRCLE DESIGN.

FOR AFTER-SUN LOTIONS; AROMATHERAPY BODY CARE PRODUCTS, NAMELY, BODY LOTION, SHOWER GEL, CUTICLE CREAM, SHAMPOO, CONDITIONER, NON-MEDICATED LIP BALM, SOAP, BODY POLISH, BODY AND FOOT SCRUB AND NON-MEDICATED FOOT CREAM; BAR SOAP; BATH AND SHOWER GELS AND SALTS NOT FOR MEDICAL PURPOSES; BATH CREAM; BATH GEL; BATH GELS; BATH LOTION; BATH SOAPS; BATH SOAPS IN LIQUID, SOLID OR GEL FORM; BATHING LOTIONS; BEAUTY CREAMS; BEAUTY CREAMS FOR BODY CARE; BEAUTY LOTIONS; BODY BUTTER; BODY CREAM; BODY CREAM SOAP; BODY CREAMS; BODY LOTION; BODY LOTIONS; BODY SCRUB; COCOA BUTTER FOR COSMETIC PURPOSES; FACE AND BODY BEAUTY CREAMS; FACE AND BODY CREAMS; FACE AND BODY LOTIONS; FACE MILK AND LOTIONS; FACIAL SCRUBS; HAIR SHAMPOO; HAIR SHAMPOOS AND CONDITIONERS; HAND LOTIONS; LIP BALM; LIP BALM; LIQUID BATH SOAPS; LIQUID SOAP; LIQUID SOAPS; LIQUID SOAPS FOR HANDS, FACE AND BODY; LOTIONS FOR FACE AND BODY CARE; MASSAGE CREAMS; MOISTURIZING CREAMS; NON-MEDICATED LIP BALM THAT DOES NOT CONTAIN BEESWAX; SCENTED BODY LOTIONS AND CREAMS; SHAMPOOS; SHEA BUTTER FOR COSMETIC PURPOSES; SHOWER AND BATH GEL; SHOWER GEL; SHOWER GELS; SKIN AND BODY TOPICAL LOTIONS, CREAMS AND OILS FOR COSMETIC USE; SKIN CARE PREPARATIONS, NAMELY, BODY BALM; SKIN CLEANSING LOTION; SKIN CREAM; SKIN CREAMS; SKIN CREAMS IN LIQUID AND IN SOLID FORM; SKIN CREAMS IN LIQUID AND SOLID; SKIN CREAMS IN LIQUID AND SOLID FORM; SKIN LOTION; SKIN LOTIONS; SKIN SOAP; SOAPS FOR BODY CARE; SOAPS FOR PERSONAL USE; SUN CARE LOTIONS; SUN TAN GEL; SUN TAN LOTION; SUN-BLOCK LOTIONS; SUN-TANNING OILS AND LOTIONS; SUNSCREEN CREAM; SUNSCREEN CREAMS; TANNING AND AFTER-SUN MILKS, GELS AND OILS (U.S. CLS. 1, 4, 6, 50, 51 AND 52).

JOHN E. MICHOS, EXAMINING ATTORNEY

CLASS 3—(Continued).

SN 77-724,328. FAITH, TAMRA, BELTON, TX. FILED 4-28-2009.

Hiney Helpers

THE MARK CONSISTS OF AN UPPER CASE "H" AND LOWER CASE "I, N, E, Y". THE LOWER CASE LETTERS HAVE DOTS AROUND THEM; AN UPPER CASE "H" AND LOWER CASE "E, L, P, E, R, S" ALSO WITH DOTS AROUND THEM.

FOR DISPOSABLE WIPES IMPREGNATED WITH CLEANSING CHEMICALS OR COMPOUNDS FOR PERSONAL HYGIENE (U.S. CLS. 1, 4, 6, 50, 51 AND 52).

NAAKWAMA ANKRAH, EXAMINING ATTORNEY

SN 77-724,904. HAX PHEROCEUTICALS, LLC, TRUMBAUERSVILLE, PA. FILED 4-29-2009.

PHEROCID

THE MARK CONSISTS OF STANDARD CHARACTERS WITHOUT CLAIM TO ANY PARTICULAR FONT, STYLE, SIZE, OR COLOR.

FOR BODY SPRAY USED AS A PERSONAL DEODORANT AND AS FRAGRANCE; DEODORANTS AND ANTIPERSPIRANTS; PERFUMES, AFTERSHAVES AND COLOGNES; SHOWER GEL (U.S. CLS. 1, 4, 6, 50, 51 AND 52).

ALEXANDER L. POWERS, EXAMINING ATTORNEY

SN 77-725,017. THE PROCTER & GAMBLE COMPANY, CINCINNATI, OH. FILED 4-29-2009.

HONEY BE QUICK

THE MARK CONSISTS OF STANDARD CHARACTERS WITHOUT CLAIM TO ANY PARTICULAR FONT, STYLE, SIZE, OR COLOR.

OWNER OF U.S. REG. NO. 3,525,118.

FOR HAIR COLORING PREPARATIONS (U.S. CLS. 1, 4, 6, 50, 51 AND 52).

MATTHEW PAPPAS, EXAMINING ATTORNEY

CLASS 3—(Continued).

SN 77-725,054. THE PROCTER & GAMBLE COMPANY, CINCINNATI, OH. FILED 4-29-2009.

LATTE WHIRL

THE MARK CONSISTS OF STANDARD CHARACTERS WITHOUT CLAIM TO ANY PARTICULAR FONT, STYLE, SIZE, OR COLOR.

OWNER OF U.S. REG. NO. 3,599,300.
FOR HAIR COLORING PREPARATIONS (U.S. CLS. 1, 4, 6, 50, 51 AND 52).
MATTHEW PAPPAS, EXAMINING ATTORNEY

SN 77-725,066. SEPHORA USA, INC., SAN FRANCISCO, CA. FILED 4-29-2009.

KAT VON D SAINT

THE MARK CONSISTS OF STANDARD CHARACTERS WITHOUT CLAIM TO ANY PARTICULAR FONT, STYLE, SIZE, OR COLOR.

OWNER OF U.S. REG. NO. 3,604,028.
THE NAME(S), PORTRAIT(S), AND/OR SIGNATURE(S) SHOWN IN THE MARK IDENTIFIES "KAT VON D", WHOSE CONSENT(S) TO REGISTER IS MADE OF RECORD.

FOR COLOGNES, PERFUMES AND COSMETICS (U.S. CLS. 1, 4, 6, 50, 51 AND 52).
DOUGLAS LEE, EXAMINING ATTORNEY

SN 77-725,078. SEPHORA USA, INC., SAN FRANCISCO, CA. FILED 4-29-2009.

KAT VON D SINNER

THE MARK CONSISTS OF STANDARD CHARACTERS WITHOUT CLAIM TO ANY PARTICULAR FONT, STYLE, SIZE, OR COLOR.

OWNER OF U.S. REG. NO. 3,604,028.
THE NAME(S), PORTRAIT(S), AND/OR SIGNATURE(S) SHOWN IN THE MARK IDENTIFIES "KAT VON D", WHOSE CONSENT(S) TO REGISTER IS MADE OF RECORD.

FOR COLOGNES, PERFUMES AND COSMETICS (U.S. CLS. 1, 4, 6, 50, 51 AND 52).
DOUGLAS LEE, EXAMINING ATTORNEY

CLASS 3—(Continued).

SN 77-725,210. CHANEL, INC., NEW YORK, NY. FILED 4-29-2009.

NOIR OBSCUR

THE MARK CONSISTS OF STANDARD CHARACTERS WITHOUT CLAIM TO ANY PARTICULAR FONT, STYLE, SIZE, OR COLOR.

NO CLAIM IS MADE TO THE EXCLUSIVE RIGHT TO USE "NOIR", APART FROM THE MARK AS SHOWN.
THE ENGLISH TRANSLATION OF "NOIR OBSCUR" IN THE MARK IS OBSCURE BLACK.
FOR COSMETICS (U.S. CLS. 1, 4, 6, 50, 51 AND 52).
LINDA ORNDORFF, EXAMINING ATTORNEY

SN 77-725,268. BC INTERNATIONAL COSMETIC & IMAGE SERVICES, INC., ORLANDO, FL. FILED 4-29-2009.

BEAUTICONTROL ACTION

THE MARK CONSISTS OF STANDARD CHARACTERS WITHOUT CLAIM TO ANY PARTICULAR FONT, STYLE, SIZE, OR COLOR.

OWNER OF U.S. REG. NOS. 1,856,494, 3,480,487 AND OTHERS.
FOR PERFUMERY, DEODORANTS FOR PERSONAL USE, NON-MEDICATED SKIN CARE PREPARATIONS, BATH GEL, BODY SOAPS (U.S. CLS. 1, 4, 6, 50, 51 AND 52).
KEVIN DINALLO, EXAMINING ATTORNEY

SN 77-725,529. BONITA FACE & BODY, LLC, EAST GREENWICH, RI. FILED 4-29-2009.



NO CLAIM IS MADE TO THE EXCLUSIVE RIGHT TO USE "BOTANICALS", APART FROM THE MARK AS SHOWN.

THE MARK CONSISTS OF THE STYLIZED TEXT "BE NATURALLY EMPOWERED B BONITA BOTANICALS BE BEAUTIFUL BE BONITA".

FOR ANTI-AGING CLEANSER; ANTI-AGING MOISTURIZER; ANTI-WRINKLE CREAM; BODY LOTIONS; BODY SCRUB; BODY WASHES; EXFOLIANTS FOR SKIN; EYE CREAM; EYE GELS; FACE AND BODY BEAUTY CREAMS; FACIAL BEAUTY MASKS; FACIAL CLEANSERS; FACIAL MASKS; FACIAL SCRUBS; FACIAL WASHES; HAIR CONDITIONER; HAIR SHAMPOO; LOTIONS FOR FACE AND BODY CARE; SKIN LOTIONS; SKIN MOISTURIZER MASKS; SKIN TONERS; SUN SCREEN (U.S. CLS. 1, 4, 6, 50, 51 AND 52).
DORITT L. CARROLL, EXAMINING ATTORNEY

CLASS 3—(Continued).

SN 77-725,631. RUE 37 LLC, LONG ISLAND CITY, NY.
FILED 4-30-2009.

L'EAU DE VIE PERFUME

THE MARK CONSISTS OF STANDARD CHARACTERS WITHOUT CLAIM TO ANY PARTICULAR FONT, STYLE, SIZE, OR COLOR.

NO CLAIM IS MADE TO THE EXCLUSIVE RIGHT TO USE "PERFUME", APART FROM THE MARK AS SHOWN.

THE ENGLISH TRANSLATION OF "L'EAU DE VIE" IN THE MARK IS "WATER OF LIFE".

FOR EAU DE PARFUM; PERFUME (U.S. CLS. 1, 4, 6, 50, 51 AND 52).

ELLEN B. AWRICH, EXAMINING ATTORNEY

SN 77-725,704. KAO KABUSHIKI KAISHA, TA KAO CORPORATION, CHUO-KU, TOKYO, JAPAN, FILED 4-30-2009.

MELTING DIAMONDS

THE MARK CONSISTS OF STANDARD CHARACTERS WITHOUT CLAIM TO ANY PARTICULAR FONT, STYLE, SIZE, OR COLOR.

FOR HAIR CARE PREPARATIONS (U.S. CLS. 1, 4, 6, 50, 51 AND 52).

DAVID H. STINE, EXAMINING ATTORNEY

SN 77-725,841. COMBE INCORPORATED, WHITE PLAINS, NY. FILED 4-30-2009.

JUST FOR MEN

THE MARK CONSISTS OF STANDARD CHARACTERS WITHOUT CLAIM TO ANY PARTICULAR FONT, STYLE, SIZE, OR COLOR.

OWNER OF U.S. REG. NOS. 1,508,758, 3,171,120 AND OTHERS.

SEC. 2(F).
FOR COSMETICS, NAMELY, SHAMPOOS (U.S. CLS. 1, 4, 6, 50, 51 AND 52).

SAMUEL E. SHARPER JR., EXAMINING ATTORNEY

CLASS 3—(Continued).

SN 77-725,864. PEDERSEN, SCOTT, ITHACA, NY. FILED 4-30-2009.

DASH

THE MARK CONSISTS OF STANDARD CHARACTERS WITHOUT CLAIM TO ANY PARTICULAR FONT, STYLE, SIZE, OR COLOR.

FOR COSMETICS IN GENERAL, INCLUDING PERFUMES (U.S. CLS. 1, 4, 6, 50, 51 AND 52).

PATRICIA EVANKO, EXAMINING ATTORNEY

SN 77-725,970. COMBE INCORPORATED, WHITE PLAINS, NY. FILED 4-30-2009.



OWNER OF U.S. REG. NOS. 1,508,758, 3,171,120 AND OTHERS.

THE MARK CONSISTS OF THE WORDS "JUST FOR MEN" ENCLOSED WITHIN A RECTANGULAR FRAME.

SEC. 2(F).
FOR COSMETICS, NAMELY, SHAMPOOS (U.S. CLS. 1, 4, 6, 50, 51 AND 52).

SAMUEL E. SHARPER JR., EXAMINING ATTORNEY

SN 77-726,133. COMBE INCORPORATED, WHITE PLAINS, NY. FILED 4-30-2009.

VAGISIL

THE MARK CONSISTS OF STANDARD CHARACTERS WITHOUT CLAIM TO ANY PARTICULAR FONT, STYLE, SIZE, OR COLOR.

OWNER OF U.S. REG. NOS. 1,424,503, 2,971,826 AND OTHERS.

FOR NON-MEDICATED WASHCLOTHS INFUSED WITH LATHERING SYNTHETIC DETERGENTS FOR FEMININE USE (U.S. CLS. 1, 4, 6, 50, 51 AND 52).

SAMUEL E. SHARPER JR., EXAMINING ATTORNEY

CLASS 3—(Continued).

SN 77-726,283. HY-VEE, INC., WEST DES MOINES, IA.
FILED 4-30-2009.

Mother's Choice

THE MARK CONSISTS OF STANDARD CHARACTERS
WITHOUT CLAIM TO ANY PARTICULAR FONT, STYLE,
SIZE, OR COLOR.

OWNER OF U.S. REG. NOS. 2,821,158, 3,319,368 AND
OTHERS.

FOR BABY WASH FOR HAIR AND BODY (U.S. CLS. 1,
4, 6, 50, 51 AND 52).

FIRST USE 12-13-2007; IN COMMERCE 12-13-2007.

WANDA KAY PRICE, EXAMINING ATTORNEY

CLASS 3—(Continued).

SN 77-726,445. LAKSILU INC., LOS ANGELES, CA. FILED 4-
30-2009.

365 Days Sexy Women

THE MARK CONSISTS OF STANDARD CHARACTERS
WITHOUT CLAIM TO ANY PARTICULAR FONT, STYLE,
SIZE, OR COLOR.

NO CLAIM IS MADE TO THE EXCLUSIVE RIGHT TO
USE "WOMEN", APART FROM THE MARK AS SHOWN.

FOR BODY LOTIONS; PERFUME; SHOWER GELS
(U.S. CLS. 1, 4, 6, 50, 51 AND 52).

FIRST USE 2-1-2009; IN COMMERCE 2-1-2009.

JAMES STEIN, EXAMINING ATTORNEY

SN 77-726,297. SUPRE, INC., DALLAS, TX. FILED 4-30-2009.

Bronze Persuasion

THE MARK CONSISTS OF STANDARD CHARACTERS
WITHOUT CLAIM TO ANY PARTICULAR FONT, STYLE,
SIZE, OR COLOR.

NO CLAIM IS MADE TO THE EXCLUSIVE RIGHT TO
USE "BRONZE", APART FROM THE MARK AS SHOWN.

FOR INDOOR AND OUTDOOR TANNING PRO-
DUCTS, NAMELY, NON-MEDICATED TAN DARKEN-
ING LOTIONS AND SKIN MOISTURIZERS (U.S. CLS. 1,
4, 6, 50, 51 AND 52).

FIRST USE 2-27-2009; IN COMMERCE 3-15-2009.

SEAN CROWLEY, EXAMINING ATTORNEY

SN 77-727,071. GENOMMA LAB INTERNACIONAL, S.A.B.
DE C.V., C.P., MEXICO, FILED 5-1-2009.

GOICOECHEA

THE MARK CONSISTS OF STANDARD CHARACTERS
WITHOUT CLAIM TO ANY PARTICULAR FONT, STYLE,
SIZE, OR COLOR.

FOR SKIN AND BODY CREAM (U.S. CLS. 1, 4, 6, 50, 51
AND 52).

GEOFFREY FOSDICK, EXAMINING ATTORNEY

SN 77-726,416. LAKSILU INC., LOS ANGELES, CA. FILED 4-
30-2009.

365 Days Sexy Men

THE MARK CONSISTS OF STANDARD CHARACTERS
WITHOUT CLAIM TO ANY PARTICULAR FONT, STYLE,
SIZE, OR COLOR.

NO CLAIM IS MADE TO THE EXCLUSIVE RIGHT TO
USE "MEN", APART FROM THE MARK AS SHOWN.

FOR BODY LOTIONS; PERFUMES AND COLOGNES;
SHOWER GELS (U.S. CLS. 1, 4, 6, 50, 51 AND 52).

FIRST USE 2-1-2009; IN COMMERCE 2-1-2009.

JAMES STEIN, EXAMINING ATTORNEY

SN 77-727,131. GENOMMA LAB INTERNACIONAL, S.A.B.
DE C.V., C.F., MEXICO, FILED 5-1-2009.

MA EVANS

THE MARK CONSISTS OF STANDARD CHARACTERS
WITHOUT CLAIM TO ANY PARTICULAR FONT, STYLE,
SIZE, OR COLOR.

FOR SHAMPOO, HAIR DYES (U.S. CLS. 1, 4, 6, 50, 51
AND 52).

ALICE BENMAMAN, EXAMINING ATTORNEY

CLASS 3—(Continued).

SN 77-727,136. GENOMMA LAB INTERNACIONAL, S.A.B. DE C.V., D.F., MEXICO, FILED 5-1-2009.

MEDICASP

THE MARK CONSISTS OF STANDARD CHARACTERS WITHOUT CLAIM TO ANY PARTICULAR FONT, STYLE, SIZE, OR COLOR.
FOR SHAMPOO (U.S. CLS. 1, 4, 6, 50, 51 AND 52).
ALICE BENMAMAN, EXAMINING ATTORNEY

SN 77-727,656. GORMAN, DAWN M., PITMAN, NJ. FILED 5-2-2009.

Streaking for a Cure

THE MARK CONSISTS OF STANDARD CHARACTERS WITHOUT CLAIM TO ANY PARTICULAR FONT, STYLE, SIZE, OR COLOR.
FOR HAIR COLOURING AND DYES (U.S. CLS. 1, 4, 6, 50, 51 AND 52).
G. MAYERSCHOFF, EXAMINING ATTORNEY

SN 77-728,047. MISSION PRODUCT HOLDINGS, INC., NEW YORK, NY. FILED 5-4-2009.

HAND, BODY AND SOLE

THE MARK CONSISTS OF STANDARD CHARACTERS WITHOUT CLAIM TO ANY PARTICULAR FONT, STYLE, SIZE, OR COLOR.
FOR COSMETIC CREAMS FOR SKIN CARE; DEODORANT FOR PERSONAL USE; DEODORANTS AND ANTIPERSPIRANTS; DEODORANTS FOR BODY CARE; LOTIONS FOR SKIN; NON-MEDICATED FOOT CREAM; NON-MEDICATED SKIN CARE PREPARATIONS; SKIN CLEANSERS; SKIN MOISTURIZER; SUN BLOCK PREPARATIONS; SUN SCREEN; SUN SCREEN PREPARATIONS; SUN-BLOCK LOTIONS (U.S. CLS. 1, 4, 6, 50, 51 AND 52).
LAURA HAMMEL, EXAMINING ATTORNEY

CLASS 3—(Continued).

SN 77-728,288. JEFFREY ALAN DEANE, HOLLYWOOD, CA. FILED 5-4-2009.

WEN HEALTHY HAIR CARE SYSTEM

THE MARK CONSISTS OF STANDARD CHARACTERS WITHOUT CLAIM TO ANY PARTICULAR FONT, STYLE, SIZE, OR COLOR.
OWNER OF U.S. REG. NO. 2,771,105.
NO CLAIM IS MADE TO THE EXCLUSIVE RIGHT TO USE "HEALTHY HAIR CARE SYSTEM", APART FROM THE MARK AS SHOWN.
FOR HAIR CARE PREPARATIONS (U.S. CLS. 1, 4, 6, 50, 51 AND 52).
FIRST USE 11-2-2007; IN COMMERCE 11-2-2007.
MICHAEL SOUDERS, EXAMINING ATTORNEY

SN 77-728,370. RANDALL PRODUCTIONS COMPANY, CLEVELAND, OH. FILED 5-4-2009.

UNBRIDLED

THE MARK CONSISTS OF STANDARD CHARACTERS WITHOUT CLAIM TO ANY PARTICULAR FONT, STYLE, SIZE, OR COLOR.
FOR PERFUMES, COLOGNES, EAU DE TOILETTE, SOAPS, COSMETICS, BATH SALTS, PERFUME OILS, BATH AND SHOWER GEL, BATH POWDER, SCENTED BODY SPRAY, TOILET WATER, GELS, FOAMS AND SALTS FOR THE BATH AND SHOWER, SHAVING FOAMS AND CREAMS; SHAMPOOS, CONDITIONERS, HAIR CARE PREPARATIONS, DEODORANTS, SKIN LOTIONS, ESSENTIAL OILS, SKIN CREAMS, SKIN TONERS (U.S. CLS. 1, 4, 6, 50, 51 AND 52).
FIRST USE 2-15-2009; IN COMMERCE 2-15-2009.
SUE LAWRENCE, EXAMINING ATTORNEY

SN 77-728,461. REVLON CONSUMER PRODUCTS CORPORATION, NEW YORK, NY. FILED 5-4-2009.

CLINICAL PLUS

THE MARK CONSISTS OF STANDARD CHARACTERS WITHOUT CLAIM TO ANY PARTICULAR FONT, STYLE, SIZE, OR COLOR.
NO CLAIM IS MADE TO THE EXCLUSIVE RIGHT TO USE "CLINICAL", APART FROM THE MARK AS SHOWN.
FOR ANTIPERSPIRANTS AND DEODORANTS FOR PERSONAL USE; BODY SPRAY USED AS A PERSONAL DEODORANT AND AS FRAGRANCE; DEODORANTS AND ANTIPERSPIRANTS (U.S. CLS. 1, 4, 6, 50, 51 AND 52).
ODESSA BIBBINS, EXAMINING ATTORNEY

CLASS 3—(Continued).

SN 77-728,474. REVLON CONSUMER PRODUCTS CORPORATION, NEW YORK, NY. FILED 5-4-2009.

SMART SOLID CLINICAL PLUS

THE MARK CONSISTS OF STANDARD CHARACTERS WITHOUT CLAIM TO ANY PARTICULAR FONT, STYLE, SIZE, OR COLOR.

NO CLAIM IS MADE TO THE EXCLUSIVE RIGHT TO USE "SOLID" "CLINICAL" APART FROM THE MARK AS SHOWN. ("SOLID" LIMITED TO GOODS: ANTIPERSPIRANTS AND DEODORANTS FOR PERSONAL USE; AND DEODORANTS AND ANTIPERSPIRANTS), APART FROM THE MARK AS SHOWN.

FOR ANTIPERSPIRANTS AND DEODORANTS FOR PERSONAL USE; BODY SPRAY USED AS A PERSONAL DEODORANT AND AS FRAGRANCE; DEODORANTS AND ANTIPERSPIRANTS (U.S. CLS. 1, 4, 6, 50, 51 AND 52).

ODESSA BIBBINS, EXAMINING ATTORNEY

SN 77-728,500. REVLON CONSUMER PRODUCTS CORPORATION, NEW YORK, NY. FILED 5-4-2009.

CLINICAL PERFORMANCE

THE MARK CONSISTS OF STANDARD CHARACTERS WITHOUT CLAIM TO ANY PARTICULAR FONT, STYLE, SIZE, OR COLOR.

NO CLAIM IS MADE TO THE EXCLUSIVE RIGHT TO USE "CLINICAL". APART FROM THE MARK AS SHOWN.

FOR ANTIPERSPIRANTS AND DEODORANTS FOR PERSONAL USE; BODY SPRAY USED AS A PERSONAL DEODORANT AND AS FRAGRANCE; DEODORANTS AND ANTIPERSPIRANTS (U.S. CLS. 1, 4, 6, 50, 51 AND 52).

ODESSA BIBBINS, EXAMINING ATTORNEY

SN 77-728,508. BULLY, LLC, CHICAGO, IL. FILED 5-4-2009.

Lock & Loaded

THE MARK CONSISTS OF STANDARD CHARACTERS WITHOUT CLAIM TO ANY PARTICULAR FONT, STYLE, SIZE, OR COLOR.

FOR HAIR SHAMPOOS AND CONDITIONERS; HAIR SPRAYS AND HAIR GELS; HAIR STYLING FIXATIVE IN THE NATURE OF HAIR WAX; HAIR STYLING GEL; HAIR STYLING PREPARATIONS (U.S. CLS. 1, 4, 6, 50, 51 AND 52).

MARK T. MULLEN, EXAMINING ATTORNEY

CLASS 3—(Continued).

SN 77-728,515. REVLON CONSUMER PRODUCTS CORPORATION, NEW YORK, NY. FILED 5-4-2009.

SMART SOLID CLINICAL PERFORMANCE

THE MARK CONSISTS OF STANDARD CHARACTERS WITHOUT CLAIM TO ANY PARTICULAR FONT, STYLE, SIZE, OR COLOR.

NO CLAIM IS MADE TO THE EXCLUSIVE RIGHT TO USE "SOLID" "CLINICAL" - ("SOLID" LIMITED TO THE GOODS: ANTIPERSPIRANTS AND DEODORANTS FOR PERSONAL USE; DEODORANTS AND ANTIPERSPIRANTS), APART FROM THE MARK AS SHOWN.

FOR ANTIPERSPIRANTS AND DEODORANTS FOR PERSONAL USE; BODY SPRAY USED AS A PERSONAL DEODORANT AND AS FRAGRANCE; DEODORANTS AND ANTIPERSPIRANTS (U.S. CLS. 1, 4, 6, 50, 51 AND 52).

ODESSA BIBBINS, EXAMINING ATTORNEY

SN 77-729,229. THE PROCTER & GAMBLE COMPANY, CINCINNATI, OH. FILED 5-5-2009.

FRESH MEADOW

THE MARK CONSISTS OF STANDARD CHARACTERS WITHOUT CLAIM TO ANY PARTICULAR FONT, STYLE, SIZE, OR COLOR.

FOR PERSONAL DEODORANTS (U.S. CLS. 1, 4, 6, 50, 51 AND 52).

MATTHEW PAPPAS, EXAMINING ATTORNEY

CLASS 3—(Continued).

SN 77-729,659. KATHARINE LHEUREUX, NEW YORK, NY.
FILED 5-5-2009.

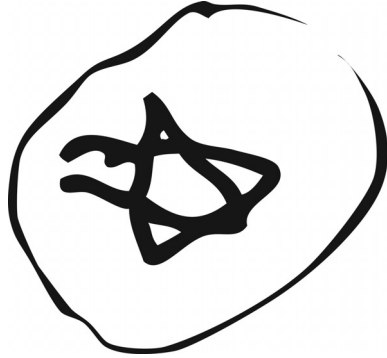

THE MARK CONSISTS OF A HANDWRITTEN STAR IN A CIRCLE.

FOR EYE SERUM; FACIAL MASKS; SOAP AND LIP BALM; NON-MEDICATED SKIN CARE PREPARATIONS, NAMELY, CLEANSERS, LOTIONS, OILS AND SERUMS; FACIAL CLEANSER; FACIAL LOTION; PURE COSMETIC OIL FOR FACE AND BODY; FACIAL SERUM (U.S. CLS. 1, 4, 6, 50, 51 AND 52).

FIRST USE 3-2-2009; IN COMMERCE 3-3-2009.
LAKEISHA LEWIS, EXAMINING ATTORNEY

SN 77-729,774. DISNEY ENTERPRISES, INC., BURBANK, CA. FILED 5-5-2009.

TOY STORY

THE MARK CONSISTS OF STANDARD CHARACTERS WITHOUT CLAIM TO ANY PARTICULAR FONT, STYLE, SIZE, OR COLOR.

FOR COSMETICS; DENTIFRICES; NON-MEDICATED TOILETRIES; FRAGRANCES FOR PERSONAL USE; ROOM FRAGRANCES (U.S. CLS. 1, 4, 6, 50, 51 AND 52).
CHRISIE B. KING, EXAMINING ATTORNEY

SN 77-730,249. CHURCH & DWIGHT CO., INC., PRINCETON, NJ. FILED 5-6-2009.

CALYPSO FRESH

THE MARK CONSISTS OF STANDARD CHARACTERS WITHOUT CLAIM TO ANY PARTICULAR FONT, STYLE, SIZE, OR COLOR.

FOR FABRIC SOFTENERS; LAUNDRY DETERGENTS (U.S. CLS. 1, 4, 6, 50, 51 AND 52).
MICHAEL KEATING, EXAMINING ATTORNEY

CLASS 3—(Continued).

SN 77-730,263. CHURCH & DWIGHT CO., INC., PRINCETON, NJ. FILED 5-6-2009.

SUMMER FIESTA

THE MARK CONSISTS OF STANDARD CHARACTERS WITHOUT CLAIM TO ANY PARTICULAR FONT, STYLE, SIZE, OR COLOR.

FOR FABRIC SOFTENERS; LAUNDRY DETERGENTS (U.S. CLS. 1, 4, 6, 50, 51 AND 52).

MICHAEL KEATING, EXAMINING ATTORNEY

SN 77-731,253. MISSION PRODUCT HOLDINGS, INC., NEW YORK, NY. FILED 5-7-2009.

SPORTIFIED

THE MARK CONSISTS OF STANDARD CHARACTERS WITHOUT CLAIM TO ANY PARTICULAR FONT, STYLE, SIZE, OR COLOR.

FOR COSMETIC CREAMS FOR SKIN CARE; DEODORANT FOR PERSONAL USE; DEODORANTS AND ANTIPERSPIRANTS; DEODORANTS FOR BODY CARE; LOTIONS FOR SKIN; NON-MEDICATED FOOT CREAM; NON-MEDICATED SKIN CARE PREPARATIONS; SKIN CLEANSERS; SKIN MOISTURIZER; SUN BLOCK PREPARATIONS; SUN SCREEN; SUN SCREEN PREPARATIONS; SUN-BLOCK LOTIONS (U.S. CLS. 1, 4, 6, 50, 51 AND 52).

LAURA HAMMEL, EXAMINING ATTORNEY

SN 77-734,530. EVEREADY BATTERY COMPANY, INC., ST. LOUIS, MO. FILED 5-12-2009.

EDGE ECLIPSE

THE MARK CONSISTS OF STANDARD CHARACTERS WITHOUT CLAIM TO ANY PARTICULAR FONT, STYLE, SIZE, OR COLOR.

OWNER OF U.S. REG. NOS. 897,059, 2,725,689 AND OTHERS.

FOR SHAVING GEL (U.S. CLS. 1, 4, 6, 50, 51 AND 52).
FIRST USE 1-18-2008; IN COMMERCE 1-18-2008.

AISHA SALEM, EXAMINING ATTORNEY

CLASS 3—(Continued).

SN 77-734,972. MOSHE INC, DBA SCENT-SATION, LOS ANGELES, CA. FILED 5-12-2009.

Passe

THE MARK CONSISTS OF STANDARD CHARACTERS WITHOUT CLAIM TO ANY PARTICULAR FONT, STYLE, SIZE, OR COLOR.

THE ENGLISH TRANSLATION OF "PASSE" IN THE MARK IS PAST OR OLD FASHIONED.

FOR COLOGNES, PERFUMES AND COSMETICS; COSMETICS IN GENERAL, INCLUDING PERFUMES; DISINFECTING PERFUMED SOAPS; EAU DE PERFUME; ESSENTIAL OILS AS PERFUME FOR LAUNDRY PURPOSES; LIQUID PERFUMES; OILS FOR PERFUMES AND SCENTS; PERFUME; PERFUME OILS; PERFUME OILS FOR THE MANUFACTURE OF COSMETIC PREPARATIONS; PERFUMED CREAMS; PERFUMED EXTRACTS FOR TISSUES AND PERFUMES; PERFUMED PASTE; PERFUMED POWDER; PERFUMED POWDERS; PERFUMED SOAP; PERFUMED SOAPS; PERFUMED TALCUM POWDER; PERFUMES; PERFUMES AND COLOGNES; PERFUMES AND TOILET WATERS; PERFUMES FOR INDUSTRIAL PURPOSES; PERFUMES, AFTERSHAVES AND COLOGNES; PERFUMES, EAU DE COLOGNES AND AFTERSHAVES; PERFUMES, EAUX DE COLOGNE AND AFTERSHAVES; PERFUMING SACHETS (U.S. CLS. 1, 4, 6, 50, 51 AND 52).
FIRST USE 5-12-2009; IN COMMERCE 5-12-2009.
BARBARA A. GOLD, EXAMINING ATTORNEY

CLASS 3—(Continued).

SN 77-738,048. SCHERING-PLOUGH HEALTHCARE PRODUCTS, INC., MEMPHIS, TN. FILED 5-15-2009.



NO CLAIM IS MADE TO THE EXCLUSIVE RIGHT TO USE "FACES", APART FROM THE MARK AS SHOWN. THE MARK CONSISTS OF THE WORD "FACES" WITH A FANCIFUL SUN DESIGN ABOVE IT.

FOR SUN BLOCK PREPARATIONS; SUN SCREEN PREPARATIONS (U.S. CLS. 1, 4, 6, 50, 51 AND 52).
KIM MONINGHOFF, EXAMINING ATTORNEY

SN 77-738,200. THE PROCTER & GAMBLE COMPANY, CINCINNATI, OH. FILED 5-15-2009.

SN 77-735,763. SPARITUAL, LLC, VAN NUYS, CA. FILED 5-13-2009.



SOLE MATE

THE MARK CONSISTS OF STANDARD CHARACTERS WITHOUT CLAIM TO ANY PARTICULAR FONT, STYLE, SIZE, OR COLOR.

FOR SKIN CARE PREPARATIONS, NAMELY, FOOT BALM (U.S. CLS. 1, 4, 6, 50, 51 AND 52).
PRISCILLA MILTON, EXAMINING ATTORNEY

THE STIPPLING IS FOR SHADING PURPOSES ONLY. THE MARK CONSISTS OF A TWISTED RIBBON-LIKE DESIGN APPLIED TO THE PACKAGING FOR THE GOODS. THE MATTER SHOWN BY THE BROKEN LINES IS NOT PART OF THE MARK. IT SERVES ONLY TO SHOW THE POSITION OF THE MARK ON THE PACKAGING FOR THE GOODS.

FOR HAIR COLORING PREPARATIONS (U.S. CLS. 1, 4, 6, 50, 51 AND 52).
MATTHEW PAPPAS, EXAMINING ATTORNEY

CLASS 3—(Continued).

SN 77-740,848. CHURCH & DWIGHT CO., INC., PRINCETON, NJ. FILED 5-20-2009.

CLASS 3—(Continued).

SN 77-745,524. MOSHE INC, DBA SCENT-SATION, LOS ANGELES, CA. FILED 5-27-2009.

ARM & HAMMER

THE MARK CONSISTS OF STANDARD CHARACTERS WITHOUT CLAIM TO ANY PARTICULAR FONT, STYLE, SIZE, OR COLOR.

OWNER OF U.S. REG. NOS. 930,654, 2,678,903 AND OTHERS.

FOR DENTIFRICES, NAMELY, TOOTHPASTE, TOOTH GELS AND PREPARATIONS FOR WHITENING TEETH (U.S. CLS. 1, 4, 6, 50, 51 AND 52).

FIRST USE 7-31-1984; IN COMMERCE 7-31-1984.
MICHAEL KEATING, EXAMINING ATTORNEY

SN 77-742,745. CHURCH & DWIGHT CO., INC., PRINCETON, NJ. FILED 5-22-2009.

Adulation

MENTADENT

THE MARK CONSISTS OF STANDARD CHARACTERS WITHOUT CLAIM TO ANY PARTICULAR FONT, STYLE, SIZE, OR COLOR.

OWNER OF U.S. REG. NOS. 1,827,994 AND 1,832,568.

FOR TEETH WHITENING KIT, COMPRISING OF TOOTHPASTE AND TOOTH POLISH; TEETH WHITENING PREPARATIONS (U.S. CLS. 1, 4, 6, 50, 51 AND 52).

FIRST USE 2-0-2009; IN COMMERCE 2-0-2009.
MICHAEL KEATING, EXAMINING ATTORNEY

SN 77-742,749. CHURCH & DWIGHT CO., INC., PRINCETON, NJ. FILED 5-22-2009.

MENTADENT

THE MARK CONSISTS OF STANDARD CHARACTERS WITHOUT CLAIM TO ANY PARTICULAR FONT, STYLE, SIZE, OR COLOR.

OWNER OF U.S. REG. NOS. 1,827,994 AND 1,832,568.

FOR MOUTHWASH (U.S. CLS. 1, 4, 6, 50, 51 AND 52).

MICHAEL KEATING, EXAMINING ATTORNEY

THE MARK CONSISTS OF STANDARD CHARACTERS WITHOUT CLAIM TO ANY PARTICULAR FONT, STYLE, SIZE, OR COLOR.

FOR COLOGNES, PERFUMES AND COSMETICS; COSMETICS IN GENERAL, INCLUDING PERFUMES; DISINFECTING PERFUMED SOAPS; EAU DE PERFUME; ESSENTIAL OILS AS PERFUME FOR LAUNDRY PURPOSES; LIQUID PERFUMES; OILS FOR PERFUMES AND SCENTS; PERFUME; PERFUME OILS; PERFUME OILS FOR THE MANUFACTURE OF COSMETIC PREPARATIONS; PERFUMED CREAMS; PERFUMED EXTRACTS FOR TISSUES AND PERFUMES; PERFUMED PASTE; PERFUMED POWDER; PERFUMED POWDERS; PERFUMED SOAP; PERFUMED SOAPS; PERFUMED TALCUM POWDER; PERFUMES; PERFUMES AND COLOGNES; PERFUMES AND TOILET WATERS; PERFUMES FOR INDUSTRIAL PURPOSES; PERFUMES, AFTERSHAVES AND COLOGNES; PERFUMES, EAU DE COLOGNE AND AFTERSHAVES; PERFUMES, EAUX DE COLOGNE AND AFTERSHAVES; PERFUMING SACHETS (U.S. CLS. 1, 4, 6, 50, 51 AND 52).

FIRST USE 5-27-2009; IN COMMERCE 5-27-2009.
BARBARA A. GOLD, EXAMINING ATTORNEY

CLASS 3—(Continued).

SN 77-747,189. REJUVEN8 LABORATORIES, INC., MISSISSAUGA, ONTARIO, CANADA, FILED 5-29-2009.

GREEN ECO GLO

THE MARK CONSISTS OF STANDARD CHARACTERS WITHOUT CLAIM TO ANY PARTICULAR FONT, STYLE, SIZE, OR COLOR.

NO CLAIM IS MADE TO THE EXCLUSIVE RIGHT TO USE "GREEN", APART FROM THE MARK AS SHOWN.

FOR AROMATHERAPY BODY CARE PRODUCTS, NAMELY, BODY LOTION, SHOWER GEL, CUTICLE CREAM, SHAMPOO, CONDITIONER, NON-MEDICATED LIP BALM, SOAP, BODY POLISH, BODY AND FOOT SCRUB AND NON-MEDICATED FOOT CREAM; BEAUTY BEVERAGES, NAMELY, FRUIT JUICES AND ENERGY DRINK CONTAINING NUTRITIONAL SUPPLEMENTS, VITAMIN AND MINERAL SUPPLEMENTS, NUTRITIONAL ADDITIVES FOR USE IN FOODS AND DIETARY SUPPLEMENTS FOR HUMAN CONSUMPTION, PLANT AND HERB EXTRACTS FOR COSMETIC PURPOSES AND MADE AVAILABLE THROUGH HEALTH CARE AND BEAUTY PRODUCT CATEGORIES; BUFFING COMPOUND FOR WOOD, LEATHER, GLASS, PLASTIC; COSMETIC PRODUCTS IN THE FORM OF AEROSOLS FOR SKIN CARE; COSMETIC PRODUCTS IN THE FORM OF AEROSOLS FOR SKINCARE; DECALCIFYING AND DESCALING PREPARATIONS FOR CLEANING HOUSEHOLD PRODUCTS; ESSENTIAL OILS FOR USE IN MANUFACTURING OF NATURAL PRODUCTS; ESSENTIAL OILS FOR USE IN THE MANUFACTURE OF SCENTED PRODUCTS; HAIR PRODUCTS, NAMELY, THICKENING CONTROL CREAMS; NAIL GROOMING PRODUCTS, NAMELY, TIPS, GLUE, LACQUER AND GLITTER; NATURAL ESSENTIAL OILS; NATURAL MINERAL MAKE-UP; SHAVING SPRITZ IN THE NATURE OF A MOISTURIZING SOLUTION FOR SHAVING; SKIN CARE PRODUCTS, NAMELY, NON-MEDICATED SKIN SERUM (U.S. CLS. 1, 4, 6, 50, 51 AND 52).
KATHLEEN M. VANSTON, EXAMINING ATTORNEY

SN 77-747,212. MEIJER, INC., GRAND RAPIDS, MI. FILED 5-29-2009.

Meijer Elements

THE MARK CONSISTS OF STANDARD CHARACTERS WITHOUT CLAIM TO ANY PARTICULAR FONT, STYLE, SIZE, OR COLOR.

OWNER OF U.S. REG. NOS. 1,192,121, 1,987,970 AND OTHERS.

FOR AFTER-SHAVE CREAMS; AFTER-SHAVE GEL; AFTER-SHAVE LOTIONS; AFTERSHAVE; ANTIPERSPIRANTS AND DEODORANTS FOR PERSONAL USE; BODY WASHES; COSMETIC CREAMS FOR SKIN CARE; HAIR GELS; HAIR SHAMPOOS AND CONDITIONERS; HAND LOTIONS; LOTIONS FOR FACE AND BODY CARE; SHOWER GELS (U.S. CLS. 1, 4, 6, 50, 51 AND 52).
HENRY S. ZAK, EXAMINING ATTORNEY

CLASS 3—(Continued).

SN 77-747,312. BC INTERNATIONAL COSMETIC & IMAGE SERVICES, INC., ORLANDO, FL. FILED 5-29-2009.



OWNER OF U.S. REG. NOS. 1,856,494, 3,491,500 AND OTHERS.

NO CLAIM IS MADE TO THE EXCLUSIVE RIGHT TO USE "BEAUTY", APART FROM THE MARK AS SHOWN.

THE MARK CONSISTS OF A STYLIZED CHECKERED WALLPAPER PATTERN COMPRISING ALTERNATING LIGHT AND DARK "BC" DESIGNS. CENTERED WITHIN THE WALLPAPER IS "BEAUTY" IN A STYLIZED FONT, AND CENTERED ALONG THE BOTTOM EDGE OF THE WALLPAPER IS "BEAUTICONTROL" IN A STYLIZED FONT.

FOR PERFUMERY, NON-MEDICATED SKIN CARE PREPARATIONS (U.S. CLS. 1, 4, 6, 50, 51 AND 52).
KEVIN DINALLO, EXAMINING ATTORNEY

SN 77-755,994. SCHERING-PLOUGH HEALTHCARE PRODUCTS, INC., MEMPHIS, TN. FILED 6-10-2009.



OWNER OF U.S. REG. NOS. 693,601, 2,269,309 AND OTHERS.

THE COLOR(S) PINK, WHITE, YELLOW, BLUE, LIGHT BLUE, PURPLE, BROWN, BEIGE, LIGHT TAN IS/ARE CLAIMED AS A FEATURE OF THE MARK.

THE MARK CONSISTS OF A PINK AND WHITE SKY WITH BLUE AND LIGHT BLUE WATER IN THE DISTANCE AND PINK AND WHITE SAND THAT HAS LIGHT TAN SPECKLES ON IT IN THE FOREGROUND. THERE IS A LIGHT BLUE BEACH TOWEL ON THE SAND WITH A BROWN AND WHITE TEDDY BEAR ON IT. THERE IS AN UMBRELLA ON THE SAND OUTLINED IN BROWN WITH A BROWN POLE. THE MATERIAL OF THE UMBRELLA IS PURPLE, BLUE AND YELLOW. THERE IS A GIRL AND DOG STANDING ON THE SAND. THE GIRL IS BEIGE WITH BLUE AND WHITE SHORTS, YELLOW HAIR, BLUE BOWS, BLUE AND WHITE EYES, AND BROWN OUTLINING. THE DOG IS BROWN WITH WHITE SHADING.

FOR SUN BLOCK PREPARATIONS; SUN SCREEN PREPARATIONS (U.S. CLS. 1, 4, 6, 50, 51 AND 52).
KIM MONINGHOFF, EXAMINING ATTORNEY

CLASS 3—(Continued).

SN 77-755,995. SCHERING-PLOUGH HEALTHCARE PRODUCTS, INC., MEMPHIS, TN. FILED 6-10-2009.



OWNER OF U.S. REG. NOS. 693,601, 2,269,309 AND OTHERS.

THE COLOR(S) PINK, WHITE, BLUE, LIGHT BLUE, YELLOW, PURPLE, BEIGE, BROWN, LIGHT TAN IS/ARE CLAIMED AS A FEATURE OF THE MARK IS/ARE CLAIMED AS A FEATURE OF THE MARK.

THE MARK CONSISTS OF A PINK SKY WITH BLUE AND LIGHT BLUE WATER IN THE DISTANCE AND PINK AND WHITE SAND IN THE FOREGROUND. THERE IS A SHORT WAVY BROWN LINE ON THE SAND. THERE IS A LIGHT BLUE BEACH TOWEL ON THE SAND WITH A BROWN AND WHITE TEDDY BEAR ON IT. THERE IS AN UMBRELLA ON THE SAND OUTLINED IN BROWN WITH A BROWN POLE. THE MATERIAL OF THE UMBRELLA IS PURPLE, BLUE AND YELLOW. THERE IS A GIRL AND DOG STANDING ON THE SAND. THE GIRL IS BEIGE WITH BLUE AND WHITE SHORTS, YELLOW HAIR, BLUE BOWS, BLUE AND WHITE EYES, AND BROWN OUTLINING. THE DOG IS BROWN WITH WHITE SHADING. THERE IS A PINK PAIL WITH A BROWN OUTLINE ON THE SAND. THERE IS LIGHT TAN SAND IN THE BUCKET WITH A BROWN SAND SHOVEL IN IT.

FOR SUN BLOCK PREPARATIONS; SUN SCREEN PREPARATIONS (U.S. CLS. 1, 4, 6, 50, 51 AND 52).

KIM MONINGHOFF, EXAMINING ATTORNEY

CLASS 3—(Continued).

SN 77-759,868. FARRAGO LABS, COLDSTREAM, CANADA, FILED 6-15-2009.

NÜFRESH

THE MARK CONSISTS OF STANDARD CHARACTERS WITHOUT CLAIM TO ANY PARTICULAR FONT, STYLE, SIZE, OR COLOR.

FOR NON-MEDICATED DENTAL RINSE; NON-MEDICATED MOUTH RINSE; NON-MEDICATED MOUTH WASH AND RINSE (U.S. CLS. 1, 4, 6, 50, 51 AND 52).

FIRST USE 5-1-2009; IN COMMERCE 6-1-2009.

JOHN WILKE, EXAMINING ATTORNEY

SN 77-757,391. L'OREAL USA CREATIVE, INC., NEW YORK, NY. FILED 6-11-2009.

NATURE'S DETOX

THE MARK CONSISTS OF STANDARD CHARACTERS WITHOUT CLAIM TO ANY PARTICULAR FONT, STYLE, SIZE, OR COLOR.

NO CLAIM IS MADE TO THE EXCLUSIVE RIGHT TO USE "DETOX", APART FROM THE MARK AS SHOWN.

FOR HAIR CARE PREPARATIONS (U.S. CLS. 1, 4, 6, 50, 51 AND 52).

JOHN HWANG, EXAMINING ATTORNEY

SN 77-758,167. PARIS PRESENTS INCORPORATED, GURNEE, IL. FILED 6-12-2009.

REFRESH YOUR WORLD

THE MARK CONSISTS OF STANDARD CHARACTERS WITHOUT CLAIM TO ANY PARTICULAR FONT, STYLE, SIZE, OR COLOR.

FOR SCENTED BODY SPRAY (U.S. CLS. 1, 4, 6, 50, 51 AND 52).

JENNIFER VASQUEZ, EXAMINING ATTORNEY

SN 77-760,148. MOSHE INC, DBA SCENT-SATION, LOS ANGELES, CA. FILED 6-15-2009.

Amon

THE MARK CONSISTS OF STANDARD CHARACTERS WITHOUT CLAIM TO ANY PARTICULAR FONT, STYLE, SIZE, OR COLOR.

FOR COLOGNES, PERFUMES AND COSMETICS; COSMETICS IN GENERAL, INCLUDING PERFUMES; DISINFECTING PERFUMED SOAPS; EAU DE PERFUME; ESSENTIAL OILS AS PERFUME FOR LAUNDRY PURPOSES; LIQUID PERFUMES; OILS FOR PERFUMES AND SCENTS; PERFUME; PERFUME OILS; PERFUME OILS FOR THE MANUFACTURE OF COSMETIC PREPARATIONS; PERFUMED CREAMS; PERFUMED EXTRACTS FOR TISSUES AND PERFUMES; PERFUMED PASTE; PERFUMED POWDER; PERFUMED POWDERS; PERFUMED SOAP; PERFUMED SOAPS; PERFUMED TALCUM POWDER; PERFUMES; PERFUMES AND COLOGNES; PERFUMES AND TOILET WATERS; PERFUMES FOR INDUSTRIAL PURPOSES; PERFUMES IN SOLID FORM; PERFUMES, AFTERSHAVES AND COLOGNES; PERFUMES, EAU DE COLOGNES AND AFTERSHAVES; PERFUMES, EAUX DE COLOGNE AND AFTERSHAVES; PERFUMING SACHETS (U.S. CLS. 1, 4, 6, 50, 51 AND 52).

FIRST USE 6-15-2009; IN COMMERCE 6-15-2009.

BARBARA A. GOLD, EXAMINING ATTORNEY

CLASS 3—(Continued).

SN 77-760,162. MOSHE INC, DBA SCENT-SATION, LOS ANGELES, CA. FILED 6-15-2009.

Telenovela

THE MARK CONSISTS OF STANDARD CHARACTERS WITHOUT CLAIM TO ANY PARTICULAR FONT, STYLE, SIZE, OR COLOR.

THE ENGLISH TRANSLATION OF "TELENOVELA" IN THE MARK IS "A MELODRAMATIC SERIALIZED SOAP OPERA TYPE FICTION PRODUCED AND AIRED ON TELEVISION IN MOST LATIN AMERICAN COUNTRIES."

FOR COLOGNES, PERFUMES AND COSMETICS; COSMETICS IN GENERAL, INCLUDING PERFUMES; DISINFECTING PERFUMED SOAPS; EAU DE PERFUME; ESSENTIAL OILS AS PERFUME FOR LAUNDRY PURPOSES; LIQUID PERFUMES; OILS FOR PERFUMES AND SCENTS; PERFUME; PERFUME OILS; PERFUME OILS FOR THE MANUFACTURE OF COSMETIC PREPARATIONS; PERFUMED CREAMS; PERFUMED EXTRACTS FOR TISSUES AND PERFUMES; PERFUMED PASTE; PERFUMED POWDER; PERFUMED POWDERS; PERFUMED SOAP; PERFUMED SOAPS; PERFUMED TALCUM POWDER; PERFUMES; PERFUMES AND COLOGNES; PERFUMES AND TOILET WATERS; PERFUMES FOR INDUSTRIAL PURPOSES; PERFUMES IN SOLID FORM; PERFUMES, AFTERSHAVES AND COLOGNES; PERFUMES, EAU DE COLOGNES AND AFTERSHAVES; PERFUMES, EAUX DE COLOGNE AND AFTERSHAVES; PERFUMING SACHETS (U.S. CLS. 1, 4, 6, 50, 51 AND 52).

FIRST USE 6-15-2009; IN COMMERCE 6-15-2009.
BARBARA A. GOLD, EXAMINING ATTORNEY

SN 77-760,186. MOSHE INC, DBA SCENT-SATION, LOS ANGELES, CA. FILED 6-15-2009.

Hieros Gamos

THE MARK CONSISTS OF STANDARD CHARACTERS WITHOUT CLAIM TO ANY PARTICULAR FONT, STYLE, SIZE, OR COLOR.

THE GREEK WORDING "HIEROS GAMOS" MEANS "HOLY MATRIMONY" IN ENGLISH.

FOR COLOGNES, PERFUMES AND COSMETICS; COSMETICS IN GENERAL, INCLUDING PERFUMES; DISINFECTING PERFUMED SOAPS; EAU DE PERFUME; ESSENTIAL OILS AS PERFUME FOR LAUNDRY PURPOSES; LIQUID PERFUMES; OILS FOR PERFUMES AND SCENTS; PERFUME; PERFUME OILS; PERFUME OILS FOR THE MANUFACTURE OF COSMETIC PREPARATIONS; PERFUMED CREAMS; PERFUMED EXTRACTS FOR TISSUES AND PERFUMES; PERFUMED PASTE; PERFUMED POWDER; PERFUMED POWDERS; PERFUMED SOAP; PERFUMED SOAPS; PERFUMED TALCUM POWDER; PERFUMES; PERFUMES AND COLOGNES; PERFUMES AND TOILET WATERS; PERFUMES FOR INDUSTRIAL PURPOSES; PERFUMES IN SOLID FORM; PERFUMES, AFTERSHAVES AND COLOGNES; PERFUMES, EAU DE COLOGNES AND AFTERSHAVES; PERFUMES, EAUX DE COLOGNE AND AFTERSHAVES; PERFUMING SACHETS (U.S. CLS. 1, 4, 6, 50, 51 AND 52).

FIRST USE 6-15-2009; IN COMMERCE 6-15-2009.
BARBARA A. GOLD, EXAMINING ATTORNEY

CLASS 3—(Continued).

SN 77-760,196. MOSHE INC, DBA SCENT-SATION, LOS ANGELES, CA. FILED 6-15-2009.

Anagram

THE MARK CONSISTS OF STANDARD CHARACTERS WITHOUT CLAIM TO ANY PARTICULAR FONT, STYLE, SIZE, OR COLOR.

FOR COLOGNES, PERFUMES AND COSMETICS; COSMETICS IN GENERAL, INCLUDING PERFUMES; DISINFECTING PERFUMED SOAPS; EAU DE PERFUME; ESSENTIAL OILS AS PERFUME FOR LAUNDRY PURPOSES; LIQUID PERFUMES; OILS FOR PERFUMES AND SCENTS; PERFUME; PERFUME OILS; PERFUME OILS FOR THE MANUFACTURE OF COSMETIC PREPARATIONS; PERFUMED CREAMS; PERFUMED EXTRACTS FOR TISSUES AND PERFUMES; PERFUMED PASTE; PERFUMED POWDER; PERFUMED POWDERS; PERFUMED SOAP; PERFUMED SOAPS; PERFUMED TALCUM POWDER; PERFUMES; PERFUMES AND COLOGNES; PERFUMES AND TOILET WATERS; PERFUMES FOR INDUSTRIAL PURPOSES; PERFUMES IN SOLID FORM; PERFUMES, AFTERSHAVES AND COLOGNES; PERFUMES, EAU DE COLOGNES AND AFTERSHAVES; PERFUMES, EAUX DE COLOGNE AND AFTERSHAVES; PERFUMING SACHETS (U.S. CLS. 1, 4, 6, 50, 51 AND 52).

FIRST USE 6-15-2009; IN COMMERCE 6-15-2009.
BARBARA A. GOLD, EXAMINING ATTORNEY

SN 77-760,499. UNILEVER SUPPLY CHAIN, INC., CLINTON, CT. FILED 6-16-2009.

WATERFRESH BREEZE

THE MARK CONSISTS OF STANDARD CHARACTERS WITHOUT CLAIM TO ANY PARTICULAR FONT, STYLE, SIZE, OR COLOR.

FOR LAUNDRY DETERGENT (U.S. CLS. 1, 4, 6, 50, 51 AND 52).

TINA L. SNAPP, EXAMINING ATTORNEY

CLASS 3—(Continued).

SN 77-762,269. BATH & BODY WORKS BRAND MANAGEMENT, INC., REYNOLDSBURG, OH. FILED 6-17-2009.

BATHWORKS

THE MARK CONSISTS OF STANDARD CHARACTERS WITHOUT CLAIM TO ANY PARTICULAR FONT, STYLE, SIZE, OR COLOR.

FOR PERSONAL CARE PRODUCTS, NAMELY, 3-IN-1 HAIR CONDITIONERS, 3-IN-1 HAIR SHAMPOOS, AFTER SUN CREAMS, AFTER-SHAVE, AFTER-SHAVE BALMS, AFTER-SHAVE CREAMS, AFTER-SHAVE EMULSIONS, AFTER-SHAVE GEL, AFTER-SHAVE LOTIONS, AFTER-SUN GELS, AFTER-SUN LOTIONS, AFTER-SUN OILS, AGE RETARDANT GEL, AGE RETARDANT LOTION, AGE SPOT REDUCING CREAMS, ANTI-AGING CREAM, ANTI-FRECKLE CREAMS, ANTI-PERSPIRANTS, ANTI-WRINKLE CREAMS, ANTI-BACTERIAL SKIN SOAPS, ANTIPERSPIRANTS FOR PERSONAL USE, AROMATHERAPY CREAMS, AROMATHERAPY LOTIONS, AROMATHERAPY OILS, ASTRINGENTS FOR COSMETIC PURPOSES, BATH BEADS, BATH CRYSTALS, BATH FOAMS, BATH GELS, BATH LOTION, BATH MILKS, BATH OILS FOR COSMETIC PURPOSES, BATH PEARLS, BATH POWDER, BATH SALTS, BATH SOAPS IN LIQUID, SOLID OR GEL FORM, BATHING LOTIONS, BAY RUMS, BEAUTY CREAMS FOR BODY CARE, BEAUTY GELS, BEAUTY LOTIONS, BEAUTY MASKS, BEAUTY MILKS, BEAUTY SERUMS, BLUSH, BLUSH PENCILS, BODY AND BEAUTY CARE COSMETICS, BODY CREAM SOAP, BODY CREAMS, BODY EMULSIONS, BODY GLITTER, BODY LOTIONS, BODY MASK CREAM, BODY MASK LOTION, BODY MASK POWDER, BODY MASKS, BODY MILKS, BODY OILS, BODY POWDER, BODY SCRUB, BODY SPRAY USED AS A PERSONAL DEODORANT AND AS FRAGRANCE, BODY SPRAYS, NAMELY, WATER IN ATOMIZED CONTAINERS USED TO PRODUCE A COOLING EFFECT, BODY WASHES, BUBBLE BATH, CLEANSING CREAMS, COLD CREAMS, COLOGNE, COLOGNE WATER, COMPACTS CONTAINING MAKE-UP, CONCEALERS FOR FACE AND BODY, CONDITIONERS, COSMETIC CREAMS, COSMETIC CREAMS FOR SKIN CARE, COSMETIC FACIAL BLOT- TING PAPERS, COSMETIC MILKS, COSMETIC OILS, COSMETIC PADS, COSMETIC PENCILS, COSMETIC PREPARATIONS AGAINST SUNBURN, COSMETIC PREPARATIONS FOR BODY CARE, COSMETIC PREPARATIONS FOR EYE LASHES, COSMETIC PREPARATIONS FOR SKIN RENEWAL, COSMETIC PRODUCTS IN THE FORM OF AEROSOLS FOR SKIN CARE, COSMETIC ROUGES, COSMETIC SOAPS, COSMETIC SUN-PROTECTING PREPARATIONS, COSMETIC SUN-TANNING PREPARATIONS, COSMETIC SUNTAN LOTIONS, COSMETICS, COSMETICS NAMELY, COMPACTS, COSMETICS, NAMELY, LIP PRIMER, COSMETICS, NAMELY, LIP REPAIRERS, CREAM SOAPS, CREAMS FOR CELLULITE REDUCTION, CREAMY FACE POWDER, CREAMY FOUNDATION, CREAMY ROUGES, CUTICLE CONDITIONERS, CUTICLE CREAM, CUTICLE REMOVING PREPARATIONS, DEODORANT FOR PERSONAL USE, DEODORANT SOAP, DEODORANTS AND ANTIPERSPIRANTS, DEODORANTS FOR BODY CARE, DEPILATORIES, DEPILATORY CREAMS, DUSTING POWDER, EAU DE PARFUM, EAU DE TOILETTE, EMERY BOARDS, ESSENTIAL OILS FOR PERSONAL USE, EXFOLIANT CREAMS, EXFOLIANTS FOR SKIN, EYE COMPRESSES FOR COSMETIC PURPOSES, EYE CREAM, EYE GELS, EYE LINER, EYE LOTIONS, EYE MAKE-UP, EYE MAKE-UP REMOVER, EYE PENCILS, EYE SHADOWS, EYEBROW COLORS, EYEBROW PENCILS, EYELINER, EYESHADOWS, FACE AND BODY BEAUTY CREAMS, FACE AND BODY CREAMS, FACE AND BODY GLITTER, FACE AND BODY LOTIONS, FACE AND BODY MILK, FACE CREAMS, FACE CREAMS FOR COSMETIC USE, FACE GLITTER, FACE MILK AND LOTIONS, FACE POWDER, FACIAL BEAUTY MASKS, FACIAL CLEANSERS, FACIAL CLEANSING MILK, FACIAL CONCEALER, FACIAL

CLASS 3—(Continued).

CREAMS, FACIAL EMULSIONS, FACIAL LOTION, FACIAL MAKE-UP, FACIAL MASKS, FACIAL SCRUBS, FACIAL WASHES, FOAM BATH, FOAMS CONTAINING COSMETICS AND SUNSCREENS, FOOT DEODORANT SPRAY, NON-MEDICATED FOOT CREAM, NON-MEDICATED FOOT LOTION, FOOT POWDER, FOUNDATION, FRAGRANCE EMITTING WICKS FOR ROOM FRAGRANCE, FRAGRANCES FOR AUTOMOBILES, FRAGRANCES FOR PERSONAL USE, GEL EYE MASKS, HAIR CARE CREAMS, HAIR CARE KITS COMPRISING NON-MEDICATED HAIR CARE PREPARATIONS, NAMELY, SHAMPOO, CONDITIONER, HAIRSTYLING PREPARATIONS, HAIR CARE LOTIONS, HAIR CARE PREPARATIONS, HAIR CLEANING PREPARATIONS, HAIR CONDITIONERS, HAIR CREAMS, HAIR GELS, HAIR LOTIONS, HAIR POMADES, HAIR REMOVING CREAM, HAIR SHAMPOO, HAIR SPRAY, HAIR STYLING PREPARATIONS, HAIR TONICS, HAND CLEANERS, HAND CLEANING PREPARATIONS, HAND CREAMS, HAND LOTIONS, HAND SOAPS, HAND WASH, INCENSE, LIP BALM, LIP CREAM, LIP GLOSS, LIP GLOSS PALATTE, LIP LINER, LIP POLISHER, LIPSTICK, LIPSTICK HOLDERS, LIPSTICKS, LIQUID BATH SOAPS, LIQUID PERFUMES, LIQUID SOAP, LIQUID SOAPS FOR HANDS, FACE AND BODY, LOOSE FACE POWDER, LOTIONS FOR CELLULITE REDUCTION, LOTIONS FOR FACE AND BODY CARE, LOTIONS FOR STRENGTHENING THE NAILS, LOTIONS FOR FACE AND BODY, MAKE UP REMOVING PREPARATIONS, MAKE-UP FOR THE FACE AND BODY, MAKE-UP KITS COMPRISED OF LIPSTICK, LIP GLOSS, BLUSH AND EYE SHADOW, MAKE-UP PENCILS, MAKE-UP POWDER, MAKE-UP REMOVER, MAKE-UP REMOVING LOTIONS, MAKE-UP REMOVING MILK, GEL, LOTIONS AND CREAMS, MASCARAS, MASSAGE OILS, MEDICATED SOAPS, MINERAL SALT IN THE NATURE OF BATH SALTS NOT FOR MEDICAL PURPOSES, MOISTURIZING CREAMS, MOISTURIZING MILKS, MOUSSE FOR HAIR, MOUTHWASHES, NAIL BUFFING PREPARATIONS, NAIL CARE PREPARATIONS, NAIL CARE PREPARATIONS, NAMELY, NAIL SOFTENERS, NAIL CREAM, NAIL ENAMEL, NAIL POLISH, NAIL POLISH REMOVERS, NIGHT CREAM, NON-MEDICATED ACNE TREATMENT PREPARATIONS, NON-MEDICATED BATH PREPARATIONS, NON-MEDICATED BODY SOAKS, NON-MEDICATED FOOT CREAM, NON-MEDICATED LIP CARE PREPARATIONS, NON-MEDICATED LIP PROTECTOR, NON-MEDICATED MOUTH WASH AND RINSE, NON-MEDICATED OINTMENTS FOR THE PREVENTION AND TREATMENT OF SUNBURN, NON-MEDICATED SCALP TREATMENT CREAM, NON-MEDICATED SKIN CARE PREPARATIONS, NON-MEDICATED SKIN CREAMS, NON-MEDICATED STIMULATING LOTIONS FOR THE SKIN, NON-MEDICATED SUN CARE PREPARATIONS, PARAFFIN WAX FOR COSMETIC PURPOSES, PATCHES CONTAINING SUN SCREEN AND SUN BLOCK FOR USE ON THE SKIN, PENCILS FOR COSMETIC PURPOSES, PERFUME, PERFUME OILS, PERFUMED CREAMS, PERFUMED POWDERS, PERFUMED SOAPS, PERFUMING SACHETS, PERSONAL DEODORANTS, POTPOURRI, PRE-MOISTENED COSMETIC TOWELETTES, PRE-SHAVE CREAMS, PRESSED FACE POWDER, ROOM FRAGRANCE REFILLS FOR NON-ELECTRIC ROOM FRAGRANCE DISPENSERS, ROOM FRAGRANCES, ROUGES, SPF SUNBLOCK TOWELETTES, SACHET-LIKE EYE PILLOWS CONTAINING FRAGRANCES, SACHETS, SCENTED BODY SPRAY, SCENTED CERAMIC STONES, SCENTED LINEN SPRAYS, SCENTED OILS USED TO PRODUCE AROMAS WHEN HEATED, SCENTED ROOM SPRAYS, SCULPTING GEL, SELF-TANNING PREPARATIONS, SHAMPOO-CONDITIONERS, SHAMPOOS, SHAVING BALM, SHAVING CREAMS, SHAVING FOAMS, SHAVING GELS, SHAVING LOTIONS, SHAVING MOUSSE, SHAVING PREPARATIONS, SHAVING SOAP, SHOWER AND BATH FOAM, SHOWER AND BATH GEL, SHOWER CREAMS, SHOWER GELS, SKIN BRONZER, SKIN BRONZING CREAMS, SKIN CARE PREPARATION, NAMELY, BODY POLISH, SKIN CARE PREPARATIONS, NAMELY, CHEMICAL PEELS FOR SKIN, SKIN CARE PRODUCTS, NAMELY, NON-MEDICATED SKIN SERUM, SKIN CLARIFIERS, SKIN CLEANSERS, SKIN CLEANSING CREAM, SKIN CLEANSING LOTION, SKIN CONDITIONERS, SKIN CREAMS, SKIN CREAMS IN LIQUID AND SOLID FORM, SKIN EMOLLIENTS, SKIN FIRMING LOTION, SKIN GELS FOR

CLASS 3—(Continued).

ACCELERATING, ENHANCING OR EXTENDING TANS, SKIN LIGHTENING CREAMS, SKIN LOTIONS, SKIN MASKS, SKIN MOISTURIZER, SKIN MOISTURIZER MASKS, SKIN SOAP, SKIN TONERS, SOAPS FOR BODY CARE, SOAPS FOR PERSONAL USE, STYLING GELS, STYLING LOTIONS, STYLING MOUSSE, SUN BLOCK, SUN BLOCK PREPARATIONS, SUN CARE LOTIONS, SUN CREAMS, SUN SCREEN, SUN SCREEN PREPARATIONS, SUN TAN LOTION, SUN TAN OIL, SUN-BLOCK LOTIONS, SUNSCREEN CREAMS, SUN-TANNING PREPARATIONS, TANNING CREAMS, TOOTH PASTE, TOPICAL SKIN SPRAYS FOR COSMETIC PURPOSES, VANISHING CREAM, WAX FOR REMOVING BODY HAIR, WRINKLE REMOVING SKIN CARE PREPARATIONS, WRINKLE RESISTANT CREAM (U.S. CLS. 1, 4, 6, 50, 51 AND 52).

SEAN CROWLEY, EXAMINING ATTORNEY

SN 77-762,276. BATH & BODY WORKS BRAND MANAGEMENT, INC., REYNOLDSBURG, OH. FILED 6-17-2009.

GYMWORKS

THE MARK CONSISTS OF STANDARD CHARACTERS WITHOUT CLAIM TO ANY PARTICULAR FONT, STYLE, SIZE, OR COLOR.

FOR PERSONAL CARE PRODUCTS, NAMELY, 3-IN-1 HAIR CONDITIONERS, 3-IN-1 HAIR SHAMPOOS, AFTER SUN CREAMS, AFTER-SHAVE, AFTER-SHAVE BALMS, AFTER-SHAVE CREAMS, AFTER-SHAVE EMULSIONS, AFTER-SHAVE GEL, AFTER-SHAVE LOTIONS, AFTER-SUN GELS, AFTER-SUN LOTIONS, AFTER-SUN OILS, AGE RETARDANT GEL, AGE RETARDANT LOTION, AGE SPOT REDUCING CREAMS, ANTI-AGING CREAM, ANTI-FRECKLE CREAMS, ANTI-PERSPIRANTS, ANTI-WRINKLE CREAMS, ANTI-BACTERIAL SKIN SOAPS, ANTIPERSPIRANTS FOR PERSONAL USE, AROMATHERAPY CREAMS, AROMATHERAPY LOTIONS, AROMATHERAPY OILS, ASTRINGENTS FOR COSMETIC PURPOSES, BATH BEADS, BATH CRYSTALS, BATH FOAMS, BATH GELS, BATH LOTION, BATH MILKS, BATH OILS FOR COSMETIC PURPOSES, BATH PEARLS, BATH POWDER, BATH SALTS, BATH SOAPS IN LIQUID, SOLID OR GEL FORM, BATHING LOTIONS, BAY RUMS, BEAUTY CREAMS FOR BODY CARE, BEAUTY GELS, BEAUTY LOTIONS, BEAUTY MASKS, BEAUTY MILKS, BEAUTY SERUMS, BLUSH, BLUSH PENCILS, BODY AND BEAUTY CARE COSMETICS, BODY CREAM SOAP, BODY CREAMS, BODY EMULSIONS, BODY GLITTER, BODY LOTIONS, BODY MASK CREAM, BODY MASK LOTION, BODY MASK POWDER, BODY MASKS, BODY MILKS, BODY OILS, BODY POWDER, BODY SCRUB, BODY SPRAY USED AS A PERSONAL DEODORANT AND AS FRAGRANCE, BODY SPRAYS, NAMELY, WATER IN ATOMIZED CONTAINERS USED TO PRODUCE A COOLING EFFECT, BODY WASHES, BUBBLE BATH, CLEANSING CREAMS, COLD CREAMS, COLOGNE, COLOGNE WATER, COMPACTS CONTAINING MAKE-UP, CONCEALERS FOR FACE AND BODY, CONDITIONERS, COSMETIC CREAMS, COSMETIC CREAMS FOR SKIN CARE, COSMETIC FACIAL BLOT- TING PAPERS, COSMETIC MILKS, COSMETIC OILS, COSMETIC PADS, COSMETIC PENCILS, COSMETIC PREPARATIONS AGAINST SUNBURN, COSMETIC PREPARATIONS FOR BODY CARE, COSMETIC PREPARATIONS FOR EYE LASHES, COSMETIC PREPARATIONS FOR SKIN RENEWAL, COSMETIC PRODUCTS IN THE FORM OF AEROSOLS FOR SKIN CARE, COSMETIC ROUGES, COSMETIC SOAPS, COSMETIC SUN-PROTECTING PREPARATIONS, COSMETIC SUN-TANNING PREPARATIONS, COSMETIC SUNTAN LOTIONS, COSMETICS, COSMETICS NAMELY, COMPACTS, COSMETICS, NAMELY, LIP PRIMER, COSMETICS, NAMELY, LIP REPAIRERS, CREAM SOAPS, CREAMS

CLASS 3—(Continued).

FOR CELLULITE REDUCTION, CREAMY FACE POWDER, CREAMY FOUNDATION, CREAMY ROUGES, CUTICLE CONDITIONERS, CUTICLE CREAM, CUTICLE REMOVING PREPARATIONS, DEODORANT FOR PERSONAL USE, DEODORANT SOAP, DEODORANTS AND ANTIPERSPIRANTS, DEODORANTS FOR BODY CARE, DEPILATORIES, DEPILATORY CREAMS, DUSTING POWDER, EAU DE PARFUM, EAU DE TOILETTE, EMERY BOARDS, ESSENTIAL OILS FOR PERSONAL USE, EXFOLIANT CREAMS, EXFOLIANTS FOR SKIN, EYE COMPRESSES FOR COSMETIC PURPOSES, EYE CREAM, EYE GELS, EYE LINER, EYE LOTIONS, EYE MAKE-UP, EYE MAKE-UP REMOVER, EYE PENCILS, EYE SHADOWS, EYEBROW COLORS, EYEBROW PENCILS, EYELINER, EYESHADOWS, FACE AND BODY BEAUTY CREAMS, FACE AND BODY CREAMS, FACE AND BODY GLITTER, FACE AND BODY LOTIONS, FACE AND BODY MILK, FACE CREAMS, FACE CREAMS FOR COSMETIC USE, FACE GLITTER, FACE MILK AND LOTIONS, FACE POWDER, FACIAL BEAUTY MASKS, FACIAL CLEANSERS, FACIAL CLEANSING MILK, FACIAL CONCEALER, FACIAL CREAMS, FACIAL EMULSIONS, FACIAL LOTION, FACIAL MAKE-UP, FACIAL MASKS, FACIAL SCRUBS, FACIAL WASHES, FOAM BATH, FOAMS CONTAINING COSMETICS AND SUNSCREENS, FOOT DEODORANT SPRAY, NON-MEDICATED FOOT CREAM, NON-MEDICATED FOOT LOTION, FOOT POWDER, FOUNDATION, FRAGRANCE EMITTING WICKS FOR ROOM FRAGRANCE, FRAGRANCES FOR AUTOMOBILES, FRAGRANCES FOR PERSONAL USE, GEL EYE MASKS, HAIR CARE CREAMS, HAIR CARE KITS COMPRISING NON-MEDICATED HAIR CARE PREPARATIONS, NAMELY, SHAMPOO, CONDITIONER, HAIRSTYLING PREPARATIONS, HAIR CARE LOTIONS, HAIR CARE PREPARATIONS, HAIR CLEANING PREPARATIONS, HAIR CONDITIONERS, HAIR CREAMS, HAIR GELS, HAIR LOTIONS, HAIR POMADES, HAIR REMOVING CREAM, HAIR SHAMPOO, HAIR SPRAY, HAIR STYLING PREPARATIONS, HAIR TONICS, HAND CLEANERS, HAND CLEANING PREPARATIONS, HAND CREAMS, HAND LOTIONS, HAND SOAPS, HAND WASH, INCENSE, LIP BALM, LIP CREAM, LIP GLOSS, LIP GLOSS PALATTE, LIP LINER, LIP POLISHER, LIPSTICK, LIPSTICK HOLDERS, LIPSTICKS, LIQUID BATH SOAPS, LIQUID PERFUMES, LIQUID SOAP, LIQUID SOAPS FOR HANDS, FACE AND BODY, LOOSE FACE POWDER, LOTIONS FOR CELLULITE REDUCTION, LOTIONS FOR FACE AND BODY CARE, LOTIONS FOR STRENGTHENING THE NAILS, LOTIONS FOR FACE AND BODY, MAKE UP REMOVING PREPARATIONS, MAKE-UP FOR THE FACE AND BODY, MAKE-UP KITS COMPRISED OF LIPSTICK, LIP GLOSS, BLUSH AND EYE SHADOW, MAKE-UP PENCILS, MAKE-UP POWDER, MAKE-UP REMOVER, MAKE-UP REMOVING LOTIONS, MAKE-UP REMOVING MILK, GEL, LOTIONS AND CREAMS, MASCARAS, MASSAGE OILS, MEDICATED SOAPS, MINERAL SALT IN THE NATURE OF BATH SALTS NOT FOR MEDICAL PURPOSES, MOISTURIZING CREAMS, MOISTURIZING MILKS, MOUSSE FOR HAIR, MOUTHWASHES, NAIL BUFFING PREPARATIONS, NAIL CARE PREPARATIONS, NAIL CARE PREPARATIONS, NAMELY, NAIL SOFTENERS, NAIL CREAM, NAIL ENAMEL, NAIL POLISH, NAIL POLISH REMOVERS, NIGHT CREAM, NON-MEDICATED ACNE TREATMENT PREPARATIONS, NON-MEDICATED BATH PREPARATIONS, NON-MEDICATED BODY SOAKS, NON-MEDICATED FOOT CREAM, NON-MEDICATED LIP CARE PREPARATIONS, NON-MEDICATED LIP PROTECTOR, NON-MEDICATED MOUTH WASH AND RINSE, NON-MEDICATED OINTMENTS FOR THE PREVENTION AND TREATMENT OF SUNBURN, NON-MEDICATED SCALP TREATMENT CREAM, NON-MEDICATED SKIN CARE PREPARATIONS, NON-MEDICATED SKIN CREAMS, NON-MEDICATED STIMULATING LOTIONS FOR THE SKIN, NON-MEDICATED SUN CARE PREPARATIONS, PARAFFIN WAX FOR COSMETIC PURPOSES, PATCHES CONTAINING SUN SCREEN AND SUN BLOCK FOR USE ON THE SKIN, PENCILS FOR COSMETIC PURPOSES, PERFUME, PERFUME OILS, PERFUMED CREAMS, PERFUMED POWDERS, PERFUMED SOAPS, PERFUMING SACHETS, PERSONAL DEODORANTS, POTPOURRI, PRE-MOISTENED COSMETIC TOWELETTES, PRE-SHAVE CREAMS, PRESSED FACE POWDER, ROOM FRAGRANCE REFILLS FOR NON-ELECTRIC ROOM FRAGRANCE DISPENSERS,

CLASS 3—(Continued).

ROOM FRAGRANCES, ROUGES, SPF SUNBLOCK TOWELETES, SACHET-LIKE EYE PILLOWS CONTAINING FRAGRANCES, SACHETS, SCENTED BODY SPRAY, SCENTED CERAMIC STONES, SCENTED LINEN SPRAYS, SCENTED OILS USED TO PRODUCE AROMAS WHEN HEATED, SCENTED ROOM SPRAYS, SCULPTING GEL, SELF-TANNING PREPARATIONS, SHAMPOO-CONDITIONERS, SHAMPOOS, SHAVING BALM, SHAVING CREAMS, SHAVING FOAMS, SHAVING GELS, SHAVING LOTIONS, SHAVING MOUSSE, SHAVING PREPARATIONS, SHAVING SOAP, SHOWER AND BATH FOAM, SHOWER AND BATH GEL, SHOWER CREAMS, SHOWER GELS, SKIN BRONZER, SKIN BRONZING CREAMS, SKIN CARE PREPARATION, NAMELY, BODY POLISH, SKIN CARE PREPARATIONS, NAMELY, CHEMICAL PEELS FOR SKIN, SKIN CARE PRODUCTS, NAMELY, NON-MEDICATED SKIN SERUM, SKIN CLARIFIERS, SKIN CLEANSERS, SKIN CLEANSING CREAM, SKIN CLEANSING LOTION, SKIN CONDITIONERS, SKIN CREAMS, SKIN CREAMS IN LIQUID AND SOLID FORM, SKIN EMOLLIENTS, SKIN FIRING LOTION, SKIN GELS FOR ACCELERATING, ENHANCING OR EXTENDING TANS, SKIN LIGHTENING CREAMS, SKIN LOTIONS, SKIN MASKS, SKIN MOISTURIZER, SKIN MOISTURIZER MASKS, SKIN SOAP, SKIN TONERS, SOAPS FOR BODY CARE, SOAPS FOR PERSONAL USE, STYLING GELS, STYLING LOTIONS, STYLING MOUSSE, SUN BLOCK, SUN BLOCK PREPARATIONS, SUN CARE LOTIONS, SUN CREAMS, SUN SCREEN, SUN SCREEN PREPARATIONS, SUN TAN LOTION, SUN TAN OIL, SUN-BLOCK LOTIONS, SUNSCREEN CREAMS, SUN-TANNING PREPARATIONS, TANNING CREAMS, TOOTH PASTE, TOPICAL SKIN SPRAYS FOR COSMETIC PURPOSES, VANISHING CREAM, WAX FOR REMOVING BODY HAIR, WRINKLE REMOVING SKIN CARE PREPARATIONS, WRINKLE RESISTANT CREAM (U.S. CLS. 1, 4, 6, 50, 51 AND 52).

SEAN CROWLEY, EXAMINING ATTORNEY

SN 77-762,280. BATH & BODY WORKS BRAND MANAGEMENT, INC., REYNOLDSBURG, OH. FILED 6-17-2009.

HANDWORKS

THE MARK CONSISTS OF STANDARD CHARACTERS WITHOUT CLAIM TO ANY PARTICULAR FONT, STYLE, SIZE, OR COLOR.

FOR PERSONAL CARE PRODUCTS, NAMELY, 3-IN-1 HAIR CONDITIONERS, 3-IN-1 HAIR SHAMPOOS, AFTER SUN CREAMS, AFTER-SHAVE, AFTER-SHAVE BALMS, AFTER-SHAVE CREAMS, AFTER-SHAVE EMULSIONS, AFTER-SHAVE GEL, AFTER-SHAVE LOTIONS, AFTER-SUN GELS, AFTER-SUN LOTIONS, AFTER-SUN OILS, AGE RETARDANT GEL, AGE RETARDANT LOTION, AGE SPOT REDUCING CREAMS, ANTI-AGING CREAM, ANTI-FRECKLE CREAMS, ANTI-PERSPIRANTS, ANTI-WRINKLE CREAMS, ANTI-BACTERIAL SKIN SOAPS, ANTIPERSPIRANTS FOR PERSONAL USE, AROMATHERAPY CREAMS, AROMATHERAPY LOTIONS, AROMATHERAPY OILS, ASTRINGENTS FOR COSMETIC PURPOSES, BATH BEADS, BATH CRYSTALS, BATH FOAMS, BATH GELS, BATH LOTION, BATH MILKS, BATH OILS FOR COSMETIC PURPOSES, BATH PEARLS, BATH POWDER, BATH SALTS, BATH SOAPS IN LIQUID, SOLID OR GEL FORM, BATHING LOTIONS, BAY RUMS, BEAUTY CREAMS FOR BODY CARE, BEAUTY GELS, BEAUTY LOTIONS, BEAUTY MASKS, BEAUTY MILKS, BEAUTY SERUMS, BLUSH, BLUSH PENCILS, BODY AND BEAUTY CARE COSMETICS, BODY CREAM SOAP, BODY CREAMS, BODY EMULSIONS, BODY GLITTER, BODY LOTIONS, BODY MASK CREAM, BODY MASK LOTION, BODY MASK POWDER, BODY MASKS, BODY MILKS, BODY OILS, BODY POWDER, BODY SCRUB,

CLASS 3—(Continued).

BODY SPRAY USED AS A PERSONAL DEODORANT AND AS FRAGRANCE, BODY SPRAYS, NAMELY, WATER IN ATOMIZED CONTAINERS USED TO PRODUCE A COOLING EFFECT, BODY WASHES, BUBBLE BATH, CLEANSING CREAMS, COLD CREAMS, COLOGNE, COLOGNE WATER, COMPACTS CONTAINING MAKE-UP, CONCEALERS FOR FACE AND BODY, CONDITIONERS, COSMETIC CREAMS, COSMETIC CREAMS FOR SKIN CARE, COSMETIC FACIAL BLOT- TING PAPERS, COSMETIC MILKS, COSMETIC OILS, COSMETIC PADS, COSMETIC PENCILS, COSMETIC PREPARATIONS AGAINST SUNBURN, COSMETIC PREPARATIONS FOR BODY CARE, COSMETIC PREPARATIONS FOR EYE LASHES, COSMETIC PREPARATIONS FOR SKIN RENEWAL, COSMETIC PRODUCTS IN THE FORM OF AEROSOLS FOR SKIN CARE, COSMETIC ROUGES, COSMETIC SOAPS, COSMETIC SUN-PROTECTING PREPARATIONS, COSMETIC SUN-TANNING PREPARATIONS, COSMETIC SUNTAN LOTIONS, COSMETICS, COSMETICS NAMELY, COMPACTS, COSMETICS, NAMELY, LIP PRIMER, COSMETICS, NAMELY, LIP REPAIRERS, CREAM SOAPS, CREAMS FOR CELLULITE REDUCTION, CREAMY FACE POWDER, CREAMY FOUNDATION, CREAMY ROUGES, CUTICLE CONDITIONERS, CUTICLE CREAM, CUTICLE REMOVING PREPARATIONS, DEODORANT FOR PERSONAL USE, DEODORANT SOAP, DEODORANTS AND ANTIPERSPIRANTS, DEODORANTS FOR BODY CARE, DEPILATORIES, DEPILATORY CREAMS, DUSTING POWDER, EAU DE PARFUM, EAU DE TOILETTE, EMERY BOARDS, ESSENTIAL OILS FOR PERSONAL USE, EXFOLIANT CREAMS, EXFOLIANTS FOR SKIN, EYE COMPRESSES FOR COSMETIC PURPOSES, EYE CREAM, EYE GELS, EYE LINER, EYE LOTIONS, EYE MAKE-UP, EYE MAKE-UP REMOVER, EYE PENCILS, EYE SHADOWS, EYEBROW COLORS, EYEBROW PENCILS, EYELINER, EYESHADOWS, FACE AND BODY BEAUTY CREAMS, FACE AND BODY CREAMS, FACE AND BODY GLITTER, FACE AND BODY LOTIONS, FACE AND BODY MILK, FACE CREAMS, FACE CREAMS FOR COSMETIC USE, FACE GLITTER, FACE MILK AND LOTIONS, FACE POWDER, FACIAL BEAUTY MASKS, FACIAL CLEANSERS, FACIAL CLEANSING MILK, FACIAL CONCEALER, FACIAL CREAMS, FACIAL EMULSIONS, FACIAL LOTION, FACIAL MAKE-UP, FACIAL MASKS, FACIAL SCRUBS, FACIAL WASHES, FOAM BATH, FOAMS CONTAINING COSMETICS AND SUNSCREENS, FOOT DEODORANT SPRAY, NON-MEDICATED FOOT CREAM, NON-MEDICATED FOOT LOTION, FOOT POWDER, FOUNDATION, FRAGRANCE EMITTING WICKS FOR ROOM FRAGRANCE, FRAGRANCES FOR AUTOMOBILES, FRAGRANCES FOR PERSONAL USE, GEL EYE MASKS, HAIR CARE CREAMS, HAIR CARE KITS COMPRISING NON-MEDICATED HAIR CARE PREPARATIONS, NAMELY, SHAMPOO, CONDITIONER, HAIRSTYLING PREPARATIONS, HAIR CARE LOTIONS, HAIR CARE PREPARATIONS, HAIR CLEANING PREPARATIONS, HAIR CONDITIONERS, HAIR CREAMS, HAIR GELS, HAIR LOTIONS, HAIR POMADES, HAIR REMOVING CREAM, HAIR SHAMPOO, HAIR SPRAY, HAIR STYLING PREPARATIONS, HAIR TONICS, HAND CLEANERS, HAND CLEANING PREPARATIONS, HAND CREAMS, HAND LOTIONS, HAND SOAPS, HAND WASH, INCENSE, LIP BALM, LIP CREAM, LIP GLOSS, LIP GLOSS PALATTE, LIP LINER, LIP POLISHER, LIPSTICK, LIPSTICK HOLDERS, LIPSTICKS, LIQUID BATH SOAPS, LIQUID PERFUMES, LIQUID SOAP, LIQUID SOAPS FOR HANDS, FACE AND BODY, LOOSE FACE POWDER, LOTIONS FOR CELLULITE REDUCTION, LOTIONS FOR FACE AND BODY CARE, LOTIONS FOR STRENGTHENING THE NAILS, LOTIONS FOR FACE AND BODY, MAKE UP REMOVING PREPARATIONS, MAKE-UP FOR THE FACE AND BODY, MAKE-UP KITS COMPRISED OF LIPSTICK, LIP GLOSS, BLUSH AND EYE SHADOW, MAKE-UP PENCILS, MAKE-UP POWDER, MAKE-UP REMOVER, MAKE-UP REMOVING LOTIONS, MAKE-UP REMOVING MILK, GEL, LOTIONS AND CREAMS, MASCARAS, MASSAGE OILS, MEDICATED SOAPS, MINERAL SALT IN THE NATURE OF BATH SALTS NOT FOR MEDICAL PURPOSES, MOISTURIZING CREAMS, MOISTURIZING MILKS, MOUSSE FOR HAIR, MOUTHWASHES, NAIL BUFFING PREPARATIONS, NAIL CARE PREPARATIONS, NAIL CARE PREPARATIONS, NAMELY, NAIL SOFTENERS, NAIL CREAM, NAIL ENAMEL, NAIL POLISH, NAIL POLISH REMOVERS, NIGHT CREAM,

CLASS 3—(Continued).

NON-MEDICATED ACNE TREATMENT PREPARATIONS, NON-MEDICATED BATH PREPARATIONS, NON-MEDICATED BODY SOAKS, NON-MEDICATED FOOT CREAM, NON-MEDICATED LIP CARE PREPARATIONS, NON-MEDICATED LIP PROTECTOR, NON-MEDICATED MOUTH WASH AND RINSE, NON-MEDICATED OINTMENTS FOR THE PREVENTION AND TREATMENT OF SUNBURN, NON-MEDICATED SCALP TREATMENT CREAM, NON-MEDICATED SKIN CARE PREPARATIONS, NON-MEDICATED SKIN CREAMS, NON-MEDICATED STIMULATING LOTIONS FOR THE SKIN, NON-MEDICATED SUN CARE PREPARATIONS, PARAFFIN WAX FOR COSMETIC PURPOSES, PATCHES CONTAINING SUN SCREEN AND SUN BLOCK FOR USE ON THE SKIN, PENCILS FOR COSMETIC PURPOSES, PERFUME, PERFUME OILS, PERFUMED CREAMS, PERFUMED POWDERS, PERFUMED SOAPS, PERFUMING SACHETS, PERSONAL DEODORANTS, POTPOURRI, PRE-MOISTENED COSMETIC TOWELETTES, PRE-SHAVE CREAMS, PRESSED FACE POWDER, ROOM FRAGRANCE REFILLS FOR NON-ELECTRIC ROOM FRAGRANCE DISPENSERS, ROOM FRAGRANCES, ROUGES, SPF SUNBLOCK TOWELETTES, SACHET-LIKE EYE PILLOWS CONTAINING FRAGRANCES, SACHETS, SCENTED BODY SPRAY, SCENTED CERAMIC STONES, SCENTED LINEN SPRAYS, SCENTED OILS USED TO PRODUCE AROMAS WHEN HEATED, SCENTED ROOM SPRAYS, SCULPTING GEL, SELF-TANNING PREPARATIONS, SHAMPOO-CONDITIONERS, SHAMPOOS, SHAVING BALM, SHAVING CREAMS, SHAVING FOAMS, SHAVING GELS, SHAVING LOTIONS, SHAVING MOUSSE, SHAVING PREPARATIONS, SHAVING SOAP, SHOWER AND BATH FOAM, SHOWER AND BATH GEL, SHOWER CREAMS, SHOWER GELS, SKIN BRONZER, SKIN BRONZING CREAMS, SKIN CARE PREPARATION, NAMELY, BODY POLISH, SKIN CARE PREPARATIONS, NAMELY, CHEMICAL PEELS FOR SKIN, SKIN CARE PRODUCTS, NAMELY, NON-MEDICATED SKIN SERUM, SKIN CLARIFIERS, SKIN CLEANSERS, SKIN CLEANSING CREAM, SKIN CLEANSING LOTION, SKIN CONDITIONERS, SKIN CREAMS, SKIN CREAMS IN LIQUID AND SOLID FORM, SKIN EMOLLIENTS, SKIN FIRMLING LOTION, SKIN GELS FOR ACCELERATING, ENHANCING OR EXTENDING TANS, SKIN LIGHTENING CREAMS, SKIN LOTIONS, SKIN MASKS, SKIN MOISTURIZER, SKIN MOISTURIZER MASKS, SKIN SOAP, SKIN TONERS, SOAPS FOR BODY CARE, SOAPS FOR PERSONAL USE, STYLING GELS, STYLING LOTIONS, STYLING MOUSSE, SUN BLOCK, SUN BLOCK PREPARATIONS, SUN CARE LOTIONS, SUN CREAMS, SUN SCREEN, SUN SCREEN PREPARATIONS, SUN TAN LOTION, SUN TAN OIL, SUN-BLOCK LOTIONS, SUNSCREEN CREAMS, SUN-TANNING PREPARATIONS, TANNING CREAMS, TOOTH PASTE, TOPICAL SKIN SPRAYS FOR COSMETIC PURPOSES, VANISHING CREAM, WAX FOR REMOVING BODY HAIR, WRINKLE REMOVING SKIN CARE PREPARATIONS, WRINKLE RESISTANT CREAM (U.S. CLS. 1, 4, 6, 50, 51 AND 52).

SEAN CROWLEY, EXAMINING ATTORNEY

CLASS 3—(Continued).

SN 77-762,284. BATH & BODY WORKS BRAND MANAGEMENT, INC., REYNOLDSBURG, OH. FILED 6-17-2009.

KIDSWORKS

THE MARK CONSISTS OF STANDARD CHARACTERS WITHOUT CLAIM TO ANY PARTICULAR FONT, STYLE, SIZE, OR COLOR.

FOR PERSONAL CARE PRODUCTS, NAMELY, 3-IN-1 HAIR CONDITIONERS, 3-IN-1 HAIR SHAMPOOS, AFTER SUN CREAMS, AFTER-SHAVE, AFTER-SHAVE BALMS, AFTER-SHAVE CREAMS, AFTER-SHAVE EMULSIONS, AFTER-SHAVE GEL, AFTER-SHAVE LOTIONS, AFTER-SUN GELS, AFTER-SUN LOTIONS, AFTER-SUN OILS, AGE RETARDANT GEL, AGE RETARDANT LOTION, AGE SPOT REDUCING CREAMS, ANTI-AGING CREAM, ANTI-FRECKLE CREAMS, ANTI-PERSPIRANTS, ANTI-WRINKLE CREAMS, ANTI-BACTERIAL SKIN SOAPS, ANTIPERSPIRANTS FOR PERSONAL USE, AROMATHERAPY CREAMS, AROMATHERAPY LOTIONS, AROMATHERAPY OILS, ASTRINGENTS FOR COSMETIC PURPOSES, BATH BEADS, BATH CRYSTALS, BATH FOAMS, BATH GELS, BATH LOTION, BATH MILKS, BATH OILS FOR COSMETIC PURPOSES, BATH PEARLS, BATH POWDER, BATH SALTS, BATH SOAPS IN LIQUID, SOLID OR GEL FORM, BATHING LOTIONS, BAY RUMS, BEAUTY CREAMS FOR BODY CARE, BEAUTY GELS, BEAUTY LOTIONS, BEAUTY MASKS, BEAUTY MILKS, BEAUTY SERUMS, BLUSH, BLUSH PENCILS, BODY AND BEAUTY CARE COSMETICS, BODY CREAM SOAP, BODY CREAMS, BODY EMULSIONS, BODY GLITTER, BODY LOTIONS, BODY MASK CREAM, BODY MASK LOTION, BODY MASK POWDER, BODY MASKS, BODY MILKS, BODY OILS, BODY POWDER, BODY SCRUB, BODY SPRAY USED AS A PERSONAL DEODORANT AND AS FRAGRANCE, BODY SPRAYS, NAMELY, WATER IN ATOMIZED CONTAINERS USED TO PRODUCE A COOLING EFFECT, BODY WASHES, BUBBLE BATH, CLEANSING CREAMS, COLD CREAMS, COLOGNE, COLOGNE WATER, COMPACTS CONTAINING MAKE-UP, CONCEALERS FOR FACE AND BODY, CONDITIONERS, COSMETIC CREAMS, COSMETIC CREAMS FOR SKIN CARE, COSMETIC FACIAL BLOT- TING PAPERS, COSMETIC MILKS, COSMETIC OILS, COSMETIC PADS, COSMETIC PENCILS, COSMETIC PREPARATIONS AGAINST SUNBURN, COSMETIC PREPARATIONS FOR BODY CARE, COSMETIC PREPARATIONS FOR EYE LASHES, COSMETIC PREPARATIONS FOR SKIN RENEWAL, COSMETIC PRODUCTS IN THE FORM OF AEROSOLS FOR SKIN CARE, COSMETIC ROUGES, COSMETIC SOAPS, COSMETIC SUN-PROTECTING PREPARATIONS, COSMETIC SUN-TANNING PREPARATIONS, COSMETIC SUNTAN LOTIONS, COSMETICS, COSMETICS NAMELY, COMPACTS, COSMETICS, NAMELY, LIP PRIMER, COSMETICS, NAMELY, LIP REPAIRERS, CREAM SOAPS, CREAMS FOR CELLULITE REDUCTION, CREAMY FACE POWDER, CREAMY FOUNDATION, CREAMY ROUGES, CUTICLE CONDITIONERS, CUTICLE CREAM, CUTICLE REMOVING PREPARATIONS, DEODORANT FOR PERSONAL USE, DEODORANT SOAP, DEODORANTS AND ANTIPERSPIRANTS, DEODORANTS FOR BODY CARE, DEPILATORIES, DEPILATORY CREAMS, DUSTING POWDER, EAU DE PARFUM, EAU DE TOILETTE, EMERY BOARDS, ESSENTIAL OILS FOR PERSONAL USE, EXFOLIANT CREAMS, EXFOLIANTS FOR SKIN, EYE COMPRESSES FOR COSMETIC PURPOSES, EYE CREAM, EYE GELS, EYE LINER, EYE LOTIONS, EYE MAKE-UP, EYE MAKE-UP REMOVER, EYE PENCILS, EYE SHADOWS, EYEBROW COLORS, EYEBROW PENCILS, EYELINER, EYESHADOWS, FACE AND BODY BEAUTY CREAMS, FACE AND BODY CREAMS, FACE AND BODY GLITTER, FACE AND BODY LOTIONS, FACE AND BODY MILK, FACE CREAMS, FACE CREAMS FOR COSMETIC USE, FACE GLITTER, FACE MILK AND LOTIONS, FACE POWDER, FACIAL BEAUTY MASKS, FACIAL CLEANSERS, FACIAL CLEANSING MILK, FACIAL CONCEALER, FACIAL

CLASS 3—(Continued).

CREAMS, FACIAL EMULSIONS, FACIAL LOTION, FACIAL MAKE-UP, FACIAL MASKS, FACIAL SCRUBS, FACIAL WASHES, FOAM BATH, FOAMS CONTAINING COSMETICS AND SUNSCREENS, FOOT DEODORANT SPRAY, NON-MEDICATED FOOT CREAM, NON-MEDICATED FOOT LOTION, FOOT POWDER, FOUNDATION, FRAGRANCE EMITTING WICKS FOR ROOM FRAGRANCE, FRAGRANCES FOR AUTOMOBILES, FRAGRANCES FOR PERSONAL USE, GEL EYE MASKS, HAIR CARE CREAMS, HAIR CARE KITS COMPRISING NON-MEDICATED HAIR CARE PREPARATIONS, NAMELY, SHAMPOO, CONDITIONER, HAIRSTYLING PREPARATIONS, HAIR CARE LOTIONS, HAIR CARE PREPARATIONS, HAIR CLEANING PREPARATIONS, HAIR CONDITIONERS, HAIR CREAMS, HAIR GELS, HAIR LOTIONS, HAIR POMADES, HAIR REMOVING CREAM, HAIR SHAMPOO, HAIR SPRAY, HAIR STYLING PREPARATIONS, HAIR TONICS, HAND CLEANERS, HAND CLEANING PREPARATIONS, HAND CREAMS, HAND LOTIONS, HAND SOAPS, HAND WASH, INCENSE, LIP BALM, LIP CREAM, LIP GLOSS, LIP GLOSS PALATTE, LIP LINER, LIP POLISHER, LIPSTICK, LIPSTICK HOLDERS, LIPSTICKS, LIQUID BATH SOAPS, LIQUID PERFUMES, LIQUID SOAP, LIQUID SOAPS FOR HANDS, FACE AND BODY, LOOSE FACE POWDER, LOTIONS FOR CELLULITE REDUCTION, LOTIONS FOR FACE AND BODY CARE, LOTIONS FOR STRENGTHENING THE NAILS, LOTIONS FOR FACE AND BODY, MAKE UP REMOVING PREPARATIONS, MAKE-UP FOR THE FACE AND BODY, MAKE-UP KITS COMPRISED OF LIPSTICK, LIP GLOSS, BLUSH AND EYE SHADOW, MAKE-UP PENCILS, MAKE-UP POWDER, MAKE-UP REMOVER, MAKE-UP REMOVING LOTIONS, MAKE-UP REMOVING MILK, GEL, LOTIONS AND CREAMS, MASCARAS, MASSAGE OILS, MEDICATED SOAPS, MINERAL SALT IN THE NATURE OF BATH SALTS NOT FOR MEDICAL PURPOSES, MOISTURIZING CREAMS, MOISTURIZING MILKS, MOUSSE FOR HAIR, MOUTHWASHES, NAIL BUFFING PREPARATIONS, NAIL CARE PREPARATIONS, NAIL CARE PREPARATIONS, NAMELY, NAIL SOFTENERS, NAIL CREAM, NAIL ENAMEL, NAIL POLISH, NAIL POLISH REMOVERS, NIGHT CREAM, NON-MEDICATED ACNE TREATMENT PREPARATIONS, NON-MEDICATED BATH PREPARATIONS, NON-MEDICATED BODY SOAKS, NON-MEDICATED FOOT CREAM, NON-MEDICATED LIP CARE PREPARATIONS, NON-MEDICATED LIP PROTECTOR, NON-MEDICATED MOUTH WASH AND RINSE, NON-MEDICATED OINTMENTS FOR THE PREVENTION AND TREATMENT OF SUNBURN, NON-MEDICATED SCALP TREATMENT CREAM, NON-MEDICATED SKIN CARE PREPARATIONS, NON-MEDICATED SKIN CREAMS, NON-MEDICATED STIMULATING LOTIONS FOR THE SKIN, NON-MEDICATED SUN CARE PREPARATIONS, PARAFFIN WAX FOR COSMETIC PURPOSES, PATCHES CONTAINING SUN SCREEN AND SUN BLOCK FOR USE ON THE SKIN, PENCILS FOR COSMETIC PURPOSES, PERFUME, PERFUME OILS, PERFUMED CREAMS, PERFUMED POWDERS, PERFUMED SOAPS, PERFUMING SACHETS, PERSONAL DEODORANTS, POTPOURRI, PRE-MOISTENED COSMETIC TOWELETTES, PRE-SHAVE CREAMS, PRESSED FACE POWDER, ROOM FRAGRANCE REFILLS FOR NON-ELECTRIC ROOM FRAGRANCE DISPENSERS, ROOM FRAGRANCES, ROUGES, SPF SUNBLOCK TOWELETTES, SACHET-LIKE EYE PILLOWS CONTAINING FRAGRANCES, SACHETS, SCENTED BODY SPRAY, SCENTED CERAMIC STONES, SCENTED LINEN SPRAYS, SCENTED OILS USED TO PRODUCE AROMAS WHEN HEATED, SCENTED ROOM SPRAYS, SCULPTING GEL, SELF-TANNING PREPARATIONS, SHAMPOO-CONDITIONERS, SHAMPOOS, SHAVING BALM, SHAVING CREAMS, SHAVING FOAMS, SHAVING GELS, SHAVING LOTIONS, SHAVING MOUSSE, SHAVING PREPARATIONS, SHAVING SOAP, SHOWER AND BATH FOAM, SHOWER AND BATH GEL, SHOWER CREAMS, SHOWER GELS, SKIN BRONZER, SKIN BRONZING CREAMS, SKIN CARE PREPARATION, NAMELY, BODY POLISH, SKIN CARE PREPARATIONS, NAMELY, CHEMICAL PEELS FOR SKIN, SKIN CARE PRODUCTS, NAMELY, NON-MEDICATED SKIN SERUM, SKIN CLARIFIERS, SKIN CLEANSERS, SKIN CLEANSING CREAM, SKIN CLEANSING LOTION, SKIN CONDITIONERS, SKIN CREAMS, SKIN CREAMS IN LIQUID AND SOLID FORM, SKIN EMOLLIENTS, SKIN FIRING LOTION, SKIN GELS FOR

CLASS 3—(Continued).

ACCELERATING, ENHANCING OR EXTENDING TANS, SKIN LIGHTENING CREAMS, SKIN LOTIONS, SKIN MASKS, SKIN MOISTURIZER, SKIN MOISTURIZER MASKS, SKIN SOAP, SKIN TONERS, SOAPS FOR BODY CARE, SOAPS FOR PERSONAL USE, STYLING GELS, STYLING LOTIONS, STYLING MOUSSE, SUN BLOCK, SUN BLOCK PREPARATIONS, SUN CARE LOTIONS, SUN CREAMS, SUN SCREEN, SUN SCREEN PREPARATIONS, SUN TAN LOTION, SUN TAN OIL, SUN-BLOCK LOTIONS, SUNSCREEN CREAMS, SUN-TANNING PREPARATIONS, TANNING CREAMS, TOOTH PASTE, TOPICAL SKIN SPRAYS FOR COSMETIC PURPOSES, VANISHING CREAM, WAX FOR REMOVING BODY HAIR, WRINKLE REMOVING SKIN CARE PREPARATIONS, WRINKLE RESISTANT CREAM (U.S. CLS. 1, 4, 6, 50, 51 AND 52).

SEAN CROWLEY, EXAMINING ATTORNEY

SN 77-762,287. BATH & BODY WORKS BRAND MANAGEMENT, INC., REYNOLDSBURG, OH. FILED 6-17-2009.

KITCHENWORKS

THE MARK CONSISTS OF STANDARD CHARACTERS WITHOUT CLAIM TO ANY PARTICULAR FONT, STYLE, SIZE, OR COLOR.

FOR PERSONAL CARE PRODUCTS, NAMELY, 3-IN-1 HAIR CONDITIONERS, 3-IN-1 HAIR SHAMPOOS, AFTER SUN CREAMS, AFTER-SHAVE, AFTER-SHAVE BALMS, AFTER-SHAVE CREAMS, AFTER-SHAVE EMULSIONS, AFTER-SHAVE GEL, AFTER-SHAVE LOTIONS, AFTER-SUN GELS, AFTER-SUN LOTIONS, AFTER-SUN OILS, AGE RETARDANT GEL, AGE RETARDANT LOTION, AGE SPOT REDUCING CREAMS, ANTI-AGING CREAM, ANTI-FRECKLE CREAMS, ANTI-PERSPIRANTS, ANTI-WRINKLE CREAMS, ANTI-BACTERIAL SKIN SOAPS, ANTIPERSPIRANTS FOR PERSONAL USE, AROMATHERAPY CREAMS, AROMATHERAPY LOTIONS, AROMATHERAPY OILS, ASTRINGENTS FOR COSMETIC PURPOSES, BATH BEADS, BATH CRYSTALS, BATH FOAMS, BATH GELS, BATH LOTION, BATH MILKS, BATH OILS FOR COSMETIC PURPOSES, BATH PEARLS, BATH POWDER, BATH SALTS, BATH SOAPS IN LIQUID, SOLID OR GEL FORM, BATHING LOTIONS, BAY RUMS, BEAUTY CREAMS FOR BODY CARE, BEAUTY GELS, BEAUTY LOTIONS, BEAUTY MASKS, BEAUTY MILKS, BEAUTY SERUMS, BLUSH, BLUSH PENCILS, BODY AND BEAUTY CARE COSMETICS, BODY CREAM SOAP, BODY CREAMS, BODY EMULSIONS, BODY GLITTER, BODY LOTIONS, BODY MASK CREAM, BODY MASK LOTION, BODY MASK POWDER, BODY MASKS, BODY MILKS, BODY OILS, BODY POWDER, BODY SCRUB, BODY SPRAY USED AS A PERSONAL DEODORANT AND AS FRAGRANCE, BODY SPRAYS, NAMELY, WATER IN ATOMIZED CONTAINERS USED TO PRODUCE A COOLING EFFECT, BODY WASHES, BUBBLE BATH, CLEANSING CREAMS, COLD CREAMS, COLOGNE, COLOGNE WATER, COMPACTS CONTAINING MAKE-UP, CONCEALERS FOR FACE AND BODY, CONDITIONERS, COSMETIC CREAMS, COSMETIC CREAMS FOR SKIN CARE, COSMETIC FACIAL BLOTING PAPERS, COSMETIC MILKS, COSMETIC OILS, COSMETIC PADS, COSMETIC PENCILS, COSMETIC PREPARATIONS AGAINST SUNBURN, COSMETIC PREPARATIONS FOR BODY CARE, COSMETIC PREPARATIONS FOR EYE LASHES, COSMETIC PREPARATIONS FOR SKIN RENEWAL, COSMETIC PRODUCTS IN THE FORM OF AEROSOLS FOR SKIN CARE, COSMETIC ROUGES, COSMETIC SOAPS, COSMETIC SUN-PROTECTING PREPARATIONS, COSMETIC SUN-TANNING PREPARATIONS, COSMETIC SUNTAN LOTIONS, COSMETICS, COSMETICS NAMELY, COMPACTS, COSMETICS, NAMELY, LIP PRIMER, COSMETICS, NAMELY, LIP REPAIRERS, CREAM SOAPS, CREAMS

CLASS 3—(Continued).

FOR CELLULITE REDUCTION, CREAMY FACE POWDER, CREAMY FOUNDATION, CREAMY ROUGES, CUTICLE CONDITIONERS, CUTICLE CREAM, CUTICLE REMOVING PREPARATIONS, DEODORANT FOR PERSONAL USE, DEODORANT SOAP, DEODORANTS AND ANTIPERSPIRANTS, DEODORANTS FOR BODY CARE, DEPILATORIES, DEPILATORY CREAMS, DUSTING POWDER, EAU DE PARFUM, EAU DE TOILETTE, EMERY BOARDS, ESSENTIAL OILS FOR PERSONAL USE, EXFOLIANT CREAMS, EXFOLIANTS FOR SKIN, EYE COMPRESSES FOR COSMETIC PURPOSES, EYE CREAM, EYE GELS, EYE LINER, EYE LOTIONS, EYE MAKE-UP, EYE MAKE-UP REMOVER, EYE PENCILS, EYE SHADOWS, EYEBROW COLORS, EYEBROW PENCILS, EYELINER, EYESHADOWS, FACE AND BODY BEAUTY CREAMS, FACE AND BODY CREAMS, FACE AND BODY GLITTER, FACE AND BODY LOTIONS, FACE AND BODY MILK, FACE CREAMS, FACE CREAMS FOR COSMETIC USE, FACE GLITTER, FACE MILK AND LOTIONS, FACE POWDER, FACIAL BEAUTY MASKS, FACIAL CLEANSERS, FACIAL CLEANSING MILK, FACIAL CONCEALER, FACIAL CREAMS, FACIAL EMULSIONS, FACIAL LOTION, FACIAL MAKE-UP, FACIAL MASKS, FACIAL SCRUBS, FACIAL WASHES, FOAM BATH, FOAMS CONTAINING COSMETICS AND SUNSCREENS, FOOT DEODORANT SPRAY, NON-MEDICATED FOOT CREAM, NON-MEDICATED FOOT LOTION, FOOT POWDER, FOUNDATION, FRAGRANCE EMITTING WICKS FOR ROOM FRAGRANCE, FRAGRANCES FOR AUTOMOBILES, FRAGRANCES FOR PERSONAL USE, GEL EYE MASKS, HAIR CARE CREAMS, HAIR CARE KITS COMPRISING NON-MEDICATED HAIR CARE PREPARATIONS, NAMELY, SHAMPOO, CONDITIONER, HAIRSTYLING PREPARATIONS, HAIR CARE LOTIONS, HAIR CARE PREPARATIONS, HAIR CLEANING PREPARATIONS, HAIR CONDITIONERS, HAIR CREAMS, HAIR GELS, HAIR LOTIONS, HAIR POMADES, HAIR REMOVING CREAM, HAIR SHAMPOO, HAIR SPRAY, HAIR STYLING PREPARATIONS, HAIR TONICS, HAND CLEANSERS, HAND CLEANING PREPARATIONS, HAND CREAMS, HAND LOTIONS, HAND SOAPS, HAND WASH, INCENSE, LIP BALM, LIP CREAM, LIP GLOSS, LIP GLOSS PALATTE, LIP LINER, LIP POLISHER, LIPSTICK, LIPSTICK HOLDERS, LIPSTICKS, LIQUID BATH SOAPS, LIQUID PERFUMES, LIQUID SOAP, LIQUID SOAPS FOR HANDS, FACE AND BODY, LOOSE FACE POWDER, LOTIONS FOR CELLULITE REDUCTION, LOTIONS FOR FACE AND BODY CARE, LOTIONS FOR STRENGTHENING THE NAILS, LOTIONS FOR FACE AND BODY, MAKE UP REMOVING PREPARATIONS, MAKE-UP FOR THE FACE AND BODY, MAKE-UP KITS COMPRISED OF LIPSTICK, LIP GLOSS, BLUSH AND EYE SHADOW, MAKE-UP PENCILS, MAKE-UP POWDER, MAKE-UP REMOVER, MAKE-UP REMOVING LOTIONS, MAKE-UP REMOVING MILK, GEL, LOTIONS AND CREAMS, MASCARAS, MASSAGE OILS, MEDICATED SOAPS, MINERAL SALT IN THE NATURE OF BATH SALTS NOT FOR MEDICAL PURPOSES, MOISTURIZING CREAMS, MOISTURIZING MILKS, MOUSSE FOR HAIR, MOUTHWASHES, NAIL BUFFING PREPARATIONS, NAIL CARE PREPARATIONS, NAIL CARE PREPARATIONS, NAMELY, NAIL SOFTENERS, NAIL CREAM, NAIL ENAMEL, NAIL POLISH, NAIL POLISH REMOVERS, NIGHT CREAM, NON-MEDICATED ACNE TREATMENT PREPARATIONS, NON-MEDICATED BATH PREPARATIONS, NON-MEDICATED BODY SOAKS, NON-MEDICATED FOOT CREAM, NON-MEDICATED LIP CARE PREPARATIONS, NON-MEDICATED LIP PROTECTOR, NON-MEDICATED MOUTH WASH AND RINSE, NON-MEDICATED OINTMENTS FOR THE PREVENTION AND TREATMENT OF SUNBURN, NON-MEDICATED SCALP TREATMENT CREAM, NON-MEDICATED SKIN CARE PREPARATIONS, NON-MEDICATED SKIN CREAMS, NON-MEDICATED STIMULATING LOTIONS FOR THE SKIN, NON-MEDICATED SUN CARE PREPARATIONS, PARAFFIN WAX FOR COSMETIC PURPOSES, PATCHES CONTAINING SUN SCREEN AND SUN BLOCK FOR USE ON THE SKIN, PENCILS FOR COSMETIC PURPOSES, PERFUME, PERFUME OILS, PERFUMED CREAMS, PERFUMED POWDERS, PERFUMED SOAPS, PERFUMING SACHETS, PERSONAL DEODORANTS, POTPOURRI, PRE-MOISTENED COSMETIC TOWELETTES, PRE-SHAVE CREAMS, PRESSED FACE POWDER, ROOM FRAGRANCE REFILLS FOR NON-ELECTRIC ROOM FRAGRANCE DISPENSERS,

CLASS 3—(Continued).

ROOM FRAGRANCES, ROUGES, SPF SUNBLOCK TOWELETTES, SACHET-LIKE EYE PILLOWS CONTAINING FRAGRANCES, SACHETS, SCENTED BODY SPRAY, SCENTED CERAMIC STONES, SCENTED LINEN SPRAYS, SCENTED OILS USED TO PRODUCE AROMAS WHEN HEATED, SCENTED ROOM SPRAYS, SCULPTING GEL, SELF-TANNING PREPARATIONS, SHAMPOO-CONDITIONERS, SHAMPOOS, SHAVING BALM, SHAVING CREAMS, SHAVING FOAMS, SHAVING GELS, SHAVING LOTIONS, SHAVING MOUSSE, SHAVING PREPARATIONS, SHAVING SOAP, SHOWER AND BATH FOAM, SHOWER AND BATH GEL, SHOWER CREAMS, SHOWER GELS, SKIN BRONZER, SKIN BRONZING CREAMS, SKIN CARE PREPARATION, NAMELY, BODY POLISH, SKIN CARE PREPARATIONS, NAMELY, CHEMICAL PEELS FOR SKIN, SKIN CARE PRODUCTS, NAMELY, NON-MEDICATED SKIN SERUM, SKIN CLARIFIERS, SKIN CLEANSERS, SKIN CLEANSING CREAM, SKIN CLEANSING LOTION, SKIN CONDITIONERS, SKIN CREAMS, SKIN CREAMS IN LIQUID AND SOLID FORM, SKIN EMOLLIENTS, SKIN FIRMLING LOTION, SKIN GELS FOR ACCELERATING, ENHANCING OR EXTENDING TANS, SKIN LIGHTENING CREAMS, SKIN LOTIONS, SKIN MASKS, SKIN MOISTURIZER, SKIN MOISTURIZER MASKS, SKIN SOAP, SKIN TONERS, SOAPS FOR BODY CARE, SOAPS FOR PERSONAL USE, STYLING GELS, STYLING LOTIONS, STYLING MOUSSE, SUN BLOCK, SUN BLOCK PREPARATIONS, SUN CARE LOTIONS, SUN CREAMS, SUN SCREEN, SUN SCREEN PREPARATIONS, SUN TAN LOTION, SUN TAN OIL, SUN-BLOCK LOTIONS, SUNSCREEN CREAMS, SUN-TANNING PREPARATIONS, TANNING CREAMS, TOOTH PASTE, TOPICAL SKIN SPRAYS FOR COSMETIC PURPOSES, VANISHING CREAM, WAX FOR REMOVING BODY HAIR, WRINKLE REMOVING SKIN CARE PREPARATIONS, WRINKLE RESISTANT CREAM (U.S. CLS. 1, 4, 6, 50, 51 AND 52).

SEAN CROWLEY, EXAMINING ATTORNEY

SN 77-762,302. BATH & BODY WORKS BRAND MANAGEMENT, INC., REYNOLDSBURG, OH. FILED 6-17-2009.

SPORTWORKS

THE MARK CONSISTS OF STANDARD CHARACTERS WITHOUT CLAIM TO ANY PARTICULAR FONT, STYLE, SIZE, OR COLOR.

FOR PERSONAL CARE PRODUCTS, NAMELY, 3-IN-1 HAIR CONDITIONERS, 3-IN-1 HAIR SHAMPOOS, AFTER SUN CREAMS, AFTER-SHAVE, AFTER-SHAVE BALMS, AFTER-SHAVE CREAMS, AFTER-SHAVE EMULSIONS, AFTER-SHAVE GEL, AFTER-SHAVE LOTIONS, AFTER-SUN GELS, AFTER-SUN LOTIONS, AFTER-SUN OILS, AGE RETARDANT GEL, AGE RETARDANT LOTION, AGE SPOT REDUCING CREAMS, ANTI-AGING CREAM, ANTI-FRECKLE CREAMS, ANTI-PERSPIRANTS, ANTI-WRINKLE CREAMS, ANTI-BACTERIAL SKIN SOAPS, ANTIPERSPIRANTS FOR PERSONAL USE, AROMATHERAPY CREAMS, AROMATHERAPY LOTIONS, AROMATHERAPY OILS, ASTRINGENTS FOR COSMETIC PURPOSES, BATH BEADS, BATH CRYSTALS, BATH FOAMS, BATH GELS, BATH LOTION, BATH MILKS, BATH OILS FOR COSMETIC PURPOSES, BATH PEARLS, BATH POWDER, BATH SALTS, BATH SOAPS IN LIQUID, SOLID OR GEL FORM, BATHING LOTIONS, BAY RUMS, BEAUTY CREAMS FOR BODY CARE, BEAUTY GELS, BEAUTY LOTIONS, BEAUTY MASKS, BEAUTY MILKS, BEAUTY SERUMS, BLUSH, BLUSH PENCILS, BODY AND BEAUTY CARE COSMETICS, BODY CREAM SOAP, BODY CREAMS, BODY EMULSIONS, BODY GLITTER, BODY LOTIONS, BODY MASK CREAM, BODY MASK LOTION, BODY MASK POWDER, BODY MASKS, BODY MILKS, BODY OILS, BODY POWDER, BODY SCRUB,

CLASS 3—(Continued).

BODY SPRAY USED AS A PERSONAL DEODORANT AND AS FRAGRANCE, BODY SPRAYS, NAMELY, WATER IN ATOMIZED CONTAINERS USED TO PRODUCE A COOLING EFFECT, BODY WASHES, BUBBLE BATH, CLEANSING CREAMS, COLD CREAMS, COLOGNE, COLOGNE WATER, COMPACTS CONTAINING MAKE-UP, CONCEALERS FOR FACE AND BODY, CONDITIONERS, COSMETIC CREAMS, COSMETIC CREAMS FOR SKIN CARE, COSMETIC FACIAL BLOT-TING PAPERS, COSMETIC MILKS, COSMETIC OILS, COSMETIC PADS, COSMETIC PENCILS, COSMETIC PREPARATIONS AGAINST SUNBURN, COSMETIC PREPARATIONS FOR BODY CARE, COSMETIC PREPARATIONS FOR EYE LASHES, COSMETIC PREPARATIONS FOR SKIN RENEWAL, COSMETIC PRODUCTS IN THE FORM OF AEROSOLS FOR SKIN CARE, COSMETIC ROUGES, COSMETIC SOAPS, COSMETIC SUN-PROTECTING PREPARATIONS, COSMETIC SUN-TANNING PREPARATIONS, COSMETIC SUNTAN LOTIONS, COSMETICS, COSMETICS NAMELY, COMPACTS, COSMETICS, NAMELY, LIP PRIMER, COSMETICS, NAMELY, LIP REPAIRERS, CREAM SOAPS, CREAMS FOR CELLULITE REDUCTION, CREAMY FACE POWDER, CREAMY FOUNDATION, CREAMY ROUGES, CUTICLE CONDITIONERS, CUTICLE CREAM, CUTICLE REMOVING PREPARATIONS, DEODORANT FOR PERSONAL USE, DEODORANT SOAP, DEODORANTS AND ANTIPERSPIRANTS, DEODORANTS FOR BODY CARE, DEPILATORIES, DEPILATORY CREAMS, DUSTING POWDER, EAU DE PARFUM, EAU DE TOILETTE, EMERY BOARDS, ESSENTIAL OILS FOR PERSONAL USE, EXFOLIANT CREAMS, EXFOLIANTS FOR SKIN, EYE COMPRESSES FOR COSMETIC PURPOSES, EYE CREAM, EYE GELS, EYE LINER, EYE LOTIONS, EYE MAKE-UP, EYE MAKE-UP REMOVER, EYE PENCILS, EYE SHADOWS, EYEBROW COLORS, EYEBROW PENCILS, EYELINER, EYESHADOWS, FACE AND BODY BEAUTY CREAMS, FACE AND BODY CREAMS, FACE AND BODY GLITTER, FACE AND BODY LOTIONS, FACE AND BODY MILK, FACE CREAMS, FACE CREAMS FOR COSMETIC USE, FACE GLITTER, FACE MILK AND LOTIONS, FACE POWDER, FACIAL BEAUTY MASKS, FACIAL CLEANSERS, FACIAL CLEANSING MILK, FACIAL CONCEALER, FACIAL CREAMS, FACIAL EMULSIONS, FACIAL LOTION, FACIAL MAKE-UP, FACIAL MASKS, FACIAL SCRUBS, FACIAL WASHES, FOAM BATH, FOAMS CONTAINING COSMETICS AND SUNSCREENS, FOOT DEODORANT SPRAY, NON-MEDICATED FOOT CREAM, NON-MEDICATED FOOT LOTION, FOOT POWDER, FOUNDATION, FRAGRANCE EMITTING WICKS FOR ROOM FRAGRANCE, FRAGRANCES FOR AUTOMOBILES, FRAGRANCES FOR PERSONAL USE, GEL EYE MASKS, HAIR CARE CREAMS, HAIR CARE KITS COMPRISING NON-MEDICATED HAIR CARE PREPARATIONS, NAMELY, SHAMPOO, CONDITIONER, HAIRSTYLING PREPARATIONS, HAIR CARE LOTIONS, HAIR CARE PREPARATIONS, HAIR CLEANING PREPARATIONS, HAIR CONDITIONERS, HAIR CREAMS, HAIR GELS, HAIR LOTIONS, HAIR POMADES, HAIR REMOVING CREAM, HAIR SHAMPOO, HAIR SPRAY, HAIR STYLING PREPARATIONS, HAIR TONICS, HAND CLEANERS, HAND CLEANING PREPARATIONS, HAND CREAMS, HAND LOTIONS, HAND SOAPS, HAND WASH, INCENSE, LIP BALM, LIP CREAM, LIP GLOSS, LIP GLOSS PALATTE, LIP LINER, LIP POLISHER, LIPSTICK, LIPSTICK HOLDERS, LIPSTICKS, LIQUID BATH SOAPS, LIQUID PERFUMES, LIQUID SOAP, LIQUID SOAPS FOR HANDS, FACE AND BODY, LOOSE FACE POWDER, LOTIONS FOR CELLULITE REDUCTION, LOTIONS FOR FACE AND BODY CARE, LOTIONS FOR STRENGTHENING THE NAILS, LOTIONS FOR FACE AND BODY, MAKE UP REMOVING PREPARATIONS, MAKE-UP FOR THE FACE AND BODY, MAKE-UP KITS COMPRISED OF LIPSTICK, LIP GLOSS, BLUSH AND EYE SHADOW, MAKE-UP PENCILS, MAKE-UP POWDER, MAKE-UP REMOVER, MAKE-UP REMOVING LOTIONS, MAKE-UP REMOVING MILK, GEL, LOTIONS AND CREAMS, MASCARAS, MASSAGE OILS, MEDICATED SOAPS, MINERAL SALT IN THE NATURE OF BATH SALTS NOT FOR MEDICAL PURPOSES, MOISTURIZING CREAMS, MOISTURIZING MILKS, MOUSSE FOR HAIR, MOUTHWASHES, NAIL BUFFING PREPARATIONS, NAIL CARE PREPARATIONS, NAIL CARE PREPARATIONS, NAMELY, NAIL SOFTENERS, NAIL CREAM, NAIL ENAMEL, NAIL POLISH, NAIL POLISH REMOVERS, NIGHT CREAM,

CLASS 3—(Continued).

NON-MEDICATED ACNE TREATMENT PREPARATIONS, NON-MEDICATED BATH PREPARATIONS, NON-MEDICATED BODY SOAKS, NON-MEDICATED FOOT CREAM, NON-MEDICATED LIP CARE PREPARATIONS, NON-MEDICATED LIP PROTECTOR, NON-MEDICATED MOUTH WASH AND RINSE, NON-MEDICATED OINTMENTS FOR THE PREVENTION AND TREATMENT OF SUNBURN, NON-MEDICATED SCALP TREATMENT CREAM, NON-MEDICATED SKIN CARE PREPARATIONS, NON-MEDICATED SKIN CREAMS, NON-MEDICATED STIMULATING LOTIONS FOR THE SKIN, NON-MEDICATED SUN CARE PREPARATIONS, PARAFFIN WAX FOR COSMETIC PURPOSES, PATCHES CONTAINING SUN SCREEN AND SUN BLOCK FOR USE ON THE SKIN, PENCILS FOR COSMETIC PURPOSES, PERFUME, PERFUME OILS, PERFUMED CREAMS, PERFUMED POWDERS, PERFUMED SOAPS, PERFUMING SACHETS, PERSONAL DEODORANTS, POTPOURRI, PRE-MOISTENED COSMETIC TOWELETTES, PRE-SHAVE CREAMS, PRESSED FACE POWDER, ROOM FRAGRANCE REFILLS FOR NON-ELECTRIC ROOM FRAGRANCE DISPENSERS, ROOM FRAGRANCES, ROUGES, SPF SUNBLOCK TOWELETTES, SACHET-LIKE EYE PILLOWS CONTAINING FRAGRANCES, SACHETS, SCENTED BODY SPRAY, SCENTED CERAMIC STONES, SCENTED LINEN SPRAYS, SCENTED OILS USED TO PRODUCE AROMAS WHEN HEATED, SCENTED ROOM SPRAYS, SCULPTING GEL, SELF-TANNING PREPARATIONS, SHAMPOO-CONDITIONERS, SHAMPOOS, SHAVING BALM, SHAVING CREAMS, SHAVING FOAMS, SHAVING GELS, SHAVING LOTIONS, SHAVING MOUSSE, SHAVING PREPARATIONS, SHAVING SOAP, SHOWER AND BATH FOAM, SHOWER AND BATH GEL, SHOWER CREAMS, SHOWER GELS, SKIN BRONZER, SKIN BRONZING CREAMS, SKIN CARE PREPARATION, NAMELY, BODY POLISH, SKIN CARE PREPARATIONS, NAMELY, CHEMICAL PEELS FOR SKIN, SKIN CARE PRODUCTS, NAMELY, NON-MEDICATED SKIN SERUM, SKIN CLARIFIERS, SKIN CLEANSERS, SKIN CLEANSING CREAM, SKIN CLEANSING LOTION, SKIN CONDITIONERS, SKIN CREAMS, SKIN CREAMS IN LIQUID AND SOLID FORM, SKIN EMOLLIENTS, SKIN FIRING LOTION, SKIN GELS FOR ACCELERATING, ENHANCING OR EXTENDING TANS, SKIN LIGHTENING CREAMS, SKIN LOTIONS, SKIN MASKS, SKIN MOISTURIZER, SKIN MOISTURIZER MASKS, SKIN SOAP, SKIN TONERS, SOAPS FOR BODY CARE, SOAPS FOR PERSONAL USE, STYLING GELS, STYLING LOTIONS, STYLING MOUSSE, SUN BLOCK, SUN BLOCK PREPARATIONS, SUN CARE LOTIONS, SUN CREAMS, SUN SCREEN, SUN SCREEN PREPARATIONS, SUN TAN LOTION, SUN TAN OIL, SUN-BLOCK LOTIONS, SUNSCREEN CREAMS, SUN-TANNING PREPARATIONS, TANNING CREAMS, TOOTH PASTE, TOPICAL SKIN SPRAYS FOR COSMETIC PURPOSES, VANISHING CREAM, WAX FOR REMOVING BODY HAIR, WRINKLE REMOVING SKIN CARE PREPARATIONS, WRINKLE RESISTANT CREAM (U.S. CLS. 1, 4, 6, 50, 51 AND 52).

SEAN CROWLEY, EXAMINING ATTORNEY

CLASS 3—(Continued).

SN 77-762,310. BATH & BODY WORKS BRAND MANAGEMENT, INC., REYNOLDSBURG, OH. FILED 6-17-2009.

MENSWORKS

THE MARK CONSISTS OF STANDARD CHARACTERS WITHOUT CLAIM TO ANY PARTICULAR FONT, STYLE, SIZE, OR COLOR.

FOR PERSONAL CARE PRODUCTS, NAMELY, 3-IN-1 HAIR CONDITIONERS, 3-IN-1 HAIR SHAMPOOS, AFTER SUN CREAMS, AFTER-SHAVE, AFTER-SHAVE BALMS, AFTER-SHAVE CREAMS, AFTER-SHAVE EMULSIONS, AFTER-SHAVE GEL, AFTER-SHAVE LOTIONS, AFTER-SUN GELS, AFTER-SUN LOTIONS, AFTER-SUN OILS, AGE RETARDANT GEL, AGE RETARDANT LOTION, AGE SPOT REDUCING CREAMS, ANTI-AGING CREAM, ANTI-FRECKLE CREAMS, ANTI-PERSPIRANTS, ANTI-WRINKLE CREAMS, ANTI-BACTERIAL SKIN SOAPS, ANTIPERSPIRANTS FOR PERSONAL USE, AROMATHERAPY CREAMS, AROMATHERAPY LOTIONS, AROMATHERAPY OILS, ASTRINGENTS FOR COSMETIC PURPOSES, BATH BEADS, BATH CRYSTALS, BATH FOAMS, BATH GELS, BATH LOTION, BATH MILKS, BATH OILS FOR COSMETIC PURPOSES, BATH PEARLS, BATH POWDER, BATH SALTS, BATH SOAPS IN LIQUID, SOLID OR GEL FORM, BATHING LOTIONS, BAY RUMS, BEAUTY CREAMS FOR BODY CARE, BEAUTY GELS, BEAUTY LOTIONS, BEAUTY MASKS, BEAUTY MILKS, BEAUTY SERUMS, BLUSH, BLUSH PENCILS, BODY AND BEAUTY CARE COSMETICS, BODY CREAM SOAP, BODY CREAMS, BODY EMULSIONS, BODY GLITTER, BODY LOTIONS, BODY MASK CREAM, BODY MASK LOTION, BODY MASK POWDER, BODY MASKS, BODY MILKS, BODY OILS, BODY POWDER, BODY SCRUB, BODY SPRAY USED AS A PERSONAL DEODORANT AND AS FRAGRANCE, BODY SPRAYS, NAMELY, WATER IN ATOMIZED CONTAINERS USED TO PRODUCE A COOLING EFFECT, BODY WASHES, BUBBLE BATH, CLEANSING CREAMS, COLD CREAMS, COLOGNE, COLOGNE WATER, COMPACTS CONTAINING MAKE-UP, CONCEALERS FOR FACE AND BODY, CONDITIONERS, COSMETIC CREAMS, COSMETIC CREAMS FOR SKIN CARE, COSMETIC FACIAL BLOT-TING PAPERS, COSMETIC MILKS, COSMETIC OILS, COSMETIC PADS, COSMETIC PENCILS, COSMETIC PREPARATIONS AGAINST SUNBURN, COSMETIC PREPARATIONS FOR BODY CARE, COSMETIC PREPARATIONS FOR EYE LASHES, COSMETIC PREPARATIONS FOR SKIN RENEWAL, COSMETIC PRODUCTS IN THE FORM OF AEROSOLS FOR SKIN CARE, COSMETIC ROUGES, COSMETIC SOAPS, COSMETIC SUN-PROTECTING PREPARATIONS, COSMETIC SUN-TANNING PREPARATIONS, COSMETIC SUNTAN LOTIONS, COSMETICS, COSMETICS NAMELY, COMPACTS, COSMETICS, NAMELY, LIP PRIMER, COSMETICS, NAMELY, LIP REPAIRERS, CREAM SOAPS, CREAMS FOR CELLULITE REDUCTION, CREAMY FACE POWDER, CREAMY FOUNDATION, CREAMY ROUGES, CUTICLE CONDITIONERS, CUTICLE CREAM, CUTICLE REMOVING PREPARATIONS, DEODORANT FOR PERSONAL USE, DEODORANT SOAP, DEODORANTS AND ANTIPERSPIRANTS, DEODORANTS FOR BODY CARE, DEPILATORIES, DEPILATORY CREAMS, DUSTING POWDER, EAU DE PARFUM, EAU DE TOILETTE, EMERY BOARDS, ESSENTIAL OILS FOR PERSONAL USE, EXFOLIANT CREAMS, EXFOLIANTS FOR SKIN, EYE COMPRESSES FOR COSMETIC PURPOSES, EYE CREAM, EYE GELS, EYE LINER, EYE LOTIONS, EYE MAKE-UP, EYE MAKE-UP REMOVER, EYE PENCILS, EYE SHADOWS, EYEBROW COLORS, EYEBROW PENCILS, EYELINER, EYESHADOWS, FACE AND BODY BEAUTY CREAMS, FACE AND BODY CREAMS, FACE AND BODY GLITTER, FACE AND BODY LOTIONS, FACE AND BODY MILK, FACE CREAMS, FACE CREAMS FOR COSMETIC USE, FACE GLITTER, FACE MILK AND LOTIONS, FACE POWDER, FACIAL BEAUTY MASKS, FACIAL CLEANSERS, FACIAL CLEANSING MILK, FACIAL CONCEALER, FACIAL

CLASS 3—(Continued).

CREAMS, FACIAL EMULSIONS, FACIAL LOTION, FACIAL MAKE-UP, FACIAL MASKS, FACIAL SCRUBS, FACIAL WASHES, FOAM BATH, FOAMS CONTAINING COSMETICS AND SUNSCREENS, FOOT DEODORANT SPRAY, NON-MEDICATED FOOT CREAM, NON-MEDICATED FOOT LOTION, FOOT POWDER, FOUNDATION, FRAGRANCE EMITTING WICKS FOR ROOM FRAGRANCE, FRAGRANCES FOR AUTOMOBILES, FRAGRANCES FOR PERSONAL USE, GEL EYE MASKS, HAIR CARE CREAMS, HAIR CARE KITS COMPRISING NON-MEDICATED HAIR CARE PREPARATIONS, NAMELY, SHAMPOO, CONDITIONER, HAIRSTYLING PREPARATIONS, HAIR CARE LOTIONS, HAIR CARE PREPARATIONS, HAIR CLEANING PREPARATIONS, HAIR CONDITIONERS, HAIR CREAMS, HAIR GELS, HAIR LOTIONS, HAIR POMADES, HAIR REMOVING CREAM, HAIR SHAMPOO, HAIR SPRAY, HAIR STYLING PREPARATIONS, HAIR TONICS, HAND CLEANSERS, HAND CLEANING PREPARATIONS, HAND CREAMS, HAND LOTIONS, HAND SOAPS, HAND WASH, INCENSE, LIP BALM, LIP CREAM, LIP GLOSS, LIP GLOSS PALATTE, LIP LINER, LIP POLISHER, LIPSTICK, LIPSTICK HOLDERS, LIPSTICKS, LIQUID BATH SOAPS, LIQUID PERFUMES, LIQUID SOAP, LIQUID SOAPS FOR HANDS, FACE AND BODY, LOOSE FACE POWDER, LOTIONS FOR CELLULITE REDUCTION, LOTIONS FOR FACE AND BODY CARE, LOTIONS FOR STRENGTHENING THE NAILS, LOTIONS FOR FACE AND BODY, MAKE UP REMOVING PREPARATIONS, MAKE-UP FOR THE FACE AND BODY, MAKE-UP KITS COMPRISED OF LIPSTICK, LIP GLOSS, BLUSH AND EYE SHADOW, MAKE-UP PENCILS, MAKE-UP POWDER, MAKE-UP REMOVER, MAKE-UP REMOVING LOTIONS, MAKE-UP REMOVING MILK, GEL, LOTIONS AND CREAMS, MASCARAS, MASSAGE OILS, MEDICATED SOAPS, MINERAL SALT IN THE NATURE OF BATH SALTS NOT FOR MEDICAL PURPOSES, MOISTURIZING CREAMS, MOISTURIZING MILKS, MOUSSE FOR HAIR, MOUTHWASHES, NAIL BUFFING PREPARATIONS, NAIL CARE PREPARATIONS, NAIL CARE PREPARATIONS, NAMELY, NAIL SOFTENERS, NAIL CREAM, NAIL ENAMEL, NAIL POLISH, NAIL POLISH REMOVERS, NIGHT CREAM, NON-MEDICATED ACNE TREATMENT PREPARATIONS, NON-MEDICATED BATH PREPARATIONS, NON-MEDICATED BODY SOAKS, NON-MEDICATED FOOT CREAM, NON-MEDICATED LIP CARE PREPARATIONS, NON-MEDICATED LIP PROTECTOR, NON-MEDICATED MOUTH WASH AND RINSE, NON-MEDICATED OINTMENTS FOR THE PREVENTION AND TREATMENT OF SUNBURN, NON-MEDICATED SCALP TREATMENT CREAM, NON-MEDICATED SKIN CARE PREPARATIONS, NON-MEDICATED SKIN CREAMS, NON-MEDICATED STIMULATING LOTIONS FOR THE SKIN, NON-MEDICATED SUN CARE PREPARATIONS, PARAFFIN WAX FOR COSMETIC PURPOSES, PATCHES CONTAINING SUN SCREEN AND SUN BLOCK FOR USE ON THE SKIN, PENCILS FOR COSMETIC PURPOSES, PERFUME, PERFUME OILS, PERFUMED CREAMS, PERFUMED POWDERS, PERFUMED SOAPS, PERFUMING SACHETS, PERSONAL DEODORANTS, POTPOURRI, PRE-MOISTENED COSMETIC TOWELETES, PRE-SHAVE CREAMS, PRESSED FACE POWDER, ROOM FRAGRANCE REFILLS FOR NON-ELECTRIC ROOM FRAGRANCE DISPENSERS, ROOM FRAGRANCES, ROUGES, SPF SUNBLOCK TOWELETES, SACHET-LIKE EYE PILLOWS CONTAINING FRAGRANCES, SACHETS, SCENTED BODY SPRAY, SCENTED CERAMIC STONES, SCENTED LINEN SPRAYS, SCENTED OILS USED TO PRODUCE AROMAS WHEN HEATED, SCENTED ROOM SPRAYS, SCULPTING GEL, SELF-TANNING PREPARATIONS, SHAMPOO-CONDITIONERS, SHAMPOOS, SHAVING BALM, SHAVING CREAMS, SHAVING FOAMS, SHAVING GELS, SHAVING LOTIONS, SHAVING MOUSSE, SHAVING PREPARATIONS, SHAVING SOAP, SHOWER AND BATH FOAM, SHOWER AND BATH GEL, SHOWER CREAMS, SHOWER GELS, SKIN BRONZER, SKIN BRONZING CREAMS, SKIN CARE PREPARATION, NAMELY, BODY POLISH, SKIN CARE PREPARATIONS, NAMELY, CHEMICAL PEELS FOR SKIN, SKIN CARE PRODUCTS, NAMELY, NON-MEDICATED SKIN SERUM, SKIN CLARIFIERS, SKIN CLEANSERS, SKIN CLEANSING CREAM, SKIN CLEANSING LOTION, SKIN CONDITIONERS, SKIN CREAMS, SKIN CREAMS IN LIQUID AND SOLID FORM, SKIN EMOLLIENTS, SKIN FIRMING LOTION, SKIN GELS FOR

CLASS 3—(Continued).

ACCELERATING, ENHANCING OR EXTENDING TANS, SKIN LIGHTENING CREAMS, SKIN LOTIONS, SKIN MASKS, SKIN MOISTURIZER, SKIN MOISTURIZER MASKS, SKIN SOAP, SKIN TONERS, SOAPS FOR BODY CARE, SOAPS FOR PERSONAL USE, STYLING GELS, STYLING LOTIONS, STYLING MOUSSE, SUN BLOCK, SUN BLOCK PREPARATIONS, SUN CARE LOTIONS, SUN CREAMS, SUN SCREEN, SUN SCREEN PREPARATIONS, SUN TAN LOTION, SUN TAN OIL, SUN-BLOCK LOTIONS, SUNSCREEN CREAMS, SUN-TANNING PREPARATIONS, TANNING CREAMS, TOOTH PASTE, TOPICAL SKIN SPRAYS FOR COSMETIC PURPOSES, VANISHING CREAM, WAX FOR REMOVING BODY HAIR, WRINKLE REMOVING SKIN CARE PREPARATIONS, WRINKLE RESISTANT CREAM (U.S. CLS. 1, 4, 6, 50, 51 AND 52).

SEAN CROWLEY, EXAMINING ATTORNEY

SN 77-762,317. BATH & BODY WORKS BRAND MANAGEMENT, INC., REYNOLDSBURG, OH. FILED 6-17-2009.

ONWORKS

THE MARK CONSISTS OF STANDARD CHARACTERS WITHOUT CLAIM TO ANY PARTICULAR FONT, STYLE, SIZE, OR COLOR.

FOR PERSONAL CARE PRODUCTS, NAMELY, 3-IN-1 HAIR CONDITIONERS, 3-IN-1 HAIR SHAMPOOS, AFTER SUN CREAMS, AFTER-SHAVE, AFTER-SHAVE BALMS, AFTER-SHAVE CREAMS, AFTER-SHAVE EMULSIONS, AFTER-SHAVE GEL, AFTER-SHAVE LOTIONS, AFTER-SUN GELS, AFTER-SUN LOTIONS, AFTER-SUN OILS, AGE RETARDANT GEL, AGE RETARDANT LOTION, AGE SPOT REDUCING CREAMS, ANTI-AGING CREAM, ANTI-FRECKLE CREAMS, ANTI-PERSPIRANTS, ANTI-WRINKLE CREAMS, ANTI-BACTERIAL SKIN SOAPS, ANTIPERSPIRANTS FOR PERSONAL USE, AROMATHERAPY CREAMS, AROMATHERAPY LOTIONS, AROMATHERAPY OILS, ASTRINGENTS FOR COSMETIC PURPOSES, BATH BEADS, BATH CRYSTALS, BATH FOAMS, BATH GELS, BATH LOTION, BATH MILKS, BATH OILS FOR COSMETIC PURPOSES, BATH PEARLS, BATH POWDER, BATH SALTS, BATH SOAPS IN LIQUID, SOLID OR GEL FORM, BATHING LOTIONS, BAY RUMS, BEAUTY CREAMS FOR BODY CARE, BEAUTY GELS, BEAUTY LOTIONS, BEAUTY MASKS, BEAUTY MILKS, BEAUTY SERUMS, BLUSH, BLUSH PENCILS, BODY AND BEAUTY CARE COSMETICS, BODY CREAM SOAP, BODY CREAMS, BODY EMULSIONS, BODY GLITTER, BODY LOTIONS, BODY MASK CREAM, BODY MASK LOTION, BODY MASK POWDER, BODY MASKS, BODY MILKS, BODY OILS, BODY POWDER, BODY SCRUB, BODY SPRAY USED AS A PERSONAL DEODORANT AND AS FRAGRANCE, BODY SPRAYS, NAMELY, WATER IN ATOMIZED CONTAINERS USED TO PRODUCE A COOLING EFFECT, BODY WASHES, BUBBLE BATH, CLEANSING CREAMS, COLD CREAMS, COLOGNE, COLOGNE WATER, COMPACTS CONTAINING MAKE-UP, CONCEALERS FOR FACE AND BODY, CONDITIONERS, COSMETIC CREAMS, COSMETIC CREAMS FOR SKIN CARE, COSMETIC FACIAL BLOT- TING PAPERS, COSMETIC MILKS, COSMETIC OILS, COSMETIC PADS, COSMETIC PENCILS, COSMETIC PREPARATIONS AGAINST SUNBURN, COSMETIC PREPARATIONS FOR BODY CARE, COSMETIC PREPARATIONS FOR EYE LASHES, COSMETIC PREPARATIONS FOR SKIN RENEWAL, COSMETIC PRODUCTS IN THE FORM OF AEROSOLS FOR SKIN CARE, COSMETIC ROUGES, COSMETIC SOAPS, COSMETIC SUN-PROTECTING PREPARATIONS, COSMETIC SUN-TANNING PREPARATIONS, COSMETIC SUNTAN LOTIONS, COSMETICS, COSMETICS NAMELY, COMPACTS, COSMETICS, NAMELY, LIP PRIMER, COSMETICS, NAMELY, LIP REPAIRERS, CREAM SOAPS, CREAMS

CLASS 3—(Continued).

FOR CELLULITE REDUCTION, CREAMY FACE POWDER, CREAMY FOUNDATION, CREAMY ROUGES, CUTICLE CONDITIONERS, CUTICLE CREAM, CUTICLE REMOVING PREPARATIONS, DEODORANT FOR PERSONAL USE, DEODORANT SOAP, DEODORANTS AND ANTIPERSPIRANTS, DEODORANTS FOR BODY CARE, DEPILATORIES, DEPILATORY CREAMS, DUSTING POWDER, EAU DE PARFUM, EAU DE TOILETTE, EMERY BOARDS, ESSENTIAL OILS FOR PERSONAL USE, EXFOLIANT CREAMS, EXFOLIANTS FOR SKIN, EYE COMPRESSES FOR COSMETIC PURPOSES, EYE CREAM, EYE GELS, EYE LINER, EYE LOTIONS, EYE MAKE-UP, EYE MAKE-UP REMOVER, EYE PENCILS, EYE SHADOWS, EYEBROW COLORS, EYEBROW PENCILS, EYELINER, EYESHADOWS, FACE AND BODY BEAUTY CREAMS, FACE AND BODY CREAMS, FACE AND BODY GLITTER, FACE AND BODY LOTIONS, FACE AND BODY MILK, FACE CREAMS, FACE CREAMS FOR COSMETIC USE, FACE GLITTER, FACE MILK AND LOTIONS, FACE POWDER, FACIAL BEAUTY MASKS, FACIAL CLEANSERS, FACIAL CLEANSING MILK, FACIAL CONCEALER, FACIAL CREAMS, FACIAL EMULSIONS, FACIAL LOTION, FACIAL MAKE-UP, FACIAL MASKS, FACIAL SCRUBS, FACIAL WASHES, FOAM BATH, FOAMS CONTAINING COSMETICS AND SUNSCREENS, FOOT DEODORANT SPRAY, NON-MEDICATED FOOT CREAM, NON-MEDICATED FOOT LOTION, FOOT POWDER, FOUNDATION, FRAGRANCE EMITTING WICKS FOR ROOM FRAGRANCE, FRAGRANCES FOR AUTOMOBILES, FRAGRANCES FOR PERSONAL USE, GEL EYE MASKS, HAIR CARE CREAMS, HAIR CARE KITS COMPRISING NON-MEDICATED HAIR CARE PREPARATIONS, NAMELY, SHAMPOO, CONDITIONER, HAIRSTYLING PREPARATIONS, HAIR CARE LOTIONS, HAIR CARE PREPARATIONS, HAIR CLEANING PREPARATIONS, HAIR CONDITIONERS, HAIR CREAMS, HAIR GELS, HAIR LOTIONS, HAIR POMADES, HAIR REMOVING CREAM, HAIR SHAMPOO, HAIR SPRAY, HAIR STYLING PREPARATIONS, HAIR TONICS, HAND CLEANERS, HAND CLEANING PREPARATIONS, HAND CREAMS, HAND LOTIONS, HAND SOAPS, HAND WASH, INCENSE, LIP BALM, LIP CREAM, LIP GLOSS, LIP GLOSS PALATTE, LIP LINER, LIP POLISHER, LIPSTICK, LIPSTICK HOLDERS, LIPSTICKS, LIQUID BATH SOAPS, LIQUID PERFUMES, LIQUID SOAP, LIQUID SOAPS FOR HANDS, FACE AND BODY, LOOSE FACE POWDER, LOTIONS FOR CELLULITE REDUCTION, LOTIONS FOR FACE AND BODY CARE, LOTIONS FOR STRENGTHENING THE NAILS, LOTIONS FOR FACE AND BODY, MAKE UP REMOVING PREPARATIONS, MAKE-UP FOR THE FACE AND BODY, MAKE-UP KITS COMPRISED OF LIPSTICK, LIP GLOSS, BLUSH AND EYE SHADOW, MAKE-UP PENCILS, MAKE-UP POWDER, MAKE-UP REMOVER, MAKE-UP REMOVING LOTIONS, MAKE-UP REMOVING MILK, GEL, LOTIONS AND CREAMS, MASCARAS, MASSAGE OILS, MEDICATED SOAPS, MINERAL SALT IN THE NATURE OF BATH SALTS NOT FOR MEDICAL PURPOSES, MOISTURIZING CREAMS, MOISTURIZING MILKS, MOUSSE FOR HAIR, MOUTHWASHES, NAIL BUFFING PREPARATIONS, NAIL CARE PREPARATIONS, NAIL CARE PREPARATIONS, NAMELY, NAIL SOFTENERS, NAIL CREAM, NAIL ENAMEL, NAIL POLISH, NAIL POLISH REMOVERS, NIGHT CREAM, NON-MEDICATED ACNE TREATMENT PREPARATIONS, NON-MEDICATED BATH PREPARATIONS, NON-MEDICATED BODY SOAKS, NON-MEDICATED FOOT CREAM, NON-MEDICATED LIP CARE PREPARATIONS, NON-MEDICATED LIP PROTECTOR, NON-MEDICATED MOUTH WASH AND RINSE, NON-MEDICATED OINTMENTS FOR THE PREVENTION AND TREATMENT OF SUNBURN, NON-MEDICATED SCALP TREATMENT CREAM, NON-MEDICATED SKIN CARE PREPARATIONS, NON-MEDICATED SKIN CREAMS, NON-MEDICATED STIMULATING LOTIONS FOR THE SKIN, NON-MEDICATED SUN CARE PREPARATIONS, PARAFFIN WAX FOR COSMETIC PURPOSES, PATCHES CONTAINING SUN SCREEN AND SUN BLOCK FOR USE ON THE SKIN, PENCILS FOR COSMETIC PURPOSES, PERFUME, PERFUME OILS, PERFUMED CREAMS, PERFUMED POWDERS, PERFUMED SOAPS, PERFUMING SACHETS, PERSONAL DEODORANTS, POTPOURRI, PRE-MOISTENED COSMETIC TOWELETTES, PRE-SHAVE CREAMS, PRESSED FACE POWDER, ROOM FRAGRANCE REFILLS FOR NON-ELECTRIC ROOM FRAGRANCE DISPENSERS,

CLASS 3—(Continued).

ROOM FRAGRANCES, ROUGES, SPF SUNBLOCK TOWELETTES, SACHET-LIKE EYE PILLOWS CONTAINING FRAGRANCES, SACHETS, SCENTED BODY SPRAY, SCENTED CERAMIC STONES, SCENTED LINEN SPRAYS, SCENTED OILS USED TO PRODUCE AROMAS WHEN HEATED, SCENTED ROOM SPRAYS, SCULPTING GEL, SELF-TANNING PREPARATIONS, SHAMPOO-CONDITIONERS, SHAMPOOS, SHAVING BALM, SHAVING CREAMS, SHAVING FOAMS, SHAVING GELS, SHAVING LOTIONS, SHAVING MOUSSE, SHAVING PREPARATIONS, SHAVING SOAP, SHOWER AND BATH FOAM, SHOWER AND BATH GEL, SHOWER CREAMS, SHOWER GELS, SKIN BRONZER, SKIN BRONZING CREAMS, SKIN CARE PREPARATION, NAMELY, BODY POLISH, SKIN CARE PREPARATIONS, NAMELY, CHEMICAL PEELS FOR SKIN, SKIN CARE PRODUCTS, NAMELY, NON-MEDICATED SKIN SERUM, SKIN CLARIFIERS, SKIN CLEANSERS, SKIN CLEANSING CREAM, SKIN CLEANSING LOTION, SKIN CONDITIONERS, SKIN CREAMS, SKIN CREAMS IN LIQUID AND SOLID FORM, SKIN EMOLLIENTS, SKIN FIRING LOTION, SKIN GELS FOR ACCELERATING, ENHANCING OR EXTENDING TANS, SKIN LIGHTENING CREAMS, SKIN LOTIONS, SKIN MASKS, SKIN MOISTURIZER, SKIN MOISTURIZER MASKS, SKIN SOAP, SKIN TONERS, SOAPS FOR BODY CARE, SOAPS FOR PERSONAL USE, STYLING GELS, STYLING LOTIONS, STYLING MOUSSE, SUN BLOCK, SUN BLOCK PREPARATIONS, SUN CARE LOTIONS, SUN CREAMS, SUN SCREEN, SUN SCREEN PREPARATIONS, SUN TAN LOTION, SUN TAN OIL, SUN-BLOCK LOTIONS, SUNSCREEN CREAMS, SUN-TANNING PREPARATIONS, TANNING CREAMS, TOOTH PASTE, TOPICAL SKIN SPRAYS FOR COSMETIC PURPOSES, VANISHING CREAM, WAX FOR REMOVING BODY HAIR, WRINKLE REMOVING SKIN CARE PREPARATIONS, WRINKLE RESISTANT CREAM (U.S. CLS. 1, 4, 6, 50, 51 AND 52).

SEAN CROWLEY, EXAMINING ATTORNEY

SN 77-762,319. BATH & BODY WORKS BRAND MANAGEMENT, INC., REYNOLDSBURG, OH. FILED 6-17-2009.

ECOWORKS

THE MARK CONSISTS OF STANDARD CHARACTERS WITHOUT CLAIM TO ANY PARTICULAR FONT, STYLE, SIZE, OR COLOR.

FOR PERSONAL CARE PRODUCTS, NAMELY, 3-IN-1 HAIR CONDITIONERS, 3-IN-1 HAIR SHAMPOOS, AFTER SUN CREAMS, AFTER-SHAVE, AFTER-SHAVE BALMS, AFTER-SHAVE CREAMS, AFTER-SHAVE EMULSIONS, AFTER-SHAVE GEL, AFTER-SHAVE LOTIONS, AFTER-SUN GELS, AFTER-SUN LOTIONS, AFTER-SUN OILS, AGE RETARDANT GEL, AGE RETARDANT LOTION, AGE SPOT REDUCING CREAMS, ANTI-AGING CREAM, ANTI-FRECKLE CREAMS, ANTI-PERSPIRANTS, ANTI-WRINKLE CREAMS, ANTI-BACTERIAL SKIN SOAPS, ANTIPERSPIRANTS FOR PERSONAL USE, AROMATHERAPY CREAMS, AROMATHERAPY LOTIONS, AROMATHERAPY OILS, ASTRINGENTS FOR COSMETIC PURPOSES, BATH BEADS, BATH CRYSTALS, BATH FOAMS, BATH GELS, BATH LOTION, BATH MILKS, BATH OILS FOR COSMETIC PURPOSES, BATH PEARLS, BATH POWDER, BATH SALTS, BATH SOAPS IN LIQUID, SOLID OR GEL FORM, BATHING LOTIONS, BAY RUMS, BEAUTY CREAMS FOR BODY CARE, BEAUTY GELS, BEAUTY LOTIONS, BEAUTY MASKS, BEAUTY MILKS, BEAUTY SERUMS, BLUSH, BLUSH PENCILS, BODY AND BEAUTY CARE COSMETICS, BODY CREAM SOAP, BODY CREAMS, BODY EMULSIONS, BODY GLITTER, BODY LOTIONS, BODY MASK CREAM, BODY MASK LOTION, BODY MASK POWDER, BODY MASKS, BODY MILKS, BODY OILS, BODY POWDER, BODY SCRUB,

CLASS 3—(Continued).

BODY SPRAY USED AS A PERSONAL DEODORANT AND AS FRAGRANCE, BODY SPRAYS, NAMELY, WATER IN ATOMIZED CONTAINERS USED TO PRODUCE A COOLING EFFECT, BODY WASHES, BUBBLE BATH, CLEANSING CREAMS, COLD CREAMS, COLOGNE, COLOGNE WATER, COMPACTS CONTAINING MAKE-UP, CONCEALERS FOR FACE AND BODY, CONDITIONERS, COSMETIC CREAMS, COSMETIC CREAMS FOR SKIN CARE, COSMETIC FACIAL BLOT- TING PAPERS, COSMETIC MILKS, COSMETIC OILS, COSMETIC PADS, COSMETIC PENCILS, COSMETIC PREPARATIONS AGAINST SUNBURN, COSMETIC PREPARATIONS FOR BODY CARE, COSMETIC PREPARATIONS FOR EYE LASHES, COSMETIC PREPARATIONS FOR SKIN RENEWAL, COSMETIC PRODUCTS IN THE FORM OF AEROSOLS FOR SKIN CARE, COSMETIC ROUGES, COSMETIC SOAPS, COSMETIC SUN-PROTECTING PREPARATIONS, COSMETIC SUN-TANNING PREPARATIONS, COSMETIC SUNTAN LOTIONS, COSMETICS, COSMETICS NAMELY, COMPACTS, COSMETICS, NAMELY, LIP PRIMER, COSMETICS, NAMELY, LIP REPAIRERS, CREAM SOAPS, CREAMS FOR CELLULITE REDUCTION, CREAMY FACE POWDER, CREAMY FOUNDATION, CREAMY ROUGES, CUTICLE CONDITIONERS, CUTICLE CREAM, CUTICLE REMOVING PREPARATIONS, DEODORANT FOR PERSONAL USE, DEODORANT SOAP, DEODORANTS AND ANTIPERSPIRANTS, DEODORANTS FOR BODY CARE, DEPILATORIES, DEPILATORY CREAMS, DUSTING POWDER, EAU DE PARFUM, EAU DE TOILETTE, EMERY BOARDS, ESSENTIAL OILS FOR PERSONAL USE, EXFOLIANT CREAMS, EXFOLIANTS FOR SKIN, EYE COMPRESSES FOR COSMETIC PURPOSES, EYE CREAM, EYE GELS, EYE LINER, EYE LOTIONS, EYE MAKE-UP, EYE MAKE-UP REMOVER, EYE PENCILS, EYE SHADOWS, EYEBROW COLORS, EYEBROW PENCILS, EYELINER, EYESHADOWS, FACE AND BODY BEAUTY CREAMS, FACE AND BODY CREAMS, FACE AND BODY GLITTER, FACE AND BODY LOTIONS, FACE AND BODY MILK, FACE CREAMS, FACE CREAMS FOR COSMETIC USE, FACE GLITTER, FACE MILK AND LOTIONS, FACE POWDER, FACIAL BEAUTY MASKS, FACIAL CLEANSERS, FACIAL CLEANSING MILK, FACIAL CONCEALER, FACIAL CREAMS, FACIAL EMULSIONS, FACIAL LOTION, FACIAL MAKE-UP, FACIAL MASKS, FACIAL SCRUBS, FACIAL WASHES, FOAM BATH, FOAMS CONTAINING COSMETICS AND SUNSCREENS, FOOT DEODORANT SPRAY, NON-MEDICATED FOOT CREAM, NON-MEDICATED FOOT LOTION, FOOT POWDER, FOUNDATION, FRAGRANCE EMITTING WICKS FOR ROOM FRAGRANCE, FRAGRANCES FOR AUTOMOBILES, FRAGRANCES FOR PERSONAL USE, GEL EYE MASKS, HAIR CARE CREAMS, HAIR CARE KITS COMPRISING NON-MEDICATED HAIR CARE PREPARATIONS, NAMELY, SHAMPOO, CONDITIONER, HAIRSTYLING PREPARATIONS, HAIR CARE LOTIONS, HAIR CARE PREPARATIONS, HAIR CLEANING PREPARATIONS, HAIR CONDITIONERS, HAIR CREAMS, HAIR GELS, HAIR LOTIONS, HAIR POMADES, HAIR REMOVING CREAM, HAIR SHAMPOO, HAIR SPRAY, HAIR STYLING PREPARATIONS, HAIR TONICS, HAND CLEANERS, HAND CLEANING PREPARATIONS, HAND CREAMS, HAND LOTIONS, HAND SOAPS, HAND WASH, INCENSE, LIP BALM, LIP CREAM, LIP GLOSS, LIP GLOSS PALATTE, LIP LINER, LIP POLISHER, LIPSTICK, LIPSTICK HOLDERS, LIPSTICKS, LIQUID BATH SOAPS, LIQUID PERFUMES, LIQUID SOAP, LIQUID SOAPS FOR HANDS, FACE AND BODY, LOOSE FACE POWDER, LOTIONS FOR CELLULITE REDUCTION, LOTIONS FOR FACE AND BODY CARE, LOTIONS FOR STRENGTHENING THE NAILS, LOTIONS FOR FACE AND BODY, MAKE UP REMOVING PREPARATIONS, MAKE-UP FOR THE FACE AND BODY, MAKE-UP KITS COMPRISED OF LIPSTICK, LIP GLOSS, BLUSH AND EYE SHADOW, MAKE-UP PENCILS, MAKE-UP POWDER, MAKE-UP REMOVER, MAKE-UP REMOVING LOTIONS, MAKE-UP REMOVING MILK, GEL, LOTIONS AND CREAMS, MASCARAS, MASSAGE OILS, MEDICATED SOAPS, MINERAL SALT IN THE NATURE OF BATH SALTS NOT FOR MEDICAL PURPOSES, MOISTURIZING CREAMS, MOISTURIZING MILKS, MOUSSE FOR HAIR, MOUTHWASHES, NAIL BUFFING PREPARATIONS, NAIL CARE PREPARATIONS, NAIL CARE PREPARATIONS, NAMELY, NAIL SOFTENERS, NAIL CREAM, NAIL ENAMEL, NAIL POLISH, NAIL POLISH REMOVERS, NIGHT CREAM,

CLASS 3—(Continued).

NON-MEDICATED ACNE TREATMENT PREPARATIONS, NON-MEDICATED BATH PREPARATIONS, NON-MEDICATED BODY SOAKS, NON-MEDICATED FOOT CREAM, NON-MEDICATED LIP CARE PREPARATIONS, NON-MEDICATED LIP PROTECTOR, NON-MEDICATED MOUTH WASH AND RINSE, NON-MEDICATED OINTMENTS FOR THE PREVENTION AND TREATMENT OF SUNBURN, NON-MEDICATED SCALP TREATMENT CREAM, NON-MEDICATED SKIN CARE PREPARATIONS, NON-MEDICATED SKIN CREAMS, NON-MEDICATED STIMULATING LOTIONS FOR THE SKIN, NON-MEDICATED SUN CARE PREPARATIONS, PARAFFIN WAX FOR COSMETIC PURPOSES, PATCHES CONTAINING SUN SCREEN AND SUN BLOCK FOR USE ON THE SKIN, PENCILS FOR COSMETIC PURPOSES, PERFUME, PERFUME OILS, PERFUMED CREAMS, PERFUMED POWDERS, PERFUMED SOAPS, PERFUMING SACHETS, PERSONAL DEODORANTS, POTPOURRI, PRE-MOISTENED COSMETIC TOWELETTES, PRE-SHAVE CREAMS, PRESSED FACE POWDER, ROOM FRAGRANCE REFILLS FOR NON-ELECTRIC ROOM FRAGRANCE DISPENSERS, ROOM FRAGRANCES, ROUGES, SPF SUNBLOCK TOWELETTES, SACHET-LIKE EYE PILLOWS CONTAINING FRAGRANCES, SACHETS, SCENTED BODY SPRAY, SCENTED CERAMIC STONES, SCENTED LINEN SPRAYS, SCENTED OILS USED TO PRODUCE AROMAS WHEN HEATED, SCENTED ROOM SPRAYS, SCULPTING GEL, SELF-TANNING PREPARATIONS, SHAMPOO-CONDITIONERS, SHAMPOOS, SHAVING BALM, SHAVING CREAMS, SHAVING FOAMS, SHAVING GELS, SHAVING LOTIONS, SHAVING MOUSSE, SHAVING PREPARATIONS, SHAVING SOAP, SHOWER AND BATH FOAM, SHOWER AND BATH GEL, SHOWER CREAMS, SHOWER GELS, SKIN BRONZER, SKIN BRONZING CREAMS, SKIN CARE PREPARATION, NAMELY, BODY POLISH, SKIN CARE PREPARATIONS, NAMELY, CHEMICAL PEELS FOR SKIN, SKIN CARE PRODUCTS, NAMELY, NON-MEDICATED SKIN SERUM, SKIN CLARIFIERS, SKIN CLEANSERS, SKIN CLEANSING CREAM, SKIN CLEANSING LOTION, SKIN CONDITIONERS, SKIN CREAMS, SKIN CREAMS IN LIQUID AND SOLID FORM, SKIN EMOLLIENTS, SKIN FIRMLING LOTION, SKIN GELS FOR ACCELERATING, ENHANCING OR EXTENDING TANS, SKIN LIGHTENING CREAMS, SKIN LOTIONS, SKIN MASKS, SKIN MOISTURIZER, SKIN MOISTURIZER MASKS, SKIN SOAP, SKIN TONERS, SOAPS FOR BODY CARE, SOAPS FOR PERSONAL USE, STYLING GELS, STYLING LOTIONS, STYLING MOUSSE, SUN BLOCK, SUN BLOCK PREPARATIONS, SUN CARE LOTIONS, SUN CREAMS, SUN SCREEN, SUN SCREEN PREPARATIONS, SUN TAN LOTION, SUN TAN OIL, SUN-BLOCK LOTIONS, SUNSCREEN CREAMS, SUN-TANNING PREPARATIONS, TANNING CREAMS, TOOTH PASTE, TOPICAL SKIN SPRAYS FOR COSMETIC PURPOSES, VANISHING CREAM, WAX FOR REMOVING BODY HAIR, WRINKLE REMOVING SKIN CARE PREPARATIONS, WRINKLE RESISTANT CREAM (U.S. CLS. 1, 4, 6, 50, 51 AND 52).

SEAN CROWLEY, EXAMINING ATTORNEY

SN 77-762,645. L'OREAL USA CREATIVE, INC., NEW YORK, NY. FILED 6-18-2009.

24HR BOLD

THE MARK CONSISTS OF STANDARD CHARACTERS WITHOUT CLAIM TO ANY PARTICULAR FONT, STYLE, SIZE, OR COLOR.

NO CLAIM IS MADE TO THE EXCLUSIVE RIGHT TO USE "24 HR", APART FROM THE MARK AS SHOWN.

FOR MASCARA (U.S. CLS. 1, 4, 6, 50, 51 AND 52).

JOHN HWANG, EXAMINING ATTORNEY

CLASS 3—(Continued).

SN 77-763,238. REVLON CONSUMER PRODUCTS CORPORATION, NEW YORK, NY. FILED 6-18-2009.

REVLON COLORBURST

THE MARK CONSISTS OF STANDARD CHARACTERS WITHOUT CLAIM TO ANY PARTICULAR FONT, STYLE, SIZE, OR COLOR.

OWNER OF U.S. REG. NOS. 1,625,545, 3,035,671 AND OTHERS.

FOR LIPSTICK (U.S. CLS. 1, 4, 6, 50, 51 AND 52).
ODESSA BIBBINS, EXAMINING ATTORNEY

SN 77-764,873. L'OREAL, PARIS, FRANCE, FILED 6-22-2009.

EVERSTRONG

THE MARK CONSISTS OF STANDARD CHARACTERS WITHOUT CLAIM TO ANY PARTICULAR FONT, STYLE, SIZE, OR COLOR.

FOR HAIR CARE PREPARATIONS AND NON-MEDICATED HAIR TREATMENT PREPARATIONS (U.S. CLS. 1, 4, 6, 50, 51 AND 52).

JENNIFER HETU, EXAMINING ATTORNEY

SN 77-766,240. PARIS PRESENTS INCORPORATED, GURNEE, IL. FILED 6-23-2009.

PASSION FOR CHANGE

THE MARK CONSISTS OF STANDARD CHARACTERS WITHOUT CLAIM TO ANY PARTICULAR FONT, STYLE, SIZE, OR COLOR.

FOR BODY SPRAYS (U.S. CLS. 1, 4, 6, 50, 51 AND 52).
JENNIFER VASQUEZ, EXAMINING ATTORNEY

CLASS 3—(Continued).

SN 77-766,302. PARIS PRESENTS INCORPORATED, GURNEE, IL. FILED 6-23-2009.

RIPE FOR GIVING

THE MARK CONSISTS OF STANDARD CHARACTERS WITHOUT CLAIM TO ANY PARTICULAR FONT, STYLE, SIZE, OR COLOR.
FOR BODY SPRAYS (U.S. CLS. 1, 4, 6, 50, 51 AND 52).
JENNIFER VASQUEZ, EXAMINING ATTORNEY

SN 77-768,442. HALO, PURELY FOR PETS, INC., TAMPA, FL. FILED 6-25-2009.

HOLISTICLEAN

THE MARK CONSISTS OF STANDARD CHARACTERS WITHOUT CLAIM TO ANY PARTICULAR FONT, STYLE, SIZE, OR COLOR.
FOR PET ODOR REMOVERS; PET STAIN REMOVERS (U.S. CLS. 1, 4, 6, 50, 51 AND 52).
FRED MANDIR, EXAMINING ATTORNEY

SN 77-775,245. SCHERING-PLOUGH HEALTHCARE PRODUCTS, INC., MEMPHIS, TN. FILED 7-7-2009.



THE COLOR(S) WHITE, YELLOW, BLUE, TAN, AND GRAY IS/ARE CLAIMED AS A FEATURE OF THE MARK.
THE MARK CONSISTS OF A WHITE BACKGROUND WITH A DESIGN OF A SEMI-ROUND YELLOW SUN; A STYLIZED SWIRL OF BLUE WATER, A STYLIZED SWIRL OF TAN SAND AND A STYLIZED SWIRL OF GRAY UNDERNEATH THE SUN.
FOR SUN BLOCK PREPARATIONS; SUN SCREEN PREPARATIONS (U.S. CLS. 1, 4, 6, 50, 51 AND 52).
KIM MONINGHOFF, EXAMINING ATTORNEY

CLASS 3—(Continued).

SN 77-780,285. L'OREAL USA CREATIVE, INC., NEW YORK, NY. FILED 7-14-2009.

THE CLASSIC VOLUM' EXPRESS

THE MARK CONSISTS OF STANDARD CHARACTERS WITHOUT CLAIM TO ANY PARTICULAR FONT, STYLE, SIZE, OR COLOR.
OWNER OF U.S. REG. NOS. 2,221,985, 3,551,550 AND OTHERS.
FOR MASCARA (U.S. CLS. 1, 4, 6, 50, 51 AND 52).
JOHN HWANG, EXAMINING ATTORNEY

SN 77-780,362. L'OREAL USA CREATIVE, INC., NEW YORK, NY. FILED 7-15-2009.

THE TURBO VOLUM' EXPRESS

THE MARK CONSISTS OF STANDARD CHARACTERS WITHOUT CLAIM TO ANY PARTICULAR FONT, STYLE, SIZE, OR COLOR.
OWNER OF U.S. REG. NOS. 2,221,985, 2,934,223 AND 3,551,550.
FOR MASCARA (U.S. CLS. 1, 4, 6, 50, 51 AND 52).
JOHN HWANG, EXAMINING ATTORNEY

SN 77-781,714. L'OREAL USA CREATIVE, INC., NEW YORK, NY. FILED 7-15-2009.

**MIDNIGHT RECOVERY
CONCENTRATE**

THE MARK CONSISTS OF STANDARD CHARACTERS WITHOUT CLAIM TO ANY PARTICULAR FONT, STYLE, SIZE, OR COLOR.
NO CLAIM IS MADE TO THE EXCLUSIVE RIGHT TO USE "CONCENTRATE", APART FROM THE MARK AS SHOWN.
FOR NON-MEDICATED SKIN CARE PREPARATIONS (U.S. CLS. 1, 4, 6, 50, 51 AND 52).
JOHN HWANG, EXAMINING ATTORNEY

CLASS 3—(Continued).

SN 77-782,888. L'OREAL USA CREATIVE, INC., NEW YORK, NY. FILED 7-16-2009.

COLOURISTS' SOLUTION

THE MARK CONSISTS OF STANDARD CHARACTERS WITHOUT CLAIM TO ANY PARTICULAR FONT, STYLE, SIZE, OR COLOR.

OWNER OF U.S. REG. NO. 2,259,199.
FOR HAIR CARE PREPARATIONS AND NON-MEDICATED HAIR AND SCALP TREATMENT PREPARATIONS (U.S. CLS. 1, 4, 6, 50, 51 AND 52).
JOHN HWANG, EXAMINING ATTORNEY

SN 78-638,254. TENEBRUSO, RALPH, NESCONSET, NY. FILED 5-26-2005.

CALLIE GIRL

THE MARK CONSISTS OF STANDARD CHARACTERS WITHOUT CLAIM TO ANY PARTICULAR FONT, STYLE, SIZE, OR COLOR.

OWNER OF U.S. REG. NO. 3,012,144.
NO CLAIM IS MADE TO THE EXCLUSIVE RIGHT TO USE "GIRL", APART FROM THE MARK AS SHOWN.
FOR COSMETICS (U.S. CLS. 1, 4, 6, 50, 51 AND 52).
NANCY CLARKE, EXAMINING ATTORNEY

SN 78-641,791. SOAP & GLORY LIMITED, LONDON, UNITED KINGDOM, FILED 6-2-2005.

science friction

THE MARK CONSISTS OF STANDARD CHARACTERS WITHOUT CLAIM TO ANY PARTICULAR FONT, STYLE, SIZE, OR COLOR.

OWNER OF UNITED KINGDOM REG. NO. 6619, DATED 1-6-2006, EXPIRES 6-22-2015.
FOR FACIAL EXFOLIATING SCRUBS, BODY EXFOLIATING SCRUBS, FACIAL AND BODY EXFOLIATING GELS, FACIAL AND BODY EXFOLIATING MASKS (U.S. CLS. 1, 4, 6, 50, 51 AND 52).
SOPHIA S. KIM, EXAMINING ATTORNEY

CLASS 3—(Continued).

SN 78-734,213. BATH & BODY WORK BRAND MANAGEMENT, INC., REYNOLDSBURG, OH. FILED 10-17-2005.

FLOWER TRICKS

THE MARK CONSISTS OF STANDARD CHARACTERS WITHOUT CLAIM TO ANY PARTICULAR FONT, STYLE, SIZE, OR COLOR.

FOR LIP BALM, SUN BLOCK FOR LIPS, LIP GLOSS, LIP PAINT, NON-MEDICATED LIP PROTECTOR, LIP SHINE, LIP TINT, NON-MEDICATED LIP TREATMENT PREPARATION, NAIL POLISH, EYE MAKEUP, MAKEUP, EYE CREAM, BLUSH, CREAM BLUSH, EYE LINER, MASCARA, NAIL LACQUER, EYE SHADOW POWDER, CHEEK STAIN, SKIN BRONZING CREAMS, NAMELY, BODY BRONZER, FACE BRONZING GEL, LEG BRONZING SPRAY (U.S. CLS. 1, 4, 6, 50, 51 AND 52).
JUSTINE D. PARKER, EXAMINING ATTORNEY

SN 78-809,277. DOUGLAS GLEASON ESTATES, LLC, LOS ANGELES, CA. FILED 2-7-2006.

TrueBlue

THE MARK CONSISTS OF STANDARD CHARACTERS WITHOUT CLAIM TO ANY PARTICULAR FONT, STYLE, SIZE, OR COLOR.

OWNER OF U.S. REG. NO. 3,382,664.
FOR NON-MEDICATED PET BATHING AND GROOMING PRODUCTS, NAMELY, PET SHAMPOO, PET CONDITIONER, PET CREAM RINSE, PET DETANGLING SPRAY; NON-MEDICATED PET HEALTH CARE PRODUCTS, NAMELY, PET DENTAL CLEANING WIPES AND PET EAR CLEANING WIPES (U.S. CLS. 1, 4, 6, 50, 51 AND 52).
DEBRA LEE, EXAMINING ATTORNEY

SN 79-062,164. WORLD BEAUTY DIRECT LTD, TORTOLA, BR. VIRGIN ISLANDS, FILED 10-17-2008.

SKINVITALS

The new face of skin care

OWNER OF INTERNATIONAL REGISTRATION 0868572 DATED 10-28-2005, EXPIRES 10-28-2015.

FOR SKIN AND BODY CARE PREPARATIONS, NAMELY, FACIAL MOISTURISERS, SKIN CARE PREPARATIONS, FACIAL AND BODY CREAMS AND LOTIONS; COSMETICS; NON-MEDICATED TOILETRIES; PERFUMES (U.S. CLS. 1, 4, 6, 50, 51 AND 52).
LINDA MICKLEBURGH, EXAMINING ATTORNEY

CLASS 3—(Continued).

SN 79-064,790. PARFUMS GIVENCHY, FRANCE, FILED 12-9-2008.

2 CLEAN TO BE TRUE

PRIORITY DATE OF 6-17-2008 IS CLAIMED.
OWNER OF INTERNATIONAL REGISTRATION 0991847
DATED 12-9-2008, EXPIRES 12-9-2018.

THE MARK CONSISTS OF THE WORD "2 CLEAN TO BE TRUE".

FOR COSMETIC PRODUCTS FOR REMOVING MAKE-UP (U.S. CLS. 1, 4, 6, 50, 51 AND 52).
MARCIE MILONE, EXAMINING ATTORNEY

SN 79-065,272. PARFUMS CHRISTIAN DIOR, FRANCE, FILED 12-19-2008.

ESCALE A PONDICHERY

PRIORITY DATE OF 6-20-2008 IS CLAIMED.
OWNER OF INTERNATIONAL REGISTRATION 0993162
DATED 12-19-2008, EXPIRES 12-19-2018.

OWNER OF U.S. REG. NO. 3,530,088.
THE ENGLISH TRANSLATION OF "ESCALE A PONDICHERY" IN THE MARK IS STOPOVER IN PONDICHERY.

FOR PERFUMES AND EAUX DE TOILETTE (U.S. CLS. 1, 4, 6, 50, 51 AND 52).
ROBERT STRUCK, EXAMINING ATTORNEY

SN 79-065,364. PARFUMS CHRISTIAN DIOR, FRANCE, FILED 1-20-2009.

LES RHUMBS

OWNER OF INTERNATIONAL REGISTRATION 0993421
DATED 1-20-2009, EXPIRES 1-20-2019.

THE ENGLISH TRANSLATION OF "LES RHUMBS" IN THE MARK IS THE RHUMBS.

FOR SCENTED TOILET SOAPS FOR BODY CARE; PERFUMES; EAUX DE COLOGNE; TOILET WATER; ESSENTIAL OILS FOR PERSONAL USE; MILKS, LOTIONS, CREAMS, EMULSIONS, AND SCENTED GEL COSMETICS, ALL FOR THE FACE AND BODY; DEODORANTS FOR PERSONAL USE; HAIR LOTIONS (U.S. CLS. 1, 4, 6, 50, 51 AND 52).

ROBERT STRUCK, EXAMINING ATTORNEY

SN 79-065,365. PARFUMS CHRISTIAN DIOR, FRANCE, FILED 1-20-2009.

GRANVILLE

OWNER OF INTERNATIONAL REGISTRATION 0993422
DATED 1-20-2009, EXPIRES 1-20-2019.

FOR SCENTED TOILET SOAPS FOR BODY CARE; PERFUMES; EAUX DE COLOGNE; TOILET WATER; ESSENTIAL OILS FOR PERSONAL USE; MILKS, LOTIONS, CREAMS, EMULSIONS, AND SCENTED GEL COSMETICS, ALL FOR THE FACE AND BODY; DEODORANTS FOR PERSONAL USE; HAIR LOTIONS (U.S. CLS. 1, 4, 6, 50, 51 AND 52).

ROBERT STRUCK, EXAMINING ATTORNEY

CLASS 3—(Continued).

SN 79-065,483. THIERRY MUGLER PARFUMS S.A.S., FRANCE, FILED 1-6-2009.

WOMANITY

THE MARK CONSISTS OF STANDARD CHARACTERS WITHOUT CLAIM TO ANY PARTICULAR FONT, STYLE, SIZE, OR COLOR.

PRIORITY DATE OF 7-8-2008 IS CLAIMED.

OWNER OF INTERNATIONAL REGISTRATION 0993781
DATED 1-6-2009, EXPIRES 1-6-2019.

FOR PERFUMES, TOILET WATER, EAU DE COLOGNE, BATH AND SHOWER PREPARATIONS FOR COSMETIC PURPOSES, DEODORANTS FOR PERSONAL USE, PERFUMED SOAPS, PERFUMED TALCUM POWDER, SCENTED COSMETIC CREAMS, SCENTED COSMETIC LOTIONS, NON-MEDICATED LOTIONS AND GELS FOR SKIN CARE, PERFUMERY, COSMETICS, HAIR LOTIONS (U.S. CLS. 1, 4, 6, 50, 51 AND 52).

AMEETA JORDAN, EXAMINING ATTORNEY

SN 79-066,196. MOSLEM AHMAD, UKRAINE, FILED 12-31-2008.



OWNER OF INTERNATIONAL REGISTRATION 0995801
DATED 12-31-2008, EXPIRES 12-31-2018.

NO CLAIM IS MADE TO THE EXCLUSIVE RIGHT TO USE "COLLECTION", APART FROM THE MARK AS SHOWN.

FOR LIPSTICKS, EYE SHADOWS, NAIL POLISH, COMPACT FACE POWDER, COSMETIC PENCILS, EYEBROW PENCILS, MAKE-UP POWDER, COSMETIC CREAMS, LOTIONS FOR COSMETIC PURPOSES, MASSAGE CREAMS, MILK FOR COSMETIC PURPOSES, MASCARA, HAIR OILS, CREAMY FOUNDATIONS, FOUNDATIONS, SHAMPOOS, AFTER-SHAVE LOTIONS, ALMOND SOAPS, ANTIBACTERIAL SKIN SOAPS, ANTIBACTERIAL SOAP, BAR SOAP, BATH SOAPS, BATH SOAPS IN LIQUID, SOLID OR GEL FORM, BODY CREAM SOAP, CAKES OF TOILET SOAP, COSMETIC SOAPS, CREAM SOAPS, DEODORANT SOAP, DETERGENT SOAP, DISINFECTANT SOAPS, DISINFECTING PERFUMED SOAPS, GRANULATED SOAPS, HAND SOAPS, INDUSTRIAL SOAP, LAUNDRY SOAP, LIQUID BATH SOAPS, LIQUID SOAP, LIQUID SOAP USED IN FOOT BATH, LIQUID SOAPS, LIQUID SOAPS FOR HANDS, FACE AND BODY, LIQUID SOAPS FOR HANDS AND FACE, LOOFAH SOAPS, MEDICATED SOAPS, PERFUMED SOAPS, SADDLE SOAP, SHAVING SOAP, SKIN SOAP, TOILET WATERS, PERFUMES (U.S. CLS. 1, 4, 6, 50, 51 AND 52).

KRISTINA MORRIS, EXAMINING ATTORNEY

CLASS 3—(Continued).

SN 79-066,289. GROUPE LEA NATURE, FRANCE, FILED 6-2-2008.

NATESSANCE

THE MARK CONSISTS OF STANDARD CHARACTERS WITHOUT CLAIM TO ANY PARTICULAR FONT, STYLE, SIZE, OR COLOR.

OWNER OF INTERNATIONAL REGISTRATION 0996084 DATED 6-2-2008, EXPIRES 6-2-2018.

THE WORDING "NATESSANCE" HAS NO MEANING IN A FOREIGN LANGUAGE.

FOR ALUM STONES FOR PERSONAL COSMETIC USE, COSMETIC PREPARATIONS FOR SLIMMING PURPOSES, SUN-TANNING PREPARATIONS, COSMETIC NON-MEDICATED BATH PREPARATIONS, BATH SALTS NOT FOR MEDICAL PURPOSES, SHAVING SOAP, BEAUTY MASKS, SKIN WHITENING CREAMS, HAIR LOTIONS, COSMETIC PREPARATIONS FOR EYELASHES, DEPILATORY WAX, EAU-DE-COLOGNE, DECORATIVE TRANSFERS FOR COSMETIC PURPOSES, COSMETICS, COSMETIC PENCILS, COSMETIC CREAM, MAKE-UP REMOVING PREPARATIONS, DENTIFRICES, DEODORANTS FOR PERSONAL USE, TOILET WATER, INCENSE, MAKE-UP, AQUEOUS AROMATIC ADDITIVES FOR USE IN THE MANUFACTURE OF ROOM FRESHENERS AND COSMETICS, FUMIGATION INCENSES AND AROMATHERAPY OILS, OILS FOR TOILETRY PURPOSES, ESSENTIAL OILS, OILS FOR PERFUMES AND SCENTS, CLEANSING MILKS, LIPSTICK, LOTIONS FOR COSMETIC PURPOSES, AFTER-SHAVE LOTIONS, MAKE-UP PREPARATIONS, NAIL CARE PREPARATIONS, PERFUMES, POMADES FOR COSMETIC PURPOSES, PUMICE STONE FOR PERSONAL USE, POTPOURRIS, MAKE-UP POWDER, SHAVING PREPARATIONS, SOAPS, TISSUES IMPREGNATED WITH COSMETIC LOTIONS, EYEBROW COSMETICS, EYEBROW PENCILS, COSMETIC DYES, NAMELY, HAIR DYES (U.S. CLS. 1, 4, 6, 50, 51 AND 52).

SCOTT BIBB, EXAMINING ATTORNEY

CLASS 4—(Continued).

SN 77-461,045. STONESTREET STABLES, LLC, LEXINGTON, KY. FILED 4-29-2008.

CURLIN

THE MARK CONSISTS OF STANDARD CHARACTERS WITHOUT CLAIM TO ANY PARTICULAR FONT, STYLE, SIZE, OR COLOR.

FOR CANDLES (U.S. CLS. 1, 6 AND 15).

THEODORE MCBRIDE, EXAMINING ATTORNEY

SN 77-622,773. PACIFIC TRADE INTERNATIONAL, INC., ROCKVILLE, MD. FILED 11-26-2008.

MODERN LIGHT**CLASS 4—LUBRICANTS AND FUELS**

SN 77-203,420. PROPEC INC., LACHENAIE, CANADA, FILED 6-11-2007.



PRIORITY CLAIMED UNDER SEC. 44(D) ON CANADA APPLICATION NO. 1350409, FILED 6-6-2007.

OWNER OF CANADA REG. NO. TMA735410, DATED 2-27-2009, EXPIRES 2-27-2024.

NO CLAIM IS MADE TO THE EXCLUSIVE RIGHT TO USE "ODOR", APART FROM THE MARK AS SHOWN.

THE MARK CONSISTS OF THE WORDS "THE ODOR" IN A TEXT BUBBLE AND THE WORD "CATCHER" BELOW.

FOR CANDLES (U.S. CLS. 1, 6 AND 15).

ADA HAN, EXAMINING ATTORNEY

THE MARK CONSISTS OF STANDARD CHARACTERS WITHOUT CLAIM TO ANY PARTICULAR FONT, STYLE, SIZE, OR COLOR.

NO CLAIM IS MADE TO THE EXCLUSIVE RIGHT TO USE "LIGHT", APART FROM THE MARK AS SHOWN.

FOR SCENTED CANDLES, NAMELY, SCENTED PILLAR CANDLES; SCENTED FILLED CANDLES; SCENTED TEA LIGHT CANDLES; SCENTED CANDLE GIFT SETS, NAMELY, FILLED SCENTED MINI-LAMP CANDLES, SCENTED PILLAR CANDLES, SCENTED VOTIVE CANDLES, SCENTED TEA LIGHT CANDLES, AND SCENTED DINNER LIGHT CANDLES IN GLASS, WOOD AND METAL CONTAINERS AND CANDLE PLATES, ALL SOLD AS A UNIT; AND SCENTED CANDLE GARDENS, NAMELY; SCENTED CANDLES IN GLASS, WOOD AND METAL CONTAINERS AND CANDLE PLATES TOGETHER WITH COLORED AND WHITE ROCKS, ALL SOLD AS A UNIT (U.S. CLS. 1, 6 AND 15).

FIRST USE 7-12-2009; IN COMMERCE 7-12-2009.

SANI KHOURI, EXAMINING ATTORNEY

CLASS 4—(Continued).

SN 77-622,783. PACIFIC TRADE INTERNATIONAL, INC.,
ROCKVILLE, MD. FILED 11-26-2008.

REFRESHAIR

THE MARK CONSISTS OF STANDARD CHARACTERS WITHOUT CLAIM TO ANY PARTICULAR FONT, STYLE, SIZE, OR COLOR.

FOR SCENTED CANDLES, NAMELY, SCENTED PILLAR CANDLES; SCENTED FILLED CANDLES; SCENTED TEA LIGHT CANDLES; SCENTED CANDLE GIFT SETS, NAMELY, FILLED SCENTED MINI-LAMP CANDLES, SCENTED PILLAR CANDLES, SCENTED VOTIVE CANDLES, SCENTED TEA LIGHT CANDLES, AND SCENTED DINNER LIGHT CANDLES IN GLASS, WOOD AND METAL CONTAINERS AND CANDLE PLATES, ALL SOLD AS A UNIT; AND SCENTED CANDLE GARDENS, NAMELY, SCENTED CANDLES IN GLASS, WOOD AND METAL CONTAINERS AND CANDLE PLATES TOGETHER WITH COLORED AND WHITE ROCKS, ALL SOLD AS A UNIT (U.S. CLS. 1, 6 AND 15).

FIRST USE 7-12-2009; IN COMMERCE 7-12-2009.
SANI KHOURI, EXAMINING ATTORNEY

CLASS 4—(Continued).

SN 77-715,296. KRISTI SHANKS, DBA KISSED BY KC,
WALDORF, MD. FILED 4-16-2009.



THE COLOR(S) BROWN, AQUA, AND WHITE IS/ARE CLAIMED AS A FEATURE OF THE MARK.

THE MARK CONSISTS OF THE STYLIZED WORDING "KISSED BY KC" IN WHITE WITH A WHITE HALO AND WHITE RAYS OF LIGHT EMANATING FROM IT APPEARING ABOVE THE WORD "KISSED," WHICH ALL APPEARS WITHIN AN AQUA CIRCLE WITH SCALLOPED EDGES, BELOW WHICH IS THE STYLIZED WORDING "TOTAL WELLBEING. NATURALLY." IN AQUA, ALL AGAINST A BROWN BACKGROUND WITH AQUA BORDER.

FOR SCENTED CANDLES (U.S. CLS. 1, 6 AND 15).
FIRST USE 2-1-2009; IN COMMERCE 4-1-2009.
ANDREW LEASER, EXAMINING ATTORNEY

SN 77-722,677. NEWPOINT GAS, LP, COLLEGE STATION,
TX. FILED 4-27-2009.

AmiCalc

THE MARK CONSISTS OF STANDARD CHARACTERS WITHOUT CLAIM TO ANY PARTICULAR FONT, STYLE, SIZE, OR COLOR.

FOR NATURAL GAS (U.S. CLS. 1, 6 AND 15).
FIRST USE 4-1-2009; IN COMMERCE 4-1-2009.
MORGAN WYNNE, EXAMINING ATTORNEY

SN 77-639,726. VERN LEWIS WELDING SUPPLY INC.,
AVONDALE, AZ. FILED 12-24-2008.

ALTANE

THE MARK CONSISTS OF STANDARD CHARACTERS WITHOUT CLAIM TO ANY PARTICULAR FONT, STYLE, SIZE, OR COLOR.

FOR PROPANE GAS SOLD IN CYLINDERS FOR USE IN TORCHES (U.S. CLS. 1, 6 AND 15).
FIRST USE 12-1-2005; IN COMMERCE 1-1-2006.
WILLIAM ROSSMAN, EXAMINING ATTORNEY

SN 77-723,467. JETER, JAMES, LAGUNA HILLS, CA. AND
LAWRENCE, KENNETH, LAGUNA HILLS, CA. FILED 4-
27-2009.

**Aromachology, we move you
forward**

THE MARK CONSISTS OF STANDARD CHARACTERS WITHOUT CLAIM TO ANY PARTICULAR FONT, STYLE, SIZE, OR COLOR.

NO CLAIM IS MADE TO THE EXCLUSIVE RIGHT TO USE "AROMACHOLOGY", APART FROM THE MARK AS SHOWN.

FOR CANDLES; SCENTED CANDLES (U.S. CLS. 1, 6 AND 15).
KEVIN DINALLO, EXAMINING ATTORNEY

CLASS 4—(Continued).

SN 77-723,690. CARLINO, CRISTINA M., PARADISE VALLEY, AZ. FILED 4-28-2009.

ART OF GRACE

THE MARK CONSISTS OF STANDARD CHARACTERS WITHOUT CLAIM TO ANY PARTICULAR FONT, STYLE, SIZE, OR COLOR.

OWNER OF U.S. REG. NO. 3,581,660.
FOR CANDLE-MAKING KITS; CANDLES (U.S. CLS. 1, 6 AND 15).
JUDITH HELFMAN, EXAMINING ATTORNEY

CLASS 4—(Continued).

SN 77-724,489. FUGLERUD, GERALD, ESTEVAN, SK, CANADA, FILED 4-28-2009.

XM-5

THE MARK CONSISTS OF STANDARD CHARACTERS WITHOUT CLAIM TO ANY PARTICULAR FONT, STYLE, SIZE, OR COLOR.

FOR NON-CHEMICAL OIL ADDITIVE FOR COMBUSTION ENGINES, HYDRAULIC SYSTEMS, AUTOMATIC TRANSMISSIONS AND GEAR ASSEMBLIES (U.S. CLS. 1, 6 AND 15).

FIRST USE 12-14-1979; IN COMMERCE 4-30-1986.
GINA HAYES, EXAMINING ATTORNEY

SN 77-723,819. PAUL FRANKE, BOULDER, CO. FILED 4-28-2009.



NO CLAIM IS MADE TO THE EXCLUSIVE RIGHT TO USE "BIODIESEL", APART FROM THE MARK AS SHOWN. THE COLOR(S) GREEN, LIGHT GREEN, BLACK, WHITE IS/ARE CLAIMED AS A FEATURE OF THE MARK.

THE MARK CONSISTS OF THE WORDING "LEAP" APPEARS IN THE COLOR GREEN AND IN STYLIZED FONT AND IN ALL CAPITAL LETTERS, A LINE IS MISSING FROM THE A IN THE WORDING "LEAP", BELOW THE WORDING "LEAP" APPEARS THE WORDING "BIODIESEL", THE WORDING "BIODIESEL" APPEARS IN THE COLOR BLACK AND STYLIZED FONT AND IN ALL LOWER CASE LETTERING, ABOVE THE "A" AND "P" IN THE WORDING "LEAP" APPEARS A GREEN FROG LEAPING TO THE RIGHT, THE FROG'S BODY IS LIGHT GREEN WITH THREE GREEN SPOTS APPEARING ON THE FROG'S BACK AND THE STOMACH OF THE FROG APPEARING IN GREEN, THE FROG'S EYE LID IS GREEN, THE FROG'S EYE BALL IS WHITE AND THE CENTER OF THE EYEBALL IS BLACK.

FOR BIOFUELS; FOSSIL FUEL SUBSTITUTES, NAMELY, BIOFUELS (U.S. CLS. 1, 6 AND 15).
TRACY FLETCHER, EXAMINING ATTORNEY

CLASS 5—PHARMACEUTICALS

SN 76-690,312. NAMDARI, BAHRAM, MILWAUKEE, WI. FILED 6-6-2008.

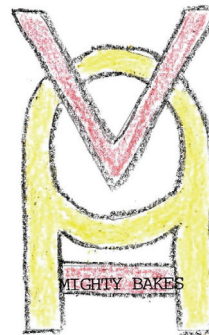

THE COLOR(S) RED, YELLOW, BLACK AND WHITE IS/ARE CLAIMED AS A FEATURE OF THE MARK.

THE MARK CONSISTS OF THE COLOR WHITE: APPEARS AS BACKGROUND DESIGN; COLOR BLACK: OUTLINES AND COMPANY NAME "MIGHTY BAKES"; COLOR RED: THE LETTER "V" AND THE HORIZONTAL LINE RUNNING BENEATH THE LETTER "O"; COLOR YELLOW: THE LETTER "O" AND THE VERTICAL LINES RUNNING BELOW EACH SIDE; COMPANY NAME: "MIGHTY BAKES" APPEARS ON THE HORIZONTAL LINE RUNNING BENEATH THE LETTER "O".

FOR HIGH PROTEIN POWDER FOR USE AS A NUTRITIONAL SUPPLEMENT IN VARIOUS BAKED GOODS (U.S. CLS. 6, 18, 44, 46, 51 AND 52).
RUSS HERMAN, EXAMINING ATTORNEY

CLASS 5—(Continued).

SN 76-696,600. VITALITY CORPORATION, RENO, NV.
FILED 4-1-2009.



NO CLAIM IS MADE TO THE EXCLUSIVE RIGHT TO USE "WEIGHT LOSS", APART FROM THE MARK AS SHOWN.

THE MARK CONSISTS OF THE WORDS "4-WAY" HYPHENATED BY AN ARROW DISPOSED ABOVE THE WORDS "WEIGHT LOSS"; FOUR ARROWS POINTING IN OPPOSITE VERTICAL AND HORIZONTAL DIRECTIONS; AND STREAKS EMANATING FROM THE MIDDLE OF THE MARK WITHIN THE MARK AND INTERMEDIATE THE VERTICAL AND HORIZONTAL ARROWS.

FOR DIETARY SUPPLEMENTS (U.S. CLS. 6, 18, 44, 46, 51 AND 52).

FIRST USE 2-1-2009; IN COMMERCE 2-1-2009.
ANDREA SAUNDERS, EXAMINING ATTORNEY

SN 76-697,190. UCKELE ANIMAL HEALTH DISTRIBUTING CO., DBA UCKELE HEALTH & NUTRITION, INC., BLISSFIELD, MI. FILED 5-4-2009.

COCOSOYA

THE MARK CONSISTS OF STANDARD CHARACTERS WITHOUT CLAIM TO ANY PARTICULAR FONT, STYLE, SIZE, OR COLOR.

FOR NUTRITIONAL SUPPLEMENTS (U.S. CLS. 6, 18, 44, 46, 51 AND 52).

FIRST USE 6-30-1982; IN COMMERCE 6-30-1982.
DAVID C. REIHNER, EXAMINING ATTORNEY

SN 77-012,756. GLOBAL UNIQUE PRODUCTS CORPORATION, NORTH HILLS, NY. FILED 10-3-2006.

PIKUP

THE MARK CONSISTS OF STANDARD CHARACTERS WITHOUT CLAIM TO ANY PARTICULAR FONT, STYLE, SIZE, OR COLOR.

FOR VITAMIN FORTIFIED BEVERAGES; VITAMIN PREPARATIONS (U.S. CLS. 6, 18, 44, 46, 51 AND 52).
JOHN LINCOSKI, EXAMINING ATTORNEY

CLASS 5—(Continued).

SN 77-111,883. MOSKOWITZ, BARRY, BROOKLYN, NY.
FILED 2-20-2007.

Superior Tasting & A Healthy Choice

THE MARK CONSISTS OF STANDARD CHARACTERS WITHOUT CLAIM TO ANY PARTICULAR FONT, STYLE, SIZE, OR COLOR.

NO CLAIM IS MADE TO THE EXCLUSIVE RIGHT TO USE "SUPERIOR TASTING", APART FROM THE MARK AS SHOWN.

FOR NUTRITIONALLY FORTIFIED BEVERAGES (U.S. CLS. 6, 18, 44, 46, 51 AND 52).

FIRST USE 2-15-2007; IN COMMERCE 2-15-2007.
RICHARD WHITE, EXAMINING ATTORNEY

SN 77-115,101. ELSAFY, TAMER, CAPE CORAL, FL. FILED 2-23-2007.

Flexcin with CM8

THE MARK CONSISTS OF STANDARD CHARACTERS WITHOUT CLAIM TO ANY PARTICULAR FONT, STYLE, SIZE, OR COLOR.

OWNER OF U.S. REG. NO. 2,939,913.

FOR VITAMIN AND MINERAL SUPPLEMENTS; VITAMIN SUPPLEMENTS (U.S. CLS. 6, 18, 44, 46, 51 AND 52).

WENDY GOODMAN, EXAMINING ATTORNEY

SN 77-130,146. NEW LIFE TECHNOLOGY, INC., DAWSON, GA. FILED 3-13-2007.

HEALTH TO GO

THE MARK CONSISTS OF STANDARD CHARACTERS WITHOUT CLAIM TO ANY PARTICULAR FONT, STYLE, SIZE, OR COLOR.

NO CLAIM IS MADE TO THE EXCLUSIVE RIGHT TO USE "HEALTH", APART FROM THE MARK AS SHOWN.

FOR MINERAL SUPPLEMENTS; NUTRITIONAL SUPPLEMENTS; VITAMIN SUPPLEMENTS; DIETARY SUPPLEMENTS; DIETARY FOOD SUPPLEMENTS; VITAMINS; ALL OF THE ABOVE FORMULATED AS A LIQUID SPRAY CAPSULE, TABLET OR LIQUID MARKETED FOR DAILY CONSUMPTION (U.S. CLS. 6, 18, 44, 46, 51 AND 52).

FIRST USE 9-25-2006; IN COMMERCE 9-25-2006.
WILLIAM ROSSMAN, EXAMINING ATTORNEY

CLASS 5—(Continued).

SN 77-147,936. ASHTON SYNDICATE, LAS VEGAS, NV.
FILED 4-3-2007.

SLIMTABS

THE MARK CONSISTS OF STANDARD CHARACTERS
WITHOUT CLAIM TO ANY PARTICULAR FONT, STYLE,
SIZE, OR COLOR.

FOR HERBAL SUPPLEMENTS (U.S. CLS. 6, 18, 44, 46,
51 AND 52).

MELVIN AXILBUND, EXAMINING ATTORNEY

SN 77-215,703. NOVARTIS AG, BASEL, SWITZERLAND,
FILED 6-26-2007.

SENTINEL SPECTRUM

THE MARK CONSISTS OF STANDARD CHARACTERS
WITHOUT CLAIM TO ANY PARTICULAR FONT, STYLE,
SIZE, OR COLOR.

OWNER OF SWITZERLAND REG. NO. 543706, DATED 3-
9-2006, EXPIRES 2-23-2016.

FOR COMBINATION ORAL FLEA AND WORM CON-
TROL PREPARATIONS FOR DOGS AND CATS (U.S.
CLS. 6, 18, 44, 46, 51 AND 52).

HEATHER SAPP, EXAMINING ATTORNEY

SN 77-238,175. ULTRADENT PRODUCTS, INC., SOUTH
JORDAN, UT. FILED 7-25-2007.

PEAK

THE MARK CONSISTS OF STANDARD CHARACTERS
WITHOUT CLAIM TO ANY PARTICULAR FONT, STYLE,
SIZE, OR COLOR.

FOR BONDING AND PRIMER MATERIALS FOR
DENTAL PURPOSES (U.S. CLS. 6, 18, 44, 46, 51 AND 52).

DAVID MURRAY, EXAMINING ATTORNEY

CLASS 5—(Continued).

SN 77-263,426. SASKATOON COLOSTRUM COMPANY
LTD., THE, SASKATOON, SK, CANADA, FILED 8-24-2007.

AFTER COLOSTRUM

THE MARK CONSISTS OF STANDARD CHARACTERS
WITHOUT CLAIM TO ANY PARTICULAR FONT, STYLE,
SIZE, OR COLOR.

NO CLAIM IS MADE TO THE EXCLUSIVE RIGHT TO
USE "COLOSTRUM", APART FROM THE MARK AS
SHOWN.

FOR DIETARY SUPPLEMENT, ANIMAL FEED AD-
DITIVE FOR USE AS A NUTRITIONAL OR IMMUNE
SUPPLEMENT CONTAINING DRIED BOVINE COLOS-
TRUM (U.S. CLS. 6, 18, 44, 46, 51 AND 52).

AMOS T. MATTHEWS, JR., EXAMINING ATTORNEY

SN 77-295,013. NHC LIMITED, SURREY CR7 8LZ, UNITED
KINGDOM, FILED 10-3-2007.

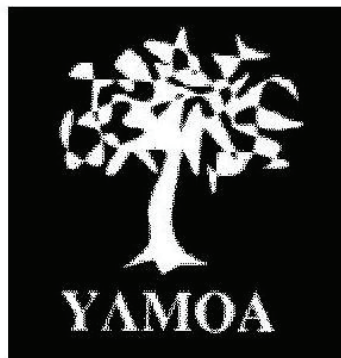

OWNER OF UNITED KINGDOM REG. NO. 2310167,
DATED 7-9-2004, EXPIRES 9-9-2012.

SEC. 2(F) AS TO "YAMOA".

FOR HERBAL PREPARATIONS CONTAINING TREE
BARK FROM THE FUNTUMIA ELASTICA GUM TREE,
IN POWDER AND CAPSULE FORM FOR THE SUPPORT
OF THE RESPIRATORY SYSTEM (U.S. CLS. 6, 18, 44, 46,
51 AND 52).

NAKWAMA ANKRAH, EXAMINING ATTORNEY

CLASS 5—(Continued).

SN 77-302,434. HISAMITSU PHARMACEUTICAL CO., INC., SAGA, JAPAN, FILED 10-12-2007.

SALONPAS ARTHRITIS PAIN

THE MARK CONSISTS OF STANDARD CHARACTERS WITHOUT CLAIM TO ANY PARTICULAR FONT, STYLE, SIZE, OR COLOR.

OWNER OF U.S. REG. NOS. 2,758,897, 2,992,606 AND OTHERS.

NO CLAIM IS MADE TO THE EXCLUSIVE RIGHT TO USE "ARTHRITIS PAIN", APART FROM THE MARK AS SHOWN.

FOR MEDICATED TRANSDERMAL PATCHES FOR THE TEMPORARY RELIEF OF ACHES AND PAINS OF MUSCLES AND JOINTS ASSOCIATED WITH ARTHRITIS, SIMPLE BACKACHES, STRAINS, BRUISES AND SPRAINS (U.S. CLS. 6, 18, 44, 46, 51 AND 52).

FIRST USE 9-30-2008; IN COMMERCE 9-30-2008.
AMY ALFIERI, EXAMINING ATTORNEY

SN 77-356,068. DANIEL, PHUOC T., LOS ANGELES, CA. FILED 12-19-2007.

REVIVE WITH THI

THE MARK CONSISTS OF STANDARD CHARACTERS WITHOUT CLAIM TO ANY PARTICULAR FONT, STYLE, SIZE, OR COLOR.

FOR MEDICATED LOTIONS FOR HAND, BODY AND FOOT (U.S. CLS. 6, 18, 44, 46, 51 AND 52).

FIRST USE 4-5-2008; IN COMMERCE 4-5-2008.
SANI KHOURI, EXAMINING ATTORNEY

SN 77-364,541. VILLAGE CANDLE, INC., TOPSHAM, ME. FILED 1-4-2008.

TREE SCENTER

THE MARK CONSISTS OF STANDARD CHARACTERS WITHOUT CLAIM TO ANY PARTICULAR FONT, STYLE, SIZE, OR COLOR.

NO CLAIM IS MADE TO THE EXCLUSIVE RIGHT TO USE "TREE", APART FROM THE MARK AS SHOWN.

FOR AIR FRESHENERS (U.S. CLS. 6, 18, 44, 46, 51 AND 52).

SALLY SHIH, EXAMINING ATTORNEY

CLASS 5—(Continued).

SN 77-389,801. ISP INVESTMENTS INC., WILMINGTON, DE. FILED 2-6-2008.



THE MARK CONSISTS OF A DEPICTION OF A HOUSE BENEATH THE TERM "CLEANGUARD" AND WITHIN A PARTIAL CIRCLE DESIGN.

FOR BIOCIDES AND FUNGICIDES (U.S. CLS. 6, 18, 44, 46, 51 AND 52).

FIRST USE 3-1-2006; IN COMMERCE 3-1-2006.
ALLISON SCHRODY, EXAMINING ATTORNEY

SN 77-406,992. CALIFORNIA ACADEMY OF HEALTH, INC., TEMECULA, CA. FILED 2-27-2008.

ABSOLUTE ACAI

THE MARK CONSISTS OF STANDARD CHARACTERS WITHOUT CLAIM TO ANY PARTICULAR FONT, STYLE, SIZE, OR COLOR.

NO CLAIM IS MADE TO THE EXCLUSIVE RIGHT TO USE "ACAI", APART FROM THE MARK AS SHOWN.

FOR VITAMIN AND MINERAL SUPPLEMENTS CONTAINING ACAI; DIETARY AND NUTRITIONAL SUPPLEMENTS CONTAINING ACAI (U.S. CLS. 6, 18, 44, 46, 51 AND 52).

FIRST USE 9-0-2007; IN COMMERCE 9-0-2007.
ANGELA M. MICHELI, EXAMINING ATTORNEY

SN 77-418,759. TARA GERIA, WARREN, NJ. FILED 3-11-2008.

Pro-active Foods

THE MARK CONSISTS OF STANDARD CHARACTERS WITHOUT CLAIM TO ANY PARTICULAR FONT, STYLE, SIZE, OR COLOR.

NO CLAIM IS MADE TO THE EXCLUSIVE RIGHT TO USE "FOODS", APART FROM THE MARK AS SHOWN.

FOR FOOD FOR MEDICALLY RESTRICTED DIETS (U.S. CLS. 6, 18, 44, 46, 51 AND 52).

TINA BROWN, EXAMINING ATTORNEY

CLASS 5—(Continued).

SN 77-441,572. KOWA PHARMACEUTICALS AMERICA, INC., MONTGOMERY, AL. FILED 4-7-2008.

EVOLT

THE MARK CONSISTS OF STANDARD CHARACTERS WITHOUT CLAIM TO ANY PARTICULAR FONT, STYLE, SIZE, OR COLOR.
FOR ANALGESIC PREPARATIONS; ANTI-INFLAMMATORIES (U.S. CLS. 6, 18, 44, 46, 51 AND 52).
KOURTNEE HODGES, EXAMINING ATTORNEY

SN 77-444,591. PROSOURCE PERFORMANCE PRODUCTS, INC., MANASQUAN, NJ. FILED 4-10-2008.

NUTRIPURE

THE MARK CONSISTS OF STANDARD CHARACTERS WITHOUT CLAIM TO ANY PARTICULAR FONT, STYLE, SIZE, OR COLOR.
FOR DIETARY AND NUTRITIONAL SUPPLEMENTS (U.S. CLS. 6, 18, 44, 46, 51 AND 52).
FIRST USE 1-0-2001; IN COMMERCE 1-0-2001.
TARA PATE, EXAMINING ATTORNEY

SN 77-485,356. PREVTEC MICROBIA INC., SAINTE - HYACINTHE, CANADA, FILED 5-28-2008.

PREVTEC MICROBIA

THE MARK CONSISTS OF STANDARD CHARACTERS WITHOUT CLAIM TO ANY PARTICULAR FONT, STYLE, SIZE, OR COLOR.
PRIORITY CLAIMED UNDER SEC. 44(D) ON CANADA APPLICATION NO. 1395541, FILED 5-14-2008.
OWNER OF CANADA REG. NO. TMA742856, DATED 6-30-2009, EXPIRES 6-30-2024.
FOR VETERINARY VACCINES (U.S. CLS. 6, 18, 44, 46, 51 AND 52).
CHARLES L. JENKINS, EXAMINING ATTORNEY

CLASS 5—(Continued).

SN 77-485,364. PREVTEC MICROBIA INC., SAINTE - HYACINTHE, CANADA, FILED 5-28-2008.

COLIPROTEC

THE MARK CONSISTS OF STANDARD CHARACTERS WITHOUT CLAIM TO ANY PARTICULAR FONT, STYLE, SIZE, OR COLOR.
PRIORITY CLAIMED UNDER SEC. 44(D) ON CANADA APPLICATION NO. 1395546, FILED 5-14-2008.
OWNER OF CANADA REG. NO. TMA742855, DATED 6-30-2009, EXPIRES 6-30-2024.
FOR VETERINARY VACCINES (U.S. CLS. 6, 18, 44, 46, 51 AND 52).
CHARLES L. JENKINS, EXAMINING ATTORNEY

SN 77-504,383. MYUNG SHIK SONG, DBA LUMBRIKO USA, INC., IRVINE, CA. FILED 6-20-2008.

LUMBRIKO

THE MARK CONSISTS OF STANDARD CHARACTERS WITHOUT CLAIM TO ANY PARTICULAR FONT, STYLE, SIZE, OR COLOR.
THE WORDING "LUMBRIKO" HAS NO MEANING IN A FOREIGN LANGUAGE.
FOR FOODS FOR MEDICAL PURPOSES THAT HELP IN THE TREATMENT OF THROMBOLYSIS (U.S. CLS. 6, 18, 44, 46, 51 AND 52).
FIRST USE 11-1-2005; IN COMMERCE 11-1-2005.
BILL DAWE, EXAMINING ATTORNEY

SN 77-520,333. BEWELL HEALTH, LLC, DBA BEWELL HEALTH PRODUCTS, COLUMBIA, MO. FILED 7-11-2008.

Little Squirt to go

THE MARK CONSISTS OF STANDARD CHARACTERS WITHOUT CLAIM TO ANY PARTICULAR FONT, STYLE, SIZE, OR COLOR.
FOR ORGANIC NASAL RINSE KIT DIRECTED TOWARDS CHILDREN, THE ELDERLY, AND TRAVELERS COMPRISED OF PHARMACEUTICAL GRADE SODIUM CHLORIDE AND SODIUM BICARBONATE WITH A NASAL WASH BOTTLE FOR THE PURPOSE OF EITHER ISOTONIC AND HYPERTONIC SALINE NASAL WASHINGS TO REFRESH THE NASAL MEMBRANE, MOISTURIZE, AND WASH AWAY NASAL PARTICLES (U.S. CLS. 6, 18, 44, 46, 51 AND 52).
FIRST USE 1-28-2008; IN COMMERCE 1-28-2008.
GEORGIA CARTY, EXAMINING ATTORNEY

CLASS 5—(Continued).

SN 77-582,267. BROERS, TRENTON A., DBA ROCKHARD LABORATORIES LLC, ALPHARETTA, GA. AND MIKLOS, JOHN R., DBA ROCKHARD LABORATORIES LLC, ALPHARETTA, GA. FILED 9-30-2008.

RockHard Weekend

THE MARK CONSISTS OF STANDARD CHARACTERS WITHOUT CLAIM TO ANY PARTICULAR FONT, STYLE, SIZE, OR COLOR.

FOR DIETARY AND NUTRITIONAL SUPPLEMENTS; DIETARY SUPPLEMENTS; DIETARY SUPPLEMENTS FOR HUMAN CONSUMPTION; HERBAL SUPPLEMENTS; NUTRACEUTICALS FOR USE AS A DIETARY SUPPLEMENT (U.S. CLS. 6, 18, 44, 46, 51 AND 52).

HEATHER SAPP, EXAMINING ATTORNEY

SN 77-595,103. EMERGENT BIOSOLUTIONS INC., ROCKVILLE, MD. FILED 10-17-2008.

TYELLA

THE MARK CONSISTS OF STANDARD CHARACTERS WITHOUT CLAIM TO ANY PARTICULAR FONT, STYLE, SIZE, OR COLOR.

THE WORDING "TYELLA" HAS NO MEANING IN A FOREIGN LANGUAGE.

FOR PHARMACEUTICAL, VETERINARY, PROPHYLACTIC, AND THERAPEUTIC PREPARATIONS ALL FOR USE IN THE TREATMENT OF DISEASES ASSOCIATED WITH SALMONELLA ENTERICA VAR. TYPHI INFECTION (U.S. CLS. 6, 18, 44, 46, 51 AND 52).

ELISSA GARBER KON, EXAMINING ATTORNEY

SN 77-595,118. EMERGENT BIOSOLUTIONS INC., ROCKVILLE, MD. FILED 10-17-2008.

TYVELLA

THE MARK CONSISTS OF STANDARD CHARACTERS WITHOUT CLAIM TO ANY PARTICULAR FONT, STYLE, SIZE, OR COLOR.

THE WORDING "TYVELLA" HAS NO MEANING IN A FOREIGN LANGUAGE.

FOR PHARMACEUTICAL, VETERINARY, PROPHYLACTIC, AND THERAPEUTIC PREPARATIONS ALL FOR USE IN THE TREATMENT OF DISEASES ASSOCIATED WITH SALMONELLA ENTERICA VAR. TYPHI INFECTION (U.S. CLS. 6, 18, 44, 46, 51 AND 52).

ELISSA GARBER KON, EXAMINING ATTORNEY

CLASS 5—(Continued).

SN 77-595,128. EMERGENT BIOSOLUTIONS INC., ROCKVILLE, MD. FILED 10-17-2008.

TYPHELLA

THE MARK CONSISTS OF STANDARD CHARACTERS WITHOUT CLAIM TO ANY PARTICULAR FONT, STYLE, SIZE, OR COLOR.

THE WORDING "TYPHELLA" HAS NO MEANING IN A FOREIGN LANGUAGE.

FOR PHARMACEUTICAL, VETERINARY, PROPHYLACTIC, AND THERAPEUTIC PREPARATIONS ALL FOR USE IN THE TREATMENT OF DISEASES ASSOCIATED WITH SALMONELLA ENTERICA VAR. TYPHI INFECTION (U.S. CLS. 6, 18, 44, 46, 51 AND 52).

ELISSA GARBER KON, EXAMINING ATTORNEY

SN 77-595,139. EMERGENT BIOSOLUTIONS INC., ROCKVILLE, MD. FILED 10-17-2008.

TYFELLA

THE MARK CONSISTS OF STANDARD CHARACTERS WITHOUT CLAIM TO ANY PARTICULAR FONT, STYLE, SIZE, OR COLOR.

THE WORDING "TYFELLA" HAS NO MEANING IN A FOREIGN LANGUAGE.

FOR PHARMACEUTICAL, VETERINARY, PROPHYLACTIC, AND THERAPEUTIC PREPARATIONS ALL FOR USE IN THE TREATMENT OF DISEASES ASSOCIATED WITH SALMONELLA ENTERICA VAR. TYPHI INFECTION (U.S. CLS. 6, 18, 44, 46, 51 AND 52).

ELISSA GARBER KON, EXAMINING ATTORNEY

CLASS 5—(Continued).

SN 77-596,135. S & W SALES, LLC, ATLANTA, MI. FILED 10-20-2008.

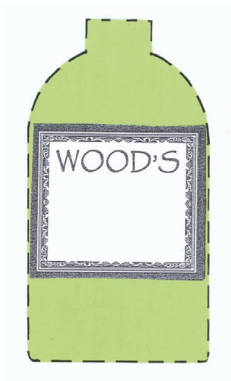

THE COLOR(S) GREEN AND BLACK IS/ARE CLAIMED AS A FEATURE OF THE MARK.

THE MARK CONSISTS OF THE COLOR GREEN AS APPLIED TO A BOTTLE, WITH A SQUARE LABEL HAVING THE BLACK TEXT "WOOD'S" AND A SQUARE BLACK FILIGREE BORDER. THE SQUARE LABEL IS SHOWN IN WHITE FOR CLARITY ONLY AND THE WHITE COLOR IS NOT PART OF THE MARK. THE MATTER SHOWN BY DOTTED LINES IS NOT PART OF THE MARK AND SERVES ONLY TO SHOW THE POSITION OF THE MARK ON PACKAGING FOR THE GOODS.

FOR INSECT REPELLENTS (U.S. CLS. 6, 18, 44, 46, 51 AND 52).

FIRST USE 5-31-2004; IN COMMERCE 5-31-2004.
REBECCA EISINGER, EXAMINING ATTORNEY

CLASS 5—(Continued).

SN 77-599,064. JESSE BAR LLC, GREAT FALLS, VA. FILED 10-23-2008.

Jesse Bar

THE MARK CONSISTS OF STANDARD CHARACTERS WITHOUT CLAIM TO ANY PARTICULAR FONT, STYLE, SIZE, OR COLOR.

NO CLAIM IS MADE TO THE EXCLUSIVE RIGHT TO USE "BAR", APART FROM THE MARK AS SHOWN.

FOR FOOD FOR MEDICALLY RESTRICTED DIETS (U.S. CLS. 6, 18, 44, 46, 51 AND 52).

FIRST USE 5-24-2008; IN COMMERCE 5-24-2008.
CAROLINE WOOD, EXAMINING ATTORNEY

SN 77-600,030. NAL PHARMA LTD, TORTOLA, BR. VIRGIN ISLANDS, FILED 10-24-2008.

SN 77-596,492. MICRO-SCIENTIFIC INDUSTRIES, INC., ROLLING MEADOWS, IL. FILED 10-20-2008.

OPTI-CIDE 3



THE MARK CONSISTS OF STANDARD CHARACTERS WITHOUT CLAIM TO ANY PARTICULAR FONT, STYLE, SIZE, OR COLOR.

OWNER OF U.S. REG. NO. 2,198,922.
FOR DISINFECTANTS FOR MEDICAL INSTRUMENTS; DISINFECTANT HOSPITAL SURFACE CLEANERS (U.S. CLS. 6, 18, 44, 46, 51 AND 52).

FIRST USE 1-31-2007; IN COMMERCE 1-31-2007.
JIM RINGLE, EXAMINING ATTORNEY

NO CLAIM IS MADE TO THE EXCLUSIVE RIGHT TO USE "PHARMA", APART FROM THE MARK AS SHOWN.

THE MARK CONSISTS OF AN ILLUSTRATION OF AN ATOMIC MODEL ON THE LEFT SEPARATED BY VERTICAL LINE WITH THE WORDS "NAL" OVER THE WORD "PHARMA" TO THE RIGHT OF THE VERTICAL LINE.

FOR PHARMACEUTICAL PREPARATIONS FOR USE IN UROLOGY, PAIN MANAGEMENT AND ONCOLOGY (U.S. CLS. 6, 18, 44, 46, 51 AND 52).

DAVID I, EXAMINING ATTORNEY

CLASS 5—(Continued).

SN 77-602,506. INTEGRA LIFESCIENCES CORPORATION, PLAINSBORO, NJ. FILED 10-28-2008.



OWNER OF U.S. REG. NOS. 2,573,450, 3,014,369 AND OTHERS.

THE MARK CONSISTS OF "INTEGRA" WORD WITH PARALLEL WAVE DESIGN AT LEFT.

FOR SURGICAL IMPLANTS COMPRISING MATERIAL DERIVED FROM LIVING TISSUE IN THE NATURE OF TISSUE REGENERATION MATRICES FOR REGENERATING SKIN, BONE, NERVE OR DURA MATER; HUMAN ALLOGRAFT BONE IMPLANTS; WOUND DRESSINGS; IMPLANTABLE OR GRAFTABLE MEDICAL DEVICES COMPRISING MATERIAL DERIVED FROM LIVING TISSUE FOR USE IN THE TREATMENT OF THE NERVOUS SYSTEM, SKIN, BONE OR TENDON; BONE GRAFT SUBSTITUTE COMPRISING MATERIAL DERIVED FROM LIVING TISSUE; PHARMACEUTICAL PREPARATION COMPRISING COLLAGEN USED FOR NEUROSURGERY, ORTHOPEDIC SURGERY, SPINE SURGERY, RECONSTRUCTIVE SURGERY, PLASTIC SURGERY, AND GENERAL SURGERY; MEDICAL IMPLANTS COMPRISING MATERIAL DERIVED FROM LIVING TISSUE FOR ORTHOPEDIC OR SPINAL APPLICATIONS (U.S. CLS. 6, 18, 44, 46, 51 AND 52).

TOBY BULLOFF, EXAMINING ATTORNEY

SN 77-611,455. HEMCON MEDICAL TECHNOLOGIES, INC., TIGARD, OR. FILED 11-10-2008.

CHITOGAUZE

THE MARK CONSISTS OF STANDARD CHARACTERS WITHOUT CLAIM TO ANY PARTICULAR FONT, STYLE, SIZE, OR COLOR.

OWNER OF U.S. REG. NO. 3,264,070.
FOR BANDAGES FOR SKIN WOUNDS (U.S. CLS. 6, 18, 44, 46, 51 AND 52).

GINA FINK, EXAMINING ATTORNEY

SN 77-612,442. SCHERING CORPORATION, KENILWORTH, NJ. FILED 11-12-2008.

NOTHING CURES BETTER

THE MARK CONSISTS OF STANDARD CHARACTERS WITHOUT CLAIM TO ANY PARTICULAR FONT, STYLE, SIZE, OR COLOR.

FOR ANTIFUNGAL SKIN PREPARATION (U.S. CLS. 6, 18, 44, 46, 51 AND 52).

AMY ALFIERI, EXAMINING ATTORNEY

CLASS 5—(Continued).

SN 77-613,451. THE ULTIMATE LIFE, INC., SANTA BARBARA, CA. FILED 11-13-2008.

THE ULTIMATE FLORAZYME

THE MARK CONSISTS OF STANDARD CHARACTERS WITHOUT CLAIM TO ANY PARTICULAR FONT, STYLE, SIZE, OR COLOR.

FOR NUTRITIONAL ACIDOPHILUS AND DIGESTIVE ENZYME SUPPLEMENT (U.S. CLS. 6, 18, 44, 46, 51 AND 52).

FIRST USE 1-5-1996; IN COMMERCE 1-5-1996.
CHRISTOPHER BUONGIORNO, EXAMINING ATTORNEY

SN 77-613,624. THE ULTIMATE LIFE, INC., SANTA BARBARA, CA. FILED 11-13-2008.

THE NAME SAYS IT ALL

THE MARK CONSISTS OF STANDARD CHARACTERS WITHOUT CLAIM TO ANY PARTICULAR FONT, STYLE, SIZE, OR COLOR.

FOR DIETARY NUTRITIONAL DRINK MIX FOR USE AS A MEAL REPLACEMENT (U.S. CLS. 6, 18, 44, 46, 51 AND 52).

FIRST USE 6-1-1983; IN COMMERCE 6-1-1983.
CHRISTOPHER BUONGIORNO, EXAMINING ATTORNEY

SN 77-613,664. THE ULTIMATE LIFE, INC., SANTA BARBARA, CA. FILED 11-13-2008.



THE MARK CONSISTS OF A VERTICAL DOUBLE SPIRAL MEETING AT THE TOP AND BOTTOM WRAPPED AROUND A VERTICAL LINE.

FOR DIETARY NUTRITIONAL DRINK MIX FOR USE AS A MEAL REPLACEMENT (U.S. CLS. 6, 18, 44, 46, 51 AND 52).

FIRST USE 6-1-1983; IN COMMERCE 6-1-1983.
CHRISTOPHER BUONGIORNO, EXAMINING ATTORNEY

CLASS 5—(Continued).

SN 77-615,617. BIG BUCKS ENTERPRISES, INC., DBA MESSINA WILDLIFE MANAGEMENT, WASHINGTON, NJ. FILED 11-17-2008.



OWNER OF U.S. REG. NOS. 3,010,020, 3,639,099 AND OTHERS.

NO CLAIM IS MADE TO THE EXCLUSIVE RIGHT TO USE "WILDLIFE'S CAT", APART FROM THE MARK AS SHOWN.

THE MARK CONSISTS OF THE WORDS "MESSINA WILDLIFE'S CAT STOPPER" SUPERIMPOSED OVER A STYLIZED CAT DESIGN WITHIN A STOP SIGN.

FOR ANIMAL AND INSECT REPELLANTS (U.S. CLS. 6, 18, 44, 46, 51 AND 52).

FIRST USE 11-1-2007; IN COMMERCE 11-1-2007.
DAVID YONTEF, EXAMINING ATTORNEY

CLASS 5—(Continued).

SN 77-616,456. FERRING B.V., 2132 JX HOOFDDORP, NETHERLANDS, FILED 11-18-2008.

GONAREMON

THE MARK CONSISTS OF STANDARD CHARACTERS WITHOUT CLAIM TO ANY PARTICULAR FONT, STYLE, SIZE, OR COLOR.

OWNER OF BENELUX REG. NO. 0593955, DATED 8-21-1996, RENEWED AS REG. NO. 0593955, DATED 3-22-2006, EXPIRES 8-21-2016.

FOR PHARMACEUTICAL PRODUCTS AND SUBSTANCES FOR USE IN THE TREATMENT OF ONCOLOGICAL, UROLOGICAL, GYNECOLOGICAL AND REPRODUCTIVE DISEASES AND CONDITIONS (U.S. CLS. 6, 18, 44, 46, 51 AND 52).

KATHLEEN LORENZO, EXAMINING ATTORNEY

SN 77-621,522. SCHERING-PLOUGH HEALTHCARE PRODUCTS, INC., MEMPHIS, TN. FILED 11-25-2008.

IT'S ABOUT TIME

THE MARK CONSISTS OF STANDARD CHARACTERS WITHOUT CLAIM TO ANY PARTICULAR FONT, STYLE, SIZE, OR COLOR.

FOR PHARMACEUTICAL PREPARATIONS FOR THE TREATMENT OF GASTROINTESTINAL PROBLEMS AND DISEASES (U.S. CLS. 6, 18, 44, 46, 51 AND 52).

CURTIS FRENCH, EXAMINING ATTORNEY

SN 77-615,631. BIG BUCKS ENTERPRISES, INC., DBA MESSINA WILDLIFE MANAGEMENT, WASHINGTON, NJ. FILED 11-17-2008.



OWNER OF U.S. REG. NOS. 3,010,020, 3,639,099 AND OTHERS.

NO CLAIM IS MADE TO THE EXCLUSIVE RIGHT TO USE "WILDLIFE'S SQUIRREL", APART FROM THE MARK AS SHOWN.

THE MARK CONSISTS OF THE WORDS "MESSINA WILDLIFE'S SQUIRREL STOPPER" SUPERIMPOSED OVER A STYLIZED SQUIRREL DESIGN WITHIN A STOP SIGN.

FOR ANIMAL AND INSECT REPELLANTS (U.S. CLS. 6, 18, 44, 46, 51 AND 52).

FIRST USE 11-1-2007; IN COMMERCE 11-1-2007.
DAVID YONTEF, EXAMINING ATTORNEY

SN 77-622,977. CARR, ROGER K., SAN DIEGO, CA. FILED 11-27-2008.

PrimaVu

THE MARK CONSISTS OF STANDARD CHARACTERS WITHOUT CLAIM TO ANY PARTICULAR FONT, STYLE, SIZE, OR COLOR.

FOR EYE COMPRESSES; EYE DROPS; EYE WASHES; IRRIGATING SOLUTIONS FOR EYE USE; PHARMACEUTICAL PREPARATIONS FOR THE TREATMENT OF EYE DISEASES AND CONDITIONS (U.S. CLS. 6, 18, 44, 46, 51 AND 52).

FIRST USE 2-28-2004; IN COMMERCE 2-28-2004.
KELLEY WELLS, EXAMINING ATTORNEY

CLASS 5—(Continued).

SN 77-630,651. CJ CHEILJEDANG CORPORATION, SEOUL, REPUBLIC OF KOREA, FILED 12-10-2008.



CLASS 5—(Continued).

SN 77-643,422. FERRER INTERNACIONAL, S.A., BARCELONA, SPAIN, FILED 1-5-2009.

SINCRONIUM

NO CLAIM IS MADE TO THE EXCLUSIVE RIGHT TO USE THE ENGLISH WORD "POWER" AND THE NON-LATIN CHARACTERS THAT MEAN "POWER," TO RELIEVE HANGOVER SYMPTOMS BEFORE AND/OR AFTER DRINKING, AND BEVERAGE FOR BUSINESSMEN THAT FREQUENTLY DRINK LIQUOR, APART FROM THE MARK AS SHOWN.

THE COLOR(S) LIGHT GREEN, DARK GREEN, RED, WHITE, GOLD, BLUE, BLACK, ORANGE, AND YELLOW IS/ARE CLAIMED AS A FEATURE OF THE MARK.

THE MARK CONSISTS OF LIGHT AND DARK GREEN HORIZONTAL STRIPES ABOVE A RED DIAGONAL STRIPE CONTAINING WHITE KOREAN CHARACTERS WITH A BLACK BOX BELOW CONTAINING KOREAN CHARACTERS IN GOLD AND GREEN WITH THE WORD "POWER" IN RED OUTLINED IN BLACK WITH A RED, ORANGE, YELLOW, AND WHITE GRAPHIC ELEMENT BENEATH IT WITH A BLUE STARBURST GRAPHIC ELEMENT TO THE LEFT WITH RED AND GREEN CIRCULAR GRAPHIC ELEMENTS BELOW IT WITH LIGHT GREEN AND DARK GREEN HORIZONTAL STRIPES BELOW THE BLACK BOX.

THE FOREIGN WORDING IN THE MARK TRANSLATES INTO ENGLISH AS TO RELIEVE HANGOVER SYMPTOMS BEFORE AND/OR AFTER; CONDITION; "POWER"; AND BEVERAGE FOR BUSINESSMEN THAT FREQUENTLY DRINK LIQUOR.

THE NON-LATIN CHARACTERS IN THE MARK THAT MEAN CONDITION IN ENGLISH TRANSLITERATE TO CONDITION. THE NON-LATIN CHARACTERS IN THE MARK THAT MEAN "POWER" IN ENGLISH TRANSLITERATE TO "POWER." THE NON-LATIN CHARACTERS IN THE MARK THAT MEAN TO RELIEVE HANGOVER SYMPTOMS BEFORE AND/OR AFTER DRINKING TRANSLITERATE TO EUMJUJEONHU SUKCHWIHAESO. THE NON-LATIN CHARACTERS IN THE MARK THAT MEAN BEVERAGE FOR BUSINESSMEN THAT FREQUENTLY DRINK LIQUOR IN ENGLISH TRANSLITERATE TO JEODAEAGA MANEUN BUSINESSMANUI DRINK.

FOR PHARMACEUTICAL PREPARATION TO RELIEVE HANGOVER SYMPTOMS; PHARMACEUTICAL PREPARATION TO PREVENT AND/OR ELIMINATE HANGOVER SYMPTOMS; NUTRIENTS, TONICS AND ALTERNATIVES, NAMELY, NUTRITIONAL SUPPLEMENTS FOR MEDICAL PURPOSES (U.S. CLS. 6, 18, 44, 46, 51 AND 52).

LINDSEY RUBIN, EXAMINING ATTORNEY

THE MARK CONSISTS OF STANDARD CHARACTERS WITHOUT CLAIM TO ANY PARTICULAR FONT, STYLE, SIZE, OR COLOR.

PRIORITY CLAIMED UNDER SEC. 44(D) ON SPAIN APPLICATION NO. 2854842, FILED 12-1-2008.

OWNER OF SPAIN REG. NO. 2854842, DATED 4-16-2009, EXPIRES 12-1-2018.

FOR PHARMACEUTICAL PREPARATIONS FOR THE TREATMENT OF MOUTH AND THROAT INFECTIONS, COUGH REMEDIES, NAMELY, COUGH DROPS, COUGH EXPECTORANTS, COUGH LOZENGES, COUGH SYRUPS, COUGH TREATMENT PREPARATIONS, MEDICAL PREPARATION FOR CONTROLLING BLOOD PRESSURE, NAMELY, CARDIOVASCULAR TREATMENT PREPARATIONS, NAMELY, HYPOLIPEMIA PREPARATIONS, HIGH BLOOD PRESSURE PREPARATIONS; ANTIBIOTICS, CEREBRAL TONIC, NAMELY, PHARMACEUTICAL PREPARATIONS ACTING ON THE CENTRAL NERVOUS SYSTEMS, TISSUE STIMULANTS, NAMELY, PHARMACEUTICAL PREPARATIONS FOR TREATING SKIN DISORDERS, CENTRAL NERVOUS SYSTEM STIMULATORS, PHARMACEUTICAL PREPARATIONS FOR THE TREATMENT OF INTESTINAL WORMS, SEDATIVES, PHARMACEUTICAL PREPARATIONS FOR THE TREATMENT OF HEMORRHAGING, PHARMACEUTICAL PREPARATIONS FOR THE TREATMENT OF DIARRHEA, PHARMACEUTICAL PREPARATIONS FOR THE TREATMENT OF TONSILLITIS, ANTIPYRETIC ANALGESICS, NAMELY, PHARMACEUTICAL PREPARATIONS FOR REDUCING FEVERS, MEDICAL PREPARATIONS FOR THE TREATMENT OF GASTRIC DYSPEPSIA, PHARMACEUTICAL PREPARATIONS FOR THE TREATMENT OF ACETONEMIA, PHARMACEUTICAL PREPARATIONS FOR THE TREATMENT OF GASTRIC ULCERS, PROTECTIVE FOR HEPATIC CELLS, NAMELY, PHARMACEUTICAL PREPARATIONS FOR THE TREATMENT OF THE LIVER (U.S. CLS. 6, 18, 44, 46, 51 AND 52).

THEODORE MCBRIDE, EXAMINING ATTORNEY

CLASS 5—(Continued).

SN 77-643,448. FERRER INTERNACIONAL, S.A., BARCELONA, SPAIN, FILED 1-5-2009.

CLASS 5—(Continued).

SN 77-643,478. FERRER INTERNACIONAL, S.A., BARCELONA, SPAIN, FILED 1-5-2009.

ESFERIUM

SPHERIUM

THE MARK CONSISTS OF STANDARD CHARACTERS WITHOUT CLAIM TO ANY PARTICULAR FONT, STYLE, SIZE, OR COLOR.

PRIORITY CLAIMED UNDER SEC. 44(D) ON SPAIN APPLICATION NO. 2854838, FILED 12-1-2008.

OWNER OF SPAIN REG. NO. 2854838, DATED 4-16-2009, EXPIRES 12-1-2018.

FOR PHARMACEUTICAL PREPARATIONS FOR THE TREATMENT OF MOUTH AND THROAT INFECTIONS, COUGH REMEDIES, NAMELY, COUGH DROPS, COUGH EXPECTORANTS, COUGH LOZENGES, COUGH SYRUPS, COUGH TREATMENT PREPARATIONS, MEDICAL PREPARATION FOR CONTROLLING BLOOD PRESSURE, NAMELY, CARDIOVASCULAR TREATMENT PREPARATIONS, NAMELY, HYPOLIPEMIA PREPARATIONS, HIGH BLOOD PRESSURE PREPARATIONS; ANTIBIOTICS, CEREBRAL TONIC, NAMELY, PHARMACEUTICAL PREPARATIONS ACTING ON THE CENTRAL NERVOUS SYSTEMS, TISSUE STIMULANTS, NAMELY, PHARMACEUTICAL PREPARATIONS FOR TREATING SKIN DISORDERS, CENTRAL NERVOUS SYSTEM STIMULATORS, PHARMACEUTICAL PREPARATIONS FOR THE TREATMENT OF INTESTINAL WORMS, SEDATIVES, PHARMACEUTICAL PREPARATIONS FOR THE TREATMENT OF HEMORRHAGING, PHARMACEUTICAL PREPARATIONS FOR THE TREATMENT OF DIARRHEA, PHARMACEUTICAL PREPARATIONS FOR THE TREATMENT OF TONSILLITIS, ANTIPYRETIC ANALGESICS, NAMELY, PHARMACEUTICAL PREPARATIONS FOR REDUCING FEVERS, MEDICAL PREPARATIONS FOR THE TREATMENT OF GASTRIC DYSPEPSIA, PHARMACEUTICAL PREPARATIONS FOR THE TREATMENT OF ACETONEMIA, PHARMACEUTICAL PREPARATIONS FOR THE TREATMENT OF GASTRIC ULCERS, PROTECTIVE FOR HEPATIC CELLS, NAMELY, PHARMACEUTICAL PREPARATIONS FOR THE TREATMENT OF THE LIVER (U.S. CLS. 6, 18, 44, 46, 51 AND 52).

THEODORE MCBRIDE, EXAMINING ATTORNEY

THE MARK CONSISTS OF STANDARD CHARACTERS WITHOUT CLAIM TO ANY PARTICULAR FONT, STYLE, SIZE, OR COLOR.

PRIORITY CLAIMED UNDER SEC. 44(D) ON SPAIN APPLICATION NO. 2854837, FILED 12-1-2008.

OWNER OF SPAIN REG. NO. 2854837, DATED 4-16-2009, EXPIRES 12-1-2018.

FOR PHARMACEUTICAL PREPARATIONS FOR THE TREATMENT OF MOUTH AND THROAT INFECTIONS, COUGH REMEDIES, NAMELY, COUGH DROPS, COUGH EXPECTORANTS, COUGH LOZENGES, COUGH SYRUPS, COUGH TREATMENT PREPARATIONS, MEDICAL PREPARATION FOR CONTROLLING BLOOD PRESSURE, NAMELY, CARDIOVASCULAR TREATMENT PREPARATIONS, NAMELY, HYPOLIPEMIA PREPARATIONS, HIGH BLOOD PRESSURE PREPARATIONS; ANTIBIOTICS, CEREBRAL TONIC, NAMELY, PHARMACEUTICAL PREPARATIONS ACTING ON THE CENTRAL NERVOUS SYSTEMS, TISSUE STIMULANTS, NAMELY, PHARMACEUTICAL PREPARATIONS FOR TREATING SKIN DISORDERS, CENTRAL NERVOUS SYSTEM STIMULATORS, PHARMACEUTICAL PREPARATIONS FOR THE TREATMENT OF INTESTINAL WORMS, SEDATIVES, PHARMACEUTICAL PREPARATIONS FOR THE TREATMENT OF HEMORRHAGING, PHARMACEUTICAL PREPARATIONS FOR THE TREATMENT OF DIARRHEA, PHARMACEUTICAL PREPARATIONS FOR THE TREATMENT OF TONSILLITIS, ANTIPYRETIC ANALGESICS, NAMELY, PHARMACEUTICAL PREPARATIONS FOR REDUCING FEVERS, MEDICAL PREPARATIONS FOR THE TREATMENT OF GASTRIC DYSPEPSIA, PHARMACEUTICAL PREPARATIONS FOR THE TREATMENT OF ACETONEMIA, PHARMACEUTICAL PREPARATIONS FOR THE TREATMENT OF GASTRIC ULCERS, PROTECTIVE FOR HEPATIC CELLS, NAMELY, PHARMACEUTICAL PREPARATIONS FOR THE TREATMENT OF THE LIVER (U.S. CLS. 6, 18, 44, 46, 51 AND 52).

THEODORE MCBRIDE, EXAMINING ATTORNEY

CLASS 5—(Continued).

SN 77-643,498. FERRER INTERNACIONAL, S.A., BARCELONA, SPAIN, FILED 1-5-2009.

CLASS 5—(Continued).

SN 77-643,529. FERRER INTERNACIONAL, S.A., BARCELONA, SPAIN, FILED 1-5-2009.

SPHERIA

TRINOMIA

THE MARK CONSISTS OF STANDARD CHARACTERS WITHOUT CLAIM TO ANY PARTICULAR FONT, STYLE, SIZE, OR COLOR.

PRIORITY CLAIMED UNDER SEC. 44(D) ON SPAIN APPLICATION NO. 2854839, FILED 12-1-2008.

OWNER OF SPAIN REG. NO. 2854839, DATED 4-16-2009, EXPIRES 12-1-2018.

FOR PHARMACEUTICAL PREPARATIONS FOR THE TREATMENT OF MOUTH AND THROAT INFECTIONS, COUGH REMEDIES, NAMELY, COUGH DROPS, COUGH EXPECTORANTS, COUGH LOZENGES, COUGH SYRUPS, COUGH TREATMENT PREPARATIONS, MEDICAL PREPARATION FOR CONTROLLING BLOOD PRESSURE, NAMELY, CARDIOVASCULAR TREATMENT PREPARATIONS, NAMELY, HYPOLIPEMIA PREPARATIONS, HIGH BLOOD PRESSURE PREPARATIONS; ANTIBIOTICS, CEREBRAL TONIC, NAMELY, PHARMACEUTICAL PREPARATIONS ACTING ON THE CENTRAL NERVOUS SYSTEMS, TISSUE STIMULANTS, NAMELY, PHARMACEUTICAL PREPARATIONS FOR TREATING SKIN DISORDERS, CENTRAL NERVOUS SYSTEM STIMULATORS, PHARMACEUTICAL PREPARATIONS FOR THE TREATMENT OF INTESTINAL WORMS, SEDATIVES, PHARMACEUTICAL PREPARATIONS FOR THE TREATMENT OF HEMORRHAGING, PHARMACEUTICAL PREPARATIONS FOR THE TREATMENT OF DIARRHEA, PHARMACEUTICAL PREPARATIONS FOR THE TREATMENT OF TONSILLITIS, ANTIPYRETIC ANALGESICS, NAMELY, PHARMACEUTICAL PREPARATIONS FOR REDUCING FEVERS, MEDICAL PREPARATIONS FOR THE TREATMENT OF GASTRIC DYSPEPSIA, PHARMACEUTICAL PREPARATIONS FOR THE TREATMENT OF ACETONEMIA, PHARMACEUTICAL PREPARATIONS FOR THE TREATMENT OF GASTRIC ULCERS, PROTECTIVE FOR HEPATIC CELLS, NAMELY, PHARMACEUTICAL PREPARATIONS FOR THE TREATMENT OF THE LIVER (U.S. CLS. 6, 18, 44, 46, 51 AND 52).

THEODORE MCBRIDE, EXAMINING ATTORNEY

THE MARK CONSISTS OF STANDARD CHARACTERS WITHOUT CLAIM TO ANY PARTICULAR FONT, STYLE, SIZE, OR COLOR.

PRIORITY CLAIMED UNDER SEC. 44(D) ON SPAIN APPLICATION NO. 2.854.845, FILED 12-1-2008, REG. NO. 2.854.845, DATED 4-16-2009, EXPIRES 12-1-2018.

FOR PHARMACEUTICAL PREPARATIONS FOR THE TREATMENT OF MOUTH AND THROAT INFECTIONS, COUGH REMEDIES, NAMELY, COUGH DROPS, COUGH EXPECTORANTS, COUGH LOZENGES, COUGH SYRUPS, COUGH TREATMENT PREPARATIONS, MEDICAL PREPARATION FOR CONTROLLING BLOOD PRESSURE, NAMELY, CARDIOVASCULAR TREATMENT PREPARATIONS, NAMELY, HYPOLIPEMIA PREPARATIONS, HIGH BLOOD PRESSURE PREPARATIONS; ANTIBIOTICS, CEREBRAL TONIC, NAMELY, PHARMACEUTICAL PREPARATIONS ACTING ON THE CENTRAL NERVOUS SYSTEMS, TISSUE STIMULANTS, NAMELY, PHARMACEUTICAL PREPARATIONS FOR TREATING SKIN DISORDERS, CENTRAL NERVOUS SYSTEM STIMULATORS, PHARMACEUTICAL PREPARATIONS FOR THE TREATMENT OF INTESTINAL WORMS, SEDATIVES, PHARMACEUTICAL PREPARATIONS FOR THE TREATMENT OF HEMORRHAGING, PHARMACEUTICAL PREPARATIONS FOR THE TREATMENT OF DIARRHEA, PHARMACEUTICAL PREPARATIONS FOR THE TREATMENT OF TONSILLITIS, ANTIPYRETIC ANALGESICS, NAMELY, PHARMACEUTICAL PREPARATIONS FOR REDUCING FEVERS, MEDICAL PREPARATIONS FOR THE TREATMENT OF GASTRIC DYSPEPSIA, PHARMACEUTICAL PREPARATIONS FOR THE TREATMENT OF ACETONEMIA, PHARMACEUTICAL PREPARATIONS FOR THE TREATMENT OF GASTRIC ULCERS, PROTECTIVE FOR HEPATIC CELLS, NAMELY, PHARMACEUTICAL PREPARATIONS FOR THE TREATMENT OF THE LIVER (U.S. CLS. 6, 18, 44, 46, 51 AND 52).

THEODORE MCBRIDE, EXAMINING ATTORNEY

CLASS 5—(Continued).

SN 77-643,542. FERRER INTERNACIONAL, S.A., BARCELONA, SPAIN, FILED 1-5-2009.

TRINOMIC

THE MARK CONSISTS OF STANDARD CHARACTERS WITHOUT CLAIM TO ANY PARTICULAR FONT, STYLE, SIZE, OR COLOR.

PRIORITY CLAIMED UNDER SEC. 44(D) ON SPAIN APPLICATION NO. 2854844, FILED 12-1-2008.

OWNER OF SPAIN REG. NO. 2854844, DATED 4-16-2009, EXPIRES 12-1-2018.

FOR PHARMACEUTICAL PREPARATIONS FOR THE TREATMENT OF MOUTH AND THROAT INFECTIONS, COUGH REMEDIES, NAMELY, COUGH DROPS, COUGH EXPECTORANTS, COUGH LOZENGES, COUGH SYRUPS, COUGH TREATMENT PREPARATIONS, MEDICAL PREPARATION FOR CONTROLLING BLOOD PRESSURE, NAMELY, CARDIOVASCULAR TREATMENT PREPARATIONS, NAMELY, HYPOLIPEMIA PREPARATIONS, HIGH BLOOD PRESSURE PREPARATIONS; ANTIBIOTICS, CEREBRAL TONIC, NAMELY, PHARMACEUTICAL PREPARATIONS ACTING ON THE CENTRAL NERVOUS SYSTEMS, TISSUE STIMULANTS, NAMELY, PHARMACEUTICAL PREPARATIONS FOR TREATING SKIN DISORDERS, CENTRAL NERVOUS SYSTEM STIMULATORS, PHARMACEUTICAL PREPARATIONS FOR THE TREATMENT OF INTESTINAL WORMS, SEDATIVES, PHARMACEUTICAL PREPARATIONS FOR THE TREATMENT OF HEMORRHAGING, PHARMACEUTICAL PREPARATIONS FOR THE TREATMENT OF DIARRHEA, PHARMACEUTICAL PREPARATIONS FOR THE TREATMENT OF TONSILLITIS, ANTIPYRETIC ANALGESICS, NAMELY, PHARMACEUTICAL PREPARATIONS FOR REDUCING FEVERS, MEDICAL PREPARATIONS FOR THE TREATMENT OF GASTRIC DYSPEPSIA, PHARMACEUTICAL PREPARATIONS FOR THE TREATMENT OF ACETONEMIA, PHARMACEUTICAL PREPARATIONS FOR THE TREATMENT OF GASTRIC ULCERS, PROTECTIVE FOR HEPATIC CELLS, NAMELY, PHARMACEUTICAL PREPARATIONS FOR THE TREATMENT OF THE LIVER (U.S. CLS. 6, 18, 44, 46, 51 AND 52).

THEODORE MCBRIDE, EXAMINING ATTORNEY

CLASS 5—(Continued).

SN 77-643,578. FERRER INTERNACIONAL, S.A., BARCELONA, SPAIN, FILED 1-5-2009.

ESFERIA

THE MARK CONSISTS OF STANDARD CHARACTERS WITHOUT CLAIM TO ANY PARTICULAR FONT, STYLE, SIZE, OR COLOR.

PRIORITY CLAIMED UNDER SEC. 44(D) ON SPAIN APPLICATION NO. 2854840, FILED 12-1-2008.

OWNER OF SPAIN REG. NO. 2854840, DATED 4-16-2009, EXPIRES 12-1-2018.

FOR PHARMACEUTICAL PREPARATIONS FOR THE TREATMENT OF MOUTH AND THROAT INFECTIONS, COUGH REMEDIES, NAMELY, COUGH DROPS, COUGH EXPECTORANTS, COUGH LOZENGES, COUGH SYRUPS, COUGH TREATMENT PREPARATIONS, MEDICAL PREPARATION FOR CONTROLLING BLOOD PRESSURE, NAMELY, CARDIOVASCULAR TREATMENT PREPARATIONS, NAMELY, HYPOLIPEMIA PREPARATIONS, HIGH BLOOD PRESSURE PREPARATIONS; ANTIBIOTICS, CEREBRAL TONIC, NAMELY, PHARMACEUTICAL PREPARATIONS ACTING ON THE CENTRAL NERVOUS SYSTEMS, TISSUE STIMULANTS, NAMELY, PHARMACEUTICAL PREPARATIONS FOR TREATING SKIN DISORDERS, CENTRAL NERVOUS SYSTEM STIMULATORS, PHARMACEUTICAL PREPARATIONS FOR THE TREATMENT OF INTESTINAL WORMS, SEDATIVES, PHARMACEUTICAL PREPARATIONS FOR THE TREATMENT OF HEMORRHAGING, PHARMACEUTICAL PREPARATIONS FOR THE TREATMENT OF DIARRHEA, PHARMACEUTICAL PREPARATIONS FOR THE TREATMENT OF TONSILLITIS, ANTIPYRETIC ANALGESICS, NAMELY, PHARMACEUTICAL PREPARATIONS FOR REDUCING FEVERS, MEDICAL PREPARATIONS FOR THE TREATMENT OF GASTRIC DYSPEPSIA, PHARMACEUTICAL PREPARATIONS FOR THE TREATMENT OF ACETONEMIA, PHARMACEUTICAL PREPARATIONS FOR THE TREATMENT OF GASTRIC ULCERS, PROTECTIVE FOR HEPATIC CELLS, NAMELY, PHARMACEUTICAL PREPARATIONS FOR THE TREATMENT OF THE LIVER (U.S. CLS. 6, 18, 44, 46, 51 AND 52).

THEODORE MCBRIDE, EXAMINING ATTORNEY

SN 77-648,912. BIONICHE LIFE SCIENCES INC., BELLEVILLE, ONTARIO, CANADA, FILED 1-14-2009.

BUTEQUINE

THE MARK CONSISTS OF STANDARD CHARACTERS WITHOUT CLAIM TO ANY PARTICULAR FONT, STYLE, SIZE, OR COLOR.

FOR VETERINARY ANTI-INFLAMMATORY PREPARATION (U.S. CLS. 6, 18, 44, 46, 51 AND 52).

TIMOTHY FINNEGAN, EXAMINING ATTORNEY

CLASS 5—(Continued).

SN 77-663,963. MUELLER SPORTS MEDICINE, INC., PRAIRIE DU SAC, WI. FILED 2-5-2009.

SPORT CARE

THE MARK CONSISTS OF STANDARD CHARACTERS WITHOUT CLAIM TO ANY PARTICULAR FONT, STYLE, SIZE, OR COLOR.

OWNER OF U.S. REG. NO. 2,240,165.
SEC. 2(F).

FOR TAPE AND TAPING SUPPLIES FOR MEDICAL PURPOSES, NAMELY, MEDICAL ADHESIVE TAPE, MEDICAL COHESIVE TAPE, MEDICAL PRETAPING FOAM UNDERWRAP, MEDICAL PRETAPING SPRAY ADHERENT; FIRST AID KITS; ATHLETIC TRAINERS' KITS COMPRISED PRIMARILY OF ADHESIVE BANDAGES, MEDICAL ADHESIVE TAPE, GAUZE PADS FOR DRESSINGS, MEDICAL COHESIVE TAPE, ANTI-BIOTIC OINTMENTS, ANTISEPTIC SPRAY, SPRAY-ON BANDAGES AND ICE BAGS FOR MEDICAL PURPOSES; ANALGESIC OINTMENTS AND BALMS; MEDICAL AND SURGICAL DRESSINGS, NAMELY, BLISTER PADS, WOUND DRESSINGS; NONMEDICATED TOPICAL GELS AND OINTMENTS FOR USE AS PERSONAL LUBRICANTS ON SKIN; ALL PURPOSE DISINFECTANTS AND ANTIBACTERIAL CLEANERS FOR SURFACES; SPRAY ON BANDAGES FOR SKIN WOUNDS; ANTISEPTIC SPRAYS AND OINTMENTS FOR MEDICAL USE; ADHESIVE BANDAGES (U.S. CLS. 6, 18, 44, 46, 51 AND 52).

FIRST USE 6-28-1985; IN COMMERCE 6-28-1985.
TAMARA FRAZIER, EXAMINING ATTORNEY

SN 77-672,960. NEW ROOTS HERBAL, VAUDREUIL-DORION, CANADA, FILED 2-18-2009.

Serra-Plex

THE MARK CONSISTS OF STANDARD CHARACTERS WITHOUT CLAIM TO ANY PARTICULAR FONT, STYLE, SIZE, OR COLOR.

FOR DIETARY SUPPLEMENTS (U.S. CLS. 6, 18, 44, 46, 51 AND 52).

FIRST USE 1-1-2006; IN COMMERCE 1-1-2006.
KRISTIN CARLSON, EXAMINING ATTORNEY

CLASS 5—(Continued).

SN 77-672,973. TOP TM, LLC, BOCA RATON, FL. FILED 2-18-2009.

UNDERWAY

THE MARK CONSISTS OF STANDARD CHARACTERS WITHOUT CLAIM TO ANY PARTICULAR FONT, STYLE, SIZE, OR COLOR.

FOR VITAMINS AND DIETARY AND NUTRITIONAL SUPPLEMENTS, APPETITE SUPPRESSANTS, NUTRITIONAL ADDITIVES FOR MEDICAL PURPOSES FOR USE IN FOODS AND DIETARY SUPPLEMENTS FOR HUMAN CONSUMPTION, NUTRITIONAL SHAKES AS MEAL REPLACEMENTS, NUTRITIONAL FORTIFIED BEVERAGES, DIETARY DRINKS USED AS MEAL REPLACEMENTS AND SUPPLEMENTS, MEAL REPLACEMENT SOUPS, BARS, COOKIES, POWDERS, AND SHAKES (U.S. CLS. 6, 18, 44, 46, 51 AND 52).

AMY ALFIERI, EXAMINING ATTORNEY

SN 77-679,967. RHINOSYSTEMS, INC., ELYRIA, OH. FILED 2-27-2009.

NATURE'S DECONGESTANT

THE MARK CONSISTS OF STANDARD CHARACTERS WITHOUT CLAIM TO ANY PARTICULAR FONT, STYLE, SIZE, OR COLOR.

NO CLAIM IS MADE TO THE EXCLUSIVE RIGHT TO USE "DECONGESTANT", APART FROM THE MARK AS SHOWN.

FOR NASAL RINSE (U.S. CLS. 6, 18, 44, 46, 51 AND 52).

FIRST USE 6-1-2009; IN COMMERCE 6-1-2009.
ALICIA COLLINS, EXAMINING ATTORNEY

SN 77-680,307. NATROL, INC., CHATSWORTH, CA. FILED 2-27-2009.

NUHAIR

OWNER OF U.S. REG. NOS. 2,476,814, 2,643,394 AND 2,884,181.

THE MARK CONSISTS OF THE WORD "NUHAIR" IN STYLIZED LETTERS WITH A DESIGN OF A HAIR FOLLICLE APPEARING AS PART OF THE LETTER "A".

FOR HERBAL DIETARY SUPPLEMENTS; HAIR GROWTH STIMULANTS, NAMELY TABLETS AND SERUMS FOR HAIR LOSS, REGROWTH AND THINNING HAIR (U.S. CLS. 6, 18, 44, 46, 51 AND 52).

NICHOLAS ALTREE, EXAMINING ATTORNEY

CLASS 5—(Continued).

SN 77-684,041. SIPCAM AGRO USA, INC., DURHAM, NC.
FILED 3-5-2009.

Enhanced Turf Quality

THE MARK CONSISTS OF STANDARD CHARACTERS WITHOUT CLAIM TO ANY PARTICULAR FONT, STYLE, SIZE, OR COLOR.

NO CLAIM IS MADE TO THE EXCLUSIVE RIGHT TO USE "TURF QUALITY", APART FROM THE MARK AS SHOWN.

FOR PESTICIDES FOR TURF AND ORNAMENTAL APPLICATIONS (U.S. CLS. 6, 18, 44, 46, 51 AND 52).

SOPHIA S. KIM, EXAMINING ATTORNEY

CLASS 5—(Continued).

SN 77-684,710. LABORATOIRE THERAMEX, MONACO,
MONACO, FILED 3-5-2009.

NELEME

THE MARK CONSISTS OF STANDARD CHARACTERS WITHOUT CLAIM TO ANY PARTICULAR FONT, STYLE, SIZE, OR COLOR.

PRIORITY CLAIMED UNDER SEC. 44(D) ON MONACO APPLICATION NO. 28614, FILED 11-13-2008, REG. NO. 08.27074, DATED 12-15-2008, EXPIRES 12-15-2018.

FOR PHARMACEUTICAL PRODUCTS, NAMELY, FEMALE CONTRACEPTIVES (U.S. CLS. 6, 18, 44, 46, 51 AND 52).

ZACHARY BELLO, EXAMINING ATTORNEY

SN 77-684,403. LABORATOIRE THERAMEX, MONACO,
MONACO, FILED 3-5-2009.

OAYSA

THE MARK CONSISTS OF STANDARD CHARACTERS WITHOUT CLAIM TO ANY PARTICULAR FONT, STYLE, SIZE, OR COLOR.

PRIORITY CLAIMED UNDER SEC. 44(D) ON MONACO APPLICATION NO. 28613, FILED 11-13-2008, REG. NO. 08.27073, DATED 12-15-2008, EXPIRES 12-15-2018.

FOR PHARMACEUTICAL PRODUCTS, NAMELY, FEMALE CONTRACEPTIVES (U.S. CLS. 6, 18, 44, 46, 51 AND 52).

ZACHARY BELLO, EXAMINING ATTORNEY

SN 77-684,807. LABORATOIRE THERAMEX, MONACO,
MONACO, FILED 3-5-2009.

SCYAN

THE MARK CONSISTS OF STANDARD CHARACTERS WITHOUT CLAIM TO ANY PARTICULAR FONT, STYLE, SIZE, OR COLOR.

PRIORITY CLAIMED UNDER SEC. 44(D) ON MONACO APPLICATION NO. 28610, FILED 11-13-2008, REG. NO. 08.27070, DATED 11-13-2008, EXPIRES 11-13-2018.

FOR PHARMACEUTICAL PRODUCTS, NAMELY, FEMALE CONTRACEPTIVES (U.S. CLS. 6, 18, 44, 46, 51 AND 52).

ZACHARY BELLO, EXAMINING ATTORNEY

SN 77-684,463. EXPLOREX TECHNOLOGIES INC., MISSISSAUGA, ONTARIO, CANADA, FILED 3-5-2009.

Anabolic Rage

THE MARK CONSISTS OF STANDARD CHARACTERS WITHOUT CLAIM TO ANY PARTICULAR FONT, STYLE, SIZE, OR COLOR.

NO CLAIM IS MADE TO THE EXCLUSIVE RIGHT TO USE "ANABOLIC", APART FROM THE MARK AS SHOWN.

FOR NUTRITIONAL SUPPLEMENTS; DIETARY SUPPLEMENTS (U.S. CLS. 6, 18, 44, 46, 51 AND 52).

KATHERINE CHANG, EXAMINING ATTORNEY

SN 77-692,306. HAR EVEN INTERNATIONAL, SAN RAFAEL, CA. FILED 3-16-2009.

Immunepet

THE MARK CONSISTS OF STANDARD CHARACTERS WITHOUT CLAIM TO ANY PARTICULAR FONT, STYLE, SIZE, OR COLOR.

FOR VETERINARY PREPARATIONS AND NUTRACEUTICALS FOR DOGS AND CATS FOR THE SUPPORT OF KIDNEY AND LIVER FUNCTIONS, SKELETAL HEALTH, AND THE IMMUNE SYSTEM (U.S. CLS. 6, 18, 44, 46, 51 AND 52).

KEVIN CORWIN, EXAMINING ATTORNEY

CLASS 5—(Continued).

SN 77-693,127. DOTFIT, LLC, LAFAYETTE, CA. FILED 3-17-2009.

dotFIT Pure Promise

THE MARK CONSISTS OF STANDARD CHARACTERS WITHOUT CLAIM TO ANY PARTICULAR FONT, STYLE, SIZE, OR COLOR.

FOR NUTRITIONAL PRODUCTS, NAMELY, NUTRITIONAL SUPPLEMENTS AND DIETARY SUPPLEMENTS IN THE FORM OF NUTRITIONAL BARS AND COOKIES; NUTRITIONAL SUPPLEMENTS IN THE NATURE OF DRINK MIXES AND POWDERS; NUTRITIONAL DRINK MIX OR POWDER FOR USE AS A MEAL REPLACEMENT; VITAMINS (U.S. CLS. 6, 18, 44, 46, 51 AND 52).

BARBARA BROWN, EXAMINING ATTORNEY

SN 77-694,119. MELVITA, F-07150, LAGORCE, FRANCE, FILED 3-18-2009.

MELVITA

THE MARK CONSISTS OF STANDARD CHARACTERS WITHOUT CLAIM TO ANY PARTICULAR FONT, STYLE, SIZE, OR COLOR.

OWNER OF FRANCE REG. NO. 013082092, DATED 2-2-2001, EXPIRES 2-2-2011.

OWNER OF U.S. REG. NO. 3,324,783.

FOR DIETARY AND NUTRITIONAL SUPPLEMENTS (U.S. CLS. 6, 18, 44, 46, 51 AND 52).

MATTHEW PAPPAS, EXAMINING ATTORNEY

SN 77-700,541. INGENIOUS DESIGNS LLC, ST. PETERSBURG, FL. FILED 3-27-2009.

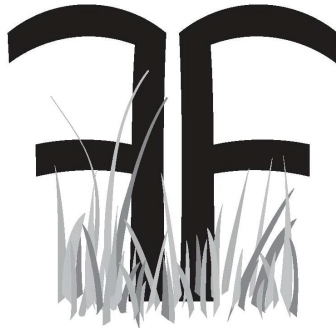

THE MARK CONSISTS OF THE LETTER "F" AND A MIRROR IMAGE OF THE LETTER "F" SITTING IN A BED OF GRASS.

FOR ODOR NEUTRALIZER MADE OF PLASTIC FOR HOUSEHOLD AND PERSONAL USE (U.S. CLS. 6, 18, 44, 46, 51 AND 52).

BARBARA BROWN, EXAMINING ATTORNEY

CLASS 5—(Continued).

SN 77-706,458. ZAVOS DIAGNOSTIC LABORATORIES, INC., LEXINGTON, KY. FILED 4-3-2009.

THE ZAVOS HOME CONCEPTION KIT

THE MARK CONSISTS OF STANDARD CHARACTERS WITHOUT CLAIM TO ANY PARTICULAR FONT, STYLE, SIZE, OR COLOR.

NO CLAIM IS MADE TO THE EXCLUSIVE RIGHT TO USE "HOME CONCEPTION KIT", APART FROM THE MARK AS SHOWN.

FOR KITS IN THE FIELD OF REPRODUCTION AND INFERTILITY, CONSISTING PRIMARILY OF OVULATION PREDICTION TESTS, PREGNANCY TESTS, SEMINAL COLLECTION DEVICES, TEST TUBES, CERVICAL CUP WITH STEM, LUBRICANT, AND OVULATION CHARTS SOLD AS A UNIT (U.S. CLS. 6, 18, 44, 46, 51 AND 52).

FIRST USE 1-15-2009; IN COMMERCE 1-15-2009.

RENEE SERVANCE, EXAMINING ATTORNEY

SN 77-708,398. SMITHKLINE BEECHAM CORPORATION, PHILADELPHIA, PA. FILED 4-7-2009.

LP3

THE MARK CONSISTS OF STANDARD CHARACTERS WITHOUT CLAIM TO ANY PARTICULAR FONT, STYLE, SIZE, OR COLOR.

FOR MEDICATED DENTIFRICES, MEDICATED MOUTHWASHES, MEDICATED CHEWING GUM AND LOZENGES FOR DENTAL HYGIENE (U.S. CLS. 6, 18, 44, 46, 51 AND 52).

ANDREW RHIM, EXAMINING ATTORNEY

SN 77-711,904. MANZEN, LLC, LAS VEGAS, NV. FILED 4-10-2009.

JOINT ARMOUR

THE MARK CONSISTS OF STANDARD CHARACTERS WITHOUT CLAIM TO ANY PARTICULAR FONT, STYLE, SIZE, OR COLOR.

NO CLAIM IS MADE TO THE EXCLUSIVE RIGHT TO USE "JOINT", APART FROM THE MARK AS SHOWN.

FOR DIETARY AND NUTRITIONAL SUPPLEMENTS (U.S. CLS. 6, 18, 44, 46, 51 AND 52).

ANGELA DUONG, EXAMINING ATTORNEY

CLASS 5—(Continued).

SN 77-711,909. MANZEN, LLC, LAS VEGAS, NV. FILED 4-10-2009.

NEURO SWITCH

THE MARK CONSISTS OF STANDARD CHARACTERS WITHOUT CLAIM TO ANY PARTICULAR FONT, STYLE, SIZE, OR COLOR.

NO CLAIM IS MADE TO THE EXCLUSIVE RIGHT TO USE "NEURO", APART FROM THE MARK AS SHOWN.

FOR DIETARY AND NUTRITIONAL SUPPLEMENTS; DIETARY SUPPLEMENTAL DRINKS; MEAL REPLACEMENT AND DIETARY SUPPLEMENT DRINK MIXES; MEAL REPLACEMENT DRINKS; NUTRITIONALLY FORTIFIED BEVERAGES; NUTRITIONALLY FORTIFIED WATER; POWDERED NUTRITIONAL SUPPLEMENT DRINK MIX; VITAMIN FORTIFIED BEVERAGES (U.S. CLS. 6, 18, 44, 46, 51 AND 52).

ANGELA DUONG, EXAMINING ATTORNEY

SN 77-711,911. MANZEN, LLC, LAS VEGAS, NV. FILED 4-10-2009.

NOXV2

THE MARK CONSISTS OF STANDARD CHARACTERS WITHOUT CLAIM TO ANY PARTICULAR FONT, STYLE, SIZE, OR COLOR.

OWNER OF U.S. REG. NO. 3,165,738.

FOR DIETARY AND NUTRITIONAL SUPPLEMENTS; DIETARY SUPPLEMENTAL DRINKS; MEAL REPLACEMENT AND DIETARY SUPPLEMENT DRINK MIXES; MEAL REPLACEMENT DRINKS; NUTRITIONALLY FORTIFIED BEVERAGES; NUTRITIONALLY FORTIFIED WATER; POWDERED NUTRITIONAL SUPPLEMENT DRINK MIX; VITAMIN FORTIFIED BEVERAGES (U.S. CLS. 6, 18, 44, 46, 51 AND 52).

ANGELA DUONG, EXAMINING ATTORNEY

SN 77-712,603. GENETIC TESTING INSTITUTE, INC., WAUKESHA, WI. FILED 4-13-2009.

E-QUATE

THE MARK CONSISTS OF STANDARD CHARACTERS WITHOUT CLAIM TO ANY PARTICULAR FONT, STYLE, SIZE, OR COLOR.

FOR DIAGNOSTIC KITS, FOR MEDICAL PURPOSES, CONTAINING CHEMICALS AND REAGENTS FOR DETECTING ANTIBODIES TO FACTOR VIII (U.S. CLS. 6, 18, 44, 46, 51 AND 52).

ALYSSA STEEL, EXAMINING ATTORNEY

CLASS 5—(Continued).

SN 77-713,444. KEMIRA CHEMICALS, INC., KENNESAW, GA. FILED 4-14-2009.

AMA

THE MARK CONSISTS OF STANDARD CHARACTERS WITHOUT CLAIM TO ANY PARTICULAR FONT, STYLE, SIZE, OR COLOR.

OWNER OF U.S. REG. NO. 1,721,260.

FOR ANTI-MICROBIAL CHEMICAL PREPARATIONS FOR USE IN PAPER MILL WASTE SYSTEMS, RECIRCULATING, COOLING WATER SYSTEMS, AND OIL FIELD DRILLING MUDS, COMPLETED FLUIDS AND WATER TREATMENTS (U.S. CLS. 6, 18, 44, 46, 51 AND 52).

FIRST USE 0-0-1975; IN COMMERCE 0-0-1975.

LINDA ESTRADA, EXAMINING ATTORNEY

SN 77-716,226. SHAWN NUTRACEUTICALS, LLC, AVEN-
TURA, FL. FILED 4-17-2009.

Shawn Nutraceuticals

THE MARK CONSISTS OF STANDARD CHARACTERS WITHOUT CLAIM TO ANY PARTICULAR FONT, STYLE, SIZE, OR COLOR.

NO CLAIM IS MADE TO THE EXCLUSIVE RIGHT TO USE "NUTRACEUTICALS", APART FROM THE MARK AS SHOWN.

FOR DIETARY SUPPLEMENTS (U.S. CLS. 6, 18, 44, 46, 51 AND 52).

CHRISTINE COOPER, EXAMINING ATTORNEY

SN 77-716,430. HOSPIRA, INC., LAKE FOREST, IL. FILED 4-17-2009.

ISUPREL

THE MARK CONSISTS OF STANDARD CHARACTERS WITHOUT CLAIM TO ANY PARTICULAR FONT, STYLE, SIZE, OR COLOR.

OWNER OF U.S. REG. NO. 436,982.

FOR PHARMACEUTICAL PRODUCT FOR THE TREATMENT OF CARDIOVASCULAR AND PULMONARY DISEASES (U.S. CLS. 6, 18, 44, 46, 51 AND 52).

FIRST USE 1-28-1947; IN COMMERCE 1-28-1947.

CHRIS WELLS, EXAMINING ATTORNEY

CLASS 5—(Continued).

SN 77-716,791. MEDTECH PRODUCTS, INC., IRVINGTON, NY. FILED 4-17-2009.

TAGTARGET

THE MARK CONSISTS OF STANDARD CHARACTERS WITHOUT CLAIM TO ANY PARTICULAR FONT, STYLE, SIZE, OR COLOR.

FOR PROTECTIVE SKIN SHIELD IN THE NATURE OF AN ADHESIVE BANDAGE FOR USE WITH SKIN TREATMENT PRODUCTS (U.S. CLS. 6, 18, 44, 46, 51 AND 52).

SUE LAWRENCE, EXAMINING ATTORNEY

CLASS 5—(Continued).

SN 77-720,316. NORTHERN EXPLORER LLC, OVERLAND PARK, KS. FILED 4-23-2009.

STORE IT RIGHT

THE MARK CONSISTS OF STANDARD CHARACTERS WITHOUT CLAIM TO ANY PARTICULAR FONT, STYLE, SIZE, OR COLOR.

FOR ANIMAL REPELLANTS; INSECT REPELLENTS (U.S. CLS. 6, 18, 44, 46, 51 AND 52).

FIRST USE 6-18-2008; IN COMMERCE 8-29-2008.

SAIMA MAKHDOOM, EXAMINING ATTORNEY

SN 77-717,446. DIABETICA RESEARCH SOLUTIONS, INC., BOCA RATON, FL. FILED 4-20-2009.

DRSI RESTORE ENERGY

THE MARK CONSISTS OF STANDARD CHARACTERS WITHOUT CLAIM TO ANY PARTICULAR FONT, STYLE, SIZE, OR COLOR.

NO CLAIM IS MADE TO THE EXCLUSIVE RIGHT TO USE "RESTORE ENERGY", APART FROM THE MARK AS SHOWN.

FOR POWDERED NUTRITIONAL SUPPLEMENT DRINK MIX (U.S. CLS. 6, 18, 44, 46, 51 AND 52).

YAT SYE, LEE, EXAMINING ATTORNEY

SN 77-720,549. ALLMAX NUTRITION INC., TORONTO, CANADA, FILED 4-23-2009.

HEMANOVOL

THE MARK CONSISTS OF STANDARD CHARACTERS WITHOUT CLAIM TO ANY PARTICULAR FONT, STYLE, SIZE, OR COLOR.

THE WORDING "HEMANOVOL" HAS NO MEANING IN A FOREIGN LANGUAGE.

FOR DIETARY SUPPLEMENTS (U.S. CLS. 6, 18, 44, 46, 51 AND 52).

TAMARA FRAZIER, EXAMINING ATTORNEY

SN 77-717,525. ALTAIR THERAPEUTICS, INC., SAN DIEGO, CA. FILED 4-20-2009.

ALTAIR THERAPEUTICS

THE MARK CONSISTS OF STANDARD CHARACTERS WITHOUT CLAIM TO ANY PARTICULAR FONT, STYLE, SIZE, OR COLOR.

NO CLAIM IS MADE TO THE EXCLUSIVE RIGHT TO USE "THERAPEUTICS", APART FROM THE MARK AS SHOWN.

FOR PHARMACEUTICAL PREPARATIONS FOR TREATING ALLERGIC RHINITIS AND ASTHMA; PHARMACEUTICAL PRODUCTS FOR TREATING RESPIRATORY DISEASES AND ASTHMA (U.S. CLS. 6, 18, 44, 46, 51 AND 52).

MARK SPARACINO, EXAMINING ATTORNEY

SN 77-720,558. ALLMAX NUTRITION INC., TORONTO, CANADA, FILED 4-23-2009.

CREMAGNAVOL

THE MARK CONSISTS OF STANDARD CHARACTERS WITHOUT CLAIM TO ANY PARTICULAR FONT, STYLE, SIZE, OR COLOR.

THE WORDING "CREMAGNAVOL" HAS NO MEANING IN A FOREIGN LANGUAGE.

FOR DIETARY SUPPLEMENTS (U.S. CLS. 6, 18, 44, 46, 51 AND 52).

TAMARA FRAZIER, EXAMINING ATTORNEY

CLASS 5—(Continued).

SN 77-720,603. ALLMAX NUTRITION INC., TORONTO, CANADA, FILED 4-23-2009.

POSTMAX

THE MARK CONSISTS OF STANDARD CHARACTERS WITHOUT CLAIM TO ANY PARTICULAR FONT, STYLE, SIZE, OR COLOR.
THE WORDING "POSTMAX" HAS NO MEANING IN A FOREIGN LANGUAGE.
FOR DIETARY SUPPLEMENTS (U.S. CLS. 6, 18, 44, 46, 51 AND 52).
TAMARA FRAZIER, EXAMINING ATTORNEY

SN 77-720,674. ALLMAX NUTRITION INC., TORONTO, CANADA, FILED 4-23-2009.

ALLWHEY

THE MARK CONSISTS OF STANDARD CHARACTERS WITHOUT CLAIM TO ANY PARTICULAR FONT, STYLE, SIZE, OR COLOR.
THE WORDING "ALLWHEY" HAS NO MEANING IN A FOREIGN LANGUAGE.
FOR DIETARY SUPPLEMENTS (U.S. CLS. 6, 18, 44, 46, 51 AND 52).
FIRST USE 10-6-2006; IN COMMERCE 12-19-2006.
TAMARA FRAZIER, EXAMINING ATTORNEY

SN 77-720,714. ALLMAX NUTRITION INC., TORONTO, CANADA, FILED 4-23-2009.

ISOFEMME

THE MARK CONSISTS OF STANDARD CHARACTERS WITHOUT CLAIM TO ANY PARTICULAR FONT, STYLE, SIZE, OR COLOR.
THE WORDING "ISOFEMME" HAS NO MEANING IN A FOREIGN LANGUAGE.
FOR DIETARY SUPPLEMENTS (U.S. CLS. 6, 18, 44, 46, 51 AND 52).
FIRST USE 9-10-2007; IN COMMERCE 3-7-2008.
TAMARA FRAZIER, EXAMINING ATTORNEY

CLASS 5—(Continued).

SN 77-722,133. AIM INTERNATIONAL, INC., DBA THE AIM COMPANIES, NAMPA, ID. FILED 4-24-2009.

AIM PROPEAS

THE MARK CONSISTS OF STANDARD CHARACTERS WITHOUT CLAIM TO ANY PARTICULAR FONT, STYLE, SIZE, OR COLOR.
OWNER OF U.S. REG. NOS. 1,992,409, 2,330,457 AND OTHERS.
FOR DIETARY AND NUTRITIONAL SUPPLEMENTS, NAMELY VEGETABLE PROTEIN IN POWDER FORM AND NUTRITIONAL SNACK BARS (U.S. CLS. 6, 18, 44, 46, 51 AND 52).
MARILYN IZZI, EXAMINING ATTORNEY

SN 77-722,652. SCHWEITZZ DIST. INC., FLUSHING, NY. FILED 4-27-2009.

SCHWEITZZ

THE MARK CONSISTS OF STANDARD CHARACTERS WITHOUT CLAIM TO ANY PARTICULAR FONT, STYLE, SIZE, OR COLOR.
FOR DIETARY SUPPLEMENTS; VITAMINS (U.S. CLS. 6, 18, 44, 46, 51 AND 52).
FIRST USE 1-1-1989; IN COMMERCE 1-1-1989.
KATHRYN COWARD, EXAMINING ATTORNEY

SN 77-723,050. BIG BOOM BRANDS, LLC, WEST PALM BEACH, FL. FILED 4-27-2009.

Horoscope Diet

THE MARK CONSISTS OF STANDARD CHARACTERS WITHOUT CLAIM TO ANY PARTICULAR FONT, STYLE, SIZE, OR COLOR.
NO CLAIM IS MADE TO THE EXCLUSIVE RIGHT TO USE "DIET", APART FROM THE MARK AS SHOWN.
FOR DIETARY AND NUTRITIONAL SUPPLEMENTS (U.S. CLS. 6, 18, 44, 46, 51 AND 52).
DAVID YONTEF, EXAMINING ATTORNEY

CLASS 5—(Continued).

SN 77-723,161. CALIFORNIA SCENTS, IRVINE, CA. FILED 4-27-2009.

Mini-Scents

THE MARK CONSISTS OF STANDARD CHARACTERS WITHOUT CLAIM TO ANY PARTICULAR FONT, STYLE, SIZE, OR COLOR.

SEC. 2(F).
FOR AIR FRESHENERS (U.S. CLS. 6, 18, 44, 46, 51 AND 52).

FIRST USE 2-28-1999; IN COMMERCE 2-28-1999.
NAAKWAMA ANKRAH, EXAMINING ATTORNEY

CLASS 5—(Continued).

SN 77-723,421. DR. SAMUEL WALTERS, DBA OPTOMED PHARMACEUTICALS, SCOTTSDALE, AZ. FILED 4-27-2009.

Detox Gold

THE MARK CONSISTS OF STANDARD CHARACTERS WITHOUT CLAIM TO ANY PARTICULAR FONT, STYLE, SIZE, OR COLOR.

NO CLAIM IS MADE TO THE EXCLUSIVE RIGHT TO USE "DETOX", APART FROM THE MARK AS SHOWN.

FOR DIETARY SUPPLEMENT (U.S. CLS. 6, 18, 44, 46, 51 AND 52).
FIRST USE 4-7-2009; IN COMMERCE 4-7-2009.
MARK PILARO, EXAMINING ATTORNEY

SN 77-723,317. THOMASON, RANDALL W., DBA ROGUE RESEARCH, SURPRISE, AZ. FILED 4-27-2009.

DESERT DEFENSE

THE MARK CONSISTS OF STANDARD CHARACTERS WITHOUT CLAIM TO ANY PARTICULAR FONT, STYLE, SIZE, OR COLOR.

FOR DIETARY SUPPLEMENTS FOR HUMAN CONSUMPTION; DIETARY SUPPLEMENTS FOR PETS (U.S. CLS. 6, 18, 44, 46, 51 AND 52).

FIRST USE 11-1-2008; IN COMMERCE 3-28-2009.
C. DIONNE CLYBURN, EXAMINING ATTORNEY

SN 77-723,540. BAY BREEZE HOLDINGS, LLC, RIVERVIEW, FL. FILED 4-27-2009.

Fast and Furious Energy

THE MARK CONSISTS OF STANDARD CHARACTERS WITHOUT CLAIM TO ANY PARTICULAR FONT, STYLE, SIZE, OR COLOR.

NO CLAIM IS MADE TO THE EXCLUSIVE RIGHT TO USE "ENERGY", APART FROM THE MARK AS SHOWN.

FOR VITAMIN FORTIFIED BEVERAGES (U.S. CLS. 6, 18, 44, 46, 51 AND 52).
TEJBIR SINGH, EXAMINING ATTORNEY

SN 77-723,411. DR. SAMUEL WALTERS, DBA OPTOMED PHARMACEUTICALS, SCOTTSDALE, AZ. FILED 4-27-2009.

Will Power

THE MARK CONSISTS OF STANDARD CHARACTERS WITHOUT CLAIM TO ANY PARTICULAR FONT, STYLE, SIZE, OR COLOR.

FOR DIETARY SUPPLEMENT (U.S. CLS. 6, 18, 44, 46, 51 AND 52).
FIRST USE 3-15-2009; IN COMMERCE 3-15-2009.
MARK PILARO, EXAMINING ATTORNEY

SN 77-723,699. TEVA PHARMACEUTICALS USA, INC., NORTH WALES, PA. FILED 4-28-2009.

EDENITY

THE MARK CONSISTS OF STANDARD CHARACTERS WITHOUT CLAIM TO ANY PARTICULAR FONT, STYLE, SIZE, OR COLOR.

FOR PHARMACEUTICAL PREPARATIONS FOR THE PREVENTION OF PREGNANCY (U.S. CLS. 6, 18, 44, 46, 51 AND 52).

JUDITH HELFMAN, EXAMINING ATTORNEY

CLASS 5—(Continued).

SN 77-723,742. J.H. KINKADE, LLC, CODY, WY. FILED 4-28-2009.

TRAUMA TENT

THE MARK CONSISTS OF STANDARD CHARACTERS WITHOUT CLAIM TO ANY PARTICULAR FONT, STYLE, SIZE, OR COLOR.
FOR MEDICAL WOUND DRESSING (U.S. CLS. 6, 18, 44, 46, 51 AND 52).
JANICE L. MCMORROW, EXAMINING ATTORNEY

CLASS 5—(Continued).

SN 77-723,956. PHARMAVITE LLC, MISSION HILLS, CA. FILED 4-28-2009.

PHARMAVITE

THE MARK CONSISTS OF STANDARD CHARACTERS WITHOUT CLAIM TO ANY PARTICULAR FONT, STYLE, SIZE, OR COLOR.
FOR DIETARY SUPPLEMENTS (U.S. CLS. 6, 18, 44, 46, 51 AND 52).
JENNY PARK, EXAMINING ATTORNEY

SN 77-723,881. NOEL & JOHN TURNER, NEWPORT BEACH, CA. FILED 4-28-2009.

omeganyx

THE MARK CONSISTS OF STANDARD CHARACTERS WITHOUT CLAIM TO ANY PARTICULAR FONT, STYLE, SIZE, OR COLOR.
FOR NUTRITIONAL SUPPLEMENTS (U.S. CLS. 6, 18, 44, 46, 51 AND 52).
MARK PILARO, EXAMINING ATTORNEY

SN 77-724,176. R&D HOLDINGS, SAN CLEMENTE, CA. FILED 4-28-2009.

FIGHT!

THE MARK CONSISTS OF STANDARD CHARACTERS WITHOUT CLAIM TO ANY PARTICULAR FONT, STYLE, SIZE, OR COLOR.
FOR MEAL REPLACEMENT BARS (U.S. CLS. 6, 18, 44, 46, 51 AND 52).
JOHN E. MICHOS, EXAMINING ATTORNEY

SN 77-723,901. E. I. DU PONT DE NEMOURS AND COMPANY, WILMINGTON, DE. FILED 4-28-2009.

REACTOR

THE MARK CONSISTS OF STANDARD CHARACTERS WITHOUT CLAIM TO ANY PARTICULAR FONT, STYLE, SIZE, OR COLOR.
FOR HERBICIDES FOR AGRICULTURAL USE (U.S. CLS. 6, 18, 44, 46, 51 AND 52).
MARTHA FROMM, EXAMINING ATTORNEY

SN 77-724,211. BIG BOOM BRANDS, LLC, WEST PALM BEACH, FL. FILED 4-28-2009.

Beauty Science

THE MARK CONSISTS OF STANDARD CHARACTERS WITHOUT CLAIM TO ANY PARTICULAR FONT, STYLE, SIZE, OR COLOR.
OWNER OF U.S. REG. NO. 3,165,762.
NO CLAIM IS MADE TO THE EXCLUSIVE RIGHT TO USE "SCIENCE", APART FROM THE MARK AS SHOWN.
FOR DIETARY AND NUTRITIONAL SUPPLEMENTS (U.S. CLS. 6, 18, 44, 46, 51 AND 52).
DAVID YONTEF, EXAMINING ATTORNEY

CLASS 5—(Continued).

SN 77-724,295. CELLADAMUSA, INC., KERHONKSON, NY.
FILED 4-28-2009.

Celladam

THE MARK CONSISTS OF STANDARD CHARACTERS WITHOUT CLAIM TO ANY PARTICULAR FONT, STYLE, SIZE, OR COLOR.

FOR FOOD SUPPLEMENTS (U.S. CLS. 6, 18, 44, 46, 51 AND 52).

FIRST USE 6-17-2008; IN COMMERCE 6-17-2008.
ROSELLE HERRERA, EXAMINING ATTORNEY

CLASS 5—(Continued).

SN 77-724,586. HEALTHY DIRECTIONS, LLC, POTOMAC, MD. FILED 4-29-2009.

SLEEK LEGS

THE MARK CONSISTS OF STANDARD CHARACTERS WITHOUT CLAIM TO ANY PARTICULAR FONT, STYLE, SIZE, OR COLOR.

NO CLAIM IS MADE TO THE EXCLUSIVE RIGHT TO USE "LEGS", APART FROM THE MARK AS SHOWN.

FOR VITAMINS AND NUTRITIONAL SUPPLEMENTS (U.S. CLS. 6, 18, 44, 46, 51 AND 52).
MELVIN AXILBUND, EXAMINING ATTORNEY

SN 77-724,454. PHARMAVITE LLC, MISSION HILLS, CA.
FILED 4-28-2009.

NATURE MADE - INSPIRED BY
NATURE, MADE BETTER BY
SCIENCE

THE MARK CONSISTS OF STANDARD CHARACTERS WITHOUT CLAIM TO ANY PARTICULAR FONT, STYLE, SIZE, OR COLOR.

OWNER OF U.S. REG. NOS. 1,963,505, 2,592,200 AND OTHERS.

FOR VITAMINS, MINERALS AND DIETARY SUPPLEMENTS (U.S. CLS. 6, 18, 44, 46, 51 AND 52).
JENNY PARK, EXAMINING ATTORNEY

SN 77-724,698. SCHERING-PLOUGH HEALTHCARE PRODUCTS, INC., MEMPHIS, TN. FILED 4-29-2009.

ODOR-X

THE MARK CONSISTS OF STANDARD CHARACTERS WITHOUT CLAIM TO ANY PARTICULAR FONT, STYLE, SIZE, OR COLOR.

FOR MEDICATED FOOT POWDER (U.S. CLS. 6, 18, 44, 46, 51 AND 52).
JOHN SCHUYLER YARD, EXAMINING ATTORNEY

SN 77-724,532. DR. LY NATURAL HEALTH, INC., MUSCLE SHOALS, AL. FILED 4-28-2009.

DrLy

THE MARK CONSISTS OF STANDARD CHARACTERS WITHOUT CLAIM TO ANY PARTICULAR FONT, STYLE, SIZE, OR COLOR.

FOR DIETARY AND NUTRITIONAL SUPPLEMENTS; DIETARY AND NUTRITIONALLY FORTIFIED FOOD PRODUCTS ADAPTED FOR MEDICAL USE; HERBAL SUPPLEMENTS; HERBAL TEAS FOR MEDICINAL PURPOSES; NUTRACEUTICALS FOR USE AS A DIETARY SUPPLEMENT; VITAMIN AND MINERAL SUPPLEMENTS (U.S. CLS. 6, 18, 44, 46, 51 AND 52).
SETH A. RAPPAPORT, EXAMINING ATTORNEY

SN 77-724,977. NATURMED, INC., CAMP VERDE, AZ. FILED 4-29-2009.

SECRETAGOGUE HGH PLUS

THE MARK CONSISTS OF STANDARD CHARACTERS WITHOUT CLAIM TO ANY PARTICULAR FONT, STYLE, SIZE, OR COLOR.

NO CLAIM IS MADE TO THE EXCLUSIVE RIGHT TO USE "SECRETAGOGUE HGH", APART FROM THE MARK AS SHOWN.

FOR DIETARY SUPPLEMENTS (U.S. CLS. 6, 18, 44, 46, 51 AND 52).
FIRST USE 10-1-2001; IN COMMERCE 10-23-2001.
HEATHER THOMPSON, EXAMINING ATTORNEY

CLASS 5—(Continued).

SN 77-725,097. METAGENICS, INC., SAN CLEMENTE, CA.
FILED 4-29-2009.

Phytoganix

THE MARK CONSISTS OF STANDARD CHARACTERS WITHOUT CLAIM TO ANY PARTICULAR FONT, STYLE, SIZE, OR COLOR.

FOR DIETARY AND NUTRITIONAL SUPPLEMENTS (U.S. CLS. 6, 18, 44, 46, 51 AND 52).

FIRST USE 4-2-2009; IN COMMERCE 4-2-2009.
ELLEN PERKINS, EXAMINING ATTORNEY

SN 77-725,394. GENESIS HEALTH PRODUCTS, INC, DBA GENESIS HEALTH PRODUCTS, BEAVERTON, OR.
FILED 4-29-2009.

Jungle Balm

THE MARK CONSISTS OF STANDARD CHARACTERS WITHOUT CLAIM TO ANY PARTICULAR FONT, STYLE, SIZE, OR COLOR.

NO CLAIM IS MADE TO THE EXCLUSIVE RIGHT TO USE "BALM", APART FROM THE MARK AS SHOWN.

FOR ANALGESIC BALM; ANALGESIC PREPARATIONS; ANALGESICS; BALMS FOR MEDICAL PURPOSES; HERBAL TOPICAL CREAMS, GELS, SALVES, SPRAYS, POWDER, BALMS, LINIMENT AND OINTMENTS FOR THE RELIEF OF ACHE AND PAIN; HERBS FOR MEDICINAL PURPOSES; MEDICAL CLEANSERS FOR SKIN AND WOUNDS; MEDICINAL HERB EXTRACTS; MEDICINAL HERBAL EXTRACTS FOR MEDICAL PURPOSES; MUSCLE SOAKS; PAIN RELIEF MEDICATION; PLANT EXTRACTS FOR MEDICAL, VETERINARY AND PHARMACEUTICAL PURPOSES; RUBBING COMPOUND FOR MEDICAL AND/OR THERAPEUTIC USE; TOPICAL ANALGESICS; TOPICAL ANESTHETICS (U.S. CLS. 6, 18, 44, 46, 51 AND 52).

FIRST USE 4-24-2009; IN COMMERCE 4-24-2009.
HEATHER SAPP, EXAMINING ATTORNEY

SN 77-725,512. MEY CORPORATION, CHAPEL HILL, NC.
FILED 4-29-2009.

VOLCONTROL

THE MARK CONSISTS OF STANDARD CHARACTERS WITHOUT CLAIM TO ANY PARTICULAR FONT, STYLE, SIZE, OR COLOR.

FOR CHEMICAL HERBICIDES FOR AGRICULTURAL, INDUSTRIAL, COMMERCIAL, HOME AND GARDEN WEED CONTROL (U.S. CLS. 6, 18, 44, 46, 51 AND 52).

KATHLEEN M. VANSTON, EXAMINING ATTORNEY

CLASS 5—(Continued).

SN 77-725,514. MEY CORPORATION, CHAPEL HILL, NC.
FILED 4-29-2009.

SOYAFEN

THE MARK CONSISTS OF STANDARD CHARACTERS WITHOUT CLAIM TO ANY PARTICULAR FONT, STYLE, SIZE, OR COLOR.

FOR CHEMICAL HERBICIDES FOR AGRICULTURAL, INDUSTRIAL, COMMERCIAL, HOME AND GARDEN WEED CONTROL (U.S. CLS. 6, 18, 44, 46, 51 AND 52).

KATHLEEN M. VANSTON, EXAMINING ATTORNEY

SN 77-725,819. PFIZER INC., NEW YORK, NY. FILED 4-30-2009.

CADARTA

THE MARK CONSISTS OF STANDARD CHARACTERS WITHOUT CLAIM TO ANY PARTICULAR FONT, STYLE, SIZE, OR COLOR.

FOR VETERINARY VACCINES; VETERINARY PREPARATIONS, VACCINES AND SUBSTANCES FOR THE PREVENTION AND TREATMENT OF PARASITIC INFECTIONS, INFLAMMATION AND INFLAMMATORY DISEASES, RESPIRATORY AND INFECTIOUS DISEASES, IMMUNOLOGICAL, BACTERIAL, VIRAL AND FUNGAL DISEASES, OSTEOPOROSIS, CARDIOVASCULAR DISEASE, CENTRAL NERVOUS SYSTEM DISEASES AND DISORDERS, UROLOGICAL, UROGENITAL AND URINARY DISORDERS, GASTROINTESTINAL DISORDERS, MUSCULOSKELETAL DISORDERS, ALLERGIES, DIABETES, HYPERTENSION, STROKE, CANCER, BLOOD, PAIN, OBESITY, DIGESTIVE DISORDERS, OPHTHALMOLOGICAL DISORDERS, BEHAVIORAL DISORDERS, REPRODUCTIVE DISORDERS, DERMATOLOGICAL DISORDERS, TOOTH DECAY, TOOTH SENSITIVITY, GINGIVITIS, HALITOSIS AND PERIODONTAL DISEASE AND FOR SKIN AND TISSUE REPAIR AND TO LOWER CHOLESTEROL; NUTRITIONAL ADDITIVES AND FOOD SUPPLEMENTS FOR MEDICAL PURPOSES; ALL OF THE FOREGOING FOR TREATING FELINES, CANINES, BOVINES, PORCINES, EQUINES, LLAMAS, RABBITS, RODENTS, BIRDS, FERRETS, POULTRY, GOATS AND SHEEP (U.S. CLS. 6, 18, 44, 46, 51 AND 52).

CAROLYN CATALDO, EXAMINING ATTORNEY

CLASS 5—(Continued).

SN 77-726,066. WINKELMAN, NATHAN LEN, RICE, MN.
FILED 4-30-2009.

DLI

THE MARK CONSISTS OF STANDARD CHARACTERS WITHOUT CLAIM TO ANY PARTICULAR FONT, STYLE, SIZE, OR COLOR.

FOR VETERINARY VACCINES FOR SWINE (U.S. CLS. 6, 18, 44, 46, 51 AND 52).
FIRST USE 11-24-2008; IN COMMERCE 12-15-2008.
JAMES LOVELACE, EXAMINING ATTORNEY

SN 77-726,078. JOHNSON & JOHNSON, NEW BRUNSWICK,
NJ. FILED 4-30-2009.

NO LE PUEDES PONER PAUSA A
LA VIDA

THE MARK CONSISTS OF STANDARD CHARACTERS WITHOUT CLAIM TO ANY PARTICULAR FONT, STYLE, SIZE, OR COLOR.

THE ENGLISH TRANSLATION OF "NO LE PUEDES PONER PAUSA A LA VIDA" IN THE MARK IS YOU CAN'T PAUSE LIFE.

FOR PHARMACEUTICAL PREPARATIONS, NAMELY, ANTIHISTAMINES, DECONGESTANTS, SINUS, AND ALLERGY PREPARATIONS (U.S. CLS. 6, 18, 44, 46, 51 AND 52).
JEFFREY LOOK, EXAMINING ATTORNEY

SN 77-726,179. CHURCH & DWIGHT CO., INC., PRINCETON, NJ. FILED 4-30-2009.

FIRST RESPONSE

THE MARK CONSISTS OF STANDARD CHARACTERS WITHOUT CLAIM TO ANY PARTICULAR FONT, STYLE, SIZE, OR COLOR.

OWNER OF U.S. REG. NOS. 1,684,262, 2,463,969 AND 3,428,360.

FOR GELS FOR USE AS PERSONAL LUBRICANT; MEDICAL LUBRICANT, NAMELY, VAGINAL LUBRICANTS; SILICONE-BASED PERSONAL LUBRICANTS; WATER-BASED PERSONAL LUBRICANTS (U.S. CLS. 6, 18, 44, 46, 51 AND 52).
MICHAEL KEATING, EXAMINING ATTORNEY

CLASS 5—(Continued).

SN 77-726,196. GLENMARK GENERICS LTD., ANDHERI (EAST) MUMBAI, INDIA, FILED 4-30-2009.

AINEA

THE MARK CONSISTS OF STANDARD CHARACTERS WITHOUT CLAIM TO ANY PARTICULAR FONT, STYLE, SIZE, OR COLOR.

FOR CONTRACEPTIVES; HORMONES FOR MEDICAL PURPOSES; ORAL CONTRACEPTIVES (U.S. CLS. 6, 18, 44, 46, 51 AND 52).
JAMES STEIN, EXAMINING ATTORNEY

SN 77-726,212. GLENMARK GENERICS LTD., ANDHERI (EAST) MUMBAI, INDIA, FILED 4-30-2009.

ASTARTE

THE MARK CONSISTS OF STANDARD CHARACTERS WITHOUT CLAIM TO ANY PARTICULAR FONT, STYLE, SIZE, OR COLOR.

FOR CONTRACEPTIVES; HORMONES FOR MEDICAL PURPOSES; ORAL CONTRACEPTIVES (U.S. CLS. 6, 18, 44, 46, 51 AND 52).
JAMES STEIN, EXAMINING ATTORNEY

SN 77-726,223. GLENMARK GENERICS LTD., ANDHERI (EAST) MUMBAI, INDIA, FILED 4-30-2009.

BRIELLYN

THE MARK CONSISTS OF STANDARD CHARACTERS WITHOUT CLAIM TO ANY PARTICULAR FONT, STYLE, SIZE, OR COLOR.

FOR CONTRACEPTIVES; HORMONES FOR MEDICAL PURPOSES; ORAL CONTRACEPTIVES (U.S. CLS. 6, 18, 44, 46, 51 AND 52).
JAMES STEIN, EXAMINING ATTORNEY

CLASS 5—(Continued).

SN 77-726,228. GLENMARK GENERICS LTD., ANDHERI (EAST) MUMBAI, INDIA, FILED 4-30-2009.

BRIALLYN

THE MARK CONSISTS OF STANDARD CHARACTERS WITHOUT CLAIM TO ANY PARTICULAR FONT, STYLE, SIZE, OR COLOR.

FOR CONTRACEPTIVES; HORMONES FOR MEDICAL PURPOSES; ORAL CONTRACEPTIVES (U.S. CLS. 6, 18, 44, 46, 51 AND 52).

JAMES STEIN, EXAMINING ATTORNEY

CLASS 5—(Continued).

SN 77-726,246. GLENMARK GENERICS LTD., ANDHERI (EAST) MUMBAI, INDIA, FILED 4-30-2009.

VERAINA

THE MARK CONSISTS OF STANDARD CHARACTERS WITHOUT CLAIM TO ANY PARTICULAR FONT, STYLE, SIZE, OR COLOR.

FOR CONTRACEPTIVES; HORMONES FOR MEDICAL PURPOSES; ORAL CONTRACEPTIVES (U.S. CLS. 6, 18, 44, 46, 51 AND 52).

JAMES STEIN, EXAMINING ATTORNEY

SN 77-726,238. GLENMARK GENERICS LTD., ANDHERI (EAST) MUMBAI, INDIA, FILED 4-30-2009.

JACINDA

THE MARK CONSISTS OF STANDARD CHARACTERS WITHOUT CLAIM TO ANY PARTICULAR FONT, STYLE, SIZE, OR COLOR.

FOR CONTRACEPTIVES; HORMONES FOR MEDICAL PURPOSES; ORAL CONTRACEPTIVES (U.S. CLS. 6, 18, 44, 46, 51 AND 52).

JAMES STEIN, EXAMINING ATTORNEY

SN 77-726,267. NOVARTIS AG, BASEL, SWITZERLAND, FILED 4-30-2009.

SWINEFLUNOV

THE MARK CONSISTS OF STANDARD CHARACTERS WITHOUT CLAIM TO ANY PARTICULAR FONT, STYLE, SIZE, OR COLOR.

FOR VACCINES FOR HUMAN USE (U.S. CLS. 6, 18, 44, 46, 51 AND 52).

THEODORE MCBRIDE, EXAMINING ATTORNEY

SN 77-726,241. GLENMARK GENERICS LTD., ANDHERI (EAST) MUMBAI, INDIA, FILED 4-30-2009.

ROSEANA

THE MARK CONSISTS OF STANDARD CHARACTERS WITHOUT CLAIM TO ANY PARTICULAR FONT, STYLE, SIZE, OR COLOR.

FOR CONTRACEPTIVES; HORMONES FOR MEDICAL PURPOSES; ORAL CONTRACEPTIVES (U.S. CLS. 6, 18, 44, 46, 51 AND 52).

JAMES STEIN, EXAMINING ATTORNEY

SN 77-726,284. BLISTEX INC., OAK BROOK, IL. FILED 4-30-2009.

NATURAL CONTROL

THE MARK CONSISTS OF STANDARD CHARACTERS WITHOUT CLAIM TO ANY PARTICULAR FONT, STYLE, SIZE, OR COLOR.

NO CLAIM IS MADE TO THE EXCLUSIVE RIGHT TO USE "NATURAL", APART FROM THE MARK AS SHOWN.

FOR MEDICATED TOPICAL PREPARATIONS FOR HUMAN USE FOR CLEANSING THE SKIN, TO PREVENT OR ALLEVIATE THE SYMPTOMS OF ACNE AND OTHER SKIN AFFLICTIONS, FOR SKIN CARE PROTECTION, AND APPLICATORS OR PADS FOR THE FOREGOING ITEMS ALL SOLD AS A UNIT (U.S. CLS. 6, 18, 44, 46, 51 AND 52).

CURTIS FRENCH, EXAMINING ATTORNEY

CLASS 5—(Continued).

SN 77-726,287. BLISTEX INC., OAK BROOK, IL. FILED 4-30-2009.

NATURALLY STRONG

THE MARK CONSISTS OF STANDARD CHARACTERS WITHOUT CLAIM TO ANY PARTICULAR FONT, STYLE, SIZE, OR COLOR.

FOR MEDICATED TOPICAL PREPARATIONS FOR HUMAN USE FOR CLEANSING THE SKIN, TO PREVENT OR ALLEVIATE THE SYMPTOMS OF ACNE AND OTHER SKIN AFFLICTIONS, FOR SKIN CARE PROTECTION, AND APPLICATORS OR PADS FOR THE FOREGOING ITEMS ALL SOLD AS A UNIT (U.S. CLS. 6, 18, 44, 46, 51 AND 52).

CURTIS FRENCH, EXAMINING ATTORNEY

SN 77-726,302. NOVARTIS AG, BASEL, SWITZERLAND, FILED 4-30-2009.

SWINEVAX

THE MARK CONSISTS OF STANDARD CHARACTERS WITHOUT CLAIM TO ANY PARTICULAR FONT, STYLE, SIZE, OR COLOR.

FOR VACCINES FOR HUMAN USE (U.S. CLS. 6, 18, 44, 46, 51 AND 52).

THEODORE MCBRIDE, EXAMINING ATTORNEY

SN 77-726,336. NOVARTIS AG, BASEL, SWITZERLAND, FILED 4-30-2009.

SWIFLUVAX

THE MARK CONSISTS OF STANDARD CHARACTERS WITHOUT CLAIM TO ANY PARTICULAR FONT, STYLE, SIZE, OR COLOR.

FOR VACCINES FOR HUMAN USE (U.S. CLS. 6, 18, 44, 46, 51 AND 52).

THEODORE MCBRIDE, EXAMINING ATTORNEY

CLASS 5—(Continued).

SN 77-726,389. NOVARTIS AG, BASEL, SWITZERLAND, FILED 4-30-2009.

SLUVAX

THE MARK CONSISTS OF STANDARD CHARACTERS WITHOUT CLAIM TO ANY PARTICULAR FONT, STYLE, SIZE, OR COLOR.

FOR VACCINES FOR HUMAN USE (U.S. CLS. 6, 18, 44, 46, 51 AND 52).

THEODORE MCBRIDE, EXAMINING ATTORNEY

SN 77-726,403. WATSON PHARMACEUTICALS, INC., CORONA, CA. FILED 4-30-2009.

MATZIM

THE MARK CONSISTS OF STANDARD CHARACTERS WITHOUT CLAIM TO ANY PARTICULAR FONT, STYLE, SIZE, OR COLOR.

FOR PHARMACEUTICALS, NAMELY, CALCIUM CHANNEL BLOCKERS (U.S. CLS. 6, 18, 44, 46, 51 AND 52).

WILLIAM ROSSMAN, EXAMINING ATTORNEY

SN 77-726,456. NOVARTIS AG, BASEL, SWITZERLAND, FILED 4-30-2009.

PANOFLU

THE MARK CONSISTS OF STANDARD CHARACTERS WITHOUT CLAIM TO ANY PARTICULAR FONT, STYLE, SIZE, OR COLOR.

FOR VACCINES FOR HUMAN USE (U.S. CLS. 6, 18, 44, 46, 51 AND 52).

THEODORE MCBRIDE, EXAMINING ATTORNEY

CLASS 5—(Continued).

SN 77-726,540. LOVELAND PRODUCTS, INC., GREELEY, CO. FILED 4-30-2009.

WHITEOUT

THE MARK CONSISTS OF STANDARD CHARACTERS WITHOUT CLAIM TO ANY PARTICULAR FONT, STYLE, SIZE, OR COLOR.
FOR HERBICIDES (U.S. CLS. 6, 18, 44, 46, 51 AND 52).
JUDITH HELFMAN, EXAMINING ATTORNEY

SN 77-726,579. BAYWOOD INTERNATIONAL, INC., SCOTTSDALE, AZ. FILED 4-30-2009.

LIFEGEVITY

THE MARK CONSISTS OF STANDARD CHARACTERS WITHOUT CLAIM TO ANY PARTICULAR FONT, STYLE, SIZE, OR COLOR.
FOR DIETARY AND NUTRITIONAL SUPPLEMENTS (U.S. CLS. 6, 18, 44, 46, 51 AND 52).
GEORGE LORENZO, EXAMINING ATTORNEY

SN 77-726,600. NISSEN, DAVID, BROOKLYN, NY. FILED 4-30-2009.

SKY HI FORMULAS

THE MARK CONSISTS OF STANDARD CHARACTERS WITHOUT CLAIM TO ANY PARTICULAR FONT, STYLE, SIZE, OR COLOR.
NO CLAIM IS MADE TO THE EXCLUSIVE RIGHT TO USE "FORMULAS", APART FROM THE MARK AS SHOWN.
FOR NUTRACEUTICALS FOR USE AS A DIETARY SUPPLEMENT; NUTRITIONAL SUPPLEMENTS (U.S. CLS. 6, 18, 44, 46, 51 AND 52).
JERI J. FICKES, EXAMINING ATTORNEY

CLASS 5—(Continued).

SN 77-726,639. LIFE SMART LABS, INC., MILLIS, MA. FILED 4-30-2009.

EXTENZITE

THE MARK CONSISTS OF STANDARD CHARACTERS WITHOUT CLAIM TO ANY PARTICULAR FONT, STYLE, SIZE, OR COLOR.
FOR DIETARY SUPPLEMENTS; HERBAL MALE ENHANCEMENT CAPSULES (U.S. CLS. 6, 18, 44, 46, 51 AND 52).
FIRST USE 1-0-2009; IN COMMERCE 1-0-2009.
KIMBERLY FRYE, EXAMINING ATTORNEY

SN 77-726,750. OMNIRELIANT HOLDINGS, INC., CLEARWATER, FL. FILED 5-1-2009.

EZ CLEAR ACNE

THE MARK CONSISTS OF STANDARD CHARACTERS WITHOUT CLAIM TO ANY PARTICULAR FONT, STYLE, SIZE, OR COLOR.
NO CLAIM IS MADE TO THE EXCLUSIVE RIGHT TO USE "CLEAR ACNE", APART FROM THE MARK AS SHOWN.
FOR ACNE MEDICATIONS; ACNE TREATMENT PREPARATIONS (U.S. CLS. 6, 18, 44, 46, 51 AND 52).
DOMINIC FATHY, EXAMINING ATTORNEY

SN 77-726,782. HOFF, B. LYNNE, SUNDRE, ALBERTA, CANADA, FILED 5-1-2009.

BIOEQUINE

THE MARK CONSISTS OF STANDARD CHARACTERS WITHOUT CLAIM TO ANY PARTICULAR FONT, STYLE, SIZE, OR COLOR.
FOR ANIMAL FEED SUPPLEMENTS (U.S. CLS. 6, 18, 44, 46, 51 AND 52).
FIRST USE 8-1-2004; IN COMMERCE 10-1-2008.
HENRY S. ZAK, EXAMINING ATTORNEY

CLASS 5—(Continued).

SN 77-726,852. ORGANOGENESIS INC., CANTON, MA.
FILED 5-1-2009.

REVITIX

THE MARK CONSISTS OF STANDARD CHARACTERS WITHOUT CLAIM TO ANY PARTICULAR FONT, STYLE, SIZE, OR COLOR.

FOR MEDICATED SKIN CARE PREPARATIONS CONTAINING REGENERATIVE SKIN COMPLEXES FOR USE BY DERMATOLOGISTS AND PLASTIC SURGEONS TO APPLY TO PATIENTS' SKIN FOR SKIN REJUVENATION, TREATMENT OF WRINKLES AND SKIN TREATMENT AFTER LASER RESURFACING, CHEMICAL PEELS AND OTHER MEDICAL PROCEDURES (U.S. CLS. 6, 18, 44, 46, 51 AND 52).

EVELYN BRADLEY, EXAMINING ATTORNEY

CLASS 5—(Continued).

SN 77-726,923. GF/CF SOLUTIONS LLC, TARPON SPRINGS, FL. FILED 5-1-2009.



ANGEL'S DREAM

THE STIPPLING IS FOR SHADING PURPOSES ONLY. THE MARK CONSISTS OF THE STYLIZED WORDS "ANGEL'S DREAM". AN IMAGE OF A HALO OVER THE LETTER "A" IN THE WORD "ANGEL".

FOR GLUTEN-FREE AND CASEIN-FREE DESSERT PRODUCTS AND SNACKS TO ACCOMMODATE SPECIAL MEDICAL AND HEALTH CONDITIONS (U.S. CLS. 6, 18, 44, 46, 51 AND 52).

JORDAN BAKER, EXAMINING ATTORNEY

SN 77-726,891. ASTRAZENECA AB, SODERTALJE, SWEDEN, FILED 5-1-2009.



Certriad

THE MARK CONSISTS OF THE WORD "CERTRIAD" COMBINED WITH A DESIGN ELEMENT ABOVE THE WORD THAT SHOWS ONE LINE SWEEPING TO THE RIGHT AND BECOMING THREE LINES ACCENTED BY THREE DOTS.

FOR PHARMACEUTICAL PREPARATIONS AND SUBSTANCES FOR THE TREATMENT OF DISEASES AND DISORDERS OF THE CARDIOVASCULAR SYSTEM (U.S. CLS. 6, 18, 44, 46, 51 AND 52).

PAUL CROWLEY, EXAMINING ATTORNEY

SN 77-726,976. NOVARTIS AG, BASEL, SWITZERLAND, FILED 5-1-2009.

TRIACARE

THE MARK CONSISTS OF STANDARD CHARACTERS WITHOUT CLAIM TO ANY PARTICULAR FONT, STYLE, SIZE, OR COLOR.

FOR SEAWATER FOR CLEANSING AND RINSING NASAL PASSAGES; NON-MEDICATED COUGH AND COLD SYRUPS (U.S. CLS. 6, 18, 44, 46, 51 AND 52).

THEODORE MCBRIDE, EXAMINING ATTORNEY

SN 77-726,919. PURDUE PRODUCTS L.P., STAMFORD, CT. FILED 5-1-2009.

SEKOKOT TO GO

THE MARK CONSISTS OF STANDARD CHARACTERS WITHOUT CLAIM TO ANY PARTICULAR FONT, STYLE, SIZE, OR COLOR.

OWNER OF U.S. REG. NOS. 569,581 AND 975,365. FOR LAXATIVES (U.S. CLS. 6, 18, 44, 46, 51 AND 52).

NAAKWAMA ANKRAH, EXAMINING ATTORNEY

SN 77-726,998. ASTRAZENECA UK LIMITED, LONDON, UNITED KINGDOM, FILED 5-1-2009.



Vimovo

THE COLOR(S) ORANGE AND GREEN IS/ARE CLAIMED AS A FEATURE OF THE MARK.

THE MARK CONSISTS OF THE WORD "VIMOVO" COMBINED WITH A DESIGN ELEMENT AFTER THE WORD THAT SHOWS TWO WINGS. THE WORD "VIMOVO" APPEARS IN ORANGE, ONE OF THE WINGS IS GREEN AND ONE OF THE WINGS IS ORANGE.

FOR PHARMACEUTICAL PREPARATIONS AND SUBSTANCES FOR THE TREATMENT OF PAIN AND INFLAMMATION (U.S. CLS. 6, 18, 44, 46, 51 AND 52).

MICHAEL KEATING, EXAMINING ATTORNEY

CLASS 5—(Continued).

SN 77-727,027. VITAMEC, INC., VAN NUYS, CA. FILED 5-1-2009.

Gummi King

THE MARK CONSISTS OF STANDARD CHARACTERS WITHOUT CLAIM TO ANY PARTICULAR FONT, STYLE, SIZE, OR COLOR.

NO CLAIM IS MADE TO THE EXCLUSIVE RIGHT TO USE "GUMMI", APART FROM THE MARK AS SHOWN.

FOR VITAMINS AND NUTRITIONAL SUPPLEMENTS (U.S. CLS. 6, 18, 44, 46, 51 AND 52).

FIRST USE 1-18-2008; IN COMMERCE 1-18-2008.
JAY FLOWERS, EXAMINING ATTORNEY

CLASS 5—(Continued).

SN 77-727,047. GOOD HEALTH NATURALLY INC., LAS VEGAS, NV. FILED 5-1-2009.

POWERSORB

THE MARK CONSISTS OF STANDARD CHARACTERS WITHOUT CLAIM TO ANY PARTICULAR FONT, STYLE, SIZE, OR COLOR.

FOR DIETARY SUPPLEMENTS; HERBAL SUPPLEMENTS; MINERAL FOOD SUPPLEMENTS; NUTRITIONAL SUPPLEMENTS; VITAMIN SUPPLEMENTS (U.S. CLS. 6, 18, 44, 46, 51 AND 52).

MARGERY A. TIERNEY, EXAMINING ATTORNEY

SN 77-727,034. GOOD HEALTH NATURALLY INC., LAS VEGAS, NV. FILED 5-1-2009.

REFOCUS

THE MARK CONSISTS OF STANDARD CHARACTERS WITHOUT CLAIM TO ANY PARTICULAR FONT, STYLE, SIZE, OR COLOR.

FOR DIETARY SUPPLEMENTS; HERBAL SUPPLEMENTS; MINERAL FOOD SUPPLEMENTS; NUTRITIONAL SUPPLEMENTS; VITAMIN SUPPLEMENTS (U.S. CLS. 6, 18, 44, 46, 51 AND 52).

FIRST USE 4-15-2009; IN COMMERCE 4-15-2009.
MARGERY A. TIERNEY, EXAMINING ATTORNEY

SN 77-727,051. GENOMMA LAB INTERNACIONAL, S.A.B. DE C.V., C.P., MEXICO, FILED 5-1-2009.

GARGAX

THE MARK CONSISTS OF STANDARD CHARACTERS WITHOUT CLAIM TO ANY PARTICULAR FONT, STYLE, SIZE, OR COLOR.

FOR MEDICATED MOUTH WASH FOR USE IN REDUCING INFLAMMATION, IRRITATION, AND SORE THROAT (U.S. CLS. 6, 18, 44, 46, 51 AND 52).

GEOFFREY FOSDICK, EXAMINING ATTORNEY

SN 77-727,045. GENOMMA LAB INTERNACIONAL, S.A.B. DE C.V., C.P., MEXICO, FILED 5-1-2009.

DALAY

THE MARK CONSISTS OF STANDARD CHARACTERS WITHOUT CLAIM TO ANY PARTICULAR FONT, STYLE, SIZE, OR COLOR.

FOR MEDICATED PREPARATIONS FOR USE IN THE TREATMENT OF MODERATE NERVOUS TENSION, IRRITABILITY, AND SLEEPLESSNESS (U.S. CLS. 6, 18, 44, 46, 51 AND 52).

GEOFFREY FOSDICK, EXAMINING ATTORNEY

SN 77-727,061. GENOMMA LAB INTERNACIONAL, S.A.B. DE C.V., C.P., MEXICO, FILED 5-1-2009.

GENOPRAZOL

THE MARK CONSISTS OF STANDARD CHARACTERS WITHOUT CLAIM TO ANY PARTICULAR FONT, STYLE, SIZE, OR COLOR.

FOR MEDICATED PREPARATIONS FOR USE IN THE TREATMENT OF GASTROINTESTINAL DYSFUNCTION (U.S. CLS. 6, 18, 44, 46, 51 AND 52).

GEOFFREY FOSDICK, EXAMINING ATTORNEY

CLASS 5—(Continued).

SN 77-727,084. GENOMMA LAB INTERNACIONAL, S.A.B. DE C.V., C.P., MEXICO, FILED 5-1-2009.

GOICOTABS

THE MARK CONSISTS OF STANDARD CHARACTERS WITHOUT CLAIM TO ANY PARTICULAR FONT, STYLE, SIZE, OR COLOR.

FOR MEDICATED PREPARATIONS FOR USE IN THE TREATMENT OF SYMPTOMS OF CHRONIC AND PERIPHERAL VENOUS INSUFFICIENCY (U.S. CLS. 6, 18, 44, 46, 51 AND 52).

GEOFFREY FOSDICK, EXAMINING ATTORNEY

CLASS 5—(Continued).

SN 77-727,145. GENOMMA LAB INTERNACIONAL, S.A.B. DE C.V., D.F., MEXICO, FILED 5-1-2009.

METABOLTONICS

THE MARK CONSISTS OF STANDARD CHARACTERS WITHOUT CLAIM TO ANY PARTICULAR FONT, STYLE, SIZE, OR COLOR.

FOR MEDICATED PREPARATIONS USED FOR THE INDUCEMENT OF WEIGHT LOSS (U.S. CLS. 6, 18, 44, 46, 51 AND 52).

ALICE BENMAMAN, EXAMINING ATTORNEY

SN 77-727,090. GENOMMA LAB INTERNACIONAL, S.A.B. DE C.V., C.P., MEXICO, FILED 5-1-2009.

POINTTS

THE MARK CONSISTS OF STANDARD CHARACTERS WITHOUT CLAIM TO ANY PARTICULAR FONT, STYLE, SIZE, OR COLOR.

FOR MEDICATED PREPARATIONS FOR USE IN THE TREATMENT OF WARTS AND MOLES (U.S. CLS. 6, 18, 44, 46, 51 AND 52).

ALICE BENMAMAN, EXAMINING ATTORNEY

SN 77-727,107. GENOMMA LAB INTERNACIONAL, S.A.B. DE C.V., D.F., MEXICO, FILED 5-1-2009.

DERMOPRADA

THE MARK CONSISTS OF STANDARD CHARACTERS WITHOUT CLAIM TO ANY PARTICULAR FONT, STYLE, SIZE, OR COLOR.

FOR MEDICATED PREPARATIONS FOR USE IN THE TREATMENT OF WARTS AND MOLES (U.S. CLS. 6, 18, 44, 46, 51 AND 52).

ALICE BENMAMAN, EXAMINING ATTORNEY

SN 77-727,233. PURDUE PRODUCTS L.P., STAMFORD, CT. FILED 5-1-2009.

Senokot *TO GO*

OWNER OF U.S. REG. NOS. 569,581 AND 975,365.

THE MARK CONSISTS OF THE WORDS "SENOKOT TO GO", WITH PLANT LEAVES FORMING PART OF THE LETTER "K" AND GHOSTING OF THE WORDS "TO GO" TO INDICATE MOVEMENT.

FOR LAXATIVES (U.S. CLS. 6, 18, 44, 46, 51 AND 52).
 NAAKWAMA ANKRAH, EXAMINING ATTORNEY

SN 77-727,321. PURDUE PRODUCTS L.P., STAMFORD, CT. FILED 5-1-2009.

Senokot

OWNER OF U.S. REG. NOS. 569,581 AND 975,365.

THE MARK CONSISTS OF THE WORD "SENOKOT", WITH PLANT LEAVES FORMING PART OF THE LETTER "K".

FOR LAXATIVES (U.S. CLS. 6, 18, 44, 46, 51 AND 52).
 NAAKWAMA ANKRAH, EXAMINING ATTORNEY

CLASS 5—(Continued).

SN 77-727,337. PURDUE PRODUCTS L.P., STAMFORD, CT. FILED 5-1-2009.

Senokot-S

OWNER OF U.S. REG. NO. 1,178,790.
THE MARK CONSISTS OF THE WORD "SEKOKOT-S", WITH PLANT LEAVES FORMING PART OF THE LETTER "K".
FOR LAXATIVES (U.S. CLS. 6, 18, 44, 46, 51 AND 52).
NAAKWAMA ANKRAH, EXAMINING ATTORNEY

CLASS 5—(Continued).

SN 77-728,286. FIBROGEN, INC., SAN FRANCISCO, CA. FILED 5-4-2009.

FIBROGEN

THE MARK CONSISTS OF STANDARD CHARACTERS WITHOUT CLAIM TO ANY PARTICULAR FONT, STYLE, SIZE, OR COLOR.
OWNER OF U.S. REG. NO. 2,942,261.
FOR ANTI-CONNECTIVE TISSUE GROWTH FACTOR ANTIBODIES FOR CLINICAL OR PHARMACEUTICAL USE; PROLYL HYDROXYLASE INHIBITORS FOR VETERINARY USE (U.S. CLS. 6, 18, 44, 46, 51 AND 52).
WANDA KAY PRICE, EXAMINING ATTORNEY

SN 77-728,126. CCH NUTRITION CORPORATION, FORT LAUDERDALE, FL. FILED 5-4-2009.

molocure

THE MARK CONSISTS OF STANDARD CHARACTERS WITHOUT CLAIM TO ANY PARTICULAR FONT, STYLE, SIZE, OR COLOR.
FOR VITAMIN SUPPLEMENTS (U.S. CLS. 6, 18, 44, 46, 51 AND 52).
FIRST USE 1-1-1996; IN COMMERCE 3-1-1996.
JOHN WILKE, EXAMINING ATTORNEY

SN 77-728,329. UNION SUPPLY COMPANY, RANCHO DOMINGUEZ, CA. FILED 5-4-2009.

SIMLINE

THE MARK CONSISTS OF STANDARD CHARACTERS WITHOUT CLAIM TO ANY PARTICULAR FONT, STYLE, SIZE, OR COLOR.
FOR VITAMINS (U.S. CLS. 6, 18, 44, 46, 51 AND 52).
FIRST USE 9-1-2007; IN COMMERCE 9-1-2007.
DAVID MILLER, EXAMINING ATTORNEY

SN 77-728,154. CCH NUTRITION CORPORATION, FORT LAUDERDALE, FL. FILED 5-4-2009.

A.M.P. MOLO-CURE

THE MARK CONSISTS OF STANDARD CHARACTERS WITHOUT CLAIM TO ANY PARTICULAR FONT, STYLE, SIZE, OR COLOR.
NO CLAIM IS MADE TO THE EXCLUSIVE RIGHT TO USE "A.M.P.", APART FROM THE MARK AS SHOWN.
FOR VITAMIN SUPPLEMENTS (U.S. CLS. 6, 18, 44, 46, 51 AND 52).
FIRST USE 1-1-1996; IN COMMERCE 3-1-1996.
JOHN WILKE, EXAMINING ATTORNEY

SN 77-728,862. JOHNSON & JOHNSON, NEW BRUNSWICK, NJ. FILED 5-5-2009.

NO LE PUEDES PONER  A LA VIDA

THE MARK CONSISTS OF A PAUSE BUTTON BETWEEN THE SPANISH WORDS "NO LE PUEDES PONER" AND "A LA VIDA".
THE ENGLISH TRANSLATION OF "NO LE PUEDES PONER" AND "A LA VIDA" IN THE MARK IS YOU CAN'T AND LIFE.
FOR PHARMACEUTICAL PREPARATIONS, NAMELY, ANTIHISTAMINES, DECONGESTANTS, SINUS AND ALLERGY PREPARATIONS (U.S. CLS. 6, 18, 44, 46, 51 AND 52).
JEFFREY LOOK, EXAMINING ATTORNEY

CLASS 5—(Continued).

SN 77-729,378. HOPE'S CHANCE, LLC, VERNON HILLS, IL. FILED 5-5-2009.

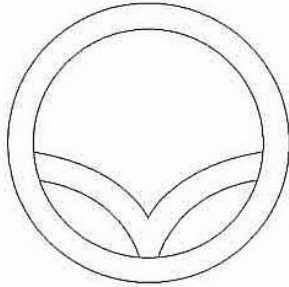

THE MARK CONSISTS OF A ROUNDED "V" IN A CIRCLE.
FOR VITAMINS (U.S. CLS. 6, 18, 44, 46, 51 AND 52).
FRANK LATTUCA, EXAMINING ATTORNEY

CLASS 5—(Continued).

SN 77-731,145. SCHERING-PLOUGH HEALTHCARE PRODUCTS, INC., MEMPHIS, TN. FILED 5-7-2009.

ENDURAHOLD

THE MARK CONSISTS OF STANDARD CHARACTERS WITHOUT CLAIM TO ANY PARTICULAR FONT, STYLE, SIZE, OR COLOR.
FOR ADHESIVE SOLD AS A COMPONENT OF FOOT RELATED PRODUCTS, NAMELY, CORN PADS, CAL-LUS PADS, AND BUNION PADS (U.S. CLS. 6, 18, 44, 46, 51 AND 52).
JOHN SCHUYLER YARD, EXAMINING ATTORNEY

SN 77-731,389. RAMCO, PALM SPRINGS, CA. FILED 5-7-2009.

MEDI-COAT

THE MARK CONSISTS OF STANDARD CHARACTERS WITHOUT CLAIM TO ANY PARTICULAR FONT, STYLE, SIZE, OR COLOR.
FOR ANTIFUNGAL PREPARATIONS (U.S. CLS. 6, 18, 44, 46, 51 AND 52).
ANDREW LEASER, EXAMINING ATTORNEY

SN 77-730,419. S. C. JOHNSON & SON, INC., RACINE, WI. FILED 5-6-2009.



OWNER OF U.S. REG. NOS. 2,373,630, 3,452,510 AND OTHERS.
THE MARK CONSISTS OF THE WORDING "RAID MAX" WITH A CHEVRON DESIGN AND LIGHTNING BOLT.
FOR INSECTICIDES (U.S. CLS. 6, 18, 44, 46, 51 AND 52).
AISHA SALEM, EXAMINING ATTORNEY

SN 77-731,515. PROCTER & GAMBLE COMPANY, THE, CINCINNATI, OH. FILED 5-7-2009.

THE NIGHTTIME SNIFFLING,
SNEEZING, COUGHING,
ACHING, FEVER, BEST SLEEP
YOU EVER GOT WITH A COLD
... . MEDICINE

THE MARK CONSISTS OF STANDARD CHARACTERS WITHOUT CLAIM TO ANY PARTICULAR FONT, STYLE, SIZE, OR COLOR.
OWNER OF U.S. REG. NO. 1,531,572.
FOR MEDICINAL PREPARATIONS FOR THE RELIEF OF COUGH, COLD, AND FLU SYMPTOMS (U.S. CLS. 6, 18, 44, 46, 51 AND 52).
MATTHEW PAPPAS, EXAMINING ATTORNEY

CLASS 5—(Continued).

SN 77-732,792. LIFE SMART LABS, INC., DBA LIFE SMART LABS, INC, MILLIS, MA. FILED 5-8-2009.

EXTENGIN

THE MARK CONSISTS OF STANDARD CHARACTERS WITHOUT CLAIM TO ANY PARTICULAR FONT, STYLE, SIZE, OR COLOR.

FOR HERBAL MALE ENHANCEMENT CAPSULES (U.S. CLS. 6, 18, 44, 46, 51 AND 52).
FIRST USE 3-1-2009; IN COMMERCE 4-1-2009.
KIMBERLY FRYE, EXAMINING ATTORNEY

SN 77-732,835. LIFE SMART LABS, INC., DBA LIFE SMART LABS, INC., MILLIS, MA. FILED 5-8-2009.

SEXTAGIN

THE MARK CONSISTS OF STANDARD CHARACTERS WITHOUT CLAIM TO ANY PARTICULAR FONT, STYLE, SIZE, OR COLOR.

FOR HERBAL MALE ENHANCEMENT CAPSULES (U.S. CLS. 6, 18, 44, 46, 51 AND 52).
FIRST USE 4-1-2009; IN COMMERCE 5-1-2009.
KIMBERLY FRYE, EXAMINING ATTORNEY

SN 77-733,610. PFIZER INC., NEW YORK, NY. FILED 5-11-2009.

KYGO

THE MARK CONSISTS OF STANDARD CHARACTERS WITHOUT CLAIM TO ANY PARTICULAR FONT, STYLE, SIZE, OR COLOR.

FOR PHARMACEUTICAL PREPARATIONS FOR THE TREATMENT OF CARDIOVASCULAR, CENTRAL NERVOUS SYSTEM, ENDOCRINE, GASTROINTESTINAL, GYNECOLOGICAL, HEMATOLOGIC, IMMUNOLOGICAL, INFECTIOUS, INFLAMMATORY, MENOPAUSAL, METABOLIC, MUSCULOSKELETAL, NEUROLOGICAL, ONCOLOGICAL, OPHTHALMOLOGICAL, PSYCHIATRIC, RESPIRATORY, SLEEP, UROGENITAL, UROLOGICAL AND VIRAL DISEASES AND DISORDERS; PHARMACEUTICAL PREPARATIONS FOR THE TREATMENT OF ALLERGIES, ERECTILE DYSFUNCTION, SEXUAL DYSFUNCTION, OBESITY, PAIN, INFLAMMATION, HIV/AIDS, AND ALZHEIMER'S DISEASE; PHARMACEUTICAL PREPARATIONS, NAMELY, ANTIFUNGAL PREPARATIONS, DERMATOLOGICAL PREPARATIONS, SMOKING CESSATION PREPARATIONS; VACCINES FOR HUMAN USE; ADJUVANTS FOR USE WITH HUMAN VACCINES (U.S. CLS. 6, 18, 44, 46, 51 AND 52).
CAROLYN CATALDO, EXAMINING ATTORNEY

CLASS 5—(Continued).

SN 77-733,614. PFIZER INC., NEW YORK, NY. FILED 5-11-2009.

XIDORGEX

THE MARK CONSISTS OF STANDARD CHARACTERS WITHOUT CLAIM TO ANY PARTICULAR FONT, STYLE, SIZE, OR COLOR.

FOR PHARMACEUTICAL PREPARATIONS FOR THE TREATMENT OF CARDIOVASCULAR, CENTRAL NERVOUS SYSTEM, ENDOCRINE, GASTROINTESTINAL, GYNECOLOGICAL, HEMATOLOGIC, IMMUNOLOGICAL, INFECTIOUS, INFLAMMATORY, MENOPAUSAL, METABOLIC, MUSCULOSKELETAL, NEUROLOGICAL, ONCOLOGICAL, OPHTHALMOLOGICAL, PSYCHIATRIC, RESPIRATORY, SLEEP, UROGENITAL, UROLOGICAL AND VIRAL DISEASES AND DISORDERS; PHARMACEUTICAL PREPARATIONS FOR THE TREATMENT OF ALLERGIES, ERECTILE DYSFUNCTION, SEXUAL DYSFUNCTION, OBESITY, PAIN, INFLAMMATION, HIV/AIDS, AND ALZHEIMER'S DISEASE; PHARMACEUTICAL PREPARATIONS, NAMELY, ANTIFUNGAL PREPARATIONS, DERMATOLOGICAL PREPARATIONS, SMOKING CESSATION PREPARATIONS; VACCINES FOR HUMAN USE; ADJUVANTS FOR USE WITH HUMAN VACCINES (U.S. CLS. 6, 18, 44, 46, 51 AND 52).

CAROLYN CATALDO, EXAMINING ATTORNEY

SN 77-733,616. PFIZER INC., NEW YORK, NY. FILED 5-11-2009.

CIBINQO

THE MARK CONSISTS OF STANDARD CHARACTERS WITHOUT CLAIM TO ANY PARTICULAR FONT, STYLE, SIZE, OR COLOR.

FOR PHARMACEUTICAL PREPARATIONS FOR THE TREATMENT OF CARDIOVASCULAR, CENTRAL NERVOUS SYSTEM, ENDOCRINE, GASTROINTESTINAL, GYNECOLOGICAL, HEMATOLOGIC, IMMUNOLOGICAL, INFECTIOUS, INFLAMMATORY, MENOPAUSAL, METABOLIC, MUSCULOSKELETAL, NEUROLOGICAL, ONCOLOGICAL, OPHTHALMOLOGICAL, PSYCHIATRIC, RESPIRATORY, SLEEP, UROGENITAL, UROLOGICAL AND VIRAL DISEASES AND DISORDERS; PHARMACEUTICAL PREPARATIONS FOR THE TREATMENT OF ALLERGIES, ERECTILE DYSFUNCTION, SEXUAL DYSFUNCTION, OBESITY, PAIN, INFLAMMATION, HIV/AIDS, AND ALZHEIMER'S DISEASE; PHARMACEUTICAL PREPARATIONS, NAMELY, ANTIFUNGAL PREPARATIONS, DERMATOLOGICAL PREPARATIONS, SMOKING CESSATION PREPARATIONS; VACCINES FOR HUMAN USE; ADJUVANTS FOR USE WITH HUMAN VACCINES (U.S. CLS. 6, 18, 44, 46, 51 AND 52).
CAROLYN CATALDO, EXAMINING ATTORNEY

CLASS 5—(Continued).

SN 77-736,344. NATROL, INC., CHATSWORTH, CA. FILED 5-13-2009.

MOOD MELT

THE MARK CONSISTS OF STANDARD CHARACTERS WITHOUT CLAIM TO ANY PARTICULAR FONT, STYLE, SIZE, OR COLOR.
FOR DIETARY SUPPLEMENTS (U.S. CLS. 6, 18, 44, 46, 51 AND 52).
BARBARA BROWN, EXAMINING ATTORNEY

CLASS 5—(Continued).

SN 77-743,086. SPELLING TELEVISION INC., STUDIO CITY, CA. FILED 5-22-2009.

MELROSE PLACE

THE MARK CONSISTS OF STANDARD CHARACTERS WITHOUT CLAIM TO ANY PARTICULAR FONT, STYLE, SIZE, OR COLOR.
OWNER OF U.S. REG. NOS. 1,821,796 AND 2,350,925.
FOR ADHESIVE BANDAGES, VITAMINS (U.S. CLS. 6, 18, 44, 46, 51 AND 52).
KRISTIN CARLSON, EXAMINING ATTORNEY

SN 77-736,381. NATROL, INC., CHATSWORTH, CA. FILED 5-13-2009.

REPLENISH NOW

THE MARK CONSISTS OF STANDARD CHARACTERS WITHOUT CLAIM TO ANY PARTICULAR FONT, STYLE, SIZE, OR COLOR.
FOR DIETARY SUPPLEMENTS (U.S. CLS. 6, 18, 44, 46, 51 AND 52).
BARBARA BROWN, EXAMINING ATTORNEY

SN 77-743,758. WATSON PHARMACEUTICALS, INC., CORONA, CA. FILED 5-24-2009.

MEZTIA

THE MARK CONSISTS OF STANDARD CHARACTERS WITHOUT CLAIM TO ANY PARTICULAR FONT, STYLE, SIZE, OR COLOR.
FOR PHARMACEUTICALS, NAMELY, CALCIUM CHANNEL BLOCKERS (U.S. CLS. 6, 18, 44, 46, 51 AND 52).
WILLIAM ROSSMAN, EXAMINING ATTORNEY

SN 77-742,429. LOVELAND PRODUCTS, INC., GREELEY, CO. FILED 5-21-2009.

DIVERSE

THE MARK CONSISTS OF STANDARD CHARACTERS WITHOUT CLAIM TO ANY PARTICULAR FONT, STYLE, SIZE, OR COLOR.
FOR INSECTICIDES AND PESTICIDES FOR AGRICULTURAL, TURF AND ORNAMENTAL USE (U.S. CLS. 6, 18, 44, 46, 51 AND 52).
JUDITH HELFMAN, EXAMINING ATTORNEY

SN 77-745,871. BLISTEX INC., OAK BROOK, IL. FILED 5-27-2009.

COOL BURST

THE MARK CONSISTS OF STANDARD CHARACTERS WITHOUT CLAIM TO ANY PARTICULAR FONT, STYLE, SIZE, OR COLOR.
FOR MEDICATED LIP CARE PREPARATIONS, MEDICATED TOPICAL CREAMS, LOTIONS, GELS, BALMS, AND/OR OINTMENTS FOR HUMAN USE FOR LIP AND SKIN DRYNESS, COLD SORES, AND FOR LIP AND SKIN CARE (U.S. CLS. 6, 18, 44, 46, 51 AND 52).
CURTIS FRENCH, EXAMINING ATTORNEY

CLASS 5—(Continued).

SN 77-746,601. E. I. DU PONT DE NEMOURS AND COMPANY, WILMINGTON, DE. FILED 5-28-2009.

REALM

THE MARK CONSISTS OF STANDARD CHARACTERS WITHOUT CLAIM TO ANY PARTICULAR FONT, STYLE, SIZE, OR COLOR.

FOR HERBICIDES FOR USE IN AGRICULTURE (U.S. CLS. 6, 18, 44, 46, 51 AND 52).

MARTHA FROMM, EXAMINING ATTORNEY

SN 77-746,905. BLISTEX INC., OAK BROOK, IL. FILED 5-28-2009.

**DISCOVER BLISS. DISCOVER
BLISTEX.**

THE MARK CONSISTS OF STANDARD CHARACTERS WITHOUT CLAIM TO ANY PARTICULAR FONT, STYLE, SIZE, OR COLOR.

OWNER OF U.S. REG. NOS. 804,558, 2,817,472 AND OTHERS.

FOR MEDICATED LIP CARE PREPARATIONS, MEDICATED TOPICAL CREAMS, LOTIONS, GELS, BALMS, AND/OR OINTMENTS FOR HUMAN USE FOR LIP AND SKIN DRYNESS, COLD SORES, AND FOR LIP AND SKIN CARE (U.S. CLS. 6, 18, 44, 46, 51 AND 52).

CURTIS FRENCH, EXAMINING ATTORNEY

SN 77-749,216. ADVANCED VISION RESEARCH, INC., WOBURN, MA. FILED 6-1-2009.

THERATEARS XTRA

THE MARK CONSISTS OF STANDARD CHARACTERS WITHOUT CLAIM TO ANY PARTICULAR FONT, STYLE, SIZE, OR COLOR.

OWNER OF U.S. REG. NOS. 2,041,112, 2,770,188 AND 3,181,614.

FOR EYE DROPS (U.S. CLS. 6, 18, 44, 46, 51 AND 52).

MARK SHINER, EXAMINING ATTORNEY

CLASS 5—(Continued).

SN 77-751,206. CHR. HANSEN A/S, MILWAUKEE, WI. FILED 6-3-2009.

MICRO-TECH

THE MARK CONSISTS OF STANDARD CHARACTERS WITHOUT CLAIM TO ANY PARTICULAR FONT, STYLE, SIZE, OR COLOR.

FOR NUTRITIONAL SUPPLEMENT WITH STREPTOCOCCUS FAECIUM FOR POULTRY AND ANIMAL FEEDS (U.S. CLS. 6, 18, 44, 46, 51 AND 52).

FIRST USE 11-29-1984; IN COMMERCE 11-29-1984.

GINA FINK, EXAMINING ATTORNEY

SN 77-751,899. NUGEN TECHNOLOGIES, INC., SAN CARLOS, CA. FILED 6-4-2009.

WT-OVATION

THE MARK CONSISTS OF STANDARD CHARACTERS WITHOUT CLAIM TO ANY PARTICULAR FONT, STYLE, SIZE, OR COLOR.

OWNER OF U.S. REG. NOS. 3,099,464, 3,197,706 AND 3,407,410.

FOR CHEMICALS, ASSAYS, REAGENTS AND KITS CONSISTING PRIMARILY OF CHEMICALS, ASSAYS, AND REAGENTS FOR THE ANALYSIS OF NUCLEIC ACIDS, PROTEINS AND ANTIBODIES FOR CLINICAL MEDICAL AND MEDICAL DIAGNOSTIC USE; CHEMICALS, ASSAYS, REAGENTS AND KITS CONSISTING PRIMARILY OF CHEMICALS, ASSAYS, AND REAGENTS FOR NUCLEIC ACID SEQUENCE AMPLIFICATION, SEQUENCING AND SEQUENCE ANALYSIS AND DETECTION, OLIGONUCLEOTIDES, CDNA AND RNA LIBRARIES AND MICROARRAYS FOR CLINICAL MEDICAL AND MEDICAL DIAGNOSTIC USE (U.S. CLS. 6, 18, 44, 46, 51 AND 52).

PATRICIA EVANKO, EXAMINING ATTORNEY

SN 77-752,159. E. I. DU PONT DE NEMOURS AND COMPANY, WILMINGTON, DE. FILED 6-4-2009.

CYAZYPYR

THE MARK CONSISTS OF STANDARD CHARACTERS WITHOUT CLAIM TO ANY PARTICULAR FONT, STYLE, SIZE, OR COLOR.

FOR INSECTICIDES FOR USE IN AGRICULTURE (U.S. CLS. 6, 18, 44, 46, 51 AND 52).

MARTHA FROMM, EXAMINING ATTORNEY

CLASS 5—(Continued).

SN 77-754,095. SANOFI-AVENTIS, PARIS, FRANCE, FILED 6-8-2009.

YSTAPLIS

THE MARK CONSISTS OF STANDARD CHARACTERS WITHOUT CLAIM TO ANY PARTICULAR FONT, STYLE, SIZE, OR COLOR.

FOR PHARMACEUTICAL PREPARATIONS FOR THE TREATMENT OF DIABETES (U.S. CLS. 6, 18, 44, 46, 51 AND 52).

RON FAIRBANKS, EXAMINING ATTORNEY

SN 77-754,502. PFIZER INC., NEW YORK, NY. FILED 6-8-2009.

JETTIZO

THE MARK CONSISTS OF STANDARD CHARACTERS WITHOUT CLAIM TO ANY PARTICULAR FONT, STYLE, SIZE, OR COLOR.

FOR PHARMACEUTICAL PREPARATIONS FOR THE TREATMENT OF CARDIOVASCULAR, CENTRAL NERVOUS SYSTEM, ENDOCRINE, GASTROINTESTINAL, GYNECOLOGICAL, HEMATOLOGIC, IMMUNOLOGICAL, INFECTIOUS, INFLAMMATORY, MENOPAUSAL, METABOLIC, MUSCULOSKELETAL, NEUROLOGICAL, ONCOLOGICAL, OPHTHALMOLOGICAL, PSYCHIATRIC, RESPIRATORY, SLEEP, UROGENITAL, UROLOGICAL AND VIRAL DISEASES AND DISORDERS; PHARMACEUTICAL PREPARATIONS FOR THE TREATMENT OF ALLERGIES, ERECTILE DYSFUNCTION, SEXUAL DYSFUNCTION, OBESITY, PAIN, INFLAMMATION, HIV/AIDS, AND ALZHEIMER'S DISEASE; PHARMACEUTICAL PREPARATIONS, NAMELY, ANTIFUNGAL PREPARATIONS, DERMATOLOGICAL PREPARATIONS, SMOKING CESSATION PREPARATIONS; VACCINES FOR HUMAN USE; ADJUVANTS FOR USE WITH HUMAN VACCINES (U.S. CLS. 6, 18, 44, 46, 51 AND 52).

CAROLYN CATALDO, EXAMINING ATTORNEY

SN 77-755,320. E. I. DU PONT DE NEMOURS AND COMPANY, WILMINGTON, DE. FILED 6-9-2009.

ABUNDIT

THE MARK CONSISTS OF STANDARD CHARACTERS WITHOUT CLAIM TO ANY PARTICULAR FONT, STYLE, SIZE, OR COLOR.

FOR HERBICIDES FOR AGRICULTURAL USE (U.S. CLS. 6, 18, 44, 46, 51 AND 52).

MARTHA FROMM, EXAMINING ATTORNEY

CLASS 5—(Continued).

SN 77-757,206. WATSON PHARMACEUTICALS, INC., CORONA, CA. FILED 6-11-2009.

PRINCON

THE MARK CONSISTS OF STANDARD CHARACTERS WITHOUT CLAIM TO ANY PARTICULAR FONT, STYLE, SIZE, OR COLOR.

FOR PHARMACEUTICALS, NAMELY, ORAL CONTRACEPTIVES (U.S. CLS. 6, 18, 44, 46, 51 AND 52).

WILLIAM ROSSMAN, EXAMINING ATTORNEY

SN 77-757,221. WATSON PHARMACEUTICALS, INC., CORONA, CA. FILED 6-11-2009.

BASIO

THE MARK CONSISTS OF STANDARD CHARACTERS WITHOUT CLAIM TO ANY PARTICULAR FONT, STYLE, SIZE, OR COLOR.

FOR PHARMACEUTICALS, NAMELY, ORAL CONTRACEPTIVES (U.S. CLS. 6, 18, 44, 46, 51 AND 52).

WILLIAM ROSSMAN, EXAMINING ATTORNEY

SN 77-761,859. WYETH, MADISON, NJ. FILED 6-17-2009.

I'M ALL ADVIL

THE MARK CONSISTS OF STANDARD CHARACTERS WITHOUT CLAIM TO ANY PARTICULAR FONT, STYLE, SIZE, OR COLOR.

OWNER OF U.S. REG. NOS. 1,298,347, 1,635,943 AND 1,942,746.

FOR ANALGESIC, ANTI-PYRETIC, ANTI-INFLAMMATORY, COLD, SINUS, FLU AND ALLERGY PREPARATIONS (U.S. CLS. 6, 18, 44, 46, 51 AND 52).

ESTHER BELENKER, EXAMINING ATTORNEY

CLASS 5—(Continued).

SN 77-762,334. BLISTEX INC., OAK BROOK, IL. FILED 6-17-2009.

ESSENTIALS

THE MARK CONSISTS OF STANDARD CHARACTERS WITHOUT CLAIM TO ANY PARTICULAR FONT, STYLE, SIZE, OR COLOR.

FOR MEDICATED LIP CARE PREPARATIONS, MEDICATED TOPICAL CREAMS, LOTIONS, GELS, BALMS, AND/OR OINTMENTS FOR HUMAN USE FOR LIP AND SKIN DRYNESS, COLD SORES, AND FOR LIP AND SKIN CARE (U.S. CLS. 6, 18, 44, 46, 51 AND 52).

CURTIS FRENCH, EXAMINING ATTORNEY

SN 77-762,344. BLISTEX INC., OAK BROOK, IL. FILED 6-17-2009.

MOISTURE MELT

THE MARK CONSISTS OF STANDARD CHARACTERS WITHOUT CLAIM TO ANY PARTICULAR FONT, STYLE, SIZE, OR COLOR.

NO CLAIM IS MADE TO THE EXCLUSIVE RIGHT TO USE "MOISTURE", APART FROM THE MARK AS SHOWN.

FOR MEDICATED LIP CARE PREPARATIONS, MEDICATED TOPICAL CREAMS, LOTIONS, GELS, BALMS, AND/OR OINTMENTS FOR HUMAN USE FOR LIP DRYNESS, COLD SORES, AND FOR LIP CARE (U.S. CLS. 6, 18, 44, 46, 51 AND 52).

CURTIS FRENCH, EXAMINING ATTORNEY

SN 77-762,703. RBC LIFE SCIENCES, INC., IRVING, TX. FILED 6-18-2009.

NeuroBright

THE MARK CONSISTS OF STANDARD CHARACTERS WITHOUT CLAIM TO ANY PARTICULAR FONT, STYLE, SIZE, OR COLOR.

FOR DIETARY AND NUTRITIONAL SUPPLEMENTS (U.S. CLS. 6, 18, 44, 46, 51 AND 52).

KATHERINE E. HALMEN, EXAMINING ATTORNEY

CLASS 5—(Continued).

SN 77-765,148. ASTRAZENECA AB, SODERTALJE, SWEDEN, FILED 6-22-2009.

RELOMBI

THE MARK CONSISTS OF STANDARD CHARACTERS WITHOUT CLAIM TO ANY PARTICULAR FONT, STYLE, SIZE, OR COLOR.

FOR PHARMACEUTICAL PREPARATIONS FOR THE TREATMENT OF DISEASES AND DISORDERS OF THE CARDIOVASCULAR, GASTROINTESTINAL, RESPIRATORY AND NERVOUS SYSTEMS; PHARMACEUTICAL PREPARATIONS FOR THE TREATMENT OF PAIN, INFLAMMATION AND INFECTION; PHARMACEUTICAL PREPARATIONS FOR THE TREATMENT OF CANCER, DIABETES, OBESITY, AND PSYCHIATRIC AND NEUROLOGICAL DISEASES AND DISORDERS (U.S. CLS. 6, 18, 44, 46, 51 AND 52).

PAUL CROWLEY, EXAMINING ATTORNEY

SN 77-765,250. PFIZER INC., NEW YORK, NY. FILED 6-22-2009.

MYREGO

THE MARK CONSISTS OF STANDARD CHARACTERS WITHOUT CLAIM TO ANY PARTICULAR FONT, STYLE, SIZE, OR COLOR.

FOR PHARMACEUTICAL PREPARATIONS FOR THE TREATMENT OF CARDIOVASCULAR, CENTRAL NERVOUS SYSTEM, ENDOCRINE, GASTROINTESTINAL, GYNECOLOGICAL, HEMATOLOGIC, IMMUNOLOGICAL, INFECTIOUS, INFLAMMATORY, MENOPAUSAL, METABOLIC, MUSCULOSKELETAL, NEUROLOGICAL, ONCOLOGICAL, OPHTHALMOLOGICAL, PSYCHIATRIC, RESPIRATORY, SLEEP, UROGENITAL, UROLOGICAL AND VIRAL DISEASES AND DISORDERS; PHARMACEUTICAL PREPARATIONS FOR THE TREATMENT OF ALLERGIES, ERECTILE DYSFUNCTION, SEXUAL DYSFUNCTION, OBESITY, PAIN, INFLAMMATION, HIV/AIDS, AND ALZHEIMER'S DISEASE; PHARMACEUTICAL PREPARATIONS, NAMELY, ANTIFUNGAL PREPARATIONS, DERMATOLOGICAL PREPARATIONS, SMOKING CESSATION PREPARATIONS; VACCINES FOR HUMAN USE; ADJUVANTS FOR USE WITH HUMAN VACCINES (U.S. CLS. 6, 18, 44, 46, 51 AND 52).

CAROLYN CATALDO, EXAMINING ATTORNEY

CLASS 5—(Continued).

SN 78-410,033. NANODEL TECHNOLOGIES, GMBH, MAGDEBURG, FED REP GERMANY, FILED 4-29-2004.

NANODEL

THE MARK CONSISTS OF STANDARD CHARACTERS WITHOUT CLAIM TO ANY PARTICULAR FONT, STYLE, SIZE, OR COLOR.

FOR DRUG DELIVERY AGENTS IN THE FORM OF CHEMICAL AND PHARMACEUTICAL EXCIPIENT FOR THE DELIVERY AND DILUTION OF DRUG (U.S. CLS. 6, 18, 44, 46, 51 AND 52).

JULIE WATSON, EXAMINING ATTORNEY

SN 78-688,020. NOVARTIS AG, BASEL, SWITZERLAND, FILED 8-8-2005.

ULTRA CHEWS

THE MARK CONSISTS OF STANDARD CHARACTERS WITHOUT CLAIM TO ANY PARTICULAR FONT, STYLE, SIZE, OR COLOR.

OWNER OF SWITZERLAND REG. NO. 542396, DATED 1-9-2006, EXPIRES 1-9-2016.

NO CLAIM IS MADE TO THE EXCLUSIVE RIGHT TO USE "CHEWS", APART FROM THE MARK AS SHOWN.

FOR ANTIPARASITIC VETERINARY PREPARATIONS (U.S. CLS. 6, 18, 44, 46, 51 AND 52).

CHARLES L. JENKINS, EXAMINING ATTORNEY

SN 78-746,584. KAKEN PHARMACEUTICAL CO., LTD., TOKYO, JAPAN, FILED 11-3-2005.

FIBLAST

THE MARK CONSISTS OF STANDARD CHARACTERS WITHOUT CLAIM TO ANY PARTICULAR FONT, STYLE, SIZE, OR COLOR.

FOR THERAPEUTIC PHARMACEUTICAL PREPARATIONS TO PROMOTE TISSUE REPAIR AND ANGIOGENESIS (U.S. CLS. 6, 18, 44, 46, 51 AND 52).

SUSAN LESLIE DUBOIS, EXAMINING ATTORNEY

CLASS 5—(Continued).

SN 79-058,953. YICHANG HUMANWELL; PHARMACEUTICAL CO., LTD., CHINA, FILED 3-17-2008.



OWNER OF INTERNATIONAL REGISTRATION 0977511 DATED 3-17-2008, EXPIRES 3-17-2018.

THE MARK CONSISTS OF AN OVAL ABOVE THREE CURVED BANDS RESEMBLING A STICK FIGURE AND THE WORDING "RUNFULL".

FOR MEDICINES FOR HUMAN PURPOSES, NAMELY, PHARMACEUTICAL PREPARATIONS IN THE NATURE OF ANTIDEPRESSANTS; CAPSULES FOR PHARMACEUTICAL PURPOSES, NAMELY, PHARMACEUTICAL PREPARATIONS IN CAPSULE IN THE NATURE OF ANTIDEPRESSANTS; PHARMACEUTICAL PREPARATIONS, NAMELY, PHARMACEUTICAL PREPARATIONS IN THE NATURE OF ANTIDEPRESSANTS; CHEMICO-PHARMACEUTICAL PREPARATIONS, NAMELY, PHARMACEUTICAL PREPARATIONS IN THE NATURE OF ANTIDEPRESSANTS; INJECTION, NAMELY, INJECTABLE DERMAL FILLER; TABLET, NAMELY, ANTIBIOTIC TABLETS; TINCTURES, NAMELY, SOLUTION OF MEDICINAL SUBSTANCE FOR DISINFECTION OF WOUNDS IN AN ALCOHOLIC SOLVENT; ACQUEOUS FORMULATION, NAMELY, CONTACT LENS CLEANING SOLUTION; RAW MATERIAL MEDICINE, NAMELY, GELATIN CAPSULES SOLD EMPTY FOR PHARMACEUTICALS; ENCAPSULATED PILL, NAMELY, DECONGESTANT CAPSULES (U.S. CLS. 6, 18, 44, 46, 51 AND 52).

APRIL ROACH, EXAMINING ATTORNEY

SN 79-062,488. GUIZHOU YIBAI PHARMACEUTICAL COMPANY LIMITED, CHINA, FILED 9-12-2008.



OWNER OF INTERNATIONAL REGISTRATION 0985946 DATED 9-12-2008, EXPIRES 9-12-2018.

THE MARK CONSISTS OF FOUR STYLIZED LETTERS "KEKE" AND TWO NON-LATIN CHARACTERS.

THE ENGLISH TRANSLATION OF THE FOREIGN WORD(S) IN THE MARK IS "GRAM CHARACTER."

THE NON-LATIN CHARACTERS IN THE MARK TRANSLITERATE TO "KE KE" AND THIS MEANS GRAM CHARACTER IN ENGLISH.

FOR MEDICINES FOR HUMAN PURPOSES, NAMELY, PHARMACEUTICAL PREPARATIONS FOR THE TREATMENT OF VIRAL, CARDIOVASCULAR, RESPIRATORY RELATED DISEASES AND DISORDERS; CAPSULES SOLD EMPTY FOR PHARMACEUTICAL PURPOSES (U.S. CLS. 6, 18, 44, 46, 51 AND 52).

KIMBERLY PERRY, EXAMINING ATTORNEY

CLASS 5—(Continued).

SN 79-062,503. NATUMIN PHARMA AB, SWEDEN, FILED 7-24-2008.

DUOMARE

THE MARK CONSISTS OF STANDARD CHARACTERS WITHOUT CLAIM TO ANY PARTICULAR FONT, STYLE, SIZE, OR COLOR.

PRIORITY DATE OF 1-29-2008 IS CLAIMED.

OWNER OF INTERNATIONAL REGISTRATION 0985986 DATED 7-24-2008, EXPIRES 7-24-2018.

THE WORDING "DUOMARE" HAS NO MEANING IN A FOREIGN LANGUAGE.

FOR FOOD SUPPLEMENTS BASED ON SHARK LIVER OIL AND FISH OIL (U.S. CLS. 6, 18, 44, 46, 51 AND 52).

LIEF MARTIN, EXAMINING ATTORNEY

SN 79-062,628. BASF SE, FED REP GERMANY, FILED 10-28-2008.

CULMINATE

THE MARK CONSISTS OF STANDARD CHARACTERS WITHOUT CLAIM TO ANY PARTICULAR FONT, STYLE, SIZE, OR COLOR.

OWNER OF INTERNATIONAL REGISTRATION 0793511 DATED 11-4-2002, EXPIRES 11-4-2012.

FOR PESTICIDES, PREPARATIONS FOR DESTROYING VERMIN, FUNGICIDES, HERBICIDES, INSECTICIDES (U.S. CLS. 6, 18, 44, 46, 51 AND 52).

ELIZABETH HUGHITT, EXAMINING ATTORNEY

SN 79-063,022. GUIZHOU YIBAI PHARMACEUTICAL COMPANY LIMITED, GUIZHOU PROVINCE, CHINA, FILED 9-12-2008.



OWNER OF INTERNATIONAL REGISTRATION 0987286 DATED 9-12-2008, EXPIRES 9-12-2018.

THE MARK CONSISTS OF FOUR CHINESE CHARACTERS ABOVE THE NUMBER "100" ABOVE A CURVED BAND, WHICH CURVES THROUGH THE NUMBERS "00" SUPERIMPOSED ON TOP OF AN OVAL.

THE ENGLISH TRANSLATION OF THE WORDING ZUO ZU YI BAI IN THE MARK IS DO BEST TO BENEFIT IN MANY ASPECTS.

THE NON-LATIN CHARACTERS IN THE MARK TRANSLITERATE TO ZUO ZU YI BAI.

FOR MEDICINES FOR HUMAN PURPOSES FOR THE TREATMENT OF GASTROINTESTINAL DISEASES; PHARMACEUTICAL PREPARATIONS FOR THE TREATMENT OF VIRAL, CARDIOVASCULAR, RESPIRATORY RELATED DISEASES AND DISORDERS; BIOLOGICAL PREPARATIONS FOR MEDICAL PURPOSES; DIETETIC SUBSTANCES ADAPTED FOR MEDICAL USE, NAMELY, DIETETIC SUGAR FOR MEDICAL USE, DIETETIC FOODS ADAPTED FOR MEDICAL USE (U.S. CLS. 6, 18, 44, 46, 51 AND 52).

MYRIAH HABEB, EXAMINING ATTORNEY

CLASS 5—(Continued).

SN 79-065,167. STRAKAN INTERNATIONAL LIMITED, UNITED KINGDOM, FILED 1-21-2009.

SERAPMAX

THE MARK CONSISTS OF STANDARD CHARACTERS WITHOUT CLAIM TO ANY PARTICULAR FONT, STYLE, SIZE, OR COLOR.

PRIORITY DATE OF 1-13-2009 IS CLAIMED.

OWNER OF INTERNATIONAL REGISTRATION 0992906 DATED 1-21-2009, EXPIRES 1-21-2019.

FOR PHARMACEUTICAL AND MEDICINAL PREPARATIONS AND SUBSTANCES FOR THE TREATMENT OF METABOLIC DISORDERS, HORMONE DEFICIENCIES, SKIN DISEASES, SKIN DISORDERS, BONE DISEASES, BONE DISORDERS, SEXUALLY TRANSMITTED DISEASES, DISEASES OF THE CENTRAL NERVOUS SYSTEM, CANCER, MICROBIAL CONDITIONS AND INFECTIONS, RECTAL CONDITIONS, RECTAL DISEASES AND RECTAL DISORDERS, VITAMIN AND MINERAL DEFICIENCIES, PAIN, GASTROINTESTINAL CONDITIONS, AND CARDIOVASCULAR CONDITIONS; PHARMACEUTICAL PREPARATIONS, SUBSTANCES AND GELS FOR HORMONE REPLACEMENT; SANITARY PREPARATIONS FOR MEDICAL USE; DIETETIC FOODS AND DIETETIC FOOD SUPPLEMENTS ADAPTED FOR MEDICAL USE; MEDICAL PLASTERS; MATERIALS FOR DRESSINGS, NAMELY, BURN DRESSINGS, SURGICAL DRESSINGS, AND WOUND DRESSINGS; GAUZES AND BANDAGES FOR DRESSINGS; TRANSDERMAL PATCHES CONTAINING PHARMACEUTICAL PREPARATION FOR THE TREATMENT OF METABOLIC DISORDERS, HORMONE DEFICIENCIES, SKIN DISEASES, SKIN DISORDERS, BONE DISEASES, BONE DISORDERS, SEXUALLY TRANSMITTED DISEASES, DISEASES OF THE CENTRAL NERVOUS SYSTEM, CANCER, MICROBIAL CONDITIONS AND INFECTIONS, RECTAL CONDITIONS, RECTAL DISEASES AND RECTAL DISORDERS, VITAMIN AND MINERAL DEFICIENCIES, PAIN, GASTROINTESTINAL CONDITIONS, AND CARDIOVASCULAR CONDITIONS (U.S. CLS. 6, 18, 44, 46, 51 AND 52).

ROBERT STRUCK, EXAMINING ATTORNEY

SN 79-066,429. GRIFOLS, S.A., SPAIN, FILED 2-5-2009.

ALBUMEDIA

THE MARK CONSISTS OF STANDARD CHARACTERS WITHOUT CLAIM TO ANY PARTICULAR FONT, STYLE, SIZE, OR COLOR.

OWNER OF INTERNATIONAL REGISTRATION 0958173 DATED 12-26-2007, EXPIRES 12-26-2017.

FOR HUMAN PLASMA DERIVED PROTEIN SUPPLEMENTS CONTAINING ALBUMIN, USED IN MAMMAL CELL CULTURED SOLUTIONS FOR PHARMACEUTICAL AND MEDICAL PURPOSES (U.S. CLS. 6, 18, 44, 46, 51 AND 52).

KELLY CHOE, EXAMINING ATTORNEY

CLASS 5—(Continued).

SN 79-070,048. ZERIA PHARMACEUTICAL CO., LTD., JAPAN, FILED 4-28-2009.

FIDLEEC

PRIORITY DATE OF 11-10-2008 IS CLAIMED.
OWNER OF INTERNATIONAL REGISTRATION 1005582
DATED 4-28-2009, EXPIRES 4-28-2019.

FOR PHARMACEUTICAL PREPARATIONS FOR THE
TREATMENT OF GASTROINTESTINAL DISEASES AND
DISORDERS (U.S. CLS. 6, 18, 44, 46, 51 AND 52).
MIDGE BUTLER, EXAMINING ATTORNEY

SN 79-070,236. SANOFI-AVENTIS, FRANCE, FILED 4-22-2009.

TELVIORÉ

THE MARK CONSISTS OF STANDARD CHARACTERS
WITHOUT CLAIM TO ANY PARTICULAR FONT, STYLE,
SIZE, OR COLOR.

PRIORITY DATE OF 10-27-2008 IS CLAIMED.
OWNER OF INTERNATIONAL REGISTRATION 1006126
DATED 4-22-2009, EXPIRES 4-22-2019.

FOR PHARMACEUTICAL PRODUCTS FOR CANCER
PREVENTION AND TREATMENT (U.S. CLS. 6, 18, 44, 46,
51 AND 52).
RON FAIRBANKS, EXAMINING ATTORNEY

CLASS 6—METAL GOODS

SN 77-469,635. VICWEST OPERATING LIMITED PARTNER-
SHIP, OAKVILLE, ONTARIO, CANADA, FILED 5-8-2008.

WESTOR

THE MARK CONSISTS OF STANDARD CHARACTERS
WITHOUT CLAIM TO ANY PARTICULAR FONT, STYLE,
SIZE, OR COLOR.

PRIORITY CLAIMED UNDER SEC. 44(D) ON CANADA
APPLICATION NO. 1371315, FILED 11-8-2007, REG. NO.
TMA738780, DATED 4-24-2009, EXPIRES 4-24-2024.

FOR METAL GRAIN BINS (U.S. CLS. 2, 12, 13, 14, 23,
25 AND 50).
BONNIE LUKEN, EXAMINING ATTORNEY

CLASS 6—(Continued).

SN 77-581,288. ROLL-N-GO, INC., PRIOR LAKE, MN. FILED
9-29-2008.

ALUMAQUICK

THE MARK CONSISTS OF STANDARD CHARACTERS
WITHOUT CLAIM TO ANY PARTICULAR FONT, STYLE,
SIZE, OR COLOR.

FOR SUPPORTABLE METAL DOCKS, NAMELY, SEC-
TIONAL METAL DOCKS THAT ARE SUPPORTED ON
LEGS; KITS USED TO MAKE SUPPORTABLE METAL
DOCKS FROM METAL DOCK SECTIONS; AND, STRUC-
TURAL PARTS AND FITTINGS THEREFOR, NAMELY,
METAL DOCK SECTIONS, LEG PIPES, LEG BRACKETS,
SECTIONAL BRACKETS, DOCK BUMPERS AND DOCK
CLEATS (U.S. CLS. 2, 12, 13, 14, 23, 25 AND 50).

NANCY CLARKE, EXAMINING ATTORNEY

SN 77-589,658. NAN JUEN INTERNATIONAL CO., LTD.,
YING-GE TOWN, TAIWAN, FILED 10-9-2008.



OWNER OF U.S. REG. NO. 2,493,103.

THE MARK CONSISTS OF A STYLIZED LETTER "R"
AND THE STYLIZED TERM "REPON".

FOR METAL SLIDING GUIDE RAIL FOR DRAWERS;
METAL RAILS FOR FURNITURE; STEEL BALL RAILS;
METAL HINGES FOR FURNITURE AND WINDOWS
AND DOORS; METAL ACCESSORIES FOR FURNI-
TURE, NAMELY, METAL HANDLES FOR DOORS,
METAL DOOR LATCHES, METAL SCREWS, METAL
BOLTS; METAL SLIDING RAIL FOR DRAWERS; STEEL
BALLS FOR GUIDE RAILS; METAL SLIDING RAILS
FOR WINDOWS AND DOORS (U.S. CLS. 2, 12, 13, 14, 23,
25 AND 50).

BRIAN PINO, EXAMINING ATTORNEY

CLASS 6—(Continued).

SN 77-592,752. HS VALVE CO., LTD, DAEGU, REPUBLIC OF KOREA, FILED 10-14-2008.



THE MARK CONSISTS OF A HALF CIRCLE DESIGN ABOVE A TRIANGLE WITH ITS TOP CUT OFF. THE LETTER "H" APPEARS NEXT TO THE CIRCLE/TRIANGLE DESIGN AND THE DESIGN IS REPEATED AGAIN AFTER THE "H", BUT WITH THE CIRCLE ON THE BOTTOM AND TRIANGLE ON THE TOP. THE DESIGN IS THEN FOLLOWED BY THE LETTERS "HS".

FOR VALVES OF METAL NOT BEING PARTS OF MACHINES, MANUALLY OPERATED WATER-PIPE VALVES OF METAL, PIPE COUPLING OF METAL, FLANGES OF METAL AND METAL SPRINGS (U.S. CLS. 2, 12, 13, 14, 23, 25 AND 50).

CAROLINE WOOD, EXAMINING ATTORNEY

CLASS 6—(Continued).

SN 77-658,501. POWER CURBERS, INC., SALISBURY, NC. FILED 1-28-2009.



NO CLAIM IS MADE TO THE EXCLUSIVE RIGHT TO USE "AMERICAN, INC.", APART FROM THE MARK AS SHOWN.

THE MARK CONSISTS OF THE WORDS "ANVIL AMERICAN, INC." WITH A DRAWING OF AN ANVIL AND TWO HORIZONTAL BARS AT THE TOP AND BOTTOM OF THE DESIGN.

FOR STRINGLINE GUIDANCE SYSTEM COMPONENTS FOR PAVING EQUIPMENT, NAMELY, METAL STAKES, METAL CLAMPS, STRINGLINE, METAL LINE RODS, METAL RADIUS CLIPS, TENSION WINCHES, METAL BOLTS, AND STRINGLINE KITS, COMPRISING STRINGLINE STAKES, LINE RODS, LINE CLAMPS, SENSOR CORDS AND TENSION WINCHES, ALL SOLD AS A UNIT (U.S. CLS. 2, 12, 13, 14, 23, 25 AND 50).

RONALD AIKENS, EXAMINING ATTORNEY

SN 77-612,280. GRAY METAL SOUTH, INC., DUNN, NC. FILED 11-11-2008.

**Get Your Ducts In A Row
With Gray Metal South**

THE MARK CONSISTS OF STANDARD CHARACTERS WITHOUT CLAIM TO ANY PARTICULAR FONT, STYLE, SIZE, OR COLOR.

FOR PRE-FABRICATED METAL HEATING, VENTILATING AND AIR CONDITIONING AIR DUCT AND FITTINGS, NAMELY, ANGLES, BOOTS, COLLARS, ELBOWS, INCREASERS, PIPES, REDUCERS, SEALING COLLARS, SPIN-FITTINGS, TAKEOFFS, TEES, TRUNKS, TRUNK ELBOWS, WALL STACKS AND WYES (U.S. CLS. 2, 12, 13, 14, 23, 25 AND 50).

PAUL CROWLEY, EXAMINING ATTORNEY

SN 77-658,543. POWER CURBERS, INC., SALISBURY, NC. FILED 1-28-2009.

ANVIL AMERICAN

THE MARK CONSISTS OF STANDARD CHARACTERS WITHOUT CLAIM TO ANY PARTICULAR FONT, STYLE, SIZE, OR COLOR.

NO CLAIM IS MADE TO THE EXCLUSIVE RIGHT TO USE "AMERICAN", APART FROM THE MARK AS SHOWN.

FOR STRINGLINE GUIDANCE SYSTEM COMPONENTS FOR PAVING EQUIPMENT, NAMELY, METAL STAKES, METAL CLAMPS, STRINGLINE, METAL LINE RODS, METAL RADIUS CLIPS, TENSION WINCHES, METAL BOLTS, AND STRINGLINE KITS, COMPRISING STRINGLINE STAKES, LINE RODS, LINE CLAMPS, SENSOR CORDS AND TENSION WINCHES, ALL SOLD AS A UNIT (U.S. CLS. 2, 12, 13, 14, 23, 25 AND 50).

RONALD AIKENS, EXAMINING ATTORNEY

SN 77-636,808. SEVERSTAL COLUMBUS, LLC, COLUMBUS, MS. FILED 12-19-2008.

SEVERFORM

THE MARK CONSISTS OF STANDARD CHARACTERS WITHOUT CLAIM TO ANY PARTICULAR FONT, STYLE, SIZE, OR COLOR.

FOR FLAT-ROLLED STEEL SHEET AND PLATE (U.S. CLS. 2, 12, 13, 14, 23, 25 AND 50).

DARRYL SPRUILL, EXAMINING ATTORNEY

SN 77-672,248. JARES, ROY, PHOENIX, AZ. FILED 2-17-2009.

R STEEL CONNECTORS

THE MARK CONSISTS OF STANDARD CHARACTERS WITHOUT CLAIM TO ANY PARTICULAR FONT, STYLE, SIZE, OR COLOR.

NO CLAIM IS MADE TO THE EXCLUSIVE RIGHT TO USE "STEEL CONNECTORS", APART FROM THE MARK AS SHOWN.

FOR STEEL CONNECTORS BEING PIPE CONNECTORS (U.S. CLS. 2, 12, 13, 14, 23, 25 AND 50).

MATTHEW KLINE, EXAMINING ATTORNEY

CLASS 6—(Continued).

SN 77-710,309. MPI CONCEPTS, INC., HUDSONVILLE, MI. FILED 4-9-2009.

TRACKBRACK

THE MARK CONSISTS OF STANDARD CHARACTERS WITHOUT CLAIM TO ANY PARTICULAR FONT, STYLE, SIZE, OR COLOR.

FOR METAL BRACKETS FOR GARAGE DOOR OPENERS AND TRACKS (U.S. CLS. 2, 12, 13, 14, 23, 25 AND 50).

MELVIN AXILBUND, EXAMINING ATTORNEY

SN 77-716,122. MAGNOLIA UNDERDECK FINISHING, LLC, CHAMBLEE, GA. FILED 4-17-2009.

MAGNOLIA UNDERDECK FINISHING

THE MARK CONSISTS OF STANDARD CHARACTERS WITHOUT CLAIM TO ANY PARTICULAR FONT, STYLE, SIZE, OR COLOR.

NO CLAIM IS MADE TO THE EXCLUSIVE RIGHT TO USE "UNDERDECK FINISHING", APART FROM THE MARK AS SHOWN.

FOR METAL BUILDING MATERIALS, NAMELY, PERMANENT METAL ROOF AND CEILING STRUCTURES FOR PLACEMENT BENEATH OUTDOOR DECKS (U.S. CLS. 2, 12, 13, 14, 23, 25 AND 50).

FIRST USE 2-9-2009; IN COMMERCE 2-9-2009. MICHELE SWAIN, EXAMINING ATTORNEY

CLASS 6—(Continued).

SN 77-721,232. TWENTIETH CENTURY FOX FILM CORPORATION, LOS ANGELES, CA. FILED 4-23-2009.



OWNER OF U.S. REG. NO. 3,001,994. THE MARK CONSISTS OF THE STYLIZED WORDS "THE ADVENTURES OF DIGGER AND FRIENDS" WHICH APPEAR INSIDE OF TWO OVAL CONCENTRIC LINES, THE WORDS "FOX SPORTS" WHICH APPEAR UNDER THE WORD "FRIENDS" AND INSIDE OF THE OVAL SHAPE OVERLAPPING ON THE BOTTOM OF THE INNER OVAL LINE AND FIVE COSTUMED GOPHER CHARACTERS WHICH APPEAR ABOVE THE OUTER OVAL LINE.

FOR METAL KEY CHAINS; METAL LICENSE PLATES (U.S. CLS. 2, 12, 13, 14, 23, 25 AND 50). LINDA LAVACHE, EXAMINING ATTORNEY

SN 77-722,209. PROGRESSIVE FASTENING, INC., SEATTLE, WA. FILED 4-24-2009.

PRO-LOC

THE MARK CONSISTS OF STANDARD CHARACTERS WITHOUT CLAIM TO ANY PARTICULAR FONT, STYLE, SIZE, OR COLOR.

FOR METAL GOODS, NAMELY, SUPPORT BRACKETS FOR PIPE (U.S. CLS. 2, 12, 13, 14, 23, 25 AND 50).

FIRST USE 11-9-1985; IN COMMERCE 11-9-1985. DAVID I, EXAMINING ATTORNEY

CLASS 6—(Continued).

SN 77-722,217. PROGRESSIVE FASTENING, INC., SEATTLE, WA. FILED 4-24-2009.

PRO-WAY

THE MARK CONSISTS OF STANDARD CHARACTERS WITHOUT CLAIM TO ANY PARTICULAR FONT, STYLE, SIZE, OR COLOR.

FOR METAL GOODS, NAMELY, A STANDARD CONNECTABLE TO AN OVERHEAD STRUCTURE TO SERVE AS A MOUNT FOR ELECTRICAL WIRING (U.S. CLS. 2, 12, 13, 14, 23, 25 AND 50).

FIRST USE 4-9-1987; IN COMMERCE 10-2-1987.
DAVID I, EXAMINING ATTORNEY

CLASS 6—(Continued).

SN 77-724,215. ACCURIDE INTERNATIONAL INC., SANTA FE SPRINGS, CA. FILED 4-28-2009.

ACTION-ASSIST

THE MARK CONSISTS OF STANDARD CHARACTERS WITHOUT CLAIM TO ANY PARTICULAR FONT, STYLE, SIZE, OR COLOR.

FOR METAL SLIDES FOR DRAWERS (U.S. CLS. 2, 12, 13, 14, 23, 25 AND 50).

GEORGE LORENZO, EXAMINING ATTORNEY

SN 77-722,772. MESKER DOOR, INC., HUNTSVILLE, AL. FILED 4-27-2009.

ENVIOUS

THE MARK CONSISTS OF STANDARD CHARACTERS WITHOUT CLAIM TO ANY PARTICULAR FONT, STYLE, SIZE, OR COLOR.

FOR METAL DOORS (U.S. CLS. 2, 12, 13, 14, 23, 25 AND 50).

JEFF DEFORD, EXAMINING ATTORNEY

SN 77-725,285. TEJAS TUBULAR PRODUCTS, INC., HOUSTON, TX. FILED 4-29-2009.

TTF

THE MARK CONSISTS OF STANDARD CHARACTERS WITHOUT CLAIM TO ANY PARTICULAR FONT, STYLE, SIZE, OR COLOR.

FOR METAL PIPE CONNECTORS, NAMELY, THREADED CONNECTIONS OF METAL FOR ATTACHING TO TUBING USED IN OIL AND GAS WELL OPERATIONS (U.S. CLS. 2, 12, 13, 14, 23, 25 AND 50).

JAY BESCH, EXAMINING ATTORNEY

SN 77-724,093. CAMP, ROBERT, MESQUITE, TX. FILED 4-28-2009.



THE MARK CONSISTS OF THE STYLIZED LETTERS "Q", "U", "I", "K", "L", "A", "T", "C", AND "H" WITH A STYLIZED HYPHEN BETWEEN "QUIK" AND "LATCH". THE TAIL OF THE LETTER "Q" IS SIMPLY AN ABSTRACT DESIGN.

FOR METAL LATCHES (U.S. CLS. 2, 12, 13, 14, 23, 25 AND 50).

FIRST USE 4-1-2009; IN COMMERCE 4-25-2009.
KATHLEEN M. VANSTON, EXAMINING ATTORNEY

SN 77-725,320. TEJAS TUBULAR PRODUCTS, INC., HOUSTON, TX. FILED 4-29-2009.

TMSF

THE MARK CONSISTS OF STANDARD CHARACTERS WITHOUT CLAIM TO ANY PARTICULAR FONT, STYLE, SIZE, OR COLOR.

FOR METAL THREADED COUPLINGS AND CASING FOR USE IN OIL AND GAS WELL OPERATIONS (U.S. CLS. 2, 12, 13, 14, 23, 25 AND 50).

JAY BESCH, EXAMINING ATTORNEY

CLASS 6—(Continued).

SN 77-725,419. TWENTIETH CENTURY FOX FILM CORPORATION, LOS ANGELES, CA. FILED 4-29-2009.

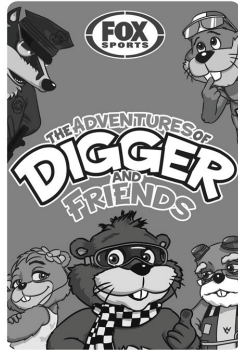

OWNER OF U.S. REG. NO. 3,001,994.
THE MARK CONSISTS OF THE STYLIZED WORDS "THE ADVENTURES OF DIGGER AND FRIENDS" WHICH APPEAR IN THE CENTER, THE WORDS "FOX SPORTS" WHICH APPEAR INSIDE OF THE OVAL SHAPE ON THE TOP CENTER AND FIVE COSTUMED GOPHER CHARACTERS, AND ALL ARE DISPLAYED INSIDE OF THE RECTANGULAR BACKGROUND.
FOR METAL KEY CHAINS; METAL LICENSE PLATES (U.S. CLS. 2, 12, 13, 14, 23, 25 AND 50).
LINDA LAVACHE, EXAMINING ATTORNEY

SN 77-725,589. SOVILOK COMPANY, FLUSHING, MI. FILED 4-29-2009.

SOVILOK BREAKINBLOCKER

THE MARK CONSISTS OF STANDARD CHARACTERS WITHOUT CLAIM TO ANY PARTICULAR FONT, STYLE, SIZE, OR COLOR.
FOR DOOR FITTINGS OF METAL; METAL MULTI-POINT LOCKING SYSTEM IN A WOOD DOOR (U.S. CLS. 2, 12, 13, 14, 23, 25 AND 50).
FIRST USE 1-22-2009; IN COMMERCE 1-23-2009.
BRIAN PINO, EXAMINING ATTORNEY

CLASS 6—(Continued).

SN 77-726,543. TOTAL STRUCTURES, INC., VENTURA, CA. FILED 4-30-2009.

OMNI

THE MARK CONSISTS OF STANDARD CHARACTERS WITHOUT CLAIM TO ANY PARTICULAR FONT, STYLE, SIZE, OR COLOR.

FOR METAL STRUCTURAL TRUSS SYSTEMS, NAMELY, METAL STRUCTURAL TRUSSES AND METAL FORK-END CONNECTORS THAT CREATE HINGES AND ANGLES IN ANY ORIENTATION, FOR THE CREATION OF PERMANENT AND NON-PERMANENT STRUCTURES (U.S. CLS. 2, 12, 13, 14, 23, 25 AND 50).

FIRST USE 10-20-2000; IN COMMERCE 10-20-2000.
JOHN KELLY, EXAMINING ATTORNEY

SN 77-727,444. M2M, LLC, MANASSAS, VA. FILED 5-1-2009.

Grill Like A Pro

THE MARK CONSISTS OF STANDARD CHARACTERS WITHOUT CLAIM TO ANY PARTICULAR FONT, STYLE, SIZE, OR COLOR.

FOR CAST IRON BARBECUE GRATES (U.S. CLS. 2, 12, 13, 14, 23, 25 AND 50).

FIRST USE 9-1-2008; IN COMMERCE 9-1-2008.
JANET LEE, EXAMINING ATTORNEY

SN 77-728,330. TEJAS TUBULAR PRODUCTS, INC., HOUSTON, TX. FILED 5-4-2009.

TTS

THE MARK CONSISTS OF STANDARD CHARACTERS WITHOUT CLAIM TO ANY PARTICULAR FONT, STYLE, SIZE, OR COLOR.

FOR METAL PIPE CONNECTORS, NAMELY, THREADED CONNECTIONS OF METAL FOR ATTACHING TO TUBING USED IN OIL AND GAS WELL OPERATIONS (U.S. CLS. 2, 12, 13, 14, 23, 25 AND 50).

JAY BESCH, EXAMINING ATTORNEY

CLASS 6—(Continued).

SN 77-728,622. HDD ROTARY SALES, LLC., CONROE, TX. FILED 5-4-2009.

MXT

THE MARK CONSISTS OF STANDARD CHARACTERS WITHOUT CLAIM TO ANY PARTICULAR FONT, STYLE, SIZE, OR COLOR.

FOR METAL COUPLING FOR USE IN OIL AND GAS DRILL PIPES AS A JOINT CONNECTOR (U.S. CLS. 2, 12, 13, 14, 23, 25 AND 50).

TARAH HARDY, EXAMINING ATTORNEY

CLASS 6—(Continued).

SN 79-064,911. DEUTSCHE EDELSTAHLWERKE GMBH, FED REP GERMANY, FILED 11-25-2008.

Corrodur

THE MARK CONSISTS OF STANDARD CHARACTERS WITHOUT CLAIM TO ANY PARTICULAR FONT, STYLE, SIZE, OR COLOR.

PRIORITY DATE OF 7-18-2008 IS CLAIMED.

OWNER OF INTERNATIONAL REGISTRATION 0992154 DATED 11-25-2008, EXPIRES 11-25-2018.

FOR UNWROUGHT AND SEMI-WROUGHT COMMON METALS, IN PARTICULAR STEEL, STAINLESS STEEL AND BRIGHT STEEL; SEMI-FINISHED PRODUCTS OF STEEL IN THE FORM OF RODS, PLATES, SHEETS, BILLETS, BLOCKS, WIRE, PROFILES, RINGS; AUXILIARY WELDING MATERIALS OF METAL (U.S. CLS. 2, 12, 13, 14, 23, 25 AND 50).

ALEXANDER L. POWERS, EXAMINING ATTORNEY

SN 77-737,749. LIBERTY HARDWARE MFG. CORP., WINSTON-SALEM, NC. FILED 5-15-2009.

VORTEX

THE MARK CONSISTS OF STANDARD CHARACTERS WITHOUT CLAIM TO ANY PARTICULAR FONT, STYLE, SIZE, OR COLOR.

FOR METAL GROUND ANCHORS (U.S. CLS. 2, 12, 13, 14, 23, 25 AND 50).

THEODORE MCBRIDE, EXAMINING ATTORNEY

SN 79-064,912. DEUTSCHE EDELSTAHLWERKE GMBH, FED REP GERMANY, FILED 11-25-2008.

Formadur

THE MARK CONSISTS OF STANDARD CHARACTERS WITHOUT CLAIM TO ANY PARTICULAR FONT, STYLE, SIZE, OR COLOR.

PRIORITY DATE OF 7-18-2008 IS CLAIMED.

OWNER OF INTERNATIONAL REGISTRATION 0992155 DATED 11-25-2008, EXPIRES 11-25-2018.

FOR UNWROUGHT AND SEMI-WROUGHT COMMON METALS, IN PARTICULAR STEEL, STAINLESS STEEL AND BRIGHT STEEL; SEMI-FINISHED PRODUCTS OF STEEL IN THE FORM OF RODS, PLATES, SHEETS, BILLETS, BLOCKS, WIRE, PROFILES, RINGS; AUXILIARY WELDING MATERIALS OF METAL (U.S. CLS. 2, 12, 13, 14, 23, 25 AND 50).

ALEXANDER L. POWERS, EXAMINING ATTORNEY

SN 77-743,087. SPELLING TELEVISION INC., STUDIO CITY, CA. FILED 5-22-2009.

MELROSE PLACE

THE MARK CONSISTS OF STANDARD CHARACTERS WITHOUT CLAIM TO ANY PARTICULAR FONT, STYLE, SIZE, OR COLOR.

OWNER OF U.S. REG. NOS. 1,821,796 AND 2,350,925.

FOR METAL KEY CHAINS (U.S. CLS. 2, 12, 13, 14, 23, 25 AND 50).

KRISTIN CARLSON, EXAMINING ATTORNEY

SN 79-064,913. DEUTSCHE EDELSTAHLWERKE GMBH, FED REP GERMANY, FILED 11-25-2008.

Permodur

THE MARK CONSISTS OF STANDARD CHARACTERS WITHOUT CLAIM TO ANY PARTICULAR FONT, STYLE, SIZE, OR COLOR.

PRIORITY DATE OF 7-18-2008 IS CLAIMED.

OWNER OF INTERNATIONAL REGISTRATION 0992156 DATED 11-25-2008, EXPIRES 11-25-2018.

FOR UNWROUGHT AND SEMI-WROUGHT COMMON METALS, IN PARTICULAR STEEL, STAINLESS STEEL AND BRIGHT STEEL; SEMI-FINISHED PRODUCTS OF STEEL IN THE FORM OF RODS, PLATES, SHEETS, BILLETS, BLOCKS, WIRE, PROFILES, RINGS; AUXILIARY WELDING MATERIALS OF METAL (U.S. CLS. 2, 12, 13, 14, 23, 25 AND 50).

ALEXANDER L. POWERS, EXAMINING ATTORNEY

CLASS 6—(Continued).

SN 79-064,914. DEUTSCHE EDELSTAHLWERKE GMBH,
FED REP GERMANY, FILED 11-25-2008.

Electrodur

THE MARK CONSISTS OF STANDARD CHARACTERS WITHOUT CLAIM TO ANY PARTICULAR FONT, STYLE, SIZE, OR COLOR.

PRIORITY DATE OF 7-18-2008 IS CLAIMED.

OWNER OF INTERNATIONAL REGISTRATION 0992157 DATED 11-25-2008, EXPIRES 11-25-2018.

FOR UNWROUGHT AND SEMI-WROUGHT COMMON METALS, IN PARTICULAR STEEL, STAINLESS STEEL AND BRIGHT STEEL; SEMI-FINISHED PRODUCTS OF STEEL IN THE FORM OF RODS, PLATES, SHEETS, BILLETS, BLOCKS, WIRE, PROFILES, RINGS; AUXILIARY WELDING MATERIALS OF METAL (U.S. CLS. 2, 12, 13, 14, 23, 25 AND 50).

ALEXANDER L. POWERS, EXAMINING ATTORNEY

SN 79-064,915. DEUTSCHE EDELSTAHLWERKE GMBH,
FED REP GERMANY, FILED 11-24-2008.

Duodur

THE MARK CONSISTS OF STANDARD CHARACTERS WITHOUT CLAIM TO ANY PARTICULAR FONT, STYLE, SIZE, OR COLOR.

PRIORITY DATE OF 7-18-2008 IS CLAIMED.

OWNER OF INTERNATIONAL REGISTRATION 0992158 DATED 11-24-2008, EXPIRES 11-24-2018.

FOR UNWROUGHT AND SEMI-WROUGHT COMMON METALS, IN PARTICULAR STEEL, STAINLESS STEEL AND BRIGHT STEEL; SEMI-FINISHED PRODUCTS OF STEEL IN THE FORM OF RODS, PLATES, SHEETS, BILLETS, BLOCKS, WIRE PROFILES, RINGS; AUXILIARY WELDING MATERIALS OF METAL, NAMELY, METAL WELDING RODS, WELDING WIRE (U.S. CLS. 2, 12, 13, 14, 23, 25 AND 50).

DANIEL CAPSHAW, EXAMINING ATTORNEY

SN 79-064,919. DEUTSCHE EDELSTAHLWERKE GMBH,
58452 WITTEN, FED REP GERMANY, FILED 11-24-2008.

Microdur

THE MARK CONSISTS OF STANDARD CHARACTERS WITHOUT CLAIM TO ANY PARTICULAR FONT, STYLE, SIZE, OR COLOR.

PRIORITY DATE OF 7-18-2008 IS CLAIMED.

OWNER OF INTERNATIONAL REGISTRATION 0992162 DATED 11-24-2008, EXPIRES 11-24-2018.

FOR UNWROUGHT AND SEMI-WROUGHT COMMON METALS, IN PARTICULAR STEEL, STAINLESS STEEL AND BRIGHT STEEL; SEMI-FINISHED PRODUCTS OF STEEL IN THE FORM OF RODS, PLATES, SHEETS, BILLETS, BLOCKS, WIRE PROFILES, RINGS; AUXILIARY WELDING MATERIALS OF METAL, NAMELY, METAL WELDING RODS, WELDING WIRE (U.S. CLS. 2, 12, 13, 14, 23, 25 AND 50).

DANIEL CAPSHAW, EXAMINING ATTORNEY

CLASS 6—(Continued).

SN 79-064,922. DEUTSCHE EDELSTAHLWERKE GMBH,
FED REP GERMANY, FILED 11-25-2008.

Acidur

THE MARK CONSISTS OF STANDARD CHARACTERS WITHOUT CLAIM TO ANY PARTICULAR FONT, STYLE, SIZE, OR COLOR.

PRIORITY DATE OF 7-18-2008 IS CLAIMED.

OWNER OF INTERNATIONAL REGISTRATION 0992165 DATED 11-25-2008, EXPIRES 11-25-2018.

FOR UNWROUGHT AND SEMI-WROUGHT COMMON METALS, IN PARTICULAR STEEL, STAINLESS STEEL AND BRIGHT STEEL; SEMI-FINISHED PRODUCTS OF STEEL IN THE FORM OF RODS, PLATES, SHEETS, BILLETS, BLOCKS, WIRE, PROFILES, RINGS; AUXILIARY WELDING MATERIALS OF METAL (U.S. CLS. 2, 12, 13, 14, 23, 25 AND 50).

ALEXANDER L. POWERS, EXAMINING ATTORNEY

SN 79-067,153. DEUTSCHE EDELSTAHLWERKE GMBH,
FED REP GERMANY, FILED 11-25-2008.

Rapidur

THE MARK CONSISTS OF STANDARD CHARACTERS WITHOUT CLAIM TO ANY PARTICULAR FONT, STYLE, SIZE, OR COLOR.

PRIORITY DATE OF 7-18-2008 IS CLAIMED.

OWNER OF INTERNATIONAL REGISTRATION 0998421 DATED 11-25-2008, EXPIRES 11-25-2018.

THE WORDING "RAPIDUR" HAS NO MEANING IN A FOREIGN LANGUAGE.

FOR UNWROUGHT AND SEMI-WROUGHT COMMON METALS, IN PARTICULAR STEEL, STAINLESS STEEL AND BRIGHT STEEL; SEMI-FINISHED PRODUCTS OF STEEL IN THE FORM OF RODS, PLATES, SHEETS, BILLETS, BLOCKS, WIRE PROFILES, RINGS; AUXILIARY WELDING MATERIALS OF METAL, NAMELY, METAL WELDING RODS, WELDING WIRE (U.S. CLS. 2, 12, 13, 14, 23, 25 AND 50).

ELI HELLMAN, EXAMINING ATTORNEY

CLASS 6—(Continued).

SN 79-067,641. XI'AN HIDA INDUSTRIAL CO., LTD, XI'AN, CHINA, FILED 3-25-2009.



OWNER OF INTERNATIONAL REGISTRATION 0999751 DATED 3-25-2009, EXPIRES 3-25-2019.

THE MARK CONSISTS OF A FLAME.

FOR FITTINGS OF METAL FOR FURNITURE; NON-ELECTRIC DOOR BELLS; WORKS OF ART OF COMMON METAL; SIGNBOARDS OF METAL; FLUID STORAGE TANKS OF METAL; METAL BIRD BATHS STRUCTURES; HARDWARE OF METAL, NAMELY, METAL WRENCHES, METAL PLIERS, METAL SCREWS (U.S. CLS. 2, 12, 13, 14, 23, 25 AND 50).

RAUL CORDOVA, EXAMINING ATTORNEY

CLASS 7—(Continued).

SN 76-686,578. DIAMOND FEEDERS, INGRAM, TX. FILED 2-6-2008.

LUNKER XTREME

THE MARK CONSISTS OF STANDARD CHARACTERS WITHOUT CLAIM TO ANY PARTICULAR FONT, STYLE, SIZE, OR COLOR.

FOR MECHANIZED ANIMAL FEEDERS, REPLACEMENT ACCESSORIES AND REPLACEMENT PARTS FOR SAME (U.S. CLS. 13, 19, 21, 23, 31, 34 AND 35).

FIRST USE 8-1-2005; IN COMMERCE 8-1-2005.

SANDRA MANIOS, EXAMINING ATTORNEY

SN 76-686,579. DIAMOND FEEDERS, INGRAM, TX. FILED 2-6-2008.

PET STOP

THE MARK CONSISTS OF STANDARD CHARACTERS WITHOUT CLAIM TO ANY PARTICULAR FONT, STYLE, SIZE, OR COLOR.

NO CLAIM IS MADE TO THE EXCLUSIVE RIGHT TO USE "PET", APART FROM THE MARK AS SHOWN.

FOR MECHANIZED ANIMAL FEEDERS, REPLACEMENT ACCESSORIES AND REPLACEMENT PARTS FOR SAME (U.S. CLS. 13, 19, 21, 23, 31, 34 AND 35).

FIRST USE 8-1-2005; IN COMMERCE 8-1-2005.

SANDRA MANIOS, EXAMINING ATTORNEY

CLASS 7—MACHINERY

SN 76-377,541. DAISHOWA SEIKI KABUSHIKI KAISHA, DBA BIG DAISHOWA SEIKI CO LTD, OSAKA 579-8013, JAPAN, FILED 3-1-2002.

MTC

FOR MACHINE TOOLS, NAMELY, METAL WORKING MACHINING CENTERS, METAL WORKING TURNING CENTERS, METAL WORKING UNIVERSAL MACHINES, METAL WORKING MILLING MACHINES, METAL WORKING BORING MACHINES, METAL WORKING LATHES, METAL WORKING GRINDING MACHINES AND METAL WORKING MULTIPLE MACHINE TOOLS; CUTTING TOOLS, NAMELY CUTTING BITS FOR METAL WORKING MACHINES AND MILLING CUTTERS; MACHINE TOOL HOLDERS (U.S. CLS. 13, 19, 21, 23, 31, 34 AND 35).

DAVID ELTON, EXAMINING ATTORNEY

SN 76-686,580. DIAMOND FEEDERS, INGRAM, TX. FILED 2-6-2008.

PROTEIN EXPRESS

THE MARK CONSISTS OF STANDARD CHARACTERS WITHOUT CLAIM TO ANY PARTICULAR FONT, STYLE, SIZE, OR COLOR.

NO CLAIM IS MADE TO THE EXCLUSIVE RIGHT TO USE "PROTEIN", APART FROM THE MARK AS SHOWN.

FOR MECHANIZED ANIMAL FEEDERS, REPLACEMENT ACCESSORIES AND REPLACEMENT PARTS FOR SAME (U.S. CLS. 13, 19, 21, 23, 31, 34 AND 35).

FIRST USE 8-1-2005; IN COMMERCE 8-1-2005.

SANDRA MANIOS, EXAMINING ATTORNEY

CLASS 7—(Continued).

SN 76-691,437. BOULDIN CORPORATION, MORRISON, TN.
FILED 7-21-2008.

BOULDIN & LAWSON

THE MARK CONSISTS OF STANDARD CHARACTERS WITHOUT CLAIM TO ANY PARTICULAR FONT, STYLE, SIZE, OR COLOR.

OWNER OF U.S. REG. NOS. 3,021,600 AND 3,330,100.
FOR NURSERY AND PLANTING MACHINES, NAMELY, SEEDERS, SEED CLEANERS, POT FILLERS, COMPRESSED BALE BUSTERS, BAGGERS, FLAT FIL- LERS, TRAY FILLERS, CONVEYORS, TAGGERS, TRAY DISPENSERS, POT DISPENSERS, ACCUMULATOR MA- CHINE TABLES, HOPPERS, DIBBLING MACHINES, SOIL MIXERS, SHREDDERS, FLUFFERS, POTTING MACHINES, AUTOMATED TRANSPLANTERS, TRAY SEPARATORS, ROBOTIC FLAT HANDLERS, PALLETIZ- ING MACHINES, VIBRATORY SCREEN SEPARATORS FOR PEAT, ROSE WRAPPERS, GRINDERS, MACHINES FOR SEPARATING RECYCLABLE MATERIALS, MIX- ING AND TRANSPLANTING SYSTEMS COMPRISED PRIMARILY OF MIXING MACHINES AND AGRICUL- TURAL MACHINES FOR TRANSPLANTING PLANTS, AND PACKAGING MACHINES; ORDNANCE DEFOR- MERS, NAMELY, BENDING MACHINES, FOR MILI- TARY APPLICATIONS; SYSTEMS FOR PROCESSING MUNICIPAL SOLID WASTE COMPRISED PRIMARILY OF WASTE COMPACTING MACHINES AND WASTE MATERIAL CONVEYING MACHINES (U.S. CLS. 13, 19, 21, 23, 31, 34 AND 35).

FIRST USE 5-1-1976; IN COMMERCE 5-1-1976.
MICHAEL GAAFAR, EXAMINING ATTORNEY

SN 76-693,035. GOODWAY TECHNOLOGIES CORPORA- TION, STAMFORD, CT. FILED 9-22-2008.



OWNER OF U.S. REG. NO. 3,616,450.
THE MARK CONSISTS OF THE WORDS "COILJET" WITH A SPRAY DESIGN WITHIN AN OVAL.
FOR MACHINES FOR CLEANING COILS OF HVAC UNITS (U.S. CLS. 13, 19, 21, 23, 31, 34 AND 35).
HOWARD SMIGA, EXAMINING ATTORNEY

CLASS 7—(Continued).

SN 76-695,406. EMH, INCORPORATED, VALLEY CITY, OH.
FILED 1-22-2009.

EMH

THE MARK CONSISTS OF STANDARD CHARACTERS WITHOUT CLAIM TO ANY PARTICULAR FONT, STYLE, SIZE, OR COLOR.

FOR OVERHEAD CRANE SYSTEMS COMPRISED OF CRANES, HOISTS, AND STRUCTURAL PARTS THERE- FOR, FOR HANDLING MATERIAL (U.S. CLS. 13, 19, 21, 23, 31, 34 AND 35).

FIRST USE 3-30-1988; IN COMMERCE 6-30-1988.
CARYN GLASSER, EXAMINING ATTORNEY

SN 76-697,108. VORA, THEODORE C., HOUSTON, TX.
FILED 4-27-2009.



OWNER OF U.S. REG. NO. 3,218,921.
NO CLAIM IS MADE TO THE EXCLUSIVE RIGHT TO USE "RIG", APART FROM THE MARK AS SHOWN.

THE COLOR(S) BLACK, ORANGE AND LIGHT OLIVE GREEN IS/ARE CLAIMED AS A FEATURE OF THE MARK.

THE MARK CONSISTS OF THE WORDS "ROCKET RIG" IN BLOCK LETTERING, COLORED LIGHT OLIVE GREEN AGAINST A BLACK BACKGROUND WITH AN ORANGE-COLORED UNDERLINING; THE LETTER "I" IN THE WORD "RIG" IS FORMED AS A TOP PERSPECTIVE VIEW OF A STYLIZED DRILLING RIG, COLORED ORANGE.

FOR WELL DRILLING MACHINES (U.S. CLS. 13, 19, 21, 23, 31, 34 AND 35).
FIRST USE 9-7-2006; IN COMMERCE 9-7-2006.
APRIL HESIK, EXAMINING ATTORNEY

SN 76-697,178. MIGHTY MITE INDUSTRIES, INC., CANBY, OR. FILED 5-1-2009.

MIGHTY MITE

THE MARK CONSISTS OF STANDARD CHARACTERS WITHOUT CLAIM TO ANY PARTICULAR FONT, STYLE, SIZE, OR COLOR.

FOR SAWMILLS (U.S. CLS. 13, 19, 21, 23, 31, 34 AND 35).

FIRST USE 12-0-1976; IN COMMERCE 12-0-1976.
ALYSSA STEEL, EXAMINING ATTORNEY

CLASS 7—(Continued).

SN 77-260,652. HAYWARD INDUSTRIES, INC., ELIZABETH, NJ. FILED 8-21-2007.

AQUARAY

THE MARK CONSISTS OF STANDARD CHARACTERS WITHOUT CLAIM TO ANY PARTICULAR FONT, STYLE, SIZE, OR COLOR.

OWNER OF U.S. REG. NOS. 1,383,031, 2,184,852 AND 2,234,984.

FOR UNDERWATER SWIMMING POOL CLEANING MACHINES FOR CLEANING THE SURFACE OF A RESIDENTIAL SWIMMING POOL (U.S. CLS. 13, 19, 21, 23, 31, 34 AND 35).

DEBRA LEE, EXAMINING ATTORNEY

CLASS 7—(Continued).

SN 77-412,822. INDUSOURCE, INC., PLYMOUTH, MI. FILED 3-4-2008.

SPEED TRACE

THE MARK CONSISTS OF STANDARD CHARACTERS WITHOUT CLAIM TO ANY PARTICULAR FONT, STYLE, SIZE, OR COLOR.

FOR CARBIDE END MILLS FOR MILLING INDUSTRIAL MATERIALS (U.S. CLS. 13, 19, 21, 23, 31, 34 AND 35).

FIRST USE 9-21-2006; IN COMMERCE 9-21-2006.

FRANK LATTUCA, EXAMINING ATTORNEY

SN 77-393,903. MOLD HOTRUNNER SOLUTIONS INC., GEORGETOWN, CANADA, FILED 2-11-2008.

MHS

THE MARK CONSISTS OF STANDARD CHARACTERS WITHOUT CLAIM TO ANY PARTICULAR FONT, STYLE, SIZE, OR COLOR.

PRIORITY CLAIMED UNDER SEC. 44(D) ON CANADA APPLICATION NO. 1380361, FILED 1-23-2008, REG. NO. TMA743275, DATED 7-10-2009, EXPIRES 7-10-2024.

FOR HOTRUNNER SYSTEMS, COMPRISED OF NOZZLES, MANIFOLDS, BUSHINGS, HOT VALVES, GATES, CONTROLLERS, INJECTION MOLDING SOLUTIONS AND OPERATION MANUALS SOLD IN CONNECTION THEREWITH (U.S. CLS. 13, 19, 21, 23, 31, 34 AND 35).

JAY FLOWERS, EXAMINING ATTORNEY

SN 77-412,834. INDUSOURCE, INC., PLYMOUTH, MI. FILED 3-4-2008.

TRACE TOOLS

THE MARK CONSISTS OF STANDARD CHARACTERS WITHOUT CLAIM TO ANY PARTICULAR FONT, STYLE, SIZE, OR COLOR.

NO CLAIM IS MADE TO THE EXCLUSIVE RIGHT TO USE "TOOLS", APART FROM THE MARK AS SHOWN.

FOR CARBIDE END MILLS FOR MILLING INDUSTRIAL MATERIALS (U.S. CLS. 13, 19, 21, 23, 31, 34 AND 35).

FIRST USE 9-21-2006; IN COMMERCE 9-21-2006.

FRANK LATTUCA, EXAMINING ATTORNEY

SN 77-393,947. MOLD HOTRUNNER SOLUTIONS INC., GEORGETOWN, CANADA, FILED 2-11-2008.

RHEO-PRO

THE MARK CONSISTS OF STANDARD CHARACTERS WITHOUT CLAIM TO ANY PARTICULAR FONT, STYLE, SIZE, OR COLOR.

PRIORITY CLAIMED UNDER SEC. 44(D) ON CANADA APPLICATION NO. 1380363, FILED 1-23-2008, REG. NO. TMA743267, DATED 7-10-2009, EXPIRES 7-10-2024.

FOR HOTRUNNER SYSTEMS, COMPRISED OF NOZZLES, MANIFOLDS, BUSHINGS, HOT VALVES, GATES, CONTROLLERS, INJECTION MOLDING SOLUTIONS AND OPERATION MANUALS SOLD IN CONNECTION THEREWITH (U.S. CLS. 13, 19, 21, 23, 31, 34 AND 35).

JAY FLOWERS, EXAMINING ATTORNEY

SN 77-451,731. NGK SPARK PLUG CO., LTD., NAGOYA CITY, JAPAN, FILED 4-18-2008.

D-POWER

THE MARK CONSISTS OF STANDARD CHARACTERS WITHOUT CLAIM TO ANY PARTICULAR FONT, STYLE, SIZE, OR COLOR.

FOR IGNITION APPARATUS AND THEIR ACCESSORIES BEING PARTS OF INTERNAL COMBUSTION ENGINES OF ALL KINDS, NAMELY, SPARK PLUGS, GLOW PLUGS, SPARK PLUG CAPS, SPARK PLUG CABLES AND SPARK PLUG IGNITION COILS (U.S. CLS. 13, 19, 21, 23, 31, 34 AND 35).

BARBARA GAYNOR, EXAMINING ATTORNEY

CLASS 7—(Continued).

SN 77-482,853. A&G DESIGN WORX, LA MIRADA, CA. FILED 5-23-2008.

Turbo Tiller Plus

THE MARK CONSISTS OF STANDARD CHARACTERS WITHOUT CLAIM TO ANY PARTICULAR FONT, STYLE, SIZE, OR COLOR.

NO CLAIM IS MADE TO THE EXCLUSIVE RIGHT TO USE "TILLER", APART FROM THE MARK AS SHOWN.

FOR GARDENING TOOL, NAMELY, POWER OPERATED COMBINATION TILLER DRIVER AND DEVICE FOR TRIMMING LANDSCAPE NEAR SPRINKLERS (U.S. CLS. 13, 19, 21, 23, 31, 34 AND 35).

MARK SPARACINO, EXAMINING ATTORNEY

CLASS 7—(Continued).

SN 77-575,667. ROTARY COMPRESSION TECHNOLOGIES, INC., SIDNEY, OH. FILED 9-22-2008.



THE MARK CONSISTS OF STYLIZED LION. FOR GAS COMPRESSORS AND STRUCTURAL PARTS THEREOF AND REPLACEMENT PARTS THEREFOR (U.S. CLS. 13, 19, 21, 23, 31, 34 AND 35).

FIRST USE 3-19-1976; IN COMMERCE 3-19-1976. EDWARD FENNESSY, EXAMINING ATTORNEY

SN 77-537,991. ARIENS COMPANY, BRILLION, WI. FILED 8-4-2008.

PRO ZOOM

THE MARK CONSISTS OF STANDARD CHARACTERS WITHOUT CLAIM TO ANY PARTICULAR FONT, STYLE, SIZE, OR COLOR.

OWNER OF U.S. REG. NOS. 2,528,359, 2,855,130 AND 3,096,698.

NO CLAIM IS MADE TO THE EXCLUSIVE RIGHT TO USE "PRO", APART FROM THE MARK AS SHOWN.

FOR LAWN MOWERS (U.S. CLS. 13, 19, 21, 23, 31, 34 AND 35).

ALEX KEAM, EXAMINING ATTORNEY

SN 77-589,089. MARINE METAL PRODUCTS CO., CLEARWATER, FL. FILED 10-9-2008.

Bubbles

THE MARK CONSISTS OF STANDARD CHARACTERS WITHOUT CLAIM TO ANY PARTICULAR FONT, STYLE, SIZE, OR COLOR.

FOR FISHING PRODUCTS, NAMELY, BAIT TANK AND LIVEWELL AERATORS AND AERATION SYSTEMS (U.S. CLS. 13, 19, 21, 23, 31, 34 AND 35).

FIRST USE 7-15-1983; IN COMMERCE 7-15-1983. JOHN SCHUYLER YARD, EXAMINING ATTORNEY

SN 77-566,179. MULTIPET INDUSTRIA E COMERCIO DE EMBALAGENS PLASTICAS LTDA, TOLEDO, BRAZIL, FILED 9-9-2008.

MULTIPET

THE MARK CONSISTS OF STANDARD CHARACTERS WITHOUT CLAIM TO ANY PARTICULAR FONT, STYLE, SIZE, OR COLOR.

FOR ELECTRIC FULLY-AUTOMATIC MACHINES FOR PRODUCING PLASTIC BOTTLES; ELECTRIC SEMI-AUTOMATIC MACHINES FOR PRODUCING PLASTIC BOTTLES; SEMI-AUTOMATIC BLOW MOLDING MACHINE; BLOW MOLDS FOR USE IN THE MANUFACTURING OF BOTTLES; AIR BOOSTERS FOR HIGH PRESSURE AIR COMPRESSORS; AND MACHINES THAT MAKE PLASTIC BOTTLES (U.S. CLS. 13, 19, 21, 23, 31, 34 AND 35).

FIRST USE 1-22-1997; IN COMMERCE 1-22-1997. EMILY CARLSEN, EXAMINING ATTORNEY

SN 77-592,566. KMT AQUA-DYNE, INC., HOUSTON, TX. FILED 10-14-2008.

BLASTMAX

THE MARK CONSISTS OF STANDARD CHARACTERS WITHOUT CLAIM TO ANY PARTICULAR FONT, STYLE, SIZE, OR COLOR.

FOR WATER PUMPS FOR USE IN INDUSTRIAL CLEANING, SURFACE PREPARATION, HYDROSTATIC TESTING AND HYDRO DEMOLITION (U.S. CLS. 13, 19, 21, 23, 31, 34 AND 35).

RENEE MCCRAY, EXAMINING ATTORNEY

CLASS 7—(Continued).

SN 77-595,957. MICHAELS STORES PROCUREMENT COMPANY, INC., IRVING, TX. FILED 10-20-2008.

ARTMINDS

THE MARK CONSISTS OF STANDARD CHARACTERS WITHOUT CLAIM TO ANY PARTICULAR FONT, STYLE, SIZE, OR COLOR.
FOR HOT MELT GLUE GUNS (U.S. CLS. 13, 19, 21, 23, 31, 34 AND 35).
RICHARD WHITE, EXAMINING ATTORNEY

SN 77-602,855. YTL INTERNATIONAL, LLC, SANTA FE SPRINGS, CA. FILED 10-29-2008.

Yard Commander

THE MARK CONSISTS OF STANDARD CHARACTERS WITHOUT CLAIM TO ANY PARTICULAR FONT, STYLE, SIZE, OR COLOR.
NO CLAIM IS MADE TO THE EXCLUSIVE RIGHT TO USE "YARD", APART FROM THE MARK AS SHOWN.
FOR NON-MOTORIZED MECHANICAL SPREADERS FOR HOME YARD USE (U.S. CLS. 13, 19, 21, 23, 31, 34 AND 35).
JASON BLAIR, EXAMINING ATTORNEY

CLASS 7—(Continued).

SN 77-603,692. ALLOY KINGDOM CORPORATION, PEKING, CHINA, FILED 10-30-2008.

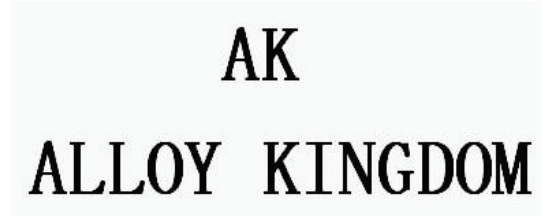

NO CLAIM IS MADE TO THE EXCLUSIVE RIGHT TO USE "ALLOY", APART FROM THE MARK AS SHOWN.
THE MARK CONSISTS OF "AK ALLOY KINGDOM".
FOR BAND SAWS; BLADES FOR POWER SAWS; BORING MACHINES; CHAIN SAWS; CIRCULAR SAWS; CUTTING MACHINES; CUTTING MACHINES; DIAMOND-POINTED METAL-CUTTING TOOLS; DIE-CUTTING MACHINES; ELECTRIC CHAIN SAWS; ELECTRIC DRILLS; ELECTRIC GRATERS; ELECTRIC HAMMERS; ELECTRIC HAND-HELD DRILLS; ELECTRIC KNIFE SHARPENERS; ELECTRIC KNIVES; ELECTRIC WAX-POLISHING MACHINES FOR INDUSTRIAL PURPOSES; FIBER CUTTING MACHINES; GRINDERS; HAND-HELD BATTERY ACTUATED HYDRAULIC CRIMP TOOL; JIG SAWS; LUMBERING BAND SAWS; MACHINE PARTS, NAMELY, BEARINGS; MACHINE PARTS, NAMELY, GRINDSTONES; METALWORKING MACHINE TOOLS; PNEUMATIC DRILLS; PNEUMATIC GREASE GUNS; PNEUMATIC HAMMERS; PNEUMATIC HAMMERS; PNEUMATIC PUMPS; POLISHING MACHINES FOR USE IN GRINDING AND POLISHING METAL, WOOD, CERAMICS AND PLASTICS; PORTABLE SAW MILLS; POWER SAW BLADES; POWER TOOLS, NAMELY, SCROLL SAWS; POWER-OPERATED GRINDING WHEELS; POWER-OPERATED POLISHERS; POWER-OPERATED SAWS; PRESSURE SWITCHES AND SENSORS FOR MONITORING, CONTROLLING, AND SWITCHING HYDRAULIC OR PNEUMATIC SYSTEMS BEING SOLD AS A UNIT WITH MANUFACTURING MACHINES; TOOL GRINDING MACHINES; VIBRATORY GRINDING MACHINES; WOOD GRINDING MACHINES; WOOD SAWING MACHINES; ALL OF THE FOREGOING GOODS COMPOSED OF ALLOY (U.S. CLS. 13, 19, 21, 23, 31, 34 AND 35).
ANDREW RHIM, EXAMINING ATTORNEY

SN 77-607,741. TURF ALLIANCE, LLC, WELLAND, CANADA, FILED 11-5-2008.

BLUE HAND

THE MARK CONSISTS OF STANDARD CHARACTERS WITHOUT CLAIM TO ANY PARTICULAR FONT, STYLE, SIZE, OR COLOR.
FOR SYNTHETIC TURF MAINTENANCE AND INSTALLATION EQUIPMENT, NAMELY, SYNTHETIC TURF SWEEPERS AND GROOMERS (U.S. CLS. 13, 19, 21, 23, 31, 34 AND 35).
SAIMA MAKHDOOM, EXAMINING ATTORNEY

CLASS 7—(Continued).

SN 77-609,237. FIELDTURF TARKETT INC., TMR-MON-TREAL, CANADA, FILED 11-6-2008.

SWEEPRIGHT

THE MARK CONSISTS OF STANDARD CHARACTERS WITHOUT CLAIM TO ANY PARTICULAR FONT, STYLE, SIZE, OR COLOR.

FOR TURF MAINTENANCE EQUIPMENT, NAMELY, GROOMERS, SWEEPERS, DRAG BRUSHES, DRAG RAKES (U.S. CLS. 13, 19, 21, 23, 31, 34 AND 35).
SHANNON TWOHIG, EXAMINING ATTORNEY

SN 77-617,858. TURF ALLIANCE, LLC, WELLAND, CANADA, FILED 11-19-2008.

TURF TURTLE

THE MARK CONSISTS OF STANDARD CHARACTERS WITHOUT CLAIM TO ANY PARTICULAR FONT, STYLE, SIZE, OR COLOR.

NO CLAIM IS MADE TO THE EXCLUSIVE RIGHT TO USE "TURF", APART FROM THE MARK AS SHOWN.

FOR SYNTHETIC TURF MAINTENANCE EQUIPMENT, NAMELY, SYNTHETIC TURF SWEEPER, VACUUM AND GROOMER (U.S. CLS. 13, 19, 21, 23, 31, 34 AND 35).

SAIMA MAKHDOOM, EXAMINING ATTORNEY

SN 77-622,204. MARINE METAL PRODUCTS CO., CLEAR-WATER, FL. FILED 11-26-2008.

Quiet Bubbles

THE MARK CONSISTS OF STANDARD CHARACTERS WITHOUT CLAIM TO ANY PARTICULAR FONT, STYLE, SIZE, OR COLOR.

NO CLAIM IS MADE TO THE EXCLUSIVE RIGHT TO USE "QUIET", APART FROM THE MARK AS SHOWN.

FOR FISHING PRODUCTS, NAMELY, BAIT TANK AND LIVEWELL AERATORS (U.S. CLS. 13, 19, 21, 23, 31, 34 AND 35).

FIRST USE 7-31-1998; IN COMMERCE 7-31-1998.
JOHN SCHUYLER YARD, EXAMINING ATTORNEY

CLASS 7—(Continued).

SN 77-622,253. MARINE METAL PRODUCTS CO., CLEAR-WATER, FL. FILED 11-26-2008.

Cool Bubbles

THE MARK CONSISTS OF STANDARD CHARACTERS WITHOUT CLAIM TO ANY PARTICULAR FONT, STYLE, SIZE, OR COLOR.

FOR FISHING PRODUCTS, NAMELY, BAIT TANK AND LIVEWELL AERATION SYSTEMS (U.S. CLS. 13, 19, 21, 23, 31, 34 AND 35).

FIRST USE 7-31-1989; IN COMMERCE 7-31-1989.
JOHN SCHUYLER YARD, EXAMINING ATTORNEY

SN 77-622,260. MARINE METAL PRODUCTS CO., CLEAR-WATER, FL. FILED 11-26-2008.

Power Bubbles

THE MARK CONSISTS OF STANDARD CHARACTERS WITHOUT CLAIM TO ANY PARTICULAR FONT, STYLE, SIZE, OR COLOR.

FOR FISHING PRODUCTS, NAMELY, BAIT TANK AND LIVEWELL AERATORS (U.S. CLS. 13, 19, 21, 23, 31, 34 AND 35).

FIRST USE 7-31-1999; IN COMMERCE 7-31-1999.
JOHN SCHUYLER YARD, EXAMINING ATTORNEY

SN 77-630,051. SHINKO ELECTRIC CO., LTD., TOKYO, JAPAN, FILED 12-10-2008.

SELARM

THE MARK CONSISTS OF STANDARD CHARACTERS WITHOUT CLAIM TO ANY PARTICULAR FONT, STYLE, SIZE, OR COLOR.

FOR LOADING AND UNLOADING MACHINES AND APPARATUS; SEMICONDUCTOR MANUFACTURING MACHINES AND SYSTEMS; ROBOTS FOR CONVEYING SEMICONDUCTORS AND LIQUID CRYSTAL SUBSTRATES (U.S. CLS. 13, 19, 21, 23, 31, 34 AND 35).

DEBRA LEE, EXAMINING ATTORNEY

CLASS 7—(Continued).

SN 77-654,852. ADVANCED INDUSTRIAL DEVICES, LLC, TULSA, OK. FILED 1-22-2009.

CLASS 7—(Continued).

SN 77-663,881. GUARDAIR CORPORATION, CHICOPEE, MA. FILED 2-5-2009.

TORQUE MASTER

LAZER PALM SWITCH

THE MARK CONSISTS OF STANDARD CHARACTERS WITHOUT CLAIM TO ANY PARTICULAR FONT, STYLE, SIZE, OR COLOR.

NO CLAIM IS MADE TO THE EXCLUSIVE RIGHT TO USE "TORQUE", APART FROM THE MARK AS SHOWN.

FOR AC INDUCTION MOTORS (U.S. CLS. 13, 19, 21, 23, 31, 34 AND 35).

FIRST USE 1-1-2006; IN COMMERCE 1-1-2006.
JAMES A. RAUEN, EXAMINING ATTORNEY

THE MARK CONSISTS OF STANDARD CHARACTERS WITHOUT CLAIM TO ANY PARTICULAR FONT, STYLE, SIZE, OR COLOR.

NO CLAIM IS MADE TO THE EXCLUSIVE RIGHT TO USE "PALM SWITCH", APART FROM THE MARK AS SHOWN.

FOR PNEUMATIC HAND-OPERATED TOOLS FOR INDUSTRIAL AND CONSTRUCTION USE, NAMELY, HAND-HELD SAFETY AIR GUNS USED FOR CLEANING AND MAINTENANCE (U.S. CLS. 13, 19, 21, 23, 31, 34 AND 35).
RONALD AIKENS, EXAMINING ATTORNEY

SN 77-655,751. LONGYEAR TM, INC., SOUTH JORDAN, UT. FILED 1-23-2009.

SN 77-666,087. MAX TOOL, LLC, LA VERNE, CA. FILED 2-9-2009.



OWNER OF U.S. REG. NOS. 968,971 AND 2,421,665.

FOR EARTH DRILLING MACHINES AND PARTS AND ACCESSORIES THEREFOR, NAMELY, ROCK DRILLS, DRILL PIPE, DRILL TUBING, DRILL ROD SHANK ADAPTER, OVERSHOT ASSEMBLIES, REAMERS, WATER SWIVELS FOR EARTH DRILLING EQUIPMENT, HOISTING PLUGS, CASINGS, CASING CUTTER, CASING SHOES, CASING BITS, TAPS FOR DRILL RODS, CASINGS, AND OUTER TUBES, ADAPTERS FOR DRILL RODS, WATER SWIVELS, HOISTING PLUGS, CASINGS AND RECOVERY TOOLS, DEFLECTION WEDGES, CONVERSION KITS FOR CORE BARRELS, OVERSHOT ASSEMBLIES, AND WATER SWIVELS, WIRELINE LOADING CHAMBERS, PNEUMATIC FEEDLEG FOR ROCK DRILLS, AUGERS, WATER PUMPS FOR EARTH DRILLING TOOLS AND EQUIPMENT, PACKERS, GROUT MIXING AND PUMPING UNITS, BAILERS (U.S. CLS. 13, 19, 21, 23, 31, 34 AND 35).
GRETTA YAO, EXAMINING ATTORNEY

NO CLAIM IS MADE TO THE EXCLUSIVE RIGHT TO USE "POWER SYSTEMS", APART FROM THE MARK AS SHOWN.

THE MARK CONSISTS OF THE WORDS "DUROMAX NEXT GENERATION POWER SYSTEMS" WITH THE LETTERING FOR "DURO" AND "NEXT GENERATION" LOCATED ADJACENT TO THE LETTERING OF "MAX" AND "POWER SYSTEMS". THE BACKGROUND OF "MAX" AND "POWER SYSTEMS" IS SHADED, AND THE MARK IS ENCOMPASSED IN A RECTANGLE WITH SLIGHTLY CURVED EDGES AND A THIN VERTICAL LINE BETWEEN THE SEPARATE BLOCKS OF LETTERING.

FOR PORTABLE GAS OPERATED POWER GENERATORS; PORTABLE GAS OPERATED WATER PUMPS FOR IRRIGATION AND FOR THE REMOVAL OF LIQUIDS FROM SWIMMING POOLS, FLOODED AREAS, STREAMS, LAKES, RESERVOIRS AND OTHER BODIES OF WATER; PORTABLE GAS UTILITY AND GENERAL PURPOSE ENGINES FOR OPERATING PRESSURE WASHERS, GO-KARTS, AIR COMPRESSORS, LOG SPLITTERS, AND PORTABLE EQUIPMENT (U.S. CLS. 13, 19, 21, 23, 31, 34 AND 35).
JORDAN BAKER, EXAMINING ATTORNEY

CLASS 7—(Continued).

SN 77-670,579. JIG IP HOLDING, LLC, HAMPSTEAD, NH. FILED 2-13-2009.

GREEN SCREENS

THE MARK CONSISTS OF STANDARD CHARACTERS WITHOUT CLAIM TO ANY PARTICULAR FONT, STYLE, SIZE, OR COLOR.

NO CLAIM IS MADE TO THE EXCLUSIVE RIGHT TO USE "GREEN", APART FROM THE MARK AS SHOWN.

FOR SORTING MACHINES FOR SOLID WASTE AND SINGLE STREAM WASTE, FIBER AND CONTAINER WASTE, FERROUS AND NON-FERROUS MATERIAL; CONVEYORS (U.S. CLS. 13, 19, 21, 23, 31, 34 AND 35).

DAWN FELDMAN, EXAMINING ATTORNEY

SN 77-694,503. BLOUNT, INC., PORTLAND, OR. FILED 3-19-2009.

POWERGRIT

THE MARK CONSISTS OF STANDARD CHARACTERS WITHOUT CLAIM TO ANY PARTICULAR FONT, STYLE, SIZE, OR COLOR.

FOR POWER OPERATED SAWS AND COMPONENT PARTS THEREFOR, NAMELY, CUTTING CHAIN, GUIDE BARS, SPROCKETS, MOTOR HEADS, POWER SUPPLY UNITS AND PIPE-CLAMP CUTTING FIXTURES (U.S. CLS. 13, 19, 21, 23, 31, 34 AND 35).

LEIGH CAROLINE CASE, EXAMINING ATTORNEY

SN 77-707,798. DURST PHOTOTECHNIK AG, BRIXEN, ITALY, FILED 4-6-2009.

ROTOWORX

THE MARK CONSISTS OF STANDARD CHARACTERS WITHOUT CLAIM TO ANY PARTICULAR FONT, STYLE, SIZE, OR COLOR.

FOR PRINTING EQUIPMENT, NAMELY, A MODULAR WEB FED, COMBINATION DIGITAL UV COATER AND SEMI ROTARY DIE-CUT AND CONVERTING MACHINE FOR USE IN THE AREA OF PRINTING AND IN PRINTING ENVIRONMENTS FOR COMMERCIAL OR INDUSTRIAL USE (U.S. CLS. 13, 19, 21, 23, 31, 34 AND 35).

BARNEY CHARLON, EXAMINING ATTORNEY

CLASS 7—(Continued).

SN 77-708,083. STEVE WHELAN, SANTA CLARA, CA. FILED 4-6-2009.



NO CLAIM IS MADE TO THE EXCLUSIVE RIGHT TO USE "WIRELESS", APART FROM THE MARK AS SHOWN.

THE MARK CONSISTS OF THE WORDING "WIRELESS" AND "WHISKERS" IN A STYLIZED FONT ABOVE AND BELOW A DESIGN COMPONENT CONSISTING OF THE SHADED HEAD OF A CAT WITH LONG WHISKERS AND RADIATION LINES BOTH TO THE LEFT AND RIGHT.

FOR ELECTRONIC FEEDER FOR ANIMALS (U.S. CLS. 13, 19, 21, 23, 31, 34 AND 35).

JILL C. ALT, EXAMINING ATTORNEY

SN 77-712,046. WENDELL STANLEY WRIGHT, DBA RLD PERFORMANCE, TEMECULA, CA. AND STEPHEN CRAIG STANLEY, DBA SD ENGINE, SAN DIEGO, CA. FILED 4-11-2009.

Flowline Machined

THE MARK CONSISTS OF STANDARD CHARACTERS WITHOUT CLAIM TO ANY PARTICULAR FONT, STYLE, SIZE, OR COLOR.

NO CLAIM IS MADE TO THE EXCLUSIVE RIGHT TO USE "MACHINED", APART FROM THE MARK AS SHOWN. FOR CYLINDER HEADS FOR ENGINES (U.S. CLS. 13, 19, 21, 23, 31, 34 AND 35).

FIRST USE 9-1-2008; IN COMMERCE 4-3-2009.

TAMARA FRAZIER, EXAMINING ATTORNEY

SN 77-712,328. ASTEC INDUSTRIES, INC., CHATTANOOGA, TN. FILED 4-13-2009.



THE MARK CONSISTS OF A STYLIZED FLAT VERSION OF THE LETTER "C".

FOR SCREEDS FOR ASPHALT PAVING MACHINES; ASPHALT PAVING MACHINES; WINDROW PICKUP MACHINES (U.S. CLS. 13, 19, 21, 23, 31, 34 AND 35).

FIRST USE 0-0-2000; IN COMMERCE 0-0-2000.

LINDA ORNDORFF, EXAMINING ATTORNEY

CLASS 7—(Continued).

SN 77-715,127. OMAX CORPORATION, KENT, WA. FILED 4-16-2009.

MAXIEM WATERJETS

THE MARK CONSISTS OF STANDARD CHARACTERS WITHOUT CLAIM TO ANY PARTICULAR FONT, STYLE, SIZE, OR COLOR.

OWNER OF U.S. REG. NOS. 1,992,387, 2,882,969 AND 3,012,170.

NO CLAIM IS MADE TO THE EXCLUSIVE RIGHT TO USE "WATERJETS", APART FROM THE MARK AS SHOWN.

FOR COMPUTER-CONTROLLED, POWER-OPERATED MACHINE TOOL FOR ABRASIVE JET CUTTING AND MACHINING; MACHINES AND MACHINE TOOLS FOR THE CUTTING AND FORMING OF MATERIALS (U.S. CLS. 13, 19, 21, 23, 31, 34 AND 35).

CAROLINE WOOD, EXAMINING ATTORNEY

SN 77-723,465. CR INNOVATIONS LLC, LEWISTOWN, PA. FILED 4-27-2009.

Eco Drain Dragon

THE MARK CONSISTS OF STANDARD CHARACTERS WITHOUT CLAIM TO ANY PARTICULAR FONT, STYLE, SIZE, OR COLOR.

NO CLAIM IS MADE TO THE EXCLUSIVE RIGHT TO USE "ECO DRAIN", APART FROM THE MARK AS SHOWN.

FOR ATTACHMENT FOR WET VACUUM TO UN-CLOG DRAINS OR RETRIEVE ITEMS IN DRAIN (U.S. CLS. 13, 19, 21, 23, 31, 34 AND 35).

FIRST USE 6-28-2007; IN COMMERCE 7-30-2007.

TOBY BULLOFF, EXAMINING ATTORNEY

SN 77-723,684. BOGDEN, INC., DBA MTRACTOR, THORP, WA. FILED 4-28-2009.

MTRACTOR

THE MARK CONSISTS OF STANDARD CHARACTERS WITHOUT CLAIM TO ANY PARTICULAR FONT, STYLE, SIZE, OR COLOR.

FOR TRACTOR ATTACHMENTS, NAMELY, FRONT LOADERS AND BACKHOES (U.S. CLS. 13, 19, 21, 23, 31, 34 AND 35).

RICHARD WHITE, EXAMINING ATTORNEY

CLASS 7—(Continued).

SN 77-723,779. BRUCE STEVENS, STOW, OH. FILED 4-28-2009.

DEAD NUTS

THE MARK CONSISTS OF STANDARD CHARACTERS WITHOUT CLAIM TO ANY PARTICULAR FONT, STYLE, SIZE, OR COLOR.

FOR MITER FIXTURES FOR USE ON A POWER-OPERATED STATIONARY DISC TYPE SANDER TO PRODUCE 45 AND 90 DEGREE ANGLES FOR ALL TYPES OF MOULDINGS, PICTURE FRAMING, AND CABINET MAKING APPLICATIONS (U.S. CLS. 13, 19, 21, 23, 31, 34 AND 35).

BRIAN PINO, EXAMINING ATTORNEY

SN 77-723,997. DIVERSIFIED DYNAMICS CORPORATION, MINNEAPOLIS, MN. FILED 4-28-2009.

COMMANDMAX

THE MARK CONSISTS OF STANDARD CHARACTERS WITHOUT CLAIM TO ANY PARTICULAR FONT, STYLE, SIZE, OR COLOR.

FOR HAND-HELD MOTORIZED HIGH VOLUME LOW PRESSURE PAINT SPRAYERS (U.S. CLS. 13, 19, 21, 23, 31, 34 AND 35).

CORY BOONE, EXAMINING ATTORNEY

SN 77-724,225. GALBREATH LLC, WINAMAC, IN. FILED 4-28-2009.

SHORT PAK

THE MARK CONSISTS OF STANDARD CHARACTERS WITHOUT CLAIM TO ANY PARTICULAR FONT, STYLE, SIZE, OR COLOR.

FOR WASTE COMPACTORS (U.S. CLS. 13, 19, 21, 23, 31, 34 AND 35).

STEVEN JACKSON, EXAMINING ATTORNEY

CLASS 7—(Continued).

SN 77-724,443. SPRINGBOARD BIODIESEL, LLC, CHICO, CA. FILED 4-28-2009.

SpringPro

THE MARK CONSISTS OF STANDARD CHARACTERS WITHOUT CLAIM TO ANY PARTICULAR FONT, STYLE, SIZE, OR COLOR.

FOR BIODIESEL-GENERATION MACHINES, NAMELY, MIXING EQUIPMENT, PUMPS AND HEATERS (U.S. CLS. 13, 19, 21, 23, 31, 34 AND 35).

FIRST USE 2-25-2009; IN COMMERCE 2-25-2009.
KATHERINE CHANG, EXAMINING ATTORNEY

CLASS 7—(Continued).

SN 77-727,175. KEITH MANUFACTURING CO., MADRAS, OR. FILED 5-1-2009.

KEITH

THE MARK CONSISTS OF STANDARD CHARACTERS WITHOUT CLAIM TO ANY PARTICULAR FONT, STYLE, SIZE, OR COLOR.

FOR CONVEYOR SYSTEMS, NAMELY, RECIPROCATING FLOOR CONVEYORS AND PARTS THEREFOR (U.S. CLS. 13, 19, 21, 23, 31, 34 AND 35).

FIRST USE 1-15-1982; IN COMMERCE 1-15-1982.
JUSTINE D. PARKER, EXAMINING ATTORNEY

SN 77-727,044. WATERTRONICS, HARTLAND, WI. FILED 5-1-2009.

BLACKMAX

THE MARK CONSISTS OF STANDARD CHARACTERS WITHOUT CLAIM TO ANY PARTICULAR FONT, STYLE, SIZE, OR COLOR.

FOR SUBMERSIBLE PUMP SUPPORTS AND SUBMERSIBLE PUMP SYSTEMS COMPRISING SUBMERSIBLE SLEDS, PUMPS AND CONNECTION PIPING ALL SOLD TOGETHER AS A UNIT (U.S. CLS. 13, 19, 21, 23, 31, 34 AND 35).

FIRST USE 1-24-1996; IN COMMERCE 4-29-1996.
MARGERY A. TIERNEY, EXAMINING ATTORNEY

SN 77-727,210. KEITH MANUFACTURING CO., MADRAS, OR. FILED 5-1-2009.

KEITH UNDERNEATH

THE MARK CONSISTS OF STANDARD CHARACTERS WITHOUT CLAIM TO ANY PARTICULAR FONT, STYLE, SIZE, OR COLOR.

FOR CONVEYOR SYSTEMS, NAMELY, RECIPROCATING FLOOR CONVEYORS AND PARTS THEREFOR (U.S. CLS. 13, 19, 21, 23, 31, 34 AND 35).

FIRST USE 5-31-1995; IN COMMERCE 5-31-1995.
JUSTINE D. PARKER, EXAMINING ATTORNEY

SN 77-727,132. MAYTAG CORPORATION, BENTON HARBOR, MI. FILED 5-1-2009.



THE MARK CONSISTS OF "FRESH HOLD" WITH FAN DESIGN.

FOR VENTILATION SYSTEM SOLD AS AN INTEGRAL PART OF A CLOTHES WASHING MACHINE (U.S. CLS. 13, 19, 21, 23, 31, 34 AND 35).

DEIRDRE ROBERTSON, EXAMINING ATTORNEY

SN 77-728,533. CROWLAND S.A., MONTEVIDEO/DF, URUGUAY, FILED 5-4-2009.

MONDIAL

THE MARK CONSISTS OF STANDARD CHARACTERS WITHOUT CLAIM TO ANY PARTICULAR FONT, STYLE, SIZE, OR COLOR.

THE ENGLISH TRANSLATION OF "MONDIAL" IN THE MARK IS WORLD.

FOR ELECTRIC FOOD PROCESSORS; VACUUM CLEANERS; ELECTRIC BLENDERS FOR HOUSEHOLD PURPOSES; ELECTRIC VACUUM CLEANERS, PORTABLE OR NOT (U.S. CLS. 13, 19, 21, 23, 31, 34 AND 35).

PATRICIA EVANKO, EXAMINING ATTORNEY

CLASS 7—(Continued).

SN 77-728,606. CALDER, ASHAL CHAD, CYPRESS, TX. FILED 5-4-2009.

Heleta

THE MARK CONSISTS OF STANDARD CHARACTERS WITHOUT CLAIM TO ANY PARTICULAR FONT, STYLE, SIZE, OR COLOR.

FOR ABRASIVE BELTS FOR POWER-OPERATED SANDERS; ABRASIVE DISKS FOR POWER-OPERATED GRINDERS; ABRASIVE DISKS FOR POWER-OPERATED SANDERS; AIR-OPERATED POWER TOOLS, NAMELY, DRILLS, GRINDERS, ORBITAL SANDERS; BLADES FOR POWER SAWS; CEMENTED CARBIDE CUTTING TOOLS; GRINDERS; KITS COMPRISED OF SANDPAPER SHEETS CONFIGURED TO FIT POWER-OPERATED SANDERS; POWER SAW BLADES; POWER-OPERATED ABRASIVE WHEELS; POWER-OPERATED GRINDING WHEELS; POWER-OPERATED TOOLS, NAMELY, GRINDERS; PRECISION MACHINE TOOLS, NAMELY, HARD METAL TOOLS, HIGH SPEED STEEL (HSS) TOOLS, CARBIDE TOOLS, CERAMIC TOOLS, POLY CRYSTALLINE DIAMOND (PCD) TOOLS, AND DIAMOND-COATED AND DIAMOND-UNCOATED TOOLS, AND HARD METAL TOOLS, ALL FOR USE IN THE CUTTING AND FORMING OF MATERIALS BY OTHERS; WIRE WHEELS FOR POWER-OPERATED GRINDERS (U.S. CLS. 13, 19, 21, 23, 31, 34 AND 35).

FIRST USE 5-6-2009; IN COMMERCE 5-6-2009.
APRIL ROACH, EXAMINING ATTORNEY

CLASS 7—(Continued).

SN 77-731,938. GEMVISION CORPORATION, LLC., DBA GEMVISION, DAVENPORT, IA. FILED 5-7-2009.

REVO540

THE MARK CONSISTS OF STANDARD CHARACTERS WITHOUT CLAIM TO ANY PARTICULAR FONT, STYLE, SIZE, OR COLOR.

FOR MILLING MACHINES FOR METALWORKING; MILLING MACHINES, PARTICULARLY FOR MILLING MACHINES CONFIGURED FOR USE WITH COMPUTER HARDWARE AND SOFTWARE FOR PRODUCTION OF JEWELRY AND CUSTOM JEWELRY.; MILLING MACHINES, PARTICULARLY FOR PRODUCTION OF JEWELRY AND CUSTOM JEWELRY (U.S. CLS. 13, 19, 21, 23, 31, 34 AND 35).

FIRST USE 2-5-2003; IN COMMERCE 2-5-2003.
GINA HAYES, EXAMINING ATTORNEY

SN 77-738,980. TRILINK SAW CHAIN, LLC, ATLANTA, GA. FILED 5-18-2009.

TRILINK SAW CHAIN

SN 77-729,743. MIGHTY MITE INDUSTRIES, INC., CANBY, OR. FILED 5-5-2009.

MINI MITE

THE MARK CONSISTS OF STANDARD CHARACTERS WITHOUT CLAIM TO ANY PARTICULAR FONT, STYLE, SIZE, OR COLOR.

FOR SAWMILLS (U.S. CLS. 13, 19, 21, 23, 31, 34 AND 35).
FIRST USE 12-0-1976; IN COMMERCE 12-0-1976.
ALYSSA STEEL, EXAMINING ATTORNEY

THE MARK CONSISTS OF STANDARD CHARACTERS WITHOUT CLAIM TO ANY PARTICULAR FONT, STYLE, SIZE, OR COLOR.

OWNER OF U.S. REG. NO. 3,551,732.
NO CLAIM IS MADE TO THE EXCLUSIVE RIGHT TO USE "SAW CHAIN", APART FROM THE MARK AS SHOWN.
FOR GUIDE BARS FOR CHAIN SAWS (U.S. CLS. 13, 19, 21, 23, 31, 34 AND 35).
FIRST USE 1-14-2007; IN COMMERCE 1-14-2007.
LINDA LAVACHE, EXAMINING ATTORNEY

CLASS 7—(Continued).

SN 79-062,736. LIFAN INDUSTRY (GROUP) CO., LTD.,
400037 CHONGQING CITY, CHINA, FILED 11-25-2008.

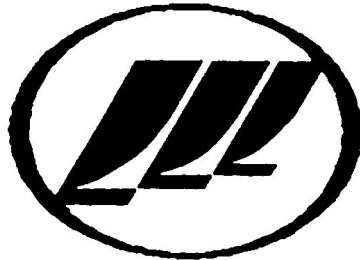

OWNER OF INTERNATIONAL REGISTRATION 0986603
DATED 11-25-2008, EXPIRES 11-25-2018.

THE MARK CONSISTS OF THE LETTERS "LL" INSIDE
OF AN OVAL.

FOR GASOLINE ENGINES NOT FOR LAND VEHICLES;
DIESEL ENGINES NOT FOR LAND VEHICLES;
CARBURETORS; FUEL ECONOMIZERS FOR MOTORS
AND ENGINES; GENERATORS OF ELECTRICITY (U.S.
CLS. 13, 19, 21, 23, 31, 34 AND 35).

LINDSEY RUBIN, EXAMINING ATTORNEY

CLASS 7—(Continued).

SN 79-066,189. N.V. DENYS, NAAMLOZE VENNOOTSCHAP,
BELGIUM, FILED 2-10-2009.

FRIEX

THE MARK CONSISTS OF STANDARD CHARACTERS
WITHOUT CLAIM TO ANY PARTICULAR FONT, STYLE,
SIZE, OR COLOR.

OWNER OF INTERNATIONAL REGISTRATION 0995778
DATED 2-10-2009, EXPIRES 2-10-2019.

FOR GAS-OPERATED WELDING APPARATUS,
NAMELY, MACHINES; GAS-OPERATED SOLDERING
BLOW PIPES; METAL WELDING MACHINES, NAMELY,
SAWS AND CUTTERS; MACHINE TOOLS, NAMELY,
GAS WELDING GUNS; MOTORS EXCEPT FOR LAND
VEHICLES (U.S. CLS. 13, 19, 21, 23, 31, 34 AND 35).

LEIGH CAROLINE CASE, EXAMINING ATTORNEY

SN 79-062,793. LIFAN INDUSTRY (GROUP) CO., LTD.,
400037 CHONGQING CITY, CHINA, FILED 11-25-2008.

LIFAN

OWNER OF INTERNATIONAL REGISTRATION 0986747
DATED 11-25-2008, EXPIRES 11-25-2018.

OWNER OF U.S. REG. NOS. 2,685,324, 3,112,287 AND
OTHERS.

THE MARK CONSISTS OF THE WORDING "LIFAN" IN
ITALICS.

THE ENGLISH TRANSLATION OF THE WORD "LIFAN"
IN THE MARK IS POWER HOIST SAIL.

FOR AGRICULTURAL MACHINES, NAMELY, CUL-
TIVATORS, HARVESTERS, DISK HARROWS, SEEDERS,
SOWERS; LAWNMOWERS; HARVESTING MACHINES,
NAMELY, REAPING MACHINES, FODDER PRESSES;
DISHWASHERS; ELECTRIC BLENDERS FOR HOUSE-
HOLD PURPOSES; ELECTRIC HAND DRILLS; EMER-
GENCY ELECTRIC POWER GENERATORS; ENGINES,
OTHER THAN FOR LAND VEHICLES; PISTONS FOR
ENGINES; CENTRIFUGAL PUMPS; SELF-PROPELLED
ROAD SWEEPING MACHINES; COMPRESSED AIR MA-
CHINES; WASHING MACHINES FOR INDUSTRIAL
PARTS AND FOR HOUSEHOLD PURPOSES; WRING-
ING MACHINES FOR LAUNDRY; ELEVATORS (U.S.
CLS. 13, 19, 21, 23, 31, 34 AND 35).

LINDSEY RUBIN, EXAMINING ATTORNEY

CLASS 8—HAND TOOLS

SN 77-320,388. CHAPIN MANUFACTURING, INC., BATA-
VIA, NY. FILED 11-2-2007.



NO CLAIM IS MADE TO THE EXCLUSIVE RIGHT TO
USE THE DESIGN OF THE CYLINDRICAL RESERVOIR
CONTAINER, THE STIRRUP HANDLE, THE LARGE COL-
LARED OPENING AT THE TOP OF THE RESERVOIR, AND
THE SPRAYER AND SPRAYER HOSE, APART FROM THE
MARK AS SHOWN.

THE MARK CONSISTS OF A THREE-DIMENSIONAL
DEPICTION OF A HAND PUMP HAVING A TOTAL OF
EIGHT DEPRESSIONS FORMING RINGS ENCIRCLING A
CYLINDRICAL RESERVOIR WITH THREE CLOSELY

CLASS 8—(Continued).

SPACED RINGS EXTENDING AROUND THE BOTTOM HALF OF THE RESERVOIR, THREE CLOSELY SPACED RINGS AROUND THE UPPER HALF OF THE CYLINDER, AND TWO CLOSELY SPACED RINGS AROUND THE CYLINDER ADJACENT THE JUNCTURE OF THE CYLINDER AND INWARDLY TAPERING PORTION OF THE TOP PART OF THE RESERVOIR, AND A TRIANGULAR CLAMP AT THE TOP OPENING OF THE RESERVOIR TO WHICH A STIRRUP SHAPED HANDLE ATTACHES IN THE MIDDLE OF THE CLAMP.

SEC. 2(F).

FOR HAND OPERATED SPRAYERS OF LIQUIDS, NAMELY, SOLVENTS, OILS, AQUEOUS SOLUTIONS, SUSPENSIONS, EMULSIONS AND FOAMS OF PESTICIDES, HERBICIDES, MICROBICIDES, DISINFECTANTS, SOAPS, CLEANERS, FERTILIZERS FOR HOME, INDUSTRY, CONSTRUCTION, LAWN, GARDEN, FARM, FIELD, MARINE AND PEST CONTROL USE (U.S. CLS. 23, 28 AND 44).

FIRST USE 12-31-1950; IN COMMERCE 12-31-1950.
BARBARA A. GOLD, EXAMINING ATTORNEY

CLASS 8—(Continued).

SN 77-587,304. MIW ASSOCIATES LLC, HAVERTOWN, PA. FILED 10-7-2008.

GOT WINTER? WORK SMART!

THE MARK CONSISTS OF STANDARD CHARACTERS WITHOUT CLAIM TO ANY PARTICULAR FONT, STYLE, SIZE, OR COLOR.

FOR HAND TOOLS, NAMELY, ICE SCRAPERS, ICE PICKS, SNOW DEFLECTORS, AND SHOVELS; ABRADING TOOLS (U.S. CLS. 23, 28 AND 44).

ALICE SUE CARRUTHERS, EXAMINING ATTORNEY

SN 77-459,136. AMES TRUE TEMPER PROPERTIES, INC., WILMINGTON, DE. FILED 4-28-2008.

ROTO GRIP

THE MARK CONSISTS OF STANDARD CHARACTERS WITHOUT CLAIM TO ANY PARTICULAR FONT, STYLE, SIZE, OR COLOR.

NO CLAIM IS MADE TO THE EXCLUSIVE RIGHT TO USE "GRIP", APART FROM THE MARK AS SHOWN.

FOR MANUALLY OPERATED LAWN AND GARDEN HAND TOOLS, NAMELY, LONG-HANDLED TOOLS, NAMELY, RAKES (U.S. CLS. 23, 28 AND 44).
KRISTIN CARLSON, EXAMINING ATTORNEY

SN 77-594,089. RIPPA TOOLS, LLC, YUCAIPA, CA. FILED 10-16-2008.

LET THE GOPHER DO YOUR WORK

THE MARK CONSISTS OF STANDARD CHARACTERS WITHOUT CLAIM TO ANY PARTICULAR FONT, STYLE, SIZE, OR COLOR.

FOR HAND TOOLS, NAMELY, SHOVELS, PICKS, HOES, AND POST-HOLE DIGGERS (U.S. CLS. 23, 28 AND 44).

ZHALEH DELANEY, EXAMINING ATTORNEY

SN 77-595,953. MICHAELS STORES PROCUREMENT COMPANY, INC., IRVING, TX. FILED 10-20-2008.

ARTMINDS

THE MARK CONSISTS OF STANDARD CHARACTERS WITHOUT CLAIM TO ANY PARTICULAR FONT, STYLE, SIZE, OR COLOR.

FOR ARTISTS' HAND TOOLS FOR SHAPING, SCULPTING, AND SCORING CLAY AND MODELING COMPOUNDS, NAMELY, SCULPTING KNIVES, FOLDING KNIVES, TRIM BLADES; SCISSORS; ARTISTS' HAND TOOLS FOR CUTTING CLAY AND MODELING COMPOUNDS, NAMELY, ART KNIVES, CRAFT KNIVES, PUTTY KNIVES; ARTISTS' HAND TOOLS, NAMELY, PICKS AND SCRAPERS FOR USE WITH CLAY AND MODELING COMPOUNDS (U.S. CLS. 23, 28 AND 44).

PAUL CROWLEY, EXAMINING ATTORNEY

SN 77-546,903. VISOR PERFORMANCE, INC., WILLIAMSVILLE, NY. FILED 8-14-2008.

**DeltaDriver
Reach the Un-Reachable**

THE MARK CONSISTS OF STANDARD CHARACTERS WITHOUT CLAIM TO ANY PARTICULAR FONT, STYLE, SIZE, OR COLOR.

FOR HAND TOOLS, NAMELY, SCREWDRIVERS; SCREWDRIVERS (U.S. CLS. 23, 28 AND 44).

ANDREW LEASER, EXAMINING ATTORNEY

CLASS 8—(Continued).

SN 77-634,925. STAND TOOLS ENTERPRISE CO., LTD., TAICHUNG CITY, TAIWAN, FILED 12-17-2008.



THE MARK CONSISTS OF THE WORD "RISTAR" IN A STYLIZED FORM WITH THE LETTER "I" DOTTED WITH A STAR.

FOR HAND TOOLS, NAMELY, SCREWDRIVERS, SPANNERS, WRENCHES, SCREW WRENCHES, SCREW KEYS IN THE NATURE OF HEX KEYS WRENCHES, RATCHETS, RATCHET HEADS, RATCHET WRENCHES, BIT HOLDERS FOR HAND DRILLS (U.S. CLS. 23, 28 AND 44).

FIRST USE 11-28-2008; IN COMMERCE 11-28-2008.
AISHA SALEM, EXAMINING ATTORNEY

CLASS 8—(Continued).

SN 77-691,561. R & B MARKETING CORPORATION, GAFFNEY, SC. FILED 3-16-2009.



NO CLAIM IS MADE TO THE EXCLUSIVE RIGHT TO USE "HARDWOOD WRENCH", APART FROM THE MARK AS SHOWN.

THE MARK CONSISTS OF AN OVAL DESIGN, INSIDE WHICH THE WORD "HARDWOOD" APPEARS, ABOVE A CAPITAL LETTER "H", WHICH IS ABOVE A CAPITAL LETTER "W", WHICH IS ABOVE THE WORD "WRENCH".

FOR HAND TOOLS, NAMELY, WRENCHES IN THE NATURE OF A HAND-OPERATED DECK TOOL CONSISTING OF A CLAMP WITH A HANDLE FOR USE IN BENDING BOARDS AND INSTALLING TONGUE AND GROOVE FLOORING (U.S. CLS. 23, 28 AND 44).

FIRST USE 4-30-2009; IN COMMERCE 4-30-2009.
KATHERINE STOIDES, EXAMINING ATTORNEY

SN 77-670,861. FAROUK SYSTEMS, INC., HOUSTON, TX. FILED 2-14-2009.



THE MARK CONSISTS OF A STYLIZED "V" AND A STYLIZED "7".
FOR HAIR CLIPPERS (U.S. CLS. 23, 28 AND 44).
YAT SYE, LEE, EXAMINING ATTORNEY

SN 77-692,054. BOEING MANAGEMENT COMPANY, SEAL BEACH, CA. FILED 3-16-2009.



OWNER OF U.S. REG. NOS. 2,243,668, 2,383,795 AND OTHERS.

THE MARK CONSISTS OF A SINGLE LINE CIRCLE INTERSECTED BY A CURVED LINE AND ALSO INTERSECTED BY A TRIANGLE WITH ONE CURVED SIDE, WITH THE CIRCLE SUGGESTING THE GLOBE, THE CURVED LINE SUGGESTING AN ORBIT, AND THE TRIANGLE SUGGESTING AN AIRPLANE OR AIRCRAFT.

FOR FOLDING HAND TOOLS, NAMELY, PLIERS, KNIVES, TWEEZERS, SCREWDRIVERS, FILES, CAN OPENERS, AND SCISSORS; SCREWDRIVERS (U.S. CLS. 23, 28 AND 44).

FIRST USE 2-23-2009; IN COMMERCE 2-23-2009.
GEORGE LORENZO, EXAMINING ATTORNEY

CLASS 8—(Continued).

SN 77-693,108. SCRIPPS NETWORKS, LLC, KNOXVILLE, TN. FILED 3-17-2009.

MAN CAVES

THE MARK CONSISTS OF STANDARD CHARACTERS WITHOUT CLAIM TO ANY PARTICULAR FONT, STYLE, SIZE, OR COLOR.

FOR CUTLERY, NAMELY, KNIVES; HAND TOOLS, NAMELY, DRILLS (U.S. CLS. 23, 28 AND 44).
TEJBIR SINGH, EXAMINING ATTORNEY

SN 77-720,033. BENCHMADE KNIFE CO., INC., OREGON CITY, OR. FILED 4-22-2009.



OWNER OF U.S. REG. NO. 3,129,594.

NO CLAIM IS MADE TO THE EXCLUSIVE RIGHT TO USE "GENUINE" AND "MECHANICS", APART FROM THE MARK AS SHOWN.

THE MARK CONSISTS OF AN ELONGATED OVAL CONTAINING A CIRCLE AND TWO ARCS ON THE LEFT AND THE WORDS "GENUINE AXIS MECHANICS" ON THE RIGHT.

FOR KNIVES, NAMELY, FOLDING KNIVES AND POCKET KNIVES AND COMPONENTS THEREOF, NAMELY, HANDLES, BLADES, HANDLE LINERS, HINGING MECHANISMS AND MECHANISMS TO SECURE A BLADE IN THE OPEN POSITION (U.S. CLS. 23, 28 AND 44).

FIRST USE 1-2-2006; IN COMMERCE 1-2-2006.
KRISTIN CARLSON, EXAMINING ATTORNEY

SN 77-722,582. USA BRANDS, LLC, HOMER GLEN, IL. FILED 4-26-2009.

LIBERTY Tabletop

THE MARK CONSISTS OF STANDARD CHARACTERS WITHOUT CLAIM TO ANY PARTICULAR FONT, STYLE, SIZE, OR COLOR.

FOR FLATWARE, NAMELY, FORKS, KNIVES, AND SPOONS (U.S. CLS. 23, 28 AND 44).
FIRST USE 4-16-2009; IN COMMERCE 4-16-2009.
KRISTIN DAHLING, EXAMINING ATTORNEY

CLASS 8—(Continued).

SN 77-724,515. USA BRANDS, LLC, HOMER GLEN, IL. FILED 4-28-2009.

Baby Liberty

THE MARK CONSISTS OF STANDARD CHARACTERS WITHOUT CLAIM TO ANY PARTICULAR FONT, STYLE, SIZE, OR COLOR.

NO CLAIM IS MADE TO THE EXCLUSIVE RIGHT TO USE "BABY", APART FROM THE MARK AS SHOWN.

FOR FLATWARE, NAMELY, FORKS, KNIVES, AND SPOONS (U.S. CLS. 23, 28 AND 44).

FIRST USE 4-16-2009; IN COMMERCE 4-16-2009.
KRISTIN DAHLING, EXAMINING ATTORNEY

SN 77-724,842. WAHL CLIPPER CORPORATION, STERLING, IL. FILED 4-29-2009.

T-STYLER PRO

THE MARK CONSISTS OF STANDARD CHARACTERS WITHOUT CLAIM TO ANY PARTICULAR FONT, STYLE, SIZE, OR COLOR.

OWNER OF U.S. REG. NO. 3,572,580.
FOR ELECTRIC HAIR TRIMMERS (U.S. CLS. 23, 28 AND 44).

ELLEN PERKINS, EXAMINING ATTORNEY

SN 77-725,098. WAHL CLIPPER CORPORATION, STERLING, IL. FILED 4-29-2009.

ECHO

THE MARK CONSISTS OF STANDARD CHARACTERS WITHOUT CLAIM TO ANY PARTICULAR FONT, STYLE, SIZE, OR COLOR.

FOR ELECTRIC HAIR TRIMMERS (U.S. CLS. 23, 28 AND 44).

ELLEN PERKINS, EXAMINING ATTORNEY

CLASS 8—(Continued).

SN 77-733,959. FORD MOTOR COMPANY, DEARBORN, MI.
FILED 5-11-2009.

F-100

THE MARK CONSISTS OF STANDARD CHARACTERS WITHOUT CLAIM TO ANY PARTICULAR FONT, STYLE, SIZE, OR COLOR.

FOR HAND TOOLS, NAMELY, FOLDING KNIVES, PEN KNIVES AND POCKET KNIVES (U.S. CLS. 23, 28 AND 44).

EVELYN BRADLEY, EXAMINING ATTORNEY

SN 77-752,777. HEARTHMARK, LLC, DALEVILLE, IN.
FILED 6-5-2009.



THE MARK CONSISTS OF A CIRCLE DIVIDED IN QUADRANTS BY CROSSHAIRS WITH AN ECLIPSE CENTERED OVER THE CROSSHAIRS TO REPRESENT A GLOBE OF THE EARTH POSITIONED ABOVE A HAND WITH THE LITERAL ELEMENTS OF "EARTH IN MIND SOLUTIONS" POSITIONED TO THE RIGHT OF THE GLOBE AND HAND.

FOR PLASTIC CUTLERY, NAMELY, FORKS, KNIVES, AND SPOONS (U.S. CLS. 23, 28 AND 44).

FIRST USE 5-8-2009; IN COMMERCE 5-8-2009.
BILL DAWE, EXAMINING ATTORNEY

SN 79-067,538. ESSENSUELLE, FRANCE, FILED 2-23-2009.

Essensuelle

OWNER OF INTERNATIONAL REGISTRATION 0999546 DATED 2-23-2009, EXPIRES 2-23-2019.

THE MARK CONSISTS OF THE WORD "ESSENSUELLE" IN A STYLIZED FORMAT.

FOR MANICURE AND PEDICURE ACCESSORIES, NAMELY, CUTICLE TWEEZERS, CUTICLE NIPPERS, NAIL FILES, NAIL NIPPERS, NAIL CLIPPERS, CUTICLE PUSHERS, RASPS; RAZORS, HAIR-REMOVING TWEEZERS, SCISSORS (U.S. CLS. 23, 28 AND 44).

FRANK LATTUCA, EXAMINING ATTORNEY

CLASS 9—ELECTRICAL AND SCIENTIFIC APPARATUS

SN 76-695,368. ATX NETWORKS CORP., AJAX, ONTARIO, CANADA, FILED 1-21-2009.

UCrypt

THE MARK CONSISTS OF THE WORD "UCRYPT" AND A DESIGN OF A KEY HOLD.

FOR TRANSMITTING AND RECEIVING APPARATUS FOR RADIO AND TELEVISION BROADCASTING AND FOR LONG-DISTANCE TRANSMISSION; RECEIVERS FOR RECEIVING CABLE TELEVISION; RECEIVERS FOR AUDIO AND VIDEO; ELECTRONIC ENCRYPTION UNITS; CABLE TELEVISION TRANSMITTERS; DEMODULATORS; ENCODING AND DECODING APPARATUS AND INSTRUMENTS; AND ELECTRONIC APPARATUS AND DEVICES FOR CONTROLLING ACCESS TO PAY-TELEVISION SERVICES (U.S. CLS. 21, 23, 26, 36 AND 38).

JULIE WATSON, EXAMINING ATTORNEY

SN 76-695,461. ALLENTOWN CAGING AND EQUIPMENT CO., ALLENTOWN, NJ. FILED 1-26-2009.

SENSUS

THE MARK CONSISTS OF STANDARD CHARACTERS WITHOUT CLAIM TO ANY PARTICULAR FONT, STYLE, SIZE, OR COLOR.

FOR COMPUTER HARDWARE, RADIO IDENTIFICATION FREQUENCY READERS, RADIO FREQUENCY IDENTIFICATION TAGS, AND SOFTWARE USED FOR TRACKING AND MANAGING LABORATORY ANIMALS (U.S. CLS. 21, 23, 26, 36 AND 38).

FIRST USE 11-0-2008; IN COMMERCE 11-0-2008.
EMILY CARLSEN, EXAMINING ATTORNEY

CLASS 9—(Continued).

SN 76-696,752. JOHNSON, ALBERT RAY, LOS ANGELES, CA. FILED 4-7-2009.



NO CLAIM IS MADE TO THE EXCLUSIVE RIGHT TO USE "ENTERTAINMENT", APART FROM THE MARK AS SHOWN.

THE COLOR(S) GREEN AND BLACK IS/ARE CLAIMED AS A FEATURE OF THE MARK.

THE MARK CONSISTS OF THE ELEMENTS "A1 / 4WAY ENTERTAINMENT" IN A CURVED PRESENTATION IN THE COLORS GREEN AND BLACK; INSIDE THE CURVED PRESENTATION IS THE NUMERAL "1" WITH FOUR LETTER "A"'S CURVED ON THE RIGHT SIDE OF THE NUMERAL, ALL OF THE ELEMENTS ARE IN THE COLOR GREEN WITH SHADES OF BLACK.

FOR PRE-RECORDED CDS FEATURING MUSIC (U.S. CLS. 21, 23, 26, 36 AND 38).

CHRISTOPHER BUONGIORNO, EXAMINING ATTORNEY

SN 77-015,178. STONES THROW RECORDS, LLC, LOS ANGELES, CA. FILED 10-5-2006.

STONES THROW

THE MARK CONSISTS OF STANDARD CHARACTERS WITHOUT CLAIM TO ANY PARTICULAR FONT, STYLE, SIZE, OR COLOR.

FOR DOWNLOADABLE MUSICAL SOUND RECORDINGS; MUSICAL SOUND RECORDINGS; MUSICAL VIDEO RECORDINGS (U.S. CLS. 21, 23, 26, 36 AND 38).

FIRST USE 4-1-1996; IN COMMERCE 4-1-1996.
LINDSEY RUBIN, EXAMINING ATTORNEY

CLASS 9—(Continued).

SN 77-055,071. OPHTHONIX, INC., VISTA, CA. FILED 12-1-2006.



OWNER OF U.S. REG. NO. 3,188,278.

NO CLAIM IS MADE TO THE EXCLUSIVE RIGHT TO USE "HIGH RESOLUTION LENSES", APART FROM THE MARK AS SHOWN.

THE MARK CONSISTS OF THE STYLIZED WORD "IZON" (WITH AN INVERTED "I") WITH THE WORDS "HIGH RESOLUTION LENSES" UNDERNEATH IN A STYLIZED FONT.

FOR EYEGLASSES; PRESCRIPTION SUNGLASS LENSES; EYEGGLASS LENSES (U.S. CLS. 21, 23, 26, 36 AND 38).

MARY ROSSMAN, EXAMINING ATTORNEY

SN 77-121,892. STEWART, MARK-LAMBERT SWARTOUT, BASINGSTOKE, UNITED KINGDOM, FILED 3-5-2007.

LIKE NO OTHER MUSIC

THE MARK CONSISTS OF STANDARD CHARACTERS WITHOUT CLAIM TO ANY PARTICULAR FONT, STYLE, SIZE, OR COLOR.

OWNER OF CANADA REG. NO. TMA633851, DATED 2-28-2005, EXPIRES 2-28-2020.

OWNER OF U.S. REG. NOS. 2,594,797 AND 2,752,987.

FOR DOWNLOADABLE RING TONES VIA THE INTERNET AND WIRELESS DEVICES; DOWNLOADABLE GRAPHICS, MUSIC, AUDIO FILES FEATURING MUSIC, TECHNOLOGY, SELF-IMPROVEMENT, HEALTH, PHILOSOPHY, PSYCHOLOGY, BUSINESS, LAW, SPOKEN WORD; DIGITAL MEDIA IN THE FORM OF DOWNLOADABLE AUDIO FILES AND DOWNLOADABLE VIDEO FILES FEATURING MUSIC, TECHNOLOGY, SELF-IMPROVEMENT, HEALTH, PHILOSOPHY, PSYCHOLOGY, BUSINESS, LAW, SPOKEN WORD; DOWNLOADABLE ELECTRONIC DATA FILES FEATURING MUSIC, TECHNOLOGY, SELF-IMPROVEMENT, HEALTH, PHILOSOPHY, PSYCHOLOGY, BUSINESS, LAW, SPOKEN WORD; DOWNLOADABLE WEBCASTS FEATURING MUSIC, TECHNOLOGY, SELF-IMPROVEMENT, HEALTH, PHILOSOPHY, PSYCHOLOGY, BUSINESS, LAW, SPOKEN WORD; DOWNLOADABLE ELECTRONIC JOURNALS FEATURING MUSIC, TECHNOLOGY, SELF-IMPROVEMENT, HEALTH, PHILOSOPHY, PSYCHOLOGY, BUSINESS, LAW, SPOKEN WORD; DOWNLOADABLE BLOGS FEATURING MUSIC, TECHNOLOGY, SELF-IMPROVEMENT, HEALTH, PHILOSOPHY, PSYCHOLOGY, BUSINESS, LAW, SPOKEN WORD; DOWNLOADABLE MAGAZINES FEATURING MUSIC, TECHNOLOGY, SELF-IMPROVEMENT, HEALTH, PHILOSOPHY, PSYCHOLOGY, BUSINESS, LAW, SPOKEN WORD; DOWNLOADABLE PUBLICATIONS IN THE NATURE OF MAGAZINES, ARTICLES, NEWSLETTERS, TECHNICAL BULLETINS, RESEARCH SUMMARIES, REFERENCE MATERIALS, REPORTS, AND EDUCATIONAL MATERIALS FEATURING MUSIC, TECHNOLOGY, SELF-IMPROVEMENT, HEALTH, PHILOSOPHY, PSYCHOLOGY, BUSINESS, LAW, SPOKEN WORD; DOWNLOADABLE DATA FILES FEATUR-

CLASS 9—(Continued).

ING MUSIC, TECHNOLOGY, SELF-IMPROVEMENT, HEALTH, PHILOSOPHY, PSYCHOLOGY, BUSINESS, LAW, SPOKEN WORD; DOWNLOADABLE MUSICAL SOUND RECORDINGS; DOWNLOADABLE SOFTWARE FOR USE IN ONLINE CONTENT CREATION, MANAGEMENT AND DISTRIBUTION; DOWNLOADABLE PODCASTS IN THE FIELD OF MUSIC, TECHNOLOGY, SELF-IMPROVEMENT, HEALTH, PHILOSOPHY, PSYCHOLOGY, BUSINESS, LAW, SPOKEN WORD; DOWNLOADABLE ELECTRONIC PUBLICATIONS IN THE NATURE OF MAGAZINES, ARTICLES, NEWSLETTERS, TECHNICAL BULLETINS, RESEARCH SUMMARIES, REFERENCE MATERIALS, REPORTS, AND EDUCATIONAL MATERIALS IN THE FIELD OF MUSIC, TECHNOLOGY, SELF-IMPROVEMENT, HEALTH, PHILOSOPHY, PSYCHOLOGY, BUSINESS, LAW, SPOKEN WORD; DOWNLOADABLE VIDEO RECORDINGS FEATURING MUSIC, TECHNOLOGY, SELF-IMPROVEMENT, HEALTH, PHILOSOPHY, PSYCHOLOGY, BUSINESS, LAW, SPOKEN WORD; PRE-RECORDED DIGITAL MEDIA FEATURING MUSIC, TECHNOLOGY, SELF-IMPROVEMENT, HEALTH, PHILOSOPHY, PSYCHOLOGY, BUSINESS, LAW, AND SPOKEN WORD; MUSICAL SOUND RECORDINGS; SOUND RECORDINGS FEATURING MUSIC, TECHNOLOGY, SELF-IMPROVEMENT, HEALTH, PHILOSOPHY, PSYCHOLOGY, BUSINESS, AND LAW; PRE-RECORDED DIGITAL MATERIALS, NAMELY, CDS, DVDS, AND DOWNLOADABLE AUDIO FILES, FEATURING MUSIC, TECHNOLOGY, SELF-IMPROVEMENT, HEALTH, PHILOSOPHY, PSYCHOLOGY, BUSINESS, LAW, AND SPOKEN WORD; PRE-RECORDED VIDEOTAPES, AUDIO DISCS, CDS, DVDS AND VIDEO DISKS FEATURING MUSIC, TECHNOLOGY, SELF-IMPROVEMENT, HEALTH, PHILOSOPHY, PSYCHOLOGY, BUSINESS, LAW, AND SPOKEN WORD; PRE-RECORDED CDS, VIDEO TAPES, LASER DISKS AND DVDS FEATURING MUSIC, TECHNOLOGY, SELF-IMPROVEMENT, HEALTH, PHILOSOPHY, PSYCHOLOGY, BUSINESS, LAW, AND SPOKEN WORD; MULTIMEDIA SOFTWARE, NAMELY, MULTIMEDIA SOFTWARE RECORDED ON DIGITAL MEDIA FEATURING MUSIC, TECHNOLOGY, SELF-IMPROVEMENT, HEALTH, PHILOSOPHY, PSYCHOLOGY, BUSINESS, LAW, AND SPOKEN WORD; COMPUTER SERVERS; COMPUTERS AND INSTRUCTIONAL MANUALS SOLD AS A UNIT; AUTOMATED SYSTEMS, NAMELY, SOFTWARE, HARDWARE AND COMMUNICATIONS DEVICES FOR PLANNING, SCHEDULING, CONTROLLING, MONITORING AND PROVIDING OF DOWNLOADABLE DIGITAL MEDIA; ENTERTAINMENT SYSTEM COMPRISED OF A COMPUTER, MULTIPLE DISPLAY SCREEN, MULTIPLE INPUT DEVICES AND A PRINTER; COMPUTER SOFTWARE, NAMELY, COMPUTER SOFTWARE FOR CREATING AND UPLOADING, DOWNLOADING AND DISTRIBUTING DIGITAL MEDIA; COMPUTERS, DEVICES OR APPARATUS FOR BROADCASTING, PROCESSING, RECORDING, TRANSMISSION, BROADCASTING OR REPRODUCTION OF SOUND, IMAGES OR DATA; COMPUTER PROGRAMS FOR EDITING, ADMINISTRATION AND DOWNLOADING OF DIGITAL MEDIA; INTERACTIVE PROGRAMS NAMELY, PROGRAMS FOR THE INTERACTIVE DIGITAL DISTRIBUTION OF ONLINE MEDIA (U.S. CLS. 21, 23, 26, 36 AND 38).

ANN E. SAPPENFIELD, EXAMINING ATTORNEY

CLASS 9—(Continued).

SN 77-134,496. CATALYST SYSTEMS CORPORATION, CHICAGO, IL. FILED 3-19-2007.

MOJO

THE MARK CONSISTS OF STANDARD CHARACTERS WITHOUT CLAIM TO ANY PARTICULAR FONT, STYLE, SIZE, OR COLOR.

FOR COMPUTER SOFTWARE, NAMELY, DEVELOPMENT TOOLS USED TO ORCHESTRATE THE COMPILING AND LINKING PROCESS OF CUSTOM BUSINESS APPLICATIONS (U.S. CLS. 21, 23, 26, 36 AND 38).

LOURDES AYALA, EXAMINING ATTORNEY

SN 77-143,995. PARROT, PARIS, FRANCE, FILED 3-29-2007.

PARROT SOUND SYSTEM

THE MARK CONSISTS OF STANDARD CHARACTERS WITHOUT CLAIM TO ANY PARTICULAR FONT, STYLE, SIZE, OR COLOR.

PRIORITY CLAIMED UNDER SEC. 44(D) ON ERPNCMNTY TM OFC APPLICATION NO. 0054580427, FILED 10-31-2006, REG. NO. 005458427, DATED 10-18-2007, EXPIRES 10-31-2016.

OWNER OF U.S. REG. NOS. 3,500,791, 3,623,067 AND 3,637,273.

NO CLAIM IS MADE TO THE EXCLUSIVE RIGHT TO USE "SOUND SYSTEM", APART FROM THE MARK AS SHOWN.

FOR COMPUTER SOFTWARE FOR WIRELESS CONTENT DELIVERY, APPARATUS FOR WIRELESS TRANSMISSION OF ACOUSTIC INFORMATION, NAMELY, WIRELESS HI-FI SPEAKERS WITH DIGITAL AMPLIFIERS, EQUALIZER AND DECODER (U.S. CLS. 21, 23, 26, 36 AND 38).

JAMES STEIN, EXAMINING ATTORNEY

CLASS 9—(Continued).

SN 77-167,475. TELEPHARMACY SOLUTIONS, INC., VERNON HILLS, IL. FILED 4-27-2007.

TELEPHARMACY SOLUTIONS

THE MARK CONSISTS OF STANDARD CHARACTERS WITHOUT CLAIM TO ANY PARTICULAR FONT, STYLE, SIZE, OR COLOR.

OWNER OF U.S. REG. NOS. 2,596,170, 2,793,454 AND OTHERS.

NO CLAIM IS MADE TO THE EXCLUSIVE RIGHT TO USE "TELEPHARMACY", APART FROM THE MARK AS SHOWN.

SEC. 2(F).

FOR AUTOMATIC DISPENSING SYSTEMS, NAMELY, AUTOMATED PHARMACEUTICAL DISPENSING MACHINES AND AUTOMATED ARTICLE DISPENSING MACHINES USED IN PHARMACY-LIKE SETTINGS FOR DISPENSING OF PACKAGED PHARMACEUTICALS AND MEDICAL PRODUCTS, COMPUTER SOFTWARE FOR OPERATING THE AUTOMATED PHARMACEUTICAL DISPENSING SYSTEM, AND DATA, VIDEO AND AUDIO APPARATUS COMPRISED OF VIDEO SCREENS, VIDEO CAMERAS, SPEAKERS, AND TELECOMMUNICATIONS TRANSMITTERS FOR COMMUNICATIONS BETWEEN A CUSTOMER AND A PHARMACIST (U.S. CLS. 21, 23, 26, 36 AND 38).

FIRST USE 11-30-1997; IN COMMERCE 11-30-1997.
CHARLOTTE CORWIN, EXAMINING ATTORNEY

CLASS 9—(Continued).

SN 77-184,064. POTTER, JAMES TODD, SPICEWOOD, TX. FILED 5-17-2007.

GRADUATION DAY

THE MARK CONSISTS OF STANDARD CHARACTERS WITHOUT CLAIM TO ANY PARTICULAR FONT, STYLE, SIZE, OR COLOR.

FOR AUDIO DIGITAL TAPES FEATURING MUSIC AND DIGITAL FILES, NAMELY, RECORDED MUSIC, AND SOFTWARE TEMPLATES USED TO POPULATE AUDIO VISUAL SLIDESHOWS INCORPORATING SAID RECORDED MUSIC (U.S. CLS. 21, 23, 26, 36 AND 38).

FIRST USE 5-26-2006; IN COMMERCE 4-16-2007.
FRANK LATTUCA, EXAMINING ATTORNEY

SN 77-176,501. OMONTE D. WARD, YORKTOWN, VA. FILED 5-9-2007.



THE MARK CONSISTS OF THE TERM "DROPZONE" IN HIGHLY STYLIZED LETTERS THAT LOOK LIKE WOOD, WITH SPEAKERS REPRESENTING THE CENTERS OF BOTH LETTERS "O" AND NAILS THROUGH THE POINTS OF CONNECTION IN THE LETTERS.

FOR MUSICAL SOUND RECORDINGS; MUSICAL VIDEO RECORDINGS; SOUND RECORDINGS FEATURING MUSIC AND MUSIC VIDEOS; VIDEO RECORDINGS FEATURING MUSIC AND MUSIC VIDEOS; VISUAL RECORDINGS AND AUDIO VISUAL RECORDINGS FEATURING MUSIC AND ANIMATION; AUDIO RECORDINGS FEATURING MUSIC AND MUSIC VIDEOS; DIGITAL PHOTO FRAMES FOR DISPLAYING DIGITAL PICTURES, VIDEO CLIPS AND MUSIC; DOWNLOADABLE MP3 FILES, MP3 RECORDINGS, ONLINE DISCUSSION BOARDS, WEB CASTS, POD CASTS FEATURING MUSIC, AUDIO BOOKS AND NEWS BROADCASTS; DOWNLOADABLE MUSICAL SOUND RECORDINGS; DOWNLOADABLE RING TONES, GRAPHICS AND MUSIC VIA A GLOBAL COMPUTER NETWORK AND WIRELESS DEVICES; DOWNLOADABLE VIDEO RECORDINGS FEATURING MUSIC AND MUSIC VIDEOS; DOWNLOADABLE MUSIC AND VIDEO VIA THE INTERNET AND WIRELESS DEVICES (U.S. CLS. 21, 23, 26, 36 AND 38).

FIRST USE 6-1-1995; IN COMMERCE 3-27-1997.
MYRIAH HABEEB, EXAMINING ATTORNEY

SN 77-201,550. SIRIUS XM RADIO INC., NEW YORK, NY. FILED 6-8-2007.



THE MARK CONSISTS OF A HEART.

FOR A FEATURE FOR RECORDING, SAVING AND MANAGING AUDIO, VIDEO AND DATA INFORMATION, SOLD AS A COMPONENT OF APPARATUS FOR RECEIVING BROADCAST AUDIO, VIDEO AND DATA TRANSMISSIONS (U.S. CLS. 21, 23, 26, 36 AND 38).

THOMAS MANOR, EXAMINING ATTORNEY

CLASS 9—(Continued).

SN 77-211,573. JANE NORMAN (HOLDINGS) LIMITED, LONDON, UNITED KINGDOM, FILED 6-21-2007.

JANE NORMAN

THE MARK CONSISTS OF STANDARD CHARACTERS WITHOUT CLAIM TO ANY PARTICULAR FONT, STYLE, SIZE, OR COLOR.

PRIORITY CLAIMED UNDER SEC. 44(D) ON ERN CMNTY TM OFC APPLICATION NO. 5999181, FILED 6-13-2007, REG. NO. 005999181, DATED 7-8-2009, EXPIRES 6-13-2017.

THE NAME(S), PORTRAIT(S), AND/OR SIGNATURE(S) SHOWN IN THE MARK DOES NOT IDENTIFY A PARTICULAR LIVING INDIVIDUAL.

FOR SUNGLASSES; SUNGLASS CASES; SPECTACLES; SPECTACLE CASES; CONTAINERS FOR CONTACT LENSES; ELECTRONICALLY ENCODED AND MAGNETICALLY ENCODED GIFT CARDS; ELECTRONICALLY ENCODED AND MAGNETICALLY ENCODED DEBIT AND CREDIT CARDS; ELECTRONICALLY ENCODED AND MAGNETICALLY ENCODED CHARGE CARDS; ELECTRONICALLY ENCODED AND MAGNETICALLY ENCODED CASH CARDS (U.S. CLS. 21, 23, 26, 36 AND 38).

LEIGH CAROLINE CASE, EXAMINING ATTORNEY

SN 77-225,285. ALARMCARE INDUSTRIES, INC., TORONTO, CANADA, FILED 7-9-2007.

ALARMCARE

THE MARK CONSISTS OF STANDARD CHARACTERS WITHOUT CLAIM TO ANY PARTICULAR FONT, STYLE, SIZE, OR COLOR.

PRIORITY CLAIMED UNDER SEC. 44(D) ON CANADA APPLICATION NO. 1354059, FILED 6-29-2007.

OWNER OF CANADA REG. NO. TMA736,084, DATED 3-10-2009, EXPIRES 3-10-2024.

FOR MEDICAL MONITORING PRODUCTS FOR SENIORS IN THE NATURE OF PERSONAL EMERGENCY RESPONSE SYSTEMS, NAMELY, AN EMERGENCY SIGNAL TRANSMITTER IN THE FORM OF A PENDANT WORN BY A USER AND AN ELECTRONIC TWO-WAY COMMUNICATION DEVICE FEATURING VOICE TRANSMISSION (U.S. CLS. 21, 23, 26, 36 AND 38).

JAY BESCH, EXAMINING ATTORNEY

CLASS 9—(Continued).

SN 77-252,527. PEOPLENET COMMUNICATIONS CORPORATION, CHASKA, MN. FILED 8-10-2007.

PEOPLENET BLU

THE MARK CONSISTS OF STANDARD CHARACTERS WITHOUT CLAIM TO ANY PARTICULAR FONT, STYLE, SIZE, OR COLOR.

OWNER OF U.S. REG. NOS. 2,194,078, 3,385,318 AND OTHERS.

FOR NAVIGATION APPARATUS FOR VEHICLES IN THE NATURE OF ON-BOARD COMPUTERS (U.S. CLS. 21, 23, 26, 36 AND 38).

SHARON MEIER, EXAMINING ATTORNEY

SN 77-261,549. APCON, INC., WILSONVILLE, OR. FILED 8-22-2007.

Intelliscan

THE MARK CONSISTS OF STANDARD CHARACTERS WITHOUT CLAIM TO ANY PARTICULAR FONT, STYLE, SIZE, OR COLOR.

FOR COMPUTER NETWORK SOFTWARE FOR MANAGING AND IMPROVING PHYSICAL LAYER CONNECTIONS BETWEEN A COMPUTER AND COMPUTER NETWORK (U.S. CLS. 21, 23, 26, 36 AND 38).

ALICIA COLLINS, EXAMINING ATTORNEY

SN 77-268,667. MILESTONE AV TECHNOLOGIES LLC, SAVAGE, MN. FILED 8-30-2007.

SANUS FOUNDATIONS HD PRO

THE MARK CONSISTS OF STANDARD CHARACTERS WITHOUT CLAIM TO ANY PARTICULAR FONT, STYLE, SIZE, OR COLOR.

OWNER OF U.S. REG. NOS. 1,600,890, 2,662,879 AND 2,674,634.

NO CLAIM IS MADE TO THE EXCLUSIVE RIGHT TO USE "HD", APART FROM THE MARK AS SHOWN.

FOR MECHANICAL MOUNTING SYSTEMS, NAMELY, MOUNTING ARMS FOR LIQUID CRYSTAL DISPLAYS, PLASMA DISPLAYS, AND CATHODE RAY TUBE DISPLAYS (U.S. CLS. 21, 23, 26, 36 AND 38).

CYNTHIA SLOAN, EXAMINING ATTORNEY

CLASS 9—(Continued).

SN 77-268,692. MILESTONE AV TECHNOLOGIES LLC,
SAVAGE, MN. FILED 8-30-2007.

SANUS ELEMENTS HD PRO

THE MARK CONSISTS OF STANDARD CHARACTERS WITHOUT CLAIM TO ANY PARTICULAR FONT, STYLE, SIZE, OR COLOR.

OWNER OF U.S. REG. NOS. 1,600,890, 2,662,879 AND 2,674,634.

NO CLAIM IS MADE TO THE EXCLUSIVE RIGHT TO USE "HD", APART FROM THE MARK AS SHOWN.

FOR COMPONENTS FOR AUDIO AND VIDEO EQUIPMENT, NAMELY, MECHANICAL MOUNTING SYSTEMS, NAMELY, MOUNTING ARMS FOR LIQUID CRYSTAL DISPLAYS, PLASMA DISPLAYS, AND CATHODE RAY TUBE DISPLAYS, AUDIO AND VIDEO CABLES AND CONNECTORS (U.S. CLS. 21, 23, 26, 36 AND 38).

CYNTHIA SLOAN, EXAMINING ATTORNEY

SN 77-268,714. MILESTONE AV TECHNOLOGIES LLC,
SAVAGE, MN. FILED 8-30-2007.

SANUS HD PRO

THE MARK CONSISTS OF STANDARD CHARACTERS WITHOUT CLAIM TO ANY PARTICULAR FONT, STYLE, SIZE, OR COLOR.

OWNER OF U.S. REG. NO. 2,674,634.

NO CLAIM IS MADE TO THE EXCLUSIVE RIGHT TO USE "HD", APART FROM THE MARK AS SHOWN.

FOR COMPONENTS FOR AUDIO AND VIDEO EQUIPMENT, NAMELY, MECHANICAL MOUNTING SYSTEMS, NAMELY, MOUNTING ARMS FOR LIQUID CRYSTAL DISPLAYS, PLASMA DISPLAYS, AND CATHODE RAY TUBE DISPLAYS, AUDIO AND VIDEO CABLES AND CONNECTORS (U.S. CLS. 21, 23, 26, 36 AND 38).

CYNTHIA SLOAN, EXAMINING ATTORNEY

CLASS 9—(Continued).

SN 77-276,115. METTLER-TOLEDO AG, GREIFENSEE,
SWITZERLAND, FILED 9-11-2007.

EASYMAX

THE MARK CONSISTS OF STANDARD CHARACTERS WITHOUT CLAIM TO ANY PARTICULAR FONT, STYLE, SIZE, OR COLOR.

PRIORITY CLAIMED UNDER SEC. 44(D) ON SWITZERLAND APPLICATION NO. 52893/2007, FILED 3-14-2007, REG. NO. 557972, DATED 5-1-2007, EXPIRES 3-14-2017.

FOR AUTOMATED EQUIPMENT AND PLANTS FOR LABORATORY APPLICATIONS AS FAR AS INCLUDED IN THIS CLASS, NAMELY, SOFTWARE FOR MEASURING OF PHYSICAL, CHEMICAL AND ANALYTICAL PROPERTIES FOR ENSURING SAFETY OF PRODUCTION PROCESSES, QUALITY OF PRODUCTS, PROFITABILITY OF THE PRODUCTION, OPTIMIZATION OF THE PRODUCTION PROCESS AND ENVIRONMENTAL COMPATIBILITY OF INDUSTRIAL PROCESS; LABORATORY REACTORS; LABORATORY ROBOTS; TRUE MODELS OF REACTORS FOR LABORATORY USE; ALL FOR MEASURING OF PHYSICAL, CHEMICAL AND ANALYTICAL PROPERTIES FOR ENSURING SAFETY OF PRODUCTION PROCESSES, QUALITY OF PRODUCTS, PROFITABILITY OF THE PRODUCTION, OPTIMIZATION OF THE PRODUCTION PROCESS AND ENVIRONMENTAL COMPATIBILITY OF INDUSTRIAL PROCESS AND REPLACEMENT PARTS THEREOF, NAMELY, LABORATORY VESSELS, SPECIFICALLY, TITRATOR PLATES, TEST TUBES, BEAKERS, FLASKS; GLASSWARE FOR SCIENTIFIC EXPERIMENTS; COMPUTER PROGRAMS FOR USE IN DATABASE MANAGEMENT AND IN THE FIELD OF LABORATORY REACTORS AND LABORATORY ROBOTS FOR OPERATING LABORATORY REACTORS AND ROBOTS, RECORDING DATA AND PROCESSING DATA; DATA PROCESSING DEVICES, NAMELY, DATA PROCESSORS, MOBILE DATA RECEIVERS, DATA SENDERS; ELECTRONIC CONTROLS FOR CONTROLLING LABORATORY REACTORS AND LABORATORY ROBOTS; DISPLAYS, NAMELY, LCD, LED, TFT, TOUCH SCREEN AND SCREEN PROJECTOR DISPLAYS; TEMPERATURE SENSORS; PRESSURE SENSORS; FLOW SENSORS; LIQUID LEVEL SENSORS; PH MEASUREMENT SENSORS; CONDUCTIVITY SENSORS; SENSORS USED IN LABORATORY REACTORS AND LABORATORY ROBOTS, NAMELY, ELECTRIC SENSORS, ELECTRONIC SENSORS, SPECTROSCOPIC SENSORS, AND INFRARED SENSORS FOR USE AS A PART OF THE LABORATORY REACTORS AND ROBOTS, SENSING PHYSICAL, CHEMICAL AND ANALYTICAL PROPERTIES FOR ENSURING SAFETY OF PRODUCTION PROCESSES, QUALITY OF PRODUCTS, PROFITABILITY OF THE PRODUCTION, OPTIMIZATION OF THE PRODUCTION PROCESS AND ENVIRONMENTAL COMPATIBILITY OF INDUSTRIAL PROCESS (U.S. CLS. 21, 23, 26, 36 AND 38).

TINA BROWN, EXAMINING ATTORNEY

CLASS 9—(Continued).

SN 77-292,891. ARISTOCRAT TECHNOLOGIES AUSTRALIA PTY LTD, NORTH RYDE, NSW, AUSTRALIA, FILED 10-1-2007.

KICK'N ASS

THE MARK CONSISTS OF STANDARD CHARACTERS WITHOUT CLAIM TO ANY PARTICULAR FONT, STYLE, SIZE, OR COLOR.

PRIORITY CLAIMED UNDER SEC. 44(D) ON AUSTRALIA APPLICATION NO. 1174076, FILED 5-3-2007, REG. NO. 1174076, DATED 5-3-2007, EXPIRES 5-3-2017.

FOR GAMING MACHINES AND SOFTWARE FOR GAMING PURPOSES (U.S. CLS. 21, 23, 26, 36 AND 38).
ESTHER BELENKER, EXAMINING ATTORNEY

SN 77-337,121. RATECH ELECTRONICS LIMITED, VAUGHAN, CANADA, FILED 11-26-2007.

GEL ROD

THE MARK CONSISTS OF STANDARD CHARACTERS WITHOUT CLAIM TO ANY PARTICULAR FONT, STYLE, SIZE, OR COLOR.

PRIORITY CLAIMED UNDER SEC. 44(D) ON CANADA APPLICATION NO. 1372192, FILED 11-15-2007.
SEC. 2(F).

FOR VIDEO CABLE USED FOR PIPE AND SEWER INSPECTION (U.S. CLS. 21, 23, 26, 36 AND 38).
FIRST USE 3-31-2002; IN COMMERCE 3-31-2002.
TRACY CROSS, EXAMINING ATTORNEY

SN 77-340,719. IGT, RENO, NV. FILED 11-30-2007.

WORLD SAFARI

THE MARK CONSISTS OF STANDARD CHARACTERS WITHOUT CLAIM TO ANY PARTICULAR FONT, STYLE, SIZE, OR COLOR.

FOR SLOT MACHINES; COMPUTER SOFTWARE AND FIRMWARE FOR GAMES OF CHANCE ON ANY COMPUTERIZED PLATFORM, INCLUDING DEDICATED GAMING CONSOLES, VIDEO BASED SLOT MACHINES, REEL BASED SLOT MACHINES, AND VIDEO LOTTERY TERMINALS (U.S. CLS. 21, 23, 26, 36 AND 38).
STEPHEN AQUILA, EXAMINING ATTORNEY

CLASS 9—(Continued).

SN 77-343,446. MICRORISC S.R.O., JIČÍN 50601, CZECH REPUBLIC, FILED 12-4-2007.

IQMESH

THE MARK CONSISTS OF STANDARD CHARACTERS WITHOUT CLAIM TO ANY PARTICULAR FONT, STYLE, SIZE, OR COLOR.

FOR ELECTRIC AND ELECTRONIC APPARATUS AND DEVICES ADAPTED FOR WIRELESS COMMUNICATION BY MEANS OF COMMUNICATION PROTOCOL, NAMELY, TRANSCEIVERS, RADIO MODEMS, HYBRID INTEGRATED CIRCUITS, WIRELESS OPTICAL DATA LINKS FOR THE RADIO FREQUENCY TRANSMISSION OF VOICE, DATA AND DATA TEXT SIGNALS FOR USE IN TELEMETRY AND HOME AND OFFICE AUTOMATION, AND DEVELOPMENT KITS FOR SUCH DEVICES, COMPRISED OF COMPUTER INTERFACE BOARDS; SOFTWARE FOR HOME AND OFFICE AUTOMATION FOR LIGHTING, HVAC, AND SECURITY SYSTEM MONITORY AND CONTROL APPLICATIONS (U.S. CLS. 21, 23, 26, 36 AND 38).

MARY BOAGNI, EXAMINING ATTORNEY

SN 77-352,131. FUSION GEOPHYSICAL, LLC, NORMAN, OK. FILED 12-14-2007.

BOOST

THE MARK CONSISTS OF STANDARD CHARACTERS WITHOUT CLAIM TO ANY PARTICULAR FONT, STYLE, SIZE, OR COLOR.

FOR DATA PROCESSING SOFTWARE FEATURE OF A GEOPHYSICAL SOFTWARE SUITE FOR APPLYING BLUE OPTIMIZATION BY ORTHOGONAL TRANSFORMS TO ANALYSIS OF SEISMIC DATA IN THE OIL AND GAS INDUSTRY (U.S. CLS. 21, 23, 26, 36 AND 38).
FIRST USE 7-31-2007; IN COMMERCE 9-27-2007.
PRISCILLA MILTON, EXAMINING ATTORNEY

CLASS 9—(Continued).

SN 77-368,313. 3DV SYSTEMS LTD., 20692 YOKNEAM ILIT, ISRAEL, FILED 1-10-2008.

ZCAM

THE MARK CONSISTS OF STANDARD CHARACTERS WITHOUT CLAIM TO ANY PARTICULAR FONT, STYLE, SIZE, OR COLOR.

PRIORITY CLAIMED UNDER SEC. 44(D) ON ISRAEL APPLICATION NO. 206459, FILED 12-3-2007, REG. NO. 206459, DATED 5-6-2009, EXPIRES 12-3-2017.

FOR CAMERAS; CAMERA COMPONENTS, NAMELY, LENSES, IMAGING SENSORS AND SEMICONDUCTOR CHIP SETS COMPRISED PRIMARILY OF SEMICONDUCTOR CHIPS, CIRCUIT BOARD ASSEMBLIES, AND INTEGRATED CIRCUITS (U.S. CLS. 21, 23, 26, 36 AND 38).

ESTHER A. BORSUK, EXAMINING ATTORNEY

CLASS 9—(Continued).

SN 77-405,317. FORWARD PROCUREMENT & LOGISTICS INC., JOHNSON CITY, TN. FILED 2-25-2008.

GREEN RAMP

THE MARK CONSISTS OF STANDARD CHARACTERS WITHOUT CLAIM TO ANY PARTICULAR FONT, STYLE, SIZE, OR COLOR.

NO CLAIM IS MADE TO THE EXCLUSIVE RIGHT TO USE "RAMP", APART FROM THE MARK AS SHOWN.

FOR TACTICAL GEAR AND TACTICAL EQUIPMENT FOR MILITARY, LAW ENFORCEMENT AND DEFENSE APPLICATIONS, NAMELY, PROTECTIVE CLOTHING COMPRISED OF GLOVES AND TACTICAL VESTS, PROTECTIVE EYEWEAR, PROTECTIVE SAFETY GOGGLES, PROTECTIVE HELMETS, BODY ARMOR (U.S. CLS. 21, 23, 26, 36 AND 38).

INGRID C. EULIN, EXAMINING ATTORNEY

SN 77-374,235. OCELOT ENGINEERING, INC., SAN BERNARDINO, CA. FILED 1-17-2008.

OCELOT

THE MARK CONSISTS OF STANDARD CHARACTERS WITHOUT CLAIM TO ANY PARTICULAR FONT, STYLE, SIZE, OR COLOR.

FOR MOTORCYCLE HELMETS, NAMELY, PROTECTIVE HELMETS FOR MOTORCYCLE RIDING AND RACING (U.S. CLS. 21, 23, 26, 36 AND 38).

FIRST USE 5-1-1993; IN COMMERCE 5-1-1993.

KATHLEEN LORENZO, EXAMINING ATTORNEY

SN 77-405,566. KELLY-MOORE PAINT COMPANY, INC., SAN CARLOS, CA. FILED 2-25-2008.

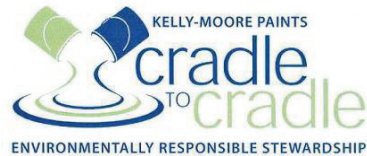

OWNER OF U.S. REG. NOS. 1,244,936, 2,711,280 AND OTHERS.

NO CLAIM IS MADE TO THE EXCLUSIVE RIGHT TO USE "ENVIRONMENTALLY RESPONSIBLE STEWARDSHIP"; "CRADLE TO CRADLE" AND "PAINTS", APART FROM THE MARK AS SHOWN.

THE COLOR(S) BLUE AND GREEN IS/ARE CLAIMED AS A FEATURE OF THE MARK.

THE MARK CONSISTS OF THE NAME "KELLY MOORE PAINTS" IN BLUE; THE WORDS "CRADLE TO CRADLE" IN BLUE AND THE SECOND "CRADLE" IN GREEN; THE NAME "ENVIRONMENTALLY RESPONSIBLE STEWARDSHIP" IN BLUE; AND TWO STYLIZED TILTED PAINT CANS SPILLING PAINT INTO A COMMON POOL WITH THE PAINT CAN ON THE LEFT AND ITS STREAM IN GREEN AND THE PAINT CAN ON THE RIGHT AND ITS STREAM IN BLUE.

FOR PRE-RECORDED AUDIO TAPES FEATURING INSTRUCTION ON DESIGNING AND ANALYZING COLOR SCHEMES FOR INTERIOR BUILDINGS, EXTERIOR BUILDINGS AND OTHER AREAS; AND COMPUTER SOFTWARE PROGRAMS RECORDED ON COMPACT DISCS FOR USE IN DESIGNING AND ANALYZING COLOR SCHEMES FOR INTERIOR BUILDINGS, EXTERIOR BUILDINGS AND OTHER AREAS (U.S. CLS. 21, 23, 26, 36 AND 38).

HENRY S. ZAK, EXAMINING ATTORNEY

SN 77-374,306. OCELOT ENGINEERING, INC., SAN BERNARDINO, CA. FILED 1-17-2008.

OCELOT

THE MARK CONSISTS OF STANDARD CHARACTERS WITHOUT CLAIM TO ANY PARTICULAR FONT, STYLE, SIZE, OR COLOR.

FOR PROTECTIVE MOTORCYCLE BOOTS AND PROTECTIVE MOTORCYCLE GLOVES FOR MOTORCYCLE RIDING AND RACING (U.S. CLS. 21, 23, 26, 36 AND 38).

FIRST USE 5-1-1993; IN COMMERCE 5-1-1993.

KATHLEEN LORENZO, EXAMINING ATTORNEY

CLASS 9—(Continued).

SN 77-406,370. SAKAR ACQUISITION L.L.C., EDISON, NJ. FILED 2-26-2008.

CLASS 9—(Continued).

SN 77-421,278. JR., GARCIA, FRANK, WALNUT, CA. FILED 3-13-2008.

WE MAKE IT EASY

THE MARK CONSISTS OF STANDARD CHARACTERS WITHOUT CLAIM TO ANY PARTICULAR FONT, STYLE, SIZE, OR COLOR.

FOR CAMERAS, DIGITAL CAMERAS, VIDEO CAMERAS, CAMERA PHONES, CAMERA STANDS AND TRIPODS, CAMERA LENSES AND FILTERS, TELESCOPES, AND CARRYING CASES FOR CAMERAS (U.S. CLS. 21, 23, 26, 36 AND 38).

FIRST USE 0-0-1988; IN COMMERCE 0-0-1988.
ANDREA SAUNDERS, EXAMINING ATTORNEY

SN 77-414,780. TERADYNE, INC, NORTH READING, MA. FILED 3-6-2008.

OpenFLEX Certified

THE MARK CONSISTS OF STANDARD CHARACTERS WITHOUT CLAIM TO ANY PARTICULAR FONT, STYLE, SIZE, OR COLOR.

NO CLAIM IS MADE TO THE EXCLUSIVE RIGHT TO USE "CERTIFIED", APART FROM THE MARK AS SHOWN.

FOR AUTOMATIC TEST SYSTEMS, EQUIPMENT AND COMPONENTS FOR ELECTRONIC DEVICES AND DATA NETWORKS, NAMELY, SEMICONDUCTOR CHIPS, PRINTED CIRCUIT BOARDS, ELECTRONIC ASSEMBLIES, AND DATA NETWORKS (U.S. CLS. 21, 23, 26, 36 AND 38).

CAROLYN CATALDO, EXAMINING ATTORNEY

SN 77-420,345. MEDIVOICE LLC, WHITE PLAINS, NY. FILED 3-12-2008.

MediVoice

THE MARK CONSISTS OF STANDARD CHARACTERS WITHOUT CLAIM TO ANY PARTICULAR FONT, STYLE, SIZE, OR COLOR.

FOR COMPUTER SOFTWARE, NAMELY, MOBILE WIRELESS VOICE INTERACTIVE SOFTWARE FOR WIRELESS CONTENT DELIVERY OF ELECTRONIC MEDICAL RECORDS AND OTHER ELECTRONIC HEALTHCARE APPLICATIONS, NAMELY, ELECTRONIC PRESCRIPTION PROCESSING (U.S. CLS. 21, 23, 26, 36 AND 38).

AISHA SALEM, EXAMINING ATTORNEY

Solar WindTracer System - Following the Trail of the Sun and Wind

THE MARK CONSISTS OF STANDARD CHARACTERS WITHOUT CLAIM TO ANY PARTICULAR FONT, STYLE, SIZE, OR COLOR.

NO CLAIM IS MADE TO THE EXCLUSIVE RIGHT TO USE "SOLAR" AND "SYSTEM", APART FROM THE MARK AS SHOWN.

FOR RENEWABLE GREEN ENERGY SYSTEM, NAMELY, A POWER GENERATION AND ELECTRICAL DISTRIBUTION SYSTEM, NAMELY, POWER DISTRIBUTION PANELS FEATURING AN AUTOMATED PROCESS CONTROL WITH MICRO-PROCESSOR BASED HARDWARE PRIMARILY CONSISTING OF SOLAR CELLS, INVERTERS, ELECTRONIC CIRCUITS TO CONVERT THE OUTPUTS FROM A DC OUTPUT LEVEL TO AN AC OUTPUT LEVEL AND COMPUTER OPERATING PROGRAMS THEREFOR ALL FOR UPLOADING AC ELECTRICITY TO A POWER GRID BY HARVESTING SOLAR AND WIND POWER (U.S. CLS. 21, 23, 26, 36 AND 38).

CHARISMA HAMPTON, EXAMINING ATTORNEY

CLASS 9—(Continued).

SN 77-432,109. MICROPHASE CORPORATION, NORWALK, CT. FILED 3-26-2008.

CLASS 9—(Continued).

SN 77-440,251. LINT SENTRY, LLC, VAN NUYS, CA. FILED 4-4-2008.



THE MARK CONSISTS OF AN OVAL WITH A DIAGONAL LINE DIVIDING THE OVAL INTO TWO SIDES. A DESIGN OF THE GREEK LETTER "MU" IS ON THE LEFT SIDE OF THE LINE IN THE OVAL AND A DESIGN OF THE GREEK LETTER "PHI" IS ON THE RIGHT SIDE OF THE LINE IN THE OVAL.

FOR ELECTRONIC AND MICROWAVE COMPONENTS AND SOLID STATE DEVICES, NAMELY, LOW PASS, HIGH PASS, BAND PASS, AND BAND REJECTION ELECTRICAL SIGNAL TRANSMISSION FILTERS FOR HIGH FREQUENCY, VERY HIGH FREQUENCY, ULTRA HIGH FREQUENCY AND MICROWAVE RANGES, INCLUDING THOSE FOR WAVEGUIDE AND COAXIAL PURPOSES; OPTICAL AND MICROWAVE CHANNEL FILTERS; MULTIPLEXERS; PRESELECTORS, NAMELY, RADIO FREQUENCY PRESELECTORS; RADIO FREQUENCY PROCESSING DEVICES, NAMELY, EQUALIZERS; POWER DIVIDERS IN THE NATURE OF SIGNAL SPLITTERS FOR ELECTRONIC APPARATUS; RADIO FREQUENCY MODULATORS; SIGNAL FREQUENCY MODULATORS FOR USE WITH TELECOMMUNICATIONS EQUIPMENT; CONVERTERS FOR CONVERTING FREQUENCIES BOTH UP AND DOWN; FREQUENCY MULTIPLIERS; DETECTORS FOR RADIO FREQUENCIES; DETECTOR LOG VIDEO AMPLIFIERS, THRESHOLD DETECTORS FOR DETECTING RADIO FREQUENCIES; AMPLIFIERS; PRE-AMPLIFIERS; ELECTRONIC AND MICROWAVE COMPONENTS FOR TELECOMMUNICATIONS EQUIPMENT, NAMELY, DIRECTIONAL COUPLERS; DIODE SWITCHES; TELEMETRY CONVERTERS; AND MICROWAVE RECEIVERS (U.S. CLS. 21, 23, 26, 36 AND 38). FIRST USE 11-23-1954; IN COMMERCE 11-23-1954.

MAUREEN DALL, EXAMINING ATTORNEY



NO CLAIM IS MADE TO THE EXCLUSIVE RIGHT TO USE "LINT", APART FROM THE MARK AS SHOWN.

THE COLOR(S) BLUE, YELLOW, GREEN IS/ARE CLAIMED AS A FEATURE OF THE MARK.

THE MARK CONSISTS OF THE WORD "LINT" IN BLUE WITH THE WORD "SENTRY" ALSO IN BLUE DIRECTLY BELOW THE WORD "LINT" WITH BOTH WORDS SUPERIMPOSED OVER A YELLOW SQUARE SET ON AN ANGLE. A SHADED GREEN CIRCLE DIRECTLY OVER THE "I" IN THE WORD "LINT" WHICH SERVES AS THE DOT OF THE "I".

FOR AN ACCESSORY IN THE NATURE OF AN ELECTRONIC SENSOR FOR DETECTING LINT INSIDE A CLOTHES DRYER (U.S. CLS. 21, 23, 26, 36 AND 38).

SHANNON TWOHIG, EXAMINING ATTORNEY

SN 77-460,454. CDC SOFTWARE CORPORATION, ATLANTA, GA. FILED 4-29-2008.

CDC SUPPLY CHAIN

THE MARK CONSISTS OF STANDARD CHARACTERS WITHOUT CLAIM TO ANY PARTICULAR FONT, STYLE, SIZE, OR COLOR.

NO CLAIM IS MADE TO THE EXCLUSIVE RIGHT TO USE "SUPPLY CHAIN", APART FROM THE MARK AS SHOWN.

FOR COMPUTER SOFTWARE, NAMELY, APPLICATIONS FOR WHOLESALE, RETAIL, AND MANUFACTURING DISTRIBUTION COMPANIES TO PRIMARILY OPTIMIZE AND MANAGE ORDER FULFILLMENT AND REPLENISHMENT PROCESSES AND INITIATE THE TRANSPORTATION THEREOF (U.S. CLS. 21, 23, 26, 36 AND 38).

MAYUR VAGHANI, EXAMINING ATTORNEY

CLASS 9—(Continued).

SN 77-460,702. R2AD, LLC, FALLS CHURCH, VA. FILED 4-29-2008.

R2AD

THE MARK CONSISTS OF STANDARD CHARACTERS WITHOUT CLAIM TO ANY PARTICULAR FONT, STYLE, SIZE, OR COLOR.

FOR COMPUTER HARDWARE; COMPUTER SOFTWARE FOR CONTROLLING AND MANAGING ACCESS SERVER APPLICATIONS; COMPUTER SOFTWARE FOR CONTROLLING ENTITIES IN GEOSPATIAL SYSTEMS, NAMELY, SOFTWARE WHICH TRACKS VEHICLES, PERSONS, SUPPLIES, WHICH ARE THEN CORRELATED AND DISPLAYED IN TABULAR, TEXTUAL, CHARTS, OR GRAPHICAL SYMBOLIC FORMS ON A MAP AND GRAPHICAL USER INTERFACES TO PROVIDE INVENTORY, SITUATIONAL AWARENESS, STATUS, AND BUSINESS ANALYSIS (U.S. CLS. 21, 23, 26, 36 AND 38).

FIRST USE 5-1-2004; IN COMMERCE 5-1-2004.
JIM RINGLE, EXAMINING ATTORNEY

CLASS 9—(Continued).

SN 77-469,788. DAVIS INSTRUMENTS, HAYWARD, CA. FILED 5-8-2008.

WEATHER WIZARD

THE MARK CONSISTS OF STANDARD CHARACTERS WITHOUT CLAIM TO ANY PARTICULAR FONT, STYLE, SIZE, OR COLOR.

NO CLAIM IS MADE TO THE EXCLUSIVE RIGHT TO USE "WEATHER", APART FROM THE MARK AS SHOWN.

FOR WEATHER MEASURING APPARATUS; NAMELY, INSTRUMENTS FOR MEASURING INDOOR AND OUTDOOR TEMPERATURE AND HUMIDITY, WIND SPEED AND DIRECTION, RAIN AND BAROMETRIC PRESSURE; COMPUTER SOFTWARE AND INSTRUCTION MANUAL SOLD THEREWITH FOR OBTAINING, ANALYZING, AND GRAPHING WEATHER RELATED DATA (U.S. CLS. 21, 23, 26, 36 AND 38).

FIRST USE 9-0-1991; IN COMMERCE 9-0-1991.
CHRISIE B. KING, EXAMINING ATTORNEY

SN 77-464,179. LUCIMA PTY LTD, NORTH SYDNEY, AUSTRALIA, FILED 5-2-2008.

SLEEP NURSE

THE MARK CONSISTS OF STANDARD CHARACTERS WITHOUT CLAIM TO ANY PARTICULAR FONT, STYLE, SIZE, OR COLOR.

OWNER OF AUSTRALIA REG. NO. 1149370, DATED 11-29-2006, EXPIRES 11-29-2016.

NO CLAIM IS MADE TO THE EXCLUSIVE RIGHT TO USE "SLEEP", APART FROM THE MARK AS SHOWN.

FOR APPARATUS FOR RECORDING, TRANSMISSION OR REPRODUCTION OF SOUND OR IMAGES (U.S. CLS. 21, 23, 26, 36 AND 38).

MELISSA VALLILLO, EXAMINING ATTORNEY

SN 77-476,853. EQUIPEMENTS COMACT INC./COMACT EQUIPMENT INC., CANTON TREMBLAY, QUEBEC, CANADA, FILED 5-16-2008.

EDGEXPERT

THE MARK CONSISTS OF STANDARD CHARACTERS WITHOUT CLAIM TO ANY PARTICULAR FONT, STYLE, SIZE, OR COLOR.

PRIORITY CLAIMED UNDER SEC. 44(D) ON CANADA APPLICATION NO. 1373170, FILED 11-22-2007, REG. NO. TMA739529, DATED 5-6-2009, EXPIRES 5-6-2024.

FOR ELECTRONIC VISION SYSTEM COMPRISING SCANNERS, OPTIC DISCS, INDUSTRIAL COMPUTERS, ENCODERS AND SOFTWARE APPLIED TO EDGING OPERATION IN THE LUMBER AND THE SAWMILL INDUSTRY (U.S. CLS. 21, 23, 26, 36 AND 38).

PAUL F. GAST, EXAMINING ATTORNEY

CLASS 9—(Continued).

SN 77-478,160. KAI RONG INDUSTRIAL CO., LTD., TAIPEI COUNTY, TAIWAN, FILED 5-19-2008.

CLASS 9—(Continued).

SN 77-478,186. KAI RONG INDUSTRIAL CO., LTD., TAIPEI COUNTY, TAIWAN, FILED 5-19-2008.

magi mags



NO CLAIM IS MADE TO THE EXCLUSIVE RIGHT TO USE "MAGS", APART FROM THE MARK AS SHOWN.

THE MARK CONSISTS OF THE WORDS MAGI MAGS. FOR ENCODED MAGNETIC CARDS; DEMAGNETIZING APPARATUS FOR MAGNETIC TAPES; ELECTROMAGNETIC COILS; ELECTRONIC TAGS FOR GOODS; MAGNETICALLY ENCODED IDENTIFICATION BRACELETS; MAGNETIC ENCODERS; PROTECTIVE FACE-SHIELDS FOR WORKERS; MAGNETIC IDENTITY CARDS; LEVEL MEASURING MACHINES; TRAFFIC LIGHTS; BLANK MAGNETIC COMPUTER TAPES; MAGNETIC WIRES; MAGNETS; DECORATIVE MAGNETS; OPTICS IN THE NATURE OF OPTIC LENS; MATHEMATICAL INSTRUMENTS, NAMELY, CALCULATORS AND ABACUSES; MEASURING APPARATUS, NAMELY, COMPASSES, TAPER GAUGES, PROTRACTORS, AND DIGITAL PROTRACTORS; MOUSE PADS; LUMINOUS OR MECHANICAL ROAD SIGNS; MEASURING INSTRUMENTS, NAMELY, GRADUATED RULERS, AND MEASURING TAPES; SMART CARDS IN THE NATURE OF INTEGRATED CIRCUIT CARDS; TEACHING APPARATUS, NAMELY, MEDICAL TEACHING MANNEQUINS; SAFETY PRODUCTS, NAMELY, REFLECTING DISCS TO BE WORN FOR THE PREVENTION OF TRAFFIC ACCIDENTS; VEHICLE BREAK-DOWN WARNING TRIANGLES; VIDEO SCREENS (U.S. CLS. 21, 23, 26, 36 AND 38).

COLLEEN DOMBROW, EXAMINING ATTORNEY

THE COLOR(S) BLACK AND GRAY IS/ARE CLAIMED AS A FEATURE OF THE MARK.

THE MARK CONSISTS OF THE NUMBER 3 WITH THE + SYMBOL AT THE UPPER RIGHT, BOTH IN SHADES OF THE COLOR GRAY ENCLOSED WITH A BLACK BORDER. FOR ENCODED MAGNETIC CARDS; DEMAGNETIZING APPARATUS FOR MAGNETIC TAPES; ELECTROMAGNETIC COILS; ELECTRONIC TAGS FOR GOODS; MAGNETICALLY ENCODED IDENTIFICATION BRACELETS; MAGNETIC ENCODERS; PROTECTIVE FACE-SHIELDS FOR WORKERS; MAGNETIC IDENTITY CARDS; LEVEL MEASURING MACHINES; TRAFFIC LIGHTS; BLANK MAGNETIC COMPUTER TAPES; MAGNETIC WIRES; MAGNETS; DECORATIVE MAGNETS; OPTICS IN THE NATURE OF OPTIC LENS; MATHEMATICAL INSTRUMENTS, NAMELY, CALCULATORS AND ABACUSES; MEASURING APPARATUS, NAMELY, COMPASSES, TAPER GAUGES, PROTRACTORS, AND DIGITAL PROTRACTORS; MOUSE PADS; LUMINOUS OR MECHANICAL ROAD SIGNS; MEASURING INSTRUMENTS, NAMELY, GRADUATED RULERS, AND MEASURING TAPES; SMART CARDS IN THE NATURE OF INTEGRATED CIRCUIT CARDS; TEACHING APPARATUS, NAMELY, MEDICAL TEACHING MANNEQUINS; SAFETY PRODUCTS, NAMELY, REFLECTING DISCS TO BE WORN FOR THE PREVENTION OF TRAFFIC ACCIDENTS; VEHICLE BREAK-DOWN WARNING TRIANGLES; VIDEO SCREENS (U.S. CLS. 21, 23, 26, 36 AND 38).

COLLEEN DOMBROW, EXAMINING ATTORNEY

CLASS 9—(Continued).

SN 77-480,198. WATERS TECHNOLOGIES CORPORATION, WILMINGTON, DE. FILED 5-21-2008.

TRIZAIC

THE MARK CONSISTS OF STANDARD CHARACTERS WITHOUT CLAIM TO ANY PARTICULAR FONT, STYLE, SIZE, OR COLOR.

FOR ANALYTICAL EQUIPMENT FOR PERFORMING PHYSICAL, BIOLOGICAL AND CHEMICAL SEPARATIONS, MEASUREMENT, SCREENING, ANALYSIS AND IDENTIFICATION, NAMELY, SYSTEMS OF LIQUID CHROMATOGRAPHY APPARATUS COMPRISING PUMPS, AUTOSAMPLERS, FILTERS, OPTICAL DETECTORS AND OPERATING SOFTWARE FOR USE THEREWITH; SCIENTIFIC APPARATUS, NAMELY, LIQUID CHROMATOGRAPHY APPARATUS AND MASS SPECTROMETERS AND THEIR COMPONENTS PARTS AND OPERATIONAL SOFTWARE FOR USE THEREWITH (U.S. CLS. 21, 23, 26, 36 AND 38).

STEVEN PEREZ, EXAMINING ATTORNEY

SN 77-485,917. URBACH, JULIAN M., SHERMAN OAKS, CA. FILED 5-29-2008.

OTOY

THE MARK CONSISTS OF STANDARD CHARACTERS WITHOUT CLAIM TO ANY PARTICULAR FONT, STYLE, SIZE, OR COLOR.

THE MARK "OTOY" HAS NO MEANING IN A FOREIGN LANGUAGE.

FOR COMPUTER SOFTWARE IN THE FIELD OF ARTIFICIAL INTELLIGENCE PROVIDING END USERS WITH AN INTELLIGENT ARTIFICIAL INTELLIGENCE AGENT CAPABLE OF INFORMATION RETRIEVAL, ANSWERING NOVEL AND ARBITRARY QUESTIONS, AND MANAGEMENT OF SOFTWARE OR COMPUTATION TASKS; COMPUTER SEARCH ENGINE SOFTWARE; COMPUTER SOFTWARE, NAMELY, WEB BASED OPERATING SYSTEM PROGRAMS; COMPUTER HARDWARE FOR ROBOTICS AND SOFTWARE FOR CONTROLLING THE MOVEMENTS OF ROBOTS AND FOR ROBOT ANIMATIONS, AND FOR PROGRAMMING ROBOT ANIMATIONS; COMPUTER SOFTWARE PROGRAM PROVIDING A NATURAL LANGUAGE PARSER SYSTEM FOR USE AS AN INTELLIGENT SEARCH AGENT; COMPUTER SOFTWARE PROGRAMS PROVIDING FOR THE REMOTE SERVING OF COMPUTER PROGRAMS; HANDHELD MOBILE DIGITAL ELECTRONIC DEVICES FOR THE SENDING AND RECEIVING OF TELEPHONE CALLS, ELECTRONIC MAILS, AND OTHER DIGITAL DATA, FOR USE AS A DIGITAL FORMAT AUDIO PLAYER, AND FOR USE AS A HANDHELD MOBILE DIGITAL ELECTRONIC DEVICES FOR THE SENDING AND RECEIVING OF TELEPHONE CALLS, ELECTRONIC MAILS, AND OTHER DIGITAL DATA, FOR USE AS A DIGITAL FORMAT AUDIO PLAYER, AND FOR USE AS A HANDHELD COMPUTER, PERSONAL DIGITAL ASSISTANT, ELECTRONIC ORGANIZER, ELECTRONIC NOTEPAD, AND CAMERA (U.S. CLS. 21, 23, 26, 36 AND 38).

AMOS T. MATTHEWS, JR., EXAMINING ATTORNEY

CLASS 9—(Continued).

SN 77-499,840. NATURAL ARTS MEDIA LLC, SPRING VALLEY, CA. FILED 6-16-2008.



NO CLAIM IS MADE TO THE EXCLUSIVE RIGHT TO USE "ARTS MEDIA LLC", APART FROM THE MARK AS SHOWN.

THE COLOR(S) BLACK, GREEN, PURPLE, WHITE, BLUE AND YELLOW IS/ARE CLAIMED AS A FEATURE OF THE MARK.

THE MARK CONSISTS OF A DESIGN OF A PURPLE MOVIE CAMERA TO THE LEFT OF A BLACK PALM TREE WITH GREEN LEAVES ON A BLUE BACK GROUND WITH TWO YELLOW AND WHITE CONCENTRIC CIRCLES AND THREE STAGGERED BLACK LINES THROUGH IT ABOVE THE FADED BLACK WORD "NATURAL" OVER A BLUE "ARTS MEDIA LLC".

FOR DIGITAL MEDIA, NAMELY, PRE-RECORDED VIDEO CASSETTES, DIGITAL VIDEO DISCS, DIGITAL VERSATILE DISCS, DOWNLOADABLE AUDIO AND VIDEO RECORDINGS, DVDS, AND HIGH DEFINITION DIGITAL DISKS FEATURING AUDIO AND VIDEO NATURE SCENES (U.S. CLS. 21, 23, 26, 36 AND 38).

FIRST USE 2-0-2008; IN COMMERCE 2-0-2008.

JASON TURNER, EXAMINING ATTORNEY

SN 77-500,435. JAE HYUNG LEE, JUNG-GU, DAEJEON, REPUBLIC OF KOREA, FILED 6-17-2008.



PRIORITY CLAIMED UNDER SEC. 44(D) ON REPUBLIC OF KOREA APPLICATION NO. 402008002223, FILED 5-8-2008.

OWNER OF REPUBLIC OF KOREA REG. NO. 0782702, DATED 3-13-2009, EXPIRES 3-13-2019.

THE COLOR(S) WHITE, YELLOW, GOLD, PINK, BLUE, GREEN, BLACK, PURPLE, BROWN, BEIGE AND LAVENDER IS/ARE CLAIMED AS A FEATURE OF THE MARK.

THE MARK CONSISTS OF A WOMAN NEXT TO THE WORDS "MY GODDESS" ON A RECTANGULAR BACKGROUND WITH SPARKLES AND A DECORATIVE BORDER. THE COLOR GOLD APPEARS IN THE MARK AS THE COLOR OF THE WOMAN'S NECKLACE AND THE BEADS AROUND HER HEAD. THE COLOR YELLOW APPEARS IN THE MARK AS THE COLOR OF SOME OF THE TINY, SPARKLING CIRCLES FOUND ON THE BACKGROUND OF THE MARK. THE COLOR PINK APPEARS AS THE COLOR OF SOME THE TINY, SPARKLING CIRCLES ON THE BACKGROUND AS WELL AND AS THE COLOR OF THE WORDING "MY GODDESS". THE COLOR BLUE APPEARS IN THE MARK AS THE COLOR OF SOME OF THE TINY, SPARKLING CIRCLES ON THE BACKGROUND OF THE MARK, AND AS OUTLINING AROUND THE WORDS "MY GODDESS". THE COLOR GREEN

CLASS 9—(Continued).

APPEARS AS THE COLOR IN THE CENTER OF THE RECTANGULAR BACKGROUND. THE COLOR BLACK APPEARS AS THE COLOR TO THE RIGHT AND LEFT OF THE GREEN COLOR ON THE RECTANGULAR BACKGROUND OF THE MARK. THE COLOR PURPLE APPEARS AS THE TRIM AROUND THE LETTERS IN THE WORDING OF THE MARK. THE COLOR BROWN APPEARS IN THE MARK AS THE COLOR OF THE WOMAN'S/GODDESS' HAIR. THE COLOR BEIGE APPEARS IN THE MARK AS THE COLOR OF THE SKIN OF THE WOMAN/GODDESS AND AS THE COLOR OF THE BORDER AROUND THE RECTANGULAR BACKGROUND. THE COLOR LAVENDER APPEARS AS THE COLOR OF THE CLOTHING WORN BY THE WOMAN/GODDESS. THE COLOR WHITE APPEARS IN THE MARK AS THE CENTERS AND SPARKLES OF SOME OF THE TINY, SPARKLING CIRCLES ON THE BACKGROUND OF THE MARK, AND AS SPARKLES AND OUTLINING FOR THE WORDS "MY GODDESS".

FOR SLOT MACHINES (U.S. CLS. 21, 23, 26, 36 AND 38).

JAMES MACFARLANE, EXAMINING ATTORNEY

CLASS 9—(Continued).

SN 77-500,472. JAE HYUNG LEE, JUNG-GU, DAEJEON, REPUBLIC OF KOREA, FILED 6-17-2008.



SN 77-500,445. JAE HYUNG LEE, JUNG-GU, DAEJEON, REPUBLIC OF KOREA, FILED 6-17-2008.



PRIORITY CLAIMED UNDER SEC. 44(D) ON REPUBLIC OF KOREA APPLICATION NO. 402008002222, FILED 5-8-2008.

OWNER OF REPUBLIC OF KOREA REG. NO. 0782701, DATED 3-13-2009, EXPIRES 3-13-2019.

NO CLAIM IS MADE TO THE EXCLUSIVE RIGHT TO USE "MULTI-LEVEL PROGRESSIVE JACKPOT", APART FROM THE MARK AS SHOWN.

THE COLOR(S) WHITE, BLACK, GRAY, YELLOW, GREEN, GOLD AND RED IS/ARE CLAIMED AS A FEATURE OF THE MARK.

THE MARK CONSISTS OF THE WORDS "RICH GARDEN MULTI-LEVEL PROGRESSIVE JACKPOT" WITH A WING AFTER THE LETTER "N", ON A STARRY BACKGROUND WITH A PARTIAL BORDER. THE COLOR WHITE APPEARS IN THE MARK AS THE COLOR OF THE STARS AND THE COLOR OF THE WORDING "MULTI-LEVEL PROGRESSIVE JACKPOT". THE COLOR BLACK APPEARS AS THE COLOR OF PORTIONS OF THE BACKGROUND COLOR OF THE MARK. THE COLOR GRAY APPEARS IN THE MARK AS PORTIONS OF THE BACKGROUND COLOR OF THE MARK AND AS THE COLOR OF THE VINE BORDER AROUND THE TOP AND SIDES OF THE BACKGROUND OF THE MARK. THE COLOR YELLOW APPEARS IN THE MARK AS THE COLOR OF THE CENTER OF THE LETTERS IN THE WORDING "RICH GARDEN" AND AS THE COLOR OF A PORTION OF THE WING AT THE END OF THE WORD "GARDEN". THE COLOR GREEN APPEARS AS THE COLOR OF THE TOP AND BOTTOM OF THE LETTERS IN THE WORDING "RICH GARDEN". THE COLOR GOLD APPEARS IN THE MARK AS THE COLOR OF THE WING AT THE END OF THE WORD "GARDEN" AND AS THE COLOR OF THE TRIM AROUND LETTERS IN THE WORDING "RICH GARDEN". THE COLOR RED APPEARS IN THE MARK AS PORTIONS OF THE SCROLL AT THE BOTTOM OF THE LETTER "R", IN THE WORDING "RICH", AND IN THE WING.

FOR SLOT MACHINES (U.S. CLS. 21, 23, 26, 36 AND 38).

JAMES MACFARLANE, EXAMINING ATTORNEY

PRIORITY CLAIMED UNDER SEC. 44(D) ON REPUBLIC OF KOREA APPLICATION NO. 402008002223, FILED 5-8-2008.

OWNER OF REPUBLIC OF KOREA REG. NO. 0782704, DATED 3-13-2009, EXPIRES 3-13-2019.

THE COLOR(S) BLACK, BLUE, LIGHT BLUE, GREEN, YELLOW, ORANGE, RED, AND WHITE IS/ARE CLAIMED AS A FEATURE OF THE MARK.

THE MARK CONSISTS OF THE WORDS "BLUE BLUE" NEXT TO A SPACE MOBILE WITH ARMS CONTAINING A PILOT, BOTH IN FRONT OF A RAINBOW OVAL WITH LINES RADIATING FROM THE EDGE OF THE OVAL. THE COLOR BLUE APPEARS IN THE MARK AS THE COLOR OF THE BACKGROUND, THE COLOR OF THE OUTER BORDER OF THE OVAL, AS PART OF THE COLOR OF THE WORDING "BLUE BLUE", AS THE HELMET OF THE SPACE MOBILE PILOT, AND AS PORTIONS OF THE SMALL BUBBLES AROUND THE WORDING AND ON THE BACKGROUND. THE COLOR LIGHT BLUE APPEARS IN THE MARK AS THE COLOR OF THE OVAL NEXT TO THE OUTER BLUE OVAL, AS PART OF THE COLOR OF THE WORDING "BLUE BLUE", AND AS PORTIONS OF THE SMALL BUBBLES AROUND THE WORDING AND ON THE BACKGROUND. THE COLOR BLUE APPEARS IN THE MARK AGAIN AS THE COLOR OF THE INNER OVAL NEXT TO THE LIGHT BLUE OVAL. THE COLOR GREEN APPEARS AS THE COLOR OF THE OVAL NEXT TO THE INNER BLUE OVAL, AS A PORTION OF THE SPACE MOBILE AND ITS ARMS, AS OUTLINING OF THE WORDS "BLUE BLUE", AS THE SHIRT AND FACE OF THE SPACE MOBILE PILOT, AND AS DOTS ON THE INSTRUMENTATION INSIDE THE SPACE MOBILE. THE COLOR YELLOW APPEARS AS THE COLOR OF THE INNER OVAL NEXT TO THE GREEN OVAL AND AS THE COLOR OF THE SPACE MOBILE, AS WELL AS THE COLOR OF THE BORDER AROUND THE LETTERS IN THE WORDING OF THE MARK. THE COLOR ORANGE APPEARS AS THE COLOR OF THE INNER OVAL NEXT TO THE YELLOW OVAL AND AS THE EYES, MOUTH AND A DOT ON THE HEAD OF THE SPACE MOBILE PILOT. THE COLOR RED APPEARS AS THE COLOR OF THE CENTER OF THE OVALS. THE COLOR WHITE APPEARS AS THE COLOR OF THE RAYS SHOOTING OUT OF THE OVAL ONTO THE BLUE BACKGROUND, AS THE COLOR OF THE EARS ON TOP OF THE SPACE MOBILE, AS THE COLOR OF THE HANDS ON THE ARMS OF THE SPACE MOBILE, AS PART OF THE INSTRUMENTATION INSIDE THE SPACE MOBILE, AND AS PORTIONS OF THE SMALL BUBBLES AROUND THE WORDING AND ON THE BACKGROUND. THE COLOR BLACK APPEARS AS SOME OF THE INSTRUMENTATION INSIDE THE SPACE MOBILE, AND AS PART OF THE BODY UNDER THE WING OF THE SPACE MOBILE.

FOR SLOT MACHINES (U.S. CLS. 21, 23, 26, 36 AND 38).

JAMES MACFARLANE, EXAMINING ATTORNEY

CLASS 9—(Continued).

SN 77-500,577. JAE HYUNG LEE, JUNG-GU, DAEJEON, REPUBLIC OF KOREA, FILED 6-17-2008.



PRIORITY CLAIMED UNDER SEC. 44(D) ON REPUBLIC OF KOREA APPLICATION NO. 402008002223, FILED 5-8-2008.

OWNER OF REPUBLIC OF KOREA REG. NO. 0782703, DATED 3-13-2009, EXPIRES 3-13-2019.

THE COLOR(S) BLACK, GRAY, GOLD, WHITE AND YELLOW IS/ARE CLAIMED AS A FEATURE OF THE MARK.

THE MARK CONSISTS OF THE WORDS "WHAT A GOLD" ON A DECORATIVE BACKGROUND. THE COLOR BLACK APPEARS IN THE MARK AS A PORTION OF THE BACKGROUND AND AS OUTLINING ON THE WORDING "WHAT A GOLD". THE COLOR GRAY ALSO APPEARS AS A PORTION OF THE BACKGROUND. THE COLOR GOLD APPEARS IN THE MARK AS A PORTION OF THE COLOR OF THE WORDING "WHAT A GOLD", AND AS A PORTION OF THE COLOR OF THE DESIGN GOING THROUGHOUT THE BACKGROUND OF THE MARK. THE COLOR WHITE APPEARS IN THE MARK AS THE COLOR OF THE LITTLE DOTS FOUND ON THE BACKGROUND, AS A PORTION OF THE DESIGN ON THE BACKGROUND, AND AS A PORTION OF THE WORDING "WHAT A GOLD". THE COLOR YELLOW APPEARS IN THE MARK AS A PORTION OF THE COLOR OF THE LETTERS "WHAT A GOLD".

FOR SLOT MACHINES (U.S. CLS. 21, 23, 26, 36 AND 38).

JAMES MACFARLANE, EXAMINING ATTORNEY

SN 77-509,436. POWERTRAVELLER LIMITED, ALTON HAMPSHIRE, ENGLAND, FILED 6-26-2008.

POWER GORILLA

THE MARK CONSISTS OF STANDARD CHARACTERS WITHOUT CLAIM TO ANY PARTICULAR FONT, STYLE, SIZE, OR COLOR.

NO CLAIM IS MADE TO THE EXCLUSIVE RIGHT TO USE "POWER", APART FROM THE MARK AS SHOWN.

FOR APPARATUSES FOR RECORDING, TRANSMITTING OR REPRODUCING SOUNDS OR IMAGES; BLANK MAGNETIC DATA CARRIERS; MODEMS; TELEPHONE CONNECTIONS, NAMELY, PLUGS AND SOCKETS; TELEPHONE APPARATUSES; LAP TOP COMPUTERS; BATTERIES; BATTERY CHARGERS; ELECTRIC CABLES; COMPUTERS AND COMPUTER PERIPHERAL DEVICES; ENCODERS; PORTABLE TELEPHONES; TRANSMITTERS OF ELECTRONIC SIGNALS; TELECOMMUNICATION TRANSMITTERS; ELECTRIC TERMINALS, NAMELY, TELEPHONE TERMINALS (U.S. CLS. 21, 23, 26, 36 AND 38).

ANGELA DUONG, EXAMINING ATTORNEY

CLASS 9—(Continued).

SN 77-513,140. MAASLAND N.V., 3147 PA MAASLUIS, NETHERLANDS, FILED 7-2-2008.

HUBBLE

THE MARK CONSISTS OF STANDARD CHARACTERS WITHOUT CLAIM TO ANY PARTICULAR FONT, STYLE, SIZE, OR COLOR.

OWNER OF U.S. REG. NO. 2,673,425.

SEC. 2(F).

FOR MEASURING, REGULATING, CONTROL, AND MONITORING SENSORS FOR USE IN CONNECTION WITH THE QUALITY CONTROL OF MILK PRODUCTION, CLEANING, AND STORAGE PROCESSES. ELECTRONIC HARDWARE AND SOFTWARE FOR PROCESSING, STORING, AND PRESENTING DATA IN CONNECTION WITH THE AFOREMENTIONED GOODS (U.S. CLS. 21, 23, 26, 36 AND 38).

FIRST USE 10-31-2002; IN COMMERCE 12-31-2003.

INGA ERVIN, EXAMINING ATTORNEY

SN 77-514,356. TOURNAMENT ONE CORP, STAMFORD, CT. FILED 7-3-2008.

Tug Fu War

THE MARK CONSISTS OF STANDARD CHARACTERS WITHOUT CLAIM TO ANY PARTICULAR FONT, STYLE, SIZE, OR COLOR.

FOR COMPUTER GAME SOFTWARE; COMPUTER GRAPHICS SOFTWARE; ELECTRONIC GAME SOFTWARE; ELECTRONIC GAME SOFTWARE FOR CELLULAR TELEPHONES; ELECTRONIC INTERACTIVE BOARD GAMES FOR USE WITH EXTERIOR MONITOR, ELECTRONIC GAME SOFTWARE FOR HANDHELD ELECTRONIC DEVICES; ELECTRONIC GAME SOFTWARE FOR WIRELESS DEVICES; ELECTRONIC GAME SOFTWARE, NAMELY, AN ELECTRONIC CRAPS GAME; ELECTRONIC GAME SOFTWARE, NAMELY, AN ELECTRONIC VIDEO CRAPS GAME; GAME SOFTWARE; GAMING SOFTWARE THAT GENERATES OR DISPLAYS WAGER OUTCOMES OF GAMING MACHINES; INTERACTIVE VIDEO GAMES OF VIRTUAL REALITY COMPRISED OF COMPUTER HARDWARE AND SOFTWARE; VIRTUAL REALITY GAME SOFTWARE; VIDEO GAME SOFTWARE; VIDEO GAME SOFTWARE, NAMELY, A VIDEO CRAPS GAME; INTERACTIVE COMPUTER KIOSKS COMPRISING COMPUTERS, COMPUTER HARDWARE, COMPUTER PERIPHERALS, AND COMPUTER OPERATING SOFTWARE, FOR USE AS GAMBLING AND GAMING MACHINES IN CASINOS, GAMING, LOTTERY, KENO; DOWNLOADABLE SOFTWARE FOR GAMES, CASINO GAMES, GAMING MACHINES, VIDEO LOTTERY TERMINALS AND KENO; DOWNLOADABLE SOFTWARE FOR COMPUTER SOFTWARE AND FIRMWARE FOR GAMES OF CHANCE ON ANY COMPUTERIZED PLATFORM, INCLUDING DEDICATED GAMING CONSOLES, VIDEO BASED SLOT MACHINES, REEL BASED SLOT MACHINES, AND VIDEO LOTTERY TERMINALS; COMPUTER SOFTWARE FOR USE IN RELATION TO DIGITAL ANIMATION AND SPECIAL EFFECTS OF IMAGES; GAMBLING MACHINES; VIRTUAL REALITY GAME SOFTWARE FOR CASINOS, GAMING, LOTTERY AND KENO (U.S. CLS. 21, 23, 26, 36 AND 38).

BERYL GARDNER, EXAMINING ATTORNEY

CLASS 9—(Continued).

SN 77-515,954. ICOP DIGITAL, INC., LENEXA, KS. FILED 7-7-2008.

ICOP LIVE

THE MARK CONSISTS OF STANDARD CHARACTERS WITHOUT CLAIM TO ANY PARTICULAR FONT, STYLE, SIZE, OR COLOR.

OWNER OF U.S. REG. NOS. 3,059,261, 3,060,613 AND OTHERS.

NO CLAIM IS MADE TO THE EXCLUSIVE RIGHT TO USE "LIVE", APART FROM THE MARK AS SHOWN.

FOR INTEGRATED ELECTRONIC HARDWARE AND SOFTWARE TECHNOLOGIES FOR STREAMING AUDIO AND VIDEO TO PROVIDE SURVEILLANCE, SITUATIONAL AWARENESS, AND COMMUNICATION, NAMELY, MOBILE AND ON-SITE ELECTRONIC SURVEILLANCE SYSTEMS WITH AUDIO AND VIDEO MONITORING AND RECORDING FEATURES COMPRISED OF VIDEO CAMERAS AND MICROPHONES AND WIRELESS ACCESS POINT DEVICES FOR ACCESS TO A GLOBAL COMPUTER NETWORK IN THE FIELDS OF WAREHOUSES, OFFICE BUILDINGS, RESIDENTIAL BUILDINGS, COMMERCIAL BUILDINGS, BUILDING SITES, AND MAJOR INFRASTRUCTURES NAMELY, SCHOOLS, ELECTRICAL SUBSTATIONS, WATER TREATMENT CENTERS, WASTE TREATMENT CENTERS, DAMS, AIRPORTS, HYDROELECTRIC FACILITIES, ENTERTAINMENT EVENT LOCATIONS, PORTS-OF-ENTRY AND TRANSPORTATION MEDIUMS, NAMELY, AUTOMOBILES, BUSES AND TRAINS FOR USE BY EMERGENCY RESPONDERS, NAMELY, POLICE, FIRE DEPARTMENT, MILITARY, AND PRIVATE SECURITY (U.S. CLS. 21, 23, 26, 36 AND 38).

WON TEAK OH, EXAMINING ATTORNEY

SN 77-520,695. REVERB NETWORKS, INC., ASHBURN, VA. FILED 7-11-2008.

EasyBeams

THE MARK CONSISTS OF STANDARD CHARACTERS WITHOUT CLAIM TO ANY PARTICULAR FONT, STYLE, SIZE, OR COLOR.

FOR COMPUTER SOFTWARE FOR USE IN MANAGEMENT OF WIRELESS TELECOMMUNICATION NETWORKS, WHICH PROVIDES THE ABILITY TO DEFINE BEAMS IN ANGULAR DIRECTION, MAGNITUDE AND WIDTH THROUGH A GRAPHICAL USER INTERFACE (GUI) OVERLAID ON MAPS; GRAPHICAL USER INTERFACE SOFTWARE (U.S. CLS. 21, 23, 26, 36 AND 38).

FIRST USE 10-1-2007; IN COMMERCE 1-24-2008.

FLORENTINA BLANDU, EXAMINING ATTORNEY

CLASS 9—(Continued).

SN 77-540,011. ADVANCED GEOSCIENCES, INC., AUSTIN, TX. FILED 8-6-2008.

AGI ADVANCED GEOSCIENCES,
INC.

THE MARK CONSISTS OF STANDARD CHARACTERS WITHOUT CLAIM TO ANY PARTICULAR FONT, STYLE, SIZE, OR COLOR.

NO CLAIM IS MADE TO THE EXCLUSIVE RIGHT TO USE "GEOSCIENCES, INC.", APART FROM THE MARK AS SHOWN.

SEC. 2(F) AS TO "ADVANCED GEOSCIENCES, INC.". FOR COMPUTER SOFTWARE FOR MODELING AND INTERPRETATION OF RESISTIVITY, SELF POTENTIAL, STREAMING POTENTIAL, SPONTANEOUS POTENTIAL AND INDUCED POLARIZATION, ALL IN THE FIELD OF GEOPHYSICAL DATA; ELECTRONIC IMAGING APPARATUS IN THE FIELD OF GEOSCIENCES NOT FOR MEDICAL USE; ELECTRODES; SWITCH BOXES; METERS AND PROBES FOR RECORDING RESISTIVITY, SELF POTENTIAL, STREAMING POTENTIAL, SPONTANEOUS POTENTIAL AND INDUCED POLARIZATION, ALL FOR USE IN CONNECTION WITH GEOPHYSICAL DATA; MULTI-TRANSMITTERS AND RECEIVERS SPATIALLY SEPARATED FOR USE IN THE FIELD OF MEASURING RESISTIVITY, SELF POTENTIAL, STREAMING POTENTIAL, SPONTANEOUS POTENTIAL AND INDUCED POLARIZATION, ALL FOR USE IN CONNECTION WITH GEOPHYSICAL DATA; ELECTRONIC SENSORS FOR MEASURING, RECORDING AND ANALYZING GEOPHYSICAL FORMATIONS AND EDDY CURRENTS; ELECTRONIC SYSTEM APPARATUS FOR REMOTELY MONITORING AND RECORDING SCHEDULED AND UN-SCHEDULED DATA ACQUISITION OF RESISTIVITY, SELF POTENTIAL, STREAMING POTENTIAL, SPONTANEOUS POTENTIAL AND INDUCED POLARIZATION GEOPHYSICAL DATA IN SOIL AND WATER AND TO AUTOMATICALLY TRANSMIT SUCH DATA OVER THE INTERNET TO ONE OR SEVERAL RECIPIENTS; BOREHOLE INSTRUMENTATION, NAMELY DATA ACQUISITION UNITS USED TO RECORD AND ANALYZE BOREHOLE VARIABLES AND PARAMETERS AND FOR TRANSMITTING AND MAKING A PERMANENT RECORD OF THOSE VARIABLES AND PARAMETERS; ELECTRIC AND CONNECTION CABLES; CABLES AND FIBERS FOR ANALOG AND DIGITAL ELECTRICAL AND OPTICAL SIGNAL AND DATA TRANSMISSION; CABLES AND FIBERS FOR THE TRANSMISSION OF IMAGES; BOREHOLE CABLES, UNDERWATER AND LAND CABLES, ALL USED FOR ELECTRICAL TRANSMISSION (U.S. CLS. 21, 23, 26, 36 AND 38).

FIRST USE 10-10-1996; IN COMMERCE 10-10-1996.
BARNEY CHARLON, EXAMINING ATTORNEY

SN 77-544,108. DECURTIS ENTERPRISES, INC., DBA EPACKD, WEST CHESTER, PA. FILED 8-11-2008.

QUADCASE

THE MARK CONSISTS OF STANDARD CHARACTERS WITHOUT CLAIM TO ANY PARTICULAR FONT, STYLE, SIZE, OR COLOR.

FOR COMPUTER CARRYING CASES (U.S. CLS. 21, 23, 26, 36 AND 38).

SUE LAWRENCE, EXAMINING ATTORNEY

CLASS 9—(Continued).

SN 77-549,758. MIS QUALITY MANAGEMENT CORP., WILMINGTON, DE. FILED 8-18-2008.

MOODY'S CREDITCYCLE

THE MARK CONSISTS OF STANDARD CHARACTERS WITHOUT CLAIM TO ANY PARTICULAR FONT, STYLE, SIZE, OR COLOR.

OWNER OF U.S. REG. NOS. 871,342, 3,190,114 AND OTHERS.

NO CLAIM IS MADE TO THE EXCLUSIVE RIGHT TO USE "CREDIT CYCLE", APART FROM THE MARK AS SHOWN.

FOR COMPUTER SOFTWARE FOR USE IN ECONOMETRIC ANALYSIS AND FORECASTING FINANCIAL TRENDS AND STATISTICS (U.S. CLS. 21, 23, 26, 36 AND 38).

FIRST USE 11-3-2008; IN COMMERCE 12-22-2008.
HEATHER BIDDULPH, EXAMINING ATTORNEY

SN 77-552,293. C&D TECHNOLOGIES, INC., BLUE BELL, PA. FILED 8-21-2008.

C&D TRUE FRONT ACCESS

THE MARK CONSISTS OF STANDARD CHARACTERS WITHOUT CLAIM TO ANY PARTICULAR FONT, STYLE, SIZE, OR COLOR.

OWNER OF U.S. REG. NOS. 206,922, 2,204,400 AND OTHERS.

NO CLAIM IS MADE TO THE EXCLUSIVE RIGHT TO USE "TRUE FRONT ACCESS", APART FROM THE MARK AS SHOWN.

FOR INDUSTRIAL BATTERIES (U.S. CLS. 21, 23, 26, 36 AND 38).

STEPHEN AQUILA, EXAMINING ATTORNEY

SN 77-559,170. VOYANT INTERNATIONAL CORPORATION, MOUNTAIN VIEW, CA. FILED 8-29-2008.



THE MARK CONSISTS OF THE WORD "ROCKETSTREAM" WITH A STYLIZED DESIGN COMPRISED OF FOUR CONNECTED CIRCLES IN A TRIANGULAR CONFIGURATION APPEARING TO THE LEFT OF THE WORDING.

FOR COMPUTER SOFTWARE FOR ENHANCING TRANSMISSION SPEEDS (U.S. CLS. 21, 23, 26, 36 AND 38).

FIRST USE 3-31-2007; IN COMMERCE 3-31-2007.
LINDA E. BLOHM, EXAMINING ATTORNEY

CLASS 9—(Continued).

SN 77-563,403. ALARM SPECIALIST CORPORATION, DBA EMG, SARASOTA, FL. FILED 9-5-2008.



NO CLAIM IS MADE TO THE EXCLUSIVE RIGHT TO USE "ALARM SPECIALIST CORPORATION", APART FROM THE MARK AS SHOWN.

THE COLOR(S) WHITE, BLACK AND RED IS/ARE CLAIMED AS A FEATURE OF THE MARK.

THE MARK CONSISTS OF THE WORDING "EMG" IN BLACK WITH A WHITE OUTLINE POSITIONED INSIDE A BLACK CIRCLE DESIGN. ABOVE AND BELOW THE WORDING AND PARTIALLY BEHIND THE CIRCLE DESIGN IS A BROKEN RECTANGULAR BACKGROUND IN RED. THE BACKGROUND OF THE WORDING, BETWEEN THE TWO PORTIONS OF THE RED RECTANGULAR BACKGROUND, IS THE COLOR WHITE.

FOR ACCESS CONTROL AND ALARM MONITORING SYSTEMS; ALARM INSTALLATIONS AND ALARMS (U.S. CLS. 21, 23, 26, 36 AND 38).

FIRST USE 7-6-1973; IN COMMERCE 7-6-1973.
MARK PILARO, EXAMINING ATTORNEY

SN 77-564,975. VITY TECHNOLOGY, 56850 - CAUDAN, FRANCE, FILED 9-8-2008.

VITY

THE MARK CONSISTS OF STANDARD CHARACTERS WITHOUT CLAIM TO ANY PARTICULAR FONT, STYLE, SIZE, OR COLOR.

FOR ELECTRONIC CONTROL SYSTEMS CONSISTING OF REMOTE CONTROLS, NETWORK BUS INTERFACES AND CONTROLLERS, AND COMPUTER SOFTWARE, FOR CONTROLLING AUDIOVISUAL AND ENVIRONMENTAL DEVICES (U.S. CLS. 21, 23, 26, 36 AND 38).

FIRST USE 1-30-2001; IN COMMERCE 1-30-2001.
LINDA M. KING, EXAMINING ATTORNEY

CLASS 9—(Continued).

SN 77-565,404. IMAGINATION TECHNOLOGIES LTD.,
HERTFORDSHIRE, UNITED KINGDOM, FILED 9-9-2008.

PURE LOUNGE

THE MARK CONSISTS OF STANDARD CHARACTERS
WITHOUT CLAIM TO ANY PARTICULAR FONT, STYLE,
SIZE, OR COLOR.

OWNER OF ERPN CMNTY TM OFC REG. NO. 7014897,
DATED 1-14-2009, EXPIRES 6-24-2018.

OWNER OF U.S. REG. NO. 3,034,119.

FOR RADIO RECEIVERS; RECEIVING EQUIPMENT
AND APPARATUS FOR FM, DAB AND INTERNET
RADIO OVER A WIRELESS NETWORK (U.S. CLS. 21,
23, 26, 36 AND 38).

JILL PRATER, EXAMINING ATTORNEY

SN 77-565,987. ZIPPMARK, INC., WILMINGTON, DE. FILED
9-9-2008.



OWNER OF U.S. REG. NOS. 317,219, 2,052,508 AND
OTHERS.

THE MARK CONSISTS OF THE TERM "ZIPPO" WITH A
FLAME DESIGN OVER THE "I".

FOR DOWNLOADABLE SOFTWARE FOR ELECTRO-
NIC DEVICES FEATURING AUDIO AND VISUAL FILES
AND GRAPHIC DESIGNS TO SIMULATE A LIGHTER
(U.S. CLS. 21, 23, 26, 36 AND 38).

SUSAN RICHARDS, EXAMINING ATTORNEY

SN 77-571,842. TRU-TEST CORPORATION LIMITED, MT.
WELLINGTON, NEW ZEALAND, FILED 9-17-2008.

UNIGIZER

THE MARK CONSISTS OF STANDARD CHARACTERS
WITHOUT CLAIM TO ANY PARTICULAR FONT, STYLE,
SIZE, OR COLOR.

PRIORITY CLAIMED UNDER SEC. 44(D) ON NEW
ZEALAND APPLICATION NO. 794755, FILED 8-22-2008,
REG. NO. 794755, DATED 8-22-2008, EXPIRES 8-22-2018.

FOR ENERGIZERS AND CONTROLLERS FOR ELEC-
TRIC FENCES (U.S. CLS. 21, 23, 26, 36 AND 38).

NAKIA HENRY, EXAMINING ATTORNEY

CLASS 9—(Continued).

SN 77-572,187. STEPHAN JENKINS PRODUCTIONS, INC.,
SAN RAFAEL, CA. FILED 9-17-2008.

THIRD EYE BLIND

THE MARK CONSISTS OF STANDARD CHARACTERS
WITHOUT CLAIM TO ANY PARTICULAR FONT, STYLE,
SIZE, OR COLOR.

FOR AUDIO AND VIDEO RECORDINGS FEATURING
PERFORMANCES BY MUSICAL ARTISTS (U.S. CLS. 21,
23, 26, 36 AND 38).

FIRST USE 11-0-1993; IN COMMERCE 11-0-1993.

NAPOLEON SHARMA, EXAMINING ATTORNEY

SN 77-572,631. AURASOUND, INC., SANTA FE SPRINGS,
CA. FILED 9-17-2008.

AURA SOUND

THE MARK CONSISTS OF STANDARD CHARACTERS
WITHOUT CLAIM TO ANY PARTICULAR FONT, STYLE,
SIZE, OR COLOR.

OWNER OF U.S. REG. NOS. 1,991,593 AND 2,196,818.

NO CLAIM IS MADE TO THE EXCLUSIVE RIGHT TO
USE "SOUND", APART FROM THE MARK AS SHOWN.

FOR ELECTRONIC AUDIO EQUIPMENT, NAMELY,
STEREO SPEAKER MOTORS, TELEVISION SPEAKERS,
LOUDSPEAKERS, ELECTRIC VOICE COIL ACTUA-
TORS, AND STEREO SPEAKERS (U.S. CLS. 21, 23, 26,
36 AND 38).

FIRST USE 2-0-1995; IN COMMERCE 2-0-1995.

SARA THOMAS, EXAMINING ATTORNEY

CLASS 9—(Continued).

SN 77-572,852. INTRALOT SA, ATHENS, GREECE, FILED 9-18-2008.

CORONIS

THE MARK CONSISTS OF STANDARD CHARACTERS WITHOUT CLAIM TO ANY PARTICULAR FONT, STYLE, SIZE, OR COLOR.

FOR ELECTRONIC TERMINALS FOR AN ELECTRONIC LOTTERY SYSTEM, WHICH VALIDATES LOTTERY TICKETS, AND COMPUTER SOFTWARE FOR THE VALIDATION OF LOTTERY TICKETS, SOLD AS A UNIT; ELECTRONIC TERMINALS FOR ENTERTAINING, NAMELY, VIDEO LOTTERY TERMINALS, LOTTERY TERMINALS AND COMPUTER GAME SOFTWARE FOR VIDEO LOTTERY TERMINALS, LOTTERY TERMINALS, SOLD AS A UNIT; ELECTRONIC TERMINALS FOR GAMES OF CHANCE, NAMELY, KENO TERMINALS, BINGO TERMINALS, BETTING TERMINALS AND COMPUTER GAME SOFTWARE FOR KENO TERMINALS, BINGO TERMINALS, BETTING TERMINALS, SOLD AS A UNIT; CASH REGISTERS FOR ELECTRONIC LOTTERY SYSTEMS (U.S. CLS. 21, 23, 26, 36 AND 38).

FIRST USE 5-2-2002; IN COMMERCE 11-3-2004.
HEATHER BIDDULPH, EXAMINING ATTORNEY

SN 77-576,782. INVENSTAR, LLC, BOCA RATON, FL. FILED 9-23-2008.

Touch Suite

THE MARK CONSISTS OF STANDARD CHARACTERS WITHOUT CLAIM TO ANY PARTICULAR FONT, STYLE, SIZE, OR COLOR.

OWNER OF U.S. REG. NO. 3,532,228.

NO CLAIM IS MADE TO THE EXCLUSIVE RIGHT TO USE "SUITE", APART FROM THE MARK AS SHOWN.

FOR COMPUTER HARDWARE AND COMPUTER SOFTWARE FOR RETAIL INVENTORY MANAGEMENT, SOLD AS A UNIT; COMPUTER PROGRAMS FOR SMALL BUSINESS MANAGEMENT, NAMELY, MANAGING ALL ASPECTS OF OPERATIONS SUCH AS CLIENTS, STAFF, VENDORS, PRODUCTS, SERVICES, MARKETING, FINANCE, PAYMENT TRANSACTIONS AND PROCESSING, LOYALTY PROGRAMS, BILL PAYMENTS, TIME AND ATTENDANCE, PAYROLL, SECURITY AND LOSS PREVENTION, MULTIMEDIA ITEMS, INTERNET USE, MESSAGING, AND THE POINT-OF-SALE; COMPUTER PROGRAMS USED FOR ELECTRONIC CASH REGISTER SYSTEMS; COMPUTER SOFTWARE AND HARDWARE FOR SMALL BUSINESS MANAGEMENT, NAMELY, MANAGING ALL ASPECTS OF OPERATIONS SUCH AS CLIENTS, STAFF, VENDORS, PRODUCTS, SERVICES, MARKETING, FINANCE, PAYMENT TRANSACTIONS AND PROCESSING, LOYALTY PROGRAMS, BILL PAYMENTS, TIME AND ATTENDANCE, PAYROLL, SECURITY AND LOSS PREVENTION, MULTIMEDIA ITEMS, INTERNET USE, MESSAGING, AND THE POINT-OF-SALE (U.S. CLS. 21, 23, 26, 36 AND 38).

FIRST USE 10-31-2007; IN COMMERCE 2-15-2008.
ERIN FALK, EXAMINING ATTORNEY

CLASS 9—(Continued).

SN 77-579,194. EUBANKS, GRIER, SAN LUIS OBISPO, CA. FILED 9-25-2008.



THE STIPPLING IS FOR SHADING PURPOSES ONLY. THE MARK CONSISTS OF THE STYLIZED TEXT "BUZZ" INSIDE A CIRCLE WITH A FLY AND THE STYLIZED "FLY TABS" BELOW.

FOR LABORATORY EQUIPMENT USED TO FILL VIALS WITH FOOD FOR FRUIT FLIES, NAMELY, FLY VIAL FILLERS; LABORATORY EQUIPMENT, NAMELY, CAPS FOR LABORATORY VIALS (U.S. CLS. 21, 23, 26, 36 AND 38).

FIRST USE 3-1-2007; IN COMMERCE 3-1-2007.
EVELYN BRADLEY, EXAMINING ATTORNEY

SN 77-582,792. APRENTIX CORPORATION, SAN JOSE, CA. FILED 10-1-2008.

FOUNDEK

THE MARK CONSISTS OF STANDARD CHARACTERS WITHOUT CLAIM TO ANY PARTICULAR FONT, STYLE, SIZE, OR COLOR.

FOR COMPUTER SOFTWARE FOR ACCOUNTING PURPOSES (U.S. CLS. 21, 23, 26, 36 AND 38).

ALEXANDER L. POWERS, EXAMINING ATTORNEY

SN 77-583,227. MOOG INC., AURORA, NY. FILED 10-1-2008.



THE MARK CONSISTS OF THE LETTERS "R", "A", "H" AND "D" STYLIZED.

FOR REMOTE ACOUSTIC HAILING DEVICE ENABLING COMMUNICATION BETWEEN A DEFENDER AND AN INTRUDER (U.S. CLS. 21, 23, 26, 36 AND 38).

DAVID ELTON, EXAMINING ATTORNEY

CLASS 9—(Continued).

SN 77-585,648. GPR CORPORATION, DAVIE, FL. FILED 10-4-2008.

ABICS

THE MARK CONSISTS OF STANDARD CHARACTERS WITHOUT CLAIM TO ANY PARTICULAR FONT, STYLE, SIZE, OR COLOR.

FOR INDUSTRIAL CRANE AND HOIST POSITIONING SOLUTION, NAMELY, POSITION LOOP CONTROLLER SOFTWARE (U.S. CLS. 21, 23, 26, 36 AND 38).
SHAUNIA CARLYLE, EXAMINING ATTORNEY

CLASS 9—(Continued).

SN 77-586,044. XOMA TECHNOLOGY LTD., HAMILTON, BERMUDA, FILED 10-6-2008.

XABTRACKER

THE MARK CONSISTS OF STANDARD CHARACTERS WITHOUT CLAIM TO ANY PARTICULAR FONT, STYLE, SIZE, OR COLOR.

FOR COMPUTER SOFTWARE, NAMELY, DATA MANAGEMENT SOFTWARE USED TO SCREEN ANTI-BODY EXPRESSION LIBRARIES AND INVENTORY THEIR OUTPUT (U.S. CLS. 21, 23, 26, 36 AND 38).

JEFFREY LOOK, EXAMINING ATTORNEY

SN 77-586,063. XOMA TECHNOLOGY LTD., HAMILTON, BERMUDA, FILED 10-6-2008.

SN 77-585,867. SHENZHEN SI SEMICONDUCTORS CO., LTD., SHENZHEN, CHINA, FILED 10-6-2008.



THE MARK CONSISTS OF A SQUARE WITH ITS LEFT AND RIGHT SIDES SLANTING TO THE RIGHT AND THE STYLIZED LETTERING "SI" WITHIN THE SQUARE.

FOR COMPUTER PERIPHERAL DEVICES; OPTICAL CHARACTER READERS; BLANK OPTICAL DATA MEDIA; BLANK OPTICAL DISCS; BLANK RECORDABLE OPTICAL DISCS; CURRENT RECTIFIERS; BLANK INTEGRATED CIRCUIT CARD; ELECTRONIC TRANSISTORS; SEMICONDUCTOR DEVICES; BLANK MAGNETIC DATA CARRIERS; LIGHTING BALLASTS; INTEGRATED CIRCUIT CHIP FOR COMPUTING AS A COMPONENT OF VIDEO GAMES SOFTWARE; INTEGRATED CIRCUIT CHIP FOR COMPUTERS; BLANK INTEGRATED CIRCUIT CHIPS; INTEGRATED CIRCUIT CHIPS FOR ENCODING AND DECODING DIGITAL VIDEO; INTEGRATED CIRCUIT CHIPS FOR DIGITAL VIDEO COMPRESSION AND DECOMPRESSION; INTEGRATED CIRCUITS; ELECTRICAL TRANS-DUCER; VACUUM TUBES; DISCHARGE TUBES, ELECTRIC, OTHER THAN FOR LIGHTING; AND AMPLIFYING TUBES (U.S. CLS. 21, 23, 26, 36 AND 38).
KRISTIN CARLSON, EXAMINING ATTORNEY

PLATYPUS

THE MARK CONSISTS OF STANDARD CHARACTERS WITHOUT CLAIM TO ANY PARTICULAR FONT, STYLE, SIZE, OR COLOR.

FOR COMPUTER SOFTWARE, NAMELY, DATA MANAGEMENT SOFTWARE USED TO SCREEN AND INVENTORY ANTIBODY-PRODUCING CELL LINES (U.S. CLS. 21, 23, 26, 36 AND 38).

JEFFREY LOOK, EXAMINING ATTORNEY

SN 77-586,068. XOMA TECHNOLOGY LTD., HAMILTON, BERMUDA, FILED 10-6-2008.

ABLIMS

THE MARK CONSISTS OF STANDARD CHARACTERS WITHOUT CLAIM TO ANY PARTICULAR FONT, STYLE, SIZE, OR COLOR.

FOR COMPUTER SOFTWARE, NAMELY, DATA MANAGEMENT SOFTWARE USED TO TRACK THE PRODUCTION AND INVENTORY OF ANTIBODIES (U.S. CLS. 21, 23, 26, 36 AND 38).

JEFFREY LOOK, EXAMINING ATTORNEY

CLASS 9—(Continued).

SN 77-586,094. XOMA TECHNOLOGY LTD., HAMILTON, BERMUDA, FILED 10-6-2008.

PHENOM

THE MARK CONSISTS OF STANDARD CHARACTERS WITHOUT CLAIM TO ANY PARTICULAR FONT, STYLE, SIZE, OR COLOR.

FOR COMPUTER SOFTWARE FOR USE IN ANALYZING ANTIBODIES FOR THE PURPOSE OF HUMANIZATION (U.S. CLS. 21, 23, 26, 36 AND 38).

JEFFREY LOOK, EXAMINING ATTORNEY

SN 77-586,480. BRAY, DAVID WILLIAM, SUNDANCE, WY. FILED 10-6-2008.

QUIET-FURY

THE MARK CONSISTS OF STANDARD CHARACTERS WITHOUT CLAIM TO ANY PARTICULAR FONT, STYLE, SIZE, OR COLOR.

FOR CONSUMER ELECTRONICS, NAMELY, VOLUME CONTROL UNITS FOR USE WITH AUDIO DEVICES (U.S. CLS. 21, 23, 26, 36 AND 38).

MICHELLE DUBOIS, EXAMINING ATTORNEY

SN 77-587,828. LOGAN IP HOLDINGS, LLC, LOGAN, UT. FILED 10-7-2008.

TROG

THE MARK CONSISTS OF STANDARD CHARACTERS WITHOUT CLAIM TO ANY PARTICULAR FONT, STYLE, SIZE, OR COLOR.

FOR EYEGLASSES, SUNGLASSES, EYEGLASS RETAINERS AND RETAINING CORDS; EYEGLASS AND SUNGLASS ACCESSORIES, NAMELY, NECK CORDS, HEAD STRAPS, MEDALLIONS IN THE NATURE OF APPARATUS FOR ADJUSTING LENGTH OF EYEGLASS RETAINING CORDS AND NECK CORDS, MODULAR CONNECTORS FOR EYEGLASS RETAINING COMPONENTS USED TO ATTACH ADDITIONAL COMPONENTS AND TO ADJUST THE LENGTH OF THE CORD, AND EYEGLASS STRAPS THAT RESTRAIN EYEWEAR FROM MOVEMENT OR AS STORAGE OF EYEWEAR ON A WEARER; COMPUTER SOFTWARE FOR PROVIDING PRODUCT SALES INFORMATION AND COMPUTER GAME SOFTWARE USED VIA COMPUTERS, MOBILE PHONES, WIRELESS DEVICES, AND HANDHELDS (U.S. CLS. 21, 23, 26, 36 AND 38).

CARRIE GENOVESE, EXAMINING ATTORNEY

CLASS 9—(Continued).

SN 77-588,131. REAL IMAGE MEDIA TECHNOLOGIES PVT. LTD, BALAJINAGAR, INDIA, FILED 10-8-2008.

QUBE XP-S

THE MARK CONSISTS OF STANDARD CHARACTERS WITHOUT CLAIM TO ANY PARTICULAR FONT, STYLE, SIZE, OR COLOR.

PRIORITY CLAIMED UNDER SEC. 44(D) ON INDIA APPLICATION NO. 1709618, FILED 7-11-2008.

FOR COMPUTER HARDWARE AND COMPUTER SOFTWARE PROGRAMS IN THE NATURE OF A SERVER THAT ALLOWS DOWNLOADING AND PROJECTION OF MOTION PICTURES AND PRE-SHOW MARKETING, AND THEATER AUTOMATION FOR E-CINEMA (U.S. CLS. 21, 23, 26, 36 AND 38).

FIRST USE 6-1-2008; IN COMMERCE 6-1-2008.

NORA BUCHANAN WILL, EXAMINING ATTORNEY

SN 77-588,221. REAL IMAGE MEDIA TECHNOLOGIES PVT. LTD, BALAJINAGAR, INDIA, FILED 10-8-2008.

QUBE XP-D

THE MARK CONSISTS OF STANDARD CHARACTERS WITHOUT CLAIM TO ANY PARTICULAR FONT, STYLE, SIZE, OR COLOR.

FOR COMPUTER HARDWARE AND COMPUTER SOFTWARE PROGRAMS IN THE NATURE OF A SERVER THAT ALLOWS DOWNLOADING AND PROJECTION OF MOTION PICTURES AND PRE-SHOW MARKETING, AND THEATER AUTOMATION FOR DCI COMPLIANT D-CINEMA MARKET (U.S. CLS. 21, 23, 26, 36 AND 38).

FIRST USE 7-1-2003; IN COMMERCE 7-1-2003.

NORA BUCHANAN WILL, EXAMINING ATTORNEY

SN 77-588,271. REAL IMAGE MEDIA TECHNOLOGIES PVT. LTD, BALAJINAGAR, INDIA, FILED 10-8-2008.



THE MARK CONSISTS OF A RECTANGLE WITH ROUNDED EDGES WITH THE WORD "QUBE" IN BIG LETTERS AND THE LETTERS "XP - S" IN SMALLER LETTERS, WHEREIN THE BACKGROUND IS BLACK AND THE LETTERING IS WHITE.

FOR COMPUTER HARDWARE AND COMPUTER SOFTWARE PROGRAMS IN THE NATURE OF A SERVER THAT ALLOWS DOWNLOADING AND PROJECTION OF MOTION PICTURES AND PRE-SHOW MARKETING, AND THEATER AUTOMATION FOR E-CINEMA (U.S. CLS. 21, 23, 26, 36 AND 38).

FIRST USE 6-1-2008; IN COMMERCE 6-1-2008.

NORA BUCHANAN WILL, EXAMINING ATTORNEY

CLASS 9—(Continued).

SN 77-589,062. REAL IMAGE MEDIA TECHNOLOGIES PVT. LTD, BALAJINAGAR, INDIA, FILED 10-9-2008.

CLASS 9—(Continued).

SN 77-589,577. LENIHAN, MARY GERARD, ST. LOUIS, MO. FILED 10-9-2008.

QUBE XP-E

THE MARK CONSISTS OF STANDARD CHARACTERS WITHOUT CLAIM TO ANY PARTICULAR FONT, STYLE, SIZE, OR COLOR.

FOR COMPUTER HARDWARE AND COMPUTER SOFTWARE PROGRAMS IN THE NATURE OF A SERVER THAT ALLOWS DOWNLOADING AND PROJECTION OF MOTION PICTURES AND PRE-SHOW MARKETING, AND THEATER AUTOMATION FOR CINEMA (U.S. CLS. 21, 23, 26, 36 AND 38).

FIRST USE 7-1-2003; IN COMMERCE 7-1-2003.
NORA BUCHANAN WILL, EXAMINING ATTORNEY

INSPIRING SELF MIND

THE MARK CONSISTS OF STANDARD CHARACTERS WITHOUT CLAIM TO ANY PARTICULAR FONT, STYLE, SIZE, OR COLOR.

FOR DVDS, CD ROMS, PRERECORDED VIDEO TAPES, AND DOWNLOADABLE AUDIO AND VIDEO RECORDINGS REGARDING SPIRITUALITY AND SPIRITUAL DEVELOPMENT (U.S. CLS. 21, 23, 26, 36 AND 38).

LINDA MICKLEBURGH, EXAMINING ATTORNEY

SN 77-589,556. LENIHAN, MARY GERARD, ST. LOUIS, MO. FILED 10-9-2008.

CUBICLE SELF MIND

THE MARK CONSISTS OF STANDARD CHARACTERS WITHOUT CLAIM TO ANY PARTICULAR FONT, STYLE, SIZE, OR COLOR.

FOR DVDS, CD ROMS, PRERECORDED VIDEO TAPES, AND DOWNLOADABLE AUDIO AND VIDEO RECORDINGS REGARDING SPIRITUALITY AND SPIRITUAL DEVELOPMENT (U.S. CLS. 21, 23, 26, 36 AND 38).

LINDA MICKLEBURGH, EXAMINING ATTORNEY

SN 77-589,748. TABLETOP MEDIA, LLC, DALALS, TX. FILED 10-9-2008.

SN 77-589,570. LENIHAN, MARY GERARD, ST. LOUIS, MO. FILED 10-9-2008.

ZIOSK

INSPIRING TO SERVE LOVE

THE MARK CONSISTS OF STANDARD CHARACTERS WITHOUT CLAIM TO ANY PARTICULAR FONT, STYLE, SIZE, OR COLOR.

FOR DVDS, CD ROMS, PRERECORDED VIDEO TAPES, AND DOWNLOADABLE AUDIO AND VIDEO RECORDINGS REGARDING SPIRITUALITY AND SPIRITUAL DEVELOPMENT (U.S. CLS. 21, 23, 26, 36 AND 38).

LINDA MICKLEBURGH, EXAMINING ATTORNEY

THE MARK CONSISTS OF STANDARD CHARACTERS WITHOUT CLAIM TO ANY PARTICULAR FONT, STYLE, SIZE, OR COLOR.

FOR POS (POINT OF SERVICE) DEVICES FOR RESTAURANT OPERATION AND MANAGEMENT, FEATURING PAY AT THE TABLE FUNCTIONS, CUSTOMER LOYALTY PROGRAM ACCESS AND INFORMATION, SATISFACTION SURVEYS, DIGITAL RESTAURANT PROMOTIONS, AND TABLESIDE ORDERING (U.S. CLS. 21, 23, 26, 36 AND 38).

LINDA MICKLEBURGH, EXAMINING ATTORNEY

CLASS 9—(Continued).

SN 77-590,007. DEQ SYSTÈMES CORP., ST-ROMUALD, CANADA, FILED 10-10-2008.

LUCKY PLAYER JACKPOT

THE MARK CONSISTS OF STANDARD CHARACTERS WITHOUT CLAIM TO ANY PARTICULAR FONT, STYLE, SIZE, OR COLOR.

OWNER OF U.S. REG. NO. 2,976,544.
NO CLAIM IS MADE TO THE EXCLUSIVE RIGHT TO USE "PLAYER" AND "JACKPOT", APART FROM THE MARK AS SHOWN.

FOR GAMING MACHINES; GAMING SOFTWARE; ELECTRONIC GAMING AND NON-GAMING SYSTEMS WHICH ARE AUXILIARY TO LIVE CASINO GAMING TABLES, BINGO AND GAMING MACHINES, CONSISTING PRIMARILY OF LED AND LCD DISPLAY UNITS, COMPUTER HARDWARE AND COMPUTER SOFTWARE FOR RANDOMLY CHOOSING VALUES OF JACKPOTS AND RANDOMLY CHOOSING CARDS, NUMBERS AND OTHER SYMBOLS ASSOCIATED WITH LIVE CASINO TABLE GAMES PLAY, FOR PROGRAMMING OPTIONS WHEN PLAYING ALONG WITH LIVE CASINO TABLE GAMES, BINGO, AND GAMING MACHINES, AND FOR OPERATING ELECTRONIC CASINO GAME MACHINES IN CONJUNCTION WITH LIVE CASINO GAME PLAY (U.S. CLS. 21, 23, 26, 36 AND 38).
RENEE SERVANCE, EXAMINING ATTORNEY

CLASS 9—(Continued).

SN 77-590,020. DEQ SYSTÈMES CORP., ST-ROMUALD, CANADA, FILED 10-10-2008.



OWNER OF U.S. REG. NO. 2,976,544.
NO CLAIM IS MADE TO THE EXCLUSIVE RIGHT TO USE "PLAYER" AND "JACKPOT", APART FROM THE MARK AS SHOWN.

THE MARK CONSISTS OF A REPRESENTATION OF A CIRCULAR POKER CHIP HAVING THE STYLIZED LETTERS "L", "P", "J" IN THE CENTER AND SURROUNDED BY THE WORDING "LUCKY PLAYER JACKPOT" REPEATED TWICE.

FOR GAMING MACHINES; GAMING SOFTWARE; ELECTRONIC GAMING AND NON-GAMING SYSTEMS WHICH ARE AUXILIARY TO LIVE CASINO GAMING TABLES, BINGO AND GAMING MACHINES, CONSISTING PRIMARILY OF LED AND LCD DISPLAY UNITS, COMPUTER HARDWARE AND COMPUTER SOFTWARE FOR RANDOMLY CHOOSING VALUES OF JACKPOTS AND RANDOMLY CHOOSING CARDS, NUMBERS AND OTHER SYMBOLS ASSOCIATED WITH LIVE CASINO TABLE GAMES PLAY, FOR PROGRAMMING OPTIONS WHEN PLAYING ALONG WITH LIVE CASINO TABLE GAMES, BINGO, AND GAMING MACHINES, AND FOR OPERATING ELECTRONIC CASINO GAME MACHINES IN CONJUNCTION WITH LIVE CASINO GAME PLAY (U.S. CLS. 21, 23, 26, 36 AND 38).
RENEE SERVANCE, EXAMINING ATTORNEY

SN 77-591,201. LENIHAN, MARY GERARD, ST. LOUIS, MO. FILED 10-13-2008.

WORLD NEEDS YOUR HELP ORGANIZATION—NOW!

THE MARK CONSISTS OF STANDARD CHARACTERS WITHOUT CLAIM TO ANY PARTICULAR FONT, STYLE, SIZE, OR COLOR.

FOR DVDS, CD ROMS, PRERECORDED VIDEO TAPES, AND DOWNLOADABLE AUDIO AND VIDEO RECORDINGS REGARDING SPIRITUALITY AND SPIRITUAL DEVELOPMENT (U.S. CLS. 21, 23, 26, 36 AND 38).
LINDA MICKLEBURGH, EXAMINING ATTORNEY

CLASS 9—(Continued).

SN 77-591,216. LENIHAN, MARY GERARD, ST. LOUIS, MO. FILED 10-13-2008.

I.S. MIND

THE MARK CONSISTS OF STANDARD CHARACTERS WITHOUT CLAIM TO ANY PARTICULAR FONT, STYLE, SIZE, OR COLOR.

FOR DVDS, CD ROMS, PRERECORDED VIDEO TAPES, AND DOWNLOADABLE AUDIO AND VIDEO RECORDINGS REGARDING SPIRITUALITY AND SPIRITUAL DEVELOPMENT (U.S. CLS. 21, 23, 26, 36 AND 38).

LINDA MICKLEBURGH, EXAMINING ATTORNEY

CLASS 9—(Continued).

SN 77-592,593. COKINETIC SYSTEMS CORPORATION, WHITE PLAINS, NY. FILED 10-14-2008.

Translachat

THE MARK CONSISTS OF STANDARD CHARACTERS WITHOUT CLAIM TO ANY PARTICULAR FONT, STYLE, SIZE, OR COLOR.

FOR COMPUTER SOFTWARE FOR A SYSTEM OF LANGUAGE TRANSLATION WITHIN A REAL-TIME CHAT FORMAT (U.S. CLS. 21, 23, 26, 36 AND 38).

LINDA ORNDORFF, EXAMINING ATTORNEY

SN 77-591,523. IBASE TECHNOLOGY (USA) INC., SUNNYVALE, CA. FILED 10-13-2008.

Signature Book

THE MARK CONSISTS OF STANDARD CHARACTERS WITHOUT CLAIM TO ANY PARTICULAR FONT, STYLE, SIZE, OR COLOR.

FOR COMPUTER HARDWARE AND COMPUTER PERIPHERAL DEVICES (U.S. CLS. 21, 23, 26, 36 AND 38).

GENE MACIOL, EXAMINING ATTORNEY

SN 77-592,993. DERIVACTIV, LLC, EDEN PRAIRIE, MN. FILED 10-15-2008.

MuniMarket Pulse

THE MARK CONSISTS OF STANDARD CHARACTERS WITHOUT CLAIM TO ANY PARTICULAR FONT, STYLE, SIZE, OR COLOR.

FOR DOWNLOADABLE SOUND RECORDINGS FEATURING AUDIO INFORMATION ABOUT MUNICIPAL FINANCING MARKETS (U.S. CLS. 21, 23, 26, 36 AND 38).

FIRST USE 11-30-2007; IN COMMERCE 11-30-2007.

MIDGE BUTLER, EXAMINING ATTORNEY

SN 77-592,517. COKINETIC SYSTEMS CORPORATION, WHITE PLAINS, NY. FILED 10-14-2008.

NewGoo

THE MARK CONSISTS OF STANDARD CHARACTERS WITHOUT CLAIM TO ANY PARTICULAR FONT, STYLE, SIZE, OR COLOR.

FOR COMPUTER SOFTWARE FOR A SYSTEM OF RICH INTERNET AND CLOUD-COMPUTING BASED APPLICATION CONSTRUCTION AND DELIVERY IN THE FIELD OF SOFTWARE APPLICATIONS (U.S. CLS. 21, 23, 26, 36 AND 38).

LINDA ORNDORFF, EXAMINING ATTORNEY

SN 77-593,447. DESIGN READY CONTROLS, INC., ROCKFORD, MN. FILED 10-15-2008.

APE

THE MARK CONSISTS OF STANDARD CHARACTERS WITHOUT CLAIM TO ANY PARTICULAR FONT, STYLE, SIZE, OR COLOR.

FOR COMPUTER SOFTWARE, NAMELY, EXPERT SYSTEMS SOFTWARE, TO AUTOMATE ENGINEERING AND PRICING PROCESSES RELATED TO MANUFACTURING (U.S. CLS. 21, 23, 26, 36 AND 38).

FIRST USE 4-4-2006; IN COMMERCE 6-29-2006.

KAREN K. BUSH, EXAMINING ATTORNEY

CLASS 9—(Continued).

SN 77-594,784. OPHIR-SPIRICON INC., LOGAN, UT. FILED 10-17-2008.

BeamMaker

THE MARK CONSISTS OF STANDARD CHARACTERS WITHOUT CLAIM TO ANY PARTICULAR FONT, STYLE, SIZE, OR COLOR.

FOR COMPUTER SOFTWARE FOR A USER TO SYNTHETICALLY GENERATE AND MODEL A LASER BEAM PROFILE (U.S. CLS. 21, 23, 26, 36 AND 38).

FIRST USE 1-1-2009; IN COMMERCE 6-17-2009.

KELLEY WELLS, EXAMINING ATTORNEY

SN 77-594,870. ALEETE, LLC, STRONGSVILLE, OH. FILED 10-17-2008.

BareCase

THE MARK CONSISTS OF STANDARD CHARACTERS WITHOUT CLAIM TO ANY PARTICULAR FONT, STYLE, SIZE, OR COLOR.

FOR BAGS AND CASES SPECIALLY ADAPTED FOR HOLDING OR CARRYING PORTABLE TELEPHONES AND TELEPHONE EQUIPMENT AND ACCESSORIES; BEEPER CARRYING CASES; CAMERA CASES; CARRYING CASES FOR CELL PHONES; CARRYING CASES FOR RADIO PAGERS; CARRYING CASES SPECIALLY ADAPTED FOR POCKET CALCULATORS AND CELLPHONES; CASES FOR ELECTRONIC DIARIES; CASES FOR MOBILE PHONES; CASES FOR PHOTOGRAPHIC APPARATUS; CASES FOR POCKET CALCULATORS; CASES FOR TELEPHONES; CELL PHONE COVERS; CELLULAR PHONE ACCESSORY CHARMS; COMPUTER CARRYING CASES; DEVICES FOR HANDS-FREE USE OF MOBILE PHONES; FITTED PLASTIC FILMS KNOWN AS SKINS FOR COVERING AND PROVIDING A SCRATCH PROOF BARRIER OR PROTECTION FOR ELECTRONIC DEVICES, NAMELY, MP3 PLAYERS, MOBILE TELEPHONES, SMART TELEPHONES, DIGITAL CAMERAS, GLOBAL POSITIONING SYSTEMS AND PERSONAL DIGITAL ASSISTANTS; HANDS FREE KITS FOR PHONES; MOBILE PHONE STRAPS; PROTECTIVE CARRYING CASES FOR PORTABLE MUSIC PLAYERS, NAMELY, MP3 PLAYERS; PROTECTIVE CARRYING CASES SPECIALLY ADAPTED FOR GLOBAL POSITIONING SYSTEM (GPS) APPARATUS; PROTECTIVE CARRYING CASES SPECIALLY ADAPTED FOR PERSONAL DIGITAL ASSISTANTS (PDA); PROTECTIVE CARRYING CASES SPECIALLY ADAPTED FOR VIDEO GAME CONSOLES FOR USE WITH AN EXTERNAL DISPLAY SCREEN OR MONITOR; PROTECTIVE COVERS AND CASES FOR CELL PHONES, LAPTOPS AND PORTABLE MEDIA PLAYERS; SPECIALTY HOLSTER FOR CARRYING CELLULAR PHONES, PAGERS, AND/OR PERSONAL DIGITAL ASSISTANTS (U.S. CLS. 21, 23, 26, 36 AND 38).

FIRST USE 3-5-2007; IN COMMERCE 4-4-2009.

STEVEN R. FINE, EXAMINING ATTORNEY

CLASS 9—(Continued).

SN 77-594,919. BI INC., BOULDER, CO. FILED 10-17-2008.

BI TAD

THE MARK CONSISTS OF STANDARD CHARACTERS WITHOUT CLAIM TO ANY PARTICULAR FONT, STYLE, SIZE, OR COLOR.

OWNER OF U.S. REG. NOS. 1,788,412, 2,848,852 AND OTHERS.

THE WORDING "BI TAD" HAS NO MEANING IN A FOREIGN LANGUAGE.

FOR ELECTRONIC DEVICE TO MONITOR ALCOHOL TRANSDERMALLY AND REPORT INFORMATION TO A HOST COMPUTER FOR OFFICER INTERPRETATION AND ANALYSIS; LOCATION MONITOR USING RADIO FREQUENCY DETECTION FOR USE IN LOCATING AND REPORTING THE LOCATION OF PERSONS (U.S. CLS. 21, 23, 26, 36 AND 38).

LAURA KOVALSKY, EXAMINING ATTORNEY

SN 77-594,926. GULF MARKETING, INC., DBA GULF INDUSTRIAL SOLUTIONS, WAUKEGAN, IL. FILED 10-17-2008.



THE MARK CONSISTS OF AN OUTLINE BLACK SQUARE WITH ROUNDED CORNERS. THE BACKGROUND OF THE SQUARE CONSISTS OF GRAYSCALE SHADING WITH A LINE CURVING FROM THE LOWER LEFT SIDE TO THE UPPER RIGHT SIDE OF THE SQUARE. THE LITERAL ELEMENT "PERMASAFE" APPEARS INSIDE THE SQUARE AT THE TOP LEFT. A PERSON WEARING FALL ARREST EQUIPMENT APPEARS BELOW THE LITERAL ELEMENT ON THE LEFT SIDE. THE HEAD OF A PERSON WEARING SAFETY HELMET, SAFETY GLASSES, EAR PROTECTION AND A RESPIRATION MASK APPEARS IN THE BOTTOM RIGHT CORNER OF THE SQUARE.

FOR FALL PROTECTION EQUIPMENT FOR FALL RESTRAINT AND FALL ARREST, NAMELY, BARS, ANCHORS, HARNESES, LINES, LANYARDS, CARABINERS AND ANCHORAGE CONNECTORS; PROTECTIVE CLOTHING AND HEADGEAR; PROTECTIVE EYEWEAR; PROTECTIVE FACE MASKS NOT FOR MEDICAL PURPOSES (U.S. CLS. 21, 23, 26, 36 AND 38).

TARAH HARDY, EXAMINING ATTORNEY

CLASS 9—(Continued).

SN 77-595,827. NAMSUNG CORPORATION, SEOUL, REPUBLIC OF KOREA, FILED 10-20-2008.

CLASS 9—(Continued).

SN 77-595,851. DJR HOLDINGS, LLC, NEW YORK, NY, FILED 10-20-2008.

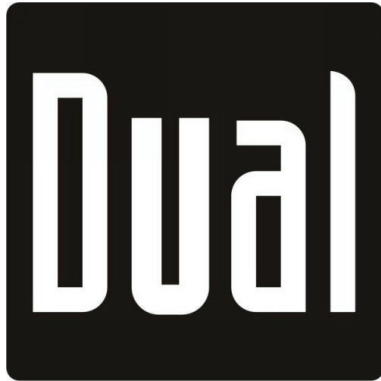
DEF JAM ELECTRONICS

OWNER OF U.S. REG. NO. 2,527,705.

THE MARK CONSISTS OF THE WORD "DUAL" IN STYLIZED LETTERING WITHIN A RECTANGULAR DESIGN.

FOR PERSONAL CONSUMER ELECTRONICS, NAMELY, HOME AUDIO SPEAKERS, LOUDSPEAKERS, SUBWOOFERS, AND DVD PLAYERS; HANDS FREE COMMUNICATION DEVICES, NAMELY, DEVICES FOR HANDS-FREE USE OF MOBILE PHONES; USB DEVICES, NAMELY, USB HUBS; AUDIO TAPE RECORDERS AND TAPE PLAYERS AND REPLACEMENT PARTS THEREOF; AUDIO CASSETTE PLAYERS; CD PLAYERS, CD CHANGERS AND REPLACEMENT PARTS THEREOF; MP3 PLAYERS; STEREO AND MONO TUNERS; STEREO AMPLIFIERS; LOUDSPEAKERS; TELEVISION AND VIDEO EQUIPMENT, NAMELY, TELEVISION SETS, VIDEO CAMERAS, VIDEO MONITORS; IN-CAR MULTIMEDIA DEVICES, NAMELY, MOBILE PHONES; MOBILE INFORMATION AND ENTERTAINMENT ELECTRONICS, NAMELY, MOBILE AUDIO RECEIVERS, AMPLIFIERS, SPEAKERS, SUBWOOFERS AND ACCESSORIES, NAMELY, AUDIO SPEAKER ENCLOSURES; MOBILE VIDEO SYSTEMS COMPRISED OF DIGITAL CAMERAS; PORTABLE GPS NAVIGATION DEVICES; MARINE AUDIO RECEIVERS AND SPEAKERS; MOBILE HD RADIOS; PORTABLE AND IN-CAR DVD PLAYERS; IN-CAR ACCESSORIES FOR CONSUMER ELECTRONICS PRODUCTS, NAMELY, IN-CAR TELEPHONE HANDSET CRADLES (U.S. CLS. 21, 23, 26, 36 AND 38).

FIRST USE 1-0-2003; IN COMMERCE 7-0-2003.

DAVID MURRAY, EXAMINING ATTORNEY

THE MARK CONSISTS OF STANDARD CHARACTERS WITHOUT CLAIM TO ANY PARTICULAR FONT, STYLE, SIZE, OR COLOR.

OWNER OF U.S. REG. NOS. 1,790,763, 2,361,626 AND OTHERS.

NO CLAIM IS MADE TO THE EXCLUSIVE RIGHT TO USE "ELECTRONICS", APART FROM THE MARK AS SHOWN.

FOR CONSUMER ELECTRONICS AND RELATED PRODUCTS, NAMELY, PERSONAL STEREO, STEREO RECEIVERS AND TUNERS, AMPLIFIERS, RECEIVERS FOR AUDIO AND VIDEO EQUIPMENT, HEADPHONES, MICROPHONES, COMPACT DISC PLAYERS, DIGITAL AUDIO PLAYERS, AUDIO CASSETTE TAPE PLAYERS, PORTABLE MEDIA PLAYERS, MP3 PLAYERS, PHONOGRAPH RECORD PLAYERS, DVD MACHINES, LOUDSPEAKERS AND AUDIO SPEAKERS, LOUDSPEAKER RACKS AND CABINETS, VIDEO CAMERAS AND CAMCORDERS, TV AND VIDEO CONVERTERS, VIDEO TAPE RECORDERS, VIDEO CASSETTE RECORDERS, AUDIO CASSETTE RECORDERS, AUDIO TAPE RECORDERS, DIGITAL AUDIO TAPE RECORDERS, AND DIGITAL VIDEO RECORDERS; PHOTOGRAPHIC CAMERAS, DIGITAL CAMERAS, COMPUTER CAMERAS AND CAMERA CASES; TELEVISIONS AND TELEVISION ANTENNAS, REMOTE CONTROLS FOR TELEVISIONS AND RADIOS, RADIOS, TWO-WAY RADIOS, RADIO PAGERS, CARRYING CASES FOR RADIO PAGERS, RADIO TRANSMITTERS, RADIO RECEIVERS, RADIO TRANSCEIVERS, RADIO BASE STATIONS, MODEMS, GLOBAL POSITIONING UNITS, VIDEO CAMERAS, VIDEO COMPUTER AND GLOBAL COMPUTER NETWORK TERMINAL MONITORS, SATELLITE RECEIVERS, AND COMPUTER E-COMMERCE SOFTWARE TO ALLOW USERS TO PERFORM ELECTRONIC BUSINESS TRANSACTIONS VIA A GLOBAL COMPUTER NETWORK; CARRYING CASES FOR THE FOREGOING GOODS AND REPLACEMENT PARTS FOR THE FOREGOING GOODS; INSTRUCTION MANUALS DISTRIBUTED WITH THE FOREGOING; COMPUTER AND RELATED PRODUCTS, NAMELY, COMPUTERS AND INSTRUCTIONAL MANUALS SOLD AS A UNIT, LAPTOP COMPUTERS, MOBILE COMPUTERS, COMPUTER MONITORS AND TERMINALS, COMPUTER MOUSE, COMPUTER MOUSE IN THE NATURE OF TRACKBALLS AND TOUCH PADS, COMPUTER HARDWARE, COMPUTER OPERATING SYSTEMS AND PROGRAMS, COMPUTER PRINTERS, COMPUTER SCREEN SAVER SOFTWARE AND COMPUTER SEARCH ENGINE SOFTWARE, COMPUTER SOFTWARE DEVELOPMENTS TOOLS, COMPUTER SOFTWARE FOR APPLICATION AND DATABASE INTEGRATION, COMPUTER GAME SOFTWARE AND PROGRAMS, INTERACTIVE MULTIMEDIA COMPUTER GAME PROGRAM, COMPUTER GRAPHICS BOARDS AND SOFTWARE, COMPUTER JOYSTICKS AND KEYPADS, COMPUTER KEYBOARDS, HEADSETS FOR USE WITH COMPUTERS, JACKETS FOR COMPUTER DISKS, WRIST RESTS AND SUPPORTS FOR COMPUTER MOUSE USERS, WRIST RESTS FOR USE WITH COMPUTERS, AND COMPUTER KEYBOARD WRIST PADS; COMPUTER STANDS SPECIALLY DESIGNED FOR HOLDING A COMPUTER, PRINTER AND ACCESSORIES; TELEPHONES, CORDLESS, WIRELESS OR SATELLITE TELEPHONES; CELLULAR TELEPHONES, PREPAID CELLULAR TELEPHONES USED IN CONNECTION WITH PREPAID AIRTIME CELLULAR TELEPHONE COMMUNICATION SERVICES, VIDEOPHONES, RADIO TELEPHONES, AND PAGERS; PREPAID MAGNETICALLY ENCODED TELEPHONE CALLING CARDS; MAGNETICALLY ENCODED CREDIT CARDS; MAGNETICALLY ENCODED DEBIT CARDS; CAR KITS FOR THE ADAPTATION OF PHONES AND PORTABLE COMPUTERS FOR VEHICULAR USE, PRINCIPALLY COMPOSED OF MOUNT,

CLASS 9—(Continued).

CRADLE, HEADSET, AUDIO SPEAKERS, MICROPHONES, EXTERNAL ANTENNA CONNECTORS, BATTERY, BATTERY CHARGER AND CARRYING CASE MARKETED AS A UNIT; CAR NAVIGATION COMPUTERS; BATTERIES AND BATTERY CHARGERS; ELECTRONIC HANDHELD UNITS FOR THE WIRELESS RECEIPT AND TRANSMISSION OF DATA THAT ENABLE THE USER TO KEEP TRACK OF OR MANAGE PERSONAL INFORMATION; SOFTWARE FOR THE REDIRECTION OF MESSAGES, GLOBAL COMPUTER NETWORK E-MAIL, AND OTHER DATA TO ONE OR MORE ELECTRONIC HANDHELD UNITS FROM A DATA STORE ON OR ASSOCIATED WITH A PERSONAL COMPUTER OR A SERVER; SOFTWARE FOR THE SYNCHRONIZATION OF DATA BETWEEN A REMOTE STATION OR UNIT AND A FIXED OR REMOTE STATION OR UNIT; ELECTRONIC PERSONAL ORGANIZERS; PERSONAL DIGITAL ASSISTANTS; HANDHELD COMPUTERS AND ORGANIZERS IN THE NATURE OF A HANDHELD COMPUTING DEVICE AND A CRADLE WHICH ALLOWS THE EXCHANGE OF INFORMATION BETWEEN THE HANDHELD COMPUTING DEVICE AND A DESKTOP COMPUTER AND SOFTWARE PROGRAMS FOR PERSONAL INFORMATION MANAGEMENT AND FOR COMMUNICATION TO AND FROM THE HANDHELD COMPUTING UNIT; MAGNETS, DECORATIVE MAGNETS, REFRIGERATOR MAGNETS AND NOVELTY MAGNETS; MOUSE PADS; COMPACT DISC CASES; FITTED CASES FOR STORAGE AND TRANSPORTATION, NAMELY, CASES FOR THE FOLLOWING GOODS— COMPACT DISCS, AUDIO CASSETTES, VIDEO CASSETTES, CD-ROMS, HOME VIDEO GAMES CARTRIDGES, TAPES AND DISCS, HOME VIDEO GAME ACCESSORIES, COMPUTERS, HANDHELD COMPUTERS, LAPTOP COMPUTERS, NOTEBOOK COMPUTERS, COMPUTER PRINTERS, COMPUTER MONITORS, COMPUTER KEYBOARDS, COMPUTER HARDWARE, COMPUTER SOFTWARE, COMPUTER MOUSE, CAMERAS, CAMCORDERS AND PORTABLE PHONES (U.S. CLS. 21, 23, 26, 36 AND 38).

G. MAYERSCHOFF, EXAMINING ATTORNEY

CLASS 9—(Continued).

SN 77-597,252. E.F. JOHNSON COMPANY, IRVING, TX. FILED 10-21-2008.

IP25 STARGATE DISPATCH CONSOLE

THE MARK CONSISTS OF STANDARD CHARACTERS WITHOUT CLAIM TO ANY PARTICULAR FONT, STYLE, SIZE, OR COLOR.

NO CLAIM IS MADE TO THE EXCLUSIVE RIGHT TO USE "DISPATCH CONSOLE", APART FROM THE MARK AS SHOWN.

FOR COMPUTER SOFTWARE AND HARDWARE FOR USE IN MANAGING COMMUNICATIONS WITH EMERGENCY PERSONNEL (U.S. CLS. 21, 23, 26, 36 AND 38).

CHRIS WELLS, EXAMINING ATTORNEY

SN 77-598,580. STRATEGIC PARTNERS, INC., CHATSWORTH, CA. FILED 10-22-2008.

SN 77-597,250. E.F. JOHNSON COMPANY, IRVING, TX. FILED 10-21-2008.

STARGATE DISPATCH CONSOLE

THE MARK CONSISTS OF STANDARD CHARACTERS WITHOUT CLAIM TO ANY PARTICULAR FONT, STYLE, SIZE, OR COLOR.

NO CLAIM IS MADE TO THE EXCLUSIVE RIGHT TO USE "DISPATCH CONSOLE", APART FROM THE MARK AS SHOWN.

FOR COMPUTER SOFTWARE AND HARDWARE FOR USE IN MANAGING COMMUNICATIONS WITH EMERGENCY PERSONNEL (U.S. CLS. 21, 23, 26, 36 AND 38).

CHRIS WELLS, EXAMINING ATTORNEY

Inspired Comfort

THE MARK CONSISTS OF STANDARD CHARACTERS WITHOUT CLAIM TO ANY PARTICULAR FONT, STYLE, SIZE, OR COLOR.

FOR AUDIO RECORDINGS FEATURING MUSIC, RELAXATION EXERCISES AND MOTIVATIONAL LECTURES PERTAINING TO SELF-IMPROVEMENT AND PERSONAL GROWTH; COMPACT DISCS FEATURING MUSIC, RELAXATION EXERCISES AND MOTIVATIONAL LECTURES PERTAINING TO SELF-IMPROVEMENT AND PERSONAL GROWTH; DOWNLOADABLE MP3 FILES AND MP3 RECORDINGS FEATURING MUSIC, RELAXATION EXERCISES AND MOTIVATIONAL LECTURES PERTAINING TO SELF-IMPROVEMENT AND PERSONAL GROWTH; DOWNLOADABLE MUSICAL SOUND RECORDINGS; MUSICAL SOUND RECORDINGS; PRE-RECORDED CDS FEATURING MUSIC, RELAXATION EXERCISES AND MOTIVATIONAL LECTURES PERTAINING TO SELF-IMPROVEMENT AND PERSONAL GROWTH; PRE-RECORDED DIGITAL MEDIA FEATURING MUSIC, RELAXATION EXERCISES AND MOTIVATIONAL LECTURES PERTAINING TO SELF-IMPROVEMENT AND PERSONAL GROWTH; SOUND RECORDINGS FEATURING MUSIC, RELAXATION EXERCISES AND MOTIVATIONAL LECTURES PERTAINING TO SELF-IMPROVEMENT AND PERSONAL GROWTH (U.S. CLS. 21, 23, 26, 36 AND 38).

NATALIE POLZER, EXAMINING ATTORNEY

CLASS 9—(Continued).

SN 77-601,822. FORD MOTOR COMPANY, DEARBORN, MI.
FILED 10-28-2008.

ECOGUIDE

THE MARK CONSISTS OF STANDARD CHARACTERS
WITHOUT CLAIM TO ANY PARTICULAR FONT, STYLE,
SIZE, OR COLOR.

FOR INSTRUMENT PANEL DISPLAYS PROVIDING
INFORMATION ON VEHICLE PERFORMANCE FOR
AUTOMOBILES (U.S. CLS. 21, 23, 26, 36 AND 38).
GIANCARLO CASTRO, EXAMINING ATTORNEY

CLASS 9—(Continued).

SN 77-607,078. AHMA, FREDERICK, MD. FILED 11-4-2008.

OSIRIS

THE MARK CONSISTS OF STANDARD CHARACTERS
WITHOUT CLAIM TO ANY PARTICULAR FONT, STYLE,
SIZE, OR COLOR.

FOR COMPUTER HARDWARE AND COMPUTER
SOFTWARE FOR CLEANSING DATA BEFORE MEDI-
CAL BILLS ARE PROCESSED (U.S. CLS. 21, 23, 26, 36
AND 38).
SANDRA MANIOS, EXAMINING ATTORNEY

SN 77-602,165. NUMONICS CORPORATION, MONTGO-
MERYVILLE, PA. FILED 10-28-2008.

INTELLISLATE

THE MARK CONSISTS OF STANDARD CHARACTERS
WITHOUT CLAIM TO ANY PARTICULAR FONT, STYLE,
SIZE, OR COLOR.

FOR COMPUTER HARDWARE AND SOFTWARE FOR
ELECTRONIC PRESENTATION, TRANSMISSION, STO-
RAGE AND PRINTING OF TEXT AND GRAPHICS (U.S.
CLS. 21, 23, 26, 36 AND 38).

FIRST USE 6-30-2009; IN COMMERCE 6-30-2009.
STEPHEN AQUILA, EXAMINING ATTORNEY

SN 77-608,936. PEERDRUM INC., ST. AUGUSTINE, FL.
FILED 11-6-2008.

PEERDRUM

THE MARK CONSISTS OF STANDARD CHARACTERS
WITHOUT CLAIM TO ANY PARTICULAR FONT, STYLE,
SIZE, OR COLOR.

FOR SYSTEM COMPRISED OF COMPUTER SOFT-
WARE AND COMPUTER HARDWARE FOR MONITOR-
ING MULTIPLE COMPUTERS THROUGH A VIRTUAL
ELECTRONIC WORKSPACE AND FOR PROVIDING
COMMUNICATION AND FILE SHARING BETWEEN
USERS (U.S. CLS. 21, 23, 26, 36 AND 38).

BERNICE MIDDLETON, EXAMINING ATTORNEY

SN 77-602,692. SUPERIOR RADIANT PRODUCTS LTD.,
STONEY CREEK, ONTARIO, CANADA, FILED 10-29-2008.

SRP ACCU-RATE

THE MARK CONSISTS OF STANDARD CHARACTERS
WITHOUT CLAIM TO ANY PARTICULAR FONT, STYLE,
SIZE, OR COLOR.

OWNER OF U.S. REG. NOS. 2,513,851 AND 2,808,103.
FOR ELECTROMECHANICAL CONTROLS FOR CON-
TROLLING GAS FIRED RADIANT HEATERS; COMPU-
TER PROGRAMS FOR CONTROLLING GAS FIRED
RADIANT HEATERS; ELECTRICAL SWITCHED CON-
TROL PANELS, SWITCH ASSEMBLIES, RIGID PRINTED
CIRCUIT BOARDS, ALL FOR CONTROLLING GAS
FIRED RADIANT HEATERS (U.S. CLS. 21, 23, 26, 36
AND 38).

ANDREW LEASER, EXAMINING ATTORNEY

SN 77-609,662. TEXAS MEMORY SYSTEMS, INC., HOUS-
TON, TX. FILED 11-7-2008.

Flash Brick

THE MARK CONSISTS OF STANDARD CHARACTERS
WITHOUT CLAIM TO ANY PARTICULAR FONT, STYLE,
SIZE, OR COLOR.

NO CLAIM IS MADE TO THE EXCLUSIVE RIGHT TO
USE "FLASH", APART FROM THE MARK AS SHOWN.

FOR COMPUTER MEMORY, NAMELY, BLANK COM-
PUTER SOLID STATE DISCS (U.S. CLS. 21, 23, 26, 36
AND 38).

JORDAN BAKER, EXAMINING ATTORNEY

CLASS 9—(Continued).

SN 77-609,961. WEALTH GROUP SOFTWARE, L.L.C., NAPERVILLE, IL. FILED 11-7-2008.



The logo for "Market Researcher" features the word "Market" in a yellow, bubbly font with a red outline, and the word "Researcher" in a similar yellow font with a red outline, positioned below "Market".

NO CLAIM IS MADE TO THE EXCLUSIVE RIGHT TO USE "MARKET RESEARCHER", APART FROM THE MARK AS SHOWN.

THE COLOR(S) YELLOW AND RED IS/ARE CLAIMED AS A FEATURE OF THE MARK.

THE MARK CONSISTS OF THE WORDS "MARKET RESEARCHER" IN YELLOW WITH A RED BORDER.

FOR COMPUTER SOFTWARE FOR ANALYZING INVESTMENT DATA (U.S. CLS. 21, 23, 26, 36 AND 38).

KAREN K. BUSH, EXAMINING ATTORNEY

SN 77-610,879. NEC SYSTEM TECHNOLOGIES, LTD., OSAKA-SHI, OSAKA, JAPAN, FILED 11-10-2008.

GRANTERRA

THE MARK CONSISTS OF STANDARD CHARACTERS WITHOUT CLAIM TO ANY PARTICULAR FONT, STYLE, SIZE, OR COLOR.

THE WORDING "GRANTERRA" HAS NO MEANING IN A FOREIGN LANGUAGE.

FOR COMPUTER SOFTWARE FOR IMAGE PROCESSING; COMPUTER SOFTWARE FOR USE IN GRAPHIC INFORMATION SYSTEMS FOR ANALYZING GEOGRAPHICAL INFORMATION; COMPUTER SOFTWARE FOR MAP DESIGN; COMPUTER SOFTWARE FOR CREATING THREE DIMENSIONAL IMAGES BY STEREO PROCESSING SYSTEM; COMPUTER SOFTWARE FOR CREATING A DIGITAL SURFACE MODEL FROM AERIAL IMAGES (U.S. CLS. 21, 23, 26, 36 AND 38).

BRIAN PINO, EXAMINING ATTORNEY

CLASS 9—(Continued).

SN 77-611,151. ONLINE DEVELOPMENT INC., AKA OLDI, KNOXVILLE, TN. FILED 11-10-2008.

cATM

THE MARK CONSISTS OF LOWER CASE "C" AND UPPER CASE "ATM" RUN TOGETHER AS "cATM".

FOR AUTOMATED PROCESS CONTROL SYSTEM, NAMELY, MICRO-PROCESSOR BASED HARDWARE AND SOFTWARE USED TO MONITOR THE STATUS OF INDUSTRIAL MACHINERY, NAMELY, TURBINES, GENERATORS AND COMPRESSORS; AUTOMATED PROCESS CONTROL SYSTEM, NAMELY, MICRO-PROCESSOR BASED HARDWARE AND SOFTWARE USED TO MONITOR THE STATUS OF INDUSTRIAL PROCESSES, NAMELY, POWER GENERATION, ELECTRICAL DISTRIBUTION AND OIL AND GAS PROCESSING; AUTOMATED SELF CONTAINED ELECTRONIC SURVEILLANCE DEVICES THAT CAN BE DEPLOYED TO GATHER EVIDENCE OR INTELLIGENCE IN REMOTE LOCATIONS; AUTOMATED SYSTEMS, NAMELY, SOFTWARE, HARDWARE AND COMMUNICATIONS DEVICES FOR PLANNING, SCHEDULING, CONTROLLING, MONITORING AND PROVIDING INFORMATION ON TRANSPORTATION ASSETS AND PARTS THEREOF; COMPUTER SOFTWARE TO AUTOMATE DATA WAREHOUSING; FACTORY AUTOMATION SOFTWARE, NAMELY, SOFTWARE TO INTEGRATE MANUFACTURING MACHINE OPERATIONS, TRACK PROBLEMS AND GENERATE PRODUCTION REPORTS; INDUSTRIAL AUTOMATION CONTROLS; SOFTWARE FOR MONITORING AND CONTROLLING COMMUNICATION BETWEEN COMPUTERS AND AUTOMATED MACHINE SYSTEMS (U.S. CLS. 21, 23, 26, 36 AND 38).

FIRST USE 7-0-2007; IN COMMERCE 11-0-2007.

MARCIE MILONE, EXAMINING ATTORNEY

SN 77-612,333. DISNEY ENTERPRISES, INC., BURBANK, CA. FILED 11-11-2008.

STORYPIX

THE MARK CONSISTS OF STANDARD CHARACTERS WITHOUT CLAIM TO ANY PARTICULAR FONT, STYLE, SIZE, OR COLOR.

FOR DIGITAL CAMERAS; COMPUTER SOFTWARE FOR USE IN RELATION TO DIGITAL IMAGES, NAMELY, SOFTWARE FOR EDITING, ORGANIZING, PROCESSING AND VIEWING DIGITAL IMAGES (U.S. CLS. 21, 23, 26, 36 AND 38).

FIRST USE 10-1-2008; IN COMMERCE 10-1-2008.

RON FAIRBANKS, EXAMINING ATTORNEY

CLASS 9—(Continued).

SN 77-612,483. RITE-HITE HOLDING CORPORATION, MILWAUKEE, WI. FILED 11-12-2008.

POTENTIA

THE MARK CONSISTS OF STANDARD CHARACTERS WITHOUT CLAIM TO ANY PARTICULAR FONT, STYLE, SIZE, OR COLOR.

FOR COMPUTER SOFTWARE FOR USE IN MANAGING INTELLECTUAL PROPERTY (IP) ASSETS, NAMELY, SOFTWARE FOR USE IN THE DOCKETING OF INTELLECTUAL PROPERTY ASSETS, PROVIDING COLLABORATIVE DECISION-MAKING TOOLS FOR INTELLECTUAL PROPERTY ASSET RENEWALS, PROVIDING FOR THE IMPORTATION AND EXPORTATION OF IP ANNUITY FEES AND PAYMENTS INFORMATION, AND PROVIDING WORKFLOW MANAGEMENT TOOLS FOR INTELLECTUAL PROPERTY ADMINISTRATION (U.S. CLS. 21, 23, 26, 36 AND 38).

MARY CRAWFORD, EXAMINING ATTORNEY

SN 77-612,539. R & M MATERIALS HANDLING, INC., SPRINGFIELD, OH. FILED 11-12-2008.

CONTROLMASTER

THE MARK CONSISTS OF STANDARD CHARACTERS WITHOUT CLAIM TO ANY PARTICULAR FONT, STYLE, SIZE, OR COLOR.

FOR ELECTRICAL MONITORING APPARATUS FOR USE IN MONITORING AND VARYING THE ROTATIONAL SPEED OF ALTERNATING CURRENT HOIST, TROLLEY, AND BRIDGE MOTORS USED ON CRANES, JIBS, AND MONORAILS IN THE OVERHEAD MATERIAL HANDLING INDUSTRY (U.S. CLS. 21, 23, 26, 36 AND 38).

FIRST USE 4-1-1992; IN COMMERCE 4-1-1992.
ANDREA SAUNDERS, EXAMINING ATTORNEY

SN 77-612,908. ADAMS RITE MANUFACTURING CO., POMONA, CA. FILED 11-12-2008.

eForce

THE MARK CONSISTS OF STANDARD CHARACTERS WITHOUT CLAIM TO ANY PARTICULAR FONT, STYLE, SIZE, OR COLOR.

FOR A SURFACE MOUNTED, KEYLESS METAL LOCKSET AND HANDLE WITH BATTERY POWERED NUMERIC TOUCH PAD THAT LOCKS AND UNLOCKS DOORS WITH EXIT DEVICES, DEADLATCHES, DEAD-BOLTS OR OTHER DOOR HARDWARE (U.S. CLS. 21, 23, 26, 36 AND 38).

FIRST USE 9-1-2008; IN COMMERCE 9-1-2008.
JOHN SCHUYLER YARD, EXAMINING ATTORNEY

CLASS 9—(Continued).

SN 77-613,817. BEYER, PHILIP P., SMYRNA, TN. FILED 11-13-2008.

SYSTEM BUSTER

THE MARK CONSISTS OF STANDARD CHARACTERS WITHOUT CLAIM TO ANY PARTICULAR FONT, STYLE, SIZE, OR COLOR.

FOR COMPUTER SOFTWARE PLATFORMS FOR BUSINESS PROCESS MANAGEMENT (U.S. CLS. 21, 23, 26, 36 AND 38).

FIRST USE 10-0-2005; IN COMMERCE 10-0-2005.
DAVON HATCHETT, EXAMINING ATTORNEY

SN 77-616,285. THE TIFFEN COMPANY, LLC, HAUPPAUGE, NY. FILED 11-18-2008.

PHOTOFX

THE MARK CONSISTS OF STANDARD CHARACTERS WITHOUT CLAIM TO ANY PARTICULAR FONT, STYLE, SIZE, OR COLOR.

FOR COMPUTER SOFTWARE, NAMELY, SOFTWARE FOR EDITING IMAGES PERFORMED BY FILTERING, DIFFUSING, COLORING, POLARIZING, VIGNETTING, ENHANCING AND CUSTOMIZING IMAGES (U.S. CLS. 21, 23, 26, 36 AND 38).

MICHAEL WEBSTER, EXAMINING ATTORNEY

SN 77-616,287. THE TIFFEN COMPANY, LLC, HAUPPAUGE, NY. FILED 11-18-2008.

FOTOFX

THE MARK CONSISTS OF STANDARD CHARACTERS WITHOUT CLAIM TO ANY PARTICULAR FONT, STYLE, SIZE, OR COLOR.

FOR COMPUTER SOFTWARE, NAMELY, SOFTWARE FOR EDITING IMAGES PERFORMED BY FILTERING, DIFFUSING, COLORING, POLARIZING, VIGNETTING, ENHANCING AND CUSTOMIZING IMAGES (U.S. CLS. 21, 23, 26, 36 AND 38).

MICHAEL WEBSTER, EXAMINING ATTORNEY

CLASS 9—(Continued).

SN 77-617,803. FLOORCOVERINGS INTERNATIONAL, LTD., SMYRNA, GA. FILED 11-19-2008.

InspireNet

THE MARK CONSISTS OF STANDARD CHARACTERS WITHOUT CLAIM TO ANY PARTICULAR FONT, STYLE, SIZE, OR COLOR.

FOR DOWNLOADABLE COMPUTER SOFTWARE FOR COLOR ANALYSIS, SPACE PLANNING, FURNITURE SELECTION, MATERIAL AND SURFACE SELECTION, AND LAYOUT DESIGN IN THE FIELD OF INTERIOR DESIGN (U.S. CLS. 21, 23, 26, 36 AND 38).

FIRST USE 8-15-2007; IN COMMERCE 8-15-2007.
ANDREW LEASER, EXAMINING ATTORNEY

SN 77-618,030. BROADCAST LIVE TECHNOLOGIES INC., VICTORIA, B.C., CANADA, FILED 11-19-2008.

BUGG

THE MARK CONSISTS OF STANDARD CHARACTERS WITHOUT CLAIM TO ANY PARTICULAR FONT, STYLE, SIZE, OR COLOR.

FOR RADIO RECEIVERS AND TRANSMITTERS, NAMELY, RADIO RECEIVERS FOR MOUNTING OVER THE EAR OF A SPECTATOR AT A LIVE SPORTING EVENT, AND RADIO TRANSMITTERS FOR BROADCASTING REAL-TIME COMMENTARY AND ANALYSIS OF THE LIVE SPORTING EVENT TO THE SPECTATORS WEARING THE RECEIVERS (U.S. CLS. 21, 23, 26, 36 AND 38).

FRED MANDIR, EXAMINING ATTORNEY

CLASS 9—(Continued).

SN 77-624,023. PANASONIC CORPORATION, OSAKA, JAPAN, FILED 12-1-2008.



OWNER OF U.S. REG. NO. 2,943,376.

NO CLAIM IS MADE TO THE EXCLUSIVE RIGHT TO USE "IMAGE VIEWER", APART FROM THE MARK AS SHOWN.

THE COLOR(S) LIGHT BLUE, MEDIUM BLUE AND BLACK IS/ARE CLAIMED AS A FEATURE OF THE MARK.

THE MARK CONSISTS OF THE WORDS "VIERA IMAGE VIEWER" IN STYLIZED BLACK LETTERS LOCATED BELOW A RECTANGLE TRUNCATED AT ITS UPPER RIGHT CORNER, WITH ROUGHLY THE UPPER LEFT HALF SHADED IN MEDIUM BLUE AND THE LOWER RIGHT CORNER PROGRESSIVELY SHADED FROM LIGHT BLUE TO MEDIUM BLUE, IN SQUARES FROM THE LOWER-RIGHT CORNER.

FOR PLASMA TELEVISIONS; LCD TELEVISIONS; VIDEO APPARATUS, NAMELY, SLIM TELEVISION SETS, VIDEO CASSETTE RECORDERS, DIGITAL VIDEO DISC PLAYERS OR DIGITAL VIDEO DISC RECORDERS, ALL EQUIPPED WITH A FLAT DISPLAY (U.S. CLS. 21, 23, 26, 36 AND 38).

DAWN FELDMAN, EXAMINING ATTORNEY

SN 77-624,270. NIKON CORPORATION, TOKYO, JAPAN, FILED 12-1-2008.

BDC PREDATOR RETICLE

THE MARK CONSISTS OF STANDARD CHARACTERS WITHOUT CLAIM TO ANY PARTICULAR FONT, STYLE, SIZE, OR COLOR.

NO CLAIM IS MADE TO THE EXCLUSIVE RIGHT TO USE "BDC" OR "RETICLE", APART FROM THE MARK AS SHOWN.

FOR RIFLE SCOPES (U.S. CLS. 21, 23, 26, 36 AND 38).
ALLISON SCHRODY, EXAMINING ATTORNEY

CLASS 9—(Continued).

SN 77-624,493. SCHOLASTIC INC., NEW YORK, NY. FILED 12-2-2008.

DIGGING FOR DINOSAURS

THE MARK CONSISTS OF STANDARD CHARACTERS WITHOUT CLAIM TO ANY PARTICULAR FONT, STYLE, SIZE, OR COLOR.

NO CLAIM IS MADE TO THE EXCLUSIVE RIGHT TO USE "DINOSAURS", APART FROM THE MARK AS SHOWN.

FOR MULTI PLATFORM INTERACTIVE VIDEO GAME DISCS AND COMPUTER GAME PROGRAMS FOR CHILDREN (U.S. CLS. 21, 23, 26, 36 AND 38).

KATHY DE JONGE, EXAMINING ATTORNEY

SN 77-625,951. VEGAS.COM, LLC, HENDERSON, NV. FILED 12-3-2008.



THE MARK CONSISTS OF A FIGURE RESEMBLING A HEXAGON SURROUNDED BY THREE PARTIAL HEXAGONS TO THE LEFT OF THE TEXT "CYLLENIUS".

FOR COMPUTER SOFTWARE FOR MANAGING AND PROCESSING ONSITE TICKETING, ACCESS CONTROL, ELECTRONIC IDENTIFICATION, CONTROLLED SPENDING, CONTACT MANAGEMENT, ECOMMERCE SHOPPING CARTS, CALL CENTERS, CUSTOMER SERVICE, CONCIERGE SERVICES, CASHLESS PAYMENT PROCESSING, MARKETING AND PROMOTIONS CAMPAIGNS, AND COMPUTER SOFTWARE FOR SEARCHING, PURCHASING AND PROVIDING INFORMATION REGARDING HOSPITALITY, TRAVEL AND ENTERTAINMENT-RELATED SERVICES AND MERCHANDISE; COMPUTER SOFTWARE FOR USE IN OPERATING KEYLESS ENTRY SYSTEMS, ACCESS CONTROL DEVICES, POINT OF SALE SYSTEMS, VENDING, ARCADES, RADIO-FREQUENCY IDENTIFICATION (RFID) DEVICES, MOBILE ELECTRONIC DEVICES, AND COMPUTERS CONNECTED TO THE INTERNET (U.S. CLS. 21, 23, 26, 36 AND 38).

FIRST USE 10-22-2007; IN COMMERCE 10-22-2007.
MATTHEW KLINE, EXAMINING ATTORNEY

SN 77-628,766. WGI INNOVATIONS, LTD., GRAND PRAIRIE, TX. FILED 12-8-2008.



THE MARK CONSISTS OF THE WORD "EDGE" IN LETTERS THAT LEAN.

FOR HANDHELD LASER RANGEFINDERS (U.S. CLS. 21, 23, 26, 36 AND 38).

EMILY CARLSEN, EXAMINING ATTORNEY

CLASS 9—(Continued).

SN 77-631,387. SOFTGENETICS, LLC, STATE COLLEGE, PA. FILED 12-11-2008.

CONDENSATION TOOL

THE MARK CONSISTS OF STANDARD CHARACTERS WITHOUT CLAIM TO ANY PARTICULAR FONT, STYLE, SIZE, OR COLOR.

NO CLAIM IS MADE TO THE EXCLUSIVE RIGHT TO USE "TOOL", APART FROM THE MARK AS SHOWN.

FOR COMPUTER SOFTWARE COMPONENT FOR ERROR REDUCTION, INCREASE READING LENGTH, DECREASE READING COUNT, SOLD AS AN INTEGRAL COMPONENT OF COMPUTER SOFTWARE FOR ASSEMBLY, EXPRESSION, AND MUTATION ANALYSIS OF DNA SEQUENCES (U.S. CLS. 21, 23, 26, 36 AND 38).

FIRST USE 6-15-2008; IN COMMERCE 6-15-2008.
KAREN K. BUSH, EXAMINING ATTORNEY

SN 77-632,002. EICHLER, DONALD G., TA EICHLER VALVE CO., EDMOND, OK. FILED 12-12-2008.



NO CLAIM IS MADE TO THE EXCLUSIVE RIGHT TO USE "VALVE CO.", APART FROM THE MARK AS SHOWN.

THE MARK CONSISTS OF A STYLIZED "EV" WITH THE STYLIZED WORDS "EICHLER VALVE CO." TO THE LOWER RIGHT OF THE "EV" WITH A LINE EXTENDING FROM THE SIDE OF THE "V" TO UNDER THE WORDS "EICHLER VALVE CO.".

FOR EXCESS FLOW VALVES FOR NATURAL GAS (U.S. CLS. 21, 23, 26, 36 AND 38).

FIRST USE 4-25-2008; IN COMMERCE 4-25-2008.
KOURTNEE HODGES, EXAMINING ATTORNEY

CLASS 9—(Continued).

SN 77-634,458. E.F. JOHNSON COMPANY, IRVING, TX.
FILED 12-16-2008.

DISCOVER MIC

THE MARK CONSISTS OF STANDARD CHARACTERS WITHOUT CLAIM TO ANY PARTICULAR FONT, STYLE, SIZE, OR COLOR.

NO CLAIM IS MADE TO THE EXCLUSIVE RIGHT TO USE "MIC", APART FROM THE MARK AS SHOWN.

FOR SPEAKER MICROPHONE FOR USE WITH MOBILE RADIOS FOR TRANSMITTING GPS LOCATION INFORMATION (U.S. CLS. 21, 23, 26, 36 AND 38).

CHRIS WELLS, EXAMINING ATTORNEY

SN 77-636,424. BROADCAST TOOLS, INC., SEDRO WOOLLEY, WA. FILED 12-18-2008.

SITE SENTINEL

THE MARK CONSISTS OF STANDARD CHARACTERS WITHOUT CLAIM TO ANY PARTICULAR FONT, STYLE, SIZE, OR COLOR.

NO CLAIM IS MADE TO THE EXCLUSIVE RIGHT TO USE "SITE", APART FROM THE MARK AS SHOWN.

FOR ELECTRONIC DEVICES, NAMELY, COMPUTER HARDWARE USED TO REMOTELY MONITOR AND CONTROL BROADCAST AND AUDIOVISUAL RECEIVERS VIA THE INTERNET (U.S. CLS. 21, 23, 26, 36 AND 38).

FIRST USE 2-9-2009; IN COMMERCE 2-9-2009.

BRENDAN MCCAULEY, EXAMINING ATTORNEY

SN 77-639,382. BLUEVIEW TECHNOLOGIES, INC., SEATTLE, WA. FILED 12-23-2008.

BLUEVIEW

THE MARK CONSISTS OF STANDARD CHARACTERS WITHOUT CLAIM TO ANY PARTICULAR FONT, STYLE, SIZE, OR COLOR.

OWNER OF U.S. REG. NO. 3,338,780.

FOR SONAR AND COMPONENT PARTS THEREOF; SOFTWARE ASSOCIATED WITH SONAR SYSTEMS FOR USE IN OPERATION OF SONAR SYSTEMS (U.S. CLS. 21, 23, 26, 36 AND 38).

FIRST USE 1-1-2008; IN COMMERCE 1-1-2008.

DOMINIC FATHY, EXAMINING ATTORNEY

CLASS 9—(Continued).

SN 77-641,012. QUALTECH GLOBAL LTD, KOWLOON, HONG KONG, FILED 12-29-2008.

Qualtech

THE MARK CONSISTS OF STANDARD CHARACTERS WITHOUT CLAIM TO ANY PARTICULAR FONT, STYLE, SIZE, OR COLOR.

FOR ACCUMULATOR BOXES; AMUSEMENT APPARATUS ADAPTED FOR USE WITH AN EXTERNAL DISPLAY SCREEN OR MONITOR; AUDIO-VIDEO RECEIVERS; CASES FOR DISKETTES AND COMPACT DISKS; COMPONENTS FOR GAMING MACHINES, NAMELY, CONTROLLERS, DISPLAYS, BUTTON PANELS, BOLSTERS, ELECTRICAL WIRING, AND COMPUTER HARDWARE AND SOFTWARE ASSOCIATED THEREWITH; COMPUTER GAME CONSOLES FOR USE WITH AN EXTERNAL DISPLAY SCREEN OR MONITOR; COMPUTER MONITORS; CONVERTERS; DATA PROCESSORS; EAR PLUGS FOR SLEEPING; EAR PLUGS FOR SOUNDPROOFING; EAR PLUGS NOT FOR MEDICAL PURPOSES; EARPHONES AND HEADPHONES; ELECTRIC ACCUMULATORS; ELECTRIC CABLES AND WIRES; ELECTRONIC AND VIDEO GAME CONTROLLERS INCORPORATED INTO EXERCISE MACHINES; HAND-HELD UNITS FOR PLAYING ELECTRONIC GAMES FOR USE WITH EXTERNAL DISPLAY SCREEN OR MONITOR; JOYSTICKS FOR VIDEO GAMES; JUKE BOXES; MICROPHONES; MP3 PLAYERS; MP4 PLAYERS; PLAYER-OPERATED ELECTRONIC CONTROLLERS FOR ELECTRONIC VIDEO GAME MACHINES; PROTECTIVE CARRYING CASES SPECIALLY ADAPTED FOR VIDEO GAME CONSOLES FOR USE WITH AN EXTERNAL DISPLAY SCREEN OR MONITOR; RECORD PLAYERS; REMOTE CURSOR CONTROLS FOR COMPUTERS; TRANSMITTERS OF ELECTRONIC SIGNALS; VIDEO GAME CONSOLES FOR USE WITH AN EXTERNAL DISPLAY SCREEN OR MONITOR; VIDEO GAME INTERACTIVE REMOTE CONTROL UNITS; VIDEO GAME MACHINES FOR USE WITH EXTERNAL DISPLAY SCREEN OR MONITOR; VIDEO OUTPUT GAME MACHINES FOR USE WITH EXTERNAL DISPLAY SCREEN OR MONITOR (U.S. CLS. 21, 23, 26, 36 AND 38).

FIRST USE 5-4-2005; IN COMMERCE 8-24-2007.

GEOFFREY FOSDICK, EXAMINING ATTORNEY

SN 77-644,519. SHANGHAI UPUN ELECTRIC CO., LIMITED, SHANGHAI, CHINA, FILED 1-7-2009.

UPUN

THE MARK CONSISTS OF THE WORD "UPUN" SHOWN IN STYLIZED LETTERING.

THE WORDING "UPUN" HAS NO MEANING IN A FOREIGN LANGUAGE.

FOR CABLE CONNECTORS; CIRCUIT BREAKERS; CONNECTORS FOR ELECTRONIC CIRCUITS; ELECTRIC CONNECTIONS; ELECTRIC RELAYS; ELECTRICAL CONNECTION BOXES; ELECTRICAL CONTROLLING DEVICES; ELECTRICAL POWER SUPPLIES; ELECTRICAL RELAYS AND TRANSFORMERS; INDICATOR LIGHTS (U.S. CLS. 21, 23, 26, 36 AND 38).

AMEEN IMAM, EXAMINING ATTORNEY

CLASS 9—(Continued).

SN 77-645,063. DRI CORPORATION, DALLAS, TX. FILED 1-7-2009.

A WORLD OF TRANSIT COMMUNICATIONS AND SECURITY SOLUTIONS

THE MARK CONSISTS OF STANDARD CHARACTERS WITHOUT CLAIM TO ANY PARTICULAR FONT, STYLE, SIZE, OR COLOR.
FOR HARDWARE, NAMELY, ELECTRONIC DISPLAY UNITS, AND COMPUTER SOFTWARE FOR USE ON MASS TRANSIT VEHICLES FOR THE PURPOSE OF PROVIDING PASSENGERS AND TRANSPORTATION OPERATORS WITH REAL-TIME INFORMATION TO ASSIST IN THE SAFE AND EFFICIENT USE OF PUBLIC TRANSPORTATION (U.S. CLS. 21, 23, 26, 36 AND 38).
INGRID C. EULIN, EXAMINING ATTORNEY

SN 77-645,584. UNIVERSAL CITY STUDIOS LLLP, UNIVERSAL CITY, CA. FILED 1-8-2009.

NUTTY COMEDY COLLECTION

THE MARK CONSISTS OF STANDARD CHARACTERS WITHOUT CLAIM TO ANY PARTICULAR FONT, STYLE, SIZE, OR COLOR.
NO CLAIM IS MADE TO THE EXCLUSIVE RIGHT TO USE "COMEDY COLLECTION", APART FROM THE MARK AS SHOWN.
FOR SERIES OF PRE-RECORDED AND INTERACTIVE VIDEO RECORDINGS IN ALL FORMATS FEATURING MOTION PICTURES (U.S. CLS. 21, 23, 26, 36 AND 38).
KELLY BOULTON, EXAMINING ATTORNEY

SN 77-652,250. RENKARA MEDIA GROUP, INC., INVERNESS, IL. FILED 1-19-2009.

iComedian

THE MARK CONSISTS OF STANDARD CHARACTERS WITHOUT CLAIM TO ANY PARTICULAR FONT, STYLE, SIZE, OR COLOR.
FOR SOFTWARE APPLICATIONS FOR THE PERFORMANCE OF PREDEFINED JOKES THROUGH THE DISPLAY OF TEXT AND PLAYBACK OF AUDIO RECORDINGS, UTILIZING MOBILE COMMUNICATION DEVICES (U.S. CLS. 21, 23, 26, 36 AND 38).
KELLEY WELLS, EXAMINING ATTORNEY

CLASS 9—(Continued).

SN 77-652,684. LUTRON ELECTRONICS CO., INC., COOPERSBURG, PA. FILED 1-20-2009.

MEADOWLARK

THE MARK CONSISTS OF STANDARD CHARACTERS WITHOUT CLAIM TO ANY PARTICULAR FONT, STYLE, SIZE, OR COLOR.
OWNER OF U.S. REG. NO. 1,472,979.
FOR LIGHTING CONTROLS, NAMELY, ELECTRIC LIGHT DIMMERS; ELECTRONIC CONTROLS FOR SETTING CEILING FAN SPEEDS (U.S. CLS. 21, 23, 26, 36 AND 38).
STEPHEN AQUILA, EXAMINING ATTORNEY

SN 77-653,187. YORK LABORATORIES, LLC, YORK, PA. FILED 1-21-2009.

GREASE THIEF

THE MARK CONSISTS OF STANDARD CHARACTERS WITHOUT CLAIM TO ANY PARTICULAR FONT, STYLE, SIZE, OR COLOR.
NO CLAIM IS MADE TO THE EXCLUSIVE RIGHT TO USE "GREASE", APART FROM THE MARK AS SHOWN.
FOR APPARATUS TO ACQUIRE A GREASE SAMPLE FOR SUBSEQUENT TESTING FROM A GREASE-LUBRICATED COMPONENT SUCH AS A BEARING, GEAR, VALVE ACTUATOR, ELECTRIC MOTOR HOUSING, BUSHING, OR LUBRICATED SLIDING SURFACE, NAMELY, A NON-MEDICAL SYRINGE, AND GREASE TESTING APPARATUS FOR MEASURING ONE OR MORE PHYSICAL PROPERTIES OF A GREASE SAMPLE, NAMELY, AN EXTRUSION DIE, A PUSHER TO EXTRUDE THE GREASE THROUGH THE DIE OPENING, AND A SENSOR FOR MEASURING THE FORCE APPLIED BY THE PUSHER EXTRUDING THE GREASE (U.S. CLS. 21, 23, 26, 36 AND 38).
FIRST USE 4-21-2008; IN COMMERCE 6-12-2008.
SHARON MEIER, EXAMINING ATTORNEY

SN 77-656,846. Z-BOX ARTIST GROUP, LLC, NASHVILLE, TN. FILED 1-26-2009.

Z-BOX ARTIST GROUP

THE MARK CONSISTS OF STANDARD CHARACTERS WITHOUT CLAIM TO ANY PARTICULAR FONT, STYLE, SIZE, OR COLOR.
NO CLAIM IS MADE TO THE EXCLUSIVE RIGHT TO USE "ARTIST GROUP", APART FROM THE MARK AS SHOWN.
FOR MUSICAL SOUND RECORDINGS AND AUDIO-VISUAL RECORDINGS FEATURING MUSICAL ENTERTAINMENT (U.S. CLS. 21, 23, 26, 36 AND 38).
MEGHAN REINHART, EXAMINING ATTORNEY

CLASS 9—(Continued).

SN 77-659,390. NETWORK VOX SOFTWARE LTDA., JOINVILLE, BRAZIL, FILED 1-29-2009.



THE MARK CONSISTS OF A DESIGN OF A SQUARE, WITH THE TOP RIGHT HAND CORNER OF THE SQUARE SEPARATED FROM THE REST OF THE SQUARE, FOLLOWED BY THE WORD "DRIMIO".

FOR COMPUTER PROGRAMS TO PROVIDE AN ONLINE ENVIRONMENT IN WHICH PEOPLE AND COMPANIES ARE ABLE TO SHARE CONTENTS, INFORMATION AND PROMOTIONS RELATED TO TRADEMARKS (U.S. CLS. 21, 23, 26, 36 AND 38).

RONALD MCMORROW, EXAMINING ATTORNEY

SN 77-660,519. SPIDESCAPE PRODUCTS, INC., DBA DEUS RESCUE, LONE TREE, CO. FILED 1-30-2009.

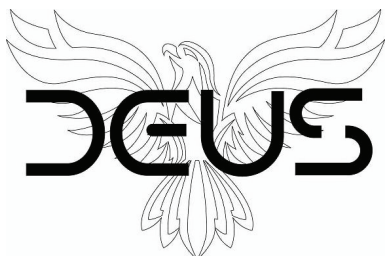

THE MARK CONSISTS OF THE WORD "DEUS" IN FRONT OF A BIRD.

FOR SAFETY MECHANISM, NAMELY, A CONTROLLED DESCENT DEVICE COMPRISED OF AT LEAST ONE SLOWING MECHANISM THAT ALLOWS FOR A REGULATED DESCENT AT A SAFE SPEED (U.S. CLS. 21, 23, 26, 36 AND 38).

KATHLEEN LORENZO, EXAMINING ATTORNEY

SN 77-666,300. PHOENIX INTEGRATION, INC., WAYNE, PA. FILED 2-9-2009.

PHX SIMULATION SANDBOX

THE MARK CONSISTS OF STANDARD CHARACTERS WITHOUT CLAIM TO ANY PARTICULAR FONT, STYLE, SIZE, OR COLOR.

NO CLAIM IS MADE TO THE EXCLUSIVE RIGHT TO USE "SIMULATION SANDBOX", APART FROM THE MARK AS SHOWN.

FOR COMPUTER SOFTWARE FOR INDUSTRIAL DESIGN, TESTING, ENGINEERING AND DEVELOPMENT OF TECHNICAL PRODUCTS (U.S. CLS. 21, 23, 26, 36 AND 38).

KOURTNEE HODGES, EXAMINING ATTORNEY

CLASS 9—(Continued).

SN 77-667,059. SCHEELS ALL SPORTS, INC., FARGO, ND. FILED 2-10-2009.



OWNER OF U.S. REG. NO. 2,814,941.

NO CLAIM IS MADE TO THE EXCLUSIVE RIGHT TO USE "HD", APART FROM THE MARK AS SHOWN.

THE MARK CONSISTS OF THE WORD "SCHEELS" WITH THE WORD "PARAGON" DIRECTLY BELOW AND THE LETTERS "HD" RIGHT JUSTIFIED BELOW "PARAGON".

FOR BINOCULARS (U.S. CLS. 21, 23, 26, 36 AND 38).

FIRST USE 8-1-2007; IN COMMERCE 8-1-2007.

GINA FINK, EXAMINING ATTORNEY

SN 77-668,829. CAI YIMEI, NINGBO, ZHEJIANG, CHINA, FILED 2-11-2009.



NO CLAIM IS MADE TO THE EXCLUSIVE RIGHT TO USE "911 SIGNAL", APART FROM THE MARK AS SHOWN.

THE MARK CONSISTS OF NUMBERS "911" AND WORD "SIGNAL". THE TOP OF THE LETTER "S" AND THE TOP OF THE LETTER "Y" EXTEND TO FORM A HALF OVAL AROUND THE WORD.

FOR ALARM INSTALLATIONS AND ALARMS; ELECTRIC SWITCHES; ELECTRONIC LED SIGNS; EMERGENCY WARNING LIGHTS; FLASHING SAFETY LIGHTS; LOUDSPEAKERS; ROTATING LIGHTS; SAFETY EQUIPMENT, NAMELY, BEACON LIGHTS; SIRENS; TRAFFIC-LIGHT APPARATUS (U.S. CLS. 21, 23, 26, 36 AND 38).

ERIN FALK, EXAMINING ATTORNEY

CLASS 9—(Continued).

SN 77-669,299. POWER-NAP, L.L.C., BEACHWOOD, OH. FILED 2-12-2009.

COLORS

THE MARK CONSISTS OF STANDARD CHARACTERS WITHOUT CLAIM TO ANY PARTICULAR FONT, STYLE, SIZE, OR COLOR.

FOR SOUND RECORDINGS FEATURING AUDIBLE AND SUB-AUDIBLE PATTERNS OF SOUND FREQUENCIES, RECORDED MUSIC PRODUCED BY MODULATED CARRIER WAVES, AND/OR OCEAN SOUNDS AND RUNNING WATER OR OTHER SOUNDS OF NATURE, AND/OR WHITE NOISE FOR USE IN MEDITATION OR AS A SLEEP AID (U.S. CLS. 21, 23, 26, 36 AND 38).

FIRST USE 8-22-2008; IN COMMERCE 8-22-2008. MARY CRAWFORD, EXAMINING ATTORNEY

SN 77-669,354. POWER-NAP, L.L.C., BEACHWOOD, OH. FILED 2-12-2009.

DIVE

THE MARK CONSISTS OF STANDARD CHARACTERS WITHOUT CLAIM TO ANY PARTICULAR FONT, STYLE, SIZE, OR COLOR.

FOR SOUND RECORDINGS FEATURING AUDIBLE AND SUB-AUDIBLE PATTERNS OF SOUND FREQUENCIES, RECORDED MUSIC PRODUCED BY MODULATED CARRIER WAVES, AND/OR OCEAN SOUNDS AND RUNNING WATER OR OTHER SOUNDS OF NATURE, AND/OR WHITE NOISE FOR USE IN MEDITATION OR AS A SLEEP AID (U.S. CLS. 21, 23, 26, 36 AND 38).

FIRST USE 11-12-2005; IN COMMERCE 11-12-2005. MARY CRAWFORD, EXAMINING ATTORNEY

SN 77-672,915. STEPHEN A. FARNOW, DBA JUST THE SKINNY PUBLISHING, LA JOLLA, CA. FILED 2-18-2009.

Just the Skinny

THE MARK CONSISTS OF STANDARD CHARACTERS WITHOUT CLAIM TO ANY PARTICULAR FONT, STYLE, SIZE, OR COLOR.

FOR DOWNLOADABLE ELECTRONIC PUBLICATIONS IN THE NATURE OF INSTRUCTIONAL BOOKS IN THE FIELD OF HOW TO USE THE COMPUTER SOFTWARE OF OTHERS; ELECTRONIC PUBLICATIONS, NAMELY, INSTRUCTIONAL BOOKS FEATURING HOW TO USE THE COMPUTER SOFTWARE OF OTHERS RECORDED ON COMPUTER MEDIA (U.S. CLS. 21, 23, 26, 36 AND 38).

FIRST USE 2-12-2009; IN COMMERCE 2-12-2009. MARGARET POWER, EXAMINING ATTORNEY

CLASS 9—(Continued).

SN 77-672,993. STEPHEN A. FARNOW, DBA JUST THE SKINNY PUBLISHING, LA JOLLA, CA. FILED 2-18-2009.

Just the SKINNY

THE MARK CONSISTS OF THE WORDS "JUST THE" WITH THE TRAILING "T" IN "JUST" BEING IN COMMON WITH THE LEADING "T" IN "THE", AND BOTH WORDS STACKED ON TOP OF THE WORD "SKINNY".

FOR DOWNLOADABLE ELECTRONIC PUBLICATIONS IN THE NATURE OF INSTRUCTIONAL BOOKS IN THE FIELD OF HOW TO USE THE COMPUTER SOFTWARE OF OTHERS; ELECTRONIC PUBLICATIONS, NAMELY, INSTRUCTIONAL BOOKS FEATURING HOW TO USE THE COMPUTER SOFTWARE OF OTHERS RECORDED ON COMPUTER MEDIA (U.S. CLS. 21, 23, 26, 36 AND 38).

FIRST USE 2-12-2009; IN COMMERCE 2-12-2009. MARGARET POWER, EXAMINING ATTORNEY

SN 77-673,227. KLEINMAN, STEPHANIE, STUDIO CITY, CA. FILED 2-18-2009.

FABRIC STUDIO

NO CLAIM IS MADE TO THE EXCLUSIVE RIGHT TO USE "STUDIO", APART FROM THE MARK AS SHOWN.

THE MARK CONSISTS OF THE LETTERS "FA", THE LETTER "B" WRITTEN IN STYLIZED FORM WITH A SEWING NEEDLE ACTING AS THE LEFT SIDE OF THE "B" AND A STRING OF YARN ACTING AS THE RIGHT SIDE OF THE "B", THE LETTERS "RIC", AND THE WORD "STUDIO".

FOR COMPUTER SOFTWARE FOR DESIGNING AND PRINTING FABRIC (U.S. CLS. 21, 23, 26, 36 AND 38).

FIRST USE 12-1-2007; IN COMMERCE 3-1-2008. HEATHER THOMPSON, EXAMINING ATTORNEY

CLASS 9—(Continued).

SN 77-677,863. ABBYY SOFTWARE LTD., NICOSIA, CYPRUS, FILED 2-25-2009.

TouchTo

THE MARK CONSISTS OF STANDARD CHARACTERS WITHOUT CLAIM TO ANY PARTICULAR FONT, STYLE, SIZE, OR COLOR.

FOR SOFTWARE, FOR USE WITH TOUCH-SCREEN SCANNING DEVICES, FOR OPTICAL CHARACTER RECOGNITION, EXTRACTION, INDEXING, ORGANIZATION AND TRANSMISSION OF DATA FROM HARD-COPY DOCUMENTS (U.S. CLS. 21, 23, 26, 36 AND 38).

FIRST USE 2-11-2009; IN COMMERCE 2-11-2009.
ERIN FALK, EXAMINING ATTORNEY

SN 77-681,350. INERA, INC., NEWTON, MA. FILED 3-2-2009.

INERA

THE MARK CONSISTS OF STANDARD CHARACTERS WITHOUT CLAIM TO ANY PARTICULAR FONT, STYLE, SIZE, OR COLOR.

OWNER OF U.S. REG. NO. 2,320,691.

THE WORDING "INERA" HAS NO MEANING IN A FOREIGN LANGUAGE.

FOR COMPUTER SOFTWARE FOR EDITING DOCUMENTS AND GENERATING STRUCTURED MARKUP USED IN TRADITIONAL PRINTING AND PUBLICATION AND IN PUBLICATION ON COMPUTERS AND LOCAL, WIDE AREA AND GLOBAL NETWORKS (U.S. CLS. 21, 23, 26, 36 AND 38).

FIRST USE 6-9-2009; IN COMMERCE 6-9-2009.
APRIL HESIK, EXAMINING ATTORNEY

SN 77-682,452. DARREL EDWARDS INC., SAN DIEGO, CA. FILED 3-3-2009.

Dr. D's Lighthouse Learning

THE MARK CONSISTS OF STANDARD CHARACTERS WITHOUT CLAIM TO ANY PARTICULAR FONT, STYLE, SIZE, OR COLOR.

NO CLAIM IS MADE TO THE EXCLUSIVE RIGHT TO USE "LEARNING", APART FROM THE MARK AS SHOWN.

THE NAME(S), PORTRAIT(S), AND/OR SIGNATURE(S) SHOWN IN THE MARK IDENTIFIES DARREL EDWARDS, WHOSE CONSENT(S) TO REGISTER IS MADE OF RECORD.

FOR EDUCATIONAL SOFTWARE FEATURING INSTRUCTION IN HOW TO BUILD TESTS FOR SELF-TESTING AND LEARNING IN ANY SUBJECT MATTER (U.S. CLS. 21, 23, 26, 36 AND 38).

CHERYL CLAYTON, EXAMINING ATTORNEY

CLASS 9—(Continued).

SN 77-685,296. AUTEK, INC., ROWLAND HEIGHTS, CA. FILED 3-6-2009.

D&C

THE MARK CONSISTS OF STANDARD CHARACTERS WITHOUT CLAIM TO ANY PARTICULAR FONT, STYLE, SIZE, OR COLOR.

FOR EYEWEAR; NOSE GUARDS WHICH CAN BE WORN BY ATTACHMENT TO EYEWEAR SUCH AS SUNGLASSES AND SKI GOGGLES (U.S. CLS. 21, 23, 26, 36 AND 38).

FIRST USE 1-3-2009; IN COMMERCE 1-3-2009.
RONALD AIKENS, EXAMINING ATTORNEY

SN 77-685,448. VICTOR B. MASON, APPLE VALLEY, CA. FILED 3-6-2009.

MOJAVE

THE MARK CONSISTS OF STANDARD CHARACTERS WITHOUT CLAIM TO ANY PARTICULAR FONT, STYLE, SIZE, OR COLOR.

FOR ELECTRICAL APPARATUS FOR USE WITH MUSICAL INSTRUMENTS, NAMELY, AMPLIFIERS; SOUND AMPLIFIERS; MUSICAL INSTRUMENT AMPLIFIERS; GUITAR AMPLIFIERS; AMPLIFIER SPEAKER CABINETS AND SPEAKER ENCLOSURES; COMPONENTS, ACCESSORIES AND REPLACEMENT PARTS FOR THE FOREGOING GOODS, NAMELY, SPEAKERS, AMPLIFIERS POWER CORDS, ELECTRONIC FOOT PEDAL CONTROLS, AMPLIFIER CORNERS, AMPLIFIER HANDLES, AMPLIFIERS KNOBS, AMPLIFIER CONTROLS, ADJUSTABLE ELECTRONIC AUDIO BIAS CONTROLS, ADJUSTABLE ELECTRONIC FEEDBACK CONTROLS, VARIABLE POWER CONTROLS, POWER DAMPENING CONTROLS, CAPACITORS, DIODES, TRANSISTORS, TRANSFORMERS, VARIABLE TRANSFORMERS, AMPLIFIER TUBES, ELECTRONIC AUDIO REVERBERATION UNITS, ELECTRONIC FOOT PEDAL CONTROLS AND ASSEMBLIES THEREFOR, AMPLIFIER SWITCHES (U.S. CLS. 21, 23, 26, 36 AND 38).

FIRST USE 7-21-2001; IN COMMERCE 7-21-2001.
HEATHER THOMPSON, EXAMINING ATTORNEY

CLASS 9—(Continued).

SN 77-687,146. KYE SYSTEMS CORP., TAIPEI HSIEN, TAIWAN, FILED 3-10-2009.



THE MARK CONSISTS OF A STYLIZED MARK OF "AGAMA".

FOR COMPUTERS, COMPUTER HARDWARE, COMPUTER PERIPHERALS, DATA PROCESSING EQUIPMENT; DATA INPUT AND OUTPUT DEVICES, NAMELY, KEYBOARDS, AND COMPUTER PRINTERS; POINTING DEVICES FOR USE WITH COMPUTERS, NAMELY, LASER POINTERS; COMPUTER CURSOR CONTROL DEVICES, NAMELY, COMPUTER MOUSE, MOUSE PADS, TRACKBALLS, KEYBOARDS, SCANNERS, COMPUTER PRINTERS, MULTI-FUNCTION COMPUTER PRINTERS; HANDWRITING INPUT DEVICES, NAMELY, DIGITIZER TABLETS, DIGITAL NOTEPADS, AND DIGITAL PENS; VIDEO AND COMPUTER GAME PROGRAMS; VIDEO GAME CONTROL DEVICE WITH VIDEO GAME PROGRAMS AND DISPLAYS; GAME CONTROL DEVICES FOR COMPUTER GAME AND VIDEO GAME, NAMELY, JOYSTICKS, GAME PADS, RACING WHEELS; COMPUTER MONITORS, LIQUID CRYSTAL DISPLAYS, LIQUID CRYSTAL DISPLAY PROJECTORS; LASER POINTERS AND LUMINOUS POINTERS FOR USE WITH COMPUTERS; WIRELESS PRESENTERS IN THE NATURE OF A WIRELESS REMOTE POINTER; REMOTE CURSOR CONTROLS FOR COMPUTERS; APPARATUS FOR RECORDING, TRANSMISSION OR REPRODUCTION OF SOUND AND IMAGES; AUDIO SPEAKERS, LOUDSPEAKERS, AMPLIFIERS, STEREO TUNERS; HOME THEATER SYSTEMS COMPRISED OF PERSONAL STEREO AND AMPLIFIERS; SOUND CARDS; VIDEO CAPTURE CARDS, VIDEO DISPLAYS CARDS, GRAPHICS CARDS; MICROPHONES, HEADPHONES, EARPHONES, HEADSETS FOR USE WITH COMPUTERS; REMOTE CONTROLS FOR ENTERTAINMENT DEVICES, NAMELY, TELEVISIONS AND STEREO; VIDEO BOXES FOR USE WITH TELEVISIONS; SET-TOP BOXES; DIGITAL VIDEO FRAMES FOR DISPLAYING DIGITAL PICTURES, VIDEO CLIPS AND MUSIC; DVD PLAYERS, MP3 PLAYERS, MP4 PLAYERS, PORTABLE MEDIA PLAYERS, COMBINATION VIDEO PLAYERS AND RECORDERS; DIGITAL VIDEO RECORDERS; DIGITAL AUDIO PLAYERS; PERSONAL STEREO; RADIOS; PHOTOGRAPHIC AND OPTICAL APPARATUS AND INSTRUMENTS, NAMELY, CAMERAS, CAMCORDERS, DIGITAL CAMERAS, COMPUTER CAMERAS, VIDEO CAMERAS, WEB CAMERAS, DIGITAL VIDEO CAMCORDERS, TRIPODS FOR CAMERAS; STANDS AND SUPPORTS FOR PHOTOGRAPHIC APPARATUS, NAMELY, CAMERAS; IP NETWORK CAMERAS; DATA STORAGE DEVICES, NAMELY, HARD DISCS; COMPUTER STORAGE DEVICES, NAMELY ELECTRONIC CARD READERS, FLASH DRIVES, PEN DRIVES, COMPUTER DISC DRIVES; COMPUTER NETWORKING AND COMMUNICATION DEVICES, NAMELY, MODEMS, COMPUTER NETWORK HUBS, SWITCHES, ROUTERS, BRIDGES, GLOBAL POSITION SYSTEMS, COMPUTER NETWORK INTERFACE CARDS, PCMCIA CARDS; COMPUTER FAX MODEM CARDS; LAN ACCESS POINTS FOR CONNECTING NETWORK COMPUTER USERS; ELECTRICAL POWER SUPPLIES; UNINTERRUPTIBLE POWER SUPPLIES; COMPUTER DOCKING STATION; PERSONAL DIGITAL ASSISTANTS; CHARGING APPLIANCES FOR RECHARGEABLE EQUIPMENT, BATTERY CHARGERS, BATTERY

CLASS 9—(Continued).

CHARGE DEVICES; INTERNET PHONES; OPTICAL DATA MEDIA FOR RECORDING COMPUTER PROGRAMS, NAMELY, CD-ROMS AND BLANK COMPUTER DISCS; BAREBONE SYSTEMS, NAMELY, COMPUTER MAIN BOARDS, COMPUTER CARRYING CASES, COMPUTER CABLES; COMPUTER CARD ADAPTERS; COMPUTER NETWORK ADAPTERS; ETHERNET ADAPTERS; FLASH CARD ADAPTERS; COMPUTER SOFTWARE RECORDED ON CD-ROMS FOR USE IN THE OPERATION OF COMPUTER PERIPHERALS THEREFORE (U.S. CLS. 21, 23, 26, 36 AND 38).

AISHA CLARKE, EXAMINING ATTORNEY

SN 77-687,790. SAMSUNG ELECTRONICS CO., LTD., SUWON-SI, GYEONGGI-DO, REPUBLIC OF KOREA, FILED 3-10-2009.

SAMSUNG LUXIA ENGINE

THE MARK CONSISTS OF STANDARD CHARACTERS WITHOUT CLAIM TO ANY PARTICULAR FONT, STYLE, SIZE, OR COLOR.

OWNER OF U.S. REG. NOS. 2,774,743, 2,929,519 AND OTHERS.

NO CLAIM IS MADE TO THE EXCLUSIVE RIGHT TO USE "ENGINE", APART FROM THE MARK AS SHOWN.

THE ENGLISH TRANSLATION OF "SAMSUNG" IN THE MARK IS THREE STARS. THE WORDING "LUXIA" HAS NO MEANING IN A FOREIGN LANGUAGE.

FOR TELEVISION RECEIVERS; DVD PLAYERS; HOME THEATER SYSTEM COMPRISING TELEVISION RECEIVERS, DVD PLAYERS, AUDIO AMPLIFIERS AND AUDIO SPEAKERS (U.S. CLS. 21, 23, 26, 36 AND 38).

ROBIN MITTLER, EXAMINING ATTORNEY

SN 77-689,552. GENERATE HOLDINGS, INC., SANTA MONICA, CA. FILED 3-12-2009.

DEGENERATE COMEDY

THE MARK CONSISTS OF STANDARD CHARACTERS WITHOUT CLAIM TO ANY PARTICULAR FONT, STYLE, SIZE, OR COLOR.

NO CLAIM IS MADE TO THE EXCLUSIVE RIGHT TO USE "COMEDY", APART FROM THE MARK AS SHOWN.

FOR VIDEO AND AUDIO RECORDINGS, NAMELY, COMEDY DVDS AND CDS (U.S. CLS. 21, 23, 26, 36 AND 38).

PAUL MORENO, EXAMINING ATTORNEY

CLASS 9—(Continued).

SN 77-690,654. PITNEY BOWES SOFTWARE INC., LANHAM, MD. FILED 3-13-2009.

ASCENTIA

THE MARK CONSISTS OF STANDARD CHARACTERS WITHOUT CLAIM TO ANY PARTICULAR FONT, STYLE, SIZE, OR COLOR.

FOR DOWNLOADABLE COMPUTER SOFTWARE FOR ALLOWING INSURANCE CARRIERS TO INSTANTLY VISUALIZE AND ANALYZE POLICY DATA AND RISK EXPOSURE (U.S. CLS. 21, 23, 26, 36 AND 38).

GEOFFREY FOSDICK, EXAMINING ATTORNEY

SN 77-693,062. GT BIOMESCILT LIGHT LIMITED, KOWLOON, HONG KONG, FILED 3-17-2009.



THE MARK CONSISTS OF "LEDIGAMI" INSIDE A RECTANGLE WITH A GEOMETRIC BALL DESIGN TO THE RIGHT OF THE WORDS.

FOR VIDEO DISPLAYS, VIDEO SCREENS (U.S. CLS. 21, 23, 26, 36 AND 38).

ROBIN CHOSID, EXAMINING ATTORNEY

SN 77-693,377. CHANDRADASA, THANUSHKA, DBA BLISSFUL INTERFACES, COLOMBO 09, SRI LANKA, FILED 3-18-2009.



NO CLAIM IS MADE TO THE EXCLUSIVE RIGHT TO USE "INTERFACES", APART FROM THE MARK AS SHOWN.

THE COLOR(S) WHITE, BLUE IS/ARE CLAIMED AS A FEATURE OF THE MARK.

THE MARK CONSISTS OF "BLISSFUL INTERFACES" TEXT IN WHITE COLOR, ON LIGHT BLUE BACKGROUND.

FOR COMPUTER SOFTWARE THAT PROVIDES WEB-BASED ACCESS TO APPLICATIONS AND SERVICES THROUGH A WEB OPERATING SYSTEM OR PORTAL INTERFACE; COMPUTER SOFTWARE, NAMELY, SOFTWARE DEVELOPMENT TOOLS FOR THE CREATION OF MOBILE INTERNET APPLICATIONS AND CLIENT INTERFACES; USER INTERFACES FOR ELECTROTECHNICAL AND ELECTRONIC DEVICES (U.S. CLS. 21, 23, 26, 36 AND 38).

MARIA-VICTORIA SUAREZ, EXAMINING ATTORNEY

CLASS 9—(Continued).

SN 77-694,161. C3 ENTERTAINMENT, INC., GLENDALE, CA. FILED 3-18-2009.

LOS TRES CHIFLADOS

THE MARK CONSISTS OF STANDARD CHARACTERS WITHOUT CLAIM TO ANY PARTICULAR FONT, STYLE, SIZE, OR COLOR.

OWNER OF U.S. REG. NOS. 2,294,556, 2,305,060 AND OTHERS.

THE ENGLISH TRANSLATION OF "LOS TRES CHIFLADOS" IN THE MARK IS THE THREE STOOGES.

FOR GAMING MACHINES, NAMELY, DEVICES WHICH ACCEPT A WAGER (U.S. CLS. 21, 23, 26, 36 AND 38).

G. MAYERSCHOFF, EXAMINING ATTORNEY

SN 77-694,553. FORESEE RESULTS, INC., ANN ARBOR, MI. FILED 3-19-2009.

FORESEE

THE MARK CONSISTS OF STANDARD CHARACTERS WITHOUT CLAIM TO ANY PARTICULAR FONT, STYLE, SIZE, OR COLOR.

FOR E-COMMERCE AND ANALYTICAL SOFTWARE, NAMELY, FOR WEB ANALYTICS AND PARTICULARLY THE MEASUREMENT OF CUSTOMER SATISFACTION (U.S. CLS. 21, 23, 26, 36 AND 38).

WILLIAM BRECKENFELD, EXAMINING ATTORNEY

SN 77-697,226. DESIGNED METAL CONNECTIONS, INC., GARDENA, CA. FILED 3-23-2009.

DMC POWER

THE MARK CONSISTS OF STANDARD CHARACTERS WITHOUT CLAIM TO ANY PARTICULAR FONT, STYLE, SIZE, OR COLOR.

NO CLAIM IS MADE TO THE EXCLUSIVE RIGHT TO USE "POWER", APART FROM THE MARK AS SHOWN.

FOR ELECTRONIC CABLE CONNECTORS, BUS CONNECTORS AND GROUNDING CONNECTORS FOR USE IN THE ELECTRIC UTILITY INDUSTRY (U.S. CLS. 21, 23, 26, 36 AND 38).

SHAILA SETTLES, EXAMINING ATTORNEY

CLASS 9—(Continued).

SN 77-697,437. ROBINSON, ERIC, CAMP LEJEUNE, NC. FILED 3-24-2009.

S.O.A.P. ON A ROPE

THE MARK CONSISTS OF STANDARD CHARACTERS WITHOUT CLAIM TO ANY PARTICULAR FONT, STYLE, SIZE, OR COLOR.

FOR COMPUTER STORAGE DEVICE WITH SOFTWARE FOR THE STORAGE AND RETRIEVAL OF ELECTRONIC DATA FOR USE BY MEDICAL PROFESSIONALS (U.S. CLS. 21, 23, 26, 36 AND 38).

PRISCILLA MILTON, EXAMINING ATTORNEY

SN 77-701,345. BUREAU VERITAS, REGISTRE INTERNATIONAL DE CLASSIFICATION DE NAVIRES ET D'AERONEFS, COURBEVOIE 92400, FRANCE, FILED 3-27-2009.

BUREAU VERITAS CHEMICAL COMPLIANCE REGISTER

THE MARK CONSISTS OF STANDARD CHARACTERS WITHOUT CLAIM TO ANY PARTICULAR FONT, STYLE, SIZE, OR COLOR.

OWNER OF U.S. REG. NOS. 2,871,545, 3,425,829 AND OTHERS.

NO CLAIM IS MADE TO THE EXCLUSIVE RIGHT TO USE "BUREAU", "CHEMICAL", AND "COMPLIANCE REGISTER", APART FROM THE MARK AS SHOWN.

THE ENGLISH TRANSLATION OF "VERITAS" IN THE MARK IS TRUTH.

FOR COMPUTER SOFTWARE FOR CREATING SEARCHABLE DATABASES OF INFORMATION AND DATA FOR DATA ASCERTAINMENT FROM SUPPLY CHAINS OF PRODUCTS AS TO THEIR CHEMICAL INGREDIENTS (U.S. CLS. 21, 23, 26, 36 AND 38).

DARRYL SPRUILL, EXAMINING ATTORNEY

SN 77-702,426. TIMES FIBER COMMUNICATIONS, INC, WALLINGFORD, CT. FILED 3-30-2009.

BroadStream
PRODUCTS

NO CLAIM IS MADE TO THE EXCLUSIVE RIGHT TO USE "PRODUCTS", APART FROM THE MARK AS SHOWN.

THE MARK CONSISTS OF THE LITERAL ELEMENTS "BROAD" AND "TREAM" WITH A STYLIZED "S" IN BETWEEN THE TERMS AND IN THE SHAPE OF A CABLE AND THE TERM "PRODUCTS" BELOW THE LETTERING "TREAM".

FOR COAXIAL CABLES (U.S. CLS. 21, 23, 26, 36 AND 38).

FIRST USE 2-16-2009; IN COMMERCE 3-1-2009.

DAWN FELDMAN, EXAMINING ATTORNEY

CLASS 9—(Continued).

SN 77-702,434. UNZUETA, FRANK, SAN PEDRO, CA. FILED 3-30-2009.

SUNSTONE RECORDS

THE MARK CONSISTS OF STANDARD CHARACTERS WITHOUT CLAIM TO ANY PARTICULAR FONT, STYLE, SIZE, OR COLOR.

NO CLAIM IS MADE TO THE EXCLUSIVE RIGHT TO USE "RECORDS", APART FROM THE MARK AS SHOWN.

FOR AUDIO CASSETTES, COMPACT DISCS, AND MUSICAL SOUND RECORDINGS, ALL FEATURING MUSIC, MUSICAL PERFORMANCES, MUSICAL VIDEOS, AND PHOTOGRAPHS; DOWNLOADABLE AUDIO FILES FEATURING MUSIC, MUSICAL PERFORMANCES, MUSICAL VIDEOS, AND PHOTOGRAPHS; DOWNLOADABLE RING TONES VIA THE INTERNET AND WIRELESS DEVICES; DOWNLOADABLE RING TONES FOR MOBILE PHONES (U.S. CLS. 21, 23, 26, 36 AND 38).

FIRST USE 9-30-1991; IN COMMERCE 9-30-1991.

LINDA E. BLOHM, EXAMINING ATTORNEY

SN 77-704,093. VISUAL RESPONSE MARKETING GROUP, INC, MARIETTA, GA. FILED 4-1-2009.



THE MARK CONSISTS OF THE STYLIZED TEXT "V" INSIDE A CIRCLE. TO THE RIGHT THERE IS THE STYLIZED TEXT "MAILCARDS".

FOR PRE-RECORDED CD-ROM OR DVD FEATURING ADVERTISEMENTS LAMINATED ONTO A POSTCARD THAT CAN BE MAILED, SOLD AS A SOUVENIR, USED AS A HAND-OUT OR A VARIETY OF OTHER MARKETING AND COMMUNICATION APPLICATIONS (U.S. CLS. 21, 23, 26, 36 AND 38).

FIRST USE 12-0-2005; IN COMMERCE 12-0-2005.

JENNIFER VASQUEZ, EXAMINING ATTORNEY

SN 77-706,070. STEFAN SOLVELL, WELLESLEY, MA. FILED 4-3-2009.

PUFFMINDER

THE MARK CONSISTS OF STANDARD CHARACTERS WITHOUT CLAIM TO ANY PARTICULAR FONT, STYLE, SIZE, OR COLOR.

FOR ELECTRONIC TIMERS IN PLASTIC CASES USED AS A REMINDER TO TAKE INHALATION MEDICATION (U.S. CLS. 21, 23, 26, 36 AND 38).

FIRST USE 3-26-2009; IN COMMERCE 3-26-2009.

WILLIAM BRECKENFELD, EXAMINING ATTORNEY

CLASS 9—(Continued).

SN 77-706,106. DANGLE INCORPORATED, WHITE BEAR LAKE, MN. FILED 4-3-2009.

Cool-Fire

THE MARK CONSISTS OF STANDARD CHARACTERS WITHOUT CLAIM TO ANY PARTICULAR FONT, STYLE, SIZE, OR COLOR.

FOR PROTECTIVE CLOTHING, NAMELY, HEATED GARMENTS IN THE NATURE OF APPAREL CONSISTING OF CARBON FIBER WHICH PRODUCES HEAT (U.S. CLS. 21, 23, 26, 36 AND 38).

FIRST USE 11-22-2006; IN COMMERCE 11-22-2006.

PAUL E. FAHRENKOPF, EXAMINING ATTORNEY

SN 77-707,190. JAYAMOHAN, JAY, FAIRFAX, VA. FILED 4-6-2009.

Zikzana

THE MARK CONSISTS OF STANDARD CHARACTERS WITHOUT CLAIM TO ANY PARTICULAR FONT, STYLE, SIZE, OR COLOR.

THE WORDING "ZIKZANA" HAS NO MEANING IN A FOREIGN LANGUAGE.

FOR COMPUTER APPLICATION SOFTWARE FOR MOBILE PHONES; COMPUTER SOFTWARE FOR CREATING SEARCHABLE DATABASES OF INFORMATION AND DATA; COMPUTER SOFTWARE FOR ENCRYPTION; COMPUTER SOFTWARE FOR THE COLLECTION, EDITING, ORGANIZING, MODIFYING, BOOK MARKING, TRANSMISSION, STORAGE AND SHARING OF DATA AND INFORMATION (U.S. CLS. 21, 23, 26, 36 AND 38).

JESSICA FATHY, EXAMINING ATTORNEY

SN 77-707,937. OPTIMIZE TECHNOLOGIES, INC., OREGON CITY, OR. FILED 4-6-2009.

FREE-TURN

THE MARK CONSISTS OF STANDARD CHARACTERS WITHOUT CLAIM TO ANY PARTICULAR FONT, STYLE, SIZE, OR COLOR.

FOR SCIENTIFIC INSTRUMENTS, NAMELY, CHECK VALVE HOUSINGS FOR SAMPLE PREPARATION AND OTHER ANALYTICAL TECHNIQUES INVOLVING FILTRATION OF SOLVENTS, MOBILE PHASES, AND SAMPLES, FOR USE IN THE FIELDS OF LIQUID CHROMATOGRAPHY (LC) AND MASS SPECTROMETRY (MS), AS WELL AS LIQUID CHROMATOGRAPHY/MASS SPECTROMETRY (LC/MS) AND FLUID TRANSFER IN SCIENTIFIC INSTRUMENTS (U.S. CLS. 21, 23, 26, 36 AND 38).

FIRST USE 0-0-1996; IN COMMERCE 0-0-1996.

GINA FINK, EXAMINING ATTORNEY

CLASS 9—(Continued).

SN 77-711,194. INSULATION SOURCES, INC., DBA ICO RALLY, PALO ALTO, CA. FILED 4-9-2009.

ICO RALLY

THE MARK CONSISTS OF STANDARD CHARACTERS WITHOUT CLAIM TO ANY PARTICULAR FONT, STYLE, SIZE, OR COLOR.

FOR MATERIALS FOR CONNECTING, INSULATING AND HARNESSING ELECTRICAL WIRING, NAMELY, INSULATED SOLDER LESS TERMINALS, HEAT SHRINKABLE PLASTIC CONDUITS, FLEXIBLE IRRADIATED POLYOLEFIN CONDUITS, SEMI-RIGID IRRADIATED POLYOLEFIN CONDUITS, IRRADIATED FLEXIBLE VINYL CONDUITS, FLEXIBLE POLYTETRAFLUOROETHYLENE CONDUITS, SPIRAL CUT PLASTIC CONDUITS FOR HARNESSING A VARIETY OF WIRES, PLASTIC CONDUITS WITH A ZIPPER THERON, PLASTIC LACING CORD AND STRIPS (U.S. CLS. 21, 23, 26, 36 AND 38).

FIRST USE 9-30-1968; IN COMMERCE 9-30-1968.

ANN E. SAPPENFIELD, EXAMINING ATTORNEY

SN 77-711,371. VIPDESK CONNECT, INC., ALEXANDRIA, VA. FILED 4-10-2009.

Virtual Voice

THE MARK CONSISTS OF STANDARD CHARACTERS WITHOUT CLAIM TO ANY PARTICULAR FONT, STYLE, SIZE, OR COLOR.

NO CLAIM IS MADE TO THE EXCLUSIVE RIGHT TO USE "VIRTUAL", APART FROM THE MARK AS SHOWN.

FOR DOWNLOADABLE JOURNALS, MAGAZINES AND NEWSLETTERS IN THE NATURE OF INDUSTRY NEWS AND UPDATES IN THE FIELD OF OUT-SOURCED VIRTUAL CALL CENTER SERVICES (U.S. CLS. 21, 23, 26, 36 AND 38).

FIRST USE 9-5-2006; IN COMMERCE 9-5-2006.

BARBARA BROWN, EXAMINING ATTORNEY

CLASS 9—(Continued).

SN 77-712,091. SEA TO SUN RECORDINGS, NEW YORK, NY. FILED 4-12-2009.

SEA TO SUN RECORDINGS

THE MARK CONSISTS OF STANDARD CHARACTERS WITHOUT CLAIM TO ANY PARTICULAR FONT, STYLE, SIZE, OR COLOR.

NO CLAIM IS MADE TO THE EXCLUSIVE RIGHT TO USE "RECORDINGS", APART FROM THE MARK AS SHOWN.

FOR DIGITAL MATERIALS, NAMELY, CDS, DOWNLOADABLE AUDIO FILES, AND VIDEOS FEATURING MUSIC (U.S. CLS. 21, 23, 26, 36 AND 38).

FIRST USE 9-1-2000; IN COMMERCE 2-1-2002.
NANCY CLARKE, EXAMINING ATTORNEY

SN 77-712,632. BOOKSTORE MANAGER, INC., ABILENE, TX. FILED 4-13-2009.

RMS GOLD

THE MARK CONSISTS OF STANDARD CHARACTERS WITHOUT CLAIM TO ANY PARTICULAR FONT, STYLE, SIZE, OR COLOR.

OWNER OF U.S. REG. NO. 2,774,209.

NO CLAIM IS MADE TO THE EXCLUSIVE RIGHT TO USE "RMS", APART FROM THE MARK AS SHOWN.
SEC. 2(F).

FOR COMPUTER SOFTWARE FOR USE IN DATABASE MANAGEMENT, INVENTORY CONTROL MANAGEMENT, BUSINESS MANAGEMENT AND POINT OF SALE FUNCTIONS DIRECTED TOWARD BOOKSTORES (U.S. CLS. 21, 23, 26, 36 AND 38).

FIRST USE 7-1-2001; IN COMMERCE 7-1-2001.
WANDA KAY PRICE, EXAMINING ATTORNEY

SN 77-713,115. UNISON PARTNERS, LLC, DBA UNISON AGENCY, WASHINGTON, DC. FILED 4-14-2009.

Fuseon

THE MARK CONSISTS OF STANDARD CHARACTERS WITHOUT CLAIM TO ANY PARTICULAR FONT, STYLE, SIZE, OR COLOR.

FOR COMPUTER SOFTWARE THAT PROVIDES WEB-BASED ACCESS TO APPLICATIONS AND SERVICES THROUGH A WEB OPERATING SYSTEM OR PORTAL INTERFACE (U.S. CLS. 21, 23, 26, 36 AND 38).

FIRST USE 5-30-2003; IN COMMERCE 5-30-2003.
BRENDAN MCCAULEY, EXAMINING ATTORNEY

CLASS 9—(Continued).

SN 77-714,179. AVERMEDIA INFORMATION, INC., MILPITAS, CA. FILED 4-15-2009.

AVERTV EXPRESS

THE MARK CONSISTS OF STANDARD CHARACTERS WITHOUT CLAIM TO ANY PARTICULAR FONT, STYLE, SIZE, OR COLOR.

OWNER OF U.S. REG. NO. 2,618,034.

FOR DIGITAL VIDEO DEVICE, NAMELY, A PORTABLE PC-TV TUNER CARD FOR PROCESSING AND TRANSFERRING IMAGES, LIVE DIGITAL/ANALOG TV SIGNAL AND OTHER DATA BETWEEN CONSUMER ELECTRONIC DEVICES FOR VIEWING, VIDEO CONFERENCING AND DIGITAL VIDEO EDITING (U.S. CLS. 21, 23, 26, 36 AND 38).

HENRY S. ZAK, EXAMINING ATTORNEY

SN 77-714,252. CLEAR CHANNEL MANAGEMENT SERVICES, INC., SAN ANTONIO, TX. FILED 4-15-2009.

Z-PLAYERS

THE MARK CONSISTS OF STANDARD CHARACTERS WITHOUT CLAIM TO ANY PARTICULAR FONT, STYLE, SIZE, OR COLOR.

FOR COMPUTER SOFTWARE APPLICATION FOR MANAGEMENT OF AUDIO FILES (U.S. CLS. 21, 23, 26, 36 AND 38).

FIRST USE 4-15-2009; IN COMMERCE 4-15-2009.
REGINA DRUMMOND, EXAMINING ATTORNEY

SN 77-715,295. OSRAM SYLVANIA INC., DANVERS, MA. FILED 4-16-2009.

SYLVANIA

THE MARK CONSISTS OF STANDARD CHARACTERS WITHOUT CLAIM TO ANY PARTICULAR FONT, STYLE, SIZE, OR COLOR.

OWNER OF U.S. REG. NOS. 1,325,543, 1,411,188 AND OTHERS.

FOR HEADPHONES AND EARPHONES (U.S. CLS. 21, 23, 26, 36 AND 38).

FIRST USE 4-0-2008; IN COMMERCE 5-0-2008.
ANDREW LEASER, EXAMINING ATTORNEY

CLASS 9—(Continued).

SN 77-715,947. POSITION IMAGING, INC., PORTSMOUTH, NH. FILED 4-17-2009.

3D-Trax

THE MARK CONSISTS OF STANDARD CHARACTERS WITHOUT CLAIM TO ANY PARTICULAR FONT, STYLE, SIZE, OR COLOR.

FOR COMPUTER SOFTWARE AND HARDWARE FOR TRACKING POSITIONS OF WIRELESS DEVICES (U.S. CLS. 21, 23, 26, 36 AND 38).

GRETCHEN ULRICH, EXAMINING ATTORNEY

SN 77-716,529. LINEAR MARKET TECHNICAL SERVICES CORP., POTTSTOWN, PA. FILED 4-17-2009.

CLEANCHARGE

THE MARK CONSISTS OF STANDARD CHARACTERS WITHOUT CLAIM TO ANY PARTICULAR FONT, STYLE, SIZE, OR COLOR.

FOR MONITORING AND ALARM SYSTEM FOR USE WITH BATTERIES THAT RECOGNIZES OCCURRENCE OF OVER-VOLTAGE CHARGE CONDITION OF BATTERY (U.S. CLS. 21, 23, 26, 36 AND 38).

MORGAN WYNNE, EXAMINING ATTORNEY

SN 77-716,697. WHIRLWIND CONCEPTS, INC., SPOKANE, WA. FILED 4-17-2009.



NO CLAIM IS MADE TO THE EXCLUSIVE RIGHT TO USE "WASHER FLUID DISPENSER", APART FROM THE MARK AS SHOWN.

THE MARK CONSISTS OF THE WORD "SPENSER" WITH THE WORDS "WASHER FLUID DISPENSER" UNDERNEATH, AND A RAIN DROP NEXT TO THE WORDS, ALL ENCOMPASSED BY A CIRCLE.

FOR VENDING MACHINES; AUTOMATED WINDSHIELD WASHING FLUID DISPENSERS (U.S. CLS. 21, 23, 26, 36 AND 38).

BRIDGETT SMITH, EXAMINING ATTORNEY

CLASS 9—(Continued).

SN 77-717,869. RESEARCH IN MOTION LIMITED, WATERLOO, ONTARIO, CANADA, FILED 4-20-2009.

SUREPRESS

THE MARK CONSISTS OF STANDARD CHARACTERS WITHOUT CLAIM TO ANY PARTICULAR FONT, STYLE, SIZE, OR COLOR.

PRIORITY CLAIMED UNDER SEC. 44(D) ON CANADA APPLICATION NO. 1,415,134, FILED 10-20-2008.

OWNER OF U.S. REG. NO. 3,074,101.

FOR HARDWARE AND SOFTWARE INTEGRATING A GRAPHIC USER INTERFACE WITH SENSOR INPUT FOR USE WITH ELECTRONIC HANDHELD UNITS; ELECTRONIC HANDHELD UNITS WITH TOUCH SCREENS FOR THE WIRELESS TRANSMISSION OF DATA AND/OR VOICE SIGNALS; COMPUTER COMMUNICATION SOFTWARE FOR THE SYNCHRONIZATION, TRANSMISSION AND SHARING OF DATA, CALENDAR, CONTENT AND MESSAGING BETWEEN ONE OR MORE ELECTRONIC HANDHELD UNITS AND DATA STORED ON OR ASSOCIATED WITH A COMPUTER (U.S. CLS. 21, 23, 26, 36 AND 38).

FIRST USE 11-30-2008; IN COMMERCE 11-30-2008.

PAUL F. GAST, EXAMINING ATTORNEY

SN 77-718,088. MATT SINROD, DBA DOLLHOUSE DIGITAL, LOS ANGELES, CA. FILED 4-20-2009.

Dollhouse Digital

THE MARK CONSISTS OF STANDARD CHARACTERS WITHOUT CLAIM TO ANY PARTICULAR FONT, STYLE, SIZE, OR COLOR.

NO CLAIM IS MADE TO THE EXCLUSIVE RIGHT TO USE "DIGITAL", APART FROM THE MARK AS SHOWN.

FOR PRE-RECORDED DIGITAL MEDIA FEATURING ADULT ORIENTED CONTENT; PRE-RECORDED DVDS FEATURING ADULT ORIENTED CONTENT (U.S. CLS. 21, 23, 26, 36 AND 38).

ANDREA K. NADELMAN, EXAMINING ATTORNEY

CLASS 9—(Continued).

SN 77-718,352. PRISTINE SERVICES, INC., WHITE PLAINS, NY. FILED 4-21-2009.

THE PRISTINE VIEW

THE MARK CONSISTS OF STANDARD CHARACTERS WITHOUT CLAIM TO ANY PARTICULAR FONT, STYLE, SIZE, OR COLOR.

OWNER OF U.S. REG. NOS. 2,522,295, 2,643,989 AND 2,734,933.

FOR DOWNLOADABLE ELECTRONIC PUBLICATIONS IN THE NATURE OF NEWSLETTERS FEATURING NEWS, COMMENTARY, FINANCIAL SERVICES AND TOPICS OF INTEREST TO INVESTORS AND TRADERS (U.S. CLS. 21, 23, 26, 36 AND 38).

FIRST USE 8-29-2007; IN COMMERCE 8-29-2007.
KIMBERLY PERRY, EXAMINING ATTORNEY

CLASS 9—(Continued).

SN 77-718,616. ASTRO PAK CORPORATION, DOWNEY, CA. FILED 4-21-2009.



OWNER OF U.S. REG. NOS. 2,968,215 AND 3,558,149.
NO CLAIM IS MADE TO THE EXCLUSIVE RIGHT TO USE "PAK", APART FROM THE MARK AS SHOWN.

THE COLOR(S) BLUE, WHITE AND GOLD IS/ARE CLAIMED AS A FEATURE OF THE MARK.

THE MARK CONSISTS OF BLUE RECTANGLE CONTAINING A STYLIZED LETTER "A" IN LIGHT BLUE WITH A GOLD SUNBURST SURROUNDED BY A DARK BLUE CIRCLE IN THE CENTER OF THE LETTER "A". THE WORDING "ASTRO PAK" APPEARS IN WHITE. THE WORDING "ROUGE" IN WHITE AND "ALERT" IN GOLD APPEARS BELOW "ASTRO PAK".

FOR PASSIVATION MONITORS (U.S. CLS. 21, 23, 26, 36 AND 38).

FIRST USE 2-0-2009; IN COMMERCE 2-0-2009.
ESTHER A. BORSUK, EXAMINING ATTORNEY

SN 77-719,293. UNITED STATES GOLF ASSOCIATION, AKA USGA, FAR HILLS, NJ. FILED 4-22-2009.

TruFirm

FOR IMPACT MEASUREMENT AND ANALYSIS SYSTEM COMPRISED OF AN APPARATUS FOR TESTING FLEXIBILITY, DATA PROCESSING COMPUTER SOFTWARE, AND INSTRUCTION MANUAL FOR SPORTS FIELD SURFACES (U.S. CLS. 21, 23, 26, 36 AND 38).

FIRST USE 9-30-2008; IN COMMERCE 3-17-2009.
NICHOLAS COLEMAN, EXAMINING ATTORNEY

SN 77-718,541. ABANDON INTERACTIVE ENTERTAINMENT, LLC, PACIFIC PALISADES, CA. FILED 4-21-2009.

FREAKY SPACE

THE MARK CONSISTS OF STANDARD CHARACTERS WITHOUT CLAIM TO ANY PARTICULAR FONT, STYLE, SIZE, OR COLOR.

OWNER OF U.S. REG. NOS. 3,344,789, 3,631,810 AND 3,640,234.

FOR COMPUTER SOFTWARE FOR ELECTRONIC GAMES AND ENTERTAINMENT, NAMELY, COMPUTER GAME SOFTWARE USED AND PLAYED ON MOBILE AND CELLULAR TELEPHONES, HANDHELD COMPUTERS, PERSONAL COMPUTERS AND PERSONAL DIGITAL ASSISTANTS; DOWNLOADABLE ELECTRONIC GAME PROGRAMS; DOWNLOADABLE RING TONES; DOWNLOADABLE PRERECORDED MUSIC AND GRAPHICS IN THE FORM OF COMPUTER SCREEN SAVERS; DOWNLOADABLE VOICE RINGTONES DOWNLOADABLE WALL PAPERS, NAMELY, STILL IMAGES FOR BACKGROUNDS ON PHONE SCREENS; DOWNLOADABLE ANIMATED IMAGES FOR USE ON PHONE SCREENS; COMPUTER PROGRAMS FOR DOWNLOADING IMAGES FOR MOBILE TELECOMMUNICATION DEVICES, NAMELY, MOBILE AND CELLULAR TELEPHONES, HANDHELD COMPUTERS, PERSONAL COMPUTERS AND PERSONAL DIGITAL ASSISTANTS ALL VIA THE GLOBAL COMPUTER NETWORK AND WIRELESS DEVICES; COMPUTER SOFTWARE FOR USE IN THE DESIGN, DEVELOPMENT AND EXECUTION OF WIRELESS COMPUTER GAMES; AND DIGITAL MAGNETIC DISCS, VHS TAPES, AND SOFTWARE FEATURING TELEVISION PROGRAMS AND MOTION PICTURE FILMS (U.S. CLS. 21, 23, 26, 36 AND 38).

JEAN IM, EXAMINING ATTORNEY

SN 77-719,430. KOEI CO., LTD., YOKOHAMA, JAPAN, FILED 4-22-2009.

UNCHARTED WATERS ONLINE

THE MARK CONSISTS OF STANDARD CHARACTERS WITHOUT CLAIM TO ANY PARTICULAR FONT, STYLE, SIZE, OR COLOR.

NO CLAIM IS MADE TO THE EXCLUSIVE RIGHT TO USE "ONLINE", APART FROM THE MARK AS SHOWN.

FOR COMPUTER GAME DISCS; COMPUTER GAME PROGRAMS, COMPUTER GAME SOFTWARE; VIDEO GAME DISCS, VIDEO GAME PROGRAMS, VIDEO GAME SOFTWARE, USER MANUALS PROVIDED TOGETHER THEREWITH AS A UNIT (U.S. CLS. 21, 23, 26, 36 AND 38).

LINDA M. KING, EXAMINING ATTORNEY

CLASS 9—(Continued).

SN 77-719,647. NETWITNESS CORPORATION, HERNDON, VA. FILED 4-22-2009.

NETWITNESS INSIGHT

THE MARK CONSISTS OF STANDARD CHARACTERS WITHOUT CLAIM TO ANY PARTICULAR FONT, STYLE, SIZE, OR COLOR.

OWNER OF U.S. REG. NOS. 2,674,324 AND 3,541,286. FOR SOFTWARE USED TO CALCULATE AND REMEDIATE RISKS ASSOCIATED WITH NETWORK VULNERABILITIES, CONFIGURATION, AND SENSITIVE DATA ON COMPUTER AND NETWORK DEVICES (U.S. CLS. 21, 23, 26, 36 AND 38).

HENRY S. ZAK, EXAMINING ATTORNEY

SN 77-719,902. SANGSIN EDP CO., LTD., SUWON-SHI, KYUNGKI-DO, REPUBLIC OF KOREA, FILED 4-22-2009.

iPARTNER

THE MARK CONSISTS OF LETTER "I" FOLLOWED BY WORD "PARTNER".

FOR BATTERY CHARGERS (U.S. CLS. 21, 23, 26, 36 AND 38).

FIRST USE 12-0-2008; IN COMMERCE 12-0-2008.

ROBERT C. CLARK JR., EXAMINING ATTORNEY

SN 77-719,920. APPLE INC., CUPERTINO, CA. FILED 4-22-2009.

MAGIC MOVE

THE MARK CONSISTS OF STANDARD CHARACTERS WITHOUT CLAIM TO ANY PARTICULAR FONT, STYLE, SIZE, OR COLOR.

FOR COMPUTER SOFTWARE FOR PRESENTATION GRAPHICS, NAMELY, SOFTWARE FOR GENERATING, STORING, RETRIEVING, MANIPULATING AND ALTERING TEXTS AND GRAPHICS FOR USE IN PRESENTATIONS AND UTILITY PROGRAMS FOR USE THEREWITH (U.S. CLS. 21, 23, 26, 36 AND 38).

FIRST USE 1-6-2009; IN COMMERCE 1-6-2009.

DAVID MURRAY, EXAMINING ATTORNEY

CLASS 9—(Continued).

SN 77-720,070. TIGER DEVELOPMENT, INC., DBA FLYING TIGER ENTERTAINMENT, INC., FULLERTON, CA. FILED 4-22-2009.



THE COLOR(S) KELLY GREEN, YELLOW, ORANGE, ORANGE-RED, RED, TAN, BLUE, PINK, BLACK IS/ARE CLAIMED AS A FEATURE OF THE MARK.

THE MARK CONSISTS OF THE WORDS "DONUT COP DROP" WITH THE "O" IN "DONUT", COLORED TAN WITH BLUE FROSTING AND PINK, YELLOW, AND GREEN-DASHED SPRINKLES. THE REMAINING LETTERS ARE FILLED WITH A GRADIENT STARTING WITH YELLOW AT THE TOP OF THE LETTER, GRADUALLY CHANGING TO ORANGE AND THEN RED. THE LETTERS ARE OUTLINED AND ACCENTED WITH BLACK. THE BACKGROUND IS KELLY GREEN.

FOR COMPUTER GAME SOFTWARE; ELECTRONIC GAME SOFTWARE FOR CELLULAR TELEPHONES (U.S. CLS. 21, 23, 26, 36 AND 38).

FIRST USE 2-1-2009; IN COMMERCE 7-1-2009.

RENEE SERVANCE, EXAMINING ATTORNEY

SN 77-720,191. HILLVIEW SYSTEMS, AUSTIN, TX. FILED 4-22-2009.

BoxBoss

THE MARK CONSISTS OF STANDARD CHARACTERS WITHOUT CLAIM TO ANY PARTICULAR FONT, STYLE, SIZE, OR COLOR.

FOR COMPUTER SOFTWARE THAT PROVIDES WEB-BASED ACCESS TO APPLICATIONS AND SERVICES THROUGH A WEB OPERATING SYSTEM OR PORTAL INTERFACE (U.S. CLS. 21, 23, 26, 36 AND 38).

AARON BRODSKY, EXAMINING ATTORNEY

CLASS 9—(Continued).

SN 77-721,227. TWENTIETH CENTURY FOX FILM CORPORATION, LOS ANGELES, CA. FILED 4-23-2009.



OWNER OF U.S. REG. NOS. 2,033,557, 2,903,242 AND 3,001,994.

NO CLAIM IS MADE TO THE EXCLUSIVE RIGHT TO USE "SPORTS", APART FROM THE MARK AS SHOWN.

THE MARK CONSISTS OF THE STYLIZED WORDS "THE ADVENTURES OF DIGGER AND FRIENDS" WHICH APPEAR INSIDE OF TWO OVAL CONCENTRIC LINES, THE WORDS "FOX SPORTS" WHICH APPEAR UNDER THE WORD "FRIENDS" AND INSIDE OF THE OVAL SHAPE OVERLAPPING ON THE BOTTOM OF THE INNER OVAL LINE AND FIVE COSTUMED GOPHER CHARACTERS WHICH APPEAR ABOVE THE OUTER OVAL LINE.

FOR PRE-RECORDED DVDS IN THE FIELDS OF SPORTS AND COMEDY; PRE-RECORDED CDS IN THE FIELDS OF SPORTS AND COMEDY; DOWNLOADABLE AUDIO AND VIDEO RECORDINGS IN THE FIELDS OF SPORTS AND COMEDY; DOWNLOADABLE TELEVISION PROGRAMS VIA THE INTERNET IN THE FIELDS OF SPORTS AND COMEDY; DOWNLOADABLE RING TONES, GRAPHICS, WALLPAPER, AND MUSIC VIA A GLOBAL COMPUTER NETWORK AND WIRELESS DEVICES; COMPUTER SCREEN SAVER SOFTWARE; VIDEO GAME AND COMPUTER GAME SOFTWARE; MOUSE PADS; HOLDERS FOR CDS AND DVDS, NAMELY, CD AND DVD SLEEVES, CASES, AND BINDERS; DISPOSABLE CAMERAS (U.S. CLS. 21, 23, 26, 36 AND 38).

LINDA LAVACHE, EXAMINING ATTORNEY

SN 77-721,496. BODY STARS, LTD., BARCELONA, SPAIN, FILED 4-24-2009.

KRISTEN BJORN

THE MARK CONSISTS OF STANDARD CHARACTERS WITHOUT CLAIM TO ANY PARTICULAR FONT, STYLE, SIZE, OR COLOR.

THE NAME SHOWN IN THE MARK DOES NOT IDENTIFY A PARTICULAR LIVING INDIVIDUAL.

FOR PRE-RECORDED DIGITAL VIDEO TAPES AND DISCS FEATURING ADULT-THEMED ENTERTAINMENT (U.S. CLS. 21, 23, 26, 36 AND 38).

FIRST USE 4-0-1988; IN COMMERCE 4-0-1988.

KRISTIN CARLSON, EXAMINING ATTORNEY

CLASS 9—(Continued).

SN 77-721,501. BUCK CONSULTANTS, LLC, NEW YORK, NY. FILED 4-24-2009.

ALM EXPRESS

THE MARK CONSISTS OF STANDARD CHARACTERS WITHOUT CLAIM TO ANY PARTICULAR FONT, STYLE, SIZE, OR COLOR.

NO CLAIM IS MADE TO THE EXCLUSIVE RIGHT TO USE "ALM", APART FROM THE MARK AS SHOWN.

FOR FINANCIAL SOFTWARE, NAMELY, SOFTWARE FOR INVESTMENT AND RISK ANALYSIS BUT NOT FOR ESTIMATING LOSSES FOR INSURANCE PURPOSES (U.S. CLS. 21, 23, 26, 36 AND 38).

FIRST USE 2-20-2009; IN COMMERCE 2-20-2009.
ZHALEH DELANEY, EXAMINING ATTORNEY

SN 77-721,593. FLEET SAFETY EQUIPMENT, INC., MEMPHIS, TN. FILED 4-24-2009.

PANNIN TECHNOLOGY

THE MARK CONSISTS OF STANDARD CHARACTERS WITHOUT CLAIM TO ANY PARTICULAR FONT, STYLE, SIZE, OR COLOR.

NO CLAIM IS MADE TO THE EXCLUSIVE RIGHT TO USE "TECHNOLOGY", APART FROM THE MARK AS SHOWN.

FOR AUDIO AND VIDEO RECORDING DEVICES, NAMELY, DIGITAL AUDIO RECORDERS AND VIDEO RECORDERS; COMPUTERS (U.S. CLS. 21, 23, 26, 36 AND 38).

JANET LEE, EXAMINING ATTORNEY

SN 77-721,686. SAMADPOUR, MANSOUR, LAKE FOREST PARK, WA. FILED 4-24-2009.

TenderScope

THE MARK CONSISTS OF STANDARD CHARACTERS WITHOUT CLAIM TO ANY PARTICULAR FONT, STYLE, SIZE, OR COLOR.

FOR OPTICAL READER FOR DETERMINING THE TENDERNESS OF MEAT (U.S. CLS. 21, 23, 26, 36 AND 38).

MARGERY A. TIERNEY, EXAMINING ATTORNEY

CLASS 9—(Continued).

SN 77-721,726. CORVENTIS, INC., SAN JOSE, CA. FILED 4-24-2009.

CARDIOPROTECT

THE MARK CONSISTS OF STANDARD CHARACTERS WITHOUT CLAIM TO ANY PARTICULAR FONT, STYLE, SIZE, OR COLOR.

FOR COMPUTER HARDWARE; COMPUTER SOFTWARE WHICH RECEIVES, TRANSMITS, PROCESSES, STORES AND DISPLAYS MEDICAL DATA FOR REMOTELY CONNECTING PATIENTS TO MEDICAL PERSONNEL (U.S. CLS. 21, 23, 26, 36 AND 38).

HAI-LY LAM, EXAMINING ATTORNEY

SN 77-721,782. CHIPWORKS, INC., OTTOWA, CANADA, FILED 4-24-2009.

ICWORKS

THE MARK CONSISTS OF STANDARD CHARACTERS WITHOUT CLAIM TO ANY PARTICULAR FONT, STYLE, SIZE, OR COLOR.

FOR DESIGN ANALYSIS SOFTWARE FOR USE IN SEMICONDUCTOR, ELECTRONICS AND SYSTEM REVERSE ENGINEERING (U.S. CLS. 21, 23, 26, 36 AND 38).

LINDA ESTRADA, EXAMINING ATTORNEY

SN 77-721,784. UPDATE SOFTWARE, INC., HOPLAND, CA. FILED 4-24-2009.

VinCLUB

OWNER OF U.S. REG. NO. 2,784,867.

THE MARK CONSISTS OF THE LITERAL ELEMENT OF MARK IN STYLIZED FORM, COMPOSED OF AN UPPER-CASE "V", LOWERCASE "i" AND "n", AND UPPER-CASE "C", "L", "U" AND "B", WITH THE "C" FURTHER STYLIZED TO RESEMBLE A WINE BOTTLE BY PORTRAYING THE NECK OF A WINE BOTTLE POSITIONED ON TOP OF THE "C" AND THE "C" FORMING THE REMAINING SHAPE OF THE BOTTLE.

FOR DOWNLOADABLE SOFTWARE FOR USE IN THE ADMINISTRATION AND MANAGEMENT OF WINE CLUBS (U.S. CLS. 21, 23, 26, 36 AND 38).

FIRST USE 1-10-2009; IN COMMERCE 1-10-2009.

MARILYN IZZI, EXAMINING ATTORNEY

CLASS 9—(Continued).

SN 77-721,853. PROGEO MONITORING GMBH, GROßBEER 14979, FED REP GERMANY, FILED 4-24-2009.

PROGEO

THE MARK CONSISTS OF STANDARD CHARACTERS WITHOUT CLAIM TO ANY PARTICULAR FONT, STYLE, SIZE, OR COLOR.

FOR MEASURING, SIGNALLING, MONITORING SYSTEMS FOR DETECTING AND LOCATING LEAKS, AND ELECTRIC AND ELECTRONIC DEVICES USED IN SYSTEMS FOR DETECTING AND LOCATING LEAKS (U.S. CLS. 21, 23, 26, 36 AND 38).

FIRST USE 6-1-2007; IN COMMERCE 6-1-2007.

JULIE GUTTADAURO, EXAMINING ATTORNEY

SN 77-721,986. MAGUS (PTY) LTD., STELLENBOSCH 7600, SOUTH AFRICA, FILED 4-24-2009.

ANTENNA MAGUS

THE MARK CONSISTS OF STANDARD CHARACTERS WITHOUT CLAIM TO ANY PARTICULAR FONT, STYLE, SIZE, OR COLOR.

NO CLAIM IS MADE TO THE EXCLUSIVE RIGHT TO USE "ANTENNA", APART FROM THE MARK AS SHOWN.

FOR SOFTWARE FOR DESIGNING ANTENNAS (U.S. CLS. 21, 23, 26, 36 AND 38).

JANICE KIM, EXAMINING ATTORNEY

SN 77-722,207. MANATEE, INC., HOUSTON, TX. FILED 4-24-2009.

B-MAP

THE MARK CONSISTS OF STANDARD CHARACTERS WITHOUT CLAIM TO ANY PARTICULAR FONT, STYLE, SIZE, OR COLOR.

FOR INTERACTIVE BROWSER BASED SOFTWARE FOR MANAGEMENT OF DOCUMENTS, PROCEDURES AND INFORMATION (U.S. CLS. 21, 23, 26, 36 AND 38).

DAVID I, EXAMINING ATTORNEY

CLASS 9—(Continued).

SN 77-722,262. DENKE, KURT A., DBA BLUE JEANS CABLE, SEATTLE, WA. FILED 4-24-2009.

Blue Jeans Cable

THE MARK CONSISTS OF STANDARD CHARACTERS WITHOUT CLAIM TO ANY PARTICULAR FONT, STYLE, SIZE, OR COLOR.

NO CLAIM IS MADE TO THE EXCLUSIVE RIGHT TO USE "CABLE", APART FROM THE MARK AS SHOWN.

FOR AUDIO CABLES; CABLE CONNECTORS; CABLES AND FIBRES FOR THE TRANSMISSION OF SOUNDS AND IMAGES; CABLES FOR ELECTRICAL AND OPTICAL SIGNAL TRANSMISSION SYSTEMS; CABLES FOR ELECTRICAL OR OPTICAL SIGNAL TRANSMISSION; CABLES FOR OPTICAL SIGNAL TRANSMISSION; CABLES, ELECTRIC; COAXIAL CABLES; CONSUMER ELECTRONIC PRODUCTS, NAMELY, AUDIO AMPLIFIERS, AUDIO SPEAKERS, AUDIO RECEIVERS, ELECTRICAL AUDIO AND SPEAKER CABLES AND CONNECTORS, HOME THEATER SYSTEMS, AUDIO DECODERS, VIDEO DECODERS, SPEAKERS, POWER CONVERSION DEVICES, POWER CONVERTERS, AND POWER INVERTERS; ELECTRIC CABLES, WIRES, CONDUCTORS AND CONNECTION FITTINGS THEREFOR; ELECTRONIC CABLES; MICROPHONE CABLES; OPTICAL FIBER CABLES; STEREO CABLES (U.S. CLS. 21, 23, 26, 36 AND 38).

FIRST USE 4-1-2002; IN COMMERCE 4-1-2002.
CORY BOONE, EXAMINING ATTORNEY

SN 77-722,453. WEBER, TED A., DBA WEBER SPEAKERS, KOKOMO, IN. FILED 4-25-2009.

MASCO

THE MARK CONSISTS OF STANDARD CHARACTERS WITHOUT CLAIM TO ANY PARTICULAR FONT, STYLE, SIZE, OR COLOR.

FOR AUDIO AMPLIFIERS (U.S. CLS. 21, 23, 26, 36 AND 38).

MARY BOAGNI, EXAMINING ATTORNEY

SN 77-722,456. ROGERS, JAMES M, WILMINGTON, DE. FILED 4-25-2009.

GAS

THE MARK CONSISTS OF STANDARD CHARACTERS WITHOUT CLAIM TO ANY PARTICULAR FONT, STYLE, SIZE, OR COLOR.

FOR COMPUTER GAME SOFTWARE FOR PERSONAL COMPUTERS AND HOME VIDEO GAME CONSOLES (U.S. CLS. 21, 23, 26, 36 AND 38).

TRACY FLETCHER, EXAMINING ATTORNEY

CLASS 9—(Continued).

SN 77-722,475. TRIPINK MEDIA, LLC, MIAMI, FL. FILED 4-26-2009.

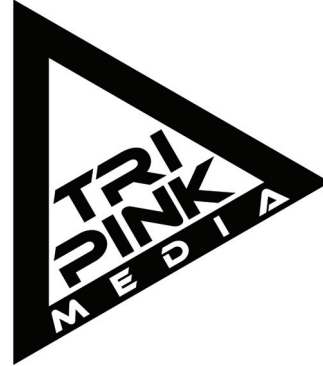

NO CLAIM IS MADE TO THE EXCLUSIVE RIGHT TO USE "MEDIA", APART FROM THE MARK AS SHOWN.

THE MARK CONSISTS OF A TILTED TRIANGLE, WITH THE STYLIZED WORDS "TRI PINK" APPEARING IN THE MIDDLE OF THE TRIANGLE, AND THE STYLIZED WORD "MEDIA" APPEARING AGAINST THE BOTTOM BORDER OF THE TRIANGLE.

FOR LCD PROJECTORS USED TO DISPLAY ADVERTISEMENTS THAT ARE INCORPORATED INTO TRUCKS (U.S. CLS. 21, 23, 26, 36 AND 38).

FIRST USE 2-1-2009; IN COMMERCE 3-1-2009.
ANDREW LEASER, EXAMINING ATTORNEY

SN 77-722,547. FRANTISEK, NICKOLAS N., DBA RUNWAY CHIC, TOLEDO, OH. FILED 4-26-2009.

Runway Chic

THE MARK CONSISTS OF STANDARD CHARACTERS WITHOUT CLAIM TO ANY PARTICULAR FONT, STYLE, SIZE, OR COLOR.

SEC. 2(F).

FOR DOWNLOADABLE ELECTRONIC PUBLICATIONS IN THE NATURE OF MAGAZINES IN THE FIELD OF FASHION (U.S. CLS. 21, 23, 26, 36 AND 38).

FIRST USE 5-12-1992; IN COMMERCE 5-12-1992.

KATHRYN COWARD, EXAMINING ATTORNEY

SN 77-722,624. KARLIS TILLERS, AKA KARL TILLER, RIGA, LATVIA, FILED 4-27-2009.

ueSafe

THE MARK CONSISTS OF STANDARD CHARACTERS WITHOUT CLAIM TO ANY PARTICULAR FONT, STYLE, SIZE, OR COLOR.

FOR INTERNET SERVERS (U.S. CLS. 21, 23, 26, 36 AND 38).

JACLYN KIDWELL, EXAMINING ATTORNEY

CLASS 9—(Continued).

SN 77-722,627. KIMBERLY ROBSON-ORTIZ, DBA LUX-LOCATOR, LONDON, UNITED KINGDOM, FILED 4-27-2009.

LUX-LOCATOR

THE MARK CONSISTS OF STANDARD CHARACTERS WITHOUT CLAIM TO ANY PARTICULAR FONT, STYLE, SIZE, OR COLOR.

FOR ELECTRONIC DEVICES USED TO LOCATE LOST ARTICLES EMPLOYING THE GLOBAL POSITIONING SYSTEM OR CELLULAR COMMUNICATION NETWORKS (U.S. CLS. 21, 23, 26, 36 AND 38).

GENE MACIOL, EXAMINING ATTORNEY

SN 77-722,749. TAYLOR, COREY, NEW YORK, NY. FILED 4-27-2009.

GYPSY BABIES

THE MARK CONSISTS OF STANDARD CHARACTERS WITHOUT CLAIM TO ANY PARTICULAR FONT, STYLE, SIZE, OR COLOR.

FOR SERIES OF MUSICAL SOUND RECORDINGS AND MUSICAL VIDEO RECORDINGS (U.S. CLS. 21, 23, 26, 36 AND 38).

JEFF DEFORD, EXAMINING ATTORNEY

SN 77-722,805. ARES CORPORATION, BURLINGAME, CA. FILED 4-27-2009.

BLUTRAIN

THE MARK CONSISTS OF STANDARD CHARACTERS WITHOUT CLAIM TO ANY PARTICULAR FONT, STYLE, SIZE, OR COLOR.

FOR COMPUTER SOFTWARE FOR THE SIMULATION, ANALYSIS, EDUCATION AND TRAINING OF SECURITY OR DEFENSE FORCES AGAINST OPPOSING FORCES AND THREATS (U.S. CLS. 21, 23, 26, 36 AND 38).

MARGERY A. TIERNEY, EXAMINING ATTORNEY

CLASS 9—(Continued).

SN 77-722,879. STRANDS, INC., CORVALLIS, OR. FILED 4-27-2009.

anti:bleh

THE MARK CONSISTS OF STANDARD CHARACTERS WITHOUT CLAIM TO ANY PARTICULAR FONT, STYLE, SIZE, OR COLOR.

FOR COMPUTER SOFTWARE FOR CREATING INDICES OF EVENTS AND DATA; DOWNLOADABLE COMPUTER SOFTWARE FOR SEARCHING, RETRIEVING AND ACCESSING EVENTS AND DATA VIA A GLOBAL COMPUTER NETWORK; COMPUTER SOFTWARE TO ENABLE PEER-TO-PEER NETWORKING AND DATA SHARING VIA ELECTRONIC COMMUNICATIONS NETWORKS; SEARCH ENGINE SOFTWARE; COMPUTER SOFTWARE FOR CONDUCTING AND COORDINATING REAL-TIME AND ASYNCHRONOUS COMMUNICATIONS AMONG COMPUTER USERS SHARING INFORMATION AND EVENT DATA VIA ELECTRONIC COMMUNICATIONS NETWORKS (U.S. CLS. 21, 23, 26, 36 AND 38).

FIRST USE 3-24-2009; IN COMMERCE 3-24-2009.

ALEX KEAM, EXAMINING ATTORNEY

SN 77-723,009. GOLDWIRE, DUSHON, MR., AKA BLAK-POPPI, FARROCKAWAY, NY. FILED 4-27-2009.

clean up records

THE MARK CONSISTS OF STANDARD CHARACTERS WITHOUT CLAIM TO ANY PARTICULAR FONT, STYLE, SIZE, OR COLOR.

NO CLAIM IS MADE TO THE EXCLUSIVE RIGHT TO USE "RECORDS", APART FROM THE MARK AS SHOWN.

FOR AUDIO RECORDINGS FEATURING ENTERTAINMENT (U.S. CLS. 21, 23, 26, 36 AND 38).

STEVEN JACKSON, EXAMINING ATTORNEY

SN 77-723,076. FRACTEL INC., NEW ALBANY, OH. FILED 4-27-2009.

Fractel

THE MARK CONSISTS OF STANDARD CHARACTERS WITHOUT CLAIM TO ANY PARTICULAR FONT, STYLE, SIZE, OR COLOR.

FOR COMPUTER HARDWARE, NAMELY, FIREWALLS; COMPUTER SOFTWARE FOR THE CREATION OF FIREWALLS (U.S. CLS. 21, 23, 26, 36 AND 38).

STEVEN JACKSON, EXAMINING ATTORNEY

CLASS 9—(Continued).

SN 77-723,121. U.S.G. ENTERPRISES, INC., MARINA DEL REY, CA. FILED 4-27-2009.

iSea

THE MARK CONSISTS OF STANDARD CHARACTERS WITHOUT CLAIM TO ANY PARTICULAR FONT, STYLE, SIZE, OR COLOR.

FOR COMPUTER APPLICATION SOFTWARE FOR USE ON AND WITH MOBILE COMPUTING DEVICES AND WIRELESS COMMUNICATION DEVICES (U.S. CLS. 21, 23, 26, 36 AND 38).

SHAUNIA CARLYLE, EXAMINING ATTORNEY

CLASS 9—(Continued).

SN 77-723,486. B.E. MEYERS & COMPANY, INC., AKA MEYERS LASERS, REDMOND, WA. FILED 4-27-2009.

MilliPoint

THE MARK CONSISTS OF STANDARD CHARACTERS WITHOUT CLAIM TO ANY PARTICULAR FONT, STYLE, SIZE, OR COLOR.

FOR LASERS NOT FOR MEDICAL USE (U.S. CLS. 21, 23, 26, 36 AND 38).

FIRST USE 4-1-2009; IN COMMERCE 4-1-2009.

KATHLEEN M. VANSTON, EXAMINING ATTORNEY

SN 77-723,227. CORBIS CORPORATION, NEW YORK, NY. FILED 4-27-2009.

OUTLINE

THE MARK CONSISTS OF STANDARD CHARACTERS WITHOUT CLAIM TO ANY PARTICULAR FONT, STYLE, SIZE, OR COLOR.

FOR DOWNLOADABLE DIGITAL PHOTOGRAPHS (U.S. CLS. 21, 23, 26, 36 AND 38).

FIRST USE 7-10-1998; IN COMMERCE 7-10-1998.

EDWARD NELSON, EXAMINING ATTORNEY

SN 77-723,493. B.E. MEYERS & COMPANY, INC., AKA MEYERS LASERS, REDMOND, WA. FILED 4-27-2009.

PicoPoint

THE MARK CONSISTS OF STANDARD CHARACTERS WITHOUT CLAIM TO ANY PARTICULAR FONT, STYLE, SIZE, OR COLOR.

FOR LASERS NOT FOR MEDICAL USE (U.S. CLS. 21, 23, 26, 36 AND 38).

FIRST USE 4-1-2009; IN COMMERCE 4-1-2009.

KATHLEEN M. VANSTON, EXAMINING ATTORNEY

SN 77-723,477. U.S.G. ENTERPRISES, INC., MARINA DEL REY, CA. FILED 4-27-2009.



THE MARK CONSISTS OF TWO OCEAN WAVES AND THE WORD "ISEA".

FOR COMPUTER APPLICATION SOFTWARE FOR USE ON AND WITH MOBILE COMPUTING DEVICES AND WIRELESS COMMUNICATION DEVICES (U.S. CLS. 21, 23, 26, 36 AND 38).

SHAUNIA CARLYLE, EXAMINING ATTORNEY

SN 77-723,509. B.E. MEYERS & COMPANY, INC., AKA MEYERS LASERS, REDMOND, WA. FILED 4-27-2009.

NanoPoint

THE MARK CONSISTS OF STANDARD CHARACTERS WITHOUT CLAIM TO ANY PARTICULAR FONT, STYLE, SIZE, OR COLOR.

FOR LASERS NOT FOR MEDICAL USE (U.S. CLS. 21, 23, 26, 36 AND 38).

FIRST USE 4-1-2009; IN COMMERCE 4-1-2009.

KATHLEEN M. VANSTON, EXAMINING ATTORNEY

CLASS 9—(Continued).

SN 77-723,519. ATHENA ISG/GTXXTREME, INC., RANCHO CUCAMONGA, CA. FILED 4-27-2009.

WiSync

THE MARK CONSISTS OF STANDARD CHARACTERS WITHOUT CLAIM TO ANY PARTICULAR FONT, STYLE, SIZE, OR COLOR.

FOR COMPUTER HARDWARE AND SOFTWARE, FOR USE WITH AND TO CONTROL/INTERFACE WITH WIRELESS MEDICAL PATIENT MONITORING EQUIPMENT AND SENSORS, FOR RECEIVING, PROCESSING, TRANSMITTING, AND DISPLAYING DATA (U.S. CLS. 21, 23, 26, 36 AND 38).

LAKEISHA LEWIS, EXAMINING ATTORNEY

CLASS 9—(Continued).

SN 77-723,607. TELSTAR, S.A., 08226 TERRASSA, SPAIN, FILED 4-28-2009.

LYOSUITE

THE MARK CONSISTS OF STANDARD CHARACTERS WITHOUT CLAIM TO ANY PARTICULAR FONT, STYLE, SIZE, OR COLOR.

FOR SOFTWARE FOR THE USE, OPERATION AND CONTROL OF FREEZE DRYING MACHINES, AUTOCLAVE MACHINES, STERILIZATION MACHINES AND ULTRA LOW TEMPERATURE FREEZERS (U.S. CLS. 21, 23, 26, 36 AND 38).

FIRST USE 3-1-2009; IN COMMERCE 3-1-2009.

KATHERINE CONNOLLY, EXAMINING ATTORNEY

SN 77-723,557. SCOTT CHARLES MCGREGOR, CEDAR PARK, TX. FILED 4-27-2009.

Cooking Is Easy

THE MARK CONSISTS OF STANDARD CHARACTERS WITHOUT CLAIM TO ANY PARTICULAR FONT, STYLE, SIZE, OR COLOR.

FOR AUDIO AND VIDEO RECORDINGS FEATURING COOKING LESSONS (U.S. CLS. 21, 23, 26, 36 AND 38).

ANDREW LEASER, EXAMINING ATTORNEY

SN 77-723,693. THE POWERWISE GROUP, INC., BOCA RATON, FL. FILED 4-28-2009.

MOTORWISE FX

THE MARK CONSISTS OF STANDARD CHARACTERS WITHOUT CLAIM TO ANY PARTICULAR FONT, STYLE, SIZE, OR COLOR.

FOR ELECTRONIC CONTROLLERS AND MICRO-PROCESSOR-BASED HARDWARE SYSTEMS USED TO REDUCE POWER CONSUMPTION (U.S. CLS. 21, 23, 26, 36 AND 38).

TEJBIR SINGH, EXAMINING ATTORNEY

SN 77-723,593. M&FC HOLDING, LLC, RALEIGH, NC. FILED 4-28-2009.

COMMANDLINK

THE MARK CONSISTS OF STANDARD CHARACTERS WITHOUT CLAIM TO ANY PARTICULAR FONT, STYLE, SIZE, OR COLOR.

FOR WIRELESS INTERFACE DEVICE AND SOFTWARE THAT FACILITATES CONNECTIVITY BETWEEN AN ELECTRICITY, GAS OR WATER UTILITY TRANSCIEVER AND A HAND HELD DEVICE OR COMPUTER, ALLOWING ACCESS AND CONTROL OF THE UTILITY TRANSCIEVER(S) FOR PROGRAMMING AND TROUBLESHOOTING IN ADVANCED METERING AND POWER DISTRIBUTION INFRASTRUCTURE SYSTEMS (U.S. CLS. 21, 23, 26, 36 AND 38).

NAKIA HENRY, EXAMINING ATTORNEY

SN 77-723,695. THE POWERWISE GROUP, INC., BOCA RATON, FL. FILED 4-28-2009.

ECOWISE FX

THE MARK CONSISTS OF STANDARD CHARACTERS WITHOUT CLAIM TO ANY PARTICULAR FONT, STYLE, SIZE, OR COLOR.

FOR ELECTRONIC CONTROLLERS AND MICRO-PROCESSOR-BASED HARDWARE SYSTEMS USED TO REDUCE POWER CONSUMPTION (U.S. CLS. 21, 23, 26, 36 AND 38).

TEJBIR SINGH, EXAMINING ATTORNEY

CLASS 9—(Continued).

SN 77-723,716. DRI CORPORATION, DALLAS, TX. FILED 4-28-2009.

CLASS 9—(Continued).

SN 77-723,745. MAXTENA, INC, BLACKSBURG, VA. FILED 4-28-2009.

MOBILITE

XWAVES

THE MARK CONSISTS OF STANDARD CHARACTERS WITHOUT CLAIM TO ANY PARTICULAR FONT, STYLE, SIZE, OR COLOR.

FOR ELECTRONIC TRANSIT DESTINATION INFORMATION SIGNS USED ON PUBLIC TRANSPORTATION (U.S. CLS. 21, 23, 26, 36 AND 38).

NAAKWAMA ANKRAH, EXAMINING ATTORNEY

THE MARK CONSISTS OF STANDARD CHARACTERS WITHOUT CLAIM TO ANY PARTICULAR FONT, STYLE, SIZE, OR COLOR.

FOR ANTENNAE; ANTENNAS; ANTENNAS FOR RADIO, FOR TELEVISION; ANTENNAS FOR WIRELESS COMMUNICATIONS APPARATUS; ELECTROMAGNETIC APPARATUS USED TO GENERATE OR MEASURE MAGNETIC FIELDS; ELECTRONIC COMBINERS FOR CONNECTING ANTENNAS AND RECEIVERS; MICROWAVE ANTENNAE; RADAR; RADAR RECEIVERS WITH AMPLIFIERS; VEHICLE LOCATING, TRACKING AND SECURITY SYSTEM COMPRISED OF AN ANTENNA AND RADIO TRANSMITTER TO BE PLACED IN A VEHICLE (U.S. CLS. 21, 23, 26, 36 AND 38).

JANICE L. MCMORROW, EXAMINING ATTORNEY

SN 77-723,722. MONTGOMERY, JOHN, DBA STARTWORKS, MENLO PARK, CA. FILED 4-28-2009.

SN 77-723,808. DRI CORPORATION, DALLAS, TX. FILED 4-28-2009.

STARTWORKS

TRANSITMEDIA

THE MARK CONSISTS OF STANDARD CHARACTERS WITHOUT CLAIM TO ANY PARTICULAR FONT, STYLE, SIZE, OR COLOR.

FOR DIGITAL MATERIALS, NAMELY, DVDS AND DOWNLOADABLE MEDIA FILES FEATURING EDUCATIONAL MATERIALS AND INFORMATION IN THE FIELDS OF BUSINESS, LAW, FINANCING AND VENTURE CAPITAL; DIGITAL MEDIA, NAMELY, DVDS AND DOWNLOADABLE MEDIA FILES FEATURING EDUCATIONAL MATERIALS AND INFORMATION IN THE FIELDS OF BUSINESS, LAW, FINANCING AND VENTURE CAPITAL; DVDS FEATURING EDUCATIONAL MATERIALS AND INFORMATION IN THE FIELDS OF BUSINESS, LAW, FINANCING AND VENTURE CAPITAL (U.S. CLS. 21, 23, 26, 36 AND 38).

FIRST USE 2-5-2009; IN COMMERCE 2-5-2009.

JENNY PARK, EXAMINING ATTORNEY

THE MARK CONSISTS OF STANDARD CHARACTERS WITHOUT CLAIM TO ANY PARTICULAR FONT, STYLE, SIZE, OR COLOR.

FOR HARDWARE, NAMELY, ELECTRONIC DISPLAY UNITS, AND COMPUTER SOFTWARE FOR USE ON MASS TRANSIT VEHICLES FOR THE PURPOSE OF PROVIDING PASSENGERS AND TRANSPORTATION OPERATORS WITH REAL-TIME INFORMATION TO ASSIST IN THE SAFE AND EFFICIENT USE OF PUBLIC TRANSPORTATION (U.S. CLS. 21, 23, 26, 36 AND 38).

NAAKWAMA ANKRAH, EXAMINING ATTORNEY

CLASS 9—(Continued).

SN 77-723,840. MOTOROLA, INC., SCHAUMBURG, IL.
FILED 4-28-2009.

QUANTICO

THE MARK CONSISTS OF STANDARD CHARACTERS WITHOUT CLAIM TO ANY PARTICULAR FONT, STYLE, SIZE, OR COLOR.

FOR CELLULAR PHONES; CELLULAR PHONES WITH ELECTRONIC MESSAGING CAPABILITIES; CELLULAR PHONES WITH DIGITAL CAMERA AND VIDEO CAMERA CAPABILITIES; CELLULAR PHONES WITH MP3, AUDIO, AND VIDEO PLAYER CAPABILITIES; CELLULAR PHONES WITH ELECTRONIC GAME CAPABILITIES; CELLULAR PHONES WITH NAVIGATION AND GLOBAL POSITIONING (GPS) CAPABILITIES; WIRELESS COMMUNICATION DEVICES FEATURING VOICE, DATA AND IMAGE TRANSMISSION; CELLULAR PHONE BATTERIES, BATTERY CHARGERS AND POWER ADAPTORS (U.S. CLS. 21, 23, 26, 36 AND 38).

HELENE LIWINSKI, EXAMINING ATTORNEY

SN 77-723,857. MOTOROLA, INC., SCHAUMBURG, IL.
FILED 4-28-2009.

SQUALL

THE MARK CONSISTS OF STANDARD CHARACTERS WITHOUT CLAIM TO ANY PARTICULAR FONT, STYLE, SIZE, OR COLOR.

FOR CELLULAR PHONES; CELLULAR PHONES WITH ELECTRONIC MESSAGING CAPABILITIES; CELLULAR PHONES WITH DIGITAL CAMERA AND VIDEO CAMERA CAPABILITIES; CELLULAR PHONES WITH MP3, AUDIO, AND VIDEO PLAYER CAPABILITIES; CELLULAR PHONES WITH ELECTRONIC GAME CAPABILITIES; CELLULAR PHONES WITH NAVIGATION AND GLOBAL POSITIONING (GPS) CAPABILITIES; WIRELESS COMMUNICATION DEVICES FEATURING VOICE, DATA AND IMAGE TRANSMISSION; CELLULAR PHONE BATTERIES, BATTERY CHARGERS AND POWER ADAPTORS (U.S. CLS. 21, 23, 26, 36 AND 38).

HELENE LIWINSKI, EXAMINING ATTORNEY

CLASS 9—(Continued).

SN 77-723,935. HYPERTHERM INC., HANOVER, NH. FILED
4-28-2009.

CUTPRO

THE MARK CONSISTS OF STANDARD CHARACTERS WITHOUT CLAIM TO ANY PARTICULAR FONT, STYLE, SIZE, OR COLOR.

FOR COMMUNICATIONS SOFTWARE FOR COMPUTER CONTROLLED PLASMA ARC CUTTING OR WELDING SYSTEMS THAT FACILITATES THE PROGRAMMING OF COMPUTER NUMERICAL CONTROLS, CUTTING PROFILES, OR SHAPES (U.S. CLS. 21, 23, 26, 36 AND 38).

MARGERY A. TIERNEY, EXAMINING ATTORNEY

SN 77-723,936. TECHWAY SERVICES, INC., GRAND PRAIRIE, TX. FILED 4-28-2009.



THE MARK CONSISTS OF THE STYLIZED LETTER "E" WITHIN A BOX BACKGROUND.

FOR COMPUTER SOFTWARE FOR DATA DESTRUCTION (U.S. CLS. 21, 23, 26, 36 AND 38).

FIRST USE 4-1-2006; IN COMMERCE 4-1-2006.
GISELLE AGOSTO, EXAMINING ATTORNEY

SN 77-723,948. APPLIED SCIENCE INTERNATIONAL, LLC,
RALEIGH, NC. FILED 4-28-2009.

ASI

THE MARK CONSISTS OF STANDARD CHARACTERS WITHOUT CLAIM TO ANY PARTICULAR FONT, STYLE, SIZE, OR COLOR.

FOR SOFTWARE USED IN DESIGNING LIGHT GAUGE STEEL COMPONENTS USED IN BUILDINGS AND SOFTWARE FOR ANALYZING AND VISUALLY SIMULATING STRUCTURAL FAILURES CAUSED BY MANMADE AND NATURAL HAZARDS (U.S. CLS. 21, 23, 26, 36 AND 38).

FIRST USE 0-0-2004; IN COMMERCE 0-0-2004.
LINDA ORNDORFF, EXAMINING ATTORNEY

CLASS 9—(Continued).

SN 77-723,953. TECHWAY SERVICES, INC., GRAND PRAIRIE, TX. FILED 4-28-2009.

EBAN

THE MARK CONSISTS OF STANDARD CHARACTERS WITHOUT CLAIM TO ANY PARTICULAR FONT, STYLE, SIZE, OR COLOR.
FOR COMPUTER SOFTWARE FOR DATA DESTRUCTION (U.S. CLS. 21, 23, 26, 36 AND 38).
FIRST USE 4-1-2006; IN COMMERCE 4-1-2006.
GISELLE AGOSTO, EXAMINING ATTORNEY

SN 77-723,962. ADDCO LLC, ST. PAUL, MN. FILED 4-28-2009.

ADDCO

THE MARK CONSISTS OF STANDARD CHARACTERS WITHOUT CLAIM TO ANY PARTICULAR FONT, STYLE, SIZE, OR COLOR.
OWNER OF U.S. REG. NOS. 2,525,084 AND 2,642,057.
FOR ELECTRONICALLY CONTROLLED CHANGEABLE MESSAGE SIGNS FOR TRAFFIC FLOW CONTROL PURPOSES (U.S. CLS. 21, 23, 26, 36 AND 38).
FIRST USE 2-0-1988; IN COMMERCE 2-0-1988.
GINA HAYES, EXAMINING ATTORNEY

SN 77-724,192. ARROW LOCK MANUFACTURING COMPANY, SALEM, VA. FILED 4-28-2009.

REVOLUTION

THE MARK CONSISTS OF STANDARD CHARACTERS WITHOUT CLAIM TO ANY PARTICULAR FONT, STYLE, SIZE, OR COLOR.
FOR ELECTRONIC LOCKSET (U.S. CLS. 21, 23, 26, 36 AND 38).
KATHLEEN M. VANSTON, EXAMINING ATTORNEY

CLASS 9—(Continued).

SN 77-724,222. MYTELEHEALTH SOLUTIONS, LLC, LA JOLLA, CA. FILED 4-28-2009.

MYTELEHEALTH

THE MARK CONSISTS OF STANDARD CHARACTERS WITHOUT CLAIM TO ANY PARTICULAR FONT, STYLE, SIZE, OR COLOR.
FOR COMPUTER PERIPHERALS AND SOFTWARE FOR CONTROLLING AND MANAGING PATIENT CARE AND COMPLIANCE (U.S. CLS. 21, 23, 26, 36 AND 38).
JORDAN BAKER, EXAMINING ATTORNEY

SN 77-724,260. SHARK EYES, INC., LOS ANGELES, CA. FILED 4-28-2009.

D'amor

THE MARK CONSISTS OF CAPITAL "D" WITH HYPHEN WITH AMOR ON THE SAME LINE AS THE HYPHEN.
THE ENGLISH TRANSLATION OF "D'AMOR" IS "WITH LOVE".
FOR SUNGLASSES AND SPECTACLES (U.S. CLS. 21, 23, 26, 36 AND 38).
FIRST USE 4-7-2009; IN COMMERCE 4-15-2009.
SOPHIA S. KIM, EXAMINING ATTORNEY

SN 77-724,310. GAI MARCOS, DBA TRICERASOFT, BRAMPTON, ONTARIO, CANADA, FILED 4-28-2009.

MP3+G

THE MARK CONSISTS OF STANDARD CHARACTERS WITHOUT CLAIM TO ANY PARTICULAR FONT, STYLE, SIZE, OR COLOR.
OWNER OF CANADA REG. NO. TMA736531, DATED 3-19-2009, EXPIRES 3-19-2024.
OWNER OF CANADA REG. NO. TMA736531, DATED 3-19-2009, EXPIRES 3-19-2024.
FOR COMPUTER SOFTWARE, NAMELY, SOFTWARE THAT COMBINES AUDIO COMPUTER FILES AND GRAPHICS COMPUTER FILES FOR USE WITH COMPUTER KARAOKE SOFTWARE APPLICATIONS AND KARAOKE PLAYERS AND MACHINES (U.S. CLS. 21, 23, 26, 36 AND 38).
WENDY JUN, EXAMINING ATTORNEY

CLASS 9—(Continued).

SN 77-724,381. BARBARA CREATIONS, INC., SKOKIE, IL.
FILED 4-28-2009.

CLASS 9—(Continued).

SN 77-724,642. VXI CORPORATION, ROLLINSFORD, NH.
FILED 4-29-2009.

DESIGNERS DOUBLES

THE MARK CONSISTS OF STANDARD CHARACTERS
WITHOUT CLAIM TO ANY PARTICULAR FONT, STYLE,
SIZE, OR COLOR.

OWNER OF U.S. REG. NO. 2,778,575.

NO CLAIM IS MADE TO THE EXCLUSIVE RIGHT TO
USE "DESIGNERS", APART FROM THE MARK AS
SHOWN.

FOR SUNGLASSES (U.S. CLS. 21, 23, 26, 36 AND 38).

FIRST USE 11-16-2002; IN COMMERCE 11-16-2002.

DEBRA LEE, EXAMINING ATTORNEY

TRIA

THE MARK CONSISTS OF STANDARD CHARACTERS
WITHOUT CLAIM TO ANY PARTICULAR FONT, STYLE,
SIZE, OR COLOR.

FOR TELEPHONE HEADSETS (U.S. CLS. 21, 23, 26, 36
AND 38).

TINA L. SNAPP, EXAMINING ATTORNEY

SN 77-724,491. DEMOREPORTS, LLC, BRUNSWICK, OH.
FILED 4-28-2009.

SiteStar

THE MARK CONSISTS OF STANDARD CHARACTERS
WITHOUT CLAIM TO ANY PARTICULAR FONT, STYLE,
SIZE, OR COLOR.

FOR COMPUTER SOFTWARE FOR DEMOGRAPHIC
ANALYSIS, MAPPING, AND SITE SELECTION WITH
GPS CAPABILITY (U.S. CLS. 21, 23, 26, 36 AND 38).

GINA HAYES, EXAMINING ATTORNEY

SN 77-724,645. DIMI, P.A., INC., NEW YORK, NY. FILED 4-
29-2009.

SN 77-724,507. ATLANTIC OPTICAL COMPANY, INCORPO-
RATED, CHATSWORTH, CA. FILED 4-28-2009.

GREENFREAK**GEEK EYEWEAR**

THE MARK CONSISTS OF STANDARD CHARACTERS
WITHOUT CLAIM TO ANY PARTICULAR FONT, STYLE,
SIZE, OR COLOR.

NO CLAIM IS MADE TO THE EXCLUSIVE RIGHT TO
USE "EYEWEAR", APART FROM THE MARK AS SHOWN.
FOR EYEWEAR; EYEGLASS FRAMES; EYEWEAR
CASES (U.S. CLS. 21, 23, 26, 36 AND 38).

FIRST USE 10-2-2008; IN COMMERCE 10-2-2008.

WILLIAM P. SHANAHAN, EXAMINING ATTORNEY

THE MARK CONSISTS OF STANDARD CHARACTERS
WITHOUT CLAIM TO ANY PARTICULAR FONT, STYLE,
SIZE, OR COLOR.

FOR COMPUTER HARDWARE AND SOFTWARE
SYSTEM FOR REMOTELY MONITORING ENVIRON-
MENTAL CONDITIONS AND CONTROLLING DEVICES
WITHIN A BUILDING, FACILITY, GROUNDS, OR
DESIGNATED SPATIAL AREA (U.S. CLS. 21, 23, 26, 36
AND 38).

TINA L. SNAPP, EXAMINING ATTORNEY

CLASS 9—(Continued).

SN 77-724,707. SARBAKAN INC., QUEBEC, QUEBEC, CANADA, FILED 4-29-2009.

Dig It Up

THE MARK CONSISTS OF STANDARD CHARACTERS WITHOUT CLAIM TO ANY PARTICULAR FONT, STYLE, SIZE, OR COLOR.

FOR COMPUTER GAME PROGRAMS; COMPUTER GAME PROGRAMS, CARTRIDGES, AND CASSETTES; COMPUTER GAME SOFTWARE; COMPUTER GAME SOFTWARE FOR PERSONAL COMPUTERS AND HOME VIDEO GAME CONSOLES; COMPUTER GAME SOFTWARE FOR USE WITH PERSONAL COMPUTERS, HOME VIDEO GAME CONSOLES USED WITH TELEVISIONS, AND FOR ARCADE-BASED VIDEO GAME CONSOLES; COMPUTER PROGRAMS FOR VIDEO AND COMPUTER GAMES; ELECTRONIC GAME PROGRAMS; ELECTRONIC GAME SOFTWARE; ELECTRONIC GAME SOFTWARE FOR CELLULAR TELEPHONES; ELECTRONIC GAME SOFTWARE FOR HANDHELD ELECTRONIC DEVICES; ELECTRONIC GAME SOFTWARE FOR WIRELESS DEVICES; ELECTRONIC INTERACTIVE BOARD GAMES FOR USE WITH EXTERNAL MONITOR; GAME SOFTWARE; INTERACTIVE MULTIMEDIA COMPUTER GAME PROGRAM; INTERACTIVE VIDEO GAME PROGRAMS; VIDEO AND COMPUTER GAME PROGRAMS; VIDEO GAME SOFTWARE; VIRTUAL REALITY GAME SOFTWARE (U.S. CLS. 21, 23, 26, 36 AND 38).
SHAILA SETTLES, EXAMINING ATTORNEY

SN 77-724,744. CODE BLUE CORPORATION, HOLLAND, MI. FILED 4-29-2009.

TOOLVOX

THE MARK CONSISTS OF STANDARD CHARACTERS WITHOUT CLAIM TO ANY PARTICULAR FONT, STYLE, SIZE, OR COLOR.

FOR COMPUTER SERVERS (U.S. CLS. 21, 23, 26, 36 AND 38).
MICHAEL KEATING, EXAMINING ATTORNEY

SN 77-724,816. MEDITATION SOLUTIONS, LLC, SAN ANTONIO, TX. FILED 4-29-2009.

ZEN2GO

THE MARK CONSISTS OF STANDARD CHARACTERS WITHOUT CLAIM TO ANY PARTICULAR FONT, STYLE, SIZE, OR COLOR.

FOR SOUND RECORDINGS FEATURING MEDITATIONS (U.S. CLS. 21, 23, 26, 36 AND 38).
FIRST USE 3-17-2009; IN COMMERCE 3-17-2009.
LESLEY LAMOTHE, EXAMINING ATTORNEY

CLASS 9—(Continued).

SN 77-724,871. GE MDS, LLC., ROCHESTER, NY. FILED 4-29-2009.

MDS WiYZ

THE MARK CONSISTS OF STANDARD CHARACTERS WITHOUT CLAIM TO ANY PARTICULAR FONT, STYLE, SIZE, OR COLOR.

OWNER OF U.S. REG. NOS. 2,744,018, 3,069,769 AND OTHERS.
FOR WIRELESS GATEWAY AND RADIO TRANSMISSION AND RECEIVING EQUIPMENT (U.S. CLS. 21, 23, 26, 36 AND 38).
CURTIS FRENCH, EXAMINING ATTORNEY

SN 77-724,998. POLYCOM, INC., 4750 WILLOW ROAD, CA. FILED 4-29-2009.

RMX

THE MARK CONSISTS OF STANDARD CHARACTERS WITHOUT CLAIM TO ANY PARTICULAR FONT, STYLE, SIZE, OR COLOR.

OWNER OF U.S. REG. NO. 3,450,205.
FOR COMMUNICATIONS SERVERS (U.S. CLS. 21, 23, 26, 36 AND 38).
FIRST USE 2-28-2007; IN COMMERCE 2-28-2007.
MIDGE BUTLER, EXAMINING ATTORNEY

SN 77-724,999. EMERGING DISPLAY TECHNOLOGIES CORPORATION, IRVINE, CA. FILED 4-29-2009.

POLYTOUCH

THE MARK CONSISTS OF STANDARD CHARACTERS WITHOUT CLAIM TO ANY PARTICULAR FONT, STYLE, SIZE, OR COLOR.

FOR TOUCH PANELS (U.S. CLS. 21, 23, 26, 36 AND 38).
BARBARA RUTLAND, EXAMINING ATTORNEY

CLASS 9—(Continued).

SN 77-725,012. INNOVATIVE SPECTATOR PRODUCTS, INC., GAINESVILLE, GA. FILED 4-29-2009.

LapCeiver

THE MARK CONSISTS OF STANDARD CHARACTERS WITHOUT CLAIM TO ANY PARTICULAR FONT, STYLE, SIZE, OR COLOR.

FOR PORTABLE HAND-HELD ELECTRONIC DEVICE FOR RECEIVING AND DISPLAYING RACE TRACK LAP TIMES FOR A RACE VEHICLE (U.S. CLS. 21, 23, 26, 36 AND 38).

FIRST USE 8-1-2008; IN COMMERCE 8-1-2008.
MICHAEL KEATING, EXAMINING ATTORNEY

CLASS 9—(Continued).

SN 77-725,081. COVEROO, INC., SAN FRANCISCO, CA. FILED 4-29-2009.

COVEROO

THE MARK CONSISTS OF STANDARD CHARACTERS WITHOUT CLAIM TO ANY PARTICULAR FONT, STYLE, SIZE, OR COLOR.

FOR PROTECTIVE CASES FOR CELL PHONES, LAP-TOPS AND PORTABLE MEDIA PLAYERS (U.S. CLS. 21, 23, 26, 36 AND 38).

FIRST USE 11-26-2008; IN COMMERCE 11-26-2008.
BRIAN PINO, EXAMINING ATTORNEY

SN 77-725,263. PLAY THE SMART WAY, LLC, SEATTLE, WA. FILED 4-29-2009.

Play The Smart Way

THE MARK CONSISTS OF STANDARD CHARACTERS WITHOUT CLAIM TO ANY PARTICULAR FONT, STYLE, SIZE, OR COLOR.

FOR DOWNLOADABLE ELECTRONIC PUBLICATIONS IN THE NATURE OF ELECTRONIC BOOKS, PAMPHLETS, AND BROCHURES IN THE FIELD OF INFORMATION ABOUT AND ANALYSIS OF STATE LOTTERY GAMES (U.S. CLS. 21, 23, 26, 36 AND 38).

FIRST USE 3-27-2009; IN COMMERCE 3-27-2009.
BARBARA GAYNOR, EXAMINING ATTORNEY

SN 77-725,034. JOSE ANTONIO AGUILAR JIMENEZ, AKA PEPE AGUILAR, WOODLAND HILLS, CA. FILED 4-29-2009.

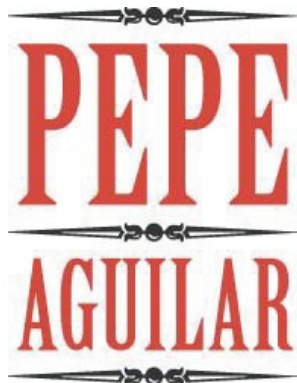

THE COLOR(S) RED AND BLACK IS/ARE CLAIMED AS A FEATURE OF THE MARK.

THE MARK CONSISTS OF THE NAME "PEPE AGUILAR" IS IN THE COLOR RED AND IS SEPERATED ON TOP IN THE MIDDLE AND ON THE BOTTOM BY BLACK LINES.

FOR DIGITAL MEDIA, NAMELY, CDS FEATURING PRE-RECORDED MUSIC (U.S. CLS. 21, 23, 26, 36 AND 38).

FIRST USE 1-1-1981; IN COMMERCE 1-1-1991.
GEOFFREY FOSDICK, EXAMINING ATTORNEY

SN 77-725,291. BALD BRUTUS LLC, STUDIO CITY, CA. FILED 4-29-2009.

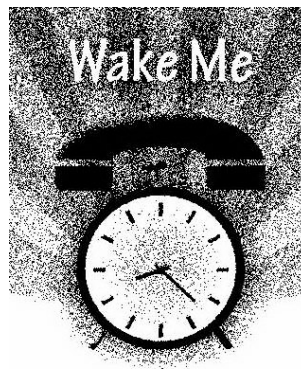

THE STIPPLING IS FOR SHADING PURPOSES ONLY. THE MARK CONSISTS OF THE STYLIZED TEXT "WAKE ME" WITH AN ALARM CLOCK.

FOR ALARM-CLOCK SOFTWARE FOR HANDHELD WIFI DEVICES, NAMELY, SMARTPHONES, PDAS, INDIVIDUAL MEDIA DEVICES/PLAYERS, ALLOWING USERS TO SEND AND RECEIVE WAKE UP CALLS TO EACH OTHER (U.S. CLS. 21, 23, 26, 36 AND 38).

LINDA MICKLEBURGH, EXAMINING ATTORNEY

CLASS 9—(Continued).

SN 77-725,306. NUMA INTERNATIONAL LLC, MIAMI BEACH, FL. FILED 4-29-2009.



THE COLOR(S) BLUE AND ORANGE IS/ARE CLAIMED AS A FEATURE OF THE MARK.

THE MARK CONSISTS OF THE WORD "NUMA" IN STYLIZED LETTERS. AROUND THE LETTER "N" APPEARS THE DRAWING OF A PLANET IN ORBIT. THE COLOR BLUE APPEARS IN THE LETTERS "N", "U" AND "M". THE COLOR ORANGE APPEARS IN THE LETTER "A" AND IN THE DESIGN OF THE PLANET IN ORBIT.

THE WORDING "NUMA" HAS NO MEANING IN A FOREIGN LANGUAGE.

FOR GLOBAL POSITIONING SYSTEM (GPS) CONSISTING OF COMPUTERS, COMPUTER SOFTWARE, TRANSMITTERS, RECEIVERS, AND NETWORK INTERFACE DEVICES; LASER OBJECT DETECTORS FOR USE ON VEHICLES; NAVIGATION APPARATUS FOR VEHICLES; RADAR OBJECT DETECTORS FOR USE ON VEHICLES; VEHICLE MOUNTED GPS SENSOR FOR DETERMINING THE RATE OF MOTION FOR A VEHICLE (U.S. CLS. 21, 23, 26, 36 AND 38).

JAY BESCH, EXAMINING ATTORNEY

SN 77-725,350. ECLICK INTERACTIVE, INC., PORT HOPE, ON, CANADA, FILED 4-29-2009.

Runway Diaries

THE MARK CONSISTS OF STANDARD CHARACTERS WITHOUT CLAIM TO ANY PARTICULAR FONT, STYLE, SIZE, OR COLOR.

FOR MOTION PICTURE FILMS ABOUT MODELING AND FASHION RELATED TOPICS (U.S. CLS. 21, 23, 26, 36 AND 38).

WON TEAK OH, EXAMINING ATTORNEY

SN 77-725,386. WAH LEI FOOTWEAR (U.S.A.) CORPORATION, SOUTH EL MONTE, CA. FILED 4-29-2009.

TRUSTY

THE MARK CONSISTS OF STANDARD CHARACTERS WITHOUT CLAIM TO ANY PARTICULAR FONT, STYLE, SIZE, OR COLOR.

FOR BATTERIES (U.S. CLS. 21, 23, 26, 36 AND 38).

DAVID C. REIHNER, EXAMINING ATTORNEY

CLASS 9—(Continued).

SN 77-725,397. MOUNTAIN SHADES, INC., WHEAT RIDGE, CO. FILED 4-29-2009.

HYDROGLARE

THE MARK CONSISTS OF STANDARD CHARACTERS WITHOUT CLAIM TO ANY PARTICULAR FONT, STYLE, SIZE, OR COLOR.

FOR PROTECTIVE EYEWEAR; SPORTS EYEWEAR; SUNGLASSES (U.S. CLS. 21, 23, 26, 36 AND 38).

HEATHER SAPP, EXAMINING ATTORNEY

SN 77-725,426. DIRECT SOLUTIONS INC., LEHI, UT. FILED 4-29-2009.

DataTree

THE MARK CONSISTS OF STANDARD CHARACTERS WITHOUT CLAIM TO ANY PARTICULAR FONT, STYLE, SIZE, OR COLOR.

FOR COMPUTER SOFTWARE FOR THE STORAGE AND RETRIEVAL OF CONTACT, MARKETING, DEMOGRAPHIC, PSYCHOGRAPHIC, AND RELATED INFORMATION IN A RELATIONAL DATABASE (U.S. CLS. 21, 23, 26, 36 AND 38).

ROBERT C. CLARK JR., EXAMINING ATTORNEY

CLASS 9—(Continued).

SN 77-725,431. QSC AUDIO PRODUCTS, LLC, COSTA MESA, CA. FILED 4-29-2009.

CLASS 9—(Continued).

SN 77-725,432. TWENTIETH CENTURY FOX FILM CORPORATION, LOS ANGELES, CA. FILED 4-29-2009.



THE MARK CONSISTS OF A STYLIZED LETTER "Q".
 FOR SOFTWARE USED TO ACCEPT, MODIFY, PROCESS, MIX, ROUTE, TRANSPORT, AMPLIFY, MONITOR, INTERFACE WITH AND CONTROL AUDIO SIGNALS AND CONTROL DATA, AND TO CONTROL AUDIO, EQUIPMENT ON A NETWORK; AUDIO CONTROL AND PROCESSING SOFTWARE; SOFTWARE FOR MONITORING, MANAGING AND CONTROLLING AMPLIFIERS ON A NETWORK; SOFTWARE FOR USE IN CREATING GRAPHIC USER INTERFACES FOR CONTROL AND MONITORING OF THE FOREGOING SYSTEMS (U.S. CLS. 21, 23, 26, 36 AND 38).
 FIRST USE 4-1-2009; IN COMMERCE 4-1-2009.
 WON TEAK OH, EXAMINING ATTORNEY

OWNER OF U.S. REG. NOS. 2,033,557, 2,903,242 AND 3,001,994.
 NO CLAIM IS MADE TO THE EXCLUSIVE RIGHT TO USE "SPORTS", APART FROM THE MARK AS SHOWN.
 THE MARK CONSISTS OF THE STYLIZED WORDS "THE ADVENTURES OF DIGGER AND FRIENDS" WHICH APPEAR IN THE CENTER, THE WORDS "FOX SPORTS" WHICH APPEAR INSIDE OF THE OVAL SHAPE ON THE TOP CENTER AND FIVE COSTUMED GOPHER CHARACTERS, AND ALL ARE DISPLAYED INSIDE OF THE RECTANGULAR BACKGROUND.
 FOR PRE-RECORDED DVDS IN THE FIELDS OF SPORTS AND COMEDY; PRE-RECORDED CDS IN THE FIELDS OF SPORTS AND COMEDY; DOWNLOADABLE AUDIO AND VIDEO RECORDINGS IN THE FIELDS OF SPORTS AND COMEDY; DOWNLOADABLE TELEVISION PROGRAMS VIA THE INTERNET IN THE FIELDS OF SPORTS AND COMEDY; DOWNLOADABLE RING TONES, GRAPHICS, WALLPAPER, AND MUSIC VIA A GLOBAL COMPUTER NETWORK AND WIRELESS DEVICES; COMPUTER SCREEN SAVER SOFTWARE; VIDEO GAME AND COMPUTER GAME SOFTWARE; MOUSE PADS; HOLDERS FOR CDS AND DVDS, NAMELY, CD AND DVD SLEEVES, CASES, AND BINDERS; DISPOSABLE CAMERAS (U.S. CLS. 21, 23, 26, 36 AND 38).
 LINDA LAVACHE, EXAMINING ATTORNEY

CLASS 9—(Continued).

SN 77-725,455. MCGHEE, EARL, PELHAM, NH. FILED 4-29-2009.

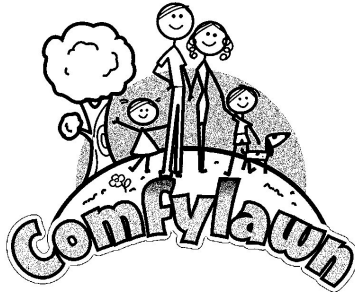

THE MARK CONSISTS OF THE WORDING "COMFY-LAWN" IN A STYLIZED FONT AND THE DESIGN OF FIVE STICK FIGURES RESEMBLING A MAN, WOMAN, LITTLE GIRL, LITTLE BOY AND DOG APPEARING ABOVE THE WORDING. A TREE APPEARS NEXT TO THE LITTLE GIRL, A FLOWER APPEARS IN FRONT OF HER, AND THEY ARE ALL STANDING ON A ROUND-SHAPED PIECE OF LAND WITH AN IMAGE OF THE SUN APPEARING BEHIND THEM.

FOR DIGITAL MEDIA, NAMELY, DVDS FEATURING DO IT YOURSELF LAWN RENOVATION, IRRIGATION, PUTTING GREEN, VARIOUS LANDSCAPING (U.S. CLS. 21, 23, 26, 36 AND 38).

RENEE MCCRAY, EXAMINING ATTORNEY

SN 77-725,459. SHELTERED WINGS, INC., MIDDLETOWN, WI. FILED 4-29-2009.

ATLAS

THE MARK CONSISTS OF STANDARD CHARACTERS WITHOUT CLAIM TO ANY PARTICULAR FONT, STYLE, SIZE, OR COLOR.

FOR BINOCULARS; SPOTTING SCOPES (U.S. CLS. 21, 23, 26, 36 AND 38).

WON TEAK OH, EXAMINING ATTORNEY

SN 77-725,469. BRAUNSTEIN + BERNDT GMBH, D-71522 BACKNANG, FED REP GERMANY, FILED 4-29-2009.

SoundPLAN

THE MARK CONSISTS OF STANDARD CHARACTERS WITHOUT CLAIM TO ANY PARTICULAR FONT, STYLE, SIZE, OR COLOR.

FOR COMPUTER SOFTWARE FOR EVALUATING AND ANALYZING NOISE AND AIR POLLUTION LEVELS (U.S. CLS. 21, 23, 26, 36 AND 38).

FIRST USE 0-0-1989; IN COMMERCE 0-0-1989.

DANNEAN HETZEL, EXAMINING ATTORNEY

CLASS 9—(Continued).

SN 77-725,496. WIRELESS DYNAMICS INC., CALGARY, CANADA, FILED 4-29-2009.

iCarte

THE MARK CONSISTS OF STANDARD CHARACTERS WITHOUT CLAIM TO ANY PARTICULAR FONT, STYLE, SIZE, OR COLOR.

FOR ELECTRONIC DEVICE, NAMELY, APPARATUS COMPRISED OF COMPUTER HARDWARE AND SOFTWARE FOR MANAGING AND PROCESSING ELECTRONIC INFORMATION SUCH AS CREDIT CARDS, ELECTRONIC TICKETS, CUSTOMER LOYALTY CARDS, ELECTRONIC COUPONS AND NEAR FIELD COMMUNICATION (NFC) FOR USE WITH MOBILE COMPUTING DEVICES SUCH AS PERSONAL DIGITAL ASSISTANTS, SMARTPHONES, CELLULAR PHONES, IPHONES, COMPUTERS, LAPTOPS AND INTERACTIVE KIOSKS (U.S. CLS. 21, 23, 26, 36 AND 38).

NAAKWAMA ANKRAH, EXAMINING ATTORNEY

SN 77-725,530. MEYER SOUND LABORATORIES, INCORPORATED, BERKELEY, CA. FILED 4-29-2009.

MINA

THE MARK CONSISTS OF STANDARD CHARACTERS WITHOUT CLAIM TO ANY PARTICULAR FONT, STYLE, SIZE, OR COLOR.

FOR LOUDSPEAKERS (U.S. CLS. 21, 23, 26, 36 AND 38).

THEODORE MCBRIDE, EXAMINING ATTORNEY

SN 77-725,674. FCI AMERICAS TECHNOLOGY, INC., CARSON CITY, NV. FILED 4-30-2009.

There is only one IMPLO

THE MARK CONSISTS OF STANDARD CHARACTERS WITHOUT CLAIM TO ANY PARTICULAR FONT, STYLE, SIZE, OR COLOR.

FOR ELECTRICAL CONNECTORS (U.S. CLS. 21, 23, 26, 36 AND 38).

ERNEST SHOSHO, EXAMINING ATTORNEY

CLASS 9—(Continued).

SN 77-725,755. MODULAR SECURITY SYSTEMS, INC.,
IRONTON, OH. FILED 4-30-2009.

MAC

THE MARK CONSISTS OF STANDARD CHARACTERS WITHOUT CLAIM TO ANY PARTICULAR FONT, STYLE, SIZE, OR COLOR.

OWNER OF U.S. REG. NO. 3,567,102.

FOR SELF-CONTAINED, MODULAR ENTRY/EXIT SECURITY PORTALS EQUIPPED WITH ELECTRONIC ACCESS CONTROL DEVICES FOR IDENTIFICATION OF AUTHORIZED PERSONS (U.S. CLS. 21, 23, 26, 36 AND 38).

FIRST USE 2-1-2005; IN COMMERCE 2-1-2005.

MIDGE BUTLER, EXAMINING ATTORNEY

CLASS 9—(Continued).

SN 77-725,796. MODULAR SECURITY SYSTEMS, INC.,
IRONTON, OH. FILED 4-30-2009.



OWNER OF U.S. REG. NO. 3,567,102.

THE COLOR(S) RED, WHITE, BLUE, BLUE, GRAY, AND BLACK IS/ARE CLAIMED AS A FEATURE OF THE MARK.

THE MARK CONSISTS OF A BLUE CUBIC BOX WITH RENDITIONS OF THREE DOORS ON THE FRONT SIDE. TWO OF THE DOORS ARE WHITE AND INCLUDE INTERWOVEN BLACK BARS WITH THE CENTRAL DOOR BEING BLUE FRAMED IN WHITE. THE RED LETTERS MAC ARE OULINED IN WHITE AND RUN VERTICALLY ALONG THE LEFT SIDE OF THE BLUE BOX, THE COMBINATION OF THE LETTERS AND BOX BEING BACKED BY A BLACK AND GREY RENDITION OF INTERWOVEN LINKED FENCING.

FOR SELF-CONTAINED, MODULAR ENTRY/EXIT SECURITY PORTALS EQUIPPED WITH ELECTRONIC ACCESS CONTROL DEVICES FOR IDENTIFICATION OF AUTHORIZED PERSONS (U.S. CLS. 21, 23, 26, 36 AND 38).

FIRST USE 2-1-2005; IN COMMERCE 2-1-2005.

MIDGE BUTLER, EXAMINING ATTORNEY

SN 77-725,763. MODULAR SECURITY SYSTEMS, INC.,
IRONTON, OH. FILED 4-30-2009.

MSSI

THE MARK CONSISTS OF STANDARD CHARACTERS WITHOUT CLAIM TO ANY PARTICULAR FONT, STYLE, SIZE, OR COLOR.

FOR SELF-CONTAINED, MODULAR ENTRY/EXIT SECURITY PORTALS EQUIPPED WITH ELECTRONIC ACCESS CONTROL DEVICES FOR IDENTIFICATION OF AUTHORIZED PERSONS (U.S. CLS. 21, 23, 26, 36 AND 38).

FIRST USE 2-1-2005; IN COMMERCE 2-1-2005.

MIDGE BUTLER, EXAMINING ATTORNEY

SN 77-725,804. MONTGOMERY, BRANDON T, DBA BLU-DOTONE AMP WORKS, LLC, CENTENNIAL, CO. FILED 4-30-2009.

Hi-Plains Drifter

THE MARK CONSISTS OF STANDARD CHARACTERS WITHOUT CLAIM TO ANY PARTICULAR FONT, STYLE, SIZE, OR COLOR.

FOR GUITAR AMPLIFIERS (U.S. CLS. 21, 23, 26, 36 AND 38).

FIRST USE 8-13-2004; IN COMMERCE 8-13-2004.

DOMINICK J. SALEMI, EXAMINING ATTORNEY

CLASS 9—(Continued).

SN 77-725,830. PHOTOPROTECTIVE TECHNOLOGIES, INC., SAN ANTONIO, TX. FILED 4-30-2009.

MELAVISION

THE MARK CONSISTS OF STANDARD CHARACTERS WITHOUT CLAIM TO ANY PARTICULAR FONT, STYLE, SIZE, OR COLOR.

FOR ANTI-GLARE GLASSES; ANTI-GLARE SPECTACLES; ANTI-REFLECTIVE LENSES; ANTIREFLECTION COATED EYEGLASSES; CHILDREN'S EYE GLASSES; COMPUTER SCREEN FILTERS; CORRECTIVE GLASSES; EYEGLOSS CASES; EYEGLOSS FRAMES; EYEGLOSS LENSES; EYEGASSES; EYEWEAR; EYEWEAR CASES; FILTERS FOR OPTICAL DEVICES; GLACIER EYEGASSES; GOGGLES FOR SPORTS; LENSES FOR SUNGLASSES; MOTORCYCLE GOGGLES; NIGHT VISION GOGGLES; OPHTHALMIC LENSES; OPTICAL FILTERS; OPTICAL FILTERS FOR SCREENS; OPTICAL GLASSES; OPTICAL LENSES; OPTICAL REFLECTORS; POLARIZING SPECTACLES; PROTECTIVE EYEGLASSES; PROTECTIVE EYEWEAR; PROTECTIVE EYEWEAR AND COMPONENT PARTS THEREOF; PROTECTIVE SPECTACLES; READING EYEGASSES; READING GLASSES; SAFETY EYEWEAR; SAFETY GOGGLES; SKI GLASSES; SKI GOGGLES; SNOW GOGGLES; SPECTACLE GLASSES; SPECTACLE LENS BLANKS; SPECTACLE LENSES; SPECTACLES; SPECTACLES, FRAMES AND CASES; SPORTS EYEWEAR; SPORTS GLASSES; SUNGLASS LENSES; SUNGLASSES; SUNGLASSES AND SPECTACLES (U.S. CLS. 21, 23, 26, 36 AND 38).

FIRST USE 7-4-1994; IN COMMERCE 12-1-1995.
KATHRYN COWARD, EXAMINING ATTORNEY

SN 77-725,931. POSIQ, INC., SAN JOSE, CA. FILED 4-30-2009.

POSIQ

THE MARK CONSISTS OF STANDARD CHARACTERS WITHOUT CLAIM TO ANY PARTICULAR FONT, STYLE, SIZE, OR COLOR.

FOR DOWNLOADABLE COMPUTER SOFTWARE FOR USE IN THE HOSPITALITY INDUSTRY, NAMELY, SOFTWARE FOR TRANSMITTING REPORTS AND TASKS TO MOBILE DEVICES (U.S. CLS. 21, 23, 26, 36 AND 38).

TEJBIR SINGH, EXAMINING ATTORNEY

CLASS 9—(Continued).

SN 77-726,015. PANDUIT, TINLEY PARK, IL. FILED 4-30-2009.

WYR-GRID

THE MARK CONSISTS OF STANDARD CHARACTERS WITHOUT CLAIM TO ANY PARTICULAR FONT, STYLE, SIZE, OR COLOR.

FOR CABLING AND ROUTING DEVICE FOR ELECTRICAL COMMUNICATION CABLES AND FIBER OPTIC CABLES IN THE NATURE OF AN OVERHEAD CABLE MANAGEMENT PATHWAY SYSTEM COMPRISING A CABLE ROUTING TRAY (U.S. CLS. 21, 23, 26, 36 AND 38).

DAVID ELTON, EXAMINING ATTORNEY

SN 77-726,065. GARY FONG, INC., SEATTLE, WA. FILED 4-30-2009.

FLIP-CAGE

THE MARK CONSISTS OF STANDARD CHARACTERS WITHOUT CLAIM TO ANY PARTICULAR FONT, STYLE, SIZE, OR COLOR.

FOR CAMERA STANDS (U.S. CLS. 21, 23, 26, 36 AND 38).

JAMES LOVELACE, EXAMINING ATTORNEY

SN 77-726,274. MPK, INC., COLUMBIA, MD. FILED 4-30-2009.

SWIPE & RIDE

THE MARK CONSISTS OF STANDARD CHARACTERS WITHOUT CLAIM TO ANY PARTICULAR FONT, STYLE, SIZE, OR COLOR.

OWNER OF U.S. REG. NO. 2,830,969.
SEC. 2(F).
FOR MAGNETIC CODED CARDS FOR USE FOR SPECIFIED GOODS OR SERVICES (U.S. CLS. 21, 23, 26, 36 AND 38).

FIRST USE 10-0-2002; IN COMMERCE 10-0-2002.
TARAH HARDY, EXAMINING ATTORNEY

CLASS 9—(Continued).

SN 77-726,351. INTERMEDIA PUBLIC RELATIONS INC., PEORIA, AZ. FILED 4-30-2009.

OBSIDIAN

THE MARK CONSISTS OF STANDARD CHARACTERS WITHOUT CLAIM TO ANY PARTICULAR FONT, STYLE, SIZE, OR COLOR.

FOR ELECTRONIC DEVICE FOR READING AND DISPLAYING DOWNLOADABLE TEXT AND IMAGES (U.S. CLS. 21, 23, 26, 36 AND 38).

SANDRA MANIOS, EXAMINING ATTORNEY

CLASS 9—(Continued).

SN 77-726,513. WAYFORWARD TECHNOLOGIES, INC., VALENCIA, CA. FILED 4-30-2009.

Mighty Flip Champs!

THE MARK CONSISTS OF STANDARD CHARACTERS WITHOUT CLAIM TO ANY PARTICULAR FONT, STYLE, SIZE, OR COLOR.

FOR DOWNLOADABLE VIDEO GAME SOFTWARE (U.S. CLS. 21, 23, 26, 36 AND 38).

MAYUR VAGHANI, EXAMINING ATTORNEY

SN 77-726,387. WPFY, INC., WILMINGTON, DE. FILED 4-30-2009.

AC-90

THE MARK CONSISTS OF STANDARD CHARACTERS WITHOUT CLAIM TO ANY PARTICULAR FONT, STYLE, SIZE, OR COLOR.

OWNER OF U.S. REG. NO. 1,535,959.

SEC. 2(F).

FOR ELECTRIC CABLES (U.S. CLS. 21, 23, 26, 36 AND 38).

FIRST USE 1-28-1981; IN COMMERCE 1-28-1981.

MICHAEL SOUDERS, EXAMINING ATTORNEY

SN 77-726,563. SHOALS TECHNOLOGIES GROUP, LLC, DBA SHOALS TECHNOLOGIES GROUP, PORTLAND, TN. FILED 4-30-2009.

Shoals Connect

THE MARK CONSISTS OF STANDARD CHARACTERS WITHOUT CLAIM TO ANY PARTICULAR FONT, STYLE, SIZE, OR COLOR.

NO CLAIM IS MADE TO THE EXCLUSIVE RIGHT TO USE "CONNECT", APART FROM THE MARK AS SHOWN.

FOR ELECTRICAL CONNECTORS (U.S. CLS. 21, 23, 26, 36 AND 38).

KIMBERLY FRYE, EXAMINING ATTORNEY

SN 77-726,484. SOMI OH, SANTA CLARA, CA. FILED 4-30-2009.

NightingaleLens

THE MARK CONSISTS OF STANDARD CHARACTERS WITHOUT CLAIM TO ANY PARTICULAR FONT, STYLE, SIZE, OR COLOR.

FOR CONTACT LENS BLANKS (U.S. CLS. 21, 23, 26, 36 AND 38).

MARK SPARACINO, EXAMINING ATTORNEY

SN 77-726,635. UBIQUITI NETWORKS, INC., DBA UBIBUITI NETWORKS, MILPITAS, CA. FILED 4-30-2009.

AirView

THE MARK CONSISTS OF STANDARD CHARACTERS WITHOUT CLAIM TO ANY PARTICULAR FONT, STYLE, SIZE, OR COLOR.

FOR ELECTRONIC MAGNETOSTRICTIVE EQUIPMENT, NAMELY, A WAVE GENERATOR, WAVE SENSOR AND WAVE ANALYZER (U.S. CLS. 21, 23, 26, 36 AND 38).

FIRST USE 2-25-2009; IN COMMERCE 3-18-2009.

PATRICIA EVANKO, EXAMINING ATTORNEY

CLASS 9—(Continued).

SN 77-726,650. VIDEO GAMING TECHNOLOGIES, INC., BRENTWOOD, TN. FILED 4-30-2009.

LOOSEY GOOSEY

THE MARK CONSISTS OF STANDARD CHARACTERS WITHOUT CLAIM TO ANY PARTICULAR FONT, STYLE, SIZE, OR COLOR.

FOR COMPUTER SOFTWARE AND FIRMWARE FOR GAMES OF CHANCE ON ANY COMPUTERIZED PLATFORM, INCLUDING DEDICATED GAMING CONSOLES, VIDEO BASED SLOT MACHINES, REEL BASED SLOT MACHINES, AND VIDEO LOTTERY TERMINALS; GAMING DEVICES, NAMELY, GAMING MACHINES, SLOT MACHINES, BINGO MACHINES, WITH OR WITHOUT VIDEO OUTPUT (U.S. CLS. 21, 23, 26, 36 AND 38).

KATHRYN COWARD, EXAMINING ATTORNEY

SN 77-726,654. UBIQUITI NETWORKS, INC., INC., DBA UBIQUITI NETWORKS, INC., MILPITAS, CA. FILED 4-30-2009.

AirControl

THE MARK CONSISTS OF STANDARD CHARACTERS WITHOUT CLAIM TO ANY PARTICULAR FONT, STYLE, SIZE, OR COLOR.

FOR COMMUNICATIONS SOFTWARE FOR CONNECTING COMPUTER NETWORK USERS; COMPUTER SOFTWARE FOR COMMUNICATING WITH USERS OF HAND-HELD COMPUTERS; COMPUTER SOFTWARE FOR CONTROLLING AND MANAGING ACCESS SERVER APPLICATIONS; COMPUTER SOFTWARE FOR MANAGEMENT OF COMMUNICATION EQUIPMENT (U.S. CLS. 21, 23, 26, 36 AND 38).

TOBY BULLOFF, EXAMINING ATTORNEY

SN 77-726,661. UBIQUITI NETWORKS, INC., DBA UBIQUITI NETWORKS, MILPITAS, CA. FILED 4-30-2009.

AirBlast

THE MARK CONSISTS OF STANDARD CHARACTERS WITHOUT CLAIM TO ANY PARTICULAR FONT, STYLE, SIZE, OR COLOR.

FOR COMMUNICATIONS SOFTWARE FOR CONNECTING COMPUTER NETWORK USERS.; COMPUTER SOFTWARE FOR TDMA POINT TO POINT PROTOCOL; TELECOMMUNICATIONS AND DATA NETWORKING HARDWARE, NAMELY, DEVICES FOR TRANSPORTING AND AGGREGATING VOICE, DATA, AND VIDEO COMMUNICATIONS ACROSS MULTIPLE NETWORK INFRASTRUCTURES AND COMMUNICATIONS PROTOCOLS (U.S. CLS. 21, 23, 26, 36 AND 38).

PATRICIA EVANKO, EXAMINING ATTORNEY

CLASS 9—(Continued).

SN 77-726,935. YOSEF SHIMRON, LEONIA, NJ. FILED 5-1-2009.

Paynada

THE MARK CONSISTS OF STANDARD CHARACTERS WITHOUT CLAIM TO ANY PARTICULAR FONT, STYLE, SIZE, OR COLOR.

FOR CONSUMER COUPONS DOWNLOADED FROM A GLOBAL COMPUTER NETWORK (U.S. CLS. 21, 23, 26, 36 AND 38).

THOMAS MANOR, EXAMINING ATTORNEY

SN 77-726,965. DIXIE IRON WORKS, LTD, ALICE, TX. FILED 5-1-2009.

IntraCube

THE MARK CONSISTS OF STANDARD CHARACTERS WITHOUT CLAIM TO ANY PARTICULAR FONT, STYLE, SIZE, OR COLOR.

FOR COMPUTER SOFTWARE FOR THE COLLECTION, EDITING, ORGANIZING, MODIFYING, BOOK MARKING, TRANSMISSION, STORAGE AND SHARING OF DATA AND INFORMATION; COMPUTER SOFTWARE FOR THE FIELD OF WAREHOUSING AND DISTRIBUTION, TO MANAGE TRANSACTIONAL DATA, PROVIDE STATISTICAL ANALYSIS, AND PRODUCE NOTIFICATIONS AND REPORTS; COMPUTER SOFTWARE FOR USE IN CUSTOMER RELATIONSHIP MANAGEMENT (CRM); COMPUTER SOFTWARE THAT PROVIDES REAL-TIME, INTEGRATED BUSINESS MANAGEMENT INTELLIGENCE BY COMBINING INFORMATION FROM VARIOUS DATABASES AND PRESENTING IT IN AN EASY-TO-UNDERSTAND USER INTERFACE; COMPUTER SOFTWARE TO MONITOR AND CONTROL FACTORY MANUFACTURING PROCESSES; COMPUTER SOFTWARE, NAMELY, AN APPLICATION ALLOWING SALES AND FIELD SERVICE EMPLOYEES TO UPDATE AND RECEIVE DATA STORED IN AN ENTERPRISE'S COMPUTER DATABASES IN REAL TIME, USING A MOBILE DEVICE, WITH FULL TELEPHONY INTEGRATION WITH THE TELEPHONE AND/OR SOFTWARE FEATURES OF THE MOBILE DEVICE (U.S. CLS. 21, 23, 26, 36 AND 38).

SUSAN LESLIE DUBOIS, EXAMINING ATTORNEY

CLASS 9—(Continued).

SN 77-727,141. ARCODE CORPORATION, POTOMAC, MD. FILED 5-1-2009.

Arcode

THE MARK CONSISTS OF STANDARD CHARACTERS WITHOUT CLAIM TO ANY PARTICULAR FONT, STYLE, SIZE, OR COLOR.

FOR COMPUTER E-COMMERCE SOFTWARE TO ALLOW USERS TO PERFORM ELECTRONIC BUSINESS TRANSACTIONS VIA A GLOBAL COMPUTER NETWORK; COMPUTER SEARCH ENGINE SOFTWARE; SOFTWARE FOR ENSURING THE SECURITY OF ELECTRONIC MAIL (U.S. CLS. 21, 23, 26, 36 AND 38).
APRIL ROACH, EXAMINING ATTORNEY

SN 77-727,142. MAGNETIC COMPONENTS, INC., SCHILLER PARK, IL. FILED 5-1-2009.

ClassicTone

THE MARK CONSISTS OF STANDARD CHARACTERS WITHOUT CLAIM TO ANY PARTICULAR FONT, STYLE, SIZE, OR COLOR.

FOR TRANSFORMERS (U.S. CLS. 21, 23, 26, 36 AND 38).
BRIDGETT SMITH, EXAMINING ATTORNEY

SN 77-727,166. USA TIGER GROUP INC, NEW YORK, NY. FILED 5-1-2009.



THE MARK CONSISTS OF THE STYLIZED NUMBER "0", FOLLOW BY ANOTHER STYLIZED NUMBER "0" AT 90 DEGREE ANGLE, FOLLOW BY ANOTHER STYLIZED NUMBER "0".

FOR EYE GLASSES (U.S. CLS. 21, 23, 26, 36 AND 38).
FIRST USE 1-18-2009; IN COMMERCE 4-8-2009.
DEIRDRE ROBERTSON, EXAMINING ATTORNEY

CLASS 9—(Continued).

SN 77-727,184. HONEYWELL INTERNATIONAL INC., MORRISTOWN, NJ. FILED 5-1-2009.

AV8OR ACE

THE MARK CONSISTS OF STANDARD CHARACTERS WITHOUT CLAIM TO ANY PARTICULAR FONT, STYLE, SIZE, OR COLOR.

FOR ELECTRONIC NAVIGATIONAL, POSITIONING AND WEATHER MONITORING APPARATUS AND INSTRUMENTS (U.S. CLS. 21, 23, 26, 36 AND 38).
TEJBIR SINGH, EXAMINING ATTORNEY

SN 77-727,214. RNA NETWORKS, INC., PORTLAND, OR. FILED 5-1-2009.

RNAvirtual

THE MARK CONSISTS OF STANDARD CHARACTERS WITHOUT CLAIM TO ANY PARTICULAR FONT, STYLE, SIZE, OR COLOR.

FOR COMPUTER SOFTWARE, NAMELY, SOFTWARE FOR USE IN ACCELERATING COMPUTER APPLICATIONS, DISTRIBUTING NETWORK-BASED COMPUTER DATA, AND INFORMATION STORAGE VIRTUALIZATION IN HETEROGENEOUS INFORMATION TECHNOLOGY INFRASTRUCTURES (U.S. CLS. 21, 23, 26, 36 AND 38).
LINDA ORNDORFF, EXAMINING ATTORNEY

SN 77-727,230. INTEGRITY HEALTH FRANCHISES, LLC, MANCHESTER, NH. FILED 5-1-2009.



NO CLAIM IS MADE TO THE EXCLUSIVE RIGHT TO USE "COACH FITNESS PROGRAMS", APART FROM THE MARK AS SHOWN.

THE COLOR(S) BLACK, BLUE, WHITE AND GRAY IS/ARE CLAIMED AS A FEATURE OF THE MARK.

THE MARK CONSISTS OF THE WORD "EZ" IN BLUE AND THE WORD "COACH" IN GRAY. THERE IS A FIGURE OF A ABSTRACT HUMAN HOLDING A DUMBBELL IN ONE HAND AND A CHECKMARK IN THE OTHER. THE FIGURE IS BLACK WITH A WHITE VISOR AND THE CHECKMARK IS BLUE. THE WORDS "FITNESS PROGRAMS" ARE BLACK.

FOR COMPUTER SOFTWARE PLATFORMS FOR CREATING EXERCISE PROGRAMS (U.S. CLS. 21, 23, 26, 36 AND 38).

ZACHARY BELLO, EXAMINING ATTORNEY

CLASS 9—(Continued).

SN 77-727,242. RNA NETWORKS, INC., PORTLAND, OR.
FILED 5-1-2009.

RNAmanager

THE MARK CONSISTS OF STANDARD CHARACTERS WITHOUT CLAIM TO ANY PARTICULAR FONT, STYLE, SIZE, OR COLOR.

FOR COMPUTER SOFTWARE, NAMELY, SOFTWARE FOR USE IN ACCELERATING COMPUTER APPLICATIONS, DISTRIBUTING NETWORK-BASED COMPUTER DATA, AND INFORMATION STORAGE VIRTUALIZATION IN HETEROGENEOUS INFORMATION TECHNOLOGY INFRASTRUCTURES (U.S. CLS. 21, 23, 26, 36 AND 38).

LINDA ORNDORFF, EXAMINING ATTORNEY

SN 77-727,253. RNA NETWORKS, INC., PORTLAND, OR.
FILED 5-1-2009.

RNAmessenger

THE MARK CONSISTS OF STANDARD CHARACTERS WITHOUT CLAIM TO ANY PARTICULAR FONT, STYLE, SIZE, OR COLOR.

FOR COMPUTER SOFTWARE, NAMELY, SOFTWARE FOR USE IN ACCELERATING COMPUTER APPLICATIONS, DISTRIBUTING NETWORK-BASED COMPUTER DATA, AND INFORMATION STORAGE VIRTUALIZATION IN HETEROGENEOUS INFORMATION TECHNOLOGY INFRASTRUCTURES (U.S. CLS. 21, 23, 26, 36 AND 38).

LINDA ORNDORFF, EXAMINING ATTORNEY

SN 77-727,307. TSONGAS LITIGATION CONSULTING, INC.,
PORTLAND, OR. FILED 5-1-2009.

SOLON

THE MARK CONSISTS OF STANDARD CHARACTERS WITHOUT CLAIM TO ANY PARTICULAR FONT, STYLE, SIZE, OR COLOR.

FOR COMPUTER SOFTWARE FOR USE IN THE FIELD OF AIDING LAWYERS IN SYSTEMATICALLY CHOOSING A JURY (U.S. CLS. 21, 23, 26, 36 AND 38).

JOHN GARTNER, EXAMINING ATTORNEY

CLASS 9—(Continued).

SN 77-727,357. MAD OTTER GAMES, INC., EUGENE, OR.
FILED 5-1-2009.

Villagers and Heroes

THE MARK CONSISTS OF STANDARD CHARACTERS WITHOUT CLAIM TO ANY PARTICULAR FONT, STYLE, SIZE, OR COLOR.

FOR COMPUTER GAME CARTRIDGES (U.S. CLS. 21, 23, 26, 36 AND 38).

H. M. FISHER, EXAMINING ATTORNEY

SN 77-727,367. ESSENTIA SOFTWARE CORPORATION,
COLLEGEVILLE, PA. FILED 5-1-2009.

ELDERCAREPAY

THE MARK CONSISTS OF STANDARD CHARACTERS WITHOUT CLAIM TO ANY PARTICULAR FONT, STYLE, SIZE, OR COLOR.

FOR COMPUTER PAYROLL SOFTWARE FOR DOMESTIC EMPLOYERS (U.S. CLS. 21, 23, 26, 36 AND 38).
FIRST USE 2-1-2000; IN COMMERCE 7-19-2006.

KATHRYN COWARD, EXAMINING ATTORNEY

SN 77-727,437. BRINQA, LLC, AUSTIN, TX. FILED 5-1-2009.

brinQa

THE MARK CONSISTS OF STANDARD CHARACTERS WITHOUT CLAIM TO ANY PARTICULAR FONT, STYLE, SIZE, OR COLOR.

FOR COMPUTER SOFTWARE FOR GOVERNANCE, RISK MANAGEMENT AND COMPLIANCE, FOR AUTOMATING DATA AGGREGATION AND ANALYSIS, REPORTING AND COMPLIANCE, FOR CONTROLS MANAGEMENT AND CONTINUOUS CONTROLS MONITORING, AND FOR FACILITATING CORPORATE COMPLIANCE WITH GOVERNMENT STANDARDS AND REGULATIONS, ALL IN THE AREA OF ENTERPRISE INFORMATION TECHNOLOGY (U.S. CLS. 21, 23, 26, 36 AND 38).

FIRST USE 2-26-2009; IN COMMERCE 2-26-2009.

JULIE GUTTADAURO, EXAMINING ATTORNEY

CLASS 9—(Continued).

SN 77-727,563. IGT, RENO, NV. FILED 5-1-2009.

AZTEC PYRAMID

THE MARK CONSISTS OF STANDARD CHARACTERS WITHOUT CLAIM TO ANY PARTICULAR FONT, STYLE, SIZE, OR COLOR.

OWNER OF U.S. REG. NO. 3,007,919.
FOR GAMING MACHINES, NAMELY, DEVICES WHICH ACCEPT A WAGER (U.S. CLS. 21, 23, 26, 36 AND 38).

MELISSA VALLILLO, EXAMINING ATTORNEY



SN 77-727,564. IGT, RENO, NV. FILED 5-1-2009.

CRYSTAL KINGDOM

THE MARK CONSISTS OF STANDARD CHARACTERS WITHOUT CLAIM TO ANY PARTICULAR FONT, STYLE, SIZE, OR COLOR.

FOR GAMING MACHINES, NAMELY, DEVICES WHICH ACCEPT A WAGER (U.S. CLS. 21, 23, 26, 36 AND 38).

MELISSA VALLILLO, EXAMINING ATTORNEY



SN 77-727,567. IGT, RENO, NV. FILED 5-1-2009.

SCARLET MOON

THE MARK CONSISTS OF STANDARD CHARACTERS WITHOUT CLAIM TO ANY PARTICULAR FONT, STYLE, SIZE, OR COLOR.

OWNER OF U.S. REG. NO. 2,935,234.
FOR GAMING MACHINES, NAMELY, DEVICES WHICH ACCEPT A WAGER (U.S. CLS. 21, 23, 26, 36 AND 38).

MELISSA VALLILLO, EXAMINING ATTORNEY

CLASS 9—(Continued).

SN 77-727,588. ORION IMAGES CORPORATION, WESTMINSTER, CA. FILED 5-1-2009.



THE COLOR(S) BLUE AND RED IS/ARE CLAIMED AS A FEATURE OF THE MARK.

THE MARK CONSISTS OF THE WORD "ORION" IN BLUE LETTERING, THE LETTERING HAVING A SQUARED FORMAT WITH A DIAGONAL OPENING ON THE UPPER LEFT SIDE OF EACH LETTER, EXCEPT THAT THE "I" IN "ORION" IS IN RED LETTERING, EXTENDING ABOVE AND BELOW THE OTHER LETTERS SLIGHTLY, THE SHAPE OF THE LETTER "I" IN THE STYLIZED SHAPE OF A WAVE OR THE IMAGE OF A HYSTERISIS LOOP.

FOR INDUSTRIAL SURVEILLANCE MONITORS (U.S. CLS. 21, 23, 26, 36 AND 38).

MIDGE BUTLER, EXAMINING ATTORNEY



SN 77-727,724. PROTEC GAMES, INC., HENDERSON, NV. FILED 5-2-2009.

CASH AND CANNONS

THE MARK CONSISTS OF STANDARD CHARACTERS WITHOUT CLAIM TO ANY PARTICULAR FONT, STYLE, SIZE, OR COLOR.

FOR GAMING MACHINES, NAMELY, VIDEO AND SLOT MACHINES AND COMPUTERIZED VIDEO TABLE GAMES FOR GAMING PURPOSES (U.S. CLS. 21, 23, 26, 36 AND 38).

LEIGH CAROLINE CASE, EXAMINING ATTORNEY



SN 77-727,727. PROTEC GAMES, INC., HENDERSON, NV. FILED 5-2-2009.

JACKPOT DINER

THE MARK CONSISTS OF STANDARD CHARACTERS WITHOUT CLAIM TO ANY PARTICULAR FONT, STYLE, SIZE, OR COLOR.

NO CLAIM IS MADE TO THE EXCLUSIVE RIGHT TO USE "JACKPOT", APART FROM THE MARK AS SHOWN.

FOR GAMING MACHINES, NAMELY, VIDEO AND SLOT MACHINES AND COMPUTERIZED VIDEO TABLE GAMES FOR GAMING PURPOSES (U.S. CLS. 21, 23, 26, 36 AND 38).

LEIGH CAROLINE CASE, EXAMINING ATTORNEY

CLASS 9—(Continued).

SN 77-727,731. PROTEC GAMES, INC., HENDERSON, NV. FILED 5-2-2009.

CLASS 9—(Continued).

SN 77-727,829. TYLER, ONAJE R, DBA IN THE WIND PRODUCTIONS, OAKLAND, CA. FILED 5-3-2009.

WILD ANIMALS

In The Wind Productions

THE MARK CONSISTS OF STANDARD CHARACTERS WITHOUT CLAIM TO ANY PARTICULAR FONT, STYLE, SIZE, OR COLOR.

FOR GAMING MACHINES, NAMELY, VIDEO AND SLOT MACHINES AND COMPUTERIZED VIDEO TABLE GAMES FOR GAMING PURPOSES (U.S. CLS. 21, 23, 26, 36 AND 38).

LEIGH CAROLINE CASE, EXAMINING ATTORNEY

THE MARK CONSISTS OF STANDARD CHARACTERS WITHOUT CLAIM TO ANY PARTICULAR FONT, STYLE, SIZE, OR COLOR.

NO CLAIM IS MADE TO THE EXCLUSIVE RIGHT TO USE "PRODUCTIONS", APART FROM THE MARK AS SHOWN.

FOR DOWNLOADABLE RING TONES, MUSIC, ELECTRONIC GAMES VIA THE INTERNET AND WIRELESS DEVICES; ELECTRICAL CABLES FOR MUSICAL INSTRUMENTS; ELECTRICAL CIRCUITS FOR USE IN AMUSEMENT GAME MACHINES FOR REPRODUCING MUSIC, SPEECH AND SPECIAL EFFECTS; ELECTRICAL PICKUPS FOR USE WITH MUSICAL INSTRUMENTS; ELECTRICAL VOICE INTRACOMMUNICATIONS SYSTEMS COMPRISING CONTROL STATIONS, INTERFACE MODULES, FRAMES, CONTROLLER CARDS, CONNECTORS, POWER SUPPLIES, PANELS AND MOUNTINGS FOR USE IN THE PRODUCTION OF LIVE MUSICAL PERFORMANCES, THEATRE, AND OTHER LIVE EVENTS; JUKE BOXES; MUSIC RECORDINGS SOLD AS A KIT WITH A MASK; MUSIC-COMPOSITION SOFTWARE; MUSICAL INSTRUMENT ADAPTORS; MUSICAL INSTRUMENT AMPLIFIERS; MUSICAL INSTRUMENT CONNECTORS; MUSICAL SOUND RECORDINGS; MUSICAL VIDEO RECORDINGS; PHONOGRAPH RECORDS FEATURING MUSIC; PROTECTIVE CARRYING CASES FOR PORTABLE MUSIC PLAYERS, NAMELY, MP3 PLAYERS; SOUND RECORDINGS FEATURING MUSIC; VIDEO RECORDINGS FEATURING MUSIC; VISUAL RECORDINGS AND AUDIO VISUAL RECORDINGS FEATURING MUSIC AND ANIMATION; WIRELESS COMMUNICATION DEVICE FEATURING VOICE, DATA AND IMAGE TRANSMISSION INCLUDING VOICE, TEXT AND PICTURE MESSAGING, A VIDEO AND STILL IMAGE CAMERA, ALSO FUNCTIONAL TO PURCHASE MUSIC, GAMES, VIDEO AND SOFTWARE APPLICATIONS OVER THE AIR FOR DOWNLOADING TO THE DEVICE (U.S. CLS. 21, 23, 26, 36 AND 38).

EVELYN BRADLEY, EXAMINING ATTORNEY

SN 77-727,733. PROTEC GAMES, INC., HENDERSON, NV. FILED 5-2-2009.

FAST AND FIERY

THE MARK CONSISTS OF STANDARD CHARACTERS WITHOUT CLAIM TO ANY PARTICULAR FONT, STYLE, SIZE, OR COLOR.

FOR GAMING MACHINES, NAMELY, VIDEO AND SLOT MACHINES AND COMPUTERIZED VIDEO TABLE GAMES FOR GAMING PURPOSES (U.S. CLS. 21, 23, 26, 36 AND 38).

LEIGH CAROLINE CASE, EXAMINING ATTORNEY

CLASS 9—(Continued).

SN 77-728,649. NEIL A. LANE, INC., LOS ANGELES, CA. FILED 5-4-2009.

NEIL LANE

THE MARK CONSISTS OF STANDARD CHARACTERS WITHOUT CLAIM TO ANY PARTICULAR FONT, STYLE, SIZE, OR COLOR.

OWNER OF U.S. REG. NOS. 3,022,921, 3,652,651 AND OTHERS.

FOR PROTECTIVE EYEWEAR; EYEGLASSES AND EYEGASS FRAMES; SUNGLASSES AND SUNGLASS FRAMES; CLIP-ON SUNGLASSES; OPERA GLASSES; SPECTACLES AND SPECTACLE FRAMES; LENSES FOR EYEGLASSES, SUNGLASSES AND SPECTACLES; EYEGASS, SUNGLASS AND SPECTACLE CASES; EYEGASS, SUNGLASS AND SPECTACLE STRAPS; EYEGASS, SUNGLASS AND SPECTACLE CHAINS; GOGGLES FOR SPORTS; MAGNETS; DECORATIVE MAGNETS; REFRIGERATOR MAGNETS; NOVELTY MAGNETS; MOUSE PADS; COMPACT DISC CASES; FITTED CASES FOR STORAGE AND TRANSPORTATION, NAMELY, CASES FOR COMPACT DISCS, AUDIO CASSETTES, VIDEO CASSETTES, CD-ROMS, COMPUTERS, COMPUTER ACCESSORIES, CAMERAS, CAMCORDERS AND PORTABLE PHONES; COMPUTER CARRYING CASES; WRIST RESTS AND SUPPORTS FOR COMPUTER MOUSE USERS; WRIST RESTS FOR COMPUTERS; COMPUTER KEYBOARD WRIST PADS (U.S. CLS. 21, 23, 26, 36 AND 38).

HELENE LIWINSKI, EXAMINING ATTORNEY

SN 77-728,876. IGT, RENO, NV. FILED 5-5-2009.

DIAMOND NIGHTS

THE MARK CONSISTS OF STANDARD CHARACTERS WITHOUT CLAIM TO ANY PARTICULAR FONT, STYLE, SIZE, OR COLOR.

FOR GAMING MACHINES, NAMELY, DEVICES WHICH ACCEPT A WAGER (U.S. CLS. 21, 23, 26, 36 AND 38).

MELISSA VALLILLO, EXAMINING ATTORNEY

CLASS 9—(Continued).

SN 77-729,131. INTOUCH TECHNOLOGIES, INC., DBA INTOUCH HEALTH, GOLETA, CA. FILED 5-5-2009.

RP-LITE

THE MARK CONSISTS OF STANDARD CHARACTERS WITHOUT CLAIM TO ANY PARTICULAR FONT, STYLE, SIZE, OR COLOR.

OWNER OF U.S. REG. NOS. 3,105,069 AND 3,373,938.
FOR REMOTELY CONTROLLED SYSTEM FOR USE IN WIRELESS TELECOMMUNICATIONS COMPRISED OF COMPUTER HARDWARE, COMPUTER SOFTWARE, MONITORS, CAMERAS, MOTORS AND A MOBILE PLATFORM THAT IS MANIPULATED BY A REMOTE OPERATOR TO TRANSMIT 2-WAY AUDIO AND VIDEO COMMUNICATIONS AND OTHER ELECTRONIC DATA (U.S. CLS. 21, 23, 26, 36 AND 38).

DOUGLAS LEE, EXAMINING ATTORNEY

SN 77-729,222. TWENTIETH CENTURY FOX FILM CORPORATION, LOS ANGELES, CA. FILED 5-5-2009.

THE CLEVELAND SHOW

THE MARK CONSISTS OF STANDARD CHARACTERS WITHOUT CLAIM TO ANY PARTICULAR FONT, STYLE, SIZE, OR COLOR.

NO CLAIM IS MADE TO THE EXCLUSIVE RIGHT TO USE "SHOW", APART FROM THE MARK AS SHOWN.

FOR PRE-RECORDED DVDS FEATURING COMEDY; PRE-RECORDED CDS FEATURING COMEDY; DOWNLOADABLE AUDIO AND VIDEO RECORDINGS FEATURING COMEDY; DOWNLOADABLE TELEVISION PROGRAMS FEATURING COMEDY VIA THE INTERNET; DOWNLOADABLE RING TONES, GRAPHICS, WALLPAPER, AND MUSIC VIA A GLOBAL COMPUTER NETWORK AND WIRELESS DEVICES; COMPUTER SCREEN SAVER SOFTWARE; VIDEO AND COMPUTER GAME SOFTWARE (U.S. CLS. 21, 23, 26, 36 AND 38).

JASON BLAIR, EXAMINING ATTORNEY

SN 77-729,453. EINSTRUCTION CORPORATION, DENTON, TX. FILED 5-5-2009.

CPS PULSE

THE MARK CONSISTS OF STANDARD CHARACTERS WITHOUT CLAIM TO ANY PARTICULAR FONT, STYLE, SIZE, OR COLOR.

FOR COMPUTER HARDWARE; INTERACTIVE COMPUTER SOFTWARE USED FOR EDUCATIONAL ASSESSMENT (U.S. CLS. 21, 23, 26, 36 AND 38).

HENRY S. ZAK, EXAMINING ATTORNEY

CLASS 9—(Continued).

SN 77-729,463. EINSTRUCTION CORPORATION, DENTON, TX. FILED 5-5-2009.

CPS

THE MARK CONSISTS OF STANDARD CHARACTERS WITHOUT CLAIM TO ANY PARTICULAR FONT, STYLE, SIZE, OR COLOR.

FOR COMPUTER HARDWARE; INTERACTIVE COMPUTER SOFTWARE USED FOR EDUCATIONAL ASSESSMENT (U.S. CLS. 21, 23, 26, 36 AND 38).

HENRY S. ZAK, EXAMINING ATTORNEY

SN 77-729,490. XIAM TECHNOLOGIES LIMITED, SAN DIEGO, CA. FILED 5-5-2009.

IT'S MOBILE LIFESTYLE MEETS MOBILE CONTENT.

THE MARK CONSISTS OF STANDARD CHARACTERS WITHOUT CLAIM TO ANY PARTICULAR FONT, STYLE, SIZE, OR COLOR.

FOR COMPUTER SOFTWARE, NAMELY, COMPUTER SOFTWARE DEVELOPMENT TOOLS; COMPUTER SOFTWARE USED TO FACILITATE INTERFACES BETWEEN COMPUTER SOFTWARE AND/OR COMPUTER HARDWARE USED IN WIRELESS COMMUNICATION DEVICES, OR WITHIN MIXED NETWORKS EMPLOYING WIRELESS AND NON-WIRELESS COMMUNICATION DEVICES; COMPUTER SOFTWARE APPLICATIONS FOR CERTIFYING THAT OTHER COMPUTER SOFTWARE APPLICATIONS MEET CERTAIN STANDARDS; COMPUTER SOFTWARE USED TO INTERPRET INFORMATION, AND TO INTEGRATE, INTERPRET AND ORGANIZE DATA BETWEEN DIFFERENT WIRELESS AND/OR NON-WIRELESS DEVICES AND COMPUTER SOFTWARE APPLICATIONS; COMPUTER SOFTWARE FOR DEVELOPING AND MANAGING DISTRIBUTED APPLICATION COMPUTER SOFTWARE IN A WIRELESS OR MIXED NETWORK EMPLOYING WIRELESS AND NON-WIRELESS COMMUNICATION INTERFACES; COMPUTER SOFTWARE FOR USE IN ADVERTISING AND MARKETING NAMELY PROMOTING THE GOODS AND SERVICES OF OTHERS; COMPUTER SOFTWARE FOR DISSEMINATION OF ADVERTISING FOR OTHERS VIA AN ONLINE COMMUNICATIONS NETWORK ON THE INTERNET; COMPUTER SOFTWARE FOR MARKETING, ADVERTISING AND PROMOTING THE RETAIL GOODS AND SERVICES OF OTHERS TO WIRELESS COMMUNICATION DEVICES AND/OR COMPUTERS; COMMUNICATIONS SOFTWARE FOR CONNECTING GLOBAL COMPUTER NETWORKS (U.S. CLS. 21, 23, 26, 36 AND 38).

DAVID HOFFMAN, EXAMINING ATTORNEY

CLASS 9—(Continued).

SN 77-729,747. IGT, RENO, NV. FILED 5-5-2009.

SHOGUN

THE MARK CONSISTS OF STANDARD CHARACTERS WITHOUT CLAIM TO ANY PARTICULAR FONT, STYLE, SIZE, OR COLOR.

FOR GAMING MACHINES, NAMELY, DEVICES WHICH ACCEPT A WAGER (U.S. CLS. 21, 23, 26, 36 AND 38).

MELISSA VALLILLO, EXAMINING ATTORNEY

SN 77-731,612. SILVER CREEK ENTERTAINMENT, GRANTS PASS, OR. FILED 5-7-2009.

Hardwood Games

THE MARK CONSISTS OF STANDARD CHARACTERS WITHOUT CLAIM TO ANY PARTICULAR FONT, STYLE, SIZE, OR COLOR.

NO CLAIM IS MADE TO THE EXCLUSIVE RIGHT TO USE "GAMES", APART FROM THE MARK AS SHOWN.

FOR COMPONENTS FOR GAMING MACHINES, NAMELY, CONTROLLERS, DISPLAYS, BUTTON PANELS, BOLSTERS, ELECTRICAL WIRING, AND COMPUTER HARDWARE AND SOFTWARE ASSOCIATED THEREWITH; COMPUTER GAME CARTRIDGES; COMPUTER GAME CARTRIDGES AND DISCS; COMPUTER GAME CASSETTES; COMPUTER GAME CONSOLES FOR USE WITH AN EXTERNAL DISPLAY SCREEN OR MONITOR; COMPUTER GAME DISCS; COMPUTER GAME EQUIPMENT, NAMELY, DISCS; COMPUTER GAME JOYSTICKS; COMPUTER GAME PROGRAMS; COMPUTER GAME PROGRAMS, CARTRIDGES, AND CASSETTES; COMPUTER GAME SOFTWARE; COMPUTER GAME SOFTWARE FOCUSING ON ACHIEVING A SET OF GOALS, POSITIONS, OWNERSHIP, AND CREDENTIALS, AND PROFESSIONAL AND SOCIAL STATUS, AND GOOD FORTUNE NECESSARY TO SUCCEED PROFESSIONALLY AND PERSONALLY, AND NOT REFERRING EITHER TO A GROUP OF SOFTWARE FOR USE IN COMMERCE OR TO A GROUP OF OFFICES; COMPUTER GAME SOFTWARE FOR GAMING MACHINES INCLUDING SLOT MACHINES OR VIDEO LOTTERY TERMINALS; COMPUTER GAME SOFTWARE FOR GAMING MACHINES, NAMELY, SLOT MACHINES AND VIDEO LOTTERY TERMINALS; COMPUTER GAME SOFTWARE FOR PERSONAL COMPUTERS AND HOME VIDEO GAME CONSOLES; COMPUTER GAME SOFTWARE FOR USE WITH PERSONAL COMPUTERS, HOME VIDEO GAME CONSOLES USED WITH TELEVISIONS, AND FOR ARCADE-BASED VIDEO GAME CONSOLES; COMPUTER GAME SOFTWARE, NAMELY, A COMPUTER CRAPS GAME; COMPUTER GAME TAPES; COMPUTER PROGRAMS FOR PRE-RECORDED GAMES; COMPUTER PROGRAMS FOR VIDEO AND COMPUTER GAMES; COMPUTER SOFTWARE AND FIRMWARE FOR GAMES OF CHANCE ON ANY COMPUTERIZED PLATFORM, INCLUDING DEDICATED GAMING CONSOLES, VIDEO BASED SLOT MACHINES, REEL BASED SLOT MACHINES, AND VIDEO LOTTERY TERMINALS; COMPUTER SOFTWARE, NAMELY, GAME ENGINE SOFTWARE FOR VIDEO GAME DEVELOPMENT AND OPERATION; COMPUTERIZED VIDEO GAME TABLES FOR GAMING PURPOSES, NAMELY, A COMPUTERIZED VIDEO CRAPS GAME TABLE; COMPUTERIZED

CLASS 9—(Continued).

VIDEO TABLE GAMES FOR GAMING PURPOSES; DOWNLOADABLE AUDIO FILES, MULTIMEDIA FILES, TEXT FILES, E-MAILS, WRITTEN DOCUMENTS, AUDIO MATERIAL, VIDEO MATERIAL AND GAMES FEATURING INFORMATION IN THE FORM OF DOWNLOADABLE SHORT EDUCATIONAL/TRAINING COMMUNICATIONS IN THE FIELD OF HUMAN RESOURCE DEVELOPMENT FOR THE PROMOTION OF EMPLOYEE RETENTION, CAREER GROWTH AND INCREASED PRODUCTIVITY FOR EMPLOYEES AND EMPLOYERS; DOWNLOADABLE COMPUTER PROGRAMS FEATURING POSITIONABLE GAME PIECE FIGURES FOR USE IN THE FIELD OF COMPUTER GAMES; DOWNLOADABLE GAMES VIA THE INTERNET AND WIRELESS DEVICES; ELECTRICAL CIRCUITS FOR USE IN AMUSEMENT GAME MACHINES FOR REPRODUCING MUSIC, SPEECH AND SPECIAL EFFECTS; ELECTRONIC AND ELECTRO-MECHANICAL GAMING TABLES WITH VIDEO OUTPUT; ELECTRONIC AND VIDEO GAME CONTROLLERS INCORPORATED INTO EXERCISE MACHINES; ELECTRONIC GAME PROGRAMS; ELECTRONIC GAME SOFTWARE; ELECTRONIC GAME SOFTWARE FOR CELLULAR TELEPHONES; ELECTRONIC GAME SOFTWARE FOR HANDHELD ELECTRONIC DEVICES; ELECTRONIC GAME SOFTWARE FOR WIRELESS DEVICES; ELECTRONIC GAME SOFTWARE, NAMELY, AN ELECTRONIC CRAPS GAME; ELECTRONIC GAME SOFTWARE, NAMELY, AN ELECTRONIC VIDEO CRAPS GAME; ELECTRONIC INTERACTIVE BOARD GAMES FOR USE WITH EXTERNAL MONITOR; FACE PLATES FOR VIDEO GAME CONSOLES FOR USE WITH EXTERNAL MONITORS; GAME CONTROLLERS FOR COMPUTER GAMES; GAME SOFTWARE; GAMES ADAPTED FOR USE WITH TELEVISION RECEIVERS; GAMING DEVICES, NAMELY, GAMING MACHINES, SLOT MACHINES, BINGO MACHINES, WITH OR WITHOUT VIDEO OUTPUT; GAMING EQUIPMENT, NAMELY, SLOT MACHINES WITH OR WITHOUT VIDEO OUTPUT; GAMING MACHINES; GAMING MACHINES INCLUDING SLOT MACHINES OR VIDEO LOTTERY TERMINALS; GAMING MACHINES THAT GENERATE OR DISPLAY WAGER OUTCOMES; GAMING MACHINES, NAMELY, SLOT MACHINES AND VIDEO LOTTERY TERMINALS; GAMING MACHINES, NAMELY, DEVICES WHICH ACCEPT A WAGER; GAMING MACHINES, NAMELY, ELECTRONIC SLOT AND BINGO MACHINES; GAMING SOFTWARE THAT GENERATES OR DISPLAYS WAGER OUTCOMES OF GAMING MACHINES; GUITAR SKINS FOR ELECTRONIC GUITAR GAME CONTROLLERS; HAND HELD JOY STICK UNITS FOR PLAYING VIDEO GAMES; HAND-HELD ELECTRONIC GAMES ADAPTED FOR USE WITH TELEVISION RECEIVERS ONLY; HAND-HELD UNITS FOR PLAYING ELECTRONIC GAMES FOR USE WITH EXTERNAL DISPLAY SCREEN OR MONITOR; HIGH PERFORMANCE COMPUTER HARDWARE WITH SPECIALIZED FEATURES FOR ENHANCED GAME PLAYING ABILITY; INTERACTIVE MULTIMEDIA COMPUTER GAME PROGRAM; INTERACTIVE VIDEO GAME PROGRAM, NAMELY, A VIDEO CRAPS GAME; INTERACTIVE VIDEO GAME PROGRAMS; INTERACTIVE VIDEO GAMES OF VIRTUAL REALITY COMPRISED OF COMPUTER HARDWARE AND SOFTWARE; JOYSTICKS FOR VIDEO GAMES; MACHINE FOR PLAYING GAMES OF CHANCE, NAMELY, CRAPS; MACHINES FOR PLAYING GAMES OF CHANCE; PLAYER-OPERATED ELECTRONIC CONTROLLERS FOR ELECTRONIC VIDEO GAME MACHINES; PROTECTIVE CARRYING CASES SPECIALLY ADAPTED FOR VIDEO GAME CONSOLES FOR USE WITH AN EXTERNAL DISPLAY SCREEN OR MONITOR; STAND ALONE VIDEO GAMING MACHINES, NAMELY, A VIDEO CRAPS GAME MACHINE; TABLE-TOP UNITS FOR PLAYING ELECTRONIC GAMES OTHER THAN IN CONJUNCTION WITH A TELEVISION OR COMPUTER, NAMELY, AN ELECTRONIC CRAPS GAME; VIDEO AND COMPUTER GAME PROGRAMS; VIDEO GAME CARTRIDGES; VIDEO GAME CARTRIDGES AND CASSETTES; VIDEO GAME CARTRIDGES AND DISCS; VIDEO GAME CONSOLES FOR USE WITH AN EXTERNAL DISPLAY SCREEN OR MONITOR; VIDEO GAME DISCS; VIDEO GAME INTERACTIVE CONTROL FLOOR PADS OR MATS; VIDEO GAME INTERACTIVE HAND HELD REMOTE CONTROLS FOR PLAYING ELECTRONIC GAMES; VIDEO GAME INTERACTIVE REMOTE CONTROL UNITS;

CLASS 9—(Continued).

VIDEO GAME JOYSTICKS; VIDEO GAME MACHINES FOR USE WITH EXTERNAL DISPLAY SCREEN OR MONITOR; VIDEO GAME MACHINES FOR USE WITH TELEVISIONS; VIDEO GAME SOFTWARE; VIDEO GAME SOFTWARE, NAMELY, A VIDEO CRAPS GAME; VIDEO GAME TAPE CASSETTES; VIDEO OUTPUT GAME MACHINES FOR USE WITH EXTERNAL DISPLAY SCREEN OR MONITOR; VIDEO OUTPUT GAME MACHINES FOR USE WITH TELEVISIONS; VIRTUAL REALITY GAME SOFTWARE; WIRELESS COMMUNICATION DEVICE FEATURING VOICE, DATA AND IMAGE TRANSMISSION INCLUDING VOICE, TEXT AND PICTURE MESSAGING, A VIDEO AND STILL IMAGE CAMERA, ALSO FUNCTIONAL TO PURCHASE MUSIC, GAMES, VIDEO AND SOFTWARE APPLICATIONS OVER THE AIR FOR DOWNLOADING TO THE DEVICE (U.S. CLS. 21, 23, 26, 36 AND 38).

FIRST USE 12-27-2000; IN COMMERCE 3-1-2004.
REBECCA GILBERT, EXAMINING ATTORNEY

SN 77-732,146. ARCTICA STUDIOS, GLENDALE, CA. FILED 5-7-2009.

ARCTICA

THE MARK CONSISTS OF STANDARD CHARACTERS WITHOUT CLAIM TO ANY PARTICULAR FONT, STYLE, SIZE, OR COLOR.

FOR PRE-RECORDED, AUDIO DISCS AND COMPACT DISCS FEATURING MUSIC AND STORIES; COMPUTER GAME CARTRIDGES AND COMPUTER GAME DISCS; PRE-RECORDED DVDS, DIGITAL VERSATILE DISCS, DIGITAL VIDEO DISCS FEATURING LIVE ACTION AND ANIMATED ENTERTAINMENT, COMPUTER GAME SOFTWARE (U.S. CLS. 21, 23, 26, 36 AND 38).

BRIDGETT SMITH, EXAMINING ATTORNEY

SN 77-732,927. MOTOROLA, INC., SCHAUMBURG, IL. FILED 5-8-2009.

BACKFLIP

THE MARK CONSISTS OF STANDARD CHARACTERS WITHOUT CLAIM TO ANY PARTICULAR FONT, STYLE, SIZE, OR COLOR.

FOR CELLULAR PHONES; CELLULAR PHONES WITH ELECTRONIC MESSAGING CAPABILITIES; CELLULAR PHONES WITH DIGITAL CAMERA AND VIDEO CAMERA CAPABILITIES; CELLULAR PHONES WITH MP3, AUDIO, AND VIDEO PLAYER CAPABILITIES; CELLULAR PHONES WITH ELECTRONIC GAME CAPABILITIES; CELLULAR PHONES WITH NAVIGATION AND GLOBAL POSITIONING (GPS) CAPABILITIES; WIRELESS COMMUNICATION DEVICES FEATURING VOICE, DATA AND IMAGE TRANSMISSION; CELLULAR PHONE BATTERIES, BATTERY CHARGERS AND POWER ADAPTORS (U.S. CLS. 21, 23, 26, 36 AND 38).

HELENE LIWINSKI, EXAMINING ATTORNEY

CLASS 9—(Continued).

SN 77-733,461. EDWARDS, LUKE J, GOLD COAST, AUSTRALIA, FILED 5-11-2009.

USAs

THE MARK CONSISTS OF STANDARD CHARACTERS WITHOUT CLAIM TO ANY PARTICULAR FONT, STYLE, SIZE, OR COLOR.

FOR CASES FOR SPECTACLES AND SUNGLASSES; EYEGLASS CASES; EYEGLASSES; EYEWEAR; EYEWEAR ACCESSORIES, NAMELY, STRAPS, NECK CORDS AND HEAD STRAPS WHICH RESTRAIN EYEWEAR FROM MOVEMENT ON A WEARER; EYEWEAR CASES; SPECTACLES; SUNGLASSES; UNMOUNTED SPECTACLE FRAMES (U.S. CLS. 21, 23, 26, 36 AND 38).
ERIN FALK, EXAMINING ATTORNEY

CLASS 9—(Continued).

SN 77-737,125. HIGHLIGHTS FOR CHILDREN, INC., COLUMBUS, OH. FILED 5-14-2009.

WYATT THE RIOT

SN 77-734,472. AINSWORTH GAME TECHNOLOGY LIMITED, NEWINGTON, AUSTRALIA, FILED 5-12-2009.

Dragon Festival

THE MARK CONSISTS OF STANDARD CHARACTERS WITHOUT CLAIM TO ANY PARTICULAR FONT, STYLE, SIZE, OR COLOR.

FOR COMPUTER SOFTWARE AND FIRMWARE FOR GAMES OF CHANCE ON ANY COMPUTERIZED PLATFORM, INCLUDING DEDICATED GAMING CONSOLES, VIDEO BASED SLOT MACHINES, REEL BASED SLOT MACHINES, AND VIDEO LOTTERY TERMINALS (U.S. CLS. 21, 23, 26, 36 AND 38).
WILLIAM VERHOSEK, EXAMINING ATTORNEY

SN 77-735,156. PFIZER INC., NEW YORK, NY. FILED 5-12-2009.

IHHP

THE MARK CONSISTS OF STANDARD CHARACTERS WITHOUT CLAIM TO ANY PARTICULAR FONT, STYLE, SIZE, OR COLOR.

FOR COMPUTER SOFTWARE FOR THE CREATION OF A VACCINE PROTOCOL (U.S. CLS. 21, 23, 26, 36 AND 38).

FIRST USE 12-31-2006; IN COMMERCE 12-31-2006.
CAROLYN CATALDO, EXAMINING ATTORNEY

THE MARK CONSISTS OF STANDARD CHARACTERS WITHOUT CLAIM TO ANY PARTICULAR FONT, STYLE, SIZE, OR COLOR.

"WYATT THE RIOT" DOES NOT IDENTIFY A LIVING INDIVIDUAL.

FOR BABY MONITORS, BICYCLE HELMETS, BIOLOGICAL MICROSCOPES, BLANK DIGITAL STORAGE MEDIA, CALCULATORS, CAMERAS, CASES FOR CHILDREN'S EYE GLASSES, CD STORAGE RACKS, CD STORAGE WALLETS, CHILDREN'S EDUCATIONAL SOFTWARE, CHILDREN'S EDUCATIONAL MUSIC CDS AND DVDS, CHILDREN'S EYE GLASSES, CHILDREN'S VIDEO TAPES, COMPACT DISC PLAYERS, COMPUTER GAME CARTRIDGES AND DISCS, COMPUTER GAME PROGRAMS, COMPUTER GAME SOFTWARE, DECORATIVE MAGNETS, DECORATIVE SWITCH PLATE COVERS, ELECTRONIC DIARIES, ELECTRONIC PUBLICATIONS, NAMELY, BOOKS AND MAGAZINES FEATURING STORIES FOR CHILDREN, PUZZLES, GAMES AND EDUCATIONAL MATERIALS IN THE FIELD OF HANDWRITING, READING, GRAMMAR, MATH, GEOGRAPHY AND HISTORY, ELECTRONIC TIMERS, KARAOKE PLAYERS, MP3 PLAYERS, MOUSEPADS, PORTABLE MEDIA PLAYERS, PORTABLE RADIOS, VIDEO GAME CARTRIDGES AND DISCS, VIDEO GAME INTERACTIVE CONTROL FLOOR PADS OR MATS, AND HAND-HELD UNITS FOR PLAYING ELECTRONIC GAMES FOR USE WITH EXTERNAL DISPLAY SCREEN OR MONITOR (U.S. CLS. 21, 23, 26, 36 AND 38).

TINA BROWN, EXAMINING ATTORNEY

CLASS 9—(Continued).

SN 77-737,195. HIGHLIGHTS FOR CHILDREN, INC., COLUMBUS, OH. FILED 5-14-2009.

WYATT ROGERS

THE MARK CONSISTS OF STANDARD CHARACTERS WITHOUT CLAIM TO ANY PARTICULAR FONT, STYLE, SIZE, OR COLOR.

"WYATT ROGERS" DOES NOT IDENTIFY A LIVING INDIVIDUAL.

FOR BABY MONITORS, BICYCLE HELMETS, BIOLOGICAL MICROSCOPES, BLANK DIGITAL STORAGE MEDIA, CALCULATORS, CAMERAS, CASES FOR CHILDREN'S EYE GLASSES, CD STORAGE RACKS, CD STORAGE WALLETS, CHILDREN'S EDUCATIONAL SOFTWARE, CHILDREN'S EDUCATIONAL MUSIC CDS AND DVDS, CHILDREN'S EYE GLASSES, CHILDREN'S VIDEO TAPES, COMPACT DISC PLAYERS, COMPUTER GAME CARTRIDGES AND DISCS, COMPUTER GAME PROGRAMS, COMPUTER GAME SOFTWARE, DECORATIVE MAGNETS, DECORATIVE SWITCH PLATE COVERS, ELECTRONIC DIARIES, ELECTRONIC PUBLICATIONS, NAMELY, BOOKS AND MAGAZINES FEATURING STORIES FOR CHILDREN, PUZZLES, GAMES AND EDUCATIONAL MATERIALS IN THE FIELD OF HANDWRITING, READING, GRAMMAR, MATH, GEOGRAPHY AND HISTORY, ELECTRONIC TIMERS, KARAOKE PLAYERS, MP3 PLAYERS, MOUSEPADS, PORTABLE MEDIA PLAYERS, PORTABLE RADIOS, VIDEO GAME CARTRIDGES AND DISCS, VIDEO GAME INTERACTIVE CONTROL FLOOR PADS OR MATS, AND HAND-HELD UNITS FOR PLAYING ELECTRONIC GAMES FOR USE WITH EXTERNAL DISPLAY SCREEN OR MONITOR (U.S. CLS. 21, 23, 26, 36 AND 38).

TINA BROWN, EXAMINING ATTORNEY

SN 77-738,126. CARL ZEISS AG, 73447 OBERKOCHEN, FED REP GERMANY, FILED 5-15-2009.

FLOW

THE MARK CONSISTS OF STANDARD CHARACTERS WITHOUT CLAIM TO ANY PARTICULAR FONT, STYLE, SIZE, OR COLOR.

OWNER OF FED REP GERMANY REG. NO. 302008065039, DATED 4-21-2009, EXPIRES 10-31-2018.

FOR SOFTWARE USED DURING NEUROSURGERY TO VISUALIZE AND INTERPRET THE FLOW OF BLOOD AND TO ANALYZE DATA FROM THE OPERATION (U.S. CLS. 21, 23, 26, 36 AND 38).

SHARON MEIER, EXAMINING ATTORNEY

CLASS 9—(Continued).

SN 77-738,240. EMERGING DISPLAY TECHNOLOGIES CORPORATION, IRVINE, CA. FILED 5-15-2009.

EDT

THE MARK CONSISTS OF STANDARD CHARACTERS WITHOUT CLAIM TO ANY PARTICULAR FONT, STYLE, SIZE, OR COLOR.

OWNER OF U.S. REG. NO. 2,556,740.
FOR LIQUID CRYSTAL DISPLAYS (U.S. CLS. 21, 23, 26, 36 AND 38).

FIRST USE 1-31-1998; IN COMMERCE 1-31-1998.

BARBARA RUTLAND, EXAMINING ATTORNEY

SN 77-738,267. MOTOROLA, INC., SCHAUMBURG, IL. FILED 5-15-2009.

DEVOUR

THE MARK CONSISTS OF STANDARD CHARACTERS WITHOUT CLAIM TO ANY PARTICULAR FONT, STYLE, SIZE, OR COLOR.

FOR CELLULAR PHONES; CELLULAR PHONES WITH ELECTRONIC MESSAGING CAPABILITIES; CELLULAR PHONES WITH DIGITAL CAMERA AND VIDEO CAMERA CAPABILITIES; CELLULAR PHONES WITH MP3, AUDIO, AND VIDEO PLAYER CAPABILITIES; CELLULAR PHONES WITH ELECTRONIC GAME CAPABILITIES; CELLULAR PHONES WITH NAVIGATION AND GLOBAL POSITIONING (GPS) CAPABILITIES; WIRELESS COMMUNICATION DEVICES FEATURING VOICE, DATA AND IMAGE TRANSMISSION; CELLULAR PHONE BATTERIES, BATTERY CHARGERS AND POWER ADAPTORS (U.S. CLS. 21, 23, 26, 36 AND 38).

HELENE LIWINSKI, EXAMINING ATTORNEY

CLASS 9—(Continued).

SN 77-738,287. MOTOROLA, INC., SCHAUMBURG, IL.
FILED 5-15-2009.

INNATE

THE MARK CONSISTS OF STANDARD CHARACTERS WITHOUT CLAIM TO ANY PARTICULAR FONT, STYLE, SIZE, OR COLOR.

FOR CELLULAR PHONES; CELLULAR PHONES WITH ELECTRONIC MESSAGING CAPABILITIES; CELLULAR PHONES WITH DIGITAL CAMERA AND VIDEO CAMERA CAPABILITIES; CELLULAR PHONES WITH MP3, AUDIO, AND VIDEO PLAYER CAPABILITIES; CELLULAR PHONES WITH ELECTRONIC GAME CAPABILITIES; CELLULAR PHONES WITH NAVIGATION AND GLOBAL POSITIONING (GPS) CAPABILITIES; WIRELESS COMMUNICATION DEVICES FEATURING VOICE, DATA AND IMAGE TRANSMISSION; CELLULAR PHONE BATTERIES, BATTERY CHARGERS AND POWER ADAPTORS (U.S. CLS. 21, 23, 26, 36 AND 38).

HELENE LIWINSKI, EXAMINING ATTORNEY

SN 77-738,298. MOTOROLA, INC., SCHAUMBURG, IL.
FILED 5-15-2009.

FIEND

THE MARK CONSISTS OF STANDARD CHARACTERS WITHOUT CLAIM TO ANY PARTICULAR FONT, STYLE, SIZE, OR COLOR.

FOR CELLULAR PHONES; CELLULAR PHONES WITH ELECTRONIC MESSAGING CAPABILITIES; CELLULAR PHONES WITH DIGITAL CAMERA AND VIDEO CAMERA CAPABILITIES; CELLULAR PHONES WITH MP3, AUDIO, AND VIDEO PLAYER CAPABILITIES; CELLULAR PHONES WITH ELECTRONIC GAME CAPABILITIES; CELLULAR PHONES WITH NAVIGATION AND GLOBAL POSITIONING (GPS) CAPABILITIES; WIRELESS COMMUNICATION DEVICES FEATURING VOICE, DATA AND IMAGE TRANSMISSION; CELLULAR PHONE BATTERIES, BATTERY CHARGERS AND POWER ADAPTORS (U.S. CLS. 21, 23, 26, 36 AND 38).

HELENE LIWINSKI, EXAMINING ATTORNEY

CLASS 9—(Continued).

SN 77-739,659. SONY CORPORATION, TOKYO, JAPAN,
FILED 5-18-2009.



NO CLAIM IS MADE TO THE EXCLUSIVE RIGHT TO USE "HIGH-EFFICIENCY BACKLIGHT", APART FROM THE MARK AS SHOWN.

THE MARK CONSISTS OF THE WORDING HIGH-EFFICIENCY BACKLIGHT APPEARING IN THE RIGHT SIDE OF A RECTANGLE, WITH A STYLIZED COMPUTER SCREEN IN THE LEFT SIDE OF A RECTANGLE.

FOR TELEVISION SETS; LCD TELEVISION SETS; PDP TELEVISION SETS; PROJECTION TELEVISION SETS; DVD PLAYERS, DVD RECORDERS; HARD DISK VIDEO RECORDERS; VIDEO PROJECTORS; LCD COMPUTER DISPLAYS; MOBILE PHONES; PERSONAL COMPUTERS (U.S. CLS. 21, 23, 26, 36 AND 38).

H. M. FISHER, EXAMINING ATTORNEY

SN 77-739,676. GRIDMOBILITY LLC, KIRKLAND, WA.
FILED 5-18-2009.

Color of the Electron

THE MARK CONSISTS OF STANDARD CHARACTERS WITHOUT CLAIM TO ANY PARTICULAR FONT, STYLE, SIZE, OR COLOR.

FOR ELECTRIC AND ELECTRONIC CIRCUITS; ELECTRIC INSTALLATIONS FOR THE REMOTE CONTROL OF INDUSTRIAL OPERATIONS; ELECTRIC PLUGS; ELECTRIC SWITCHES; ELECTRICAL CONNECTION BOXES; ELECTRICAL CONTROLLING DEVICES; ELECTRICAL DISTRIBUTION BOXES; ELECTRICAL ENERGY UTILIZATION METERING DEVICES COMPLETE WITH RELATED SOFTWARE; ELECTRICAL OUTLETS; ELECTRICAL PLUG DEVICE ENABLING CONNECTION AND DISCONNECTION OF POWER AND/OR CONTROL CABLES; ELECTRICAL PLUGS AND SOCKETS; WIRELESS CONTROLLER TO MONITOR AND CONTROL THE FUNCTIONING OF OTHER ELECTRONIC DEVICES (U.S. CLS. 21, 23, 26, 36 AND 38).

FRED MANDIR, EXAMINING ATTORNEY

CLASS 9—(Continued).

SN 77-739,732. SEAGATE TECHNOLOGY LLC, SCOTTS VALLEY, CA. FILED 5-18-2009.

PULSAR

THE MARK CONSISTS OF STANDARD CHARACTERS WITHOUT CLAIM TO ANY PARTICULAR FONT, STYLE, SIZE, OR COLOR.

FOR SOLID STATE STORAGE, NAMELY, A NONVOLATILE STORAGE MEDIUM THAT EMPLOYS INTEGRATED CIRCUITS (U.S. CLS. 21, 23, 26, 36 AND 38).

MARK PILARO, EXAMINING ATTORNEY

SN 77-740,502. SEAGATE TECHNOLOGY LLC, SCOTTS VALLEY, CA. FILED 5-19-2009.

PULSAR

THE MARK CONSISTS OF STANDARD CHARACTERS WITHOUT CLAIM TO ANY PARTICULAR FONT, STYLE, SIZE, OR COLOR.

FOR SOLID STATE STORAGE, NAMELY, A NONVOLATILE STORAGE MEDIUM THAT EMPLOYS INTEGRATED CIRCUITS (U.S. CLS. 21, 23, 26, 36 AND 38).

MARK PILARO, EXAMINING ATTORNEY

CLASS 9—(Continued).

SN 77-740,763. WHITE, JOHN A., III, ENCINO, CA. FILED 5-19-2009.



THE MARK CONSISTS OF AN OUTLINE OF A WORLD GLOBE WITH THREE EQUAL SIZED HUMAN FIGURINES PLACED SIDE BY SIDE PROPORTIONATELY OVER THE WORLD GLOBE WITH A BOX SURROUNDING THE WORLD GLOBE AND THE WORDS "THIRD MAN" CENTERED ABOVE THE BOX.

FOR SOUND RECORDINGS FEATURING MUSIC, NAMELY, PRERECORDED COMPACT DISCS, PHONOGRAPH RECORDS, ANALOG TAPES, AND DIGITAL TAPES; VIDEO RECORDINGS FEATURING MUSIC VIDEO AND MUSIC DOCUMENTARY, NAMELY, PRERECORDED DIGITAL VIDEO DISCS, ANALOG TAPES, DIGITAL TAPES AND LASER DISCS; DOWNLOADABLE MUSIC DATA VIA THE INTERNET AND OTHER COMPUTER AND ELECTRONIC COMMUNICATION NETWORKS (U.S. CLS. 21, 23, 26, 36 AND 38).

FIRST USE 5-0-2002; IN COMMERCE 5-0-2002.

KATHERINE STOIDES, EXAMINING ATTORNEY

SN 77-740,812. AINSWORTH GAME TECHNOLOGY LIMITED, NEWINGTON, AUSTRALIA, FILED 5-20-2009.

Red Hot Dragons

THE MARK CONSISTS OF STANDARD CHARACTERS WITHOUT CLAIM TO ANY PARTICULAR FONT, STYLE, SIZE, OR COLOR.

FOR COMPUTER SOFTWARE AND FIRMWARE FOR GAMES OF CHANCE ON ANY COMPUTERIZED PLATFORM, INCLUDING DEDICATED GAMING CONSOLES, VIDEO BASED SLOT MACHINES, REEL BASED SLOT MACHINES, AND VIDEO LOTTERY TERMINALS (U.S. CLS. 21, 23, 26, 36 AND 38).

WILLIAM VERHOSEK, EXAMINING ATTORNEY

CLASS 9—(Continued).

SN 77-741,708. DIGITAT CONCEPTS, WEST PALM BEACH, FL. FILED 5-20-2009.

SWITCH BUDS

THE MARK CONSISTS OF STANDARD CHARACTERS WITHOUT CLAIM TO ANY PARTICULAR FONT, STYLE, SIZE, OR COLOR.

NO CLAIM IS MADE TO THE EXCLUSIVE RIGHT TO USE "BUDS", APART FROM THE MARK AS SHOWN.

FOR EARPHONES AND HEADPHONES WITH GRAPHICS FOR USE WITH MUSIC DEVICES (U.S. CLS. 21, 23, 26, 36 AND 38).

JENNIFER VASQUEZ, EXAMINING ATTORNEY

CLASS 9—(Continued).

SN 77-748,526. VIDEO GAMING TECHNOLOGIES, INC., BRENTWOOD, TN. FILED 5-31-2009.

LOCK STOCK & BARREL

THE MARK CONSISTS OF STANDARD CHARACTERS WITHOUT CLAIM TO ANY PARTICULAR FONT, STYLE, SIZE, OR COLOR.

FOR COMPUTER SOFTWARE AND FIRMWARE FOR GAMES OF CHANCE ON ANY COMPUTERIZED PLATFORM, INCLUDING DEDICATED GAMING CONSOLES, VIDEO BASED SLOT MACHINES, REEL BASED SLOT MACHINES, AND VIDEO LOTTERY TERMINALS; GAMING DEVICES, NAMELY, GAMING MACHINES, SLOT MACHINES, BINGO MACHINES, WITH OR WITHOUT VIDEO OUTPUT (U.S. CLS. 21, 23, 26, 36 AND 38).

KATHRYN COWARD, EXAMINING ATTORNEY

SN 77-743,429. CADILLAC JACK, INC., DULUTH, GA. FILED 5-22-2009.

LEGENDS OF THE ORIENT

THE MARK CONSISTS OF STANDARD CHARACTERS WITHOUT CLAIM TO ANY PARTICULAR FONT, STYLE, SIZE, OR COLOR.

FOR GAMING MACHINES, NAMELY, ELECTRONIC SLOT AND BINGO MACHINES (U.S. CLS. 21, 23, 26, 36 AND 38).

ESTHER A. BORSUK, EXAMINING ATTORNEY

SN 77-748,527. VIDEO GAMING TECHNOLOGIES, INC., BRENTWOOD, TN. FILED 5-31-2009.

BUBBA'S WATTERIN' HOLE

THE MARK CONSISTS OF STANDARD CHARACTERS WITHOUT CLAIM TO ANY PARTICULAR FONT, STYLE, SIZE, OR COLOR.

FOR COMPUTER SOFTWARE AND FIRMWARE FOR GAMES OF CHANCE ON ANY COMPUTERIZED PLATFORM, INCLUDING DEDICATED GAMING CONSOLES, VIDEO BASED SLOT MACHINES, REEL BASED SLOT MACHINES, AND VIDEO LOTTERY TERMINALS; GAMING DEVICES, NAMELY, GAMING MACHINES, SLOT MACHINES, BINGO MACHINES, WITH OR WITHOUT VIDEO OUTPUT (U.S. CLS. 21, 23, 26, 36 AND 38).

KATHRYN COWARD, EXAMINING ATTORNEY

SN 77-748,525. VIDEO GAMING TECHNOLOGIES, INC., BRENTWOOD, TN. FILED 5-31-2009.

PATRIOTIC PATOUTS

THE MARK CONSISTS OF STANDARD CHARACTERS WITHOUT CLAIM TO ANY PARTICULAR FONT, STYLE, SIZE, OR COLOR.

FOR COMPUTER SOFTWARE AND FIRMWARE FOR GAMES OF CHANCE ON ANY COMPUTERIZED PLATFORM, INCLUDING DEDICATED GAMING CONSOLES, VIDEO BASED SLOT MACHINES, REEL BASED SLOT MACHINES, AND VIDEO LOTTERY TERMINALS; GAMING DEVICES, NAMELY, GAMING MACHINES, SLOT MACHINES, BINGO MACHINES, WITH OR WITHOUT VIDEO OUTPUT (U.S. CLS. 21, 23, 26, 36 AND 38).

KATHRYN COWARD, EXAMINING ATTORNEY

SN 77-748,529. VIDEO GAMING TECHNOLOGIES, INC., BRENTWOOD, TN. FILED 5-31-2009.

PIECE OF CAKE

THE MARK CONSISTS OF STANDARD CHARACTERS WITHOUT CLAIM TO ANY PARTICULAR FONT, STYLE, SIZE, OR COLOR.

FOR COMPUTER SOFTWARE AND FIRMWARE FOR GAMES OF CHANCE ON ANY COMPUTERIZED PLATFORM, INCLUDING DEDICATED GAMING CONSOLES, VIDEO BASED SLOT MACHINES, REEL BASED SLOT MACHINES, AND VIDEO LOTTERY TERMINALS; GAMING DEVICES, NAMELY, GAMING MACHINES, SLOT MACHINES, BINGO MACHINES, WITH OR WITHOUT VIDEO OUTPUT (U.S. CLS. 21, 23, 26, 36 AND 38).

KATHRYN COWARD, EXAMINING ATTORNEY

CLASS 9—(Continued).

SN 77-748,530. VIDEO GAMING TECHNOLOGIES, INC., BRENTWOOD, TN. FILED 5-31-2009.

BBQ BONANZA

THE MARK CONSISTS OF STANDARD CHARACTERS WITHOUT CLAIM TO ANY PARTICULAR FONT, STYLE, SIZE, OR COLOR.

FOR COMPUTER SOFTWARE AND FIRMWARE FOR GAMES OF CHANCE ON ANY COMPUTERIZED PLATFORM, INCLUDING DEDICATED GAMING CONSOLES, VIDEO BASED SLOT MACHINES, REEL BASED SLOT MACHINES, AND VIDEO LOTTERY TERMINALS; GAMING DEVICES, NAMELY, GAMING MACHINES, SLOT MACHINES, BINGO MACHINES, WITH OR WITHOUT VIDEO OUTPUT (U.S. CLS. 21, 23, 26, 36 AND 38).

KATHRYN COWARD, EXAMINING ATTORNEY

SN 77-748,531. VIDEO GAMING TECHNOLOGIES, INC., BRENTWOOD, TN. FILED 5-31-2009.

MAD AS A HATTER

THE MARK CONSISTS OF STANDARD CHARACTERS WITHOUT CLAIM TO ANY PARTICULAR FONT, STYLE, SIZE, OR COLOR.

FOR COMPUTER SOFTWARE AND FIRMWARE FOR GAMES OF CHANCE ON ANY COMPUTERIZED PLATFORM, INCLUDING DEDICATED GAMING CONSOLES, VIDEO BASED SLOT MACHINES, REEL BASED SLOT MACHINES, AND VIDEO LOTTERY TERMINALS; GAMING DEVICES, NAMELY, GAMING MACHINES, SLOT MACHINES, BINGO MACHINES, WITH OR WITHOUT VIDEO OUTPUT (U.S. CLS. 21, 23, 26, 36 AND 38).

KATHRYN COWARD, EXAMINING ATTORNEY

SN 77-748,532. VIDEO GAMING TECHNOLOGIES, INC., BRENTWOOD, TN. FILED 5-31-2009.

EAGER BEAVER

THE MARK CONSISTS OF STANDARD CHARACTERS WITHOUT CLAIM TO ANY PARTICULAR FONT, STYLE, SIZE, OR COLOR.

FOR COMPUTER SOFTWARE AND FIRMWARE FOR GAMES OF CHANCE ON ANY COMPUTERIZED PLATFORM, INCLUDING DEDICATED GAMING CONSOLES, VIDEO BASED SLOT MACHINES, REEL BASED SLOT MACHINES, AND VIDEO LOTTERY TERMINALS; GAMING DEVICES, NAMELY, GAMING MACHINES, SLOT MACHINES, BINGO MACHINES, WITH OR WITHOUT VIDEO OUTPUT (U.S. CLS. 21, 23, 26, 36 AND 38).

KATHRYN COWARD, EXAMINING ATTORNEY

CLASS 9—(Continued).

SN 77-748,534. VIDEO GAMING TECHNOLOGIES, INC., BRENTWOOD, TN. FILED 5-31-2009.

FEELIN' GROOVY

THE MARK CONSISTS OF STANDARD CHARACTERS WITHOUT CLAIM TO ANY PARTICULAR FONT, STYLE, SIZE, OR COLOR.

FOR COMPUTER SOFTWARE AND FIRMWARE FOR GAMES OF CHANCE ON ANY COMPUTERIZED PLATFORM, INCLUDING DEDICATED GAMING CONSOLES, VIDEO BASED SLOT MACHINES, REEL BASED SLOT MACHINES, AND VIDEO LOTTERY TERMINALS; GAMING DEVICES, NAMELY, GAMING MACHINES, SLOT MACHINES, BINGO MACHINES, WITH OR WITHOUT VIDEO OUTPUT (U.S. CLS. 21, 23, 26, 36 AND 38).

KATHRYN COWARD, EXAMINING ATTORNEY

SN 77-750,243. MOTOROLA, INC., SCHAUMBURG, IL. FILED 6-2-2009.

VANQUISH

THE MARK CONSISTS OF STANDARD CHARACTERS WITHOUT CLAIM TO ANY PARTICULAR FONT, STYLE, SIZE, OR COLOR.

FOR CELLULAR PHONES; CELLULAR PHONES WITH ELECTRONIC MESSAGING CAPABILITIES; CELLULAR PHONES WITH DIGITAL CAMERA AND VIDEO CAMERA CAPABILITIES; CELLULAR PHONES WITH MP3, AUDIO, AND VIDEO PLAYER CAPABILITIES; CELLULAR PHONES WITH ELECTRONIC GAME CAPABILITIES; CELLULAR PHONES WITH NAVIGATION AND GLOBAL POSITIONING (GPS) CAPABILITIES; WIRELESS COMMUNICATION DEVICES FEATURING VOICE, DATA AND IMAGE TRANSMISSION; CELLULAR PHONE BATTERIES, BATTERY CHARGERS AND POWER ADAPTORS (U.S. CLS. 21, 23, 26, 36 AND 38).

HELENE LIWINSKI, EXAMINING ATTORNEY

CLASS 9—(Continued).

SN 77-750,248. MOTOROLA, INC., SCHAUMBURG, IL. FILED 6-2-2009.

MILESTONE

THE MARK CONSISTS OF STANDARD CHARACTERS WITHOUT CLAIM TO ANY PARTICULAR FONT, STYLE, SIZE, OR COLOR.

FOR CELLULAR PHONES; CELLULAR PHONES WITH ELECTRONIC MESSAGING CAPABILITIES; CELLULAR PHONES WITH DIGITAL CAMERA AND VIDEO CAMERA CAPABILITIES; CELLULAR PHONES WITH MP3, AUDIO, AND VIDEO PLAYER CAPABILITIES; CELLULAR PHONES WITH ELECTRONIC GAME CAPABILITIES; CELLULAR PHONES WITH NAVIGATION AND GLOBAL POSITIONING (GPS) CAPABILITIES; WIRELESS COMMUNICATION DEVICES FEATURING VOICE, DATA AND IMAGE TRANSMISSION; CELLULAR PHONE BATTERIES, BATTERY CHARGERS AND POWER ADAPTORS (U.S. CLS. 21, 23, 26, 36 AND 38).
HELENE LIWINSKI, EXAMINING ATTORNEY

SN 77-750,903. NAV N GO KFT, BUDAPEST, HUNGARY, FILED 6-3-2009.



OWNER OF U.S. REG. NO. 3,546,985.
THE MARK CONSISTS OF THE WORDS "IGO AMIGO" WITH A LOWER CASE "I" AND "GO" IN CAPITAL BLOCK LETTERS WITH THE WORD "AMIGO" IN LOWER CASE LETTERS BELOW "IGO".
THE ENGLISH TRANSLATION OF "AMIGO" IN THE MARK IS FRIEND.
FOR COMPUTER PROGRAMS AND SOFTWARE FOR USE IN FIXED OR HANDHELD MICROCOMPUTERS ENABLING NAVIGATION BY THE USE OF GLOBAL POSITIONING SYSTEMS (GPS) DATA (U.S. CLS. 21, 23, 26, 36 AND 38).
JUSTINE D. PARKER, EXAMINING ATTORNEY

CLASS 9—(Continued).

SN 77-752,066. GE MDS, LLC., ROCHESTER, NY. FILED 6-4-2009.

MDS MERCURY

THE MARK CONSISTS OF STANDARD CHARACTERS WITHOUT CLAIM TO ANY PARTICULAR FONT, STYLE, SIZE, OR COLOR.

OWNER OF U.S. REG. NOS. 2,674,366, 2,744,018 AND 2,819,486.
FOR WIRELESS GATEWAY AND RADIO COMMUNICATION DEVICE WITH APPLICATIONS IN THE AREAS OF UTILITIES, ENERGY, OIL AND GAS, AND PUBLIC SAFETY AND TRAFFIC APPLICATIONS BY PUBLIC AGENCIES (U.S. CLS. 21, 23, 26, 36 AND 38).
FIRST USE 2-28-2007; IN COMMERCE 2-28-2007.
CURTIS FRENCH, EXAMINING ATTORNEY

SN 77-752,522. BARBARA CREATIONS, INC., SKOKIE, IL. FILED 6-4-2009.

ECOSPEX

THE MARK CONSISTS OF STANDARD CHARACTERS WITHOUT CLAIM TO ANY PARTICULAR FONT, STYLE, SIZE, OR COLOR.

OWNER OF U.S. REG. NO. 3,611,494.
FOR READING GLASSES (U.S. CLS. 21, 23, 26, 36 AND 38).
DEBRA LEE, EXAMINING ATTORNEY

SN 77-752,539. BARBARA CREATIONS, INC., SKOKIE, IL. FILED 6-4-2009.

ECOSHADES

THE MARK CONSISTS OF STANDARD CHARACTERS WITHOUT CLAIM TO ANY PARTICULAR FONT, STYLE, SIZE, OR COLOR.

FOR SUNGLASSES (U.S. CLS. 21, 23, 26, 36 AND 38).
DEBRA LEE, EXAMINING ATTORNEY

CLASS 9—(Continued).

SN 77-752,928. THE POWERWISE GROUP, INC., BOCA RATON, FL. FILED 6-5-2009.

ECOWISE

THE MARK CONSISTS OF STANDARD CHARACTERS WITHOUT CLAIM TO ANY PARTICULAR FONT, STYLE, SIZE, OR COLOR.

FOR ELECTRONIC CONTROLLERS AND MICRO-PROCESSOR-BASED HARDWARE SYSTEMS USED TO REDUCE POWER CONSUMPTION (U.S. CLS. 21, 23, 26, 36 AND 38).

TEJBIR SINGH, EXAMINING ATTORNEY

CLASS 9—(Continued).

SN 77-755,376. E. I. DU PONT DE NEMOURS AND COMPANY, WILMINGTON, DE. FILED 6-9-2009.

SUPREL

THE MARK CONSISTS OF STANDARD CHARACTERS WITHOUT CLAIM TO ANY PARTICULAR FONT, STYLE, SIZE, OR COLOR.

OWNER OF U.S. REG. NOS. 2,940,710 AND 3,561,118. FOR PROTECTIVE CLOTHING (U.S. CLS. 21, 23, 26, 36 AND 38).

MARTHA FROMM, EXAMINING ATTORNEY

SN 77-754,064. GENERAL ELECTRIC COMPANY, SCHECTADY, NY. FILED 6-8-2009.

TRUECOURSE

THE MARK CONSISTS OF STANDARD CHARACTERS WITHOUT CLAIM TO ANY PARTICULAR FONT, STYLE, SIZE, OR COLOR.

FOR AVIONIC SENSOR SYSTEMS, NAMELY, NAVIGATION SYSTEMS (U.S. CLS. 21, 23, 26, 36 AND 38).

ZACHARY BELLO, EXAMINING ATTORNEY

SN 77-756,955. CADILLAC JACK, INC., DULUTH, GA. FILED 6-11-2009.

SCOTLAND YARD

THE MARK CONSISTS OF STANDARD CHARACTERS WITHOUT CLAIM TO ANY PARTICULAR FONT, STYLE, SIZE, OR COLOR.

FOR GAMING MACHINES, NAMELY, ELECTRONIC SLOT AND BINGO MACHINES (U.S. CLS. 21, 23, 26, 36 AND 38).

ESTHER A. BORSUK, EXAMINING ATTORNEY

SN 77-754,100. USA TIGER GROUP INC, NEW YORK, NY. FILED 6-8-2009.

GO

THE MARK CONSISTS OF THE UPPER CASE STYLIZED LETTERS "G" FOLLOWED BY THE UPPER CASE INVERTED STYLIZED LETTERS "O".

FOR EYEGLASSES (U.S. CLS. 21, 23, 26, 36 AND 38). FIRST USE 3-8-2009; IN COMMERCE 5-18-2009.

DEIRDRE ROBERTSON, EXAMINING ATTORNEY

SN 77-758,225. SAMSUNG ELECTRONICS CO., LTD., SUWON-SI, GYEONGGI-DO, REPUBLIC OF KOREA, FILED 6-12-2009.

SAMSUNG ENTRO

THE MARK CONSISTS OF STANDARD CHARACTERS WITHOUT CLAIM TO ANY PARTICULAR FONT, STYLE, SIZE, OR COLOR.

OWNER OF U.S. REG. NOS. 2,774,743, 2,929,519 AND OTHERS.

THE ENGLISH TRANSLATION OF "ENTRO" IN THE MARK IS "WITHIN".

FOR MOBILE PHONES; SMARTPHONES (U.S. CLS. 21, 23, 26, 36 AND 38).

JAMES STEIN, EXAMINING ATTORNEY

CLASS 9—(Continued).

SN 77-758,287. PURE DIGITAL TECHNOLOGIES LLC, SAN FRANCISCO, CA. FILED 6-12-2009.

FLIP MINO

THE MARK CONSISTS OF STANDARD CHARACTERS WITHOUT CLAIM TO ANY PARTICULAR FONT, STYLE, SIZE, OR COLOR.

FOR CAMCORDERS (U.S. CLS. 21, 23, 26, 36 AND 38).
FIRST USE 10-30-2007; IN COMMERCE 6-4-2008.
ANDREA BUTLER, EXAMINING ATTORNEY

SN 77-760,325. AINSWORTH GAME TECHNOLOGY LIMITED, NEWINGTON, AUSTRALIA, FILED 6-15-2009.

Mustang Money

THE MARK CONSISTS OF STANDARD CHARACTERS WITHOUT CLAIM TO ANY PARTICULAR FONT, STYLE, SIZE, OR COLOR.

FOR COMPUTER SOFTWARE AND FIRMWARE FOR GAMES OF CHANCE ON ANY COMPUTERIZED PLATFORM, INCLUDING DEDICATED GAMING CONSOLES, VIDEO BASED SLOT MACHINES, REEL BASED SLOT MACHINES, AND VIDEO LOTTERY TERMINALS (U.S. CLS. 21, 23, 26, 36 AND 38).
WILLIAM VERHOSEK, EXAMINING ATTORNEY

SN 77-761,605. REVLOX CONSUMER PRODUCTS CORPORATION, NEW YORK, NY. FILED 6-17-2009.

SMOOTHSTAY

THE MARK CONSISTS OF STANDARD CHARACTERS WITHOUT CLAIM TO ANY PARTICULAR FONT, STYLE, SIZE, OR COLOR.

FOR ELECTRIC HAIR STRAIGHTENER (U.S. CLS. 21, 23, 26, 36 AND 38).
ODESSA BIBBINS, EXAMINING ATTORNEY

CLASS 9—(Continued).

SN 77-762,959. KEYNOTE SYSTEMS, INC., SAN MATEO, CA. FILED 6-18-2009.

KEYNOTE

THE MARK CONSISTS OF STANDARD CHARACTERS WITHOUT CLAIM TO ANY PARTICULAR FONT, STYLE, SIZE, OR COLOR.

OWNER OF U.S. REG. NOS. 2,163,063, 3,147,424 AND OTHERS.

FOR COMPUTER HARDWARE; COMPUTER HARDWARE APPLIANCES THAT COLLECT DATA FOR THE PURPOSE OF MEASURING, MONITORING, TESTING AND IMPROVING THE QUALITY OF SERVICES ON GLOBAL COMPUTER NETWORKS AND LOCAL AND WIDE AREA NETWORKS; COMPUTER HARDWARE APPLIANCES FOR WEB PERFORMANCE MEASUREMENT (U.S. CLS. 21, 23, 26, 36 AND 38).

FIRST USE 0-0-1996; IN COMMERCE 0-0-1996.
BILL DAWE, EXAMINING ATTORNEY

SN 77-763,733. HONEYWELL INTERNATIONAL INC., MORRISTOWN, NJ. FILED 6-19-2009.

AQUARESET

THE MARK CONSISTS OF STANDARD CHARACTERS WITHOUT CLAIM TO ANY PARTICULAR FONT, STYLE, SIZE, OR COLOR.

FOR TEMPERATURE SENSORS (U.S. CLS. 21, 23, 26, 36 AND 38).
TEJBIR SINGH, EXAMINING ATTORNEY

SN 77-764,276. ADDCO LLC, ST. PAUL, MN. FILED 6-19-2009.

IMAGO

THE MARK CONSISTS OF STANDARD CHARACTERS WITHOUT CLAIM TO ANY PARTICULAR FONT, STYLE, SIZE, OR COLOR.

FOR LUMINOUS VARIABLE/DYNAMIC SIGNS USING LIGHT EMITTING DIODES AND ELECTRONIC CONTROLLERS TO PRODUCE REAL-TIME AND PROGRAMMABLE MESSAGES AND INFORMATION DISPLAYS (U.S. CLS. 21, 23, 26, 36 AND 38).
GINA HAYES, EXAMINING ATTORNEY

CLASS 9—(Continued).

SN 77-776,782. AFFECTIVA, INC., NEWTONVILLE, MA. FILED 7-8-2009.

AFFECTIVA

THE MARK CONSISTS OF STANDARD CHARACTERS WITHOUT CLAIM TO ANY PARTICULAR FONT, STYLE, SIZE, OR COLOR.

FOR ELECTRONIC SENSORS, COMPUTER HARDWARE AND COMPUTER SOFTWARE PROGRAMS FOR USE IN COLLECTING, TESTING, MEASURING AND EVALUATING DEMONSTRATIVE PHYSIOLOGICAL EXPRESSIONS AND SIGNALS (U.S. CLS. 21, 23, 26, 36 AND 38).

MICHAEL TANNER, EXAMINING ATTORNEY

CLASS 9—(Continued).

SN 77-977,546. RELIANT ENERGY RETAIL HOLDINGS, LLC, HOUSTON, TX. FILED 9-29-2008.

e-Sense

THE MARK CONSISTS OF LOWER CASE "E" FOLLOWED BY A DASH THE CAPITALIZED WORD "SENSE".

FOR COMPUTER SYSTEM COMPRISED OF HARDWARE AND SOFTWARE FOR REMOTELY MONITORING ENVIRONMENTAL CONDITIONS AND CONTROLLING DEVICES WITHIN A BUILDING, FACILITY, GROUNDS, OR DESIGNATED SPATIAL AREA; ELECTRICAL ENERGY UTILIZATION METERING DEVICES COMPLETE WITH RELATED METERING AND MEASURING SOFTWARE; HOME AND OFFICE AUTOMATION SYSTEMS COMPRISING WIRELESS AND WIRED CONTROLLERS, CONTROLLED DEVICES, NAMELY, THERMOSTATS, OFFICE EQUIPMENT AND APPLIANCES AND SOFTWARE FOR POWER CONSUMPTION, POWER GENERATION, AND OTHER HOME AND OFFICE POWER MONITORING AND CONTROL APPLICATIONS; ENERGY COST AND USAGE MONITORS AND HARDWARE AND SOFTWARE FOR ENERGY COST AND USAGE (U.S. CLS. 21, 23, 26, 36 AND 38).

JOHN SCHUYLER YARD, EXAMINING ATTORNEY

SN 77-776,928. SQUARE GROUPER, LLC, MIAMI BEACH, FL. FILED 7-8-2009.

SQUARE GROUPER

THE MARK CONSISTS OF STANDARD CHARACTERS WITHOUT CLAIM TO ANY PARTICULAR FONT, STYLE, SIZE, OR COLOR.

FOR COMPUTER GAME PROGRAMS AND COMPUTER GAME SOFTWARE; COMPUTER GAME PROGRAMS AND COMPUTER GAME SOFTWARE FOR USE BY AND DELIVERY TO PERSONAL COMPUTERS, VIDEO GAME CONSOLES, HAND HELD COMPUTING DEVICES, MOBILE COMPUTING DEVICES, AND OTHER COMPUTING DEVICES (U.S. CLS. 21, 23, 26, 36 AND 38).

JANICE KIM, EXAMINING ATTORNEY

SN 78-530,849. TAKE-TWO INTERACTIVE SOFTWARE, INC., NEW YORK, NY. FILED 12-10-2004.

SNOW

THE MARK CONSISTS OF STANDARD CHARACTERS WITHOUT CLAIM TO ANY PARTICULAR FONT, STYLE, SIZE, OR COLOR.

FOR COMPUTER GAME SOFTWARE, ELECTRONIC GAME PROGRAMS, VIDEO GAME DISKS AND CARTRIDGES (U.S. CLS. 21, 23, 26, 36 AND 38).

ALEXANDER L. POWERS, EXAMINING ATTORNEY

CLASS 9—(Continued).

SN 78-834,703. DAYSTAR FILTERS LLC, WARRENSBURG, MO. FILED 3-10-2006.

DAYSTAR

THE MARK CONSISTS OF STANDARD CHARACTERS WITHOUT CLAIM TO ANY PARTICULAR FONT, STYLE, SIZE, OR COLOR.
FOR OPTICAL FILTERS AND AUXILIARY OPTICAL EQUIPMENT, NAMELY, TELESCOPES AND OPTICAL BENCHES (U.S. CLS. 21, 23, 26, 36 AND 38).
FIRST USE 2-28-1975; IN COMMERCE 2-28-1975.
MARY BOAGNI, EXAMINING ATTORNEY

CLASS 9—(Continued).

SN 78-972,529. FELKER, MATTHEW N., BROOKFIELD, WI. FILED 9-12-2006.



SN 78-895,345. PROCONNEXX GMBH, SAARBRUECKEN, FED REP GERMANY, FILED 5-30-2006.

take me home

THE MARK CONSISTS OF STANDARD CHARACTERS WITHOUT CLAIM TO ANY PARTICULAR FONT, STYLE, SIZE, OR COLOR.
FOR CELLULAR TELEPHONES (U.S. CLS. 21, 23, 26, 36 AND 38).
KATHERINE CHANG, EXAMINING ATTORNEY

FOR VIDEO GAMES (U.S. CLS. 21, 23, 26, 36 AND 38).
ELLEN PERKINS, EXAMINING ATTORNEY

SN 78-951,991. GLOTO CORP., FULTON, MD. FILED 8-15-2006.

CELLBLOCK

THE MARK CONSISTS OF STANDARD CHARACTERS WITHOUT CLAIM TO ANY PARTICULAR FONT, STYLE, SIZE, OR COLOR.
FOR COMPUTER SOFTWARE FOR USE IN DATABASE MANAGEMENT; COMPUTER SOFTWARE FOR UPLOADING, MANIPULATING AND ENHANCING DIGITAL CONTENT (U.S. CLS. 21, 23, 26, 36 AND 38).
KATHERINE CONNOLLY, EXAMINING ATTORNEY

SN 79-037,533. FUJITSU SIEMENS COMPUTERS GMBH, FED REP GERMANY, FILED 11-2-2006.

x10sure

PRIORITY DATE OF 7-18-2006 IS CLAIMED.
OWNER OF INTERNATIONAL REGISTRATION 0921585 DATED 11-2-2006, EXPIRES 11-2-2016.
FOR COMPUTER SOFTWARE FOR CONFIGURING SERVERS; AND COMPUTER SOFTWARE FOR USE IN IT CONSOLIDATION WITH RESPECT TO SYSTEM AVAILABILITY (U.S. CLS. 21, 23, 26, 36 AND 38).
INGRID C. EULIN, EXAMINING ATTORNEY

CLASS 9—(Continued).

SN 79-056,226. CRANE CO. (DELAWARE CORPORATION), STAMFORD, CT. FILED 3-18-2008.

currenza c²

PRIORITY DATE OF 9-20-2007 IS CLAIMED.
OWNER OF INTERNATIONAL REGISTRATION 0970583A DATED 3-18-2008, EXPIRES 3-18-2018.
THE WORDING "CURRENZA" HAS NO MEANING IN A FOREIGN LANGUAGE.

FOR APPARATUS FOR STORING AND READING INFORMATION WITH THE AID OF CHIP CARDS, PLUG-IN CARDS AND/OR CHIP KEYS, NAMELY, ELECTRONIC CARD READERS FOR STORING AND READING INFORMATION WITH THE AID OF CHIP CARDS, PLUG-IN CARDS AND/OR CHIP KEYS FOR AUTOMATIC CASH AND BANKNOTE DISPENSING MACHINES, FOR AUTOMATIC MACHINES FOR GOODS, GAMES AND SERVICES, FOR TIME RECORDING APPARATUS AND FOR MONITORING ACCESS AUTHORIZATION; ENCODED ELECTRONIC CHIP CARDS, CHIP KEYS, PLUG-IN CARDS AND SOFTWARE FOR PAYING GOODS AND/OR SERVICES IN AUTOMATIC MACHINES FOR GOODS, GAMES AND SERVICES; ELECTRONIC COIN AND BANKNOTE TESTING APPARATUS, APPARATUS FOR PROCESSING COINS AND BANKNOTES, NAMELY, MONEY COUNTING AND SORTING MACHINES FOR AUTOMATIC CASH AND BANKNOTE DISPENSING MACHINES, AND FOR AUTOMATIC MACHINES FOR GOODS, GAMES AND SERVICES; CURRENCY COUNTING MACHINES CONSISTING OF PCS, SOFTWARE FOR COUNTING CURRENCY, CHIP CARD ENCODING AND READING APPARATUS, CHIP CARDS, TICKET PRINTERS, JOURNAL PRINTERS FOR CONTINUOUS CHECKING OF TURNOVER, CUSTOMER DISPLAYS FOR CUSTOMER INFORMATION CONCERNING PRICES/CREDIT CONDITIONS, LOCKING CASH BOXES FOR AUTOMATIC CASH AND BANKNOTE DISPENSING MACHINES, AND FOR MANUALLY OPERATED CASH REGISTERS (U.S. CLS. 21, 23, 26, 36 AND 38).

KEVIN CORWIN, EXAMINING ATTORNEY

SN 79-057,342. CONTRINEX SA, SWITZERLAND, FILED 7-15-2008.

Safetindex

THE MARK CONSISTS OF STANDARD CHARACTERS WITHOUT CLAIM TO ANY PARTICULAR FONT, STYLE, SIZE, OR COLOR.

OWNER OF INTERNATIONAL REGISTRATION 0973261 DATED 7-15-2008, EXPIRES 7-15-2018.

FOR OPTICAL, PHOTOGRAPHIC, MEASURING, SIGNALING, SIGNAL CHECKING APPARATUS AND INSTRUMENTS, NAMELY, PHOTOELECTRIC PRESENCE SENSORS, NAMELY, SAFETY LIGHT CURTAINS, SIGNAL PROCESSORS, SAFETY RELAYS; ELECTRONIC COMPONENTS, NAMELY, CONNECTORS, SWITCHES, LIGHT EMITTING DIODES (LEDS) AND ELECTRONIC CIRCUITS FOR AUTOMATION AND MEASUREMENT TECHNIQUES; PROXIMITY AND PHOTOELECTRONIC SENSORS (U.S. CLS. 21, 23, 26, 36 AND 38).

SARA THOMAS, EXAMINING ATTORNEY

CLASS 9—(Continued).

SN 79-062,803. SIGRIST-PHOTOMETER AG, SWITZERLAND, FILED 11-6-2008.

SIGRIST

THE MARK CONSISTS OF STANDARD CHARACTERS WITHOUT CLAIM TO ANY PARTICULAR FONT, STYLE, SIZE, OR COLOR.

PRIORITY DATE OF 6-2-2008 IS CLAIMED.
OWNER OF INTERNATIONAL REGISTRATION 0986792 DATED 11-6-2008, EXPIRES 11-6-2018.

SEC. 2(F).
FOR APPARATUS, INSTRUMENTS AND INSTALLATIONS FOR OPTICAL AND PHOTOMETRIC MEASUREMENT OF LIQUID AND GASEOUS MATERIALS, NAMELY, INSTRUMENTS FOR MONITORING WATER AND AIR QUALITY AND PRODUCTION PROCESSES SUCH AS BEER BREWING AND OIL PRODUCTION (U.S. CLS. 21, 23, 26, 36 AND 38).

WENDY JUN, EXAMINING ATTORNEY

SN 79-063,929. TONGXIANG SENON AUDIO CO., LTD., CHINA, FILED 8-3-2008.

SenonAudio

OWNER OF INTERNATIONAL REGISTRATION 0989652 DATED 8-3-2008, EXPIRES 8-3-2018.

THE MARK CONSISTS OF THE WORDING "SENONAUDIO" IN STYLIZED FONT.

FOR CABINETS FOR LOUDSPEAKERS; DIAPHRAGMS, NAMELY, AUDIO SPEAKERS; LOUDSPEAKERS; MICROPHONES; SOUND TRANSMITTING APPARATUS; HORNS FOR LOUDSPEAKERS; PERSONAL STEREO; EAR PLUGS NOT FOR MEDICAL PURPOSES (U.S. CLS. 21, 23, 26, 36 AND 38).

ROBERT STRUCK, EXAMINING ATTORNEY

SN 79-065,064. YOKOGAWA ELECTRIC CORPORATION, JAPAN, FILED 10-15-2008.

DAQStudio

PRIORITY DATE OF 4-25-2008 IS CLAIMED.
OWNER OF INTERNATIONAL REGISTRATION 0992533 DATED 10-15-2008, EXPIRES 10-15-2018.

OWNER OF U.S. REG. NOS. 2,802,167 AND 2,857,389.
FOR INFORMATION GATHERING APPARATUS WHICH HAS FUNCTIONS TO STORE THE DATA MEASURED BY REMOTE MONITORING AND TO SEND A STORED DATA UPON REQUEST, NAMELY, ELECTRONIC RECORDERS FOR STORING AND ARCHIVING INFORMATION RELATED TO TEMPERATURE, PRESSURE, FLOW AND OTHER PHYSICAL DATA FROM SENSORS; DATA ACQUISITION APPARATUS WHICH HAS FUNCTIONS TO STORE THE DATA MEASURED BY REMOTE MONITORING AND TO SEND A STORED DATA UPON REQUEST, NAMELY, MOBILE DATA RECEIVERS AND MOBILE DATA RECEIVERS USING COMMUNICATION NETWORKS; DATA LOGGERS, NAMELY, ELECTRONIC MEASURING DEVICES, NAMELY, TEMPERATURE INDICATORS, TEMPERATURE SENSORS, PRESSURE

CLASS 9—(Continued).

GAUGES, PRESSURE INDICATORS, FLOW METERS; DATA COLLECTING DEVICES, NAMELY, APPARATUS FOR RECORDING DATA IN THE NATURE OF TEMPERATURE, PRESSURE, FLOW AND OTHER SUCH PHYSICAL DATA FROM SENSORS; RECORD AND DISPLAY UNITS OF MEASUREMENT DATA, NAMELY, VIDEO MONITORS FOR RECORDED WAVE FORMS OF MEASURED DATA AND MEASURED VALUES; COMPUTER PROGRAMS FOR ANALYZING MEASURED DATA, NAMELY, COMPUTER SOFTWARE FOR USE IN DATABASE MANAGEMENT, FOR USE IN LOGGING, ANALYZING, MANIPULATING AND MANAGING THE TEMPERATURE, PRESSURE, FLOW DATA FOR USE IN THE PROCESS DATA FIELD; MEASURING APPARATUS, NAMELY, SIGNAL ANALYZERS FOR ANALYSIS OF ABNORMAL CONDITIONS OF SIGNALS OF MEASURED DATA RELATED TO TEMPERATURE, PRESSURE, FLOW AND OTHER PHYSICAL DATA FROM SENSORS; ELECTRIC AND MAGNETIC METERS AND VOLTAGE TESTERS (U.S. CLS. 21, 23, 26, 36 AND 38).

SCOTT BIBB, EXAMINING ATTORNEY

SN 79-068,128. TASK GEOMODELLING LIMITED, UNITED KINGDOM, FILED 3-9-2009.

attitude

OWNER OF INTERNATIONAL REGISTRATION 1000885 DATED 3-9-2009, EXPIRES 3-9-2019.

THE COLOR(S) MAGENTA IS/ARE CLAIMED AS A FEATURE OF THE MARK.

THE MARK CONSISTS OF THE STYLIZED WORD "ATTITUDE" WHICH APPEARS IN MAGENTA.

FOR GEOLOGICAL COMPUTER SOFTWARE FOR ANALYZING DATA FROM OIL-FIELD EXPLOITATION AND GEOLOGICAL PROSPECTING RESEARCH AND SURVEYS (U.S. CLS. 21, 23, 26, 36 AND 38).

JENNIFER MARTIN, EXAMINING ATTORNEY

CLASS 10—MEDICAL APPARATUS

SN 76-665,749. INTUITIVE SURGICAL, INC., SUNNYVALE, CA. FILED 9-8-2006.



NO CLAIM IS MADE TO THE EXCLUSIVE RIGHT TO USE "3D HD", APART FROM THE MARK AS SHOWN.

FOR COMPUTERIZED SURGICAL MANIPULATION SYSTEM COMPRISED OF RESOSCOPABLE TOOLS, NAMELY, LAPAROSCOPES, ENDOSCOPES, TROCARS, CANNULAS, CUTTERS, CLAMPS, ELEVATORS, GOUGES, KNIVES, SCOPE PREHEATERS, LIGHT SOURCES, CABLES AND COMPONENT PARTS, ELECTROSURGICAL INSTRUMENTS, ELECTROCAUTERY INSTRUMENTS, LASER INSTRUMENTS, ULTRASOUND INSTRUMENTS, LENS CLEANING, SCRUB AND BIOPSY BRUSHES, CLIP APPLIERS AND CLIPS, TACK APPLIERS AND TACKS, APPLICATORS, LIGATURE CARRIERS, NEEDLE HOLDERS, CLAMPS, HEMOSTATS, GRASPERS, CURETTES, INSTRUMENT GUIDES, LIGATURE PASSING AND KNOTTING INSTRUMENTS, NEEDLES, RETRACTORS, SNARES, STYLETS, FORCEPS, DISSECTORS, CALIPERS, SCISSORS, SUCTION AND IRRIGATION PROBES, STERILE DRAPES, HEMOSTATS, AMPUTATION HOOKS, OSTEOTOMES, SAWS, RETAINERS, SUTURING APPARATUS, MEASURING TAPES, CHISELS AND CONTRACTORS, FILES, SKIN GRAFT EXPANDERS, LANCETS, MALLET, PLIERS, HAMMERS, RASPS, SPATULAS, AND STRIPPERS; SURGICAL INSTRUMENTS, NAMELY, SCALPELS, SCALPEL BLADES AND HANDLES, STAPLERS, TACKERS, CLIP APPLIERS, ELECTROCAUTERY TOOLS, FORCEPS, NEEDLE HOLDERS, GUIDES AND DRIVERS, GRASPERS, AND KITTENERS; AND A SURGEON'S CONSOLE, MASTER CONTROL, IMMERSIVE VIDEO DISPLAY, CAMERA IMAGE PROCESSING EQUIPMENT, SURGICAL MANIPULATION SYSTEM SOFTWARE AND INSTRUCTIONAL MANUALS PROVIDED AS A UNIT, PATIENT-SIDE CART WITH SET-UP ARMS AND MANIPULATOR SLAVE ARMS, AND STERILE ADAPTORS TO CONNECT ARMS TO INSTRUMENTS (U.S. CLS. 26, 39 AND 44).

SCOTT BIBB, EXAMINING ATTORNEY

SN 76-681,164. FIREFLY MEDICAL, INC., FORT COLLINS, CO. FILED 8-27-2007.

FIREFLY MEDICAL

THE MARK CONSISTS OF STANDARD CHARACTERS WITHOUT CLAIM TO ANY PARTICULAR FONT, STYLE, SIZE, OR COLOR.

NO CLAIM IS MADE TO THE EXCLUSIVE RIGHT TO USE "MEDICAL", APART FROM THE MARK AS SHOWN.

FOR MEDICAL EQUIPMENT, NAMELY, INFUSION MANAGEMENT APPARATUS AND INTRAVENOUS STANDS (U.S. CLS. 26, 39 AND 44).

JILL PRATER, EXAMINING ATTORNEY

CLASS 10—(Continued).

SN 76-690,156. HOT HEADS OF AMERICA LLC, PHILADELPHIA, PA. FILED 5-30-2008.



NO CLAIM IS MADE TO THE EXCLUSIVE RIGHT TO USE "AMERICA LLC", APART FROM THE MARK AS SHOWN.

THE MARK CONSISTS OF "HOT HEADZ OF AMERICA LLC" WITH A DESIGN OF A SUN REPRESENTING A HUMAN FACE AND MOUNTAINS.

FOR HEALTHCARE PRODUCTS, NAMELY, HOT AND COLD PACKS WITH AROMATHERAPY, HOT AND COLD PACKS, COOLING BANDANAS, COOLING WRAPS, COOLING HATS FOR THERAPEUTIC PURPOSES (U.S. CLS. 26, 39 AND 44).

KEVON CHISOLM, EXAMINING ATTORNEY

SN 76-695,296. BUTH, FREDRICK A., SHAWANO, WI. FILED 1-14-2009.

Chi-G

THE MARK CONSISTS OF STANDARD CHARACTERS WITHOUT CLAIM TO ANY PARTICULAR FONT, STYLE, SIZE, OR COLOR.

FOR APPARATUS FOR ACUPRESSURE THERAPY (U.S. CLS. 26, 39 AND 44).

DARRYL SPRULL, EXAMINING ATTORNEY

SN 76-697,203. POLOMSKY, JEFF, BRISTOLVILLE, OH. FILED 5-4-2009.

MLP TWIST

THE MARK CONSISTS OF STANDARD CHARACTERS WITHOUT CLAIM TO ANY PARTICULAR FONT, STYLE, SIZE, OR COLOR.

NO CLAIM IS MADE TO THE EXCLUSIVE RIGHT TO USE "TWIST", APART FROM THE MARK AS SHOWN.

FOR ASSISTIVE SWIVEL DEVICE ON WHICH A PATIENT SITS OR STANDS WHILE GETTING INTO OR OUT OF BED (U.S. CLS. 26, 39 AND 44).

AMY KERTGATE, EXAMINING ATTORNEY

CLASS 10—(Continued).

SN 77-088,631. NHC TECHNOLOGY LIMITED, DENBIGH-SHIRE, UNITED KINGDOM, FILED 1-23-2007.



FOR MASSAGE APPARATUS AND APPLIANCES FOR EQUINE USE, NAMELY, VIBRATORY MASSAGE APPARATUS AND ELECTRIC MASSAGE APPLIANCES FOR THERAPEUTIC PURPOSES AND REPLACEMENT PARTS THEREFOR (U.S. CLS. 26, 39 AND 44).

FIRST USE 0-0-2004; IN COMMERCE 0-0-2004.
NAPOLEON SHARMA, EXAMINING ATTORNEY

SN 77-195,680. SCICAN LTD., TORONTO, CANADA, FILED 6-1-2007.

STATIS

THE MARK CONSISTS OF STANDARD CHARACTERS WITHOUT CLAIM TO ANY PARTICULAR FONT, STYLE, SIZE, OR COLOR.

PRIORITY CLAIMED UNDER SEC. 44(D) ON CANADA APPLICATION NO. 1347121, FILED 5-11-2007, REG. NO. TMA740508, DATED 5-21-2009, EXPIRES 5-21-2024.

FOR DENTAL HANDPIECES AND DENTAL TURBINES (U.S. CLS. 26, 39 AND 44).

BERYL GARDNER, EXAMINING ATTORNEY

SN 77-404,698. CALIFORNIA EXOTIC NOVELTIES LLC, CHINO, CA. FILED 2-25-2008.

THE ZONE

THE MARK CONSISTS OF STANDARD CHARACTERS WITHOUT CLAIM TO ANY PARTICULAR FONT, STYLE, SIZE, OR COLOR.

SEE ATTACHED DOCUMENT

FOR ADULT SEXUAL AIDS, NAMELY, VIBRATORS (U.S. CLS. 26, 39 AND 44).

LAURIE MAYES, EXAMINING ATTORNEY

CLASS 10—(Continued).

SN 77-412,784. LIVETEC INGENIEURBUERO GMBH, LOER-RACH, FED REP GERMANY, FILED 3-4-2008.

PACET10

THE MARK CONSISTS OF STANDARD CHARACTERS WITHOUT CLAIM TO ANY PARTICULAR FONT, STYLE, SIZE, OR COLOR.

PRIORITY CLAIMED UNDER SEC. 44(D) ON FED REP GERMANY APPLICATION NO. 30758205, FILED 9-5-2007, REG. NO. 30758205, DATED 1-9-2008, EXPIRES 9-30-2017.

FOR SURGICAL, MEDICAL AND VETERINARY INSTRUMENTS AND APPARATUS, NAMELY, SPHYGMOMANOMETER, MEDICAL EQUIPMENT FOR DIAGNOSTIC AND THERAPEUTIC PURPOSES IN THE RANGE OF CARDIOLOGY, NAMELY, APPARATUS FOR DEFIBRILLATION, CARDIAC DEFIBRILLATION ELECTRODES, CARDIAC ELECTRODES, CARDIAC PROBES, CARDIAC PACEMAKER, PROGRAMMING AND INSPECTION DEVICES FOR PACEMAKERS, SURGICAL IMPLANTS COMPRISING ARTIFICIAL MATERIAL (U.S. CLS. 26, 39 AND 44).

PRISCILLA MILTON, EXAMINING ATTORNEY

SN 77-415,751. SAWA, DR. THOMAS M., MISSISSAUGA, CANADA, FILED 3-7-2008.



PRIORITY CLAIMED UNDER SEC. 44(D) ON CANADA APPLICATION NO. 1365520, FILED 10-10-2007, REG. NO. 1365520, DATED 4-27-2009, EXPIRES 4-27-2024. FOR ORTHOPEDIC BRACES (U.S. CLS. 26, 39 AND 44). MARK RADEMACHER, EXAMINING ATTORNEY

CLASS 10—(Continued).

SN 77-471,704. FOREVER YOUNG INTERNATIONAL, INC., ESCONDIDO, CA. FILED 5-12-2008.

GLACIAL GEL

THE MARK CONSISTS OF STANDARD CHARACTERS WITHOUT CLAIM TO ANY PARTICULAR FONT, STYLE, SIZE, OR COLOR.

NO CLAIM IS MADE TO THE EXCLUSIVE RIGHT TO USE "GEL", APART FROM THE MARK AS SHOWN.

FOR THERMAL SELF-COOLING APPLICATORS FOR COOLING AND APPLYING SKIN LOTIONS, SKIN CREAMS, NON-MEDICATED COSMETIC OINTMENTS, AND BEAUTY GELS FOR THERAPEUTIC PURPOSES (U.S. CLS. 26, 39 AND 44).

ROBERT STRUCK, EXAMINING ATTORNEY

SN 77-475,386. ENCORE PATH, INC., BALTIMORE, MD. FILED 5-15-2008.



THE COLOR(S) YELLOW AND BLUE IS/ARE CLAIMED AS A FEATURE OF THE MARK.

THE MARK CONSISTS OF THE WORD "TAILWIND" IN BLUE WITH YELLOW WINGS PROTRUDING FROM THE "T".

FOR REHABILITATIVE DEVICES FOR CLINICAL AND HOME USE, NAMELY, DEVICES FOR REHABILITATION OF LIMBS AFFECTED BY DISEASES AND DISORDERS, NAMELY, FORCE AND MOTION TESTING APPARATUS AND EXERCISE MACHINES FOR THERAPEUTIC AND MEDICAL PURPOSES; PHYSICAL EXERCISE APPARATUS FOR MEDICAL PURPOSES (U.S. CLS. 26, 39 AND 44).

ALEXANDER L. POWERS, EXAMINING ATTORNEY

SN 77-481,092. OPTIBRAND LTD., LLC, FORT COLLINS, CO. FILED 5-22-2008.

CLEARVIEW

THE MARK CONSISTS OF STANDARD CHARACTERS WITHOUT CLAIM TO ANY PARTICULAR FONT, STYLE, SIZE, OR COLOR.

FOR VETERINARY IMAGING PRODUCTS, NAMELY, DIGITAL VIDEO CAMERAS, BIO-MICROSCOPES AND OTOSCOPES FOR THE OPTICAL IMAGING OF THE EYE OR EAR OF AN ANIMAL (U.S. CLS. 26, 39 AND 44).

GINA FINK, EXAMINING ATTORNEY

CLASS 10—(Continued).

SN 77-559,441. HELEN OF TROY LIMITED, ST. MICHAEL, BARBADOS, FILED 8-29-2008.

OXO

THE MARK CONSISTS OF STANDARD CHARACTERS WITHOUT CLAIM TO ANY PARTICULAR FONT, STYLE, SIZE, OR COLOR.

PRIORITY CLAIMED UNDER SEC. 44(D) ON BARBADOS APPLICATION NO. 8124892, FILED 8-8-2008.

OWNER OF U.S. REG. NOS. 1,652,173, 1,917,087 AND OTHERS.

FOR DISPOSABLE SYRINGES; INJECTION DEVICE FOR PHARMACEUTICALS; INJECTION SYRINGES; MEDICAL APPARATUS FOR INTRODUCING PHARMACEUTICAL PREPARATIONS INTO THE HUMAN BODY; MEDICAL NEEDLES AND INTRODUCERS; MEDICAL SYRINGES; SYRINGES FOR MEDICAL PURPOSES AND FOR INJECTIONS (U.S. CLS. 26, 39 AND 44).
MARC LEIPZIG, EXAMINING ATTORNEY

SN 77-572,334. OSTEOLIFE BIOMEDICAL LLC, MIAMI, FL. FILED 9-17-2008.

OSTEOLIFE

THE MARK CONSISTS OF STANDARD CHARACTERS WITHOUT CLAIM TO ANY PARTICULAR FONT, STYLE, SIZE, OR COLOR.

FOR DENTAL IMPLANTS; METAL AND NONMETAL DENTAL IMPLANTS; METAL AND NONMETAL ORTHOPEDIC IMPLANTS; METAL AND NONMETAL DENTAL IMPLANTS AND TITANIUM AND TITANIUM ALLOY ORTHOPEDIC OR DENTAL IMPLANTS (U.S. CLS. 26, 39 AND 44).

KELLY BOULTON, EXAMINING ATTORNEY

SN 77-583,625. MOSZKITO, INC., SCOTTSDALE, AZ. FILED 10-1-2008.

ARCHY

THE MARK CONSISTS OF STANDARD CHARACTERS WITHOUT CLAIM TO ANY PARTICULAR FONT, STYLE, SIZE, OR COLOR.

FOR ORTHOPEDIC FOOTWEAR, NAMELY, SANDALS WITH CONTOURED FOOTBEDS (U.S. CLS. 26, 39 AND 44).

FIRST USE 8-0-2006; IN COMMERCE 8-0-2006.
JENNIFER HETU, EXAMINING ATTORNEY

CLASS 10—(Continued).

SN 77-595,114. WESTPORT MEDICAL, INC., SALEM, OR. FILED 10-17-2008.

THE EXTRACTION ADVANTAGE

THE MARK CONSISTS OF STANDARD CHARACTERS WITHOUT CLAIM TO ANY PARTICULAR FONT, STYLE, SIZE, OR COLOR.

NO CLAIM IS MADE TO THE EXCLUSIVE RIGHT TO USE "EXTRACTION", APART FROM THE MARK AS SHOWN.

FOR SURGICAL INSTRUMENTS FOR DENTAL AND MEDICAL APPLICATIONS, NAMELY, INSTRUMENTS FOR USE IN EXTRACTION OF TEETH, COMPACTING BONE, AND HARVESTING BONE (U.S. CLS. 26, 39 AND 44).

NAKIA HENRY, EXAMINING ATTORNEY

SN 77-597,316. FRANTZ DESIGN, INC., AUSTIN, TX. FILED 10-21-2008.

EMA CUSTOM

THE MARK CONSISTS OF STANDARD CHARACTERS WITHOUT CLAIM TO ANY PARTICULAR FONT, STYLE, SIZE, OR COLOR.

NO CLAIM IS MADE TO THE EXCLUSIVE RIGHT TO USE "CUSTOM", APART FROM THE MARK AS SHOWN, FOR ORAL DEVICES TO CONTROL SNORING AND SLEEP APNEA (U.S. CLS. 26, 39 AND 44).

FIRST USE 8-25-2008; IN COMMERCE 8-25-2008.
ANTHONY RINKER, EXAMINING ATTORNEY

SN 77-600,785. CORDIS CORPORATION, MIAMI LAKES, FL. FILED 10-27-2008.

CONNECTION OF CHOICE

THE MARK CONSISTS OF STANDARD CHARACTERS WITHOUT CLAIM TO ANY PARTICULAR FONT, STYLE, SIZE, OR COLOR.

FOR MEDICAL DEVICES FOR DIAGNOSTIC MAPPING, NAMELY, DISPLAY MONITORS, COMPUTER HARDWARE, AND COMPUTER SOFTWARE FOR USE IN DIAGNOSTIC PROCEDURES (U.S. CLS. 26, 39 AND 44).

BARBARA A. GOLD, EXAMINING ATTORNEY

CLASS 10—(Continued).

SN 77-601,733. ZHEJIANG LOVER HEALTH SCIENCE AND TECHNOLOGY DEVELOPMENT CO., LTD., HUZHOU CITY, ZHEJIANG, CHINA, FILED 10-28-2008.



THE MARK CONSISTS OF THE WORDS "FUNZONE" "FUNZONE" WITH THE WORDS "FUN" AND "ZONE" FORMING RIGHT ANGLES AND THE LETTER "N" IN "FUN" ALSO SERVING AS THE LETTER "Z" IN "ZONE" ALL WITHIN A RECTANGULAR BACKGROUND.

FOR ABDOMINAL BELTS; CONDOMS; CONTRACEPTIVES; DENTAL INSTRUMENTS, NAMELY, PICKS, BURRS, MIRRORS; ELECTRIC MASSAGE APPLIANCES, NAMELY, ELECTRIC VIBRATING MASSAGER; FEEDING BOTTLES; GLOVES FOR MASSAGE; MASSAGE APPARATUS AND INSTRUMENTS; PHYSICAL EXERCISE APPARATUS, FOR MEDICAL PURPOSES; SURGICAL IMPLANTS COMPRISING ARTIFICIAL MATERIAL (U.S. CLS. 26, 39 AND 44).

CARYN GLASSER, EXAMINING ATTORNEY

SN 77-602,933. SYNCRO MEDICAL INNOVATIONS, INC., YOUNGSTOWN, OH. FILED 10-29-2008.



NO CLAIM IS MADE TO THE EXCLUSIVE RIGHT TO USE "MEDICAL", APART FROM THE MARK AS SHOWN.

THE MARK CONSISTS OF THE WORDS "SYNCRO MEDICAL INNOVATIONS" AND "ENHANCING THE HEALING HANDS OF MEDICINE WORLDWIDE", WITH A STYLIZED REPRESENTATION OF A PERSON HOLDING A GLOBE ON TOP OF ONE ARM BETWEEN THE WORDS "ENHANCING" AND "THE", AND THE GLOBE APPEARING INSTEAD OF THE LETTER "O" IN THE WORD "SYNCRO".

FOR ENTERAL FEEDING TUBES; MEDICAL PRODUCTS, DEVICES, AND APPARATUS, NAMELY, FEEDING TUBES, MAGNETS, AND ELECTROMAGNETS; MEDICAL PRODUCTS, DEVICES, AND APPARATUS, NAMELY, FEEDING TUBE DELOGGING DEVICE, FEEDING TUBE ANCHORING DEVICE, AND DEVICE TO CONFIRM THAT THE FEEDING TUBE IS IN THE PROPER LOCATION INSIDE THE BODY (U.S. CLS. 26, 39 AND 44).

JOHN WILKE, EXAMINING ATTORNEY

CLASS 10—(Continued).

SN 77-607,712. CORVENTIS, INC., SAN JOSE, CA. FILED 11-5-2008.

PIIX

THE MARK CONSISTS OF STANDARD CHARACTERS WITHOUT CLAIM TO ANY PARTICULAR FONT, STYLE, SIZE, OR COLOR.

FOR MEDICAL DEVICE, NAMELY, ELECTRONIC DEVICE, COMPRISING SENSORS FOR MONITORING VITAL SIGNS AND OTHER PHYSIOLOGICAL PARAMETERS AND DETECTING MEDICAL EVENTS, USED AS A MEANS OF RECEIVING, REMOTELY TRANSMITTING, PROCESSING, STORING AND DISPLAYING PATIENT MEDICAL DATA (U.S. CLS. 26, 39 AND 44).

SETH A. RAPPAPORT, EXAMINING ATTORNEY

SN 77-608,927. SMITH & NEPHEW, INC., MEMPHIS, TN. FILED 11-6-2008.

DYNAMOMITE

THE MARK CONSISTS OF STANDARD CHARACTERS WITHOUT CLAIM TO ANY PARTICULAR FONT, STYLE, SIZE, OR COLOR.

PRIORITY CLAIMED UNDER SEC. 44(D) ON ERPN CMNTY TM OFC APPLICATION NO. 007317704, FILED 10-15-2008, REG. NO. 007317704, DATED 5-14-2009, EXPIRES 10-15-2018.

FOR SURGICAL SUTURE ANCHORS (U.S. CLS. 26, 39 AND 44).

CORY BOONE, EXAMINING ATTORNEY

SN 77-612,043. BUDDY BEDS LLC, DBA BUDDY BEDS LLC, DENVER, CO. FILED 11-11-2008.

BUDDY BED

THE MARK CONSISTS OF STANDARD CHARACTERS WITHOUT CLAIM TO ANY PARTICULAR FONT, STYLE, SIZE, OR COLOR.

OWNER OF U.S. REG. NO. 3,564,743.

NO CLAIM IS MADE TO THE EXCLUSIVE RIGHT TO USE "BED", APART FROM THE MARK AS SHOWN.

FOR POLYURETHANE PLASTIC HIGH ENERGY ABSORPTION CUSHION MATERIAL USED BY ANIMALS OR HUMANS AS A THERAPEUTIC DEVICE PROVIDING SUPPORT AND COMFORT WHILE PREVENTING PRESSURE POINTS AND ABSORBING SHOCK FOR MEDICAL USE (U.S. CLS. 26, 39 AND 44).

FIRST USE 1-1-1993; IN COMMERCE 1-1-1995.

JORDAN BAKER, EXAMINING ATTORNEY

CLASS 10—(Continued).

SN 77-623,466. BIOCONTROL MEDICAL LTD., YEHUD, ISRAEL, FILED 12-1-2008.

CardioFit

THE MARK CONSISTS OF STANDARD CHARACTERS WITHOUT CLAIM TO ANY PARTICULAR FONT, STYLE, SIZE, OR COLOR.

FOR AN IMPLANTABLE SYSTEM CONSISTING OF ELECTRONIC IMPLANTABLE STIMULATORS, EXTERNAL STIMULATORS, STIMULATION ELECTRODES, AND STIMULATION LEADS FOR STIMULATING NEURAL TISSUE TO TREAT CARDIAC PATHOLOGIES (U.S. CLS. 26, 39 AND 44).

ASMAT KHAN, EXAMINING ATTORNEY

CLASS 10—(Continued).

SN 77-640,073. CAREMED SUPPLY INC., XINDIAN, TAIPEI COUNTY, TAIWAN, FILED 12-26-2008.



THE COLOR(S) LEMON GREEN AND ROYAL BLUE IS/ ARE CLAIMED AS A FEATURE OF THE MARK.

THE MARK CONSISTS OF TWO ABSTRACT SHAPED BODIES EACH JOINING ONE HAND TO THE OTHER'S HAND AND ONE FOOT TO THE OTHER'S FOOT, FORMING A HEART SHAPE WITH THE JOINED HANDS AND FEET, AND EACH RAISING THE UNJOINED HAND IN THE AIR, WHEREIN ONE BODY SHAPE IS IN LEMON GREEN AND THE OTHER IS IN ROYAL BLUE.

FOR AIR MATTRESSES FOR MEDICAL PURPOSES; BEDS FOR MEDICAL PURPOSES; STRETCHERS WITH WHEELS; PUMPS FOR MEDICAL PURPOSES, NAMELY, INTERMITTENT PNEUMATIC COMPRESSION PUMPS FOR MEDICAL PURPOSES; CUSHIONS FOR MEDICAL PURPOSES; MEDICAL STRETCHERS; HEATING CUSHIONS FOR MEDICAL PURPOSES (U.S. CLS. 26, 39 AND 44).

FIRST USE 5-1-2005; IN COMMERCE 5-1-2005.

GINA FINK, EXAMINING ATTORNEY

SN 77-626,403. CORDIS CORPORATION, MIAMI LAKES, FL. FILED 12-4-2008.

TRIBUTARY

THE MARK CONSISTS OF STANDARD CHARACTERS WITHOUT CLAIM TO ANY PARTICULAR FONT, STYLE, SIZE, OR COLOR.

FOR ENDOVASCULAR STENT GRAFT SYSTEM, COMPRISING, ENDOGRAFTS, CATHETERS, AND BALLOONS (U.S. CLS. 26, 39 AND 44).

BARBARA A. GOLD, EXAMINING ATTORNEY

SN 77-641,377. LIKO AB, LULEÅ, SWEDEN, FILED 12-30-2008.

LIKO

THE MARK CONSISTS OF STANDARD CHARACTERS WITHOUT CLAIM TO ANY PARTICULAR FONT, STYLE, SIZE, OR COLOR.

OWNER OF U.S. REG. NOS. 1,643,509 AND 3,547,161.

THE WORDING "LIKO" HAS NO MEANING IN A FOREIGN LANGUAGE.

FOR FURNITURE FOR MEDICAL USE, NAMELY, LEG SUPPORT EXTENDERS FOR ATTACHMENT TO FURNITURE; MEDICAL AIDS FOR DISABLED PEOPLE, NAMELY, MOBILE AND STATIONARY INVALID AND PATIENT LIFTS, SLINGS; STRETCHERS, WALKING AIDS, WALKERS TO AID IN MOBILITY, CRUTCHES AND CANES FOR MEDICAL USE (U.S. CLS. 26, 39 AND 44).

WILLIAM ROSSMAN, EXAMINING ATTORNEY

CLASS 10—(Continued).

SN 77-642,116. PANASONIC CORPORATION, OSAKA, JAPAN, FILED 12-31-2008.

COMIMI

THE MARK CONSISTS OF STANDARD CHARACTERS WITHOUT CLAIM TO ANY PARTICULAR FONT, STYLE, SIZE, OR COLOR.

FOR HEARING AIDS FOR THE DEAF, BEING ACOUSTIC AIDS (U.S. CLS. 26, 39 AND 44).

RUDY R. SINGLETON, EXAMINING ATTORNEY

SN 77-658,480. GLAXO GROUP LIMITED, GREENFORD, MIDDLESEX, UNITED KINGDOM, FILED 1-28-2009.

GEMISYS

THE MARK CONSISTS OF STANDARD CHARACTERS WITHOUT CLAIM TO ANY PARTICULAR FONT, STYLE, SIZE, OR COLOR.

FOR MEDICAL AND SURGICAL APPARATUS AND INSTRUMENTS, NAMELY, INHALERS SOLD EMPTY, AND STRUCTURAL PARTS AND FITTINGS THEREFOR (U.S. CLS. 26, 39 AND 44).

JOHN WILKE, EXAMINING ATTORNEY

SN 77-661,463. IZI MEDICAL PRODUCTS, LLC, BALTIMORE, MD. FILED 2-2-2009.

SPHERZ

THE MARK CONSISTS OF STANDARD CHARACTERS WITHOUT CLAIM TO ANY PARTICULAR FONT, STYLE, SIZE, OR COLOR.

SEC. 2(F).

FOR SURGICAL INSTRUMENTS FOR USE IN ORTHOPEDIC SURGERY, SPINAL SURGERY, NEUROSURGERY, ENT SURGERY, AND IMAGE GUIDED SURGERY, NAMELY, MARKERS THAT ASSIST WITH REGISTRATION AND INSTRUMENT TRACKING DURING IMAGE GUIDED SURGERIES (U.S. CLS. 26, 39 AND 44).

FIRST USE 2-28-2003; IN COMMERCE 2-28-2003.
KRISTIN CARLSON, EXAMINING ATTORNEY

CLASS 10—(Continued).

SN 77-661,526. CARDIO SISTEMAS COMERCIAL INDUSTRIAL LTDA., SAO PAULO, BRAZIL, FILED 2-2-2009.



OWNER OF BRAZIL REG. NO. 820173410, DATED 3-22-2005, EXPIRES 3-22-2015.

THE MARK CONSISTS OF THE WORD "CARDIOS" SET FORTH BELOW A SWIRL SHAPE.

FOR HOLTER ANALYZERS, HOLTER MONITORS/RECORDERS, HEART MONITORS/RECORDERS, VITAL SIGNS MONITORS/RECORDERS, MULTICARDIOGRAPHS, BLOOD PRESSURE MONITORS, PORTABLE BLOOD PRESSURE MONITORS, ELECTROCARDIOGRAPHS, PARTS FOR ELECTROCARDIOGRAPHS (U.S. CLS. 26, 39 AND 44).

JILL C. ALT, EXAMINING ATTORNEY

SN 77-662,621. FOOT SOLUTIONS, INC., MARIETTA, GA. FILED 2-3-2009.



OWNER OF U.S. REG. NOS. 2,479,987 AND 2,558,576.

NO CLAIM IS MADE TO THE EXCLUSIVE RIGHT TO USE "FOOT," "TECHNOLOGY" AND "ADVANCED BIOMECHANICAL SUPPORT", APART FROM THE MARK AS SHOWN.

THE MARK CONSISTS OF AN OUTLINE OF A HUMAN FORM OVER A CIRCLE TO THE LEFT OF THE TERM "FOOT SOLUTIONS TECHNOLOGY" WITH A FOOT DESIGN BETWEEN THE WORDS "FOOT" AND "SOLUTIONS", WHICH IS ABOVE THE TERM "A.B.S" WHICH IS ABOVE THE TERM "ADVANCED BIOMECHANICAL SUPPORT"

FOR ARCH SUPPORTS FOR BOOTS OR SHOES; ORTHOTIC INSERTS FOR FOOTWEAR (U.S. CLS. 26, 39 AND 44).

TARA PATE, EXAMINING ATTORNEY

CLASS 10—(Continued).

SN 77-667,498. SI-BONE, INC., SARATOGA, CA. FILED 2-10-2009.

SI-BONE

THE MARK CONSISTS OF STANDARD CHARACTERS WITHOUT CLAIM TO ANY PARTICULAR FONT, STYLE, SIZE, OR COLOR.

FOR ORTHOPEDIC SURGICAL IMPLANTS, NAMELY, RODS USED TO IMMOBILIZE AND FUSE JOINTS (U.S. CLS. 26, 39 AND 44).

RENEE SERVANCE, EXAMINING ATTORNEY

SN 77-675,314. GALEMED CORPORATION, TAIPEI 114, TAIWAN, FILED 2-21-2009.

GaleMed

THE MARK CONSISTS OF THE WORD "GALEMED" WITH THE LETTERS "MED" BEING BROKEN LETTERS HAVING A PLURALITY OF HORIZONTAL BARS PASSING THROUGH THE LETTERS.

FOR AEROSOL DISPENSERS FOR MEDICAL USE; ANESTHESIA DELIVERY APPARATUS; ANESTHESIA MASKS; APPARATUS FOR ARTIFICIAL RESPIRATION; CPR MASKS; CANNULAE; CATHETERS; MEDICAL ELECTRODES; ENDOTRACHEAL TUBES; FILTERS FOR FILTERING A PATIENTS AIR INHALATION AND EXHALATION; INHALERS FOR THERAPEUTIC USE (SOLD EMPTY); MEDICAL EXAMINATION LAMPS; LARYNGOSCOPES; SURGICAL MASKS; MASKS FOR USE BY MEDICAL PERSONNEL; NEBULIZERS FOR RESPIRATION THERAPY; OXYGEN MASKS FOR MEDICAL USE; OXYGEN MONITORS; MEDICAL TUBING FOR OXYGEN THERAPY, AEROSOL THERAPY, VENTILATION CIRCUITS, ANESTHESIA CIRCUITS, SPIROMETERS, SLEEP THERAPY DEVICES; RESPIRATORS FOR ARTIFICIAL RESPIRATION; RESUSCITATION APPARATUS; RESUSCITATORS; THERMOMETERS FOR MEDICAL PURPOSES; TONGUE DEPRESSORS; TRACHEOSTOMY TUBES (U.S. CLS. 26, 39 AND 44).

FIRST USE 1-2-1997; IN COMMERCE 1-31-1997.
LINDA MICKLEBURGH, EXAMINING ATTORNEY

CLASS 10—(Continued).

SN 77-699,164. MARK L. ANDERSON, SPRING VALLEY, WI. FILED 3-25-2009.



NO CLAIM IS MADE TO THE EXCLUSIVE RIGHT TO USE "K9, FIRST AID AND POLICE & MILITARY", APART FROM THE MARK AS SHOWN.

THE COLOR(S) RED, BLACK AND WHITE IS/ARE CLAIMED AS A FEATURE OF THE MARK.

THE MARK CONSISTS OF A BADGE SHAPED DESIGN COLORED IN RED WITH A SMALL LOWER PORTION COLORED IN BLACK. THE RED PORTION CONTAINS A CENTERED WHITE CROSS AND WITHIN THE CROSS THE WORDS "K9 FIRST AID" IN THE COLOR RED, THE WORDS "POLICE & MILITARY" IN THE COLOR BLACK, AND A SILHOUTTE OF A POLICE DOG IN THE COLOR BLACK. IN THE SMALL BLACK LOWER PORTION IS A CENTERED STAR IN THE COLOR WHITE. THE ENTIRE BADGE SHAPE IS OUTLINED IN THE COLOR WHITE, INCLUDING THE SEPERATION OF THE RED AND BLACK PORTIONS OF THE BADGE SHAPE.

FOR MEDICAL KIT, NAMELY, A FIRST AID KIT FOR DOGS WORKING IN POLICE OR MILITARY UNITS (U.S. CLS. 26, 39 AND 44).

FIRST USE 1-1-2009; IN COMMERCE 1-1-2009.
DOMINICK J. SALEMI, EXAMINING ATTORNEY

SN 77-700,632. MED ASSOCIATES, INC., ST. ALBANS, VT. FILED 3-27-2009.



NO CLAIM IS MADE TO THE EXCLUSIVE RIGHT TO USE "DISCOUNT DISPOSABLES", APART FROM THE MARK AS SHOWN.

THE MARK CONSISTS OF A STYLIZED MEDICAL ELECTRODE COLLAR ON A SOLID SQUARE BACKGROUND AND THE WORDING "DISCOUNT DISPOSABLES".

FOR MEDICAL DEVICES AND INSTRUMENTS FOR USE IN MEASURING PHYSIOLOGICAL AND CARDIOVASCULAR PARAMETERS, NAMELY, MEDICAL ELECTRODES AND ADHESIVE COLLARS THEREFOR, ELECTROCARDIOGRAPHS, ELECTROENCEPHALOGRAPHS AND ELECTROMYOGRAPHS (U.S. CLS. 26, 39 AND 44).

FIRST USE 3-11-2003; IN COMMERCE 3-27-2003.
MARTHA FROMM, EXAMINING ATTORNEY

CLASS 10—(Continued).

SN 77-708,255. SYNTHES USA, LLC, WEST CHESTER, PA. FILED 4-7-2009.

STENOFIX

THE MARK CONSISTS OF STANDARD CHARACTERS WITHOUT CLAIM TO ANY PARTICULAR FONT, STYLE, SIZE, OR COLOR.

FOR SURGICAL IMPLANTS COMPOSED OF NON-LIVING MATERIALS; MEDICAL AND SURGICAL APPARATUS AND INSTRUMENTS, NAMELY, HAMMER, TRIAL ORTHOPEDIC IMPLANTS AND IMPLANT INSERTION TOOLS (U.S. CLS. 26, 39 AND 44).

ALEXANDER L. POWERS, EXAMINING ATTORNEY

SN 77-714,552. GREEN TO GROW, LOS ANGELES, CA. FILED 4-15-2009.

YOU ARE WHAT YOU KNOW

THE MARK CONSISTS OF STANDARD CHARACTERS WITHOUT CLAIM TO ANY PARTICULAR FONT, STYLE, SIZE, OR COLOR.

FOR BABY BOTTLE NIPPLES; BABY BOTTLES (U.S. CLS. 26, 39 AND 44).

FIRST USE 8-26-2007; IN COMMERCE 8-26-2007.

KOURTNEE HODGES, EXAMINING ATTORNEY

SN 77-722,795. ENABLE YOUR LIFE, INC., FOOTHILL RANCH, CA. FILED 4-27-2009.



THE COLOR(S) DARK BLUE, LIGHT BLUE, LIGHT GREEN IS/ARE CLAIMED AS A FEATURE OF THE MARK.

THE MARK CONSISTS OF HUMAN CHARACTER JUMPING IN THE AIR IN DARK AND LIGHT BLUE, WITH A LIGHT GREEN ARCH WITH THE WORDS "ENABLE" IN LIGHT BLUE AND "YOUR LIFE" IN LIGHT GREEN. THE WORD "ENABLE" HAS "ABLE" IN BOLD.

FOR BAGS SPECIALLY ADAPTED FOR HOLDING CRUTCHES; CANES FOR MEDICAL PURPOSES; CRUTCHES; CRUTCHES AND TIPS THEREFOR; DECORATIVE COVERINGS FOR CRUTCHES; MEDICAL EQUIPMENT FOR PEDIATRIC PATIENTS, NAMELY, MULTIPLE POSITION SAFETY SEAT; MULTIPLE-POCKETED CARRIER FOR PERSONAL ITEMS SPECIALLY ADAPTED FOR ATTACHMENT TO ORTHOPEDIC WALKERS; ORTHOPEDIC WALKERS; ROLLATORS; WALKERS FOR USE BY MOBILITY-IMPAIRED INDIVIDUALS; WALKERS TO AID IN MOBILITY (U.S. CLS. 26, 39 AND 44).

COURTNEY MCCORMICK, EXAMINING ATTORNEY

CLASS 10—(Continued).

SN 77-723,063. MEDFILTERS, GREENSBORO, NC. FILED 4-27-2009.

Tri-Guard

THE MARK CONSISTS OF STANDARD CHARACTERS WITHOUT CLAIM TO ANY PARTICULAR FONT, STYLE, SIZE, OR COLOR.

FOR MULTIPURPOSE DISPOSABLE DEVICE, NAMELY, A FOAM TIP PROTECTOR, FOR USE IN PRE AND POST PROCESSING OF MEDICAL ENDOSCOPY EQUIPMENT, NAMELY, FLEXIBLE ENDOSCOPES (U.S. CLS. 26, 39 AND 44).

AMY KERTGATE, EXAMINING ATTORNEY

SN 77-723,475. SADRA MEDICAL, INC., CAMPBELL, CA. FILED 4-27-2009.

SADRA MEDICAL

THE MARK CONSISTS OF STANDARD CHARACTERS WITHOUT CLAIM TO ANY PARTICULAR FONT, STYLE, SIZE, OR COLOR.

NO CLAIM IS MADE TO THE EXCLUSIVE RIGHT TO USE "MEDICAL", APART FROM THE MARK AS SHOWN.

FOR MEDICAL DEVICES AND INSTRUMENTS FOR USE IN THE TREATMENT OF CARDIAC, CARDIOVASCULAR, AND HEART VALVE DISEASE AND DISORDERS, NAMELY CATHETERS, PACEMAKERS, AND REPLACEMENT HEART VALVES MADE OF ARTIFICIAL MATERIAL (U.S. CLS. 26, 39 AND 44).

DORITT L. CARROLL, EXAMINING ATTORNEY

SN 77-723,481. SADRA MEDICAL, INC., CAMPBELL, CA. FILED 4-27-2009.

SADRA

THE MARK CONSISTS OF STANDARD CHARACTERS WITHOUT CLAIM TO ANY PARTICULAR FONT, STYLE, SIZE, OR COLOR.

FOR MEDICAL DEVICES AND INSTRUMENTS FOR USE IN THE TREATMENT OF CARDIAC, CARDIOVASCULAR, AND HEART VALVE DISEASE AND DISORDERS, NAMELY, CATHETERS, PACEMAKERS, AND REPLACEMENT HEART VALVES MADE OF ARTIFICIAL MATERIAL (U.S. CLS. 26, 39 AND 44).

DORITT L. CARROLL, EXAMINING ATTORNEY

CLASS 10—(Continued).

SN 77-723,640. ROBERTSON, SONDRÁ T., WILMINGTON, NC. FILED 4-28-2009.

RX FETCH

THE MARK CONSISTS OF STANDARD CHARACTERS WITHOUT CLAIM TO ANY PARTICULAR FONT, STYLE, SIZE, OR COLOR.

NO CLAIM IS MADE TO THE EXCLUSIVE RIGHT TO USE "RX", APART FROM THE MARK AS SHOWN.

FOR PRESCRIPTION MEDICINE CARRIER, NAMELY, A SPECIALLY ADAPTED PATIENT CARRYING CASE FOR ORGANIZING AND TRANSPORTING PRESCRIPTION MEDICINE CONTAINERS AND PILLS; PRESCRIPTION MEDICINE CARRIER, NAMELY, A SPECIALLY ADAPTED BAG FOR ORGANIZING AND TRANSPORTING PRESCRIPTION MEDICINE CONTAINERS AND PILLS BY PATIENTS FOR MEDICAL PURPOSES (U.S. CLS. 26, 39 AND 44).

HANNO RITTNER, EXAMINING ATTORNEY

SN 77-724,652. HOME DIAGNOSTICS, INC., FORT LAUDERDALE, FL. FILED 4-29-2009.

TRUEDRAW

THE MARK CONSISTS OF STANDARD CHARACTERS WITHOUT CLAIM TO ANY PARTICULAR FONT, STYLE, SIZE, OR COLOR.

FOR LANCING DEVICES FOR BLOOD GLUCOSE TESTING (U.S. CLS. 26, 39 AND 44).

TINA L. SNAPP, EXAMINING ATTORNEY

SN 77-724,987. HEITKAMP, ROBERT, DBA MIDWEST APPLIED TECHNOLOGIES, MANTODOR, ND. FILED 4-29-2009.

Site Saver

THE MARK CONSISTS OF STANDARD CHARACTERS WITHOUT CLAIM TO ANY PARTICULAR FONT, STYLE, SIZE, OR COLOR.

FOR MEDICAL INSTRUMENTS AND DEVICES, NAMELY, EXTERNAL FIXATORS (U.S. CLS. 26, 39 AND 44).

KATHLEEN LORENZO, EXAMINING ATTORNEY

CLASS 10—(Continued).

SN 77-725,147. AMO MANUFACTURING USA, LLC, SANTA ANA, CA. FILED 4-29-2009.

THE NEW SHAPE OF VISION

THE MARK CONSISTS OF STANDARD CHARACTERS WITHOUT CLAIM TO ANY PARTICULAR FONT, STYLE, SIZE, OR COLOR.

FOR MEDICAL LASERS (U.S. CLS. 26, 39 AND 44).

FIRST USE 10-21-2000; IN COMMERCE 1-11-2001.

DAVID C. REIHNER, EXAMINING ATTORNEY

SN 77-725,203. THERAPY PRODUCTS, INC., DBA ERCHONIA MEDICAL, MCKINNEY, TX. FILED 4-29-2009.

ZERONA

THE MARK CONSISTS OF STANDARD CHARACTERS WITHOUT CLAIM TO ANY PARTICULAR FONT, STYLE, SIZE, OR COLOR.

OWNER OF U.S. REG. NO. 3,632,803.

FOR LASERS FOR MEDICAL USE (U.S. CLS. 26, 39 AND 44).

FIRST USE 2-8-2008; IN COMMERCE 2-8-2008.

SETH A. RAPPAPORT, EXAMINING ATTORNEY

SN 77-725,387. TREBCO SPECIALTY PRODUCTS, INC., ORANGE, CT. FILED 4-29-2009.

WUBBANUB

THE MARK CONSISTS OF STANDARD CHARACTERS WITHOUT CLAIM TO ANY PARTICULAR FONT, STYLE, SIZE, OR COLOR.

FOR PACIFIERS FOR BABIES AND POUCHES FOR PACIFIERS FOR BABIES (U.S. CLS. 26, 39 AND 44).

FIRST USE 10-1-1999; IN COMMERCE 10-1-1999.

THEODORE MCBRIDE, EXAMINING ATTORNEY

CLASS 10—(Continued).

SN 77-725,770. U.S. ENDOSCOPY GROUP, INC., MENTOR, OH. FILED 4-30-2009.

VELOCITY

THE MARK CONSISTS OF STANDARD CHARACTERS WITHOUT CLAIM TO ANY PARTICULAR FONT, STYLE, SIZE, OR COLOR.

FOR MEDICAL DEVICE, NAMELY, PUMP AND IRRIGATION SYSTEM FOR USE IN AN ENDOSCOPIC PROCEDURE (U.S. CLS. 26, 39 AND 44).

RENEE SERVANCE, EXAMINING ATTORNEY

CLASS 10—(Continued).

SN 77-726,348. EXTREMITY MEDICAL LLC, PARSIPPANY, NJ. FILED 4-30-2009.

TRAPEZZ

THE MARK CONSISTS OF STANDARD CHARACTERS WITHOUT CLAIM TO ANY PARTICULAR FONT, STYLE, SIZE, OR COLOR.

FOR MEDICAL DEVICES, NAMELY, AN IMPLANT THAT REPLACES THE TRAPEZIUM BONE IN THE HAND FOR CARPOMETACARPAL ARTHRITIS (U.S. CLS. 26, 39 AND 44).

ALICE SUE CARRUTHERS, EXAMINING ATTORNEY

SN 77-726,114. SPECTRUM THERAPY PRODUCTS, INC., JASPER, MI. FILED 4-30-2009.

AIR BAPS

THE MARK CONSISTS OF STANDARD CHARACTERS WITHOUT CLAIM TO ANY PARTICULAR FONT, STYLE, SIZE, OR COLOR.

OWNER OF U.S. REG. NO. 1,312,191. FOR PHYSICAL EXERCISE APPARATUS, FOR MEDICAL PURPOSES (U.S. CLS. 26, 39 AND 44).

FIRST USE 3-16-2009; IN COMMERCE 3-16-2009. NAAKWAMA ANKRAH, EXAMINING ATTORNEY

SN 77-726,353. EXTREMITY MEDICAL LLC, PARSIPPANY, NJ. FILED 4-30-2009.



SN 77-726,172. SMITH & NEPHEW, INC., MEMPHIS, TN. FILED 4-30-2009.

TRUCATH

THE MARK CONSISTS OF STANDARD CHARACTERS WITHOUT CLAIM TO ANY PARTICULAR FONT, STYLE, SIZE, OR COLOR.

FOR INJECTION INSTRUMENTS WITH NEEDLES; MEDICAL NEEDLES AND INTRODUCERS; CATHETERS (U.S. CLS. 26, 39 AND 44).

RONALD MCMORROW, EXAMINING ATTORNEY

OWNER OF U.S. REG. NO. 3,652,074. THE MARK CONSISTS OF THE LETTERS "TRAPEZZ"; THE "X" IS REPRESENTED AS A STYLIZED PERSON WITH A SEMICIRCLE ABOVE THE STYLIZED PERSON.

FOR MEDICAL DEVICES, NAMELY, AN IMPLANT THAT REPLACES THE TRAPEZIUM BONE IN THE HAND FOR CARPOMETACARPAL ARTHRITIS (U.S. CLS. 26, 39 AND 44).

ALICE SUE CARRUTHERS, EXAMINING ATTORNEY

CLASS 10—(Continued).

SN 77-726,487. JACOBSON, RONALD, HOUSTON, TX. FILED 4-30-2009.

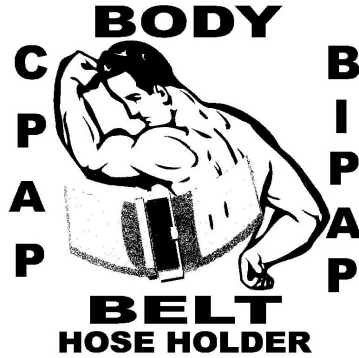

NO CLAIM IS MADE TO THE EXCLUSIVE RIGHT TO USE "CPAP", "BIPAP" AND "BODY BELT HOSE HOLDER", APART FROM THE MARK AS SHOWN.

THE STIPPLING IS FOR SHADING PURPOSES ONLY. THE MARK CONSISTS OF THE STYLIZED TEXT "CPAP BIPAP BODY BELT HOSE HOLDER" WITH A MALE BODY BUILDER IN THE CENTER. HE IS ALSO WEARING A BELT.

FOR AN ELASTIC BELT WITH A PLASTIC BUCKLE USED TO HOLD IN PLACE THE HOSE CONNECTING A CONTINUOUS POSITIVE AIRWAY PRESSURE (CPAP) OR A BILEVEL POSITIVE AIRWAY PRESSURE (BIPAP) MACHINE TO ITS FACE MASK, TO PREVENT AIR LEAKS CAUSED BY PULLING ON THE HOSE AND TO ALLOW MORE FREEDOM OF MOVEMENT WHILE SLEEPING (U.S. CLS. 26, 39 AND 44).
SUSAN STIGLITZ, EXAMINING ATTORNEY

SN 77-727,231. TRANSENERIX, INC., DURHAM, NC. FILED 5-1-2009.

ADVANCING SURGERY THROUGH
INNOVATION

THE MARK CONSISTS OF STANDARD CHARACTERS WITHOUT CLAIM TO ANY PARTICULAR FONT, STYLE, SIZE, OR COLOR.

FOR MEDICAL DEVICES, NAMELY, DISPOSABLE ACCESS PORT SURGICAL DEVICES FOR USE IN GENERAL LAPAROSCOPIC PROCEDURES FOR THE PASSING OF MULTIPLE RIGID AND FLEXIBLE LAPAROSCOPIC INSTRUMENTS THROUGH A SINGLE PORT (U.S. CLS. 26, 39 AND 44).
DAWN FELDMAN, EXAMINING ATTORNEY

CLASS 10—(Continued).

SN 77-730,084. OLYMPUS MEDICAL SYSTEMS CORP., TOKYO, JAPAN, FILED 5-6-2009.

EndoArm

THE MARK CONSISTS OF STANDARD CHARACTERS WITHOUT CLAIM TO ANY PARTICULAR FONT, STYLE, SIZE, OR COLOR.

FOR INTEGRATED SYSTEMS COMPRISED OF AN ENDOSCOPE AND A SCOPE HOLDER FOR ENDOSCOPIC SURGERY (U.S. CLS. 26, 39 AND 44).
JAMES LOVELACE, EXAMINING ATTORNEY

SN 77-731,939. PIPEDREAM PRODUCTS, INC., CHATSWORTH, CA. FILED 5-7-2009.

WOW VIBE!

THE MARK CONSISTS OF STANDARD CHARACTERS WITHOUT CLAIM TO ANY PARTICULAR FONT, STYLE, SIZE, OR COLOR.

NO CLAIM IS MADE TO THE EXCLUSIVE RIGHT TO USE "VIBE", APART FROM THE MARK AS SHOWN. FOR ADULT SEXUAL STIMULATION AIDS, NAMELY, VIBRATORS AND MASSAGE DEVICES (U.S. CLS. 26, 39 AND 44).
SALLY SHIH, EXAMINING ATTORNEY

SN 77-733,005. SILICON VALLEY MEDICAL INSTRUMENTS, INC., FREMONT, CA. FILED 5-8-2009.

SVMI

THE MARK CONSISTS OF STANDARD CHARACTERS WITHOUT CLAIM TO ANY PARTICULAR FONT, STYLE, SIZE, OR COLOR.

FOR MEDICAL APPARATUS AND INSTRUMENTS FOR TREATING CARDIOVASCULAR DISEASE; MEDICAL INSTRUMENT FOR CARDIOVASCULAR DIAGNOSTICS (U.S. CLS. 26, 39 AND 44).
WON TEAK OH, EXAMINING ATTORNEY

CLASS 10—(Continued).

SN 77-735,220. SILICON VALLEY MEDICAL INSTRUMENTS, INC., FREMONT, CA. FILED 5-12-2009.



THE MARK CONSISTS OF STYLIZED LETTERING. FOR MEDICAL APPARATUS AND INSTRUMENTS FOR TREATING CARDIOVASCULAR DISEASE; MEDICAL INSTRUMENT FOR CARDIOVASCULAR DIAGNOSTICS (U.S. CLS. 26, 39 AND 44).
WON TEAK OH, EXAMINING ATTORNEY

SN 77-737,815. HITACHI MEDICAL CORPORATION, TOKYO, JAPAN, FILED 5-15-2009.

Preirus

THE MARK CONSISTS OF STANDARD CHARACTERS WITHOUT CLAIM TO ANY PARTICULAR FONT, STYLE, SIZE, OR COLOR.

OWNER OF JAPAN REG. NO. 5192395, DATED 12-26-2008, EXPIRES 6-11-2018.

FOR MEDICAL DIAGNOSTIC APPARATUS, NAMELY, ULTRASOUND IMAGING APPARATUS FOR MEDICAL USE, AND PARTS AND FITTINGS THEREFOR (U.S. CLS. 26, 39 AND 44).

MARGERY A. TIERNEY, EXAMINING ATTORNEY

SN 77-744,946. THERAPY PRODUCTS, INC., DBA ERCHONIA MEDICAL, MCKINNEY, TX. FILED 5-26-2009.

VERJU'

THE MARK CONSISTS OF STANDARD CHARACTERS WITHOUT CLAIM TO ANY PARTICULAR FONT, STYLE, SIZE, OR COLOR.

FOR LASERS FOR MEDICAL USE (U.S. CLS. 26, 39 AND 44).

SETH A. RAPPAPORT, EXAMINING ATTORNEY

CLASS 10—(Continued).

SN 77-746,468. PIPEDREAM PRODUCTS, INC., CHATSWORTH, CA. FILED 5-28-2009.

WALL BANGERS

THE MARK CONSISTS OF STANDARD CHARACTERS WITHOUT CLAIM TO ANY PARTICULAR FONT, STYLE, SIZE, OR COLOR.

FOR ADULT SEXUAL STIMULATION AIDS, NAMELY, ARTIFICIAL PENISES, DILDOS, VIBRATORS AND MASSAGE DEVICES (U.S. CLS. 26, 39 AND 44).

FIRST USE 1-20-2005; IN COMMERCE 1-20-2005.
SALLY SHIH, EXAMINING ATTORNEY

SN 77-759,862. SMITH & NEPHEW, INC., MEMPHIS, TN. FILED 6-15-2009.

PROVANGIO

THE MARK CONSISTS OF STANDARD CHARACTERS WITHOUT CLAIM TO ANY PARTICULAR FONT, STYLE, SIZE, OR COLOR.

FOR SUTURES (U.S. CLS. 26, 39 AND 44).

RONALD MCMORROW, EXAMINING ATTORNEY

SN 77-776,811. AFFECTIVA, INC, NEWTONVILLE, MA. FILED 7-8-2009.

AFFECTIVA

THE MARK CONSISTS OF STANDARD CHARACTERS WITHOUT CLAIM TO ANY PARTICULAR FONT, STYLE, SIZE, OR COLOR.

FOR MEDICAL APPARATUS AND INSTRUMENTS FOR MEASURING, MONITORING AND EVALUATING DEMONSTRATIVE PHYSIOLOGICAL EXPRESSIONS FOR DIAGNOSTIC AND THERAPEUTIC PURPOSES (U.S. CLS. 26, 39 AND 44).

MICHAEL TANNER, EXAMINING ATTORNEY

CLASS 10—(Continued).

SN 78-055,280. W. L. GORE & ASSOCIATES, INC., NEWARK, DE. FILED 3-27-2001.

HELEX

FOR PERMANENT SURGICAL IMPLANTS AND CATHETER-DEPLOYED PERMANENT SURGICAL IMPLANTS OF ARTIFICIAL MATERIAL USED TO SEAL BLOOD LEAKS OF THE HEART (U.S. CLS. 26, 39 AND 44).

AMY HELLA, EXAMINING ATTORNEY

SN 78-614,798. NAKANISHI INC., TOCHIGI-KEN, JAPAN, FILED 4-22-2005.

IENDO

THE MARK CONSISTS OF STANDARD CHARACTERS WITHOUT CLAIM TO ANY PARTICULAR FONT, STYLE, SIZE, OR COLOR.

OWNER OF JAPAN REG. NO. 4909992, DATED 11-18-2005, EXPIRES 11-18-2015.

FOR DENTAL AND SURGICAL MACHINES AND APPARATUS, NAMELY, DENTAL HANDPIECES, SURGICAL HANDPIECES, AIR MOTORS FOR DENTAL HANDPIECES, AIR MOTORS FOR SURGICAL HANDPIECES, MICRO-MOTORS FOR DENTAL HANDPIECES, MICRO-MOTORS FOR SURGICAL HANDPIECES; DENTAL CLEANING, POLISHING AND CUTTING DEVICES, NAMELY, DENTAL AIR SCALERS, ULTRASONIC SCALERS FOR DENTAL USE, ULTRASONIC CUTTERS FOR DENTAL USE; INSTRUMENTS FOR MEASURING ROOT CANAL LENGTH (U.S. CLS. 26, 39 AND 44).

H. M. FISHER, EXAMINING ATTORNEY

SN 78-810,285. RAYNER INTRAOCULAR LENSES LIMITED, CHESHAM; BUCKINGHAMSHIRE, UNITED KINGDOM, FILED 2-8-2006.

C-FLEX

THE MARK CONSISTS OF STANDARD CHARACTERS WITHOUT CLAIM TO ANY PARTICULAR FONT, STYLE, SIZE, OR COLOR.

OWNER OF ERPN CMNTY TM OFC REG. NO. 004942439, DATED 1-29-2009, EXPIRES 3-2-2016.

FOR INTRAOCULAR LENSES (U.S. CLS. 26, 39 AND 44).

GRETTA YAO, EXAMINING ATTORNEY

CLASS 10—(Continued).

SN 78-817,631. RAYNER INTRAOCULAR LENSES LIMITED, CHESHAM, BUCKINGHAMSHIRE HP5 1DJ, UNITED KINGDOM, FILED 2-17-2006.

M-FLEX

THE MARK CONSISTS OF STANDARD CHARACTERS WITHOUT CLAIM TO ANY PARTICULAR FONT, STYLE, SIZE, OR COLOR.

OWNER OF ERPN CMNTY TM OFC REG. NO. 004942454, DATED 5-24-2007, EXPIRES 3-2-2016.

FOR INTRAOCULAR LENSES (U.S. CLS. 26, 39 AND 44).

GRETTA YAO, EXAMINING ATTORNEY

SN 78-817,641. RAYNER INTRAOCULAR LENSES LIMITED, CHESHAM, BUCKINGHAMSHIRE HP5 1DJ, UNITED KINGDOM, FILED 2-17-2006.

T-FLEX

THE MARK CONSISTS OF STANDARD CHARACTERS WITHOUT CLAIM TO ANY PARTICULAR FONT, STYLE, SIZE, OR COLOR.

OWNER OF ERPN CMNTY TM OFC REG. NO. 004942389, DATED 4-12-2007, EXPIRES 3-2-2016.

FOR INTRAOCULAR LENSES (U.S. CLS. 26, 39 AND 44).

GRETTA YAO, EXAMINING ATTORNEY

SN 79-034,131. COUSIN BIOTECH SAS, F-59117 WERVICQ SUD, FRANCE, FILED 12-12-2006.

ART DISC

PRIORITY DATE OF 6-16-2006 IS CLAIMED.
OWNER OF INTERNATIONAL REGISTRATION 0912133 DATED 12-12-2006, EXPIRES 12-12-2016.

NO CLAIM IS MADE TO THE EXCLUSIVE RIGHT TO USE "DISC", APART FROM THE MARK AS SHOWN.

FOR ORTHOPEDIC ARTICLES, NAMELY, ORTHOPEDIC FIXATION DEVICES USED IN ORTHOPEDIC TRANSPLANT AND/OR IMPLANT SURGERY (U.S. CLS. 26, 39 AND 44).

CHRISTINE BLOMQUIST, EXAMINING ATTORNEY

CLASS 10—(Continued).

SN 79-050,659. STRAUMANN HOLDING AG, SWITZERLAND, FILED 11-30-2007.

Consistent Emergence Profiles

THE MARK CONSISTS OF STANDARD CHARACTERS WITHOUT CLAIM TO ANY PARTICULAR FONT, STYLE, SIZE, OR COLOR.

PRIORITY DATE OF 5-31-2007 IS CLAIMED.

OWNER OF INTERNATIONAL REGISTRATION 0955538 DATED 11-30-2007, EXPIRES 11-30-2017.

NO CLAIM IS MADE TO THE EXCLUSIVE RIGHT TO USE "EMERGENCE PROFILES", APART FROM THE MARK AS SHOWN.

FOR SURGICAL, MEDICAL, DENTAL AND DENTAL IMPLANT INSTRUMENTS AND APPARATUS, NAMELY, SECONDARY PARTS, RATCHETS, TORQUE ATTACHMENTS FOR RATCHETS, ADAPTORS FOR RATCHETS, SCREWING IN TOOLS, SCREWDRIVERS, FITTINGS FOR SCREWDRIVERS, SCREWS, PINS, CAPS, DEPTH GAUGES, THREAD CUTTERS, BANDS, ANCHORS, CYLINDERS, BONE TRANSPLANT SYSTEMS FEATURING CORING REAMERS AND CYLINDRICAL REAMERS USED TO TRANSFER AND GRAFT BONE DURING SURGERY; ADAPTORS, LABORATORY HANDLES, MARKING INSTRUMENTS, EXTENSION SLEEVES, PLASTIC NECKS, TRANSFER AIDS, ACTIVATORS AND DEACTIVATORS FOR CROSSPIECE MATRICES, EXTRACTORS, RINGS, SPRINGS, MARKING TOOLS, APPLICATORS, POSITIONING SLEEVES, JAW MODELS, AND INSTRUMENTS FOR THE CARE AND MAINTENANCE OF IMPLANTS; DENTAL IMPLANTS OF SYNTHETIC MATERIALS, PROSTHESIS COMPONENTS, NAMELY, DENTURES AND PARTS THEREOF, FOR DENTISTRY, ENDOPROSTHESES AND PARTS THEREOF FOR DENTISTRY, ENDOPROSTHESES FOR HUMAN, DENTAL AND VETERINARY MEDICINE USES (U.S. CLS. 26, 39 AND 44).

JACLYN KIDWELL, EXAMINING ATTORNEY

CLASS 10—(Continued).

SN 79-059,671. OVERMED INNOVATION SRL, ITALY, FILED 1-8-2008.

ROBODERM

THE MARK CONSISTS OF STANDARD CHARACTERS WITHOUT CLAIM TO ANY PARTICULAR FONT, STYLE, SIZE, OR COLOR.

PRIORITY DATE OF 9-5-2007 IS CLAIMED.

OWNER OF INTERNATIONAL REGISTRATION 0979241 DATED 1-8-2008, EXPIRES 1-8-2018.

FOR ABDOMINAL BELTS, CORSETS AND PADS; ELECTRIC ACUPUNCTURE INSTRUMENTS; AIR PILLOWS, AIR CUSHIONS AND AIR MATTRESSES ALL FOR MEDICAL PURPOSES; ANAESTHETIC INHALERS, SOLD EMPTY; APPARATUS FOR ACUPRESSURE THERAPY; APPARATUS FOR CELLULITE TREATMENT, REDUCTION AND ELIMINATION; APPARATUS FOR MAGNET THERAPY; APPARATUS FOR PHYSICAL TRAINING FOR MEDICAL USE; APPARATUS FOR VIBRATIONAL THERAPY, NAMELY, TUNING FORKS; BEAUTY AND COSMETIC STERILIZING POUCHES; BED VIBRATORS; BODY-FAT MONITORS; CARBON ARC LAMP UNITS FOR THERAPEUTIC PURPOSES; COMPRESSION BANDAGES; ELASTIC BANDAGES AND ELASTIC STOCKINGS FOR MEDICAL PURPOSES; ELECTRIC FOOT SPA MASSAGERS; ELECTRIC MASSAGE APPARATUS FOR HOUSEHOLD PURPOSES; ELECTRIC MASSAGE APPLIANCES, NAMELY, ELECTRIC VIBRATING MASSAGER; ELECTROMEDICAL REHABILITATIVE AND PAIN MANAGEMENT PRODUCTS FOR CLINICAL AND HOME USE, NAMELY, ELECTRICAL NERVE AND MUSCLE STIMULATORS, ULTRASONIC STIMULATORS, MAGNET THERAPY STIMULATORS AND LASER THERAPY STIMULATORS; EXERCISE MACHINES FOR THERAPEUTIC PURPOSES; GLOVES FOR MASSAGE; INFRARED RADIATOR UNITS FOR THERAPEUTIC PURPOSES; LASERS FOR THE COSMETIC TREATMENT OF THE FACE AND SKIN; MASSAGE APPARATUS FOR MEDICAL USE; MASSAGE CHAIRS; MASSAGING APPARATUS FOR PERSONAL USE; MEDICAL ELECTRODES; MEDICAL X-RAY APPARATUS; THERAPEUTIC SAUNAS; THERMO-ELECTRIC COMPRESSES; ULTRAVIOLET LAMPS FOR MEDICAL PURPOSES (U.S. CLS. 26, 39 AND 44).

STEVEN PEREZ, EXAMINING ATTORNEY

SN 79-061,889. MAQUET CRITICAL CARE AB, SE-171 95 SOLNA, SWEDEN, FILED 10-22-2008.

SERVO-I

THE MARK CONSISTS OF STANDARD CHARACTERS WITHOUT CLAIM TO ANY PARTICULAR FONT, STYLE, SIZE, OR COLOR.

PRIORITY DATE OF 6-17-2008 IS CLAIMED.

OWNER OF INTERNATIONAL REGISTRATION 0984459 DATED 10-22-2008, EXPIRES 10-22-2018.

OWNER OF U.S. REG. NOS. 2,401,632, 2,481,465 AND 2,955,173.

FOR ELECTRO-MEDICAL AND MEDICAL APPARATUS AND INSTRUMENTS, NAMELY, VENTILATOR SYSTEMS COMPRISED OF VENTILATORS, NEBULIZERS FOR RESPIRATORY THERAPY, RESPIRATORY MONITORS AND DIAGNOSTIC MODULES THEREFOR (U.S. CLS. 26, 39 AND 44).

ELI HELLMAN, EXAMINING ATTORNEY

CLASS 10—(Continued).

SN 79-063,281. MAQUET CRITICAL CARE AB, SOLNA, SWEDEN, FILED 11-24-2008.

SERVO-S

THE MARK CONSISTS OF STANDARD CHARACTERS WITHOUT CLAIM TO ANY PARTICULAR FONT, STYLE, SIZE, OR COLOR.

PRIORITY DATE OF 6-17-2008 IS CLAIMED.

OWNER OF INTERNATIONAL REGISTRATION 0987953 DATED 11-24-2008, EXPIRES 11-24-2018.

OWNER OF U.S. REG. NOS. 2,401,632, 2,481,465 AND 2,955,173.

FOR ELECTRO-MEDICAL AND MEDICAL APPARATUS AND INSTRUMENTS, NAMELY, VENTILATOR SYSTEMS COMPRISED OF VENTILATORS, NEBULIZERS FOR RESPIRATORY THERAPY, RESPIRATORY MONITORS AND DIAGNOSTIC MODULES THEREFOR (U.S. CLS. 26, 39 AND 44).

ELI HELLMAN, EXAMINING ATTORNEY

SN 79-064,885. SALTS HEALTHCARE LIMITED, UNITED KINGDOM, FILED 7-29-2008.

DERMACOL

THE MARK CONSISTS OF STANDARD CHARACTERS WITHOUT CLAIM TO ANY PARTICULAR FONT, STYLE, SIZE, OR COLOR.

OWNER OF INTERNATIONAL REGISTRATION 0992080 DATED 7-29-2008, EXPIRES 7-29-2018.

FOR OSTOMY BAGS AND POUCHES, PARTICULARLY COLOSTOMY, UROSTOMY AND ILEOSTOMY BAGS AND POUCHES; OSTOMY SEALS, FLANGES AND RINGS; ALL OF THE FOREGOING FOR MEDICAL PURPOSES AND MEDICAL PARTS AND FITTINGS FOR THE AFORESAID GOODS (U.S. CLS. 26, 39 AND 44).

SHARON MEIER, EXAMINING ATTORNEY

SN 79-068,266. GN RESOUND A/S, DENMARK, FILED 3-14-2009.

INTERTON START

THE MARK CONSISTS OF STANDARD CHARACTERS WITHOUT CLAIM TO ANY PARTICULAR FONT, STYLE, SIZE, OR COLOR.

PRIORITY DATE OF 2-14-2009 IS CLAIMED.

OWNER OF INTERNATIONAL REGISTRATION 1001304 DATED 3-14-2009, EXPIRES 3-14-2019.

OWNER OF U.S. REG. NO. 3,627,299.

THE WORDING "INTERTON" HAS NO MEANING IN A FOREIGN LANGUAGE.

FOR HEARING AIDS (U.S. CLS. 26, 39 AND 44).

WILLIAM ROSSMAN, EXAMINING ATTORNEY

CLASS 11—ENVIRONMENTAL CONTROL APPARATUS

SN 76-694,785. ALLEN, DAVID M., BLACHLY, OR. FILED 12-15-2008.

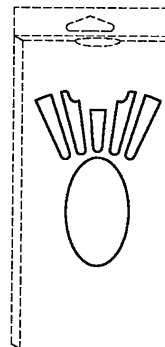

NO CLAIM IS MADE TO THE EXCLUSIVE RIGHT TO USE THE EXTERNAL SHAPE OF THE PACKAGE, APART FROM THE MARK AS SHOWN.

THE MARK CONSISTS OF A CONFIGURATION, NAMELY, A SERIES OF DIVERGING DIRECTED CUTOUTS HAVING AN OVERALL RECTANGULAR SHAPE, IN A PACKAGE THAT IS DEPICTED IN DOTTED LINES, WITH THE CUTOUTS RADIATING FROM AN ELLIPTICAL OPENING IN THE PACKAGE WHEREBY A FLASHLIGHT RECEIVED IN THE OPENING AND UPON BEING ENERGIZED GENERATES A SIMULATION OF SUNBEAMS THROUGH THE DIVERGING CUTOUTS.

FOR BATTERY OPERATED PERSONAL FLASHLIGHTS (U.S. CLS. 13, 21, 23, 31 AND 34).

FIRST USE 9-8-1997; IN COMMERCE 9-8-1997.

TRACY WHITTAKER-BROWN, EXAMINING ATTORNEY

SN 76-696,389. CASA TECHNOLOGIES (HANGZHOU) CO., LTD., HANGZHOU CITY, ZHEJIANG PROVINCE, CHINA, FILED 3-18-2009.



THE MARK CONSISTS OF THE STYLIZED WORD "CASA" OVER A PARTIAL SILHOUETTE OF A HOUSE.

FOR ELECTRIC HEATERS FOR COMMERCIAL USE; HOT-AIR SPACE HEATING APPARATUS FOR INDUSTRIAL PURPOSES; HOT-WATER SPACE HEATING APPARATUS FOR INDUSTRIAL PURPOSES; STEAM HEATING APPARATUS FOR INDUSTRIAL PURPOSES; ELECTRIC HEATING FANS; SAUNAS; ELECTRIC FOOT WARMERS; ELECTRIC RADIATORS; RADIATORS FOR HEATING; NON-ELECTRIC POCKET WARMERS, NAMELY, CHEMICALLY-ACTIVATED HEATING PACKETS FOR WARMING HANDS, NOT FOR MEDICAL PURPOSES; AND BED WARMERS (U.S. CLS. 13, 21, 23, 31 AND 34).

FIRST USE 11-0-2007; IN COMMERCE 2-0-2009.

RONALD AIKENS, EXAMINING ATTORNEY

CLASS 11—(Continued).

SN 76-697,104. CLEAN WORK BOOTH, INC., JACKSONVILLE, FL. FILED 4-27-2009.

C . W . B .

THE MARK CONSISTS OF STANDARD CHARACTERS WITHOUT CLAIM TO ANY PARTICULAR FONT, STYLE, SIZE, OR COLOR.
FOR CLEAN ROOMS, NAMELY, PORTABLE CLEAN ROOMS (U.S. CLS. 13, 21, 23, 31 AND 34).
FIRST USE 11-29-2006; IN COMMERCE 11-29-2006.
GEOFFREY FOSDICK, EXAMINING ATTORNEY

SN 77-100,216. ALLISON SATTAUR-LOPEZ, BOCA RATON, FL. AND ROBERT LOEPZ, BOCA RATON, FL. FILED 2-6-2007.

EUROLITÉ

THE MARK CONSISTS OF STYLIZED LETTERS SPELLING THE NAME "EUROLITE".
FOR AUTOMOTIVE LIGHTING, NAMELY, FOG LIGHTS; DRIVING LIGHTS IN THE NATURE OF HEADLIGHTS, SPOT LAMPS, XENON LIGHT BULBS, AND TAIL LAMPS FOR AUTOMOTIVE TAIL LIGHTS (U.S. CLS. 13, 21, 23, 31 AND 34).
FIRST USE 4-0-1997; IN COMMERCE 4-0-1997.
GINA FINK, EXAMINING ATTORNEY

SN 77-259,803. PROMO-AD & ASSOCIATES INC., TORONTO, CANADA, FILED 8-20-2007.

HANDY-GLO

THE MARK CONSISTS OF STANDARD CHARACTERS WITHOUT CLAIM TO ANY PARTICULAR FONT, STYLE, SIZE, OR COLOR.
PRIORITY CLAIMED UNDER SEC. 44(D) ON CANADA APPLICATION NO. 1351627. FILED 6-13-2007.
FOR DEVICE FOR THE DETECTION OF UNSANITIZED AREAS OF WASHED HANDS CONSISTING PRIMARILY OF ULTRAVIOLET LIGHT (U.S. CLS. 13, 21, 23, 31 AND 34).
LEIGH CAROLINE CASE, EXAMINING ATTORNEY

CLASS 11—(Continued).

SN 77-432,565. GULFSTREAM PLASTICS LTD., CAMBRIDGE, CANADA, FILED 3-26-2008.

WATERDANCE

THE MARK CONSISTS OF STANDARD CHARACTERS WITHOUT CLAIM TO ANY PARTICULAR FONT, STYLE, SIZE, OR COLOR.
FOR PERSONAL CARE FOOT SPAS, NAMELY, PEDICURE STATIONS FOR USE IN PEDICURE SALONS AND DAY SPAS (U.S. CLS. 13, 21, 23, 31 AND 34).
BARNEY CHARLON, EXAMINING ATTORNEY

SN 77-448,507. NEXXUS LIGHTING, INC., ORLANDO, FL. FILED 4-15-2008.

ARRAY LIGHTING

THE MARK CONSISTS OF STANDARD CHARACTERS WITHOUT CLAIM TO ANY PARTICULAR FONT, STYLE, SIZE, OR COLOR.
NO CLAIM IS MADE TO THE EXCLUSIVE RIGHT TO USE "LIGHTING", APART FROM THE MARK AS SHOWN.
FOR LAMPS, LIGHTING FIXTURES AND LIGHT BULBS (U.S. CLS. 13, 21, 23, 31 AND 34).
JANICE KIM, EXAMINING ATTORNEY

SN 77-448,826. NEXXUS LIGHTING, INC., ORLANDO, FL. FILED 4-15-2008.

ARRAY

THE MARK CONSISTS OF STANDARD CHARACTERS WITHOUT CLAIM TO ANY PARTICULAR FONT, STYLE, SIZE, OR COLOR.
FOR LAMPS, LIGHTING FIXTURES AND LIGHT BULBS (U.S. CLS. 13, 21, 23, 31 AND 34).
JANICE KIM, EXAMINING ATTORNEY

CLASS 11—(Continued).

SN 77-468,031. LI, YANG DONG, FLUSHING, NY. FILED S.R. 5-7-2008; AM. P.R. 7-8-2009.



NO CLAIM IS MADE TO THE EXCLUSIVE RIGHT TO USE "LANTERN" AND THE NON-LATIN CHARACTERS THAT MEAN "PALACE LANTERN", APART FROM THE MARK AS SHOWN.

THE COLOR(S) RED IS/ARE CLAIMED AS A FEATURE OF THE MARK.

THE MARK CONSISTS OF A CHINESE LANTERN DESIGN AND THE WORDING "DONGYI LANTERN" AND CHINESE CHARACTERS, WITH THE DESIGN AND THE WORDING AND CHINESE CHARACTERS ALL DISPLAYED ENTIRELY IN RED.

THE ENGLISH TRANSLATION OF "DONGYI" IN THE MARK IS EASTERN ART.

THE NON-LATIN CHARACTERS IN THE MARK TRANSLITERATE TO "DONG YI GONG DENG" AND THIS MEANS EASTERN ART PALACE LANTERN IN ENGLISH.

FOR LANTERNS (U.S. CLS. 13, 21, 23, 31 AND 34). DANIEL CAPSHAW, EXAMINING ATTORNEY

SN 77-532,388. NITRO-LIFT TECHNOLOGIES, L.L.C., HOUSTON, TX. FILED 7-28-2008.

CONG

THE MARK CONSISTS OF STANDARD CHARACTERS WITHOUT CLAIM TO ANY PARTICULAR FONT, STYLE, SIZE, OR COLOR.

FOR NITROGEN-GENERATION EQUIPMENT AND COMPONENTS, NAMELY, NITROGEN GENERATORS AND ASSOCIATED NOZZLES SOLD AS A UNIT (U.S. CLS. 13, 21, 23, 31 AND 34).

DORITT L. CARROLL, EXAMINING ATTORNEY

SN 77-558,656. VENTEX CERAMICS CO., LTD., GANGNAM-GU, SEOUL, REPUBLIC OF KOREA, FILED 8-29-2008.



NO CLAIM IS MADE TO THE EXCLUSIVE RIGHT TO USE "FRESH AIR BATHROOMS", APART FROM THE MARK AS SHOWN.

THE COLOR(S) ORANGE, BLUE, RED, GRAY, LIGHT GREEN, DARK GREEN, AND BLACK IS/ARE CLAIMED AS A FEATURE OF THE MARK.

THE MARK CONSISTS OF THE COLOR ORANGE APPEARING IN THE LETTER "V" OF THE TERM "VENTEX", THE COLOR BLUE APPEARING IN THE TWO

CLASS 11—(Continued).

OCCURRENCES OF THE LETTER "E" IN THE TERM "VENTEX", THE COLOR RED APPEARING IN THE LETTER "N" IN THE TERM "VENTEX" AND IN THE HEAD OF THE ROSE, THE COLOR GRAY APPEARING IN THE LETTER "T" IN THE TERM "VENTEX", THE COLOR LIGHT GREEN APPEARING IN THE LETTER "X" IN THE TERM "VENTEX", THE COLOR DARK GREEN IN THE WORDING "AIR" AND THE STEM OF THE ROSE, AND THE COLOR BLACK APPEARING IN THE WORDING "FOR FRESH" AND "BATHROOMS".

FOR TOILET BOWLS, TOILET SEATS, BIDETS, TOILET STOOL UNITS WITH A WASHING WATER SQUIRTER, DISINFECTANT DISPENSERS FOR BIDETS, DISINFECTANT DISPENSERS FOR TOILETS (U.S. CLS. 13, 21, 23, 31 AND 34).

JOHN KELLY, EXAMINING ATTORNEY

SN 77-564,506. HAVELLS SYLVANIA FIXTURES UK LIMITED, EAST SUSSEX, UNITED KINGDOM, FILED 9-8-2008.

CONCORD

THE MARK CONSISTS OF STANDARD CHARACTERS WITHOUT CLAIM TO ANY PARTICULAR FONT, STYLE, SIZE, OR COLOR.

OWNER OF UNITED KINGDOM REG. NO. 1491649, DATED 6-11-1993, EXPIRES 2-21-2019.

FOR ELECTRIC LIGHTING FIXTURES AND PARTS FOR THE AFORESAID (U.S. CLS. 13, 21, 23, 31 AND 34). EVELYN BRADLEY, EXAMINING ATTORNEY

SN 77-585,242. GTLPETROL LLC, NEW YORK, NY. FILED 10-3-2008.

I-SG2

THE MARK CONSISTS OF STANDARD CHARACTERS WITHOUT CLAIM TO ANY PARTICULAR FONT, STYLE, SIZE, OR COLOR.

FOR CHEMICAL PROCESSING EQUIPMENT IN THE NATURE OF PRODUCTION EQUIPMENT FOR HYDROGEN GAS AND SYNTHESIS GASES, NAMELY, A CHEMICAL REACTOR PRESSURE VESSEL FOR PARTIAL OXIDATION OF METHANE AND STEAM METHANE REFORMING, SAID VESSEL INCLUDING A BURNER, CATALYST FILLED TUBES, AND OPTIONALLY, A HEAT EXCHANGER (U.S. CLS. 13, 21, 23, 31 AND 34).

KEVIN CORWIN, EXAMINING ATTORNEY

CLASS 11—(Continued).

SN 77-594,402. MEMIOS, LLC, GREENSBORO, ND. FILED 10-16-2008.

MEMIOS

THE MARK CONSISTS OF STANDARD CHARACTERS WITHOUT CLAIM TO ANY PARTICULAR FONT, STYLE, SIZE, OR COLOR.

THE WORDING "MEMIOS" HAS NO MEANING IN A FOREIGN LANGUAGE.

FOR PNEUMATIC WASTE DISPOSAL SYSTEMS COMPRISING CHUTES, PIPING AND BLOWERS FOR LARGE SCALE WASTE TRANSFER AND MANAGEMENT IN BUILDINGS, INDUSTRIAL FACILITIES, STADIUMS, HOSPITALS AND OTHER HIGH VOLUME ENVIRONMENTS (U.S. CLS. 13, 21, 23, 31 AND 34).

DAVID HOFFMAN, EXAMINING ATTORNEY

CLASS 11—(Continued).

SN 77-629,734. SPENCER GIFTS LLC, EGG HARBOR TOWNSHIP, NJ. FILED 12-9-2008.

STROBE PLUS

THE MARK CONSISTS OF STANDARD CHARACTERS WITHOUT CLAIM TO ANY PARTICULAR FONT, STYLE, SIZE, OR COLOR.

NO CLAIM IS MADE TO THE EXCLUSIVE RIGHT TO USE "STROBE", APART FROM THE MARK AS SHOWN.

FOR STROBE LIGHT (U.S. CLS. 13, 21, 23, 31 AND 34). FIRST USE 7-1-2007; IN COMMERCE 7-1-2007.

LEIGH CAROLINE CASE, EXAMINING ATTORNEY

SN 77-601,413. CYALUME TECHNOLOGIES, INC., WEST SPRINGFIELD, MA. FILED 10-27-2008.

TAC GLOW

THE MARK CONSISTS OF STANDARD CHARACTERS WITHOUT CLAIM TO ANY PARTICULAR FONT, STYLE, SIZE, OR COLOR.

NO CLAIM IS MADE TO THE EXCLUSIVE RIGHT TO USE "GLOW", APART FROM THE MARK AS SHOWN.

FOR CHEMILUMINESCENT LIGHTING DEVICES, NAMELY, ROUND AND OVAL SHAPED LIGHT STICKS (U.S. CLS. 13, 21, 23, 31 AND 34).

FIRST USE 9-1-2005; IN COMMERCE 4-4-2006.

DAVID MILLER, EXAMINING ATTORNEY

THE MARK CONSISTS OF STANDARD CHARACTERS WITHOUT CLAIM TO ANY PARTICULAR FONT, STYLE, SIZE, OR COLOR.

OWNER OF U.S. REG. NOS. 2,523,311, 3,376,542 AND OTHERS.

NO CLAIM IS MADE TO THE EXCLUSIVE RIGHT TO USE "GRILL", APART FROM THE MARK AS SHOWN.

FOR BARBECUE GRILLS; ROTISSERIES; BARBECUE GRILL REPAIR KITS PRIMARILY CONTAINING STRUCTURAL REPLACEMENT GRILL PARTS, IGNITOR KITS, HOSE/REGULATOR ASSEMBLIES, REPLACEMENT CONTROL KNOBS, SINGLE AND DUAL BAR BURNERS, SINGLE AND DUAL H BURNERS, STAINLESS STEEL SINGLE BURNERS; BARBECUE ACCESSORIES, NAMELY, ELECTRIC KETTLE CHARCOAL STARTER, ELECTRIC STANDARD CHARCOAL STARTER, 12-LED GRILL LIGHT, 3-IN-1 GRILL LIGHT, ELECTRONIC IGNITION UTILITY LIGHTER; PORCELAIN HEAT PLATES, ROCK GRATES AND BARBECUE SMOKER BOXES (U.S. CLS. 13, 21, 23, 31 AND 34).

FIRST USE 9-0-2008; IN COMMERCE 9-0-2008.

ESTHER BELENKER, EXAMINING ATTORNEY

SN 77-607,894. THE GILLETTE COMPANY, BOSTON, MA. FILED 11-5-2008.

DAYLITE TOUGH

THE MARK CONSISTS OF STANDARD CHARACTERS WITHOUT CLAIM TO ANY PARTICULAR FONT, STYLE, SIZE, OR COLOR.

OWNER OF U.S. REG. NO. 3,509,532.

FOR FLASHLIGHTS, HEADLAMPS IN THE NATURE OF LIGHTS WORN ON THE HEAD, SPOTLIGHTS, LANTERNS (U.S. CLS. 13, 21, 23, 31 AND 34).

TRACY CROSS, EXAMINING ATTORNEY

SN 77-670,212. SUNBEAM PRODUCTS, INC., DBA JARDEN CONSUMER SOLUTIONS, BOCA RATON, FL. FILED 12-13-2009.

FreshSource

THE MARK CONSISTS OF STANDARD CHARACTERS WITHOUT CLAIM TO ANY PARTICULAR FONT, STYLE, SIZE, OR COLOR.

FOR WATER FILTRATION DEVICES, NAMELY, WATER FILTERS AND WATER DISPENSING PRODUCTS, NAMELY, WATER DISPENSERS (U.S. CLS. 13, 21, 23, 31 AND 34).

ZACHARY BELLO, EXAMINING ATTORNEY

CLASS 11—(Continued).

SN 77-672,684. SPAFINITY, INC., GERMANTOWN, WI. FILED 2-18-2009.



NO CLAIM IS MADE TO THE EXCLUSIVE RIGHT TO USE "PEDICURE EQUIPMENT", APART FROM THE MARK AS SHOWN.

THE COLOR(S) GRAY AND RED IS/ARE CLAIMED AS A FEATURE OF THE MARK.

THE MARK CONSISTS OF THE WORDS "SPAFINITY" IN UPPER CASE SILVER LETTERS ABOVE THE WORDS "PEDICURE EQUIPMENT" IN UPPER CASE SILVER LETTERS IN SMALLER FONT AND A RED INFINITY SYMBOL WITH TWO DIAGONAL SLASHES THROUGH THE MIDDLE OF THE SYMBOL ABOVE THE WORD "SPAFINITY".

FOR PORTABLE FOOT BATHS FOR USE IN PEDICURE SALONS AND DAY SPAS (U.S. CLS. 13, 21, 23, 31 AND 34).

FIRST USE 9-22-2008; IN COMMERCE 9-22-2008.
KAREN K. BUSH, EXAMINING ATTORNEY

SN 77-674,909. FEIT ELECTRIC COMPANY, PICO RIVERA, CA. FILED 2-20-2009.

Surge Sentry

THE MARK CONSISTS OF STANDARD CHARACTERS WITHOUT CLAIM TO ANY PARTICULAR FONT, STYLE, SIZE, OR COLOR.

NO CLAIM IS MADE TO THE EXCLUSIVE RIGHT TO USE "SURGE", APART FROM THE MARK AS SHOWN.

FOR LIGHT BULBS THAT ARE MADE TO WITHSTAND VOLTAGE SURGES (U.S. CLS. 13, 21, 23, 31 AND 34).

KATHLEEN LORENZO, EXAMINING ATTORNEY

SN 77-686,169. TRADE MANAGEMENT GROUP LIMITED, NASSAU, BAHAMAS, FILED 3-9-2009.

WAVE LIGHT

THE MARK CONSISTS OF STANDARD CHARACTERS WITHOUT CLAIM TO ANY PARTICULAR FONT, STYLE, SIZE, OR COLOR.

NO CLAIM IS MADE TO THE EXCLUSIVE RIGHT TO USE "LIGHT", APART FROM THE MARK AS SHOWN.

FOR LIGHTING FIXTURES (U.S. CLS. 13, 21, 23, 31 AND 34).

JAY BESCH, EXAMINING ATTORNEY

CLASS 11—(Continued).

SN 77-692,174. BOEING MANAGEMENT COMPANY, SEAL BEACH, CA. FILED 3-16-2009.



OWNER OF U.S. REG. NOS. 2,243,668, 2,383,795 AND OTHERS.

THE MARK CONSISTS OF A SINGLE LINE CIRCLE INTERSECTED BY A CURVED LINE AND ALSO INTERSECTED BY A TRIANGLE WITH ONE CURVED SIDE, WITH THE CIRCLE SUGGESTING THE GLOBE, THE CURVED LINE SUGGESTING AN ORBIT, AND THE TRIANGLE SUGGESTING AN AIRPLANE OR AIRCRAFT. FOR FLASHLIGHTS; HEADLAMPS (U.S. CLS. 13, 21, 23, 31 AND 34).

FIRST USE 2-23-2009; IN COMMERCE 2-23-2009.
GEORGE LORENZO, EXAMINING ATTORNEY

SN 77-692,437. ABR ENTERPRISES, INC., NEW YORK, NY. FILED 3-17-2009.



NO CLAIM IS MADE TO THE EXCLUSIVE RIGHT TO USE "ENTERPRISES, INC.", APART FROM THE MARK AS SHOWN.

THE COLOR(S) RED AND BLACK IS/ARE CLAIMED AS A FEATURE OF THE MARK.

THE MARK CONSISTS OF THE PHRASE "ABR ENTERPRISES, INC." IN BLACK NEXT TO A RED DESIGN OF TWO TRIANGLES ONE ON TOP OF THE OTHER.

FOR OUTDOOR ELECTRIC LIGHTING FIXTURES AND LIGHT BULBS (U.S. CLS. 13, 21, 23, 31 AND 34).

FIRST USE 3-12-2009; IN COMMERCE 3-12-2009.
CHERYL CLAYTON, EXAMINING ATTORNEY

CLASS 11—(Continued).

SN 77-693,998. SCRIPPS NETWORKS, LLC, KNOXVILLE, TN. FILED 3-18-2009.

MAN CAVES

THE MARK CONSISTS OF STANDARD CHARACTERS WITHOUT CLAIM TO ANY PARTICULAR FONT, STYLE, SIZE, OR COLOR.

FOR LIGHTING FIXTURES; APPARATUS FOR COOKING, NAMELY, COOKTOPS; REFRIGERATORS; WATER COOLERS (U.S. CLS. 13, 21, 23, 31 AND 34).

TEJBIR SINGH, EXAMINING ATTORNEY

SN 77-703,569. MOEN INCORPORATED, NORTH OLMSTED, OH. FILED 3-31-2009.

1255

THE MARK CONSISTS OF STANDARD CHARACTERS WITHOUT CLAIM TO ANY PARTICULAR FONT, STYLE, SIZE, OR COLOR.

FOR PLUMBING PRODUCTS, NAMELY, VALVE CARTRIDGES (U.S. CLS. 13, 21, 23, 31 AND 34).

FIRST USE 3-23-2009; IN COMMERCE 3-23-2009.

RUDY R. SINGLETON, EXAMINING ATTORNEY

CLASS 11—(Continued).

SN 77-707,159. I - SAVE INTERNATIONAL LIMITED, CHAIWAN, HONG KONG, FILED 4-6-2009.



i-SAVE

THE COLOR(S) GREEN, BLACK AND WHITE IS/ARE CLAIMED AS A FEATURE OF THE MARK.

THE MARK CONSISTS OF THE FOLLOWING: A WHITE BACKGROUND, A GREEN RECTANGLE OF WHICH THERE ARE TWO CURVE LINES WITH GREEN TIPS, ONE IS FROM TOP DOWNWARD TO THE LEFT AND THE OTHER IS FROM BOTTOM UPWARD TO THE RIGHT. BELOW THE RECTANGLE IS THE WORD "I-SAVE" IN BLACK.

FOR ARC LAMPS; BICYCLE LIGHTS; BOOK LIGHTS; CEILING LIGHTS; DIVING LIGHTS; ELECTRIC LIGHTS FOR CHRISTMAS TREES; FLUORESCENT LAMPS; HIGH INTENSITY SEARCH LIGHTS; LAMPS; LAMPS FOR OUTDOOR USE; LED LIGHT ASSEMBLIES FOR STREET LIGHTS, SIGNS, COMMERCIAL LIGHTING, AUTOMOBILES, BUILDINGS, AND OTHER ARCHITECTURAL USES; LED LIGHT BULBS; LIGHT BULBS; LIGHTS FOR VEHICLES; POCKET SEARCH LIGHTS; PROJECTOR LAMPS; ULTRAVIOLET RAY LAMPS, NOT FOR MEDICAL PURPOSES (U.S. CLS. 13, 21, 23, 31 AND 34).

FIRST USE 12-1-2008; IN COMMERCE 12-1-2008.

MICHELE SWAIN, EXAMINING ATTORNEY

SN 77-708,833. PURELY ENTERPRISES, LLC, KNOXVILLE, TN. FILED 4-7-2009.



NO CLAIM IS MADE TO THE EXCLUSIVE RIGHT TO USE "IONIC", APART FROM THE MARK AS SHOWN.

THE MARK CONSISTS OF THE WORDS "IONIC LIFESTYLE" FOLLOWED BY FIVE CURVED LINES AND FIVE STARS OF VARYING SIZES.

FOR NEGATIVE ION GENERATORS FOR THE TREATMENT OF AIR AND FOR USE AS AN AIR PURIFIER (U.S. CLS. 13, 21, 23, 31 AND 34).

FIRST USE 2-1-2008; IN COMMERCE 6-1-2008.

ELIZABETH KAJUBI, EXAMINING ATTORNEY

CLASS 11—(Continued).

SN 77-708,851. PURELY ENTERPRISES, LLC, KNOXVILLE, TN. FILED 4-7-2009.



PurelyAnion

NO CLAIM IS MADE TO THE EXCLUSIVE RIGHT TO USE "ANION", APART FROM THE MARK AS SHOWN.

THE MARK CONSISTS OF A PLANT WITH TWO LEAVES COMING OUT OF A REPRESENTATION OF GROUND, FOLLOWED BY THE WORDS "PURELY ANION" WITHOUT A SPACE.

FOR COMPACT FLUORESCENT LIGHT BULBS WITH BUILT-IN NEGATIVE ION GENERATORS (U.S. CLS. 13, 21, 23, 31 AND 34).

FIRST USE 2-1-2008; IN COMMERCE 6-1-2008.
ELIZABETH KAJUBI, EXAMINING ATTORNEY

SN 77-714,964. TERRABRITE INC., TAIPEI CITY, TAIWAN, FILED 4-16-2009.

TerraBrite

THE MARK CONSISTS OF STANDARD CHARACTERS WITHOUT CLAIM TO ANY PARTICULAR FONT, STYLE, SIZE, OR COLOR.

FOR AQUARIUM LIGHTS; FLASHLIGHTS; FLUORESCENT LAMPS; LIGHT BULBS; LIGHT DIFFUSERS; LIGHTING FIXTURES; SOLAR LIGHT FIXTURES, NAMELY, INDOOR AND OUTDOOR SOLAR POWERED LIGHTING UNITS AND FIXTURES; READING LAMPS; RECESSED CEILING LIGHTS; ELECTRIC LIGHT DECORATIVE STRINGS; AND DECORATIVE LIGHTING FIXTURES; DISINFECTANT LAMPS, NAMELY, ULTRAVIOLET LAMPS, NOT FOR MEDICAL PURPOSES; TABLE LIGHTS, NAMELY, LIGHTING FIXTURES FOR PLACEMENT OVER TABLES (U.S. CLS. 13, 21, 23, 31 AND 34).

FIRST USE 4-3-2009; IN COMMERCE 4-3-2009.
ELLEN B. AWRICH, EXAMINING ATTORNEY

SN 77-722,619. ELEMENT INNOVATION CONSULTING, INC., BURNABY, BC, CANADA, FILED 4-27-2009.

EAGTAC

THE MARK CONSISTS OF STANDARD CHARACTERS WITHOUT CLAIM TO ANY PARTICULAR FONT, STYLE, SIZE, OR COLOR.

FOR FLASHLIGHTS (U.S. CLS. 13, 21, 23, 31 AND 34).
FIRST USE 4-22-2009; IN COMMERCE 4-22-2009.
JACLYN KIDWELL, EXAMINING ATTORNEY

CLASS 11—(Continued).

SN 77-723,583. UNITED INNOVATION INC., ALLEN, TX. FILED 4-28-2009.

UNINNOV

THE MARK CONSISTS OF STANDARD CHARACTERS WITHOUT CLAIM TO ANY PARTICULAR FONT, STYLE, SIZE, OR COLOR.

FOR LED (LIGHT EMITTING DIODE) LIGHTING FIXTURES; LED (LIGHT EMITTING DIODES) LIGHTING FIXTURES FOR USE IN DISPLAY, COMMERCIAL, INDUSTRIAL, RESIDENTIAL, AND ARCHITECTURAL ACCENT LIGHTING APPLICATIONS; LED LIGHT ASSEMBLIES FOR STREET LIGHTS, SIGNS, COMMERCIAL LIGHTING, AUTOMOBILES, BUILDINGS, AND OTHER ARCHITECTURAL USES; LED LIGHT BULBS; LED LIGHTING FIXTURES FOR INDOOR AND OUTDOOR LIGHTING APPLICATIONS (U.S. CLS. 13, 21, 23, 31 AND 34).

FIRST USE 10-25-2008; IN COMMERCE 3-1-2009.
KATHERINE CHANG, EXAMINING ATTORNEY

SN 77-723,924. STEELCASE INC., GRAND RAPIDS, MI. FILED 4-28-2009.

CAMPFIRE

THE MARK CONSISTS OF STANDARD CHARACTERS WITHOUT CLAIM TO ANY PARTICULAR FONT, STYLE, SIZE, OR COLOR.

FOR LAMPS (U.S. CLS. 13, 21, 23, 31 AND 34).
MARY CRAWFORD, EXAMINING ATTORNEY

SN 77-724,066. ALD-HOLCROFT VACUUM TECHNOLOGIES CO., INC., WIXOM, MI. FILED 4-28-2009.

NITROTHERM

THE MARK CONSISTS OF STANDARD CHARACTERS WITHOUT CLAIM TO ANY PARTICULAR FONT, STYLE, SIZE, OR COLOR.

FOR INDUSTRIAL FURNACES (U.S. CLS. 13, 21, 23, 31 AND 34).
ELLEN B. AWRICH, EXAMINING ATTORNEY

CLASS 11—(Continued).

SN 77-725,214. BLUEINGREEN, LLC, FAYETTEVILLE, AR.
FILED 4-29-2009.

BLUEINGREEN

THE MARK CONSISTS OF STANDARD CHARACTERS WITHOUT CLAIM TO ANY PARTICULAR FONT, STYLE, SIZE, OR COLOR.

FOR ENVIRONMENTAL CONTROL APPARATUS, NAMELY, PARTICLE ACTIVATORS FOR USE IN SOIL REMEDIATION, DRINKING WATER TREATMENT, MUNICIPAL AND INDUSTRIAL WASTEWATER TREATMENT (U.S. CLS. 13, 21, 23, 31 AND 34).

RICHARD A. STRASER, EXAMINING ATTORNEY

CLASS 11—(Continued).

SN 77-725,258. POROUS MEDIA CORPORATION, CONROE, TX. FILED 4-29-2009.

UNIFORM PLUS

THE MARK CONSISTS OF STANDARD CHARACTERS WITHOUT CLAIM TO ANY PARTICULAR FONT, STYLE, SIZE, OR COLOR.

FOR GENERAL INDUSTRIAL FILTER MEDIA PRIMARILY MADE OF INORGANIC OR ORGANIC FIBERS FOR THE PURIFICATION AND FILTRATION OF AIR AND FLUIDS (U.S. CLS. 13, 21, 23, 31 AND 34).

FIRST USE 6-1-1987; IN COMMERCE 6-1-1987.

LINDA MICKLEBURGH, EXAMINING ATTORNEY

SN 77-725,217. POROUS MEDIA CORPORATION, CONROE, TX. FILED 4-29-2009.

GENESIS

THE MARK CONSISTS OF STANDARD CHARACTERS WITHOUT CLAIM TO ANY PARTICULAR FONT, STYLE, SIZE, OR COLOR.

FOR GENERAL INDUSTRIAL USE REPLACEMENT FILTERS FOR PURIFICATION OF AIR AND NONAQUEOUS INDUSTRIAL FLUIDS (U.S. CLS. 13, 21, 23, 31 AND 34).

FIRST USE 12-6-1993; IN COMMERCE 12-6-1993.

LINDA MICKLEBURGH, EXAMINING ATTORNEY

SN 77-725,364. SMASHRAY, LTD., SYLVANIA, OH. FILED 4-29-2009.

SMASHRAY

THE MARK CONSISTS OF STANDARD CHARACTERS WITHOUT CLAIM TO ANY PARTICULAR FONT, STYLE, SIZE, OR COLOR.

FOR LED (LIGHT EMITTING DIODE) LIGHTING FIXTURES (U.S. CLS. 13, 21, 23, 31 AND 34).

MELISSA VALLILLO, EXAMINING ATTORNEY

SN 77-725,241. POROUS MEDIA CORPORATION, CONROE, TX. FILED 4-29-2009.

UNIFORM

THE MARK CONSISTS OF STANDARD CHARACTERS WITHOUT CLAIM TO ANY PARTICULAR FONT, STYLE, SIZE, OR COLOR.

FOR GENERAL INDUSTRIAL FILTER MEDIA PRIMARILY MADE OF INORGANIC OR ORGANIC FIBERS FOR THE PURIFICATION AND FILTRATION OF AIR AND FLUIDS (U.S. CLS. 13, 21, 23, 31 AND 34).

FIRST USE 9-1-1984; IN COMMERCE 9-1-1984.

LINDA MICKLEBURGH, EXAMINING ATTORNEY

SN 77-725,632. FREE FLOW PRODUCTS, ONTARIO, CA. FILED 4-30-2009.



NO CLAIM IS MADE TO THE EXCLUSIVE RIGHT TO USE "SPAS", APART FROM THE MARK AS SHOWN.

THE MARK CONSISTS OF THE WORD "AQUATERRA" WITH THE WORD "SPAS" APPEARING BENEATH AND THE "Q" IN "AQUATERRA" FEATURING TWO SWERVING CROSSING LINES.

FOR SPAS IN THE NATURE OF HEATED POOLS (U.S. CLS. 13, 21, 23, 31 AND 34).

FIRST USE 12-31-2008; IN COMMERCE 12-31-2008.

MELVIN AXILBUND, EXAMINING ATTORNEY

CLASS 11—(Continued).

SN 77-726,106. MELLEGÅRD & NAGI AB, SKÖVDE, SWEDEN, FILED 4-30-2009.



**WATER TREATMENT
PRODUCTS**

NO CLAIM IS MADE TO THE EXCLUSIVE RIGHT TO USE "WATER TREATMENT PRODUCTS", APART FROM THE MARK AS SHOWN.

THE MARK CONSISTS OF THE LETTERS "MN" IN LOWER CASE WITH A CIRCLE CONTAINING A REPRESENTATION OF A DROP OF WATER TO THE RIGHT OF FOUR VERTICAL LINES AND SUPERIMPOSED BETWEEN THE LETTERS "M" AND "N" ALL ABOVE THE WORDS "WATER TREATMENT PRODUCTS".

FOR WATER PURIFYING APPARATUS; WATER PURIFICATION INSTALLATIONS; WATER SOFTENING APPARATUS AND INSTALLATIONS; WATER FILTERING APPARATUS; SEPARATORS FOR THE CLEANING AND PURIFICATION OF LIQUIDS; WATER TREATMENT EQUIPMENT, NAMELY, PURIFYING AND FILTRATION APPARATUS THAT RECOVER RECYCLABLE COMPONENTS FROM WATER TREATMENT RESIDUAL MATERIALS (U.S. CLS. 13, 21, 23, 31 AND 34).
ERIN FALK, EXAMINING ATTORNEY

SN 77-726,494. AMERICAN-DE ROSA LAMPARTS LLC., COMMERCE, CA. FILED 4-30-2009.

ARACRUZ

THE MARK CONSISTS OF STANDARD CHARACTERS WITHOUT CLAIM TO ANY PARTICULAR FONT, STYLE, SIZE, OR COLOR.

FOR CEILING FAN, LIGHTING FIXTURE (U.S. CLS. 13, 21, 23, 31 AND 34).
KATHLEEN LORENZO, EXAMINING ATTORNEY

SN 77-726,502. SUREFIRE, LLC, FOUNTAIN VALLEY, CA. FILED 4-30-2009.

LIGHT. DESIGNED.

THE MARK CONSISTS OF STANDARD CHARACTERS WITHOUT CLAIM TO ANY PARTICULAR FONT, STYLE, SIZE, OR COLOR.

NO CLAIM IS MADE TO THE EXCLUSIVE RIGHT TO USE "LIGHT", APART FROM THE MARK AS SHOWN.

FOR ILLUMINATION PRODUCTS, NAMELY, FLASHLIGHTS AND HEADLAMPS (U.S. CLS. 13, 21, 23, 31 AND 34).

JANICE KIM, EXAMINING ATTORNEY

CLASS 11—(Continued).

SN 77-726,507. 99 FITTINGS, LLC, VILLA PARK, CA. FILED 4-30-2009.

99 F

THE MARK CONSISTS OF STANDARD CHARACTERS WITHOUT CLAIM TO ANY PARTICULAR FONT, STYLE, SIZE, OR COLOR.

FOR PLUMBING FITTINGS, NAMELY, SHOWER SPRAYERS, SINK SPRAYERS; PLUMBING FITTINGS, NAMELY, AERATORS FOR FAUCETS; PLUMBING FITTINGS, NAMELY, BIBBS; PLUMBING FITTINGS, NAMELY, COCKS; PLUMBING FITTINGS, NAMELY, COUPLERS; PLUMBING FITTINGS, NAMELY, DRAINS; PLUMBING FITTINGS, NAMELY, FAUCET FILTERS; PLUMBING FITTINGS, NAMELY, SHOWER CONTROL VALVES; PLUMBING FITTINGS, NAMELY, SINK STRAINERS; PLUMBING FITTINGS, NAMELY, SPOUTS; PLUMBING FITTINGS, NAMELY, TRAPS; PLUMBING FITTINGS, NAMELY, TUB CONTROL VALVES; PLUMBING FITTINGS, NAMELY, VALVES (U.S. CLS. 13, 21, 23, 31 AND 34).

FIRST USE 9-10-2003; IN COMMERCE 9-10-2003.

KIMBERLY FRYE, EXAMINING ATTORNEY

SN 77-726,520. AMERICAN-DE ROSA LAMPARTS LLC., COMMERCE, CA. FILED 4-30-2009.

CAPETOWN

THE MARK CONSISTS OF STANDARD CHARACTERS WITHOUT CLAIM TO ANY PARTICULAR FONT, STYLE, SIZE, OR COLOR.

FOR CEILING FAN, LIGHTING FIXTURE (U.S. CLS. 13, 21, 23, 31 AND 34).
KATHLEEN LORENZO, EXAMINING ATTORNEY

SN 77-726,552. AMERICAN-DE ROSA LAMPARTS LLC., COMMERCE, CA. FILED 4-30-2009.

DECORAMA

THE MARK CONSISTS OF STANDARD CHARACTERS WITHOUT CLAIM TO ANY PARTICULAR FONT, STYLE, SIZE, OR COLOR.

FOR CEILING FAN, LIGHTING FIXTURE (U.S. CLS. 13, 21, 23, 31 AND 34).

KATHLEEN LORENZO, EXAMINING ATTORNEY

CLASS 11—(Continued).

SN 77-726,569. AMERICAN-DE ROSA LAMPARTS LLC.,
COMMERCE, CA. FILED 4-30-2009.

CLASS 11—(Continued).

SN 77-727,183. TOPAZ LIGHTING CORPORATION, HOLTS-
VILLE, NY. FILED 5-1-2009.

HERITAGE SQUARE

conserv-A-watt

THE MARK CONSISTS OF STANDARD CHARACTERS
WITHOUT CLAIM TO ANY PARTICULAR FONT, STYLE,
SIZE, OR COLOR.
FOR CEILING FAN, LIGHTING FIXTURE (U.S. CLS.
13, 21, 23, 31 AND 34).
KATHLEEN LORENZO, EXAMINING ATTORNEY

THE MARK CONSISTS OF STANDARD CHARACTERS
WITHOUT CLAIM TO ANY PARTICULAR FONT, STYLE,
SIZE, OR COLOR.
FOR ELECTRIC LIGHT BULBS (U.S. CLS. 13, 21, 23, 31
AND 34).
FIRST USE 4-13-2009; IN COMMERCE 4-27-2009.
ERNEST SHOSHO, EXAMINING ATTORNEY

SN 77-727,103. C. CRETORS & CO., CHICAGO, IL. FILED 5-1-
2009.

SN 77-727,204. TITAN TECHNOLOGIES INC., MIAMI, FL.
FILED 5-1-2009.

TITAN

THE MARK CONSISTS OF STYLIZED LETTER "M" AND
A STYLIZED NUMBER FIVE (5).
FOR ELECTRIC POPCORN POPPERS (U.S. CLS. 13, 21,
23, 31 AND 34).
JENNIFER DIXON, EXAMINING ATTORNEY

THE MARK CONSISTS OF STANDARD CHARACTERS
WITHOUT CLAIM TO ANY PARTICULAR FONT, STYLE,
SIZE, OR COLOR.
FOR TANKLESS WATER HEATERS (U.S. CLS. 13, 21,
23, 31 AND 34).
FIRST USE 11-1-1987; IN COMMERCE 11-1-1987.
HELENE LIWINSKI, EXAMINING ATTORNEY

SN 77-727,106. C. CRETORS & CO., CHICAGO, IL. FILED 5-1-
2009.

SN 77-727,239. SUN BD CORPORATION, WATERLOO, NY.
FILED 5-1-2009.

SunFocus

THE MARK CONSISTS OF THE WORD "MACH" IN
STYLIZED FORM WITH A STYLIZED NUMBER FIVE (5).
FOR ELECTRIC POPCORN POPPERS (U.S. CLS. 13, 21,
23, 31 AND 34).
JENNIFER DIXON, EXAMINING ATTORNEY

THE MARK CONSISTS OF STANDARD CHARACTERS
WITHOUT CLAIM TO ANY PARTICULAR FONT, STYLE,
SIZE, OR COLOR.
FOR SOLAR OVENS; HYBRID SOLAR OVENS (U.S.
CLS. 13, 21, 23, 31 AND 34).
DAWN FELDMAN, EXAMINING ATTORNEY

CLASS 11—(Continued).

SN 77-728,804. PARKER DAVIS HVAC INTERNATIONAL, INC., DBA SCHNEIDER KRUPPS ADVANCED THERMODYNAMICS CORP., MIAMI, FL. FILED 5-4-2009.

Schneider-Krupps

THE MARK CONSISTS OF STANDARD CHARACTERS WITHOUT CLAIM TO ANY PARTICULAR FONT, STYLE, SIZE, OR COLOR.

FOR AIR CONDITIONERS; AIR CONDITIONING APPARATUS; CENTRAL HEATING RADIATORS; HEAT PUMPS; HEATING SYSTEMS COMPOSED PRIMARILY OF TUBES, PIPES AND MANIFOLDS THROUGH WHICH WARM OR HIGH TEMPERATURE WATER CIRCULATES; HEATING SYSTEMS COMPOSED PRIMARILY OF TUBES, PIPES AND PRE-ASSEMBLED MANIFOLDS THROUGH WHICH COLD OR LOW TEMPERATURE WATER CIRCULATES; RADIATORS; SOLAR HEAT COLLECTION PANELS; SOLAR THERMAL AIR SYSTEMS FOR HEATING PURPOSES (U.S. CLS. 13, 21, 23, 31 AND 34).

KATHERINE CONNOLLY, EXAMINING ATTORNEY

SN 77-752,171. AS IP HOLDCO, LLC, PISCATAWAY, NJ. FILED 6-4-2009.

VENETO II

THE MARK CONSISTS OF STANDARD CHARACTERS WITHOUT CLAIM TO ANY PARTICULAR FONT, STYLE, SIZE, OR COLOR.

OWNER OF U.S. REG. NO. 2,724,317.
FOR TOILETS (U.S. CLS. 13, 21, 23, 31 AND 34).
FIRST USE 1-1-2008; IN COMMERCE 1-1-2008.
DAVID COLLIER, EXAMINING ATTORNEY

SN 77-754,110. AS IP HOLDCO, LLC, PISCATAWAY, NJ. FILED 6-8-2009.

OUTREACH

THE MARK CONSISTS OF STANDARD CHARACTERS WITHOUT CLAIM TO ANY PARTICULAR FONT, STYLE, SIZE, OR COLOR.

FOR FAUCETS (U.S. CLS. 13, 21, 23, 31 AND 34).
DAVID COLLIER, EXAMINING ATTORNEY

CLASS 11—(Continued).

SN 77-754,176. AS IP HOLDCO, LLC, PISCATAWAY, NJ. FILED 6-8-2009.

LADONIA

THE MARK CONSISTS OF STANDARD CHARACTERS WITHOUT CLAIM TO ANY PARTICULAR FONT, STYLE, SIZE, OR COLOR.

FOR FAUCETS (U.S. CLS. 13, 21, 23, 31 AND 34).
DAVID COLLIER, EXAMINING ATTORNEY

SN 77-754,981. AS IP HOLDCO, LLC, PISCATAWAY, NJ. FILED 6-9-2009.

SHEFFIELD

THE MARK CONSISTS OF STANDARD CHARACTERS WITHOUT CLAIM TO ANY PARTICULAR FONT, STYLE, SIZE, OR COLOR.

FOR FAUCETS (U.S. CLS. 13, 21, 23, 31 AND 34).
DAVID COLLIER, EXAMINING ATTORNEY

SN 77-760,804. HNI TECHNOLOGIES INC., MUSCATINE, IA. FILED 6-16-2009.

ECO-CHOICE

THE MARK CONSISTS OF STANDARD CHARACTERS WITHOUT CLAIM TO ANY PARTICULAR FONT, STYLE, SIZE, OR COLOR.

FOR FURNACE BOILERS; FURNACES; HEATING BOILERS (U.S. CLS. 13, 21, 23, 31 AND 34).
VIVIAN MICZNIK FIRST, EXAMINING ATTORNEY

CLASS 11—(Continued).

SN 77-760,971. KONINKLIJKE PHILIPS ELECTRONICS N.V., EINDHOVEN, NETHERLANDS, FILED 6-16-2009.

GULLWING

THE MARK CONSISTS OF STANDARD CHARACTERS WITHOUT CLAIM TO ANY PARTICULAR FONT, STYLE, SIZE, OR COLOR.

FOR ELECTRIC LIGHTING FIXTURES (U.S. CLS. 13, 21, 23, 31 AND 34).

FIRST USE 0-0-1997; IN COMMERCE 0-0-1997.
ASMAT KHAN, EXAMINING ATTORNEY

CLASS 11—(Continued).

SN 79-060,921. UHDE INVENTA-FISCHER GMBH, BERLIN, FED REP GERMANY, FILED 9-5-2008.

DISCAGE

THE MARK CONSISTS OF STANDARD CHARACTERS WITHOUT CLAIM TO ANY PARTICULAR FONT, STYLE, SIZE, OR COLOR.

OWNER OF INTERNATIONAL REGISTRATION 0816972 DATED 12-15-2003, EXPIRES 12-15-2013.

FOR POLYMERISATION INSTALLATIONS, NAMELY, PLANTS FOR PRODUCTION OF POLYMERS (U.S. CLS. 13, 21, 23, 31 AND 34).

WENDY JUN, EXAMINING ATTORNEY

SN 78-821,521. SUN WATER SYSTEMS, INC., FORT WORTH, TX. FILED 2-23-2006.

EQ-300

THE MARK CONSISTS OF STANDARD CHARACTERS WITHOUT CLAIM TO ANY PARTICULAR FONT, STYLE, SIZE, OR COLOR.

OWNER OF U.S. REG. NO. 3,398,399.

FOR WATER FILTERS AND WHOLE HOUSE WATER FILTRATION SYSTEMS CONSISTING OF PURIFICATION TANKS AND FIBROUS WATER FILTRATION MEDIA (U.S. CLS. 13, 21, 23, 31 AND 34).

FIRST USE 4-1-2002; IN COMMERCE 4-1-2002.
MARY BOAGNI, EXAMINING ATTORNEY

CLASS 12—VEHICLES

SN 77-429,243. AMERICAN TIRE DISTRIBUTORS, INC., HUNTERSVILLE, NC. FILED 3-24-2008.

O.E. PERFORMANCE

THE MARK CONSISTS OF STANDARD CHARACTERS WITHOUT CLAIM TO ANY PARTICULAR FONT, STYLE, SIZE, OR COLOR.

SEC. 2(F).

FOR WHEEL RIMS FOR VEHICLES (U.S. CLS. 19, 21, 23, 31, 35 AND 44).

FIRST USE 10-0-2000; IN COMMERCE 10-0-2000.
GRETTA YAO, EXAMINING ATTORNEY

SN 78-825,169. LEE, MICHAEL J, BURBANK, CA. FILED S.R. 2-28-2006; AM. P.R. 11-27-2007.

LITTON

THE MARK CONSISTS OF STANDARD CHARACTERS WITHOUT CLAIM TO ANY PARTICULAR FONT, STYLE, SIZE, OR COLOR.

SEC. 2(F).

FOR GAS AND ELECTRIC COOKING APPLIANCES, NAMELY, RANGES, MICROWAVE OVENS AND COOK-TOPS FOR COMMERCIAL OR DOMESTIC USE (U.S. CLS. 13, 21, 23, 31 AND 34).

INGA ERVIN, EXAMINING ATTORNEY

SN 77-432,730. SHANGHAI BIKO AUTOMOTIVE PART CO., LTD., JINSHAN, SHANGHAI, CHINA, FILED 3-27-2008.

BIKO

THE WORDING "BIKO" HAS NO MEANING IN ENGLISH.

FOR AIR PUMPS OF AUTOMOBILES; AUTOMOBILE CHASSIS; ENGINES FOR LAND VEHICLES; AUTOMOBILE BODIES; SUN BLINDS ADAPTED FOR AUTOMOBILES (U.S. CLS. 19, 21, 23, 31, 35 AND 44).

FIRST USE 9-20-2003; IN COMMERCE 12-15-2003.

BRENDAN MCCAULEY, EXAMINING ATTORNEY

CLASS 12—(Continued).

SN 77-455,192. YAMAHA HATSUDOKI KABUSHIKI KAISHA, SHIZUOKA-KEN, JAPAN, FILED 4-22-2008.

ADVENTURER

THE MARK CONSISTS OF STANDARD CHARACTERS WITHOUT CLAIM TO ANY PARTICULAR FONT, STYLE, SIZE, OR COLOR.

FOR GASOLINE AND ELECTRIC POWERED MOTORIZED GOLF CARTS AND TWO-SEAT LIGHT UTILITY LAND VEHICLES IN THE NATURE OF CARTS, AND STRUCTURAL PARTS THEREFORE (U.S. CLS. 19, 21, 23, 31, 35 AND 44).

MICHAEL GAAFAR, EXAMINING ATTORNEY

SN 77-488,767. UNICELL LIMITED, TORONTO, CANADA, FILED 6-2-2008.

QUICKSIDER

THE MARK CONSISTS OF STANDARD CHARACTERS WITHOUT CLAIM TO ANY PARTICULAR FONT, STYLE, SIZE, OR COLOR.

PRIORITY CLAIMED UNDER SEC. 44(D) ON CANADA APPLICATION NO. 1377490, FILED 12-27-2007, REG. NO. TMA742,477, DATED 6-23-2009, EXPIRES 6-23-2024.

FOR DELIVERY VEHICLES, NAMELY, TRUCKS AND VANS (U.S. CLS. 19, 21, 23, 31, 35 AND 44).

ANGELA DUONG, EXAMINING ATTORNEY

SN 77-506,642. LUND, INC., SUWANEE, GA. FILED 6-24-2008.

SEAMLESS VENTVISORS

THE MARK CONSISTS OF STANDARD CHARACTERS WITHOUT CLAIM TO ANY PARTICULAR FONT, STYLE, SIZE, OR COLOR.

OWNER OF U.S. REG. NOS. 1,121,806, 3,464,513 AND OTHERS.

NO CLAIM IS MADE TO THE EXCLUSIVE RIGHT TO USE "SEAMLESS", APART FROM THE MARK AS SHOWN. SEC. 2(F) VENTVISORS.

FOR SHADES AND VISORS FOR DOORS AND WINDOWS OF AUTOMOTIVE VEHICLES (U.S. CLS. 19, 21, 23, 31, 35 AND 44).

FIRST USE 8-14-2008; IN COMMERCE 8-14-2008.
ELLEN B. AWRICH, EXAMINING ATTORNEY

CLASS 12—(Continued).

SN 77-544,423. WATER BONNET MFG., INC., BRADENTON, FL. FILED 8-12-2008.



THE MARK CONSISTS OF THE WORDS "WATER" AND THE WORD "BONNET" WITH THE LETTER "B" IN THE FORM OF AN ANCHOR.

FOR (BASED ON USE IN COMMERCE) BOAT WINDSHIELDS AND WINDOWS, (BASED ON INTENT TO USE) CANVAS BOAT TOPS, BOAT CURTAINS AND FITTED BOAT COVERS (U.S. CLS. 19, 21, 23, 31, 35 AND 44).

FIRST USE 1-1-1954; IN COMMERCE 1-1-1954.
DAVID C. REIHNER, EXAMINING ATTORNEY

SN 77-555,302. MILES ELECTRIC VEHICLES, INC., SANTA MONICA, CA. FILED 8-25-2008.



THE MARK CONSISTS OF AN IMAGE OF A GASOLINE PUMP IN THE CENTER OF THE UNIVERSAL PROHIBITION SYMBOL.

FOR ELECTRIC VEHICLES, NAMELY, CARS, TRUCKS AND SEDANS (U.S. CLS. 19, 21, 23, 31, 35 AND 44).

DAVID MILLER, EXAMINING ATTORNEY

SN 77-573,007. COMMERCIAL VEHICLE GROUP, INC., NEW ALBANY, OH. FILED 9-18-2008.

GSX-3000

THE MARK CONSISTS OF STANDARD CHARACTERS WITHOUT CLAIM TO ANY PARTICULAR FONT, STYLE, SIZE, OR COLOR.

FOR VEHICLE SEATS FOR USE IN COMMERCIAL VEHICLES (U.S. CLS. 19, 21, 23, 31, 35 AND 44).

H. M. FISHER, EXAMINING ATTORNEY

CLASS 12—(Continued).

SN 77-578,134. RICKAN CORPORATION, DBA DOETSCH ENTERPRISES, EL CAJON, CA. FILED 9-24-2008.

Baja Ryder

THE MARK CONSISTS OF STANDARD CHARACTERS WITHOUT CLAIM TO ANY PARTICULAR FONT, STYLE, SIZE, OR COLOR.

FOR VEHICLE PARTS, NAMELY, SHOCK ABSORBERS (U.S. CLS. 19, 21, 23, 31, 35 AND 44).

FIRST USE 7-1-2008; IN COMMERCE 7-1-2008.
GEORGIA CARTY, EXAMINING ATTORNEY

SN 77-592,227. CHRYSLER LLC, AUBURN HILLS, MI. FILED 10-14-2008.

SIXPACK

THE MARK CONSISTS OF STANDARD CHARACTERS WITHOUT CLAIM TO ANY PARTICULAR FONT, STYLE, SIZE, OR COLOR.

FOR INTERNAL COMBUSTION ENGINES FOR AUTOMOBILES (U.S. CLS. 19, 21, 23, 31, 35 AND 44).
FONG HSU, EXAMINING ATTORNEY

SN 77-592,991. THOR TECH, INC., SAGINAW, MI. FILED 10-15-2008.

GO-KAMP

THE MARK CONSISTS OF STANDARD CHARACTERS WITHOUT CLAIM TO ANY PARTICULAR FONT, STYLE, SIZE, OR COLOR.

FOR RECREATIONAL VEHICLES, NAMELY, TRAVEL TRAILERS, FIFTH WHEEL TRAILERS AND SPORT UTILITY TRAILERS (U.S. CLS. 19, 21, 23, 31, 35 AND 44).
RICHARD A. STRASER, EXAMINING ATTORNEY

CLASS 12—(Continued).

SN 77-594,104. LIL PICK UP INC., ROWLAND HEIGHTS, CA. FILED 10-16-2008.



NO CLAIM IS MADE TO THE EXCLUSIVE RIGHT TO USE "PICKUP", APART FROM THE MARK AS SHOWN.

THE COLOR(S) LIGHT ORANGE, LIGHT GRAY, GRAY AND WHITE IS/ARE CLAIMED AS A FEATURE OF THE MARK.

THE MARK CONSISTS OF A GRAY BACKGROUND; A LIGHT ORANGE TRIANGLE WITH A GRAY SLANTED "L" SHAPE CUT-OUT IN THE MIDDLE WITH AN OPENING ON THE RIGHT SIDE OF THE TRIANGLE; THE WORDS "LIL PICKUP" APPEAR IN LIGHT GRAY AT THE BOTTOM AND FADE INTO WHITE AT THE TOP OF THE LETTERS, TO THE RIGHT TO THE TRIANGLE IN CAPITALIZED FONT; THE FONT OF "LIL" IS LARGER THAN THE FONT OF THE WORD "PICKUP".

FOR ON-ROAD AND OFF-ROAD PICK-UP TRUCKS, UTILITY TERRAIN VEHICLES (UTVS) (U.S. CLS. 19, 21, 23, 31, 35 AND 44).

ELLEN PERKINS, EXAMINING ATTORNEY

SN 77-603,242. THOR TECH, INC., SAGINAW, MI. FILED 10-29-2008.

SATELLITE

THE MARK CONSISTS OF STANDARD CHARACTERS WITHOUT CLAIM TO ANY PARTICULAR FONT, STYLE, SIZE, OR COLOR.

FOR RECREATIONAL VEHICLES, NAMELY, TRAVEL TRAILERS (U.S. CLS. 19, 21, 23, 31, 35 AND 44).

FIRST USE 0-0-2008; IN COMMERCE 0-0-2008.

RICHARD A. STRASER, EXAMINING ATTORNEY

SN 77-606,846. HONEYWELL INTERNATIONAL INC., MORRISTOWN, NJ. FILED 11-4-2008.

T-HAWK

THE MARK CONSISTS OF STANDARD CHARACTERS WITHOUT CLAIM TO ANY PARTICULAR FONT, STYLE, SIZE, OR COLOR.

FOR PORTABLE COMPACT UNMANNED AIR VEHICLE FOR SURVEILLANCE AND RECONNAISSANCE APPLICATIONS (U.S. CLS. 19, 21, 23, 31, 35 AND 44).

SHANNON TWOHIG, EXAMINING ATTORNEY

CLASS 12—(Continued).

SN 77-609,206. THOR TECH, INC., SAGINAW, MI. FILED 11-6-2008.

RETREAT

THE MARK CONSISTS OF STANDARD CHARACTERS WITHOUT CLAIM TO ANY PARTICULAR FONT, STYLE, SIZE, OR COLOR.

FOR RECREATIONAL VEHICLES, NAMELY, TRAVEL TRAILERS (U.S. CLS. 19, 21, 23, 31, 35 AND 44).

FIRST USE 0-0-2004; IN COMMERCE 0-0-2004.

RICHARD A. STRASER, EXAMINING ATTORNEY

SN 77-617,294. BRYANT HARBAUGH, YORK, PA. FILED 11-19-2008.



NO CLAIM IS MADE TO THE EXCLUSIVE RIGHT TO USE "SUSPENSION", APART FROM THE MARK AS SHOWN.

THE MARK CONSISTS OF THE STYLIZED WORDING "LOTEK SUSPENSION" WITH A CURVED LINE TO THE LEFT OF THE WORDING.

FOR SUSPENSION SYSTEMS FOR AUTOMOBILES COMPRISED OF SHOCKS, SPRINGS, AND COILS (U.S. CLS. 19, 21, 23, 31, 35 AND 44).

FIRST USE 10-30-2008; IN COMMERCE 10-30-2008.

REBECCA SMITH, EXAMINING ATTORNEY

SN 77-625,591. TBC BRANDS, LLC, LAS VEGAS, NV. FILED 12-3-2008.

TRACMASTER WINTER XSI

THE MARK CONSISTS OF STANDARD CHARACTERS WITHOUT CLAIM TO ANY PARTICULAR FONT, STYLE, SIZE, OR COLOR.

OWNER OF U.S. REG. NO. 3,199,237.

NO CLAIM IS MADE TO THE EXCLUSIVE RIGHT TO USE "WINTER", APART FROM THE MARK AS SHOWN.

FOR CAR AND LIGHT TRUCK TIRES (U.S. CLS. 19, 21, 23, 31, 35 AND 44).

MICHAEL LITZAU, EXAMINING ATTORNEY

CLASS 12—(Continued).

SN 77-637,113. SPECIALIZED BICYCLE COMPONENTS, INC., MORGAN HILL, CA. FILED 12-19-2008.

ARIEL

THE MARK CONSISTS OF STANDARD CHARACTERS WITHOUT CLAIM TO ANY PARTICULAR FONT, STYLE, SIZE, OR COLOR.

FOR BICYCLES AND BICYCLE FRAMES (U.S. CLS. 19, 21, 23, 31, 35 AND 44).

FIRST USE 7-10-2008; IN COMMERCE 7-10-2008.

PAUL E. FAHRENKOPF, EXAMINING ATTORNEY

SN 77-657,267. TRACKMOBILE, INC., LAGRANGE, GA. FILED 1-27-2009.

TRACKMOBILE PARTS GROUP

THE MARK CONSISTS OF STANDARD CHARACTERS WITHOUT CLAIM TO ANY PARTICULAR FONT, STYLE, SIZE, OR COLOR.

OWNER OF U.S. REG. NO. 1,769,972.

NO CLAIM IS MADE TO THE EXCLUSIVE RIGHT TO USE "PARTS GROUP", APART FROM THE MARK AS SHOWN.

FOR STRUCTURAL PARTS FOR MOBILE RAIL CAR MOVERS (U.S. CLS. 19, 21, 23, 31, 35 AND 44).

FIRST USE 1-5-2004; IN COMMERCE 1-5-2004.

CYNTHIA SLOAN, EXAMINING ATTORNEY

CLASS 12—(Continued).

SN 77-660,756. SPRATT CYCLE SUPPORT, INC., PONTE VEDRA BEACH, FL. FILED 1-31-2009.



OWNER OF U.S. REG. NO. 2,615,567.
 NO CLAIM IS MADE TO THE EXCLUSIVE RIGHT TO USE "CYCLES" AND "AMERICA", APART FROM THE MARK AS SHOWN.
 THE MARK CONSISTS OF A FLEUR-DE-LIS DESIGN WITH THE TERM "CYCLES" TO THE LEFT AND NEAR THE TOP OF THE DESIGN, THE TERM "MERCIER" APPEARS IN THE MIDDLE OF THE DESIGN, AND THE TERM "AMERICA" APPEARS UNDERNEATH THE DESIGN IN A CURVED FORMAT.
 FOR BICYCLES (U.S. CLS. 19, 21, 23, 31, 35 AND 44).
 FIRST USE 1-29-2009; IN COMMERCE 1-29-2009.
 CHRISTOPHER BUONGIORNO, EXAMINING ATTORNEY

SN 77-673,849. TRACKER MARINE, L.L.C., SPRINGFIELD, MO. FILED 2-19-2009.

AMERICA'S FAVORITE BOATS

THE MARK CONSISTS OF STANDARD CHARACTERS WITHOUT CLAIM TO ANY PARTICULAR FONT, STYLE, SIZE, OR COLOR.
 OWNER OF U.S. REG. NOS. 2,956,254 AND 2,997,476.
 NO CLAIM IS MADE TO THE EXCLUSIVE RIGHT TO USE "BOATS", APART FROM THE MARK AS SHOWN.
 SEC. 2(F).
 FOR BOATS (U.S. CLS. 19, 21, 23, 31, 35 AND 44).
 FIRST USE 3-0-2002; IN COMMERCE 3-0-2002.
 JULIE WATSON, EXAMINING ATTORNEY

CLASS 12—(Continued).

SN 77-684,451. CONTINENTAL TIRE DE MÉXICO, S.A. DE C.V., MÉXICO, DF, MEXICO, FILED 3-5-2009.

EUZKADI

THE MARK CONSISTS OF STANDARD CHARACTERS WITHOUT CLAIM TO ANY PARTICULAR FONT, STYLE, SIZE, OR COLOR.
 OWNER OF MEXICO REG. NO. 872203, DATED 3-15-2005, EXPIRES 10-27-2014.
 THE ENGLISH TRANSLATION OF "EUZKADI" IN THE MARK IS BASQUE.
 FOR TIRES (U.S. CLS. 19, 21, 23, 31, 35 AND 44).
 ROSELLE HERRERA, EXAMINING ATTORNEY

SN 77-688,711. DELAWARE AMERICAN MOTORS, LLC, PATERSON, NJ. FILED 3-11-2009.



NO CLAIM IS MADE TO THE EXCLUSIVE RIGHT TO USE "MOTORCYCLES", APART FROM THE MARK AS SHOWN.
 THE COLOR(S) BLACK, WHITE AND RED IS/ARE CLAIMED AS A FEATURE OF THE MARK.
 THE MARK CONSISTS OF THE CAPITAL LETTER "D", WHICH IS WHITE IN COLOR AND IS ENCLOSED IN A BLACK BOX. THE CAPITAL LETTER "A", WHICH IS WHITE IN COLOR AND IS ENCLOSED IN A RED BOX. THE CAPITAL LETTER "M", WHICH IS WHITE IN COLOR AND IS ENCLOSED IN A BLACK BOX. AND THE WORD "MOTORCYCLES" APPEARING BELOW THE BOXES.
 SEC. 2(F) AS TO "DAM MOTORCYCLES".
 FOR (BASED ON USE IN COMMERCE) MOTORCYCLES; (BASED ON INTENT TO USE) MOPEDS; MOTOR SCOOTERS; MOTORIZED SCOOTERS; SCOOTERS (U.S. CLS. 19, 21, 23, 31, 35 AND 44).
 FIRST USE 1-1-2002; IN COMMERCE 1-1-2002.
 HENRY S. ZAK, EXAMINING ATTORNEY

SN 77-698,631. MICHELIN NORTH AMERICA, INC., GREENVILLE, SC. FILED 3-25-2009.

XHA

THE MARK CONSISTS OF STANDARD CHARACTERS WITHOUT CLAIM TO ANY PARTICULAR FONT, STYLE, SIZE, OR COLOR.
 OWNER OF U.S. REG. NOS. 558,774, 1,431,032 AND OTHERS.
 FOR PNEUMATIC TIRES FOR VEHICLE WHEELS (U.S. CLS. 19, 21, 23, 31, 35 AND 44).
 ROBERT C. CLARK JR., EXAMINING ATTORNEY

CLASS 12—(Continued).

SN 77-712,891. LANCE POWERSPORTS INC., ONTARIO, CA.
FILED 4-13-2009.

Vienna

THE MARK CONSISTS OF STANDARD CHARACTERS
WITHOUT CLAIM TO ANY PARTICULAR FONT, STYLE,
SIZE, OR COLOR.

FOR MOTORCYCLES (U.S. CLS. 19, 21, 23, 31, 35 AND
44).

NICHOLAS ALTREE, EXAMINING ATTORNEY

CLASS 12—(Continued).

SN 77-721,223. TWENTIETH CENTURY FOX FILM COR-
PORATION, LOS ANGELES, CA. FILED 4-23-2009.



SN 77-717,299. MICHELIN NORTH AMERICA, INC.,
GREENVILLE, SC. FILED 4-20-2009.

XMCL

THE MARK CONSISTS OF STANDARD CHARACTERS
WITHOUT CLAIM TO ANY PARTICULAR FONT, STYLE,
SIZE, OR COLOR.

OWNER OF U.S. REG. NOS. 558,774 AND 2,574,537.

FOR PNEUMATIC TIRES FOR VEHICLE WHEELS
(U.S. CLS. 19, 21, 23, 31, 35 AND 44).

FIRST USE 5-0-2006; IN COMMERCE 1-0-2007.

ROBERT C. CLARK JR., EXAMINING ATTORNEY

OWNER OF U.S. REG. NO. 3,001,994.

THE MARK CONSISTS OF THE STYLIZED WORDS "THE
ADVENTURES OF DIGGER AND FRIENDS" WHICH
APPEAR INSIDE OF TWO OVAL CONCENTRIC LINES,
THE WORDS "FOX SPORTS" WHICH APPEAR UNDER
THE WORD "FRIENDS" AND INSIDE OF THE OVAL
SHAPE OVERLAPPING ON THE BOTTOM OF THE INNER
OVAL LINE AND FIVE COSTUMED GOPHER CHAR-
ACTERS WHICH APPEAR ABOVE THE OUTER OVAL LINE.

FOR LICENSE PLATE FRAMES; LICENSE PLATE
HOLDERS (U.S. CLS. 19, 21, 23, 31, 35 AND 44).

LINDA LAVACHE, EXAMINING ATTORNEY

SN 77-722,128. MAX LELLI, SRL, GROSSETO, ITALY, FILED
4-24-2009.

SN 77-718,393. RCR ENTERPRISES, LLC, WELCOME, NC.
FILED 4-21-2009.

31

OWNER OF U.S. REG. NO. 3,428,362.

THE MARK CONSISTS OF THE NUMBER "31" IN A
STYLIZED FORM.

FOR LICENSE PLATE FRAMES (U.S. CLS. 19, 21, 23,
31, 35 AND 44).

FIRST USE 2-9-1997; IN COMMERCE 2-9-1997.

AMY KERTGATE, EXAMINING ATTORNEY



THE MARK CONSISTS OF GRAPHIC IMAGE OF HORNS
SURROUNDING THE IMAGE OF A FACE.

FOR BICYCLES AND BICYCLE FRAMES (U.S. CLS.
19, 21, 23, 31, 35 AND 44).

FIRST USE 11-10-2007; IN COMMERCE 11-10-2007.

TARA PATE, EXAMINING ATTORNEY

CLASS 12—(Continued).

SN 77-722,686. UNICORN TIRE CORPORATION, MEMPHIS, TN. FILED 4-27-2009.

CLASS 12—(Continued).

SN 77-725,324. JOSEPH GRANNEY, DBA CHUB, SANTA CRUZ, CA. FILED 4-29-2009.

TRAVELSTAR

THE MARK CONSISTS OF STANDARD CHARACTERS WITHOUT CLAIM TO ANY PARTICULAR FONT, STYLE, SIZE, OR COLOR.
FOR TIRES (U.S. CLS. 19, 21, 23, 31, 35 AND 44).
LESLEY LAMOTHE, EXAMINING ATTORNEY



SN 77-724,635. GENERAL MOTORS COMPANY, DETROIT, MI. FILED 4-29-2009.

Z28

THE MARK CONSISTS OF STANDARD CHARACTERS WITHOUT CLAIM TO ANY PARTICULAR FONT, STYLE, SIZE, OR COLOR.
FOR MOTOR LAND VEHICLES, NAMELY, AUTOMOBILES (U.S. CLS. 19, 21, 23, 31, 35 AND 44).
SHAILA SETTLES, EXAMINING ATTORNEY



SN 77-725,022. LADD, ROBERT, A. DBA ROBB LADD YACHT DESIGN, ANNAPOLIS, MD. FILED 4-29-2009.

Skye

THE MARK CONSISTS OF STANDARD CHARACTERS WITHOUT CLAIM TO ANY PARTICULAR FONT, STYLE, SIZE, OR COLOR.
FOR BOAT HULLS; PROPELLER-DRIVEN BOATS; SAIL BOATS; VESSELS (U.S. CLS. 19, 21, 23, 31, 35 AND 44).
ODESSA BIBBINS, EXAMINING ATTORNEY

CHUB

THE MARK CONSISTS OF STANDARD CHARACTERS WITHOUT CLAIM TO ANY PARTICULAR FONT, STYLE, SIZE, OR COLOR.
FOR BICYCLE PARTS, NAMELY, WHEEL HUBS (U.S. CLS. 19, 21, 23, 31, 35 AND 44).
FIRST USE 12-31-2001; IN COMMERCE 12-31-2001.
JAY BESCH, EXAMINING ATTORNEY



SN 77-725,439. TWENTIETH CENTURY FOX FILM CORPORATION, LOS ANGELES, CA. FILED 4-29-2009.



OWNER OF U.S. REG. NO. 3,001,994.
THE MARK CONSISTS OF THE STYLIZED WORDS "THE ADVENTURES OF DIGGER AND FRIENDS" WHICH APPEAR IN THE CENTER, THE WORDS "FOX SPORTS" WHICH APPEAR INSIDE OF THE OVAL SHAPE ON THE TOP CENTER AND FIVE COSTUMED GOPHER CHARACTERS, AND ALL ARE DISPLAYED INSIDE OF THE RECTANGULAR BACKGROUND.
FOR LICENSE PLATE FRAMES; LICENSE PLATE HOLDERS (U.S. CLS. 19, 21, 23, 31, 35 AND 44).
LINDA LAVACHE, EXAMINING ATTORNEY

CLASS 12—(Continued).

SN 77-726,361. HUBERT CHEN, TAICHUNG COUNTY, TAIWAN, AND KUEI-TANG LIAO, TAICHUNG COUNTY, TAIWAN, FILED 4-30-2009.



THE MARK CONSISTS OF THE LETTERS "HGW" IN STYLIZED MANNER.

FOR BICYCLES, BICYCLE STRUCTURAL PARTS, NAMELY, ALUMINUM ALLOY HUBS, STEEL HUBS, BICYCLE HUBS, COASTER BRAKE HUBS, SKEWERS, AXLE SETS, SEAT PINS; TIRES FOR BICYCLES (U.S. CLS. 19, 21, 23, 31, 35 AND 44).

MARIAM MAHMOUDI, EXAMINING ATTORNEY

SN 77-726,795. FORD MOTOR COMPANY, DEARBORN, MI. FILED 5-1-2009.



OWNER OF U.S. REG. NO. 2,268,150.
THE MARK CONSISTS OF A DEPICTION OF A COBRA SNAKE WITH A RAISED NECK AND HEAD, AND A COILED LOWER PORTION.

FOR AUTOMOBILES, BADGES FOR VEHICLES, AUTOMOBILE WHEELS, BADGES FOR AUTOMOBILE WHEEL CENTERS (U.S. CLS. 19, 21, 23, 31, 35 AND 44).

FIRST USE 1-1-1969; IN COMMERCE 1-1-1969.
EVELYN BRADLEY, EXAMINING ATTORNEY

SN 77-728,775. HORAN, RICHARD JOSEPH, BELLE HARBOR, NY. FILED 5-4-2009.

Rollerlock

THE MARK CONSISTS OF STANDARD CHARACTERS WITHOUT CLAIM TO ANY PARTICULAR FONT, STYLE, SIZE, OR COLOR.

FOR OARLOCKS (U.S. CLS. 19, 21, 23, 31, 35 AND 44).
FIRST USE 5-4-2008; IN COMMERCE 5-4-2008.
STEVEN R. FOSTER, EXAMINING ATTORNEY

CLASS 12—(Continued).

SN 77-730,688. RANDALL PRODUCTIONS COMPANY, CLEVELAND, OH. FILED 5-6-2009.

GOTTA RIDE

THE MARK CONSISTS OF STANDARD CHARACTERS WITHOUT CLAIM TO ANY PARTICULAR FONT, STYLE, SIZE, OR COLOR.

OWNER OF U.S. REG. NO. 3,135,477.
FOR LICENSE PLATE FRAMES (U.S. CLS. 19, 21, 23, 31, 35 AND 44).

FIRST USE 4-7-2005; IN COMMERCE 4-7-2005.
SUE LAWRENCE, EXAMINING ATTORNEY

SN 77-732,215. FORD MOTOR COMPANY, DEARBORN, MI. FILED 5-8-2009.



OWNER OF U.S. REG. NOS. 1,793,586 AND 1,793,587.
THE COLOR(S) GREEN, BLACK, GRAY AND WHITE IS/ ARE CLAIMED AS A FEATURE OF THE MARK.

THE MARK CONSISTS OF A SLIGHTLY CURVED ROAD WHICH TURNS INTO A LEAF, AND A SQUARE WITH CURVED CORNERS. THE COLOR GREEN APPEARS IN THE LEAF DESIGN. THE COLORS WHITE AND GRAY APPEAR IN THE STEM OF THE LEAF, IN THE LEAF, IN THE ROAD AND IN THE SQUARE. THE COLOR BLACK APPEARS IN THE SQUARE.

FOR AUTOMOBILES AND THEIR STRUCTURAL PARTS; AUTOMOBILE ENGINES (U.S. CLS. 19, 21, 23, 31, 35 AND 44).

FIRST USE 1-17-2009; IN COMMERCE 1-17-2009.
EVELYN BRADLEY, EXAMINING ATTORNEY

CLASS 12—(Continued).

SN 77-736,048. WORKSVILLE, LLC, ENGLEWOOD, CO.
FILED 5-13-2009.

Choo Choo Wagon

THE MARK CONSISTS OF STANDARD CHARACTERS WITHOUT CLAIM TO ANY PARTICULAR FONT, STYLE, SIZE, OR COLOR.

NO CLAIM IS MADE TO THE EXCLUSIVE RIGHT TO USE "WAGON", APART FROM THE MARK AS SHOWN, FOR CHILDREN'S WAGONS (U.S. CLS. 19, 21, 23, 31, 35 AND 44).

SUE LAWRENCE, EXAMINING ATTORNEY

SN 77-977,620. DELOREAN MOTOR COMPANY, INC.,
HUMBLE, TX. FILED 7-30-2008.

DE LOREAN

THE NAME(S), PORTRAIT(S), AND/OR SIGNATURE(S) SHOWN IN THE MARK DOES NOT IDENTIFY A PARTICULAR LIVING INDIVIDUAL.

THE MARK CONSISTS OF THE STYLIZED WORD "DE LOREAN", WITH A HALF-SPACE BETWEEN THE "E" AND THE "L".

FOR AUTOMOBILES, AUTOMOBILE PARTS AND ACCESSORIES, NAMELY, FITTED CAR COVER, TRIM INSIGNIA FOR VEHICLES (U.S. CLS. 19, 21, 23, 31, 35 AND 44).

FIRST USE 7-1-1995; IN COMMERCE 7-1-1995.
CYNTHIA TRIPI, EXAMINING ATTORNEY

SN 79-055,959. BECKER MARINE SYSTEMS GMBH & CO.
KG, FED REP GERMANY, FILED 6-17-2008.

Schilling-Ruder

OWNER OF INTERNATIONAL REGISTRATION 0316645
DATED 7-12-1966, EXPIRES 7-12-2016.

THE ENGLISH TRANSLATION OF "RUDER" IS ROWING; OAR; RUDDER; OR HELM.

FOR RUDDER INSTALLATIONS, NAMELY, RUDDERS, RUDDER POSTS, RUDDER TRUNKS, RUDDER QUADRANTS, RUDDER POSITION TRANSMITTERS, RUDDER POSITION INDICATORS, RUDDER HOSE, RUDDER TAILS, RUDDER BLADES, RUDDER PINNACLES, RUDDERS WITH AND WITHOUT AN ARTICULATED FIN FOR SEA, COASTAL AND RIVER SHIPS AND STEERING GEARS (U.S. CLS. 19, 21, 23, 31, 35 AND 44).

CYNTHIA SLOAN, EXAMINING ATTORNEY

CLASS 12—(Continued).

SN 79-057,920. CAMPAGNOLO S.R.L., VICENZA (VI),
ITALY, FILED 5-6-2008.

RED PASSION

THE MARK CONSISTS OF STANDARD CHARACTERS WITHOUT CLAIM TO ANY PARTICULAR FONT, STYLE, SIZE, OR COLOR.

PRIORITY DATE OF 2-28-2008 IS CLAIMED.

OWNER OF INTERNATIONAL REGISTRATION 0974718
DATED 5-6-2008, EXPIRES 5-6-2018.

FOR BICYCLE PARTS, COMPONENTS AND ACCESSORIES, NAMELY, BICYCLE WHEELS; RIMS AND SPOKES FOR BICYCLE WHEELS; PEDALS; WHEEL HUBS FOR BICYCLES, NAMELY, HUB QUICK RELEASE DEVICES AND HUBS COMPRISING THE AFORE-MENTIONED DEVICES; REAR DERAILLEURS; FRONT DERAILLEURS; GEAR WHEELS AND SETS OF GEAR WHEELS; BICYCLE GEARS, NAMELY, PINIONS AND PINION ASSEMBLIES; FREEWHEELS; TRANSMISSION CHAINS; BRAKES; BRAKE SHOES; DISK BRAKES; CABLE GUIDES; GEAR LEVER KNOBS, NAMELY, CONTROL BUTTONS AND LEVERS; SADDLE POSTS AND SADDLES; PUMPS AND HOLDERS FOR PUMPS; SHAFTS AND BEARINGS FOR CRANKS AND FOR PEDALS; FRONT AND REAR FORKS; BOTTOM BRACKETS; BOTTOM BRACKET ASSEMBLIES; HANDLEBAR CONNECTIONS AND HANDLEBARS; RIGID AND SUSPENSION FORKS; KICKSTANDS; PNEUMATIC TIRES; TUBULAR TIRES; INNER TUBES; BEAD TIRES; RIM TAPES FOR TUBELESS TIRES; VALVES; ALL THE AFORESAID PRODUCTS DESIGNED FOR BICYCLES (U.S. CLS. 19, 21, 23, 31, 35 AND 44).

SCOTT BIBB, EXAMINING ATTORNEY

SN 79-060,698. RÁBA FUTÓMU KFT., HUNGARY, FILED 7-28-2008.

MAXS

PRIORITY DATE OF 7-21-2008 IS CLAIMED.

OWNER OF INTERNATIONAL REGISTRATION 0981535
DATED 7-28-2008, EXPIRES 7-28-2018.

THE APPLIED-FOR MARK CONSISTS OF THE STYLIZED WORDING, "MAXS" UNDERLINED WITH A DOTTED LINE.

FOR AXLE AND UNDER-CARRIAGE FOR LAND VEHICLES (U.S. CLS. 19, 21, 23, 31, 35 AND 44).

MARILYN IZZI, EXAMINING ATTORNEY

CLASS 12—(Continued).

SN 79-062,297. EUROFREN BRAKES, S.L.U., SPAIN, FILED 9-26-2008.



OWNER OF INTERNATIONAL REGISTRATION 0985419 DATED 9-26-2008, EXPIRES 9-26-2018.

THE COLOR(S) BLACK, WHITE AND RED IS/ARE CLAIMED AS A FEATURE OF THE MARK.

THE MARK CONSISTS OF THE COLOR(S) BLACK, WHITE AND RED WITH THE COLOR BLACK APPEARING IN THE BACKGROUND RECTANGLE, THE COLOR WHITE APPEARING IN THE LETTERS "WOKING" AND THE COLOR RED APPEARING IN THE HORIZONTAL "T" AND IN THE SQUARE OVER THE LETTER "H".

FOR LAND VEHICLES OTHER THAN MACHINES FOR BUILDING, SHOVEL LOADERS OR EXCAVATORS; FRICTION PADS AND BRAKE LINERS FOR BRAKES FOR LAND VEHICLES OTHER THAN LAND VEHICLES FOR BUILDING, SHOVEL LOADERS OR EXCAVATORS (U.S. CLS. 19, 21, 23, 31, 35 AND 44).

COLLEEN KEARNEY, EXAMINING ATTORNEY

CLASS 13—FIREARMS

SN 76-697,189. CLAYTON R. CAYWOOD, CEDAREGE, CO. FILED 5-4-2009.

KICKBUSTER

THE MARK CONSISTS OF STANDARD CHARACTERS WITHOUT CLAIM TO ANY PARTICULAR FONT, STYLE, SIZE, OR COLOR.

FOR FIREARM ACCESSORIES, NAMELY, RECOIL ABSORBING STRAPS FOR RIFLES, PISTOLS AND OTHER HANDHELD FIREARMS (U.S. CLS. 2 AND 9).

FIRST USE 4-15-2009; IN COMMERCE 4-15-2009.

DAVID YONTEF, EXAMINING ATTORNEY

SN 77-302,079. DPMS FIREARMS, LLC, WINDHAM, ME. FILED 10-11-2007.

PANTHER

THE MARK CONSISTS OF STANDARD CHARACTERS WITHOUT CLAIM TO ANY PARTICULAR FONT, STYLE, SIZE, OR COLOR.

FOR RIFLES (U.S. CLS. 2 AND 9).

FIRST USE 0-0-1995; IN COMMERCE 0-0-1995.

DAVID YONTEF, EXAMINING ATTORNEY

CLASS 13—(Continued).

SN 77-455,681. RANGE SYSTEMS, NEW HOPE, MN. FILED 4-23-2008.

GUARDIAN JR

THE MARK CONSISTS OF STANDARD CHARACTERS WITHOUT CLAIM TO ANY PARTICULAR FONT, STYLE, SIZE, OR COLOR.

FOR SHOOTING RANGE EQUIPMENT, NAMELY, CLEARING DEVICES FOR FIREARMS, NAMELY, BULLETPROOF CONTAINERS FOR DISCHARGING FIREARMS TO ENSURE THAT THE FIREARMS ARE CLEARED OF AMMUNITION (U.S. CLS. 2 AND 9).

FIRST USE 1-1-1999; IN COMMERCE 1-1-1999.

BRENDAN MCCAULEY, EXAMINING ATTORNEY

SN 77-456,138. RANGE SYSTEMS, NEW HOPE, MN. FILED 4-23-2008.

GUARDIAN TS

THE MARK CONSISTS OF STANDARD CHARACTERS WITHOUT CLAIM TO ANY PARTICULAR FONT, STYLE, SIZE, OR COLOR.

FOR SHOOTING RANGE EQUIPMENT, NAMELY, CLEARING DEVICES FOR FIREARMS, NAMELY, BULLETPROOF CONTAINERS FOR DISCHARGING FIREARMS TO ENSURE THAT THE FIREARMS ARE CLEARED OF AMMUNITION (U.S. CLS. 2 AND 9).

FIRST USE 1-1-1999; IN COMMERCE 1-1-1999.

BRENDAN MCCAULEY, EXAMINING ATTORNEY

SN 77-456,206. RANGE SYSTEMS, NEW HOPE, MN. FILED 4-23-2008.

GUARDIAN

THE MARK CONSISTS OF STANDARD CHARACTERS WITHOUT CLAIM TO ANY PARTICULAR FONT, STYLE, SIZE, OR COLOR.

FOR SHOOTING RANGE EQUIPMENT, NAMELY, CLEARING DEVICES FOR FIREARMS, NAMELY, BULLETPROOF CONTAINERS FOR DISCHARGING FIREARMS TO ENSURE THAT THE FIREARMS ARE CLEARED OF AMMUNITION (U.S. CLS. 2 AND 9).

FIRST USE 1-1-1999; IN COMMERCE 1-1-1999.

BRENDAN MCCAULEY, EXAMINING ATTORNEY

CLASS 13—(Continued).

SN 77-511,457. TROY INDUSTRIES, INC., WEST SPRINGFIELD, MA. FILED 6-30-2008.

TROY

THE MARK CONSISTS OF STANDARD CHARACTERS WITHOUT CLAIM TO ANY PARTICULAR FONT, STYLE, SIZE, OR COLOR.

FOR FIREARMS AND WEAPONS, NAMELY, RIFLES, REVOLVERS, PISTOLS, SEMI AND AUTOMATIC ASSAULT AND SNIPER RIFLES, CARBINES, SHOTGUNS, MACHINE GUNS, AND HANDGUNS; ACCESSORIES FOR SEMI AND AUTOMATIC FIREARMS, NAMELY, HAND GUARDS, GRIPS, RAILS, BUTT STOCK, MAGAZINES, SIGHTS, TACTILE SIGHTS, REFLEX SIGHTS, FLASHLIGHTS, SPECIFICALLY ADAPTED TO MOUNTING ON FIREARMS, AND MOUNTS FOR FIREARMS ACCESSORIES, SOUND SUPPRESSORS, NAMELY, SILENCERS FOR FIREARMS; FLASH AND BLAST SUPPRESSORS, NAMELY, FLASH GUARDS, FLASH ELIMINATORS, FLASH HIDERS, FLASH CONES OR MUZZLE BRAKES; GRENADE LAUNCHERS, MOUNTS FOR THE AFOREMENTIONED ACCESSORIES, BIPOD AND TRIPOD STANDS AND SLINGS; TRANSPORT AND PROTECTION ACCESSORIES, NAMELY, FIREARMS AND WEAPONS, NAMELY, RIFLES, REVOLVERS, PISTOLS, SEMI AND AUTOMATIC ASSAULT AND SNIPER RIFLES, CARBINES, SHOTGUNS, MACHINE GUNS, AND HANDGUNS, CARRYING CASES, COVERS AND CARRYING BAGS, SCOPE COVERS, WEAPONS, NAMELY, RIFLES, REVOLVERS, PISTOLS, SEMI AND AUTOMATIC ASSAULT AND SNIPER RIFLES, CARBINES, SHOTGUNS, MACHINE GUNS, AND HANDGUNS, CLEANING AND MAINTENANCE ACCESSORY KIT CASES (U.S. CLS. 2 AND 9).

FIRST USE 1-15-2003; IN COMMERCE 1-15-2003.
BARBARA BROWN, EXAMINING ATTORNEY

CLASS 13—(Continued).

SN 77-511,497. TROY INDUSTRIES, INC., WEST SPRINGFIELD, MA. FILED 6-30-2008.

MRF

THE MARK CONSISTS OF STANDARD CHARACTERS WITHOUT CLAIM TO ANY PARTICULAR FONT, STYLE, SIZE, OR COLOR.

FOR FIREARMS AND WEAPONS, NAMELY, RIFLES, REVOLVERS, PISTOLS, SEMI AND AUTOMATIC ASSAULT AND SNIPER RIFLES, CARBINES, SHOTGUNS, MACHINE GUNS, AND HANDGUNS; ACCESSORIES FOR SEMI AND AUTOMATIC FIREARMS, NAMELY, HAND GUARDS, GRIPS, RAILS, BUTT STOCK, MAGAZINES, SIGHTS, TACTILE SIGHTS, REFLEX SIGHTS, FLASHLIGHTS, SPECIFICALLY ADAPTED TO MOUNTING ON FIREARMS, AND MOUNTS FOR FIREARMS ACCESSORIES, SOUND SUPPRESSORS, NAMELY, SILENCERS FOR FIREARMS; FLASH AND BLAST SUPPRESSORS, NAMELY, FLASH GUARDS, FLASH ELIMINATORS, FLASH HIDERS, FLASH CONES OR MUZZLE BRAKES; GRENADE LAUNCHERS, MOUNTS FOR THE AFOREMENTIONED ACCESSORIES, BIPOD AND TRIPOD STANDS AND SLINGS; TRANSPORT AND PROTECTION ACCESSORIES, NAMELY, FIREARMS AND WEAPONS CARRYING CASES, COVERS AND CARRYING BAGS, SCOPE COVERS, WEAPONS SLINGS, FIREARM AND WEAPON CLEANING AND MAINTENANCE ACCESSORY KIT CASES (U.S. CLS. 2 AND 9).

FIRST USE 12-1-2003; IN COMMERCE 12-1-2003.
BARBARA BROWN, EXAMINING ATTORNEY

SN 77-604,718. O.F. MOSSBERG & SONS, INC., NORTH HAVEN, CT. FILED 10-31-2008.



THE MARK CONSISTS OF A LIGHTNING BOLT. FOR TRIGGER SYSTEMS FOR FIREARMS COMPRISED OF A SPECIALIZED TRIGGER, TRIGGER BLADE, TRIGGER GUARD AND TRIGGER ADJUSTMENT SYSTEM (U.S. CLS. 2 AND 9).

LINDA LAVACHE, EXAMINING ATTORNEY

CLASS 13—(Continued).

SN 77-714,419. MACE SECURITY INTERNATIONAL, INC., BENNINGTON, VT. FILED 4-15-2009.

MACE KEYGUARD SELF DEFENSE SPRAY

THE MARK CONSISTS OF STANDARD CHARACTERS WITHOUT CLAIM TO ANY PARTICULAR FONT, STYLE, SIZE, OR COLOR.

OWNER OF U.S. REG. NOS. 888,911, 2,010,600 AND OTHERS.

NO CLAIM IS MADE TO THE EXCLUSIVE RIGHT TO USE "SELF DEFENSE SPRAY", APART FROM THE MARK AS SHOWN.

FOR TEAR GAS DISPENSERS SOLD AS AN INTEGRAL PART OF A KEY RING (U.S. CLS. 2 AND 9).

KOURTNEE HODGES, EXAMINING ATTORNEY

SN 77-715,607. SOFT AIR USA, GRAPEVINE, TX. FILED 4-16-2009.

BAX

THE MARK CONSISTS OF STANDARD CHARACTERS WITHOUT CLAIM TO ANY PARTICULAR FONT, STYLE, SIZE, OR COLOR.

FOR FIREARM AIMING SYSTEM COMPRISED OF NON TELESCOPIC INTERNAL ADJUSTMENT KNOBS WHICH CHANGE THE TRAJECTORY OF THE PROJECTILE (U.S. CLS. 2 AND 9).

KRISTIN DAHLING, EXAMINING ATTORNEY

SN 77-723,008. MACE SECURITY INTERNATIONAL, INC., BENNINGTON, VT. FILED 4-27-2009.

THE MACE BLASTER

THE MARK CONSISTS OF STANDARD CHARACTERS WITHOUT CLAIM TO ANY PARTICULAR FONT, STYLE, SIZE, OR COLOR.

OWNER OF U.S. REG. NOS. 888,911, 2,010,600 AND OTHERS.

FOR PERSONAL AEROSOL DEFENSE SPRAY (U.S. CLS. 2 AND 9).

KOURTNEE HODGES, EXAMINING ATTORNEY

CLASS 14—JEWELRY

SN 77-067,040. SPIN MASTER LTD., TORONTO, ONTARIO, CANADA, FILED 12-19-2006.

AQUA DOTS

THE MARK CONSISTS OF STANDARD CHARACTERS WITHOUT CLAIM TO ANY PARTICULAR FONT, STYLE, SIZE, OR COLOR.

PRIORITY CLAIMED UNDER SEC. 44(D) ON CANADA APPLICATION NO. 1325030, FILED 11-21-2006, REG. NO. TMA739112, DATED 4-29-2009, EXPIRES 4-29-2024.

NO CLAIM IS MADE TO THE EXCLUSIVE RIGHT TO USE "AQUA", APART FROM THE MARK AS SHOWN.

FOR ARTS AND CRAFT KITS FOR CREATING JEWELRY OBJECTS FROM BEADS, NAMELY, PEN LIKE DISPENSERS FOR BEADS, ACCESSORIES FOR HOLDING CRAFTS CREATED FROM BEADS (U.S. CLS. 2, 27, 28 AND 50).

TINA BROWN, EXAMINING ATTORNEY

SN 77-153,863. CASIO KEISANKI KABUSHIKI KAISHA., DBA CASIO COMPUTER CO., LTD., TOKYO, JAPAN, FILED 4-11-2007.

Baby-G

THE MARK CONSISTS OF STANDARD CHARACTERS WITHOUT CLAIM TO ANY PARTICULAR FONT, STYLE, SIZE, OR COLOR.

FOR ELECTRONIC WATCHES AND CLOCKS (U.S. CLS. 2, 27, 28 AND 50).

FIRST USE 12-0-1994; IN COMMERCE 9-0-1995.

BRIDGETT SMITH, EXAMINING ATTORNEY

SN 77-373,583. TAUGNER, STEPHANIE A, INDIANAPOLIS, IN. FILED 1-16-2008.

raining blue

THE MARK CONSISTS OF STANDARD CHARACTERS WITHOUT CLAIM TO ANY PARTICULAR FONT, STYLE, SIZE, OR COLOR.

FOR BRACELETS; GEMSTONE JEWELRY; JEWELRY; JEWELRY FOR THE HEAD; RINGS; BRONZE JEWELRY; BROOCHES; COSTUME JEWELRY; DIAMOND JEWELRY; JEWELRY AND IMITATION JEWELRY; JEWELRY PINS FOR USE ON HATS; LAPEL PINS; PINS BEING JEWELRY; RINGS BEING JEWELRY; CHARMS (U.S. CLS. 2, 27, 28 AND 50).

FIRST USE 11-1-2007; IN COMMERCE 11-1-2007.

SHANNON TWOHIG, EXAMINING ATTORNEY

CLASS 14—(Continued).

SN 77-420,038. MILOR S.R.L., MILANO, ITALY, FILED 3-12-2008.



NO CLAIM IS MADE TO THE EXCLUSIVE RIGHT TO USE "ETRUSCA", APART FROM THE MARK AS SHOWN.

THE MARK CONSISTS OF THE WORD "ETRUSCA" IN FANCIFUL LETTERS WITH A SWIRL DESIGN APPEARING ABOVE THE WORD.

THE FOREIGN WORDING IN THE MARK TRANSLATES INTO ENGLISH AS ESTRUSCAN.

FOR JEWELRY, NAMELY, ANKLE BRACELETS, BEADS FOR USE IN THE MANUFACTURE OF JEWELRY, BRACELETS, BRACELETS OF PRECIOUS METAL, BROOCHES, CHARMS, CHOKERS, CLIP EARRINGS, EAR CLIPS, EAR STUDS, EARRINGS, IDENTIFICATION BRACELETS, JEWEL CHAINS, JEWEL PENDANTS, CHAINS, WATCHES, AMULETS, CROSSES, PRECIOUS METAL PLATED REAL LEAVES AND FLOWERS, LAPEL PINS, MEDALLIONS, NECK CHAINS, NECKLACES, PEARLS, PENDANTS, PINS; PRECIOUS METAL ALLOYS, PRECIOUS METALS AND THEIR ALLOYS, NAMELY, GOLD AND SILVER, PRECIOUS STONES, RINGS BEING JEWELRY, SEMI-PRECIOUS GEMSTONES, SEMI-WROUGHT PRECIOUS STONES AND THEIR IMITATIONS, SILVER AND ITS ALLOYS, SINTERED DIAMONDS, SYNTHETIC DIAMONDS, TIMEPIECES, GOLD ALLOY INGOTS, GOLD AND ITS ALLOYS; HOROLOGICAL AND CHRONOMETRIC INSTRUMENTS AND CASES, CASES FOR CLOCKS AND WATCH-MAKING, HOROLOGICAL AND CHRONOMETRIC INSTRUMENTS AND PARTS THEREOF, WATCH BANDS, WATCH BANDS AND STRAPS, WATCH BRACELETS, WATCH CASES, WATCH CHAINS, WATCH STRAPS MADE OF METAL OR LEATHER OR PLASTIC, WATCHES, WEDDING BANDS, WRIST WATCHES, WRISTWATCHES (U.S. CLS. 2, 27, 28 AND 50).

RONALD AIKENS, EXAMINING ATTORNEY

SN 77-500,935. GOLDFELLOW, LLC, WESTON, FL. FILED 6-17-2008.



OWNER OF U.S. REG. NOS. 3,567,714 AND 3,597,410. NO CLAIM IS MADE TO THE EXCLUSIVE RIGHT TO USE "GOLD", APART FROM THE MARK AS SHOWN.

THE NAME(S), PORTRAIT(S), AND/OR SIGNATURE(S) SHOWN IN THE MARK DOES NOT IDENTIFY A PARTICULAR LIVING INDIVIDUAL.

THE MARK CONSISTS OF THE WORDS "GOLD" AND "FELLOW", WITH AN IMAGE OF MAN IN BETWEEN THESE TWO WORDS.

FOR JEWELRY MADE, IN WHOLE OR IN PART, OF GOLD (U.S. CLS. 2, 27, 28 AND 50).

FIRST USE 4-8-2007; IN COMMERCE 1-8-2008. TARA PATE, EXAMINING ATTORNEY

CLASS 14—(Continued).

SN 77-558,045. SUN DIAMOND, INC., DBA SUN SOURCE, NEW YORK, NY. FILED 8-28-2008.

N2F

THE MARK CONSISTS OF STANDARD CHARACTERS WITHOUT CLAIM TO ANY PARTICULAR FONT, STYLE, SIZE, OR COLOR.

FOR JEWELRY AND WATCHES (U.S. CLS. 2, 27, 28 AND 50).

FONG HSU, EXAMINING ATTORNEY

SN 77-581,718. BRIGHT SILVER INC., LOS ANGELES, CA. FILED 9-29-2008.

BRIGHT

THE MARK CONSISTS OF STANDARD CHARACTERS WITHOUT CLAIM TO ANY PARTICULAR FONT, STYLE, SIZE, OR COLOR.

FOR JEWELRY; JEWELRY CASES; RINGS (U.S. CLS. 2, 27, 28 AND 50).

FIRST USE 8-0-2008; IN COMMERCE 8-0-2008. GINA FINK, EXAMINING ATTORNEY

SN 77-592,996. PININFARINA EXTRA S.R.L., TORINO, ITALY, FILED 10-15-2008.



OWNER OF ITALY REG. NO. 445807, DATED 9-15-1986, RENEWED AS REG. NO. 445807, DATED 5-22-2006, EXPIRES 7-11-2016.

OWNER OF U.S. REG. NOS. 1,854,151, 3,488,980 AND OTHERS.

THE MARK CONSISTS OF THE LETTER "F" STYLIZED AND THE WORD "PININFARINA" STYLIZED BOTH CONTAINED IN A RECTANGLE BOX.

FOR WATCHES, CLOCKS, CHRONOMETERS (U.S. CLS. 2, 27, 28 AND 50).

KATHRYN COWARD, EXAMINING ATTORNEY

CLASS 14—(Continued).

SN 77-595,721. ERWIN, RAINEY D, DBA RAIN E. LTD, NEW YORK, NY. FILED 10-19-2008.

RDNY

THE MARK CONSISTS OF STANDARD CHARACTERS WITHOUT CLAIM TO ANY PARTICULAR FONT, STYLE, SIZE, OR COLOR.

FOR BRACELETS; JEWELRY; JEWELRY CHAINS; JEWELRY, NAMELY, STONE PENDANTS (U.S. CLS. 2, 27, 28 AND 50).

FIRST USE 9-1-2008; IN COMMERCE 9-1-2008.

SETH A. RAPPAPORT, EXAMINING ATTORNEY

SN 77-596,797. CASIO KEISANKI KABUSHIKI KAISHA, DBA CASIO COMPUTER CO., LTD., SHIBUYA-KU, TOKYO, JAPAN, FILED 10-21-2008.

g-shock mini

THE MARK CONSISTS OF STANDARD CHARACTERS WITHOUT CLAIM TO ANY PARTICULAR FONT, STYLE, SIZE, OR COLOR.

OWNER OF U.S. REG. NO. 1,399,344.

NO CLAIM IS MADE TO THE EXCLUSIVE RIGHT TO USE "MINI", APART FROM THE MARK AS SHOWN.

FOR TIMEPIECES; CLOCKS; ELECTRONIC WATCHES; WRIST WATCHES (U.S. CLS. 2, 27, 28 AND 50).

MICHELE SWAIN, EXAMINING ATTORNEY

SN 77-597,309. TIE RACK TRADING LIMITED, BRENTFORD, MIDDLESEX, UNITED KINGDOM, FILED 10-21-2008.



PRIORITY CLAIMED UNDER SEC. 44(D) ON UNITED KINGDOM APPLICATION NO. 2497492, FILED 9-11-2008.

OWNER OF U.S. REG. NOS. 1,484,209, 1,486,947 AND 2,484,597.

NO CLAIM IS MADE TO THE EXCLUSIVE RIGHT TO USE "TIE" AND "LONDON", APART FROM THE MARK AS SHOWN.

THE COLOR(S) BROWN, ORANGE, AND WHITE IS/ARE CLAIMED AS A FEATURE OF THE MARK.

THE MARK CONSISTS OF A BROWN RECTANGULAR BOX WITH AN ORANGE BORDER. INSIDE THE BOX, ON THE FIRST LINE, THE WORDS "TIE RACK" APPEAR CENTERED, IN ALL CAPITAL WHITE LETTERS. DIRECTLY BELOW THE WORDS "TIE RACK" THE WORD "LONDON" APPEARS CENTERED, IN ALL CAPITAL WHITE LETTERS.

FOR JEWELRY, NAMELY, TIE PINS, TIE CLIPS AND CUFF LINKS (U.S. CLS. 2, 27, 28 AND 50).

MICHAEL GAAFAR, EXAMINING ATTORNEY

CLASS 14—(Continued).

SN 77-605,122. JEMERC, INC., HUNTINGTON, NY. FILED 10-31-2008.

COMMUNICATE APPRECIATE VALIDATE

THE MARK CONSISTS OF STANDARD CHARACTERS WITHOUT CLAIM TO ANY PARTICULAR FONT, STYLE, SIZE, OR COLOR.

OWNER OF U.S. REG. NOS. 2,836,006 AND 2,858,590.

FOR JEWELRY (U.S. CLS. 2, 27, 28 AND 50).

TARA PATE, EXAMINING ATTORNEY

SN 77-606,756. TRANS FINE JEWELRY, INC., DBA HUNG PHAT DIAMONDS & JEWELRY, SAN JOSE, CA. FILED 11-4-2008.

HUNG PHÁT

Diamonds & Jewelry

 The logo for HUNG PHAT Diamonds & Jewelry features the name "HUNG PHAT" in a bold, pink, sans-serif font. Below it, the words "Diamonds & Jewelry" are written in a smaller, pink, cursive font. To the right of the text is a stylized pink outline of a diamond.

NO CLAIM IS MADE TO THE EXCLUSIVE RIGHT TO USE "DIAMONDS & JEWELRY", APART FROM THE MARK AS SHOWN.

THE COLOR(S) HOT PINK FONTS WITH WHITE BACKGROUND IS/ARE CLAIMED AS A FEATURE OF THE MARK.

THE MARK CONSISTS OF THE TERM "HUNG PHAT DIAMONDS & JEWELRY" WITH THE DESIGN OF A DIAMOND AFTER THE LITERAL PORTION ALL IN HOT PINK WITH A WHITE BACKGROUND.

THE ENGLISH TRANSLATION OF "HUNG PHAT" IN THE MARK IS THRIVING PROSPERITY.

FOR BEADS FOR USE IN THE MANUFACTURE OF JEWELRY; BRACELETS; BRONZE JEWELRY; BROOCHES; CHARMS; COSTUME JEWELRY; CUT DIAMONDS; DIAMOND; DIAMOND JEWELRY; GEMSTONE JEWELRY; IDENTIFICATION BRACELETS; JEWELRY; JEWELRY AND IMITATION JEWELRY; JEWELRY BOXES; JEWELRY BOXES OF PRECIOUS METAL; JEWELRY CHAINS; JEWELRY FOR ATTACHMENT TO CLOTHING; JEWELRY FOR THE HEAD; JEWELRY IN THE NATURE OF ARMBANDS; JEWELRY PINS FOR USE ON HATS; JEWELRY RING HOLDERS; JEWELRY TO BE AFFIXED TO BIKINIS; JEWELRY WATCHES; JEWELRY, NAMELY, AMULETS; JEWELRY, NAMELY, ANKLETS; JEWELRY, NAMELY, CROSSES; JEWELRY, NAMELY, STONE PENDANTS; LAPEL PINS; LEATHER JEWELRY AND ACCESSORY BOXES; PET JEWELRY; PINS BEING JEWELRY; RINGS; WATCHES AND JEWELRY; WATCHES, CLOCKS; JEWELRY AND IMITATION JEWELRY (U.S. CLS. 2, 27, 28 AND 50).

FIRST USE 10-10-2008; IN COMMERCE 10-10-2008.

CAROLINE WOOD, EXAMINING ATTORNEY

CLASS 14—(Continued).

SN 77-608,651. TRAN, HUNG K., DBA CONTINENTAL PRECIOUS METALS, INC., SAN JOSE, CA. FILED 11-6-2008.

VANG RONG PHUNG

THE MARK CONSISTS OF STANDARD CHARACTERS WITHOUT CLAIM TO ANY PARTICULAR FONT, STYLE, SIZE, OR COLOR.

NO CLAIM IS MADE TO THE EXCLUSIVE RIGHT TO USE "VANG", APART FROM THE MARK AS SHOWN.

THE ENGLISH TRANSLATION OF "VANG RONG PHUNG" IN THE MARK IS GOLD DRAGON PHOENIX.

FOR GOLD; GOLD ALLOY INGOTS; GOLD AND ITS ALLOYS; GOLD INGOTS; GOLD, UNWORKED OR SEMI-WORKED; PRECIOUS METALS AND THEIR ALLOYS, NAMELY, GOLD; PRECIOUS METALS, NAMELY, GOLD (U.S. CLS. 2, 27, 28 AND 50).

FIRST USE 8-0-1995; IN COMMERCE 11-0-1995.
MARK SPARACINO, EXAMINING ATTORNEY

SN 77-621,035. ANA CAVALHEIRO FINE JEWELRY LLC, SANTA MONICA, CA. FILED 11-24-2008.



THE MARK IS ALL IN BLACK COLOR AND CONSISTS OF TWO CONCENTRIC CIRCLES THAT SHARE THE SAME CENTER WHERE THE LETTERS "AC" ARE. THE LETTER "A" AND "C" DO NOT SHARE THE SAME LINE, THE "A" IS UP AND THE "C" IS DOWN. IN BETWEEN THE TWO CIRCLES THERE ARE FOUR FIVE POINTED STARS POSITIONED IN THE CARDINAL POINTS.

FOR JEWELRY (U.S. CLS. 2, 27, 28 AND 50).
FIRST USE 6-30-2008; IN COMMERCE 6-30-2008.
JAMES GRIFFIN, EXAMINING ATTORNEY

CLASS 14—(Continued).

SN 77-633,510. SULLIVAN, NANCY, REDDING, CA. FILED 12-15-2008.



NO CLAIM IS MADE TO THE EXCLUSIVE RIGHT TO USE "PEARL", APART FROM THE MARK AS SHOWN.

THE MARK CONSISTS OF THE STYLIZED WORDS "PEARL DELIGHTS". IN BETWEEN THE STYLIZED WORDS IS AN IMAGE OF A PEARL INSIDE A SHELL. STYLIZED DESIGNS BELOW THE STYLIZED WORDS.

FOR JEWELRY (U.S. CLS. 2, 27, 28 AND 50).
FIRST USE 2-28-2007; IN COMMERCE 12-19-2008.
INGA ERVIN, EXAMINING ATTORNEY

SN 77-693,581. BOEING MANAGEMENT COMPANY, SEAL BEACH, CA. FILED 3-18-2009.

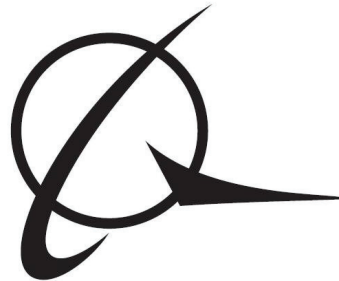

OWNER OF U.S. REG. NOS. 2,243,668, 2,314,885 AND OTHERS.

THE MARK CONSISTS OF A SINGLE LINE CIRCLE INTERSECTED BY A CURVED LINE AND ALSO INTERSECTED BY A TRIANGLE WITH ONE CURVED SIDE, WITH THE CIRCLE SUGGESTING THE GLOBE, THE CURVED LINE SUGGESTING AN ORBIT, AND THE TRIANGLE SUGGESTING AN AIRPLANE OR AIRCRAFT.

FOR WATCHES; CLOCKS; ALARM CLOCKS; LAPEL PINS (U.S. CLS. 2, 27, 28 AND 50).
FIRST USE 2-23-2009; IN COMMERCE 2-23-2009.
GEORGE LORENZO, EXAMINING ATTORNEY

SN 77-696,309. DALES INC, AKA DALES DIAMOND STORE, NEW YORK, NY. FILED 3-21-2009.

DALES

THE MARK CONSISTS OF STANDARD CHARACTERS WITHOUT CLAIM TO ANY PARTICULAR FONT, STYLE, SIZE, OR COLOR.

FOR DIAMOND JEWELRY (U.S. CLS. 2, 27, 28 AND 50).

FIRST USE 8-0-2003; IN COMMERCE 8-0-2003.
EUGENIA MARTIN, EXAMINING ATTORNEY

CLASS 14—(Continued).

SN 77-707,313. PETRONELLA, LYNN, SCOTTSDALE, AZ.
FILED 4-6-2009.



THE MARK CONSISTS OF THE STYLIZED TEXT "WORLD'S GREATEST ACHIEVEMENT BIRTH". INSIDE THERE IS A LADY HOLDING A BABY IN HER ARMS WITH A LAUREL WREATH ON MOTHERS HEAD.
FOR COLLECTIBLE COINS; JEWELRY; MEDALS AND MEDALLIONS (U.S. CLS. 2, 27, 28 AND 50).
FIRST USE 11-1-2003; IN COMMERCE 11-1-2003.
BRIAN PINO, EXAMINING ATTORNEY

SN 77-714,951. FIERSTEIN, MICHAEL HARRIS, DBA KRYPTON WATCH COMPANY, SANTA MONICA, CA. FILED 4-16-2009.

KRYPTOLITE

THE MARK CONSISTS OF STANDARD CHARACTERS WITHOUT CLAIM TO ANY PARTICULAR FONT, STYLE, SIZE, OR COLOR.
FOR WATCH DIALS FEATURING KRYPTON GAS FOR USE BY LAW ENFORCEMENT AND THE MILITARY (U.S. CLS. 2, 27, 28 AND 50).
FIRST USE 3-4-2000; IN COMMERCE 3-4-2000.
G. MAYERSCHOFF, EXAMINING ATTORNEY

SN 77-716,912. EMILEE S. ELDER, DBA EM'S GEMS, DUNCANVILLE, PA. FILED 4-18-2009.

Em's Gems

THE MARK CONSISTS OF STANDARD CHARACTERS WITHOUT CLAIM TO ANY PARTICULAR FONT, STYLE, SIZE, OR COLOR.
NO CLAIM IS MADE TO THE EXCLUSIVE RIGHT TO USE "GEMS", APART FROM THE MARK AS SHOWN.
FOR JEWELRY (U.S. CLS. 2, 27, 28 AND 50).
FIRST USE 9-1-1992; IN COMMERCE 9-1-1992.
RENEE MCCRAY, EXAMINING ATTORNEY

CLASS 14—(Continued).

SN 77-718,388. RCR ENTERPRISES, LLC, WELCOME, NC.
FILED 4-21-2009.

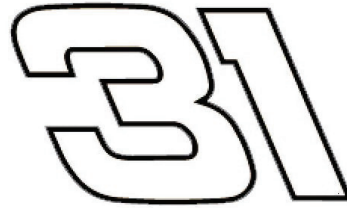

OWNER OF U.S. REG. NO. 3,428,362.
THE MARK CONSISTS OF THE NUMBER "31" IN A STYLIZED FORM.
FOR ORNAMENTAL PINS (U.S. CLS. 2, 27, 28 AND 50).
FIRST USE 2-9-1997; IN COMMERCE 2-9-1997.
AMY KERTGATE, EXAMINING ATTORNEY

SN 77-721,648. K&M ASSOCIATES, L.P., PROVIDENCE, RI.
FILED 4-24-2009.

CHARMED STYLE

THE MARK CONSISTS OF STANDARD CHARACTERS WITHOUT CLAIM TO ANY PARTICULAR FONT, STYLE, SIZE, OR COLOR.
FOR JEWELRY (U.S. CLS. 2, 27, 28 AND 50).
BRIAN PINO, EXAMINING ATTORNEY

SN 77-722,132. CRUZ, SHARI, POUGHKEEPSIE, NY. AND CRUZ, AURELIO, POUGHKEEPSIE, NY. FILED 4-24-2009.

Broken Pieces

THE MARK CONSISTS OF STANDARD CHARACTERS WITHOUT CLAIM TO ANY PARTICULAR FONT, STYLE, SIZE, OR COLOR.
FOR JEWELRY (U.S. CLS. 2, 27, 28 AND 50).
FIRST USE 12-1-2005; IN COMMERCE 12-1-2005.
MARIAM MAHMOUDI, EXAMINING ATTORNEY

CLASS 14—(Continued).

SN 77-723,842. NORMAL WATCHES LLC, NORMAL, IL.
FILED 4-28-2009.

Normal Watches

THE MARK CONSISTS OF STANDARD CHARACTERS WITHOUT CLAIM TO ANY PARTICULAR FONT, STYLE, SIZE, OR COLOR.

FOR WATCHES (U.S. CLS. 2, 27, 28 AND 50).
FIRST USE 11-15-2007; IN COMMERCE 3-15-2008.
HANNO RITTNER, EXAMINING ATTORNEY

SN 77-725,174. ROYAL CHAIN INC., NEW YORK, NY.
FILED 4-29-2009.

ENDLESS EMOTIONS

THE MARK CONSISTS OF STANDARD CHARACTERS WITHOUT CLAIM TO ANY PARTICULAR FONT, STYLE, SIZE, OR COLOR.

FOR JEWELRY, NAMELY, RINGS, BROOCHES, EARRINGS, NECKLACES, PINS, CHAINS, PENDANTS, BRACELETS, CHARMS (U.S. CLS. 2, 27, 28 AND 50).
CHRISTINA SOBRAL, EXAMINING ATTORNEY

SN 77-725,680. DENYSE CREESY, BEVERLY, MA. FILED 4-30-2009.

UE

THE MARK CONSISTS OF STANDARD CHARACTERS WITHOUT CLAIM TO ANY PARTICULAR FONT, STYLE, SIZE, OR COLOR.

FOR JEWELRY (U.S. CLS. 2, 27, 28 AND 50).
JIM RINGLE, EXAMINING ATTORNEY

CLASS 14—(Continued).

SN 77-726,034. CROSSROADS REHABILITATION CENTER, INC., DBA EASTER SEALS CROSSROADS REHABILITATION CENTER, INDIANAPOLIS, IN. FILED 4-30-2009.



THE MARK CONSISTS OF AN ARTISTIC RENDERING OF A GROWN PERSON BEING HUGGED BY A CHILD, WHERE THE BODY OF THE GROWN PERSON IS OUTLINED BY TWO CURVED LINES AND THE GROWN PERSON'S HEAD APPEARS AS A CIRCLE AND THE CHILD'S ARMS ARE OUTLINED BY A CURVED LINE AND THE CHILD'S HEAD APPEARS AS A CIRCLE.

FOR JEWELRY (U.S. CLS. 2, 27, 28 AND 50).
DAVID COLLIER, EXAMINING ATTORNEY

SN 77-726,338. BRILLIANT JEWELERS/MJJ INC., NEW YORK, NY. FILED 4-30-2009.

BAND-ABILITIES

THE MARK CONSISTS OF STANDARD CHARACTERS WITHOUT CLAIM TO ANY PARTICULAR FONT, STYLE, SIZE, OR COLOR.

FOR JEWELRY (U.S. CLS. 2, 27, 28 AND 50).
FIRST USE 11-30-2008; IN COMMERCE 11-30-2008.
RENEE SERVANCE, EXAMINING ATTORNEY

SN 77-726,537. INFINITI GROUP INTERNATIONAL, INC., DES PLAINES, IL. FILED 4-30-2009.

SMART TIME

THE MARK CONSISTS OF STANDARD CHARACTERS WITHOUT CLAIM TO ANY PARTICULAR FONT, STYLE, SIZE, OR COLOR.

NO CLAIM IS MADE TO THE EXCLUSIVE RIGHT TO USE "TIME", APART FROM THE MARK AS SHOWN.
FOR CLOCKS (U.S. CLS. 2, 27, 28 AND 50).
JOHN WILKE, EXAMINING ATTORNEY

CLASS 14—(Continued).

SN 77-726,541. INFINITI GROUP INTERNATIONAL, INC.,
DES PLAINES, IL. FILED 4-30-2009.

SMARTTIME

THE MARK CONSISTS OF STANDARD CHARACTERS
WITHOUT CLAIM TO ANY PARTICULAR FONT, STYLE,
SIZE, OR COLOR.

FOR CLOCKS (U.S. CLS. 2, 27, 28 AND 50).
JOHN WILKE, EXAMINING ATTORNEY

SN 77-726,766. THE BELL GROUP, AKA RIO GRANDE,
ALBUQUERQUE, NM. FILED 5-1-2009.

Dexterity clasp

THE MARK CONSISTS OF STANDARD CHARACTERS
WITHOUT CLAIM TO ANY PARTICULAR FONT, STYLE,
SIZE, OR COLOR.

NO CLAIM IS MADE TO THE EXCLUSIVE RIGHT TO
USE "CLASP", APART FROM THE MARK AS SHOWN.

FOR JEWELRY (U.S. CLS. 2, 27, 28 AND 50).
GISELLE AGOSTO, EXAMINING ATTORNEY

SN 77-727,118. STERLING JEWELERS INC., AKRON, OH.
FILED 5-1-2009.

IF YOUR HEART IS OPEN,
LOVE WILL ALWAYS FIND ITS
WAY IN.

THE MARK CONSISTS OF STANDARD CHARACTERS
WITHOUT CLAIM TO ANY PARTICULAR FONT, STYLE,
SIZE, OR COLOR.

FOR JEWELRY (U.S. CLS. 2, 27, 28 AND 50).
FIRST USE 11-1-2008; IN COMMERCE 11-1-2008.
DAVID HOFFMAN, EXAMINING ATTORNEY

CLASS 14—(Continued).

SN 77-727,192. GENENDER, KENNETH, NORTHBROOK, IL.
FILED 5-1-2009.

DEPOLLIER

THE MARK CONSISTS OF STANDARD CHARACTERS
WITHOUT CLAIM TO ANY PARTICULAR FONT, STYLE,
SIZE, OR COLOR.

FOR (BASED ON USE IN COMMERCE) DRESS
WATCHES (BASED ON INTENT TO USE) CASES FOR
WATCHES AND CLOCKS; CHRONOGRAPHS FOR USE
AS WATCHES; CHRONOMETRIC INSTRUMENTS AND
WATCH MOVEMENTS; CLOCK AND WATCH HANDS;
CLOCKS AND WATCHES; CLOCKS AND WATCHES
FOR PIGEON-FANCIERS; COMPLICATION WATCHES;
DIALS FOR CLOCK-AND-WATCH-MAKING; DIVING
WATCHES; JEWELLERY AND WATCHES; PARTS FOR
WATCHES; POCKET WATCHES; WATCH BANDS;
WATCH BANDS AND STRAPS; WATCH BOXES;
WATCH BRACELETS; WATCH CASES; WATCH CLASPS;
WATCH CROWNS; WATCH FACES; WATCH MOVEMENTS;
WATCH PARTS; WATCH STRAPS MADE OF
METAL OR LEATHER OR PLASTIC; WATCHES AND
JEWELRY; WATCHES, CLOCKS (U.S. CLS. 2, 27, 28 AND
50).

FIRST USE 4-21-2009; IN COMMERCE 5-1-2009.
BRIAN CALLAGHAN, EXAMINING ATTORNEY

SN 77-727,408. SKELETAL METAL, LLC, HENDERSON, NV.
FILED 5-1-2009.

SKM

THE MARK CONSISTS OF STANDARD CHARACTERS
WITHOUT CLAIM TO ANY PARTICULAR FONT, STYLE,
SIZE, OR COLOR.

FOR JEWELRY (U.S. CLS. 2, 27, 28 AND 50).
FIRST USE 7-17-2008; IN COMMERCE 7-17-2008.
JENNY PARK, EXAMINING ATTORNEY

CLASS 14—(Continued).

SN 77-727,601. ATLANTIC METALLURGICAL INCORPORATED, AKA ATLANTIC METALLURGICAL CORPORATION, SAINT CLOUD, FL. FILED 5-1-2009.

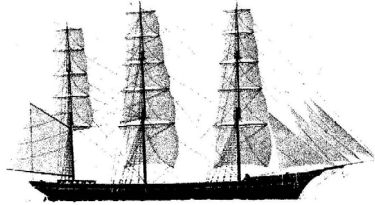

THE MARK CONSISTS OF A THREE MASTED EARLY AMERICAN SAILING SHIP.
FOR GOLD INGOTS; INGOTS OF PRECIOUS METAL; PLATINUM INGOTS; SILVER INGOTS (U.S. CLS. 2, 27, 28 AND 50).
MELISSA VALLILLO, EXAMINING ATTORNEY

SN 77-728,439. LUCKY BRAND DUNGAREES, INC., VERNON, CA. FILED 5-4-2009.

LIVE IN LOVE

THE MARK CONSISTS OF STANDARD CHARACTERS WITHOUT CLAIM TO ANY PARTICULAR FONT, STYLE, SIZE, OR COLOR.
FOR JEWELRY (U.S. CLS. 2, 27, 28 AND 50).
MICHAEL WEBSTER, EXAMINING ATTORNEY

SN 77-728,952. HOPE'S CHANCE, LLC, VERNON HILLS, IL. FILED 5-5-2009.



THE MARK CONSISTS OF ROUNDED "V" WITH A VERTICAL THROUGH THE CENTER OF THE "V".
FOR JEWELRY (U.S. CLS. 2, 27, 28 AND 50).
FRANK LATTUCA, EXAMINING ATTORNEY

CLASS 14—(Continued).

SN 77-729,140. SAM PITTS & ASSOCIATES, INC., OZARK, CO. FILED 5-5-2009.

My Prayer Bracelet

THE MARK CONSISTS OF STANDARD CHARACTERS WITHOUT CLAIM TO ANY PARTICULAR FONT, STYLE, SIZE, OR COLOR.

NO CLAIM IS MADE TO THE EXCLUSIVE RIGHT TO USE "PRAYER BRACELET", APART FROM THE MARK AS SHOWN.

FOR BRACELETS; IDENTIFICATION BRACELETS; PLASTIC BRACELETS IN THE NATURE OF JEWELRY; RUBBER OR SILICON WRISTBANDS IN THE NATURE OF A BRACELET (U.S. CLS. 2, 27, 28 AND 50).

MICHAEL ENGEL, EXAMINING ATTORNEY

SN 77-729,445. HOPE'S CHANCE, LLC, VERNON HILLS, IL. FILED 5-5-2009.

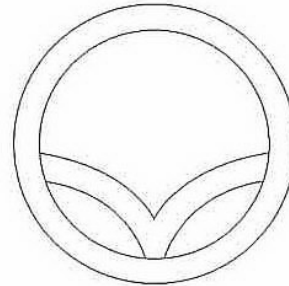

THE MARK CONSISTS OF A ROUNDED "V" IN A CIRCLE.

FOR JEWELRY (U.S. CLS. 2, 27, 28 AND 50).
FRANK LATTUCA, EXAMINING ATTORNEY

SN 77-729,565. INVICTA WATCH COMPANY OF AMERICA, INC., HOLLYWOOD, FL. FILED 5-5-2009.

INVICTA II
A COMPILATION

Twice the Value. Twice the Smarts.

OWNER OF U.S. REG. NOS. 2,947,259, 3,327,807 AND OTHERS.

THE MARK CONSISTS OF THE TERMS "INVICTA II" ABOVE A BAR THAT CONTAINS THE WORDS, "A COMPILATION"; THE PHRASE, "TWICE THE VALUE, TWICE THE SMARTS," APPEARS BELOW THE BAR.

THE ENGLISH TRANSLATION OF "INVICTA" IN THE MARK IS UNCONQUERED.

FOR WATCHES (U.S. CLS. 2, 27, 28 AND 50).
GEORGE LORENZO, EXAMINING ATTORNEY

CLASS 14—(Continued).

SN 77-731,504. ROCK AND ROLL RELIGION, INC., LOS ANGELES, CA. FILED 5-7-2009.

ENGLISH LAUNDRY FORGED
METAL

THE MARK CONSISTS OF STANDARD CHARACTERS WITHOUT CLAIM TO ANY PARTICULAR FONT, STYLE, SIZE, OR COLOR.

OWNER OF U.S. REG. NO. 2,894,885.

NO CLAIM IS MADE TO THE EXCLUSIVE RIGHT TO USE "FORGED METAL", APART FROM THE MARK AS SHOWN.

FOR BRACELETS; BROACHES; CHRONOGRAPHS FOR USE AS WATCHES; EARRINGS; JEWELLERY AND PRECIOUS STONES; JEWELRY; JEWELRY AND IMITATION JEWELRY; JEWELRY CHAINS; LAPEL PINS; MEDALS AND MEDALLIONS; NECKLACES; POCKET WATCHES; RINGS; TIE FASTENERS; WATCH BANDS; WATCHES (U.S. CLS. 2, 27, 28 AND 50).

DAVID C. REIHNER, EXAMINING ATTORNEY

SN 77-739,190. FORD MOTOR COMPANY, DEARBORN, MI. FILED 5-18-2009.

EXPLORER

THE MARK CONSISTS OF STANDARD CHARACTERS WITHOUT CLAIM TO ANY PARTICULAR FONT, STYLE, SIZE, OR COLOR.

OWNER OF U.S. REG. NO. 2,292,940.

FOR JEWELRY, NAMELY, LAPEL PINS, TIE TACKS; NON-MONETARY COLLECTIBLE COINS (U.S. CLS. 2, 27, 28 AND 50).

EVELYN BRADLEY, EXAMINING ATTORNEY

SN 77-741,549. SKELETAL METAL, LLC, HENDERSON, NV. FILED 5-20-2009.

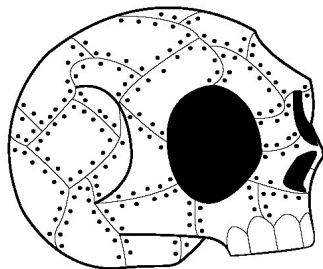

THE MARK CONSISTS OF A STYLIZED SKULL FORMED WITH A PLURALITY OF PLATES.

FOR JEWELRY APPEARING TO BE CREATED FROM A MEDICAL DEVICE OR IMPLEMENT (U.S. CLS. 2, 28 AND 50).

JENNY PARK, EXAMINING ATTORNEY

CLASS 14—(Continued).

SN 77-762,396. THE BELL GROUP, ALBUQUERQUE, NM. FILED 6-17-2009.

TemprRings

THE MARK CONSISTS OF STANDARD CHARACTERS WITHOUT CLAIM TO ANY PARTICULAR FONT, STYLE, SIZE, OR COLOR.

FOR JEWELRY (U.S. CLS. 2, 27, 28 AND 50).

GISELLE AGOSTO, EXAMINING ATTORNEY

SN 78-884,882. MAISON DU TEMPS GMBH, BAAR, SWITZERLAND, FILED 5-16-2006.

DAVAL

THE MARK CONSISTS OF STANDARD CHARACTERS WITHOUT CLAIM TO ANY PARTICULAR FONT, STYLE, SIZE, OR COLOR.

OWNER OF SWITZERLAND REG. NO. 548834, DATED 5-22-2006, EXPIRES 5-22-2016.

FOR WATCHES; JEWELLERY; HOROLOGICAL AND CHRONOMETRIC INSTRUMENTS (U.S. CLS. 2, 27, 28 AND 50).

DEIRDRE ROBERTSON, EXAMINING ATTORNEY

SN 79-061,545. SOCIETE CIVILE GAR, MONACO, FILED 9-19-2008.

eRe
BY
REPOSSI

PRIORITY DATE OF 3-20-2008 IS CLAIMED.
OWNER OF INTERNATIONAL REGISTRATION 0983630 DATED 9-19-2008, EXPIRES 9-19-2018.

OWNER OF U.S. REG. NOS. 2,068,932 AND 3,112,215.

THE MARK CONSISTS OF THE PHRASE "ERE BY REPOSSI" WHEREIN THE TERM "ERE" IS ON THE TOP LINE WITH THE LETTERS "E" HAVING CURVED BANDS EMANATING FROM THE BOTTOMS AND ARE MIRROR IMAGES OF ONE ANOTHER WITH A CAPITALIZED LETTER "R" IN THE CENTER, FOLLOWED BY THE TERM "BY" IN THE CENTER LINE FOLLOWED BY THE TERM "REPOSSI" ON THE BOTTOM LINE.

THE ENGLISH TRANSLATION OF "ERE" IN THE MARK IS ERA. THE WORDING "REPOSSI" HAS NO MEANING IN A FOREIGN LANGUAGE.

FOR JEWELLERY, PRECIOUS STONES, HOROLOGICAL AND CHRONOMETRIC INSTRUMENTS (U.S. CLS. 2, 27, 28 AND 50).

MYRIAH HABEEB, EXAMINING ATTORNEY

CLASS 14—(Continued).

SN 79-070,270. HUBLOT SA, GENÈVE, SWITZERLAND,
FILED 4-27-2009.



PRIORITY DATE OF 10-28-2008 IS CLAIMED.
OWNER OF INTERNATIONAL REGISTRATION 1006223
DATED 4-27-2009, EXPIRES 4-27-2019.
FOR JEWELLERY; HOROLOGICAL AND CHRONO-
METRIC INSTRUMENTS, NAMELY, WATCHES, WRIST-
WATCHES, WATCHBANDS, WATCH CASES, DIALS,
CLOCKS, WALL CLOCKS, CHRONOMETERS, CHRONO-
GRAPHS (U.S. CLS. 2, 27, 28 AND 50).
MIDGE BUTLER, EXAMINING ATTORNEY

CLASS 15—MUSICAL INSTRUMENTS

SN 77-332,379. GODLYKE, INC., CLIFTON, NJ. FILED 11-17-
2007.

LITTLE DIPPER

THE MARK CONSISTS OF STANDARD CHARACTERS
WITHOUT CLAIM TO ANY PARTICULAR FONT, STYLE,
SIZE, OR COLOR.
FOR ELECTRONIC EFFECTS PEDALS FOR USE
WITH MUSICAL INSTRUMENTS (U.S. CLS. 2, 21 AND
36).
JENNIFER VASQUEZ, EXAMINING ATTORNEY

CLASS 15—(Continued).

SN 77-581,707. GETCHA PULL, INCORPORATED, NEW
YORK, NY. FILED 9-29-2008.

DIMEBAG DARRELL

THE MARK CONSISTS OF STANDARD CHARACTERS
WITHOUT CLAIM TO ANY PARTICULAR FONT, STYLE,
SIZE, OR COLOR.

THE NAME "DIMEBAG DARRELL" DOES NOT IDENTIFY
A LIVING INDIVIDUAL.

FOR MUSICAL INSTRUMENTS AND ACCESSORIES,
NAMELY, ELECTRIC GUITARS, ACOUSTIC GUITARS,
BASS GUITARS, ELECTRIC PIANOS AND OTHER KEY-
BOARD INSTRUMENTS, GUITAR STRINGS AND GUITAR
PICKS (U.S. CLS. 2, 21 AND 36).

FIRST USE 2-1-1994; IN COMMERCE 2-1-1994.
ANDREW RHIM, EXAMINING ATTORNEY

SN 77-592,379. THINGS 4 STRINGS, LLC, WEST ORANGE,
NJ. FILED 10-14-2008.

BOW HOLD BUDDIES

THE MARK CONSISTS OF STANDARD CHARACTERS
WITHOUT CLAIM TO ANY PARTICULAR FONT, STYLE,
SIZE, OR COLOR.

NO CLAIM IS MADE TO THE EXCLUSIVE RIGHT TO
USE "BOW HOLD", APART FROM THE MARK AS SHOWN.
FOR VIOLIN BOW HOLD TEACHING DEVICES (U.S.
CLS. 2, 21 AND 36).

RONALD AIKENS, EXAMINING ATTORNEY

SN 77-694,020. SCRIPPS NETWORKS, LLC, KNOXVILLE,
TN. FILED 3-18-2009.

MAN CAVES

THE MARK CONSISTS OF STANDARD CHARACTERS
WITHOUT CLAIM TO ANY PARTICULAR FONT, STYLE,
SIZE, OR COLOR.

FOR MUSICAL INSTRUMENTS (U.S. CLS. 2, 21 AND
36).

TEJBIR SINGH, EXAMINING ATTORNEY

CLASS 15—(Continued).

SN 77-725,083. MARIGOLD ENTERPRISES CO, LTD, KOW-
LOON, HONG KONG, FILED 4-29-2009.

Marigold

THE MARK CONSISTS OF STANDARD CHARACTERS
WITHOUT CLAIM TO ANY PARTICULAR FONT, STYLE,
SIZE, OR COLOR.

FOR DRUMS; FLUTES; GUITARS; SAXOPHONES;
TRUMPETS (U.S. CLS. 2, 21 AND 36).

GEORGE LORENZO, EXAMINING ATTORNEY

SN 77-725,507. DISNEY ENTERPRISES, INC., BURBANK,
CA. FILED 4-29-2009.

VIPER SLAP

THE MARK CONSISTS OF STANDARD CHARACTERS
WITHOUT CLAIM TO ANY PARTICULAR FONT, STYLE,
SIZE, OR COLOR.

FOR MUSICAL INSTRUMENTS (U.S. CLS. 2, 21 AND
36).

RONALD DELGIZZI, EXAMINING ATTORNEY

SN 79-067,609. TOLITO, F-57000 METZ, FRANCE, FILED 12-
19-2008.



OWNER OF INTERNATIONAL REGISTRATION 0848363
DATED 12-2-2004, EXPIRES 12-2-2014.

NO CLAIM IS MADE TO THE EXCLUSIVE RIGHT TO
USE "STRINGS", APART FROM THE MARK AS SHOWN.

THE MARK CONSISTS OF THE STYLIZED WORDING
"SKULL STRINGS" WITH A DESIGN OF A SKULL AND
CROSS BONES ON A SQUARE BACKGROUND.

FOR STRINGS FOR MUSICAL INSTRUMENTS (U.S.
CLS. 2, 21 AND 36).

DANIEL CAPSHAW, EXAMINING ATTORNEY

**CLASS 16—PAPER GOODS AND PRINTED
MATTER**

SN 76-687,200. WALLACE, MESA DENEEN, ROCKY
MOUNT, NC. FILED 2-27-2008.

BOOKS TO READ ... BOOKS TO LOVE

THE MARK CONSISTS OF STANDARD CHARACTERS
WITHOUT CLAIM TO ANY PARTICULAR FONT, STYLE,
SIZE, OR COLOR.

FOR BOOKBINDING MATERIALS (U.S. CLS. 2, 5, 22,
23, 29, 37, 38 AND 50).

HOWARD FRIEDMAN, EXAMINING ATTORNEY

SN 76-696,326. PAGE, DREW A., ROCKWALL, TX. FILED 3-
16-2009.



TRY SA~~W~~N THESE OFF !

THE MARK CONSISTS OF AN ANIMATED BULL WITH
HUMAN FACIAL FEATURES STANDING IN THE UP-
RIGHT POSITION WITH ITS ARMS CROSSED AND STAR-
ING AT THE OBSERVER. A LINE OF "TEXT" JUST BELOW
THE BULLS ARMS WITH THE WORDING "TRY SA~~W~~N
THESE OFF".

FOR BUMPER STICKERS (U.S. CLS. 2, 5, 22, 23, 29, 37,
38 AND 50).

STEVEN JACKSON, EXAMINING ATTORNEY

SN 76-696,797. CROWN POINT GRAPHICS, CARMEL, IN.
FILED 4-8-2009.

HAMILTON CREEK DESIGNS

NO CLAIM IS MADE TO THE EXCLUSIVE RIGHT TO
USE "DESIGNS", APART FROM THE MARK AS SHOWN.

FOR GREETING CARDS (U.S. CLS. 2, 5, 22, 23, 29, 37,
38 AND 50).

TRACY CROSS, EXAMINING ATTORNEY

CLASS 16—(Continued).

SN 76-696,913. WALKER BOOKS LIMITED, LONDON SE11 5HJ, ENGLAND, FILED 4-16-2009.

MAISY

THE MARK CONSISTS OF STANDARD CHARACTERS WITHOUT CLAIM TO ANY PARTICULAR FONT, STYLE, SIZE, OR COLOR.

OWNER OF U.S. REG. NOS. 2,085,155 AND 2,112,569.

THE NAME SHOWN IN THE MARK DOES NOT IDENTIFY A PARTICULAR LIVING INDIVIDUAL.

FOR STATIONERY; GREETING CARDS (U.S. CLS. 2, 5, 22, 23, 29, 37, 38 AND 50).

FIRST USE 0-0-1997; IN COMMERCE 0-0-1997.

TINA BROWN, EXAMINING ATTORNEY

SN 77-046,814. TRI-D INNOVATIONS, INC., LENEXA, KS. FILED 11-17-2006.

MEMORY ROAD

THE MARK CONSISTS OF STANDARD CHARACTERS WITHOUT CLAIM TO ANY PARTICULAR FONT, STYLE, SIZE, OR COLOR.

FOR PHOTO ALBUMS; SCRAPBOOK ALBUMS; COMPONENTS OF PHOTO AND SCRAPBOOK ALBUMS SOLD AS A INTEGRAL PART THEREOF, NAMELY, ALBUM FRAMES AND BORDERING TRIM; STATIONERY; DRAWING TEMPLATES; METALLIC PAPER CLIPS OF VARYING DESIGN; PRE-FORMED WORDS MADE OF WIRE AND USED TO ACCENT PICTURES, BORDERS, OR SCRAPBOOK PAGES; PAPER HOLE PUNCH; INTERCHANGEABLE HOLE PUNCH FOR PAPER; DEVICE FOR PIERCING PAPER AND CASE THEREFOR; CIRCLE PAPER CUTTER DEVICE; MATS FOR CUTTING PAPER; PAPER DIE CUT SHAPES; BACKGROUND AND PRINTED PAPERS FOR USE IN SCRAPBOOKING; PAPER STICKERS; PHOTO AND SCRAPBOOK ALBUM THEME KITS CONSISTING OF PAPER IN THE NATURE OF CARDSTOCK, PRECUT PAPER IN THE FORM OF VARIOUS SHAPES AND DESIGNS, PRECUT PAPER FOR USE AS TRIM, PAPER DIE CUT SHAPES, PRINTED PAPER, DRAWING RULERS, PUNCHES AND SCISSORS; SCRAP BOOKING KITS CONSISTING OF PHOTO ALBUMS, PLAIN COLOR PAPER SHEETS, PRINT DESIGN PAPER SHEETS, SLEEVES FOR HOLDING AND PROTECTING SCRAPBOOK ALBUM PAGES, PENS, PENCILS, GLUE FOR STATIONERY OR OFFICE USE, DRAWING TEMPLATES, STICKERS, PAPER DIE CUT SHAPES AND PRECUT PAPER FOR USE IN FRAMING AND BORDERING SCRAPBOOK PAGES; MEMORY BOOKS; STATIONERY; PAPER AND PRINTED EMBLEMS; STICKERS; ADHESIVES FOR STATIONERY PURPOSES; DRAWING RULERS; WRITING PENCILS; WRITING PENS; DECALS; LOOSE LEAF PAPER; PRINTED INSTRUCTIONS AND BOOKLETS FOR HOBBY CRAFTS AND BEAD WORK; PRINTED PATTERNS FOR BEAD WORK; BOOKS ON THE SUBJECT OF BEAD WORK; PRINTED HOBBY CRAFT INSTRUCTION CARDS AND PAMPHLETS; PAPER DESIGN PUNCHES; RUBBER STAMPS; STAMP INKS; WRITING INK; STENCILS; PAPER CUTTERS (U.S. CLS. 2, 5, 22, 23, 29, 37, 38 AND 50).

CHARLOTTE CORWIN, EXAMINING ATTORNEY

CLASS 16—(Continued).

SN 77-294,287. INTERNATIONAL STORES CORP., PANAMA CITY, PANAMA, FILED 10-2-2007.



attenza

OWNER OF PANAMA REG. NO. 16530001, DATED 9-27-2007, EXPIRES 9-27-2017.

"THE MARK CONSISTS OF FIVE SHOPPING BAGS ARRANGED TO BE A FIVE-POINTED STAR."

FOR PAPER, CARDBOARD AND GOODS MADE FROM THESE MATERIALS, NAMELY, BOXES OF PAPER AND CARDBOARD, CARDBOARD PACKAGING, POSTERS; PAPER LABELS; STICKERS; AGENDAS, NOTE PAPER, PAPER FLAGS; PAPER PENNANTS; STATIONERY; WRITING PADS; LETTER PAPER; DOCUMENT FILES FOR STATIONERY; CALENDARS; PAPER CONTAINERS AND BOXES FOR STATIONERY; PHOTOGRAPHS; GREETING CARDS; POSTCARDS; ENVELOPES; BOOKBINDING MATERIAL; WRITING INSTRUMENTS, PENCILS, PENS, AND BOOKMARKS; PLASTIC MATERIALS FOR PACKAGING, NAMELY, BUBBLE PACKS, PLASTIC BAGS, PRINTED MATTER, NAMELY, BOOKS, MAGAZINES AND BROCHURES IN THE FIELDS OF TRAVEL, FASHION, HOME DESIGN, FURNITURE, ACCESSORIES, ART, SHOPPING, GARDENING AND GARDEN FURNITURE (U.S. CLS. 2, 5, 22, 23, 29, 37, 38 AND 50).

WARREN L. OLANDRIA, EXAMINING ATTORNEY

CLASS 16—(Continued).

SN 77-294,377. INTERNATIONAL STORES CORP., PANAMA CITY, PANAMA, FILED 10-2-2007.



attenza

LA MEJOR ATENCION

OWNER OF PANAMA REG. NO. 16530801, DATED 9-27-2007, EXPIRES 9-27-2017.

NO CLAIM IS MADE TO THE EXCLUSIVE RIGHT TO USE "LA MEJOR ATENCION", APART FROM THE MARK AS SHOWN.

THE MARK CONSISTS OF FIVE SHOPPING BAGS ARRANGED TO BE A FIVE-POINTED STAR.

THE FOREIGN WORDING IN THE MARK TRANSLATES INTO ENGLISH AS "BEST CARE."

FOR PAPER, CARDBOARD AND GOODS MADE FROM THESE MATERIALS, NAMELY, BOXES OF PAPER AND CARDBOARD, CARDBOARD PACKAGING, POSTERS; PAPER LABELS; STICKERS; AGENDAS, NOTE PAPER, PAPER FLAGS; PAPER PENNANTS; STATIONERY; WRITING PADS; LETTER PAPER; DOCUMENT FILES FOR STATIONERY; CALENDARS; PAPER CONTAINERS AND BOXES FOR STATIONERY; PHOTOGRAPHS; GREETING CARDS; POSTCARDS; ENVELOPES; BOOKBINDING MATERIAL; WRITING INSTRUMENTS, PENCILS, PENS, AND BOOKMARKS; PLASTIC MATERIALS FOR PACKAGING, NAMELY, BUBBLE PACKS, PLASTIC BAGS, PRINTED MATTER, NAMELY, BOOKS, MAGAZINES AND BROCHURES IN THE FIELDS OF TRAVEL, FASHION, HOME DESIGN, FURNITURE, ACCESSORIES, ART, SHOPPING, GARDENING AND GARDEN FURNITURE (U.S. CLS. 2, 5, 22, 23, 29, 37, 38 AND 50).

WARREN L. OLANDRIA, EXAMINING ATTORNEY

SN 77-320,125. HARTMAN INTERNATIONAL, LLC, SALT LAKE CITY, UT. FILED 11-2-2007.

THE COLOR CODE

THE MARK CONSISTS OF STANDARD CHARACTERS WITHOUT CLAIM TO ANY PARTICULAR FONT, STYLE, SIZE, OR COLOR.

FOR BOOKS, PRINTED SUMMARIES AND REVIEWS OF BOOKS, PRINTED INFORMATIONAL ARTICLES, PRINTED INSTRUCTIONAL MATERIALS, PRINTED FORMS AND NEWSLETTERS IN THE FIELDS OF PERSONALITY, PERSONALITY PROFILES, PERSONALITY TRAITS, CHARACTER TRAITS, COMMUNICATION, COMMUNICATION IMPROVEMENT, PERSONAL RELATIONSHIPS, PROFESSIONAL RELATIONSHIPS, EMPLOYEE RELATIONSHIPS, EMPLOYEE MANAGEMENT, DIVERSITY, TEAM WORK, BUSINESS INTERACTION, LEADERSHIP, HUMAN BEHAVIOR, CARING, SHARING, COMPASSION, INTEGRITY, CREATIVITY, HONESTY, LOYALTY, VALUES, MOTIVES, MOTIVATION, POSITIVE AFFIRMATIONS, PASSION FOR LIFE, SUCCESS IN LIFE, ENJOYMENT OF LIFE, STRESS REDUCTION, CONFLICT REDUCTION, INTERPERSONAL SKILLS, INTERPERSONAL SKILLS DEVELOPMENT, PRODUCTIVITY, SALES, PERSONAL EFFECTIVENESS, AND PERSONAL IMPROVEMENT (U.S. CLS. 2, 5, 22, 23, 29, 37, 38 AND 50).

FIRST USE 12-31-1987; IN COMMERCE 12-31-1987.

RENEE SERVANCE, EXAMINING ATTORNEY

CLASS 16—(Continued).

SN 77-388,961. O'CONNOR, PATRICIA, NEW HARTFORD, NY. FILED 2-5-2008.

FALL IN LOVE WITH YOUR
COMMUNITY



PATRICIA O'CONNOR

THE COLOR(S) ORANGE, RED, BURGUNDY, NAVY BLUE, GREEN, MUSTARD YELLOW, GRAY, AND WHITE IS/ARE CLAIMED AS A FEATURE OF THE MARK.

THE MARK CONSISTS OF THE WORDS "FALL IN LOVE WITH YOUR" IN NAVY BLUE; THE WORDS "COMMUNITY" BELOW THE PREVIOUS PHRASE WITH THE "C" AND "N" IN NAVY BLUE, THE "O" AND "I" IN GREEN, THE FIRST "M" AND "Y" IN MUSTARD YELLOW, THE SECOND "M" IN ORANGE, THE "U" IN BURGUNDY AND THE "T" IN RED. "FALL IN LOVE WITH YOUR" IS CENTERED ABOVE "COMMUNITY". BELOW THE TITLE IS A COLORED CIRCLE MANDALA OF HUMAN FORMS. EACH HUMAN FORM CONSISTS OF ONE HEAD, ONE ARM, ONE TORSO, AND TWO LEGS. THE ARM AND TWO LEGS ARE POINTED IN THE RIGHT DIRECTION UNIFORMLY AROUND THE CIRCLE. THE FIRST FORM AT THE TOP OF THE CIRCLE HAS A BURGUNDY HEAD, ORANGE TORSO AND ARM, AND MUSTARD YELLOW LEGS. GOING COUNTERCLOCKWISE AROUND THE CIRCLE, THE NEXT FORM HAS A MUSTARD YELLOW HEAD, RED TORSO AND NAVY BLUE LEGS; GREEN HEAD, MUSTARD YELLOW TORSO AND ARM, AND RED LEGS; NAVY BLUE HEAD, BURGUNDY TORSO AND ARM, AND GREEN LEGS; RED HEAD, GREEN TORSO AND ARM, AND BURGUNDY LEGS; BURGUNDY HEAD, NAVY BLUE TORSO AND ARM, AND ORANGE LEGS; ORANGE HEAD, RED TORSO AND ARM, AND MUSTARD YELLOW LEGS; NAVY BLUE HEAD, ORANGE TORSO AND ARM, AND RED LEGS; GREEN HEAD, MUSTARD YELLOW TORSO AND ARM, AND NAVY BLUE LEGS; ORANGE HEAD, GREEN TORSO AND ARM, AND BURGUNDY LEGS; RED HEAD, BURGUNDY TORSO AND ARM, AND ORANGE LEGS; MUSTARD YELLOW HEAD, NAVY BLUE TORSO AND ARM, AND GREEN LEGS. THERE IS A GRAY SHADOW EFFECT AROUND EACH OF THE HUMAN FORMS AROUND ENTIRE DESIGN OF THE CIRCLE MANDALA. BELOW THE CIRCLE MANDALA APPEARS THE NAME "PATRICIA O'CONNOR" IN NAVY BLUE. THE TITLE, CIRCLE MANDALA IMAGE OF HUMAN FORMS AND NAME "PATRICIA O'CONNOR" ARE ALL CENTERED ON A WHITE BACKGROUND.

FOR EDUCATIONAL PUBLICATIONS, NAMELY, BOOKS, GUIDES, WORKBOOKS, AND TEACHING MANUALS IN THE FIELDS OF COMMUNITY GROWTH, DEVELOPMENT AND RENEWAL (U.S. CLS. 2, 5, 22, 23, 29, 37, 38 AND 50).

ANNE FARRELL, EXAMINING ATTORNEY

CLASS 16—(Continued).

SN 77-407,007. T & T, LLC, CHARLESTOWN, ST. CHRIST-NEVIS, FILED 2-27-2008.

¡Ayy, Chihuahua!

THE MARK CONSISTS OF STANDARD CHARACTERS WITHOUT CLAIM TO ANY PARTICULAR FONT, STYLE, SIZE, OR COLOR.

OWNER OF U.S. REG. NO. 3,129,262.
FOR PRE-PAID TELEPHONE CALLING CARDS, NOT MAGNETICALLY ENCODED (U.S. CLS. 2, 5, 22, 23, 29, 37, 38 AND 50).

FIRST USE 12-31-1998; IN COMMERCE 12-31-1998.
DAVID MURRAY, EXAMINING ATTORNEY

SN 77-416,276. COLORBÖK INC., DEXTER, MI. FILED 3-7-2008.

XYZ

THE MARK CONSISTS OF STANDARD CHARACTERS WITHOUT CLAIM TO ANY PARTICULAR FONT, STYLE, SIZE, OR COLOR.

FOR INDEX CARDS, CARDS, NAMELY, MONOGRAMMED CARDS, CARDSTOCK CARDS; CARDSTOCK LETTERS; FLOCKED PAPER LETTERS; PAPER FLUTED CORRUGATED LETTERS; DECALS, NAMELY, RUB ON DECALS, FOIL STAMPED DECALS, GLITTER RUB ON DECALS; PAPER, NAMELY, PEARLESCENT PAPER, TEXTURED CARDSTOCK, FOIL STAMPED PAPER IN THE SHAPE OF ALPHABET LETTERS AND NUMBERS; STICKERS, NAMELY, LAYERED CHIPBOARD STICKERS, GLITTER CHIPBOARD STICKERS, CLEAR PLASTIC STICKERS, FOAM STICKERS, FELT STICKERS, FABRIC STICKERS IN THE SHAPE OF ALPHABET LETTERS AND NUMBERS, THREE DIMENSIONAL STICKERS, VELLUM STICKERS; CRAFT PAPER; TEXTURED PAPER; PRINTED PAPER WITH DESIGNS; SCRAPBOOK ALBUMS, PHOTO ALBUMS, BLANK JOURNALS; PAPER DIE CUTS IN VARIOUS SHAPES, SIZES AND COLORS FOR USE IN THE ARTS AND CRAFTS INDUSTRY, PAPER PUNCH OUTS IN VARIOUS SHAPES, SIZES AND COLORS FOR USE IN THE ARTS AND CRAFTS INDUSTRY, CHIPBOARD PUNCH OUTS IN VARIOUS SHAPES, SIZES AND COLORS FOR USE IN THE ARTS AND CRAFTS INDUSTRY, CARDSTOCK PUNCH OUTS IN VARIOUS SHAPES, SIZES AND COLORS FOR USE IN THE ARTS AND CRAFTS INDUSTRY (U.S. CLS. 2, 5, 22, 23, 29, 37, 38 AND 50).

INGA ERVIN, EXAMINING ATTORNEY

CLASS 16—(Continued).

SN 77-545,659. XANDER MEDIA GROUP, INC., WAYNE, PA. FILED 8-13-2008.

MONITOR

THE MARK CONSISTS OF STANDARD CHARACTERS WITHOUT CLAIM TO ANY PARTICULAR FONT, STYLE, SIZE, OR COLOR.

FOR PUBLICATION, NAMELY, A BUSINESS MAGAZINE IN THE FIELD OF FINANCE (U.S. CLS. 2, 5, 22, 23, 29, 37, 38 AND 50).

FIRST USE 3-0-1974; IN COMMERCE 5-1-1974.
HENRY S. ZAK, EXAMINING ATTORNEY

SN 77-574,109. LIVING SMART, LLC, LOUISVILLE, KY. FILED 9-19-2008.

LIVINGFORMS

THE MARK CONSISTS OF STANDARD CHARACTERS WITHOUT CLAIM TO ANY PARTICULAR FONT, STYLE, SIZE, OR COLOR.

FOR PRINTED FORMS, PRINTED SCHEDULES, AND PRINTED INSTRUCTIONS SHEETS IN THE FIELD OF RELATIONSHIPS AND LEGAL SELF HELP (U.S. CLS. 2, 5, 22, 23, 29, 37, 38 AND 50).

KIM SAITO, EXAMINING ATTORNEY

SN 77-580,556. THE JEWISH ZODIAC, LLC, WOODLAND HILLS, CA. FILED 9-28-2008.

THE HISPANIC ZODIAC

THE MARK CONSISTS OF STANDARD CHARACTERS WITHOUT CLAIM TO ANY PARTICULAR FONT, STYLE, SIZE, OR COLOR.

FOR PAPER AND PAPER ARTICLES, NAMELY, POSTERS, GREETING CARDS, CORRESPONDENCE CARDS, CALENDARS, NOTEPADS, INVITATION CARDS, GIFT CARDS, GIFT WRAP PAPER, METALLIC GIFT WRAP, STATIONERY, ENVELOPES, PAPER GIFT BAGS, ADHESIVE NOTE PADS, WRITING PADS, PENCILS, PENS, ERASERS, PAPER PLACE MATS, PAPER NAPKINS, PAPER TABLECLOTHS, PAPER TOWELS (U.S. CLS. 2, 5, 22, 23, 29, 37, 38 AND 50).

SUNG IN, EXAMINING ATTORNEY

CLASS 16—(Continued).

SN 77-580,560. THE JEWISH ZODIAC, LLC, WOODLAND HILLS, CA. FILED 9-28-2008.

THE ITALIAN ZODIAC

THE MARK CONSISTS OF STANDARD CHARACTERS WITHOUT CLAIM TO ANY PARTICULAR FONT, STYLE, SIZE, OR COLOR.

FOR PAPER AND PAPER ARTICLES, NAMELY, POSTERS, GREETING CARDS, CORRESPONDENCE CARDS, CALENDARS, NOTEPADS, INVITATION CARDS, GIFT CARDS, GIFT WRAP PAPER, METALLIC GIFT WRAP, STATIONERY, ENVELOPES, PAPER GIFT BAGS, ADHESIVE NOTE PADS, WRITING PADS, PENCILS, PENS, ERASERS, PAPER PLACE MATS, PAPER NAPKINS, PAPER TABLECLOTHS, PAPER TOWELS (U.S. CLS. 2, 5, 22, 23, 29, 37, 38 AND 50).

SUNG IN, EXAMINING ATTORNEY

SN 77-589,403. LENIHAN, MARY GERARD, ST. LOUIS, MO. FILED 10-9-2008.

WORLD NEEDS YOUR HELP ORGANIZATION—NOW!

THE MARK CONSISTS OF STANDARD CHARACTERS WITHOUT CLAIM TO ANY PARTICULAR FONT, STYLE, SIZE, OR COLOR.

FOR BOOKS, BOOKLETS, INSTRUCTION MANUALS, WORKBOOKS, AND NOTEBOOKS ALL IN THE FIELD OF SPIRITUALITY AND SPIRITUAL DEVELOPMENT (U.S. CLS. 2, 5, 22, 23, 29, 37, 38 AND 50).

LINDA MICKLEBURGH, EXAMINING ATTORNEY

SN 77-589,409. LENIHAN, MARY GERARD, ST. LOUIS, MO. FILED 10-9-2008.

I.S. MIND

THE MARK CONSISTS OF STANDARD CHARACTERS WITHOUT CLAIM TO ANY PARTICULAR FONT, STYLE, SIZE, OR COLOR.

FOR BOOKS, BOOKLETS, INSTRUCTION MANUALS, WORKBOOKS, AND NOTEBOOKS ALL IN THE FIELD OF SPIRITUALITY AND SPIRITUAL DEVELOPMENT (U.S. CLS. 2, 5, 22, 23, 29, 37, 38 AND 50).

LINDA MICKLEBURGH, EXAMINING ATTORNEY

CLASS 16—(Continued).

SN 77-590,140. JAKKS PACIFIC, INC., MALIBU, CA. FILED 10-10-2008.

SUPER LUCKIES

THE MARK CONSISTS OF STANDARD CHARACTERS WITHOUT CLAIM TO ANY PARTICULAR FONT, STYLE, SIZE, OR COLOR.

FOR WRITING INSTRUMENTS (U.S. CLS. 2, 5, 22, 23, 29, 37, 38 AND 50).

LINDA MICKLEBURGH, EXAMINING ATTORNEY

SN 77-590,162. JAKKS PACIFIC, INC., MALIBU, CA. FILED 10-10-2008.

LUCKBOTS

THE MARK CONSISTS OF STANDARD CHARACTERS WITHOUT CLAIM TO ANY PARTICULAR FONT, STYLE, SIZE, OR COLOR.

FOR WRITING INSTRUMENTS (U.S. CLS. 2, 5, 22, 23, 29, 37, 38 AND 50).

LINDA MICKLEBURGH, EXAMINING ATTORNEY

SN 77-590,183. JAKKS PACIFIC, INC., MALIBU, CA. FILED 10-10-2008.

WISECRACKERS

THE MARK CONSISTS OF STANDARD CHARACTERS WITHOUT CLAIM TO ANY PARTICULAR FONT, STYLE, SIZE, OR COLOR.

FOR WRITING INSTRUMENTS (U.S. CLS. 2, 5, 22, 23, 29, 37, 38 AND 50).

LINDA MICKLEBURGH, EXAMINING ATTORNEY

CLASS 16—(Continued).

SN 77-590,189. JAKKS PACIFIC, INC., MALIBU, CA. FILED 10-10-2008.

CLASS 16—(Continued).

SN 77-596,881. COSIMEX INC., HOBOKEN, NJ. FILED 10-21-2008.

LUMBERJACKS

THE MARK CONSISTS OF STANDARD CHARACTERS WITHOUT CLAIM TO ANY PARTICULAR FONT, STYLE, SIZE, OR COLOR.

FOR WRITING INSTRUMENTS (U.S. CLS. 2, 5, 22, 23, 29, 37, 38 AND 50).
LINDA MICKLEBURGH, EXAMINING ATTORNEY

SUNTRIO

THE MARK CONSISTS OF STANDARD CHARACTERS WITHOUT CLAIM TO ANY PARTICULAR FONT, STYLE, SIZE, OR COLOR.

FOR STATIONERY ITEMS, NAMELY, STAPLERS, STAPLES, STAPLE REMOVERS, OFFICE HOLE PUNCHERS, ADHESIVE TAPE DISPENSERS, PAPER TRIMMERS, NAMELY, PAPER CUTTERS, PENCIL SHARPENERS, PENS, FELT TIP MARKERS, DRY-ERASE WHITEBOARDS, DESK SETS (U.S. CLS. 2, 5, 22, 23, 29, 37, 38 AND 50).
MATTHEW KLINE, EXAMINING ATTORNEY

SN 77-591,646. THE UPPER DECK COMPANY, NORTH LAS VEGAS, NV. FILED 10-13-2008.

CHAMPS

THE MARK CONSISTS OF STANDARD CHARACTERS WITHOUT CLAIM TO ANY PARTICULAR FONT, STYLE, SIZE, OR COLOR.

FOR TRADING CARDS; COMIC BOOKS; COMIC STRIPS; CARTOON PRINTS; NEWSPAPER CARTOONS; CHILDREN'S BOOKS; ROLE PLAYING EQUIPMENT IN THE NATURE OF GAME BOOK MANUALS; CARD-BOARD PACKAGING; PLASTIC OR PAPER BAGS FOR PACKAGING; LUNCH BAGS; TEMPORARY BODY TATTOOS (U.S. CLS. 2, 5, 22, 23, 29, 37, 38 AND 50).
LINDA LAVACHE, EXAMINING ATTORNEY

SN 77-598,147. LEARNING PLUS ASSOCIATES, RANCHO CUCAMONGA, CA. FILED 10-22-2008.

SN 77-594,807. HOME BOX OFFICE, INC., NEW YORK, NY. FILED 10-17-2008.

HUNG

THE MARK CONSISTS OF STANDARD CHARACTERS WITHOUT CLAIM TO ANY PARTICULAR FONT, STYLE, SIZE, OR COLOR.

FOR PAPER, PRINTED MATERIALS AND GOODS MADE FROM PAPER, NAMELY, POSTCARDS, NOTEBOOKS, STICKERS, DECALS, TEMPORARY TATTOOS, PAPER COASTERS, TRIVIA CARDS, PHOTOGRAPHS, TRADING CARDS, BOOKS, CALENDARS AND POSTERS ALL FEATURING CONTENT FROM AN ONGOING TELEVISION SERIES (U.S. CLS. 2, 5, 22, 23, 29, 37, 38 AND 50).
MICHELE SWAIN, EXAMINING ATTORNEY

PRIORITY

THE MARK CONSISTS OF STANDARD CHARACTERS WITHOUT CLAIM TO ANY PARTICULAR FONT, STYLE, SIZE, OR COLOR.

OWNER OF U.S. REG. NO. 3,356,896.
FOR PRINTED ACADEMIC LESSON PLANS AND ACCOMPANYING COMPACT DISCS, DISTRIBUTED AS A UNIT, IN THE FIELD OF ENGLISH FOR GRADES 9-12 (U.S. CLS. 2, 5, 22, 23, 29, 37, 38 AND 50).
FIRST USE 2-1-2007; IN COMMERCE 2-1-2007.
KATHLEEN M. VANSTON, EXAMINING ATTORNEY

CLASS 16—(Continued).

SN 77-598,644. AMERICAN MEDIA OPERATIONS, INC., BOCA RATON, FL. FILED 10-23-2008.



THE COLOR(S) BLUE IS/ARE CLAIMED AS A FEATURE OF THE MARK.

THE MARK CONSISTS OF A BLUE DOT. FOR MAGAZINE COLUMNS ABOUT A LUCKY BLUE DOT (U.S. CLS. 2, 5, 22, 23, 29, 37, 38 AND 50). FIRST USE 6-14-1990; IN COMMERCE 6-14-1990. JAY FLOWERS, EXAMINING ATTORNEY

CLASS 16—(Continued).

SN 77-607,732. SAN FRANCISCO LESBIAN GAY BISEXUAL TRANSGENDER PRIDE CELEBRATION COMMITTEE, INC., SAN FRANCISCO, CA. FILED 11-5-2008.

THE OFFICIAL MAGAZINE OF
SAN FRANCISCO PRIDE

THE MARK CONSISTS OF STANDARD CHARACTERS WITHOUT CLAIM TO ANY PARTICULAR FONT, STYLE, SIZE, OR COLOR.

OWNER OF U.S. REG. NOS. 2,619,420, 2,838,789 AND OTHERS.

NO CLAIM IS MADE TO THE EXCLUSIVE RIGHT TO USE "MAGAZINE", APART FROM THE MARK AS SHOWN. SEC. 2(F).

FOR MAGAZINES FEATURING NEWS AND COMMENTARY IN THE FIELDS OF CURRENT EVENTS AND ENTERTAINMENT RELATING TO THE GAY, LESBIAN, BISEXUAL AND TRANSGENDER COMMUNITY (U.S. CLS. 2, 5, 22, 23, 29, 37, 38 AND 50). FIRST USE 6-1-1998; IN COMMERCE 6-1-1998.

VIVIAN MICZNIK FIRST, EXAMINING ATTORNEY

SN 77-603,056. STARLINE PUBLICATIONS, INC., PARAMUS, NJ. FILED 10-29-2008.

REBEL INK

THE MARK CONSISTS OF STANDARD CHARACTERS WITHOUT CLAIM TO ANY PARTICULAR FONT, STYLE, SIZE, OR COLOR.

OWNER OF U.S. REG. NO. 3,385,011.

NO CLAIM IS MADE TO THE EXCLUSIVE RIGHT TO USE "INK", APART FROM THE MARK AS SHOWN.

FOR MAGAZINES FEATURING TATTOOS, THE PEOPLE HAVING SUCH TATTOOS AND THE TATTOO ARTISTS CREATING THE TATTOOS (U.S. CLS. 2, 5, 22, 23, 29, 37, 38 AND 50).

NANCY CLARKE, EXAMINING ATTORNEY

SN 77-611,015. DC COMICS, NEW YORK, NY. FILED 11-10-2008.

ADVENTURE COMICS

THE MARK CONSISTS OF STANDARD CHARACTERS WITHOUT CLAIM TO ANY PARTICULAR FONT, STYLE, SIZE, OR COLOR.

OWNER OF U.S. REG. NO. 868,443.

NO CLAIM IS MADE TO THE EXCLUSIVE RIGHT TO USE "COMICS", APART FROM THE MARK AS SHOWN.

FOR COMIC BOOKS (U.S. CLS. 2, 5, 22, 23, 29, 37, 38 AND 50).

FIRST USE 10-10-1938; IN COMMERCE 11-0-2008.

JIM RINGLE, EXAMINING ATTORNEY

CLASS 16—(Continued).

SN 77-611,729. ARCTIC PAPER AB, GOTEORG, SWEDEN, FILED 11-11-2008.



OWNER OF SWEDEN REG. NO. 365917, DATED 3-12-2004, EXPIRES 3-12-2014.

OWNER OF U.S. REG. NO. 3,427,551.

NO CLAIM IS MADE TO THE EXCLUSIVE RIGHT TO USE "PAPER", APART FROM THE MARK AS SHOWN.

THE MARK CONSISTS OF THE WORDING "ARCTIC PAPER" AND TWO OVAL ELEMENTS. INSIDE OF ONE OVAL ELEMENT THERE IS A MONK WRITING, AND INSIDE OF THE OTHER OVAL ELEMENT THERE IS A CROWN AND THE LETTER "H".

FOR PAPER (U.S. CLS. 2, 5, 22, 23, 29, 37, 38 AND 50). FIRST USE 1-1-2003; IN COMMERCE 6-0-2006.

JOHN KELLY, EXAMINING ATTORNEY

SN 77-611,939. POND PRODUCTIONS, LLC, SCOTTSDALE, AZ. FILED 11-11-2008.

GROOVETOOL

THE MARK CONSISTS OF STANDARD CHARACTERS WITHOUT CLAIM TO ANY PARTICULAR FONT, STYLE, SIZE, OR COLOR.

FOR A SERIES OF HANDOUTS AND WORKSHEETS FEATURING TRAINING AND COACHING IN THE FIELD OF SELF-IMPROVEMENT USED IN CONNECTION WITH CONSULTING AND MOTIVATIONAL SPEAKING SERVICES ON SELF-IMPROVEMENT (U.S. CLS. 2, 5, 22, 23, 29, 37, 38 AND 50).

FIRST USE 3-1-2007; IN COMMERCE 3-1-2007.

MARY CRAWFORD, EXAMINING ATTORNEY

SN 77-613,071. AMERICAN GIRL, LLC, EL SEGUNDO, CA. FILED 11-12-2008.

CHRISSA

THE MARK CONSISTS OF STANDARD CHARACTERS WITHOUT CLAIM TO ANY PARTICULAR FONT, STYLE, SIZE, OR COLOR.

FOR CHILDREN'S FICTION BOOKS, CHILDREN'S ACTIVITY BOOKS, MEMORY BOOKS, POSTERS, CURRICULUM MATERIALS, NAMELY, A PRINTED TEACHER'S GUIDE AND POSTER ON THE TOPICS OF RELATIONAL AGGRESSION AND BULLYING, BOOKMARKS (U.S. CLS. 2, 5, 22, 23, 29, 37, 38 AND 50).

BILL DAWE, EXAMINING ATTORNEY

CLASS 16—(Continued).

SN 77-614,389. MATTHEW GREETINGS, LLC, DBA MATTHEW GREETINGS, COLUMBUS, OH. FILED 11-14-2008.



NO CLAIM IS MADE TO THE EXCLUSIVE RIGHT TO USE "GREETINGS", APART FROM THE MARK AS SHOWN.

THE COLOR(S) GOLD, BLUE, AND WHITE IS/ARE CLAIMED AS A FEATURE OF THE MARK.

THE MARK CONSISTS OF GOLD SUN WITH 12 CURLY SPIRALING RAYS, THE WORDS "MATTHEW GREETINGS" IN BLUE TO RIGHT OF THE SUN ON A WHITE BACKGROUND.

FOR GREETING CARDS (U.S. CLS. 2, 5, 22, 23, 29, 37, 38 AND 50).

LESLEY LAMOTHE, EXAMINING ATTORNEY

SN 77-615,336. JONESIN APPAREL INC., DBA JONESIN, PALM COAST, FL. FILED 11-16-2008.

Jonesin

THE MARK CONSISTS OF STANDARD CHARACTERS WITHOUT CLAIM TO ANY PARTICULAR FONT, STYLE, SIZE, OR COLOR.

FOR DECAL STICKERS (U.S. CLS. 2, 5, 22, 23, 29, 37, 38 AND 50).

ROBIN MITTLER, EXAMINING ATTORNEY

SN 77-624,982. PROSPER, INC., PROVO, UT. FILED 12-2-2008.

OPENOMICS

THE MARK CONSISTS OF STANDARD CHARACTERS WITHOUT CLAIM TO ANY PARTICULAR FONT, STYLE, SIZE, OR COLOR.

FOR PUBLICATIONS AND PRINTED MATERIALS, NAMELY, BOOKS, BOOKLETS, MANUALS, WORKBOOKS, INSTRUCTOR MANUALS, PAPER TRANSPARENCIES, PLASTIC TRANSPARENCIES, CHARTS, TABLES AND HANDOUTS, ALL IN THE FIELDS OF ECOMMERCE, REAL ESTATE INVESTING, STOCK MARKET INVESTING, PERSONAL FINANCE AND SMALL BUSINESS (U.S. CLS. 2, 5, 22, 23, 29, 37, 38 AND 50).

ALICIA COLLINS, EXAMINING ATTORNEY

CLASS 16—(Continued).

SN 77-629,527. JUNE BUG ENTERPRISES, INC., BEVERLY HILLS, CA. FILED 12-9-2008.

MAGIC JOHNSON

THE MARK CONSISTS OF STANDARD CHARACTERS WITHOUT CLAIM TO ANY PARTICULAR FONT, STYLE, SIZE, OR COLOR.

OWNER OF U.S. REG. NOS. 1,555,839, 3,306,681 AND OTHERS.

FOR BOOKS IN THE FIELDS OF CAREER COUNSELING, BUSINESS, BUSINESS MANAGEMENT, BUSINESS PLANNING AND DEVELOPMENT, BUSINESS FINANCING AND INVESTMENT, AND LIFE SKILLS (U.S. CLS. 2, 5, 22, 23, 29, 37, 38 AND 50).

FIRST USE 11-0-2008; IN COMMERCE 11-0-2008.
MARLENE BELL, EXAMINING ATTORNEY

CLASS 16—(Continued).

SN 77-645,725. NATIONAL OCEANIC AND ATMOSPHERIC ADMINISTRATION, WASHINGTON, DC. FILED 1-8-2009.



OWNER OF U.S. REG. NOS. 3,236,080, 3,605,624 AND OTHERS.

THE COLOR(S) BLUE, BLACK, GRAY IS/ARE CLAIMED AS A FEATURE OF THE MARK.

THE MARK CONSISTS OF THE ACRONYM "IOOS". EACH LETTER OF THE ACRONYM IS DIVIDED IN HALF. FOR THE LETTERS "I" AND "S", THE LEFT SIDE IS IN BLACK WHILE THE RIGHT SIDE IS IN BLUE, GRAY, AND BLACK. FOR THE LETTERS "O", BOTH SIDES CONSIST OF SHADES OF BLUE, GRAY, AND BLACK. THE TWO "O" LETTERS IN THE ACRONYM CONSIST OF GLOBE IMAGES WITH THE CONTINENTS BEING IN BLACK AND THE OCEAN BEING IN BLUE.

FOR PUBLICATIONS, NAMELY, BROCHURES, BOOKLETS, AND TEACHING MATERIALS IN THE FIELDS OF OPEN OCEANS, COASTAL WATERS, AND GREAT LAKES (U.S. CLS. 2, 5, 22, 23, 29, 37, 38 AND 50).

FIRST USE 8-31-2008; IN COMMERCE 8-31-2008.
DAVID ELTON, EXAMINING ATTORNEY

SN 77-636,043. NATIONAL FRANCHISEE ASSOCIATION, KENNESAW, GA. FILED 12-18-2008.

FLAME

THE MARK CONSISTS OF STANDARD CHARACTERS WITHOUT CLAIM TO ANY PARTICULAR FONT, STYLE, SIZE, OR COLOR.

SEC. 2(F).

FOR PUBLICATIONS, NAMELY, A QUARTERLY MAGAZINE WRITTEN AND PRODUCED SPECIFICALLY FOR QUICK SERVICE RESTAURANT FRANCHISEES IN THE FIELDS OF RESTAURANT INDUSTRY UPDATES AND INFORMATION (U.S. CLS. 2, 5, 22, 23, 29, 37, 38 AND 50).

FIRST USE 2-1-2001; IN COMMERCE 2-1-2001.
BRIAN NEVILLE, EXAMINING ATTORNEY

SN 77-647,990. RAGS UNLIMITED INC, GASTONIA, NC. FILED S.R. 1-13-2009; AM. P.R. 7-17-2009.

Rags Unlimited Inc

THE MARK CONSISTS OF STANDARD CHARACTERS WITHOUT CLAIM TO ANY PARTICULAR FONT, STYLE, SIZE, OR COLOR.

OWNER OF U.S. REG. NO. 2,268,432.

NO CLAIM IS MADE TO THE EXCLUSIVE RIGHT TO USE "RAGS" AND "INC", APART FROM THE MARK AS SHOWN.

FOR INDUSTRIAL DISPOSABLE WIPES NOT IMPREGNATED WITH CHEMICALS AND COMPOUNDS (U.S. CLS. 2, 5, 22, 23, 29, 37, 38 AND 50).

FIRST USE 1-1-2005; IN COMMERCE 1-1-2005.
COLLEEN DOMBROW, EXAMINING ATTORNEY

CLASS 16—(Continued).

SN 77-647,995. RAGS UNLIMITED INC, GASTONIA, NC.
FILED S.R. 1-13-2009; AM. P.R. 7-16-2009.

O.P.T

THE MARK CONSISTS OF STANDARD CHARACTERS WITHOUT CLAIM TO ANY PARTICULAR FONT, STYLE, SIZE, OR COLOR.
FOR ORANGE PAPER TOWELS (U.S. CLS. 2, 5, 22, 23, 29, 37, 38 AND 50).
FIRST USE 12-1-2008; IN COMMERCE 12-1-2008.
COLLEEN DOMBROW, EXAMINING ATTORNEY

SN 77-652,017. GARDNER, DOUGLAS DANIEL, ARLINGTON, VA. FILED 1-19-2009.

OCTO

THE MARK CONSISTS OF STANDARD CHARACTERS WITHOUT CLAIM TO ANY PARTICULAR FONT, STYLE, SIZE, OR COLOR.
FOR EDUCATIONAL PUBLICATIONS, NAMELY, EDUCATIONAL LEARNING CARDS, FLASH CARDS, ACTIVITY CARDS, WORKBOOKS, TEXTBOOKS, ACTIVITY BOOKS, STORY BOOKS, PUZZLE BOOKS, PRINTED PUZZLES, TEACHER GUIDES, MANUALS, POSTERS AND EDUCATIONAL BOOKLETS IN THE FIELD OF MATHEMATICAL AND LOGIC PUZZLES (U.S. CLS. 2, 5, 22, 23, 29, 37, 38 AND 50).
FIRST USE 1-8-2009; IN COMMERCE 1-8-2009.
DAVID ELTON, EXAMINING ATTORNEY

SN 77-662,501. DAVID E. ROGERS, SCOTTSDALE, AZ. FILED 2-3-2009.

IsoPatent

THE MARK CONSISTS OF THE WORD "ISOPATENT" WITH THE LETTERS "I" AND "P" IN CAPITAL LETTERS AND ALL OTHER LETTERS IN LOWER CASE.
FOR SERIES OF BOOKS IN THE FIELD OF EDUCATIONAL PATENT AND TRADEMARK INFORMATION, STATISTICAL, HISTORICAL PATENT INFORMATION, AND HOW WEALTH CAN BE GENERATED THROUGH INVENTIONS (U.S. CLS. 2, 5, 22, 23, 29, 37, 38 AND 50).
BRIDGETT SMITH, EXAMINING ATTORNEY

CLASS 16—(Continued).

SN 77-671,570. MALYON, CHRISTOPHER JOHN, BRISBANE, AUSTRALIA, AND MALYON, MATTHEW JOHN, BRISBANE, AUSTRALIA, FILED 2-16-2009.

F & C

THE MARK CONSISTS OF STANDARD CHARACTERS WITHOUT CLAIM TO ANY PARTICULAR FONT, STYLE, SIZE, OR COLOR.
PRIORITY CLAIMED UNDER SEC. 44(D) ON AUSTRALIA APPLICATION NO. 1275079, FILED 12-2-2008, REG. NO. 1275079, DATED 12-2-2008, EXPIRES 12-2-2018.
FOR ADHESIVE LABELS; ADHESIVES FOR STATIONERY AND HOUSEHOLD USE; DECALS; CAR STICKERS (U.S. CLS. 2, 5, 22, 23, 29, 37, 38 AND 50).
TINA BROWN, EXAMINING ATTORNEY

SN 77-674,474. DCWV ACQUISITION CORPORATION, PROVO, UT. FILED 2-20-2009.

PREMIUM STACKS

THE MARK CONSISTS OF STANDARD CHARACTERS WITHOUT CLAIM TO ANY PARTICULAR FONT, STYLE, SIZE, OR COLOR.
OWNER OF U.S. REG. NOS. 3,653,209 AND 3,653,516.
NO CLAIM IS MADE TO THE EXCLUSIVE RIGHT TO USE "PREMIUM", APART FROM THE MARK AS SHOWN.
FOR PAPER PRODUCTS FOR CRAFTS AND SCRAPBOOKING, NAMELY, PAPER AND CRAFT PAPER; SCRAPBOOK PAGES (U.S. CLS. 2, 5, 22, 23, 29, 37, 38 AND 50).
FIRST USE 12-31-2007; IN COMMERCE 12-31-2007.
BERYL GARDNER, EXAMINING ATTORNEY

SN 77-674,525. DCWV ACQUISITION CORPORATION, PROVO, UT. FILED 2-20-2009.

MAT STACK

THE MARK CONSISTS OF STANDARD CHARACTERS WITHOUT CLAIM TO ANY PARTICULAR FONT, STYLE, SIZE, OR COLOR.
OWNER OF U.S. REG. NOS. 3,653,209 AND 3,653,516.
NO CLAIM IS MADE TO THE EXCLUSIVE RIGHT TO USE "MAT", APART FROM THE MARK AS SHOWN.
FOR PAPER PRODUCTS FOR CRAFTS AND SCRAPBOOKING, NAMELY, PAPER, CRAFT PAPER AND CARDSTOCK (U.S. CLS. 2, 5, 22, 23, 29, 37, 38 AND 50).
FIRST USE 12-31-2002; IN COMMERCE 12-31-2002.
BERYL GARDNER, EXAMINING ATTORNEY

CLASS 16—(Continued).

SN 77-674,529. DCWV ACQUISITION CORPORATION, PROVO, UT. FILED 2-20-2009.

MAT STACKS

THE MARK CONSISTS OF STANDARD CHARACTERS WITHOUT CLAIM TO ANY PARTICULAR FONT, STYLE, SIZE, OR COLOR.

OWNER OF U.S. REG. NOS. 3,653,209 AND 3,653,516. NO CLAIM IS MADE TO THE EXCLUSIVE RIGHT TO USE "MAT", APART FROM THE MARK AS SHOWN.

FOR PAPER PRODUCTS FOR CRAFTS AND SCRAPBOOKING, NAMELY, PAPER, CRAFT PAPER AND CARDSTOCK (U.S. CLS. 2, 5, 22, 23, 29, 37, 38 AND 50).

FIRST USE 12-31-2001; IN COMMERCE 12-31-2001.
BERYL GARDNER, EXAMINING ATTORNEY

SN 77-674,550. DCWV ACQUISITION CORPORATION, PROVO, UT. FILED 2-20-2009.

THE PAPER STACK

THE MARK CONSISTS OF STANDARD CHARACTERS WITHOUT CLAIM TO ANY PARTICULAR FONT, STYLE, SIZE, OR COLOR.

OWNER OF U.S. REG. NOS. 3,653,209 AND 3,653,516. NO CLAIM IS MADE TO THE EXCLUSIVE RIGHT TO USE "PAPER", APART FROM THE MARK AS SHOWN.

FOR SCRAPBOOK, MEMORY, AND CRAFT PRODUCTS AND MATERIALS; SCRAPBOOK PAGES (U.S. CLS. 2, 5, 22, 23, 29, 37, 38 AND 50).

FIRST USE 12-31-2004; IN COMMERCE 12-31-2004.
BERYL GARDNER, EXAMINING ATTORNEY

SN 77-675,717. DCWV ACQUISITION CORPORATION, PROVO, UT. FILED 2-23-2009.

PREMIUM STACK

THE MARK CONSISTS OF STANDARD CHARACTERS WITHOUT CLAIM TO ANY PARTICULAR FONT, STYLE, SIZE, OR COLOR.

OWNER OF U.S. REG. NOS. 3,653,209 AND 3,653,516. NO CLAIM IS MADE TO THE EXCLUSIVE RIGHT TO USE "PREMIUM", APART FROM THE MARK AS SHOWN.

FOR PAPER PRODUCTS FOR CRAFTS AND SCRAPBOOKING, NAMELY, PAPER AND CRAFT PAPER; SCRAPBOOK PAGES (U.S. CLS. 2, 5, 22, 23, 29, 37, 38 AND 50).

FIRST USE 12-31-2007; IN COMMERCE 12-31-2007.
BERYL GARDNER, EXAMINING ATTORNEY

CLASS 16—(Continued).

SN 77-675,744. DCWV ACQUISITION CORPORATION, PROVO, UT. FILED 2-23-2009.

PAPER STACK

THE MARK CONSISTS OF STANDARD CHARACTERS WITHOUT CLAIM TO ANY PARTICULAR FONT, STYLE, SIZE, OR COLOR.

OWNER OF U.S. REG. NOS. 3,653,209 AND 3,653,516. NO CLAIM IS MADE TO THE EXCLUSIVE RIGHT TO USE "PAPER", APART FROM THE MARK AS SHOWN.

FOR PAPER PRODUCTS FOR CRAFTS AND SCRAPBOOKING, NAMELY, PAPER AND CRAFT PAPER; SCRAPBOOK PAGES (U.S. CLS. 2, 5, 22, 23, 29, 37, 38 AND 50).

FIRST USE 12-31-2005; IN COMMERCE 12-31-2005.
BERYL GARDNER, EXAMINING ATTORNEY

SN 77-676,084. DCWV ACQUISITION CORPORATION, PROVO, UT. FILED 2-23-2009.

CARDSTOCK STACK

THE MARK CONSISTS OF STANDARD CHARACTERS WITHOUT CLAIM TO ANY PARTICULAR FONT, STYLE, SIZE, OR COLOR.

OWNER OF U.S. REG. NOS. 3,653,209 AND 3,653,516. NO CLAIM IS MADE TO THE EXCLUSIVE RIGHT TO USE "CARDSTOCK", APART FROM THE MARK AS SHOWN.

FOR PAPER PRODUCTS FOR CRAFTS AND SCRAPBOOKING, NAMELY, PAPER AND CRAFT PAPER; SCRAPBOOK PAGES (U.S. CLS. 2, 5, 22, 23, 29, 37, 38 AND 50).

FIRST USE 12-31-2005; IN COMMERCE 12-31-2005.
BERYL GARDNER, EXAMINING ATTORNEY

SN 77-691,920. GUIDEPOSTS A CHURCH CORPORATION, CARMEL, NY. FILED 3-16-2009.

ANIMALS AND HEALING

THE MARK CONSISTS OF STANDARD CHARACTERS WITHOUT CLAIM TO ANY PARTICULAR FONT, STYLE, SIZE, OR COLOR.

NO CLAIM IS MADE TO THE EXCLUSIVE RIGHT TO USE "ANIMALS", APART FROM THE MARK AS SHOWN. SEC. 2(F).

FOR MAGAZINE COLUMN FEATURING PERSONAL, SPIRITUAL, POSITIVE AND FAITH-FILLED INFORMATION RELATING TO ANIMALS AND THEIR OWNERS (U.S. CLS. 2, 5, 22, 23, 29, 37, 38 AND 50).

FIRST USE 2-28-2001; IN COMMERCE 2-28-2001.
RENEE MCCRAY, EXAMINING ATTORNEY

CLASS 16—(Continued).

SN 77-692,406. GUIDEPOSTS A CHURCH CORPORATION, CARMEL, NY. FILED 3-17-2009.

COMFORT FROM BEYOND

THE MARK CONSISTS OF STANDARD CHARACTERS WITHOUT CLAIM TO ANY PARTICULAR FONT, STYLE, SIZE, OR COLOR.

SEC. 2(F).
FOR MAGAZINE COLUMN FEATURING PERSONAL, SPIRITUAL, POSITIVE AND FAITH-FILLED INFORMATION (U.S. CLS. 2, 5, 22, 23, 29, 37, 38 AND 50).

FIRST USE 1-31-2003; IN COMMERCE 1-31-2003.
RENEE MCCRAY, EXAMINING ATTORNEY

SN 77-693,514. GUIDEPOSTS A CHURCH CORPORATION, CARMEL, NY. FILED 3-18-2009.

DIVINE TOUCH

THE MARK CONSISTS OF STANDARD CHARACTERS WITHOUT CLAIM TO ANY PARTICULAR FONT, STYLE, SIZE, OR COLOR.

SEC. 2(F).
FOR MAGAZINE COLUMN FEATURING PERSONAL, SPIRITUAL, POSITIVE AND FAITH-FILLED INFORMATION (U.S. CLS. 2, 5, 22, 23, 29, 37, 38 AND 50).

FIRST USE 1-31-1997; IN COMMERCE 1-31-1997.
RENEE MCCRAY, EXAMINING ATTORNEY

SN 77-694,013. SCRIPPS NETWORKS, LLC, KNOXVILLE, TN. FILED 3-18-2009.

MAN CAVES

THE MARK CONSISTS OF STANDARD CHARACTERS WITHOUT CLAIM TO ANY PARTICULAR FONT, STYLE, SIZE, OR COLOR.

FOR BOOKS IN THE FIELD OF HOME REPAIR; PRINTED PAPER SIGNS, POSTERS, AND STATIONERY (U.S. CLS. 2, 5, 22, 23, 29, 37, 38 AND 50).

TEJBIR SINGH, EXAMINING ATTORNEY

CLASS 16—(Continued).

SN 77-694,098. AMERICAN ACADEMY OF FINANCIAL MANAGEMENT, LLC, AKA AAFM AMERICAN ACADEMY OF FINANCIAL MANAGEMENT, METAIRIE, LA. FILED 3-18-2009.

AAFM AMERICAN ACADEMY OF FINANCIAL MANAGEMENT

THE MARK CONSISTS OF STANDARD CHARACTERS WITHOUT CLAIM TO ANY PARTICULAR FONT, STYLE, SIZE, OR COLOR.

NO CLAIM IS MADE TO THE EXCLUSIVE RIGHT TO USE "FINANCIAL MANAGEMENT", APART FROM THE MARK AS SHOWN.

SEC. 2(F).
FOR EDUCATIONAL PUBLICATIONS, NAMELY, TRAINING MANUALS IN THE FIELD OF FINANCE AND MANAGEMENT (U.S. CLS. 2, 5, 22, 23, 29, 37, 38 AND 50).

FIRST USE 1-1-1996, THE MARK WAS FIRST USED ANYWHERE IN A DIFFERENT FORM OTHER THAN THAT SOUGHT TO BE REGISTERED AT LEAST AS EARLY AS 01/01/1996.; IN COMMERCE 1-1-1996, THE MARK WAS FIRST USED IN COMMERCE IN A DIFFERENT FORM OTHER THAN THAT SOUGHT TO BE REGISTERED AT LEAST AS EARLY AS 01/01/1997..

IRA J. GOODSAYD, EXAMINING ATTORNEY

SN 77-697,672. SOGOT INCORPORATED, VICTORVILLE, CA. FILED 3-24-2009.



NO CLAIM IS MADE TO THE EXCLUSIVE RIGHT TO USE "VEHICLE", APART FROM THE MARK AS SHOWN.

THE MARK CONSISTS OF THE STYLIZED WORDING "V-SOL VEHICLE SUNSCREEN." THE LETTER "O" IN THE WORD "SOL" RESEMBLES AN IMAGE OF A SUN. A DOT APPEARS TO THE RIGHT OF THE LETTER "L" IN THE WORD "V-SOL" AND TO THE LEFT OF THE LETTERS "S" IN THE WORD "SUNSCREEN".

FOR WINDOW DECALS (U.S. CLS. 2, 5, 22, 23, 29, 37, 38 AND 50).

JESSICA FATHY, EXAMINING ATTORNEY

CLASS 16—(Continued).

SN 77-702,471. ASSET MARKETING SERVICES, INC.,
BURNSVILLE, MN. FILED 3-30-2009.

GOVMINT

THE MARK CONSISTS OF STANDARD CHARACTERS
WITHOUT CLAIM TO ANY PARTICULAR FONT, STYLE,
SIZE, OR COLOR.

FOR COLLECTIBLE PAPER CURRENCY AND RE-
FERENCE BOOKS ABOUT COINS (U.S. CLS. 2, 5, 22, 23,
29, 37, 38 AND 50).

FIRST USE 3-23-2006; IN COMMERCE 3-23-2006.
DEIRDRE ROBERTSON, EXAMINING ATTORNEY

CLASS 16—(Continued).

SN 77-704,465. TRANS WESTERN POLYMERS, INC., LIVER-
MORE, CA. FILED 4-1-2009.

TEAR HALT

THE MARK CONSISTS OF STANDARD CHARACTERS
WITHOUT CLAIM TO ANY PARTICULAR FONT, STYLE,
SIZE, OR COLOR.

NO CLAIM IS MADE TO THE EXCLUSIVE RIGHT TO
USE "TEAR", APART FROM THE MARK AS SHOWN.

FOR TRASH BAGS (U.S. CLS. 2, 5, 22, 23, 29, 37, 38
AND 50).

RONALD AIKENS, EXAMINING ATTORNEY

SN 77-703,177. THE BOARD OF REGENTS OF THE UNI-
VERSITY OF IDAHO, MOSCOW, ID. FILED 3-31-2009.

BLOCK Fest

THE MARK CONSISTS OF STANDARD CHARACTERS
WITHOUT CLAIM TO ANY PARTICULAR FONT, STYLE,
SIZE, OR COLOR.

NO CLAIM IS MADE TO THE EXCLUSIVE RIGHT TO
USE "BLOCK", APART FROM THE MARK AS SHOWN.

FOR PACKAGED KITS COMPRISING PRINTED IN-
STRUCTIONAL, EDUCATIONAL, AND TEACHING MA-
TERIALS FOR EDUCATIONAL ACTIVITIES IN THE
FIELD OF EARLY CHILDHOOD EDUCATION (U.S.
CLS. 2, 5, 22, 23, 29, 37, 38 AND 50).

FIRST USE 2-22-2006; IN COMMERCE 2-22-2006.
JOHN E. MICHOS, EXAMINING ATTORNEY

SN 77-705,381. TRANS WESTERN POLYMERS, INC., LIVER-
MORE, CA. FILED 4-2-2009.

TEAR TOUGH

SN 77-704,451. TRANS WESTERN POLYMERS, INC., LIVER-
MORE, CA. FILED 4-1-2009.

TEAR TUFF

THE MARK CONSISTS OF STANDARD CHARACTERS
WITHOUT CLAIM TO ANY PARTICULAR FONT, STYLE,
SIZE, OR COLOR.

NO CLAIM IS MADE TO THE EXCLUSIVE RIGHT TO
USE "TEAR", APART FROM THE MARK AS SHOWN.

FOR TRASH BAGS (U.S. CLS. 2, 5, 22, 23, 29, 37, 38
AND 50).

RONALD AIKENS, EXAMINING ATTORNEY

THE MARK CONSISTS OF STANDARD CHARACTERS
WITHOUT CLAIM TO ANY PARTICULAR FONT, STYLE,
SIZE, OR COLOR.

NO CLAIM IS MADE TO THE EXCLUSIVE RIGHT TO
USE "TEAR", APART FROM THE MARK AS SHOWN.

FOR TRASH BAGS (U.S. CLS. 2, 5, 22, 23, 29, 37, 38
AND 50).

RONALD AIKENS, EXAMINING ATTORNEY

CLASS 16—(Continued).

SN 77-707,759. MORIN, ROLAND, DBA FREEDOM PUG, STREET, MD. FILED 4-6-2009.

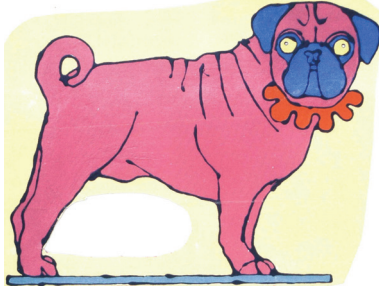

THE COLOR(S) PINK, BLUE, ORANGE, YELLOW, WHITE, AND TEAL IS/ARE CLAIMED AS A FEATURE OF THE MARK.

THE MARK CONSISTS OF A PUG WITH A PINK BODY, BLUE MASK FACE, BLUE EARS, YELLOW EYES, WHITE PUPILS, ORANGE NECK SCARF AND STANDING ON A TEAL PLATFORM. THE PUG APPEARS ON A YELLOW AND WHITE BACKGROUND.

FOR A SERIES OF BOOKS AND WRITTEN ARTICLES IN THE FIELD OF AMERICAN HISTORY; A SERIES OF BOOKS, WRITTEN ARTICLES, HANDOUTS AND WORKSHEETS IN THE FIELD OF AMERICAN HISTORY; BOOK COVERS; BOOK ENDS; BOOK MARKERS; BOOK MARKS; CHILDREN'S ACTIVITY BOOKS; CHILDREN'S BOOKS; CHILDREN'S INTERACTIVE EDUCATIONAL BOOKS; COFFEE TABLE BOOKS FEATURING AMERICAN HISTORY; DATA BOOKS; EDUCATIONAL PUBLICATIONS, NAMELY, BOOKS, HAND-OUTS, WORKBOOKS, JOURNALS, PLAYBOOKS, WORKSHEETS AND CARDS IN THE FIELD OF RIGHT-BRAIN FITNESS; EDUCATIONAL PUBLICATIONS, NAMELY, EDUCATIONAL LEARNING CARDS, FLASH CARDS, ACTIVITY CARDS, WORKBOOKS, TEXTBOOKS, ACTIVITY BOOKS, STORY BOOKS, PUZZLE BOOKS, PRINTED PUZZLES, TEACHER GUIDES, MANUALS, POSTERS AND EDUCATIONAL BOOKLETS IN THE FIELD OF AMERICAN HISTORY; GUIDE BOOKS FEATURING AMERICAN HISTORY; PICTURE BOOKS; REFERENCE BOOKS IN THE FIELD OF AMERICAN HISTORY; RESOURCE BOOKS IN THE FIELD OF AMERICAN HISTORY; SCHOLARLY BOOKS ON VARIOUS TOPICS, NAMELY, AMERICAN HISTORY; SCHOOL WRITING BOOKS; STORY BOOKS (U.S. CLS. 2, 5, 22, 23, 29, 37, 38 AND 50).

INGRID C. EULIN, EXAMINING ATTORNEY

SN 77-709,356. SHORTCUTS BY SHARON, LLC, TEANECK, NJ. FILED 4-8-2009.

QUILT BLOCK PRO

THE MARK CONSISTS OF STANDARD CHARACTERS WITHOUT CLAIM TO ANY PARTICULAR FONT, STYLE, SIZE, OR COLOR.

NO CLAIM IS MADE TO THE EXCLUSIVE RIGHT TO USE "QUILT BLOCK", APART FROM THE MARK AS SHOWN.

FOR PRINTED CHARTS (U.S. CLS. 2, 5, 22, 23, 29, 37, 38 AND 50).

FIRST USE 4-1-2009; IN COMMERCE 4-1-2009.

HOWARD B. LEVINE, EXAMINING ATTORNEY

CLASS 16—(Continued).

SN 77-710,443. DAMSEL MAGAZINE INC., SANTA ANA, CA. FILED 4-9-2009.

DAMSEL Magazine

THE MARK CONSISTS OF STANDARD CHARACTERS WITHOUT CLAIM TO ANY PARTICULAR FONT, STYLE, SIZE, OR COLOR.

NO CLAIM IS MADE TO THE EXCLUSIVE RIGHT TO USE "MAGAZINE", APART FROM THE MARK AS SHOWN. FOR MAGAZINES FEATURING WOMENS' FASHION, BEAUTY, CULTURE AND LIFESTYLE (U.S. CLS. 2, 5, 22, 23, 29, 37, 38 AND 50).

FIRST USE 9-1-2007; IN COMMERCE 9-1-2007.

BRIAN NEVILLE, EXAMINING ATTORNEY

SN 77-712,965. READY, MATTHEW A., CROSS PLAINS, WI. FILED 4-13-2009.

The Mightee Midgets Game

THE MARK CONSISTS OF STANDARD CHARACTERS WITHOUT CLAIM TO ANY PARTICULAR FONT, STYLE, SIZE, OR COLOR.

NO CLAIM IS MADE TO THE EXCLUSIVE RIGHT TO USE "GAME", APART FROM THE MARK AS SHOWN.

FOR PRINTED ROLE PLAYING GAME BOOK (U.S. CLS. 2, 5, 22, 23, 29, 37, 38 AND 50).

FIRST USE 9-17-2008; IN COMMERCE 9-17-2008.

ELLEN BURNS, EXAMINING ATTORNEY

SN 77-714,918. BUBBLE CALENDAR LLC, BROOKLYN, NY. FILED 4-15-2009.

Bubble Calendar

THE MARK CONSISTS OF STANDARD CHARACTERS WITHOUT CLAIM TO ANY PARTICULAR FONT, STYLE, SIZE, OR COLOR.

NO CLAIM IS MADE TO THE EXCLUSIVE RIGHT TO USE "CALENDAR", APART FROM THE MARK AS SHOWN.

FOR CALENDARS (U.S. CLS. 2, 5, 22, 23, 29, 37, 38 AND 50).

FIRST USE 5-31-2008; IN COMMERCE 6-21-2008.

KATHERINE STOIDES, EXAMINING ATTORNEY

CLASS 16—(Continued).

SN 77-715,136. OMAX CORPORATION, KENT, WA. FILED 4-16-2009.

MAXIEM WATERJETS

THE MARK CONSISTS OF STANDARD CHARACTERS WITHOUT CLAIM TO ANY PARTICULAR FONT, STYLE, SIZE, OR COLOR.

OWNER OF U.S. REG. NOS. 1,992,387, 2,882,969 AND 3,012,170.

NO CLAIM IS MADE TO THE EXCLUSIVE RIGHT TO USE "WATERJETS", APART FROM THE MARK AS SHOWN.

FOR MANUALS IN THE FIELD OF INSTRUCTION FOR EXPLAINING THE OPERATION OF TABLE MACHINE TOOL (U.S. CLS. 2, 5, 22, 23, 29, 37, 38 AND 50).
CAROLINE WOOD, EXAMINING ATTORNEY

CLASS 16—(Continued).

SN 77-715,829. FELSKE, COERTE, NEW YORK, NY. FILED 4-16-2009.



NO CLAIM IS MADE TO THE EXCLUSIVE RIGHT TO USE "PRESS", APART FROM THE MARK AS SHOWN.

THE MARK CONSISTS OF THE WORDS "THE DOLCE VITA PRESS" WRITTEN WITH ALL FOUR WORDS STACKED VERTICALLY, "THE" AT TOP AND "PRESS" AT BOTTOM, ALL IN A STYLIZED FONT, AND A PAIR OF SUNGLASSES BETWEEN THE "THE" AND "DOLCE".

THE ENGLISH TRANSLATION OF "DOLCE" AND "VITA" IN THE MARK IS "THE GOOD LIFE" OR "THE SWEET LIFE".

FOR SERIES OF FICTION AND NON-FICTION BOOKS ON A VARIETY OF TOPICS (U.S. CLS. 2, 5, 22, 23, 29, 37, 38 AND 50).

FONG HSU, EXAMINING ATTORNEY

SN 77-715,558. COLONUS PUBLISHING, INC., SPOKANE, WA. FILED 4-16-2009.

COLONUS HOUSE

THE MARK CONSISTS OF STANDARD CHARACTERS WITHOUT CLAIM TO ANY PARTICULAR FONT, STYLE, SIZE, OR COLOR.

FOR BOOKS IN THE FIELD MEMOIRS (U.S. CLS. 2, 5, 22, 23, 29, 37, 38 AND 50).

DANNEAN HETZEL, EXAMINING ATTORNEY

SN 77-716,277. FEDOREV, GREG, ROCKFORD, IL. FILED 4-17-2009.

The Alluring Water Lily

THE MARK CONSISTS OF STANDARD CHARACTERS WITHOUT CLAIM TO ANY PARTICULAR FONT, STYLE, SIZE, OR COLOR.

NO CLAIM IS MADE TO THE EXCLUSIVE RIGHT TO USE "WATER LILY", APART FROM THE MARK AS SHOWN.

FOR PRINTED GOODS, NAMELY, FINE ART PRINTS, CALENDERS; A SERIES OF BOOKS AND WRITTEN ARTICLES IN THE FIELD OF WATER LILIES (U.S. CLS. 2, 5, 22, 23, 29, 37, 38 AND 50).

FIRST USE 2-1-2008; IN COMMERCE 3-1-2008.

MICHAEL ENGEL, EXAMINING ATTORNEY

CLASS 16—(Continued).

SN 77-718,651. DANIEL O. REICH INCORPORATED, DBA REICH PAPER CORPORATION, BROOKLYN, NY. FILED 4-21-2009.

SAVOY

THE MARK CONSISTS OF STANDARD CHARACTERS WITHOUT CLAIM TO ANY PARTICULAR FONT, STYLE, SIZE, OR COLOR.

FOR PRINTING PAPER; WRITING PAPER; ENVELOPES; ART PAPER; CRAFT PAPER; LUMINOUS PAPER; AND FLUORESCENT PAPER (U.S. CLS. 2, 5, 22, 23, 29, 37, 38 AND 50).

JASON BLAIR, EXAMINING ATTORNEY

SN 77-719,693. PISANI, FRANK, LARCHMONT, NY. AND MURPHY, SHARON, RHINEBACK, NY. FILED 4-22-2009.

ZEPHYR'S POND

THE MARK CONSISTS OF STANDARD CHARACTERS WITHOUT CLAIM TO ANY PARTICULAR FONT, STYLE, SIZE, OR COLOR.

OWNER OF U.S. REG. NO. 2,669,504.

FOR PAPER AND PRINTED MATTER, NAMELY, SERIES OF BOOKS IN THE FIELD OF CHILDREN'S STORIES, CRAFT PROJECTS, NAMELY, CHILDREN'S ACTIVITY BOOKS, SCRAPBOOKS; STICKERS; STATIONERY; PRINTED INVITATIONS; CALENDARS; NOTEBOOKS; POSTERS; GREETING CARDS; POSTCARDS; BOOKMARKS; ADDRESS BOOKS; DATE BOOKS; ENVELOPES; GIFT CARDS; TRADING CARDS; BLANK WRITING JOURNALS; MEMO PADS, PENCILS, FOLDERS; PRINTED RECIPE CARDS; MEMO PADS; STATIONERY CONTAINING ADHESIVE ON ONE SIDE OF THE SHEETS FOR ATTACHMENT TO SURFACES; BLANK NOTE CARDS; PAPER NOTEBOOKS; ILLUSTRATIONS; APPOINTMENT BOOKS; SONG BOOKS; AUTOGRAPH BOOKS; BABY BOOKS; COLORING BOOKS; CRAYONS; PAPER BAGS; GIFT WRAPPING PAPER; TOILET PAPER; BATHROOM TISSUE; PAPER PARTY DECORATIONS; PAPER TABLECLOTHS; PAPER NAPKINS; PAPER GIFT SETS COMPRISED OF NOTEBOOKS, PENS, PENCILS, ENVELOPES, STATIONERY AND PRINTED INVITATIONS; PENS; MARKERS; MAPS; BUMPER STICKERS; MERCHANDISE BAGS; PAPER BOXES; PHOTO ALBUMS; PAPER CLIPS; LUNCH KITS, NAMELY, LUNCH BAGS, MADE OF LEATHER, CANVAS, MESH AND FABRIC (U.S. CLS. 2, 5, 22, 23, 29, 37, 38 AND 50).

AMOS T. MATTHEWS, JR., EXAMINING ATTORNEY

CLASS 16—(Continued).

SN 77-720,508. SULLIVAN, JULIE, MOORPARK, CA. FILED 4-23-2009.

Cavity Witch

THE MARK CONSISTS OF STANDARD CHARACTERS WITHOUT CLAIM TO ANY PARTICULAR FONT, STYLE, SIZE, OR COLOR.

FOR CHILDREN'S BOOKS (U.S. CLS. 2, 5, 22, 23, 29, 37, 38 AND 50).

HOWARD FRIEDMAN, EXAMINING ATTORNEY

SN 77-721,216. TWENTIETH CENTURY FOX FILM CORPORATION, LOS ANGELES, CA. FILED 4-23-2009.



OWNER OF U.S. REG. NO. 3,001,994.

NO CLAIM IS MADE TO THE EXCLUSIVE RIGHT TO USE "SPORTS", APART FROM THE MARK AS SHOWN.

THE MARK CONSISTS OF THE STYLIZED WORDS "THE ADVENTURES OF DIGGER AND FRIENDS" WHICH APPEAR INSIDE OF TWO OVAL CONCENTRIC LINES, THE WORDS "FOX SPORTS" WHICH APPEAR UNDER THE WORD "FRIENDS" AND INSIDE OF THE OVAL SHAPE OVERLAPPING ON THE BOTTOM OF THE INNER OVAL LINE AND FIVE COSTUMED GOPHER CHARACTERS WHICH APPEAR ABOVE THE OUTER OVAL LINE.

FOR STATIONERY, WRITING PAPER AND ENVELOPES; DESK CALENDARS, WALL CALENDARS; STICKERS, BOOKMARKS; GREETING CARDS; POSTERS; POSTCARDS; PENS AND PENCILS; BUMPER STICKERS; TEMPORARY TATTOOS; PERSONAL DIARIES; BLANK JOURNALS; NOTEPADS; NOTEBOOKS; WRITING PAPER; PHOTO ALBUMS; PAPER FOLDERS; PAPER DOORKNOB HANGERS; TABLE CLOTHS MADE OF PAPER, PAPER NAPKINS AND PARTY FAVORS MADE OF PAPER; WRAPPING PAPER AND PAPER GIFT TAGS; COMIC BOOKS; TRADING CARDS; CHILDREN'S BOOKS, CHILDREN'S ACTIVITY BOOKS, COLORING BOOKS; GAME BOOKS, NAMELY, PARTY GAME BOOKS, GAME BOOKS FEATURING PAPER GAMES, ACTIVITY GAME BOOKS, PUZZLE BOOKS, WORD GAME BOOKS, AND TRIVIA GAME BOOKS; SERIES OF FICTION BOOKS; FLAGS AND PENNANTS OF PAPER (U.S. CLS. 2, 5, 22, 23, 29, 37, 38 AND 50).

LINDA LAVACHE, EXAMINING ATTORNEY

CLASS 16—(Continued).

SN 77-722,300. TURNER, JONATHAN, MILPITAS, CA. FILED 4-24-2009.

CLASS 16—(Continued).

SN 77-723,132. THE TOPPS COMPANY, INC., NEW YORK, NY. FILED 4-27-2009.

PajamaMan

OWN THE OCTAGON!

THE MARK CONSISTS OF STANDARD CHARACTERS WITHOUT CLAIM TO ANY PARTICULAR FONT, STYLE, SIZE, OR COLOR.

FOR PRINTED MATTER AND PAPER GOODS, NAMELY, BOOKS FEATURING CHARACTERS FROM ANIMATED, ACTION ADVENTURE, COMEDY AND/OR DRAMA FEATURES, COMIC BOOKS, CHILDREN'S BOOKS, MAGAZINES FEATURING CHARACTERS FROM ANIMATED, ACTION ADVENTURE, COMEDY AND/OR DRAMA FEATURES, COLORING BOOKS, CHILDREN'S ACTIVITY BOOKS; STATIONERY, WRITING PAPER, ENVELOPES, NOTEBOOKS, DIARIES, NOTE CARDS, GREETING CARDS, TRADING CARDS; LITHOGRAPHS; PENS, PENCILS, CASES THEREFOR, ERASERS, CRAYONS, MARKERS, COLORED PENCILS, PAINTING SETS FOR CHILDREN, CHALK AND CHALKBOARDS FOR CHILDREN; DECALS, HEAT TRANSFERS; POSTERS; MOUNTED AND/OR UNMOUNTED PHOTOGRAPHS; BOOK COVERS, BOOK MARKS, CALENDARS, GIFT WRAPPING PAPER; PAPER PARTY FAVORS AND PAPER PARTY DECORATIONS, NAMELY, PAPER NAPKINS, PAPER DOILIES, PAPER PLACE MATS, CREPE PAPER, PAPER INVITATIONS, PAPER TABLE CLOTHS, PAPER CAKE DECORATIONS; PRINTED TRANSFERS FOR EMBROIDERY OR FABRIC APPLIQUES; PRINTED PATTERNS FOR COSTUMES, PAJAMAS, SWEATSHIRTS AND T-SHIRTS (U.S. CLS. 2, 5, 22, 23, 29, 37, 38 AND 50).

JAMES GRIFFIN, EXAMINING ATTORNEY

THE MARK CONSISTS OF STANDARD CHARACTERS WITHOUT CLAIM TO ANY PARTICULAR FONT, STYLE, SIZE, OR COLOR.

FOR TRADING CARDS AND STICKERS (U.S. CLS. 2, 5, 22, 23, 29, 37, 38 AND 50).

BRENDAN REGAN, EXAMINING ATTORNEY

SN 77-723,709. DUNCAN, KENNETH E., PITTSFIELD, MA. FILED 4-28-2009.

SN 77-722,944. HINCHMAN, MAX, LODI, CA. FILED 4-27-2009.

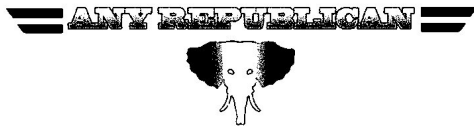

YOGASAURUS

THE STIPPLING IS FOR SHADING PURPOSES ONLY. THE MARK CONSISTS OF THE STYLIZED TEXT "ANY REPUBLICAN" WITH AN ELEPHANT.

FOR BUMPER STICKERS (U.S. CLS. 2, 5, 22, 23, 29, 37, 38 AND 50).

ZACHARY BELLO, EXAMINING ATTORNEY

THE MARK CONSISTS OF STANDARD CHARACTERS WITHOUT CLAIM TO ANY PARTICULAR FONT, STYLE, SIZE, OR COLOR.

FOR CHILDREN'S BOOKS (U.S. CLS. 2, 5, 22, 23, 29, 37, 38 AND 50).

ODESSA BIBBINS, EXAMINING ATTORNEY

CLASS 16—(Continued).

SN 77-723,784. THE BOREALIS PRESS INC., SURRY, ME.
FILED 4-28-2009.

MaliMali Cards

THE MARK CONSISTS OF STANDARD CHARACTERS WITHOUT CLAIM TO ANY PARTICULAR FONT, STYLE, SIZE, OR COLOR.

NO CLAIM IS MADE TO THE EXCLUSIVE RIGHT TO USE "CARDS", APART FROM THE MARK AS SHOWN.

FOR GREETING CARDS, PRINTED PAPER MESSAGE CARDS, POSTCARDS, CALENDARS, DESK CALENDARS, POCKET CALENDARS, PRINTED CALENDARS, WALL CALENDARS, CALENDAR DESK PADS, STATIONERY, STATIONERY WRITING PAPER AND ENVELOPES, BUMPER STICKERS, STICKERS, PAPER TAGS, CARDBOARD HANG TAGS, POSTERS, MOUNTED POSTERS, UNMOUNTED POSTERS, PRINTED PAPER SIGNS, PAPER FLAGS, PAPER BANNERS, ART PRINTS, COLOR PRINTS, LITHOGRAPHIC PRINTS, PHOTOGRAPHIC PRINTS, PICTORIAL PRINTS, PEN/INK DRAWINGS, NOTEBOOKS, NOTE CARDS, NOTE PAPER, NOTE PADS, NOTEBOOK PAPER, NOTEBOOK DIVIDERS, ANNOUNCEMENT CARDS, BOOKS, NAMELY, PICTURE BOOKS, WIRE BOUND NOTEBOOKS, WRITING PADS, BINDERS, DAILY PLANNERS; PENS, PENCILS, PEN AND PENCIL CASES AND BOXES, DECALS, PAPER BAGS AND SACKS, PAPER GIFT BAGS, WRAPPING PAPER, GIFT WRAPPING PAPER, FOLDERS, FILE FOLDERS, PAPER FOLDERS, ENVELOPES, CARDBOARD BOXES, PAPER BOXES, STATIONERY BOXES, ADDRESS LABELS, ADHESIVE LABELS, PHOTOGRAPHS, PHOTOGRAPH ALBUMS, PAPER BAGS FOR MERCHANDISE PACKAGING, PAPER POUCHES FOR PACKAGING, AND PAPER MAIL POUCHES (U.S. CLS. 2, 5, 22, 23, 29, 37, 38 AND 50).

CHRISIE B. KING, EXAMINING ATTORNEY

SN 77-724,046. JOHN MONTGOMERY, DBA STARTWORKS,
MENLO PARK, CA. FILED 4-28-2009.

STARTWORKS

THE MARK CONSISTS OF STANDARD CHARACTERS WITHOUT CLAIM TO ANY PARTICULAR FONT, STYLE, SIZE, OR COLOR.

FOR BOOKS IN THE FIELD OF BUSINESS, LAW, FINANCING AND VENTURE CAPITAL; PUBLICATIONS, NAMELY, BOOKS, COURSE MATERIALS, HANDOUTS AND OTHER PRINTED MATTER IN THE NATURE OF JOURNALS IN THE FIELDS OF BUSINESS, LAW, FINANCING AND VENTURE CAPITAL (U.S. CLS. 2, 5, 22, 23, 29, 37, 38 AND 50).

JENNY PARK, EXAMINING ATTORNEY

CLASS 16—(Continued).

SN 77-724,125. O'MEARA, JENNIFER ALICE, DBA JULIEN
ARMAND OMEARA, APTOS, CA. FILED 4-28-2009.



THE MARK CONSISTS OF THE STYLIZED LETTERING OF THE OVERLAPPING LETTERS "JAO".

FOR ART PICTURES; ART PRINTS; DRAWINGS; ETCHINGS; ILLUSTRATIONS; LITHOGRAPHIC WORKS OF ART; PAINTINGS; PHOTOGRAPHIC PRINTS; PHOTOGRAPHS; PICTORIAL PRINTS (U.S. CLS. 2, 5, 22, 23, 29, 37, 38 AND 50).

SUSAN LESLIE DUBOIS, EXAMINING ATTORNEY

SN 77-724,158. VISUAL HEALTH TOOLS, LLC, TUCSON, AZ.
FILED 4-28-2009.

Wellness Color Score

THE MARK CONSISTS OF STANDARD CHARACTERS WITHOUT CLAIM TO ANY PARTICULAR FONT, STYLE, SIZE, OR COLOR.

NO CLAIM IS MADE TO THE EXCLUSIVE RIGHT TO USE "WELLNESS", APART FROM THE MARK AS SHOWN.

FOR PRINTED CONSUMER REPORTS FEATURING INFORMATION ON WELLNESS (U.S. CLS. 2, 5, 22, 23, 29, 37, 38 AND 50).

FIRST USE 4-30-2008; IN COMMERCE 4-30-2008.

JOHN E. MICHOS, EXAMINING ATTORNEY

SN 77-724,186. FATHEAD, LLC, LIVONIA, MI. FILED 4-28-2009.

FAT TATZ

THE MARK CONSISTS OF STANDARD CHARACTERS WITHOUT CLAIM TO ANY PARTICULAR FONT, STYLE, SIZE, OR COLOR.

FOR POSTERS; ADHESIVE PLASTIC FILM WITH REMOVABLE PAPER FOR MOUNTING IMAGES FOR DECORATIVE PURPOSES (U.S. CLS. 2, 5, 22, 23, 29, 37, 38 AND 50).

MATTHEW PAPPAS, EXAMINING ATTORNEY

CLASS 16—(Continued).

SN 77-724,313. LAW, JASON, ROME, GA. FILED 4-28-2009.



NO CLAIM IS MADE TO THE EXCLUSIVE RIGHT TO USE "PUBLICATIONS", APART FROM THE MARK AS SHOWN.

THE MARK CONSISTS OF A STYLIZED DESIGN OF THE EARTH WITH AN OPEN DOOR ON IT AND A WELCOMING MAN STANDING IN FRONT OF IT WITH THE WORDING "WELCOME TO MY WORLD" ABOVE THE EARTH AND "PUBLICATIONS" UNDER THE EARTH.

FOR BOOKS IN THE FIELD OF FICTION NOVELS; NON-FICTION BOOKS ON A VARIETY OF TOPICS; PRINTED MATERIALS, NAMELY, NOVELS AND SERIES OF FICTION BOOKS AND SHORT STORIES FEATURING SCENES AND CHARACTERS BASED ON VIDEO GAMES; PUBLICATIONS, NAMELY, NOVELS IN THE FIELD OF FICTION; SERIES OF FICTION AND NON-FICTION BOOKS ON A VARIETY OF TOPICS; SERIES OF FICTION BOOKS; SERIES OF FICTION WORKS, NAMELY, NOVELS AND BOOKS (U.S. CLS. 2, 5, 22, 23, 29, 37, 38 AND 50).

KRISTIN CARLSON, EXAMINING ATTORNEY

SN 77-724,415. ASPEN MLT, INC., CULVER CITY, CA. FILED 4-28-2009.

DELLEC

THE MARK CONSISTS OF STANDARD CHARACTERS WITHOUT CLAIM TO ANY PARTICULAR FONT, STYLE, SIZE, OR COLOR.

FOR PRINTED MATTER, NAMELY, COMIC BOOKS (U.S. CLS. 2, 5, 22, 23, 29, 37, 38 AND 50).

WILLIAM VERHOSEK, EXAMINING ATTORNEY

CLASS 16—(Continued).

SN 77-724,488. THE GROVE CONSULTANTS INTERNATIONAL, SAN FRANCISCO, CA. FILED 4-28-2009.

CHARTERS

THE MARK CONSISTS OF STANDARD CHARACTERS WITHOUT CLAIM TO ANY PARTICULAR FONT, STYLE, SIZE, OR COLOR.

OWNER OF U.S. REG. NO. 2,636,930.
FOR FELT MARKING PENS (U.S. CLS. 2, 5, 22, 23, 29, 37, 38 AND 50).

FIRST USE 4-15-2001; IN COMMERCE 6-15-2001.
GINA HAYES, EXAMINING ATTORNEY

SN 77-724,778. RODGESTER, VERA, EMPORIA, VA. FILED 4-29-2009.

GLORYKIDZ

THE MARK CONSISTS OF STANDARD CHARACTERS WITHOUT CLAIM TO ANY PARTICULAR FONT, STYLE, SIZE, OR COLOR.

FOR ART ETCHINGS; ART PRINTS; PRINTED ART REPRODUCTIONS (U.S. CLS. 2, 5, 22, 23, 29, 37, 38 AND 50).

TARAH HARDY, EXAMINING ATTORNEY

SN 77-725,053. SAE INTERNATIONAL, WARRENDALE, PA. FILED 4-29-2009.

aei

THE MARK CONSISTS OF STANDARD CHARACTERS WITHOUT CLAIM TO ANY PARTICULAR FONT, STYLE, SIZE, OR COLOR.

FOR MAGAZINES FEATURING VARIOUS ENGINEERING AND DESIGN ASPECTS OF VEHICLES (U.S. CLS. 2, 5, 22, 23, 29, 37, 38 AND 50).

FIRST USE 3-0-1998; IN COMMERCE 3-0-1998.

MATTHEW PAPPAS, EXAMINING ATTORNEY

CLASS 16—(Continued).

SN 77-725,087. ASPEN MLT, INC., CULVER CITY, CA. FILED 4-29-2009.

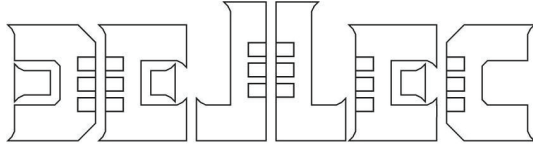

THE MARK CONSISTS OF STYLIZED FORM OF THE WORD "DELLEC".
FOR PRINTED MATTER, NAMELY, COMIC BOOKS (U.S. CLS. 2, 5, 22, 23, 29, 37, 38 AND 50).
WILLIAM VERHOSEK, EXAMINING ATTORNEY

CLASS 16—(Continued).

SN 77-725,326. NORTON, JENNIFER, L. DBA JEN NORTON ART STUDIO, JEN NORTON ILLUSTRATION AND DESIGN, SAN JOSE, CA. FILED 4-29-2009.

SN 77-725,226. ESSELTE CORPORATION, MELVILLE, NY. FILED 4-29-2009.



THE MARK CONSISTS OF THE LETTER I AND THE LETTERS "ORG", SEPARATED BY A CENTERED DOT.
FOR BINDERS (U.S. CLS. 2, 5, 22, 23, 29, 37, 38 AND 50).
AARON BRODSKY, EXAMINING ATTORNEY



SN 77-725,323. CURCIO, DENNIS, ZELIENOPLE, PA. FILED 4-29-2009.



THE MARK CONSISTS OF THE TEXT "MAKE LIFE FUN" WITH A WAVY DOTTED LINE SEPARATING THE WORDS "LIFE" AND "FUN" AND AN ARROWHEAD AT THE RIGHT END OF THE LINE, THE ARROWHEAD CONSISTING OF AN OVAL CONTAINING A DOT AND A RIGHT-POINTING TRIANGLE.
FOR A SERIES OF BOOKS, WRITTEN ARTICLES, HANDOUTS AND WORKSHEETS IN THE FIELD OF INSPIRATION (U.S. CLS. 2, 5, 22, 23, 29, 37, 38 AND 50).
MELISSA VALLILLO, EXAMINING ATTORNEY

NO CLAIM IS MADE TO THE EXCLUSIVE RIGHT TO USE "ART STUDIO", APART FROM THE MARK AS SHOWN.

THE NAME "JEN NORTON" IDENTIFIES A LIVING INDIVIDUAL WHOSE CONSENT IS OF RECORD.

THE MARK CONSISTS OF THE STYLIZED WORDING "JEN NORTON" ABOVE THE STYLIZED WORDING "ART STUDIO", AND THE DESIGN OF A STYLIZED HEART BETWEEN THE TERMS "ART" AND "STUDIO".

FOR ILLUSTRATIONS (U.S. CLS. 2, 5, 22, 23, 29, 37, 38 AND 50).

FIRST USE 10-4-2006; IN COMMERCE 10-4-2006.
JAY BESCH, EXAMINING ATTORNEY

CLASS 16—(Continued).

SN 77-725,446. TWENTIETH CENTURY FOX FILM CORPORATION, LOS ANGELES, CA. FILED 4-29-2009.

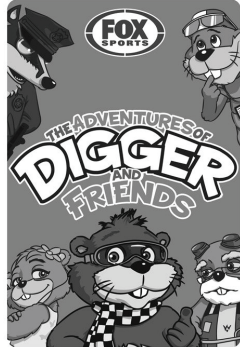

OWNER OF U.S. REG. NO. 3,001,994.

NO CLAIM IS MADE TO THE EXCLUSIVE RIGHT TO USE "SPORTS", APART FROM THE MARK AS SHOWN.

THE MARK CONSISTS OF THE STYLIZED WORDS "THE ADVENTURES OF DIGGER AND FRIENDS" WHICH APPEAR IN THE CENTER, THE WORDS "FOX SPORTS" WHICH APPEAR INSIDE OF THE OVAL SHAPE ON THE TOP CENTER AND FIVE COSTUMED GOPHER CHARACTERS, AND ALL ARE DISPLAYED INSIDE OF THE RECTANGULAR BACKGROUND.

FOR STATIONERY, WRITING PAPER AND ENVELOPES; DESK CALENDARS, WALL CALENDARS; STICKERS, BOOKMARKS; GREETING CARDS; POSTERS; POSTCARDS; PENS AND PENCILS; BUMPER STICKERS; TEMPORARY TATTOOS; PERSONAL DIARIES; BLANK JOURNALS; NOTEPADS; NOTEBOOKS; WRITING PAPER; PHOTO ALBUMS; PAPER FOLDERS; PAPER DOORKNOB HANGERS; TABLE CLOTHS MADE OF PAPER, PAPER NAPKINS AND PARTY FAVORS MADE OF PAPER; WRAPPING PAPER AND PAPER GIFT TAGS; COMIC BOOKS; TRADING CARDS; CHILDREN'S BOOKS, CHILDREN'S ACTIVITY BOOKS, COLORING BOOKS; GAME BOOKS, NAMELY, PARTY GAME BOOKS, GAME BOOKS FEATURING PAPER GAMES, ACTIVITY GAME BOOKS, PUZZLE BOOKS, WORD GAME BOOKS, AND TRIVIA GAME BOOKS; SERIES OF FICTION BOOKS; FLAGS AND PENNANTS OF PAPER (U.S. CLS. 2, 5, 22, 23, 29, 37, 38 AND 50).

LINDA LAVACHE, EXAMINING ATTORNEY

SN 77-725,559. THE BALTIMORE LIFE INSURANCE COMPANY, OWINGS MILLS, MD. FILED 4-29-2009.

SPORTSMART

THE MARK CONSISTS OF STANDARD CHARACTERS WITHOUT CLAIM TO ANY PARTICULAR FONT, STYLE, SIZE, OR COLOR.

FOR CARDS, NAMELY, IDENTIFICATION CARDS FEATURING EMERGENCY CONTACT INFORMATION (U.S. CLS. 2, 5, 22, 23, 29, 37, 38 AND 50).

DORITT L. CARROLL, EXAMINING ATTORNEY

CLASS 16—(Continued).

SN 77-725,703. TEAM B CREATIVE, LLC, BRIGHTON, MI. FILED 4-30-2009.



THE MARK CONSISTS OF THE PHRASE "FIVE WAYS TO FINISH" PRINTED IN A STYLIZED TYPE AND A PALM PRINT ON WHICH A PORTION OF THE WORD "FIVE" IS SUPERIMPOSED.

FOR PRINTED MATTER AND PAPER GOODS, NAMELY, A SERIES OF CHILDREN'S FICTION BOOKS AND BOOKMARKS (U.S. CLS. 2, 5, 22, 23, 29, 37, 38 AND 50).

FIRST USE 11-5-2005; IN COMMERCE 11-30-2005.
 NAAKWAMA ANKRAH, EXAMINING ATTORNEY

SN 77-725,847. FRIDEA GLOBAL, INC., DALLAS, TX. FILED 4-30-2009.

The Slapstick Kids

THE MARK CONSISTS OF STANDARD CHARACTERS WITHOUT CLAIM TO ANY PARTICULAR FONT, STYLE, SIZE, OR COLOR.

FOR ADDRESS BOOKS; BLANK JOURNALS; BOOKMARKS; CALENDARS; DIARIES; FOLDERS; GREETING CARDS; NOTEBOOKS; ORGANIZERS FOR STATIONERY USE; PAPER BAGS; PAPER NAPKINS; PAPER TABLECLOTHS; POSTERS; PRINTED INVITATIONS; STATIONERY; TRADING CARDS (U.S. CLS. 2, 5, 22, 23, 29, 37, 38 AND 50).

YAT SYE, LEE, EXAMINING ATTORNEY

SN 77-725,872. FRIDEA GLOBAL, INC., DALLAS, TX. FILED 4-30-2009.

Los Romanticos

THE MARK CONSISTS OF STANDARD CHARACTERS WITHOUT CLAIM TO ANY PARTICULAR FONT, STYLE, SIZE, OR COLOR.

THE ENGLISH TRANSLATION OF THE WORD "LOS ROMANTICOS" IN THE MARK IS THE ROMANTICS.

FOR ADDRESS BOOKS; BLANK JOURNALS; BOOKMARKS; CALENDARS; DIARIES; FOLDERS; GREETING CARDS; NOTEBOOKS; ORGANIZERS FOR STATIONERY USE; PAPER BAGS; PAPER NAPKINS; PAPER TABLECLOTHS; POSTERS; PRINTED INVITATIONS; STATIONERY; TRADING CARDS (U.S. CLS. 2, 5, 22, 23, 29, 37, 38 AND 50).

YAT SYE, LEE, EXAMINING ATTORNEY

CLASS 16—(Continued).

SN 77-726,088. ALLIANCE TAX AND FINANCIAL SERVICES, ATLANTA, GA. FILED 4-30-2009.

the 10 talents

THE MARK CONSISTS OF STANDARD CHARACTERS WITHOUT CLAIM TO ANY PARTICULAR FONT, STYLE, SIZE, OR COLOR.

FOR GENERAL FEATURE MAGAZINES; MAGAZINES FEATURING BUSINESS, INVESTING (U.S. CLS. 2, 5, 22, 23, 29, 37, 38 AND 50).
JEFFREY LOOK, EXAMINING ATTORNEY

CLASS 16—(Continued).

SN 77-726,625. ASPEN MLT, INC., CULVER CITY, CA. FILED 4-30-2009.

EXECUTIVE ASSISTANT

THE MARK CONSISTS OF STANDARD CHARACTERS WITHOUT CLAIM TO ANY PARTICULAR FONT, STYLE, SIZE, OR COLOR.

FOR PRINTED MATTER, NAMELY, COMIC BOOKS (U.S. CLS. 2, 5, 22, 23, 29, 37, 38 AND 50).
WILLIAM VERHOSEK, EXAMINING ATTORNEY

SN 77-726,126. TURNING POINT MINISTRIES INTERNATIONAL, HOUSTON, TX. FILED 4-30-2009.

Somebody Cares

THE MARK CONSISTS OF STANDARD CHARACTERS WITHOUT CLAIM TO ANY PARTICULAR FONT, STYLE, SIZE, OR COLOR.

OWNER OF U.S. REG. NO. 2,083,594.
FOR PRINTED CERTIFICATES; PRINTED INSTRUCTIONAL, EDUCATIONAL, AND TEACHING MATERIALS IN THE FIELD OF COMMUNITY OUTREACH AND DISASTER RELIEF (U.S. CLS. 2, 5, 22, 23, 29, 37, 38 AND 50).
FIRST USE 6-10-1983; IN COMMERCE 6-10-1983.
SALLY SHIH, EXAMINING ATTORNEY

SN 77-726,629. NEUTRAL TERRITORY, LLC, SANTA MONICA, CA. FILED 4-30-2009.

BAR MAIL

THE MARK CONSISTS OF STANDARD CHARACTERS WITHOUT CLAIM TO ANY PARTICULAR FONT, STYLE, SIZE, OR COLOR.

FOR ADHESIVE NOTE PADS; ADHESIVE NOTE PAPER; ANNOUNCEMENT CARDS; BLANK NOTE CARDS; BLANK PAPER NOTEBOOKS; NOTE BOOKS; NOTE CARDS; NOTE PADS; PAPER LABELS; PAPER NAPKINS; PAPER TAGS; SOCIAL NOTE CARDS (U.S. CLS. 2, 5, 22, 23, 29, 37, 38 AND 50).
MICHAEL WIENER, EXAMINING ATTORNEY

SN 77-726,427. DESKINZ, LLC, DENVER, CO. FILED 4-30-2009.

DESKINZ

THE MARK CONSISTS OF STANDARD CHARACTERS WITHOUT CLAIM TO ANY PARTICULAR FONT, STYLE, SIZE, OR COLOR.

FOR ADHESIVE MATERIALS FOR OFFICE USE; ADHESIVE PLASTIC FILM USED FOR MOUNTING IMAGES; ADHESIVE-BACKED LETTERS AND NUMBERS FOR USE IN MAKING DESKTOP COVERINGS; ADHESIVE-BACKED PHOTOGRAPHS; DESK BLOTTERS; DESK PADS (U.S. CLS. 2, 5, 22, 23, 29, 37, 38 AND 50).
KIMBERLY FRYE, EXAMINING ATTORNEY

SN 77-726,648. BOSLEY, MD, CRAIG L., POCATELLO, ID. FILED 4-30-2009.

The truth as I see it

THE MARK CONSISTS OF STANDARD CHARACTERS WITHOUT CLAIM TO ANY PARTICULAR FONT, STYLE, SIZE, OR COLOR.

FOR A SERIES OF BOOKS AND WRITTEN ARTICLES IN THE FIELD OF CURRENT EVENTS, POLITICS, SOCIAL ISSUES, FAMILY VALUES, MILITARY VALUES; BALL POINT PENS; BALL-POINT PENS; BALL-POINT PENS; BOOK MARKERS; BUMPER STICKERS; FOUNTAIN PENS; GRAPHIC PRINTS AND REPRESENTATIONS; GREETINGS CARDS AND POSTCARDS; PAPERWEIGHTS; PRINTS IN THE NATURE OF ART PRINTS, CANVAS ART PRINTS; WRITING IMPLEMENTS (U.S. CLS. 2, 5, 22, 23, 29, 37, 38 AND 50).
LINDSEY RUBIN, EXAMINING ATTORNEY

CLASS 16—(Continued).

SN 77-726,651. BOSLEY, MD, CRAIG L., POCATELLO, ID. FILED 4-30-2009.

Idaho Common Sense

THE MARK CONSISTS OF STANDARD CHARACTERS WITHOUT CLAIM TO ANY PARTICULAR FONT, STYLE, SIZE, OR COLOR.

NO CLAIM IS MADE TO THE EXCLUSIVE RIGHT TO USE "IDAHO", APART FROM THE MARK AS SHOWN.

FOR A SERIES OF BOOKS AND WRITTEN ARTICLES IN THE FIELD OF CURRENT EVENTS, POLITICS, SOCIAL ISSUES, FAMILY VALUES, MILITARY VALUES; BALL POINT PENS; BALL-POINT PENS; BALL-POINT PENS; BOOK MARKERS; BOOKMARKERS; BOOKMARKS; BUMPER STICKERS; FOUNTAIN PENS; GRAPHIC PRINTS AND REPRESENTATIONS; GREETING CARDS; GREETINGS CARDS AND POSTCARDS; PAPERWEIGHTS; PRINTS IN THE NATURE OF ART PRINTS, CANVAS ART PRINTS; WRITING IMPLEMENTS (U.S. CLS. 2, 5, 22, 23, 29, 37, 38 AND 50).

LINDSEY RUBIN, EXAMINING ATTORNEY

SN 77-726,667. FERRER, ANDREW A, NEW YORK, NY. FILED 5-1-2009.

andyice

THE MARK CONSISTS OF STANDARD CHARACTERS WITHOUT CLAIM TO ANY PARTICULAR FONT, STYLE, SIZE, OR COLOR.

FOR GRAPHIC ART REPRODUCTIONS (U.S. CLS. 2, 5, 22, 23, 29, 37, 38 AND 50).

FIRST USE 12-29-1999; IN COMMERCE 9-1-2002.

LESLIE RICHARDS, EXAMINING ATTORNEY

SN 77-726,731. SAKURA COLOR PRODUCTS CORPORATION, OSAKA, JAPAN, FILED 5-1-2009.



THE MARK CONSISTS OF A PLANT STEM WITH TWO LEAVES WITHIN A BOX.

FOR RUBBER ERASERS; STATIONERY (U.S. CLS. 2, 5, 22, 23, 29, 37, 38 AND 50).

JOHN GARTNER, EXAMINING ATTORNEY

CLASS 16—(Continued).

SN 77-726,801. RANSOM, HOLLY C., RIVERTON, CT. FILED 5-1-2009.

Got Life? Live it!!!

THE MARK CONSISTS OF STANDARD CHARACTERS WITHOUT CLAIM TO ANY PARTICULAR FONT, STYLE, SIZE, OR COLOR.

FOR PRINTED VISUALS IN THE NATURE OF PRINTED PROMOTIONAL MATERIALS (U.S. CLS. 2, 5, 22, 23, 29, 37, 38 AND 50).

DANNEAN HETZEL, EXAMINING ATTORNEY

SN 77-727,004. AGC, LLC, CLEVELAND, OH. FILED 5-1-2009.

CARLTON CARDS

THE MARK CONSISTS OF STANDARD CHARACTERS WITHOUT CLAIM TO ANY PARTICULAR FONT, STYLE, SIZE, OR COLOR.

OWNER OF U.S. REG. NO. 1,537,379.

NO CLAIM IS MADE TO THE EXCLUSIVE RIGHT TO USE "CARDS", APART FROM THE MARK AS SHOWN.

FOR GREETING CARDS (U.S. CLS. 2, 5, 22, 23, 29, 37, 38 AND 50).

FIRST USE 12-31-1986; IN COMMERCE 12-31-1986.

WENDY JUN, EXAMINING ATTORNEY

SN 77-727,129. M-J ENTERPRISES INC, PEABODY, MA. FILED 5-1-2009.

LIVIN' THE ADVENTURE

THE MARK CONSISTS OF STANDARD CHARACTERS WITHOUT CLAIM TO ANY PARTICULAR FONT, STYLE, SIZE, OR COLOR.

FOR BLANK WRITING JOURNALS; CHILDREN'S ACTIVITY BOOKS; CHILDREN'S BOOKS; COLORING BOOKS; DIARIES; SONG BOOKS; STICKERS (U.S. CLS. 2, 5, 22, 23, 29, 37, 38 AND 50).

MELVIN AXILBUND, EXAMINING ATTORNEY

CLASS 16—(Continued).

SN 77-727,225. TIME INC., NEW YORK, NY. FILED 5-1-2009.

INSTYLE

THE MARK CONSISTS OF STANDARD CHARACTERS WITHOUT CLAIM TO ANY PARTICULAR FONT, STYLE, SIZE, OR COLOR.

OWNER OF U.S. REG. NOS. 1,851,469, 3,460,800 AND OTHERS.

FOR BOOKS IN THE FIELD OF FASHION, BEAUTY, CELEBRITIES, LIFESTYLES, WEDDINGS, ENTERTAINING, AND TOPICS OF GENERAL INTEREST (U.S. CLS. 2, 5, 22, 23, 29, 37, 38 AND 50).

FIRST USE 10-1-2003; IN COMMERCE 10-1-2003.
ZACHARY BELLO, EXAMINING ATTORNEY

SN 77-727,273. ADVANCED IMAGE DIRECT, FULLERTON, CA. FILED 5-1-2009.

Cloud2Mail

THE MARK CONSISTS OF STANDARD CHARACTERS WITHOUT CLAIM TO ANY PARTICULAR FONT, STYLE, SIZE, OR COLOR.

FOR LETTER PAPER (U.S. CLS. 2, 5, 22, 23, 29, 37, 38 AND 50).

JOHN GARTNER, EXAMINING ATTORNEY

SN 77-727,336. HUGH HEWITT, IRVINE, CA. FILED 5-1-2009.

OIIOHH

THE MARK CONSISTS OF STANDARD CHARACTERS WITHOUT CLAIM TO ANY PARTICULAR FONT, STYLE, SIZE, OR COLOR.

FOR BUMPER STICKERS (U.S. CLS. 2, 5, 22, 23, 29, 37, 38 AND 50).

JOHN DWYER, EXAMINING ATTORNEY

CLASS 16—(Continued).

SN 77-727,365. SOURCE INTERLINK MAGAZINES, LLC, LOS ANGELES, CA. FILED 5-1-2009.

PROJECT AMERICAN HEROES

THE MARK CONSISTS OF STANDARD CHARACTERS WITHOUT CLAIM TO ANY PARTICULAR FONT, STYLE, SIZE, OR COLOR.

FOR PERIODICAL MAGAZINES FEATURING REBUILT AUTOMOBILES (U.S. CLS. 2, 5, 22, 23, 29, 37, 38 AND 50).

FIRST USE 2-1-2007; IN COMMERCE 7-1-2007.

KATHRYN COWARD, EXAMINING ATTORNEY

SN 77-727,976. BARILLA G.E.R. FRATELLI - SOCIETÀ PER AZIONI, PARMA, ITALY, FILED 5-4-2009.

SHARE THE TABLE

THE MARK CONSISTS OF STANDARD CHARACTERS WITHOUT CLAIM TO ANY PARTICULAR FONT, STYLE, SIZE, OR COLOR.

FOR PRINTED PUBLICATIONS IN THE NATURE OF MAGAZINES, PAMPHLETS, BROCHURES, AND BOOKS OFFERING RECIPES AND INFORMATION RELATING TO FOOD PRODUCTS, MEALS, DINNERS, AND FAMILY RELATIONSHIPS; PAPER BANNERS, POSTERS, NOTEPADS, CALENDARS, FOLDERS, PENS, PAPER NAPKINS, PAPER PLACEMATS; PAPER STORAGE CONTAINERS FOR PASTA; PAPER TABLECLOTHS (U.S. CLS. 2, 5, 22, 23, 29, 37, 38 AND 50).

KRISTIN DAHLING, EXAMINING ATTORNEY

SN 77-728,139. BARILLA G.E.R. FRATELLI - SOCIETÀ PER AZIONI, PARMA, ITALY, FILED 5-4-2009.

**SHARE THE TABLE THE
BARILLA FAMILY DINNER
PROJECT**

THE MARK CONSISTS OF STANDARD CHARACTERS WITHOUT CLAIM TO ANY PARTICULAR FONT, STYLE, SIZE, OR COLOR.

OWNER OF U.S. REG. NOS. 897,460, 2,965,649 AND OTHERS.

NO CLAIM IS MADE TO THE EXCLUSIVE RIGHT TO USE "FAMILY DINNER", APART FROM THE MARK AS SHOWN.

FOR PRINTED PUBLICATIONS IN THE NATURE OF MAGAZINES, PAMPHLETS, BROCHURES, AND BOOKS OFFERING RECIPES AND INFORMATION RELATING TO FOOD PRODUCTS, MEALS, DINNERS, AND FAMILY RELATIONSHIPS; PAPER BANNERS, POSTERS, NOTEPADS, CALENDARS, FOLDERS, PENS, PAPER NAPKINS, PAPER PLACEMATS; PAPER STORAGE CONTAINERS FOR PASTA; TABLE CLOTHS OF PAPER (U.S. CLS. 2, 5, 22, 23, 29, 37, 38 AND 50).

KRISTIN DAHLING, EXAMINING ATTORNEY

CLASS 16—(Continued).

SN 77-728,261. PRINTMARK INDUSTRIES, INC., HAZLETON, PA. FILED 5-4-2009.

CHANGE-WORKS

THE MARK CONSISTS OF STANDARD CHARACTERS WITHOUT CLAIM TO ANY PARTICULAR FONT, STYLE, SIZE, OR COLOR.

FOR COIN WRAPPERS (U.S. CLS. 2, 5, 22, 23, 29, 37, 38 AND 50).

JACLYN KIDWELL, EXAMINING ATTORNEY

SN 77-728,281. ASPEN MLT, INC., CULVER CITY, CA. FILED 5-4-2009.



THE MARK CONSISTS OF A STYLIZED VERSION OF THE WORDS "EXECUTIVE ASSISTANT".

FOR PRINTED MATTER, NAMELY, COMIC BOOKS (U.S. CLS. 2, 5, 22, 23, 29, 37, 38 AND 50).

WILLIAM VERHOSEK, EXAMINING ATTORNEY

SN 77-728,457. ANDERSON, PARK, LA JOLLA, CA. FILED 5-4-2009.

CSIBORG

THE MARK CONSISTS OF STANDARD CHARACTERS WITHOUT CLAIM TO ANY PARTICULAR FONT, STYLE, SIZE, OR COLOR.

FOR PRINTED PUBLICATIONS, NAMELY, BOOKS, MAGAZINES, FAN CLUB NEWSLETTERS, NEWSLETTERS, AND BULLETINS IN THE FIELD OF ENTERTAINMENT; NEWSPAPER AND MAGAZINE COMIC STRIPS; CARTOON STRIPS; SERIES OF FICTION BOOKS; SERIES OF GRAPHIC NOVELS; SERIES OF COMIC BOOKS (U.S. CLS. 2, 5, 22, 23, 29, 37, 38 AND 50).

DANNEAN HETZEL, EXAMINING ATTORNEY

CLASS 16—(Continued).

SN 77-728,614. MEADWESTVACO CORPORATION, GLEN ALLEN, VA. FILED 5-4-2009.

DAY RUNNER DESIGN YOUR DAY

THE MARK CONSISTS OF STANDARD CHARACTERS WITHOUT CLAIM TO ANY PARTICULAR FONT, STYLE, SIZE, OR COLOR.

OWNER OF U.S. REG. NOS. 1,938,002, 3,028,737 AND OTHERS.

FOR APPOINTMENT BOOKS; DESK CALENDARS; FILE FOLDERS; PAPER HANG TAGS; STORAGE CONTAINERS MADE OF PAPER; WALL CALENDARS (U.S. CLS. 2, 5, 22, 23, 29, 37, 38 AND 50).

FIRST USE 9-1-2007; IN COMMERCE 9-1-2007.

JILL PRATER, EXAMINING ATTORNEY

SN 77-731,557. REMODELERS ADVANTAGE, INC., LAUREL, MD. FILED 5-7-2009.

PowerTips

THE MARK CONSISTS OF STANDARD CHARACTERS WITHOUT CLAIM TO ANY PARTICULAR FONT, STYLE, SIZE, OR COLOR.

FOR A NEWSLETTER PROVIDING BUSINESS MANAGEMENT CONSULTATION AND ADVICE TO COMPANIES ENGAGED IN CUSTOM CONSTRUCTION AND BUILDING RENOVATION AND REMODELING (U.S. CLS. 2, 5, 22, 23, 29, 37, 38 AND 50).

FIRST USE 9-1-2004; IN COMMERCE 9-1-2004.

SUNG IN, EXAMINING ATTORNEY

SN 77-732,187. ARCTICA STUDIOS, GLENDALE, CA. FILED 5-8-2009.

ARCTICA

THE MARK CONSISTS OF STANDARD CHARACTERS WITHOUT CLAIM TO ANY PARTICULAR FONT, STYLE, SIZE, OR COLOR.

FOR COLORING BOOKS; SERIES OF FICTION BOOKS; STORY BOOKS; TRADING CARDS (U.S. CLS. 2, 5, 22, 23, 29, 37, 38 AND 50).

BRIDGETT SMITH, EXAMINING ATTORNEY

CLASS 16—(Continued).

SN 77-732,967. ESSELTE CORPORATION, MELVILLE, NY.
FILED 5-8-2009.

CLASS 16—(Continued).

SN 77-737,155. HIGHLIGHTS FOR CHILDREN, INC., CO-
LUMBUS, OH. FILED 5-14-2009.

SUREHOOK

THE MARK CONSISTS OF STANDARD CHARACTERS
WITHOUT CLAIM TO ANY PARTICULAR FONT, STYLE,
SIZE, OR COLOR.
FOR HANGING FOLDERS (U.S. CLS. 2, 5, 22, 23, 29,
37, 38 AND 50).
AARON BRODSKY, EXAMINING ATTORNEY



SN 77-732,979. ESSELTE CORPORATION, MELVILLE, NY.
FILED 5-8-2009.

SUREHOOK TECHNOLOGY

THE MARK CONSISTS OF STANDARD CHARACTERS
WITHOUT CLAIM TO ANY PARTICULAR FONT, STYLE,
SIZE, OR COLOR.
NO CLAIM IS MADE TO THE EXCLUSIVE RIGHT TO
USE "TECHNOLOGY", APART FROM THE MARK AS
SHOWN.
FOR HANGING FOLDERS (U.S. CLS. 2, 5, 22, 23, 29,
37, 38 AND 50).
AARON BRODSKY, EXAMINING ATTORNEY



SN 77-734,653. GREEN BAY CONVERTING, INC., GREEN
BAY, WI. FILED 5-12-2009.

Bright Dawn

THE MARK CONSISTS OF STANDARD CHARACTERS
WITHOUT CLAIM TO ANY PARTICULAR FONT, STYLE,
SIZE, OR COLOR.
FOR TISSUE PAPER PRODUCTS, NAMELY, BATH-
ROOM TISSUE, PAPER TOWELS, PAPER NAPKINS
AND FACIAL TISSUE (U.S. CLS. 2, 5, 22, 23, 29, 37, 38
AND 50).
CYNTHIA SLOAN, EXAMINING ATTORNEY

WYATT THE RIOT

THE MARK CONSISTS OF STANDARD CHARACTERS
WITHOUT CLAIM TO ANY PARTICULAR FONT, STYLE,
SIZE, OR COLOR.
THE NAME "WYATT THE RIOT" DOES NOT IDENTIFY
A LIVING INDIVIDUAL.
FOR ADDRESS BOOKS AND DIARIES, NOTE PADS,
NOTE PAPER, NOTEBOOKS, ART AND PHOTOGRAPH
PORTFOLIO CASES, ARTS AND CRAFT PAINT KITS,
ARTISTS' BRUSHES, AUTOGRAPH BOOKS, BABY
BOOKS, PENS, BLANK JOURNALS, BOOKMARKS, CA-
LENDARS, DIARIES, MAGAZINES FOR CHILDREN,
CHILDREN'S BOOKS, CHILDREN'S INTERACTIVE
EDUCATIONAL BOOKS, COLORING BOOKS, PENCILS,
CRAFT PAPER, DECALS, DESKTOP ORGANIZERS,
DISPOSABLE DIAPERS, DISPOSABLE NAPKINS,
DRAWING RULERS, DRY ERASE WRITING BOARDS,
EASELS, MARKERS, FLASH CARDS, GIFT WRAPPING
PAPER, GREETING CARDS AND POSTCARDS, MOD-
ELING CLAY FOR CHILDREN, MODELING MATERI-
ALS AND COMPOUNDS FOR USE BY CHILDREN, PEN
AND PENCIL CASES, CRAYONS, STATIONERY,
PHOTOGRAPH ALBUMS AND SCRAPBOOKS, POS-
TERS, SCHOOL SUPPLY KITS CONTAINING VARIOUS
COMBINATIONS OF SELECTED SCHOOL SUPPLIES,
NAMELY, WRITING INSTRUMENTS, PENS, PENCILS,
MECHANICAL PENCILS, ERASERS, MARKERS, CRAY-
ONS, HIGHLIGHTERS, FOLDERS, NOTEBOOKS, PA-
PER, PROTRACTORS, PAPER CLIPS, PENCIL
SHARPENERS, WRITING GRIPS, GLUE AND BOOK
MARKS, SCHOOL WRITING BOOKS, STAMP ALBUMS,
STAMP PADS, STENCILS, STICKERS, TRADING CARDS
AND SKETCH PADS (U.S. CLS. 2, 5, 22, 23, 29, 37, 38
AND 50).
TINA BROWN, EXAMINING ATTORNEY

CLASS 16—(Continued).

SN 77-737,175. HIGHLIGHTS FOR CHILDREN, INC., COLUMBUS, OH. FILED 5-14-2009.

WYATT ROGERS

THE MARK CONSISTS OF STANDARD CHARACTERS WITHOUT CLAIM TO ANY PARTICULAR FONT, STYLE, SIZE, OR COLOR.

THE NAME "WYATT ROGERS" DOES NOT IDENTIFY A LIVING INDIVIDUAL.

FOR ADDRESS BOOKS AND DIARIES, NOTE PADS, NOTE PAPER, NOTEBOOKS, ART AND PHOTOGRAPH PORTFOLIO CASES, ARTS AND CRAFT PAINT KITS, ARTISTS' BRUSHES, AUTOGRAPH BOOKS, BABY BOOKS, PENS, BLANK JOURNALS, BOOKMARKS, CALENDARS, DIARIES, MAGAZINES FOR CHILDREN, CHILDREN'S BOOKS, CHILDREN'S INTERACTIVE EDUCATIONAL BOOKS, COLORING BOOKS, PENCILS, CRAFT PAPER, DECALS, DESKTOP ORGANIZERS, DISPOSABLE DIAPERS, DISPOSABLE NAPKINS, DRAWING RULERS, DRY ERASE WRITING BOARDS, EASELS, MARKERS, FLASH CARDS, GIFT WRAPPING PAPER, GREETING CARDS AND POSTCARDS, MODELING CLAY FOR CHILDREN, MODELING MATERIALS AND COMPOUNDS FOR USE BY CHILDREN, PEN AND PENCIL CASES, CRAYONS, STATIONERY, PHOTOGRAPH ALBUMS AND SCRAPBOOKS, POSTERS, SCHOOL SUPPLY KITS CONTAINING VARIOUS COMBINATIONS OF SELECTED SCHOOL SUPPLIES, NAMELY, WRITING INSTRUMENTS, PENS, PENCILS, MECHANICAL PENCILS, ERASERS, MARKERS, CRAYONS, HIGHLIGHTERS, FOLDERS, NOTEBOOKS, PAPER, PROTRACTORS, PAPER CLIPS, PENCIL SHARPENERS, WRITING GRIPS, GLUE AND BOOK MARKS, SCHOOL WRITING BOOKS, STAMP ALBUMS, STAMP PADS, STENCILS, STICKERS, TRADING CARDS AND SKETCH PADS (U.S. CLS. 2, 5, 22, 23, 29, 37, 38 AND 50).

TINA BROWN, EXAMINING ATTORNEY

SN 77-740,799. NVIDIA CORPORATION, SANTA CLARA, CA. FILED 5-19-2009.

NVISION

THE MARK CONSISTS OF STANDARD CHARACTERS WITHOUT CLAIM TO ANY PARTICULAR FONT, STYLE, SIZE, OR COLOR.

OWNER OF U.S. REG. NO. 3,584,516.

FOR MAGAZINES RELATING TO COMPUTERS AND VIDEO GAMING (U.S. CLS. 2, 5, 22, 23, 29, 37, 38 AND 50).

MARGERY A. TIERNEY, EXAMINING ATTORNEY

CLASS 16—(Continued).

SN 77-742,795. HORSESHOE MARKETING, LLC, MAMARONECK, NY. FILED 5-22-2009.

KITTEN SOFT

THE MARK CONSISTS OF STANDARD CHARACTERS WITHOUT CLAIM TO ANY PARTICULAR FONT, STYLE, SIZE, OR COLOR.

NO CLAIM IS MADE TO THE EXCLUSIVE RIGHT TO USE "SOFT", APART FROM THE MARK AS SHOWN.

FOR FACIAL TISSUE; PAPER TOWELS; TOILET PAPER (U.S. CLS. 2, 5, 22, 23, 29, 37, 38 AND 50).

GISELLE AGOSTO, EXAMINING ATTORNEY

SN 77-752,055. FKA DISTRIBUTING CO., DBA HOMEDICS, INC., COMMERCE TOWNSHIP, MI. FILED 6-4-2009.

FASTPASS

THE MARK CONSISTS OF STANDARD CHARACTERS WITHOUT CLAIM TO ANY PARTICULAR FONT, STYLE, SIZE, OR COLOR.

FOR PAPER SHREDDERS FOR HOME AND OFFICE USE (U.S. CLS. 2, 5, 22, 23, 29, 37, 38 AND 50).

ESTHER BELENKER, EXAMINING ATTORNEY

SN 77-752,064. FKA DISTRIBUTING CO., DBA HOMEDICS, INC., COMMERCE TOWNSHIP, MI. FILED 6-4-2009.

ECOLOGIC

THE MARK CONSISTS OF STANDARD CHARACTERS WITHOUT CLAIM TO ANY PARTICULAR FONT, STYLE, SIZE, OR COLOR.

FOR PAPER SHREDDERS FOR HOME AND OFFICE USE (U.S. CLS. 2, 5, 22, 23, 29, 37, 38 AND 50).

ESTHER BELENKER, EXAMINING ATTORNEY

CLASS 16—(Continued).

SN 77-765,421. AGC, LLC, CLEVELAND, OH. FILED 6-22-2009.



THE COLOR(S) RED, BLUE, AND YELLOW IS/ARE CLAIMED AS A FEATURE OF THE MARK.

THE MARK CONSISTS OF THE WORDING "FLYING LEAP" WITH A DESIGN ELEMENT OF A SMALL BLUE BIRD WITH YELLOW BEAK AND EXTENDED WINGS BETWEEN THE WORDS "FLYING" AND "LEAP". THE BIRD IS WEARING GOGGLES AND A RED HELMET.

FOR GREETING CARDS (U.S. CLS. 2, 5, 22, 23, 29, 37, 38 AND 50).

WENDY JUN, EXAMINING ATTORNEY

SN 77-770,232. THE BOREALIS PRESS INC., SURRY, ME. FILED 6-29-2009.

HeyMaliMali

THE MARK CONSISTS OF STANDARD CHARACTERS WITHOUT CLAIM TO ANY PARTICULAR FONT, STYLE, SIZE, OR COLOR.

FOR GREETING CARDS, PRINTED PAPER MESSAGE CARDS, POSTCARDS, CALENDARS, DESK CALENDARS, POCKET CALENDARS, PRINTED CALENDARS, WALL CALENDARS, CALENDAR DESK PADS, STATIONERY, STATIONERY WRITING PAPER AND ENVELOPES, BUMPER STICKERS, STICKERS, PAPER TAGS, CARDBOARD HANG TAGS, POSTERS, MOUNTED POSTERS, UNMOUNTED POSTERS, PRINTED PAPER SIGNS, PAPER FLAGS, PAPER BANNERS, ART PRINTS, COLOR PRINTS, LITHOGRAPHIC PRINTS, PHOTOGRAPHIC PRINTS, PICTORIAL PRINTS, PEN/INK DRAWINGS, NOTEBOOKS, NOTE CARDS, NOTE PAPER, NOTE PADS, NOTEBOOK PAPER, NOTEBOOK DIVIDERS, ANNOUNCEMENT CARDS, BOOKS, NAMELY, PICTURE BOOKS, WIRE BOUND NOTEBOOKS, WRITING PADS, BINDERS, DAILY PLANNERS; PENS, PENCILS, PEN AND PENCIL CASES AND BOXES, DECALS, PAPER BAGS AND SACKS, PAPER GIFT BAGS, WRAPPING PAPER, GIFT WRAPPING PAPER, FOLDERS, FILE FOLDERS, PAPER FOLDERS, ENVELOPES, CARDBOARD BOXES, PAPER BOXES, STATIONERY BOXES, ADDRESS LABELS, ADHESIVE LABELS, PHOTOGRAPHS, PHOTOGRAPH ALBUMS, PAPER BAGS FOR MERCHANDISE PACKAGING, PAPER POUCHES FOR PACKAGING, AND PAPER MAIL POUCHES (U.S. CLS. 2, 5, 22, 23, 29, 37, 38 AND 50).

FIRST USE 5-10-2009; IN COMMERCE 5-10-2009.
CHRISIE B. KING, EXAMINING ATTORNEY

CLASS 16—(Continued).

SN 78-614,193. WASHINGTON'S BIRTHDAY CELEBRATION ASSOCIATION, INC., LAREDO, TX. FILED 4-21-2005.

BY GEORGE

THE MARK CONSISTS OF STANDARD CHARACTERS WITHOUT CLAIM TO ANY PARTICULAR FONT, STYLE, SIZE, OR COLOR.

FOR MAGAZINES FEATURING INFORMATION ABOUT THE CITY OF LAREDO'S ANNUAL COMMUNITY FESTIVALS WHICH FEATURE A VARIETY OF ACTIVITIES NAMELY, RE-ENACTMENTS, EDUCATIONAL PROGRAMS, PAGEANTS AND BALLS, ART EXHIBITIONS, PARADES, CONCERTS, MUSICALS, AIR SHOWS, BARBEQUES, AMATEUR SPORTING EVENTS, CARNIVALS, COCKTAIL PARTIES, LUNCHEONS AND DANCES (U.S. CLS. 2, 5, 22, 23, 29, 37, 38 AND 50).

FIRST USE 8-1-2001; IN COMMERCE 8-1-2001.
JENNIFER VASQUEZ, EXAMINING ATTORNEY

SN 78-742,816. COOKIE JAR ENTERTAINMENT INC., MONTREAL, CANADA, FILED 10-28-2005.



NO CLAIM IS MADE TO THE EXCLUSIVE RIGHT TO USE "TV", APART FROM THE MARK AS SHOWN.

FOR PRINTED PUBLICATIONS, NAMELY, BOOKS FEATURING CHILDREN'S EDUCATION AND ENTERTAINMENT TOPICS AND THEMES; STORY BOOKS, NOVELS FEATURING CHILDREN'S EDUCATION AND ENTERTAINMENT TOPICS AND THEMES; PRINTED PUBLICATIONS IN THE FIELD OF CHILDREN'S EDUCATION AND ENTERTAINMENT, NAMELY, BOOKS, WORKBOOKS, COLORING BOOKS, ACTIVITY BOOKS, STORY BOOKS, MANGA COMIC BOOKS, GRAPHIC NOVELS, COMIC BOOKS, MAGAZINES, BLANK JOURNALS, INTERACTIVE BOOKS, BOOKS WITH CASSETTE TAPES SOLD AS A UNIT, BOOKS WITH VIDEO TAPES SOLD AS A UNIT; STICKERS; STATIONERY, NAMELY, BLANK JOURNALS, DIARIES, NOTE BOOKS; ARTS AND CRAFT KITS, NAMELY, ARTS, CRAFT AND PAINT KITS COMPRISED OF PAINT, PAINT SETS, AND MODELING CLAY; GREETING CARDS, GIFT WRAP STICKERS, TEMPORARY TATTOOS, GIFT BOXES, POSTCARDS, NOTE PAPER, WRITING PAPER, STICKER BOOKS, CALENDARS, POSTERS; PAPER PARTY PRODUCTS, NAMELY, PARTY NAPKINS, BAGS AND ORNAMENTS; SCRAPBOOKING SUPPLIES IN THE NATURE OF SCRAPBOOK PAGES, ALBUMS, COLORED PAPER AND STICKERS; PAPER PARTY FAVORS; SCHOOL SUPPLIES, NAMELY, PENS, PENCILS, PEN AND PENCIL CASES AND BOXES, PENCIL SHARPENERS AND PAPER FOLDERS; CALENDAR DESK PADS, CALENDAR DESK STANDS, DESK FILE TRAYS, DESK PADS, DESK SETS, DESK STAND AND HOLDERS FOR PENS, PENCILS AND INK, AND HOLDERS FOR DESK ACCESSORIES; DESK/TABLE TOP ITEMS, NAMELY, DESKSTANDS, FILE TRAYS, DESK PADS, DESK SETS, WRITING INSTRUMENTS (U.S. CLS. 2, 5, 22, 23, 29, 37, 38 AND 50).

KATHERINE E. HALMEN, EXAMINING ATTORNEY

CLASS 16—(Continued).

SN 78-801,476. DRAGONFLY INNOVATION, INC., BOULDER, CO. FILED 1-27-2006.

DRAGONFLY INNOVATION

THE MARK CONSISTS OF STANDARD CHARACTERS WITHOUT CLAIM TO ANY PARTICULAR FONT, STYLE, SIZE, OR COLOR.

FOR ARTS AND CRAFT CLAY KITS; ARTS AND CRAFT PAINT KITS; PAINTING SETS; CHILDREN'S EDUCATIONAL ACTIVITY KITS COMPRISING INK STAMPS AND IMPRESSION STAMPS; CHILDREN'S EDUCATIONAL ACTIVITY KITS COMPRISING BLANK PUZZLES, PUZZLE POSTCARDS, AND ENVELOPES; CHILDREN'S EDUCATIONAL ACTIVITY KITS COMPRISING MATERIALS FOR MAKING PUPPETS; CHILDREN'S EDUCATIONAL ACTIVITY KITS COMPRISING PAPER FOR MAKING SCULPTURES; CHILDREN'S EDUCATIONAL ACTIVITY KITS COMPRISING PAPER FOR MAKING FLOWERS; CHILDREN'S EDUCATIONAL ACTIVITY KITS FOR MAKING MOSAICS; CHILDREN'S EDUCATIONAL ACTIVITY KITS COMPRISING INK AND PAPER FOR MAKING MARBLIZED PAPER; CHILDREN'S EDUCATIONAL ACTIVITY KITS COMPRISING BLANK GREETING CARDS AND ENVELOPES; CHILDREN'S EDUCATIONAL ACTIVITY KITS FOR DECORATING FLOWER POTS; STATIONERY; STATIONERY-TYPE PORTFOLIOS; PENCILS; MARKERS; PAINT BRUSHES; GLUE AND GLUE STICK FOR STATIONERY OR HOUSEHOLD USE; MODELING CLAY; EASELS; CHALK; COLORING BOOKS (U.S. CLS. 2, 5, 22, 23, 29, 37, 38 AND 50).

SALLY SHIH, EXAMINING ATTORNEY

SN 78-907,599. 1080 EDUCATION INC., SCHUYLerville, NY. FILED 6-14-2006.

Go2Science

THE MARK CONSISTS OF STANDARD CHARACTERS WITHOUT CLAIM TO ANY PARTICULAR FONT, STYLE, SIZE, OR COLOR.

NO CLAIM IS MADE TO THE EXCLUSIVE RIGHT TO USE "SCIENCE" OR "GO", APART FROM THE MARK AS SHOWN.

FOR PRINTED INSTRUCTIONAL, EDUCATIONAL, AND TEACHING MATERIALS IN THE FIELD OF MATH, SCIENCE, TECHNOLOGY AND EDUCATION (U.S. CLS. 2, 5, 22, 23, 29, 37, 38 AND 50).

LINDA MICKLEBURGH, EXAMINING ATTORNEY

CLASS 16—(Continued).

SN 79-063,967. RICHEMONT ITALIA S.P.A., ITALY, FILED 10-31-2008.

PROGETTO D'AUTORE

THE MARK CONSISTS OF STANDARD CHARACTERS WITHOUT CLAIM TO ANY PARTICULAR FONT, STYLE, SIZE, OR COLOR.

PRIORITY DATE OF 5-20-2008 IS CLAIMED. OWNER OF INTERNATIONAL REGISTRATION 0989732 DATED 10-31-2008, EXPIRES 10-31-2018.

THE ENGLISH TRANSLATION OF "PROGETTO D'AUTORE" IN THE MARK IS AUTHOR'S PROJECT.

FOR WRITING INSTRUMENTS, NAMELY, PENS, FOUNTAIN PENS, BALLPOINT PENS, FELT-TIP PENS, ROLLER BALLS, DOCUMENT MARKERS, PENCILS; WRITING INK; PEN INK REFILLS; POUCHES FOR WRITING INSTRUMENTS, GIFT CASES FOR WRITING INSTRUMENTS; PEN AND PENCIL HOLDERS (U.S. CLS. 2, 5, 22, 23, 29, 37, 38 AND 50).

REBECCA SMITH, EXAMINING ATTORNEY

CLASS 17—RUBBER GOODS

SN 77-352,899. JIM PATTISON ENTERPRISES LTD., VANCOUVER, CANADA, FILED 12-14-2007.

COROCEL

THE MARK CONSISTS OF STANDARD CHARACTERS WITHOUT CLAIM TO ANY PARTICULAR FONT, STYLE, SIZE, OR COLOR.

PRIORITY CLAIMED UNDER SEC. 44(D) ON CANADA APPLICATION NO. 1373587, FILED 11-28-2007.

FOR (BASED ON INTENT TO USE) PLASTICS IN THE FORM OF SHEETS; (BASED ON INTENT TO USE) AND (BASED ON 44(D) PRIORITY APPLICATION) FOAM PLASTIC SHEETS FOR DISPLAYS AND SIGNS (U.S. CLS. 1, 5, 12, 13, 35 AND 50).

SUNG IN, EXAMINING ATTORNEY

CLASS 17—(Continued).

SN 77-486,216. KABUSHIKI KAISHA TAKARA (TAKARA PAC LTD.), OSAKA-SHI, OSAKA-FU, JAPAN, FILED 5-29-2008.



PRIORITY CLAIMED UNDER SEC. 44(D) ON JAPAN APPLICATION NO. 2008-13653, FILED 2-26-2008, REG. NO. 5175894, DATED 10-24-2008, EXPIRES 10-24-2018.

NO CLAIM IS MADE TO THE EXCLUSIVE RIGHT TO USE "GRIP", APART FROM THE MARK AS SHOWN.

THE MARK CONSISTS OF THE STYLIZED WORDING "TPGRIP".

FOR SELF-ADHESIVE TAPES FOR INDUSTRIAL AND COMMERCIAL USE; AND DOUBLE-SIDED, SELF-ADHESIVE-COATED PLASTIC SHEET-PADS, USED IN THE PROCESSING OF EYEGLASS LENSES (U.S. CLS. 1, 5, 12, 13, 35 AND 50).

PRISCILLA MILTON, EXAMINING ATTORNEY

SN 77-555,685. ADAMS, CHRISTOPHER M, WINDERMERE, FL. FILED 8-26-2008.



Laptop Lifts

NO CLAIM IS MADE TO THE EXCLUSIVE RIGHT TO USE "LAPTOP LIFTS", APART FROM THE MARK AS SHOWN.

THE COLOR(S) DARK GREY, LIGHT BLUE, BLUE, DARK BLUE, SILVER, GREY IS/ARE CLAIMED AS A FEATURE OF THE MARK.

THE MARK CONSISTS OF A 3D STYLED GRAPHIC WITH WORDING UNDERNEATH. IT CONTAINS A STYLIZED GRAPHIC REPRESENTATION OF A COMPUTER TURNED UP AT AN ANGLE SO THAT THE BOTTOM IS EXPOSED. THE COMPUTER IS A DARK GREY AND THE SCREEN OF THE COMPUTER HAS A SHADING EFFECT FROM LIGHT BLUE TO BLUE TO DARK BLUE. IT IS PLACED OVER A BUTTON-LIKE BACKGROUND WITH SHADING FROM LIGHT BLUE TO BLUE TO DARK BLUE IN THE CENTER AND A SILVERY EDGE WITH A 3D EFFECT. THERE IS A STYLIZED REPRESENTATION OF THE PRODUCT ON THE BOTTOM OF THE COMPUTER REPRESENTED IN A DARK BLUE AS A PARALLEL PAIR OF STICK - OBJECTS WITH ROUNDED EDGES. UNDERNEATH THIS IMAGE THERE IS 3D STYLED TEXT IN A SAN-SERIF FONT WITH THE FIRST LETTER CAPITALIZED - "LAPTOP LIFTS". THE WORD "LAPTOP" IS GREY AND THE WORD "LIFTS" IS BLUE.

FOR PADDING MATERIALS OF RUBBER OR PLASTIC FOR USE IN RESTING A LAPTOP COMPUTER ON A SURFACE (U.S. CLS. 1, 5, 12, 13, 35 AND 50).

ERNEST SHOSHO, EXAMINING ATTORNEY

CLASS 17—(Continued).

SN 77-576,542. WINDOW FILM DEPOT, INC., MARIETTA, GA. FILED 9-23-2008.

SOLAFILM

THE MARK CONSISTS OF STANDARD CHARACTERS WITHOUT CLAIM TO ANY PARTICULAR FONT, STYLE, SIZE, OR COLOR.

FOR TINTED, LAMINATED AND REFLECTIVE SINGLE-LAYER PLASTIC FILMS FOR USE IN COMMERCIAL, HOME OR AUTO WINDOWS AND NOT SUITABLE FOR USE IN CONNECTION WITH MODEL TOYS; ANTI-DAZZLE FILMS FOR WINDOWS (U.S. CLS. 1, 5, 12, 13, 35 AND 50).

KIM MONINGHOFF, EXAMINING ATTORNEY

SN 77-597,403. CSC SCREEDING LIMITED, BUCKINGHAMSHIRE, UNITED KINGDOM, FILED 10-21-2008.

FLEXIDRY

THE MARK CONSISTS OF STANDARD CHARACTERS WITHOUT CLAIM TO ANY PARTICULAR FONT, STYLE, SIZE, OR COLOR.

PRIORITY CLAIMED UNDER SEC. 44(D) ON ERPNTY TM OFC APPLICATION NO. 007320691, FILED 10-16-2008, REG. NO. 007320691, DATED 5-14-2009, EXPIRES 10-16-2018.

FOR RESIN-BASED SEALANTS FOR USE ON FLOORS; RESINS IN EXTRUDED FORM FOR FLOOR SCREEDING (U.S. CLS. 1, 5, 12, 13, 35 AND 50).

JAMES LOVELACE, EXAMINING ATTORNEY

SN 77-684,227. ULTRAFLEX SYSTEMS, INC., RANDOLPH, NJ. FILED 3-5-2009.

UltraStyrene

THE MARK CONSISTS OF STANDARD CHARACTERS WITHOUT CLAIM TO ANY PARTICULAR FONT, STYLE, SIZE, OR COLOR.

OWNER OF U.S. REG. NOS. 2,533,694, 3,310,716 AND OTHERS.

FOR DURABLE, RIGID, WHITE PLASTIC SHEETS FOR USE IN THE MANUFACTURE OF DISPLAYS, SIGNS, SCROLLING POP SIGNS, BANNERS, BUS SHELTER SIGNS, AND TRADE SHOW BOOTH GRAPHICS (U.S. CLS. 1, 5, 12, 13, 35 AND 50).

FIRST USE 7-0-2003; IN COMMERCE 7-0-2003.

HEATHER BIDDULPH, EXAMINING ATTORNEY

CLASS 17—(Continued).

SN 77-715,535. DON R. EMLER, RANCHO DOMINGUEZ, CA. FILED 4-16-2009.

EVERLAST PACKING

THE MARK CONSISTS OF STANDARD CHARACTERS WITHOUT CLAIM TO ANY PARTICULAR FONT, STYLE, SIZE, OR COLOR.

NO CLAIM IS MADE TO THE EXCLUSIVE RIGHT TO USE "PACKING", APART FROM THE MARK AS SHOWN.

FOR MUFFLER PACKING MATERIAL FOR MOTORCYCLES AND OFF-ROAD VEHICLES (U.S. CLS. 1, 5, 12, 13, 35 AND 50).

C. DIONNE CLYBURN, EXAMINING ATTORNEY

SN 77-720,639. TAIPEI DUCT INDUSTRIES CORPORATION, TAICHUNG HSIEN, TAIWAN, FILED 4-23-2009.

TARPFOIL

THE MARK CONSISTS OF STANDARD CHARACTERS WITHOUT CLAIM TO ANY PARTICULAR FONT, STYLE, SIZE, OR COLOR.

FOR POLYURETHANE AND METAL FOIL FILM USED AS A MOISTER VAPOR BARRIER; POLYURETHANE AND METAL FOIL RADIANT BARRIER FILM USED AS BUILDING INSULATION (U.S. CLS. 1, 5, 12, 13, 35 AND 50).

RENEE SERVANCE, EXAMINING ATTORNEY

SN 77-720,673. TAIPEI DUCT INDUSTRIES CORPORATION, TAICHUNG HSIEN, TAIWAN, FILED 4-23-2009.

VAPORCLAD

THE MARK CONSISTS OF STANDARD CHARACTERS WITHOUT CLAIM TO ANY PARTICULAR FONT, STYLE, SIZE, OR COLOR.

FOR POLYURETHANE AND METAL FOIL FILM USED AS A MOISTER VAPOR BARRIER; POLYURETHANE AND METAL FOIL RADIANT BARRIER FILM USED AS BUILDING INSULATION (U.S. CLS. 1, 5, 12, 13, 35 AND 50).

RENEE SERVANCE, EXAMINING ATTORNEY

CLASS 17—(Continued).

SN 77-722,639. HENKEL CORPORATION, ROCKY HILL, CT. FILED 4-27-2009.

VP-275

THE MARK CONSISTS OF STANDARD CHARACTERS WITHOUT CLAIM TO ANY PARTICULAR FONT, STYLE, SIZE, OR COLOR.

FOR SILICONE-BASED SEALANTS FOR USE IN THE CONSTRUCTION INDUSTRY (U.S. CLS. 1, 5, 12, 13, 35 AND 50).

FIRST USE 1-31-1997; IN COMMERCE 1-31-1997.

HEATHER SAPP, EXAMINING ATTORNEY

SN 77-722,641. HENKEL CORPORATION, ROCKY HILL, CT. FILED 4-27-2009.

HM-270

THE MARK CONSISTS OF STANDARD CHARACTERS WITHOUT CLAIM TO ANY PARTICULAR FONT, STYLE, SIZE, OR COLOR.

FOR SILICONE-BASED SEALANTS FOR USE IN THE CONSTRUCTION INDUSTRY (U.S. CLS. 1, 5, 12, 13, 35 AND 50).

FIRST USE 1-31-1997; IN COMMERCE 1-31-1997.

HEATHER SAPP, EXAMINING ATTORNEY

SN 77-724,255. PARAGON FILMS, INC., TULSA, OK. FILED 4-28-2009.

FORCE FILMS

THE MARK CONSISTS OF STANDARD CHARACTERS WITHOUT CLAIM TO ANY PARTICULAR FONT, STYLE, SIZE, OR COLOR.

OWNER OF U.S. REG. NOS. 1,598,570, 3,060,234 AND 3,062,712.

NO CLAIM IS MADE TO THE EXCLUSIVE RIGHT TO USE "FILMS", APART FROM THE MARK AS SHOWN.

FOR PLASTIC STRETCH FILM FOR INDUSTRIAL AND COMMERCIAL PACKAGING (U.S. CLS. 1, 5, 12, 13, 35 AND 50).

FIRST USE 5-31-2009; IN COMMERCE 5-31-2009.

JOHN E. MICHOS, EXAMINING ATTORNEY

CLASS 17—(Continued).

SN 77-724,278. PARAGON FILMS, INC., TULSA, OK. FILED 4-28-2009.

CLASS 17—(Continued).

SN 77-724,820. PARAGON FILMS, INC., TULSA, OK. FILED 4-29-2009.

FORCE V

THE MARK CONSISTS OF STANDARD CHARACTERS WITHOUT CLAIM TO ANY PARTICULAR FONT, STYLE, SIZE, OR COLOR.

OWNER OF U.S. REG. NOS. 1,598,571, 3,060,234 AND 3,062,712.

FOR PLASTIC STRETCH FILM FOR INDUSTRIAL AND COMMERCIAL PACKAGING (U.S. CLS. 1, 5, 12, 13, 35 AND 50).

FIRST USE 5-31-2009; IN COMMERCE 5-31-2009.
JOHN E. MICHOS, EXAMINING ATTORNEY



OWNER OF U.S. REG. NOS. 1,598,571, 3,167,502 AND OTHERS.

THE LINING IS A FEATURE OF THE MARK AND DOES NOT INDICATE COLOR.

THE MARK CONSISTS OF THE TERMS "GLOBAL FORCE" INSIDE A CIRCLE WITH A DESIGN OF STYLIZED BIRD AND NORTH AMERICA IN THE BACKGROUND.

FOR PLASTIC STRETCH FILM FOR INDUSTRIAL AND COMMERCIAL PACKAGING (U.S. CLS. 1, 5, 12, 13, 35 AND 50).

FIRST USE 5-6-2009; IN COMMERCE 5-6-2009.
JOHN E. MICHOS, EXAMINING ATTORNEY

SN 77-724,780. PARAGON FILMS, INC., TULSA, OK. FILED 4-29-2009.



SN 77-724,838. PARAGON FILMS, INC., TULSA, OK. FILED 4-29-2009.

GLOBAL FORCE

OWNER OF U.S. REG. NOS. 1,609,053, 3,062,712 AND OTHERS.

THE LINING IS A FEATURE OF THE MARK AND DOES NOT INDICATE COLOR.

THE MARK CONSISTS OF THE TERM "FORCE V" INSIDE A CIRCLE, WITH A STYLIZED BIRD DESIGN BEHIND THE TERM "FORCE V".

FOR PLASTIC STRETCH FILM FOR INDUSTRIAL AND COMMERCIAL PACKAGING (U.S. CLS. 1, 5, 12, 13, 35 AND 50).

FIRST USE 5-31-2009; IN COMMERCE 5-31-2009.
JOHN E. MICHOS, EXAMINING ATTORNEY

THE MARK CONSISTS OF STANDARD CHARACTERS WITHOUT CLAIM TO ANY PARTICULAR FONT, STYLE, SIZE, OR COLOR.

OWNER OF U.S. REG. NOS. 1,598,571, 3,167,502 AND OTHERS.

FOR PLASTIC STRETCH FILM FOR INDUSTRIAL AND COMMERCIAL PACKAGING (U.S. CLS. 1, 5, 12, 13, 35 AND 50).

FIRST USE 5-6-2009; IN COMMERCE 5-6-2009.
JOHN E. MICHOS, EXAMINING ATTORNEY

CLASS 17—(Continued).

SN 77-725,709. PARAGON FILMS, INC., TULSA, OK. FILED 4-30-2009.



OWNER OF U.S. REG. NOS. 1,609,053, 3,062,712 AND OTHERS.

NO CLAIM IS MADE TO THE EXCLUSIVE RIGHT TO USE "ULTIMATE", APART FROM THE MARK AS SHOWN. THE LINING IS A FEATURE OF THE MARK AND DOES NOT INDICATE COLOR.

THE MARK CONSISTS OF THE TERMS "ULTIMATE FORCE" INSIDE A CIRCLE WITH A STYLIZED DESIGN OF A BIRD BEHIND THE TERMS "ULTIMATE FORCE".

FOR PLASTIC STRETCH FILM FOR INDUSTRIAL AND COMMERCIAL PACKAGING (U.S. CLS. 1, 5, 12, 13, 35 AND 50).

FIRST USE 5-6-2009; IN COMMERCE 5-6-2009.
JOHN E. MICHOS, EXAMINING ATTORNEY

CLASS 17—(Continued).

SN 77-725,759. PARAGON FILMS, INC., TULSA, OK. FILED 4-30-2009.



OWNER OF U.S. REG. NOS. 1,609,053, 3,062,712 AND OTHERS.

THE LINING IS A FEATURE OF THE MARK AND DOES NOT INDICATE COLOR.

THE MARK CONSISTS OF THE TERMS "POWER FORCE" INSIDE A CIRCLE WITH A STYLIZED BIRD DESIGN AND LIGHTNING BOLT BEHIND THE TERMS "POWER FORCE".

FOR PLASTIC STRETCH FILM FOR INDUSTRIAL AND COMMERCIAL PACKAGING (U.S. CLS. 1, 5, 12, 13, 35 AND 50).

FIRST USE 5-13-2009; IN COMMERCE 5-13-2009.
JOHN E. MICHOS, EXAMINING ATTORNEY

SN 77-725,745. PARAGON FILMS, INC., TULSA, OK. FILED 4-30-2009.

POWER FORCE

THE MARK CONSISTS OF STANDARD CHARACTERS WITHOUT CLAIM TO ANY PARTICULAR FONT, STYLE, SIZE, OR COLOR.

OWNER OF U.S. REG. NOS. 1,598,571, 3,062,712 AND OTHERS.

FOR PLASTIC STRETCH FILM FOR INDUSTRIAL AND COMMERCIAL PACKAGING (U.S. CLS. 1, 5, 12, 13, 35 AND 50).

FIRST USE 5-13-2009; IN COMMERCE 5-13-2009.
JOHN E. MICHOS, EXAMINING ATTORNEY

SN 77-726,792. PRINSCO, INC., WILLMAR, MN. FILED 5-1-2009.

GOLDLOK

THE MARK CONSISTS OF STANDARD CHARACTERS WITHOUT CLAIM TO ANY PARTICULAR FONT, STYLE, SIZE, OR COLOR.

FOR NON-METAL PIPE COUPLINGS AND JOINTS (U.S. CLS. 1, 5, 12, 13, 35 AND 50).

SUE LAWRENCE, EXAMINING ATTORNEY

CLASS 17—(Continued).

SN 77-727,062. SOUTHERN POLYMER, INC., ATLANTA, GA. FILED 5-1-2009.

PRIMALENE

THE MARK CONSISTS OF STANDARD CHARACTERS WITHOUT CLAIM TO ANY PARTICULAR FONT, STYLE, SIZE, OR COLOR.

FOR FULL LINE OF THERMOPLASTIC MATERIALS, NAMELY, POLYPROPYLENE, POLYETHYLENE AND POLYSTYRENE IN THE FORM OF PELLETS OR FLAKES, FOR FURTHER MANUFACTURE (U.S. CLS. 1, 5, 12, 13, 35 AND 50).

ALICE SUE CARRUTHERS, EXAMINING ATTORNEY

CLASS 18—(Continued).

SN 77-397,492. SUTTON, RHONA, NEW YORK, NY. FILED 2-14-2008.

B'eautilique

NO CLAIM IS MADE TO THE EXCLUSIVE RIGHT TO USE "BOUTIQUE", APART FROM THE MARK AS SHOWN. THE MARK CONSISTS OF STYLIZED WORD "B'EAUTIQUE" OVERLAPPING A SHADED CIRCLE.

FOR STRAW HAND BAGS (U.S. CLS. 1, 2, 3, 22 AND 41).

FIRST USE 7-31-2003; IN COMMERCE 7-31-2003.
BERYL GARDNER, EXAMINING ATTORNEY

CLASS 18—LEATHER GOODS

SN 77-302,516. GUCCI AMERICA, INC., NEW YORK, NY. FILED 10-12-2007.

JOY

THE MARK CONSISTS OF STANDARD CHARACTERS WITHOUT CLAIM TO ANY PARTICULAR FONT, STYLE, SIZE, OR COLOR.

FOR WALLETS, PURSES, HANDBAGS, SHOULDER BAGS, CLUTCH BAGS, TOTE BAGS, VALISES, SUITCASES, DUFFLE BAGS, CREDIT CARD CASES, BUSINESS CARD CASES, KEY CASES, COSMETIC CASES SOLD EMPTY, BRIEFCASES AND ATTACHE CASES (U.S. CLS. 1, 2, 3, 22 AND 41).

FIRST USE 9-26-2007; IN COMMERCE 10-1-2007.
JILL C. ALT, EXAMINING ATTORNEY

SN 77-398,617. SUTTON, RHONA, NEW YORK, NY. FILED 2-15-2008.

**mini
B'eautilique**

NO CLAIM IS MADE TO THE EXCLUSIVE RIGHT TO USE "BOUTIQUE", APART FROM THE MARK AS SHOWN. THE MARK CONSISTS OF STYLIZED WORDS MINI "B'EAUTIQUE" OVERLAPPING A SHADED CIRCLE.

FOR STRAW HAND BAGS (U.S. CLS. 1, 2, 3, 22 AND 41).

FIRST USE 7-31-2004; IN COMMERCE 7-31-2004.
BERYL GARDNER, EXAMINING ATTORNEY

SN 77-310,971. ALFA TRAVELGEAR, INC., LOS ANGELES, CA. FILED 10-23-2007.

Je Veux Handbags

THE MARK CONSISTS OF STANDARD CHARACTERS WITHOUT CLAIM TO ANY PARTICULAR FONT, STYLE, SIZE, OR COLOR.

NO CLAIM IS MADE TO THE EXCLUSIVE RIGHT TO USE "HANDBAGS", APART FROM THE MARK AS SHOWN.

THE ENGLISH TRANSLATION OF THE WORD "JE VEUX" IN THE MARK IS I WANT.

FOR LUGGAGES, TRAVELING BAGS, AND HANDBAGS (U.S. CLS. 1, 2, 3, 22 AND 41).

APRIL ROACH, EXAMINING ATTORNEY

SN 77-440,840. PARTAIN, JILL A, BUENA VISTA, VA. FILED 4-4-2008.

Plia Designs

THE MARK CONSISTS OF STANDARD CHARACTERS WITHOUT CLAIM TO ANY PARTICULAR FONT, STYLE, SIZE, OR COLOR.

NO CLAIM IS MADE TO THE EXCLUSIVE RIGHT TO USE "DESIGNS", APART FROM THE MARK AS SHOWN. THE FOREIGN WORDING IN THE MARK TRANSLATES INTO ENGLISH AS "HE/SHE/IT FOLDED".

FOR HANDBAGS, PURSES AND WALLETS (U.S. CLS. 1, 2, 3, 22 AND 41).

SCOTT BIBB, EXAMINING ATTORNEY

CLASS 18—(Continued).

SN 77-480,706. AUDIGIER BRAND MANAGEMENT GROUP, LLC., BEVERLY HILLS, CA. FILED 5-21-2008.

**SAVOIR FAIRE BY CHRISTIAN
AUDIGIER**

THE MARK CONSISTS OF STANDARD CHARACTERS WITHOUT CLAIM TO ANY PARTICULAR FONT, STYLE, SIZE, OR COLOR.

THE NAME "CHRISTIAN AUDIGIER" IDENTIFIES A LIVING INDIVIDUAL WHOSE CONSENT IS OF RECORD.

THE FOREIGN WORDING IN THE MARK TRANSLATES INTO ENGLISH AS INSTINCTIVE ABILITY TO KNOW HOW TO DEAL WITH ANY SITUATION THAT ARISES.

FOR HANDBAGS, TOTE BAGS; CLUTCH BAGS, LUGGAGE, TRAVELING BAGS, WALLETS, PURSES, COIN PURSES, KEY CASES, CREDIT CARD CASES, BUSINESS CARD CASES (U.S. CLS. 1, 2, 3, 22 AND 41).
TEJBIR SINGH, EXAMINING ATTORNEY

SN 77-595,943. MICHAELS STORES PROCUREMENT COMPANY, INC., IRVING, TX. FILED 10-20-2008.

ARTMINDS

THE MARK CONSISTS OF STANDARD CHARACTERS WITHOUT CLAIM TO ANY PARTICULAR FONT, STYLE, SIZE, OR COLOR.

FOR TOTE BAGS (U.S. CLS. 1, 2, 3, 22 AND 41).
PAUL CROWLEY, EXAMINING ATTORNEY

SN 77-596,916. OVERTON ENTERPRISES, LLC, AUSTIN, TX. FILED 10-21-2008.

**SPIBELT SMALL PERSONAL
ITEM BELT**

THE MARK CONSISTS OF STANDARD CHARACTERS WITHOUT CLAIM TO ANY PARTICULAR FONT, STYLE, SIZE, OR COLOR.

NO CLAIM IS MADE TO THE EXCLUSIVE RIGHT TO USE "SMALL PERSONAL ITEM BELT", APART FROM THE MARK AS SHOWN.

FOR WEARABLE POUCHES FOR HOLDING SMALL ARTICLES DURING PHYSICAL ACTIVITIES (U.S. CLS. 1, 2, 3, 22 AND 41).

FIRST USE 12-31-2006; IN COMMERCE 3-31-2007.
JAY FLOWERS, EXAMINING ATTORNEY

CLASS 18—(Continued).

SN 77-599,060. HOME BOX OFFICE, INC., NEW YORK, NY. FILED 10-23-2008.

HUNG

THE MARK CONSISTS OF STANDARD CHARACTERS WITHOUT CLAIM TO ANY PARTICULAR FONT, STYLE, SIZE, OR COLOR.

FOR ALL PURPOSE CARRYING BAGS, COIN PURSES, CLUTCH BAGS AND PURSES, DUFFLE BAGS, HANDBAGS, LUGGAGE, LUGGAGE TAGS, SHOULDER BAGS, SPORTS BAGS, BACKPACKS, MESSENGER BAGS, OVERNIGHT BAGS, TOTE BAGS, TRAVEL BAGS, WALLETS, WRISTLET BAGS, COSMETIC BAGS SOLD EMPTY; UMBRELLAS; TRUNKS; ATTACHE CASES (U.S. CLS. 1, 2, 3, 22 AND 41).

MICHELE SWAIN, EXAMINING ATTORNEY

SN 77-604,690. PRESSLER, DENISE K., DBA KD WESTERN WORKS, BETHEL ISLAND, CA. AND PRESSLER, KURT T., DBA KD WESTERN WORKS, BETHEL ISLAND, CA. FILED 10-30-2008.

Natural Look CatchMask

THE MARK CONSISTS OF STANDARD CHARACTERS WITHOUT CLAIM TO ANY PARTICULAR FONT, STYLE, SIZE, OR COLOR.

FOR HORSE FLY VEILS FOR HORSES (U.S. CLS. 1, 2, 3, 22 AND 41).

MARIAM MAHMOUDI, EXAMINING ATTORNEY

SN 77-615,564. STREICHER'S, INC., PLYMOUTH, MN. FILED 11-17-2008.



NO CLAIM IS MADE TO THE EXCLUSIVE RIGHT TO USE "GEAR", APART FROM THE MARK AS SHOWN.

THE COLOR(S) BLACK AND BLUE IS/ARE CLAIMED AS A FEATURE OF THE MARK.

THE MARK CONSISTS OF A STYLIZED LETTER "D" IN BLUE, TILTED OFF-VERTICAL AND CONTAINED WITHIN A BLUE CROSS-HAIR DESIGN CONSISTING OF A CIRCLE WITH FOUR OUTWARD POINTING MARKS LOCATED EVERY 90 (NINETY) DEGREES. THE WORD "GEAR" IS COLORED BLUE. THE WORD "DEFENDER" IS IN BLACK.

FOR LUGGAGE AND TRUNKS (U.S. CLS. 1, 2, 3, 22 AND 41).

FIRST USE 0-0-2007; IN COMMERCE 1-1-2008.

ANGELA M. MICHELI, EXAMINING ATTORNEY

CLASS 18—(Continued).

SN 77-644,493. LEE, ARI K.W., LAS VEGAS, NV. FILED 1-7-2009.

ZIPPEEBAG

THE MARK CONSISTS OF STANDARD CHARACTERS WITHOUT CLAIM TO ANY PARTICULAR FONT, STYLE, SIZE, OR COLOR.
FOR MESSENGER BAGS (U.S. CLS. 1, 2, 3, 22 AND 41).
FIRST USE 9-1-2008; IN COMMERCE 9-1-2008.
CAROLINE WOOD, EXAMINING ATTORNEY

CLASS 18—(Continued).

SN 77-690,681. KELLEY, GAYLE A., DBA GRACEGAYLE, BROCKTON, MA. FILED 3-13-2009.



THE NAME "GRACEGAYLE" DOES NOT IDENTIFY A LIVING INDIVIDUAL.
THE COLOR(S) LIGHT BLUE, BLUE, WHITE, GREEN IS/ ARE CLAIMED AS A FEATURE OF THE MARK.
THE MARK CONSISTS OF THE COLOR LIGHT BLUE WHICH APPEARS IN THE WORD "GRACE" AND IN THE DEPICTION OF A PURSE. THE COLOR BLUE APPEARS IN THE WORD "GAYLE" AND IN THE HANDLE OF THE PURSE. THE COLOR WHITE APPEARS IN THE LETTERS "GG". THE COLOR GREEN APPEARS IN THE WORDING "TRAVELING WITH GRACE".
FOR BACKPACKS, BOOK BAGS, SPORTS BAGS, BUM BAGS, WALLETS AND HANDBAGS; EVENING HANDBAGS; FASHION HANDBAGS; HANDBAGS; HANDBAGS FOR MEN; HANDBAGS, PURSES AND WALLETS; STRAPS FOR HANDBAGS (U.S. CLS. 1, 2, 3, 22 AND 41).
EVELYN BRADLEY, EXAMINING ATTORNEY

SN 77-654,288. ACCESSORIES BY JOANN HUTH, INC., BRYN MAWR, PA. FILED 1-22-2009.

Accessories by JoAnn Huth

THE MARK CONSISTS OF STANDARD CHARACTERS WITHOUT CLAIM TO ANY PARTICULAR FONT, STYLE, SIZE, OR COLOR.
NO CLAIM IS MADE TO THE EXCLUSIVE RIGHT TO USE "ACCESSORIES", APART FROM THE MARK AS SHOWN.
THE NAME(S), PORTRAIT(S), AND/OR SIGNATURE(S) SHOWN IN THE MARK IDENTIFIES "JOANN HUTH", WHOSE CONSENT(S) TO REGISTER IS MADE OF RECORD.
FOR HANDBAGS, NAMELY, FASHION HANDBAGS, EVENING HANDBAGS, PURSES, HANDBAG INSERTS AND COMPARTMENT PURSE INSERTS (U.S. CLS. 1, 2, 3, 22 AND 41).
FIRST USE 10-1-2007; IN COMMERCE 10-1-2007.
MICHAEL WEBSTER, EXAMINING ATTORNEY

SN 77-710,339. BBC INTERNATIONAL, LLC, BOCA RATON, FL. FILED 4-9-2009.

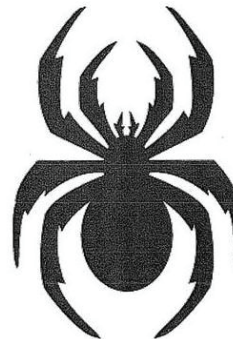

THE MARK CONSISTS OF THE DESIGN OF A SPIDER.
FOR BACKPACKS, FANNY PACKS, MESSENGER BAGS AND ROLL BAGS (U.S. CLS. 1, 2, 3, 22 AND 41).
DAVID I, EXAMINING ATTORNEY

CLASS 18—(Continued).

SN 77-721,212. TWENTIETH CENTURY FOX FILM CORPORATION, LOS ANGELES, CA. FILED 4-23-2009.



OWNER OF U.S. REG. NO. 3,001,994.
NO CLAIM IS MADE TO THE EXCLUSIVE RIGHT TO USE "SPORTS", APART FROM THE MARK AS SHOWN.

THE MARK CONSISTS OF THE STYLIZED WORDS "THE ADVENTURES OF DIGGER AND FRIENDS" WHICH APPEAR INSIDE OF TWO OVAL CONCENTRIC LINES, THE WORDS "FOX SPORTS" WHICH APPEAR UNDER THE WORD "FRIENDS" AND INSIDE OF THE OVAL SHAPE OVERLAPPING ON THE BOTTOM OF THE INNER OVAL LINE AND FIVE COSTUMED GOPHER CHARACTERS WHICH APPEAR ABOVE THE OUTER OVAL LINE.

FOR KNAPSACKS AND BACKPACKS; PURSES; WALLETS; UMBRELLAS; TOTE BAGS, BOOK BAGS, SCHOOL BAGS; OVERNIGHT BAGS; BEACH BAGS; FANNY PACKS; HANDBAGS; SPORTS BAGS; TRAVEL BAGS; TOILETRY BAGS SOLD EMPTY; LUGGAGE; BRIEFCASES (U.S. CLS. 1, 2, 3, 22 AND 41).

LINDA LAVACHE, EXAMINING ATTORNEY

SN 77-721,508. EDDIE BAUER, INC., BELLEVUE, WA. FILED 4-24-2009.

**THE LIGHTEST, TOUGHEST
DUFFELS ON EARTH.**

THE MARK CONSISTS OF STANDARD CHARACTERS WITHOUT CLAIM TO ANY PARTICULAR FONT, STYLE, SIZE, OR COLOR.

FOR ALL PURPOSE SPORT BAGS; ALL-PURPOSE ATHLETIC BAGS; ALL-PURPOSE CARRYING BAGS; ATHLETIC BAGS; BACK PACKS; CARRY-ALL BAGS; DUFFEL BAGS; DUFFEL BAGS FOR TRAVEL; GYM BAGS; HIKING BAGS; LUGGAGE; MESSENGER BAGS; OVERNIGHT BAGS; SHOULDER BAGS; SLING BAGS; SPORTS BAGS; SPORTS PACKS; TRAVEL BAGS; TRAVELING BAGS; WHEELED BAGS; WHEELED DUFFLE BAGS (U.S. CLS. 1, 2, 3, 22 AND 41).

PAULA MAHONEY, EXAMINING ATTORNEY

CLASS 18—(Continued).

SN 77-724,097. PARNU, INC., SAN FRANCISCO, CA. FILED 4-28-2009.

Gürdle

THE MARK CONSISTS OF STANDARD CHARACTERS WITHOUT CLAIM TO ANY PARTICULAR FONT, STYLE, SIZE, OR COLOR.

FOR STRAPS FOR LUGGAGE (U.S. CLS. 1, 2, 3, 22 AND 41).

Laurie Mayes, Examining Attorney

SN 77-724,183. SCHNEIDER SADDLERY CO., INC., CHAGRIN FALLS, OH. FILED 4-28-2009.

V-Free

THE MARK CONSISTS OF STANDARD CHARACTERS WITHOUT CLAIM TO ANY PARTICULAR FONT, STYLE, SIZE, OR COLOR.

FOR HORSE BLANKETS; HORSE FLANKS AND SHANKS, NAMELY, HORSE PROTECTIVE PADDING, BRACES, AND LEG BOOTS FOR THE FLANKS AND LEGS; PADS FOR HORSE SADDLES (U.S. CLS. 1, 2, 3, 22 AND 41).

FIRST USE 8-5-2002; IN COMMERCE 8-5-2002.

Emily Carlsen, Examining Attorney

SN 77-724,914. TROYER, KATHERINE EMURIAN, RAMSEY, NJ. FILED 4-29-2009.

Bag Hugger

THE MARK CONSISTS OF STANDARD CHARACTERS WITHOUT CLAIM TO ANY PARTICULAR FONT, STYLE, SIZE, OR COLOR.

NO CLAIM IS MADE TO THE EXCLUSIVE RIGHT TO USE "BAG", APART FROM THE MARK AS SHOWN.

FOR TOTE BAGS TO CARRY REUSABLE GROCERY AND/OR SHOPPING BAGS TO FACILITATE THE USE OF REUSABLE GROCERY AND/OR SHOPPING BAGS IN SHOPPING (U.S. CLS. 1, 2, 3, 22 AND 41).

Theodore McBride, Examining Attorney

CLASS 18—(Continued).

SN 77-725,517. TWENTIETH CENTURY FOX FILM CORPORATION, LOS ANGELES, CA. FILED 4-29-2009.

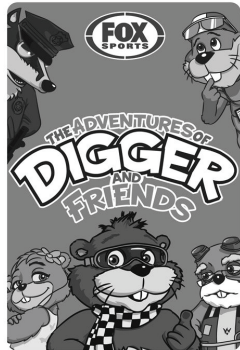

OWNER OF U.S. REG. NO. 3,001,994.
 NO CLAIM IS MADE TO THE EXCLUSIVE RIGHT TO USE "SPORTS", APART FROM THE MARK AS SHOWN.
 THE MARK CONSISTS OF THE STYLIZED WORDS "THE ADVENTURES OF DIGGER AND FRIENDS" WHICH APPEAR IN THE CENTER, THE WORDS "FOX SPORTS" WHICH APPEAR INSIDE OF THE OVAL SHAPE ON THE TOP CENTER AND FIVE COSTUMED GOPHER CHARACTERS, AND ALL ARE DISPLAYED INSIDE OF THE RECTANGULAR BACKGROUND.
 FOR KNAPSACKS AND BACKPACKS; PURSES; WALLETS; UMBRELLAS; TOTE BAGS, BOOK BAGS, SCHOOL BAGS; OVERNIGHT BAGS; BEACH BAGS; FANNY PACKS; HANDBAGS; SPORTS BAGS; TRAVEL BAGS; TOILETRY BAGS SOLD EMPTY; LUGGAGE; BRIEFCASES (U.S. CLS. 1, 2, 3, 22 AND 41).
 LINDA LAVACHE, EXAMINING ATTORNEY

SN 77-726,214. THE H.D. LEE COMPANY, INC., WILMINGTON, DE. FILED 4-30-2009.

RIDERS

THE MARK CONSISTS OF STANDARD CHARACTERS WITHOUT CLAIM TO ANY PARTICULAR FONT, STYLE, SIZE, OR COLOR.
 OWNER OF U.S. REG. NO. 2,653,579.
 FOR ALL-PURPOSE CARRYING BAGS; HANDBAGS, PURSES AND WALLETS; IMITATION LEATHER KEY CHAINS; KEY-CASES; LEATHER KEY CHAINS; TOTE BAGS; TRAVEL BAGS; TRAVEL CASES; WALLETS (U.S. CLS. 1, 2, 3, 22 AND 41).
 ZACHARY BELLO, EXAMINING ATTORNEY

CLASS 18—(Continued).

SN 77-727,257. MARZELLE DESIGNS, LLC, PLYMOUTH, MN. FILED 5-1-2009.

**BLIZZARD MONKEY
 BEACH MONKEY**

THE MARK CONSISTS OF STANDARD CHARACTERS WITHOUT CLAIM TO ANY PARTICULAR FONT, STYLE, SIZE, OR COLOR.
 FOR BACKPACKS, PACKS FOR ATTACHMENT TO BACKPACKS (U.S. CLS. 1, 2, 3, 22 AND 41).
 KATHLEEN M. VANSTON, EXAMINING ATTORNEY

SN 77-728,375. TREVITT, BROOKE, LOUISVILLE, KY. FILED 5-4-2009.

ENJOY CHANGE

THE MARK CONSISTS OF STANDARD CHARACTERS WITHOUT CLAIM TO ANY PARTICULAR FONT, STYLE, SIZE, OR COLOR.
 FOR SETS CONSISTING OF A PURSE AND FOOTWEAR SOLD AS A UNIT (U.S. CLS. 1, 2, 3, 22 AND 41).
 CHRISTINA SOBRAL, EXAMINING ATTORNEY

SN 77-733,473. EDWARDS, LUKE J, GOLD COAST, AUSTRALIA, FILED 5-11-2009.

USAs

THE MARK CONSISTS OF STANDARD CHARACTERS WITHOUT CLAIM TO ANY PARTICULAR FONT, STYLE, SIZE, OR COLOR.
 FOR ALL PURPOSE SPORT BAGS; ATHLETIC BAGS; CLUTCH BAGS; DUFFEL BAGS; GYM BAGS; HANDBAGS; LUGGAGE; POCKET WALLETS; PURSES; RUCKSACKS; SATCHELS; SHOULDER BAGS; SPORT BAGS; TOTE BAGS; TRAVEL BAGS; UMBRELLAS; WAIST BAGS; WALLETS (U.S. CLS. 1, 2, 3, 22 AND 41).
 ERIN FALK, EXAMINING ATTORNEY

CLASS 18—(Continued).

SN 77-748,839. PARNU, INC., SAN FRANCISCO, CA. FILED 6-1-2009.



THE COLOR(S) BLUE AND BLACK IS/ARE CLAIMED AS A FEATURE OF THE MARK.
THE MARK CONSISTS OF THE LETTER "G" IN BLUE, THE LETTERS "ÜRDLE" IN BLACK, AND THE WORDS "KEEP IT ALL TOGETHER" IN BLUE WITH A BLACK "K" TITLED TO THE LEFT AND OUTLINED IN BLUE.
FOR STRAPS FOR LUGGAGE (U.S. CLS. 1, 2, 3, 22 AND 41).
LAURIE MAYES, EXAMINING ATTORNEY

CLASS 18—(Continued).

SN 77-748,910. PARNU, INC., SAN FRANCISCO, CA. FILED 6-1-2009.



THE COLOR(S) PINK AND BLACK IS/ARE CLAIMED AS A FEATURE OF THE MARK.
THE MARK CONSISTS OF THE LETTER "G" IN PINK, THE LETTERS "ÜRDLE" IN BLACK, AND THE WORDS "KEEP IT ALL TOGETHER" IN PINK WITH A BLACK "K" TITLED TO THE LEFT AND OUTLINED IN PINK.
FOR STRAPS FOR LUGGAGE (U.S. CLS. 1, 2, 3, 22 AND 41).
LAURIE MAYES, EXAMINING ATTORNEY

SN 77-748,879. PARNU, INC., SAN FRANCISCO, CA. FILED 6-1-2009.



THE COLOR(S) GREEN AND BLACK IS/ARE CLAIMED AS A FEATURE OF THE MARK.
THE MARK CONSISTS OF THE LETTER "G" IN GREEN, THE LETTERS "ÜRDLE" IN BLACK, AND THE WORDS "KEEP IT ALL TOGETHER" IN GREEN WITH A BLACK "K" TITLED TO THE LEFT AND OUTLINED IN GREEN.
FOR STRAPS FOR LUGGAGE (U.S. CLS. 1, 2, 3, 22 AND 41).
LAURIE MAYES, EXAMINING ATTORNEY

SN 77-748,951. PARNU, INC., SAN FRANCISCO, CA. FILED 6-1-2009.



THE COLOR(S) ORANGE AND BLACK IS/ARE CLAIMED AS A FEATURE OF THE MARK.
THE MARK CONSISTS OF THE LETTER "G" IN ORANGE, THE LETTERS "GURDLE" IN BLACK, AND THE WORDS "KEEP IT ALL TOGETHER" IN ORANGE WITH A BLACK "K" TITLED TO THE LEFT AND OUTLINED IN ORANGE.
FOR STRAPS FOR LUGGAGE (U.S. CLS. 1, 2, 3, 22 AND 41).
LAURIE MAYES, EXAMINING ATTORNEY

CLASS 18—(Continued).

SN 77-748,989. PARNU, INC., SAN FRANCISCO, CA. FILED 6-1-2009.



THE MARK CONSISTS OF THE WORD "GÜRDLE", AND THE WORDS "KEEP IT ALL TOGETHER" WITH THE "K" TILTED TO THE LEFT, UNDER THE WORD "GÜRDLE". FOR STRAPS FOR LUGGAGE (U.S. CLS. 1, 2, 3, 22 AND 41).

Laurie Mayes, Examining Attorney

CLASS 18—(Continued).

SN 78-829,468. M. J. AINGE & CO. LIMITED, HEREFORDSHIRE, UNITED KINGDOM, FILED 3-5-2006.



THE MARK CONSISTS OF STANDARD CHARACTERS WITHOUT CLAIM TO ANY PARTICULAR FONT, STYLE, SIZE, OR COLOR.

PRIORITY CLAIMED UNDER SEC. 44(D) ON ERPN CMNTY TM OFC APPLICATION NO. 4708376, FILED 10-26-2005, REG. NO. 004708376, DATED 10-26-2006, EXPIRES 10-26-2015.

FOR EQUESTRIAN RELATED ARTICLES, NAMELY, WHIPS, SADDLERY AND HARNESS; HORSE BRIDLES, HEADCOLLARS, NOSEBANDS, REINS, MARTINGALES, BREASTPLATES, AND BREASTGIRTHS (U.S. CLS. 1, 2, 3, 22 AND 41).

Janice Kim, Examining Attorney

SN 78-620,377. SADEQ, YZAN, CLEVELAND, OH. FILED 4-29-2005.



THE FOREIGN WORDING IN THE MARK TRANSLATES INTO ENGLISH AS LION.

FOR LEATHER AND IMITATION LEATHER ARTICLES OF LUGGAGE, NAMELY, SUIT BAGS; BUSINESS CASES; ATTACHE CASES; BRIEFCASES; SUITCASES; VALISES; HANDBAGS; SHOULDER BAGS; CASUAL BAGS, NAMELY, CARRY-ALL BAGS AND DUFFLE BAGS; RUCKSACKS; BACKPACKS; SCHOOL BAGS; SATCHELS; GYM BAGS; TOTE BAGS; SHOPPING BAGS MADE OF TEXTILE; HOLDALLS; GARMENT BAGS FOR TRAVEL, NAMELY, COVER BAGS FOR CLOTHING FOR TRAVEL PURPOSES; SHOE BAGS FOR TRAVEL; COSMETIC BAGS SOLD EMPTY; BEACH BAGS; HIP BAGS; FELT POUCHES; PURSES; WALLETS; BILLFOLDS; BUSINESS CARD CASES; KEY CASES; LUGGAGE TAGS; ANIMAL SKINS AND HIDES; NON-MOTORIZED, COLLAPSIBLE LUGGAGE CARTS; TRAVELING BAGS; UMBRELLAS; PARASOLS; WALKING STICKS; WHIPS; HARNESSES AND SADDLERY (U.S. CLS. 1, 2, 3, 22 AND 41).

Sara Thomas, Examining Attorney

SN 79-066,041. CHEN YUPING, GUANGZHOU, GUANGDONG, CHINA, FILED 2-16-2009.



OWNER OF INTERNATIONAL REGISTRATION 0995403 DATED 2-16-2009, EXPIRES 2-16-2019.

THE MARK CONSISTS OF A DEVICE IN THE SHAPE OF GOLDFISH.

FOR PELTS; UMBRELLAS; CLOTHING FOR PETS; BACKPACKS; TRIMMINGS OF LEATHER FOR FURNITURE; IMITATION LEATHER; HANDBAGS; BRIEFCASES; TRAVELLING SETS, BEING LEATHERWARE, NAMELY, TRAVELING BAGS, ROLLER SUITCASE; CANES (U.S. CLS. 1, 2, 3, 22 AND 41).

Allison Holtz, Examining Attorney

CLASS 19—NON-METALLIC BUILDING MATERIALS

SN 76-389,709. ROYAL GROUP, INC., WOODBRIDGE, ONTARIO, CANADA, FILED 3-28-2002.

DURA COLOR

PRIORITY CLAIMED UNDER SEC. 44(D) ON CANADA APPLICATION NO. 1135451, FILED 3-27-2002.

NO CLAIM IS MADE TO THE EXCLUSIVE RIGHT TO USE "COLOR", APART FROM THE MARK AS SHOWN.
FOR VINYL SIDING (U.S. CLS. 1, 12, 33 AND 50).
AMY C. KEAN, EXAMINING ATTORNEY

SN 76-598,835. IKO INDUSTRIES LTD., TORONTO, ONTARIO M6A 3A1, CANADA, FILED 6-23-2004.

DYNASTY

THE MARK CONSISTS OF STANDARD CHARACTERS WITHOUT CLAIM TO ANY PARTICULAR FONT, STYLE, SIZE, OR COLOR.

PRIORITY CLAIMED UNDER SEC. 44(D) ON CANADA APPLICATION NO. 1,202,267, FILED 12-24-2003, REG. NO. TMA735768, DATED 3-5-2009, EXPIRES 3-5-2024.

FOR ROOFING SHINGLES (U.S. CLS. 1, 12, 33 AND 50).

FIRST USE 5-0-1996; IN COMMERCE 5-0-1996.
AISHA CLARKE, EXAMINING ATTORNEY

SN 76-686,660. HEITMAN HOLDINGS, INC., ANAHEIM, CA. FILED 2-8-2008.

BROOKS PRODUCTS

THE MARK CONSISTS OF STANDARD CHARACTERS WITHOUT CLAIM TO ANY PARTICULAR FONT, STYLE, SIZE, OR COLOR.

SUBJECT TO CONCURRENT USE PROCEEDING NO. 94002174 WITH REG. NO. 3359572 FILED SEPTEMBER 15, 2005. APPLICANT SEEKS EXCLUSIVE RIGHT TO USE THE MARK IN THE STATES OF CALIFORNIA, OREGON, WASHINGTON, ARIZONA, NEVADA, UTAH, IDAHO, NEW MEXICO, COLORADO, WYOMING, MONTANA, ALASKA AND HAWAII.

NO CLAIM IS MADE TO THE EXCLUSIVE RIGHT TO USE "PRODUCTS", APART FROM THE MARK AS SHOWN. SEC. 2(F).

FOR PRECAST CONCRETE PRODUCTS, NAMELY, CONCRETE VAULTS FOR USE WITH WATER METERS, WATER VALVES, GAS METERS, GAS VALVES, POWER EQUIPMENT, TELEPHONE EQUIPMENT, IRRIGATION EQUIPMENT, AND SEWERS, CONCRETE MANHOLES, CONCRETE SUPPORT PADS FOR POWER TRANSFORMERS, CONCRETE BOXES FOR USE AS IRRIGATION CONDUITS, CONCRETE SEWER CLEAN-OUT BOXES (U.S. CLS. 1, 12, 33 AND 50).

FIRST USE 8-0-1953; IN COMMERCE 9-0-1953.
JOHN DWYER, EXAMINING ATTORNEY

CLASS 19—(Continued).

SN 76-695,586. VX INC., MANHEIM, PA. FILED 2-3-2009.

Main Street

VINYL SYSTEMS

NO CLAIM IS MADE TO THE EXCLUSIVE RIGHT TO USE "VINYL SYSTEMS", APART FROM THE MARK AS SHOWN.

THE COLOR(S) BLACK AND RED IS/ARE CLAIMED AS A FEATURE OF THE MARK.

THE MARK CONSISTS OF THE WORDS "MAIN STREET" IN THE COLOR BLACK WITH A BLACK LINE UNDERNEATH THESE WORDS AND THE TERM "VINYL SYSTEMS" IN THE COLOR RED UNDERNEATH THE TERM "MAIN STREET".

FOR NONMETALLIC BUILDING MATERIALS USED TO MANUFACTURE RAILINGS AND FENCING; NON-METALLIC RIGID PIPES FOR BUILDING; NONMETALLIC TRANSPORTABLE BUILDING MATERIALS USED IN MANUFACTURING RAILINGS AND FENCING (U.S. CLS. 1, 12, 33 AND 50).

HENRY S. ZAK, EXAMINING ATTORNEY

SN 77-320,222. INNOVARIS AG, 6341 BAAR, SWITZERLAND, FILED 11-2-2007.

DUPLEX

THE MARK CONSISTS OF STANDARD CHARACTERS WITHOUT CLAIM TO ANY PARTICULAR FONT, STYLE, SIZE, OR COLOR.

OWNER OF ERPN CMNTY TM OFC REG. NO. 006470637, DATED 10-14-2008, EXPIRES 11-29-2017.

FOR LAMINATE AND HARDWOOD FLOORING (U.S. CLS. 1, 12, 33 AND 50).

ANDREA SAUNDERS, EXAMINING ATTORNEY

SN 77-421,668. APPLIED FELTS, INC., MARTINSVILLE, VA. FILED 3-13-2008.



YOUR SUCCESS IS OUR SUCCESS

NO CLAIM IS MADE TO THE EXCLUSIVE RIGHT TO USE "APPLIED FELTS", APART FROM THE MARK AS SHOWN.

THE MARK CONSISTS OF A BALL WITH FIBER WHICH APPEARS TO THE LEFT OF THE WORDS.

FOR FELT LINERS USED IN THE REHABILITATION OF UNDERGROUND SEWER LINES USING THE CURED-IN-PLACE-PIPE (CIPP) PROCESS (U.S. CLS. 1, 12, 33 AND 50).

FIRST USE 1-1-2000; IN COMMERCE 1-1-2000.

KATHERINE STOIDES, EXAMINING ATTORNEY

CLASS 19—(Continued).

SN 77-446,170. VERMONT STRUCTURAL SLATE COMPANY, INC., FAIR HAVEN, VT. FILED 4-11-2008.

GREEN MOUNTAIN MIST QUARTZITE

THE MARK CONSISTS OF STANDARD CHARACTERS WITHOUT CLAIM TO ANY PARTICULAR FONT, STYLE, SIZE, OR COLOR.

NO CLAIM IS MADE TO THE EXCLUSIVE RIGHT TO USE "QUARTZITE", APART FROM THE MARK AS SHOWN.

FOR NATURAL STONE (U.S. CLS. 1, 12, 33 AND 50).
FIRST USE 0-0-1983; IN COMMERCE 0-0-1983.
NANCY CLARKE, EXAMINING ATTORNEY

SN 77-573,297. NORTH WOOD FLOORING LLC, COLEMAN, WI. FILED 9-18-2008.

WILDERNESS PLANK

THE MARK CONSISTS OF STANDARD CHARACTERS WITHOUT CLAIM TO ANY PARTICULAR FONT, STYLE, SIZE, OR COLOR.

NO CLAIM IS MADE TO THE EXCLUSIVE RIGHT TO USE "PLANK", APART FROM THE MARK AS SHOWN.

FOR WOOD FLOORING (U.S. CLS. 1, 12, 33 AND 50).
FIRST USE 8-13-2008; IN COMMERCE 8-13-2008.
JILL PRATER, EXAMINING ATTORNEY

SN 77-577,613. NATURA HOME, DBA NATURA 51, BROOKLYN, NY. FILED 9-24-2008.

NATURA⁵¹

THE COLOR(S) GREY AND GREEN IS/ARE CLAIMED AS A FEATURE OF THE MARK.

THE MARK CONSISTS OF THE STYLIZED WORD "NATURA" IN THE COLOR GREY, WITH THE NUMBER "51", IN SUPERSCRIPIT, IN THE COLOR GREEN.

THE FOREIGN WORDING IN THE MARK TRANSLATES INTO ENGLISH AS "NATURE."

FOR ENVIRONMENTALLY-RESTORATIVE BUILDING MATERIALS, NAMELY, BUILDING COMPONENTS MADE FROM SUSTAINABLY HARVESTED WOODS, CONSISTING PRIMARILY OF POSTS, BEAMS, RAFTERS, STRINGERS, TRANSOMS, PRE-WIRED AND PRE-PLUMBED PANEL WALLS, RAILINGS, STAIRS, BARGE BOARDS, RIDGE BEAMS, PANEL DOORS, SHEAR WALLS, ROOF TRUSSES, BAMBOO PLYWOOD, ARCHITECTURAL PLYWOOD, ROOFING SHINGLES AND MILLWORK FOR USE IN PRE-FABRICATED LOW INCOME AND DISASTER RELIEF HOUSING, EXCLUDING CABINETS, CERAMICS, CARDBOARDS, PLASTICS, GARDEN IMPLEMENTS AND WINDOW TREATMENTS (U.S. CLS. 1, 12, 33 AND 50).

JERI J. FICKES, EXAMINING ATTORNEY

CLASS 19—(Continued).

SN 77-592,392. VINCE GUERRA, ANCASTER, CANADA, FILED 10-14-2008.

METSTAR

THE MARK CONSISTS OF STANDARD CHARACTERS WITHOUT CLAIM TO ANY PARTICULAR FONT, STYLE, SIZE, OR COLOR.

FOR COMPOSITE SHINGLES AND ASPHALT SHINGLES (U.S. CLS. 1, 12, 33 AND 50).

RONALD AIKENS, EXAMINING ATTORNEY

SN 77-595,710. KTECH CONCEPTS, INKSTER, MI. FILED 10-19-2008.



THE MARK CONSISTS OF THE WORDING "REDIRAMP" TO THE RIGHT OF A DESIGN ELEMENT THAT CONSISTS OF A PERSON IN A WHEELCHAIR RIDING ON A RAMP OVER AN OBSTACLE.

FOR NON-METAL WHEELCHAIR RAMPS (U.S. CLS. 1, 12, 33 AND 50).

FIRST USE 2-12-2007; IN COMMERCE 8-10-2008.
SETH A. RAPPAPORT, EXAMINING ATTORNEY

SN 77-596,089. STOCK BUILDING SUPPLY LLC, RALEIGH, NC. FILED 10-20-2008.

ARTRIM

THE MARK CONSISTS OF STANDARD CHARACTERS WITHOUT CLAIM TO ANY PARTICULAR FONT, STYLE, SIZE, OR COLOR.

FOR NON-METAL BUILDING MATERIALS, NAMELY, PLYWOOD, WOOD MOLDINGS, WOOD COLUMNS, WOOD RAILINGS, PVC FASCIA AND SOFFITS, AND NON-METAL FASCIA AND SOFFITS; NON-METAL STAIR PARTS, NAMELY, STAIR TREADS, RAILS, RISERS, RAILINGS, BALUSTERS AND NEWEL POSTS (U.S. CLS. 1, 12, 33 AND 50).

LINDA LAVACHE, EXAMINING ATTORNEY

CLASS 19—(Continued).

SN 77-596,861. POINT-FIVE WINDOWS, INC., FORT COLLINS, CO. FILED 10-21-2008.

POINT FIVE

THE MARK CONSISTS OF STANDARD CHARACTERS WITHOUT CLAIM TO ANY PARTICULAR FONT, STYLE, SIZE, OR COLOR.

FOR WOOD WINDOWS AND DOORS; METAL CLAD WOOD WINDOWS AND DOORS (U.S. CLS. 1, 12, 33 AND 50).

FIRST USE 8-31-1981; IN COMMERCE 2-28-1982.
JEFFREY LOOK, EXAMINING ATTORNEY

SN 77-597,174. QUICKFLASH WEATHERPROOFING PRODUCTS, INC., LAS VEGAS, NV. FILED 10-21-2008.

QUICKFLASH

THE MARK CONSISTS OF STANDARD CHARACTERS WITHOUT CLAIM TO ANY PARTICULAR FONT, STYLE, SIZE, OR COLOR.

OWNER OF U.S. REG. NOS. 2,718,907 AND 2,720,933.
FOR WEATHERPROOFING PRODUCTS, NAMELY, NON-METAL BUILDING FLASHING (U.S. CLS. 1, 12, 33 AND 50).

FIRST USE 7-1-2000; IN COMMERCE 7-1-2000.
MATTHEW KLINE, EXAMINING ATTORNEY

SN 77-683,344. JERRY C. REEVES, PE, TUALATIN, OR. FILED 3-4-2009.

CHI-BUILDER

THE MARK CONSISTS OF STANDARD CHARACTERS WITHOUT CLAIM TO ANY PARTICULAR FONT, STYLE, SIZE, OR COLOR.

FOR NON-METAL PORTABLE ENVIRONMENTS IN THE NATURE OF BUILDINGS USED FOR SPIRITUAL, MENTAL AND PHYSICAL HEALTH; NON-METAL PORTABLE ROOMS FOR PERSONAL AND ENERGETIC DEVELOPMENT (U.S. CLS. 1, 12, 33 AND 50).

TARAH HARDY, EXAMINING ATTORNEY

CLASS 19—(Continued).

SN 77-699,612. OLDCASTLE MATERIALS, INC., ATLANTA, GA. FILED 3-26-2009.

EccoCon

THE MARK CONSISTS OF STANDARD CHARACTERS WITHOUT CLAIM TO ANY PARTICULAR FONT, STYLE, SIZE, OR COLOR.

FOR BLOCKS OF CONCRETE; CAISSONS FOR CONSTRUCTION WORK UNDER WATER; CONCRETE; CONCRETE BUILDING MATERIALS, NAMELY, BLOCKS, BRICKS, SLABS, PANELS, WALLS, FOOTINGS; CONCRETE DRAINAGE STRUCTURES, NAMELY, STORM MANHOLES; CONCRETE DRAINAGE STRUCTURES, NAMELY, TRENCH DRAINS; CONCRETE FLOORS; CONCRETE PANELS; CONCRETE PIPES; CONCRETE RETAINING WALLS; CONCRETE ROAD PAVEMENT BOARDS; CONCRETE WALLS; CONCRETE WALLS FOR BUILDING; CONSTRUCTION MATERIALS, NAMELY, ENERGY CONSERVING PRECAST CONCRETE SLABS; CONSTRUCTION MATERIALS, NAMELY, CONCRETE SLABS DESIGNED TO INCREASE ENERGY EFFICIENCY AND ENERGY CONSERVATION; CONSTRUCTION MATERIALS, NAMELY, ENERGY CONSERVING CONCRETE SLABS; CRASH BARRIERS OF CONCRETE FOR ROADS; INDUSTRIAL CONCRETE FOR USE IN CIVIL ENGINEERING WORKS; SLABS OF CONCRETE DESIGNED TO CONSERVE ENERGY; SLABS OF CONCRETE; STONE FOR BUILDING AND CONSTRUCTION (U.S. CLS. 1, 12, 33 AND 50).

FIRST USE 7-30-2008; IN COMMERCE 7-30-2008.
KHANH LE, EXAMINING ATTORNEY

SN 77-718,532. PETER SCOTT MACIULEWICZ, AUBURN, NY. FILED 4-21-2009.

MASTERPIECE SHUTTERS

THE MARK CONSISTS OF STANDARD CHARACTERS WITHOUT CLAIM TO ANY PARTICULAR FONT, STYLE, SIZE, OR COLOR.

NO CLAIM IS MADE TO THE EXCLUSIVE RIGHT TO USE "SHUTTERS", APART FROM THE MARK AS SHOWN.
FOR INTERIOR NON-METAL WINDOW SHUTTERS (U.S. CLS. 1, 12, 33 AND 50).

ZACHARY BELLO, EXAMINING ATTORNEY

CLASS 19—(Continued).

SN 77-718,659. ADVANCED BUILDING PRODUCTS, INC., SPRINGVALE, ME. FILED 4-21-2009.

SOUND CATCHER

THE MARK CONSISTS OF STANDARD CHARACTERS WITHOUT CLAIM TO ANY PARTICULAR FONT, STYLE, SIZE, OR COLOR.

NO CLAIM IS MADE TO THE EXCLUSIVE RIGHT TO USE "SOUND", APART FROM THE MARK AS SHOWN.

FOR PLIABLE SHEET MATERIAL MADE OF ENTANGLED STRANDS OF SYNTHETIC FIBER LAMINATED TO FABRIC FOR USE AS AN ACOUSTIC DAMPER IN RESIDENTIAL, COMMERCIAL AND INDUSTRIAL BUILDING CONSTRUCTION (U.S. CLS. 1, 12, 33 AND 50).

HEATHER BIDDULPH, EXAMINING ATTORNEY



SN 77-723,374. EMPIRE RESOURCE RECOVERY, LLC, NEW ROCHELLE, NY. FILED 4-27-2009.

Pozzotive Plus

THE MARK CONSISTS OF STANDARD CHARACTERS WITHOUT CLAIM TO ANY PARTICULAR FONT, STYLE, SIZE, OR COLOR.

OWNER OF U.S. REG. NO. 3,584,674.

FOR DRY OR WET READY-MIX MIXTURES FOR CEMENT; CEMENT MIXES; CONCRETE; CONCRETE BLOCKS, PIPES, AND PAVERS; CONCRETE BUILDING MATERIALS, NAMELY, BLOCKS, BRICKS, SLABS, PANELS, AND WALLS (U.S. CLS. 1, 12, 33 AND 50).

CHRISTINE COOPER, EXAMINING ATTORNEY



SN 77-723,621. VOGIAS, DAVID A., FORT MYERS, FL. FILED 4-28-2009.

CAGE SHADES

THE MARK CONSISTS OF STANDARD CHARACTERS WITHOUT CLAIM TO ANY PARTICULAR FONT, STYLE, SIZE, OR COLOR.

NO CLAIM IS MADE TO THE EXCLUSIVE RIGHT TO USE "SHADES", APART FROM THE MARK AS SHOWN.

FOR NONMETAL PATIO ENCLOSURES (U.S. CLS. 1, 12, 33 AND 50).

FRED MANDIR, EXAMINING ATTORNEY

CLASS 19—(Continued).

SN 77-724,165. ROSETTA HARDSCAPES LLC, CHARLEVOIX, MI. FILED 4-28-2009.

BELVEDERE

THE MARK CONSISTS OF STANDARD CHARACTERS WITHOUT CLAIM TO ANY PARTICULAR FONT, STYLE, SIZE, OR COLOR.

FOR CONCRETE BLOCKS (U.S. CLS. 1, 12, 33 AND 50).
KIM MONINGHOFF, EXAMINING ATTORNEY



SN 77-724,212. ROSETTA HARDSCAPES LLC, CHARLEVOIX, MI. FILED 4-28-2009.

CLAREMONT

THE MARK CONSISTS OF STANDARD CHARACTERS WITHOUT CLAIM TO ANY PARTICULAR FONT, STYLE, SIZE, OR COLOR.

FOR CONCRETE BLOCKS (U.S. CLS. 1, 12, 33 AND 50).
KIM MONINGHOFF, EXAMINING ATTORNEY



SN 77-724,275. FULLMER & SON LLC, GRASS VALLEY, CA. FILED 4-28-2009.

J&D Blocking

THE MARK CONSISTS OF STANDARD CHARACTERS WITHOUT CLAIM TO ANY PARTICULAR FONT, STYLE, SIZE, OR COLOR.

NO CLAIM IS MADE TO THE EXCLUSIVE RIGHT TO USE "BLOCKING", APART FROM THE MARK AS SHOWN.

FOR PLASTIC BLOCKS USED IN CONSTRUCTION, NAMELY, FOR DECKS, OVER HANGS, STAIRCASES, POSTS, BEAMS, AND LEDGERS (U.S. CLS. 1, 12, 33 AND 50).

LOURDES AYALA, EXAMINING ATTORNEY

CLASS 19—(Continued).

SN 77-724,713. DESLAURIERS, INC., LAGRANGE PARK, IL.
FILED 4-29-2009.

ECON-O-SLEEVE

THE MARK CONSISTS OF STANDARD CHARACTERS WITHOUT CLAIM TO ANY PARTICULAR FONT, STYLE, SIZE, OR COLOR.

FOR FORMS MADE OF PLASTIC FOR FORMING HOLES IN CONCRETE FLOORS AND WALLS (U.S. CLS. 1, 12, 33 AND 50).

FIRST USE 7-31-1994; IN COMMERCE 7-31-1994.
SUE LAWRENCE, EXAMINING ATTORNEY

CLASS 19—(Continued).

SN 77-727,216. WILLIAM C. LOVE, OCKLAWAHA, FL.
FILED 5-1-2009.

5/10/FLASHPATCH

THE MARK CONSISTS OF STANDARD CHARACTERS WITHOUT CLAIM TO ANY PARTICULAR FONT, STYLE, SIZE, OR COLOR.

FOR FILLING CEMENT (U.S. CLS. 1, 12, 33 AND 50).
ERIN FALK, EXAMINING ATTORNEY

SN 77-724,994. CHANG, IVY, ARLINGTON, TX. FILED 4-29-2009.

EXPRESS YOURSELF



PUCCINI

OWNER OF U.S. REG. NOS. 3,368,381 AND 3,370,975.
THE MARK CONSISTS OF THE WORDS "EXPRESS YOURSELF" OVER A STYLIZED "P" ON TOP OF FOUR BOXES WITH THE WORD "PUCCINI" UNDERNEATH.

FOR NATURAL STONE, NAMELY, MARBLE, GRANITE, SLATE, AND TRAVERTINE; GLASS TILE (U.S. CLS. 1, 12, 33 AND 50).

JAMES A. RAUEN, EXAMINING ATTORNEY

SN 77-729,073. EAGLE MATERIALS IP LLC, DALLAS, TX.
FILED 5-5-2009.



OWNER OF U.S. REG. NO. 3,274,074.

THE MARK CONSISTS OF THE LETTER "M" CONTAINED WITHIN AN OCTAGON FOLLOWED BY THE LETTERS "BLOC".

FOR WALLBOARD (U.S. CLS. 1, 12, 33 AND 50).

FIRST USE 5-13-2009; IN COMMERCE 5-13-2009.
DORITT L. CARROLL, EXAMINING ATTORNEY

SN 77-726,680. ECCOLOGIE LLC, SHARON, CT. FILED 5-1-2009.

GNOME-MAN'S LAND

THE MARK CONSISTS OF STANDARD CHARACTERS WITHOUT CLAIM TO ANY PARTICULAR FONT, STYLE, SIZE, OR COLOR.

FOR FIGURINES OF CONCRETE (U.S. CLS. 1, 12, 33 AND 50).

FIRST USE 4-26-2009; IN COMMERCE 4-26-2009.
WILLIAM VERHOSEK, EXAMINING ATTORNEY

SN 79-060,673. IVT INSTALLATIONS- UND; VERBINDUNGSTECHNIK GMBH & CO. KG, FED REP GERMANY,
FILED 7-2-2008.

nanostabil

THE MARK CONSISTS OF STANDARD CHARACTERS WITHOUT CLAIM TO ANY PARTICULAR FONT, STYLE, SIZE, OR COLOR.

OWNER OF INTERNATIONAL REGISTRATION 0981483 DATED 7-2-2008, EXPIRES 7-2-2018.

FOR NON-METAL BUILDING MATERIALS, NAMELY, PLASTIC TUBES AND PIPES COATED WITH A LAYER OF NANOPARTICLES OF METAL, AND CONTAINING A TRANSPARENT TOP ADHESIVE SEALING LAYER, USED FOR BUILDING AND CONSTRUCTION (U.S. CLS. 1, 12, 33 AND 50).

NAPOLEON SHARMA, EXAMINING ATTORNEY

CLASS 20—FURNITURE AND ARTICLES NOT OTHERWISE CLASSIFIED

SN 77-385,429. SIS-USA INC., LONDONDERRY, NH. FILED 1-31-2008.

UP.GRADE

THE MARK CONSISTS OF STANDARD CHARACTERS WITHOUT CLAIM TO ANY PARTICULAR FONT, STYLE, SIZE, OR COLOR.

FOR ADJUSTABLE FURNITURE, NAMELY, TABLES AND CHAIRS PRIMARILY FOR SCHOOLS (U.S. CLS. 2, 13, 22, 25, 32 AND 50).

KEVIN CORWIN, EXAMINING ATTORNEY

SN 77-397,774. BURRIDGE, MICHAEL D., SANTA BARBARA, CA. FILED 2-15-2008.



THE MARK CONSISTS OF THE STYLIZED TERM "ABARI" LOCATED WITHIN AN OVAL DESIGN.

THE ENGLISH TRANSLATION OF "ABARI" IN THE MARK IS NETTING NEEDLE.

FOR FURNITURE; OFFICE FURNITURE (U.S. CLS. 2, 13, 22, 25, 32 AND 50).

BARNEY CHARLON, EXAMINING ATTORNEY

SN 77-554,947. ADVANSA B.V., NL-2132 NG HOOFDDORP, NETHERLANDS, FILED 8-25-2008.

ADVANSATHERMOODRY

THE MARK CONSISTS OF STANDARD CHARACTERS WITHOUT CLAIM TO ANY PARTICULAR FONT, STYLE, SIZE, OR COLOR.

PRIORITY CLAIMED UNDER SEC. 44(D) ON ERPNCMNTY TM OFC APPLICATION NO. 7186125, FILED 8-25-2008, REG. NO. 007186125, DATED 3-12-2009, EXPIRES 8-25-2018.

OWNER OF U.S. REG. NO. 3,272,499.

FOR SLEEPING BAGS FOR CAMPING (U.S. CLS. 2, 13, 22, 25, 32 AND 50).

HEATHER THOMPSON, EXAMINING ATTORNEY

CLASS 20—(Continued).

SN 77-583,193. GARME COLCHONES, S.L., BENIPARRELL, VALENCIA, SPAIN, FILED 10-1-2008.



PRIORITY CLAIMED UNDER SEC. 44(D) ON SPAIN APPLICATION NO. 2840589, FILED 8-7-2008, REG. NO. 2840589, DATED 1-21-2009, EXPIRES 8-7-2018.

NO CLAIM IS MADE TO THE EXCLUSIVE RIGHT TO USE "SLEEP SYSTEMS", APART FROM THE MARK AS SHOWN.

THE COLOR(S) RED, YELLOW, GREEN, BLUE, VIOLET, ORANGE, GREY AND WHITE IS/ARE CLAIMED AS A FEATURE OF THE MARK.

THE MARK CONSISTS OF THE WORDS "LITTLE GEMS SLEEP SYSTEMS BY JOYA" IN STYLIZED PRINT. THE WORDS APPEAR ON A WHITE BACKGROUND, OUTLINED IN THE COLOR GREY. THE INITIAL "L" AND "E" IN "LITTLE" AND THE "M" IN "GEMS" APPEAR IN THE COLOR RED; THE "I" IN "LITTLE" AND THE "E" IN "GEMS" APPEAR IN THE COLOR YELLOW; THE INITIAL "T" IN "LITTLE" AND THE "G" IN "GEMS" APPEAR IN THE COLOR GREEN; THE SECOND "T" IN "LITTLE" AND THE "S" IN "GEMS" APPEAR IN THE COLOR BLUE; THE SECOND "L" IN "LITTLE" AND THE WORDS "SLEEP SYSTEM BY JOYA" APPEAR IN THE COLOR VIOLET.

THE FOREIGN WORDING IN THE MARK TRANSLATES INTO ENGLISH AS "JEWEL".

FOR MATTRESSES, PILLOWS (U.S. CLS. 2, 13, 22, 25, 32 AND 50).

FIRST USE 9-30-2008; IN COMMERCE 9-30-2008.

ELLEN BURNS, EXAMINING ATTORNEY

SN 77-594,126. NLP FURNITURE INDUSTRIES, INC., SAN DIEGO, CA. FILED 10-16-2008.

PREMIER SLEEP SYSTEMS

THE MARK CONSISTS OF STANDARD CHARACTERS WITHOUT CLAIM TO ANY PARTICULAR FONT, STYLE, SIZE, OR COLOR.

NO CLAIM IS MADE TO THE EXCLUSIVE RIGHT TO USE "SLEEP SYSTEMS", APART FROM THE MARK AS SHOWN.

FOR FURNITURE, NAMELY SLEEPER SOFAS (U.S. CLS. 2, 13, 22, 25, 32 AND 50).

FIRST USE 3-19-2009; IN COMMERCE 3-19-2009.

DOMINICK J. SALEMI, EXAMINING ATTORNEY

CLASS 20—(Continued).

SN 77-597,696. MISS MATCHED, INC., NEW YORK, NY. FILED 10-22-2008.

LITTLEMISSMATCHED

THE MARK CONSISTS OF STANDARD CHARACTERS WITHOUT CLAIM TO ANY PARTICULAR FONT, STYLE, SIZE, OR COLOR.

OWNER OF U.S. REG. NOS. 3,475,092, 3,565,831 AND OTHERS.

FOR PICTURE FRAMES; SLEEPING BAGS; FITTED FURNITURE COVERS (U.S. CLS. 2, 13, 22, 25, 32 AND 50).

DARRYL SPRUILL, EXAMINING ATTORNEY

SN 77-622,038. BLUMENTHAL DISTRIBUTING, INC., DBA OFFICE STAR PRODUCTS, ONTARIO, CA. FILED 11-25-2008.

5500

THE MARK CONSISTS OF STANDARD CHARACTERS WITHOUT CLAIM TO ANY PARTICULAR FONT, STYLE, SIZE, OR COLOR.

FOR OFFICE FURNITURE (U.S. CLS. 2, 13, 22, 25, 32 AND 50).

FIRST USE 6-0-2004; IN COMMERCE 6-0-2004.
CHRISTOPHER BUONGIORNO, EXAMINING ATTORNEY

SN 77-635,365. AMERICAN GIRL, LLC, EL SEGUNDO, CA. FILED 12-17-2008.

AMERICAN GIRL CRAFTS

THE MARK CONSISTS OF STANDARD CHARACTERS WITHOUT CLAIM TO ANY PARTICULAR FONT, STYLE, SIZE, OR COLOR.

OWNER OF U.S. REG. NOS. 1,269,348, 2,612,486 AND OTHERS.

NO CLAIM IS MADE TO THE EXCLUSIVE RIGHT TO USE "CRAFTS", APART FROM THE MARK AS SHOWN.

FOR PAPER PICTURE FRAMES, PAPER PHOTO FRAMES (U.S. CLS. 2, 13, 22, 25, 32 AND 50).

BILL DAWE, EXAMINING ATTORNEY

CLASS 20—(Continued).

SN 77-687,336. MECHOSHADE SYSTEMS, INC., LONG ISLAND CITY, NY. FILED 3-10-2009.

DESIGN WITH LIGHT

THE MARK CONSISTS OF STANDARD CHARACTERS WITHOUT CLAIM TO ANY PARTICULAR FONT, STYLE, SIZE, OR COLOR.

FOR INTERIOR MANUAL ROLLER WINDOW SHADE SYSTEMS COMPRISED OF WINDOW SHADES AND SHADE CONTROLLERS; INTERIOR MANUAL SKYLIGHT SHADE SYSTEMS COMPRISED OF SKYLIGHT SHADES AND SKYLIGHT SHADE CONTROLLERS; INTERIOR MOTORIZED ROLLER WINDOW SHADE SYSTEMS COMPRISED OF WINDOW SHADES, MOTORS AND SHADE CONTROLLERS; INTERIOR MOTORIZED SKYLIGHT SHADE SYSTEMS COMPRISED OF SKYLIGHT SHADES, MOTORS AND SKYLIGHT SHADE CONTROLLERS (U.S. CLS. 2, 13, 22, 25, 32 AND 50).

FIRST USE 1-0-1997; IN COMMERCE 1-0-1997.
LINDA ORNDORFF, EXAMINING ATTORNEY

SN 77-693,884. TURTLE SHELL INDUSTRIES LLC, NEW YORK, NY. FILED 3-18-2009.

TURTLESHELL

THE MARK CONSISTS OF STANDARD CHARACTERS WITHOUT CLAIM TO ANY PARTICULAR FONT, STYLE, SIZE, OR COLOR.

FOR PROTECTIVE COVERS COMPOSED PRIMARILY OF POLYCARBONATE USED FOR PROTECTION AGAINST DAMAGE FROM WATER AND FALLING DEBRIS TO BE MOUNTED ABOVE COMPUTER RACKS, STORAGE CASES, INSTRUMENTS AND THE LIKE (U.S. CLS. 2, 13, 22, 25, 32 AND 50).

FIRST USE 3-14-2009; IN COMMERCE 3-14-2009.
TARA PATE, EXAMINING ATTORNEY

CLASS 20—(Continued).

SN 77-709,143. TACTOOL INDUSTRIES, LLC., HENDERSON, NV. FILED 4-7-2009.

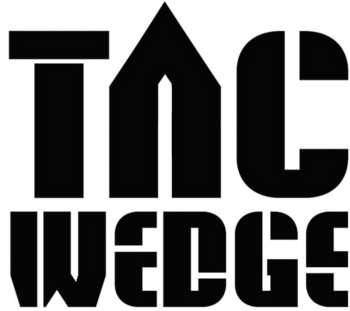

NO CLAIM IS MADE TO THE EXCLUSIVE RIGHT TO USE "WEDGE", APART FROM THE MARK AS SHOWN. THE MARK CONSISTS OF THE WORDS "TAC" AND "WEDGE" IN STYLIZED FORM. FOR DOOR STOPS AND DOOR CHOCKS OF PLASTIC (U.S. CLS. 2, 13, 22, 25, 32 AND 50). FIRST USE 4-2-2009; IN COMMERCE 4-2-2009. SUSAN RICHARDS, EXAMINING ATTORNEY

SN 77-710,529. WORLD CLASS FURNITURE DESIGN, SAN DIEGO, CA. FILED 4-9-2009.



THE STIPPLING IS FOR SHADING PURPOSES ONLY. THE NAME "JONATHAN FRANC" DOES NOT IDENTIFY A LIVING INDIVIDUAL. THE MARK CONSISTS OF THE STYLIZED WORDS AND LETTERS "JONATHAN FJ FRANC" WITH THE TERMS "JONATHAN FRANC" UNDERLINED AND THE LETTERS "FJ" ARE SET ON THEIR SIDES AND FORM A CUBE-LIKE DESIGN. FOR FURNITURE (U.S. CLS. 2, 13, 22, 25, 32 AND 50). FIRST USE 6-1-2008; IN COMMERCE 7-1-2008. RICHARD WHITE, EXAMINING ATTORNEY

CLASS 20—(Continued).

SN 77-718,027. HOWARD PACKAGING CORPORATION, WAYNE, NJ. FILED 4-20-2009.

INFO-4-LIFE FRAME

THE MARK CONSISTS OF STANDARD CHARACTERS WITHOUT CLAIM TO ANY PARTICULAR FONT, STYLE, SIZE, OR COLOR. NO CLAIM IS MADE TO THE EXCLUSIVE RIGHT TO USE "FRAME", APART FROM THE MARK AS SHOWN. FOR A FRAME KIT FOR DISPLAYING PERSONAL HEALTH AND MEDICAL INFORMATION FOR USE IN MEDICAL AND HEALTH EMERGENCIES CONSISTING OF MAGNETIC FRAMES WITH MEDICAL AND HEALTH FORMS FOR DISPLAYING SUCH INFORMATION AND NOTIFICATION STICKERS TO ALERT EMERGENCY PERSONNEL AND OTHER RESPONDERS TO A MEDICAL OR HEALTH EMERGENCY OF THE LOCATION OF SUCH FRAME (U.S. CLS. 2, 13, 22, 25, 32 AND 50). DAVID I, EXAMINING ATTORNEY

SN 77-718,381. RCR ENTERPRISES, LLC, WELCOME, NC. FILED 4-21-2009.



OWNER OF U.S. REG. NO. 3,428,362. THE MARK CONSISTS OF THE NUMBER "31" IN A STYLIZED FORMAT. FOR CLEAR PLASTIC HOLDERS FOR BADGES; PLASTIC BANNERS; PLASTIC FLAGS (U.S. CLS. 2, 13, 22, 25, 32 AND 50). FIRST USE 2-9-1997; IN COMMERCE 2-9-1997. AMY KERTGATE, EXAMINING ATTORNEY

SN 77-719,709. HOLDEN, JEFFREY H., WINSTON SALEM, NC. FILED 4-22-2009.

KEY STASH

THE MARK CONSISTS OF STANDARD CHARACTERS WITHOUT CLAIM TO ANY PARTICULAR FONT, STYLE, SIZE, OR COLOR. NO CLAIM IS MADE TO THE EXCLUSIVE RIGHT TO USE "KEY", APART FROM THE MARK AS SHOWN. FOR NON-METAL KEY HOLDERS (U.S. CLS. 2, 13, 22, 25, 32 AND 50). EDWARD NELSON, EXAMINING ATTORNEY

CLASS 20—(Continued).

SN 77-720,585. FURTH AND ASSOCIATES, GREENWICH, CT. FILED 4-23-2009.

PETAINER

THE MARK CONSISTS OF STANDARD CHARACTERS WITHOUT CLAIM TO ANY PARTICULAR FONT, STYLE, SIZE, OR COLOR.

FOR CONTAINERS FOR USE IN TRANSPORTING DOMESTIC ANIMALS (U.S. CLS. 2, 13, 22, 25, 32 AND 50).

BRENDAN REGAN, EXAMINING ATTORNEY

SN 77-721,050. CLOSED LOOP ENVIRONMENTAL ALLIANCE NETWORK INC., BOLTON, ONTARIO, CANADA, FILED 4-23-2009.

PATRIOT HANGER

THE MARK CONSISTS OF STANDARD CHARACTERS WITHOUT CLAIM TO ANY PARTICULAR FONT, STYLE, SIZE, OR COLOR.

NO CLAIM IS MADE TO THE EXCLUSIVE RIGHT TO USE "HANGER", APART FROM THE MARK AS SHOWN.

FOR CLOTHES HANGERS (U.S. CLS. 2, 13, 22, 25, 32 AND 50).

SARA THOMAS, EXAMINING ATTORNEY

CLASS 20—(Continued).

SN 77-721,206. TWENTIETH CENTURY FOX FILM CORPORATION, LOS ANGELES, CA. FILED 4-23-2009.



OWNER OF U.S. REG. NO. 3,001,994.
NO CLAIM IS MADE TO THE EXCLUSIVE RIGHT TO USE "SPORTS", APART FROM THE MARK AS SHOWN.

THE MARK CONSISTS OF THE STYLIZED WORDS "THE ADVENTURES OF DIGGER AND FRIENDS" WHICH APPEAR INSIDE OF TWO OVAL CONCENTRIC LINES, THE WORDS "FOX SPORTS" WHICH APPEAR UNDER THE WORD "FRIENDS" AND INSIDE OF THE OVAL SHAPE OVERLAPPING ON THE BOTTOM OF THE INNER OVAL LINE AND FIVE COSTUMED GOPHER CHARACTERS WHICH APPEAR ABOVE THE OUTER OVAL LINE.

FOR PLASTIC FLAGS; NON-METAL AND NON-LEATHER KEY CHAINS; PLASTIC KEY CHAINS; NON-METAL LICENSE PLATES; PLASTIC LICENSE PLATES (U.S. CLS. 2, 13, 22, 25, 32 AND 50).

LINDA LAVACHE, EXAMINING ATTORNEY

SN 77-721,530. REDI REACH LLC, FAIRPORT, NY. FILED 4-24-2009.

Redi Reach

THE MARK CONSISTS OF STANDARD CHARACTERS WITHOUT CLAIM TO ANY PARTICULAR FONT, STYLE, SIZE, OR COLOR.

FOR SHELVING AND COMPONENT PARTS THEREOF, NAMELY, SHELVES AND BRACKETS SOLD AS A UNIT (U.S. CLS. 2, 13, 22, 25, 32 AND 50).

PRISCILLA MILTON, EXAMINING ATTORNEY

CLASS 20—(Continued).

SN 77-721,554. VICTORY LAND GROUP, INC., BARTLETT, IL. FILED 4-24-2009.

CLASS 20—(Continued).

SN 77-723,932. STEELCASE INC., GRAND RAPIDS, MI. FILED 4-28-2009.

CREATE EZ

CAMPFIRE

THE MARK CONSISTS OF STANDARD CHARACTERS WITHOUT CLAIM TO ANY PARTICULAR FONT, STYLE, SIZE, OR COLOR.
FOR FURNITURE (U.S. CLS. 2, 13, 22, 25, 32 AND 50).
KATHERINE CONNOLLY, EXAMINING ATTORNEY

THE MARK CONSISTS OF STANDARD CHARACTERS WITHOUT CLAIM TO ANY PARTICULAR FONT, STYLE, SIZE, OR COLOR.
FOR OFFICE FURNITURE (U.S. CLS. 2, 13, 22, 25, 32 AND 50).
MARY CRAWFORD, EXAMINING ATTORNEY

SN 77-723,060. TRIDENT DESIGN, LLC, COLUMBUS, OH. FILED 4-27-2009.

SN 77-724,111. FIRE KING INTERNATIONAL, LLC, NEW ALBANY, IN. FILED 4-28-2009.

SCRIPTSAFE

HEMI

THE MARK CONSISTS OF STANDARD CHARACTERS WITHOUT CLAIM TO ANY PARTICULAR FONT, STYLE, SIZE, OR COLOR.
FOR NON-METAL SAFES (U.S. CLS. 2, 13, 22, 25, 32 AND 50).
AMY KERTGATE, EXAMINING ATTORNEY

THE MARK CONSISTS OF STANDARD CHARACTERS WITHOUT CLAIM TO ANY PARTICULAR FONT, STYLE, SIZE, OR COLOR.
FOR FILING CABINETS (U.S. CLS. 2, 13, 22, 25, 32 AND 50).
MATTHEW PAPPAS, EXAMINING ATTORNEY

SN 77-723,905. COOK, BRUCE E., BETHALTO, IL. FILED 4-28-2009.

SN 77-724,772. HENSCHEL-STEINAU, INC., ENGLEWOOD, NJ. FILED 4-29-2009.

THE SAUCE TOOL

EZ ROLL

THE MARK CONSISTS OF STANDARD CHARACTERS WITHOUT CLAIM TO ANY PARTICULAR FONT, STYLE, SIZE, OR COLOR.
FOR NON-METAL BOTTLE CAPS FOR BARBEQUE SAUCE BOTTLES WITH AN ATTACHED BRUSH (U.S. CLS. 2, 13, 22, 25, 32 AND 50).
FIRST USE 4-15-2009; IN COMMERCE 4-15-2009.
CHRISIE B. KING, EXAMINING ATTORNEY

THE MARK CONSISTS OF STANDARD CHARACTERS WITHOUT CLAIM TO ANY PARTICULAR FONT, STYLE, SIZE, OR COLOR.
OWNER OF U.S. REG. NO. 3,481,646.
FOR GRAVITY-FEED POINT-OF-PURCHASE MERCHANDISE DISPLAY AND DISPENSERS (U.S. CLS. 2, 13, 22, 25, 32 AND 50).
FIRST USE 4-27-2009; IN COMMERCE 4-27-2009.
TARAH HARDY, EXAMINING ATTORNEY

CLASS 20—(Continued).

SN 77-725,191. CARPIN MANUFACTURING, INC., WATERBURY, CT. FILED 4-29-2009.

SMART GLIDE

THE MARK CONSISTS OF STANDARD CHARACTERS WITHOUT CLAIM TO ANY PARTICULAR FONT, STYLE, SIZE, OR COLOR.

NO CLAIM IS MADE TO THE EXCLUSIVE RIGHT TO USE "GLIDE", APART FROM THE MARK AS SHOWN.

FOR FURNITURE PARTS, NAMELY, GLIDES (U.S. CLS. 2, 13, 22, 25, 32 AND 50).

BARBARA GAYNOR, EXAMINING ATTORNEY

SN 77-725,689. ROSET USA CORPORATION, NEW YORK, NY. FILED 4-30-2009.

Togo

THE MARK CONSISTS OF STANDARD CHARACTERS WITHOUT CLAIM TO ANY PARTICULAR FONT, STYLE, SIZE, OR COLOR.

FOR FURNITURE (U.S. CLS. 2, 13, 22, 25, 32 AND 50). FIRST USE 6-30-1983; IN COMMERCE 6-30-1983.

KATINA MISTER, EXAMINING ATTORNEY

SN 77-726,417. SITWELL, LLC, CERRITOS, CA. FILED 4-30-2009.

Sitmesh

THE MARK CONSISTS OF STANDARD CHARACTERS WITHOUT CLAIM TO ANY PARTICULAR FONT, STYLE, SIZE, OR COLOR.

FOR CHAIRS (U.S. CLS. 2, 13, 22, 25, 32 AND 50).

RENEE SERVANCE, EXAMINING ATTORNEY

CLASS 20—(Continued).

SN 77-727,003. PAYER, TODD, ERWINNA, PA. FILED 5-1-2009.

I X

THE MARK CONSISTS OF STANDARD CHARACTERS WITHOUT CLAIM TO ANY PARTICULAR FONT, STYLE, SIZE, OR COLOR.

FOR GLASS AND PLASTIC EYES FOR TAXIDERMY (U.S. CLS. 2, 13, 22, 25, 32 AND 50).

JAY FLOWERS, EXAMINING ATTORNEY

SN 77-727,258. CORPORATE IMAGES HOLDINGS PARTNERSHIP, SURREY, BC, CANADA, FILED 5-1-2009.

SONAX

THE MARK CONSISTS OF STANDARD CHARACTERS WITHOUT CLAIM TO ANY PARTICULAR FONT, STYLE, SIZE, OR COLOR.

OWNER OF U.S. REG. NO. 2,265,940.

FOR FURNITURE (U.S. CLS. 2, 13, 22, 25, 32 AND 50).

FIRST USE 10-0-1982; IN COMMERCE 11-0-1986.

JUSTINE D. PARKER, EXAMINING ATTORNEY

SN 77-727,354. SANDY ARTHUR, BOWEN ISLAND, BC, CANADA, FILED 5-1-2009.

Communicushions

THE MARK CONSISTS OF STANDARD CHARACTERS WITHOUT CLAIM TO ANY PARTICULAR FONT, STYLE, SIZE, OR COLOR.

FOR PILLOWS; PILLOWS WITH PERSONALIZED MESSAGES; DECORATED GIFT PILLOW FEATURING A PRINTED IMAGE; PILLOW PACKAGED IN MAILER SENT THROUGH THE MAIL (U.S. CLS. 2, 13, 22, 25, 32 AND 50).

KATINA MISTER, EXAMINING ATTORNEY

CLASS 20—(Continued).

SN 77-728,249. ZENITH PRODUCTS CORPORATION, NEW CASTLE, DE. FILED 5-4-2009.

CLASS 20—(Continued).

SN 77-767,913. AMERICAN WOODMARK CORPORATION, WINCHESTER, VA. FILED 6-25-2009.

TwistTight

DESIGNER'S CHOICE

THE MARK CONSISTS OF STANDARD CHARACTERS WITHOUT CLAIM TO ANY PARTICULAR FONT, STYLE, SIZE, OR COLOR.

OWNER OF U.S. REG. NO. 3,212,192.
SEC. 2(F).
FOR SHOWER CURTAIN RODS; SHOWER RODS (U.S. CLS. 2, 13, 22, 25, 32 AND 50).
FIRST USE 4-30-1994; IN COMMERCE 4-30-1994.
JACLYN KIDWELL, EXAMINING ATTORNEY

THE MARK CONSISTS OF STANDARD CHARACTERS WITHOUT CLAIM TO ANY PARTICULAR FONT, STYLE, SIZE, OR COLOR.

OWNER OF U.S. REG. NOS. 2,736,491, 2,816,617 AND 3,025,363.
SEC. 2(F).
FOR KITCHEN CABINETS AND BATHROOM VANITIES (U.S. CLS. 2, 13, 22, 25, 32 AND 50).
FIRST USE 5-0-1998; IN COMMERCE 8-0-1998.
DAWN FELDMAN, EXAMINING ATTORNEY

SN 77-731,122. JOHN G. WILSON, JOPLIN, MO. FILED 5-7-2009.

SN 77-782,918. COOK, BRUCE E., BETHALTO, IL. FILED 7-16-2009.

Woven Dimensions

No better way to Treat Your Meat

THE MARK CONSISTS OF STANDARD CHARACTERS WITHOUT CLAIM TO ANY PARTICULAR FONT, STYLE, SIZE, OR COLOR.

NO CLAIM IS MADE TO THE EXCLUSIVE RIGHT TO USE "WOVEN", APART FROM THE MARK AS SHOWN.

FOR CAMPING FURNITURE; CAST STONE HOUSEHOLD AND GARDEN FURNITURE; CUSHIONS; FITTED FABRIC FURNITURE COVERS; FITTED FURNITURE COVER NOT OF FABRIC; FITTED FURNITURE LEG COVERS FOR FLOOR PROTECTION PURPOSES; FURNITURE; FURNITURE FOR CAMPING; FURNITURE FOR HOUSE, OFFICE AND GARDEN; FURNITURE FRAMES; FURNITURE MADE FROM STEEL TUBING; FURNITURE MADE FROM WOOD OR SUBSTITUTES FOR WOOD; FURNITURE MOLDINGS; FURNITURE OF METAL; LAWN FURNITURE; METAL FURNITURE; METAL FURNITURE AND FURNITURE FOR CAMPING; OUTDOOR FURNITURE; PLASTIC FURNITURE FOR GARDENS; RESIDENTIAL AND COMMERCIAL FURNITURE; RESIDENTIAL AND COMMERCIAL WROUGHT IRON FURNITURE; SCREENS; SEATING FURNITURE; SEATS; STONE FURNITURE; TABLES (U.S. CLS. 2, 13, 22, 25, 32 AND 50).
SAIMA MAKHDOOM, EXAMINING ATTORNEY

THE MARK CONSISTS OF STANDARD CHARACTERS WITHOUT CLAIM TO ANY PARTICULAR FONT, STYLE, SIZE, OR COLOR.

FOR NON-METAL BOTTLE CAPS FOR BARBEQUE SAUCE BOTTLES WITH AN ATTACHED BRUSH (U.S. CLS. 2, 13, 22, 25, 32 AND 50).
FIRST USE 7-13-2009; IN COMMERCE 7-13-2009.
CHRISIE B. KING, EXAMINING ATTORNEY

CLASS 20—(Continued).

SN 78-877,721. IN-STORE PRODUCTS LIMITED, MISSISSAUGA, CANADA, FILED 5-5-2006.



PRIORITY CLAIMED UNDER SEC. 44(D) ON CANADA APPLICATION NO. 1,278,899, FILED 11-8-2005, REG. NO. TMA727,477, DATED 10-30-2008, EXPIRES 10-30-2023.

NO CLAIM IS MADE TO THE EXCLUSIVE RIGHT TO USE "BOX", APART FROM THE MARK AS SHOWN.

FOR OPEN TOP PLASTIC CONTAINERS FOR USE IN SHOPPING, SOLD EMPTY, AND LIDS FOR OPEN TOP PLASTIC CONTAINERS FOR USE IN SHOPPING (U.S. CLS. 2, 13, 22, 25, 32 AND 50).

DAVID MURRAY, EXAMINING ATTORNEY

SN 78-897,687. MILIEU DESIGN, LOGAN, UT. FILED 5-31-2006.



NO CLAIM IS MADE TO THE EXCLUSIVE RIGHT TO USE "DESIGN", APART FROM THE MARK AS SHOWN.

THE COLOR(S) GREEN AND ORANGE IS/ARE CLAIMED AS A FEATURE OF THE MARK.

THE MARK CONSISTS OF THE FOLLOWING: AN ORANGE CIRCULAR ELEMENT WHERE THE ORANGE BAND THICKENS AS IT EXTENDS FROM THE TOP TO THE BOTTOM, AND HAVING A NOTCH IN THE CENTER

CLASS 20—(Continued).

OF THE BOTTOM THICKER PORTION OF THE CIRCULAR ELEMENT, WITH THE WORDS "MILIEU DESIGN" APPEARING BENEATH THE ORANGE CIRCULAR ELEMENT, THE WORD "DESIGN" BEING LOCATED BENEATH, AND IN A SMALLER FONT SIZE THAN, THE WORD "MILIEU", WITH A LINE OF ORANGE APPEARING BETWEEN THE WORDS "MILIEU" AND "DESIGN". BOTH THE WORDS "MILIEU" AND "DESIGN" APPEAR IN THE COLOR GREEN. THE COLOR GRAY REPRESENTS BACKGROUND AREAS AND IS NOT PART OF THE MARK.

THE FOREIGN WORDING IN THE MARK TRANSLATES INTO ENGLISH AS ENVIRONMENT.

FOR FURNITURE, SUCH AS OFFICE FURNITURE, HOME FURNITURE, INCLUDING CABINETS, AND OTHER FURNITURE (U.S. CLS. 2, 13, 22, 25, 32 AND 50).

FIRST USE 10-1-1998; IN COMMERCE 10-1-1998.
WANDA KAY PRICE, EXAMINING ATTORNEY

SN 78-905,181. TK CANADA LIMITED, DOWNSVIEW, ONTARIO, CANADA, FILED 6-9-2006.

AUDIENCE

THE MARK CONSISTS OF STANDARD CHARACTERS WITHOUT CLAIM TO ANY PARTICULAR FONT, STYLE, SIZE, OR COLOR.

PRIORITY CLAIMED UNDER SEC. 44(D) ON CANADA APPLICATION NO. 1303000, FILED 5-26-2006, REG. NO. TMA725603, DATED 10-8-2008, EXPIRES 10-8-2023.

FOR OFFICE FURNITURE, NAMELY, BOARDROOM TABLES AND STORAGE UNITS, NAMELY, STORAGE CABINETS, BOOKCASES, LATERAL FILING CABINETS, CREDENZAS AND MOUNTED SHELVING (U.S. CLS. 2, 13, 22, 25, 32 AND 50).

ANTHONY RINKER, EXAMINING ATTORNEY

SN 79-061,979. HÅG AS, NORWAY, FILED 9-4-2008.

HÅG IN BALANCE

THE MARK CONSISTS OF STANDARD CHARACTERS WITHOUT CLAIM TO ANY PARTICULAR FONT, STYLE, SIZE, OR COLOR.

OWNER OF INTERNATIONAL REGISTRATION 0984686 DATED 9-4-2008, EXPIRES 9-4-2018.

OWNER OF U.S. REG. NOS. 2,475,553, 2,934,443 AND OTHERS.

THE WORDING "HÅG" HAS NO MEANING IN A FOREIGN LANGUAGE.

FOR FURNITURE, CHAIRS WITH AND WITHOUT FOOTSTOOLS, PARTS, ACCESSORIES AND EQUIPMENT FOR THE AFOREMENTIONED GOODS, NAMELY, ARMRESTS, FOOTRESTS, TILTING FOOTSTOOLS AND FOOTPLATES (U.S. CLS. 2, 13, 22, 25, 32 AND 50).

LIEF MARTIN, EXAMINING ATTORNEY

CLASS 20—(Continued).

SN 79-066,518. VS VEREINIGTE SPEZIALMÖBELFABRIKEN; GMBH & CO. KG, FED REP GERMANY, FILED 2-20-2009.

PANTOSWING

THE MARK CONSISTS OF STANDARD CHARACTERS WITHOUT CLAIM TO ANY PARTICULAR FONT, STYLE, SIZE, OR COLOR.

PRIORITY DATE OF 12-11-2008 IS CLAIMED. OWNER OF INTERNATIONAL REGISTRATION 0996752 DATED 2-20-2009, EXPIRES 2-20-2019.

FOR OFFICE CHAIRS, CONFERENCE ROOM CHAIRS, CHAIRS FOR MEETINGS AND SCHOOL CHAIRS, PARTS FOR ALL THE AFORESAID GOODS (U.S. CLS. 2, 13, 22, 25, 32 AND 50).

JOHN DWYER, EXAMINING ATTORNEY



SN 79-067,499. VS VEREINIGTE SPEZIALMÖBELFABRIKEN; GMBH & CO. KG, FED REP GERMANY, FILED 2-20-2009.

PANTOMOVE

THE MARK CONSISTS OF STANDARD CHARACTERS WITHOUT CLAIM TO ANY PARTICULAR FONT, STYLE, SIZE, OR COLOR.

PRIORITY DATE OF 12-11-2008 IS CLAIMED. OWNER OF INTERNATIONAL REGISTRATION 0999433 DATED 2-20-2009, EXPIRES 2-20-2019.

FOR FURNITURE; CHAIRS, OFFICE CHAIRS, CONFERENCE ROOM CHAIRS, CHAIRS FOR MEETINGS AND SCHOOL CHAIRS, PARTS FOR ALL THE AFORESAID GOODS (U.S. CLS. 2, 13, 22, 25, 32 AND 50).

CHRIS WELLS, EXAMINING ATTORNEY

CLASS 21—HOUSEWARES AND GLASS

SN 77-335,860. PARKSIDE OPTICAL INC., VANCOUVER, CANADA, FILED 11-22-2007.

NAVKLEAR

THE MARK CONSISTS OF STANDARD CHARACTERS WITHOUT CLAIM TO ANY PARTICULAR FONT, STYLE, SIZE, OR COLOR.

PRIORITY CLAIMED UNDER SEC. 44(D) ON CANADA APPLICATION NO. 1372946, FILED 11-20-2007, REG. NO. TMA742,518, DATED 6-23-2009, EXPIRES 6-23-2024.

FOR HAND-HELD, MANUALLY-OPERATED CLEANING DEVICE FEATURING A CLEANING PAD AND A BRUSH FOR CLEANING AND POLISHING VISUAL DISPLAY PANELS AND VISUAL DISPLAY UNITS, COMPUTER MONITOR SCREENS, TELEVISION SCREENS, GPS SCREENS, RADAR SCREENS, CRT (CATHODE RAY TUBE) AND LCD (LIQUID CRYSTAL DISPLAY) DEVICES, COPIER BEDS, SCANNER BEDS AND OPTICAL SURFACES; A KIT CONSISTING OF A MICROFIBRE CLOTH, CONDITIONING TISSUES AND A HAND-HELD, MANUALLY-OPERATED CLEANING DEVICE FEATURING A CLEANING PAD AND A BRUSH, ALL FOR CLEANING AND POLISHING VISUAL DISPLAY PANELS AND VISUAL DISPLAY UNITS, COMPUTER MONITOR SCREENS, TELEVISION SCREENS, GPS SCREENS, RADAR SCREENS, CRT (CATHODE RAY TUBE) AND LCD (LIQUID CRYSTAL DISPLAY) DEVICES, COPIER BEDS, SCANNER BEDS AND OPTICAL SURFACES (U.S. CLS. 2, 13, 23, 29, 30, 33, 40 AND 50).

KELLY BOULTON, EXAMINING ATTORNEY



SN 77-408,363. ECOIST, LLC, MIAMI, FL. FILED 2-28-2008.

ECOIST

THE MARK CONSISTS OF STANDARD CHARACTERS WITHOUT CLAIM TO ANY PARTICULAR FONT, STYLE, SIZE, OR COLOR.

OWNER OF U.S. REG. NOS. 3,070,679 AND 3,223,355. FOR HOME ACCESSORIES, NAMELY, COASTERS MADE FROM RECYCLED PLASTIC-BASED MATERIALS AND DECORATIVE BASKETS MADE FROM RECYCLED PLASTIC-BASED MATERIALS (U.S. CLS. 2, 13, 23, 29, 30, 33, 40 AND 50).

FIRST USE 0-0-2004; IN COMMERCE 0-0-2004. LINDSEY RUBIN, EXAMINING ATTORNEY

CLASS 21—(Continued).

SN 77-448,271. LEADING INDUSTRY, INC., OXNARD, CA. FILED 4-15-2008.

ECO-CUP

THE MARK CONSISTS OF STANDARD CHARACTERS WITHOUT CLAIM TO ANY PARTICULAR FONT, STYLE, SIZE, OR COLOR.

FOR THERMOFORMED FOOD GRADE POLYETHYLENETERAPHTHALATE (PET) BEVERAGE CUPS (U.S. CLS. 2, 13, 23, 29, 30, 33, 40 AND 50).

KRISTIN CARLSON, EXAMINING ATTORNEY

SN 77-460,975. STONESTREET STABLES, LLC, LEXINGTON, KY. FILED 4-29-2008.

CURLIN

THE MARK CONSISTS OF STANDARD CHARACTERS WITHOUT CLAIM TO ANY PARTICULAR FONT, STYLE, SIZE, OR COLOR.

FOR HOUSEHOLD AND KITCHEN UTENSILS, NAMELY, LADLES, URNS, SPLATTER SCREENS, SERVINGWARE FOR SERVING FOOD, COOKING UTENSILS, NAMELY, GRILLS AND GRILL COVERS, COOKING UTENSILS, NAMELY, WIRE BASKETS; HOUSEHOLD AND KITCHEN UTENSILS, NAMELY, GRATERS, SIEVES, SPATULAS, COOKING STRAINERS, TURNERS, POT AND PAN SCRAPERS, ROLLING PINS, WHISKS, SKIMMERS, SERVING TONGS, AND WOOD CHOPPING BLOCKS; CONTAINERS FOR HOUSEHOLD OR KITCHEN USE NOT OF PRECIOUS METAL; COMBS AND BATH SPONGES; HAIR BRUSHES; ARTICLES FOR CLEANING PURPOSES, NAMELY, ABRASIVE PADS AND BRUSHES FOR KITCHEN PURPOSES; BEVERAGE GLASSWARE, DINNERWARE, BARWARE, NAMELY, SELTZER BOTTLES, PORCELAIN AND EARTHENWARE MUGS; MUGS (U.S. CLS. 2, 13, 23, 29, 30, 33, 40 AND 50).

THEODORE MCBRIDE, EXAMINING ATTORNEY

CLASS 21—(Continued).

SN 77-562,874. LOOPS LLC, FERNDALE, WA. FILED 9-4-2008.

Loops

THE MARK CONSISTS OF STANDARD CHARACTERS WITHOUT CLAIM TO ANY PARTICULAR FONT, STYLE, SIZE, OR COLOR.

OWNER OF U.S. REG. NOS. 2,439,791, 2,743,767 AND OTHERS.

SEC. 2(F).

FOR DENTAL FLOSS; TOOTHBRUSH HOLDERS; TOOTHBRUSHES (U.S. CLS. 2, 13, 23, 29, 30, 33, 40 AND 50).

FIRST USE 7-0-1996; IN COMMERCE 7-0-1996.

TRACY WHITTAKER-BROWN, EXAMINING ATTORNEY

SN 77-570,865. THE FULL IMPACT, LLC, RED HOOK, NY. FILED 9-16-2008.

FLOWER POCKETS FRESH CUTTINGS

THE MARK CONSISTS OF STANDARD CHARACTERS WITHOUT CLAIM TO ANY PARTICULAR FONT, STYLE, SIZE, OR COLOR.

NO CLAIM IS MADE TO THE EXCLUSIVE RIGHT TO USE "FLOWER" AND "FRESH CUTTINGS", APART FROM THE MARK AS SHOWN.

FOR PORTABLE, COLLAPSIBLE VASES (U.S. CLS. 2, 13, 23, 29, 30, 33, 40 AND 50).

FIRST USE 7-27-2008; IN COMMERCE 7-27-2008.

HAI-LY LAM, EXAMINING ATTORNEY

CLASS 21—(Continued).

SN 77-578,591. JACLYN SMITH INTERNATIONAL, INC., LOS ANGELES, CA. FILED 9-25-2008.



THE MARK CONSISTS OF THE STYLIZED LETTERS "JS".

FOR BEVERAGE GLASSWARE; STEMWARE; DECANTERS, VASES NOT MADE OF PRECIOUS METAL; BOTTLE OPENERS; WINE BOTTLE CRADLES; BAKING DISHES AND BAKEWARE; COOKWARE, NAMELY, POTS, PANS, POT LIDS, POT AND PAN COVERS, SKILLETS, DISHES, COLANDERS, AND TEA KETTLES; CARVING BOARDS; CUTTING BOARDS; SPOON RESTS; TRIVETS; SALT AND PEPPER SHAKERS; NAPKIN HOLDERS AND NAPKIN RINGS NOT OF PRECIOUS METAL (U.S. CLS. 2, 13, 23, 29, 30, 33, 40 AND 50).
JACQUELINE A. LAVINE, EXAMINING ATTORNEY

SN 77-580,100. COMBINE INTERNATIONAL, INC., TROY, MI. FILED 9-26-2008.

AVIGNA

THE MARK CONSISTS OF STANDARD CHARACTERS WITHOUT CLAIM TO ANY PARTICULAR FONT, STYLE, SIZE, OR COLOR.

FOR FIGURINES, STATUES, STATUETTES, SCULPTURES AND ORNAMENTS, ALL MADE OF GLASS, CHINA, CRYSTAL, EARTHENWARE, TERRA COTTA AND PORCELAIN; VASES (U.S. CLS. 2, 13, 23, 29, 30, 33, 40 AND 50).
MARLENE BELL, EXAMINING ATTORNEY

CLASS 21—(Continued).

SN 77-580,557. THE JEWISH ZODIAC, LLC, WOODLAND HILLS, CA. FILED 9-28-2008.

THE HISPANIC ZODIAC

THE MARK CONSISTS OF STANDARD CHARACTERS WITHOUT CLAIM TO ANY PARTICULAR FONT, STYLE, SIZE, OR COLOR.

FOR DINNERWARE, PLATES, CUPS, SAUCERS, SERVING PLATTERS, MUGS, DRINKING GLASSES, NAPKIN RINGS NOT OF PRECIOUS METAL, PAPER CUPS, AND PAPER PLATES (U.S. CLS. 2, 13, 23, 29, 30, 33, 40 AND 50).
SUNG IN, EXAMINING ATTORNEY

SN 77-580,561. THE JEWISH ZODIAC, LLC, WOODLAND HILLS, CA. FILED 9-28-2008.

THE ITALIAN ZODIAC

THE MARK CONSISTS OF STANDARD CHARACTERS WITHOUT CLAIM TO ANY PARTICULAR FONT, STYLE, SIZE, OR COLOR.

FOR DINNERWARE, PLATES, CUPS, SAUCERS, SERVING PLATTERS, MUGS, DRINKING GLASSES, NAPKIN RINGS NOT OF PRECIOUS METAL, PAPER CUPS, AND PAPER PLATES (U.S. CLS. 2, 13, 23, 29, 30, 33, 40 AND 50).
SUNG IN, EXAMINING ATTORNEY

SN 77-583,105. PLAYTEX PRODUCTS LLC, SHELTON, CT. FILED 10-1-2008.

DRIP-CATCH CUFF

THE MARK CONSISTS OF STANDARD CHARACTERS WITHOUT CLAIM TO ANY PARTICULAR FONT, STYLE, SIZE, OR COLOR.

OWNER OF U.S. REG. NO. 3,006,455.
NO CLAIM IS MADE TO THE EXCLUSIVE RIGHT TO USE "CUFF", APART FROM THE MARK AS SHOWN.
FOR GLOVES FOR HOUSEHOLD PURPOSES (U.S. CLS. 2, 13, 23, 29, 30, 33, 40 AND 50).
CHRISTOPHER BUONGIORNO, EXAMINING ATTORNEY

CLASS 21—(Continued).

SN 77-588,277. BED BATH & BEYOND PROCUREMENT CO. INC., FARMINGDALE, NY. FILED 10-8-2008.

TAVOLA

THE MARK CONSISTS OF STANDARD CHARACTERS WITHOUT CLAIM TO ANY PARTICULAR FONT, STYLE, SIZE, OR COLOR.

THE ENGLISH TRANSLATION OF "TAVOLA" IS TABLE. FOR KITCHEN ORGANIZERS IN THE NATURE OF COUNTERTOP RACKS FOR HOLDING COFFEE CARTRIDGES (U.S. CLS. 2, 13, 23, 29, 30, 33, 40 AND 50).
LINDA LAVACHE, EXAMINING ATTORNEY

SN 77-591,424. MASCO CANADA LIMITED, LONDON, ONTARIO, CANADA, FILED 10-13-2008.

HANNAH

THE MARK CONSISTS OF STANDARD CHARACTERS WITHOUT CLAIM TO ANY PARTICULAR FONT, STYLE, SIZE, OR COLOR.

FOR BATH ACCESSORIES, NAMELY, TOWEL BARS, TOWEL RINGS AND TOILET TISSUE HOLDERS (U.S. CLS. 2, 13, 23, 29, 30, 33, 40 AND 50).
HEATHER THOMPSON, EXAMINING ATTORNEY

SN 77-594,431. PACIFIC TRADE INTERNATIONAL, INC., ROCKVILLE, MD. FILED 10-16-2008.

MODERN LIGHT

THE MARK CONSISTS OF STANDARD CHARACTERS WITHOUT CLAIM TO ANY PARTICULAR FONT, STYLE, SIZE, OR COLOR.

NO CLAIM IS MADE TO THE EXCLUSIVE RIGHT TO USE "LIGHT", APART FROM THE MARK AS SHOWN.

FOR FRAGRANT OIL WARMERS AND BURNERS; CANDLE ACCESSORIES, NOT OF PRECIOUS METAL, NAMELY, CANDLE HOLDERS, CANDLE VOTIVES AND CANDLE PLATES (U.S. CLS. 2, 13, 23, 29, 30, 33, 40 AND 50).

SANI KHOURI, EXAMINING ATTORNEY

CLASS 21—(Continued).

SN 77-595,480. BERARD, NICHOLAS J., NOVI, MI. FILED 10-17-2008.

Tailgate Commando

THE MARK CONSISTS OF STANDARD CHARACTERS WITHOUT CLAIM TO ANY PARTICULAR FONT, STYLE, SIZE, OR COLOR.

NO CLAIM IS MADE TO THE EXCLUSIVE RIGHT TO USE "TAILGATE", APART FROM THE MARK AS SHOWN. FOR PORTABLE BEVERAGE COOLERS (U.S. CLS. 2, 13, 23, 29, 30, 33, 40 AND 50).

RUSS HERMAN, EXAMINING ATTORNEY

SN 77-595,933. MICHAELS STORES PROCUREMENT COMPANY, INC., IRVING, TX. FILED 10-20-2008.

ARTMINDS

THE MARK CONSISTS OF STANDARD CHARACTERS WITHOUT CLAIM TO ANY PARTICULAR FONT, STYLE, SIZE, OR COLOR.

FOR GLASS MOSAICS NOT FOR BUILDING (U.S. CLS. 2, 13, 23, 29, 30, 33, 40 AND 50).

PAUL CROWLEY, EXAMINING ATTORNEY

SN 77-609,165. CASABELLA HOLDINGS, LLC, BLAUVELT, NY. FILED 11-6-2008.

BE WILD

THE MARK CONSISTS OF STANDARD CHARACTERS WITHOUT CLAIM TO ANY PARTICULAR FONT, STYLE, SIZE, OR COLOR.

FOR HOUSEHOLD CLEANING TOOLS, NAMELY SPONGES, CLOTHS, MOPS, BROOMS, SCRUBBING BRUSHES AND DUSTERS (U.S. CLS. 2, 13, 23, 29, 30, 33, 40 AND 50).

KOURTNEE HODGES, EXAMINING ATTORNEY

CLASS 21—(Continued).

SN 77-627,754. HERBST GAMING, INC., LAS VEGAS, NV. FILED 12-5-2008.



NO CLAIM IS MADE TO THE EXCLUSIVE RIGHT TO USE "CASINO", APART FROM THE MARK AS SHOWN.

THE LIKENESS (OR, "PORTRAIT") IN THE MARK DOES NOT IDENTIFY A LIVING INDIVIDUAL.

THE COLOR(S) RED, WHITE, BLACK, BEIGE AND YELLOW IS/ARE CLAIMED AS A FEATURE OF THE MARK.

THE MARK CONSISTS OF THE DEPICTION OF A SHERIFF, WEARING A WHITE SHIRT, A RED TIE, A RED AND BLACK VEST WITH A YELLOW BADGE, A BLACK HAT, A BLACK MUSTACHE AND A BEIGE FACE AND HANDS, NEXT TO THE RED WORDS "TERRIBLE'S", OVER THE WORD "RAIL". THE WORDS "RAIL CITY" ARE RED WITH A WHITE BORDER AND A BLACK OUTLINE, OVER THE WORD "CASINO" IN WHITE AGAINST A BLACK OVAL BACKGROUND.

FOR BEVERAGeware; CUPS; DRINKING STEINS; DRINKING VESSELS; FLASKS; FOAM DRINK HOLDERS; GLASS BEVERAGeware; MUGS; SHOT GLASSES (U.S. CLS. 2, 13, 23, 29, 30, 33, 40 AND 50).

FIRST USE 1-1-2007; IN COMMERCE 1-1-2007.
TIMOTHY FINNEGAN, EXAMINING ATTORNEY

CLASS 21—(Continued).

SN 77-663,360. COZY LIFE INTERNATIONAL INC., HOUSTON, TX. FILED 2-4-2009.



THE COLOR(S) RED IS/ARE CLAIMED AS A FEATURE OF THE MARK.

THE MARK CONSISTS OF AN OUTLINE OF A HOUSE IN RED COLOR, AND WORDS "COZY LIFE" IN RED COLOR INSIDE THE HOUSE OUTLINE.

FOR DINNERWARE, NAMELY, PLATES, BOWLS, TEACUPS, SAUCERS, MUGS, SUGAR BOWL AND CREAMER, PLATTERS, SALVERS, TRAYS, NAPKIN RINGS, SALT AND PEPPER SHAKERS, DRINKING GLASSES AND CUPS (U.S. CLS. 2, 13, 23, 29, 30, 33, 40 AND 50).

BRENDAN MCCAULEY, EXAMINING ATTORNEY

SN 77-665,509. PRO-MART INDUSTRIES, INC., IRVINE, CA. FILED 2-6-2009.

SMARTCLOTH

THE MARK CONSISTS OF STANDARD CHARACTERS WITHOUT CLAIM TO ANY PARTICULAR FONT, STYLE, SIZE, OR COLOR.

FOR CLEANING, DUSTING AND POLISHING CLOTHS, CLEANING RAGS (U.S. CLS. 2, 13, 23, 29, 30, 33, 40 AND 50).

JOHN E. MICHOS, EXAMINING ATTORNEY

SN 77-630,604. TARHONG MELAMINE U.S.A., INC., INDUSTRY, CA. FILED 12-10-2008.



NO CLAIM IS MADE TO THE EXCLUSIVE RIGHT TO USE "PURE MELAMINE BLENDED WITH BAMBOO FIBERS", APART FROM THE MARK AS SHOWN.

GREY IS FOR SHADING PURPOSES ONLY.

THE MARK CONSISTS OF THE WORDS "ZU PURE MELAMINE BLENDED WITH BAMBOO FIBERS" ENCLOSED IN AN OVAL WITH BAMBOO IN THE BACKGROUND.

THE WORDING "ZU" HAS NO MEANING IN A FOREIGN LANGUAGE.

FOR DINNERWARE, NAMELY, SERVICE PIECES, NAMELY, PLATTERS, TRAYS, PLATES, BOWLS, CHIP AND DIP SERVERS AND THE LIKE; DRINK WARE, NAMELY, CUPS, MUGS AND PITCHERS (U.S. CLS. 2, 13, 23, 29, 30, 33, 40 AND 50).

KATHERINE STOIDES, EXAMINING ATTORNEY

SN 77-691,150. COOK N RATE, FRESNO, CA. FILED 3-14-2009.

MUG OF DISTINCTION

THE MARK CONSISTS OF STANDARD CHARACTERS WITHOUT CLAIM TO ANY PARTICULAR FONT, STYLE, SIZE, OR COLOR.

NO CLAIM IS MADE TO THE EXCLUSIVE RIGHT TO USE "MUG", APART FROM THE MARK AS SHOWN.

FOR BEER MUGS; COFFEE CUPS, TEA CUPS AND MUGS; CUPS AND MUGS; EARTHENWARE MUGS; GLASS MUGS; MUGS; MUGS, NOT OF PRECIOUS METAL; PORCELAIN MUGS (U.S. CLS. 2, 13, 23, 29, 30, 33, 40 AND 50).

LAURA HAMMEL, EXAMINING ATTORNEY

CLASS 21—(Continued).

SN 77-695,847. REMEMBER2REMEMBER, INC., MARIETTA, GA. FILED 3-20-2009.

HE ART

THE MARK CONSISTS OF STANDARD CHARACTERS WITHOUT CLAIM TO ANY PARTICULAR FONT, STYLE, SIZE, OR COLOR.

NO CLAIM IS MADE TO THE EXCLUSIVE RIGHT TO USE "ART", APART FROM THE MARK AS SHOWN.

FOR GLASS PRISMS FOR USE AS MNEMONIC DEVICES (U.S. CLS. 2, 13, 23, 29, 30, 33, 40 AND 50).

BERYL GARDNER, EXAMINING ATTORNEY

CLASS 21—(Continued).

SN 77-708,126. S&L DESIGN SOURCING AND CONSULTING, INC., NEW YORK, NY. FILED 4-7-2009.



cell-saver
submergency kit

NO CLAIM IS MADE TO THE EXCLUSIVE RIGHT TO USE "KIT", APART FROM THE MARK AS SHOWN.

THE MARK CONSISTS OF A STYLIZED DEPICTION OF A CELL PHONE BIASECTED BY WAVY LINES INTENDED TO INDICATE WATER SURROUNDED BY A DIAMOND, ALL ABOVE THE WORDS "CELL-SAVER" ON ONE LINE AND THE WORDS "SUBMERGENCY KIT" ON THE LINE BELOW.

FOR CELL PHONE DRYING KITS COMPRISED OF ABSORBENT CLOTHS AND A SEALABLE PLASTIC BAG CONTAINING NATURAL INGREDIENTS FOR REMOVING MOISTURE (U.S. CLS. 2, 13, 23, 29, 30, 33, 40 AND 50).

KHANH LE, EXAMINING ATTORNEY

SN 77-707,612. FRANK, MATTHEW, SEATTLE, WA. FILED 4-6-2009.

Batter Pen

THE MARK CONSISTS OF STANDARD CHARACTERS WITHOUT CLAIM TO ANY PARTICULAR FONT, STYLE, SIZE, OR COLOR.

NO CLAIM IS MADE TO THE EXCLUSIVE RIGHT TO USE "BATTER", APART FROM THE MARK AS SHOWN.

FOR COOKING UTENSIL, NAMELY, BATTER DISPENSER (U.S. CLS. 2, 13, 23, 29, 30, 33, 40 AND 50).

ODESSA BIBBINS, EXAMINING ATTORNEY

SN 77-718,375. RCR ENTERPRISES, LLC, WELCOME, NC. FILED 4-21-2009.



SN 77-707,826. FRANK, MATTHEW, SEATTLE, WA. FILED 4-6-2009.

Pancake Pen

THE MARK CONSISTS OF STANDARD CHARACTERS WITHOUT CLAIM TO ANY PARTICULAR FONT, STYLE, SIZE, OR COLOR.

NO CLAIM IS MADE TO THE EXCLUSIVE RIGHT TO USE "PANCAKE", APART FROM THE MARK AS SHOWN.

FOR COOKING UTENSIL, NAMELY, BATTER DISPENSER (U.S. CLS. 2, 13, 23, 29, 30, 33, 40 AND 50).

ODESSA BIBBINS, EXAMINING ATTORNEY

OWNER OF U.S. REG. NO. 3,428,362.

THE MARK CONSISTS OF THE NUMBER "31" IN A STYLIZED FORMAT.

FOR FOAM DRINK HOLDERS (U.S. CLS. 2, 13, 23, 29, 30, 33, 40 AND 50).

FIRST USE 2-9-1997; IN COMMERCE 2-9-1997.

AMY KERTGATE, EXAMINING ATTORNEY

CLASS 21—(Continued).

SN 77-721,202. TWENTIETH CENTURY FOX FILM CORPORATION, LOS ANGELES, CA. FILED 4-23-2009.



OWNER OF U.S. REG. NO. 3,001,994.
 NO CLAIM IS MADE TO THE EXCLUSIVE RIGHT TO USE "SPORTS", APART FROM THE MARK AS SHOWN.
 THE MARK CONSISTS OF THE STYLIZED WORDS "THE ADVENTURES OF DIGGER AND FRIENDS" WHICH APPEAR INSIDE OF TWO OVAL CONCENTRIC LINES, THE WORDS "FOX SPORTS" WHICH APPEAR UNDER THE WORD "FRIENDS" AND INSIDE OF THE OVAL SHAPE OVERLAPPING ON THE BOTTOM OF THE INNER OVAL LINE AND FIVE COSTUMED GOPHER CHARACTERS WHICH APPEAR ABOVE THE OUTER OVAL LINE.
 FOR DRINKING GLASSES, CUPS, MUGS, DINNER PLATES, BOWLS; TOOTHBRUSHES; PLASTIC CUPS, PLASTIC MUGS, PLASTIC COASTERS, DISHES, GLASS BOWLS, AND BEVERAGE GLASSWARE, AND SPORTS BOTTLES SOLD EMPTY; THERMAL INSULATED WRAP FOR CANS TO KEEP THE CONTENTS COLD OR HOT; PAPER PLATES AND PAPER CUPS (U.S. CLS. 2, 13, 23, 29, 30, 33, 40 AND 50).
 LINDA LAVACHE, EXAMINING ATTORNEY

SN 77-722,088. REYNOLDS FOIL INC., DBA REYNOLDS CONSUMER PRODUCTS COMPANY, RICHMOND, VA. FILED 4-24-2009.

STAYBRITE

THE MARK CONSISTS OF STANDARD CHARACTERS WITHOUT CLAIM TO ANY PARTICULAR FONT, STYLE, SIZE, OR COLOR.
 FOR BAKING CUPS (U.S. CLS. 2, 13, 23, 29, 30, 33, 40 AND 50).
 PRISCILLA MILTON, EXAMINING ATTORNEY

CLASS 21—(Continued).

SN 77-724,336. LIEN, BRYCE, MONROVIA, CA. FILED 4-28-2009.

H₂O₄K9

THE MARK CONSISTS OF STYLIZED LETTERING CONSISTING OF THE FOLLOWING NUMBERS AND UPPER CASE LETTERS: "H2O4K9".
 FOR BOTTLES, SOLD EMPTY (U.S. CLS. 2, 13, 23, 29, 30, 33, 40 AND 50).
 VIVIAN MICZNIK FIRST, EXAMINING ATTORNEY

SN 77-725,049. OWENS-BROCKWAY GLASS CONTAINER INC., PERRYSBURG, OH. FILED 4-29-2009.

Vortex

THE MARK CONSISTS OF STANDARD CHARACTERS WITHOUT CLAIM TO ANY PARTICULAR FONT, STYLE, SIZE, OR COLOR.
 FOR BOTTLES, SOLD EMPTY (U.S. CLS. 2, 13, 23, 29, 30, 33, 40 AND 50).
 LESLEY LAMOTHE, EXAMINING ATTORNEY

SN 77-726,371. DIXIE CONSUMER PRODUCTS LLC, ATLANTA, GA. FILED 4-30-2009.

INTERLUDE

THE MARK CONSISTS OF STANDARD CHARACTERS WITHOUT CLAIM TO ANY PARTICULAR FONT, STYLE, SIZE, OR COLOR.
 FOR CUPS (U.S. CLS. 2, 13, 23, 29, 30, 33, 40 AND 50).
 GEORGE LORENZO, EXAMINING ATTORNEY

CLASS 21—(Continued).

SN 77-726,978. BAXTER STATE, LOS ANGELES, CA. FILED 5-1-2009.

Clear Advantage

THE MARK CONSISTS OF STANDARD CHARACTERS WITHOUT CLAIM TO ANY PARTICULAR FONT, STYLE, SIZE, OR COLOR.

FOR SUB-IRRIGATION PLANTERS FOR PLANTS FOR BOTH INTERIOR AND EXTERIOR USE (U.S. CLS. 2, 13, 23, 29, 30, 33, 40 AND 50).

FIRST USE 12-1-2008; IN COMMERCE 3-4-2009.
JAY FLOWERS, EXAMINING ATTORNEY

CLASS 21—(Continued).

SN 77-728,505. CHERI COTTRELL LLC, CAPE ELIZABETH, ME. FILED 5-4-2009.

HAMMY AND PAMMY

THE MARK CONSISTS OF STANDARD CHARACTERS WITHOUT CLAIM TO ANY PARTICULAR FONT, STYLE, SIZE, OR COLOR.

FOR DINNERWARE, NAMELY, PLATES, BOWLS, SAUCERS, CUPS, GLASSES, MUGS, COFFEE AND TEA POTS; ORNAMENTS MADE OF CERAMIC AND PORCELAIN; CANDLE HOLDERS; VASES; CERAMIC SCULPTURES; CONTAINERS FOR HOUSEHOLD USE (U.S. CLS. 2, 13, 23, 29, 30, 33, 40 AND 50).

TASNEEM HUSSAIN, EXAMINING ATTORNEY

SN 77-727,343. HUGH HEWITT, IRVINE, CA. FILED 5-1-2009.

OIIIOHH

THE MARK CONSISTS OF STANDARD CHARACTERS WITHOUT CLAIM TO ANY PARTICULAR FONT, STYLE, SIZE, OR COLOR.

FOR COFFEE CUPS, TEA CUPS AND MUGS (U.S. CLS. 2, 13, 23, 29, 30, 33, 40 AND 50).

JOHN DWYER, EXAMINING ATTORNEY

SN 77-977,571. FRESH WATER SYSTEMS, INC., GREENVILLE, SC. FILED 2-24-2009.

NEO TOTE

THE MARK CONSISTS OF STANDARD CHARACTERS WITHOUT CLAIM TO ANY PARTICULAR FONT, STYLE, SIZE, OR COLOR.

NO CLAIM IS MADE TO THE EXCLUSIVE RIGHT TO USE "TOTE", APART FROM THE MARK AS SHOWN.

FOR INSULATING SLEEVE HOLDERS FOR BEVERAGE CANS; NEOPRENE ZIPPERED BOTTLE HOLDERS; THERMAL INSULATED CONTAINERS FOR FOOD OR BEVERAGE (U.S. CLS. 2, 13, 23, 29, 30, 33, 40 AND 50).

FIRST USE 6-9-2009; IN COMMERCE 6-9-2009.
BRIAN PINO, EXAMINING ATTORNEY

SN 77-728,462. PARIS PRESENTS INCORPORATED, GURNEE, IL. FILED 5-4-2009.

CONTAIN & SUSTAIN

THE MARK CONSISTS OF STANDARD CHARACTERS WITHOUT CLAIM TO ANY PARTICULAR FONT, STYLE, SIZE, OR COLOR.

FOR BOTTLES, SOLD EMPTY (U.S. CLS. 2, 13, 23, 29, 30, 33, 40 AND 50).

JENNIFER VASQUEZ, EXAMINING ATTORNEY

SN 79-061,765. BOOT OX PTY LTD; ATTN: P & B LAW, AUSTRALIA, FILED 8-21-2008.

BOOTOX

THE MARK CONSISTS OF STANDARD CHARACTERS WITHOUT CLAIM TO ANY PARTICULAR FONT, STYLE, SIZE, OR COLOR.

OWNER OF INTERNATIONAL REGISTRATION 0984106 DATED 8-21-2008, EXPIRES 8-21-2018.

FOR SHOE HORNS; SHOE STRETCHERS; BOOT STRETCHERS; SHOE BRUSHES; BOOT TREES; SHOE TREES (U.S. CLS. 2, 13, 23, 29, 30, 33, 40 AND 50).

DEIRDRE ROBERTSON, EXAMINING ATTORNEY

CLASS 21—(Continued).

SN 79-063,110. NINGBO GOLDEN ELEPHANT; KITCHEN-WARE CO., LTD., CHINA, FILED 11-25-2008.



OWNER OF INTERNATIONAL REGISTRATION 0987543 DATED 11-25-2008, EXPIRES 11-25-2018.

THE MARK CONSISTS OF THE ENGLISH WORD "NGE" HAS NO SIGNIFICANCE IN THE RELEVANT TRADE OR INDUSTRY, AND HAS NO GEOGRAPHICAL SIGNIFICANCE, AND HAS NO MEANING IN A FOREIGN LANGUAGE, AND HAS NO SIGNIFICANCE AS APPLIED TO THE GOODS.

FOR COOKING POTS; IRON POTS; CONTAINERS FOR HOUSEHOLD OR KITCHEN USE NOT OF PRECIOUS METAL; ENAMEL AND PLASTIC WARE FOR EVERYDAY USE, NAMELY, BASINS, BOWLS, PLATES, KETTLES AND CUPS; NON-ELECTRIC PRESSURE COOKERS; COOKING UTENSILS, NAMELY, BATTER DISPENSER, GRILLS, WIRE BASKETS, COOKING SIEVES AND SIFTERS, NON-ELECTRIC COOKING PANS, NON-ELECTRIC COOKING STEAMERS, AND NON-ELECTRIC RICE COOKING POTS; CUPS OF PAPER OR PLASTIC; FRYING PANS; KITCHEN MIXERS, NON-ELECTRIC; TABLEWARE, NOT OF PRECIOUS METAL, NAMELY, DISHES AND PLATES NOT OF PRECIOUS METAL, CUPS NOT OF PRECIOUS METAL, CRUET STANDS NOT OF PRECIOUS METAL, COFFEE POTS NOT OF PRECIOUS METAL, AND TEA POTS NOT OF PRECIOUS METAL (U.S. CLS. 2, 13, 23, 29, 30, 33, 40 AND 50).

CAROLYN CATALDO, EXAMINING ATTORNEY

CLASS 22—CORDAGE AND FIBERS

SN 76-695,957. KIM, JUNG MOK, LOS ANGELES, CA. FILED 2-25-2009.



NO CLAIM IS MADE TO THE EXCLUSIVE RIGHT TO USE "TOP TARP", APART FROM THE MARK AS SHOWN. THE COLOR(S) BLUE, WHITE, YELLOW AND BLACK IS/ ARE CLAIMED AS A FEATURE OF THE MARK.

THE MARK CONSISTS OF THE WORDS "TOP TARP" IN BLUE COLOR WITH WHITE SHADING. A DRAWING OF A BLUE CANOPY WITH BLACK OUTLINE AND BLACK POLES APPEARS ON TOP OF THE LETTERS "R" AND "P" WITH A YELLOW BACKGROUND.

FOR CANVAS CANOPIES FOR USE AS TENT TOPS; CANVAS CANOPIES FOR USE AS SHADE COVERS; TARPAULINS USED TO COVER ITEMS; TARPAULIN COVERS, NAMELY, UNFITTED VEHICLE COVERS AND UNFITTED SPA COVERS; TENTS (U.S. CLS. 1, 2, 7, 19, 22, 42 AND 50).

FIRST USE 1-1-2009; IN COMMERCE 1-1-2009. MARY BOAGNI, EXAMINING ATTORNEY

SN 79-065,351. NINGBO NECO HOUSEWARES CO., LTD; (NINGBO NIKE JIAYONGPIN; YOUXIAN GONGSI), CHINA, FILED 12-29-2008.



OWNER OF INTERNATIONAL REGISTRATION 0993387 DATED 12-29-2008, EXPIRES 12-29-2018.

THE MARK CONSISTS OF THE STYLIZED TERM "NECO".

THE WORDING NECO HAS NO MEANING IN A FOREIGN LANGUAGE.

FOR CONTAINERS FOR HOUSEHOLD OR KITCHEN USE; LYE WASHTUBS; DUSTBINS; BRUSHES, NAMELY, WASHING BRUSHES; SCRUBBING BRUSHES; ABRASIVE SPONGES FOR SCRUBBING THE SKIN; BROOMS; CLEANING INSTRUMENTS HAND-OPERATED, NAMELY, NON-ELECTRIC CARPET CLEANERS; SPONGE HOLDERS; MOPS (U.S. CLS. 2, 13, 23, 29, 30, 33, 40 AND 50).

MARLENE BELL, EXAMINING ATTORNEY

SN 77-650,106. DESIGN LAB, LLC, DBA ORANGE22, LOS ANGELES, CA. FILED 1-15-2009.



THE MARK CONSISTS OF STANDARD CHARACTERS WITHOUT CLAIM TO ANY PARTICULAR FONT, STYLE, SIZE, OR COLOR.

FOR ARRAYS OF RESILIENT NON-METAL STRAPS THAT MAY BE ARRANGED IN PRESCRIBED ANGULAR ORIENTATIONS RELATIVE TO EACH OTHER TO ACCOMMODATE OBJECTS OF DIFFERENT SIZES, SHAPES AND CONFIGURATIONS IN ANY ONE OF A MULTIPLICITY OF DIFFERENT ARRANGEMENTS (U.S. CLS. 1, 2, 7, 19, 22, 42 AND 50).

WILLIAM ROSSMAN, EXAMINING ATTORNEY

CLASS 22—(Continued).

SN 77-690,873. SR GLOBAL INC., DBA SR GLOBAL INC., FAIRBURN, GA. FILED 3-13-2009.



NO CLAIM IS MADE TO THE EXCLUSIVE RIGHT TO USE "DROPS", APART FROM THE MARK AS SHOWN. FOR DROP CLOTHS (U.S. CLS. 1, 2, 7, 19, 22, 42 AND 50).
BRENDAN MCCAULEY, EXAMINING ATTORNEY

SN 77-697,779. NEW ENGLAND ROPES, CORP., FALL RIVER, MA. FILED 3-24-2009.

BRAIDED SAFETY BLUE

THE MARK CONSISTS OF STANDARD CHARACTERS WITHOUT CLAIM TO ANY PARTICULAR FONT, STYLE, SIZE, OR COLOR.
SEC. 2(F).
FOR ROPES (U.S. CLS. 1, 2, 7, 19, 22, 42 AND 50).
FIRST USE 2-14-1972; IN COMMERCE 2-14-1972.
MARIA-VICTORIA SUAREZ, EXAMINING ATTORNEY

SN 77-705,954. ACTIVE ENGINEERING LLC, LYNNWOOD, WA. FILED 4-3-2009.

JAKPAK

THE MARK CONSISTS OF STANDARD CHARACTERS WITHOUT CLAIM TO ANY PARTICULAR FONT, STYLE, SIZE, OR COLOR.
FOR OUTDOOR PROTECTIVE EQUIPMENT, NAMELY, A COMBINATION TENT, SLEEPING BAG AND JACKET PROVIDING PROTECTION FROM THE ELEMENTS (U.S. CLS. 1, 2, 7, 19, 22, 42 AND 50).
KATHY DE JONGE, EXAMINING ATTORNEY

CLASS 22—(Continued).

SN 77-705,957. ACTIVE ENGINEERING LLC, LYNNWOOD, WA. FILED 4-3-2009.

JAKPAK

THE MARK CONSISTS OF "JAKPAK" WITH TENT-SHAPED "A" CHARACTERS.
FOR OUTDOOR PROTECTIVE EQUIPMENT, NAMELY, A COMBINATION TENT, SLEEPING BAG AND JACKET PROVIDING PROTECTION FROM THE ELEMENTS (U.S. CLS. 1, 2, 7, 19, 22, 42 AND 50).
KATHY DE JONGE, EXAMINING ATTORNEY

SN 77-713,204. THE MEGASACK CORPORATION, MAGNOLIA, AR. FILED 4-14-2009.

MegaSack

THE MARK CONSISTS OF STANDARD CHARACTERS WITHOUT CLAIM TO ANY PARTICULAR FONT, STYLE, SIZE, OR COLOR.
FOR POLY PROPYLENE BAGS USED FOR THE STORAGE OF RAW MATERIALS OR AGRICULTURAL PRODUCTS (U.S. CLS. 1, 2, 7, 19, 22, 42 AND 50).
FIRST USE 12-31-1991; IN COMMERCE 12-31-1991.
H. M. FISHER, EXAMINING ATTORNEY

SN 77-721,197. TWENTIETH CENTURY FOX FILM CORPORATION, LOS ANGELES, CA. FILED 4-23-2009.



OWNER OF U.S. REG. NO. 3,001,994.
NO CLAIM IS MADE TO THE EXCLUSIVE RIGHT TO USE "SPORTS", APART FROM THE MARK AS SHOWN.
THE MARK CONSISTS OF THE STYLIZED WORDS "THE ADVENTURES OF DIGGER AND FRIENDS" WHICH APPEAR INSIDE OF TWO OVAL CONCENTRIC LINES, THE WORDS "FOX SPORTS" WHICH APPEAR UNDER THE WORD "FRIENDS" AND INSIDE OF THE OVAL SHAPE OVERLAPPING ON THE BOTTOM OF THE INNER OVAL LINE AND FIVE COSTUMED GOPHER CHARACTERS WHICH APPEAR ABOVE THE OUTER OVAL LINE.
FOR LANYARDS FOR USE IN HOLDING EYEGLASSES, WHISTLES, BADGES AND KEYS (U.S. CLS. 1, 2, 7, 19, 22, 42 AND 50).
LINDA LAVACHE, EXAMINING ATTORNEY

CLASS 22—(Continued).

SN 77-725,470. TWENTIETH CENTURY FOX FILM CORPORATION, LOS ANGELES, CA. FILED 4-29-2009.

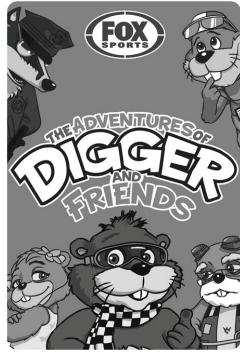

OWNER OF U.S. REG. NO. 3,001,994.
 NO CLAIM IS MADE TO THE EXCLUSIVE RIGHT TO USE "SPORTS", APART FROM THE MARK AS SHOWN.
 THE MARK CONSISTS OF THE STYLIZED WORDS "THE ADVENTURES OF DIGGER AND FRIENDS" WHICH APPEAR IN THE CENTER, THE WORDS "FOX SPORTS" WHICH APPEAR INSIDE OF THE OVAL SHAPE ON THE TOP CENTER AND FIVE COSTUMED GOPHER CHARACTERS, AND ALL ARE DISPLAYED INSIDE OF THE RECTANGULAR BACKGROUND.
 FOR LANYARDS FOR USE IN HOLDING EYEGLASSES, WHISTLES, BADGES AND KEYS (U.S. CLS. 1, 2, 7, 19, 22, 42 AND 50).
 LINDA LAVACHE, EXAMINING ATTORNEY

SN 77-726,530. POOLMASTER, INC., SACRAMENTO, CA. FILED 4-30-2009.

Pooltec

THE MARK CONSISTS OF STANDARD CHARACTERS WITHOUT CLAIM TO ANY PARTICULAR FONT, STYLE, SIZE, OR COLOR.
 FOR SWIMMING POOL SKIMMING NETS (U.S. CLS. 1, 2, 7, 19, 22, 42 AND 50).
 MICHAEL SOUDERS, EXAMINING ATTORNEY

CLASS 24—FABRICS

SN 76-697,048. INCREDIBLE MAMAS LTD., ST. THOMAS, ONTARIO N5R 0A3, CANADA, FILED 4-23-2009.

BOOBIE BLANKET WITH BURPIES

THE MARK CONSISTS OF STANDARD CHARACTERS WITHOUT CLAIM TO ANY PARTICULAR FONT, STYLE, SIZE, OR COLOR.
 NO CLAIM IS MADE TO THE EXCLUSIVE RIGHT TO USE "BLANKET WITH BURPIES", APART FROM THE MARK AS SHOWN.
 FOR NURSING BLANKETS (U.S. CLS. 42 AND 50).
 TRACY FLETCHER, EXAMINING ATTORNEY

SN 77-102,198. BRITANNICA HOME FASHIONS, INC., NEW YORK, NY. FILED 2-8-2007.

RETREAT

THE MARK CONSISTS OF STANDARD CHARACTERS WITHOUT CLAIM TO ANY PARTICULAR FONT, STYLE, SIZE, OR COLOR.
 FOR CHILDREN'S BEDDING, NAMELY, BED SHEETS; COMFORTERS AND DOWN COMFORTERS; COMFORTER COVERS; QUILTS; PILLOW SHAMS; BED DUST RUFFLES; FABRIC WINDOW VALANCES; WINDOW TREATMENTS, NAMELY, CLOTH WINDOW PANELS, CURTAINS, DRAPERIES AND CLOTH WINDOW SCARVES (U.S. CLS. 42 AND 50).
 TEJBIR SINGH, EXAMINING ATTORNEY

CLASS 24—(Continued).

SN 77-450,076. MASCOTTE HOLDINGS, INC., NEW YORK, NY. FILED 4-16-2008.

**KANYE WEST'S GLOW IN THE
DARK**

THE MARK CONSISTS OF STANDARD CHARACTERS WITHOUT CLAIM TO ANY PARTICULAR FONT, STYLE, SIZE, OR COLOR.

NO CLAIM IS MADE TO THE EXCLUSIVE RIGHT TO USE "GLOW IN THE DARK", APART FROM THE MARK AS SHOWN.

THE NAME(S), PORTRAIT(S), AND/OR SIGNATURE(S) SHOWN IN THE MARK IDENTIFIES A LIVING INDIVIDUAL, WHOSE CONSENT(S) TO REGISTER IS SUBMITTED.

FOR BED BLANKETS, RECEIVING BLANKETS, BLANKET THROWS, COMFORTERS, COMFORTER SETS AND ENSEMBLES COMPRISED OF BED SHEETS, COMFORTERS, DUST RUFFLES, AND PILLOW SHAMS, BLANKETS FOR OUTDOOR USE, QUILTS, AFGHANS, BED LINEN, BED SHEETS AND SHEET SETS COMPRISED OF FLAT SHEETS, FITTED SHEETS, AND PILLOW CASES, SOLD AS A UNIT; BED SPREADS, COVERLETS, BED SKIRTS, BED PADS, FEATHER BEDS, BED CANOPIES, PILLOW CASES, COVERS, AND SHAMS, MATTRESS COVERS AND PADS, COVERS FOR CUSHIONS, DUVETS AND DUVET COVERS, EIDERDOWNS AND EIDERDOWN COVERS; CRIB BUMPERS, CRIB SHEETS, CRIB COMFORTERS, CRIB DUST RUFFLES, DIAPER CHANGING PADS NOT OF PAPER, AND FABRIC DIAPER STACKERS; DRAPERY AND DRAPERIES, SHROUDS, SWAGS, KITCHEN TOWELS, DISH CLOTHS, BEACH TOWELS, GOLF TOWELS, HOODED TOWELS, HANDKERCHIEFS, TABLE CLOTHS NOT OF PAPER, DUST RUFFLES, POT HOLDERS, BARBECUE MITTS, OVEN MITTS, TABLE LINEN, NAPERY, FABRIC TABLE RUNNERS, TEXTILE PLACE MATS, PLACE MATS NOT OF PAPER, TEXTILE NAPKINS, CLOTH DOILIES, CLOTH AND FELT PENNANTS, CLOTH FLAGS, CLOTH COASTERS, TOWELS, BATH LINEN, HOUSEHOLD LINEN, WASH CLOTHS, AND SHOWER CURTAINS; TEXTILE WALL HANGINGS, CURTAINS, POUFS, PUFFS, FABRIC VALANCES, TAPESTRIES OF TEXTILE, AND LAP RUGS (U.S. CLS. 42 AND 50).

ELISSA GARBER KON, EXAMINING ATTORNEY

SN 77-495,867. WORTHY, ROSA, FAYETTEVILLE, GA. FILED 6-11-2008.



THE COLOR(S) LIGHT PURPLE AND DARK PURPLE IS/ ARE CLAIMED AS A FEATURE OF THE MARK.

THE MARK CONSISTS OF AN OVAL DESIGN FILLED WITH LIGHT PURPLE. THE BORDER OF THE OVAL IS IN DARK PURPLE, AND THE WORDING "SKIRT-N-CURL" IS IN DARK PURPLE IN THE CENTER OF THE OVAL.

FOR CLOTH COVER FOR THE FACE THAT IS PLACED AROUND THE HAIR LINE OF THE HEAD TO PROTECT THE SKIN OF THE FOREHEAD, EARS, SIDE OF FACE, AND NECK WHILE USING HAIR CURLING IRONS OR FLAT IRON (U.S. CLS. 42 AND 50).

GRETTA YAO, EXAMINING ATTORNEY

CLASS 24—(Continued).

SN 77-580,558. THE JEWISH ZODIAC, LLC, WOODLAND HILLS, CA. FILED 9-28-2008.

THE HISPANIC ZODIAC

THE MARK CONSISTS OF STANDARD CHARACTERS WITHOUT CLAIM TO ANY PARTICULAR FONT, STYLE, SIZE, OR COLOR.

FOR WASH CLOTHS, PLACE MATS OF TEXTILE MATERIAL, TABLECLOTHS NOT OF PAPER, PLASTIC PLACE MATS, VINYL PLACE MATS, TEXTILE TABLE RUNNERS, TEXTILE NAPKINS, OVEN MITTS, POT HOLDERS (U.S. CLS. 42 AND 50).

SUNG IN, EXAMINING ATTORNEY

SN 77-580,563. THE JEWISH ZODIAC, LLC, WOODLAND HILLS, CA. FILED 9-28-2008.

THE ITALIAN ZODIAC

THE MARK CONSISTS OF STANDARD CHARACTERS WITHOUT CLAIM TO ANY PARTICULAR FONT, STYLE, SIZE, OR COLOR.

FOR WASH CLOTHS, PLACE MATS OF TEXTILE MATERIAL, TABLECLOTHS NOT OF PAPER, PLASTIC PLACE MATS, VINYL PLACE MATS, TEXTILE TABLE RUNNERS, TEXTILE NAPKINS, OVEN MITTS, POT HOLDERS (U.S. CLS. 42 AND 50).

SUNG IN, EXAMINING ATTORNEY

SN 77-588,005. VICTOR INNOVATIVE TEXTILES LLC, FALL RIVER, MA. FILED 10-8-2008.

ATELIER

THE MARK CONSISTS OF STANDARD CHARACTERS WITHOUT CLAIM TO ANY PARTICULAR FONT, STYLE, SIZE, OR COLOR.

PRIORITY CLAIMED UNDER SEC. 44(D) ON CANADA APPLICATION NO. 1412661, FILED 9-29-2008.

THE ENGLISH TRANSLATION OF "ATELIER" IN THE MARK IS WORKSHOP.

FOR COMMERCIAL AND UPHOLSTERY FABRIC FOR OFFICE, RESIDENTIAL AND OUTDOOR FURNITURE (U.S. CLS. 42 AND 50).

FIRST USE 10-0-2008; IN COMMERCE 10-0-2008.

JANICE L. MCMORROW, EXAMINING ATTORNEY

CLASS 24—(Continued).

SN 77-588,008. VICTOR INNOVATIVE TEXTILES LLC, FALL RIVER, MA. FILED 10-8-2008.

eHome

THE MARK CONSISTS OF STANDARD CHARACTERS WITHOUT CLAIM TO ANY PARTICULAR FONT, STYLE, SIZE, OR COLOR.

PRIORITY CLAIMED UNDER SEC. 44(D) ON CANADA APPLICATION NO. 1412663, FILED 9-29-2008.

FOR COMMERCIAL AND UPHOLSTERY FABRIC FOR OFFICE, RESIDENTIAL AND OUTDOOR FURNITURE (U.S. CLS. 42 AND 50).

FIRST USE 4-0-2009; IN COMMERCE 4-0-2009.

JANICE L. MCMORROW, EXAMINING ATTORNEY

SN 77-588,010. VICTOR INNOVATIVE TEXTILES LLC, FALL RIVER, MA. FILED 10-8-2008.

Terrazzo

THE MARK CONSISTS OF STANDARD CHARACTERS WITHOUT CLAIM TO ANY PARTICULAR FONT, STYLE, SIZE, OR COLOR.

PRIORITY CLAIMED UNDER SEC. 44(D) ON CANADA APPLICATION NO. 1412667, FILED 9-29-2008.

FOR COMMERCIAL AND UPHOLSTERY FABRIC FOR OFFICE, RESIDENTIAL AND OUTDOOR FURNITURE (U.S. CLS. 42 AND 50).

FIRST USE 12-0-2005; IN COMMERCE 12-0-2005.

JANICE L. MCMORROW, EXAMINING ATTORNEY

SN 77-588,013. VICTOR INNOVATIVE TEXTILES LLC, FALL RIVER, MA. FILED 10-8-2008.

World@Home

THE MARK CONSISTS OF STANDARD CHARACTERS WITHOUT CLAIM TO ANY PARTICULAR FONT, STYLE, SIZE, OR COLOR.

PRIORITY CLAIMED UNDER SEC. 44(D) ON CANADA APPLICATION NO. 1412665, FILED 9-29-2008.

FOR COMMERCIAL AND UPHOLSTERY FABRIC FOR OFFICE, RESIDENTIAL AND OUTDOOR FURNITURE (U.S. CLS. 42 AND 50).

FIRST USE 4-0-2009; IN COMMERCE 4-0-2009.

JANICE L. MCMORROW, EXAMINING ATTORNEY

CLASS 24—(Continued).

SN 77-598,868. AMERICAN TEXTILE COMPANY, DUNELLES, PA. FILED 10-23-2008.

HUG STRAPS

THE MARK CONSISTS OF STANDARD CHARACTERS WITHOUT CLAIM TO ANY PARTICULAR FONT, STYLE, SIZE, OR COLOR.

NO CLAIM IS MADE TO THE EXCLUSIVE RIGHT TO USE "STRAPS", APART FROM THE MARK AS SHOWN.

FOR BED SHEET STRAPS (U.S. CLS. 42 AND 50).

ANDREA HACK, EXAMINING ATTORNEY

SN 77-607,174. COVER YOUR ASSETS-SEATCOVERS, INC., SANDY, UT. FILED 11-4-2008.

COVER YOUR ASSETS

THE MARK CONSISTS OF STANDARD CHARACTERS WITHOUT CLAIM TO ANY PARTICULAR FONT, STYLE, SIZE, OR COLOR.

FOR PERSONAL PORTABLE UNFITTED FABRIC SEAT COVERS TO COVER THEATER, ARENA, AND SIMILAR SEATS (U.S. CLS. 42 AND 50).

LINDA LAVACHE, EXAMINING ATTORNEY

SN 77-610,335. DISNEY ENTERPRISES, INC., BURBANK, CA. FILED 11-7-2008.

SWEET FOREST FRIENDS

THE MARK CONSISTS OF STANDARD CHARACTERS WITHOUT CLAIM TO ANY PARTICULAR FONT, STYLE, SIZE, OR COLOR.

FOR AFGHANS; BARBECUE MITTS; BATH LINEN; BATH TOWELS; BED BLANKETS; BED CANOPIES; BED LINEN; BED SHEETS; BED SKIRTS; BED SPREADS; BLANKET THROWS; CALICO; CHILDREN'S BLANKETS; CLOTH COASTERS; CLOTH DOILIES; CLOTH FLAGS; CLOTH PENNANTS; COMFORTERS; CRIB BUMPERS; CURTAINS; FABRIC FLAGS; FELT PENNANTS; GOLF TOWELS; HAND TOWELS; HANDKERCHIEFS; HOODED TOWELS; HOUSEHOLD LINEN; KITCHEN TOWELS; OVEN MITTS; PILLOW CASES; PILLOW COVERS; POT HOLDERS; QUILTS; RECEIVING BLANKETS; SILK BLANKETS; TABLE LINEN; TEXTILE NAPKINS; TEXTILE PLACE MATS; TEXTILE TABLECLOTHS; THROWS; TOWELS; WASHCLOTHS; WOOLEN BLANKETS (U.S. CLS. 42 AND 50).

RON FAIRBANKS, EXAMINING ATTORNEY

CLASS 24—(Continued).

SN 77-610,569. INVISTA NORTH AMERICA S.A.R.L., WILMINGTON, DE. FILED 11-9-2008.



OWNER OF U.S. REG. NOS. 2,990,866, 3,321,866 AND 3,532,608.

THE MARK CONSISTS OF THE DESIGN OF A THERMOMETER OUTLINED IN A DARK BORDER WITH A DARK BACKGROUND APPEARING INSIDE THE THERMOMETER BEHIND THE TERM "THERMO", WHICH APPEARS IN CONTRASTING LIGHT TEXT, AND A LIGHT BACKGROUND APPEARING BEHIND THE WORD "LITE", WHICH APPEARS IN DARK TEXT. THE THERMOMETER HAS LIGHT SHADING HORIZONTALLY FROM ABOVE THE BULB TO THE END OF "THERMO", AND DARKER SHADING ALONG THE ENTIRE BOTTOM HALF OF THE LENGTH OF THE THERMOMETER.

FOR TEXTILES AND TEXTILE GOODS, NAMELY, CLOTH TEXTILES AND TEXTILE FABRICS FOR USE IN THE MANUFACTURE OF APPAREL AND FOOTWEAR (U.S. CLS. 42 AND 50).

FIRST USE 1-10-2001; IN COMMERCE 1-10-2001.

AMY KERTGATE, EXAMINING ATTORNEY

SN 77-684,004. ULTRAFLEX SYSTEMS, INC., RANDOLPH, NJ. FILED 3-5-2009.

UltraFlag

THE MARK CONSISTS OF STANDARD CHARACTERS WITHOUT CLAIM TO ANY PARTICULAR FONT, STYLE, SIZE, OR COLOR.

OWNER OF U.S. REG. NOS. 2,533,694, 3,310,716 AND OTHERS.

FOR KNITTED 100% POLYESTER TRANSPARENT FABRIC WITH GOOD BLEED THROUGH FOR EXCELLENT COLOR BRILLIANCE FOR MAKING FLAGS AND INDOOR AND SHORT-TERM OUTDOOR HANGING BANNERS (U.S. CLS. 42 AND 50).

FIRST USE 11-0-2008; IN COMMERCE 11-0-2008.

HEATHER BIDDULPH, EXAMINING ATTORNEY

CLASS 24—(Continued).

SN 77-684,022. ULTRAFLEX SYSTEMS, INC., RANDOLPH, NJ. FILED 3-5-2009.

UltraPoplin

THE MARK CONSISTS OF STANDARD CHARACTERS WITHOUT CLAIM TO ANY PARTICULAR FONT, STYLE, SIZE, OR COLOR.

OWNER OF U.S. REG. NOS. 2,533,694, 3,310,716 AND OTHERS.

FOR KNITTED 100% POLYESTER POPLIN FABRIC WITH A WATER-BASED COATING THAT CAN BE PRINTED WITH DIRECT DYE-SUBLIMATION, TRANSFER DYE-SUBLIMATION AND UV PRINTING FOR USE IN CREATING TRADESHOW SIGNS, BANNERS AND GRAPHIC DISPLAYS (U.S. CLS. 42 AND 50).

FIRST USE 11-0-2008; IN COMMERCE 11-0-2008.

HEATHER BIDDULPH, EXAMINING ATTORNEY

SN 77-684,077. ULTRAFLEX SYSTEMS, INC., RANDOLPH, NJ. FILED 3-5-2009.

UltraCanvas

THE MARK CONSISTS OF STANDARD CHARACTERS WITHOUT CLAIM TO ANY PARTICULAR FONT, STYLE, SIZE, OR COLOR.

OWNER OF U.S. REG. NOS. 2,533,694, 3,310,716 AND OTHERS.

FOR WOVEN CANVAS FABRIC OF 100% POLYESTER THAT HAS A WATER-BASED BATH COATING FOR DIRECT DYE-SUBLIMATION, TRANSFER DYE-SUBLIMATION AND UV PRINTING FOR MAKING INDOOR AND SHORT-TERM OUTDOOR BANNERS (U.S. CLS. 42 AND 50).

FIRST USE 11-0-2008; IN COMMERCE 11-0-2008.

HEATHER BIDDULPH, EXAMINING ATTORNEY

SN 77-684,156. ULTRAFLEX SYSTEMS, INC., RANDOLPH, NJ. FILED 3-5-2009.

UltraCotton

THE MARK CONSISTS OF STANDARD CHARACTERS WITHOUT CLAIM TO ANY PARTICULAR FONT, STYLE, SIZE, OR COLOR.

OWNER OF U.S. REG. NOS. 2,533,694, 3,310,716 AND OTHERS.

FOR WOVEN 100% NATURAL COTTON FABRIC WITH A WATER-BASED COATING ON ONE SIDE FOR USE IN PRODUCTION OF INDOOR ART REPROGRAPHICS, AND THEATRICAL AND TRADESHOW EVENT SIGNS AND BANNERS (U.S. CLS. 42 AND 50).

FIRST USE 11-0-2008; IN COMMERCE 11-0-2008.

HEATHER BIDDULPH, EXAMINING ATTORNEY

CLASS 24—(Continued).

SN 77-718,399. RCR ENTERPRISES, LLC, WELCOME, NC. FILED 4-21-2009.



OWNER OF U.S. REG. NO. 3,428,362.
THE MARK CONSISTS OF THE NUMBER "31" IN A
STYLIZED FORMAT.

FOR CLOTH BANNERS; CLOTH FLAGS (U.S. CLS. 42
AND 50).

FIRST USE 2-9-1997; IN COMMERCE 2-9-1997.
AMY KERTGATE, EXAMINING ATTORNEY

SN 77-721,194. TWENTIETH CENTURY FOX FILM COR-
PORATION, LOS ANGELES, CA. FILED 4-23-2009.



OWNER OF U.S. REG. NO. 3,001,994.
NO CLAIM IS MADE TO THE EXCLUSIVE RIGHT TO
USE "SPORTS", APART FROM THE MARK AS SHOWN.

THE MARK CONSISTS OF THE STYLIZED WORDS "THE
ADVENTURES OF DIGGER AND FRIENDS" WHICH
APPEAR INSIDE OF TWO OVAL CONCENTRIC LINES,
THE WORDS "FOX SPORTS" WHICH APPEAR UNDER
THE WORD "FRIENDS" AND INSIDE OF THE OVAL
SHAPE OVERLAPPING ON THE BOTTOM OF THE INNER
OVAL LINE AND FIVE COSTUMED GOPHER CHARAC-
TERS WHICH APPEAR ABOVE THE OUTER OVAL LINE.

FOR CLOTH FLAGS, FABRIC FLAGS, NYLON
FLAGS; BED SHEETS, PILLOWCASES, PILLOW SHAMS;
BLANKETS, NAMELY, BED BLANKETS; BLANKET
THROWS, COMFORTERS, BED SPREADS, BATH TO-
WELS, BEACH TOWELS, KITCHEN TOWELS, OVEN
MITTS, BARBECUE MITTS, TABLECLOTHS NOT MADE
OF PAPER, PLACEMAT NOT MADE OF PAPER, AND
FABRIC NAPKINS (U.S. CLS. 42 AND 50).

LINDA LAVACHE, EXAMINING ATTORNEY

CLASS 24—(Continued).

SN 77-721,913. TRUEWAY CORPORATION, TAOYUAN
COUNTY 320, TAIWAN, FILED 4-24-2009.



THE MARK CONSISTS OF STANDARD CHARACTERS
WITHOUT CLAIM TO ANY PARTICULAR FONT, STYLE,
SIZE, OR COLOR.

FOR WASHCLOTHS; TEXTILE USED AS LINING FOR
CLOTHING; LINEN LINING FABRIC FOR SHOES;
FABRIC FOR BOOTS AND SHOES; CREPE CLOTH;
LINGERIE FABRIC; JERSEY FABRICS FOR CLOTHING;
ZEPHYR FABRIC; FABRICS FOR TEXTILE USE; TO-
WELS OF TEXTILE; BED COVERS; BED SHEETS;
PILLOWCASES; BED LINEN; BED SPREADS; OIL
CLOTHS; PLACE MATS NOT OF PAPER; ELASTIC
FABRICS FOR CLOTHING; FABRICS FOR THE MANU-
FACTURE OF WETSUITS AND LIFEJACKETS; JERSEY
MATERIAL; KNITTED FABRIC; KNITTED FABRICS;
NYLON FABRIC; POLYESTER FABRIC; SYNTHETIC
FIBER FABRICS; TEXTILE FABRIC INCORPORATING
WATERPROOF AND GAS PERMEABLE MEMBRANE
MADE OF EXPANDED POLYTETRAFLUOROETHY-
LENE FOR THE PROTECTION OF SENSITIVE EQUIP-
MENT AND PACKAGING FROM CONTAMINATES;
WATERPROOF FABRIC FOR MANUFACTURING
CLOTHING, FURNITURE AND AUTOMOBILE UP-
HOLSTERY, AND LUGGAGE (U.S. CLS. 42 AND 50).

FIRST USE 12-1-2008; IN COMMERCE 12-1-2008.
PATRICIA EVANKO, EXAMINING ATTORNEY

SN 77-724,298. JAMES R. CRANE, FARMINGTON, IL. FILED
4-28-2009.



THE MARK CONSISTS OF STANDARD CHARACTERS
WITHOUT CLAIM TO ANY PARTICULAR FONT, STYLE,
SIZE, OR COLOR.

FOR COTTON, WOOL, AND SYNTHETIC FABRICS
HAVING CAMOUFLAGE PATTERNS (U.S. CLS. 42 AND
50).

ROSELLE HERRERA, EXAMINING ATTORNEY

CLASS 24—(Continued).

SN 77-724,800. FLAGZONE LLC, GILBERTSVILLE, PA. FILED 4-29-2009.



NO CLAIM IS MADE TO THE EXCLUSIVE RIGHT TO USE "FLAG", APART FROM THE MARK AS SHOWN.

THE COLOR(S) RED, WHITE AND BLUE IS/ARE CLAIMED AS A FEATURE OF THE MARK.

THE MARK CONSISTS OF THE WORDS "INDEPENDENCE FLAG" IN WAVY BLUE FONT WITH A ROW OF BLUE STARS WITH WHITE CENTERS ABOVE "INDEPENDENCE", A FEATHER IN RED ABOVE THE STARS AND THREE WAVY RED LINES BENEATH THE WORD "INDEPENDENCE", ALL ON A TRANSPARENT BACKGROUND.

FOR BANNERS AND FLAGS OF TEXTILE (U.S. CLS. 42 AND 50).

KATHRYN COWARD, EXAMINING ATTORNEY

CLASS 24—(Continued).

SN 77-725,474. TWENTIETH CENTURY FOX FILM CORPORATION, LOS ANGELES, CA. FILED 4-29-2009.



OWNER OF U.S. REG. NO. 3,001,994.

NO CLAIM IS MADE TO THE EXCLUSIVE RIGHT TO USE "SPORTS", APART FROM THE MARK AS SHOWN.

THE MARK CONSISTS OF THE STYLIZED WORDS "THE ADVENTURES OF DIGGER AND FRIENDS" WHICH APPEAR IN THE CENTER, THE WORDS "FOX SPORTS" WHICH APPEAR INSIDE OF THE OVAL SHAPE ON THE TOP CENTER AND FIVE COSTUMED GOPHER CHARACTERS, AND ALL ARE DISPLAYED INSIDE OF THE RECTANGULAR BACKGROUND.

FOR CLOTH FLAGS, FABRIC FLAGS, NYLON FLAGS; BED SHEETS, PILLOWCASES, PILLOW SHAMS; BLANKETS, NAMELY, BED BLANKETS; BLANKET THROWS, COMFORTERS, BED SPREADS, BATH TOWELS, BEACH TOWELS, KITCHEN TOWELS, OVEN MITTS, BARBECUE MITTS, TABLECLOTHS NOT MADE OF PAPER, PLACEMATS NOT MADE OF PAPER, AND FABRIC NAPKINS (U.S. CLS. 42 AND 50).

LINDA LAVACHE, EXAMINING ATTORNEY

SN 77-725,120. FLAGZONE LLC, GILBERTSVILLE, PA. FILED 4-29-2009.

SN 77-727,764. SNYDER MANUFACTURING, INC., DOVER, OH. FILED 5-3-2009.

AdverTex

INDEPENDENCE FLAG

THE MARK CONSISTS OF STANDARD CHARACTERS WITHOUT CLAIM TO ANY PARTICULAR FONT, STYLE, SIZE, OR COLOR.

NO CLAIM IS MADE TO THE EXCLUSIVE RIGHT TO USE "FLAG", APART FROM THE MARK AS SHOWN.

FOR BANNERS AND FLAGS OF TEXTILE (U.S. CLS. 42 AND 50).

KATHRYN COWARD, EXAMINING ATTORNEY

THE MARK CONSISTS OF STANDARD CHARACTERS WITHOUT CLAIM TO ANY PARTICULAR FONT, STYLE, SIZE, OR COLOR.

FOR BANNERS AND FLAGS OF TEXTILE; CLOTH BANNERS; FABRIC FLAGS; FABRICS FOR THE MANUFACTURE OF SIGNS; FABRICS THAT MAY OR MAY NOT HAVE PRINTED PATTERNS AND DESIGNS THEREON FOR USE IN TEXTILE APPLICATIONS, NAMELY, THE MANUFACTURE OF APPAREL, UPHOLSTERY, SIGNAGE, FLAGS, BANNERS AND WALL-PAPER; PRINTED FABRIC SIGNAGE PANELS; TEXTILE SIGNAGE PANELS; TEXTILES FOR DYE-SUBLIMATION PRINTING ; VINYL AND CLOTH TEXTILES FOR USE IN THE MANUFACTURE OF SIGNS (U.S. CLS. 42 AND 50).

FIRST USE 1-1-1996; IN COMMERCE 1-1-1996.

HELENE LIWINSKI, EXAMINING ATTORNEY

CLASS 24—(Continued).

SN 77-728,162. BARILLA G.E.R. FRATELLI - SOCIETÀ PER AZIONI, PARMA, ITALY, FILED 5-4-2009.

**SHARE THE TABLE THE
BARILLA FAMILY DINNER
PROJECT**

THE MARK CONSISTS OF STANDARD CHARACTERS WITHOUT CLAIM TO ANY PARTICULAR FONT, STYLE, SIZE, OR COLOR.

OWNER OF U.S. REG. NOS. 897,460, 2,964,682 AND OTHERS.

NO CLAIM IS MADE TO THE EXCLUSIVE RIGHT TO USE "FAMILY DINNER", APART FROM THE MARK AS SHOWN.

FOR TABLE CLOTHS NOT OF PAPER; CLOTH BANNERS; PLACE MATS NOT OF PAPER (U.S. CLS. 42 AND 50).

KRISTIN DAHLING, EXAMINING ATTORNEY

CLASS 24—(Continued).

SN 77-743,090. SPELLING TELEVISION INC., STUDIO CITY, CA. FILED 5-22-2009.

MELROSE PLACE

THE MARK CONSISTS OF STANDARD CHARACTERS WITHOUT CLAIM TO ANY PARTICULAR FONT, STYLE, SIZE, OR COLOR.

OWNER OF U.S. REG. NOS. 1,821,796 AND 2,350,925.

FOR AFGHANS; BARBECUE MITTS; BATH LINEN; BATH TOWELS; BEACH TOWELS; BED BLANKETS; BED CANOPIES; BED LINEN; BED SHEETS; BED SKIRTS; BED SPREADS; BLANKET THROWS; CLOTH COASTERS; CLOTH DOILIES; CLOTH FLAGS; CLOTH PENNANTS; COMFORTERS; CURTAINS; GOLF TOWELS; HAND TOWELS; HANDKERCHIEFS; HOUSEHOLD LINEN; KITCHEN TOWELS; OVEN MITTS; PILLOW CASES; PILLOW COVERS; POT HOLDERS; QUILTS; SILK BLANKETS; TABLE LINEN; TEXTILE NAPKINS; TEXTILE PLACE MATS; TEXTILE TABLECLOTHS; THROWS; WASHCLOTHS; WOOLEN BLANKETS; CLOTH BANNERS; TEXTILE WALL HANGINGS (U.S. CLS. 42 AND 50).

KRISTIN CARLSON, EXAMINING ATTORNEY

SN 77-733,134. TREASURE GARDEN, INC, BALDWIN PARK, CA. FILED 5-8-2009.

entexia

THE MARK CONSISTS OF STANDARD CHARACTERS WITHOUT CLAIM TO ANY PARTICULAR FONT, STYLE, SIZE, OR COLOR.

FOR FABRICS FOR THE MANUFACTURE OF UMBRELLA, AWNINGS, PAVILIONS, AND OTHER SHADE STRUCTURES, NAMELY, ARBORS, PERGOLAS AND TENT; FURNITURE COVERS, NAMELY, UNFITTED FABRIC FURNITURE COVERS, UNFITTED FURNITURE COVERS NOT OF PAPER (U.S. CLS. 42 AND 50).

TEJBIR SINGH, EXAMINING ATTORNEY

SN 79-049,325. LE JACQUARD FRANCAIS, FRANCE, FILED 12-27-2007.



PRIORITY DATE OF 7-19-2007 IS CLAIMED. OWNER OF INTERNATIONAL REGISTRATION 0951828 DATED 12-27-2007, EXPIRES 12-27-2017.

OWNER OF U.S. REG. NOS. 1,569,813 AND 2,258,620.

THE COLOR(S) BEIGE AND PINK IS/ARE CLAIMED AS A FEATURE OF THE MARK.

THE MARK CONSISTS OF A PINK VERTICAL STRIPE WITH THE WORDING "PURE COULEUR BY" IN BEIGE. THIS WORDING APPEARS VERTICALLY AT THE TOP AND BOTTOM OF THE STRIPE. IN THE CENTER OF THE STRIPE IS A BEIGE DIAMOND WITH A PINK OUTLINE EDGE AND IN THE CENTER IS THE WORDING "LE JACQUARD FRANCAIS" IN PINK LETTERING AND SMALL PINK HORIZONTAL LINE BENEATH THE WORD "FRANCAIS".

THE ENGLISH TRANSLATION OF "COULEUR" IS "COLOR" AND THE ENGLISH TRANSLATION OF "FRANCAIS" IS "FRENCH".

SEC. 2(F) AS TO JACQUARD FRANCAIS.

FOR FABRICS FOR TEXTILE USE; BED COVERS; PLASTIC BED COVERS; TABLE LINEN, NAMELY, COASTERS, NAPKINS, PLACEMATS, RUNNERS, TABLECLOTHS; LINGERIE FABRIC; TABLE AND HOUSEHOLD LINEN (U.S. CLS. 42 AND 50).

WENDY GOODMAN, EXAMINING ATTORNEY

CLASS 25—CLOTHING

SN 76-633,024. AUSTRALIA ZOO PTY LTD, BEERWAH, QUEENSLAND, 4519, AUSTRALIA, FILED 3-9-2005.



OWNER OF AUSTRALIA REG. NO. 857233, DATED 11-15-2000, EXPIRES 11-15-2010.

NO CLAIM IS MADE TO THE EXCLUSIVE RIGHT TO USE "WEAR", APART FROM THE MARK AS SHOWN.

FOR CLOTHING, NAMELY, T-SHIRTS, SHIRTS, BLOUSES AND TOPS, SHORTS AND BOARD SHORTS, SWIMWEAR, JACKETS, PULLOVERS, SWEATERS, JEANS, TROUSERS, BELTS, DRESSES, SKIRTS, SARONGS, UNDERWEAR, TRACK SUITS, NAMELY, TRACK SUIT TOPS AND TRACK SUIT TROUSERS, SCARVES; HOSIERY, NAMELY, SOCKS, FOOTWEAR, NAMELY, SHOES, BOOTS, SANDALS, THONGS AND SLIPPERS; HEADGEAR, NAMELY, HATS, CAPS, BEANIES, BERETS, CAPS WITH PEAK AND VISORS (U.S. CLS. 22 AND 39).

WILLIAM ROSSMAN, EXAMINING ATTORNEY

SN 76-690,070. 9148-3222 QUEBEC INC., SHERBROOKE (QUÉBEC) J1J 4H6, CANADA, FILED 5-28-2008.

QUINTSOUL

THE MARK CONSISTS OF STANDARD CHARACTERS WITHOUT CLAIM TO ANY PARTICULAR FONT, STYLE, SIZE, OR COLOR.

FOR SWIM SUITS; BEACH CLOTHING, NAMELY, BEACHWEAR (U.S. CLS. 22 AND 39).

CHARISMA HAMPTON, EXAMINING ATTORNEY

SN 76-691,689. KOMAN SPORTSWEAR MFG. CORP., CARLSTADT, NJ. FILED 7-30-2008.



THE MARK CONSISTS OF THE STYLIZED WORDING "I-LINK" WITH THE FIRST "I" IN THE CENTER OF A SHADED SQUARE.

FOR CLOTHING, NAMELY, PANTS; SWEATERS; JACKETS; JEANS; DOWN JACKETS; PULLOVERS; FUR COATS AND JACKETS; JOGGING PANTS; KNIT SHIRTS; LEATHER JACKETS; LEATHER PANTS; SHIRTS; TROUSERS; SHORTS; VESTS; T-SHIRTS; SWEAT SHIRTS; AND SWEAT PANTS (U.S. CLS. 22 AND 39).

MORGAN WYNNE, EXAMINING ATTORNEY

CLASS 25—(Continued).

SN 76-694,225. FALLON, BETH, ENDICOTT, NY. FILED 10-2-2008.

SOOF

THE MARK CONSISTS OF STANDARD CHARACTERS WITHOUT CLAIM TO ANY PARTICULAR FONT, STYLE, SIZE, OR COLOR.

FOR CLOTHING, NAMELY, ALBS, ANKLETS, ANORAKS, APRONS, ASCOTS, ATHLETIC UNIFORMS, BABUSHKAS, BABY BUNTING, SKI BOOT BAGS, BALLOON PANTS, BANDANAS, BANDEAUX, BASEBALL CAPS, BATHING TRUNKS, BATHING CAPS, BATHING SUITS, BATHROBES, BEACH COVERUPS, BEACHWEAR, BED JACKETS, BELTS, BERETS, BERMUDA SHORTS, BIKINIS, BLAZERS, BLOOMERS, BLOUSES, BLOUSONS, BOAS, BODY SHAPERS, BODY SUITS, BOLEROS, BONNETS, BOOTIES, BOTTOMS, BOW TIES, BOXER SHORTS, BRAS, BRASSIERES, BREECHES, BRIEFS, BUSTIERS, CAFTANS, CAMISOLES, CAPES, CAPS, CARDIGANS, CASSOCKS, CHAPS, CHASUBLES, CHEMISES, CHEMISETTES, CLOGS, CLOTH DIAPERS, CLOTH BIBS, COATS, LAB COATS, COLLARS, COMBINATIONS, COMPETITORS' NUMBERS OF TEXTILE, CORSELETS, CORSETS, FOUNDATION GARMENTS, MASQUERADE COSTUMES AND MASKS SOLD IN CONNECTION THEREWITH, MASQUERADE COSTUMES, HALLOWEEN COSTUMES, COVERALLS, COVERUPS, CRAVATS, CREEPERS, CUFFS, CULOTTES, CUMMERBUNDS, DICKIES, DRESS SHIELDS, DRESSES, DRESSING GOWNS, DRY SUITS, DUNGAREES, DUSTERS, EAR MUFFS, ESPADRILLES, EVENING GOWNS, FISHING WADERS, FISHING VESTS, FLIGHT SUITS, FOUL WEATHER GEAR, FROCKS, FUR JACKETS, FUR COATS, FUR STOLE, FUR CLOAKS, GABERDINES, GAITERS, GALOSHES, GARTER BELTS, GAUCHOS, GIRDLES, GLOVES, GOLF SHIRTS, GOWNS, GREAT COATS, GYM SUITS, GYM SHORTS, HALTER TOPS, HEAD WEAR, HEAD BANDS, HOODS, HOSIERY, HOUSECOATS, INFANT DIAPER COVERS, INFANTWEAR, JACKETS, JEANS, JERKINS, JERSEYS, JODHPURS, JOGGING SUITS, JUMPERS, JUMPSUITS, KERCHIEFS, KILTS, KIMONOS, KNEE HIGHS, KNICKERS, KNIT SHIRTS, LAB COATS, LAYETTES, LEATHER COATS, LEATHER JACKETS, LEG WARMERS, LEGGINGS, LEOTARDS, LIGHT-REFLECTING COATS, LIGHT-REFLECTING JACKETS, LINGERIE, LOUNGEWEAR, MAILLOTS, MANTILLAS, MANTLES, MINISKIRTS, MITTENS, MOCCASINS, MONEY BELTS, MUFFLERS, MUFFS, MUKIUKS, MUU MUUS, NECK BANDS, NECKERCHIEFS, NECKTIES, NECKWEAR, NEGLIGEEES, NIGHT GOWNS, NIGHT SHIRTS, NURSING APPAREL, NAMELY, NURSING BRAS AND BLOUSES, OVERALLS, OVERCOATS, OVERSHOES, PAJAMAS, PANTALOONS, PANTIES, PANTS, PANTSUITS, PANTYHOSE, PARAMENTS, PAREU, PARKAS, PEDAL PUSHERS, PEIGNOIRS, PELERINES, PELISSES, PETTICOATS, PINAFORES, PLAY SUITS, PLUS FOURS, POCKET SQUARES, POLO SHIRTS, PONCHOS, PULLOVERS, QUILTED VESTS, RAIN COATS, RAIN SUITS, RAINWEAR, ROBES, ROMPERS, RUBBERS, SARIS, SARONGS, SASHES, SCARVES, SHAWLS, SHIFTS, SHIRTS, SHORT SETS, SHORTALLS, SHORTS, SHOULDER PADS FOR CLOTHING, SHOWER CAPS, SINGLET, SKI SUITS, SKI WEAR, SKI BIBS, SKI BOOT BAGS, SKI GLOVES, SKI MASKS, SKI PANTS, SKIRTS, SKORTS, SLACKS, SLEEP MASKS, SLEEPWEAR, SLIPPERS, SLIPS, SMOCKS, SNOW SUITS, SNOW PANTS, SNOWBOARD GLOVES, SOCKS, SPORT COATS, SPORT SHIRTS, STOCKINGS, STOLE, SUIT COATS, SUITS, SUN VISORS, SUNSUITS, SUSPENDERS, SWADDLING CLOTHES, SWEAT SHORTS, SWEAT SHIRTS, SWEAT BANDS, SWEAT SUITS, SWEAT PANTS, SWEATERS, SWEAT SOCKS, SWIM TRUNKS, SWIM WEAR, SWIMSUITS, T-SHIRTS, TAILLEURS, TANGAS, TANK TOPS, TAP PANTS, TEDDIES, TENNIS WEAR, THERMAL

CLASS 25—(Continued).

SOCKS, THERMAL UNDERWEAR, TIES, BOW TIES, TIGHTS, TOE BOXES, TOGAS, TOPCOATS, TOPS, TANK TOPS, TOQUES, TRACKSUITS, TROUSERS, TUNICS, TURBANS, TURTLENECK SWEATERS, TURTLENECKS, TUXEDOS, UNDERCLOTHES, UNDERGARMENTS, UNDERPANTS, UNDERSHIRTS, UNDERWEAR, UNIFORMS, UNITARDS, V-NECK SWEATERS, VEILS, VESTED SUITS, VESTS, VISORS, WAISTCOATS, WARM UP SUITS, WATER SOCKS, WEDDING GOWNS, WET SUITS, WIND RESISTANT JACKETS, WIND SHIRTS, WRAPS, WRIST BANDS, ZOOT SUITS, AND ZORI, HEADGEAR, NAMELY, HATS AND CAPS, SHOES AND BOOTS NOT FOR SPORTS, GLOVES FOR DRIVING AUTOMOBILES AND TWO WHEELED VEHICLES (U.S. CLS. 22 AND 39).

FIRST USE 4-25-2008; IN COMMERCE 4-25-2008.
KAREN K. BUSH, EXAMINING ATTORNEY

SN 76-695,727. LEE, ESTHER, LOS ANGELES, CA. FILED 2-11-2009.



THE MARK CONSISTS OF THE WORDING "INCORRUPTIBLE LOVE" TO THE LEFT OF A HEART DESIGN ALL INSIDE A RECTANGLE.

FOR CLOTHING, NAMELY, SHIRTS, DRESSES AND PANTS (U.S. CLS. 22 AND 39).

FIRST USE 2-4-2009; IN COMMERCE 2-4-2009.
CHRISTINE COOPER, EXAMINING ATTORNEY

SN 76-697,130. UNITED LEGWEAR CO., L.L.C., NEW YORK, NY. FILED 4-29-2009.

UNITED HAPPY

THE MARK CONSISTS OF STANDARD CHARACTERS WITHOUT CLAIM TO ANY PARTICULAR FONT, STYLE, SIZE, OR COLOR.

FOR LEGWEAR, NAMELY, TIGHTS, SOCKS, HOSIERY, LEGGINGS, LEG WARMERS, PANTYHOSE STOCKINGS, AND SHOE INSOLES (U.S. CLS. 22 AND 39).

FIRST USE 4-28-2009; IN COMMERCE 4-28-2009.
KHANH LE, EXAMINING ATTORNEY

SN 76-697,185. POOF-SLINKY, INC., PLYMOUTH, MI. FILED 5-4-2009.

NATURE SHADES

THE MARK CONSISTS OF STANDARD CHARACTERS WITHOUT CLAIM TO ANY PARTICULAR FONT, STYLE, SIZE, OR COLOR.

FOR CLOTHING, NAMELY, CAPS WITH DECORATIVE VISORS (U.S. CLS. 22 AND 39).

FIRST USE 3-31-2006; IN COMMERCE 3-31-2006.
DAWN FELDMAN, EXAMINING ATTORNEY

CLASS 25—(Continued).

SN 77-075,485. STROKIN, LLC, CHASKA, MN. FILED 1-3-2007.

RIMROCK

THE MARK CONSISTS OF STANDARD CHARACTERS WITHOUT CLAIM TO ANY PARTICULAR FONT, STYLE, SIZE, OR COLOR.

FOR FOOTWEAR (U.S. CLS. 22 AND 39).
MARK SPARACINO, EXAMINING ATTORNEY

SN 77-138,601. MICHAEL DEANGELIS, STATEN ISLAND, NY. FILED 3-23-2007.

**What happens in Vegas
never happened.**

THE MARK CONSISTS OF STANDARD CHARACTERS WITHOUT CLAIM TO ANY PARTICULAR FONT, STYLE, SIZE, OR COLOR.

FOR SHORT-SLEEVED OR LONG-SLEEVED T-SHIRTS (U.S. CLS. 22 AND 39).

LEIGH CAROLINE CASE, EXAMINING ATTORNEY

SN 77-246,013. ABEJAR ENTERPRISES, CATHEDRAL CITY, CA. FILED 8-2-2007.

FORGIVEN LINE

THE MARK CONSISTS OF STANDARD CHARACTERS WITHOUT CLAIM TO ANY PARTICULAR FONT, STYLE, SIZE, OR COLOR.

NO CLAIM IS MADE TO THE EXCLUSIVE RIGHT TO USE "LINE", APART FROM THE MARK AS SHOWN.

FOR BLOUSES; ATHLETIC FOOTWEAR; ATHLETIC SHOES; BASEBALL CAPS; BEACH SHOES; CAP VISORS; CAPS; CAPS WITH VISORS; BOXER SHORTS; GYM SHORTS; SHORT SETS; SHORT TROUSERS; SHORT-SLEEVED OR LONG-SLEEVED T-SHIRTS; SHORT-SLEEVED SHIRTS; SHORTS; SWEAT SHORTS; UNDERWEAR, NAMELY, BOY SHORTS; WALKING SHORTS; HEADBANDS AGAINST SWEATING; HOODS; JERSEYS; SLEEVELESS JERSEYS; SPORTS JERSEYS; SPORTS JERSEYS AND BREECHES FOR SPORTS; SWEAT BANDS; SWEAT PANTS; SWEAT SHIRTS; SWEAT SUITS; BRIEFS; LADIES' UNDERWEAR; PANTIES; PERSPIRATION ABSORBENT UNDERWEAR CLOTHING; T-SHIRTS; THERMAL UNDERWEAR; THONGS; UNDERWEAR; WOMEN'S UNDERWEAR; CROP TOPS; JACKETS; MUSCLE TOPS; TANK TOPS; TOPS; HATS; HEADBANDS; JOGGING PANTS; PANTS; RUNNING SHOES; SHOES; TENNIS SHOES; TRACK AND FIELD SHOES; WOMEN'S SHOES; KNIT SHIRTS; LONG-SLEEVED SHIRTS; SHIRTS; SPORTS SHIRTS; SPORTS SHIRTS WITH SHORT SLEEVES (U.S. CLS. 22 AND 39).

LINDA MICKLEBURGH, EXAMINING ATTORNEY

CLASS 25—(Continued).

SN 77-291,402. EVIDENT MUSIC GROUP, LLC, CORPUS CHRISTI, TX. FILED 9-28-2007.

COLORBLIND

THE MARK CONSISTS OF STANDARD CHARACTERS WITHOUT CLAIM TO ANY PARTICULAR FONT, STYLE, SIZE, OR COLOR.

FOR CLOTHING, NAMELY, T-SHIRTS, SWEAT-SHIRTS, TANK TOPS, HATS AND JACKETS (U.S. CLS. 22 AND 39).

KATHLEEN LORENZO, EXAMINING ATTORNEY

SN 77-294,291. INTERNATIONAL STORES CORP., PANAMA CITY, PANAMA, FILED 10-2-2007.



attenza

OWNER OF PANAMA REG. NO. 16530101, DATED 9-27-2007, EXPIRES 9-27-2017.

THE MARK CONSISTS OF FIVE SHOPPING BAGS ARRANGED TO BE A FIVE-POINTED STAR.

FOR CLOTHING, NAMELY, SHIRTS AND PANTS; FOOTWEAR; HEADGEAR, NAMELY, HATS AND CAPS (U.S. CLS. 22 AND 39).

WARREN L. OLANDRIA, EXAMINING ATTORNEY

SN 77-294,338. INTERNATIONAL STORES CORP., PANAMA CITY, PANAMA, FILED 10-2-2007.



attenza

D U T Y F R E E

OWNER OF PANAMA REG. NO. 16530601, DATED 9-27-2007, EXPIRES 9-27-2017.

NO CLAIM IS MADE TO THE EXCLUSIVE RIGHT TO USE "DUTY FREE", APART FROM THE MARK AS SHOWN.

THE MARK CONSISTS OF FIVE SHOPPING BAGS ARRANGED TO BE A FIVE-POINTED STAR.

FOR CLOTHING, NAMELY, SHIRTS AND PANTS; FOOTWEAR; HEADGEAR, NAMELY, HATS AND CAPS (U.S. CLS. 22 AND 39).

WARREN L. OLANDRIA, EXAMINING ATTORNEY

CLASS 25—(Continued).

SN 77-294,381. INTERNATIONAL STORES CORP., PANAMA CITY, PANAMA, FILED 10-2-2007.



attenza

L A M E J O R A T E N C I O N

OWNER OF PANAMA REG. NO. 16529701, DATED 9-27-2007, EXPIRES 9-27-2017.

NO CLAIM IS MADE TO THE EXCLUSIVE RIGHT TO USE "LA MEJOR ATENCION", APART FROM THE MARK AS SHOWN.

THE MARK CONSISTS OF FIVE SHOPPING BAGS ARRANGED TO BE A FIVE-POINTED STAR.

THE FOREIGN WORDING IN THE MARK TRANSLATES INTO ENGLISH AS "BEST CARE".

FOR CLOTHING, NAMELY, SHIRTS AND PANTS; FOOTWEAR; HEADGEAR, NAMELY, HATS AND CAPS (U.S. CLS. 22 AND 39).

WARREN L. OLANDRIA, EXAMINING ATTORNEY

SN 77-298,655. ORIOXI INTERNATIONAL, INC., BREA, CA. FILED 10-8-2007.

smarttees

THE MARK CONSISTS OF STANDARD CHARACTERS WITHOUT CLAIM TO ANY PARTICULAR FONT, STYLE, SIZE, OR COLOR.

FOR SHIRTS; SWEAT SHIRTS; T-SHIRTS; PANTS; JACKETS; SHORTS; SKIRTS (U.S. CLS. 22 AND 39).

JANICE KIM, EXAMINING ATTORNEY

CLASS 25—(Continued).

SN 77-328,822. WILLIAMS, Aysel, DBA ORGANIC OATH, SAN JOSE, CA. AND BOWENS, CYNTHIA, UNION CITY, CA. FILED 11-13-2007.

ECO NOT EGO

THE MARK CONSISTS OF STANDARD CHARACTERS WITHOUT CLAIM TO ANY PARTICULAR FONT, STYLE, SIZE, OR COLOR.

FOR MEN'S, WOMEN'S AND CHILDREN'S CLOTHING NAMELY, SHIRTS, TSHIRTS, UNDER SHIRTS, NIGHT SHIRTS, RUGBY SHIRTS, POLO SHIRTS, CARDIGANS, JERSEYS, UNIFORMS, PANTS, TROUSERS, SLACKS, JEANS, CULOTTES, CARGO PANTS, DENIM JEANS, OVERALLS, COVERALLS, JUMPERS, JUMP SUITS, SHORTS, BOXER SHORTS, TOPS, CROP TOPS, TANK TOPS, HALTER TOPS, SWEAT SHIRTS, SWEAT SHORTS, SWEAT PANTS, WRAPS, WARM-UP SUITS, JOGGING SUITS, TRACK SUITS, PLAY SUITS, BLOUSES, SKIRTS, DRESSES, GOWNS, SWEATERS, VESTS, FLEECE VESTS, PULLOVERS, SNOW SUITS, PARKAS, CAPES, ANORAKS, PONCHOS, JACKETS, REVERSIBLE JACKETS, COATS, BLAZERS, SUITS, TURTLENECKS, CLOTH SKI BIBS, SWIMWEAR, BEACHWEAR, TENNIS WEAR, SURF WEAR, SKI WEAR, LAYETTES, INFANTWEAR, INFANTS SLEEPERS, BOOTIES, BABY BIBS NOT OF PAPER, CLOTH DIAPERS, CAPS, SWIM CAPS, BERETS, BEANIES, HATS, VISORS, HEADBANDS, WRIST BANDS, SWEAT BANDS, HEADWEAR, EAR MUFFS, APRONS, SCARVES, BANDANAS, BELTS, SUSPENDERS, NECKWEAR, TIES, NECKERCHIEFS, ASCOTS, UNDERWEAR, THERMAL UNDERWEAR, LONG UNDERWEAR, BRIEFS, SWIM AND BATHING TRUNKS, BRAS, SPORTS BRAS, BRASSIERES, BUSTIERS, CORSETS, PANTIES, THONGS, GARTERS AND GARTER BELTS, TEDDIES, GIRDLES, FOUNDATION GARMENTS, SINGLET, SOCKS, LOUNGEWEAR, ROBES, SMOCKS, UNDERCLOTHES, PAJAMAS, SLEEPWEAR, NIGHT GOWNS, LINGERIE, CAMISOLES, NEGLIGEEES, CHEMISES, CHEMISETTES, SLIPS, SARONGS, LEG WARMERS, HOSIERY, PANTYHOSE, BODY STOCKINGS, KNEE HIGHS, LEGGINGS, TIGHTS, LEOTARDS, BODY SUITS, UNITARDS, BODY SHAPERS, GLOVES, MITTENS, FOOTWEAR, SHOES, SNEAKERS, BOOTS, GALOSHES, SANDALS, FLIP-FLOPS, SLIPPERS AND RAINWEAR (U.S. CLS. 22 AND 39).

NAPOLEON SHARMA, EXAMINING ATTORNEY

SN 77-363,939. IHHR HOSPITALITY PRIVATE LIMITED, NEW DELHI, INDIA, FILED 1-4-2008.

ananda

THE MARK CONSISTS OF STANDARD CHARACTERS WITHOUT CLAIM TO ANY PARTICULAR FONT, STYLE, SIZE, OR COLOR.

OWNER OF U.S. REG. NO. 3,011,041.

THE FOREIGN WORDING IN THE MARK TRANSLATES INTO ENGLISH AS HAPPINESS OR PLEASURE.

FOR ROBES, SHIRTS, PYJAMAS AND KURTAS (U.S. CLS. 22 AND 39).

WON TEAK OH, EXAMINING ATTORNEY

CLASS 25—(Continued).

SN 77-385,965. THE CORPORATE GROUP, DBA BRAD VOLLSTEDT, LA JOLLA, CA. FILED 1-31-2008.

BRADY IS A LADY

THE MARK CONSISTS OF STANDARD CHARACTERS WITHOUT CLAIM TO ANY PARTICULAR FONT, STYLE, SIZE, OR COLOR.

FOR A-SHIRTS; CAMP SHIRTS; DRESS SHIRTS; GOLF SHIRTS; KNIT SHIRTS; LONG-SLEEVED SHIRTS; NIGHT SHIRTS; POLO SHIRTS; RUGBY SHIRTS; SHIRT FRONTS; SHIRTS; SHORT-SLEEVED OR LONG-SLEEVED T-SHIRTS; SHORT-SLEEVED SHIRTS; SLEEP SHIRTS; SPORT SHIRTS; SPORTS SHIRTS; SPORTS SHIRTS WITH SHORT SLEEVES; SWEAT SHIRTS; T-SHIRTS; TEE SHIRTS; WIND SHIRTS; YOGA SHIRTS (U.S. CLS. 22 AND 39).

JOHN GARTNER, EXAMINING ATTORNEY

SN 77-408,384. ECOIST, LLC, MIAMI, FL. FILED 2-28-2008.

ECOIST

THE MARK CONSISTS OF STANDARD CHARACTERS WITHOUT CLAIM TO ANY PARTICULAR FONT, STYLE, SIZE, OR COLOR.

OWNER OF U.S. REG. NOS. 3,070,679 AND 3,223,355.

FOR CLOTHING, NAMELY, SHIRTS, PANTS, SHORTS, JACKETS, SHOES, HATS, BELTS (U.S. CLS. 22 AND 39).

LINDSEY RUBIN, EXAMINING ATTORNEY

SN 77-417,228. MG ENTERPRISES, NASHVILLE, TN. FILED 3-10-2008.



OWNER OF U.S. REG. NO. 3,443,610.

NO CLAIM IS MADE TO THE EXCLUSIVE RIGHT TO USE "TOP-NOTCH NECKWEAR AND FURNISHINGS", APART FROM THE MARK AS SHOWN.

THE MARK CONSISTS OF THE LETTER "C" SURROUNDING A CACTUS ABOVE THE STYLIZED WORDS "CACTIES TOP-NOTCH NECKWEAR AND FURNISHINGS FOR THE COWBOY IN US ALL".

FOR CLOTHING, NAMELY, JACKETS (U.S. CLS. 22 AND 39).

FIRST USE 8-0-2007; IN COMMERCE 8-0-2007.

BERYL GARDNER, EXAMINING ATTORNEY

CLASS 25—(Continued).

SN 77-417,668. ING DIRECT BANCORP, WILMINGTON, DE. FILED 3-10-2008.

ORANGE DAYS OF GIVING

THE MARK CONSISTS OF STANDARD CHARACTERS WITHOUT CLAIM TO ANY PARTICULAR FONT, STYLE, SIZE, OR COLOR.

FOR HATS AND SHIRTS (U.S. CLS. 22 AND 39).
FIRST USE 8-16-2007; IN COMMERCE 8-16-2007.
STEPHEN AQUILA, EXAMINING ATTORNEY

SN 77-419,249. MOONEY, RICHARD W., HENDERSONVILLE, TN. FILED 3-11-2008.



THE MARK CONSISTS OF A DESIGN OF A CIRCLE WITH A RIFLE THROUGH THE CENTER. THE LETTERS "B R F" APPEAR ACROSS THE RIFLE. THE WORDING "BLACK RIFLE" APPEARS ON THE UPPER INNER RADIUS OF THE CIRCLE. THE WORDING "FEVER" APPEARS IN THE LOWER INNER RADIUS OF THE CIRCLE.

FOR HATS, TEE SHIRTS, SHIRTS, PANTS, GLOVES, HOODED SWEATSHIRT, SWEATSHIRTS, SHOES (U.S. CLS. 22 AND 39).

CIMMERIAN COLEMAN, EXAMINING ATTORNEY

SN 77-435,140. ALVARADO JR, ERNEST, DBA ETHIKAL, RANCHO CUCAMONGA, CA. FILED S.R. 3-29-2008; AM. P.R. 6-26-2009.

Ethikal

THE MARK CONSISTS OF STANDARD CHARACTERS WITHOUT CLAIM TO ANY PARTICULAR FONT, STYLE, SIZE, OR COLOR.

FOR DRESS SHIRTS; HOODED SWEAT SHIRTS; LONG-SLEEVED SHIRTS; SHORT-SLEEVED OR LONG-SLEEVED T-SHIRTS; SWEAT SHIRTS; T-SHIRTS (U.S. CLS. 22 AND 39).

FIRST USE 4-15-2008; IN COMMERCE 4-15-2008.
JANICE KIM, EXAMINING ATTORNEY

CLASS 25—(Continued).

SN 77-452,554. WILMA ANN WEAVER, DBA WILANGI OF NEW YORK, BRONX, NY. FILED 4-18-2008.

WilAngi of New York

THE MARK CONSISTS OF STANDARD CHARACTERS WITHOUT CLAIM TO ANY PARTICULAR FONT, STYLE, SIZE, OR COLOR.

NO CLAIM IS MADE TO THE EXCLUSIVE RIGHT TO USE "NEW YORK", APART FROM THE MARK AS SHOWN. FOR CLOTHING, NAMELY, SHIRTS, T-SHIRTS, PANTIES, DRESSES, SKIRTS, BLOUSES, JACKETS, COATS, CLOTH BELTS, LEATHER BELTS, CAPS, HATS, FLEECE PULLOVERS, SWEATERS, JACKETS, JEANS, PANTS, OVERALLS, SWEAT PANTS, POLO SHIRTS, SWEATSHIRTS, TANK TOPS, SHORTS, SWIM SUITS, TRUNKS, BANDANAS, SHOES, SANDALS, THERMAL UNDERWEAR, SOCKS, NIGHT GOWNS, PAJAMAS, WIND SHIRTS, PONCHOS, VESTS, BOXER SHORTS, BRIEFS, UNDERWEAR, BEANIES, VISORS, YOGA PANTS, BATHROBES, JERSEYS (U.S. CLS. 22 AND 39).
BRIAN PINO, EXAMINING ATTORNEY

SN 77-460,568. ZORREL INTERNATIONAL INC., GRANDVIEW, MO. FILED 4-29-2008.

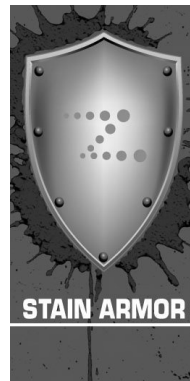

NO CLAIM IS MADE TO THE EXCLUSIVE RIGHT TO USE "STAIN", APART FROM THE MARK AS SHOWN.

THE STIPPLING IS A FEATURE OF THE MARK.

THE MARK CONSISTS OF THE DESIGN OF A SPILL COVERED BY A SHIELD WITH DOTS ON THE SHIELD IN THE FORM OF A "Z". BENEATH THE DESIGN IS THE WORDING "STAIN ARMOR" WHICH IS UNDERLINED.

FOR CLOTHING, NAMELY, PANTS, BATH ROBES, SHORTS, SPORTSWEAR, NAMELY, SWEATSHIRTS, SOCKS AND SHORTS, SPORT SHIRTS AND SPORT COATS, DRESSES, HATS, HOODS, JACKETS, JERSEYS, OVERALLS, OVERCOATS, PAJAMAS, PANTS, SHIRTS, SPORT JERSEYS, STUFF JACKETS, SWEATERS, SWIMSUITS, TEDDIES, T-SHIRTS, COLLARS FOR CLOTHING, COMBINATION CLOTHING, NAMELY, COORDINATING JOGGING SUITS, CUFFS FOR CLOTHING, FOOTWEAR, KNITWEAR, NAMELY, KNIT SHIRTS; OUTERCLOTHING, NAMELY, RAINCOATS, SWEAT PANTS, SHIRT FRONTS, SHIRT YOKES, UNDERCLOTHING, ANTI-SWEAT UNDERCLOTHING, UNIFORMS; WATERPROOF CLOTHING, NAMELY, JACKETS AND COATS (U.S. CLS. 22 AND 39).

FIRST USE 8-1-2007; IN COMMERCE 8-1-2007.
ELLEN PERKINS, EXAMINING ATTORNEY

CLASS 25—(Continued).

SN 77-493,337. TOPYED S.A., BUENOS AIRES, ARGENTINA,
FILED 6-6-2008.



PRIORITY CLAIMED UNDER SEC. 44(D) ON ARGENTINA APPLICATION NO. 2791531, FILED 12-7-2007, REG. NO. 2264078, DATED 12-17-2008, EXPIRES 12-17-2018.

THE MARK CONSISTS OF THE WORD "TIENDAS" IN STYLIZED LETTERS OVER A HORIZONTALLY POSITIONED OVAL INSIDE OF WHICH APPEARS THE WORD "VER", ALSO IN STYLIZED LETTERS.

THE FOREIGN WORDING IN THE MARK TRANSLATES INTO ENGLISH AS TO SEE STORES.

FOR BABY DOLL PYJAMAS; BEACHWEAR; BELTS; BERMUDA SHORTS; BLOUSES; BOW TIES; BRIEFS; CAPRIS; DRESS SHIRTS; DRESS SUITS; DRESSES; FOOTWEAR; GLOVES; GOWNS; HEADBANDS; HEADGEAR, NAMELY, HATS AND CAPS; LEOTARDS; LINGERIE; MEN'S SUITS, WOMEN'S SUITS; NECKTIES; OVER COATS; OVERCOATS; PAJAMAS; PANTS; POLO SHIRTS; RAIN COATS; SCARVES; SHIRTS; SHIRTS FOR SUITS; SHOES; SHORTS; SKIRT SUITS; SKIRTS AND DRESSES; SLIPPERS; SOCKS; SPORT COATS; SUIT COATS; T-SHIRTS; TIES; TROUSERS; UNDERWEAR; VESTS (U.S. CLS. 22 AND 39).

TAMARA FRAZIER, EXAMINING ATTORNEY

SN 77-509,842. STONE MOUNTAIN ACCESSORIES, INC.,
NEW YORK, NY. FILED 6-27-2008.

CODE RED

THE MARK CONSISTS OF STANDARD CHARACTERS WITHOUT CLAIM TO ANY PARTICULAR FONT, STYLE, SIZE, OR COLOR.

FOR CHILDREN'S CLOTHING, NAMELY, DRESSES, SKIRTS, SHIRTS, TOPS, TANK TOPS, HALTER TOPS, CAMISOLES, BLOUSES, T-SHIRTS, PULLOVERS, SWEATERS, CARDIGANS, VESTS, SHORTS, PANTS, CAPRIS, JEANS, LEGGINGS, TIGHTS, HOSIERY, BODY SUITS, JERSEYS, SWEAT SHIRTS, SWEAT PANTS, SWEAT SUITS, WARM UP SUITS, GYM SUITS, BATHING SUITS, BEACH COVERUPS, NIGHTGOWNS, PAJAMAS, PAJAMA PANTS, BOXER SHORTS, BATHROBES, FOOTWEAR, SHOES, BOOTS, SANDALS, SLIPPERS, SOCKS, GLOVES, MITTENS, SCARVES, BANDANAS, HEADBANDS, EAR MUFFS, HATS, CAPS, WRAPS, PONCHOS, JACKETS, COATS (U.S. CLS. 22 AND 39).

SUNG IN, EXAMINING ATTORNEY

CLASS 25—(Continued).

SN 77-533,141. MARTIN, GABRIEL, MENDOCINO, CA. AND
GAOS, ALLISON, MENDOCINO, CA. FILED 7-28-2008.

THE MARK CONSISTS OF THE NAME "INGRID" WRITTEN WITH A CAPITOL "I". LOWER CASE "NGRID" WITH A SMALL IMAGE OF A LEAF IN THE DOT OF THE 2ND "I".

FOR HATS; PANTS; SHIRTS (U.S. CLS. 22 AND 39).
FIRST USE 1-0-2000; IN COMMERCE 1-0-2000.
MARK SPARACINO, EXAMINING ATTORNEY

SN 77-534,722. DELOREAN MOTOR COMPANY, INC.,
HUMBLE, TX. FILED 7-30-2008.

DE LOREAN

THE NAME(S), PORTRAIT(S), AND/OR SIGNATURE(S) SHOWN IN THE MARK DOES NOT IDENTIFY A PARTICULAR LIVING INDIVIDUAL.

THE MARK CONSISTS OF THE STYLIZED WORD "DE LOREAN", WITH A HALF-SPACE BETWEEN THE "E" AND THE "L".

FOR CLOTHING, NAMELY, COATS, JACKETS, SHIRTS, HATS (U.S. CLS. 22 AND 39).
CYNTHIA TRIPI, EXAMINING ATTORNEY

CLASS 25—(Continued).

SN 77-539,669. AETHER, LLC., LOS ANGELES, CA. FILED 8-5-2008.



THE MARK CONSISTS OF A CIRCLE WITH THE LETTER "A" INSIDE OF WHICH THE "A" IS CROSSED BY USING AN INFINITY CIRCLE AND THE WORD "AETHER" IS BENEATH THE "A" AND INSIDE THE CIRCLE.

FOR APRES-SKI SHOES; ATHLETIC SHOES; BEACH SHOES; JACKETS; PANTS; PARKAS; POLO SHIRTS; RAIN JACKETS; SHIRTS; SHORTS; SKI AND SNOWBOARD SHOES AND PARTS THEREOF; SKI BIBS; SKI BOOT BAGS; SKI BOOTS; SKI GLOVES; SKI JACKETS; SKI MASKS; SKI PANTS; SKI SUITS; SKI TROUSERS; SKI WEAR; SKIING SHOES; SNOWBOARD PANTS; SWEAT PANTS; SWEAT SHIRTS; SWEATERS; SWIMWEAR; T-SHIRTS (U.S. CLS. 22 AND 39).

DAYNA BROWNE, EXAMINING ATTORNEY

SN 77-544,103. DEARBORN, SUSAN, WELLESLEY, MA. FILED 8-11-2008.



THE MARK CONSISTS OF A STYLIZED VERSION OF THE WORD "WHY" WITH CURVY LETTERS. THE "W" IS CAPITAL AND THE "H" AND "Y" ARE SMALL CASE. THE LETTERS ARE ABOUT 1/8 IN THICK—WITHIN THE LETTERS ARE MARKS TO MAKE THE WORD RESEMBLE A DOG. THE TOP LOOPS OF THE "W" ARE ROUNDED OUT AND UNDER LIKE EARS AND THERE IS ANOTHER SMALLER LOOP INSIDE TO MAKE THE LOOP LOOK LIKE AN EAR. THERE ARE TWO SLOOPY SHAPED EYES INSIDE THE "W" SLIGHTLY LOWER THAN THE EARS AND THE TAIL OF THE "Y" IS LENGTHENED AND CURVED TO THE LEFT UNDER OTHER LETTERS. THE LOOPED TAIL IS THE DOG'S MOUTH AND HAS A SMALL CRESCENT SHAPED CURVE IN IT. THE WORD "WHY" IS IN A CIRCLE.

FOR HATS; SWEAT SHIRTS; T-SHIRTS (U.S. CLS. 22 AND 39).

BRIAN CALLAGHAN, EXAMINING ATTORNEY

CLASS 25—(Continued).

SN 77-545,630. CRE8IVE CR8ON, INC., VIERA, FL. FILED 8-13-2008.



NO CLAIM IS MADE TO THE EXCLUSIVE RIGHT TO USE ".COM", APART FROM THE MARK AS SHOWN.

THE MARK CONSISTS OF A DRAWING OF A YOUNG ADULT FEMALE WITH THE WORD "SKANKTEES" (STYLIZED) ACROSS THE DRAWING AND THE WORD ".COM" (STYLIZED) STACKED UNDER THE WORD "SKANKTEES".

FOR CLOTHING FOR MEN, WOMEN, AND YOUNG ADULTS, NAMELY, T-SHIRT, TANK TOPS, SWEATSHIRTS, UNDERWEAR, NAMELY, THONGS AND PAJAMAS, AND EXCLUDING HEAD WEAR (U.S. CLS. 22 AND 39).

BARBARA RUTLAND, EXAMINING ATTORNEY

SN 77-546,697. CHEATING NOT, INC., ENCINO, CA. FILED 8-14-2008.



THE COLOR(S) RED AND BLACK IS/ARE CLAIMED AS A FEATURE OF THE MARK.

THE MARK CONSISTS OF THE WORDING "CHEATING-NOT" IN STYLIZED BLACK FONT AND RED CURVING LINES FORMING A STYLIZED BROKEN HEART. THE BROKEN HEART AND THE DOT ABOVE THE LETTER "I" IS RED AND THE REST OF THE LETTERS ARE BLACK.

FOR T-SHIRTS, TANK TOPS, PULLOVER HOODED SWEATSHIRTS, SKIRTS, CAMISOLES, JACKETS, SWEAT SHIRTS, SWEAT PANTS, SWEAT SUITS, SPORTS BRAS, CAMISOLE BRAS, SWEATERS, SHIRTS, SHORTS, PANTS, SOCKS, TIGHTS, LEGGINGS, CAPS, HATS, WRIST BANDS, HEAD BANDS, COATS, ROBES, PAJAMAS, CHEMISES, NIGHTGOWNS, NIGHTSHIRTS, SLIPPERS, BRAS, UNDERWEAR, CAMISOLES, SCARVES, GLOVES AND APRONS, ALL FEATURING ARTWORK, PICTURES AND HEALING WORDS FOR INDIVIDUALS WHO HAVE BEEN CHEATED ON (U.S. CLS. 22 AND 39).

STEVEN PEREZ, EXAMINING ATTORNEY

CLASS 25—(Continued).

SN 77-553,276. SMOCK COUTURE, TAMPA, FL. FILED 8-22-2008.



NO CLAIM IS MADE TO THE EXCLUSIVE RIGHT TO USE "SMOCK COUTURE", APART FROM THE MARK AS SHOWN.

THE MARK CONSISTS OF THE STYLIZED WORDS "SMOCK COUTURE" INSIDE A STYLIZED BANNER. ABOVE THE BANNER IS AN IMAGE OF A STYLIZED LETTER "S" AND "C" PUT TOGETHER.

FOR CLOTHING, NAMELY, SMOCKED DRESS, BLOUSES, T-SHIRTS, PANTS, NIGHTGOWNS, HEAD BANDS, SMOCKED PANTS, ROMPERS, PAJAMAS, NIGHT GOWNS (U.S. CLS. 22 AND 39).

MEGHAN REINHART, EXAMINING ATTORNEY

SN 77-568,263. FLANAGAN, HARLEY, TROY, NY. FILED 9-11-2008.

CRO-MAGS

THE MARK CONSISTS OF STANDARD CHARACTERS WITHOUT CLAIM TO ANY PARTICULAR FONT, STYLE, SIZE, OR COLOR.

FOR CLOTHING, NAMELY, SUITS, PANTS, TROUSERS, JEANS, OVERALLS, SHORTS, SHIRTS, SWEATERS, BLOUSES, SKIRTS, DRESSES, JACKETS, VESTS, T-SHIRTS, SWEATSHIRTS, SWEATPANTS, SUSPENDERS, NECKTIES; HEADWEAR, NAMELY, CAPS, HATS, HEADBANDS; BELTS, UNDERWEAR, SLEEPWEAR, LOUNGEWEAR; INTIMATE APPAREL, NAMELY, LINGERIE, PAJAMAS, NEGLIGEEES, CAMISOLES, SLIPS; HOSIERY, GLOVES, SCARVES; WORK-OUT GEAR, NAMELY, WARM-UP SUITS, SWEAT SUITS, SWEAT SHORTS, JOGGING SUITS, SWEAT BANDS, TANK TOPS, CROP TOPS, TRACK PANTS, CYCLE PANTS, SPORTS TOPS, SPORTS SHORTS, UNITARDS, LEOTARDS, TIGHTS, LEGGINGS, LEG WARMERS, SPORTS BRAS; OUTERWEAR, NAMELY, JACKETS, COATS; VESTS; RAINWEAR, FOOTWEAR AND SOCKS (U.S. CLS. 22 AND 39).

FIRST USE 6-1-1985; IN COMMERCE 1-1-1986.

MARILYN IZZI, EXAMINING ATTORNEY

CLASS 25—(Continued).

SN 77-572,203. STEPHAN JENKINS PRODUCTIONS, INC., SAN RAFAEL, CA. FILED 9-17-2008.

THIRD EYE BLIND

THE MARK CONSISTS OF STANDARD CHARACTERS WITHOUT CLAIM TO ANY PARTICULAR FONT, STYLE, SIZE, OR COLOR.

SEC. 2(F).

FOR SWEAT SHIRTS; T-SHIRTS (U.S. CLS. 22 AND 39).

FIRST USE 11-0-1993; IN COMMERCE 11-0-1993.

NAPOLEON SHARMA, EXAMINING ATTORNEY

SN 77-572,238. STEPHAN JENKINS PRODUCTIONS, INC., SAN RAFAEL, CA. FILED 9-17-2008.

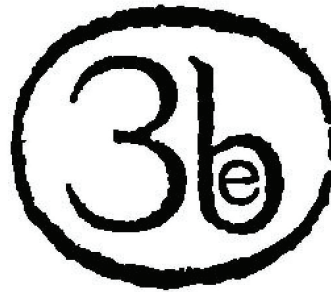

THE MARK CONSISTS OF A CIRCLE SURROUNDING BOTH THE NUMBER "3" AND A LOWERCASE "B" WITHIN WHICH IS A LOWERCASE "E".

SEC. 2(F).

FOR SWEAT SHIRTS; T-SHIRTS; UNDERWEAR (U.S. CLS. 22 AND 39).

FIRST USE 11-0-1996; IN COMMERCE 11-0-1996.

NAPOLEON SHARMA, EXAMINING ATTORNEY

SN 77-572,956. BIMINI BAY OUTFITTERS, LTD., MAHWAH, NJ. FILED 9-18-2008.

ULTRACELL

THE MARK CONSISTS OF STANDARD CHARACTERS WITHOUT CLAIM TO ANY PARTICULAR FONT, STYLE, SIZE, OR COLOR.

FOR SYNTHETIC, NYLON, POLYESTER AND POLYESTER AND COTTON BLEND FABRIC SOLD AS AN INTEGRAL COMPONENT OF FINISHED CLOTHING, NAMELY, MEN'S SHIRTS; AND CLOTHING, NAMELY, MEN'S SHIRTS (U.S. CLS. 22 AND 39).

FIRST USE 11-30-2003; IN COMMERCE 11-30-2003.

JEFFERY COWARD, EXAMINING ATTORNEY

CLASS 25—(Continued).

SN 77-573,685. YAKIRA, LLC, NEW YORK, NY. FILED 9-18-2008.

CHE GUEVARA

THE MARK CONSISTS OF STANDARD CHARACTERS WITHOUT CLAIM TO ANY PARTICULAR FONT, STYLE, SIZE, OR COLOR.

THE NAME(S), PORTRAIT(S), AND/OR SIGNATURE(S) SHOWN IN THE MARK DOES NOT IDENTIFY A PARTICULAR LIVING INDIVIDUAL.

FOR CLOTHING, NAMELY, SHIRTS, SWEATSHIRTS, PANTS, JEANS, SHORTS, SOCKS, BELTS, SLEEPWEAR AND UNDERWEAR; OUTERWEAR, NAMELY, JACKETS, COATS, PONCHOS AND PARKAS; HEADWEAR; FOOTWEAR (U.S. CLS. 22 AND 39).

CAROL SPILS, EXAMINING ATTORNEY

CLASS 25—(Continued).

SN 77-579,265. SHANGHAI VIRGIN SHOES COMPANY, MIN HANG, CHINA, FILED 9-25-2008.



SN 77-578,696. SPORTS-AHOLIC, INC., OVERLAND PARK, KS. FILED 9-25-2008.

HAWKAHOLIC

THE MARK CONSISTS OF STANDARD CHARACTERS WITHOUT CLAIM TO ANY PARTICULAR FONT, STYLE, SIZE, OR COLOR.

FOR CLOTHING, NAMELY, CAPS, HATS, VISORS, KNITTED HEAD WEAR, HEADBANDS, BANDANAS, SHIRTS, T-SHIRTS, TANK TOPS, BLOUSES, SWEATERS, TURTLENECKS, PULLOVERS, VESTS, SHORTS, PANTS, SLACKS, DRESSES, SKIRTS, BASEBALL UNIFORMS, JERSEYS, WARM-UP SUITS, JOGGING SUITS, SWEATSHIRTS, SWEAT PANTS, UNDERWEAR, BOXER SHORTS, ROBES, SLEEP WEAR, PAJAMAS, NIGHTSHIRTS, NIGHTGOWNS, SWIM WEAR, WRAPS, JACKETS, PONCHOS, CLOTH BIBS, INFANT WEAR, INFANT DIAPER COVERS, CLOTH DIAPER SETS COMPRISED OF UNDERSHIRT AND INFANT DIAPER COVER, JUMPERS, ROMPERS, COVERALLS, CREEPERS, BABY BOOTIES, TIES, BELTS, MITTENS, GLOVES, WRISTBANDS, EAR MUFFS, SCARVES, FOOTWEAR, SOCKS, HOSIERY, SLIPPERS, AND HALLOWEEN AND MASQUERADE COSTUMES (U.S. CLS. 22 AND 39).

JULIE WATSON, EXAMINING ATTORNEY

THE COLOR(S) BLACK AND WHITE IS/ARE CLAIMED AS A FEATURE OF THE MARK.

THE MARK CONSISTS OF A JUNK, A CHINESE SHIP, AND THE WORD "BIAOM"; THE JUNK IS OUTLINED IN BLACK WITH WHITE FILLING THE SPACES ENCLOSED BY THE BLACK OUTLINE; THE WORD "BIAOM" IS IN BLACK LETTERS.

FOR AFTER SKI BOOTS; ANGLERS' SHOES; ANKLE BOOTS; APRES-SKI SHOES; ATHLETIC SHOES; BALLET SHOES; BALLROOM DANCING SHOES; BASEBALL SHOES; BASKETBALL SNEAKERS; BEACH SHOES; BOOTS; BOWLING SHOES; BOXING SHOES; CANVAS SHOES; CLEATS FOR ATTACHMENT TO SPORTS SHOES; CLIMBING BOOTS; CYCLING SHOES; DANCE SHOES; DECK-SHOES; DRIVERS; FITTED SHOE OR BOOT COVERING TO PROTECT THE SHOES OR BOOT FROM WATER OR OTHER DAMAGE; FOOTBALL BOOTS AND STUDS THEREFOR; FOOTBALL SHOES; FOOTWEAR, NAMELY, WORK BOOTS; GOLF SHOES; GYMNASTIC SHOES; HANDBALL SHOES; HIKING BOOTS; HOCKEY SHOES; HORSE-RIDING BOOTS; INFANTS' SHOES AND BOOTS; LACE BOOTS; LADIES' BOOTS; LEATHER SHOES; MOTORCYCLIST BOOTS; MOUNTAINEERING BOOTS; RAIN BOOTS; RIDING BOOTS; RUBBER SHOES; RUGBY SHOES; RUNNING SHOES; SHOES; SKI AND SNOWBOARD SHOES AND PARTS THEREOF; SKI BOOTS; SKIING SHOES; SNEAKERS; SNOW BOOTS; SNOWBOARD BOOTS; SOCCER BOOTS; SOCCER SHOES; TAP SHOES; TENNIS SHOES; TRACK AND FIELD SHOES; TRAINING SHOES; VOLLEYBALL SHOES; WINTER BOOTS; WOMEN'S SHOES; WORK SHOES AND BOOTS (U.S. CLS. 22 AND 39).

MARK RADEMACHER, EXAMINING ATTORNEY

CLASS 25—(Continued).

SN 77-580,123. BOSTON RED SOX BASEBALL CLUB LIMITED PARTNERSHIP, BOSTON, MA. FILED 9-26-2008.



OWNER OF U.S. REG. NOS. 1,043,945, 1,602,303 AND OTHERS.

THE MARK CONSISTS OF THE STYLIZED REPRESENTATION OF A PAIR OF SOCKS.

SEC. 2(F) "SOCKS" AND "HOSIERY".

FOR CLOTHING, NAMELY, CAPS, HATS, VISORS, KNITTED HEADWEAR, HEADBANDS, BANDANNAS, SHIRTS, T-SHIRTS, TANK TOPS, BLOUSES, SWEATERS, TURTLENECKS, PULLOVERS, VESTS, SHORTS, PANTS, SLACKS, DRESSES, SKIRTS, BASEBALL UNIFORMS, JERSEYS, WARM-UP SUITS, JOGGING SUITS, SWEATSHIRTS, SWEATPANTS; SLEEPWEAR, INFANT WEAR, BABY BOOTIES AND FOOTWEAR, ALL NOT INCLUDING SOCKS; UNDERWEAR, BOXER SHORTS, ROBES, PAJAMAS, NIGHTSHIRTS, NIGHTGOWNS, SWIMWEAR, CLOTHING WRAPS, JACKETS, PONCHOS, CLOTH BIBS, INFANT DIAPER COVERS, CLOTH DIAPER SETS COMPRISED OF CLOTH DIAPERS, UNDERSHIRTS AND INFANT DIAPER COVER, JUMPERS, ROMPERS, COVERALLS, CREEPERS, TIES, BELTS, MITTENS, GLOVES, WRISTBANDS, EARMUFFS, SCARVES, SOCKS, HOSIERY, SLIPPERS, AND HALLOWEEN AND MASQUERADE COSTUMES (U.S. CLS. 22 AND 39).

RUDY R. SINGLETON, EXAMINING ATTORNEY

SN 77-580,559. THE JEWISH ZODIAC, LLC, WOODLAND HILLS, CA. FILED 9-28-2008.

THE HISPANIC ZODIAC

THE MARK CONSISTS OF STANDARD CHARACTERS WITHOUT CLAIM TO ANY PARTICULAR FONT, STYLE, SIZE, OR COLOR.

FOR PONCHOS, T-SHIRTS, SHIRTS, UNDERGARMENTS, LINGERIE, SWEAT SHIRTS, SWEAT PANTS, SLEEPWEAR, HEADWEAR, TANK TOPS, LOUNGEWEAR, TIES, BOXER SHORTS, UNDERWEAR (U.S. CLS. 22 AND 39).

SUNG IN, EXAMINING ATTORNEY

CLASS 25—(Continued).

SN 77-580,564. THE JEWISH ZODIAC, LLC, WOODLAND HILLS, CA. FILED 9-28-2008.

THE ITALIAN ZODIAC

THE MARK CONSISTS OF STANDARD CHARACTERS WITHOUT CLAIM TO ANY PARTICULAR FONT, STYLE, SIZE, OR COLOR.

FOR PONCHOS, T-SHIRTS, SHIRTS, UNDERGARMENTS, LINGERIE, SWEAT SHIRTS, SWEAT PANTS, SLEEPWEAR, HEADWEAR, TANK TOPS, LOUNGEWEAR, TIES, BOXER SHORTS, UNDERWEAR (U.S. CLS. 22 AND 39).

SUNG IN, EXAMINING ATTORNEY

SN 77-580,636. ANTON, JUAN JOSE, GUAYAQUIL, ECUADOR, FILED 9-28-2008.

CABO BLANCO

THE MARK CONSISTS OF STANDARD CHARACTERS WITHOUT CLAIM TO ANY PARTICULAR FONT, STYLE, SIZE, OR COLOR.

THE ENGLISH TRANSLATION OF THE WORD "CABO BLANCO" IN THE MARK IS "WHITE CAPE".

FOR HEADWEAR FOR FISHING; FOOTWEAR AND SHOES FOR FISHING; CLOTHING FOR FISHING, NAMELY, FISHING WADERS, FISHING VESTS, HIPGUARDS ESPECIALLY MADE FOR FISHING, FISHING SHIRTS (U.S. CLS. 22 AND 39).

LAURA HAMMEL, EXAMINING ATTORNEY

SN 77-587,867. FODEN, LINDSEY, E, DBA CHICLID, SANTA CRUZ, CA. FILED 10-7-2008.



THE MARK CONSISTS OF OF THE WORD "CHICLID" AND THE DESIGN OF AN OUTLINE OF A CICHLID TYPE OF FISH.

FOR HEADGEAR, NAMELY, SWIMMING CAPS, BASEBALL CAPS, AND SURF CAPS (U.S. CLS. 22 AND 39).

AARON BRODSKY, EXAMINING ATTORNEY

CLASS 25—(Continued).

SN 77-588,317. BROYLES, ERIC, KNOXVILLE, TN. FILED 10-8-2008.

CROSS CONTAMINATED

THE MARK CONSISTS OF STANDARD CHARACTERS WITHOUT CLAIM TO ANY PARTICULAR FONT, STYLE, SIZE, OR COLOR.

FOR CLOTHING AND ACCESSORIES, NAMELY, FOOTWEAR, SOCKS, SHIRTS, TOPS, SHORTS, PANTS, BOTTOMS, JEANS, DRESSES, SKIRTS, JACKETS, COATS, UNDERWEAR, BRAS, HATS, CAPS, HEADWEAR, BABY BIBS NOT OF PAPER, BABY BOTTOMS, BABY TOPS, BATHING SUITS, BIKINIS, SWIMWEAR, BELTS, VESTS, PULLOVERS, SUITS, GLOVES, LINGERIE, NECKWEAR, BOWTIES, NECKTIES, SCARVES, PAJAMAS, ROBES, SLEEPWEAR, RAINCOATS, RAINWEAR, SWEATERS, SWEATSHIRTS, SWEATPANTS, T-SHIRTS, LONG-SLEEVE SHIRTS, DRESS SHIRTS, POLO SHIRTS, AND UNDERSHIRTS (U.S. CLS. 22 AND 39).

MARIA-VICTORIA SUAREZ, EXAMINING ATTORNEY

SN 77-589,059. PATTERSON JR., DAVID C., DERITTER, LA. FILED 10-9-2008.

SICK L  VE

THE MARK CONSISTS OF THE STYLIZED LETTERS "SICK LVE" AND A STYLIZED DRAWING OF A HEART DESIGN REPRESENTING THE LETTER "O" IN THE WORD "LOVE" THE CONTRAST IN SHADING BETWEEN THE LETTERS "SICK LVE" AND THE STYLIZED DRAWING OF THE HEART DESIGN DEPICT CONTRASTING COLORS IN THE MARK.

FOR BELTS; CAPS; PANTS; SHIRTS; SOCKS; SWEAT JACKETS; SWEAT PANTS; SWEAT SHIRTS; SWEAT SHORTS; SWEAT SUITS (U.S. CLS. 22 AND 39).

AMEEN IMAM, EXAMINING ATTORNEY

CLASS 25—(Continued).

SN 77-589,574. TICKLE ME PINK SERVICES, LLC, FORT COLLINS, CO. FILED 10-9-2008.

TICKLE ME PINK

THE MARK CONSISTS OF STANDARD CHARACTERS WITHOUT CLAIM TO ANY PARTICULAR FONT, STYLE, SIZE, OR COLOR.

FOR CLOTHING, NAMELY, T-SHIRTS, SHIRTS, LONG-SLEEVED SHIRTS, POLO SHIRTS, TOPS, CROP TOPS, TANK TOPS, TANKINIS, SHORTS, BOXER SHORTS, PANTS, BOTTOMS, SWEAT SHIRTS, HOODED SWEAT SHIRTS, SWEAT JACKETS, SWEAT SHORTS, SWEAT PANTS, LOUNGEWEAR, SWEATERS, VESTS, PULLOVERS, JACKETS, REVERSIBLE JACKETS, TURTLENECKS, HATS, VISORS, HEADBANDS, WRIST BANDS, SWEAT BANDS, HEADWEAR, SCARVES, BANDANAS, BELTS, UNDERWEAR, G-STRINGS, ROBES, UNDERCLOTHES, PAJAMAS, SLEEPWEAR, GLOVES, RAINWEAR, FOOTWEAR, FLIP-FLOPS, AND SLIPPERS, ALL OF THE FOREGOING ASSOCIATED WITH THE MUSIC AND PERFORMANCES OF A MUSICAL GROUP (U.S. CLS. 22 AND 39).

VIVIAN MICZNIK FIRST, EXAMINING ATTORNEY

SN 77-589,926. CORNELL, HEIDI, LOS ANGELES, CA. FILED 10-9-2008.

32 FLAVORS BY... YFB

THE MARK CONSISTS OF STANDARD CHARACTERS WITHOUT CLAIM TO ANY PARTICULAR FONT, STYLE, SIZE, OR COLOR.

OWNER OF U.S. REG. NO. 3,176,403.

FOR BATHING SUITS; BLOUSES; COATS; DRESSES; HATS; HOODED PULLOVERS; HOODED SWEAT SHIRTS; JACKETS; JEANS; LOUNGE PANTS; PANTS; SHIRTS; SWEATERS; T-SHIRTS; TANK TOPS; TOPS; UNDERGARMENTS (U.S. CLS. 22 AND 39).

FIRST USE 8-1-2006; IN COMMERCE 8-1-2008.

TARA PATE, EXAMINING ATTORNEY

CLASS 25—(Continued).

SN 77-590,919. MICH CAL DIVERSIFIED L.L.C., DBA DANGER DAY, BURBANK, CA. FILED 10-11-2008.

DANGER DAY
THE WAY WE LIVE

THE COLOR(S) RED AND WHITE IS/ARE CLAIMED AS A FEATURE OF THE MARK.

THE MARK CONSISTS OF THE STYLIZED WORDING "DANGER DAY THE WAY WE LIVE" IN WHITE AND IS OUTLINED IN RED. THE WORDING "DANGER DAY" APPEARS IN A LARGE FONT ABOVE THE WORDING "THE WAY WE LIVE" THAT APPEARS IN SMALLER FONT.

FOR ATHLETIC APPAREL, NAMELY, SHIRTS, PANTS, JACKETS, FOOTWEAR, HATS AND CAPS, ATHLETIC UNIFORMS; CAMP SHIRTS; DRESS SHIRTS; HATS; HEADGEAR, NAMELY, HATS, CAPS, BEANIES, BANDANAS, SKI MASKS; HOODED SWEAT SHIRTS; KNIT SHIRTS; LONG-SLEEVED SHIRTS; SHIRT FRONTS; SHIRTS; SHORT-SLEEVED OR LONG-SLEEVED T-SHIRTS; SHORT-SLEEVED SHIRTS; SPORT SHIRTS; SPORTS SHIRTS; SPORTS SHIRTS WITH SHORT SLEEVES; SWEAT SHIRTS; T-SHIRTS; TEE SHIRTS; WEARABLE GARMENTS AND CLOTHING, NAMELY, SHIRTS; WIND SHIRTS (U.S. CLS. 22 AND 39).

MARLENE BELL, EXAMINING ATTORNEY

SN 77-591,234. LUZI, RACHEL J, DBA TINY TURNIP, SAN CLEMENTE, CA. FILED 10-13-2008.

Tiny Turnip

THE MARK CONSISTS OF "TINY TURNIP" ILLUSTRATED IN A STYLIZED FONT WITH THE "P" IN "TURNIP" MADE TO LOOK LIKE A TURNIP.

FOR BABY BODYSUITS; BABY TOPS; CAPS; HOODED SWEAT SHIRTS; KNIT SHIRTS; LONG-SLEEVED SHIRTS; LOUNGE PANTS; PANTS; SHIRTS; SHIRTS; SHORT SETS; SHORT-SLEEVED OR LONG-SLEEVED T-SHIRTS; SKIRTS AND DRESSES; T-SHIRTS; TIGHTS; TOPS (U.S. CLS. 22 AND 39).

FIRST USE 10-1-2003; IN COMMERCE 10-15-2003.
 CHARLOTTE CORWIN, EXAMINING ATTORNEY

CLASS 25—(Continued).

SN 77-591,375. DA-BAY INDÚSTRIA E COMÉRCIO LTDA., PORTO ALEGRE, BRAZIL, FILED 10-13-2008.



THE MARK CONSISTS OF THE LETTERS "DA-BAY" ANGLED DOWN AND TO THE RIGHT IN THE CENTER OF A WAVE LIKE CIRCLE. A LIGHTHOUSE IS BETWEEN THE TERMS "DA" AND "BAY".

FOR T-SHIRTS, SHIRTS, BOARDSHIRTS AND CAPS (U.S. CLS. 22 AND 39).

WILLIAM P. SHANAHAN, EXAMINING ATTORNEY

SN 77-593,622. BRADLEY, RHETT JAMES, DALTON, GA. FILED 10-15-2008.

Player Clothing

THE MARK CONSISTS OF STANDARD CHARACTERS WITHOUT CLAIM TO ANY PARTICULAR FONT, STYLE, SIZE, OR COLOR.

NO CLAIM IS MADE TO THE EXCLUSIVE RIGHT TO USE "CLOTHING", APART FROM THE MARK AS SHOWN.

FOR CAPS; JERSEYS; SHORT SETS; TOPS; WEARABLE GARMENTS AND CLOTHING, NAMELY, SHIRTS (U.S. CLS. 22 AND 39).

FIRST USE 7-0-2008; IN COMMERCE 7-0-2008.
 STEVEN R. FINE, EXAMINING ATTORNEY

SN 77-593,977. HEISING, JACQUELINE, ENCINITAS, CA. FILED 10-16-2008.

Angel Baby

THE MARK CONSISTS OF STANDARD CHARACTERS WITHOUT CLAIM TO ANY PARTICULAR FONT, STYLE, SIZE, OR COLOR.

NO CLAIM IS MADE TO THE EXCLUSIVE RIGHT TO USE "BABY", APART FROM THE MARK AS SHOWN.

FOR HALTER TOPS; HATS; JACKETS; JEANS; NIGHT SHIRTS; PAJAMAS; PANTIES, SHORTS AND BRIEFS; SHIRTS; SHORTS; SOCKS; SWEAT JACKETS; SWEAT PANTS; SWEAT SHIRTS; SWEAT SHORTS; TANK TOPS; TEE SHIRTS; TOPS (U.S. CLS. 22 AND 39).

ROBERT STRUCK, EXAMINING ATTORNEY

CLASS 25—(Continued).

SN 77-594,220. CAMILLA AND MARC PTY. LTD., NEW SOUTH WALES 2000, AUSTRALIA, FILED 10-16-2008.



THE MARK CONSISTS OF THE LETTER "C" IN BOLD, UPPER CASE, AN AMPERSAND AND THE LETTER "M" IN BOLD, UPPER CASE ON THE FIRST LINE. THE WORDS "CAMILLA AND MARC" IN SMALL CAPS ON THE SECOND LINE.

FOR CLOTHING, NAMELY, JEANS, PANTS, TROUSERS, SHORT TROUSERS, SHORTS, SKIRTS, DRESSES, OVERALLS, OVERCOATS, SUITS, T-SHIRTS, SINGLETs, BLOUSES, JERSEYS, JACKETS, JUMPERS, SWEATERS, CARDIGANS, PULLOVERS, TANK TOPS, VESTS, WRAPS, NECKWEAR, SWIMSUITS, BEACHWEAR, UNDERGARMENTS, LINGERIE, UNDERWEAR, BATHROBES, PAJAMAS, NIGHTWEAR, ROBES, RAINWEAR, WIND-JACKETS, SOCKS, SCARVES, CLOTHING BELTS, GLOVES, SHAWLS, WRISTBANDS, HEADWEAR, NAMELY, CAPS AND HATS; FOOTWEAR (U.S. CLS. 22 AND 39).

ROBERT STRUCK, EXAMINING ATTORNEY

CLASS 25—(Continued).

SN 77-595,707. F.O. INTERNATIONAL CO., LTD., KOBE-SHI, HYOGO-KEN, JAPAN, FILED 10-19-2008.

BOOMY ROOMY

THE MARK CONSISTS OF STANDARD CHARACTERS WITHOUT CLAIM TO ANY PARTICULAR FONT, STYLE, SIZE, OR COLOR.

FOR CHILDREN'S WEAR, NAMELY, JACKETS, JOGGING PANTS, SWEAT PANTS, SUITS, SKIRTS, TROUSERS, SMOCKS, OVERCOATS, TOPCOATS, MANTLES, RAINCOATS, CARDIGANS, SWEATERS, VESTS AND WAISTCOATS, SPORT SHIRTS, BLOUSES, POLO SHIRTS, NIGHT GOWNS, NEGLIGEEs, PAJAMAS, BATH ROBES, UNDERSHIRTS, CHEMISES, SLIPS, PANTIES, SHORTS AND BRIEFS, SWIMWEAR, SWIMMING CAPS, APRONS; SOCKS AND STOCKINGS, SCARVES, GLOVES AND MITTENS, NECKTIES, NECKERCHIEFS, BANDANAS, MUFFLERS, EAR MUFFS, HOODS, SUSPENDERS, BELTS FOR CLOTHING, RAIN BOOTS, TRAINING SHOES, OVERSHOES, SANDALS, SHOES, BOOTS, HALF-BOOTS, WOMEN'S SHOES, CANVAS SHOES, INFANTS' SHOES AND BOOTS, AND SLIPPERS; HEADGEAR, NAMELY, HATS AND CAPS; CLOTHING, NAMELY, WEARABLE COLLAR PROTECTORS (U.S. CLS. 22 AND 39).

FIRST USE 12-31-2004; IN COMMERCE 9-13-2008.

ERIN FALK, EXAMINING ATTORNEY

SN 77-594,427. PIRANA BROTHERS, LLC, OKLAHOMA CITY, OK. FILED 10-16-2008.



THE MARK CONSISTS OF TWO PIRANHA SKELETONS POSITIONED HEAD TO TAIL IN A FREESTYLE YIN YANG DESIGN.

FOR CLOTHING, NAMELY, SHIRTS, HATS, SHORTS, WARM-UP SUITS AND JACKETS (U.S. CLS. 22 AND 39). SANJEEV VOHRA, EXAMINING ATTORNEY

SN 77-596,465. BINGHAM PROFESSIONAL SERVICES, LLC, SAMMAMISH, WA. FILED 10-20-2008.



NO CLAIM IS MADE TO THE EXCLUSIVE RIGHT TO USE "U.S. GLOVE SUPPLY", APART FROM THE MARK AS SHOWN.

THE MARK CONSISTS OF A STYLIZED GLOVE WITH A WAVY LINE EXTENDING FROM THE BOTTOM OF THE GLOVE, AND THE STYLIZED WORDING "U.S. GLOVE SUPPLY".

FOR GLOVES (U.S. CLS. 22 AND 39).

JEAN IM, EXAMINING ATTORNEY

CLASS 25—(Continued).

SN 77-597,669. MISS MATCHED, INC., NEW YORK, NY. FILED 10-22-2008.

LITTLEMISSMATCHED

THE MARK CONSISTS OF STANDARD CHARACTERS WITHOUT CLAIM TO ANY PARTICULAR FONT, STYLE, SIZE, OR COLOR.

OWNER OF U.S. REG. NOS. 3,475,092, 3,565,831 AND OTHERS.

FOR CLOTHING, NAMELY, JACKETS, SWEAT-SHIRTS, SWEATERS, SOCKS, HOSIERY, LEGGINGS, TIGHTS, SWIMWEAR, PAJAMAS, UNDERWEAR, BRAS, TANK TOPS, SHIRTS, SKIRTS, DRESSES, LEG WARMERS, ARM WARMERS, ONE-PIECE GARMENTS FOR INFANTS, KIMONOS, CLOTH COVERALLS, CLOTH BIBS; PANTS, BOXER SHORTS; AND ACCESSORIES, NAMELY, BELTS, GLOVES, MITTENS, SCARVES (U.S. CLS. 22 AND 39).

DARRYL SPRUILL, EXAMINING ATTORNEY

SN 77-597,772. HARRY CARAY, LTD., CHICAGO, IL. FILED 10-22-2008.

HOLY COW!

THE MARK CONSISTS OF STANDARD CHARACTERS WITHOUT CLAIM TO ANY PARTICULAR FONT, STYLE, SIZE, OR COLOR.

OWNER OF U.S. REG. NOS. 2,216,797 AND 3,141,729.

FOR BASEBALL CAPS; CAPS; CHILDREN'S AND INFANTS' CLOTH BIBS; CLOTH BIBS; GOLF SHIRTS; HATS; HOODED SWEAT SHIRTS; JACKETS; JERSEYS; KNITTED CAPS; LONG-SLEEVED SHIRTS; NECKTIES; POLO SHIRTS; SHIRTS; SHORT-SLEEVED OR LONG-SLEEVED T-SHIRTS; SHORT-SLEEVED SHIRTS; SPORTS JACKETS; SPORTS SHIRTS; SUN VISORS; SWEAT PANTS; SWEAT SHIRTS; SWEAT SHORTS; T-SHIRTS; VISORS; WEARABLE GARMENTS AND CLOTHING, NAMELY, SHIRTS (U.S. CLS. 22 AND 39).

FIRST USE 10-21-1987; IN COMMERCE 10-21-1987.

DARRYL SPRUILL, EXAMINING ATTORNEY

CLASS 25—(Continued).

SN 77-598,182. WEINBRENNER SHOE COMPANY, INC., MERRILL, WI. FILED 10-22-2008.



OWNER OF U.S. REG. NO. 678,929.
NO CLAIM IS MADE TO THE EXCLUSIVE RIGHT TO USE "TRADEMARK", "SHOE COMPANY" AND "SINCE 1892", APART FROM THE MARK AS SHOWN.

THE MARK CONSISTS OF THE WORDS "TRADE MARK" ON THE TOP LINE WITH A WHEEL AND WINGS STYLE DESIGN BETWEEN "TRADE" AND "MARK", THE WORDS "WEINBRENNER SHOE COMPANY" APPEAR IN A BANNER WITH THE LETTER "W" INSIDE AND ON TOP OF THE BANNER IN A SHIELD TYPE DESIGN, WITH THE WORDS "SINCE 1892" BELOW ALL AT THE BOTTOM.

FOR FOOTWEAR (U.S. CLS. 22 AND 39).

FIRST USE 12-31-1892; IN COMMERCE 12-31-1892.

GIANCARLO CASTRO, EXAMINING ATTORNEY

SN 77-602,758. BEST FRIENDS LIMITED, KOWLOON, HONG KONG, FILED 10-29-2008.

COCOLULU

THE MARK CONSISTS OF STANDARD CHARACTERS WITHOUT CLAIM TO ANY PARTICULAR FONT, STYLE, SIZE, OR COLOR.

FOR CAPS; FOOTWEAR; HEADGEAR, NAMELY, HATS AND CAPS; HOODS; SHIRTS (U.S. CLS. 22 AND 39).

DANNEAN HETZEL, EXAMINING ATTORNEY

SN 77-605,378. HEALTHCARE UNIFORM COMPANY, INC., DBA LIFE UNIFORM, ST. LOUIS, MO. FILED 10-31-2008.

SCRUB ELEMENTS

THE MARK CONSISTS OF STANDARD CHARACTERS WITHOUT CLAIM TO ANY PARTICULAR FONT, STYLE, SIZE, OR COLOR.

NO CLAIM IS MADE TO THE EXCLUSIVE RIGHT TO USE "SCRUB", APART FROM THE MARK AS SHOWN.

FOR CLOTHING, NAMELY, MEDICAL UNIFORMS, SCRUBS NOT FOR SURGICAL PURPOSES, SHIRTS, TOPS, SMOCKS, TEE SHIRTS, PANTS, BOTTOMS, LAB COATS, JACKETS, HEADWEAR, CAPS, VISORS (U.S. CLS. 22 AND 39).

BARNEY CHARLON, EXAMINING ATTORNEY

CLASS 25—(Continued).

SN 77-606,044. ENH, LLC, DBA HANLEY MELLON, NEW YORK, NY. FILED 11-3-2008.

HANLEYMELLON

THE NAME(S), PORTRAIT(S), AND/OR SIGNATURE(S) SHOWN IN THE MARK IDENTIFIES "NICOLE HANLEY" AND "MATTHEW MELLON", WHOSE CONSENT(S) TO REGISTER IS MADE OF RECORD.

THE MARK CONSISTS OF STYLIZED UNITARY WORDS "HANLEYMELLON" WITH THE LETTER "Y" IN THE WORD "HANLEY", COMBINED WITH THE LETTER "M" IN THE WORD "MELLON".

FOR WOMEN'S CLOTHING, NAMELY, SUITS, DRESSES, BLAZERS, JACKETS, SWEATERS, SHORTS, SKIRTS, PANTS, COATS, SHIRTS, LEATHER PANTS, LEATHER COATS; SHOES, HATS, AND FASHION ACCESSORIES, NAMELY, GLOVES, SCARVES, CAPES, WRAPS, SOCKS, LINGERIE (U.S. CLS. 22 AND 39).
ODESSA BIBBINS, EXAMINING ATTORNEY

SN 77-607,790. MTTM WORLDWIDE, LLC, LAKE SUCCESS, NY. FILED 11-5-2008.

MOST OFFICIAL BABY

THE MARK CONSISTS OF STANDARD CHARACTERS WITHOUT CLAIM TO ANY PARTICULAR FONT, STYLE, SIZE, OR COLOR.

NO CLAIM IS MADE TO THE EXCLUSIVE RIGHT TO USE "BABY", APART FROM THE MARK AS SHOWN.

FOR FOOTWEAR; HATS; PANTS; SHIRTS; SOCKS (U.S. CLS. 22 AND 39).

RUSS HERMAN, EXAMINING ATTORNEY

SN 77-618,610. REGAN, SUSAN L., HULL, MA. FILED 11-20-2008.



THE MARK CONSISTS OF A STYLIZED FISH WITH STRIPE WITH THE WORD "ISLAND" ABOVE AND "SKUNKFISH" BELOW, ALL INSIDE A CIRCLE.

FOR HATS; JERSEYS; SHIRTS; TOPS; WRAPS (U.S. CLS. 22 AND 39).

FIRST USE 8-1-2008; IN COMMERCE 10-1-2008.

ANDREA SAUNDERS, EXAMINING ATTORNEY

CLASS 25—(Continued).

SN 77-620,345. JOL DESIGN INC., HERMOSA BEACH, CA. FILED 11-24-2008.

Savior Self

THE MARK CONSISTS OF STANDARD CHARACTERS WITHOUT CLAIM TO ANY PARTICULAR FONT, STYLE, SIZE, OR COLOR.

FOR ATHLETIC APPAREL, NAMELY, SHIRTS, PANTS, JACKETS, FOOTWEAR, HATS AND CAPS, ATHLETIC UNIFORMS (U.S. CLS. 22 AND 39).

DOUGLAS LEE, EXAMINING ATTORNEY

SN 77-621,602. NIKE, INC., BEAVERTON, OR. FILED 11-25-2008.

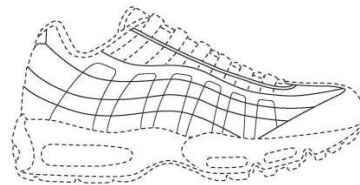

THE MARK CONSISTS OF THE DESIGN OF THE STITCHING ON THE EXTERIOR OF THE SHOE, THE DESIGN OF THE MATERIAL PANELS THAT FORM THE EXTERIOR BODY OF THE SHOE, NAMELY, THE HORIZONTAL WAVY PANELS AND THE VERTICAL RAISED PANELS ON SIDES OF THE SHOE, AND THE RELATIVE POSITION OF THESE ELEMENTS TO EACH OTHER. THE BROKEN LINES SHOW THE POSITION OF THE MARK AND ARE NOT CLAIMED AS PART OF THE MARK.

SEC. 2(F).

FOR FOOTWEAR (U.S. CLS. 22 AND 39).

FIRST USE 0-0-1995; IN COMMERCE 0-0-1995.

RICHARD WHITE, EXAMINING ATTORNEY

SN 77-623,178. BARMAKOVA, ELENA L., LOS ANGELES, CA. FILED 11-28-2008.

LENA LOREN

THE MARK CONSISTS OF STANDARD CHARACTERS WITHOUT CLAIM TO ANY PARTICULAR FONT, STYLE, SIZE, OR COLOR.

THE NAME "LENA LOREN" DOES NOT IDENTIFY A LIVING INDIVIDUAL.

FOR DRESSES; FUR COATS; HATS (U.S. CLS. 22 AND 39).

MARK T. MULLEN, EXAMINING ATTORNEY

CLASS 25—(Continued).

SN 77-624,866. PROFESSIONAL APPEARANCES, INC., CA-MARILLO, CA. FILED 12-2-2008.

CLASS 25—(Continued).

SN 77-631,360. NEW ERA CAP CO., INC., BUFFALO, NY. FILED 12-11-2008.

SOFT & CHIC

THE MARK CONSISTS OF STANDARD CHARACTERS WITHOUT CLAIM TO ANY PARTICULAR FONT, STYLE, SIZE, OR COLOR.

NO CLAIM IS MADE TO THE EXCLUSIVE RIGHT TO USE "SOFT", APART FROM THE MARK AS SHOWN.

FOR JACKETS; NURSE'S APPAREL, NAMELY, SCRUBS, TOPS, SHIRTS, JACKETS, AND PANTS; PANTS; SHIRTS; TOPS (U.S. CLS. 22 AND 39).

DORITT L. CARROLL, EXAMINING ATTORNEY



OWNER OF U.S. REG. NOS. 2,535,462, 3,122,529 AND OTHERS.

THE MARK CONSISTS OF THE LETTERS "NE" IN THE SHAPE OF A FLAG NEXT TO THE WORDS "NEW ERA".

FOR HEADWEAR, ATHLETIC APPAREL, NAMELY, HATS AND CAPS, BASEBALL CAPS AND HATS (U.S. CLS. 22 AND 39).

ELLEN PERKINS, EXAMINING ATTORNEY

SN 77-629,553. BESS, RANDALL F, DBA JUST HOODS AND TEES COMPANY, NITRO, WV. FILED 12-9-2008.



NO CLAIM IS MADE TO THE EXCLUSIVE RIGHT TO USE "JUST HOODS AND TEES COMPANY", APART FROM THE MARK AS SHOWN.

THE COLOR(S) ORANGE, GREEN, BLUE, YELLOW, PURPLE GRADIENT, BLACK, RED IS/ARE CLAIMED AS A FEATURE OF THE MARK.

THE MARK CONSISTS OF A STYLIZED LETTER "H". A GRAPHIC ELEMENT REPRESENTING A HOOD (LIKE THAT OF A HOODED SWEATSHIRT) APPEARS ON THE TOP OF THE LETTER "H". THE LETTERS "OODS" FOLLOW TO THE RIGHT OF THE STYLIZED LETTER "H". THE WORD "JUST" IN ALL CAPS APPEARS WITHIN THE GRAPHIC HOODED ELEMENT ABOVE THE STYLIZED LETTER "H". THESE ELEMENTS MADE UP THE FIRST LINE OF THE LOGO WHICH IS THEN FILLED WITH A GRADIENT MIX OF COLORS INCLUDING ORANGE, GREEN, BLUE, YELLOW, PURPLE OUTLINED IN BLACK. THE WORDS "AND TEES COMPANY" APPEARS IN THE SECOND LINE OF THE LOGO. THESE WORDS APPEAR IN THE COLOR RED.

FOR A-SHIRTS; ATHLETIC APPAREL, NAMELY, SHIRTS, PANTS, JACKETS, FOOTWEAR, HATS AND CAPS, ATHLETIC UNIFORMS; GOLF SHIRTS; HOODED SWEAT SHIRTS; KNIT SHIRTS; LONG-SLEEVED SHIRTS; MOISTURE-WICKING SPORTS SHIRTS; SHIRTS; SHORT-SLEEVED OR LONG-SLEEVED T-SHIRTS; SPORT SHIRTS; SPORTS SHIRTS; SPORTS SHIRTS WITH SHORT SLEEVES; SWEAT SHIRTS; T-SHIRTS; TEE SHIRTS; WEARABLE GARMENTS AND CLOTHING, NAMELY, SHIRTS; WIND SHIRTS (U.S. CLS. 22 AND 39).

LAURIE MAYES, EXAMINING ATTORNEY

SN 77-632,790. HARVEY BALL SMILE LIMITED, SHINAGAWA-KU TOKYO, JAPAN, FILED 12-14-2008.



THE MARK CONSISTS OF A SMILEY FACE DEPICTING A SMILE, ONE EYE, AND AN EYE PATCH AND ITS PARTIAL STRING, REPRESENTING AN EYE.

FOR CAPS; COATS; FOOTWEAR; GLOVES; HATS; NECKTIES; PAJAMAS; PANTS; SCARVES; SHIRTS; SHORTS; SKIRTS; SOCKS AND STOCKINGS; SWEATERS; SWIMSUITS; T-SHIRTS; TROUSERS; UNDERWEAR (U.S. CLS. 22 AND 39).

ODESSA BIBBINS, EXAMINING ATTORNEY

CLASS 25—(Continued).

SN 77-632,798. HARVEY BALL SMILE LIMITED, SHINAGAWA-KU TOKYO, JAPAN, FILED 12-14-2008.

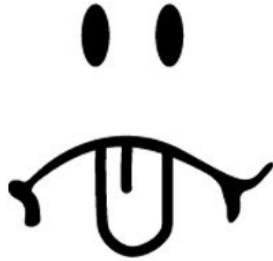

THE MARK CONSISTS OF A FACE WITH TWO SHADED VERTICAL OVALS REPRESENTING EYES, WITH A DOWN-TURNED MOUTH WITH CORNERS, WITH A TONGUE WITH A SHORT LINE EXTENDING FROM THE MOUTH, BELOW.

FOR CAPS; COATS; FOOTWEAR; GLOVES; HATS; NECKTIES; PAJAMAS; PANTS; SCARVES; SHIRTS; SHORTS; SKIRTS; SOCKS AND STOCKINGS; SWEATERS; SWIMSUITS; T-SHIRTS; TROUSERS; UNDERWEAR (U.S. CLS. 22 AND 39).

ODESSA BIBBINS, EXAMINING ATTORNEY

SN 77-632,799. HARVEY BALL SMILE LIMITED, SHINAGAWA-KU TOKYO, JAPAN, FILED 12-14-2008.



THE MARK CONSISTS OF A SMILEY FACE WITH TWO SHADED VERTICAL OVALS REPRESENTING EYES, WITH A HORIZONTAL CRESCENT MOON REPRESENTING A SMILE, BELOW.

FOR CAPS; COATS; FOOTWEAR; GLOVES; HATS; NECKTIES; PAJAMAS; PANTS; SCARVES; SHIRTS; SHORTS; SKIRTS; SOCKS AND STOCKINGS; SWEATERS; SWIMSUITS; T-SHIRTS; TROUSERS; UNDERWEAR (U.S. CLS. 22 AND 39).

ODESSA BIBBINS, EXAMINING ATTORNEY

CLASS 25—(Continued).

SN 77-632,870. MIZUNO CORPORATION, OSAKA, 541-8538, JAPAN, FILED 12-15-2008.

PROTECT PLUS

THE MARK CONSISTS OF STANDARD CHARACTERS WITHOUT CLAIM TO ANY PARTICULAR FONT, STYLE, SIZE, OR COLOR.

FOR BASEBALL SPORTING WEAR, NAMELY, JERSEYS, PANTS, WARM-UP SHIRTS, WARM-UP PANTS, SHIRTS, SLIDING SHORTS; VOLLEYBALL SPORTING WEAR, NAMELY, WARM-UP SHIRTS, WARM-UP PANTS, JERSEYS, SHIRTS, SHORTS; GOLF WEAR, NAMELY, JACKETS, PANTS, SWEATERS, SHIRTS, BEANIES; RUNNING WEAR, NAMELY, JACKETS, PANTS, WARM-UP SHIRTS, WARM-UP PANTS, SHIRTS, SHORTS; CASUAL WEAR, NAMELY, JACKETS, PANTS, SHIRTS, SHORTS, CAPS, BEANIES, HEADBANDS, SOCKS, WRISTBANDS; AND UNDERWEAR, NAMELY, UNDERSHIRTS, SHORTS, UNDERPANTS (U.S. CLS. 22 AND 39).

STEPHEN AQUILA, EXAMINING ATTORNEY

SN 77-649,064. STIFANIC, HEATHER, DBA THE INDUSTRY PROJECT LLC, BRONX, NY, FILED 1-14-2009.

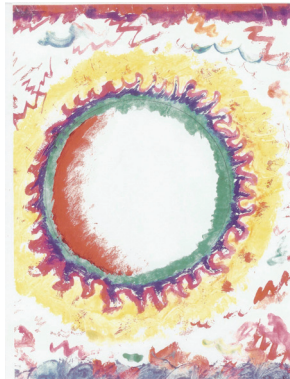

THE COLOR(S) WHITE, RED, GREEN, PURPLE, PINK, YELLOW AND BLUE IS/ARE CLAIMED AS A FEATURE OF THE MARK.

THE MARK CONSISTS OF A STYLIZED VERSION OF A SUN IN THE COLORS WHITE, RED, GREEN, PURPLE, PINK AND YELLOW ON A WHITE RECTANGULAR BACKGROUND FEATURING WAVY LINES AND FLECKS OF PINK, GREEN, RED AND BLUE COLOR ALL HAVING A TIE-DYED APPEARANCE. THE TOP BORDER OF THE RECTANGULAR BACKGROUND IS A MIX OF RED AND PURPLE COLORS, AND THE BOTTOM BORDER OF THE RECTANGULAR BACKGROUND IS A MIX OF RED AND BLUE COLORS. THE RECTANGULAR SHAPE OF THE BACKGROUND IS CLAIMED AS A FEATURE OF THE MARK.

FOR T-SHIRTS (U.S. CLS. 22 AND 39).
ZHALEH DELANEY, EXAMINING ATTORNEY

CLASS 25—(Continued).

SN 77-650,393. LATHAM JR, CHARLES W, POPE AFB, NC. FILED 1-15-2009.

CLASS 25—(Continued).

SN 77-656,142. ANDERSON, MICHAEL B, DENVER, CO. FILED 1-25-2009.

Hard Bodii

LOVE AMERICA

THE MARK CONSISTS OF STANDARD CHARACTERS WITHOUT CLAIM TO ANY PARTICULAR FONT, STYLE, SIZE, OR COLOR.

FOR TEE SHIRTS, ATHLETIC PANTS, ATHLETIC SHORTS, POLO SHIRTS, DRESS SHIRTS, DENIM PANTS, SWEAT PANTS, SWEAT SHIRTS, HOODED SWEAT SHIRTS, HOODED TEE SHIRTS, ATHLETIC JACKETS, BASEBALL CAPS, CASUAL SHIRTS, BOXER SHORTS, UNDERWEAR, SOCKS, COLLARED SHIRTS (U.S. CLS. 22 AND 39).

LINDA LAVACHE, EXAMINING ATTORNEY

THE MARK CONSISTS OF STANDARD CHARACTERS WITHOUT CLAIM TO ANY PARTICULAR FONT, STYLE, SIZE, OR COLOR.

NO CLAIM IS MADE TO THE EXCLUSIVE RIGHT TO USE "AMERICA", APART FROM THE MARK AS SHOWN. FOR BASEBALL CAPS; SHORT-SLEEVED OR LONG-SLEEVED T-SHIRTS; T-SHIRTS (U.S. CLS. 22 AND 39). RON FAIRBANKS, EXAMINING ATTORNEY

SN 77-652,277. BACKSTREETS MARKETING GROUP, INC., CHARLOTTE, NC. FILED 1-19-2009.

SN 77-666,729. 17/21 GROUP, LLC, THE, VERNON, CA. FILED 2-9-2009.



Fragile blue jeans

THE MARK CONSISTS OF A RECTANGULAR BORDER DESIGN WITHIN WHICH IS THE WORD "PAR" OVER THE WORD "ONE" WITH A FLAGSTICK IN THE MIDDLE OF THE LOWERCASE "N" IN "ONE". BETWEEN THESE TWO TERMS IS A HORIZONTAL LINE. ALSO, UNDER THE WORD "ONE" ARE THE WORDS "ONE UNDER PAR" ALL WITHIN A RECTANGULAR BORDER.

FOR GOLF SHIRTS; HATS; POLO SHIRTS; SHIRTS; SWEAT SHIRTS; T-SHIRTS (U.S. CLS. 22 AND 39). FIRST USE 1-9-2009; IN COMMERCE 1-9-2009. KATHERINE STOIDES, EXAMINING ATTORNEY

NO CLAIM IS MADE TO THE EXCLUSIVE RIGHT TO USE "BLUE JEANS", APART FROM THE MARK AS SHOWN.

THE MARK CONSISTS OF THE WORDING "FRAGILE BLUE JEANS" WHERE THE TERM "FRAGILE" IS WRITTEN IN A STYLIZED FONT AND THE WORDING "BLUE JEANS" IS WRITTEN IN LOWER-CASE STANDARD CHARACTERS AND APPEARS UNDERNEATH THE TERM "FRAGILE".

FOR JACKETS, SHIRTS, T-SHIRTS, VESTS, OVERALLS, COVERALLS, SHORTALLS, SKORTS, SWEAT PANTS, SWEAT SHIRTS, TOPS, TANK TOPS, BATHING SUITS, BATHING TRUNKS, BATH ROBES, BEACHWEAR, BIKINIS, BLAZERS, BLOUSES, CAPS, COATS, COVER-UPS, DRESSES, GLOVES, HATS, HEAD WEAR, LINGERIE, PAJAMAS, RAINWEAR, SCARVES, SKI-WEAR, SLEEPWEAR, SOCKS, SURF WEAR, SWEATERS, SWIM WEAR, UNDERWEAR, BELTS, FOOTWEAR (U.S. CLS. 22 AND 39). RICHARD WHITE, EXAMINING ATTORNEY

CLASS 25—(Continued).

SN 77-667,213. EVERLAST WORLD'S BOXING HEADQUARTERS CORPORATION, NEW YORK, NY. FILED 2-10-2009.

EVERCOOL

THE MARK CONSISTS OF STANDARD CHARACTERS WITHOUT CLAIM TO ANY PARTICULAR FONT, STYLE, SIZE, OR COLOR.

FOR CLOTHING, NAMELY, FOOTWEAR, PANTS, ROBES, SHIRTS, SHORTS, PULLOVERS, UNDERWEAR, SLEEPWEAR; BOXING JERSEYS, BOXING SHOES, BRIEFS, ELASTIC BELTS, EXERCISE SUITS, GLOVES, JACKETS, JOGGING SUITS, MUSCLE SHIRTS, SAUNA SUITS, SOCKS, STOCKINGS, SWEATPANTS, SWEATSHIRTS, T-SHIRTS, THERMAL UNDERWEAR, BOXING AND BATHING TRUNKS (U.S. CLS. 22 AND 39).

BONNIE LUKEN, EXAMINING ATTORNEY

CLASS 25—(Continued).

SN 77-670,200. ART OF TRI, LTD., TIMES SQUARE, HONG KONG, FILED 2-13-2009.



THE COLOR(S) GREY AND RED IS/ARE CLAIMED AS A FEATURE OF THE MARK.

THE MARK CONSISTS OF A RED TRIANGULAR SYMBOL POSITIONED DIRECTLY ABOVE THE WORDS "ART OF TRI" IN GREY, LOWER CASE LETTERS. THE COLOR WHITE REPRESENTS BACKGROUND, OUTLINING, SHADING AND/OR TRANSPARENT AREAS THAT ARE NOT PART OF THE MARK.

FOR HOODED SWEAT SHIRTS; LONG-SLEEVED SHIRTS; LOUNGEWEAR; SHIRTS; SHORT-SLEEVED OR LONG-SLEEVED T-SHIRTS; SHORT-SLEEVED SHIRTS; SPORT SHIRTS; SPORTS SHIRTS WITH SHORT SLEEVES; SWEAT SHIRTS; T-SHIRTS; WEARABLE GARMENTS AND CLOTHING, NAMELY, SHIRTS (U.S. CLS. 22 AND 39).

FIRST USE 1-1-2007; IN COMMERCE 1-1-2007.

AMEEN IMAM, EXAMINING ATTORNEY

SN 77-668,768. MCCUTCHEON, MATTHEW, CLAYVILLE, NY. FILED 2-11-2009.



THE MARK CONSISTS OF THE TWO-DIMENSIONAL STYLIZED REPRESENTATION OF A MOTOCROSS HELMET.

FOR CLOTHING, NAMELY, T-SHIRTS, HATS, JACKETS, SWEAT SHIRTS, RACE PANTS, RACE JERSEYS (U.S. CLS. 22 AND 39).

FIRST USE 1-2-2009; IN COMMERCE 1-2-2009.

BARBARA GAYNOR, EXAMINING ATTORNEY

SN 77-671,567. MALYON, CHRISTOPHER JOHN, BRISBANE, AUSTRALIA, AND MALYON, MATTHEW JOHN, BRISBANE, AUSTRALIA, FILED 2-16-2009.

F & C

THE MARK CONSISTS OF STANDARD CHARACTERS WITHOUT CLAIM TO ANY PARTICULAR FONT, STYLE, SIZE, OR COLOR.

PRIORITY CLAIMED UNDER SEC. 44(D) ON AUSTRALIA APPLICATION NO. 1275078, FILED 12-2-2008, REG. NO. 1275078, DATED 12-2-2008, EXPIRES 12-2-2018.

FOR ATHLETIC APPAREL, NAMELY, SHIRTS, PANTS, JACKETS, FOOTWEAR, HATS AND CAPS, ATHLETIC UNIFORMS; BOARD SHORTS; LONG-SLEEVED SHIRTS; SHORT-SLEEVED OR LONG-SLEEVED T-SHIRTS; SHORT-SLEEVED SHIRTS; SPORTS SHIRTS WITH SHORT SLEEVES; T-SHIRTS; TRIATHLON CLOTHING, NAMELY, TRIATHLON TIGHTS, TRIATHLON SHORTS, TRIATHLON SINGLETTS, TRIATHLON SHIRTS, TRIATHLON SUITS; WALKING SHORTS; BOXER SHORTS (U.S. CLS. 22 AND 39).

TINA BROWN, EXAMINING ATTORNEY

CLASS 25—(Continued).

SN 77-674,995. RAPHA DISTRIBUTION, LLC, THE COLONY, TX. FILED 2-20-2009.

VISION LIDZ

THE MARK CONSISTS OF STANDARD CHARACTERS WITHOUT CLAIM TO ANY PARTICULAR FONT, STYLE, SIZE, OR COLOR.

NO CLAIM IS MADE TO THE EXCLUSIVE RIGHT TO USE "LIDS", APART FROM THE MARK AS SHOWN.

FOR HEADWEAR (U.S. CLS. 22 AND 39).

FIRST USE 2-16-2009; IN COMMERCE 2-16-2009.

REBECCA SMITH, EXAMINING ATTORNEY

CLASS 25—(Continued).

SN 77-684,821. NASTEE, FORT MYERS, FL. FILED 3-5-2009.



THE MARK CONSISTS OF A SMALL HAND DRAWN MONKEY.

FOR (BASED ON USE IN COMMERCE) HOODED SWEAT SHIRTS; POLO SHIRTS; SHIRTS; SHORT-SLEEVED OR LONG-SLEEVED T-SHIRTS; SHORT-SLEEVED SHIRTS; T-SHIRTS; WEARABLE GARMENTS AND CLOTHING, NAMELY, SHIRTS (BASED ON INTENT TO USE) ATHLETIC APPAREL, NAMELY, SHIRTS, PANTS, JACKETS, FOOTWEAR, HATS AND CAPS, ATHLETIC UNIFORMS; DRESS SHIRTS; GOLF SHIRTS; KNIT SHIRTS; LONG-SLEEVED SHIRTS; PIQUE SHIRTS; SHIRTS FOR SUITS; SWEAT SHIRTS (U.S. CLS. 22 AND 39).

FIRST USE 10-16-1998; IN COMMERCE 5-31-2008.

AARON BRODSKY, EXAMINING ATTORNEY

SN 77-680,414. I'M OPEN, A LIMITED LIABILITY COMPANY, SANTA BARBARA, CA. FILED 2-27-2009.



THE MARK CONSISTS OF THE DESIGN OF TWO CONCENTRIC OVALS WITH THE WORDS "OPEN CONVERSATION" WITHIN THE WIDER SIDES OF THE OUTER SHADED OVAL, AND THE NUMBER "2" IN THE CENTER OF THE INNER OVAL.

FOR CLOTHING, NAMELY, T-SHIRTS, JACKETS, SWEAT PANTS, SHORTS, CAPS AND VISORS (U.S. CLS. 22 AND 39).

FIRST USE 7-9-2009; IN COMMERCE 7-9-2009.

BARBARA A. GOLD, EXAMINING ATTORNEY

SN 77-687,199. FREEMAN, PAUL M., MODESTO, CA. FILED 3-10-2009.

RESPECT

THE MARK CONSISTS OF STANDARD CHARACTERS WITHOUT CLAIM TO ANY PARTICULAR FONT, STYLE, SIZE, OR COLOR.

FOR ATHLETIC APPAREL, NAMELY, SHIRTS, PANTS, JACKETS, FOOTWEAR, HATS AND CAPS, ATHLETIC UNIFORMS; BICYCLE GLOVES; BICYCLING GLOVES; BODY SHIRTS; CLOTHING FOR ATHLETIC USE, NAMELY, PADDED SHIRTS; CLOTHING FOR WEAR IN WRESTLING GAMES; CROSS-COUNTRY GLOVES; DRESS SHIRTS; GLOVES; GLOVES FOR PERSONAL HAND CONDITIONING USE; GLOVES INCLUDING THOSE MADE OF SKIN, HIDE OR FUR; HOODED SWEAT SHIRTS; LONG-SLEEVED SHIRTS; MOISTURE-WICKING SPORTS SHIRTS; MOTORCYCLE GLOVES; OUTDOOR GLOVES; POLO SHIRTS; RIDING GLOVES; SKI GLOVES; SNOWBOARD GLOVES; SPORT SHIRTS; T-SHIRTS; TRIATHLON CLOTHING, NAMELY, TRIATHLON TIGHTS, TRIATHLON SHORTS, TRIATHLON SINGLET, TRIATHLON SHIRTS, TRIATHLON SUITS; WEARABLE GARMENTS AND CLOTHING, NAMELY, SHIRTS; WET SUIT GLOVES (U.S. CLS. 22 AND 39).

FIRST USE 1-1-2003; IN COMMERCE 6-1-2006.

LINDA M. KING, EXAMINING ATTORNEY

SN 77-683,100. RESTORED AND REDEEMED APPAREL, INC., BOCA RATON, FL. FILED 3-4-2009.

Redeemed and Restored Inc.

THE MARK CONSISTS OF STANDARD CHARACTERS WITHOUT CLAIM TO ANY PARTICULAR FONT, STYLE, SIZE, OR COLOR.

NO CLAIM IS MADE TO THE EXCLUSIVE RIGHT TO USE "INC.", APART FROM THE MARK AS SHOWN.

FOR BLOUSES; HATS; HEADBANDS; PANTS; SHIRTS; SHORTS; T-SHIRTS; WRISTBANDS (U.S. CLS. 22 AND 39).

B. PARADEWELAI, EXAMINING ATTORNEY

CLASS 25—(Continued).

SN 77-687,572. ITALIAN SHOEMAKERS, INC, DORAL, FL.
FILED 3-10-2009.

LUISA D' ORIO

THE MARK CONSISTS OF STANDARD CHARACTERS WITHOUT CLAIM TO ANY PARTICULAR FONT, STYLE, SIZE, OR COLOR.

THE NAME(S), PORTRAIT(S), AND/OR SIGNATURE(S) SHOWN IN THE MARK DOES NOT IDENTIFY A PARTICULAR LIVING INDIVIDUAL.

FOR FOOTWEAR (U.S. CLS. 22 AND 39).
FIRST USE 2-2-1998; IN COMMERCE 2-2-1998.
JASON TURNER, EXAMINING ATTORNEY

SN 77-687,738. SHABATIAN, ELHAM, LOS ANGES, CA.
FILED 3-10-2009.

AARON ASHE

THE MARK CONSISTS OF STANDARD CHARACTERS WITHOUT CLAIM TO ANY PARTICULAR FONT, STYLE, SIZE, OR COLOR.

THE NAME "AARON ASHE" DOES NOT IDENTIFY A PARTICULAR LIVING INDIVIDUAL.

FOR WOMEN'S CLOTHING, NAMELY, SHIRTS, BLOUSES, DRESSES, SKIRTS, TOPS, JACKETS, T-SHIRTS, TANK TOPS, MINI SKIRTS (U.S. CLS. 22 AND 39).

FIRST USE 10-16-2007; IN COMMERCE 10-16-2007.
KATINA MISTER, EXAMINING ATTORNEY

CLASS 25—(Continued).

SN 77-689,214. CYRUS HAKAKIAN, NEW YORK, NY.
FILED 3-12-2009.

VENINI

THE MARK CONSISTS OF STANDARD CHARACTERS WITHOUT CLAIM TO ANY PARTICULAR FONT, STYLE, SIZE, OR COLOR.

SEC. 2(F).

FOR BELTS; BIBS NOT OF CLOTH OR PAPER; CAPS; CHILDREN'S AND INFANTS' CLOTH BIBS; CHILDREN'S CLOTH EATING BIBS; CLOTH BIBS; CLOTH BIBS FOR ADULT DINERS; CLOTH BIBS FOR USE BY SENIOR CITIZENS OR PHYSICALLY- OR MENTALLY-CHALLENGED PERSONS; CLOTHING, NAMELY, KHAKIS; HOODS; JERSEYS; SHORT SETS; TIES; TOPS; TRAVEL CLOTHING CONTAINED IN A PACKAGE COMPRISING REVERSIBLE JACKETS, PANTS, SKIRTS, TOPS AND A BELT OR SCARF; TRIATHLON CLOTHING, NAMELY, TRIATHLON TIGHTS, TRIATHLON SHORTS, TRIATHLON SINGLETS, TRIATHLON SHIRTS, TRIATHLON SUITS; WEARABLE GARMENTS AND CLOTHING, NAMELY, SHIRTS; WRAPS (U.S. CLS. 22 AND 39).

FIRST USE 9-25-2001; IN COMMERCE 9-25-2001.
BARBARA GAYNOR, EXAMINING ATTORNEY

SN 77-690,726. FOOTWEAR UNLIMITED INC., FENTON, MO. FILED 3-13-2009.

SLEEKERS

THE MARK CONSISTS OF STANDARD CHARACTERS WITHOUT CLAIM TO ANY PARTICULAR FONT, STYLE, SIZE, OR COLOR.

FOR FOOTWEAR (U.S. CLS. 22 AND 39).

MATTHEW MCDOWELL, EXAMINING ATTORNEY

SN 77-691,347. HOWARD, RHONDA, DBA LIFE IS SERIOUS CLOTHING, WILMINGTON, NC. FILED S.R. 3-15-2009; AM. P.R. 7-13-2009.

Life is Serious

THE MARK CONSISTS OF STANDARD CHARACTERS WITHOUT CLAIM TO ANY PARTICULAR FONT, STYLE, SIZE, OR COLOR.

FOR SHORT-SLEEVED OR LONG-SLEEVED T-SHIRTS (U.S. CLS. 22 AND 39).

FIRST USE 3-10-2009; IN COMMERCE 3-10-2009.
MYRIAH HABEEB, EXAMINING ATTORNEY

CLASS 25—(Continued).

SN 77-692,722. JEREMY A. MADRAZO, DBA POCKET BOIS, HUNTINGTON BEACH, CA. FILED 3-17-2009.



NO CLAIM IS MADE TO THE EXCLUSIVE RIGHT TO USE "SOUTHERNCALI~HAWAII", APART FROM THE MARK AS SHOWN.

THE COLOR(S) WHITE, BLACK, YELLOW, AND BLUE IS/ARE CLAIMED AS A FEATURE OF THE MARK.

THE MARK CONSISTS OF WORDS AT TOP: "DA PLACE YOU LIKE BE" BUSINESS NAME AT CENTER: "POCKET BOIS" WITH THE "C" DRAWN TO APPEAR LIKE AN OCEAN WAVE, A YELLOW SUN BEHIND THE WORD "POCKET", A DOVE FLYING FACING THE SUN ABOVE THE LETTER "P", THE WORD "POCKET" IN WHITE AND BLUE, THE WORD "BOIS" IN WHITE, THE WORDS "SOUTHERNCALI~HAWAII" IN BLACK UNDER THE WORD "BOIS", LOGO IS OVAL IN SHAPE.

FOR ATHLETIC APPAREL, NAMELY, SHIRTS, PANTS, JACKETS, FOOTWEAR, HATS AND CAPS, ATHLETIC UNIFORMS (U.S. CLS. 22 AND 39).

FIRST USE 3-15-2009; IN COMMERCE 3-16-2009.

ANDREA BUTLER, EXAMINING ATTORNEY

SN 77-694,026. SCRIPPS NETWORKS, LLC, KNOXVILLE, TN. FILED 3-18-2009.

MAN CAVES

THE MARK CONSISTS OF STANDARD CHARACTERS WITHOUT CLAIM TO ANY PARTICULAR FONT, STYLE, SIZE, OR COLOR.

FOR CLOTHING, NAMELY, SHIRTS AND HATS (U.S. CLS. 22 AND 39).

TEJBIR SINGH, EXAMINING ATTORNEY

CLASS 25—(Continued).

SN 77-695,782. TIMES THREE CLOTHIER, LLC, NEW YORK, NY. FILED 3-20-2009.

I AM YUMMIE

THE MARK CONSISTS OF STANDARD CHARACTERS WITHOUT CLAIM TO ANY PARTICULAR FONT, STYLE, SIZE, OR COLOR.

OWNER OF U.S. REG. NO. 3,449,024.

FOR CLOTHING, NAMELY, SWIMSUITS, SWIMWEAR, FOOTWEAR, COATS, JACKETS, VESTS, OVERCOATS, RAINCOATS, TRENCH COATS, ANORAKS, PARKAS, BLAZERS, WIND RESISTANT JACKETS, CAPES, DRESSES, SHIRTS, DRESS SHIRTS, T-SHIRTS, TANK TOPS, JUMPERS, KNIT SHIRTS, WOVEN SHIRTS, SWEATERS, CARDIGANS, TURTLENECKS, DENIM JEANS, UNDERGARMENTS, LINGERIE, SLEEPWEAR, ROBES, SWEAT SUITS, SWEATSHIRTS, PANTS, DRESS SLACKS AND CASUAL SLACKS, BLOUSES, T-SHIRTS, SHORTS, SKIRTS, SOCKS, HOSIERY, STOCKINGS, LEGGINGS, TIES, SUSPENDERS, SHOES, SLIPPERS, BELTS, FOOTWEAR, NECKWEAR, ASCOTS, SCARVES, GLOVES, MITTENS, BODYSUITS, SERAPES, SHAWLS, STOLE, AND HEADWEAR (U.S. CLS. 22 AND 39).

ELIZABETH KAJUBI, EXAMINING ATTORNEY

SN 77-695,788. KARSTENS, BRADLEY, YORBA LINDA, CA. FILED 3-20-2009.

Tuck & Run

THE MARK CONSISTS OF STANDARD CHARACTERS WITHOUT CLAIM TO ANY PARTICULAR FONT, STYLE, SIZE, OR COLOR.

FOR BOOTS; CAPS; COATS; GLOVES; HATS; HEADBANDS; JACKETS; JEANS; JERSEYS; KNIT SHIRTS; SANDALS; SHOES; SHORTS; SWEAT SHIRTS; T-SHIRTS; UNDERWEAR; VISORS (U.S. CLS. 22 AND 39).

WENDY JUN, EXAMINING ATTORNEY

SN 77-696,921. MATTOX, LISA D, BIRMINGHAM, AL. FILED 3-23-2009.

BIGTALK

THE MARK CONSISTS OF STANDARD CHARACTERS WITHOUT CLAIM TO ANY PARTICULAR FONT, STYLE, SIZE, OR COLOR.

FOR CLOTHING FOR ATHLETIC USE, NAMELY, PADDED SHIRTS; GOLF PANTS, SHIRTS AND SKIRTS; GOLF SHIRTS; HATS; HEADGEAR, NAMELY, HATS, CAPS; HOODED SWEAT SHIRTS; JACKETS; LONG-SLEEVED SHIRTS; WEARABLE GARMENTS AND CLOTHING, NAMELY, SHIRTS; WIND RESISTANT JACKETS; WIND SHIRTS (U.S. CLS. 22 AND 39).

AMY HELLA, EXAMINING ATTORNEY

CLASS 25—(Continued).

SN 77-697,546. RIVERSIDE MANUFACTURING COMPANY,
MOULTRIE, GA. FILED 3-24-2009.

MASTERLINER

THE MARK CONSISTS OF STANDARD CHARACTERS
WITHOUT CLAIM TO ANY PARTICULAR FONT, STYLE,
SIZE, OR COLOR.

FOR WEARING APPAREL, NAMELY, ASSEMBLED
DETACHABLE LININGS MADE OF NATURAL AND
SYNTHETIC MATERIALS, FOR COATS AND JACKETS
(U.S. CLS. 22 AND 39).

FIRST USE 1-2-1970; IN COMMERCE 1-2-1970.
ESTHER BELENKER, EXAMINING ATTORNEY

SN 77-698,993. FEDERGREEN, RANDY, DALLAS, TX.
FILED 3-25-2009.

Randy Underpants

THE MARK CONSISTS OF STANDARD CHARACTERS
WITHOUT CLAIM TO ANY PARTICULAR FONT, STYLE,
SIZE, OR COLOR.

NO CLAIM IS MADE TO THE EXCLUSIVE RIGHT TO
USE "UNDERPANTS", APART FROM THE MARK AS
SHOWN.

THE NAME "RANDY" DOES NOT IDENTIFY A LIVING
INDIVIDUAL.

FOR BRIEFS; UNDERWEAR (U.S. CLS. 22 AND 39).
JOHN E. MICHOS, EXAMINING ATTORNEY

SN 77-699,440. KNUBIE CORPORATION, WILMINGTON,
DE. FILED 3-25-2009.

LonesomeGeorge

THE MARK CONSISTS OF STANDARD CHARACTERS
WITHOUT CLAIM TO ANY PARTICULAR FONT, STYLE,
SIZE, OR COLOR.

FOR CLOTHING AND HEADGEAR, NAMELY, BELTS,
BLAZERS, BLOUSES, BODYSUITS, CAMISOLES, CAPS,
COATS, DICKIES, DRESSES, HATS, HOSIERY, JACK-
ETS, JUMP SUITS, KNIT SHIRTS, PANTS, PULL-OVERS,
SCARVES, SHIRTS, SHORTS, SKIRTS, SKORTS,
SLACKS, SOCKS, SPORTCOATS, SWEAT PANTS,
SWEATSHIRTS, SWEATERS, SWIMWEAR, T-SHIRTS,
TANK TOPS, TIGHTS, TOPS, UNDERWEAR, VESTS,
VISORS, WINDSHIRTS, AND FOOTWEAR (U.S. CLS. 22
AND 39).

JULIE GUTTADAURO, EXAMINING ATTORNEY

CLASS 25—(Continued).

SN 77-702,340. JOHNSON, URSULA, DBA SISTA GIRL
CLOTHING, SACRAMENTO, CA. FILED 3-30-2009.



NO CLAIM IS MADE TO THE EXCLUSIVE RIGHT TO
USE "GIRL CLOTHING", APART FROM THE MARK AS
SHOWN.

FOR ATHLETIC APPAREL, NAMELY, SHIRTS,
PANTS, JACKETS, FOOTWEAR, HATS AND CAPS,
ATHLETIC UNIFORMS; BABY BIBS NOT OF PAPER;
BABY BODYSUITS; BABY BOTTOMS; BABY TOPS;
BANDANAS; CAPS WITH VISORS; CROP TOPS; DEN-
IMS; GYM PANTS; HALTER TOPS; HOODED SWEAT
SHIRTS; JOGGING PANTS; LOUNGE PANTS; NIGHT
SHIRTS; SHORT-SLEEVED OR LONG-SLEEVED T-
SHIRTS; SOCKS; SPORT SHIRTS; SUN VISORS; SWEAT
PANTS; T-SHIRTS; TANK TOPS; TUBE TOPS (U.S. CLS.
22 AND 39).

FIRST USE 2-20-2008; IN COMMERCE 2-20-2008.
JENNIFER MARTIN, EXAMINING ATTORNEY

SN 77-704,121. JONES, KAREN ELIZABETH, LAKE WORTH,
FL. FILED S.R. 4-1-2009; AM. P.R. 7-20-2009.

Double-O

THE MARK CONSISTS OF STANDARD CHARACTERS
WITHOUT CLAIM TO ANY PARTICULAR FONT, STYLE,
SIZE, OR COLOR.

FOR CLOTHING, NAMELY, BODY SHAPERS (U.S.
CLS. 22 AND 39).

FIRST USE 7-25-2008; IN COMMERCE 7-25-2008.
MICHAEL WIENER, EXAMINING ATTORNEY

CLASS 25—(Continued).

SN 77-704,532. BARNEY'S INC., NEW YORK, NY. FILED 4-1-2009.

BARNEYS NEW YORK
MADE TO MEASURE

THE MARK CONSISTS OF STANDARD CHARACTERS WITHOUT CLAIM TO ANY PARTICULAR FONT, STYLE, SIZE, OR COLOR.

OWNER OF U.S. REG. NOS. 2,963,769, 3,220,382 AND OTHERS.

NO CLAIM IS MADE TO THE EXCLUSIVE RIGHT TO USE "NEW YORK MADE TO MEASURE", APART FROM THE MARK AS SHOWN.

FOR WOMEN'S CLOTHING, NAMELY, JACKETS, COATS, BLAZERS, SWEATERS, SWEAT SHIRTS, SWEATPANTS, SLACKS, PANTS, SHORTS, BLOUSES, SHIRTS, T-SHIRTS, POLO SHIRTS, DRESSES, SKIRTS; SWIMWEAR; MEN'S CLOTHING, NAMELY, OVERCOATS, TOPCOATS, JACKETS, SWEATERS, SWEAT SHIRTS, SWEATPANTS, TROUSERS, SHORTS, SPORT SHIRTS, T-SHIRTS, POLO SHIRTS; SWIMWEAR; HATS, BELTS; SHOES, SANDALS, SLIPPERS AND BOOTS (U.S. CLS. 22 AND 39).

TRACY FLETCHER, EXAMINING ATTORNEY

SN 77-707,446. WILLIAMS, GLENN, VIDOR, TX. AND DAVILA, JESSE, VIDOR, TX. AND SEIGRIST, WILLIAM, VIDOR, TX. FILED 4-6-2009.

360 FEARLESS FIGHTERS

THE MARK CONSISTS OF STANDARD CHARACTERS WITHOUT CLAIM TO ANY PARTICULAR FONT, STYLE, SIZE, OR COLOR.

FOR CLOTHING, NAMELY, SHIRTS, T-SHIRTS, SWEATSHIRTS, HOODED T-SHIRTS, HOODED SWEATSHIRTS, TANK TOPS, JERSEYS, PANTS, SHORTS, JEANS, SWEATPANTS, JACKETS, COATS, FOOTWEAR, HATS, CAPS, BEANIES, SKULL CAPS, VISORS, ATHLETIC UNIFORMS, UNDERGARMENTS, BRIEFS, THONG UNDERWEAR, SOCKS, WRISTBANDS, HEADBANDS, BELTS, NECKTIES (U.S. CLS. 22 AND 39).

FIRST USE 4-3-2009; IN COMMERCE 4-3-2009.

REBECCA SMITH, EXAMINING ATTORNEY

CLASS 25—(Continued).

SN 77-707,764. DAVIS, EDWIN, MISSISSAUGA, CANADA, FILED 4-6-2009.



THE MARK CONSISTS OF THE STYLIZED LETTERING "SIXTY7REDD" WITH A STYLIZED SCROLL DESIGN TO THE RIGHT AND LEFT OF THE WORDING. ABOVE THE LETTERING THERE ARE TWO HORIZONTAL LINES AND THE BOTTOM LINE IS THINNER THEN THE TOP LINE. ABOVE THE LINES THERE IS, A STYLIZED "M" WITH A SCROLL ON EACH SIDE AND A CROWN WITH A CLOSED TOP FEATURING A CROSS IN THE TOP OF THE CROWN OVER THE "M". THE NEGATIVE SPACE BETWEEN THE CROWN AND THE "M" FORMS A STYLIZED "I".

FOR MEN'S AND WOMEN'S CLOTHING, NAMELY, T-SHIRTS, SHIRTS, POLO SHIRTS, SWEAT SHIRTS, JERSEYS, TANK TOPS, SHORTS, JACKETS, COATS, BELTS, CAPS, HATS, VISORS, BEANIES, FLEECE PULL-OVERS, SWEATERS, JEANS, PANTS, TROUSERS, OVERALLS, SWIM SUITS, TRUNKS, BANDANAS, SCARVES, SHOES, SANDALS, SOCKS, PAJAMAS, SWEAT PANTS, UNDERWEAR, BRIEFS, THERMAL UNDERWEAR, TRACK SUITS, CARDIGANS, PULLOVERS, TUNICS, DENIM JACKETS, DENIM COATS, DENIM PANTS, PANTIES, GLOVES, DRESSES, BLAZERS, SKIRTS, VESTS, JUMPSUITS, COVERALLS, DRESS SUITS, BLOUSES AND LINGERIE (U.S. CLS. 22 AND 39).

FIRST USE 0-0-1997; IN COMMERCE 0-0-1997.

TRACY WHITTAKER-BROWN, EXAMINING ATTORNEY

SN 77-708,574. ERMENEGILDO ZEGNA CORPORATION, ENGLEWOOD, NJ. FILED 4-7-2009.

TINDARI

THE MARK CONSISTS OF STANDARD CHARACTERS WITHOUT CLAIM TO ANY PARTICULAR FONT, STYLE, SIZE, OR COLOR.

THE WORDING "TINDARI" HAS NO MEANING IN A FOREIGN LANGUAGE.

FOR MEN'S CLOTHING, NAMELY, SUITS, JACKETS, PANTS, TROUSERS, SHORTS, COATS, SHIRTS, TOPS, SWEATERS, CARDIGANS, TIES, HATS, CAPS (U.S. CLS. 22 AND 39).

MICHAEL LITZAU, EXAMINING ATTORNEY

CLASS 25—(Continued).

SN 77-711,179. V-MODA LLC, DBA V-MODA, LLC, LOS ANGELES, CA. FILED 4-9-2009.

V V MODA

THE MARK CONSISTS OF STANDARD CHARACTERS WITHOUT CLAIM TO ANY PARTICULAR FONT, STYLE, SIZE, OR COLOR.

NO CLAIM IS MADE TO THE EXCLUSIVE RIGHT TO USE "MODA", APART FROM THE MARK AS SHOWN.

THE ENGLISH TRANSLATION OF "MODA" IN THE MARK IS "FASHION".

FOR ATHLETIC SHOES, BANDANAS, BEANIES, BELTS, BLOUSES, CAPS, DRESS SHIRTS, DRESSES, HATS, JACKETS, JEANS, PANTS, SCARVES, SHIRTS, SHOES, WEAT SHIRTS, T-SHIRTS (U.S. CLS. 22 AND 39).

FIRST USE 7-23-2006; IN COMMERCE 11-26-2006.
HEATHER THOMPSON, EXAMINING ATTORNEY

SN 77-711,181. SOURCE ABROAD, INC., INGLEWOOD, CA. FILED 4-9-2009.

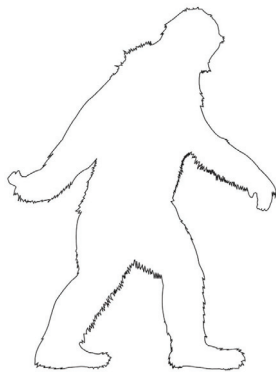

THE MARK CONSISTS OF A SILHOUETTE OF AN AUSTRALIAN CRYPTID HOMINID.

FOR APPAREL AND CLOTHING, NAMELY, CAPS, HATS, BEANIES, AND NECKWARMERS (U.S. CLS. 22 AND 39).

FIRST USE 1-30-2009; IN COMMERCE 1-30-2009.
RONALD AIKENS, EXAMINING ATTORNEY

CLASS 25—(Continued).

SN 77-711,297. THOMAS FONTAINE AND CHRISTOPHER HEARNE, DBA CARPE DESIGNS, INDIANAPOLIS, IN. FILED 4-10-2009.

Carpe  Designs

NO CLAIM IS MADE TO THE EXCLUSIVE RIGHT TO USE "DESIGNS", APART FROM THE MARK AS SHOWN.

THE MARK CONSISTS OF THE WORD "CARPE" AND THE WORD "DESIGNS" WITH AN IMAGE OF A FISH PLACED BETWEEN THE TWO WORDS.

THE ENGLISH TRANSLATION OF THE WORD "CARPE" IN THE MARK IS "SEIZE".

FOR CLOTHING, NAMELY, SHIRTS, HATS, SHORTS AND PANTS (U.S. CLS. 22 AND 39).
WANDA KAY PRICE, EXAMINING ATTORNEY

SN 77-713,901. KIM, JEE WON, DBA XZAVIER, LOS ANGELES, CA. FILED 4-14-2009.



THE MARK CONSISTS OF A FLEUR-DE-LIS LOGO WITH THE LETTERS "AXR" BELOW IN STYLIZED SCRIPT.

FOR A-SHIRTS; ATHLETIC APPAREL, NAMELY, SHIRTS, PANTS, JACKETS, FOOTWEAR, HATS AND CAPS, ATHLETIC UNIFORMS; BODY SHIRTS; BUTTON-FRONT ALOHA SHIRTS; CAMP SHIRTS; CLOTHING FOR ATHLETIC USE, NAMELY, PADDED SHIRTS; DRESS SHIRTS; GOLF PANTS, SHIRTS AND SKIRTS; GOLF SHIRTS; HOODED SWEAT SHIRTS; KNIT SHIRTS; LONG-SLEEVED SHIRTS; MOISTURE-WICKING SPORTS SHIRTS; NIGHT SHIRTS; OPEN-NECKED SHIRTS; OVER SHIRTS; PIQUE SHIRTS; POLO SHIRTS; RUGBY SHIRTS; SCIENTIFIC AND TECHNOLOGICAL APPAREL, NAMELY, SHIRTS, PANTS, JACKETS, FOOTWEAR, HATS AND CAPS, UNIFORMS; SHIRT FRONTS; SHIRT YOKES; SHIRTS; SHIRTS FOR SUITS; SHORT-SLEEVED OR LONG-SLEEVED T-SHIRTS; SHORT-SLEEVED SHIRTS; SLEEP SHIRTS; SPORT SHIRTS; SPORTS SHIRTS; SPORTS SHIRTS WITH SHORT SLEEVES; T-SHIRTS; TEE SHIRTS; TRIATHLON CLOTHING, NAMELY, TRIATHLON TIGHTS, TRIATHLON SHORTS, TRIATHLON SINGLET, TRIATHLON SHIRTS, TRIATHLON SUITS; TURTLE NECK SHIRTS; WEARABLE GARMENTS AND CLOTHING, NAMELY, SHIRTS; WIND SHIRTS; YOGA SHIRTS (U.S. CLS. 22 AND 39).

FIRST USE 6-1-2008; IN COMMERCE 6-1-2008.
FONG HSU, EXAMINING ATTORNEY

CLASS 25—(Continued).

SN 77-714,787. ADVANCE SALES GROUP, INC., LOS ANGELES, CA. FILED 4-15-2009.



THE MARK CONSISTS OF THE STYLIZED WORDING "FG FEELZ GOOD", WITH THE WORDING "FEELZ GOOD" FEATURED IN AN INCOMPLETE QUADRILATERAL CONNECTED TO AND PARTIALLY OVERLAPPING THE LETTER "G" IN "FG".

FOR A-SHIRTS; ATHLETIC APPAREL, NAMELY, SHIRTS, PANTS, JACKETS, FOOTWEAR, HATS AND CAPS, ATHLETIC UNIFORMS; CLOTHING FOR ATHLETIC USE, NAMELY, PADDED SHIRTS; DOWN JACKETS; DRESS SHIRTS; GLOVES; HATS; HEAVY JACKETS; HOODED SWEAT SHIRTS; JACKETS; JACKETS AND SOCKS; LONG-SLEEVED SHIRTS; MOISTURE-WICKING SPORTS SHIRTS; OUTDOOR GLOVES; OUTER JACKETS; PADDED JACKETS; PADDING JACKETS; RAIN JACKETS; RAINPROOF JACKETS; REVERSIBLE JACKETS; SHELL JACKETS; SHIRTS; SHORT-SLEEVED OR LONG-SLEEVED T-SHIRTS; SKI GLOVES; SKI JACKETS; SLEEVED OR SLEEVELESS JACKETS; SNOWBOARD GLOVES; SOCKS; SPORT SHIRTS; SPORTS JACKETS; SPORTS SHIRTS; SPORTS SHIRTS WITH SHORT SLEEVES; STUFF JACKETS; SWEAT JACKETS; SWEAT SHIRTS; T-SHIRTS; TEE SHIRTS; TRACK JACKETS; WATERPROOF JACKETS AND PANTS; WEARABLE GARMENTS AND CLOTHING, NAMELY, SHIRTS; WIND RESISTANT JACKETS; WIND SHIRTS; WIND-JACKETS; YOGA SHIRTS (U.S. CLS. 22 AND 39).

CYNTHIA TRIPI, EXAMINING ATTORNEY

SN 77-715,910. SCOTT TYNER, US CITIZEN, PARENT OF DYLAN TYNER, LONG BEACH, MS. FILED 4-17-2009.

RUSTIC TREE CO.

THE MARK CONSISTS OF STANDARD CHARACTERS WITHOUT CLAIM TO ANY PARTICULAR FONT, STYLE, SIZE, OR COLOR.

NO CLAIM IS MADE TO THE EXCLUSIVE RIGHT TO USE "CO.", APART FROM THE MARK AS SHOWN.

FOR CLOTHING, NAMELY, T-SHIRTS, SHIRTS, HEADWEAR AND SWEAT SHIRTS (U.S. CLS. 22 AND 39).

JENNIFER HETU, EXAMINING ATTORNEY

CLASS 25—(Continued).

SN 77-716,610. SEIGRIST, WILLIAM, VIDOR, TX. AND DAVILA, JESSE, VIDOR, TX. AND WILLIAMS, GLENN, VIDOR, TX. FILED 4-17-2009.



THE MARK CONSISTS OF THE NUMBER "360" WITH TERMS "FEARLESS FIGHTERS" APPEARING THEREUNDER IN A CIRCLE PARTIALLY COMPOSED OF PICTORIAL REPRESENTATIONS OF TWO INDIVIDUALS IN VARIOUS FIGHTING POSITIONS.

FOR CLOTHING, NAMELY, SHIRTS, T-SHIRTS, SWEATSHIRTS, HOODED T-SHIRTS, HOODED SWEATSHIRTS, TANK TOPS, JERSEYS, PANTS, SHORTS, JEANS, SWEATPANTS, JACKETS, COATS, FOOTWEAR, HATS, CAPS, BEANIES, SKULL CAPS, VISORS, ATHLETIC UNIFORMS, UNDERGARMENTS, BRIEFS, THONG UNDERWEAR, SOCKS, WRISTBANDS, HEADBANDS, BELTS, NECKTIES (U.S. CLS. 22 AND 39).

FIRST USE 4-17-2009; IN COMMERCE 4-17-2009.
REBECCA SMITH, EXAMINING ATTORNEY

SN 77-717,399. GX, INC., DAYTONA BEACH SHORES, FL. FILED 4-20-2009.

Dead End Kids

THE MARK CONSISTS OF STANDARD CHARACTERS WITHOUT CLAIM TO ANY PARTICULAR FONT, STYLE, SIZE, OR COLOR.

FOR CLOTHING FOR ADULTS, NAMELY, SHIRTS, HATS, SWEATSHIRTS, PANTS, SOCKS, SHOES, UNDERGARMENTS, SHORTS AND JACKETS (U.S. CLS. 22 AND 39).

DAVID MILLER, EXAMINING ATTORNEY

CLASS 25—(Continued).

SN 77-717,569. BYSTORM LLC, SOUTH ORANGE, NJ. FILED 4-20-2009.



THE COLOR(S) RED IS/ARE CLAIMED AS A FEATURE OF THE MARK.

THE MARK CONSISTS OF THE STYLIZED LETTERING "BYSTORM" IN RED.

FOR MOTORCYCLE APPAREL, NAMELY, VESTS, SHIRTS, PANTS, SHOES, GLOVES (U.S. CLS. 22 AND 39). FIRST USE 7-19-2008; IN COMMERCE 7-19-2008. KATHLEEN LORENZO, EXAMINING ATTORNEY

CLASS 25—(Continued).

SN 77-719,135. OGANESYAN, GAGIK, LOS ANGELES, CA. FILED 4-21-2009.



NO CLAIM IS MADE TO THE EXCLUSIVE RIGHT TO USE "COUTURE", APART FROM THE MARK AS SHOWN.

THE MARK CONSISTS OF THE STYLIZED TEXT "JAIL COUTURE" WITH A NAIL FENCE ON THE FRONT.

FOR DRESSES; HOODED SWEAT SHIRTS; JACKETS; PANTS; SHIRTS (U.S. CLS. 22 AND 39).

FIRST USE 5-14-2000; IN COMMERCE 5-14-2001. ROSELLE HERRERA, EXAMINING ATTORNEY

SN 77-719,832. CHRISTOPHER G. BABIANA, BELLINGHAM, MA. FILED 4-22-2009.

HARDCORE ANGLER

THE MARK CONSISTS OF STANDARD CHARACTERS WITHOUT CLAIM TO ANY PARTICULAR FONT, STYLE, SIZE, OR COLOR.

NO CLAIM IS MADE TO THE EXCLUSIVE RIGHT TO USE "ANGLER", APART FROM THE MARK AS SHOWN.

FOR ANGLERS' SHOES; ANORAKS; BATHING SUITS; BEACHWEAR; CAPS WITH VISORS; COATS; CREW NECKS; FISHERMEN'S JACKETS; FISHING VESTS; FISHING WADERS; FOOTWEAR; FOUL WEATHER GEAR; GLOVES; HATS; HEADBANDS; JACKETS; JEANS; MUSCLE TOPS; OVERALLS; PANTS; PONCHOS; PULLOVERS; RAIN BOOTS; RAINWEAR; SHIRTS; SHORTS; SOCKS; SWEAT SHIRTS; SWEATERS; T-SHIRTS; TANK-TOPS; TUBE TOPS; VESTS; VISORS; WIND SHIRTS; WIND VESTS; WRIST BANDS (U.S. CLS. 22 AND 39).

G. MAYERSCHOFF, EXAMINING ATTORNEY

SN 77-718,218. JOSEPH ERIC BREFO-SARPONG, NEW YORK, NY. FILED 4-21-2009.

G.F. SARPONG GUITAR

THE MARK CONSISTS OF STANDARD CHARACTERS WITHOUT CLAIM TO ANY PARTICULAR FONT, STYLE, SIZE, OR COLOR.

THE NAME(S), PORTRAIT(S), AND/OR SIGNATURE(S) SHOWN IN THE MARK DOES NOT IDENTIFY A PARTICULAR LIVING INDIVIDUAL.

FOR ATHLETIC SHOES; BATHING SUITS; BEACHWEAR; BELTS FOR CLOTHING; COATS; DOWN JACKETS; DRESSES; FOOTWEAR; GLOVES; HEADWEAR; INFANTWEAR; JEANS; LOUNGEWEAR; MEN'S AND WOMEN'S JACKETS, COATS, TROUSERS, VESTS; MEN'S SUITS, WOMEN'S SUITS; NECKTIES; NECKWEAR; OUTER JACKETS; OVERCOATS; PAJAMAS; PULLOVERS; RAINWEAR; ROBES; SCARVES; SHAWLS; SHIRTS; SHORTS; SKIING SHOES; SLEEPWEAR; SOCKS AND STOCKINGS; SPORT COATS; SPORTS SHIRTS; SUITS; SWEAT SUITS; SWEATERS; SWIMWEAR; T-SHIRTS; TRACKSUITS; TROUSERS; UNDERCLOTHES; UNDERWEAR; WATERPROOF JACKETS AND PANTS; WIND RESISTANT JACKETS (U.S. CLS. 22 AND 39).

MELVIN AXILBUND, EXAMINING ATTORNEY

SN 77-720,246. MARCIA MICHELLE HARRIS, DBA COLORVILLE, LANCASTER, CA. FILED 4-23-2009.

The Colorbets

THE MARK CONSISTS OF STANDARD CHARACTERS WITHOUT CLAIM TO ANY PARTICULAR FONT, STYLE, SIZE, OR COLOR.

FOR T-SHIRTS (U.S. CLS. 22 AND 39).

SUE LAWRENCE, EXAMINING ATTORNEY

CLASS 25—(Continued).

SN 77-720,428. FARM BOY CO-OP & FEED CO., LLC, ST. PAUL, MN. FILED 4-23-2009.

FARM BOY

THE MARK CONSISTS OF STANDARD CHARACTERS WITHOUT CLAIM TO ANY PARTICULAR FONT, STYLE, SIZE, OR COLOR.

OWNER OF U.S. REG. NOS. 2,708,114 AND 3,580,547.
SEC. 2(F).
FOR BELTS; FOOTWEAR; HATS; JACKETS; JEANS; SHIRTS; SOCKS (U.S. CLS. 22 AND 39).
FIRST USE 9-22-2000; IN COMMERCE 9-22-2000.
AMOS T. MATTHEWS, JR., EXAMINING ATTORNEY

SN 77-721,192. TWENTIETH CENTURY FOX FILM CORPORATION, LOS ANGELES, CA. FILED 4-23-2009.



OWNER OF U.S. REG. NO. 3,001,994.
NO CLAIM IS MADE TO THE EXCLUSIVE RIGHT TO USE "SPORTS", APART FROM THE MARK AS SHOWN.

THE MARK CONSISTS OF THE STYLIZED WORDS "THE ADVENTURES OF DIGGER AND FRIENDS" WHICH APPEAR INSIDE OF TWO OVAL CONCENTRIC LINES, THE WORDS "FOX SPORTS" WHICH APPEAR UNDER THE WORD "FRIENDS" AND INSIDE OF THE OVAL SHAPE OVERLAPPING ON THE BOTTOM OF THE INNER OVAL LINE AND FIVE COSTUMED GOPHER CHARACTERS WHICH APPEAR ABOVE THE OUTER OVAL LINE.

FOR T-SHIRTS; SHIRTS; PANTS; UNDERWEAR; UNDERSHIRTS; BOXER SHORTS; LONG UNDERWEAR; HATS; CAPS; SWEATSHIRTS; SWEATPANTS; SWEATERS; SKIRTS; TANK TOPS; GLOVES; SOCKS; COATS; JACKETS; VESTS; SWIMWEAR; BELTS; SCARVES; PAJAMAS; NIGHTGOWNS; NIGHTSHIRTS; SLIPPERS; ROBES; TIES; BELTS; RAIN COATS; RAIN BOOTS (U.S. CLS. 22 AND 39).
LINDA LAVACHE, EXAMINING ATTORNEY

CLASS 25—(Continued).

SN 77-721,425. DEER STAGS, INC., NEW YORK, NY. FILED 4-24-2009.

S.U.P.R.O. SOCK SUPER UNDERFOOT PEDORTHIC RADICAL ORTHOTIC

THE MARK CONSISTS OF STANDARD CHARACTERS WITHOUT CLAIM TO ANY PARTICULAR FONT, STYLE, SIZE, OR COLOR.

OWNER OF U.S. REG. NOS. 2,824,252, 2,881,969 AND 3,252,840.

NO CLAIM IS MADE TO THE EXCLUSIVE RIGHT TO USE "SOCK," "SUPER," "PEDORTHIC," AND "ORTHOTIC", APART FROM THE MARK AS SHOWN.

FOR FOOTWEAR (U.S. CLS. 22 AND 39).
FIRST USE 11-10-1999; IN COMMERCE 11-10-1999.
FRED MANDIR, EXAMINING ATTORNEY

SN 77-721,439. HBI BRANDED APPAREL ENTERPRISES, LLC, WINSTON-SALEM, NC. FILED 4-24-2009.

JMS

THE MARK CONSISTS OF STANDARD CHARACTERS WITHOUT CLAIM TO ANY PARTICULAR FONT, STYLE, SIZE, OR COLOR.

OWNER OF U.S. REG. NOS. 2,817,823, 3,595,560 AND OTHERS.

FOR BELTS FOR CLOTHING; HATS; SCARVES (U.S. CLS. 22 AND 39).
LINDA POWELL, EXAMINING ATTORNEY

CLASS 25—(Continued).

SN 77-721,548. LAWRENCE LASAROW, MALIBU, CA. FILED 4-24-2009.

SPIRIT OF THE WORDS

THE MARK CONSISTS OF STANDARD CHARACTERS WITHOUT CLAIM TO ANY PARTICULAR FONT, STYLE, SIZE, OR COLOR.

FOR ATHLETIC APPAREL, NAMELY, SHIRTS, PANTS, JACKETS, FOOTWEAR, HATS AND CAPS, ATHLETIC UNIFORMS; BODY SHIRTS; BUTTON-FRONT ALOHA SHIRTS; CAMP SHIRTS; CLOTHING FOR ATHLETIC USE, NAMELY, PADDED SHIRTS; DRESS SHIRTS; GOLF PANTS, SHIRTS AND SKIRTS; GOLF SHIRTS; HOODED SWEAT SHIRTS; KNIT SHIRTS; LONG-SLEEVED SHIRTS; MOISTURE-WICKING SPORTS SHIRTS; NIGHT SHIRTS; OPEN-NECKED SHIRTS; OVER SHIRTS; PIQUE SHIRTS; POLO SHIRTS; RUGBY SHIRTS; SCIENTIFIC AND TECHNOLOGICAL APPAREL, NAMELY, SHIRTS, PANTS, JACKETS, FOOTWEAR, HATS AND CAPS, UNIFORMS; SHIRT FRONTS; SHIRTS; SHORT-SLEEVED OR LONG-SLEEVED T-SHIRTS; SHORT-SLEEVED SHIRTS; SLEEP SHIRTS; SPORT SHIRTS; SPORTS SHIRTS; SPORTS SHIRTS WITH SHORT SLEEVES; SWEAT SHIRTS; T-SHIRTS; TEE SHIRTS; TURTLE NECK SHIRTS; WEARABLE GARMENTS AND CLOTHING, NAMELY, SHIRTS; YOGA SHIRTS (U.S. CLS. 22 AND 39).

MARK SHINER, EXAMINING ATTORNEY

SN 77-721,646. SCHERING-PLOUGH HEALTHCARE PRODUCTS, INC., MEMPHIS, TN. FILED 4-24-2009.



OWNER OF U.S. REG. NOS. 512,484, 1,257,297 AND OTHERS.

NO CLAIM IS MADE TO THE EXCLUSIVE RIGHT TO USE "MASSAGING GEL INSOLES" AND "DUAL GEL", APART FROM THE MARK AS SHOWN.

THE NAME(S), PORTRAIT(S), AND/OR SIGNATURE(S) SHOWN IN THE MARK DOES NOT IDENTIFY A PARTICULAR LIVING INDIVIDUAL.

THE COLOR(S) BLUE, LIGHT BLUE, DARK BLUE, YELLOW, PURPLE, WHITE AND GREY IS/ARE CLAIMED AS A FEATURE OF THE MARK.

THE MARK CONSISTS OF DIAGONAL WAVY BANDS OF BLUE, GREY, YELLOW, AND GREY STARTING FROM THE TOP LEFT TO THE BOTTOM RIGHT; AND CONTAINED ON TOP OF THE WAVY BANDS DR. SCHOLL'S IN WHITE STYLIZED LETTERING OUTLINED IN GREY WITH A YELLOW PERIOD IN THE FORM OF A SHADED SQUARE UNDER THE LETTER "R" IN DR. IN A COMPLETELY DARK BLUE SHADED OVAL WITHIN A GREY OVAL WITH A WHITE STARBURST DESIGN ON THE BOTTOM RIGHT OF THE GREY OVAL; UNDER WHICH

CLASS 25—(Continued).

THE TERM "MASSAGING GEL" AND A WAVY LINE IN BLUE LETTERING AND WHITE BACKGROUND, UNDER WHICH THE WORD "INSOLES" IN BLUE LETTERING, UNDER WHICH THE TERM "OUTRAGEOUS COMFORT" IN WHITE LETTERING ON A DARK BLUE RECTANGLE BAND, UNDER WHICH THE TERM "WITH DUAL GEL" IN WHITE LETTERING ON A PURPLE RECTANGLE BAND, AND TO THE RIGHT A DARK BLUE CIRCLE CONTAINING A PURPLE TEARDROP AND BLUE TEAR DROP WITH LIGHT BLUE WAVY LINES, UNDER WHICH ON THE LEFT SIDE A BLUE VERTICAL LINE CONTAINING THREE BLUE CIRCLES. THE WHITE BACKGROUND APPEARING AT THE TOP LEFT, TOP RIGHT, AND BOTTOM RIGHT ARE NOT PART OF THE MARK.

FOR INSOLES (U.S. CLS. 22 AND 39).
MELISSA VALLILLO, EXAMINING ATTORNEY

SN 77-721,681. SCHERING-PLOUGH HEALTHCARE PRODUCTS, INC., MEMPHIS, TN. FILED 4-24-2009.



OWNER OF U.S. REG. NOS. 512,484, 1,257,297 AND OTHERS.

NO CLAIM IS MADE TO THE EXCLUSIVE RIGHT TO USE "MASSAGING GEL", "EXTRA SUPPORT", "IDEAL FOR BIG & TALL MEN", AND "WIDER AND LONGER", APART FROM THE MARK AS SHOWN.

THE NAME(S), PORTRAIT(S), AND/OR SIGNATURE(S) SHOWN IN THE MARK DOES NOT IDENTIFY A PARTICULAR LIVING INDIVIDUAL.

THE COLOR(S) BLUE, DARK BLUE, YELLOW, ORANGE, WHITE AND GREY IS/ARE CLAIMED AS A FEATURE OF THE MARK.

THE MARK CONSISTS OF DIAGONAL WAVY BANDS OF BLUE, GREY, YELLOW, AND GREY STARTING FROM THE TOP LEFT TO THE BOTTOM RIGHT; AND CONTAINED ON TOP OF THE WAVY BANDS, DR. SCHOLL'S IN WHITE STYLIZED LETTERING OUTLINED IN GREY WITH A YELLOW PERIOD IN THE FORM OF A SHADED SQUARE UNDER THE LETTER "R" IN DR. IN A COMPLETELY DARK BLUE SHADED OVAL WITHIN A GREY OVAL WITH A WHITE STARBURST DESIGN ON THE BOTTOM RIGHT OF THE GREY OVAL; UNDER WHICH THE TERM MASSAGING GEL AND A WAVY LINE IN BLUE LETTERING AND WHITE BACKGROUND, UNDER WHICH THE WORDING "EXTRA SUPPORT" IN ORANGE LETTERING WITH WHITE BACKGROUND; AND UNDER WHICH THE TERM "IDEAL FOR BIG & TALL MEN" IN WHITE LETTERING ON AN ORANGE RECTANGLE BAND, AND TO THE RIGHT A CONCENTRIC CIRCLE OF ORANGE AND YELLOW, CONTAINING A GREY ARROW OUTLINED IN DARK BLUE CONTAINING THE TERM "WIDER & LONGER" IN DARK BLUE LETTERING, UNDER WHICH ON THE LEFT SIDE AN ORANGE VERTICAL LINE CONTAINING THREE ORANGE SHADED CIRCLES. THE WHITE BACKGROUND APPEARING AT THE TOP LEFT, TOP RIGHT, AND BOTTOM RIGHT ARE NOT PART OF THE MARK.

FOR INSOLES (U.S. CLS. 22 AND 39).
MELISSA VALLILLO, EXAMINING ATTORNEY

CLASS 25—(Continued).

SN 77-721,709. COLLINS, JAMES, ALEXANDRIA, VA. FILED 4-24-2009.

InsurgenTees

THE MARK CONSISTS OF STANDARD CHARACTERS WITHOUT CLAIM TO ANY PARTICULAR FONT, STYLE, SIZE, OR COLOR.

FOR HATS; JACKETS; PANTS; PARKAS; SCARVES; SHOES; SHORTS; SWEAT SHIRTS; TEE SHIRTS; TIES (U.S. CLS. 22 AND 39).

BRIAN PINO, EXAMINING ATTORNEY

CLASS 25—(Continued).

SN 77-721,832. FAR CLIFFS, LLC, HENDERSON, NV. FILED 4-24-2009.

PASSLINER

THE MARK CONSISTS OF STANDARD CHARACTERS WITHOUT CLAIM TO ANY PARTICULAR FONT, STYLE, SIZE, OR COLOR.

FOR INSERTS FOR FOOTWEAR PRIMARILY FOR NON-ORTHOPEDIC PURPOSES (U.S. CLS. 22 AND 39).

ALLISON SCHRODY, EXAMINING ATTORNEY

SN 77-721,749. WADELL, LARRY, FORT LEE, NJ. FILED 4-24-2009.

worlds greatest g-ma

THE MARK CONSISTS OF STANDARD CHARACTERS WITHOUT CLAIM TO ANY PARTICULAR FONT, STYLE, SIZE, OR COLOR.

FOR HATS; SWEAT SHIRTS; T-SHIRTS (U.S. CLS. 22 AND 39).

CHARISMA HAMPTON, EXAMINING ATTORNEY

SN 77-722,144. EDWARD J. TRESKA, NEWPORT COAST, CA. FILED 4-24-2009.

FIGHT RISK

SN 77-721,803. DAVIS, CAM, CHANDLER HEIGHTS, AZ. AND DAVIS, RACHEL, CHANDLER HEIGHTS, AZ. FILED 4-24-2009.

RATTLE N HUM

THE MARK CONSISTS OF STANDARD CHARACTERS WITHOUT CLAIM TO ANY PARTICULAR FONT, STYLE, SIZE, OR COLOR.

FOR CLOTHING, NAMELY, SHIRTS, DRESSES, PANTS, SOCKS, BELTS, SHORTS, JACKETS, SWEATERS, OVERALLS, HEADWEAR, ROMPERS AND OTHER ONE-PIECE GARMENTS FOR CHILDREN AND INFANTS, JUMPERS, DIAPER COVERS, HATS, BOOTIES, AND TIGHTS (U.S. CLS. 22 AND 39).

ELIZABETH KAJUBI, EXAMINING ATTORNEY

THE MARK CONSISTS OF STANDARD CHARACTERS WITHOUT CLAIM TO ANY PARTICULAR FONT, STYLE, SIZE, OR COLOR.

FOR HEADWEAR, FOOTWEAR AND CLOTHING, NAMELY, COATS, JACKETS, GLOVES, PANTS, SHORTS, SOCKS, SHIRTS, T-SHIRTS, TANK TOPS, JERSEYS, SWEATSHIRTS, UNDERWEAR, BOXER SHORTS, ATHLETIC UNIFORMS, SWEATBANDS, WRISTBANDS, SWIM WEAR, SKI WEAR, MOTORCYCLE JERSEYS, MOTORCYCLE BOOTS FOR WEARING AND MOTORCYCLE PANTS (U.S. CLS. 22 AND 39).

TARA PATE, EXAMINING ATTORNEY

CLASS 25—(Continued).

SN 77-722,283. LUEMME, INC., MIAMI, FL. FILED 4-24-2009.

Cosabella Amore

THE MARK CONSISTS OF STANDARD CHARACTERS WITHOUT CLAIM TO ANY PARTICULAR FONT, STYLE, SIZE, OR COLOR.

OWNER OF U.S. REG. NOS. 1,407,769, 2,562,087 AND OTHERS.

THE ENGLISH TRANSLATION OF "COSABELLA AMORE" IS "BEAUTIFUL THING LOVE."

FOR CLOTHING, NAMELY, LINGERIE AND INTIMATE APPAREL, NAMELY, BOXERS, BIKINIS, THONGS, BOYLEG UNDERPANTS, G-STRINGS, HIPSTERS, FOUNDATION GARMENTS, PANTIES, BRIEFS, BRAS, CAMISOLES, CHEMISES, BRALETTES, BUSTIERS, CORSETS, SHAPER PANTIES, NEGLIGEEES, BABY DOLLS, TEDDIES, UNDERPANTS, GIRDLES, CONTROL BRIEFS, MERRY WIDOWS, BRA SLIPS, BRIEFS, BLOOMERS, BOY SHORTS UNDERPANTS, SLIPS, PEIGNOIRS, SHIFTS, BODY STOCKINGS, BODY-SHAPERS, PANTYHOSE, HOSIERY, THIGH HIGHS, KNEE HIGHS, STOCKINGS, WAIST CINCHERS, GARTER BELTS, NIGHTGOWNS, PAJAMAS, SLEEPWEAR, BATHROBES, NIGHT SHIRTS; EVENING GOWNS; GYM WEAR NAMELY, LEOTARDS, JOGGING SUITS, TIGHTS, YOGA PANTS, UNITARDS; SPORTSWEAR, NAMELY, TOPS, POLO SHIRTS, KNIT TOPS, JEANS, DUNGAREES, TUNICS, JERSEYS, SWEATSHIRTS, HALTER TOPS, JUMPERS, JUMPSUITS, SHORTS, TANK TOPS, T-SHIRTS, PARKAS, CAPES, PONCHOS, SHAWLS, BLOUSES, SHIRTS, PANTS, SLACKS, LONG PANTS, SKIRTS, DRESSES, JACKETS, COATS, BLAZERS, SUITS, CARDIGANS, VESTS, BOLEROS; ACTIVE WEAR, NAMELY, ROMPERS, CAPRIS, KNICKERS, COVERALLS, PEDAL PUSHERS, CULOTTES, SKIWEAR, SWIMWEAR, SARONGS, BEACH COVER-UPS, WRAP-AROUNDS; BODY WEAR, NAMELY, BODYSUITS, PLAYSUITS, CATSUITS, LEGGINGS, HOT PANTS, TAP PANTS, UNDERSHIRTS; EASY WEAR, NAMELY, BED JACKETS, KIMONOS, HOUSECOATS, DUSTERS, BRUNCH COATS, LOUNGEWEAR, CAFTANS, ROBES; WOMEN'S SHOES, NAMELY, CASUAL AND DRESS SHOES, SANDALS, SLIPPERS, FLIP-FLOPS, BOOTS; WOMEN'S ACCESSORIES, NAMELY, CAPS, HATS, NECKERCHIEFS, SOCKS, LEG WARMERS, BELTS, GLOVES, MITTENS, SCARVES (U.S. CLS. 22 AND 39).

AISHA SALEM, EXAMINING ATTORNEY

SN 77-722,302. BERMAN, BRADLEY, SIMI VALLEY, CA. FILED 4-24-2009.

YOUNG EXEC\$

THE MARK CONSISTS OF STANDARD CHARACTERS WITHOUT CLAIM TO ANY PARTICULAR FONT, STYLE, SIZE, OR COLOR.

FOR A-SHIRTS; ATHLETIC APPAREL, NAMELY, SHIRTS, PANTS, JACKETS, FOOTWEAR, HATS AND CAPS, ATHLETIC UNIFORMS; HOODED SWEAT SHIRTS; JERSEYS; LONG-SLEEVED SHIRTS; POLO SHIRTS (U.S. CLS. 22 AND 39).

JENNIFER VASQUEZ, EXAMINING ATTORNEY

CLASS 25—(Continued).

SN 77-722,374. 180S, INC., BALTIMORE, MD. FILED 4-24-2009.

MULTIZONE

THE MARK CONSISTS OF STANDARD CHARACTERS WITHOUT CLAIM TO ANY PARTICULAR FONT, STYLE, SIZE, OR COLOR.

FOR CLOTHING, NAMELY, BALACLAVAS, BANDANAS, MASKS, NAMELY, SKI MASKS AND FACE MASKS WORN FOR PROTECTION AGAINST COLD WEATHER, NECK TUBES, NECK GAITERS, SCARVES, BOTTOMS, BASELAYER BOTTOMS, PANTS, MOISTURE-WICKING SPORTS PANTS, UNDERGARMENTS, UNDERSHIRTS, UNDERWEAR, BRIEFS, BOXER BRIEFS, TOPS, BASELAYER TOPS, SHIRTS, MOISTURE-WICKING SPORTS SHIRTS, SHORT-SLEEVED SHIRTS, LONG-SLEEVED SHIRTS, JACKETS, WIND RESISTANT JACKETS, SHELL JACKETS, FOOTWEAR, BOOTIES, GLOVES, OUTDOOR GLOVES, SKI GLOVES, SNOWBOARD GLOVES, MITTENS, OUTDOOR MITTENS, SKI MITTENS, SNOWBOARD MITTENS, CAPS, KNITTED CAPS, BEANIES, HATS, EAR WARMERS, AND SOCKS (U.S. CLS. 22 AND 39).

JENNY PARK, EXAMINING ATTORNEY

SN 77-722,390. WILLIAMS, EMORY L, MIAMI, FL. FILED 4-25-2009.

JIT

THE MARK CONSISTS OF STANDARD CHARACTERS WITHOUT CLAIM TO ANY PARTICULAR FONT, STYLE, SIZE, OR COLOR.

FOR BELTS; BODY SHIRTS; BRIEFS; CAPS WITH VISORS; CARGO PANTS; DENIM JACKETS; DENIMS; DRESS SHIRTS; GOLF CAPS; JACKETS; JOGGING PANTS; KNIT SHIRTS; MEN'S SOCKS; MEN'S UNDERWEAR; OVER SHIRTS; PANTS; POLO SHIRTS; RAIN JACKETS; SHIRTS FOR SUITS; SHOES; SLEEP SHIRTS; SOCKS; SPORTS SHIRTS; SUSPENDER BELTS FOR MEN; T-SHIRTS; UNDERWEAR (U.S. CLS. 22 AND 39).

FIRST USE 12-17-2006; IN COMMERCE 12-17-2006.

JACQUELINE A. LAVINE, EXAMINING ATTORNEY

SN 77-722,428. DOUGLAS CUDDIHY, DBA TDY CLOTHING, ARLINGTON, VA. FILED 4-25-2009.

TDY

THE MARK CONSISTS OF STANDARD CHARACTERS WITHOUT CLAIM TO ANY PARTICULAR FONT, STYLE, SIZE, OR COLOR.

FOR BASEBALL CAPS; T-SHIRTS (U.S. CLS. 22 AND 39).

KIMBERLY PERRY, EXAMINING ATTORNEY

CLASS 25—(Continued).

SN 77-722,603. FARRIZ DESIGN INC., STEVENSON RANCH, CA. FILED 4-27-2009.

CLASS 25—(Continued).

SN 77-722,755. TAYLOR, COREY, NEW YORK, NY. FILED 4-27-2009.

Pro Lotus Tee.

THE MARK CONSISTS OF STANDARD CHARACTERS WITHOUT CLAIM TO ANY PARTICULAR FONT, STYLE, SIZE, OR COLOR.

NO CLAIM IS MADE TO THE EXCLUSIVE RIGHT TO USE "TEE", APART FROM THE MARK AS SHOWN.

FOR SHORT-SLEEVED AND LONG-SLEEVED T-SHIRTS (U.S. CLS. 22 AND 39).

JACLYN KIDWELL, EXAMINING ATTORNEY



SN 77-722,605. FARRIZ DESIGN INC., STEVENSON RANCH, CA. FILED 4-27-2009.

Lotus Tee

THE MARK CONSISTS OF STANDARD CHARACTERS WITHOUT CLAIM TO ANY PARTICULAR FONT, STYLE, SIZE, OR COLOR.

NO CLAIM IS MADE TO THE EXCLUSIVE RIGHT TO USE "TEE", APART FROM THE MARK AS SHOWN.

FOR SHORT-SLEEVED AND LONG-SLEEVED T-SHIRTS (U.S. CLS. 22 AND 39).

JACLYN KIDWELL, EXAMINING ATTORNEY



SN 77-722,691. SOSNOVICH, CARA L, PORT JEFFERSON STATION, NY. FILED 4-27-2009.



THE MARK CONSISTS OF A STYLIZED LETTER "B" INSIDE A CIRCLE.

FOR BRAS; LINGERIE; NIGHTGOWNS; PANTIES; PANTIES, SHORTS AND BRIEFS; STRAPLESS BRAS (U.S. CLS. 22 AND 39).

ANDREA K. NADELMAN, EXAMINING ATTORNEY

GYPSY BABIES

THE MARK CONSISTS OF STANDARD CHARACTERS WITHOUT CLAIM TO ANY PARTICULAR FONT, STYLE, SIZE, OR COLOR.

FOR CLOTHING, NAMELY, T-SHIRTS, SWEAT-SHIRTS, LONG SLEEVE SHIRTS, TANK TOPS, HATS AND CAPS (U.S. CLS. 22 AND 39).

JEFF DEFORD, EXAMINING ATTORNEY



SN 77-722,887. BOMBERGER, ELIZABETH URIE, HINESBURG, VT. FILED 4-27-2009.

MY OWN WINGS

THE MARK CONSISTS OF STANDARD CHARACTERS WITHOUT CLAIM TO ANY PARTICULAR FONT, STYLE, SIZE, OR COLOR.

FOR BABY BIBS NOT OF PAPER; BABY BODYSUITS; BABY BOTTOMS; BABY BUNTING; BOOTIES; BOXER SHORTS; CAP VISORS; CAPRIS; CAPS; CAPS WITH VISORS; CLOTH BIBS; COATS; DRESSES; HATS; HEADWEAR; HOODED PULLOVERS; HOODED SWEAT SHIRTS; INFANT AND TODDLER ONE PIECE CLOTHING; INFANT DIAPER COVERS; INFANT SLEEPERS; INFANTWEAR; JACKETS; KNIT SHIRTS; LAYETTES; LEGGINGS; LONG-SLEEVED SHIRTS; LOUNGEWEAR; NIGHT SHIRTS; NIGHTWEAR; ONE PIECE GARMENT FOR INFANTS AND TODDLERS; PAJAMAS; PANTS; PONCHOS; PULLOVERS; RAINWEAR; SCARVES; SCRUBS NOT FOR MEDICAL PURPOSES; SHAWLS; SHELL JACKETS; SHIRTS; SHORT SETS; SHORT-SLEEVED OR LONG-SLEEVED T-SHIRTS; SHORT-SLEEVED SHIRTS; SHORTS; SKIRTS; SKORTS; SLEEPWEAR; SLEEVED OR SLEEVELESS JACKETS; SOCKS; SWEAT PANTS; SWEAT SHIRTS; SWEATERS; T-SHIRTS; TANK TOPS; TOPS (U.S. CLS. 22 AND 39).

ALEX KEAM, EXAMINING ATTORNEY

CLASS 25—(Continued).

SN 77-723,190. SQUARE GROUPER, LLC, MIAMI BEACH, FL. FILED 4-27-2009.

SQUARE GROUPER

THE MARK CONSISTS OF STANDARD CHARACTERS WITHOUT CLAIM TO ANY PARTICULAR FONT, STYLE, SIZE, OR COLOR.

FOR FOOTWEAR; HEAD WEAR, NAMELY, BEANIES, HATS, VISORS, CAPS; SWIMWEAR, NAMELY, BOARD SHORTS AND BIKINIS; T-SHIRTS, SHIRTS; CASUAL TOPS WITH LONG AND SHORT SLEEVES; SLEEVELESS SHIRTS, SWEAT TOPS; JACKETS, COATS, SHORTS; WALK SHORTS, LONG PANTS, TROUSERS, JEANS, DRESSES, SKIRTS (U.S. CLS. 22 AND 39).

JANICE KIM, EXAMINING ATTORNEY

SN 77-723,214. FOWERS, NIEL J., RIO NIDO, CA. FILED 4-27-2009.

Thorn Orchard

THE MARK CONSISTS OF STANDARD CHARACTERS WITHOUT CLAIM TO ANY PARTICULAR FONT, STYLE, SIZE, OR COLOR.

THE NAME "THORN ORCHARD" DOES NOT IDENTIFY A LIVING INDIVIDUAL.

FOR HATS; JACKETS; SHIRTS (U.S. CLS. 22 AND 39).
DOUGLAS LEE, EXAMINING ATTORNEY

SN 77-723,294. WEIDMER, TODD P, SAN FRANCISCO, CA. FILED 4-27-2009.



THE MARK CONSISTS OF THE WORD "MAIANS" WITH A STYLIZED LETTER M (WITH 3 PEAKS) AS THE FIRST LETTER.

FOR CANVAS SHOES; DECK-SHOES; LEISURE SHOES; WOMEN'S SHOES (U.S. CLS. 22 AND 39).

MICHAEL KEATING, EXAMINING ATTORNEY

CLASS 25—(Continued).

SN 77-723,319. SENGSTAKEN ENTERPRISES, INC., OXNARD, CA. FILED 4-27-2009.

MUCKING FABULOUS

THE MARK CONSISTS OF STANDARD CHARACTERS WITHOUT CLAIM TO ANY PARTICULAR FONT, STYLE, SIZE, OR COLOR.

FOR BASEBALL CAPS; GLOVES; JACKETS; PAJAMAS; PANTS; SHIRTS; SOCKS; SWEAT PANTS; SWEAT SHIRTS; T-SHIRTS; TANK TOPS (U.S. CLS. 22 AND 39).
C. DIONNE CLYBURN, EXAMINING ATTORNEY

SN 77-723,379. ALEXANDRE CAUGANT, LOS ANGELES, CA. AND JULIA CAUGANT, LOS ANGELES, CA. FILED 4-27-2009.

VINTAGE LAUNDRY

THE MARK CONSISTS OF STANDARD CHARACTERS WITHOUT CLAIM TO ANY PARTICULAR FONT, STYLE, SIZE, OR COLOR.

NO CLAIM IS MADE TO THE EXCLUSIVE RIGHT TO USE "VINTAGE", APART FROM THE MARK AS SHOWN.

FOR CLOTHING, NAMELY, MEN'S, WOMEN'S, MISSY'S, JUNIORS', CHILDREN'S AND INFANTS' JEANS, PANTS, TROUSERS, CAPRIS, LEGGINGS, SHORTS, OVERALLS, SKIRTS, DRESSES, TOPS, T-SHIRTS, SWEATSHIRTS, BLOUSES, SHIRTS, JACKETS, VESTS, COATS, SWEATERS, CARDIGANS, SCARVES, SOCKS, BANDANAS, NECKTIES, BELTS, BOOTS, SANDALS, FOOTWEAR, HATS, CAPS, HEADWEAR, UNDERWEAR, LINGERIE, PAJAMAS, SWIMWEAR, AND GLOVES (U.S. CLS. 22 AND 39).

CHRISTINE COOPER, EXAMINING ATTORNEY

SN 77-723,441. VERTICAL INDUSTRIES, HESPERIA, CA. FILED 4-27-2009.

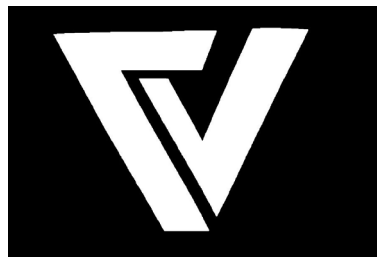

THE MARK CONSISTS OF THE STYLIZED LETTER "V" WITHIN A SQUARE CARRIER.

FOR HATS; JACKETS; SHIRTS; SWEAT SHIRTS (U.S. CLS. 22 AND 39).

TASNEEM HUSSAIN, EXAMINING ATTORNEY

CLASS 25—(Continued).

SN 77-723,576. SHEHADEH, IBRAHIM, BEND, OR. FILED 4-28-2009.

MTN-RMR

THE MARK CONSISTS OF STANDARD CHARACTERS WITHOUT CLAIM TO ANY PARTICULAR FONT, STYLE, SIZE, OR COLOR.

FOR CLOTHING, NAMELY, NECK TUBES; NECK GAITERS (U.S. CLS. 22 AND 39).

KATHERINE CHANG, EXAMINING ATTORNEY

SN 77-723,606. CAPITAL GARMENT CO. U.S.A., INC., NEWTON CENTER, MA. FILED 4-28-2009.

CLUB NUAGE

THE MARK CONSISTS OF STANDARD CHARACTERS WITHOUT CLAIM TO ANY PARTICULAR FONT, STYLE, SIZE, OR COLOR.

OWNER OF U.S. REG. NOS. 2,044,678, 2,180,354 AND 2,209,437.

THE ENGLISH TRANSLATION OF THE WORD "NUAGE" IN THE MARK IS "CLOUD"

FOR COATS, JACKETS AND OUTWEAR, NAMELY, RAINWEAR, COATS, JACKETS, SWEAT SUITS, LEISURE SUITS, SWEAT SHIRTS, AND SWEATERS (U.S. CLS. 22 AND 39).

DORITT L. CARROLL, EXAMINING ATTORNEY

SN 77-723,626. I J BROTHERS IMPORT INC, CLERMONT, FL. FILED 4-28-2009.



NO CLAIM IS MADE TO THE EXCLUSIVE RIGHT TO USE "TEE", APART FROM THE MARK AS SHOWN.

THE MARK CONSISTS OF THE WORD "HOOD" (IN HAND WRITTEN FORM) AND THE WORD "TEE" (IN SQUARE BLOCK FORM) UNDER "HOOD" ON A CLEARED PATCH OF LAND.

FOR SHORT-SLEEVED SHIRTS; SPORTS SHIRTS; SWEAT SHIRTS; T-SHIRTS; TEE SHIRTS; WEARABLE GARMENTS AND CLOTHING, NAMELY, SHIRTS (U.S. CLS. 22 AND 39).

KATINA MISTER, EXAMINING ATTORNEY

CLASS 25—(Continued).

SN 77-723,668. TYLER HANE, CLINTON, MT. FILED 4-28-2009.

BIFF IT INK

THE MARK CONSISTS OF STANDARD CHARACTERS WITHOUT CLAIM TO ANY PARTICULAR FONT, STYLE, SIZE, OR COLOR.

FOR BOARD SHORTS; CLOTHING, NAMELY, BASE LAYERS; COATS; FOOTWEAR; HEADGEAR, NAMELY, CAPS, HATS, SKULL CAPS AND VISORS; HOODED SWEAT SHIRTS; JACKETS; JEANS; JUMPERS; PANTS; POLO SHIRTS; SHORTS; SUITS; SWEATERS; T-SHIRTS; UNDERWEAR (U.S. CLS. 22 AND 39).

CAROLYN CATALDO, EXAMINING ATTORNEY

SN 77-723,806. ONE ENTERPRISES INC., STERLING, VA. FILED 4-28-2009.



THE COLOR(S) GRAY AND RED IS/ARE CLAIMED AS A FEATURE OF THE MARK.

THE MARK CONSISTS OF THE WORD "BEONDE" WITH THE LETTER "O" APPEARING IN RED, AND THE LETTERS "B", "E", "N", "D" AND "E" APPEARING IN GRAY.

FOR SPORTS APPAREL, NAMELY, SPORT COATS, SPORTS JACKETS, SPORTS JERSEYS, SPORTS PANTS, SPORTS SHIRTS, AND SPORTS SHIRTS WITH SHORT SLEEVES; OUTDOOR APPAREL, NAMELY, SHIRTS, PANTS, JACKETS, T-SHIRTS, RAIN COATS, RAIN JACKETS, RAIN SUITS, RAIN TROUSERS, WIND COATS, WIND PANTS, WIND RESISTANT JACKETS, WIND SHIRTS, WIND VESTS, AND WIND-JACKETS (U.S. CLS. 22 AND 39).

DAVID COLLIER, EXAMINING ATTORNEY

SN 77-723,843. DROWN, DANIEL, SAN MATEO, CA. FILED 4-28-2009.



THE MARK CONSISTS OF THE STYLIZED LETTERS, NUMBERS, AND WORD "H2OLDIES".

FOR HATS; SHIRTS; TEE SHIRTS (U.S. CLS. 22 AND 39).

ELLEN B. AWRICH, EXAMINING ATTORNEY

CLASS 25—(Continued).

SN 77-723,890. SCOTT RILEY, MICHELE, HARBOR CITY, CA. FILED 4-28-2009.

Jonti by design

THE MARK CONSISTS OF STANDARD CHARACTERS WITHOUT CLAIM TO ANY PARTICULAR FONT, STYLE, SIZE, OR COLOR.

FOR CAMISOLES; CAPS; CARGO PANTS; DRESSES; GLOVES; HATS; JEANS; JOGGING SUITS; KNICKERS; NIGHT GOWNS; PAJAMAS; PANTS; ROBES; SANDALS; SCARVES; SHIRTS; SHOES; SHORTS; SKIRTS; SLIPS; SOCKS; SWEATERS; T-SHIRTS; TANK TOPS; TRACK SUITS; UNDERGARMENTS (U.S. CLS. 22 AND 39).
BARBARA RUTLAND, EXAMINING ATTORNEY

SN 77-724,017. ROBOT WARS, LLC, NEW YORK, NY. FILED 4-28-2009.

ROBOT WARS

THE MARK CONSISTS OF STANDARD CHARACTERS WITHOUT CLAIM TO ANY PARTICULAR FONT, STYLE, SIZE, OR COLOR.

OWNER OF U.S. REG. NO. 1,858,931.
FOR CLOTHING, NAMELY, T-SHIRTS, CAPS, SWEATSHIRTS, SHIRTS (U.S. CLS. 22 AND 39).
TOBY BULLOFF, EXAMINING ATTORNEY

CLASS 25—(Continued).

SN 77-724,024. PATRICK DUMONT, CARMEL, CA. FILED 4-28-2009.



THE COLOR(S) BLUE IS/ARE CLAIMED AS A FEATURE OF THE MARK.

THE MARK CONSISTS OF THE STYLIZED LETTER "A" IN BLUE, THE STYLIZED LETTERS "I" IN BLUE INCLUDING THE SPIRAL DOT OVER THE "I" IN BLUE, THE STYLIZED LETTER "A" IN BLUE AND THE STYLIZED LETTER "N" IN BLUE INCLUDING THE THREE SPHERES ABOVE THE "N" IN BLUE.

FOR A-SHIRTS; ADULT NOVELTY GAG CLOTHING ITEM, NAMELY, SOCKS; ATHLETIC APPAREL, NAMELY, SHIRTS, PANTS, JACKETS, FOOTWEAR, HATS AND CAPS, ATHLETIC UNIFORMS; BALLOON PANTS; BELTS; BELTS FOR CLOTHING; BIBS NOT OF CLOTH OR PAPER; BLOUSES; BODY SHIRTS; BUTTON-FRONT ALOHA SHIRTS; CAMP SHIRTS; CAPRI PANTS; CAPS; CARGO PANTS; CHILDREN'S AND INFANTS' CLOTH BIBS; CHILDREN'S CLOTH EATING BIBS; CLOTH BIBS; CLOTH BIBS FOR ADULT DINERS; CLOTH BIBS FOR USE BY SENIOR CITIZENS OR PHYSICALLY- OR MENTALLY-CHALLENGED PERSONS; CLOTH DIAPERS; CLOTHING FOR ATHLETIC USE, NAMELY, PADDED ELBOW COMPRESSION SLEEVES; CLOTHING FOR ATHLETIC USE, NAMELY, PADDED PANTS; CLOTHING FOR ATHLETIC USE, NAMELY, PADDED SHIRTS; CLOTHING FOR ATHLETIC USE, NAMELY, PADDED SHORTS; CLOTHING FOR WEAR IN JUDO PRACTICES; CLOTHING FOR WEAR IN WRESTLING GAMES; CLOTHING, NAMELY, ARM WARMERS; CLOTHING, NAMELY, BASE LAYERS; CLOTHING, NAMELY, FOLK COSTUMES; CLOTHING, NAMELY, HAND-WARMERS; CLOTHING, NAMELY, KHAKIS; CLOTHING, NAMELY, KNEE WARMERS; CLOTHING, NAMELY, NECK TUBES; CLOTHING, NAMELY, THOBES; CLOTHING, NAMELY, WRAP-AROUNDS; CORSETS; DENIMS; DRESS SHIRTS; DUSTERS; EYESHADES; FOULARDS; GOLF PANTS, SHIRTS AND SKIRTS; GOLF SHIRTS; GYM PANTS; HOODED SWEAT SHIRTS; HOODS; INFANT AND TODDLER ONE PIECE CLOTHING; INFANT CLOTH DIAPERS; JERSEYS; JOGGING PANTS; KNIT SHIRTS; LEATHER BELTS; LEATHER PANTS; LONG-SLEEVED SHIRTS; LOUNGE PANTS; MANTLES; MOISTURE-WICKING SPORTS PANTS; MOISTURE-WICKING SPORTS SHIRTS; MUFFLERS; NIGHT SHIRTS; NON-DISPOSABLE CLOTH TRAINING PANTS; NURSE PANTS; OPEN-NECKED SHIRTS; OVER SHIRTS; PANTS; PAPER HATS FOR USE AS CLOTHING ITEMS; PARTS OF CLOTHING, NAMELY, GUSSETS FOR TIGHTS, GUSSETS FOR STOCKINGS, GUSSETS FOR BATHING SUITS, GUSSETS FOR UNDERWEAR, GUSSETS FOR LEOTARDS AND GUSSETS FOR FOOTLETS; PARTS OF CLOTHING, NAMELY, UNDERARM GUSSETS; PARTY HATS; PERSPIRATION ABSORBENT UNDERWEAR CLOTHING; PETTI-PANTS; PIQUE SHIRTS; PLEATED SKIRTS FOR FORMAL KIMONOS (HAKAMA); POLO SHIRTS; RUGBY SHIRTS; SCIENTIFIC AND TECHNOLOGICAL APPAREL, NAMELY, SHIRTS, PANTS, JACKETS, FOOTWEAR, HATS AND CAPS, UNIFORMS; SHIRTS; SHIRT FRONTS; SHIRT YOKES; SHIRTS; SHIRTS FOR SUITS; SHORT SETS; SHORT-SLEEVED OR LONG-SLEEVED T-SHIRTS; SHORT-SLEEVED SHIRTS; SHOULDER WRAPS; SKI PANTS; SKIRT SUITS; SKIRTS; SKIRTS AND DRESSES; SLEEP SHIRTS; SNOW PANTS; SNOWBOARD PANTS; SPORT SHIRTS; SPORTS PANTS; SPORTS SHIRTS; SPORTS SHIRTS WITH SHORT SLEEVES; STRETCH PANTS; SWADDLING CLOTHES; SWEAT PANTS; SWEAT SHIRTS; T-SHIRTS; TAP PANTS; TEE SHIRTS; TIES;

CLASS 25—(Continued).

TOBOGGAN HATS, PANTS AND CAPS; TOPS; TRACK PANTS; TRAVEL CLOTHING CONTAINED IN A PACKAGE COMPRISING REVERSIBLE JACKETS, PANTS, SKIRTS, TOPS AND A BELT OR SCARF; TRIATHLON CLOTHING, NAMELY, TRIATHLON TIGHTS, TRIATHLON SHORTS, TRIATHLON SINGLETS, TRIATHLON SHIRTS, TRIATHLON SUITS; TURTLE NECK SHIRTS; UNDERARM CLOTHING SHIELDS; WATERPROOF JACKETS AND PANTS; WEARABLE GARMENTS AND CLOTHING, NAMELY, SHIRTS; WIND PANTS; WIND SHIRTS; WRAPS; YOGA PANTS; YOGA SHIRTS (U.S. CLS. 22 AND 39).

DEIRDRE ROBERTSON, EXAMINING ATTORNEY

SN 77-724,032. EDWARD B. HALEY, BRIDGEWATER, MA. FILED 4-28-2009.



THE MARK CONSISTS OF A HUMAN SKULL IN FRONT OF TWO CROSSED IMAGES CONSISTING OF A GUITAR HEADSTOCK ON TOP (ABOVE THE SKULL), LOCATED IN THE UPPER RIGHT AND LEFT-HAND CORNERS, WITH TIPPING DRINKS IN THE LOWER RIGHT AND LEFT-HAND CORNERS (BELOW THE SKULL). THE DRINKS APPEAR TO BE POURING INTO THE SKULL'S MOUTH.

FOR (BASED ON USE IN COMMERCE) JERSEYS; SHIRTS; T-SHIRTS; TEE SHIRTS; TOPS; WEARABLE GARMENTS AND CLOTHING, NAMELY, SHIRTS-(BASED ON INTENT TO USE) CAPS; CAPS WITH VISORS; CLOTHING, NAMELY, BASE LAYERS; GOLF CAPS; SLEEP SHIRTS; SLEEVELESS JERSEYS; SPORT SHIRTS; SPORTS JERSEYS; SPORTS SHIRTS WITH SHORT SLEEVES; SWEAT SHIRTS (U.S. CLS. 22 AND 39).

FIRST USE 1-1-2007; IN COMMERCE 1-1-2009.
JULIE WATSON, EXAMINING ATTORNEY

SN 77-724,049. WENDY GOLD LEBERMAN, MISSION VIEJO, CA. FILED 4-28-2009.

do-tube

THE MARK CONSISTS OF STANDARD CHARACTERS WITHOUT CLAIM TO ANY PARTICULAR FONT, STYLE, SIZE, OR COLOR.

FOR BANDANAS; HEAD SCARVES; HEADBANDS; HEADBANDS AGAINST SWEATING (U.S. CLS. 22 AND 39).

JENNY PARK, EXAMINING ATTORNEY

CLASS 25—(Continued).

SN 77-724,065. GBS ENTERPRISES CORP., NEW YORK, NY. FILED 4-28-2009.

ROOBIE PEACE

THE MARK CONSISTS OF STANDARD CHARACTERS WITHOUT CLAIM TO ANY PARTICULAR FONT, STYLE, SIZE, OR COLOR.

FOR MEN'S AND WOMEN'S CLOTHING, NAMELY, SWEATSHIRTS, SHIRTS, JEANS, JACKETS, COATS, SWEATPANTS, SLACKS, SUITS, HATS, CAPS, DRESSES, SHOES, SNEAKERS, BOOTS, T-SHIRTS, BELTS, SCARVES, UNDERGARMENTS, NECKTIES, DRESS SHIRTS, COLLARED SHIRTS, RUGBY SHIRTS, KNIT SHIRTS, SHORTS, SLEEPWEAR (U.S. CLS. 22 AND 39).

TEJBIR SINGH, EXAMINING ATTORNEY

SN 77-724,245. NEW LINE FASHION, INC., CITY OF INDUSTRY, CA. FILED 4-28-2009.

ELECTEE

THE MARK CONSISTS OF STANDARD CHARACTERS WITHOUT CLAIM TO ANY PARTICULAR FONT, STYLE, SIZE, OR COLOR.

FOR COATS; DENIM JACKETS; DENIMS; DRESS SHIRTS; DRESSES; FOOTWEAR; HEADWEAR; JACKETS; JEANS; JERSEYS; JUMPERS; KNIT SHIRTS; MINISKIRTS; PAJAMAS; POLO SHIRTS; PONCHOS; PULLOVERS; SHIRTS; SHORTS; SKIRTS; SKORTS; SLACKS; SPORT COATS; SPORTS JACKETS; SPORTS SHIRTS; SUITS; SWEAT PANTS; SWEAT SHORTS; SWEATERS; T-SHIRTS; TANK TOPS; TOPCOATS; TRENCH COATS; TROUSERS; VESTS (U.S. CLS. 22 AND 39).

ZACHARY BELLO, EXAMINING ATTORNEY

SN 77-724,247. NUSOL INNOVATIONS, LLC, HOUSTON, TX. FILED 4-28-2009.



THE MARK CONSISTS OF THE WORDS "NUSOL INNOVATIONS" IN STYLIZED FORM WHERE THE LETTER "N" IN "NUSOL" IS STYLIZED TO RESEMBLE A FOOT DESIGN.

FOR SHOE INSERTS FOR PRIMARILY NON-ORTHOPEDIC PURPOSES (U.S. CLS. 22 AND 39).

SOPHIA S. KIM, EXAMINING ATTORNEY

CLASS 25—(Continued).

SN 77-724,251. NUSOL INNOVATIONS, LLC, HOUSTON, TX. FILED 4-28-2009.



THE MARK CONSISTS OF THE LETTER "N" STYLIZED AS A FOOT DESIGN WITHIN A CIRCLE.
FOR SHOE INSERTS FOR PRIMARILY NON-ORTHOPEDIC PURPOSES (U.S. CLS. 22 AND 39).
SOPHIA S. KIM, EXAMINING ATTORNEY

CLASS 25—(Continued).

SN 77-724,683. FISHER-CASTRO, NONIE MARLENE, CERES, CA. FILED 4-29-2009.



THE MARK CONSISTS OF THE IMAGE OF A CROSS CONTAINING THE STYLIZED WORDS "CHRISTIAN" WRITTEN VERTICALLY AND "SHINE" WRITTEN HORIZONTALLY.
FOR HATS; HOODED SWEAT SHIRTS; SHORT-SLEEVED OR LONG-SLEEVED T-SHIRTS; SWEAT PANTS; SWEAT SHIRTS (U.S. CLS. 22 AND 39).
NAAKWAMA ANKRAH, EXAMINING ATTORNEY

SN 77-724,306. ARROYO, XIOMARA, MIAMI, FL. FILED 4-28-2009.



THE MARK CONSISTS OF THE STYLIZED TEXT "XIOMARA LISETTE" WITH A FLOWER IN THE MIDDLE.
FOR DRESSES; JACKETS; PANTS; SHIRTS; SHOES; SKIRTS (U.S. CLS. 22 AND 39).
LINDA E. BLOHM, EXAMINING ATTORNEY

SN 77-724,799. GUGA KUERTEN PARTICIPACOES E EMPREENDIMENTOS LTDA., FLORIANOPOLIS/SC, BRAZIL, FILED 4-29-2009.

SN 77-724,484. Z DISTRIBUTION, INC., SAN JUAN CAPISTRANO, CA. FILED 4-28-2009.

Duty and Honor

THE MARK CONSISTS OF STANDARD CHARACTERS WITHOUT CLAIM TO ANY PARTICULAR FONT, STYLE, SIZE, OR COLOR.
FOR WEARING APPAREL - NAMELY, SHIRTS, SHORT-SLEEVED SHIRTS, LONG-SLEEVED SHIRTS, SPORT SHIRTS, SPORTS SHIRTS WITH SHORT SLEEVES, SPORTS SHIRTS WITH LONG SLEEVES, POLO SHIRTS, KNIT SHIRTS, T-SHIRTS, SHORT-SLEEVED T-SHIRTS, LONG-SLEEVED T-SHIRTS, JACKETS, SWEAT SHIRTS, SWEAT SUITS, SHORTS, BERMUDA SHORTS, WALKING SHORTS, SWEAT SHORTS, BLOUSES, TOPS FOR WOMEN, PANTS, JEANS, SWEAT PANTS, SWIM SUITS, HATS, CAPS, CAPS WITH VISORS, VISORS, BASEBALL CAPS, FOOTWEAR, ATHLETIC FOOTWEAR, SHOES, ATHLETIC SHOES, BOOTS, CANVAS SHOES, SANDALS, SOCKS, SWEAT BANDS, BERTS, GLOVES, WAIST BELTS (U.S. CLS. 22 AND 39).
MARILYN IZZI, EXAMINING ATTORNEY



THE NAME(S), PORTRAIT(S), AND/OR SIGNATURE(S) SHOWN IN THE MARK IDENTIFIES "GUGA KUERTEN", WHOSE CONSENT(S) TO REGISTER IS MADE OF RECORD.
THE MARK CONSISTS OF THE LETTERS "GUGA KUERTEN" IN A STYLIZED FORM.
FOR SPORTS CLOTHING, NAMELY, BERUMDA SHORTS, T-SHIRTS, SANDALS (U.S. CLS. 22 AND 39).
JENNY PARK, EXAMINING ATTORNEY

CLASS 25—(Continued).

SN 77-724,839. FGM UK LTD, TA FAIRYGOTHMOTHER, LONDON, UNITED KINGDOM, FILED 4-29-2009.

FairyGothMother

THE MARK CONSISTS OF STANDARD CHARACTERS WITHOUT CLAIM TO ANY PARTICULAR FONT, STYLE, SIZE, OR COLOR.

OWNER OF UNITED KINGDOM REG. NO. 2359397, DATED 6-2-2004, EXPIRES 6-2-2014.

SEC. 2(F).
FOR UNDERGARMENTS, NAMELY, CORSETS; EVENING GOWNS; NIGHT GOWNS; WEDDING GOWN (U.S. CLS. 22 AND 39).

FIRST USE 7-4-1999; IN COMMERCE 7-4-1999.

THEODORE MCBRIDE, EXAMINING ATTORNEY

CLASS 25—(Continued).

SN 77-724,920. COLUMBUS BASEBALL TEAM, INC., COLUMBUS, OH. FILED 4-29-2009.

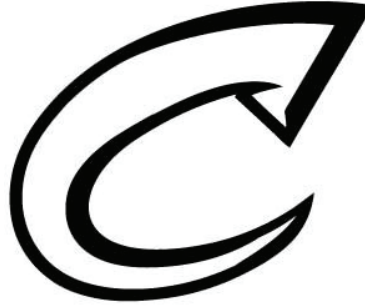

THE MARK CONSISTS OF A STYLIZED "C".

FOR CLOTHING, NAMELY, ATHLETIC UNIFORMS, BANDANAS, BOXER SHORTS, CAPS, CLOTH BABY BIBS, COATS, GOLF SHIRTS, GYM SHORTS, HATS, JACKETS, JERSEYS, JOGGING SUITS, KNIT SHIRTS, PAJAMAS, POLO SHIRTS, PONCHOS, PULLOVERS, RAIN COATS, RAINWEAR, SWEATERS, SWEAT PANTS, SWEAT SHIRTS, SWEAT SUITS, SOCKS, SPORT SHIRTS, T-SHIRTS, TANK TOPS, TIES, VISORS, WIND RESISTANT JACKETS AND WRISTBANDS (U.S. CLS. 22 AND 39).

FIRST USE 12-15-2008; IN COMMERCE 12-15-2008.

TASNEEM HUSSAIN, EXAMINING ATTORNEY

SN 77-724,881. MILLER, GARRETT, HENDERSON, NV. FILED 4-29-2009.

Adversary Clothing

THE MARK CONSISTS OF STANDARD CHARACTERS WITHOUT CLAIM TO ANY PARTICULAR FONT, STYLE, SIZE, OR COLOR.

NO CLAIM IS MADE TO THE EXCLUSIVE RIGHT TO USE "CLOTHING", APART FROM THE MARK AS SHOWN. FOR HATS; SHIRTS (U.S. CLS. 22 AND 39).

ALEXANDER L. POWERS, EXAMINING ATTORNEY

SN 77-724,924. LUCKY BRAND DUNGAREES, INC., VERNON, CA. FILED 4-29-2009.

LOOK YOUR BEST

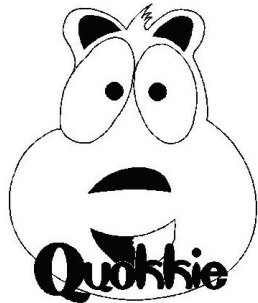

THE MARK CONSISTS OF THE STYLIZED WORD "QUOKKIE" SUPERIMPOSED ON THE FACE ON AN ANIMATED CHARACTER.

FOR ROBES (U.S. CLS. 22 AND 39).

DAVID TOOLEY, EXAMINING ATTORNEY

THE MARK CONSISTS OF STANDARD CHARACTERS WITHOUT CLAIM TO ANY PARTICULAR FONT, STYLE, SIZE, OR COLOR.

FOR BELTS; BOTTOMS; DRESSES; FOOTWEAR; HEADWEAR; JACKETS; JEANS; KNIT SHIRTS; LINGERWEAR; PANTS; SHIRTS; SHORTS; SKIRTS; SLEEPWEAR; SOCKS; SWEATERS; SWIMWEAR; T-SHIRTS; TOPS; UNDERWEAR (U.S. CLS. 22 AND 39).

MICHAEL WEBSTER, EXAMINING ATTORNEY

CLASS 25—(Continued).

SN 77-724,932. LUCKY BRAND DUNGAREES, INC., VERNON, CA. FILED 4-29-2009.

WEAR THE CLOVER IT'S LUCKY

THE MARK CONSISTS OF STANDARD CHARACTERS WITHOUT CLAIM TO ANY PARTICULAR FONT, STYLE, SIZE, OR COLOR.

OWNER OF U.S. REG. NO. 2,383,437.

FOR BELTS; BOTTOMS; DRESSES; FOOTWEAR; HEADWEAR; JACKETS; JEANS; KNIT SHIRTS; LOUNGEWEAR; PANTS; SHIRTS; SHORTS; SKIRTS; SLEEPWEAR; SOCKS; SWEATERS; SWIMWEAR; T-SHIRTS; TOPS; UNDERWEAR (U.S. CLS. 22 AND 39).

MICHAEL WEBSTER, EXAMINING ATTORNEY

CLASS 25—(Continued).

SN 77-725,151. NU ALPHA KAPPA FRATERNITY, INC., SANTA ANA, CA. FILED 4-29-2009.

NAK

THE MARK CONSISTS OF STANDARD CHARACTERS WITHOUT CLAIM TO ANY PARTICULAR FONT, STYLE, SIZE, OR COLOR.

FOR ATHLETIC APPAREL, NAMELY, SHIRTS, PANTS, JACKETS, FOOTWEAR, HATS AND CAPS, ATHLETIC UNIFORMS; BASEBALL CAPS; CHILDREN'S AND INFANT'S APPAREL, NAMELY, JUMPERS, OVERALL SLEEPWEAR, PAJAMAS, ROMPERS AND ONE-PIECE GARMENTS; DRESS SHIRTS; GLOVES; GOLF CAPS; GOLF SHIRTS; HATS; HEAVY JACKETS; HOODED SWEAT SHIRTS; JACKETS; LONG-SLEEVED SHIRTS; SCARFS; SHIRTS; SHOES; SOCKS; SPORT SHIRTS; SPORTS JACKETS; SPORTS SHIRTS; SPORTS SHIRTS WITH SHORT SLEEVES; SWEAT SHIRTS; T-SHIRTS; TEE SHIRTS; TIES; WIND RESISTANT JACKETS (U.S. CLS. 22 AND 39).

FIRST USE 2-26-1988; IN COMMERCE 2-26-1988.

SUSAN STIGLITZ, EXAMINING ATTORNEY

SN 77-725,270. SOUTH BROOKLYN YOUTH CONSORTIUM INC, BROOKLYN, NY. FILED 4-29-2009.

SN 77-724,965. COLUMBUS BASEBALL TEAM, INC., COLUMBUS, OH. FILED 4-29-2009.



OWNER OF U.S. REG. NO. 2,100,801.
THE MARK CONSISTS OF STYLIZED "CLIPPERS" WITH BOAT IN THE LOWER LEFT ARC OF THE "C".

FOR CLOTHING, NAMELY, APRONS, ATHLETIC UNIFORMS, BANDANAS, BOXER SHORTS, CAPS, CLOTH BABY BIBS, COATS, GOLF SHIRTS, GYM SHORTS, GYM SUITS, HATS, JACKETS, JERSEYS, JOGGING SUITS, KNIT SHIRTS, PAJAMAS, POLO SHIRTS, PONCHOS, PULLOVERS, RAIN COATS, RAINWEAR, SWEATERS, SWEAT PANTS, SWEAT SHIRTS, SWEAT SUITS, SOCKS, SPORT SHIRTS, T-SHIRTS, TANK TOPS, TIES, VISORS, WIND RESISTANT JACKETS AND WRISTBANDS (U.S. CLS. 22 AND 39).

FIRST USE 12-15-2008; IN COMMERCE 12-15-2008.

TASNEEM HUSSAIN, EXAMINING ATTORNEY

STOP DA VIOLENCE

THE MARK CONSISTS OF STANDARD CHARACTERS WITHOUT CLAIM TO ANY PARTICULAR FONT, STYLE, SIZE, OR COLOR.

FOR BOOTS; COATS; DRESSES; HATS; SCARVES; SNEAKERS; T-SHIRTS (U.S. CLS. 22 AND 39).

KEVIN DINALLO, EXAMINING ATTORNEY

SN 77-725,319. INGRAHAM, BRETT, GILBERT, AZ. FILED 4-29-2009.

going for #

THE MARK CONSISTS OF STANDARD CHARACTERS WITHOUT CLAIM TO ANY PARTICULAR FONT, STYLE, SIZE, OR COLOR.

FOR BANDANAS; HATS; JACKETS; PANTS; SCARVES; SHIRTS; SHOES (U.S. CLS. 22 AND 39).

JAY BESCH, EXAMINING ATTORNEY

CLASS 25—(Continued).

SN 77-725,349. CAMPANALONGA, RICHARD, LIVINGSTON, NJ. AND CAMPANALONGA, DONNA, PARSIPPANY, NJ. FILED 4-29-2009.

JACK'D INTERNATIONAL

THE MARK CONSISTS OF STANDARD CHARACTERS WITHOUT CLAIM TO ANY PARTICULAR FONT, STYLE, SIZE, OR COLOR.

NO CLAIM IS MADE TO THE EXCLUSIVE RIGHT TO USE "INTERNATIONAL", APART FROM THE MARK AS SHOWN.

FOR CLOTHING, NAMELY, SHIRTS, SHOES, HATS, JACKETS, PANTS, SOCKS, HOODED SWEAT SHIRTS, JERSEYS, SHORTS, SPORTS BRAS, BRAS, UNDERWEAR, HEAD BANDS, WRISTBANDS, GLOVES, BANDANAS, SWEATERS, T-SHIRTS, TANK TOPS, RAIN COATS, WIND-RESISTANT JACKETS, SWEAT PANTS, SWEAT SHIRTS, BRIEFS, BOXERS, BOXER-BRIEFS, DRESSES, SKIRTS, SWIM SUITS, SWIM TRUNKS, JEANS, SANDALS, BOOTS, SNEAKERS, BELTS, SCARVES, PAJAMAS, SHORT-SLEEVED OR LONG-SLEEVED T-SHIRTS, TURTLE NECK SHIRTS, BASEBALL CAPS, FLIP-FLOPS, LEG WARMERS, BODY SUITS, HEADWEAR, SPORTS SHIRTS, VESTS, BLAZERS, SUITS, SLACKS, DRESS SHOES, MARTIAL ARTS UNIFORMS, SUSPENDERS, ROBES, STOCKINGS, EAR MUFFS, CAPRIS, LINGERIE, UNDERGARMENTS, COATS, CARDIGANS (U.S. CLS. 22 AND 39).
DAVID C. REIHNER, EXAMINING ATTORNEY

CLASS 25—(Continued).

SN 77-725,429. DOUBLE-R ENTERPRISES, LLC, BOZEMAN, MT. FILED 4-29-2009.



THE MARK CONSISTS OF THE STYLIZED WORDING "LIKE A GIRL" POSITIONED TO THE LEFT OF THE WARRIOR WOMAN.

FOR CLOTHING, NAMELY, HEADWEAR, SCARVES, SHIRTS, JACKETS, PANTS, SHORTS, SKIRTS, DRESSES, AND SOCKS (U.S. CLS. 22 AND 39).

FIRST USE 4-23-2009; IN COMMERCE 4-23-2009.
WON TEAK OH, EXAMINING ATTORNEY

SN 77-725,477. TWENTIETH CENTURY FOX FILM CORPORATION, LOS ANGELES, CA. FILED 4-29-2009.

SN 77-725,414. SCHRADER, ROBERT, DALLAS, TX. FILED 4-29-2009.



THE MARK CONSISTS OF AN IMAGE OF AN ABSTRACT DESIGN.
FOR HATS; SHIRTS; SHORTS (U.S. CLS. 22 AND 39).
ROBERT C. CLARK JR., EXAMINING ATTORNEY



OWNER OF U.S. REG. NO. 3,001,994.
NO CLAIM IS MADE TO THE EXCLUSIVE RIGHT TO USE "SPORTS", APART FROM THE MARK AS SHOWN.

THE MARK CONSISTS OF THE STYLIZED WORDS "THE ADVENTURES OF DIGGER AND FRIENDS" WHICH APPEAR IN THE CENTER, THE WORDS "FOX SPORTS" WHICH APPEAR INSIDE OF THE OVAL SHAPE ON THE TOP CENTER AND FIVE COSTUMED GOPHER CHARACTERS, AND ALL ARE DISPLAYED INSIDE OF THE RECTANGULAR BACKGROUND.

FOR T-SHIRTS; SHIRTS; PANTS; UNDERWEAR; UNDERSHIRTS; BOXER SHORTS; LONG UNDERWEAR; HATS; CAPS; SWEATSHIRTS; SWEATPANTS; SWEATERS; SKIRTS; TANK TOPS; GLOVES; SOCKS; COATS; JACKETS; VESTS; SWIMWEAR; BELTS; SCARVES; PAJAMAS, NIGHTGOWNS; NIGHTSHIRTS; SLIPPERS; ROBES; TIES; BELTS; RAIN COATS; RAIN BOOTS (U.S. CLS. 22 AND 39).

LINDA LAVACHE, EXAMINING ATTORNEY

CLASS 25—(Continued).

SN 77-725,481. BRANDED THREADS, CO., MANHATTAN BEACH, CA. FILED 4-29-2009.

DAKOTA GRIZZLY

THE MARK CONSISTS OF STANDARD CHARACTERS WITHOUT CLAIM TO ANY PARTICULAR FONT, STYLE, SIZE, OR COLOR.

FOR COATS; SHIRTS; SHORTS (U.S. CLS. 22 AND 39).
FIRST USE 2-17-2009; IN COMMERCE 2-17-2009.
DANNEAN HETZEL, EXAMINING ATTORNEY



SN 77-725,495. STEWART, VICTORIA, GOLETA, CA. AND STEWART, BRYAN J., GOLETA, CA. FILED 4-29-2009.

IF I LOOK LOST PLEASE CALL



THE MARK CONSISTS OF STANDARD CHARACTERS WITHOUT CLAIM TO ANY PARTICULAR FONT, STYLE, SIZE, OR COLOR.

FOR HATS; JACKETS; SWEAT SHIRTS; SWEATERS; TEE SHIRTS (U.S. CLS. 22 AND 39).
NAAKWAMA ANKRAH, EXAMINING ATTORNEY

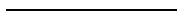

SN 77-725,553. FEEL STRONG, PORT ORANGE, FL. FILED 4-29-2009.

FEEL STRONG

THE MARK CONSISTS OF STANDARD CHARACTERS WITHOUT CLAIM TO ANY PARTICULAR FONT, STYLE, SIZE, OR COLOR.

FOR CLOTHING, NAMELY, T-SHIRTS, SHIRTS, DRESS SHIRTS, SWEAT SHIRTS, SWEAT PANTS, PANTS, JEANS, DRESS PANTS, TANK TOPS, JERSEYS, SHORTS, PAJAMAS, SWEATERS, BELTS, TIES, SCARVES, HEADWEAR, WRIST BANDS, EAR MUFFS, GLOVES, WARM UP SUITS, SUITS, WARM UP PANTS, WARM UP TOPS, HOSIERY, FOOTWEAR, JACKETS, COATS, UNDERGARMENTS, BOXER SHORTS, DRESSES, UNIFORMS, SWIMWEAR, AND TANKINIS (U.S. CLS. 22 AND 39).
JASON BLAIR, EXAMINING ATTORNEY

CLASS 25—(Continued).

SN 77-725,571. STATION CASINOS, INC., LAS VEGAS, NV. FILED 4-29-2009.

VIVA RESORT SPA CASINO

THE MARK CONSISTS OF STANDARD CHARACTERS WITHOUT CLAIM TO ANY PARTICULAR FONT, STYLE, SIZE, OR COLOR.

FOR WEARING APPAREL, NAMELY, SHIRTS, T SHIRTS, POLO SHIRTS, GOLF SHIRTS, TANK TOPS, VESTS, BLOUSES, SWEATERS, PARKAS, TURTLE-NECKS, PULLOVERS, SKIRTS, SHORTS, JEANS, SLACKS, PANTS, NIGHTSHIRTS AND NIGHT GOWNS, PAJAMAS, ROBES, ROMPERS, SOCKS, COVERALLS, MITTENS, GLOVES, UNDERGARMENTS, JERSEYS, LEOTARDS, HOSIERY, BOOTIES, SLIPPERS, SCARVES, BELTS, NECKTIES, SUSPENDERS, HEADBANDS, HATS, CAPS, VISORS, BLAZERS, RAIN PONCHOS, JACKETS, WIND RESISTANT JACKETS, WARM UP SUITS, JOGGING SUITS, SWEATSHIRTS, SWEAT PANTS, BEACH WEAR, NAMELY, BATHING SUITS, BEACH SANDALS, BEACH COVERALLS, FOOTWEAR, NAMELY SHOES, BOOTS, SANDALS, SNEAKERS AND ATHLETIC SHOES (U.S. CLS. 22 AND 39).

TRACY WHITTAKER-BROWN, EXAMINING ATTORNEY



SN 77-725,582. CHRISTOPHER NARANJO, MIRAMAR, FL. FILED 4-29-2009.



THE COLOR(S) BLACK AND GOLD IS/ARE CLAIMED AS A FEATURE OF THE MARK.

THE MARK CONSISTS OF BLACK OUTLINE HEAD WITH GOLD CROWN.

FOR TEE SHIRTS (U.S. CLS. 22 AND 39).
FRED MANDIR, EXAMINING ATTORNEY

CLASS 25—(Continued).

SN 77-725,601. FISKOLONE LLC, DBA DIVINITY FIGHT GEAR, DIVINITY MMA, CASTLE ROCK, CO. FILED 4-29-2009.



THE MARK CONSISTS OF THE LETTER "D" WITH BEVELED EDGE AND BEVELED CROSS INSET INSIDE LETTER BLANK SPACE.
FOR ATHLETIC APPAREL, NAMELY, SHIRTS, PANTS, JACKETS, FOOTWEAR, HATS AND CAPS, ATHLETIC UNIFORMS (U.S. CLS. 22 AND 39).
ELLEN BURNS, EXAMINING ATTORNEY

SN 77-725,624. SPEARS, CHAZ S, DBA PURPLE PORK, WOODBRIDGE, VA. FILED 4-30-2009.

Purple Pork

THE MARK CONSISTS OF STANDARD CHARACTERS WITHOUT CLAIM TO ANY PARTICULAR FONT, STYLE, SIZE, OR COLOR.
FOR ATHLETIC APPAREL, NAMELY, SHIRTS, PANTS, JACKETS, FOOTWEAR, HATS AND CAPS, ATHLETIC UNIFORMS (U.S. CLS. 22 AND 39).
MIDGE BUTLER, EXAMINING ATTORNEY

SN 77-725,625. MCPHERSON JR., REGINALD W., SAN LEANDRO, CA. FILED 4-30-2009.

ELEVATE BEYOND

THE MARK CONSISTS OF STANDARD CHARACTERS WITHOUT CLAIM TO ANY PARTICULAR FONT, STYLE, SIZE, OR COLOR.
FOR CLOTHING, NAMELY, T-SHIRTS, SHIRTS, SHORTS, SWEAT SHIRTS, SWEAT PANTS, HEADWEAR, PANTS, TOPS AND BOTTOMS (U.S. CLS. 22 AND 39).
KATHY DE JONGE, EXAMINING ATTORNEY

CLASS 25—(Continued).

SN 77-725,961. MCPHERSON JR., REGINALD W., SAN LEANDRO, CA. FILED 4-30-2009.



THE MARK CONSISTS OF STYLIZED LETTERS "EB" APPEARING IN THE CENTER OF TWO WINGS.
FOR CLOTHING, NAMELY, T-SHIRTS, SHIRTS, SHORTS, SWEAT SHIRTS, SWEAT PANTS, HEADWEAR, PANTS, TOPS AND BOTTOMS (U.S. CLS. 22 AND 39).
KATHY DE JONGE, EXAMINING ATTORNEY

SN 77-725,985. VECOLI, JEREMY J., RICHFIELD, MN. FILED 4-30-2009.



THE COLOR(S) RED, BLACK, AND WHITE IS/ARE CLAIMED AS A FEATURE OF THE MARK.
THE MARK CONSISTS OF A BLACK BELT TIED IN THE CENTER, WITH ITS ENDS HANGING DOWNWARD. WHITE LINES HIGHLIGHT THE CENTER KNOT AND APPEAR ON EITHER SIDE OF A THICK RED STRIPE ON THE RIGHT END OF THE BELT.
FOR MARTIAL ARTS UNIFORMS (U.S. CLS. 22 AND 39).
FIRST USE 2-6-2009; IN COMMERCE 2-6-2009.
ERNEST SHOSHO, EXAMINING ATTORNEY

SN 77-726,344. J.C. INVESTMENT PROPERTIES, CHICAGO, IL. FILED 4-30-2009.

DECEMBER DELIRIUM

THE MARK CONSISTS OF STANDARD CHARACTERS WITHOUT CLAIM TO ANY PARTICULAR FONT, STYLE, SIZE, OR COLOR.
FOR HATS; JACKETS; SHIRTS (U.S. CLS. 22 AND 39).
RENEE SERVANCE, EXAMINING ATTORNEY

CLASS 25—(Continued).

SN 77-726,469. FORTNER, TRAVIS, MELOSE, WI. FILED 4-30-2009.

Pro Veil

THE MARK CONSISTS OF STANDARD CHARACTERS WITHOUT CLAIM TO ANY PARTICULAR FONT, STYLE, SIZE, OR COLOR.

FOR HATS; JACKETS; NECK GAITERS; PANTS; PULLOVERS; SHORT-SLEEVED OR LONG-SLEEVED T-SHIRTS; T-SHIRTS; THERMAL UNDERWEAR; VESTS (U.S. CLS. 22 AND 39).

LEIGH CAROLINE CASE, EXAMINING ATTORNEY

SN 77-726,483. GREG GARNER, DBA TRAPSTAR CLOTHING, SHINGLE SPRINGS, CA. FILED 4-30-2009.

TRAPSTAR

THE MARK CONSISTS OF STANDARD CHARACTERS WITHOUT CLAIM TO ANY PARTICULAR FONT, STYLE, SIZE, OR COLOR.

FOR PANTS; SHORT-SLEEVED OR LONG-SLEEVED T-SHIRTS; T-SHIRTS (U.S. CLS. 22 AND 39).

MARK SPARACINO, EXAMINING ATTORNEY

SN 77-726,490. RIGGAN, TRIXY, SACRAMENTO, CA. FILED 4-30-2009.

fabulously BUTCH

THE MARK CONSISTS OF STANDARD CHARACTERS WITHOUT CLAIM TO ANY PARTICULAR FONT, STYLE, SIZE, OR COLOR.

FOR HATS; JACKETS; SHIRTS; SWEAT SHIRTS; UNDERWEAR (U.S. CLS. 22 AND 39).

INGA ERVIN, EXAMINING ATTORNEY

CLASS 25—(Continued).

SN 77-726,585. FAUSTINI, RICHARD, MONTVALE, NJ. FILED 4-30-2009.

Make It Happen...Failure Is Not An Option

THE MARK CONSISTS OF STANDARD CHARACTERS WITHOUT CLAIM TO ANY PARTICULAR FONT, STYLE, SIZE, OR COLOR.

FOR HATS; PANTS; PULLOVERS; SHIRTS; SWEAT PANTS; SWEAT SHIRTS; TURTLENECKS (U.S. CLS. 22 AND 39).

RENEE SERVANCE, EXAMINING ATTORNEY

SN 77-726,587. S & M BIKES, INC., SANTA ANA, CA. FILED 4-30-2009.

FIT BIKE CO.

THE MARK CONSISTS OF STANDARD CHARACTERS WITHOUT CLAIM TO ANY PARTICULAR FONT, STYLE, SIZE, OR COLOR.

OWNER OF U.S. REG. NO. 3,311,711.

NO CLAIM IS MADE TO THE EXCLUSIVE RIGHT TO USE "BIKE CO.", APART FROM THE MARK AS SHOWN.

FOR CLOTHING, NAMELY, T-SHIRTS, SHORT SLEEVED T-SHIRTS, LONG SLEEVED T-SHIRTS, JERSEYS, SWEATSHIRTS, HOODED SWEATSHIRTS, JACKETS, SHOES, APRONS, HATS (U.S. CLS. 22 AND 39).

FIRST USE 10-1-2000; IN COMMERCE 10-1-2000.

VIVIAN MICZNIK FIRST, EXAMINING ATTORNEY

SN 77-726,947. ANDERSON, CHRISTINE D., CAMERON, MT. FILED 5-1-2009.

Civilutionary

THE MARK CONSISTS OF STANDARD CHARACTERS WITHOUT CLAIM TO ANY PARTICULAR FONT, STYLE, SIZE, OR COLOR.

FOR CAPS; HATS; JACKETS; SHIRTS; SWEAT SHIRTS; T-SHIRTS (U.S. CLS. 22 AND 39).

THOMAS MANOR, EXAMINING ATTORNEY

CLASS 25—(Continued).

SN 77-726,988. WRIGHT, BRUCE DAVID, SARASOTA, FL. FILED 5-1-2009.

BIO line

THE MARK CONSISTS OF STANDARD CHARACTERS WITHOUT CLAIM TO ANY PARTICULAR FONT, STYLE, SIZE, OR COLOR.

NO CLAIM IS MADE TO THE EXCLUSIVE RIGHT TO USE "LINE", APART FROM THE MARK AS SHOWN.

FOR ATHLETIC APPAREL, NAMELY, SHIRTS, PANTS, JACKETS, FOOTWEAR, HATS AND CAPS, ATHLETIC UNIFORMS; SPORTS PANTS; SPORTS SHIRTS; SPORTS SHIRTS WITH SHORT SLEEVES; SWEAT PANTS; SWEAT SHIRTS; SWEAT SUITS; T-SHIRTS; WARM UP SUITS (U.S. CLS. 22 AND 39).

ALEXANDER L. POWERS, EXAMINING ATTORNEY

CLASS 25—(Continued).

SN 77-727,104. FOREVER FIGHTER, LLC, AKA FOREVER FIGHTER, CHANDLER, AZ. FILED 5-1-2009.

The Fight Never Ends

THE MARK CONSISTS OF STANDARD CHARACTERS WITHOUT CLAIM TO ANY PARTICULAR FONT, STYLE, SIZE, OR COLOR.

FOR ATHLETIC APPAREL, NAMELY, SHIRTS, PANTS, JACKETS, FOOTWEAR, HATS AND CAPS, ATHLETIC UNIFORMS; BALLOON PANTS; BERMUDA SHORTS; BOARD SHORTS; BODY SHIRTS; BOXER SHORTS; BRIEFS; BUTTON-FRONT ALOHA SHIRTS; CAMP SHIRTS; CAPRI PANTS; CARGO PANTS; CLOTHING FOR ATHLETIC USE, NAMELY, PADDED PANTS; CLOTHING FOR ATHLETIC USE, NAMELY, PADDED SHIRTS; CLOTHING FOR ATHLETIC USE, NAMELY, PADDED SHORTS; DENIMS; DRESS SHIRTS; FLEECE SHORTS; GOLF PANTS, SHIRTS AND SKIRTS; GOLF SHIRTS; GYM PANTS; GYM SHORTS; HAT BANDS; HATS; HEADGEAR, NAMELY, HATS, CAPS, BEANIES, BANDANAS; HOODED SWEAT SHIRTS; JOGGING PANTS; KNIT SHIRTS; LADIES' UNDERWEAR; LEATHER PANTS; LONG UNDERWEAR; LONG-SLEEVED SHIRTS; LOUNGE PANTS; MEN'S UNDERWEAR; MOISTURE-WICKING SPORTS PANTS; MOISTURE-WICKING SPORTS SHIRTS; NIGHT SHIRTS; NON-DISPOSABLE CLOTH TRAINING PANTS; NURSE PANTS; OPEN-NECKED SHIRTS; OVER SHIRTS; PANTIES, SHORTS AND BRIEFS; PANTS; PERSPIRATION ABSORBENT UNDERWEAR CLOTHING; PETTI-PANTS; PIQUE SHIRTS; POLO SHIRTS; RUGBY SHORTS; SCIENTIFIC AND TECHNOLOGICAL APPAREL, NAMELY, SHIRTS, PANTS, JACKETS, FOOTWEAR, HATS AND CAPS, UNIFORMS; SHORT OVERCOAT FOR KIMONO (HAORD); SHORT PETTICOATS; SHORT SETS; SHORT TROUSERS; SHORT-SLEEVED OR LONG-SLEEVED T-SHIRTS; SHORT-SLEEVED SHIRTS; T-SHIRTS; THERMAL UNDERWEAR; THONGS; UNDERWEAR; UNDERWEAR, NAMELY, BOY SHORTS; WOMEN'S UNDERWEAR; WOVEN OR KNITTED UNDERWEAR (U.S. CLS. 22 AND 39).

COURTNEY MCCORMICK, EXAMINING ATTORNEY

SN 77-727,081. GENIUS HAPPENS, LLC, WAUKEE, IA. FILED 5-1-2009.

GENIUS HAPPENS

THE MARK CONSISTS OF STANDARD CHARACTERS WITHOUT CLAIM TO ANY PARTICULAR FONT, STYLE, SIZE, OR COLOR.

FOR CAPS; INFANT AND TODDLER ONE PIECE CLOTHING; WEARABLE GARMENTS AND CLOTHING, NAMELY, SHIRTS (U.S. CLS. 22 AND 39).

JOHN WILKE, EXAMINING ATTORNEY

SN 77-727,097. A & H SPORTSWEAR CO. INC., STOCKERTOWN, PA. FILED 5-1-2009.

MIGHTY BRA

THE MARK CONSISTS OF STANDARD CHARACTERS WITHOUT CLAIM TO ANY PARTICULAR FONT, STYLE, SIZE, OR COLOR.

NO CLAIM IS MADE TO THE EXCLUSIVE RIGHT TO USE "BRA", APART FROM THE MARK AS SHOWN.

FOR BRAS; SWIMWEAR (U.S. CLS. 22 AND 39).

PAM WILLIS, EXAMINING ATTORNEY

SN 77-727,319. HUGH HEWITT, IRVINE, CA. FILED 5-1-2009.

OIIIOHH

THE MARK CONSISTS OF STANDARD CHARACTERS WITHOUT CLAIM TO ANY PARTICULAR FONT, STYLE, SIZE, OR COLOR.

FOR T-SHIRTS (U.S. CLS. 22 AND 39).

JOHN DWYER, EXAMINING ATTORNEY

CLASS 25—(Continued).

SN 77-727,356. BRANDT, KIMBERLY W, GODFREY, IL.
FILED 5-1-2009.

FUSS BOTTOM BLUES

THE MARK CONSISTS OF STANDARD CHARACTERS WITHOUT CLAIM TO ANY PARTICULAR FONT, STYLE, SIZE, OR COLOR.

FOR CHILDREN'S AND INFANT'S APPAREL, NAMELY, JUMPERS, OVERALL SLEEPWEAR, PAJAMAS, ROMPERS AND ONE-PIECE GARMENTS; CHILDREN'S AND INFANTS' CLOTH BIBS; INFANT AND TODDLER ONE PIECE CLOTHING (U.S. CLS. 22 AND 39).

KATINA MISTER, EXAMINING ATTORNEY

SN 77-727,423. JEE WON KIM, LOS ANGELES, CA. FILED
S.R. 5-1-2009; AM. P.R. 7-27-2009.

NOBILITY

THE MARK CONSISTS OF STANDARD CHARACTERS WITHOUT CLAIM TO ANY PARTICULAR FONT, STYLE, SIZE, OR COLOR.

FOR A-SHIRTS; ATHLETIC APPAREL, NAMELY, SHIRTS, PANTS, JACKETS, FOOTWEAR, HATS AND CAPS, ATHLETIC UNIFORMS; BODY SHIRTS; BUTTON-FRONT ALOHA SHIRTS; CAMP SHIRTS; CLOTHING FOR ATHLETIC USE, NAMELY, PADDED SHIRTS; DRESS SHIRTS; GOLF PANTS, SHIRTS AND SKIRTS; GOLF SHIRTS; HOODED SWEAT SHIRTS; KNIT SHIRTS; LONG-SLEEVED SHIRTS (U.S. CLS. 22 AND 39).

FIRST USE 5-1-2008; IN COMMERCE 5-1-2008.
JULIE WATSON, EXAMINING ATTORNEY

SN 77-727,486. DORCAS SHOES E.U, BOGOTÁ, COLOMBIA,
FILED 5-1-2009.



THE MARK CONSISTS OF THE WORD "COPPI" IN STYLIZED LETTERING NEXT TO A FOOT DESIGN. THE LETTERS "OPPI" ARE UNDERLINED.

THE WORDING "COPPI" HAS NO MEANING IN A FOREIGN LANGUAGE.

FOR FOOTWEAR (U.S. CLS. 22 AND 39).
FIRST USE 12-14-2007; IN COMMERCE 11-8-2008.
JULIE GUTTADAURO, EXAMINING ATTORNEY

CLASS 25—(Continued).

SN 77-727,780. GARABEDIAN, OHANES, NEW YORK, NY.
FILED 5-3-2009.

SIMPA

THE MARK CONSISTS OF STANDARD CHARACTERS WITHOUT CLAIM TO ANY PARTICULAR FONT, STYLE, SIZE, OR COLOR.

FOR ANKLE SOCKS; ASCOTS; ATHLETIC APPAREL, NAMELY, SHIRTS, PANTS, JACKETS, FOOTWEAR, HATS AND CAPS, ATHLETIC UNIFORMS; ATHLETIC SHOES; BATHING SUITS; BATHING SUITS FOR MEN; BELTS; BELTS FOR CLOTHING; BELTS MADE OF LEATHER; BELTS OF TEXTILE; BERMUDA SHORTS; BOARD SHORTS; BOW TIES; BOXER SHORTS; BRIEFS; CAPRI PANTS; CARGO PANTS; COATS; COATS FOR MEN AND WOMEN; COATS MADE OF COTTON; COATS OF DENIM; CROP TOPS; DENIMS; DRESS SHIRTS; DRESS SUITS; FABRIC BELTS; GLOVES; GLOVES INCLUDING THOSE MADE OF SKIN, HIDE OR FUR; GYM PANTS; GYM SHORTS; GYM SUITS; HALTER TOPS; HATS; HEADGEAR, NAMELY, HATS; HEAVY COATS; JACKETS; JACKETS AND SOCKS; JOGGING PANTS; JOGGING SUITS; KNIT SHIRTS; KNITTED GLOVES; KNITTED UNDERWEAR; LEATHER BELTS; LEATHER PANTS; LEATHER SHOES; LEISURE SHOES; LEISURE SUITS; LONG JACKETS; LONG SLEEVED VESTS; LONG UNDERWEAR; LONG-SLEEVED SHIRTS; LOUNGE PANTS; MEN'S AND WOMEN'S JACKETS, COATS, TROUSERS, VESTS; MEN'S SOCKS; MEN'S SUITS; MEN'S SUITS, WOMEN'S SUITS; MEN'S UNDERWEAR; MORNING COATS; MUSCLE TOPS; NIGHT SHIRTS; OPEN-NECKED SHIRTS; OUTER JACKETS; OVER COATS; OVER SHIRTS; PADDED JACKETS; PAJAMA BOTTOMS; PAJAMAS; PANTIES, SHORTS AND BRIEFS; PANTS; PETTI-PANTS; PIQUE SHIRTS; POLO SHIRTS; QUILTED VESTS; RAIN COATS; RAIN HATS; RAIN JACKETS; SCARVES; SCIENTIFIC AND TECHNOLOGICAL APPAREL, NAMELY, SHIRTS, PANTS, JACKETS, FOOTWEAR, HATS AND CAPS, UNIFORMS; SHIRTS; SHIRTS FOR SUITS; SHOES; SHORT SETS; SHORT TROUSERS; SHORT-SLEEVED OR LONG-SLEEVED T-SHIRTS; SHORT-SLEEVED SHIRTS; SHORTS; SILK SCARVES; SLEEP SHIRTS; SLEEVED OR SLEEVELESS JACKETS; SMALL HATS; SMOKING JACKETS; SOCKS; SOCKS AND STOCKINGS; SPORT COATS; SPORT SHIRTS; SPORTS JACKETS; SPORTS SHIRTS; SPORTS SHIRTS WITH SHORT SLEEVES; STRETCH PANTS; SUEDE JACKETS; SUIT COATS; SUITS; SWEAT JACKETS; SWEAT PANTS; SWEAT SHIRTS; SWEAT SHORTS; T-SHIRTS; TANK TOPS; TANK-TOPS; TAP PANTS; TEE SHIRTS; THERMAL SOCKS; THERMAL UNDERWEAR; THONGS; TIES; TOP COATS; TOPS; TRACK JACKETS; TRACK PANTS; TRAVEL CLOTHING CONTAINED IN A PACKAGE COMPRISING REVERSIBLE JACKETS, PANTS, SKIRTS, TOPS AND A BELT OR SCARF; TRENCH COATS; TURTLE NECK SHIRTS; UNDERWEAR; UNDERWEAR, NAMELY, BOY SHORTS; VESTED SUITS; VESTS; WAIST BELTS; WALKING SHORTS; WATERPROOF JACKETS AND PANTS; WEARABLE GARMENTS AND CLOTHING, NAMELY, SHIRTS; WIND RESISTANT JACKETS; WOOLLEN SOCKS; YOGA PANTS; YOGA SHIRTS (U.S. CLS. 22 AND 39).

SAMUEL E. SHARPER JR., EXAMINING ATTORNEY

CLASS 25—(Continued).

SN 77-727,804. LOCO LEISURE, INC., TARZANA, CA. FILED 5-3-2009.



THE COLOR(S) BLACK, WHITE, AND LIGHT GREEN IS/ ARE CLAIMED AS A FEATURE OF THE MARK.
 THE MARK CONSISTS OF THE STYLIZED WORDS "LOCO LINDO" IN BLACK, APPEARING IN A BLACK RECTANGULAR BOX, WHICH HAS FOUR VERTICAL STRIPES. THE FAR LEFT VERTICAL STRIPE IS LIGHT GREEN, THE SECOND STRIPE IS WHITE, THE THIRD STRIPE IS LIGHT GREEN AND THE FAR RIGHT STRIPE IS WHITE.
 THE ENGLISH TRANSLATION OF "LOCO LINDO" IN THE MARK IS "CRAZY BEAUTIFUL."
 FOR BLOUSES; DRESSES; JACKETS; PAJAMAS; PANTS; SCARVES; SHAWLS; SHIRTS; SHORTS; SKIRTS; SWEATERS; T-SHIRTS; VESTS; WRAPS (U.S. CLS. 22 AND 39).
 FIRST USE 9-1-1992; IN COMMERCE 9-1-1992.
 KATHERINE CONNOLLY, EXAMINING ATTORNEY

SN 77-727,890. ASHLEY MASSARO INC, CARY, NC. FILED 5-3-2009.

CAPITAL COUTURE

THE MARK CONSISTS OF STANDARD CHARACTERS WITHOUT CLAIM TO ANY PARTICULAR FONT, STYLE, SIZE, OR COLOR.
 NO CLAIM IS MADE TO THE EXCLUSIVE RIGHT TO USE "COUTURE". APART FROM THE MARK AS SHOWN.
 FOR BOTTOMS; DRESSES; JACKETS; JEANS; LINGERIE; SHIRTS; TOPS (U.S. CLS. 22 AND 39).
 TRACY WHITTAKER-BROWN, EXAMINING ATTORNEY

CLASS 25—(Continued).

SN 77-728,073. COLUMBUS BASEBALL TEAM, INC., COLUMBUS, OH. FILED 5-4-2009.



THE MARK CONSISTS OF STYLIZED "C" IN FRONT OF AN ANCHOR.
 FOR CLOTHING, NAMELY, APRONS, ATHLETIC UNIFORMS, BANDANAS, BOXER SHORTS, CAPS, CLOTH BABY BIBS, COATS, GOLF SHIRTS, GYM SHORTS, HATS, JACKETS, JERSEYS, JOGGING SUITS, KNIT SHIRTS, PAJAMAS, POLO SHIRTS, PONCHOS, PULLOVERS, RAIN COATS, RAINWEAR, SWEATERS, SWEAT PANTS, SWEAT SHIRTS, SWEAT SUITS, SOCKS, SPORT SHIRTS, T- SHIRTS, TANK TOPS, TIES, VISORS, WIND RESISTANT JACKETS AND WRISTBANDS (U.S. CLS. 22 AND 39).
 FIRST USE 12-15-2008; IN COMMERCE 12-15-2008.
 TASNEEM HUSSAIN, EXAMINING ATTORNEY

SN 77-728,208. NEW JERSEY BASKETBALL, LLC, EAST RUTHERFORD, NJ. FILED 5-4-2009.

BROOKLYN NETS

THE MARK CONSISTS OF STANDARD CHARACTERS WITHOUT CLAIM TO ANY PARTICULAR FONT, STYLE, SIZE, OR COLOR.
 NO CLAIM IS MADE TO THE EXCLUSIVE RIGHT TO USE "BROOKLYN", APART FROM THE MARK AS SHOWN.
 FOR CLOTHING, NAMELY, HOSIERY, FOOTWEAR, BASKETBALL SHOES, BASKETBALL SNEAKERS, T-SHIRTS, SHIRTS, POLO SHIRTS, SWEATSHIRTS, SWEATPANTS, PANTS, TANK TOPS, JERSEYS, SHORTS, PAJAMAS, SPORT SHIRTS, RUGBY SHIRTS, SWEATERS, BELTS, TIES, NIGHTSHIRTS, HATS, CAPS, VISORS, WARM-UP SUITS, WARM-UP PANTS, WARM-UP TOPS, SHOOTING SHIRTS, JACKETS, WIND RESISTANT JACKETS, PARKAS, COATS, BABY BIBS NOT OF PAPER, HEAD BANDS, WRIST BANDS, APRONS, UNDERGARMENTS, BOXER SHORTS, SLACKS, EAR MUFFS, GLOVES, MITTENS, SCARVES, WOVEN AND KNIT SHIRTS, JERSEY DRESSES, DRESSES, CHEER-LEADING DRESSES AND UNIFORMS, SWIM WEAR, BATHING SUITS, SWIMSUITS, BIKINIS, TANKINIS, SWIM TRUNKS, BATHING TRUNKS, BOARD SHORTS, WET SUITS, BEACH COVER-UPS, BATHING SUIT COVER-UPS, BATHING SUIT WRAPS, SANDALS, BEACH SANDALS, BEACH HATS, SUN VISORS, SWIM CAPS, BATHING CAPS, NOVELTY HEADWEAR WITH ATTACHED WIGS (U.S. CLS. 22 AND 39).
 TRACY WHITTAKER-BROWN, EXAMINING ATTORNEY

CLASS 25—(Continued).

SN 77-728,285. SEALING WAX CLOTHING COMPANY, SAN DIEGO, CA. FILED 5-4-2009.

SEALING WAX

THE MARK CONSISTS OF STANDARD CHARACTERS WITHOUT CLAIM TO ANY PARTICULAR FONT, STYLE, SIZE, OR COLOR.

FOR APRONS; ASCOTS; BABUSHKAS; BANDANAS; BANDEAUX; BATHING CAPS; BATHING SUITS; BATH-ROBES; BEACH COVER-UPS; BEACHWEAR; BEANIES; BELTS; BERETS; BIB OVERALLS; BIB SHORTS; BIKINIS; BLAZERS; BLOUSES; BOAS; BODICES; BOLEROS; BOLO TIES; BOMBER JACKETS; BONNETS; BOOTS; BOTTOMS; BOW TIES; BOXER BRIEFS; BOXER SHORTS; BRASSIERES; CAFTANS; CAPELETS; CAPES; CAPRIS; CARDIGANS; CARGO PANTS; CHAPS; CHEMISES; CHEMISSETTES; CLOAKS; CLOTHING, NAMELY, FOLK COSTUMES; COATS; COLLARS; COVERALLS; COVERUPS; CUMMERBUNDS; DRESS SHIRTS; DRESSES; DRESSING GOWNS; DUNGAREES; DUSTERS; EAR MUFFS; EAR WARMERS; EARBANDS; EVENING DRESSES; EVENING GOWNS; EYESHADES; FICHUS; FOOTIES; FOOTWEAR; FOUL WEATHER GEAR; FOULARDS; FROCKS; FULL-LENGTH KIMONOS (NAGAGI); GABERDINES; GAITERS; GAUCHOS; GILETS; GIRDLES; GLOVES; HALLOWEEN COSTUMES; HALTER TOPS; HAT BANDS; HATS; HEAD SCARVES; HEAD WEAR; HEAVY JACKETS; HOODED PULL-OVERS; HOODED SWEAT SHIRTS; HOODS; HOUSE-COATS; JACKETS; JEANS; JERKINS; JERSEYS; JODHPURS; JUMPERS; JUMPSUITS; KAFTANS; KENDO OUTFITS; KERCHIEFS; KILTS; KIMONOS; KNEE HIGHS; KNICKERS; KNIT SHIRTS; LAB COATS; LADIES' SUITS; LEG WARMERS; LEGGINGS; LINGERIE; LONG SLEEVED VESTS; LONG UNDERWEAR; MANTILLAS; MASQUERADE COSTUMES; MASQUERADE COSTUMES AND MASKS SOLD IN CONNECTION THEREWITH; MINISKIRTS; MITTENS; MIXED MARTIAL ARTS SUITS; MOCCASINS; MOCK TURTLE-NECK SWEATERS; MUFFLERS; MUFFS; MUKLUKS; NECK BANDS; NECKWEAR; NEGLIGÉES; NIGHT GOWNS; NIGHT SHIRTS; NIGHTCAPS; NIGHTDRESSES; NIGHTIES; OVER SHIRTS; OVERALLS; OVERCOATS; PAJAMAS; PANTALOONS; PANTIES; PANTS; PANTSUITS; PAREOS; PEDAL PUSHERS; PEIGNOIRS; PELERINES; PELISSES; PETTI-PANTS; PETTICOATS; PINAFORES; POCKET KERCHIEFS; POLO SHIRTS; PONCHOS; PULLOVERS; PUMPS; PUTTEES AND GAITERS; RAINWEAR; RASH GUARDS; REMOVABLE COLLARS; REVERSIBLE JACKETS; ROBES; ROMPERS; RUBBERS; RUNNING SHOES; SABOTS; SARIS; SARONGS; SASH BANDS FOR KIMONO (OBI); SASHES; SCARFS; SCARVES; SCHOOL UNIFORMS; SERAPES; SHAWLS; SHIFTS; SHIRTS; SHOES; SHORT-SLEEVED OR LONG-SLEEVED T-SHIRTS; SHORTALLS; SHORTS; SHOULDER SCARVES; SHOULDER WRAPS; SHOWER CAPS; SHRUGS; SINGLETS; SKATING OUTFITS; SKI WEAR; SKIRT SUITS; SKIRTS; SKORTS; SLACKS; SLEEP MASKS; SLEEPWEAR; SLIPOVERS; SLIPPERS; SLIPS; SMOCKS; SOCKS; STOCKINGS; STOLEES; STRETCH PANTS; SUITS; SUN VISORS; SUNDRESSES; SUNSUITS; SURF WEAR; SUSPENDERS; SWEAT-BANDS; SWEATERS; SWIMSUITS; TAILLEURS; TANK TOPS; TANK-TOPS; TANKINIS; TEE SHIRTS; TENNIS DRESSES; TENNIS WEAR; THERMAL UNDERWEAR; TIES; TIGHTS; TOGAS; TOPS; TRACK SUITS; TROUSERS; TRUNKS; TUBE TOPS; TUNICS; UNDERGARMENTS; VESTS; VISORS; WOMEN'S CEREMONIAL DRESSES; WRAPS; WRIST BANDS; ZOOT SUITS; ZORI (U.S. CLS. 22 AND 39).

ELLEN B. AWRICH, EXAMINING ATTORNEY

CLASS 25—(Continued).

SN 77-728,354. ONE DAY CLOSER, LLC, CHARLESTOWN, MA. FILED 5-4-2009.

One Day Closer

THE MARK CONSISTS OF STANDARD CHARACTERS WITHOUT CLAIM TO ANY PARTICULAR FONT, STYLE, SIZE, OR COLOR.

FOR SHIRTS, PANTS, AND SHOES (U.S. CLS. 22 AND 39).

MARK SPARACINO, EXAMINING ATTORNEY

SN 77-728,393. REAL AMERICAN BRANDS, INC., RANCHO MIRAGE, CA. FILED 5-4-2009.

GREENBLUES

THE MARK CONSISTS OF STANDARD CHARACTERS WITHOUT CLAIM TO ANY PARTICULAR FONT, STYLE, SIZE, OR COLOR.

FOR COATS OF DENIM; DENIM JACKETS; DENIMS; DRESS SHIRTS; JEANS; KNIT SHIRTS; LONG-SLEEVED SHIRTS; PANTS (U.S. CLS. 22 AND 39).

PATRICIA EVANKO, EXAMINING ATTORNEY

SN 77-728,444. DAMEWOOD, GLEN E., SILVERTON, OR. FILED 5-4-2009.

Rong

THE MARK CONSISTS OF STANDARD CHARACTERS WITHOUT CLAIM TO ANY PARTICULAR FONT, STYLE, SIZE, OR COLOR.

FOR HATS; PANTS; SWEAT SHIRTS; T-SHIRTS; TANK TOPS (U.S. CLS. 22 AND 39).

FIRST USE 7-8-2008; IN COMMERCE 7-8-2008.
CHRISTOPHER BUONGIORNO, EXAMINING ATTORNEY

CLASS 25—(Continued).

SN 77-728,481. PANTAZES, JOANNA, BEVERLY HILLS, CA. FILED 5-4-2009.

GET YOUR TEE ON

THE MARK CONSISTS OF STANDARD CHARACTERS WITHOUT CLAIM TO ANY PARTICULAR FONT, STYLE, SIZE, OR COLOR.

FOR CLOTHING, NAMELY, T-SHIRTS, CAMP SHIRTS, DRESS SHIRTS, GOLF SHIRTS, HOODS, KNIT SHIRTS, NIGHT SHIRTS, OPEN-NECKED SHIRTS, PIQUET SHIRTS, POLO SHIRTS, SHORT-SLEEVED OR LONG-SLEEVED T-SHIRTS, PRINTED T-SHIRTS, SHORT-SLEEVED SHIRTS, SLEEP SHIRTS, SPORT SHIRTS, SWEATSHIRTS, HOODED SWEATSHIRTS, SHIRTS, WIND SHIRTS, AND HOODED T-SHIRTS (U.S. CLS. 22 AND 39).

COURTNEY MCCORMICK, EXAMINING ATTORNEY

SN 77-728,509. CHERI COTTRELL LLC, CAPE ELIZABETH, ME. FILED 5-4-2009.

HAMMY AND PAMMY

THE MARK CONSISTS OF STANDARD CHARACTERS WITHOUT CLAIM TO ANY PARTICULAR FONT, STYLE, SIZE, OR COLOR.

FOR CLOTHING, NAMELY, TOPS, BOTTOMS, HEADWEAR AND FOOTWEAR (U.S. CLS. 22 AND 39).

TASNEEM HUSSAIN, EXAMINING ATTORNEY

SN 77-728,534. SERVATDJOO, AMIR ALI, LAKE BALBOA, CA. FILED 5-4-2009.

ACT RIGHT

THE MARK CONSISTS OF STANDARD CHARACTERS WITHOUT CLAIM TO ANY PARTICULAR FONT, STYLE, SIZE, OR COLOR.

FOR BELTS; HATS; JACKETS; PANTS; SHIRTS; SHOES; VISORS (U.S. CLS. 22 AND 39).

FIRST USE 1-1-2002; IN COMMERCE 10-23-2003. PATRICIA EVANKO, EXAMINING ATTORNEY

CLASS 25—(Continued).

SN 77-728,612. CALLAWAY GOLF COMPANY, CARLSBAD, CA. FILED 5-4-2009.

Chev Xtreme

THE MARK CONSISTS OF STANDARD CHARACTERS WITHOUT CLAIM TO ANY PARTICULAR FONT, STYLE, SIZE, OR COLOR.

OWNER OF U.S. REG. NO. 3,166,581.

NO CLAIM IS MADE TO THE EXCLUSIVE RIGHT TO USE "EXTREME", APART FROM THE MARK AS SHOWN. FOR GOLF CAPS (U.S. CLS. 22 AND 39).

HEATHER SAPP, EXAMINING ATTORNEY

SN 77-728,619. TAYLOR, ARTHUR R., REDONDO BEACH, CA. FILED 5-4-2009.

BASS WARRIOR

THE MARK CONSISTS OF STANDARD CHARACTERS WITHOUT CLAIM TO ANY PARTICULAR FONT, STYLE, SIZE, OR COLOR.

FOR A-SHIRTS; ADULT NOVELTY GAG CLOTHING ITEM, NAMELY, SOCKS; ATHLETIC APPAREL, NAMELY, SHIRTS, PANTS, JACKETS, FOOTWEAR, HATS AND CAPS, ATHLETIC UNIFORMS; BABY LAYETTES FOR CLOTHING; BELTS; BELTS FOR CLOTHING; BIBS NOT OF CLOTH OR PAPER; BODY SHIRTS; BUTTON-FRONT ALOHA SHIRTS; CAMP SHIRTS; CAPS; CHILDREN'S AND INFANTS' CLOTH BIBS; CHILDREN'S CLOTH EATING BIBS; CLOTH BIBS; CLOTH BIBS FOR ADULT DINERS; CLOTH BIBS FOR USE BY SENIOR CITIZENS OR PHYSICALLY- OR MENTALLY-CHALLENGED PERSONS; CLOTH DIAPERS; CLOTHING FOR ATHLETIC USE, NAMELY, PADDED ELBOW COMPRESSION SLEEVES; CLOTHING FOR ATHLETIC USE, NAMELY, PADDED PANTS; CLOTHING FOR ATHLETIC USE, NAMELY, PADDED SHIRTS; CLOTHING, NAMELY, BASE LAYERS; CLOTHING, NAMELY, KHAKIS; DRESS SHIRTS; EYE-SHADES; GOLF SHIRTS; HATS; HOODED SWEAT SHIRTS; INFANT AND TODDLER ONE PIECE CLOTHING; JERSEYS; KNIT SHIRTS; LONG-SLEEVED SHIRTS; MOISTURE-WICKING SPORTS SHIRTS; OPEN-NECKED SHIRTS; OVER SHIRTS; POLO SHIRTS; RAIN HATS; SCIENTIFIC AND TECHNOLOGICAL APPAREL, NAMELY, SHIRTS, PANTS, JACKETS, FOOTWEAR, HATS AND CAPS, UNIFORMS; SHIRTS; SHORT-SLEEVED OR LONG-SLEEVED T-SHIRTS; SHORT-SLEEVED SHIRTS; SMALL HATS; SPORT SHIRTS; SPORTS SHIRTS; SPORTS SHIRTS WITH SHORT SLEEVES; SWEAT SHIRTS; T-SHIRTS; TEE SHIRTS; TOPS; TURTLE NECK SHIRTS; WEARABLE GARMENTS AND CLOTHING, NAMELY, SHIRTS; WOOLLY HATS (U.S. CLS. 22 AND 39).

MIDGE BUTLER, EXAMINING ATTORNEY

CLASS 25—(Continued).

SN 77-728,651. THE NAT NAST COMPANY, SOUTH NORWALK, CT. FILED 5-4-2009.

NAT NAST SWING

THE MARK CONSISTS OF STANDARD CHARACTERS WITHOUT CLAIM TO ANY PARTICULAR FONT, STYLE, SIZE, OR COLOR.

OWNER OF U.S. REG. NOS. 2,502,974, 3,182,022 AND 3,276,000.

THE NAME(S), PORTRAIT(S), AND/OR SIGNATURE(S) SHOWN IN THE MARK DOES NOT IDENTIFY A PARTICULAR LIVING INDIVIDUAL.

FOR MEN'S, WOMEN'S, AND CHILDREN'S CLOTHING, NAMELY, CAPS, BELTS, BLAZERS, JACKETS, VESTS, WIND SHIRTS, GLOVES, HATS, PANTS, POLO SHIRTS, PULLOVERS, RAINWEAR, SHIRTS, SHORTS, SKIRTS, SWEATERS, T-SHIRTS AND SOCKS (U.S. CLS. 22 AND 39).

CORY BOONE, EXAMINING ATTORNEY

SN 77-728,777. KETOLA, MARTY, DBA K1 SPORTSWEAR CORP, CLOQUET, MN. FILED 5-4-2009.

HOCKEY ARMY

THE MARK CONSISTS OF STANDARD CHARACTERS WITHOUT CLAIM TO ANY PARTICULAR FONT, STYLE, SIZE, OR COLOR.

NO CLAIM IS MADE TO THE EXCLUSIVE RIGHT TO USE "HOCKEY", APART FROM THE MARK AS SHOWN.

FOR ATHLETIC APPAREL, NAMELY, SHIRTS, PANTS, JACKETS, FOOTWEAR, HATS AND CAPS, ATHLETIC UNIFORMS (U.S. CLS. 22 AND 39).

STEVEN R. FOSTER, EXAMINING ATTORNEY

SN 77-729,119. FILICE, MARIA DEL PILAR, PROSPECT HEIGHTS, IL. AND MALACSINA, TAMAS, PROSPECT HEIGHTS, IL. FILED 5-5-2009.

100K
One of a Kind

THE MARK CONSISTS OF THE LANGUAGE "100K ONE OF A KIND", WHERE "0'S IN THE TERM "100K" OVERLAP WITH EACH OTHER.

FOR BRAS; COATS; DRESSES; LINGERIE; PANTIES; PANTS; SHOES; SOCKS (U.S. CLS. 22 AND 39).

Laurie Mayes, Examining Attorney

CLASS 25—(Continued).

SN 77-732,011. EASY INDUSTRIES, LLC, DALLAS, TX. FILED 5-7-2009.

MISS OOPS SHOW STOPPERS

THE MARK CONSISTS OF STANDARD CHARACTERS WITHOUT CLAIM TO ANY PARTICULAR FONT, STYLE, SIZE, OR COLOR.

FOR NON-MEDICAL NIPPLE BREAST COVERS (U.S. CLS. 22 AND 39).

FIRST USE 7-21-2008; IN COMMERCE 7-22-2008.

HEATHER SAPP, EXAMINING ATTORNEY

SN 77-735,579. PORTAL PRODUCTIONS, LLC, BOULDER, CO. FILED 5-13-2009.

THE PORTAL

THE MARK CONSISTS OF STANDARD CHARACTERS WITHOUT CLAIM TO ANY PARTICULAR FONT, STYLE, SIZE, OR COLOR.

FOR CLOTHING, NAMELY, SHIRTS, T-SHIRTS, SWEATSHIRTS, BLOUSES, PANTS, SHORTS, DRESSES, HATS, CAPS, BASEBALL CAPS, STOCKING HATS, SCARVES, BANDANAS, JACKETS, AND RAIN JACKETS (U.S. CLS. 22 AND 39).

MARGERY A. TIERNEY, EXAMINING ATTORNEY

SN 77-743,847. WRIGHT, BRUCE DAVID, SARASOTA, FL. FILED 5-25-2009.

BIO Shirt

THE MARK CONSISTS OF STANDARD CHARACTERS WITHOUT CLAIM TO ANY PARTICULAR FONT, STYLE, SIZE, OR COLOR.

NO CLAIM IS MADE TO THE EXCLUSIVE RIGHT TO USE "SHIRT", APART FROM THE MARK AS SHOWN.

FOR GOLF SHIRTS; MOISTURE-WICKING SPORTS SHIRTS; POLO SHIRTS; SPORT SHIRTS; T-SHIRTS (U.S. CLS. 22 AND 39).

Alexander L. Powers, Examining Attorney

CLASS 25—(Continued).

SN 77-749,460. SKELETAL METAL, LLC, HENDERSON, NV. FILED 6-1-2009.

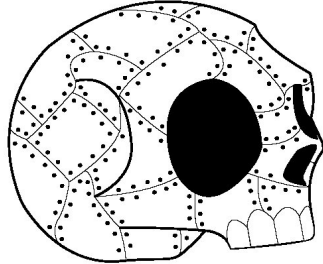

THE MARK CONSISTS OF A STYLIZED SKULL FORMED WITH A PLURALITY OF PLATES. FOR HATS; WEARABLE GARMENTS AND CLOTHING, NAMELY, SHIRTS (U.S. CLS. 22 AND 39). JENNY PARK, EXAMINING ATTORNEY

SN 77-758,748. THE 17/21 GROUP, LLC, VERNON, CA. FILED 6-12-2009.

**VIRTUAL
STRETCH**

NO CLAIM IS MADE TO THE EXCLUSIVE RIGHT TO USE "STRETCH", APART FROM THE MARK AS SHOWN. THE MARK CONSISTS OF THE TERMS "VIRTUAL STRETCH" IN STYLIZED FORM. FOR JEANS, SHORTS, SKIRTS, BOTTOMS (U.S. CLS. 22 AND 39). FIRST USE 12-1-2008; IN COMMERCE 12-1-2008. INGRID C. EULIN, EXAMINING ATTORNEY

SN 77-761,969. LUCKY BRAND DUNGAREES, INC., VERNON, CA. FILED 6-17-2009.

GOOD LUCK TEES

THE MARK CONSISTS OF STANDARD CHARACTERS WITHOUT CLAIM TO ANY PARTICULAR FONT, STYLE, SIZE, OR COLOR. NO CLAIM IS MADE TO THE EXCLUSIVE RIGHT TO USE "TEES", APART FROM THE MARK AS SHOWN. FOR T-SHIRTS (U.S. CLS. 22 AND 39). MICHAEL WEBSTER, EXAMINING ATTORNEY

CLASS 25—(Continued).

SN 77-763,688. PRESTON, METHENEY H., DBA IT'S EMOTION!, CHARLOTTE, NC. FILED 6-19-2009.

SHE'S AN EMOTION

THE MARK CONSISTS OF STANDARD CHARACTERS WITHOUT CLAIM TO ANY PARTICULAR FONT, STYLE, SIZE, OR COLOR. FOR T-SHIRTS (U.S. CLS. 22 AND 39). LAKEISHA LEWIS, EXAMINING ATTORNEY

SN 77-977,471. 17/21 GROUP, LLC, THE, VERNON, CA. FILED 2-9-2009.

Fragile
blue jeans

NO CLAIM IS MADE TO THE EXCLUSIVE RIGHT TO USE "BLUE JEANS", APART FROM THE MARK AS SHOWN. THE MARK CONSISTS OF THE WORDING "FRAGILE BLUE JEANS" WHERE THE TERM "FRAGILE" IS WRITTEN IN A STYLIZED FONT AND THE WORDING "BLUE JEANS" IS WRITTEN IN LOWER-CASE STANDARD CHARACTERS AND APPEARS UNDERNEATH THE TERM "FRAGILE". FOR JEANS, PANTS, SHORTS, SKIRTS, BOTTOMS AND TROUSERS (U.S. CLS. 22 AND 39). FIRST USE 3-0-2008; IN COMMERCE 3-0-2008. RICHARD WHITE, EXAMINING ATTORNEY

SN 78-191,331. COMSTOCK, ORION, SANTA MONICA, CA. FILED 12-4-2002.



FOR SHIRTS, PANTS AND HATS (U.S. CLS. 22 AND 39). FIRST USE 2-5-2001; IN COMMERCE 11-15-2002. MELVIN AXILBUND, EXAMINING ATTORNEY

CLASS 25—(Continued).

SN 78-268,123. LES BOXERS BOYZ INC., MONTREAL, QUEBEC, FILED 6-27-2003.

D2

FOR SKI APPAREL, NAMELY, SKI JACKETS, SKI PANTS, SKI SUITS, OUTERWEAR JACKETS, OUTERWEAR PANTS, OUTERWEAR SUITS, SNOWBOARD JACKETS, SNOWBOARD PANTS, SNOWBOARD SUITS, FLEECE JACKETS, FLEECE TOPS, SWEATERS, GLOVES, MITTS, HATS (U.S. CLS. 22 AND 39).
FIRST USE 11-0-2003; IN COMMERCE 11-0-2003.
BARBARA GAYNOR, EXAMINING ATTORNEY

SN 78-530,933. ANDRE PAUL JACKSON, CHATSWORTH, CA. FILED 12-11-2004.

DEUCEONE

THE MARK CONSISTS OF STANDARD CHARACTERS WITHOUT CLAIM TO ANY PARTICULAR FONT, STYLE, SIZE, OR COLOR.

FOR SHIRTS, PANTS, HEADWEAR, SHOES, SWEATERS, SOCKS, UNDER GARMENTS, AND JACKETS (U.S. CLS. 22 AND 39).
FIRST USE 1-1-2000; IN COMMERCE 7-22-2004.
DANIEL BRODY, EXAMINING ATTORNEY

SN 78-850,375. SHAPIRO, ROBERT, SAN FRANCISCO, CA. FILED 3-30-2006.

CALIFORNIA MISS

THE MARK CONSISTS OF STANDARD CHARACTERS WITHOUT CLAIM TO ANY PARTICULAR FONT, STYLE, SIZE, OR COLOR.

FOR CLOTHING, FOOTWEAR AND HEADWEAR, NAMELY, JACKETS, PANTS, SHORTS, HATS, CAPS, SWEATERS, SWEATPANTS, T-SHIRTS, LONG SLEEVE SHIRTS, TURTLE NECKS, SOCKS, UNDERWEAR, OVERALLS, DRESSES, SKIRTS, TANK TOPS, POLO SHIRTS, VESTS, WIND RESISTANT JACKETS, BELTS, SUN VISORS, PAJAMAS, SWIM SUITS, SWEATSHIRTS, SHOES AND SANDALS (U.S. CLS. 22 AND 39).
ASMAT KHAN, EXAMINING ATTORNEY

CLASS 25—(Continued).

SN 78-929,662. HAMMOCK DUNES CLUB, INC., PALM COAST, FL. FILED 7-14-2006.

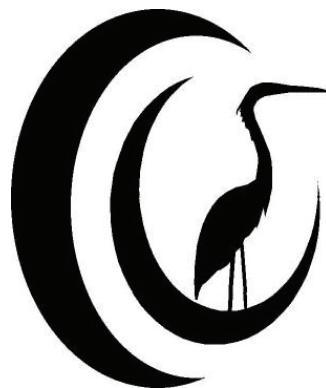

THE MARK CONSISTS OF A STYLIZED HERON INSIDE THE ARC OF A CRESCENT DESIGN WITH BOTH INSIDE THE ARC OF ANOTHER LARGER CRESCENT DESIGN TO THE LEFT.

FOR GOLF CLOTHING, NAMELY, SHIRTS, SWEATERS, VESTS, JACKETS, COATS, HATS AND VISORS (U.S. CLS. 22 AND 39).

FIRST USE 7-1-2002; IN COMMERCE 7-1-2002.
MATTHEW MCDOWELL, EXAMINING ATTORNEY

SN 78-929,746. HAMMOCK DUNES CLUB, INC., PALM COAST, FL. FILED 7-14-2006.



NO CLAIM IS MADE TO THE EXCLUSIVE RIGHT TO USE "CLUB", APART FROM THE MARK AS SHOWN.

THE MARK CONSISTS OF THE WORDING "HAMMOCK DUNES CLUB" UNDERNEATH DESIGN OF A STYLIZED HERON INSIDE THE ARC OF A CRESCENT DESIGN WITH BOTH INSIDE THE ARC OF ANOTHER LARGER CRESCENT DESIGN TO THE LEFT.

FOR GOLF CLOTHING, NAMELY, SHIRTS, SWEATERS, VESTS, JACKETS, COATS, HATS AND VISORS (U.S. CLS. 22 AND 39).

FIRST USE 6-15-2006; IN COMMERCE 6-15-2006.
MATTHEW MCDOWELL, EXAMINING ATTORNEY

CLASS 25—(Continued).

SN 78-949,517. MBL/TIGI PRODUCTS, LP, CARROLLTON, TX. FILED 8-10-2006.



FOR INFANT, CHILDREN AND ADULT CLOTHING, NAMELY, ANKLETS, ANORAKS, APRONS, ATHLETIC UNIFORMS, BABY BOOTIES, BABY BUNTING, BABY ROMPERS, BABY SLEEPERS, BANDANNAS, CLOTH BIBS, SWEAT BANDS, WRIST BANDS, BATHING SUITS, BATHING TRUNKS, BEACH COVER-UPS, BEACHWEAR, BELTS, BLAZERS, BLOUSES, BRASSIERES, BRIEFS, CHEERLEADER OUTFITS, CLOTH DIAPERS, COATS, LEATHER COATS, RAIN COATS, SPORT COATS, WAISTCOATS, JACKETS, LEATHER JACKETS, COVERALLS, FLEECE COVERALLS, INFANT COVERALLS, INFANT WEAR, DRESSES, DUNGAREES, EAR MUFFS, FOUL WEATHER GEAR, GLOVES, SHIRTS, GOLF SHIRTS, KNIT SHIRTS, NIGHT SHIRTS, POLO SHIRTS, RUGBY SHIRTS, SPORT SHIRTS, SWEATSHIRTS, T-SHIRTS, TOPS, HALTER TOPS, TANK TOPS, SHORTS, BOXER SHORTS, GYM SHORTS, SWEAT SHORTS, HOSIERY, JUMPERS, JUMPSUITS, LEG WARMERS, LINGERIE, LOUNGEWEAR, MITTENS, NEGLIGEEES, NECK BANDS, NECKERCHIEFS, NECKWEAR, NIGHT GOWNS, PAJAMAS, PANTS, BALLOON PANTS, PANTSUITS, SLACKS, SKI PANTS, SNOW PANTS, SWEAT PANTS, PANTIES, PARKAS, PONCHOS, RAINWEAR, ROBES, SCARVES, SHOWER CAPS, SKI WEAR, SKIRTS, SLEEPWEAR, SLIPS, SMOCKS, SOCKS, SWEAT SOCKS, THERMAL SOCKS, STOCKINGS, SUITS, BODY SUITS, GYM SUITS, JOGGING SUITS, FLEECE JOGGING SUITS, PLAY SUITS, SUN SUITS, SWEAT SUITS, TRACKSUITS, VESTED SUITS, WARM-UP SUITS, WIND SUITS, SUSPENDERS, SWEATERS, TURTLENECK SWEATERS, V-NECK SWEATERS, SWIM WEAR, SWIM TRUNKS, SWIMSUITS, TEDDIES, TENNIS WEAR, TIES, BOW TIES, NECK TIES, TIGHTS, TROUSERS, TURTLENECKS, TUXEDOS, UNDERPANTS, UNDERSHIRTS, UNDERWEAR, THERMAL UNDERWEAR, VEILS, VESTS, FISHING WADERS; FOOTWEAR, NAMELY, SHOES, CLOGS, GOLF SHOES, THONGS, SLIPPERS, SNEAKERS; HEADWEAR, NAMELY, BERETS, CAPS, BASEBALL CAPS, BATHING CAPS, HATS, HEAD BANDS, VISORS, SUN VISORS; COSTUMES, NAMELY, HALLOWEEN COSTUMES, MASQUERADE COSTUMES, SWIMMING COSTUMES; AND UNIFORMS (U.S. CLS. 22 AND 39).

ZHALEH DELANEY, EXAMINING ATTORNEY

CLASS 25—(Continued).

SN 79-061,243. RIEKER-SCHUH GMBH, FED REP GERMANY, FILED 10-11-2008.



OWNER OF INTERNATIONAL REGISTRATION 0349864 DATED 10-10-1968, EXPIRES 10-10-2018.
FOR SHOES (U.S. CLS. 22 AND 39).
SHARON MEIER, EXAMINING ATTORNEY

SN 79-061,518. MATTHEY CÉDRIC, SWITZERLAND, FILED 10-31-2008.

SOUL REFLECTION

THE MARK CONSISTS OF STANDARD CHARACTERS WITHOUT CLAIM TO ANY PARTICULAR FONT, STYLE, SIZE, OR COLOR.

PRIORITY DATE OF 9-9-2008 IS CLAIMED.

OWNER OF INTERNATIONAL REGISTRATION 0983565 DATED 10-31-2008, EXPIRES 10-31-2018.

FOR SPORTS CLOTHING FOR BASKETBALL, IN PARTICULAR TEE-SHIRTS, BASKETBALL TEE-SHIRTS, SLEEVELESS TEE-SHIRTS, LONG SLEEVED TEE-SHIRTS, SHORT SLEEVED TEE-SHIRTS, SWEAT SHIRTS, TRACKSUIT BOTTOMS, SLEEVELESS TEE-SHIRTS, JERSEYS, SHORTS, WARM-UP SUITS, WARM-UP BOTTOMS, WARM-UP TOPS, SPORTS TIGHTS, SPORTS HEAD BANDS, WRIST BANDS; BASKETBALL CAPS (U.S. CLS. 22 AND 39).

KRISTIN CARLSON, EXAMINING ATTORNEY

SN 79-062,952. BAKER STREET CLOTHING LIMITED, UNITED KINGDOM, FILED 10-17-2008.

STONE-DRI

THE MARK CONSISTS OF STANDARD CHARACTERS WITHOUT CLAIM TO ANY PARTICULAR FONT, STYLE, SIZE, OR COLOR.

OWNER OF INTERNATIONAL REGISTRATION 0987052 DATED 10-17-2008, EXPIRES 10-17-2018.

FOR CLOTHING, NAMELY, ARTICLES OF SPORTS CLOTHING, NAMELY, UNIFORMS; HEADGEAR, NAMELY, CAPS AND HATS; SCARVES; BEACHWEAR AND SWIMWEAR; BATHROBES; MEN'S UNDERWEAR; LADIES' UNDERWEAR; SOCKS; STOCKINGS; TIGHTS; RAINWEAR; SHIRTS; PANTS; SWEATERS; TOPS; BOTTOMS; JACKETS; COATS; JEANS; PAJAMAS; JUMPERS; PULLOVERS; TRACKSUITS (U.S. CLS. 22 AND 39).

KAREN BRACEY, EXAMINING ATTORNEY

CLASS 25—(Continued).

SN 79-063,125. MEN'S TAILORING & ALTERATIONS PTY LTD, SOUTH YARRA VIC 3141, AUSTRALIA, FILED 11-19-2008.

ARTHUR GALAN **AG**

PRIORITY DATE OF 5-19-2008 IS CLAIMED.
OWNER OF INTERNATIONAL REGISTRATION 0987574 DATED 11-19-2008, EXPIRES 11-19-2018.
FOR LEATHER CLOTHING, READY-MADE CLOTHING, KNIT CLOTHING, FOOTWEAR AND HEADGEAR, NAMELY, COATS, JACKETS, NECKTIES, OVERCOATS, PANTS, PULLOVERS, SCARVES, SHIRTS, SHOES, SKIRTS, SUITS, SWEATERS, TEE-SHIRTS, TIGHTS, TROUSERS AND VESTS (U.S. CLS. 22 AND 39).
SEAN CROWLEY, EXAMINING ATTORNEY

SN 79-063,278. CALZATURIFICIO SPERNANZONI VITTORIO E; FIGLI DI SPERNANZONI ENRICO & C. SNC, ITALY, FILED 10-31-2008.

IL GERGO

OWNER OF INTERNATIONAL REGISTRATION 0987949 DATED 10-31-2008, EXPIRES 10-31-2018.
THE ENGLISH TRANSLATION OF "IL GERGO" IN THE MARK IS THE JARGON.

FOR CLOTHING ITEMS, NAMELY, SWEATERS, CARDIGANS, SLIPS, SUITS, TROUSERS, SHORTS, JUMPERS, RAINCOATS, SUITS AND DRESSES MADE OF LEATHER, STOCKINGS AND SOCKS, GARTER BELTS, WIND-RESISTANT JACKETS, SKI-TROUSERS, FUR COATS, OVERCOATS, JACKETS, SKIRTS, DRESSES, UNDERSHIRTS, T-SHIRTS, SPORT T-SHIRTS, BLOUSES, SHIRT-COLLARS, SHIRTS, FOULARDS, BEACHWEAR, SWIMSUITS, BIKINI, TRACKSUITS, UNDERWEAR, BRAS, BRASSIERE, CORSETS, FOUNDATION SLIPS, BRIEFS AND BIKINI BRIEFS, VESTS, NIGHTGOWNS, NEGLIGEEES, PYJAMAS, GLOVES, SHAWLS, SCARVES, NECKTIES, BOW TIES, BELTS, SUSPENDERS, HATS AND CAPS, SHOES, BOOTS, LACED BOOTS, LEATHER SHOES, RUBBER SHOES, RAIN SHOES, SPORT SHOES, SANDALS, SLIPPERS, SHOE SOLES, SHOES HEELS, MOULDED SOLES FOR SHOES (U.S. CLS. 22 AND 39).
MICHAEL LITZAU, EXAMINING ATTORNEY

CLASS 25—(Continued).

SN 79-064,556. IDEALE AUSTRALIA PTY LTD, AUSTRALIA, FILED 12-12-2008.

Christina Rossi

PRIORITY DATE OF 10-22-2008 IS CLAIMED.
OWNER OF INTERNATIONAL REGISTRATION 0991270 DATED 12-12-2008, EXPIRES 12-12-2018.
THE NAME "CHRISTINA ROSSI" DOES NOT IDENTIFY A LIVING INDIVIDUAL.
FOR BRIDAL AND EVENING WEAR, NAMELY, WEDDING GOWNS, BRIDAL GOWNS, BRIDESMAID DRESSES, VEILS, EVENING GOWNS, WRAPS, DRESSES, PROM DRESSES, AND COCKTAIL DRESSES (U.S. CLS. 22 AND 39).
HEATHER SAPP, EXAMINING ATTORNEY

SN 79-069,468. LUO SHAOWEI, CHINA, FILED 4-1-2009.

VALLENSSIA

OWNER OF INTERNATIONAL REGISTRATION 0924933 DATED 3-5-2007, EXPIRES 3-5-2017.
FOR SHOES; BOOTS; SANDALS; SLIPPERS; SNEAKERS; FOOTBALL BOOTS; INSOLES; RAIN BOOTS; GALOSH; CLOTHING, NAMELY, SHIRTS, PANTS, COATS, DRESSES (U.S. CLS. 22 AND 39).
HEATHER SAPP, EXAMINING ATTORNEY

CLASS 26—FANCY GOODS

SN 77-419,699. TAYLOR, RACHEL, SEVERNA PARK, MD. FILED 3-12-2008.

Clever Doo

THE MARK CONSISTS OF THE WORDING "CLEVER DOO", IN STYLIZED FONT, WITH THE FIRST LETTER OF BOTH WORDS APPEARING IN UPPERCASE LETTERS AND OTHER LETTERS IN LOWERCASE.

FOR HAIR ACCESSORIES, NAMELY, HAIR CLIPS (U.S. CLS. 37, 39, 40, 42 AND 50).
WANDA KAY PRICE, EXAMINING ATTORNEY

CLASS 26—(Continued).

SN 77-450,086. MASCOTTE HOLDINGS, INC., NEW YORK, NY. FILED 4-16-2008.

KANYE WEST'S GLOW IN THE DARK

THE MARK CONSISTS OF STANDARD CHARACTERS WITHOUT CLAIM TO ANY PARTICULAR FONT, STYLE, SIZE, OR COLOR.

NO CLAIM IS MADE TO THE EXCLUSIVE RIGHT TO USE "GLOW IN THE DARK", APART FROM THE MARK AS SHOWN.

THE NAME(S), PORTRAIT(S), AND/OR SIGNATURE(S) SHOWN IN THE MARK IDENTIFIES A LIVING INDIVIDUAL, WHOSE CONSENT(S) TO REGISTER IS SUBMITTED.

FOR ORNAMENTAL NOVELTY BUTTONS, PRESS BUTTONS, RIVET BUTTONS, AND CAMPAIGN BUTTONS; ORNAMENTAL NOVELTY PINS; HAT PINS; HAT ORNAMENTS NOT OF PRECIOUS METAL; BELT BUCKLES; SHOE ORNAMENTS NOT OF PRECIOUS METAL; HAT PINS OF PRECIOUS METAL; HAT ORNAMENTS AND PINS NOT OF PRECIOUS METAL; ORNAMENTAL BOWS OF TEXTILE FOR DECORATION; SAFETY PINS; RIBBONS; ORNAMENTAL RIBBONS MADE OF TEXTILES; RIBBONS FOR WRAPPING AND GIFT WRAPPING; ELASTIC RIBBONS; SEWING BOXES; BUTTONS; EMBROIDERED PATCHES FOR CLOTHING; CLOTH PATCHES FOR CLOTHING; ORNAMENTAL CLOTH PATCHES; EMBROIDERED EMBLEMS; BELT BUCKLES NOT OF PRECIOUS METAL; CLOTHING BUCKLES; BELT CLASPS; ZIPPERS AND ZIPPER PULLS; SNAP FASTENERS; CLASPS FOR CLOTHING; COLLAR STAYS; HAIR ACCESSORIES, NAMELY, HAIR TIES, HAIR ORNAMENTS, HAIR PINS, BARRETTES, HAIR BANDS, HAIR RIBBONS, HAIR BOWS, PONYTAIL HOLDERS, HAIR BOWS WITH CLIPS, HAIR CLIPS, HAIR FASTENERS, HAIR PINS AND GRIPS, HAIR BUCKLES, CLAM CLIPS FOR HAIR, CLAW CLIPS, TWISTERS, HAIR SCRUNCHIES, SNAP CLIPS, ORNAMENTAL COMBS WORN ON HAIR; HAIR ROLLER CLIPS AND PINS, BOBBY PINS, CURLING PINS, NON-ELECTRIC HAIR CURLERS AND ROLLERS, BRAIDS, AND BRAIDING PINS (U.S. CLS. 37, 39, 40, 42 AND 50).
ELISSA GARBER KON, EXAMINING ATTORNEY

SN 77-563,864. WEIDNER, ERIKA, SAN FRANCISCO, CA. FILED 9-5-2008.

TAYLOR DENIM

NO CLAIM IS MADE TO THE EXCLUSIVE RIGHT TO USE "DENIM", APART FROM THE MARK AS SHOWN.

THE MARK CONSISTS OF THE STYLIZED TEXT "TAYLOR DENIM". THE "Y" HAS THE SHAPE OF A ZIPPER OPENING UP.

FOR CLOTHING ADHESIVE TAPE STRIPS USED WITH DENIM JEANS THAT TEMPORARILY ALTERS THE HEM OF THE GARMENT (U.S. CLS. 37, 39, 40, 42 AND 50).

PAULA MAHONEY, EXAMINING ATTORNEY

CLASS 26—(Continued).

SN 77-595,926. MICHAELS STORES PROCUREMENT COMPANY, INC., IRVING, TX. FILED 10-20-2008.

ARTMINDS

THE MARK CONSISTS OF STANDARD CHARACTERS WITHOUT CLAIM TO ANY PARTICULAR FONT, STYLE, SIZE, OR COLOR.

FOR PLASTIC LACING IN THE NATURE OF LACES FOR USE WITH ARTS AND CRAFTS PROJECTS FOR CONNECTING BEADS, FOR WEAVING, AND FOR KNOTTING, AND FOR MAKING KEY CHAINS, NECKLACES, BRACELETS, AND LANYARDS (U.S. CLS. 37, 39, 40, 42 AND 50).

PAUL CROWLEY, EXAMINING ATTORNEY

SN 77-608,787. DISNEY ENTERPRISES, INC., BURBANK, CA. FILED 11-6-2008.



THE NAME, PORTRAIT SHOWN IN THE MARK DOES NOT IDENTIFY A PARTICULAR LIVING INDIVIDUAL.

THE MARK CONSISTS OF A MALE FACIAL IMAGE.

FOR CLOTH ORNAMENTAL NOVELTY GOODS, NAMELY, ORNAMENTAL NOVELTY BUTTONS, ORNAMENTAL NOVELTY BADGES AND ORNAMENTAL NOVELTY PINS (U.S. CLS. 37, 39, 40, 42 AND 50).

RON FAIRBANKS, EXAMINING ATTORNEY

CLASS 26—(Continued).

SN 77-655,386. BLING STRANDS, DRAPER, UT. FILED 1-23-2009.



NO CLAIM IS MADE TO THE EXCLUSIVE RIGHT TO USE "STRANDS" AND "THE ULTIMATE HAIRSTYLE ACCESSORY", APART FROM THE MARK AS SHOWN.

THE COLOR(S) BLACK, WHITE, AND RED IS/ARE CLAIMED AS A FEATURE OF THE MARK.

THE MARK CONSISTS OF A BLACK AND WHITE DRAWING OF THE LEFT SIDE OF A WOMAN'S FACE AND HER BLACK HAIR, IN WHICH A PAIR OF RED ACCENT TINSEL STRANDS ARE VISIBLE, THE WORDS "BLING STRANDS THE ULTIMATE HAIRSTYLE ACCESSORY!" BEING PRINTED IN WHITE WITHIN A BLACK FIELD ABOVE THE WOMAN'S FACE THAT IS CONTINUOUS WITH HER BLACK HAIR.

FOR HAIR COLORING FOILS; HAIR ORNAMENTS; HAIR RIBBONS (U.S. CLS. 37, 39, 40, 42 AND 50).

FIRST USE 1-5-2009; IN COMMERCE 1-5-2009.

MEGHAN REINHART, EXAMINING ATTORNEY

SN 77-724,054. MY HANDY HOLD, LLC, DBA MY HANDY HOLD, CASTLE ROCK, CO. FILED 4-28-2009.

My Handy Hold

THE MARK CONSISTS OF STANDARD CHARACTERS WITHOUT CLAIM TO ANY PARTICULAR FONT, STYLE, SIZE, OR COLOR.

FOR LEASHES FOR GUIDING CHILDREN; REINS FOR GUIDING CHILDREN (U.S. CLS. 37, 39, 40, 42 AND 50).

FIRST USE 4-12-2009; IN COMMERCE 4-12-2009.

TEJBIR SINGH, EXAMINING ATTORNEY

CLASS 26—(Continued).

SN 77-724,441. DOWNES, KATHLEEN R., GAINESVILLE, VA. AND D'ARCANGELIS, SARAH E., BRISTOW, VA. FILED 4-28-2009.

Lilly Loops

THE MARK CONSISTS OF STANDARD CHARACTERS WITHOUT CLAIM TO ANY PARTICULAR FONT, STYLE, SIZE, OR COLOR.

NO CLAIM IS MADE TO THE EXCLUSIVE RIGHT TO USE "LOOPS", APART FROM THE MARK AS SHOWN.

FOR HAIR BOWS (U.S. CLS. 37, 39, 40, 42 AND 50).

AISHA SALEM, EXAMINING ATTORNEY

SN 77-724,784. FELICIANO, JACK, SANTA ANA, CA. FILED 4-29-2009.

REIMAGINE YOUR HAIR

THE MARK CONSISTS OF STANDARD CHARACTERS WITHOUT CLAIM TO ANY PARTICULAR FONT, STYLE, SIZE, OR COLOR.

FOR WIGS, HAIRPIECES, AND ADD-IN AND ADD-ON HAIR ACCESSORIES CONSTRUCTED PRIMARILY OF SYNTHETIC AND/OR HUMAN HAIR (U.S. CLS. 37, 39, 40, 42 AND 50).

MICHAEL WIENER, EXAMINING ATTORNEY

SN 77-724,828. FOOTGALAXY, CONNELLYS SPRINGS, NC. FILED 4-29-2009.

FOOTGALAXY

THE MARK CONSISTS OF STANDARD CHARACTERS WITHOUT CLAIM TO ANY PARTICULAR FONT, STYLE, SIZE, OR COLOR.

FOR SHOE LACES (U.S. CLS. 37, 39, 40, 42 AND 50).

FIRST USE 4-1-2007; IN COMMERCE 4-1-2007.

FRANK LATTUCA, EXAMINING ATTORNEY

CLASS 26—(Continued).

SN 77-743,098. SPELLING TELEVISION INC., STUDIO CITY, CA. FILED 5-22-2009.

MELROSE PLACE

THE MARK CONSISTS OF STANDARD CHARACTERS WITHOUT CLAIM TO ANY PARTICULAR FONT, STYLE, SIZE, OR COLOR.

OWNER OF U.S. REG. NOS. 1,821,796 AND 2,350,925. FOR BARRETTES AND HAIR SCRUNCHIES (U.S. CLS. 37, 39, 40, 42 AND 50). KRISTIN CARLSON, EXAMINING ATTORNEY



CLASS 27—(Continued).

SN 77-684,198. ULTRAFLEX SYSTEMS, INC., RANDOLPH, NJ. FILED 3-5-2009.

UltraCarpet

THE MARK CONSISTS OF STANDARD CHARACTERS WITHOUT CLAIM TO ANY PARTICULAR FONT, STYLE, SIZE, OR COLOR.

OWNER OF U.S. REG. NOS. 2,533,694, 3,310,716 AND OTHERS. FOR WHITE TUFTED PILE CARPET ESPECIALLY MADE FOR SOLVENT, ECO-SOLVENT AND UV INKJET PRINTING (U.S. CLS. 19, 20, 37, 42 AND 50). FIRST USE 10-0-2008; IN COMMERCE 10-0-2008. HEATHER BIDDULPH, EXAMINING ATTORNEY



CLASS 27—FLOOR COVERINGS

SN 76-695,031. J & J INDUSTRIES, DALTON, GA. FILED 12-29-2008.

J & J

THE MARK CONSISTS OF STANDARD CHARACTERS WITHOUT CLAIM TO ANY PARTICULAR FONT, STYLE, SIZE, OR COLOR.

FOR CARPET (U.S. CLS. 19, 20, 37, 42 AND 50). FIRST USE 0-0-1957; IN COMMERCE 0-0-1957. KHANH LE, EXAMINING ATTORNEY



SN 77-722,825. COLUMBIA INSURANCE COMPANY, OMAHA, NE. FILED 4-27-2009.

ECOEVOLUTION

THE MARK CONSISTS OF STANDARD CHARACTERS WITHOUT CLAIM TO ANY PARTICULAR FONT, STYLE, SIZE, OR COLOR.

FOR CARPETING (U.S. CLS. 19, 20, 37, 42 AND 50). DOMINIC FATHY, EXAMINING ATTORNEY



SN 77-632,958. SOUTHERN LIVING, INC., BIRMINGHAM, AL. FILED 12-15-2008.

COASTAL LIVING

THE MARK CONSISTS OF STANDARD CHARACTERS WITHOUT CLAIM TO ANY PARTICULAR FONT, STYLE, SIZE, OR COLOR.

OWNER OF U.S. REG. NOS. 2,233,877, 2,634,646 AND OTHERS. FOR FLOORING PRODUCTS, NAMELY, RUGS, CARPETS (U.S. CLS. 19, 20, 37, 42 AND 50). LINDA ESTRADA, EXAMINING ATTORNEY

SN 77-724,442. ENVIRO RESINS, INC., ALPENA, MI. FILED 4-28-2009.

ECOARMOR

THE MARK CONSISTS OF STANDARD CHARACTERS WITHOUT CLAIM TO ANY PARTICULAR FONT, STYLE, SIZE, OR COLOR.

FOR RUBBER MATS (U.S. CLS. 19, 20, 37, 42 AND 50). FIRST USE 4-25-2009; IN COMMERCE 4-25-2009. KATHERINE CHANG, EXAMINING ATTORNEY

CLASS 28—TOYS AND SPORTING GOODS

SN 76-696,766. JAY AT PLAY INTERNATIONAL HONG KONG LIMITED, HONG KONG, CHINA, FILED 4-8-2009.

SILLY SOUND BYTES

THE MARK CONSISTS OF STANDARD CHARACTERS WITHOUT CLAIM TO ANY PARTICULAR FONT, STYLE, SIZE, OR COLOR.

NO CLAIM IS MADE TO THE EXCLUSIVE RIGHT TO USE "SOUND BYTES", APART FROM THE MARK AS SHOWN.

FOR ELECTRONIC TOY PRODUCTS, NAMELY, PLUSH TOYS CONTAINING ELECTRONIC COMPONENTS WHICH FEATURE MUSIC OR SOUND MESSAGES (U.S. CLS. 22, 23, 38 AND 50).

TRACY CROSS, EXAMINING ATTORNEY

SN 77-299,693. MOOSE MOUNTAIN TOYMAKERS LTD., KOWLOON, HONG KONG, FILED 10-9-2007.

MOVIN' GROOVIN' BOP BALL

THE MARK CONSISTS OF STANDARD CHARACTERS WITHOUT CLAIM TO ANY PARTICULAR FONT, STYLE, SIZE, OR COLOR.

NO CLAIM IS MADE TO THE EXCLUSIVE RIGHT TO USE "BALL", APART FROM THE MARK AS SHOWN.

FOR TOYS, NAMELY, ACTION SKILL GAMES (U.S. CLS. 22, 23, 38 AND 50).

SANJEEV VOHRA, EXAMINING ATTORNEY

SN 77-371,881. MATTEL, INC., EL SEGUNDO, CA. FILED 1-15-2008.

STUNT JUMP DUEL

THE MARK CONSISTS OF STANDARD CHARACTERS WITHOUT CLAIM TO ANY PARTICULAR FONT, STYLE, SIZE, OR COLOR.

OWNER OF U.S. REG. NOS. 3,205,395, 3,294,598 AND OTHERS.

NO CLAIM IS MADE TO THE EXCLUSIVE RIGHT TO USE "JUMP", APART FROM THE MARK AS SHOWN.

FOR TOYS, GAMES AND PLAYTHINGS, NAMELY, TOY VEHICLES, TOY VEHICLE PLAYSETS, TOY VEHICLE TRACKSETS AND ACCESSORIES FOR ALL OF THE FOREGOING (U.S. CLS. 22, 23, 38 AND 50).

JAY FLOWERS, EXAMINING ATTORNEY

CLASS 28—(Continued).

SN 77-395,149. FLARE FITTINGS, INC., KALAMAZOO, MI. FILED 2-12-2008.



THE MARK CONSISTS OF THE WORD GRIP IN STYLIZED FONT.

FOR PAINTBALL GUNS, GEAR AND ACCESSORIES, NAMELY, COMPRESSED AIR CANISTERS, ACCELERANTS, CYLINDERS, REGULATORS, VALVES, BARRELS AND PARTS FOR THE FOREGOING (U.S. CLS. 22, 23, 38 AND 50).

BARBARA RUTLAND, EXAMINING ATTORNEY

SN 77-411,520. ANGEL PLAYING CARDS CO., LTD., CHUOKU OSAKA, JAPAN, FILED 3-3-2008.

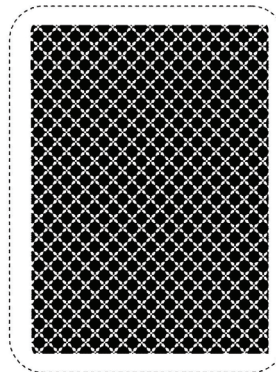

THE MARK CONSISTS OF A DESIGN APPEARING ON THE BACK OF PLAYING CARDS COMPRISING AN ARRAY OF "X" SHAPED ELEMENTS CREATING A PATTERN OF CRISS-CROSSING DIAGONAL LINES. THE BROKEN LINING IS NOT A PART OF THE MARK AND SERVES ONLY TO SHOW THE POSITION OF THE MARK ON THE GOODS.

FOR ORDINARY PLAYING CARDS (U.S. CLS. 22, 23, 38 AND 50).

STEVEN PEREZ, EXAMINING ATTORNEY

CLASS 28—(Continued).

SN 77-411,574. ANGEL PLAYING CARDS CO., LTD., CHUO-KU OSAKA, JAPAN, FILED 3-3-2008.

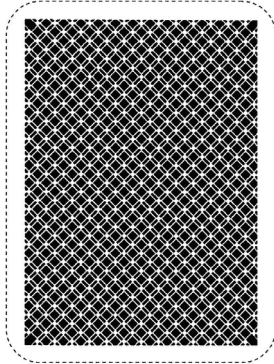

THE MARK CONSISTS OF A DESIGN APPEARING ON THE BACK OF PLAYING CARDS COMPRISING CRISS-CROSSING DOUBLE DIAGONAL LINES FORMING A REPEATING PATTERN OF DIAMONDS AND BARS. THE BROKEN LINING IS NOT A PART OF THE MARK AND SERVES ONLY TO SHOW THE POSITION OF THE MARK ON THE GOODS.

FOR PLAYING CARDS (U.S. CLS. 22, 23, 38 AND 50).
STEVEN PEREZ, EXAMINING ATTORNEY

SN 77-437,225. RAWLINGS SPORTING GOODS COMPANY, INC., ST. LOUIS, MO. FILED 4-1-2008.

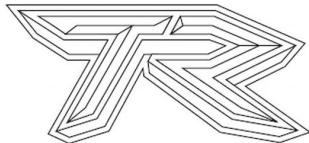

FOR SPORTING ARTICLES, NAMELY, FOOTBALLS (U.S. CLS. 22, 23, 38 AND 50).
CURTIS FRENCH, EXAMINING ATTORNEY

SN 77-441,991. ALPHA INTERNATIONAL, INC., CEDAR RAPIDS, IA. FILED 4-7-2008.

MARCHON

THE MARK CONSISTS OF STANDARD CHARACTERS WITHOUT CLAIM TO ANY PARTICULAR FONT, STYLE, SIZE, OR COLOR.

THE FOREIGN WORDING IN THE MARK TRANSLATES INTO ENGLISH AS TO WALK OR WE WALK.

FOR BATTERY OPERATED AND ELECTRIC POWER ROAD TOY VEHICLE RACING SETS (U.S. CLS. 22, 23, 38 AND 50).

KAREN BRACEY, EXAMINING ATTORNEY

CLASS 28—(Continued).

SN 77-461,019. STONESTREET STABLES, LLC, LEXINGTON, KY. FILED 4-29-2008.

CURLIN

THE MARK CONSISTS OF STANDARD CHARACTERS WITHOUT CLAIM TO ANY PARTICULAR FONT, STYLE, SIZE, OR COLOR.

FOR TOYS, NAMELY, BATH TOYS, ELECTRONIC AND MECHANICAL ACTION TOYS, BENDABLE TOYS, COLLECTABLE TOY FIGURES, ELECTRONIC LEARNING TOYS, INFANT TOYS, INFLATABLE TOYS, MECHANICAL TOYS, MODELED PLASTIC TOY FIGURINES, PARTY FAVORS IN THE NATURE OF SMALL TOYS, PET TOYS, PLUSH TOYS, POSITIONABLE TOY FIGURES, RIDE-ON TOYS, SOFT SCULPTURE TOYS, STUFFED TOY ANIMALS, TOY ANIMALS AND ACCESSORIES THEREFOR, TOY FIGURES; BOARD GAMES; ACTION SKILL GAMES; PLAYSETS FOR TOY ANIMALS AND FIGURINES; CHRISTMAS TREE ORNAMENTS AND DECORATIONS (U.S. CLS. 22, 23, 38 AND 50).

THEODORE MCBRIDE, EXAMINING ATTORNEY

SN 77-490,067. MATTEL, INC., EL SEGUNDO, CA. FILED 6-3-2008.

OUT OF SIGHT

THE MARK CONSISTS OF STANDARD CHARACTERS WITHOUT CLAIM TO ANY PARTICULAR FONT, STYLE, SIZE, OR COLOR.

FOR PARLOR GAMES, NAMELY, PLAYING CARDS, DICE, PRINTED SCORE PADS AND TIMERS, SOLD TOGETHER AS A UNIT (U.S. CLS. 22, 23, 38 AND 50).

FIRST USE 3-17-2009; IN COMMERCE 3-17-2009.
PATRICIA EVANKO, EXAMINING ATTORNEY

CLASS 28—(Continued).

SN 77-522,868. PERFECT KICK FOOTBALL COMPANY, INC., TEMECULA, CA. FILED 7-15-2008.



NO CLAIM IS MADE TO THE EXCLUSIVE RIGHT TO USE "FOOTBALL COMPANY", THE PICTORIAL REPRESENTATION OF A BLACK AND WHITE SOCCER BALL AND THE OVERALL SPHERICAL SHAPE OF A SOCCER BALL, APART FROM THE MARK AS SHOWN.

THE COLOR(S) BLACK, WHITE, DARK BLUE, BLUE, LIGHT BLUE, DARK GREEN, GREEN, YELLOW, BURNT ORANGE, ORANGE, LIGHT ORANGE IS/ARE CLAIMED AS A FEATURE OF THE MARK.

THE MARK CONSISTS OF A THREE-DIMENSIONAL MARK (SPHERE) CONTAINING SIX STYLIZED PRIMARY TARGET DESIGNS, AS FOLLOWS: TWO IN BURNT ORANGE, TWO IN DARK GREEN AND TWO IN DARK BLUE. EMANATING FROM EACH OF THE SIX PRIMARY TARGET DESIGNS ARE SIMILARLY COLORED "MIRROR" IMAGES OF STYLIZED SMILEY FACES CONNECTED TO EACH OTHER BY WAY OF THE GROTESQUE FIGURE OF A HUMAN, TWO SETS IN BLUE, DARK BLUE AND LIGHT BLUE; TWO IN ORANGE, BURNT ORANGE, AND LIGHT ORANGE; AND TWO IN GREEN, DARK GREEN AND YELLOW. SUPERIMPOSED ABOVE (AND IN LIEU OF ONE OF THE TWO STYLIZED PRIMARY TARGET DESIGNS IN DARK BLUE) IS A SHIELD DESIGN BEARING THE LETTERS "PK" IN BLACK, THE WORDS "PERFECT KICK FOOTBALL COMPANY" IN WHITE, THE IMAGE OF A STANDARD BLACK AND WHITE SOCCER BALL, AND THE WORDS "YOUR PERFECT KICK IS OUR GOAL" IN LIGHT BLUE.

FOR ACTION SKILL GAMES; ACTION TARGET GAMES; FOOT BALLS; NET BALLS; SOCCER BALLS; SPORT BALLS (U.S. CLS. 22, 23, 38 AND 50).

TARA PATE, EXAMINING ATTORNEY

SN 77-562,999. CHOKUREI, LLC, YONKERS, NY. FILED 9-5-2008.

ETERNEFIT

THE MARK CONSISTS OF STANDARD CHARACTERS WITHOUT CLAIM TO ANY PARTICULAR FONT, STYLE, SIZE, OR COLOR.

FOR PERSONAL EXERCISE MATS; YOGA MATS (U.S. CLS. 22, 23, 38 AND 50).

FIRST USE 8-28-2008; IN COMMERCE 8-28-2008.
BONNIE LUKEN, EXAMINING ATTORNEY

CLASS 28—(Continued).

SN 77-579,025. IMPERIAL TOY LLC, NORTH HILLS, CA. FILED 9-25-2008.



THE COLOR(S) GREEN, PINK AND WHITE IS/ARE CLAIMED AS A FEATURE OF THE MARK.

THE MARK CONSISTS OF STYLIZED "G" IN PINK WITH GREEN OUTLINE WITH THE REMAINDER OF THE WORD "GREEN" IN GREEN, THE PLUS SIGN IN GREEN WITH PINK OUTLINE AND "ME" IN PINK, WITH WHITE BACKGROUND WHICH MAY ALSO FEATURE A HEART SHAPED PINK BORDER.

FOR TOYS, NAMELY, PLAY COSMETICS, PLAY JEWELRY, PLAY FINGERNAILS, PLAY NAIL POLISH, PLAY SHOES, PLAY DRESSES, PLAY HANDBAGS, PLAY SUNGLASSES, TOY KEYCHAINS, PLAY CELL PHONES (U.S. CLS. 22, 23, 38 AND 50).

LAURIE KAUFMAN, EXAMINING ATTORNEY

SN 77-582,950. MEUCCI CUES, BYHALIA, MS. FILED 10-1-2008.



THE MARK CONSISTS OF THE STYLIZED WORDS "MEUCCI".

FOR BILLIARD CUES (U.S. CLS. 22, 23, 38 AND 50).
FIRST USE 1-1-1984; IN COMMERCE 1-1-1984.
RONALD AIKENS, EXAMINING ATTORNEY

CLASS 28—(Continued).

SN 77-583,437. TAYLOR MADE GOLF COMPANY, INC., CARLSBAD, CA. FILED 10-1-2008.

EXERT

THE MARK CONSISTS OF STANDARD CHARACTERS WITHOUT CLAIM TO ANY PARTICULAR FONT, STYLE, SIZE, OR COLOR.

FOR GOLF GLOVES (U.S. CLS. 22, 23, 38 AND 50).
LAKEISHA LEWIS, EXAMINING ATTORNEY

SN 77-591,626. JAKKS PACIFIC, INC., MALIBU, CA. FILED 10-13-2008.

LIQUID LIGHTNING

THE MARK CONSISTS OF STANDARD CHARACTERS WITHOUT CLAIM TO ANY PARTICULAR FONT, STYLE, SIZE, OR COLOR.

FOR TOYS, GAMES AND PLAYTHINGS, NAMELY, DOLLS, TOY VEHICLES, ACTION FIGURES, TOY FIGURES, SPINNING TOYS, TOY GUNS, AND PLAY SETS AND ACCESSORIES FOR ALL OF THE AFOREMENTIONED; KITES, INFANT TOYS, PLUSH TOYS, TOY FIGURE MOLDS, BABY MULTIPLE ACTIVITY TOYS, BATH TOYS, CHILDREN'S MULTIPLE ACTIVITY TOYS, CONSTRUCTION TOYS; WATER SQUIRTING TOYS AND ACCESSORIES THEREFOR, WATERGUNS AND ACCESSORIES THEREFOR, LASER LIGHT GUN INTERACTIVE WITH WATER AND ACCESSORIES THEREFOR, WATERGUN WITH LASER SIGHT AND ACCESSORIES THEREFOR, AND PLASTIC AND FOAM DISCS; ELECTRONIC LEARNING TOYS, FLOATS FOR RECREATIONAL USE, HANDHELD UNIT FOR PLAYING VIDEO GAMES, STAND ALONE VIDEO GAME MACHINES (U.S. CLS. 22, 23, 38 AND 50).

LINDA MICKLEBURGH, EXAMINING ATTORNEY

SN 77-592,031. JAKKS PACIFIC, INC., MALIBU, CA. FILED 10-14-2008.

STORM LIGHT WARS

THE MARK CONSISTS OF STANDARD CHARACTERS WITHOUT CLAIM TO ANY PARTICULAR FONT, STYLE, SIZE, OR COLOR.

OWNER OF U.S. REG. NOS. 2,661,920, 2,791,609 AND OTHERS.

FOR TOYS, GAMES AND PLAYTHINGS, NAMELY, ACTION FIGURES; TOY VEHICLES; TOY FIGURES; PLAYSETS AND ACCESSORIES FOR ACTION FIGURES, TOY VEHICLES AND TOY FIGURES; TOY WEAPONS, WATER SQUIRING TOYS (U.S. CLS. 22, 23, 38 AND 50).

LINDA MICKLEBURGH, EXAMINING ATTORNEY

CLASS 28—(Continued).

SN 77-594,609. EOLO SPORT INDUSTRIAS, S.A., TREMANES - GIJÓN, SPAIN, FILED 10-16-2008.



NO CLAIM IS MADE TO THE EXCLUSIVE RIGHT TO USE "TOYS INTERNATIONAL", APART FROM THE MARK AS SHOWN.

THE COLOR(S) BLACK, BLUE, YELLOW, RED AND GREEN IS/ARE CLAIMED AS A FEATURE OF THE MARK.

THE MARK CONSISTS OF THE WORDS "EOLO TOYS" IN PROMINENT STYLIZED LETTERS, THE SECOND LETTER "O" OF THE WORD "EOLO" SHOWING A SMILING FACE, AND BELOW THEM THE WORD INTERNATIONAL IN SMALLER STYLIZED LETTERS OVER A HORIZONTALLY POSITIONED OVAL SHAPED FIGURE. THE ENTIRE DESIGN APPEARS INSIDE A SQUARE. THE COLOR BLACK APPEARS IN THE OUTER LINING OF THE SQUARE AND OF EVERY LETTER OF THE WORDS "EOLO TOYS". THE COLOR BLUE APPEARS IN THE LETTERS "E" AND "T" OF THE WORDS "EOLO TOYS". THE COLOR YELLOW APPEARS IN THE LETTERS "O" AND "Y" OF THE WORDS "EOLO TOYS". THE COLOR RED APPEARS IN THE SECOND LETTER "O" OF THE WORD "EOLO", IN THE LETTER "S" OF THE WORD "TOYS" AND IN THE OVAL SHAPED FIGURE. THE COLOR GREEN APPEARS IN THE LETTERS "L" AND "O" OF THE WORDS "EOLO TOYS".

THE WORDING "EOLO" HAS NO MEANING IN A FOREIGN LANGUAGE.

FOR TOYS, NAMELY, ACTION FIGURES, BABY MULTIPLE ACTIVITY TOYS, BATH TOYS, CHILDREN'S MULTIPLE ACTIVITY TOYS, CONSTRUCTION TOYS, FLYING DISCS, TOY FIGURES, FLYING SAUCERS, FOOTBAGS, JIGSAW AND MANIPULATIVE PUZZLES, KITE REELS, PAPER FACE MASKS, PAPER PARTY HATS, COIN OR NON-COIN OPERATED PINBALL MACHINES, PLATFORM TENNIS PADDLES, PLAY BALLOONS, PLAY MOTOR CARS; GAMES, NAMELY, TIBETAN DICE GAME; JUGGLING EQUIPMENT (U.S. CLS. 22, 23, 38 AND 50).

MARK T. MULLEN, EXAMINING ATTORNEY

CLASS 28—(Continued).

SN 77-595,921. MICHAELS STORES PROCUREMENT COMPANY, INC., IRVING, TX. FILED 10-20-2008.

ARTMINDS

THE MARK CONSISTS OF STANDARD CHARACTERS WITHOUT CLAIM TO ANY PARTICULAR FONT, STYLE, SIZE, OR COLOR.

FOR STUFFED TOY ANIMALS, DOLLS, TOY TRAINS, TOY FIGURES AND ACCESSORIES THEREFOR; HOBBY CRAFT KITS FOR MAKING MODELS AND ACCESSORIES THEREFOR; HOBBY CRAFT KITS COMPRISED IN WHOLE OR IN PART OF CLAY, FOAM, FEATHERS, BEADS, WIGGLY EYES, WOOD ITEMS FOR PAINTING AND DECORATING INCLUDING LETTERS, NUMBERS, AND SHAPES, INSTRUCTION BOOKS, AND TOOLS (U.S. CLS. 22, 23, 38 AND 50).

PAUL CROWLEY, EXAMINING ATTORNEY

SN 77-600,143. CINDEK HOLDINGS LIMITED, KOWLOON BAY, HONG KONG, FILED 10-24-2008.



PRIORITY CLAIMED UNDER SEC. 44(D) ON HONG KONG APPLICATION NO. 301156842, FILED 9-7-2008, REG. NO. 301156842, DATED 7-9-2008, EXPIRES 7-9-2018.

THE MARK CONSISTS OF A SERIES OF OVERLAPPING TRIANGLES.

FOR ARTIFICIAL CHRISTMAS TREES; CHRISTMAS HOUSE DECORATIONS, NAMELY, CHRISTMAS TREE ORNAMENTS AND DECORATIONS; ARTIFICIAL CHRISTMAS GARLANDS; CHRISTMAS TREE DECORATIONS, NAMELY, ORNAMENTS, SKIRTS, STANDS, AND STAND COVERS; ARTIFICIAL SNOW FOR CHRISTMAS TREES; INFLATABLE POOLS FOR RECREATIONAL USE; PLAY SWIMMING POOLS; INFLATABLE TOYS; INFLATABLE SWIMMING POOL TOYS; INFLATABLE RIDE-ON TOYS; INFLATABLE INNER TUBES FOR AQUATIC RECREATIONAL USE; INFLATABLE TOY WATER-SLIDES; INFLATABLE TOY FURNITURE; INFLATABLE BOATS USED AS TOYS; FLOATING RECREATIONAL LOUNGE CHAIRS; INFLATABLE FLOAT MATTRESSES AND PADS FOR RECREATIONAL USE; SWIM FLOATS FOR RECREATIONAL USE; BEACH BALLS AND INFLATABLE BALLS; RING BUOYS FOR RECREATIONAL USE; SWIMMING AIDS, NAMELY, POOL RINGS (U.S. CLS. 22, 23, 38 AND 50).

TASNEEM HUSSAIN, EXAMINING ATTORNEY

CLASS 28—(Continued).

SN 77-600,330. ABRAMS GENTILE ENTERTAINMENT, INC., NEW YORK, NY. FILED 10-24-2008.

MEGO – WORLD'S GREATEST SUPER HEROES

THE MARK CONSISTS OF STANDARD CHARACTERS WITHOUT CLAIM TO ANY PARTICULAR FONT, STYLE, SIZE, OR COLOR.

FOR TOYS, NAMELY, ACTION FIGURES, PLAYSETS FOR ACTION FIGURES, PLAYSET BUILDINGS, PLAYSETS FOR DOLLS, AND ACCESSORIES THEREFOR (U.S. CLS. 22, 23, 38 AND 50).

MARY CRAWFORD, EXAMINING ATTORNEY

SN 77-602,193. PERFECT PUSHUP, LLC, MILL VALLEY, CA. FILED 10-28-2008.



OWNER OF U.S. REG. NOS. 3,300,090, 3,508,080 AND 3,517,654.

NO CLAIM IS MADE TO THE EXCLUSIVE RIGHT TO USE "PULLUP", APART FROM THE MARK AS SHOWN.

THE COLOR(S) RED AND WHITE IS/ARE CLAIMED AS A FEATURE OF THE MARK.

THE MARK CONSISTS OF THE WORDS "PERFECT PULLUP" IN WHITE WITH A RED DOT POSITIONED BETWEEN THE WORDS "PERFECT" AND "PULLUP" ON A BLACK BACKGROUND. THE COLOR BLACK REPRESENTS BACKGROUND AND IS NOT PART OF THE MARK.

FOR MANUALLY-OPERATED EXERCISE EQUIPMENT (U.S. CLS. 22, 23, 38 AND 50).

FIRST USE 1-21-2008; IN COMMERCE 1-21-2008.

TRACY CROSS, EXAMINING ATTORNEY

SN 77-602,452. MATTEL, INC., EL SEGUNDO, CA. FILED 10-28-2008.

BEACH BANDIT

THE MARK CONSISTS OF STANDARD CHARACTERS WITHOUT CLAIM TO ANY PARTICULAR FONT, STYLE, SIZE, OR COLOR.

OWNER OF U.S. REG. NO. 3,544,197.
FOR TOYS, GAMES AND PLAYTHINGS, NAMELY, TOY VEHICLES AND ACCESSORIES THEREFOR (U.S. CLS. 22, 23, 38 AND 50).

JOHN GARTNER, EXAMINING ATTORNEY

CLASS 28—(Continued).

SN 77-604,667. MATTEL, INC., EL SEGUNDO, CA. FILED 10-30-2008.

MIETTE

THE MARK CONSISTS OF STANDARD CHARACTERS WITHOUT CLAIM TO ANY PARTICULAR FONT, STYLE, SIZE, OR COLOR.

THE ENGLISH TRANSLATION OF "MIETTE" IN THE MARK IS CRUMB.

FOR TOYS, GAMES AND PLAYTHINGS, NAMELY, DOLLS, DOLL CLOTHING AND DOLL ACCESSORIES; PLUSH TOYS AND ACCESSORIES THEREFOR; TOY FIGURES AND ACCESSORIES THEREFOR (U.S. CLS. 22, 23, 38 AND 50).

JOHN GARTNER, EXAMINING ATTORNEY

SN 77-607,169. BANDAI AMERICA INCORPORATED, CYPRESS, CA. FILED 11-4-2008.

Style Your Imagination

THE MARK CONSISTS OF STANDARD CHARACTERS WITHOUT CLAIM TO ANY PARTICULAR FONT, STYLE, SIZE, OR COLOR.

FOR BENDABLE TOYS; BOARD GAMES; CARD GAMES; CHILDREN'S PLAY COSMETICS; COLLECTABLE TOY FIGURES; DOLL CASES; DOLL CLOTHING; DOLL FURNITURE; DOLL HOUSES; DOLLS AND ACCESSORIES THEREFOR; DOLLS AND PLAYSETS THEREFOR; DOLLS' CLOTHES; DRAWING TOYS; HAND HELD UNIT FOR PLAYING ELECTRONIC GAMES; HOBBY CRAFT KIT COMPRISING OF TOY SEWING MACHINE; TOY WEAVING MACHINE; FABRICS OR TOY IRON; HOBBY CRAFT SETS FOR DESIGNING AND SEWING OR MAKING DOLL FASHIONS, DESIGNING AND MAKING FASHION ACCESSORIES, DESIGNING AND MAKING GREETING CARDS, DESIGNING AND MAKING STICKERS, AND DESIGNING AND MAKING TOY JEWELRY; JIGSAW PUZZLES; LCD GAME MACHINES; MUSIC BOX TOYS; PAPER DOLLS; PLAYSETS FOR DOLLS; PLAYSETS COMPRISED OF DOLL FURNITURE, INCLUDING BEDS, CLOSET, WARDROBES, RUNWAYS, CHIFFOROBES, VANITIES AND CHESTS, HAIR SALON INCLUDING TOY ACCESSORIES, AND PHOTOGRAPHY STUDIO INCLUDING TOY ACCESSORIES; PLUSH TOYS; POP UP TOYS; PORCELAIN DOLLS; PUZZLES; SHOES FOR DOLLS; SKETCHING TOYS; SOFT SCULPTURE TOYS; TOY ARTIFICIAL FINGERNAILS; TOY BOXES; TOY FURNITURE; TOY HOUSES; TOYS, NAMELY, CHILDREN'S DRESS-UP ACCESSORIES; TRADING CARD GAMES (U.S. CLS. 22, 23, 38 AND 50).

JULIE WATSON, EXAMINING ATTORNEY

CLASS 28—(Continued).

SN 77-608,296. DISNEY ENTERPRISES, INC., BURBANK, CA. FILED 11-5-2008.

CUDDABLES

THE MARK CONSISTS OF STANDARD CHARACTERS WITHOUT CLAIM TO ANY PARTICULAR FONT, STYLE, SIZE, OR COLOR.

FOR ACTION SKILL GAMES; TOY ACTION FIGURES AND ACCESSORIES THEREFOR; BOARD GAMES; CARD GAMES; CHILDREN'S MULTIPLE ACTIVITY TOYS; BALLOONS; BATH TOYS; BEAN BAGS; BEAN BAG DOLLS; BUBBLE MAKING WANDS AND SOLUTION SETS; CHILDREN'S PLAY COSMETICS; CHRISTMAS TREE ORNAMENTS AND DECORATIONS; COLLECTABLE TOY FIGURES; CRIB MOBILES; CRIB TOYS; DOLLS; DOLL CLOTHING; DOLL ACCESSORIES; DOLL PLAYSETS; ELECTRIC ACTION TOYS; HANDHELD UNITS FOR PLAYING ELECTRONIC GAMES; INFLATABLE TOYS; JIGSAW PUZZLES; JUMP ROPES; KITES; MAGIC TRICKS; MARBLES; MANIPULATIVE GAMES; MUSIC BOX TOYS; MUSICAL TOYS; PARTY FAVORS IN THE NATURE OF SMALL TOYS; PARTY GAMES; PLAYING CARDS; PLUSH TOYS; PUPPETS; RUBBER BALLS; SNOW GLOBES; SPINNING TOPS; SQUEEZE TOYS; STUFFED TOYS; TEDDY BEARS; TOY ACTION FIGURES; TOY MOBILES; TOY FIGURES; TOY WATCHES; WIND-UP TOYS (U.S. CLS. 22, 23, 38 AND 50).

RICHARD WHITE, EXAMINING ATTORNEY

SN 77-608,614. PLAYPOWER LT FARMINGTON, INC., FARMINGTON, MO. FILED 11-6-2008.

PLAYGROUNDS FUN & EASY!

THE MARK CONSISTS OF STANDARD CHARACTERS WITHOUT CLAIM TO ANY PARTICULAR FONT, STYLE, SIZE, OR COLOR.

NO CLAIM IS MADE TO THE EXCLUSIVE RIGHT TO USE "PLAYGROUNDS", APART FROM THE MARK AS SHOWN.

FOR A FULL LINE OF OUTDOOR PLAYGROUND EQUIPMENT (U.S. CLS. 22, 23, 38 AND 50).

FRED CARL, EXAMINING ATTORNEY

CLASS 28—(Continued).

SN 77-608,796. DISNEY ENTERPRISES, INC., BURBANK, CA. FILED 11-6-2008.



THE NAME, PORTRAIT SHOWN IN THE MARK DOES NOT IDENTIFY A PARTICULAR LIVING INDIVIDUAL.

THE MARK CONSISTS OF A MALE FACIAL IMAGE.

FOR ACTION SKILL GAMES; TOY ACTION FIGURES AND ACCESSORIES THEREFOR; BOARD GAMES; CARD GAMES; CHILDREN'S MULTIPLE ACTIVITY TOYS; BADMINTON SETS; BALLOONS; BASKETBALLS; BATH TOYS; BASEBALLS; BEACH BALLS; BEAN BAGS; BEAN BAG DOLLS; TOY BUILDING BLOCKS; BOWLING BALLS; BUBBLE MAKING WANDS AND SOLUTION SETS; CHESS SETS; CHILDREN'S PLAY COSMETICS; CHRISTMAS STOCKINGS; CHRISTMAS TREE DECORATIONS EXCEPT CONFECTIONARY OR ILLUMINATION ARTICLES; COLLECTABLE TOY FIGURES; CRIB MOBILES; CRIB TOYS; DISC TOSS TOYS; DOLLS; DOLL CLOTHING; DOLL ACCESSORIES; DOLL PLAYSETS; ELECTRIC ACTION TOYS; EQUIPMENT SOLD AS A UNIT FOR PLAYING CARD GAMES; FISHING TACKLE; GOLF BALLS; GOLF GLOVES; GOLF BALL MARKERS; HAND HELD UNIT FOR PLAYING ELECTRONIC GAMES; HOCKEY PUCKS; INFLATABLE TOYS; JIGSAW PUZZLES; JUMP ROPES; KITES; MAGIC TRICKS; MARBLES; MANIPULATIVE GAMES; MECHANICAL TOYS; MUSIC BOX TOYS; MUSICAL TOYS; PARLOR GAMES; PARTY FAVORS IN THE NATURE OF SMALL TOYS; PAPER PARTY HATS; PARTY GAMES; PLAYING CARDS; PLUSH TOYS; PUPPETS; ROLLER SKATES; RUBBER BALLS; SKATEBOARDS; SNOW BOARDS; SNOW GLOBES; SOCCER BALLS; SPINNING TOPS; SQUEEZE TOYS; STUFFED TOYS; TABLE TENNIS TABLES; TALKING TOYS; TARGET GAMES; TEDDY BEARS; TENNIS BALLS; TOY BUCKET AND SHOVEL SETS; TOY MOBILES; TOY VEHICLES; TOY SCOOTERS; TOY CARS; TOY MODEL HOBBYCRAFT KITS; TOY FIGURES; TOY BANKS; TOY TRUCKS; TOY WATCHES; WIND-UP TOYS; YO-YOS (U.S. CLS. 22, 23, 38 AND 50).

RON FAIRBANKS, EXAMINING ATTORNEY

CLASS 28—(Continued).

SN 77-612,092. MATTEL, INC., EL SEGUNDO, CA. FILED 11-11-2008.

AGURA IBADEN

THE MARK CONSISTS OF STANDARD CHARACTERS WITHOUT CLAIM TO ANY PARTICULAR FONT, STYLE, SIZE, OR COLOR.

THE NAME(S), PORTRAIT(S), AND/OR SIGNATURE(S) SHOWN IN THE MARK DOES NOT IDENTIFY A PARTICULAR LIVING INDIVIDUAL.

FOR TOYS, GAMES AND PLAYTHINGS, NAMELY, TOY FIGURES AND ACCESSORIES THEREFOR; TOY ACTION FIGURES AND ACCESSORIES THEREFOR (U.S. CLS. 22, 23, 38 AND 50).

DAVID MILLER, EXAMINING ATTORNEY

SN 77-612,099. MATTEL, INC., EL SEGUNDO, CA. FILED 11-11-2008.

SABER

THE MARK CONSISTS OF STANDARD CHARACTERS WITHOUT CLAIM TO ANY PARTICULAR FONT, STYLE, SIZE, OR COLOR.

FOR TOYS, GAMES AND PLAYTHINGS, NAMELY, TOY VEHICLES AND ACCESSORIES THEREFOR (U.S. CLS. 22, 23, 38 AND 50).

DAVID MILLER, EXAMINING ATTORNEY

SN 77-612,108. MATTEL, INC., EL SEGUNDO, CA. FILED 11-11-2008.

THE VANDALS

THE MARK CONSISTS OF STANDARD CHARACTERS WITHOUT CLAIM TO ANY PARTICULAR FONT, STYLE, SIZE, OR COLOR.

FOR TOYS, GAMES AND PLAYTHINGS, NAMELY, TOY FIGURES AND ACCESSORIES THEREFOR; TOY ACTION FIGURES AND ACCESSORIES THEREFOR; TOY FIGURE PLAYSETS AND ACCESSORIES THEREFOR; TOY ACTION FIGURE PLAYSETS AND ACCESSORIES THEREFOR; TOY VEHICLES AND ACCESSORIES THEREFOR; TOY VEHICLE PLAYSETS AND ACCESSORIES THEREFOR (U.S. CLS. 22, 23, 38 AND 50).

DAVID MILLER, EXAMINING ATTORNEY

CLASS 28—(Continued).

SN 77-612,142. MATTEL, INC., EL SEGUNDO, CA. FILED 11-11-2008.

VANTOM

THE MARK CONSISTS OF STANDARD CHARACTERS WITHOUT CLAIM TO ANY PARTICULAR FONT, STYLE, SIZE, OR COLOR.

FOR TOYS, GAMES AND PLAYTHINGS, NAMELY, TOY VEHICLES AND ACCESSORIES THEREFOR (U.S. CLS. 22, 23, 38 AND 50).

SUE LAWRENCE, EXAMINING ATTORNEY

CLASS 28—(Continued).

SN 77-612,152. MATTEL, INC., EL SEGUNDO, CA. FILED 11-11-2008.

ZEMERIK

THE MARK CONSISTS OF STANDARD CHARACTERS WITHOUT CLAIM TO ANY PARTICULAR FONT, STYLE, SIZE, OR COLOR.

FOR TOYS, GAMES AND PLAYTHINGS, NAMELY, TOY FIGURES AND ACCESSORIES THEREFOR; TOY ACTION FIGURES AND ACCESSORIES THEREFOR (U.S. CLS. 22, 23, 38 AND 50).

DAVID MILLER, EXAMINING ATTORNEY

SN 77-612,143. MATTEL, INC., EL SEGUNDO, CA. FILED 11-11-2008.

VERT WHEELER

THE MARK CONSISTS OF STANDARD CHARACTERS WITHOUT CLAIM TO ANY PARTICULAR FONT, STYLE, SIZE, OR COLOR.

FOR TOYS, GAMES AND PLAYTHINGS, NAMELY, TOY FIGURES AND ACCESSORIES THEREFOR; TOY ACTION FIGURES AND ACCESSORIES THEREFOR (U.S. CLS. 22, 23, 38 AND 50).

SUE LAWRENCE, EXAMINING ATTORNEY

SN 77-612,831. MATTEL, INC., EL SEGUNDO, CA. FILED 11-12-2008.

SHOWER & SHOW

THE MARK CONSISTS OF STANDARD CHARACTERS WITHOUT CLAIM TO ANY PARTICULAR FONT, STYLE, SIZE, OR COLOR.

FOR TOYS, GAMES AND PLAYTHINGS, NAMELY, TOY ANIMALS AND ACCESSORIES THEREFOR; TOY ANIMAL PLAYSETS AND ACCESSORIES THEREFOR (U.S. CLS. 22, 23, 38 AND 50).

FIRST USE 6-8-2009; IN COMMERCE 6-8-2009.
SUE LAWRENCE, EXAMINING ATTORNEY

SN 77-612,148. MATTEL, INC., EL SEGUNDO, CA. FILED 11-11-2008.

SPINNER CORTEZ

THE MARK CONSISTS OF STANDARD CHARACTERS WITHOUT CLAIM TO ANY PARTICULAR FONT, STYLE, SIZE, OR COLOR.

NO CLAIM IS MADE TO THE EXCLUSIVE RIGHT TO USE "SPINNER", APART FROM THE MARK AS SHOWN.

FOR TOYS, GAMES AND PLAYTHINGS, NAMELY, TOY FIGURES AND ACCESSORIES THEREFOR; TOY ACTION FIGURES AND ACCESSORIES THEREFOR (U.S. CLS. 22, 23, 38 AND 50).

SUE LAWRENCE, EXAMINING ATTORNEY

SN 77-612,837. MATTEL, INC., EL SEGUNDO, CA. FILED 11-12-2008.

ARMORUS

THE MARK CONSISTS OF STANDARD CHARACTERS WITHOUT CLAIM TO ANY PARTICULAR FONT, STYLE, SIZE, OR COLOR.

FOR TOYS, GAMES AND PLAYTHINGS, NAMELY, TOY FIGURES AND ACCESSORIES THEREFOR (U.S. CLS. 22, 23, 38 AND 50).

SUE LAWRENCE, EXAMINING ATTORNEY

CLASS 28—(Continued).

SN 77-614,505. MATTEL, INC., EL SEGUNDO, CA. FILED 11-14-2008.

TANGLER ATV

THE MARK CONSISTS OF STANDARD CHARACTERS WITHOUT CLAIM TO ANY PARTICULAR FONT, STYLE, SIZE, OR COLOR.

NO CLAIM IS MADE TO THE EXCLUSIVE RIGHT TO USE "ATV", APART FROM THE MARK AS SHOWN.

FOR TOYS, GAMES AND PLAYTHINGS, NAMELY, TOY VEHICLES AND ACCESSORIES THEREFOR (U.S. CLS. 22, 23, 38 AND 50).

SUE LAWRENCE, EXAMINING ATTORNEY

SN 77-615,489. PRINCE, DAVID J, SUTTONS BAY, MI. FILED 11-17-2008.

DEER BEER

THE MARK CONSISTS OF STANDARD CHARACTERS WITHOUT CLAIM TO ANY PARTICULAR FONT, STYLE, SIZE, OR COLOR.

NO CLAIM IS MADE TO THE EXCLUSIVE RIGHT TO USE "DEER", APART FROM THE MARK AS SHOWN.

FOR SCENT LURES FOR HUNTING OR FISHING (U.S. CLS. 22, 23, 38 AND 50).

PAUL F. GAST, EXAMINING ATTORNEY

SN 77-648,253. BUMMER BEARS LLC, NEW YORK, NY. FILED 1-13-2009.



NO CLAIM IS MADE TO THE EXCLUSIVE RIGHT TO USE "BEARS", APART FROM THE MARK AS SHOWN.

THE COLOR(S) BLACK, WHITE, BROWN, PURPLE, BEIGE, ORANGE, RED IS/ARE CLAIMED AS A FEATURE OF THE MARK.

THE MARK CONSISTS OF A SAD BROWN AND WHITE

CLASS 28—(Continued).

BEAR WITH A BLACK OUTLINE AND THREE RED HEARTS AROUND ITS HEAD HOLDING A BEIGE ADHESIVE BANDAGE WITH THE STYLIZED WORDING "THEY FEEL YOUR PAIN" IN RED LETTERS ACROSS THE BANDAGE. THE STYLIZED WORDING "BUMMER BEARS" IS ON TWO LINES TO THE LEFT OF THE BEAR IN THE COLOR PURPLE. TWO LINES APPEAR UNDERNEATH THE WORDING "BUMMER BEARS" WITH THE TOP LINE IN PURPLE AND THE THICKER BOTTOM LINE IN ORANGE.

FOR PLUSH TOYS; SOFT SCULPTURE PLUSH TOYS; STUFFED AND PLUSH TOYS; STUFFED DOLLS AND ANIMALS; STUFFED TOY ANIMALS; TOY ANIMALS; TOY ANIMALS AND ACCESSORIES THEREFOR (U.S. CLS. 22, 23, 38 AND 50).

FIRST USE 7-13-2004; IN COMMERCE 7-13-2004.

JERI J. FICKES, EXAMINING ATTORNEY

SN 77-651,768. HYPER WEAR, LLC, AUSTIN, TX. FILED 1-18-2009.

SANDBELL

THE MARK CONSISTS OF STANDARD CHARACTERS WITHOUT CLAIM TO ANY PARTICULAR FONT, STYLE, SIZE, OR COLOR.

FOR DUMB-BELLS; EXERCISE WEIGHTS; FITNESS MACHINES AND EQUIPMENT, NAMELY, WEIGHTS, TREADMILLS, ROWING MACHINES, STAIR STEPPING MACHINES, RESISTANCE MACHINES, STATIONARY CYCLES (U.S. CLS. 22, 23, 38 AND 50).

FIRST USE 8-14-2008; IN COMMERCE 11-4-2008.

JESSICA A. POWERS, EXAMINING ATTORNEY

SN 77-652,866. SANG, RICHARD JINSONG, CERRITOS, CA. FILED 1-20-2009.

Maxford USA

NO CLAIM IS MADE TO THE EXCLUSIVE RIGHT TO USE "USA", APART FROM THE MARK AS SHOWN.

THE COLOR(S) WHITE, RED, BLUE IS/ARE CLAIMED AS A FEATURE OF THE MARK.

THE MARK CONSISTS OF "MAXFORD" IN BLUE WITH 3 WHITE STARS ON THE LEFT OF "M", "USA" IN RED WITH WHITE THICK LINES ON LETTERS.

FOR RADIO CONTROLLED MODEL VEHICLES (U.S. CLS. 22, 23, 38 AND 50).

FIRST USE 10-1-2003; IN COMMERCE 1-1-2004.

REBECCA GILBERT, EXAMINING ATTORNEY

CLASS 28—(Continued).

SN 77-666,060. KARSTEN MANUFACTURING CORPORATION, PHOENIX, AZ. FILED 2-9-2009.

L'I'L WACK-E

THE MARK CONSISTS OF STANDARD CHARACTERS WITHOUT CLAIM TO ANY PARTICULAR FONT, STYLE, SIZE, OR COLOR.

THE WORDING "L'I'L WACK-E" HAS NO MEANING OTHER THAN TRADEMARK SIGNIFICANCE.

FOR GOLF CLUBS (U.S. CLS. 22, 23, 38 AND 50).
APRIL HESIK, EXAMINING ATTORNEY

CLASS 28—(Continued).

SN 77-689,241. S & T INNOVATIONS, L.L.C., HARRISONVILLE, MO. FILED 3-12-2009.

GAMESTAKES

THE MARK CONSISTS OF STANDARD CHARACTERS WITHOUT CLAIM TO ANY PARTICULAR FONT, STYLE, SIZE, OR COLOR.

FOR HUNTING EQUIPMENT, NAMELY, FIELD-DRESSING KITS COMPRISED PRIMARILY OF PEGS AND ROPES (U.S. CLS. 22, 23, 38 AND 50).

YAT SYE, LEE, EXAMINING ATTORNEY

SN 77-679,264. ACTIONJETZ, LLC, PHOENIX, AZ. FILED 2-26-2009.

SMASH ME

THE MARK CONSISTS OF STANDARD CHARACTERS WITHOUT CLAIM TO ANY PARTICULAR FONT, STYLE, SIZE, OR COLOR.

FOR ACTION FIGURES AND ACCESSORIES THEREFOR; COLLECTIBLE TOY FIGURES; TOY ACTION FIGURES AND ACCESSORIES THEREFOR (U.S. CLS. 22, 23, 38 AND 50).

ALICE SUE CARRUTHERS, EXAMINING ATTORNEY

SN 77-694,152. FUNOSOPHY, INC., LONG BEACH, CA. FILED 3-18-2009.

LITTER BITS

THE MARK CONSISTS OF STANDARD CHARACTERS WITHOUT CLAIM TO ANY PARTICULAR FONT, STYLE, SIZE, OR COLOR.

NO CLAIM IS MADE TO THE EXCLUSIVE RIGHT TO USE "LITTER", APART FROM THE MARK AS SHOWN.

FOR TOYS, GAMES AND PLAYTHINGS, NAMELY, COLLECTIBLE TOY TRINKETS, NAMELY, FIGURINES, VEHICLES, ANIMALS AND TOYS, NAMELY, FIGURINES, VEHICLES, ANIMALS DISGUISED AS LITTER (U.S. CLS. 22, 23, 38 AND 50).

CHRISTINA SOBRAL, EXAMINING ATTORNEY

SN 77-684,454. HORIZON HOBBY, INC., CHAMPAIGN, IL. FILED 3-5-2009.

HOBBYZONE

THE MARK CONSISTS OF STANDARD CHARACTERS WITHOUT CLAIM TO ANY PARTICULAR FONT, STYLE, SIZE, OR COLOR.

OWNER OF U.S. REG. NOS. 2,526,081 AND 2,848,727.
FOR REMOTE CONTROLLED MODEL VEHICLES AND PARTS THEREFOR (U.S. CLS. 22, 23, 38 AND 50).

FIRST USE 8-23-2000; IN COMMERCE 8-23-2000.
CAROLINE WOOD, EXAMINING ATTORNEY

SN 77-699,371. MOYER, DAVID WAYNE, DBA RABID FIGHTWEAR, LENOIR CITY, TN. FILED 3-25-2009.

RABID

THE MARK CONSISTS OF STANDARD CHARACTERS WITHOUT CLAIM TO ANY PARTICULAR FONT, STYLE, SIZE, OR COLOR.

OWNER OF U.S. REG. NO. 3,475,210.
FOR BOXING GLOVES; MIXED MARTIAL ARTS GLOVES; SHIN PADS FOR USE IN MIXED MARTIAL ARTS (U.S. CLS. 22, 23, 38 AND 50).

FIRST USE 7-21-2007; IN COMMERCE 7-21-2007.
IRA J. GOODSaid, EXAMINING ATTORNEY

CLASS 28—(Continued).

SN 77-699,703. THE HAYWIRE GROUP, INC., INDIAN ORCHARD, MA. FILED 3-26-2009.

IT'S ALL FUN AND GAMES

THE MARK CONSISTS OF STANDARD CHARACTERS WITHOUT CLAIM TO ANY PARTICULAR FONT, STYLE, SIZE, OR COLOR.

FOR TOYS AND GAMES, NAMELY, BOARD GAMES, CARD GAMES, GAMES OF CHANCE FEATURING DIE, CHIPS, DOMINOS, PUZZLES AND THROWING AND TARGET GAMES (U.S. CLS. 22, 23, 38 AND 50).

FIRST USE 10-1-2008; IN COMMERCE 10-1-2008.
KEVIN CORWIN, EXAMINING ATTORNEY

SN 77-707,688. THE ORIGINAL STORY CLUB GAMES, LLC, CHARLESTON, SC. FILED 4-6-2009.



NO CLAIM IS MADE TO THE EXCLUSIVE RIGHT TO USE "GAMES", APART FROM THE MARK AS SHOWN.

THE MARK CONSISTS OF THE WORDS "STORYCLUB GAMES" STYLIZED SCRIPT SUPERIMPOSED ON A SHADED RECTANGULAR SHAPED BACKGROUND WITH A BROKEN STITCHING LINE IN A CONTRASTING COLOR RESEMBLING STITCHING AROUND THE EDGES.

FOR PARTY GAMES, NAMELY, STORY WRITING GAMES AND EQUIPMENT FOR PLAYING STORY WRITING GAMES, NAMELY, INSTRUCTIONS FOR RULES OF PLAY, INFORMATIONAL CARDS CONTAINING STORY STARTERS AND SUBJECTS TO WRITE ABOUT INCLUDING PEOPLE, PLACES AND THINGS, NOTEBOOKS FOR RECORDING THE STORY, BOOK MARKS AND PENCILS (U.S. CLS. 22, 23, 38 AND 50).

SHAUNIA CARLYLE, EXAMINING ATTORNEY

CLASS 28—(Continued).

SN 77-707,694. THE ORIGINAL STORY CLUB GAMES, LLC, CHARLESTON, SC. FILED 4-6-2009.

storyclub games

THE MARK CONSISTS OF STANDARD CHARACTERS WITHOUT CLAIM TO ANY PARTICULAR FONT, STYLE, SIZE, OR COLOR.

NO CLAIM IS MADE TO THE EXCLUSIVE RIGHT TO USE "GAMES", APART FROM THE MARK AS SHOWN.

FOR PARTY GAMES, NAMELY, STORY WRITING GAMES AND EQUIPMENT FOR PLAYING STORY WRITING GAMES, NAMELY, INSTRUCTIONS FOR RULES OF PLAY, INFORMATIONAL CARDS CONTAINING STORY STARTERS AND SUBJECTS TO WRITE ABOUT INCLUDING PEOPLE, PLACES AND THINGS, NOTEBOOKS FOR RECORDING THE STORY, BOOK MARKS, PENCILS (U.S. CLS. 22, 23, 38 AND 50).

SHAUNIA CARLYLE, EXAMINING ATTORNEY

SN 77-708,685. HUMANA INC., LOUISVILLE, KY. FILED 4-7-2009.

BRIGHTRABBIT

THE MARK CONSISTS OF STANDARD CHARACTERS WITHOUT CLAIM TO ANY PARTICULAR FONT, STYLE, SIZE, OR COLOR.

FOR ARCADE-TYPE ELECTRONIC EDUCATIONAL VIDEO GAMES; ELECTRONIC EDUCATIONAL GAME MACHINES FOR CHILDREN (U.S. CLS. 22, 23, 38 AND 50).

SANJEEV VOHRA, EXAMINING ATTORNEY

SN 77-708,687. HUMANA INC., LOUISVILLE, KY. FILED 4-7-2009.

BRIGHTRABBIT ACTION GAMES

THE MARK CONSISTS OF STANDARD CHARACTERS WITHOUT CLAIM TO ANY PARTICULAR FONT, STYLE, SIZE, OR COLOR.

NO CLAIM IS MADE TO THE EXCLUSIVE RIGHT TO USE "ACTION GAMES", APART FROM THE MARK AS SHOWN.

FOR ARCADE-TYPE ELECTRONIC EDUCATIONAL VIDEO GAMES; ELECTRONIC EDUCATIONAL GAME MACHINES FOR CHILDREN (U.S. CLS. 22, 23, 38 AND 50).

SANJEEV VOHRA, EXAMINING ATTORNEY

CLASS 28—(Continued).

SN 77-713,073. INAREX CO., LTD, GWANGSAN-GU, REPUBLIC OF KOREA, FILED 4-14-2009.



NO CLAIM IS MADE TO THE EXCLUSIVE RIGHT TO USE "SOFT TOYS", APART FROM THE MARK AS SHOWN. THE COLOR(S) RED, BLACK, WHITE, YELLOW AND GREY IS/ARE CLAIMED AS A FEATURE OF THE MARK. THE MARK CONSISTS OF THE STYLIZED WORD "SOFTOYS" IN RED COLOR WITH A BLACK BORDER OUTLINED IN WHITE ON A GREY BACKGROUND. THE "O" IN SOFT IS COLOURED YELLOW. THE LETTERS "SOFT" ARE IN UPPER FONT AND THE LETTERS "OYS" ARE A LOWER FONT. FOR BALLS FOR GAMES; PLUSH TOYS; STUFFED AND PLUSH TOYS; STUFFED TOYS (U.S. CLS. 22, 23, 38 AND 50).
KIMBERLY FRYE, EXAMINING ATTORNEY

CLASS 28—(Continued).

SN 77-718,850. SOL-EFFECT ENTERPRISES, INC., ARCADIA, CA. FILED 4-21-2009.



THE MARK CONSISTS OF THE STYLIZED WORDING "TURBO" WITH EIGHT HORIZONTAL LINES ATTACHED TO THE LETTER "O" FOR SKATEBOARDS, ROLLER SKATES, INLINE SKATES, AND RELATED ACCESSORIES, NAMELY, SKATEBOARD TRUCKS, SKATEBOARD DECKS, SKATEBOARD WHEELS, SKATEBOARD AND ROLLER SKATE BALL BEARINGS, SKATEBOARD RISER PADS, AND SKATEBOARD GRIP TAPES (U.S. CLS. 22, 23, 38 AND 50).
FIRST USE 12-31-1993; IN COMMERCE 12-31-1993.
FONG HSU, EXAMINING ATTORNEY

SN 77-721,185. TWENTIETH CENTURY FOX FILM CORPORATION, LOS ANGELES, CA. FILED 4-23-2009.



SN 77-718,408. RCR ENTERPRISES, LLC, WELCOME, NC. FILED 4-21-2009.



OWNER OF U.S. REG. NO. 3,428,362. THE MARK CONSISTS OF THE NUMBER "31" IN A STYLIZED FORMAT. FOR MODEL CARS (U.S. CLS. 22, 23, 38 AND 50).
FIRST USE 2-9-1997; IN COMMERCE 2-9-1997.
AMY KERTGATE, EXAMINING ATTORNEY

OWNER OF U.S. REG. NO. 3,001,994. NO CLAIM IS MADE TO THE EXCLUSIVE RIGHT TO USE "SPORTS", APART FROM THE MARK AS SHOWN. THE MARK CONSISTS OF THE STYLIZED WORDS "THE ADVENTURES OF DIGGER AND FRIENDS" WHICH APPEAR INSIDE OF TWO OVAL CONCENTRIC LINES, THE WORDS "FOX SPORTS" WHICH APPEAR UNDER THE WORD "FRIENDS" AND INSIDE OF THE OVAL SHAPE OVERLAPPING ON THE BOTTOM OF THE INNER OVAL LINE AND FIVE COSTUMED GOPHER CHARACTERS WHICH APPEAR ABOVE THE OUTER OVAL LINE. FOR CHRISTMAS TREE DECORATIONS; HAND HELD UNIT FOR PLAYING ELECTRONIC GAMES; PLUSH TOYS; PLUSH DOLLS; TOY FIGURES; FULL-SIZE STAND-ALONE ARCADE GAMES; JIGSAW AND MANIPULATIVE PUZZLES; TALKING DOLLS; SUCTION CUP DOLLS; TOY ACTION FIGURES AND ACCESSORIES THEREFOR; BOARD GAMES; CARD GAMES; PLAYING CARDS; FLYING DISCS; TOY JEWELRY; PARTY GAMES; PARLOR GAMES; ROLE PLAYING GAMES; TOY WATCHES; DART BOARDS; BENDABLE TOYS; DIECAST TOY CARS (U.S. CLS. 22, 23, 38 AND 50).
LINDA LAVACHE, EXAMINING ATTORNEY

CLASS 28—(Continued).

SN 77-721,649. MARSHALL, JOHN F. JR., FORT WALTON BEACH, FL. FILED 4-24-2009.

NUFLETCH

THE MARK CONSISTS OF STANDARD CHARACTERS WITHOUT CLAIM TO ANY PARTICULAR FONT, STYLE, SIZE, OR COLOR.

FOR ARCHERY EQUIPMENT, NAMELY, ARROW FLETCHING DEVICES AND ARROWS (U.S. CLS. 22, 23, 38 AND 50).

PAUL MORENO, EXAMINING ATTORNEY

CLASS 28—(Continued).

SN 77-723,250. SOFT AIR USA, INC., GRAPEVINE, TX. FILED 4-27-2009.

SG 556

THE MARK CONSISTS OF STANDARD CHARACTERS WITHOUT CLAIM TO ANY PARTICULAR FONT, STYLE, SIZE, OR COLOR.

FOR TOYS, NAMELY, TOY GUNS (U.S. CLS. 22, 23, 38 AND 50).

WILLIAM ROSSMAN, EXAMINING ATTORNEY

SN 77-722,201. FEARON, JOHN S., PHOENIX, AZ. AND MARK, PAUL R., LOS ANGELES, CA. FILED 4-24-2009.

**Dragon Grip**

THE MARK CONSISTS OF TWO DRAGONS NEXT TO EACH OTHER ABOVE THE WORDING "DRAGON GRIP". FOR TOY NOISEMAKERS (U.S. CLS. 22, 23, 38 AND 50).

JOHN KELLY, EXAMINING ATTORNEY

SN 77-723,746. MORGAN EVAN THORNE DECORATIVE PAINTING, LLC, MAPLEWOOD, MN. FILED 4-28-2009.



THE MARK CONSISTS OF THE WORDING "STICKY PIXIES" IN STYLIZED FONT.

FOR HOBBY CRAFT KIT COMPRISING APPLIQUES, FABRICS, GLITTER, AND ADHESIVES (U.S. CLS. 22, 23, 38 AND 50).

FIRST USE 10-15-2007; IN COMMERCE 10-15-2007.

JANICE L. MCMORROW, EXAMINING ATTORNEY

SN 77-722,626. FREESTON, JAN, OXFORD, UNITED KINGDOM, AND VAN ZYL, HEINE, OXFORD, UNITED KINGDOM, FILED 4-27-2009.

Magic Compounds

THE MARK CONSISTS OF STANDARD CHARACTERS WITHOUT CLAIM TO ANY PARTICULAR FONT, STYLE, SIZE, OR COLOR.

FOR BOARD GAMES (U.S. CLS. 22, 23, 38 AND 50).

GENE MACIOL, EXAMINING ATTORNEY

SN 77-723,900. ARCADIA DESIGNWORKS, LLC, PORTLAND, ME. FILED 4-28-2009.

TRUKLES

THE MARK CONSISTS OF STANDARD CHARACTERS WITHOUT CLAIM TO ANY PARTICULAR FONT, STYLE, SIZE, OR COLOR.

FOR EQUIPMENT AND ACCESSORIES SOLD AS A UNIT FOR PLAYING A TABLE GAME (U.S. CLS. 22, 23, 38 AND 50).

FIRST USE 2-15-2009; IN COMMERCE 2-15-2009.

CHRISIE B. KING, EXAMINING ATTORNEY

CLASS 28—(Continued).

SN 77-723,925. BELLAMAX INDUSTRIES, LLC, BOISE, ID.
FILED 4-28-2009.

PAU PAU

THE MARK CONSISTS OF STANDARD CHARACTERS
WITHOUT CLAIM TO ANY PARTICULAR FONT, STYLE,
SIZE, OR COLOR.

FOR STUFFED AND PLUSH TOYS; TOY ANIMALS
AND ACCESSORIES THEREFOR (U.S. CLS. 22, 23, 38
AND 50).

SALLY SHIH, EXAMINING ATTORNEY

SN 77-723,980. MICHAEL G. KALLERES, DELAND, FL.
FILED 4-28-2009.

TOURMINATOR

THE MARK CONSISTS OF STANDARD CHARACTERS
WITHOUT CLAIM TO ANY PARTICULAR FONT, STYLE,
SIZE, OR COLOR.

FOR GOLF CLUBS, GOLF BAGS, GOLF BALLS, GOLF
TEES (U.S. CLS. 22, 23, 38 AND 50).

CHRISIE B. KING, EXAMINING ATTORNEY

SN 77-724,238. OUT OF THE BOX PUBLISHING, INC.,
DODGEVILLE, WI. FILED 4-28-2009.

SUPER CIRCLES

THE MARK CONSISTS OF STANDARD CHARACTERS
WITHOUT CLAIM TO ANY PARTICULAR FONT, STYLE,
SIZE, OR COLOR.

FOR CARD GAMES (U.S. CLS. 22, 23, 38 AND 50).
KRISTIN DAHLING, EXAMINING ATTORNEY

CLASS 28—(Continued).

SN 77-724,244. EAGLE W. EREAUX, TUCSON, AZ. FILED 4-
28-2009.

ANATOMY CONNECTION

THE MARK CONSISTS OF STANDARD CHARACTERS
WITHOUT CLAIM TO ANY PARTICULAR FONT, STYLE,
SIZE, OR COLOR.

FOR EDUCATIONAL CARD GAMES (U.S. CLS. 22, 23,
38 AND 50).

ZACHARY BELLO, EXAMINING ATTORNEY

SN 77-724,782. MALIZIA, DAVID J, DBA PONG STAR,
SCOTIA, NY. FILED 4-29-2009.



NO CLAIM IS MADE TO THE EXCLUSIVE RIGHT TO
USE "PONG", APART FROM THE MARK AS SHOWN.

THE MARK CONSISTS OF THE WORDING "PONG
STAR" WITH THE "A" FORMED BY A DESIGN OF A
FIVE-POINTED STAR INSIDE A WINDING CIRCLE, WITH
A SEGMENT OF THE CIRCLE EXTENDING IN AN ARC
ABOVE THE WORDING.

FOR ACTION SKILL GAMES, BOARD GAMES, GO
GAMES, PARLOR GAMES, TABLETOP GAMES (U.S.
CLS. 22, 23, 38 AND 50).

FIRST USE 1-15-2009; IN COMMERCE 1-15-2009.

KRISTIN CARLSON, EXAMINING ATTORNEY

SN 77-724,851. BCI BURKE COMPANY, FOND DU LAC, WI.
FILED 4-29-2009.

NUCLEUS

THE MARK CONSISTS OF STANDARD CHARACTERS
WITHOUT CLAIM TO ANY PARTICULAR FONT, STYLE,
SIZE, OR COLOR.

FOR HEAVY DUTY PLAYGROUND EQUIPMENT,
NAMELY, PLAY STRUCTURES, CLIMBING UNITS,
SLIDES AND SLIDING POLES, SWINGS, SWING SETS,
SEE SAWS, JUNGLE GYMS, ROCKING RIDING TOYS,
CAROUSELS, PLATFORMS AND ROOFS, HANDRAILS,
PLAY STAIRS AND STEPS, BRIDGES, TURNING BARS,
STEERING WHEELS, BARRIERS, SHAPED SEATS,
FREE STANDING PLAY ENCLOSURES, FREE STAND-
ING PLAY STRUCTURES, TUNNEL AND TUBE UNITS,
PLAY PANELS, LADDERS, TUNNEL STRUCTURES IN
THE FORM OF CAPSULES, BALANCE BEAMS, AND
PARALLEL BARS (U.S. CLS. 22, 23, 38 AND 50).

THEODORE MCBRIDE, EXAMINING ATTORNEY

CLASS 28—(Continued).

SN 77-725,128. CHEUNG, JASON, UNION CITY, CA. FILED 4-29-2009.

RUINS

THE MARK CONSISTS OF STANDARD CHARACTERS WITHOUT CLAIM TO ANY PARTICULAR FONT, STYLE, SIZE, OR COLOR.
 FOR MANIPULATIVE PUZZLES (U.S. CLS. 22, 23, 38 AND 50).
 CAROLINE WOOD, EXAMINING ATTORNEY

SN 77-725,347. WINTHROP DADA, OJAI, CA. FILED 4-29-2009.

Rover Runnerz

THE MARK CONSISTS OF STANDARD CHARACTERS WITHOUT CLAIM TO ANY PARTICULAR FONT, STYLE, SIZE, OR COLOR.
 FOR PET TOYS; REMOTE CONTROL TOYS, NAMELY, CARS (U.S. CLS. 22, 23, 38 AND 50).
 KATHLEEN LORENZO, EXAMINING ATTORNEY

CLASS 28—(Continued).

SN 77-725,483. TWENTIETH CENTURY FOX FILM CORPORATION, LOS ANGELES, CA. FILED 4-29-2009.



OWNER OF U.S. REG. NO. 3,001,994.
 NO CLAIM IS MADE TO THE EXCLUSIVE RIGHT TO USE "SPORTS", APART FROM THE MARK AS SHOWN.
 THE MARK CONSISTS OF THE STYLIZED WORDS "THE ADVENTURES OF DIGGER AND FRIENDS" WHICH APPEAR IN THE CENTER, THE WORDS "FOX SPORTS" WHICH APPEAR INSIDE OF THE OVAL SHAPE ON THE TOP CENTER AND FIVE COSTUMED GOPHER CHARACTERS, AND ALL ARE DISPLAYED INSIDE OF THE RECTANGULAR BACKGROUND.

FOR CHRISTMAS TREE DECORATIONS; HAND HELD UNIT FOR PLAYING ELECTRONIC GAMES; PLUSH TOYS; PLUSH DOLLS; TOY FIGURES; FULL-SIZE STAND-ALONE ARCADE GAMES; JIGSAW AND MANIPULATIVE PUZZLES; TALKING DOLLS; SUCTION CUP DOLLS; TOY ACTION FIGURES AND ACCESSORIES THEREFOR; BOARD GAMES; CARD GAMES; PLAYING CARDS; FLYING DISCS; TOY JEWELRY; PARTY GAMES; PARLOR GAMES; ROLE PLAYING GAMES; TOY WATCHES; DART BOARDS; BENDABLE TOYS; DIECAST TOY CARS (U.S. CLS. 22, 23, 38 AND 50).

LINDA LAVACHE, EXAMINING ATTORNEY

SN 77-725,490. TROPHY HUNTER ACCESSORIES INC., HOFFMAN, MN. FILED 4-29-2009.



THE STIPPLING IS FOR SHADING PURPOSES ONLY.
 THE MARK CONSISTS OF AN IMAGE OF A FISH'S HEAD AND MOUTH WITH A LURE INSIDE A OVAL SHAPED DESIGN. THE STYLIZED WORDS "GLITTER-TAIL" IS IN THE CENTER. THE STYLIZED WORDS IS CONNECTED TO A SPINNER AND A TREBLE HOOK.
 FOR FISHING LURES (U.S. CLS. 22, 23, 38 AND 50).
 FIRST USE 4-3-2009; IN COMMERCE 4-3-2009.
 NAAKWAMA ANKRAH, EXAMINING ATTORNEY

CLASS 28—(Continued).

SN 77-725,526. FUNOSOPHY, INC., LONG BEACH, CA.
FILED 4-29-2009.

MAYBE BABY

THE MARK CONSISTS OF STANDARD CHARACTERS WITHOUT CLAIM TO ANY PARTICULAR FONT, STYLE, SIZE, OR COLOR.

FOR TOYS, GAMES AND PLAYTHINGS, NAMELY, DOLLS, DOLL FASHIONS, NAMELY, DOLL CLOTHING AND DOLL ACCESSORIES THAT REMAIN UNSEEN UNTIL OPENED (U.S. CLS. 22, 23, 38 AND 50).

CHRISTINA SOBRAL, EXAMINING ATTORNEY

CLASS 28—(Continued).

SN 77-725,652. LOUIE, MATTHEW S, LOS ANGELES, CA.
FILED 4-30-2009.



THE MARK CONSISTS OF A STICK FIGURE ENCLOSED IN A CIRCLE WHICH IS BROKEN ON THE RIGHT SIDE INFERIORITY OF THE STICK FIGURE AND THE WORDING "CHIPINATOR" IS FEATURED BELOW.

FOR GOLF TRAINING EQUIPMENT, NAMELY, A MOTORIZED GOLF CHIPPING PRACTICE AID (U.S. CLS. 22, 23, 38 AND 50).

LINDA ESTRADA, EXAMINING ATTORNEY

SN 77-725,637. MORRISSETTE, JASON A, SAN BERNARDINO, CA. FILED 4-30-2009.

ARMADA SKATEBOARDS

THE MARK CONSISTS OF STANDARD CHARACTERS WITHOUT CLAIM TO ANY PARTICULAR FONT, STYLE, SIZE, OR COLOR.

NO CLAIM IS MADE TO THE EXCLUSIVE RIGHT TO USE "SKATEBOARDS", APART FROM THE MARK AS SHOWN.

FOR SKATEBOARDS (U.S. CLS. 22, 23, 38 AND 50).

FIRST USE 0-0-2005; IN COMMERCE 0-0-2005.

TARAH HARDY, EXAMINING ATTORNEY

SN 77-726,089. JAKKS PACIFIC, INC., MALIBU, CA. FILED 4-30-2009.

SN 77-725,644. LAX, CHRISTOPHER M, SOUTHLAKE, TX.
FILED 4-30-2009.

TYPHOON FORCE**Sconudi**

THE MARK CONSISTS OF STANDARD CHARACTERS WITHOUT CLAIM TO ANY PARTICULAR FONT, STYLE, SIZE, OR COLOR.

THE WORDING "SCONUDI" HAS NO MEANING IN A FOREIGN LANGUAGE.

FOR CARD GAMES (U.S. CLS. 22, 23, 38 AND 50).

MELISSA VALLILLO, EXAMINING ATTORNEY

THE MARK CONSISTS OF STANDARD CHARACTERS WITHOUT CLAIM TO ANY PARTICULAR FONT, STYLE, SIZE, OR COLOR.

OWNER OF U.S. REG. NO. 3,104,768.

FOR OUTDOOR WATER ACTIVITY TOYS AND OUTDOOR WATER SPORTS TOYS, NAMELY, WATER GUNS AND WATER SQUIRTING YARD TOYS THAT CONNECT TO GARDEN HOSES AND SPRINKLERS (U.S. CLS. 22, 23, 38 AND 50).

JORDAN BAKER, EXAMINING ATTORNEY

CLASS 28—(Continued).

SN 77-726,153. HURST, CHRISTOPHER WILLIAM, DBA CHRIS HURST PRODUCTION, SICKLERVILLE, NJ. FILED 4-30-2009.



THE MARK CONSISTS OF A STYLIZED LETTER "C" AND A STYLIZED LETTER "H".

FOR PLAYING CARDS AND CARD GAMES (U.S. CLS. 22, 23, 38 AND 50);
KATHLEEN M. VANSTON, EXAMINING ATTORNEY

SN 77-726,453. PRIORITIZE, LLC, SCOTTSDALE, AZ. FILED 4-30-2009.

STICK TO THE CONVERSATION

THE MARK CONSISTS OF STANDARD CHARACTERS WITHOUT CLAIM TO ANY PARTICULAR FONT, STYLE, SIZE, OR COLOR.
FOR PARLOR GAMES (U.S. CLS. 22, 23, 38 AND 50).
INGA ERVIN, EXAMINING ATTORNEY

SN 77-726,610. ARCTICA STUDIOS, GLENDALE, CA. FILED 4-30-2009.

ARCTICA

THE MARK CONSISTS OF STANDARD CHARACTERS WITHOUT CLAIM TO ANY PARTICULAR FONT, STYLE, SIZE, OR COLOR.

FOR BATTERY OPERATED ACTION TOYS; BOARD GAMES; ELECTRONIC ACTION TOYS; ELECTRONICALLY OPERATED TOY MOTOR VEHICLES; MECHANICAL ACTION TOYS; MOLDED TOY FIGURES; PARTY GAMES; PLUSH TOYS; PUZZLES; TOY ROBOTS; TOY VEHICLES (U.S. CLS. 22, 23, 38 AND 50).
BRIDGETT SMITH, EXAMINING ATTORNEY

CLASS 28—(Continued).

SN 77-726,638. CHAMPION DISCS, INCORPORATED, DBA INNOVA-CHAMPION DISCS, INC., RANCHO CUCAMONGA, CA. FILED 4-30-2009.

ZEPHYR

THE MARK CONSISTS OF STANDARD CHARACTERS WITHOUT CLAIM TO ANY PARTICULAR FONT, STYLE, SIZE, OR COLOR.

FOR FLYING DISCS (U.S. CLS. 22, 23, 38 AND 50).
FIRST USE 9-0-1992; IN COMMERCE 9-0-1992.
KIM MONINGHOFF, EXAMINING ATTORNEY

SN 77-726,872. MATTEL, INC., EL SEGUNDO, CA. FILED 5-1-2009.

KID DOCTOR

THE MARK CONSISTS OF STANDARD CHARACTERS WITHOUT CLAIM TO ANY PARTICULAR FONT, STYLE, SIZE, OR COLOR.

FOR TOYS, GAMES AND PLAYTHINGS, NAMELY, DOLLS, DOLL CLOTHING AND DOLL ACCESSORIES (U.S. CLS. 22, 23, 38 AND 50).
WON TEAK OH, EXAMINING ATTORNEY

CLASS 28—(Continued).

SN 77-727,510. ZUFFA, LLC, LAS VEGAS, NV. FILED 5-1-2009.

ULTIMATE FIGHTING CHAMPIONSHIP

THE MARK CONSISTS OF STANDARD CHARACTERS WITHOUT CLAIM TO ANY PARTICULAR FONT, STYLE, SIZE, OR COLOR.

OWNER OF U.S. REG. NO. 3,044,208.
NO CLAIM IS MADE TO THE EXCLUSIVE RIGHT TO USE FIGHTING, APART FROM THE MARK AS SHOWN.

FOR EXERCISE AND FITNESS EQUIPMENT AND ACCESSORIES, NAMELY, ANKLE AND WRIST WEIGHTS; EXERCISE BARS; EXERCISE BENCHES; EXERCISE DOORWAY GYM BARS; ROWING MACHINES; STAIR-STEPPING MACHINES; STATIONARY CYCLES; ABDOMINAL BOARDS; CHEST EXPANDERS; CHEST PULLS; EXERCISE PLATFORMS; TRAMPOLINES; TREADMILLS; WEIGHT CUFFS; WEIGHTS; MANUALLY-OPERATED EXERCISE EQUIPMENT; STRESS RELIEF BALLS FOR HAND EXERCISE; BAR BELLS FOR ATHLETIC USE; WEIGHT LIFTING BELTS; WEIGHT LIFTING BENCHES AND BENCH ACCESSORIES; ELLIPTICAL MACHINES; JUMP ROPES; FIXED-GEAR STATIONARY BIKES; PROTECTIVE PADS FOR CYCLING; STATIONARY BICYCLES FOR INDOOR CYCLING; GROUP EXERCISE PLATFORMS; AND HIKING MACHINES; MARTIAL ARTS EQUIPMENT, NAMELY, KICKING SHIELDS, HEAD GUARDS, FEMALE CHEST PROTECTORS, GROIN CUPS, KARATE TARGETS, BODY SHIELDS; SPARRING VESTS, ANKLE AND HAND WRAPS, JUMP ROPES, MOUTH GUARDS, KNEE PADS, AND ELBOW PADS (U.S. CLS. 22, 23, 38 AND 50).

JOHN E. MICHOS, EXAMINING ATTORNEY



SN 77-727,797. MONGELLUZZO, MARY, HARVARD, IL. FILED 5-3-2009.

KIDOKU

THE MARK CONSISTS OF STANDARD CHARACTERS WITHOUT CLAIM TO ANY PARTICULAR FONT, STYLE, SIZE, OR COLOR.

FOR PUZZLE GAMES (U.S. CLS. 22, 23, 38 AND 50).
SUSAN LESLIE DUBOIS, EXAMINING ATTORNEY

CLASS 28—(Continued).

SN 77-728,772. MACHARDY, SCOTT, HAMPTON, NH. FILED 5-4-2009.

ADVENTURE BOWLING

THE MARK CONSISTS OF STANDARD CHARACTERS WITHOUT CLAIM TO ANY PARTICULAR FONT, STYLE, SIZE, OR COLOR.

NO CLAIM IS MADE TO THE EXCLUSIVE RIGHT TO USE "BOWLING", APART FROM THE MARK AS SHOWN, FOR APPARATUS FOR PLAYING A BOWLING GAME (U.S. CLS. 22, 23, 38 AND 50).

RICHARD A. STRASER, EXAMINING ATTORNEY



SN 77-728,778. IMAGINATION HOLDINGS PTY LTD, KENT TOWN, AUSTRALIA, FILED 5-4-2009.

BATTLE OF THE GENERATIONS

THE MARK CONSISTS OF STANDARD CHARACTERS WITHOUT CLAIM TO ANY PARTICULAR FONT, STYLE, SIZE, OR COLOR.

FOR TOYS, PLAYTHINGS AND GAMES, NAMELY, BOARD GAMES, PARTY GAMES AND PARLOR GAMES AND COMPONENT PIECES THEREOF FOR USE AS A SET AND SOLD AS A UNIT THEREWITH FOR PLAYING SUCH GAMES (U.S. CLS. 22, 23, 38 AND 50).

JANET LEE, EXAMINING ATTORNEY



SN 77-728,791. RUIZ, ANTONIO R., DBA NIGHT CLUB PRODUCTIONS, DALLAS, TX. FILED 5-4-2009.



THE MARK CONSISTS OF TWO STAR IMAGES; ONE ON EACH UPPER SIDE OF THE WORD "NIGHTCLUB".

FOR BOARD GAMES (U.S. CLS. 22, 23, 38 AND 50).
FIRST USE 1-28-2009; IN COMMERCE 3-1-2009.
HEATHER SAPP, EXAMINING ATTORNEY

CLASS 28—(Continued).

SN 77-736,047. ARCTICA STUDIOS, GLENDALE, CA. FILED 5-13-2009.

EXCAVATION ICE CAT

THE MARK CONSISTS OF STANDARD CHARACTERS WITHOUT CLAIM TO ANY PARTICULAR FONT, STYLE, SIZE, OR COLOR.

NO CLAIM IS MADE TO THE EXCLUSIVE RIGHT TO USE "CAT", APART FROM THE MARK AS SHOWN.

FOR BATTERY OPERATED ACTION TOYS; BOARD GAMES; ELECTRONIC ACTION TOYS; ELECTRONICALLY OPERATED TOY MOTOR VEHICLES; MECHANICAL ACTION TOYS; MOLDED TOY FIGURES; PARTY GAMES; PLUSH TOYS; PUZZLES; TOY ROBOTS; TOY VEHICLES (U.S. CLS. 22, 23, 38 AND 50).

BRIDGETT SMITH, EXAMINING ATTORNEY

CLASS 28—(Continued).

SN 77-736,317. ARCTICA STUDIOS, GLENDALE, CA. FILED 5-13-2009.

VECTOR 5

THE MARK CONSISTS OF STANDARD CHARACTERS WITHOUT CLAIM TO ANY PARTICULAR FONT, STYLE, SIZE, OR COLOR.

FOR BATTERY OPERATED ACTION TOYS; BOARD GAMES; ELECTRONIC ACTION TOYS; ELECTRONICALLY OPERATED TOY MOTOR VEHICLES; MECHANICAL ACTION TOYS; MOLDED TOY FIGURES; PARTY GAMES; PLUSH TOYS; PUZZLES; TOY ROBOTS; TOY VEHICLES (U.S. CLS. 22, 23, 38 AND 50).

BRIDGETT SMITH, EXAMINING ATTORNEY

SN 77-736,208. BELLAMAX INDUSTRIES, LLC, BOISE, ID. FILED 5-13-2009.

PAUCHAMA

THE MARK CONSISTS OF STANDARD CHARACTERS WITHOUT CLAIM TO ANY PARTICULAR FONT, STYLE, SIZE, OR COLOR.

FOR STUFFED AND PLUSH TOYS; TOY ANIMALS AND ACCESSORIES THEREFOR (U.S. CLS. 22, 23, 38 AND 50).

SALLY SHIH, EXAMINING ATTORNEY

SN 77-737,237. VOGIAS, DAVID A., FORT MYERS, FL. FILED 5-14-2009.

LOTTOBOARD

THE MARK CONSISTS OF STANDARD CHARACTERS WITHOUT CLAIM TO ANY PARTICULAR FONT, STYLE, SIZE, OR COLOR.

FOR HOLDERS SPECIALLY ADAPTED FOR LOTTERY SCRATCH-OFF TICKETS (U.S. CLS. 22, 23, 38 AND 50).

FRED MANDIR, EXAMINING ATTORNEY

SN 77-736,305. ARCTICA STUDIOS, GLENDALE, CA. FILED 5-13-2009.

CREVASSE SPIDER

THE MARK CONSISTS OF STANDARD CHARACTERS WITHOUT CLAIM TO ANY PARTICULAR FONT, STYLE, SIZE, OR COLOR.

NO CLAIM IS MADE TO THE EXCLUSIVE RIGHT TO USE "SPIDER", APART FROM THE MARK AS SHOWN.

FOR BATTERY OPERATED ACTION TOYS; BOARD GAMES; ELECTRONIC ACTION TOYS; ELECTRONICALLY OPERATED TOY MOTOR VEHICLES; MECHANICAL ACTION TOYS; MOLDED TOY FIGURES; PARTY GAMES; PLUSH TOYS; PUZZLES; TOY ROBOTS; TOY VEHICLES (U.S. CLS. 22, 23, 38 AND 50).

BRIDGETT SMITH, EXAMINING ATTORNEY

SN 77-739,801. POOLMASTER, INC., SACRAMENTO, CA. FILED 5-18-2009.

Poolcurrents

THE MARK CONSISTS OF STANDARD CHARACTERS WITHOUT CLAIM TO ANY PARTICULAR FONT, STYLE, SIZE, OR COLOR.

FOR INFLATABLE SWIMMING POOL TOYS, NAMELY, MATTRESSES, TUBES, RIDEABLES, LOUNGES, BOATS, REFRESHMENT FLOATS, AND BALLS (U.S. CLS. 22, 23, 38 AND 50).

MICHAEL SOUDERS, EXAMINING ATTORNEY

CLASS 28—(Continued).

SN 77-743,101. MCPHERSON, MATHEW A., NORWALK, VA.
FILED 5-22-2009.

LOGIC GRIP

THE MARK CONSISTS OF STANDARD CHARACTERS WITHOUT CLAIM TO ANY PARTICULAR FONT, STYLE, SIZE, OR COLOR.

NO CLAIM IS MADE TO THE EXCLUSIVE RIGHT TO USE "GRIP", APART FROM THE MARK AS SHOWN.

FOR ARCHERY BOWS (U.S. CLS. 22, 23, 38 AND 50).
TOBY BULLOFF, EXAMINING ATTORNEY



SN 77-743,103. SPELLING TELEVISION INC., STUDIO CITY, CA. FILED 5-22-2009.

MELROSE PLACE

THE MARK CONSISTS OF STANDARD CHARACTERS WITHOUT CLAIM TO ANY PARTICULAR FONT, STYLE, SIZE, OR COLOR.

OWNER OF U.S. REG. NOS. 1,821,796 AND 2,350,925.

FOR GAMES AND PLAYTHINGS, NAMELY, CARD GAMES, DARTS, DOLLS; PLUSH DOLLS; POSEABLE PLAY AND TOY ACTION FIGURES AND ACCESSORIES THEREOF; STAND ALONE VIDEO GAME MACHINES UTILIZING CD ROM'S, STAND ALONE VIDEO GAME MACHINES, STAND ALONE AUDIO OUTPUT GAME MACHINES, AND BOARD GAMES; SPORTING ARTICLES, NAMELY, GOLF CLUBS, BASEBALLS, FOOTBALLS, PADDLE BALLS, ACTIVITY BALLS, BASEBALL BATS; DECORATIONS FOR CHRISTMAS TREES; PLAYING CARDS, TOY MODEL HOBBY CRAFT KITS COMPOSED OF PLASTIC, VINYL AND RESIN MOLDS; JIGSAW AND MANIPULATIVE PUZZLES, TOY VEHICLES, YO-YOS, BALLOONS, TOY BANKS, COSTUME MASKS, HAND PUPPETS (U.S. CLS. 22, 23, 38 AND 50).

KRISTIN CARLSON, EXAMINING ATTORNEY



SN 77-744,735. SOFT AIR USA, INC., GRAPEVINE, TX. FILED 5-26-2009.

Model 416

THE MARK CONSISTS OF STANDARD CHARACTERS WITHOUT CLAIM TO ANY PARTICULAR FONT, STYLE, SIZE, OR COLOR.

FOR TOYS, NAMELY, TOY GUNS (U.S. CLS. 22, 23, 38 AND 50).

WILLIAM ROSSMAN, EXAMINING ATTORNEY

CLASS 28—(Continued).

SN 77-744,757. SOFT AIR USA, INC., GRAPEVINE, TX. FILED 5-26-2009.

SATURATOR

THE MARK CONSISTS OF STANDARD CHARACTERS WITHOUT CLAIM TO ANY PARTICULAR FONT, STYLE, SIZE, OR COLOR.

FOR TOYS, NAMELY, ELECTRIC WATER GUNS (U.S. CLS. 22, 23, 38 AND 50).

WILLIAM ROSSMAN, EXAMINING ATTORNEY



SN 77-745,898. SOFT AIR USA, INC., GRAPEVINE, TX. FILED 5-27-2009.

Stryke Zone

THE MARK CONSISTS OF STANDARD CHARACTERS WITHOUT CLAIM TO ANY PARTICULAR FONT, STYLE, SIZE, OR COLOR.

FOR TOYS, NAMELY, TOY GUNS THAT CAN PROPEL FOAM PROJECTILES (U.S. CLS. 22, 23, 38 AND 50).

WILLIAM ROSSMAN, EXAMINING ATTORNEY



SN 77-754,503. MCPHERSON, MATHEW A., NORWALK, WI. FILED 6-8-2009.

JEWEL

THE MARK CONSISTS OF STANDARD CHARACTERS WITHOUT CLAIM TO ANY PARTICULAR FONT, STYLE, SIZE, OR COLOR.

FOR ARCHERY BOWS (U.S. CLS. 22, 23, 38 AND 50).

TOBY BULLOFF, EXAMINING ATTORNEY

CLASS 28—(Continued).

SN 77-754,890. IMAGINATION HOLDINGS PTY LTD, KENT TOWN, AUSTRALIA, FILED 6-8-2009.

CELEBRITY

THE MARK CONSISTS OF STANDARD CHARACTERS WITHOUT CLAIM TO ANY PARTICULAR FONT, STYLE, SIZE, OR COLOR.

FOR TOYS, PLAYTHINGS AND GAMES, NAMELY, BOARD GAMES, PARTY GAMES AND PARLOR GAMES AND COMPONENT PIECES THEREOF FOR USE AS A SET AND SOLD AS A UNIT THEREWITH FOR PLAYING SUCH GAMES (U.S. CLS. 22, 23, 38 AND 50).
JANET LEE, EXAMINING ATTORNEY

SN 77-756,283. GREGG RITZ IP, LLC, STRATHAM, NH. FILED 6-10-2009.

BONE CRUSHER

THE MARK CONSISTS OF STANDARD CHARACTERS WITHOUT CLAIM TO ANY PARTICULAR FONT, STYLE, SIZE, OR COLOR.

FOR ARCHERY IMPLEMENTS, NAMELY, BOWS AND ARROWS FOR ARCHERY AND HUNTING (U.S. CLS. 22, 23, 38 AND 50).
KATHY DE JONGE, EXAMINING ATTORNEY

SN 77-759,887. MCPHERSON, MATHEW A., NORWALK, WI. FILED 6-15-2009.

PASSION

THE MARK CONSISTS OF STANDARD CHARACTERS WITHOUT CLAIM TO ANY PARTICULAR FONT, STYLE, SIZE, OR COLOR.

FOR ARCHERY BOWS (U.S. CLS. 22, 23, 38 AND 50).
TOBY BULLOFF, EXAMINING ATTORNEY

CLASS 28—(Continued).

SN 77-765,001. PRIORITIZE, LLC, SCOTTSDALE, AZ. FILED 6-22-2009.

WHAT'S YOUR TAKE?

THE MARK CONSISTS OF STANDARD CHARACTERS WITHOUT CLAIM TO ANY PARTICULAR FONT, STYLE, SIZE, OR COLOR.

FOR PARLOR GAMES (U.S. CLS. 22, 23, 38 AND 50).
INGA ERVIN, EXAMINING ATTORNEY

SN 77-765,021. PRIORITIZE, LLC, SCOTTSDALE, AZ. FILED 6-22-2009.

YOU NEVER KNOW WHERE YOUR CONVERSATIONS WILL GO

THE MARK CONSISTS OF STANDARD CHARACTERS WITHOUT CLAIM TO ANY PARTICULAR FONT, STYLE, SIZE, OR COLOR.

FOR PARLOR GAMES (U.S. CLS. 22, 23, 38 AND 50).
INGA ERVIN, EXAMINING ATTORNEY

SN 77-773,287. CALLAWAY GOLF COMPANY, CARLSBAD, CA. FILED 7-2-2009.

FT Hybrid

THE MARK CONSISTS OF STANDARD CHARACTERS WITHOUT CLAIM TO ANY PARTICULAR FONT, STYLE, SIZE, OR COLOR.

OWNER OF U.S. REG. NOS. 3,254,124, 3,308,267 AND OTHERS.
NO CLAIM IS MADE TO THE EXCLUSIVE RIGHT TO USE "HYBRID", APART FROM THE MARK AS SHOWN.
FOR GOLF BAGS (U.S. CLS. 22, 23, 38 AND 50).
HEATHER SAPP, EXAMINING ATTORNEY

CLASS 28—(Continued).

SN 77-773,392. CALLAWAY GOLF COMPANY, CARLSBAD, CA. FILED 7-2-2009.

Chev 18

THE MARK CONSISTS OF STANDARD CHARACTERS WITHOUT CLAIM TO ANY PARTICULAR FONT, STYLE, SIZE, OR COLOR.

OWNER OF U.S. REG. NO. 3,166,581.
FOR GOLF GLOVES (U.S. CLS. 22, 23, 38 AND 50).
HEATHER SAPP, EXAMINING ATTORNEY

SN 79-041,780. ECCO SKO A/S, DENMARK, FILED 7-17-2007.

ECCO

OWNER OF INTERNATIONAL REGISTRATION 0932445 DATED 7-17-2007, EXPIRES 7-17-2017.

OWNER OF U.S. REG. NOS. 3,155,456, 3,431,650 AND OTHERS.

THE ENGLISH TRANSLATION OF THE WORD "ECCO" IN THE MARK IS LOOK OR BEHOLD.

FOR GOLF BAGS WITH AND WITHOUT WHEELS, GOLF GLOVES, GOLF BALLS, GOLF TEES (U.S. CLS. 22, 23, 38 AND 50).

ZACHARY BELLO, EXAMINING ATTORNEY

SN 79-047,277. MICHELE CARTER-BUXTON, FRANCE, FILED 10-29-2007.

LETTER ROADS

THE MARK CONSISTS OF STANDARD CHARACTERS WITHOUT CLAIM TO ANY PARTICULAR FONT, STYLE, SIZE, OR COLOR.

OWNER OF INTERNATIONAL REGISTRATION 0946244 DATED 10-29-2007, EXPIRES 10-29-2017.

FOR PLAY MATS FOR USE WITH TOY VEHICLES (U.S. CLS. 22, 23, 38 AND 50).

ANGELA DUONG, EXAMINING ATTORNEY

CLASS 28—(Continued).

SN 79-068,555. SHIMANO INC, JAPAN, FILED 4-13-2009.



OWNER OF INTERNATIONAL REGISTRATION 1002052 DATED 4-13-2009, EXPIRES 4-13-2019.

THE MARK CONSISTS OF A STYLIZED LETTER "S" WITH A BEVELED EDGE AND PARTIAL SHADING OF THE MARK, AND A BACKGROUND INCLUDING TWO CONCENTRIC CIRCLES WITH DIFFERENT LINE WIDTHS AND A GRID PATTERN.

FOR FISHING REELS (U.S. CLS. 22, 23, 38 AND 50).
CAROLYN CATALDO, EXAMINING ATTORNEY

SN 79-068,720. SHIMANO INC., JAPAN, FILED 4-6-2009.

MIAKODA

THE MARK CONSISTS OF STANDARD CHARACTERS WITHOUT CLAIM TO ANY PARTICULAR FONT, STYLE, SIZE, OR COLOR.

PRIORITY DATE OF 3-17-2009 IS CLAIMED.

OWNER OF INTERNATIONAL REGISTRATION 1002525 DATED 4-6-2009, EXPIRES 4-6-2019.

THE ENGLISH TRANSLATION OF "MIAKODA" IN THE MARK IS A NATIVE AMERICAN TERM MEANING "POWER OF THE MOON".

FOR FISHING FLOATS; FISHING SINKERS; LANDING NETS FOR ANGLERS; FISHING LINES; FISHING REELS; FISHING RODS; FISHING RODS CASES; FISHING HOOKS; LURES FOR FISHING (U.S. CLS. 22, 23, 38 AND 50).

DAVID HOFFMAN, EXAMINING ATTORNEY

SN 79-069,103. SHIMANO INC, JAPAN, FILED 5-11-2009.

BAITRUNNER

THE MARK CONSISTS OF STANDARD CHARACTERS WITHOUT CLAIM TO ANY PARTICULAR FONT, STYLE, SIZE, OR COLOR.

OWNER OF INTERNATIONAL REGISTRATION 1003455 DATED 5-11-2009, EXPIRES 5-11-2019.

OWNER OF U.S. REG. NOS. 1,399,709 AND 2,455,328.

FOR FISHING FLOATS; FISHING SINKERS; LANDING NETS FOR ANGLERS; FISHING LINES; FISHING REELS; FISHING RODS; FISHING RODS CASES; FISHING HOOKS; LURES FOR FISHING (U.S. CLS. 22, 23, 38 AND 50).

CAROLYN CATALDO, EXAMINING ATTORNEY

CLASS 29—MEATS AND PROCESSED FOODS

SN 77-484,351. DIVINE BOVINE JERKY, INC., BEAUMONT, CA. FILED 5-27-2008.



OWNER OF U.S. REG. NOS. 2,552,640 AND 3,075,037.
THE MARK CONSISTS OF THE WORDING "DIVINE BOVINE IT'S GOBBLELICIOUS" WITHIN AN OVAL WITH TWO DIAMOND DESIGNS, WITHIN WHICH APPEARS A TURKEY WITH FEATHERS WEARING A TUXEDO WITH A BOW TIE, ABOVE WHICH APPEARS A HALO AGAINST A BACKGROUND, ALL OF WHICH APPEARS WITHIN TWO CONCENTRIC CIRCLES.

FOR JERKY (U.S. CL. 46).
ERIN FALK, EXAMINING ATTORNEY

CLASS 29—(Continued).

SN 77-529,623. MOTT'S LLP, RYE BROOK, NY. FILED 7-23-2008.



SN 77-529,341. OCEAN SPRAY CRANBERRIES, INC., LAKEVILLE-MIDDLEBORO, MA. FILED 7-23-2008.

CRANESSENCE

THE MARK CONSISTS OF STANDARD CHARACTERS WITHOUT CLAIM TO ANY PARTICULAR FONT, STYLE, SIZE, OR COLOR.

OWNER OF U.S. REG. NO. 3,419,838.
FOR DRIED FRUIT, YOGURT, YOGURT AND MILK BASED BEVERAGES CONTAINING FRUITS (U.S. CL. 46).

ROBERT STRUCK, EXAMINING ATTORNEY

OWNER OF U.S. REG. NO. 2,599,858.

THE LINING SHOWN IN THE UPPER LIP, BASE, AND HORIZONTAL AND VERTICAL BANDS IN THE DESIGN IS NOT PART OF THE MARK AND IS FOR SHADING PURPOSES ONLY. THE LINING SHOWN IN THE PANELS COMPRISING THE OUTER STRUCTURE OF THE PACKAGING IS A FEATURE OF THE MARK.

THE MARK CONSISTS OF A THREE-DIMENSIONAL CONFIGURATION OF PACKAGING FOR THE IDENTIFIED GOODS IN THE NATURE OF A ROUND CONTAINER WIDE AT THE TOP AND TAPERING SLIGHTLY TO THE BOTTOM WITH RIBBED AND STRIATED SIDES SUGGESTING THE APPEARANCE OF AN APPLE BARREL.

SEC. 2(F).

FOR APPLESAUCE (U.S. CL. 46).

FIRST USE 7-9-2001; IN COMMERCE 7-9-2001.

MICHAEL GAFFAR, EXAMINING ATTORNEY

CLASS 29—(Continued).

SN 77-554,035. SILVER FERN FARMS LIMITED, DUNEDIN, NEW ZEALAND, FILED 8-22-2008.



PRIORITY CLAIMED UNDER SEC. 44(D) ON NEW ZEALAND APPLICATION NO. 785101, FILED 2-29-2008, REG. NO. 785101, DATED 2-29-2008, EXPIRES 2-28-2018.

THE MARK CONSISTS OF A REPRESENTATION OF A FERN WITHIN A CIRCULAR DESIGN.

FOR MEAT, FISH, POULTRY AND GAME; SMALL GOODS, NAMELY, JERKY, BEEF JERKY, PROCESSED MEAT, DRIED MEAT, LUNCHEON MEATS, SALAMI, SAUSAGES; EDIBLE PRODUCTS MADE FROM OR INCLUDING MEAT IN THIS CLASS, NAMELY, PATES, MEAT TERRINES, MEAT JELLIES, MEAT-BASED SNACK FOODS, MEAT EXTRACTS, MEAT-BASED SPREADS, MEAT BALLS, FROZEN MEALS CONSISTING PRIMARILY OF MEAT, PACKAGED MEALS CONSISTING PRIMARILY OF MEAT, PREPARED MEALS CONSISTING PRIMARILY OF MEAT, BEEF PATTIES, UNCOOKED HAMBURGER PATTIES, HAMBURGER MEAT; EDIBLE OILS AND FATS (U.S. CL. 46).
PRISCILLA MILTON, EXAMINING ATTORNEY

CLASS 29—(Continued).

SN 77-583,900. CHUDLEIGH'S LTD., MILTON, CANADA, FILED 10-2-2008.

BALERT

THE MARK CONSISTS OF STANDARD CHARACTERS WITHOUT CLAIM TO ANY PARTICULAR FONT, STYLE, SIZE, OR COLOR.

FOR FRUIT AND DAIRY BASED SNACK CUPS, EXCLUDING ICE CREAM, ICE MILK, AND FROZEN YOGURT (U.S. CL. 46).

JEFFREY LOOK, EXAMINING ATTORNEY

SN 77-591,783. SAJO INDUSTRIES CO., LTD., SEOUL, REPUBLIC OF KOREA, FILED 10-13-2008.

사조

SN 77-577,843. SOCIETE DES CAVES ET DES PRODUCTEURS REUNIS DE ROQUEFORT SOCIETE DES CAVES (SCPR), ROQUEFORT SUR SOULZON, FRANCE, FILED 9-24-2008.



OWNER OF U.S. REG. NO. 1,416,818.

NO CLAIM IS MADE TO THE EXCLUSIVE RIGHT TO USE "FETA", APART FROM THE MARK AS SHOWN.

THE COLOR(S) GREEN AND WHITE IS/ARE CLAIMED AS A FEATURE OF THE MARK.

THE MARK CONSISTS OF GREEN AND WHITE, WITH THE WORDS "VALBRESO FETA" IN STYLIZED LETTERING, APPEARING BENEATH A STYLIZED GOAT HEAD DESIGN, THE COLOR GREEN APPEARS AS THE BACKGROUND, IN THE OUTLINE OF THE GOAT AND THE GOAT'S FACIAL FEATURES, AND THE COLOR WHITE APPEARS IN THE WORDS "VALBRESO FETA", ON THE HORIZONTAL LINES BORDERING THE WORDS "VALBRESO FETA" AND ON THE DESIGN OF THE GOAT HEAD.

FOR MILK AND DAIRY PRODUCTS, EXCLUDING ICE CREAM, ICE MILK AND FROZEN YOGURT (U.S. CL. 46).

HEATHER THOMPSON, EXAMINING ATTORNEY

THE MARK CONSISTS OF SAJO IN KOREAN CHARACTERS.

THE NON-LATIN CHARACTERS IN THE MARK TRANSLITERATE TO SAJO AND THIS MEANS THE TREND (CURRENT) OF THOUGHT IN ENGLISH.

FOR PORK; PORK CUTLETS; SAUSAGES; BEEF JERKY; HAM; OIL FOR FOOD, NAMELY, PERILLA OIL, CORN OIL, OLIVE OIL, SESAME OIL, SOYBEAN OIL, AND SUNFLOWER OIL; FISH, NOT LIVE, NAMELY, MACKERELS, SAURY, SALT-FERMENTED COD ROE, SALT-FERMENTED SEA URCHIN ROE AND SALTED SALMON ROE; SWEET LAVAR; DRIED FISH AND SHELLFISH; STEAMED OR TOASTED CAKES OF FISH PASTE; CANNED AND BOTTLED FISHERIES PRODUCTS, NAMELY, FISH, SEASHELLS, ROE, SEAWEED (U.S. CL. 46).

KATHLEEN M. VANSTON, EXAMINING ATTORNEY

CLASS 29—(Continued).

SN 77-594,855. NATIONS BEST MEAT WHOLESALERS, INC., BRONX, NY. FILED 10-17-2008.

NATIONS BEST

THE MARK CONSISTS OF STANDARD CHARACTERS WITHOUT CLAIM TO ANY PARTICULAR FONT, STYLE, SIZE, OR COLOR.

SEC. 2(F).

FOR MEATS, POULTRY AND GAME, NAMELY, LUNCHEON MEATS, PASTRAMI, CORNED BEEF, ROAST BEEF, BRISKET, TONGUE, HAMBURGER MEAT, PREPARED MEAT, SEASONED MEAT AND POULTRY; FROZEN MEAT AND GAME, PROCESSED MEAT, NAMELY, TURKEY, LAMB AND VEAL, PRESERVED MEATS AND SAUSAGES, MARINATED POULTRY (U.S. CL. 46).

FIRST USE 12-31-1978; IN COMMERCE 12-31-1978.
LOURDES AYALA, EXAMINING ATTORNEY

SN 77-595,858. CAPITOL WHOLESALE MEATS, INC., MCCOOK, IL. FILED 10-20-2008.

DIAMANTI

THE MARK CONSISTS OF STANDARD CHARACTERS WITHOUT CLAIM TO ANY PARTICULAR FONT, STYLE, SIZE, OR COLOR.

THE ENGLISH TRANSLATION OF "DIAMANTI" IN THE MARK IS "DIAMOND".

FOR MEAT PRODUCTS, NAMELY, GYROS, BEEF AND PORK PRODUCTS, NAMELY, GYROS MEAT, BEEF AND PORK (U.S. CL. 46).

JAMES STEIN, EXAMINING ATTORNEY

SN 77-600,050. FILTHY FOOD COMPANY LLC, BOCA RATON, FL. FILED 10-24-2008.



THE MARK CONSISTS OF A DEPICTION OF A PITTED OLIVE AND A PICKLE PARTIALLY INSERTED IN THE OLIVE.

FOR EDIBLE BEVERAGE AND DRINK GARNISHES, NAMELY, PICKLES, CORNICHONS, GHERKINS, PROCESSED OLIVES, STUFFED OLIVES, PROCESSED ONIONS, AND PROCESSED CHERRIES (U.S. CL. 46).

LINDA LAVACHE, EXAMINING ATTORNEY

CLASS 29—(Continued).

SN 77-616,888. COUNTRY FRESH AUSTRALASIA PTY LIMITED, ARMIDALE, AUSTRALIA, FILED 11-18-2008.



NO CLAIM IS MADE TO THE EXCLUSIVE RIGHT TO USE "FRESH AUSTRALIA", APART FROM THE MARK AS SHOWN.

THE MARK CONSISTS OF A STYLIZED DRAWING OF THE SUN RISING OVER A HILL, ALL ABOVE THE WORDS "COUNTRY FRESH AUSTRALIA".

FOR MEAT AND MEAT PRODUCTS, NAMELY, LAMB, MUTTON AND GOAT MEAT (U.S. CL. 46).

FIRST USE 11-0-2005; IN COMMERCE 11-0-2005.
VIVIAN MICZNIK FIRST, EXAMINING ATTORNEY

SN 77-619,597. HARRY O. HAHN SEAFOOD, INC., DBA ADELPHIA SEAFOOD COMPANY, WEST LAWN, PA. FILED 11-21-2008.

Best Choice for Quality

THE MARK CONSISTS OF STANDARD CHARACTERS WITHOUT CLAIM TO ANY PARTICULAR FONT, STYLE, SIZE, OR COLOR.

FOR SEAFOOD (U.S. CL. 46).

FIRST USE 0-0-1985; IN COMMERCE 0-0-1985.
LINDA E. BLOHM, EXAMINING ATTORNEY

SN 77-622,167. MM VITAOILS SDN BHD, SHAH ALAM, SELANGOR, MALAYSIA, FILED 11-26-2008.



OWNER OF U.S. REG. NO. 3,474,198.

NO CLAIM IS MADE TO THE EXCLUSIVE RIGHT TO USE "HALALOILS", APART FROM THE MARK AS SHOWN.

THE COLOR(S) ORANGE, YELLOW AND WHITE IS/ARE CLAIMED AS A FEATURE OF THE MARK.

THE MARK CONSISTS OF AN OBLONG WITH THE

CLASS 29—(Continued).

WORDS "HALALOILS" INSIDE OF IT. THE WORD "HALAL" IS IN WHITE SURROUNDED BY AN ORANGE BACKGROUND, AND THE WORD "OILS" IS ORANGE SURROUNDED BY A WHITE BACKGROUND. AROUND BOTH THE ORANGE AND WHITE BACKGROUNDS IS AN ORANGE LINE THAT IS SURROUNDED BY A LINE THAT IS ORANGE ALONG THE TOP EDGE OF THE OBLONG, AND YELLOW AROUND THE SIDES AND BOTTOM EDGE OF THE OBLONG, SURROUNDED BY AN ORANGE LINE AROUND THE ENTIRE OUTSIDE OF THE OBLONG.

FOR FOOD PRODUCTS WHICH ARE PERMISSIBLE ACCORDING TO ISLAMIC LAW, NAMELY, EDIBLE OIL, COOKING OIL, MARGARINE, VEGETABLE GHEE, VEGETABLE EDIBLE OIL, OLIVE COOKING OIL, SALAD OIL, SHORTENING (U.S. CL. 46).

FIRST USE 10-20-2008; IN COMMERCE 10-20-2008.
SARA THOMAS, EXAMINING ATTORNEY

SN 77-640,654. MARKON COOPERATIVE, INC., SALINAS, CA. FILED 12-29-2008.

READY SET SERVE

THE MARK CONSISTS OF STANDARD CHARACTERS WITHOUT CLAIM TO ANY PARTICULAR FONT, STYLE, SIZE, OR COLOR.

OWNER OF U.S. REG. NOS. 2,150,966 AND 2,155,013.
FOR PROCESSED PRODUCE, NAMELY, FRUITS AND VEGETABLES (U.S. CL. 46).
FIRST USE 5-1-1996; IN COMMERCE 5-1-1996.
MEGHAN REINHART, EXAMINING ATTORNEY

SN 77-656,404. KOREAN KORNER, INC., SILVER SPRING, MD. FILED 1-26-2009.



t h e b e s t

NO CLAIM IS MADE TO THE EXCLUSIVE RIGHT TO USE "FOOD" AND "THE BEST", APART FROM THE MARK AS SHOWN.

THE MARK CONSISTS OF THE WORDING "K FOOD" INSCRIBED IN AN OVAL, BELOW WHICH IS THE WORDING "THE BEST".

FOR TOFU (U.S. CL. 46).
CHRISTINA SOBRAL, EXAMINING ATTORNEY

CLASS 29—(Continued).

SN 77-666,545. REINHART FOODSERVICE, L.L.C., LA CROSSE, WI. FILED 2-9-2009.

SILVERBROOK

THE MARK CONSISTS OF STANDARD CHARACTERS WITHOUT CLAIM TO ANY PARTICULAR FONT, STYLE, SIZE, OR COLOR.

OWNER OF U.S. REG. NOS. 2,683,927, 2,818,389 AND 2,950,168.

FOR MEATS, NAMELY, CHICKEN; DAIRY PRODUCTS, EXCLUDING ICE CREAM, ICE MILK AND FROZEN YOGURT; BUTTER; MARGARINE; EGGS; EGG PRODUCTS NAMELY, LIQUID WHOLE EGGS, EGG WHITES AND EGG YOLKS (U.S. CL. 46).

FIRST USE 8-0-2006; IN COMMERCE 8-0-2006.
MARK PILARO, EXAMINING ATTORNEY

SN 77-670,972. ALLIED IMPORTS INC., NEW YORK, NY. FILED 2-15-2009.



NO CLAIM IS MADE TO THE EXCLUSIVE RIGHT TO USE THE NON-LATIN CHARACTERS THAT MEAN "PRODUCT", APART FROM THE MARK AS SHOWN.

THE COLOR(S) YELLOW, GREEN AND BLACK IS/ARE CLAIMED AS A FEATURE OF THE MARK.

THE MARK CONSISTS OF THREE SCATTERED GREEN LEAVES OUTLINED IN BLACK ON TOP OF THE LEFT SIDE OF A GREEN RECTANGLE WITH A YELLOW SMALLER DIAMOND OVER THE RIGHT UPPER PART OF THE RECTANGLE. THE STYLIZED ASIAN CHARACTERS APPEAR OVER THE DIAMOND AND EXTEND OUT OVER PART OF THE RECTANGLE.

THE NON-LATIN CHARACTERS IN THE MARK TRANSLITERATE TO "ZHEN PIN WEI" AND THIS MEANS GOOD/PRECIOUS PRODUCT TASTE IN ENGLISH.

FOR PROCESSED FOODS, NAMELY, VEGETABLE, FRUIT, MEAT, POULTRY, FISH, SEAFOOD, DRIED FOOD, NAMELY, MUSHROOM, NUTS AND PREPARED ENTREES CONSISTING PRIMARILY OF MEAT OR VEGETABLE (U.S. CL. 46).

FIRST USE 3-1-1997; IN COMMERCE 3-1-1997.
KOURTNEE HODGES, EXAMINING ATTORNEY

CLASS 29—(Continued).

SN 77-671,509. CONSERVAS Y CONGELADOS DE MEXICO SA DE CV, TOCHTEPEC, PUEBLA, MEXICO, FILED 2-16-2009.



THE MARK CONSISTS OF THE WORD "VALLEMEX" PLACED ON A BACKGROUND BANNER. ABOVE THE WORDING APPEAR TWO OVERLAPPING SEMI CIRCLES AND BELOW THE WORDING IS A STYLIZED UNDERLINE. THE ENTIRE MARK IS ENCLOSED IN A RECTANGLE.

FOR FROZEN FRUITS; FROZEN VEGETABLES; PICKLED VEGETABLES; PICKLES; PROCESSED CACTUS FOR FOOD PURPOSES; PROCESSED FRUITS; PROCESSED PEPPERS; PROCESSED VEGETABLES; VEGETABLES, NAMELY, CANNED HUITLACOCHE IN VEGETABLE OIL; PONCHE, NAMELY, A VEGETABLE BASED FOOD BEVERAGE (U.S. CL. 46).

COURTNEY MCCORMICK, EXAMINING ATTORNEY

SN 77-680,156. LANDS AND BUILDING, S.L., 28043 MADRID, SPAIN, FILED 2-27-2009.

ABADIA BLANCA

THE MARK CONSISTS OF STANDARD CHARACTERS WITHOUT CLAIM TO ANY PARTICULAR FONT, STYLE, SIZE, OR COLOR.

THE ENGLISH TRANSLATION OF "ABADIA BLANCA" IS WHITE ABBEY.

FOR EDIBLE OILS AND CHEESES (U.S. CL. 46).
FRANK LATTUCA, EXAMINING ATTORNEY

SN 77-681,506. GROBER INC., CAMBRIDGE, ONTARIO, CANADA, FILED 3-2-2009.

SIMPLY VEAL

THE MARK CONSISTS OF STANDARD CHARACTERS WITHOUT CLAIM TO ANY PARTICULAR FONT, STYLE, SIZE, OR COLOR.

NO CLAIM IS MADE TO THE EXCLUSIVE RIGHT TO USE "VEAL", APART FROM THE MARK AS SHOWN.

FOR VEAL; PROCESSED MEAT, NAMELY, VEAL; AND FROZEN VEAL CUTLETS (U.S. CL. 46).
TRACY WHITTAKER-BROWN, EXAMINING ATTORNEY

CLASS 29—(Continued).

SN 77-693,826. EDIBLE ARRANGEMENTS, LLC, WALLINGFORD, CT. FILED 3-18-2009.

MANGO KIWI FESTIVAL

THE MARK CONSISTS OF STANDARD CHARACTERS WITHOUT CLAIM TO ANY PARTICULAR FONT, STYLE, SIZE, OR COLOR.

OWNER OF U.S. REG. NOS. 3,434,395 AND 3,539,967.
NO CLAIM IS MADE TO THE EXCLUSIVE RIGHT TO USE "MANGO KIWI", APART FROM THE MARK AS SHOWN.

FOR FRESH FRUIT CUT INTO FLOWER SHAPES AND ARRANGED IN CONTAINERS AS FLORAL DESIGNS; PROCESSED FRUITS; ARRANGEMENTS MADE OF FRESH PROCESSED FRUIT (U.S. CL. 46).

FIRST USE 12-11-2008; IN COMMERCE 3-17-2009.
CHARLES L. JENKINS, EXAMINING ATTORNEY

SN 77-702,516. PICK A PECK PICKLES, INC., YUBA CITY, CA. FILED 3-30-2009.

Pick a Peck Pickles

THE MARK CONSISTS OF STANDARD CHARACTERS WITHOUT CLAIM TO ANY PARTICULAR FONT, STYLE, SIZE, OR COLOR.

NO CLAIM IS MADE TO THE EXCLUSIVE RIGHT TO USE "PICKLES", APART FROM THE MARK AS SHOWN.

FOR PICKLED VEGETABLES (U.S. CL. 46).
NELSON SNYDER, EXAMINING ATTORNEY

SN 77-703,541. SURAM TRADING CORPORATION, INC., CORAL GABLES, FL. FILED 3-31-2009.



NO CLAIM IS MADE TO THE EXCLUSIVE RIGHT TO USE "TIGER", APART FROM THE MARK AS SHOWN.

THE MARK CONSISTS OF THE WORDS "ROYAL TIGER" IN ALL CAPITALIZED LETTERS. THE "R" AND THE "T" ARE SLIGHTLY LARGER THAN THE OTHER LETTERS. THERE IS A "FLEUR-DE-LIS" SYMBOL INSIDE THE LETTER "O".

FOR SHRIMP (U.S. CL. 46).
FIRST USE 9-1-1996; IN COMMERCE 9-1-1996.
WANDA KAY PRICE, EXAMINING ATTORNEY

CLASS 29—(Continued).

SN 77-706,247. ASMAR, NAWAL, DBA MAMA ALIA'S KITCHEN, UNION CITY, NJ. FILED 4-3-2009.

MAMA ALIA'S KITCHEN

THE MARK CONSISTS OF STANDARD CHARACTERS WITHOUT CLAIM TO ANY PARTICULAR FONT, STYLE, SIZE, OR COLOR.

THE NAME(S), PORTRAIT(S), AND/OR SIGNATURE(S) SHOWN IN THE MARK IDENTIFIES "ALIA", WHOSE CONSENT(S) TO REGISTER IS MADE OF RECORD.

FOR HUMMUS, BABA GHANNOUJ, AND EGGPLANT SPREAD (U.S. CL. 46).

FIRST USE 4-0-2004; IN COMMERCE 4-0-2004.

DEIRDRE ROBERTSON, EXAMINING ATTORNEY

SN 77-707,512. CATANIA SPAGNA CORPORATION, AYER, MA. FILED 4-6-2009.

MARCONI NATURALS

THE MARK CONSISTS OF STANDARD CHARACTERS WITHOUT CLAIM TO ANY PARTICULAR FONT, STYLE, SIZE, OR COLOR.

OWNER OF U.S. REG. NO. 1,613,086.

NO CLAIM IS MADE TO THE EXCLUSIVE RIGHT TO USE "NATURALS", APART FROM THE MARK AS SHOWN.

FOR EDIBLE OILS, NAMELY, SAFFLOWER, CANOLA, RICE BRAN, SUNFLOWER, OLIVE, SOYBEAN, GRAPSEED AND SESAME OILS (U.S. CL. 46).

FIRST USE 3-16-2009; IN COMMERCE 3-16-2009.

SETH A. RAPPAPORT, EXAMINING ATTORNEY

SN 77-717,137. PROCOPE LLC, WILMINGTON, DE. FILED 4-20-2009.

CASA DI PROCOPE

THE MARK CONSISTS OF STANDARD CHARACTERS WITHOUT CLAIM TO ANY PARTICULAR FONT, STYLE, SIZE, OR COLOR.

OWNER OF U.S. REG. NO. 3,528,686.

THE ENGLISH TRANSLATION OF "CASA DI" IN THE MARK IS HOUSE OF.

FOR CANNED TOMATOES (U.S. CL. 46).

FIRST USE 11-8-2007; IN COMMERCE 11-8-2007.

GENE MACIOL, EXAMINING ATTORNEY

CLASS 29—(Continued).

SN 77-717,361. PRODUCTORES DEL MAR DE MEXICO, S.A. DE C.V., MAZATLAN, MEXICO, FILED 4-20-2009.

MSP BLUE SHRIMP

THE MARK CONSISTS OF STANDARD CHARACTERS WITHOUT CLAIM TO ANY PARTICULAR FONT, STYLE, SIZE, OR COLOR.

NO CLAIM IS MADE TO THE EXCLUSIVE RIGHT TO USE "BLUE SHRIMP", APART FROM THE MARK AS SHOWN.

FOR SHRIMP (U.S. CL. 46).

MATTHEW PAPPAS, EXAMINING ATTORNEY

SN 77-720,307. FOUR SEASONS DAIRY, INC., BROOKLYN, NY. FILED 4-23-2009.



NO CLAIM IS MADE TO THE EXCLUSIVE RIGHT TO USE "ODESSKAYA BRINZA", APART FROM THE MARK AS SHOWN.

THE COLOR(S) RED, BLUE, PURPLE, WHITE AND BLACK IS/ARE CLAIMED AS A FEATURE OF THE MARK.

THE MARK CONSISTS OF THE WORDS "ODESSKAYA BRINZA" IN BLUE WITH A RED OUTLINE; A SAILBOAT IN RED WITH A SAIL IN BLUE-PURPLE AND WHITE; TWO BLACK AND WHITE COWS FACING IN OPPOSITION DIRECTIONS; ALL ON A WHITE BACKGROUND INSIDE A RED CIRCLE.

THE ENGLISH TRANSLATION OF ODESSKAYA IN THE MARK IS "ODESSA", AND THE OVERALL MARK MEANS "ODESSA STYLE BRINZA CHEESE".

FOR CURD CHEESE AND FETA CHEESE (U.S. CL. 46).

FIRST USE 1-5-1999; IN COMMERCE 1-25-1999.

SUSAN LESLIE DUBOIS, EXAMINING ATTORNEY

CLASS 29—(Continued).

SN 77-722,579. LIGURIA FOODS, INC., HUMBOLDT, IA.
FILED 4-26-2009.

Gratifica

THE MARK CONSISTS OF STANDARD CHARACTERS
WITHOUT CLAIM TO ANY PARTICULAR FONT, STYLE,
SIZE, OR COLOR.

THE ENGLISH TRANSLATION OF "GRATIFICA" IS
"GRATIFYING".

FOR MEAT (U.S. CL. 46).

FIRST USE 1-1-1974; IN COMMERCE 1-1-1974.

DOUGLAS LEE, EXAMINING ATTORNEY

SN 77-722,748. GREEN PASTURE PRODUCTS, LLC,
O'NEILL, NE. FILED 4-27-2009.

GREEN PASTURE'S

THE MARK CONSISTS OF STANDARD CHARACTERS
WITHOUT CLAIM TO ANY PARTICULAR FONT, STYLE,
SIZE, OR COLOR.

FOR EDIBLE OILS (U.S. CL. 46).

FIRST USE 4-1-2004; IN COMMERCE 4-1-2004.

LAKEISHA LEWIS, EXAMINING ATTORNEY

SN 77-722,803. GREEN PASTURE PRODUCTS, LLC,
O'NEILL, NE. FILED 4-27-2009.

BLUE ICE

THE MARK CONSISTS OF STANDARD CHARACTERS
WITHOUT CLAIM TO ANY PARTICULAR FONT, STYLE,
SIZE, OR COLOR.

FOR EDIBLE OILS (U.S. CL. 46).

FIRST USE 4-1-2004; IN COMMERCE 4-1-2004.

LAKEISHA LEWIS, EXAMINING ATTORNEY

CLASS 29—(Continued).

SN 77-722,882. GLANBIA PLC, KILKENNY, IRELAND,
FILED 4-27-2009.

ENERVOLT

THE MARK CONSISTS OF STANDARD CHARACTERS
WITHOUT CLAIM TO ANY PARTICULAR FONT, STYLE,
SIZE, OR COLOR.

FOR WHEY FOR USE AS FOOD AND BEVERAGE
INGREDIENTS (U.S. CL. 46).

ALEX KEAM, EXAMINING ATTORNEY

SN 77-723,573. WILLIAMS, CHRISTIAN A., SAN MATEO,
CA. FILED 4-28-2009.

BACONE

THE MARK CONSISTS OF STANDARD CHARACTERS
WITHOUT CLAIM TO ANY PARTICULAR FONT, STYLE,
SIZE, OR COLOR.

FOR BACON (U.S. CL. 46).

KATHERINE CHANG, EXAMINING ATTORNEY

SN 77-724,708. CAJUN FUNDING CORPORATION, ATLANTA,
GA. FILED 4-29-2009.

YOU KNOW WHAT GOOD IS.

THE MARK CONSISTS OF STANDARD CHARACTERS
WITHOUT CLAIM TO ANY PARTICULAR FONT, STYLE,
SIZE, OR COLOR.

OWNER OF U.S. REG. NO. 3,558,244.

FOR FOOD PRODUCTS, NAMELY, CHICKEN, FISH,
BEEF, COLE SLAW, AND COOKED VEGETABLES,
NAMELY, POTATOES, OKRA, CORN, JALAPENO PEPPERS,
AND COLLARD GREENS; PREPARED CHICKEN
MEALS (U.S. CL. 46).

GEORGE LORENZO, EXAMINING ATTORNEY

CLASS 29—(Continued).

SN 77-724,986. IBE BUSINESS ENTERPRISE AG, ZUG, SWITZERLAND, FILED 4-29-2009.



THE COLOR(S) WHITE, GRAY, BLACK, BLUE, PINK, RED, AND PEACH IS/ARE CLAIMED AS A FEATURE OF THE MARK.

THE MARK CONSISTS OF A HUMANIZED DROP OF MILK IN SHADES OF GRAY AND WHITE, WITH BLACK FACIAL FEATURES. THE CHARACTER HAS A RED TONGUE, BLACK, WHITE AND BLUE PUPILS, PINK SHADING BENEATH THE EYES, AND RED, PEACH AND WHITE SHOES.

FOR DAIRY PRODUCTS EXCLUDING ICE CREAM, ICE MILK AND FROZEN YOGURT (U.S. CL. 46).
FIRST USE 11-30-2007; IN COMMERCE 11-30-2007.
LINDSEY RUBIN, EXAMINING ATTORNEY

CLASS 29—(Continued).

SN 77-725,255. BORGES USA, INC., FRESNO, CA. FILED 4-29-2009.

CANNONBALLS

THE MARK CONSISTS OF STANDARD CHARACTERS WITHOUT CLAIM TO ANY PARTICULAR FONT, STYLE, SIZE, OR COLOR.

FOR PROCESSED OLIVES (U.S. CL. 46).
TAMARA FRAZIER, EXAMINING ATTORNEY

SN 77-725,718. THE PARACOL COMPANY, DORAL, FL. FILED 4-30-2009.



THE MARK CONSISTS OF THE TERM "PARACOL" INSIDE AN OVAL.

FOR HEN EGGS (U.S. CL. 46).
JIM RINGLE, EXAMINING ATTORNEY

SN 77-725,014. IBE BUSINESS ENTERPRISE AG, ZUG, SWITZERLAND, FILED 4-29-2009.



THE COLOR(S) WHITE, GRAY, BLACK, BLUE, PINK, RED, YELLOW, ORANGE AND GREEN IS/ARE CLAIMED AS A FEATURE OF THE MARK.

THE MARK CONSISTS OF A HUMANIZED DROP OF MILK IN SHADES OF GRAY AND WHITE, WITH BLACK FACIAL FEATURES. THE CHARACTER HAS A RED TONGUE, BLACK, WHITE AND BLUE PUPILS, PINK SHADING BENEATH THE EYES, RED AND WHITE SHOES, AND RIDES A YELLOW AND ORANGE SURFBOARD WITH GREEN STRIPES.

FOR DAIRY PRODUCTS EXCLUDING ICE CREAM, ICE MILK AND FROZEN YOGURT (U.S. CL. 46).
FIRST USE 11-30-2007; IN COMMERCE 11-30-2007.
LINDSEY RUBIN, EXAMINING ATTORNEY

SN 77-726,404. ECCOFISH SEAFOOD, S.A., GUAYAS, ECUADOR, FILED 4-30-2009.



THE COLOR(S) BLUE IS/ARE CLAIMED AS A FEATURE OF THE MARK.

THE MARK CONSISTS OF A STYLIZED BLUE FISH APPEARING ABOVE THE WORD "ECCOFISH" WRITTEN IN A STYLIZED BLUE FONT.

FOR FISH (U.S. CL. 46).
FIRST USE 10-1-2008; IN COMMERCE 4-1-2009.
HANNO RITTNER, EXAMINING ATTORNEY

CLASS 29—(Continued).

SN 77-726,903. SHER, HOWARD, CLAYTON, MO. FILED 5-1-2009.

WHATAYA NUTS

THE MARK CONSISTS OF STANDARD CHARACTERS WITHOUT CLAIM TO ANY PARTICULAR FONT, STYLE, SIZE, OR COLOR.

FOR ALL-NATURAL SNACK FOOD, NAMELY, FLAVORED NUT CLUSTERS (U.S. CL. 46).
MIDGE BUTLER, EXAMINING ATTORNEY

SN 77-726,957. LAND O' FROST, INC., LANSING, IL. FILED 5-1-2009.

WHAT GREAT TASTE IS ALL ABOUT

THE MARK CONSISTS OF STANDARD CHARACTERS WITHOUT CLAIM TO ANY PARTICULAR FONT, STYLE, SIZE, OR COLOR.

FOR PROCESSED MEAT AND POULTRY PRODUCTS, NAMELY, COOKED AND SLICED CHICKEN, PORK, BEEF AND TURKEY (U.S. CL. 46).
EMILY CHUO, EXAMINING ATTORNEY

SN 77-727,509. THE TAYLOR GROUP, INC., GLENDALE, CO. FILED 5-1-2009.

SAM-MADE

THE MARK CONSISTS OF STANDARD CHARACTERS WITHOUT CLAIM TO ANY PARTICULAR FONT, STYLE, SIZE, OR COLOR.

FOR POTATO CHIPS (U.S. CL. 46).
FIRST USE 1-1-2003; IN COMMERCE 1-1-2003.
STEVEN R. FOSTER, EXAMINING ATTORNEY

CLASS 29—(Continued).

SN 77-736,962. GENERAL MILLS, INC., MINNEAPOLIS, MN. FILED 5-14-2009.

WICKED WEBS

THE MARK CONSISTS OF STANDARD CHARACTERS WITHOUT CLAIM TO ANY PARTICULAR FONT, STYLE, SIZE, OR COLOR.

FOR FRUIT-BASED SNACK FOOD (U.S. CL. 46).
CHARLES L. JENKINS, EXAMINING ATTORNEY

SN 77-746,996. COUNTRY CREEK FARMS, LLC, ROGERS, AR. FILED 5-28-2009.



NO CLAIM IS MADE TO THE EXCLUSIVE RIGHT TO USE "HUEVOS DE CALIDAD", APART FROM THE MARK AS SHOWN.

THE MARK CONSISTS OF AN ILLUSTRATION OF A MISSION WITHIN AN OVAL-SHAPED BACKGROUND WITH A BANNER BELOW AND IN FRONT BEARING THE WORDS "HUEVOS DE CALIDAD".

THE ENGLISH TRANSLATION OF "HUEVOS DE CALIDAD" IN THE MARK IS EGGS OF QUALITY.
FOR EGGS (U.S. CL. 46).

FIRST USE 9-1-2008; IN COMMERCE 9-1-2008.
SARA THOMAS, EXAMINING ATTORNEY

SN 77-754,197. PROMARK BRANDS INC., MERIDIAN, ID. FILED 6-8-2009.

PERFECT SHRED

THE MARK CONSISTS OF STANDARD CHARACTERS WITHOUT CLAIM TO ANY PARTICULAR FONT, STYLE, SIZE, OR COLOR.

NO CLAIM IS MADE TO THE EXCLUSIVE RIGHT TO USE "SHRED", APART FROM THE MARK AS SHOWN.
FOR PROCESSED POTATOES (U.S. CL. 46).
RENEE MCCRAY, EXAMINING ATTORNEY

CLASS 29—(Continued).

SN 77-759,614. FLIPSIDE DESIGN, LLC, CARMEL, CA.
FILED 6-15-2009.

Mini
Mega
Greens

THE MARK CONSISTS OF STANDARD CHARACTERS WITHOUT CLAIM TO ANY PARTICULAR FONT, STYLE, SIZE, OR COLOR.

NO CLAIM IS MADE TO THE EXCLUSIVE RIGHT TO USE "GREENS", APART FROM THE MARK AS SHOWN. FOR SALADS CONSISTING OF FRESH PRODUCE, VEGETABLES, WHOLE AND FRESH CUT GREENS (U.S. CL. 46).

FIRST USE 5-15-2009; IN COMMERCE 5-15-2009.
TINA KUAN, EXAMINING ATTORNEY

SN 77-759,966. JAMBA JUICE COMPANY, EMERYVILLE, CA. FILED 6-15-2009.

JAMBA

THE MARK CONSISTS OF STANDARD CHARACTERS WITHOUT CLAIM TO ANY PARTICULAR FONT, STYLE, SIZE, OR COLOR.

OWNER OF U.S. REG. NOS. 2,097,875, 3,375,313 AND OTHERS.

FOR PACKAGED SMOOTHIE KIT CONSISTING PRIMARILY OF FROZEN FRUIT AND FROZEN FRUIT AND YOGURT (U.S. CL. 46).

JAMES LOVELACE, EXAMINING ATTORNEY

SN 77-764,075. WE LOVE SOY, INC., DBA CHICAGO SOY DAIRY, WHEATON, IL. FILED 6-19-2009.

TEESE

THE MARK CONSISTS OF STANDARD CHARACTERS WITHOUT CLAIM TO ANY PARTICULAR FONT, STYLE, SIZE, OR COLOR.

FOR CHEESE SUBSTITUTES (U.S. CL. 46).
FIRST USE 2-20-2008; IN COMMERCE 3-10-2008.
DANIEL CAPSHAW, EXAMINING ATTORNEY

CLASS 29—(Continued).

SN 77-765,303. JBARA, FATEH, MONROE TOWNSHIP, NJ.
FILED 6-22-2009.

JUDE

THE MARK CONSISTS OF STANDARD CHARACTERS WITHOUT CLAIM TO ANY PARTICULAR FONT, STYLE, SIZE, OR COLOR.

FOR PROCESSED OLIVES (U.S. CL. 46).
REBECCA SMITH, EXAMINING ATTORNEY

SN 77-765,329. JBARA, FATEH, MONROE TOWNSHIP, NJ.
FILED 6-22-2009.

JUDY

THE MARK CONSISTS OF STANDARD CHARACTERS WITHOUT CLAIM TO ANY PARTICULAR FONT, STYLE, SIZE, OR COLOR.

FOR PROCESSED OLIVES (U.S. CL. 46).
REBECCA SMITH, EXAMINING ATTORNEY

SN 79-065,430. JOÃO SAMPAIO E MELLO SCHMIDT, ESTORIL, PORTUGAL, FILED 2-2-2009.

OLLIVUS

THE MARK CONSISTS OF STANDARD CHARACTERS WITHOUT CLAIM TO ANY PARTICULAR FONT, STYLE, SIZE, OR COLOR.

OWNER OF INTERNATIONAL REGISTRATION 0993606 DATED 2-2-2009. EXPIRES 2-2-2019.

THE WORDING "OLLIVUS" HAS NO MEANING IN A FOREIGN LANGUAGE.

FOR EDIBLE OLIVE OIL (U.S. CL. 46).
KAREN SEVERSON, EXAMINING ATTORNEY

CLASS 29—(Continued).

SN 79-067,427. MEJERIFORENINGEN DANISH DAIRY BOARD, DENMARK, FILED 2-27-2009.



PRIORITY DATE OF 2-16-2009 IS CLAIMED.
 OWNER OF INTERNATIONAL REGISTRATION 0999177 DATED 2-27-2009, EXPIRES 2-27-2019.
 OWNER OF U.S. REG. NOS. 1,875,725, 2,638,403 AND 3,302,726.
 NO CLAIM IS MADE TO THE EXCLUSIVE RIGHT TO USE "SINCE 1901", APART FROM THE MARK AS SHOWN.
 THE MARK CONSISTS OF THE WORDING "SINCE 1901" BELOW THE DESIGN OF A SHIELD WITH A REEL OF FILM PROTRUDING FROM EACH SIDE OF THE SHIELD. THE WORDING "LURPAK" APPEARS BELOW THE SHIELD DESIGN ALONG WITH A WAVY HORIZONTAL RIBBON.
 FOR BUTTER, BUTTER WITH FLAVOR ADDITIVES, GHEE, BUTTER SPREAD (U.S. CL. 46).
 WILLIAM BRECKENFELD, EXAMINING ATTORNEY

CLASS 29—(Continued).

SN 79-067,479. PAN XINHUA, 332100 JIANGXI PROVINCE, CHINA, FILED 12-1-2008.



OWNER OF INTERNATIONAL REGISTRATION 0999331 DATED 12-1-2008, EXPIRES 12-1-2018.
 THE MARK CONSISTS OF DEVICE, THREE CHINESE CHARACTERS AND STYLIZED WORDS "XIAN KELAI". THE DEVICE CONSISTS OF WING OF THE BIRD.
 THE ENGLISH TRANSLATION OF THE FOREIGN WORD(S) IN THE MARK IS: "CELESTIAL BEING GUEST COME".
 THE TRANSLITERATION OF THE NON-LATIN CHARACTERS IN THE MARK IS: "XIAN KE LAI".
 FOR PRESERVED MUSHROOMS; CANNED VEGETABLES; SAUERKRAUT; PRESERVED VEGETABLES; VEGETABLES, COOKED; PREPARATIONS FOR MAKING SOUP; TRUFFLES, PRESERVED; DRIED BAMBOO SHOOTS; NUTS, PREPARED; PROCESSED MANUFACTURED BEANS; TAHINI; DEHYDRATED VEGETABLE; VEGETABLE, DRIED (U.S. CL. 46).
 DAVID HOFFMAN, EXAMINING ATTORNEY

CLASS 30—STAPLE FOODS

SN 76-696,069. SOFRITO FRESCO Y PRODUCE CAMPO VERDES, LLC, MIAMI GARDENS, FL. FILED 3-2-2009.



NO CLAIM IS MADE TO THE EXCLUSIVE RIGHT TO USE "SOFRITO FRESCO Y PRODUCE", APART FROM THE MARK AS SHOWN.
 THE COLOR(S) GREEN AND BLACK ARE CALIMED AS A FEATURE OF THE MARK IS/ARE CLAIMED AS A FEATURE OF THE MARK.
 THE MARK CONSISTS OF THE WORDING "SOFRITO FRESCO Y PRODUCE CAMPO VERDES" IN GREEN LETTERING WITH BLACK BORDER ABOVE A DESIGN OF A TREE IN GREEN AND BLACK.
 THE ENGLISH TRANSLATION OF "SOFRITO FRESCO Y PRODUCE CAMPO VERDES" IN THE MARK IS FRESH LIGHTLY FRIED ONION OR GARLIC MIXTURE AND GREEN FIELD PRODUCE.
 FOR LATIN CONDIMENT CONSISTING OF A FRESH LIGHTLY FRIED ONION AND GARLIC MIXTURE USED TO SEASON TRADITIONAL FOODS (U.S. CL. 46).
 HEATHER SAPP, EXAMINING ATTORNEY

CLASS 30—(Continued).

SN 76-697,170. GEE DADDY'S, CENTERVILLE, IA. FILED 5-1-2009.

GEE DADDY'S BARBEQUE

THE MARK CONSISTS OF STANDARD CHARACTERS WITHOUT CLAIM TO ANY PARTICULAR FONT, STYLE, SIZE, OR COLOR.

NO CLAIM IS MADE TO THE EXCLUSIVE RIGHT TO USE "BARBEQUE", APART FROM THE MARK AS SHOWN.

FOR BARBEQUE SAUCE AND BARBEQUE SPICE RUB (U.S. CL. 46).

FIRST USE 5-1-2008; IN COMMERCE 5-1-2008.
JOHN WILKE, EXAMINING ATTORNEY

CLASS 30—(Continued).

SN 77-397,776. EAT RIGHT FOODS LIMITED, STOKE, NELSON, NEW ZEALAND, FILED S.R. 2-15-2008; AM. P.R. 11-30-2008.



PRIORITY CLAIMED UNDER SEC. 44(D) ON NEW ZEALAND APPLICATION NO. 776323, FILED 9-21-2007, REG. NO. 776323, DATED 4-9-2009, EXPIRES 9-21-2017.

NO CLAIM IS MADE TO THE EXCLUSIVE RIGHT TO USE "KID EATS", APART FROM THE MARK AS SHOWN.

THE COLOR(S) GREEN, WHITE AND YELLOW IS/ARE CLAIMED AS A FEATURE OF THE MARK.

THE MARK CONSISTS OF THE COLOR GREEN APPEARING IN THE WORDING "KIDEATS", THE COLOR WHITE APPEARING IN THE SHADED AREAS BEHIND THE WORDING, AND THE COLOR YELLOW APPEARING IN THE BACKGROUND.

FOR ORGANIC AND ALLERGY SENSITIVE CAKES AND COOKIES (U.S. CL. 46).
HEATHER BIDDULPH, EXAMINING ATTORNEY

SN 76-697,171. GEE DADDY'S, CENTERVILLE, IA. FILED 5-1-2009.

BEST REASON WE KNOW TO EAT MEAT!

THE MARK CONSISTS OF STANDARD CHARACTERS WITHOUT CLAIM TO ANY PARTICULAR FONT, STYLE, SIZE, OR COLOR.

FOR BARBEQUE SAUCE AND BARBEQUE SPICE RUB (U.S. CL. 46).

FIRST USE 5-1-2008; IN COMMERCE 5-1-2008.
JOHN WILKE, EXAMINING ATTORNEY

SN 77-411,694. BONOMELLI S.R.L., ZOLA PREDOSA BO, ITALY, FILED 3-3-2008.



SN 76-697,181. R.M. PALMER COMPANY, READING, PA. FILED 5-4-2009.

PIPSQUEAKS

FOR CANDY AND CHOCOLATES (U.S. CL. 46).
DAWN FELDMAN, EXAMINING ATTORNEY

OWNER OF U.S. REG. NOS. 2,224,686 AND 2,343,887.
NO CLAIM IS MADE TO THE EXCLUSIVE RIGHT TO USE "POLENTA", APART FROM THE MARK AS SHOWN.

THE MARK CONSISTS OF THE WORDS "POLENTA VALSUGANA" IN FANCIFUL FORM APPEARING BETWEEN PARALLEL HORIZONTAL LINES AND BENEATH A ROUGHLY CIRCULAR CORN DESIGN.

SEC. 2(F) AS TO "VALSUGANA".
FOR DRY MIXES CONSISTING PRIMARILY OF GROUND YELLOW CORN AND SEASONINGS FOR PREPARING POLENTA, PRE-COOKED AND READY-TO-SERVE POLENTA (U.S. CL. 46).
KEVIN CORWIN, EXAMINING ATTORNEY

CLASS 30—(Continued).

SN 77-411,751. BONOMELLI S.R.L., ZOLA PREDOSA BO, ITALY, FILED 3-3-2008.



OWNER OF U.S. REG. NOS. 2,224,686 AND 2,343,887.
NO CLAIM IS MADE TO THE EXCLUSIVE RIGHT TO USE "POLENTA", APART FROM THE MARK AS SHOWN.
THE MARK CONSISTS OF THE WORDS "POLENTA VALSUGANA" IN FANCIFUL FORM APPEARING WITHIN SLANTED LINES WITH A REPRESENTATION OF CORN.
SEC. 2(F) AS TO "VALSUGANA".
FOR DRY MIXES CONSISTING PRIMARILY OF GROUND YELLOW CORN AND SEASONINGS FOR PREPARING POLENTA, PRE-COOKED AND READY-TO-SERVE POLENTA (U.S. CL. 46).
KEVIN CORWIN, EXAMINING ATTORNEY

SN 77-412,329. NUSTEF INTERNATIONAL INC., MISSISSAUGA, CANADA, FILED 3-4-2008.

FINA

THE MARK CONSISTS OF STANDARD CHARACTERS WITHOUT CLAIM TO ANY PARTICULAR FONT, STYLE, SIZE, OR COLOR.
THE FOREIGN WORDING IN THE MARK TRANSLATES INTO ENGLISH AS FINE.
FOR COOKIES; COOKIES AND CRACKERS; WAFLES (U.S. CL. 46).
JOHN GARTNER, EXAMINING ATTORNEY

SN 77-482,453. UNILEVER N. V., ROTTERDAM, NETHERLANDS, FILED 5-23-2008.

BERTOLLI

THE MARK CONSISTS OF STANDARD CHARACTERS WITHOUT CLAIM TO ANY PARTICULAR FONT, STYLE, SIZE, OR COLOR.
OWNER OF U.S. REG. NO. 995,370.
SEC. 2(F).
FOR ICE CREAMS, FROZEN CONFECTIONS AND GELATO (U.S. CL. 46).
JENNIFER VASQUEZ, EXAMINING ATTORNEY

CLASS 30—(Continued).

SN 77-529,347. OCEAN SPRAY CRANBERRIES, INC., LAKEVILLE-MIDDLEBORO, MA. FILED 7-23-2008.

CRANESSENCE

THE MARK CONSISTS OF STANDARD CHARACTERS WITHOUT CLAIM TO ANY PARTICULAR FONT, STYLE, SIZE, OR COLOR.
OWNER OF U.S. REG. NO. 3,419,838.
FOR CHEWING GUM, HARD CANDY, SOFT CANDY, READY TO DRINK TEAS (U.S. CL. 46).
ROBERT STRUCK, EXAMINING ATTORNEY

SN 77-539,532. GALIL IMPORTING CORPORATION, SYOSSET, NY. FILED 8-5-2008.

Lior

THE MARK CONSISTS OF STANDARD CHARACTERS WITHOUT CLAIM TO ANY PARTICULAR FONT, STYLE, SIZE, OR COLOR.
THE ENGLISH TRANSLATION OF THE HEBREW WORD "LIOR" IS MY LIGHT.
FOR CANDY; CHOCOLATE; COFFEE AND TEA; FLOUR; SPICES; VINEGAR; WAFERS (U.S. CL. 46).
BRIAN PINO, EXAMINING ATTORNEY

SN 77-551,548. KABUSHIKI KAISHA YAKULT HONSHA, TOKYO, JAPAN, FILED 8-20-2008.

OLIGOMATE

THE MARK CONSISTS OF STANDARD CHARACTERS WITHOUT CLAIM TO ANY PARTICULAR FONT, STYLE, SIZE, OR COLOR.
PRIORITY CLAIMED UNDER SEC. 44(D) ON JAPAN APPLICATION NO. 2008-66039, FILED 8-11-2008, REG. NO. 5243957, DATED 7-3-2009, EXPIRES 7-3-2019.
FOR SEASONINGS; NATURAL SWEETENERS; NATURAL SWEETENERS CONTAINING OLIGOSACCHARIDES; SUGAR; FLAVORING SYRUP; TABLE SYRUP (U.S. CL. 46).
SARA THOMAS, EXAMINING ATTORNEY

CLASS 30—(Continued).

SN 77-563,024. GOLD MEDAL PRODUCTS COMPANY, CINCINNATI, OH. FILED 9-5-2008.

PLATINUM WHITE CHEDDAR

THE MARK CONSISTS OF STANDARD CHARACTERS WITHOUT CLAIM TO ANY PARTICULAR FONT, STYLE, SIZE, OR COLOR.

NO CLAIM IS MADE TO THE EXCLUSIVE RIGHT TO USE "WHITE CHEDDAR", APART FROM THE MARK AS SHOWN.

FOR WHITE CHEDDAR POPCORN COATING, NAMELY, FOOD FLAVORING (U.S. CL. 46).
JOHN DWYER, EXAMINING ATTORNEY

SN 77-563,028. GOLD MEDAL PRODUCTS COMPANY, CINCINNATI, OH. FILED 9-5-2008.

CHEDDAR CLASSIC

THE MARK CONSISTS OF STANDARD CHARACTERS WITHOUT CLAIM TO ANY PARTICULAR FONT, STYLE, SIZE, OR COLOR.

NO CLAIM IS MADE TO THE EXCLUSIVE RIGHT TO USE "CHEDDAR", APART FROM THE MARK AS SHOWN.
FOR CHEDDAR CHEESE POPCORN COATING, NAMELY, FOOD FLAVORING (U.S. CL. 46).
JOHN DWYER, EXAMINING ATTORNEY

SN 77-572,466. STANKIEWICZ, PENNY, NEW YORK, NY. FILED 9-17-2008.



NO CLAIM IS MADE TO THE EXCLUSIVE RIGHT TO USE "SUGAR", APART FROM THE MARK AS SHOWN.

THE MARK CONSISTS OF STYLIZED SCROLLWORK ON RIGHT AND LEFT SIDE OF THE WORD "SUGAR COUTURE". THE LETTER "S". THE LETTER "U". THE LETTER "G". THE LETTER "A". THE LETTER "R". THE LETTER "C". THE LETTER "O". THE LETTER "U". THE LETTER "T". THE LETTER "U". THE LETTER "R". THE LETTER "E".

FOR CUSTOM MADE CAKES AND CONFECTIONS, NAMELY, COOKIES, CUPCAKES, CAKES, SUGAR FLOWERS AND CHOCOLATES (U.S. CL. 46).

FIRST USE 3-10-2008; IN COMMERCE 3-10-2008.
JESSICA A. POWERS, EXAMINING ATTORNEY

CLASS 30—(Continued).

SN 77-573,214. GRUPO MINSA, S.A. DE C.V., TLALNEPANTLA, MEXICO, FILED 9-18-2008.

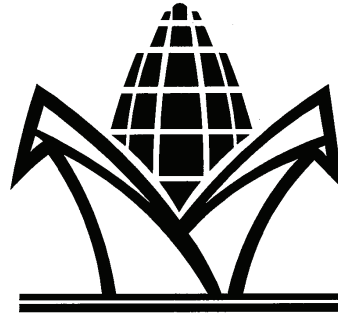

OWNER OF U.S. REG. NOS. 2,151,126 AND 2,742,761.
THE MARK CONSISTS OF AN EAR OF CORN AND ITS HUSKS.

FOR CORN FLOUR (U.S. CL. 46).
FIRST USE 1-6-1995; IN COMMERCE 1-6-1995.
GEORGE LORENZO, EXAMINING ATTORNEY

SN 77-585,291. CORPORACIÓN INDUSTRIAL ALIMENTICIA, S.A. DE C.V., EL CONVENTO, MEXICO, FILED 10-3-2008.



OWNER OF U.S. REG. NOS. 2,233,570, 2,882,186 AND OTHERS.

NO CLAIM IS MADE TO THE EXCLUSIVE RIGHT TO USE "CHILITO EN POLVO", APART FROM THE MARK AS SHOWN.

THE ENGLISH TRANSLATION OF THE WORD "CHILITO EN POLVO" IN THE MARK IS LITTLE CHILI POWDER. FOR CHILI FLAVORED FLAVOR ENHANCERS USED IN FOOD; CHILI POWDER; CHILI SEASONING; CHILI SAUCE; SALSA; SPICES (U.S. CL. 46).

MARK RADEMACHER, EXAMINING ATTORNEY

CLASS 30—(Continued).

SN 77-585,622. MODERN FOODS, INC., SOUTH EL MONTE, CA. FILED 10-4-2008.

OWNER OF U.S. REG. NO. 3,013,034.
NO CLAIM IS MADE TO THE EXCLUSIVE RIGHT TO USE THE CHINESE CHARACTER THAT TRANSLITERATES TO CHA AND TRANSLATES INTO ENGLISH AS TEA, APART FROM THE MARK AS SHOWN.
THE MARK CONSISTS OF THREE STYLIZED CHINESE CHARACTERS.
THE FOREIGN WORDING IN THE MARK TRANSLATES INTO ENGLISH AS HIGH MOUNTAIN TEA.
THE NON-LATIN CHARACTER(S) IN THE MARK TRANSLITERATE INTO KAO SHAN CHA, AND THIS MEANS HIGH MOUNTAIN TEA IN ENGLISH.
SEC. 2(F).
FOR TEA (U.S. CL. 46).
FIRST USE 12-31-1997; IN COMMERCE 9-9-2000.
MARK SPARACINO, EXAMINING ATTORNEY

CLASS 30—(Continued).

SN 77-591,812. DAERIM CORPORATION, SEOUL, REPUBLIC OF KOREA, FILED 10-13-2008.

THE MARK CONSISTS OF DAERIMSUN IN KOREAN CHARACTERS.
THE NON-LATIN CHARACTERS IN THE MARK TRANSLITERATE TO "DAERIMSUN" AND THIS MEANS LARGE FOREST AND FRESHNESS IN ENGLISH.
FOR UNCOOKED NAENG-MYUN (KOREAN BUCKWHEAT NOODLES); UNCOOKED DANG-MYUN (CHINESE NOODLES); SUSHI; HOT DOG SANDWICHES; DUMPLINGS (U.S. CL. 46).
SHANNON TWOHIG, EXAMINING ATTORNEY

SN 77-591,788. SAJO INDUSTRIES CO., LTD., SEOUL, REPUBLIC OF KOREA, FILED 10-13-2008.

THE MARK CONSISTS OF "SAJO" STYLIZED.
THE ENGLISH TRANSLATION OF THE KOREAN CHARACTERS WHOSE PHONETIC EQUIVALENT IS "SAJO" IN THE MARK IS THE TREND (CURRENT) OF THOUGHT.
FOR UNCOOKED NOODLES; JEUN (SLICE GRILLED PANCAKE); POPCORN; DUMPLINGS; SOYA SAUCE; GOCHU-JANG (FERMENTED HOT PEPPER PASTE); DOYN-JANG (FERMENTED SOYBEAN PASTE); JA-JANG (BLACK PASTE FOR NOODLE SAUCE); CHONG-GUG-JANG (FERMENTED SOYBEAN PASTE); CHUN-JANG (CHINESE SOYBEAN PASTE) (U.S. CL. 46).
KATHLEEN M. VANSTON, EXAMINING ATTORNEY

SN 77-592,917. JASON LIBS, EVANSVILLE, IN. FILED S.R. 10-15-2008; AM. P.R. 7-6-2009.

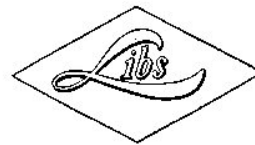

SEC. 2(F).
FOR CANDIES; CANDY; CANDY WITH COCOA; CHOCOLATE; CHOCOLATE AND CHOCOLATES; CHOCOLATE BARS; CHOCOLATE COVERED NUTS; CHOCOLATE TRUFFLES (U.S. CL. 46).
FIRST USE 10-0-1955; IN COMMERCE 10-0-1955.
MARK RADEMACHER, EXAMINING ATTORNEY

CLASS 30—(Continued).

SN 77-599,138. BEE INTERNATIONAL, CHULA VISTA, CA.
FILED 10-23-2008.



OWNER OF U.S. REG. NOS. 2,178,489, 2,700,178 AND OTHERS.

NO CLAIM IS MADE TO THE EXCLUSIVE RIGHT TO USE "JELLY BEAN", APART FROM THE MARK AS SHOWN.

THE MARK CONSISTS OF THE WORDS "JELLY BEAN" IN A STYLIZED FORMAT AND THE WORD "WERKS" IN A STYLIZED FORMAT FEATURING GEARS WRITTEN ON TOP OF A JELLY BEAN.

FOR CANDY (U.S. CL. 46).
FRANK LATTUCA, EXAMINING ATTORNEY

SN 77-599,245. BEE INTERNATIONAL, CHULA VISTA, CA.
FILED 10-23-2008.



OWNER OF U.S. REG. NOS. 2,178,489, 2,700,178 AND OTHERS.

NO CLAIM IS MADE TO THE EXCLUSIVE RIGHT TO USE "TAFFY", APART FROM THE MARK AS SHOWN.

THE MARK CONSISTS OF THE WORD "TAFFY" IN A STYLIZED FORMAT AND THE WORD "WERKS" IN A STYLIZED FORMAT FEATURING GEARS WRITTEN ON TOP OF A WRAPPED PIECE OF CANDY.

FOR CANDY (U.S. CL. 46).
FRANK LATTUCA, EXAMINING ATTORNEY

CLASS 30—(Continued).

SN 77-599,311. CJ CHEILJEDANG CORPORATION, SEOUL,
REPUBLIC OF KOREA, FILED 10-23-2008.

한뿌리

THE MARK CONSISTS OF KOREAN CHARACTERS. THE FOREIGN WORDING IN THE MARK HAS NO MEANING IN KOREAN OR ANY OTHER LANGUAGE.

THE NON-LATIN CHARACTERS IN THE MARK TRANSLITERATE TO "HAN PPU RI" AND THIS MEANS NOTHING IN ENGLISH.

FOR GINSENG TEA (U.S. CL. 46).
LINDSEY RUBIN, EXAMINING ATTORNEY

SN 77-601,773. CONCORD BRANDS, ULC, CONCORD,
ONTARIO, CANADA, FILED 10-28-2008.

HOMERUN

THE MARK CONSISTS OF STANDARD CHARACTERS WITHOUT CLAIM TO ANY PARTICULAR FONT, STYLE, SIZE, OR COLOR.

FOR CHEWING GUM (U.S. CL. 46).
FIRST USE 0-0-2004; IN COMMERCE 0-0-2004.
DAWN FELDMAN, EXAMINING ATTORNEY

SN 77-616,794. MATZOT AVIV, LTD., BENEI BRAK, ISRAEL,
FILED 11-18-2008.

AVIV

THE MARK CONSISTS OF STANDARD CHARACTERS WITHOUT CLAIM TO ANY PARTICULAR FONT, STYLE, SIZE, OR COLOR.

OWNER OF U.S. REG. NO. 2,118,605.
THE ENGLISH TRANSLATION OF "AVIV" IN THE MARK IS "SPRING".

FOR (BASED ON USE) PASTRIES, COOKIES, BREAD, CRACKERS, BISCUITS; (BASED ON INTENT TO USE) CAKES, BREAKFAST CEREALS, READY TO EAT CEREAL DERIVED FOOD BARS; GRANOLA BASED SNACK BARS; PRETZELS (U.S. CL. 46).

FIRST USE 0-0-2005; IN COMMERCE 11-0-2007.
JIM RINGLE, EXAMINING ATTORNEY

CLASS 30—(Continued).

SN 77-625,873. SWEET CANDY COMPANY, SALT LAKE CITY, UT. FILED 12-3-2008.

CANDY CORN TAFFY

THE MARK CONSISTS OF STANDARD CHARACTERS WITHOUT CLAIM TO ANY PARTICULAR FONT, STYLE, SIZE, OR COLOR.

NO CLAIM IS MADE TO THE EXCLUSIVE RIGHT TO USE "TAFFY", APART FROM THE MARK AS SHOWN.

SEC. 2(F).

FOR TAFFY (U.S. CL. 46).

FIRST USE 4-7-1994; IN COMMERCE 4-7-1994.

TEJBIR SINGH, EXAMINING ATTORNEY

SN 77-637,111. MARSAN GIDA SANAYI VE TICARET A.S., ISTANBUL, TURKEY, FILED 12-19-2008.

LA FIAMMA

THE MARK CONSISTS OF STANDARD CHARACTERS WITHOUT CLAIM TO ANY PARTICULAR FONT, STYLE, SIZE, OR COLOR.

THE FOREIGN WORDING IN THE MARK TRANSLATES INTO ENGLISH AS "THE FLAME".

FOR PASTA (U.S. CL. 46).

FIRST USE 6-21-2000; IN COMMERCE 6-21-2000.

SHAILA SETTLES, EXAMINING ATTORNEY

SN 77-638,766. ROBERT ROTHSCHILD FARM, LLC, URBANA, OH. FILED 12-23-2008.

GAME DAY GOURMET

THE MARK CONSISTS OF STANDARD CHARACTERS WITHOUT CLAIM TO ANY PARTICULAR FONT, STYLE, SIZE, OR COLOR.

NO CLAIM IS MADE TO THE EXCLUSIVE RIGHT TO USE "GOURMET", APART FROM THE MARK AS SHOWN.

FOR BERRY PANCAKE AND WAFFLE SYRUPS, FRUIT AND BERRY CHUTNEY, SALSA, MUSTARD, BARBECUE SAUCE, HORSERADISH SAUCE, FRUIT AND BALSAMIC VINEGARS, HERB VINEGARS AND SALAD DRESSINGS (U.S. CL. 46).

MAYUR VAGHANI, EXAMINING ATTORNEY

CLASS 30—(Continued).

SN 77-639,046. RICOSTA ALTA LTDA., ALAJUELA, COSTA RICA, FILED 12-23-2008.



OWNER OF COSTA RICA REG. NO. 152692, DATED 6-9-2005, EXPIRES 6-9-2015.

NO CLAIM IS MADE TO THE EXCLUSIVE RIGHT TO USE "KAFE" AND "COSTA RICA", APART FROM THE MARK AS SHOWN.

THE COLOR(S) RED, BLUE, WHITE, GOLD, GREEN, BROWN IS/ARE CLAIMED AS A FEATURE OF THE MARK.

THE MARK CONSISTS OF A VOLCANO WITH A RIBBON IN THE COLORS OF THE COSTA RICAN FLAG WAVING UP OUT THE TOP LEADING TO A SINGLE BROWN BEAN. THE TIP OF THE VOLCANO IS GOLD. BLUE SIDES LEAD FROM THE TOP TO THE BASE. AT THE BASE OF THE VOLCANO IS A GREEN WAVE. INSIDE THE VOLCANO IT READS IN LARGE CAPITAL LETTERS: "KAFE VOLKANO" (IN RED) WITH THE WORDS "COSTA RICA" BELOW IT, ALSO IN CAPS, BLUE, AND A SLIGHTLY SMALLER FONT.

THE ENGLISH TRANSLATION OF "KAFE VOLKANO" IN THE MARK IS VOLCANO COFFEE.

FOR GROUND COFFEE BEANS; ROASTED COFFEE BEANS (U.S. CL. 46).

MATTHEW KLINE, EXAMINING ATTORNEY

SN 77-641,961. EB PERFORMANCE, LLC, BOCA RATON, FL. FILED 12-31-2008.



OWNER OF U.S. REG. NO. 3,521,106.

NO CLAIM IS MADE TO THE EXCLUSIVE RIGHT TO USE "BITE-SIZE PROTEIN COOKIES", APART FROM THE MARK AS SHOWN.

THE MARK CONSISTS OF THE LETTERS "EB" WRITTEN OVER THE WORD "DYNABITES" WHICH IN TURN IS WRITTEN OVER THE WORDS "BITE-SIZE PROTEIN COOKIES" SUPERIMPOSED OVER THE "EB" ELEMENT IS A PICTURE OF A RUNNER AND A BARBELL; AN ARC EXTENDS DOWNWARD FROM THE "D" IN THE WORD "DYNABITES" AND ENDS IN A FLASH DESIGN.

FOR COOKIES (U.S. CL. 46).

MICHAEL SOUDERS, EXAMINING ATTORNEY

CLASS 30—(Continued).

SN 77-650,526. CADBURY ADAMS USA LLC, PARSIPPANY, NJ. FILED 1-15-2009.

TRIDENT FOR KIDS

THE MARK CONSISTS OF STANDARD CHARACTERS WITHOUT CLAIM TO ANY PARTICULAR FONT, STYLE, SIZE, OR COLOR.

OWNER OF U.S. REG. NOS. 591,356, 3,100,824 AND OTHERS.

NO CLAIM IS MADE TO THE EXCLUSIVE RIGHT TO USE "KIDS", APART FROM THE MARK AS SHOWN.

FOR CONFECTIONERY, NAMELY, CHEWING GUM (U.S. CL. 46).

KATHY DE JONGE, EXAMINING ATTORNEY

CLASS 30—(Continued).

SN 77-664,617. DAVIS, LAVONYA, RIVERSIDE, CA. FILED 2-5-2009.



NO CLAIM IS MADE TO THE EXCLUSIVE RIGHT TO USE "CONFECTIONS LLC", APART FROM THE MARK AS SHOWN.

THE MARK CONSISTS OF WORDING INSIDE A CIRCLE. IN THE MIDDLE OF THE CIRCLE IS THE WORDING "LOLLI TRUFF". WITH THE "O" IN "LOLLI" FORMED BY A HEART. UNDERNEATH THIS IS THE WORDING "INDULGE. WE DARE YOU!" AT THE BOTTOM OF THE CIRCLE IS THE WORDING "LOLLI TRUFF CONFECTIONS LLC".

FOR GOURMET CANDY CAKE TRUFFLES (U.S. CL. 46).

FIRST USE 8-1-2008; IN COMMERCE 8-1-2008. KIMBERLY FRYE, EXAMINING ATTORNEY

SN 77-656,421. CADBURY ADAMS USA LLC, PARSIPPANY, NJ. FILED 1-26-2009.

NEUTRA FRESH

THE MARK CONSISTS OF STANDARD CHARACTERS WITHOUT CLAIM TO ANY PARTICULAR FONT, STYLE, SIZE, OR COLOR.

NO CLAIM IS MADE TO THE EXCLUSIVE RIGHT TO USE "FRESH", APART FROM THE MARK AS SHOWN.

FOR CONFECTIONERY, NAMELY, CHEWING GUM (U.S. CL. 46).

KATHY DE JONGE, EXAMINING ATTORNEY

SN 77-676,438. HEIDORF AG, HERRENFELD, SWITZERLAND, FILED 2-23-2009.



NO CLAIM IS MADE TO THE EXCLUSIVE RIGHT TO USE "THE ORIGINAL", APART FROM THE MARK AS SHOWN.

THE MARK CONSISTS OF THE WORDS "HEIDI'S HOUSE" ABOVE A LINE DRAWING WITHIN A DOUBLE OVAL OF A GIRL AND A GOAT IN FRONT OF A HOUSE AND AN EVERGREEN TREE, AND THE WORDS "THE ORIGINAL" IN THE LOWER PORTION OF THE OVAL.

FOR COOKIES, BISCUITS, BREAD, BAKERY PRODUCTS, PASTRIES, ICE CREAM, HONEY (U.S. CL. 46). DANNEAN HETZEL, EXAMINING ATTORNEY

CLASS 30—(Continued).

SN 77-686,552. CENTRIC GROUP, L.L.C., ST. LOUIS, MO.
FILED 3-9-2009.

ZIPPY CAKES

THE MARK CONSISTS OF STANDARD CHARACTERS WITHOUT CLAIM TO ANY PARTICULAR FONT, STYLE, SIZE, OR COLOR.

NO CLAIM IS MADE TO THE EXCLUSIVE RIGHT TO USE "CAKES", APART FROM THE MARK AS SHOWN.

FOR COOKIES, HONEY BUNS, CEREAL BARS, DONUTS, WAFERS, DONUTS FORMED INTO STICKS FOR DUNKING IN BEVERAGES, BROWNIES, CUPCAKES, SNACK CAKES AND ROLLS (U.S. CL. 46).

MARK PILARO, EXAMINING ATTORNEY

CLASS 30—(Continued).

SN 77-709,477. WM. WRIGLEY JR. COMPANY, CHICAGO, IL. FILED 4-8-2009.

ACTIVE STRIPS

THE MARK CONSISTS OF STANDARD CHARACTERS WITHOUT CLAIM TO ANY PARTICULAR FONT, STYLE, SIZE, OR COLOR.

NO CLAIM IS MADE TO THE EXCLUSIVE RIGHT TO USE "STRIPS", APART FROM THE MARK AS SHOWN.

FOR CHEWING GUM (U.S. CL. 46).

MARIA-VICTORIA SUAREZ, EXAMINING ATTORNEY

SN 77-690,814. NUTRASWEET PROPERTY HOLDINGS, INC., CHICAGO, IL. FILED 3-13-2009.



THE LINING AND STIPPLING ARE FOR SHADING PURPOSES.

THE MARK CONSISTS OF A LEAF WITH A PILE OF SUGAR.

FOR SUGAR SUBSTITUTES; SWEETENER COMBINATIONS COMPRISED PRIMARILY OF NATURAL SWEETENERS (U.S. CL. 46).

ALEXANDER L. POWERS, EXAMINING ATTORNEY

SN 77-709,499. WM. WRIGLEY JR. COMPANY, CHICAGO, IL. FILED 4-8-2009.

HYDRO STRIPS

THE MARK CONSISTS OF STANDARD CHARACTERS WITHOUT CLAIM TO ANY PARTICULAR FONT, STYLE, SIZE, OR COLOR.

NO CLAIM IS MADE TO THE EXCLUSIVE RIGHT TO USE "STRIPS", APART FROM THE MARK AS SHOWN.

FOR CHEWING GUM (U.S. CL. 46).

MARIA-VICTORIA SUAREZ, EXAMINING ATTORNEY

SN 77-691,963. LESSEREVIL BRAND SNACK CO., TUCK-AHOE, NY. FILED 3-16-2009.

OFFICE ANIMALS

THE MARK CONSISTS OF STANDARD CHARACTERS WITHOUT CLAIM TO ANY PARTICULAR FONT, STYLE, SIZE, OR COLOR.

FOR CANDY COATED POPCORN; CARAMEL POPCORN; CEREAL-BASED SNACK FOODS; COOKIES; CRACKERS; GLAZED POPCORN; GRANOLA-BASED SNACK BARS; MICROWAVE POPCORN; POPCORN; POPPED POPCORN; PROCESSED POPCORN; PROCESSED UNPOPPED POPCORN; READY TO EAT, CEREAL DERIVED FOOD BARS; RICE-BASED SNACK FOODS; SNACK MIX CONSISTING PRIMARILY OF CRACKERS, PRETZELS, CANDIED NUTS AND/OR POPPED POPCORN; TEA-BASED BEVERAGES WITH FRUIT FLAVORING; UNPOPPED POPCORN; WHEAT-BASED SNACK FOODS (U.S. CL. 46).

RON FAIRBANKS, EXAMINING ATTORNEY

SN 77-711,583. TCHO VENTURES, INC., AKA TCHO, SAN FRANCISCO, CA. FILED 4-10-2009.

Serious Milk

THE MARK CONSISTS OF STANDARD CHARACTERS WITHOUT CLAIM TO ANY PARTICULAR FONT, STYLE, SIZE, OR COLOR.

NO CLAIM IS MADE TO THE EXCLUSIVE RIGHT TO USE "MILK", APART FROM THE MARK AS SHOWN.

FOR CHOCOLATE; CHOCOLATE AND CHOCOLATES; CHOCOLATE BARS; CHOCOLATE CHIPS; CHOCOLATE FOR CONFECTIONERY AND BREAD; CHOCOLATE TOPPING; CHOCOLATE TRUFFLES; CHOCOLATE-BASED FILLINGS FOR CAKES AND PIES; CHOCOLATE-BASED READY-TO-EAT FOOD BARS; CHOCOLATES AND CHOCOLATE BASED READY TO EAT CANDIES AND SNACKS (U.S. CL. 46).

JERI J. FICKES, EXAMINING ATTORNEY

CLASS 30—(Continued).

SN 77-715,290. COOK, JERROD A, DBA WILD N MILD, PETAL, MS. FILED 4-16-2009.

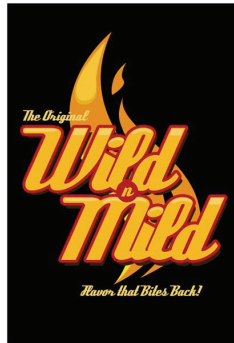

NO CLAIM IS MADE TO THE EXCLUSIVE RIGHT TO USE "ORIGINAL", APART FROM THE MARK AS SHOWN. THE COLOR(S) ORANGE, YELLOW, RED, AND BLACK IS/ARE CLAIMED AS A FEATURE OF THE MARK.

THE MARK CONSISTS OF THE STYLIZED WORDING "THE ORIGINAL WILD N MILD FLAVOR THAT BITES BACK!", WITH THE WORDS "THE ORIGINAL" APPEARING IN A SMALLER YELLOW FONT ABOVE AND TO THE LEFT OF "WILD," THE WORDS "WILD" AND "MILD" APPEARING IN A LARGER ORANGE AND YELLOW FONT OUTLINED IN RED AND SEPARATED BY THE ORANGE LETTER "N" APPEARING IN A RED CIRCLE, ALL OF WHICH APPEARS IN FRONT OF A YELLOW AND ORANGE FLAME DESIGN, BELOW WHICH IS THE WORDING "FLAVOR THAT BITES BACK!" IN A SMALLER YELLOW FONT, WITH ALL OF THE ABOVE APPEARING AGAINST A BLACK BACKGROUND.

FOR MARINADES (U.S. CL. 46).
FIRST USE 4-10-2009; IN COMMERCE 4-10-2009.
ANDREW LEASER, EXAMINING ATTORNEY

SN 77-719,422. TRUJILLO & SONS, INC., MIAMI, FL. FILED 4-22-2009.

IDEAL BRAND

THE MARK CONSISTS OF STANDARD CHARACTERS WITHOUT CLAIM TO ANY PARTICULAR FONT, STYLE, SIZE, OR COLOR.

NO CLAIM IS MADE TO THE EXCLUSIVE RIGHT TO USE "BRAND", APART FROM THE MARK AS SHOWN.

FOR MAYONNAISE; MUSTARD (U.S. CL. 46).
FIRST USE 3-2-1952; IN COMMERCE 3-2-1952.
MARY CRAWFORD, EXAMINING ATTORNEY

CLASS 30—(Continued).

SN 77-721,620. THE QUAKER OATS COMPANY, CHICAGO, IL. FILED 4-24-2009.

AUNT JEMIMA

THE MARK CONSISTS OF STANDARD CHARACTERS WITHOUT CLAIM TO ANY PARTICULAR FONT, STYLE, SIZE, OR COLOR.

OWNER OF U.S. REG. NOS. 522,386, 1,590,084 AND OTHERS.

THE NAME(S), PORTRAIT(S), AND/OR SIGNATURE(S) SHOWN IN THE MARK DOES NOT IDENTIFY A PARTICULAR LIVING INDIVIDUAL.

FOR BREAKFAST CEREALS AND OATMEAL (U.S. CL. 46).

JULIE VEPPUMTHARA, EXAMINING ATTORNEY

SN 77-721,713. R & B TOOTH ARMOUR LLC, HENDERSON, NV. FILED 4-24-2009.

Sweetnosh

THE MARK CONSISTS OF STANDARD CHARACTERS WITHOUT CLAIM TO ANY PARTICULAR FONT, STYLE, SIZE, OR COLOR.

FOR NATURAL SWEETENER (U.S. CL. 46).

CHARISMA HAMPTON, EXAMINING ATTORNEY

SN 77-722,183. TROFIMA CORPORATION, GUAYNABO, PUERTO RICO, FILED 4-24-2009.

DEL PATIO PARA TU MESA

THE MARK CONSISTS OF STANDARD CHARACTERS WITHOUT CLAIM TO ANY PARTICULAR FONT, STYLE, SIZE, OR COLOR.

THE ENGLISH TRANSLATION OF "DEL PATIO PARA TU MESA" IN THE MARK IS FROM THE SOWN FIELD FOR YOUR TABLE.

FOR COFFEE; COFFEE BASED BEVERAGES; GROUND COFFEE BEANS (U.S. CL. 46).

DAVID I, EXAMINING ATTORNEY

CLASS 30—(Continued).

SN 77-722,206. TROFIMA CORPORATION, GUAYNABO, PUERTO RICO, FILED 4-24-2009.

DEL PATIO A TU TAZA

THE MARK CONSISTS OF STANDARD CHARACTERS WITHOUT CLAIM TO ANY PARTICULAR FONT, STYLE, SIZE, OR COLOR.

THE ENGLISH TRANSLATION OF "DEL PATIO A TU TAZA" IN THE MARK IS FROM THE SOWN FIELD TO YOUR CUP.

FOR COFFEE; COFFEE BASED BEVERAGES; GROUND COFFEE BEANS (U.S. CL. 46).
DAVID I, EXAMINING ATTORNEY

CLASS 30—(Continued).

SN 77-723,044. GENERAL MILLS, INC., MINNEAPOLIS, MN. FILED 4-27-2009.



OWNER OF U.S. REG. NOS. 977,430 AND 1,306,264.
NO CLAIM IS MADE TO THE EXCLUSIVE RIGHT TO USE "CHICKEN", APART FROM THE MARK AS SHOWN.
THE MARK CONSISTS OF THE SIDE OF A HOUSE WITH A WINDOW AND THE WORDS "CHICKEN HELPER".
FOR PACKAGED MAIN MEAL MIXES CONSISTING PRIMARILY OF PASTA (U.S. CL. 46).
FIRST USE 12-29-2008; IN COMMERCE 12-29-2008.
JASON TURNER, EXAMINING ATTORNEY

SN 77-723,047. GENERAL MILLS, INC., MINNEAPOLIS, MN. FILED 4-27-2009.



OWNER OF U.S. REG. NOS. 972,518 AND 977,430.
NO CLAIM IS MADE TO THE EXCLUSIVE RIGHT TO USE "TUNA", APART FROM THE MARK AS SHOWN.
THE MARK CONSISTS OF THE SIDE OF A HOUSE WITH A WINDOW AND THE WORDS "TUNA HELPER".
FOR PACKAGED MAIN MEAL MIXES CONSISTING PRIMARILY OF PASTA (U.S. CL. 46).
FIRST USE 12-29-2008; IN COMMERCE 12-29-2008.
JASON TURNER, EXAMINING ATTORNEY

SN 77-723,055. GENERAL MILLS IP HOLDINGS I, LLC, MINNEAPOLIS, MN. FILED 4-27-2009.



SN 77-723,040. GENERAL MILLS, INC., MINNEAPOLIS, MN. FILED 4-27-2009.

OWNER OF U.S. REG. NOS. 977,430 AND 1,306,264.
NO CLAIM IS MADE TO THE EXCLUSIVE RIGHT TO USE "ASIAN CHICKEN", APART FROM THE MARK AS SHOWN.
THE MARK CONSISTS OF "THE SIDE OF A HOUSE WITH A WINDOW AND THE WORDS ASIAN CHICKEN HELPER".
FOR PACKAGED MAIN MEAL MIXES CONSISTING PRIMARILY OF PASTA OR RICE (U.S. CL. 46).
FIRST USE 12-29-2008; IN COMMERCE 12-29-2008.
JASON TURNER, EXAMINING ATTORNEY

THE SNACK YOUR HEART LOVES TOO

THE MARK CONSISTS OF STANDARD CHARACTERS WITHOUT CLAIM TO ANY PARTICULAR FONT, STYLE, SIZE, OR COLOR.
FOR SNACK MIXES CONSISTING PRIMARILY OF PROCESSED CEREALS, PRETZELS, AND CRACKERS (U.S. CL. 46).
AMY KERTGATE, EXAMINING ATTORNEY

CLASS 30—(Continued).

SN 77-723,748. WM. WRIGLEY JR. COMPANY, CHICAGO, IL. FILED 4-28-2009.

MORE FUN FOR YOUR MOUTH

THE MARK CONSISTS OF STANDARD CHARACTERS WITHOUT CLAIM TO ANY PARTICULAR FONT, STYLE, SIZE, OR COLOR.

FOR CANDY (U.S. CL. 46).
MARTHA FROMM, EXAMINING ATTORNEY

CLASS 30—(Continued).

SN 77-723,986. TEAOLGY, LLC, DARIEN, CT. FILED 4-28-2009.



THE COLOR(S) BLACK, GREEN IS/ARE CLAIMED AS A FEATURE OF THE MARK.

THE MARK CONSISTS OF WORDING AND DESIGNS ON A BLACK BACKGROUND. THERE IS A DESIGN ON THE LEFT SIDE OF THE MARK, ALL IN GREEN, OF TWO STYLIZED LEAVES, WITHIN A CIRCULAR BORDER. TO THE RIGHT OF THE DESIGN, THE WORDING "TEATANHA" IS ALSO IN GREEN.

THE WORDING "TEATANHA" HAS NO MEANING IN A FOREIGN LANGUAGE.

FOR TEA (U.S. CL. 46).
CORY BOONE, EXAMINING ATTORNEY

SN 77-724,658. PERFECTION BAKERIES, INC., AKA AUNT MILLIE'S, FORT WAYNE, IN. FILED 4-29-2009.

**Aunt Millie's Spreadables
Mini Bagels.**

THE MARK CONSISTS OF STANDARD CHARACTERS WITHOUT CLAIM TO ANY PARTICULAR FONT, STYLE, SIZE, OR COLOR.

OWNER OF U.S. REG. NO. 1,998,181.
NO CLAIM IS MADE TO THE EXCLUSIVE RIGHT TO USE "MINI BAGELS", APART FROM THE MARK AS SHOWN.

FOR BAGELS (U.S. CL. 46).
FIRST USE 2-23-2009; IN COMMERCE 2-23-2009.
JANICE KIM, EXAMINING ATTORNEY

SN 77-723,824. NEKA PASQUALE, SAN RAFAEL, CA. FILED 4-28-2009.

URBAN REMEDY

THE MARK CONSISTS OF STANDARD CHARACTERS WITHOUT CLAIM TO ANY PARTICULAR FONT, STYLE, SIZE, OR COLOR.

FOR BAGEL CHIPS; BAKERY DESSERTS; BAKERY PRODUCTS; BEVERAGES MADE OF COFFEE; BEVERAGES MADE OF TEA; BISCUITS AND BREAD; BREAD AND PASTRY; CAKES; CANDY; CANDY BARS; CEREAL BASED ENERGY BARS; CEREAL-BASED SNACK FOODS; CHOCOLATE; CHOCOLATE-BASED READY-TO-EAT FOOD BARS; COCOA; COFFEE AND TEA; COOKIES AND CRACKERS; CORN CHIPS; DRIED PASTA; EDIBLE ICES; FLOUR-BASED CHIPS; FROZEN CONFECTIONS; GRANOLA; HERBAL FOOD BEVERAGES; ICED COFFEE; ICED TEA; MILK SHAKES; POPPED POPCORN; PROCESSED CEREAL-BASED FOOD TO BE USED AS A BREAKFAST FOOD, SNACK FOOD OR INGREDIENT FOR MAKING OTHER FOODS; READY-TO-EAT CEREALS; RICE CAKES; RICE-BASED SNACK FOODS; SALAD DRESSINGS; SAUCES; SNACK CAKES; SNACK MIX CONSISTING PRIMARILY OF CRACKERS, PRETZELS, CANDIED NUTS AND/OR POPPED POPCORN; TORTILLA CHIPS; WAFERS (U.S. CL. 46).

KATINA MISTER, EXAMINING ATTORNEY

SN 77-724,662. SUGAR CREEK FOODS INTERNATIONAL, INC., RUSSELLVILLE, AR. FILED 4-29-2009.

**Cactus Sweet Frozen Yogurt
– All Natural Sweetened
with Agave**

THE MARK CONSISTS OF STANDARD CHARACTERS WITHOUT CLAIM TO ANY PARTICULAR FONT, STYLE, SIZE, OR COLOR.

NO CLAIM IS MADE TO THE EXCLUSIVE RIGHT TO USE "SWEET FROZEN YOGURT - ALL NATURAL SWEETENED WITH AGAVE", APART FROM THE MARK AS SHOWN.

FOR FROZEN YOGURT MIXES (U.S. CL. 46).
JENNIFER DIXON, EXAMINING ATTORNEY

CLASS 30—(Continued).

SN 77-724,918. NATURE'S INDULGENCE, LLC, OGDEN, UT. FILED 4-29-2009.

NATURE'S INDULGENCE

THE MARK CONSISTS OF STANDARD CHARACTERS WITHOUT CLAIM TO ANY PARTICULAR FONT, STYLE, SIZE, OR COLOR.

FOR GRANOLA (U.S. CL. 46).
FIRST USE 11-1-2007; IN COMMERCE 11-1-2007.
THEODORE MCBRIDE, EXAMINING ATTORNEY

SN 77-724,967. NEW ALBERTSON'S, INC., EDEN PRAIRIE, MN. FILED 4-29-2009.

GOOD DAY

THE MARK CONSISTS OF STANDARD CHARACTERS WITHOUT CLAIM TO ANY PARTICULAR FONT, STYLE, SIZE, OR COLOR.

OWNER OF U.S. REG. NOS. 827,274, 1,062,358 AND 1,619,325.

FOR (BASED ON INTENT TO USE) BREAKFAST CEREALS; (BASED ON USE) READY TO EAT, CEREAL DERIVED FOOD BARS (U.S. CL. 46).

FIRST USE 1-10-2009; IN COMMERCE 1-10-2009.
KATHLEEN LORENZO, EXAMINING ATTORNEY

SN 77-725,681. MARYMELLOWTEAS, PASADENA, CA. FILED 4-30-2009.

MARYMELLOWTEAS

THE MARK CONSISTS OF STANDARD CHARACTERS WITHOUT CLAIM TO ANY PARTICULAR FONT, STYLE, SIZE, OR COLOR.

FOR GOURMET AND DESIGNER TEAS (U.S. CL. 46).
FIRST USE 8-31-2008; IN COMMERCE 8-31-2008.
TEJBIR SINGH, EXAMINING ATTORNEY

CLASS 30—(Continued).

SN 77-725,727. BAHIA, PERCY, WEST ORANGE, NJ. FILED 4-30-2009.

BestWich

THE MARK CONSISTS OF STANDARD CHARACTERS WITHOUT CLAIM TO ANY PARTICULAR FONT, STYLE, SIZE, OR COLOR.

FOR SANDWICHES (U.S. CL. 46).
JAY BESCH, EXAMINING ATTORNEY

SN 77-725,822. KING COFFEE & TEA SERVICES CORP., ROYAL OAK, MI. FILED 4-30-2009.

AWESOME BARISTA

THE MARK CONSISTS OF STANDARD CHARACTERS WITHOUT CLAIM TO ANY PARTICULAR FONT, STYLE, SIZE, OR COLOR.

FOR BLACK TEA; COFFEE; COFFEE AND TEA; COFFEE BEANS; GROUND COFFEE BEANS; ROASTED COFFEE BEANS; TEA; TEA BAGS; TEA FOR INFUSIONS (U.S. CL. 46).

CAROLYN CATALDO, EXAMINING ATTORNEY

SN 77-726,000. VEREEN, SHEDWARD, NEW HAVEN, CT. FILED 4-30-2009.

SHEDWARD PIE

THE MARK CONSISTS OF STANDARD CHARACTERS WITHOUT CLAIM TO ANY PARTICULAR FONT, STYLE, SIZE, OR COLOR.

NO CLAIM IS MADE TO THE EXCLUSIVE RIGHT TO USE "PIE", APART FROM THE MARK AS SHOWN.

FOR CHOCOLATE-BASED FILLINGS FOR CAKES AND PIES; CUSTARD-BASED FILLINGS FOR CAKES AND PIES; FROZEN PIE CRUSTS; FRUIT CAKES; FRUIT COBBLERS; FRUIT PIES; PIE CRUSTS; PIES (U.S. CL. 46).

JUSTINE D. PARKER, EXAMINING ATTORNEY

CLASS 30—(Continued).

SN 77-726,195. GARDETTO'S BAKERY, INC., MINNEAPOLIS, MN. FILED 4-30-2009.

A BAG OF INTERESTING

THE MARK CONSISTS OF STANDARD CHARACTERS WITHOUT CLAIM TO ANY PARTICULAR FONT, STYLE, SIZE, OR COLOR.

FOR SNACK MIXES CONSISTING PRIMARILY OF PROCESSED CEREALS, PRETZELS AND CRACKERS (U.S. CL. 46).

MARLENE BELL, EXAMINING ATTORNEY

CLASS 30—(Continued).

SN 77-726,550. JOY MCEWEN, DBA DIGGIN' LIVIN' FARM & APIARY, CAVE JUNCTION, OR. FILED 4-30-2009.

DIGGIN' LIVIN'

THE MARK CONSISTS OF STANDARD CHARACTERS WITHOUT CLAIM TO ANY PARTICULAR FONT, STYLE, SIZE, OR COLOR.

FOR BARBECUE SAUCE; DIPPING SAUCES; HONEY; SAUCES (U.S. CL. 46).

FIRST USE 5-12-2006; IN COMMERCE 5-12-2006.

JUDITH HELFMAN, EXAMINING ATTORNEY

SN 77-726,346. ANTHONY BUAER, PALM DESERT, CA. FILED 4-30-2009.

**The Geisha's Secret Ginger
Sauce**

THE MARK CONSISTS OF STANDARD CHARACTERS WITHOUT CLAIM TO ANY PARTICULAR FONT, STYLE, SIZE, OR COLOR.

NO CLAIM IS MADE TO THE EXCLUSIVE RIGHT TO USE "GINGER SAUCE", APART FROM THE MARK AS SHOWN.

FOR DIPPING SAUCES; SOY SAUCE; TERIYAKI SAUCE (U.S. CL. 46).

MICHAEL WIENER, EXAMINING ATTORNEY

SN 77-726,712. HELP USA, INC., NEW YORK, NY. FILED 5-1-2009.

STIMULUS BAR

THE MARK CONSISTS OF STANDARD CHARACTERS WITHOUT CLAIM TO ANY PARTICULAR FONT, STYLE, SIZE, OR COLOR.

NO CLAIM IS MADE TO THE EXCLUSIVE RIGHT TO USE "BAR", APART FROM THE MARK AS SHOWN.

FOR CANDY AND CANDY BARS (U.S. CL. 46).

FIRST USE 4-13-2009; IN COMMERCE 4-13-2009.

CHRISTOPHER BUONGIORNO, EXAMINING ATTORNEY

SN 77-726,538. KATE BATH INTERNATIONAL LLC, NEW YORK, NY. FILED 4-30-2009.

SWEET DEFIANCE

THE MARK CONSISTS OF STANDARD CHARACTERS WITHOUT CLAIM TO ANY PARTICULAR FONT, STYLE, SIZE, OR COLOR.

FOR CHOCOLATE AND CHOCOLATES; CHOCOLATE BARS; CHOCOLATE CANDIES (U.S. CL. 46).

KATHERINE E. HALMEN, EXAMINING ATTORNEY

SN 77-726,713. HELP USA, INC., NEW YORK, NY. FILED 5-1-2009.

A BITE OF SWEET RECOVERY

THE MARK CONSISTS OF STANDARD CHARACTERS WITHOUT CLAIM TO ANY PARTICULAR FONT, STYLE, SIZE, OR COLOR.

FOR CANDY AND CANDY BARS (U.S. CL. 46).

FIRST USE 4-13-2009; IN COMMERCE 4-13-2009.

CHRISTOPHER BUONGIORNO, EXAMINING ATTORNEY

CLASS 30—(Continued).

SN 77-726,714. HELP USA, INC., NEW YORK, NY. FILED 5-1-2009.

BITE INTO SWEET RECOVERY

THE MARK CONSISTS OF STANDARD CHARACTERS WITHOUT CLAIM TO ANY PARTICULAR FONT, STYLE, SIZE, OR COLOR.

FOR CANDY AND CANDY BARS (U.S. CL. 46).
CHRISTOPHER BUONGIORNO, EXAMINING ATTORNEY

SN 77-726,715. HELP USA, INC., NEW YORK, NY. FILED 5-1-2009.

STIMULUS SALTY TURTLES

THE MARK CONSISTS OF STANDARD CHARACTERS WITHOUT CLAIM TO ANY PARTICULAR FONT, STYLE, SIZE, OR COLOR.

NO CLAIM IS MADE TO THE EXCLUSIVE RIGHT TO USE "SALTY TURTLES", APART FROM THE MARK AS SHOWN.

FOR CANDY AND CANDY BARS (U.S. CL. 46).
CHRISTOPHER BUONGIORNO, EXAMINING ATTORNEY

SN 77-726,716. HELP USA, INC., NEW YORK, NY. FILED 5-1-2009.

STIMULUS SNACKS

THE MARK CONSISTS OF STANDARD CHARACTERS WITHOUT CLAIM TO ANY PARTICULAR FONT, STYLE, SIZE, OR COLOR.

NO CLAIM IS MADE TO THE EXCLUSIVE RIGHT TO USE "SNACKS", APART FROM THE MARK AS SHOWN.

FOR SNACK MIX CONSISTING PRIMARILY OF CRACKERS, PRETZELS, CANDIED NUTS AND/OR POPPED POPCORN (U.S. CL. 46).

CHRISTOPHER BUONGIORNO, EXAMINING ATTORNEY

CLASS 30—(Continued).

SN 77-727,016. HIGH FIVE FROZEN YOGURT, L.L.C., ST CLOUD, FL. FILED 5-1-2009.



THE COLOR(S) PURPLE, GREEN, GRAY IS/ARE CLAIMED AS A FEATURE OF THE MARK.

THE MARK CONSISTS OF A GRAY SWOOSH MARK WITH A PURPLE AND GREEN BERRY.
FOR FROZEN YOGURT (U.S. CL. 46).

KATHERINE CONNOLLY, EXAMINING ATTORNEY

SN 77-727,457. PRETZEL-HUT, INC., ORANGE, CT. FILED 5-1-2009.

MILLION SNACKS

THE MARK CONSISTS OF STANDARD CHARACTERS WITHOUT CLAIM TO ANY PARTICULAR FONT, STYLE, SIZE, OR COLOR.

NO CLAIM IS MADE TO THE EXCLUSIVE RIGHT TO USE "SNACKS", APART FROM THE MARK AS SHOWN.

FOR BAKERY GOODS; BAKERY PRODUCTS; COOKIES; COOKIES AND CRACKERS; FOOD PACKAGE COMBINATIONS CONSISTING PRIMARILY OF BREAD, CRACKERS AND/OR COOKIES; FRUIT TEAS; GELATO; GREEN TEA; ICED TEA; INSTANT TEA; PRETZELS; SNACK MIX CONSISTING PRIMARILY OF CRACKERS, PRETZELS, CANDIED NUTS AND/OR POPPED POPCORN; TACO CHIPS; TACOS; TEA BAGS; TEA SUBSTITUTES; TEA-BASED BEVERAGES WITH FRUIT FLAVORING (U.S. CL. 46).

JASON BLAIR, EXAMINING ATTORNEY

CLASS 30—(Continued).

SN 77-727,477. PRETZEL-HUT, INC., ORANGE, CT. FILED 5-1-2009.

MILLIONSNAXS

THE MARK CONSISTS OF STANDARD CHARACTERS WITHOUT CLAIM TO ANY PARTICULAR FONT, STYLE, SIZE, OR COLOR.

FOR BAKERY GOODS; BAKERY PRODUCTS; COFFEE AND TEA; COOKIES; COOKIES AND CRACKERS; FOOD PACKAGE COMBINATIONS CONSISTING PRIMARILY OF BREAD, CRACKERS AND/OR COOKIES; FRUIT TEAS; GELATO; GREEN TEA; ICED TEA; INSTANT TEA; PRETZELS; SNACK MIX CONSISTING PRIMARILY OF CRACKERS, PRETZELS, CANDIED NUTS AND/OR POPPED POPCORN; TACO CHIPS; TACOS; TEA; TEA BAGS; TEA SUBSTITUTES; TEA-BASED BEVERAGES WITH FRUIT FLAVORING (U.S. CL. 46).

JASON BLAIR, EXAMINING ATTORNEY

SN 77-727,514. TROFIMA CORPORATION, GUAYNABO, PUERTO RICO, FILED 5-1-2009.

DEL PATIO

THE MARK CONSISTS OF STANDARD CHARACTERS WITHOUT CLAIM TO ANY PARTICULAR FONT, STYLE, SIZE, OR COLOR.

THE ENGLISH TRANSLATION OF "DEL PATIO" IN THE MARK IS FROM THE SOWN FIELD.

FOR COFFEE; COFFEE BASED BEVERAGES; GROUND COFFEE BEANS (U.S. CL. 46).

FIRST USE 4-14-2007; IN COMMERCE 4-14-2007.

DAVID I, EXAMINING ATTORNEY

SN 77-727,593. PAUL HOLYFIELD, LOS ANGELES, CA. FILED 5-1-2009.

LECTRO VITERGY

THE MARK CONSISTS OF STANDARD CHARACTERS WITHOUT CLAIM TO ANY PARTICULAR FONT, STYLE, SIZE, OR COLOR.

FOR BUBBLE GUM; CHEWING GUM; CHEWING GUMS; GUM SWEETS; SUGAR-FREE CHEWING GUM; SUGARFREE CHEWING GUM; SUGARLESS CHEWING GUM (U.S. CL. 46).

FIRST USE 3-1-2009; IN COMMERCE 3-1-2009.

GEORGE LORENZO, EXAMINING ATTORNEY

CLASS 30—(Continued).

SN 77-728,079. BARILLA G.E.R. FRATELLI - SOCIETÀ PER AZIONI, PARMA, ITALY, FILED 5-4-2009.

THE BARILLA FAMILY DINNER PROJECT

THE MARK CONSISTS OF STANDARD CHARACTERS WITHOUT CLAIM TO ANY PARTICULAR FONT, STYLE, SIZE, OR COLOR.

OWNER OF U.S. REG. NO. 897,460.

NO CLAIM IS MADE TO THE EXCLUSIVE RIGHT TO USE "FAMILY DINNER", APART FROM THE MARK AS SHOWN.

FOR PASTA, SAUCES, SALAD DRESSINGS, FOOD SEASONINGS, SEASONING MIXES, SEASONINGS, PREPARED AND/OR PACKAGED FOODS, DISHES, AND MEALS, CONSISTING PRIMARILY OF RICE, BREAD, CEREALS, NOODLES, READY-MADE SAUCES AND/OR PASTRIES (U.S. CL. 46).

ANDREA BUTLER, EXAMINING ATTORNEY

SN 77-728,224. BARILLA G.E.R. FRATELLI - SOCIETÀ PER AZIONI, PARMA, ITALY, FILED 5-4-2009.

PROJECT FAMILY DINNER

THE MARK CONSISTS OF STANDARD CHARACTERS WITHOUT CLAIM TO ANY PARTICULAR FONT, STYLE, SIZE, OR COLOR.

NO CLAIM IS MADE TO THE EXCLUSIVE RIGHT TO USE "FAMILY DINNER", APART FROM THE MARK AS SHOWN.

FOR PASTA, SAUCE, SALAD DRESSINGS, FOOD SEASONINGS, SEASONING MIXES, SEASONINGS; PREPARED AND/OR PACKAGED FOODS, DISHES, AND MEALS CONSISTING PRIMARILY OF RICE, BREAD, CEREALS, NOODLES, READY-MADE SAUCES AND/OR PASTRIES (U.S. CL. 46).

ZHALEH DELANEY, EXAMINING ATTORNEY

CLASS 30—(Continued).

SN 77-728,516. BARILLA G.E.R. FRATELLI - SOCIETÀ PER AZIONI, PARMA, ITALY, FILED 5-4-2009.

THE BARILLA SHARED DINNER
PROJECT

THE MARK CONSISTS OF STANDARD CHARACTERS WITHOUT CLAIM TO ANY PARTICULAR FONT, STYLE, SIZE, OR COLOR.

OWNER OF U.S. REG. NOS. 897,460, 2,005,752 AND OTHERS.

NO CLAIM IS MADE TO THE EXCLUSIVE RIGHT TO USE "DINNER", APART FROM THE MARK AS SHOWN.

FOR PASTA, SAUCES, SALAD DRESSINGS, FOOD SEASONINGS, SEASONING MIXES, SEASONINGS, PREPARED AND/OR PACKAGED FOODS, DISHES, AND MEALS, CONSISTING PRIMARILY OF RICE, BREAD, CEREALS, NOODLES, READY-MADE SAUCES AND/OR PASTRIES (U.S. CL. 46).

BRENDAN MCCAULEY, EXAMINING ATTORNEY

SN 77-728,784. IP BRANDS LLC, BRIDGEVILLE, PA. FILED 5-4-2009.

BFF

THE MARK CONSISTS OF STANDARD CHARACTERS WITHOUT CLAIM TO ANY PARTICULAR FONT, STYLE, SIZE, OR COLOR.

FOR READY TO DRINK COFFEE BEVERAGES (U.S. CL. 46).

DEIRDRE ROBERTSON, EXAMINING ATTORNEY

SN 77-730,024. GENERAL MILLS, INC., MINNEAPOLIS, MN. FILED 5-6-2009.

LET'S BAKE A MOMENT
TOGETHER

THE MARK CONSISTS OF STANDARD CHARACTERS WITHOUT CLAIM TO ANY PARTICULAR FONT, STYLE, SIZE, OR COLOR.

FOR CAKE MIXES; FROSTINGS (U.S. CL. 46).

CHARLES L. JENKINS, EXAMINING ATTORNEY

CLASS 30—(Continued).

SN 77-731,064. NATURAL DRINKS S.A., SAO PAULO, SP, BRAZIL, FILED 5-7-2009.



THE MARK CONSISTS OF THE WORD "CAIPIONE" IN STYLIZED LETTERS.

THE WORDING "CAIPIONE" HAS NO MEANING IN A FOREIGN LANGUAGE.

FOR FROZEN DESSERT CONSISTING OF FRUIT AND CREAM OR CREAM SUBSTITUTES (U.S. CL. 46).

MARGERY A. TIERNEY, EXAMINING ATTORNEY

SN 77-731,067. NATURAL DRINKS S.A., SAO PAULO, SP, BRAZIL, FILED 5-7-2009.

CAIPIONE

THE MARK CONSISTS OF THE WORD "CAIPIONE" IN STYLIZED LETTERS.

THE WORDING "CAIPIONE" HAS NO MEANING IN A FOREIGN LANGUAGE.

FOR FROZEN DESSERT CONSISTING OF FRUIT AND CREAM OR CREAM SUBSTITUTES (U.S. CL. 46).

MARGERY A. TIERNEY, EXAMINING ATTORNEY

SN 77-735,088. MARS, INCORPORATED, MCLEAN, VA. FILED 5-12-2009.

REVELS

THE MARK CONSISTS OF STANDARD CHARACTERS WITHOUT CLAIM TO ANY PARTICULAR FONT, STYLE, SIZE, OR COLOR.

FOR CONFECTIONERY PRODUCTS, NAMELY, CANDY, CHOCOLATES, EDIBLE CAKE DECORATIONS AND CANDY CAKE DECORATIONS (U.S. CL. 46).

BRENDAN MCCAULEY, EXAMINING ATTORNEY

CLASS 30—(Continued).

SN 77-735,225. MARS, INCORPORATED, MCLEAN, VA.
FILED 5-12-2009.



OWNER OF U.S. REG. NOS. 1,165,729, 1,533,494 AND 1,813,945.

NO CLAIM IS MADE TO THE EXCLUSIVE RIGHT TO USE "REAL CHOCOLATE", APART FROM THE MARK AS SHOWN.

FOR CONFECTIONERY PRODUCTS, NAMELY, CANDY AND FROZEN CONFECTIONERY PRODUCTS, NAMELY, FROZEN CONFECTIONS AND ICE CREAM (U.S. CL. 46).
BRENDAN MCCAULEY, EXAMINING ATTORNEY

CLASS 30—(Continued).

SN 77-735,689. HY-VEE, INC., WEST DES MOINES, IA.
FILED 5-13-2009.

1938

THE MARK CONSISTS OF STANDARD CHARACTERS WITHOUT CLAIM TO ANY PARTICULAR FONT, STYLE, SIZE, OR COLOR.
FOR SAUCES, NAMELY, STEAK SAUCE (U.S. CL. 46).
FIRST USE 9-19-1997; IN COMMERCE 9-19-1997.
WANDA KAY PRICE, EXAMINING ATTORNEY

SN 77-737,934. CADBURY ADAMS USA LLC, PARSIPPANY, NJ. FILED 5-15-2009.

TRIDENT VERVE

SN 77-735,247. MARS, INCORPORATED, MCLEAN, VA.
FILED 5-12-2009.



OWNER OF U.S. REG. NOS. 1,165,729, 1,533,494 AND 1,813,945.

NO CLAIM IS MADE TO THE EXCLUSIVE RIGHT TO USE "REAL CHOCOLATE", APART FROM THE MARK AS SHOWN.

FOR CONFECTIONERY PRODUCTS, NAMELY, CANDY AND FROZEN CONFECTIONERY PRODUCTS, NAMELY, FROZEN CONFECTIONS AND ICE CREAM (U.S. CL. 46).
BRENDAN MCCAULEY, EXAMINING ATTORNEY

THE MARK CONSISTS OF STANDARD CHARACTERS WITHOUT CLAIM TO ANY PARTICULAR FONT, STYLE, SIZE, OR COLOR.

OWNER OF U.S. REG. NOS. 591,356, 3,108,246 AND OTHERS.
FOR CONFECTIONERY, NAMELY, CHEWING GUM (U.S. CL. 46).
REBECCA SMITH, EXAMINING ATTORNEY

SN 77-737,939. CADBURY ADAMS USA LLC, PARSIPPANY, NJ. FILED 5-15-2009.

TRIDENT VITALITY

THE MARK CONSISTS OF STANDARD CHARACTERS WITHOUT CLAIM TO ANY PARTICULAR FONT, STYLE, SIZE, OR COLOR.

OWNER OF U.S. REG. NOS. 591,356, 3,108,246 AND OTHERS.
FOR CONFECTIONERY, NAMELY, CHEWING GUM (U.S. CL. 46).
REBECCA SMITH, EXAMINING ATTORNEY

CLASS 30—(Continued).

SN 77-737,941. CADBURY ADAMS USA LLC, PARSIPPANY, NJ. FILED 5-15-2009.

TRIDENT THRIVE

THE MARK CONSISTS OF STANDARD CHARACTERS WITHOUT CLAIM TO ANY PARTICULAR FONT, STYLE, SIZE, OR COLOR.

OWNER OF U.S. REG. NOS. 591,356, 3,108,246 AND OTHERS.

FOR CONFECTIONERY, NAMELY, CHEWING GUM (U.S. CL. 46).

REBECCA SMITH, EXAMINING ATTORNEY

CLASS 30—(Continued).

SN 77-750,196. CADBURY ADAMS USA LLC, PARSIPPANY, NJ. FILED 6-2-2009.

PUCKER ME BERRY

THE MARK CONSISTS OF STANDARD CHARACTERS WITHOUT CLAIM TO ANY PARTICULAR FONT, STYLE, SIZE, OR COLOR.

NO CLAIM IS MADE TO THE EXCLUSIVE RIGHT TO USE "BERRY", APART FROM THE MARK AS SHOWN.

FOR CONFECTIONERY, NAMELY, CHEWING GUM (U.S. CL. 46).

REBECCA SMITH, EXAMINING ATTORNEY

SN 77-747,316. CADBURY ADAMS USA LLC, PARSIPPANY, NJ. FILED 5-29-2009.

ETERNAL MELON

THE MARK CONSISTS OF STANDARD CHARACTERS WITHOUT CLAIM TO ANY PARTICULAR FONT, STYLE, SIZE, OR COLOR.

NO CLAIM IS MADE TO THE EXCLUSIVE RIGHT TO USE "MELON", APART FROM THE MARK AS SHOWN.

FOR CONFECTIONERY, NAMELY, CHEWING GUM (U.S. CL. 46).

REBECCA SMITH, EXAMINING ATTORNEY

SN 77-751,177. PROMARK BRANDS INC., MERIDIAN, ID. FILED 6-3-2009.

HEINZ CALIFORNIA SELECT

THE MARK CONSISTS OF STANDARD CHARACTERS WITHOUT CLAIM TO ANY PARTICULAR FONT, STYLE, SIZE, OR COLOR.

OWNER OF U.S. REG. NOS. 62,182, 2,224,447 AND OTHERS.

NO CLAIM IS MADE TO THE EXCLUSIVE RIGHT TO USE "CALIFORNIA SELECT", APART FROM THE MARK AS SHOWN.

FOR KETCHUP (U.S. CL. 46).

RENEE MCCRAY, EXAMINING ATTORNEY

SN 77-750,186. THE QUAKER OATS COMPANY, CHICAGO, IL. FILED 6-2-2009.

SOLUOAT

THE MARK CONSISTS OF STANDARD CHARACTERS WITHOUT CLAIM TO ANY PARTICULAR FONT, STYLE, SIZE, OR COLOR.

FOR OAT FLOUR (U.S. CL. 46).

JULIE VEPPUMTHARA, EXAMINING ATTORNEY

SN 77-753,793. PERFECTION BAKERIES, INC., AKA AUNT MILLIE'S, FORT WAYNE, IN. FILED 6-6-2009.

Aunt Millie's Slimwiches

THE MARK CONSISTS OF STANDARD CHARACTERS WITHOUT CLAIM TO ANY PARTICULAR FONT, STYLE, SIZE, OR COLOR.

OWNER OF U.S. REG. NO. 1,998,181.

FOR BREAD AND BUNS; BUNS (U.S. CL. 46).

JANICE KIM, EXAMINING ATTORNEY

CLASS 30—(Continued).

SN 77-755,563. THE QUAKER OATS COMPANY, CHICAGO, IL. FILED 6-9-2009.

CLASS 30—(Continued).

SN 77-762,082. GENERAL MILLS IP HOLDINGS I, LLC, MINNEAPOLIS, MN. FILED 6-17-2009.

QUAKER GRANCEREAL

THE MARK CONSISTS OF STANDARD CHARACTERS WITHOUT CLAIM TO ANY PARTICULAR FONT, STYLE, SIZE, OR COLOR.
OWNER OF U.S. REG. NOS. 1,331,144, 1,411,555 AND OTHERS.
FOR GRAIN-BASED SNACK FOOD AND COOKIES (U.S. CL. 46).
JULIE VEPPUMTHARA, EXAMINING ATTORNEY

SN 77-757,912. WE LOVE SOY, INC., DBA CHICAGO SOY DAIRY, WHEATON, IL. FILED 6-11-2009.

DANDIES

MORE GRAINS. LESS YOU.

THE MARK CONSISTS OF STANDARD CHARACTERS WITHOUT CLAIM TO ANY PARTICULAR FONT, STYLE, SIZE, OR COLOR.
FOR MARSHMALLOWS (U.S. CL. 46).
FIRST USE 3-5-2009; IN COMMERCE 3-5-2009.
DANIEL CAPSHAW, EXAMINING ATTORNEY

SN 77-759,964. SUNKIST GROWERS, INC., SHERMAN OAKS, CA. FILED 6-15-2009.

SUNKIST CITRUS BURST

THE MARK CONSISTS OF STANDARD CHARACTERS WITHOUT CLAIM TO ANY PARTICULAR FONT, STYLE, SIZE, OR COLOR.
OWNER OF U.S. REG. NOS. 301,278, 3,164,106 AND OTHERS.
NO CLAIM IS MADE TO THE EXCLUSIVE RIGHT TO USE "CITRUS", APART FROM THE MARK AS SHOWN.
FOR CANDY MINTS (U.S. CL. 46).
MARK PILARO, EXAMINING ATTORNEY

THE MARK CONSISTS OF STANDARD CHARACTERS WITHOUT CLAIM TO ANY PARTICULAR FONT, STYLE, SIZE, OR COLOR.
FOR PROCESSED CEREAL-BASED FOOD TO BE USED AS A BREAKFAST FOOD, SNACK FOOD OR INGREDIENT FOR MAKING OTHER FOODS (U.S. CL. 46).
AMY KERTGATE, EXAMINING ATTORNEY

CLASS 30—(Continued).

SN 79-056,115. KOREA YAKULT CO., LTD., REPUBLIC OF KOREA, FILED 4-7-2008.



PRIORITY DATE OF 3-14-2008 IS CLAIMED.
OWNER OF INTERNATIONAL REGISTRATION 0970306 DATED 4-7-2008, EXPIRES 4-7-2018.

OWNER OF U.S. REG. NOS. 2,539,054 AND 2,603,393.
NO CLAIM IS MADE TO THE EXCLUSIVE RIGHT TO USE "PALDO", APART FROM THE MARK AS SHOWN.

THE NAME(S), PORTRAIT(S), AND/OR SIGNATURE(S) SHOWN IN THE MARK DOES NOT IDENTIFY A PARTICULAR LIVING INDIVIDUAL.

THE COLOR(S) RED, WHITE AND BLACK IS/ARE CLAIMED AS A FEATURE OF THE MARK.

THE MARK CONSISTS OF THE COLORS RED, WHITE AND BLACK, WITH THE COLOR BLACK APPEARING IN THE WORDING OF "FUN & YUM" AND IN THE OUTLINE OF THE WORD "PALDO", THE COLOR RED APPEARS IN THE DIACRITICAL MARK OVER THE WORD "PALDO", AND THE COLOR WHITE APPEARS IN THE BACKGROUND AND THE WORD "PALDO".

THE ENGLISH TRANSLATION OF "PALDO" IN THE MARK IS "PROVINCE" OR "ADMINISTRATIVE DISTRICT."

FOR CONFECTIONERY, NAMELY, CANDY; DONUTS, DESSERT PUDDINGS, PEANUT CONFECTIONERY, RUSK, BREAD ROLLS, BUTTER BISCUITS, CONFECTIONERY, NAMELY, BONBONS, BISCUITS, BUNS, CREAM PUFF, SPRING ROLLS, BREAD, ICED CAKES, ICE CREAM, WAFFLES, WAFERS, CHOCOLATE, COOKIES, CRACKERS, CRÊPES, CONFECTIONERY FOR DECORATING CHRISTMAS TREES, CREAM BUNS, TARTS, TOFFEES, TORTILLAS, PIES, FRUIT TEA, CHINESE MATRIMONY VINE TEA, GREEN TEA, LIME TEA, BARLEY LEAVES TEA, BARLEY TEA; HERBAL INFUSIONS, NOT MEDICINAL; SWEET FLAG TEA, ICED TEA, ACANTHOPANAX TEA, OOLONG TEA, TEA-BASED BEVERAGES, STAMINA ENHANCING TEA, GINSENG TEA, TEA, TEA LEAVES, BLACK TEA, COFFEE SUBSTITUTES, DECAFFEINATED COFFEE, COFFEE BEVERAGES WITH MILK, COCOA BEVERAGES WITH MILK; CHOCOLATE FOOD BEVERAGES NOT BEING DAIRY-BASED OR VEGETABLE BASED WITH MILK; CHOCOLATE-BASED BEVERAGES, COFFEE, ARTIFICIAL COFFEE, UNROASTED COFFEE; COCOA PRODUCTS, NAMELY, COCOA POWDER; COFFEE SUBSTITUTE, NAMELY, CHICORY; COCOA-BASED BEVERAGES, VEGETAL PREPARATIONS FOR USE AS COFFEE SUBSTITUTES, NAMELY, GINGER; COFFEE-BASED BEVERAGES, COCOA, COCOA SPREAD (U.S. CL. 46).

DAYNA BROWNE, EXAMINING ATTORNEY

CLASS 30—(Continued).

SN 79-063,304. LIDL STIFTUNG & CO. KG, FED REP GERMANY, FILED 11-13-2008.

GOODY

THE MARK CONSISTS OF STANDARD CHARACTERS WITHOUT CLAIM TO ANY PARTICULAR FONT, STYLE, SIZE, OR COLOR.

OWNER OF INTERNATIONAL REGISTRATION 0676878 DATED 6-27-1997, EXPIRES 6-27-2017.

OWNER OF U.S. REG. NO. 2,703,687.
FOR CEREAL PRODUCTS FOR HUMAN CONSUMPTION, NAMELY, BREAKFAST CEREALS, PROCESSED CEREALS, AND MUESLI (U.S. CL. 46).
KEVIN CORWIN, EXAMINING ATTORNEY

CLASS 31—NATURAL AGRICULTURAL PRODUCTS

SN 76-653,141. PET CENTER, INC., LOS ANGELES, CA. FILED 1-9-2006.

CHICKEN BREAST TENDERS

THE MARK CONSISTS OF STANDARD CHARACTERS WITHOUT CLAIM TO ANY PARTICULAR FONT, STYLE, SIZE, OR COLOR.

NO CLAIM IS MADE TO THE EXCLUSIVE RIGHT TO USE "CHICKEN BREAST", APART FROM THE MARK AS SHOWN.

FOR PET FOOD AND EDIBLE PET TREATS (U.S. CLS. 1 AND 46).

FIRST USE 2-1-2002; IN COMMERCE 2-1-2002.
BARBARA BROWN, EXAMINING ATTORNEY

SN 76-693,119. HAWKES, STEPHEN, DBA CHALK HILL VINEYARD, HEALDSBURG, CA. FILED 9-25-2008.



THE MARK CONSISTS OF AN IMAGE OF A HAWK. FOR FRESH WINE GRAPES (U.S. CLS. 1 AND 46). FIRST USE 1-1-1971; IN COMMERCE 1-1-1971.
GINA FINK, EXAMINING ATTORNEY

CLASS 31—(Continued).

SN 77-373,555. MARS, INCORPORATED, MCLEAN, VA.
FILED 1-16-2008.

MARROBONE

THE MARK CONSISTS OF STANDARD CHARACTERS
WITHOUT CLAIM TO ANY PARTICULAR FONT, STYLE,
SIZE, OR COLOR.

OWNER OF U.S. REG. NO. 2,077,683.

SEC. 2(F).

FOR PET FOOD (U.S. CLS. 1 AND 46).

FIRST USE 7-1-1994; IN COMMERCE 7-1-1994.

WON TEAK OH, EXAMINING ATTORNEY

CLASS 31—(Continued).

SN 77-577,035. CELL RESPONSE FORMULATIONS, LLC,
DBA MULLIGAN PET FOOD, JACKSON, WY. FILED 9-23-
2008.

STEW STICKS

THE MARK CONSISTS OF STANDARD CHARACTERS
WITHOUT CLAIM TO ANY PARTICULAR FONT, STYLE,
SIZE, OR COLOR.

OWNER OF U.S. REG. NO. 3,209,761.

NO CLAIM IS MADE TO THE EXCLUSIVE RIGHT TO
USE "STICKS", APART FROM THE MARK AS SHOWN.

FOR PET TREATS (U.S. CLS. 1 AND 46).

FIRST USE 8-25-2008; IN COMMERCE 8-25-2008.

JULIE GUTTADAURO, EXAMINING ATTORNEY

SN 77-400,976. CLEARY, THOMAS, DBA BOHEMIAN VINE-
YARD, SAN FRANCISCO, CA. AND CLEARY, SUSAN,
DBA BOHEMIAN VINEYARD, SAN FRANCISCO, CA.
FILED 2-19-2008.

BOHEMIAN VINEYARD

THE MARK CONSISTS OF STANDARD CHARACTERS
WITHOUT CLAIM TO ANY PARTICULAR FONT, STYLE,
SIZE, OR COLOR.

NO CLAIM IS MADE TO THE EXCLUSIVE RIGHT TO
USE "VINEYARD", APART FROM THE MARK AS SHOWN.
FOR FRESH GRAPES FOR THE PRODUCTION OF
WINE (U.S. CLS. 1 AND 46).

FIRST USE 12-1-2001; IN COMMERCE 12-1-2001.

LIEF MARTIN, EXAMINING ATTORNEY

SN 77-579,547. FRANZE & YOUNG GROUP, LLC, CHICAGO,
IL. FILED 9-26-2008.

GLOBALTEX ANIMAL NUTRITION

THE MARK CONSISTS OF STANDARD CHARACTERS
WITHOUT CLAIM TO ANY PARTICULAR FONT, STYLE,
SIZE, OR COLOR.

NO CLAIM IS MADE TO THE EXCLUSIVE RIGHT TO
USE "ANIMAL NUTRITION", APART FROM THE MARK
AS SHOWN.

FOR FOOD AND EDIBLE TREATS FOR PETS AND
ANIMALS (U.S. CLS. 1 AND 46).

LAURIE KAUFMAN, EXAMINING ATTORNEY

SN 77-470,976. PROSEEDS MARKETING, INC., JEFFERSON,
OR. FILED 5-9-2008.

Water Sense

THE MARK CONSISTS OF STANDARD CHARACTERS
WITHOUT CLAIM TO ANY PARTICULAR FONT, STYLE,
SIZE, OR COLOR.

FOR GRASS SEED (U.S. CLS. 1 AND 46).

JUSTINE D. PARKER, EXAMINING ATTORNEY

SN 77-585,299. CANNABISSEUR, INC., CHULA VISTA, CA.
FILED 10-3-2008.

CANNABISSEUR

THE MARK CONSISTS OF STANDARD CHARACTERS
WITHOUT CLAIM TO ANY PARTICULAR FONT, STYLE,
SIZE, OR COLOR.

FOR AGRICULTURAL SEEDS; PLANT SEEDS (U.S.
CLS. 1 AND 46).

KIM SAITO, EXAMINING ATTORNEY

CLASS 31—(Continued).

SN 77-617,194. UNIVERSITY OF FLORIDA BOARD OF TRUSTEES, GAINESVILLE, FL. FILED 11-19-2008.

DOUBLE JOY

THE MARK CONSISTS OF STANDARD CHARACTERS WITHOUT CLAIM TO ANY PARTICULAR FONT, STYLE, SIZE, OR COLOR.

FOR FLOWER SEEDS EXCLUDING FLOWER SEEDS FOR MINIATURE ROSES (U.S. CLS. 1 AND 46).
LAURIE KAUFMAN, EXAMINING ATTORNEY

SN 77-631,462. VISTAFLOR INTERNATIONAL, INC., ROAD-TOWN, TORTOLA, BR.VIRGIN ISLANDS, FILED 12-11-2008.



THE MARK CONSISTS OF THE WORDS "VIVA LA" IN A RECTANGLE WITH THREE FLOWERS TO THE RIGHT, BELOW WHICH IS THE WORD "FIESTA" WITH THREE FLOWERS BENEATH IT, BELOW THAT IS "CON NUESTRAS FLORES".

THE FOREIGN WORDING IN THE MARK TRANSLATES INTO ENGLISH AS LIVE THE PARTY WITH OUR FLOWERS.

FOR FRESH CUT FLOWERS (U.S. CLS. 1 AND 46).
FIRST USE 7-0-2005; IN COMMERCE 7-0-2005.
LINDA MICKLEBURGH, EXAMINING ATTORNEY

SN 77-638,329. WATSON, VASHTI J., NAPLES, FL. FILED 12-22-2008.

MANE STREET MARKET

THE MARK CONSISTS OF STANDARD CHARACTERS WITHOUT CLAIM TO ANY PARTICULAR FONT, STYLE, SIZE, OR COLOR.

FOR PET FOOD, NAMELY, HORSE FOOD AND HORSE TREATS (U.S. CLS. 1 AND 46).
FIRST USE 8-1-2008; IN COMMERCE 12-17-2008.
LOURDES AYALA, EXAMINING ATTORNEY

CLASS 31—(Continued).

SN 77-650,546. CENTRAL INSTITUTE FOR EXPERIMENTAL ANIMALS, KAWASAKI, JAPAN, FILED 1-15-2009.

CIEA

THE MARK CONSISTS OF STANDARD CHARACTERS WITHOUT CLAIM TO ANY PARTICULAR FONT, STYLE, SIZE, OR COLOR.

FOR LIVE ANIMALS FOR LABORATORY EXPERIMENTS (U.S. CLS. 1 AND 46).
FIRST USE 11-15-1999; IN COMMERCE 11-15-1999.
EVELYN BRADLEY, EXAMINING ATTORNEY

SN 77-667,593. WAGGIN' TRAIN, LLC, ANDERSON, SC. FILED 2-10-2009.

CANYON CREEK RANCH

THE MARK CONSISTS OF STANDARD CHARACTERS WITHOUT CLAIM TO ANY PARTICULAR FONT, STYLE, SIZE, OR COLOR.

FOR EDIBLE PET TREAT (U.S. CLS. 1 AND 46).
FIRST USE 5-15-2009; IN COMMERCE 5-15-2009.
MATTHEW KLINE, EXAMINING ATTORNEY

SN 77-698,876. DESERT BEST TECHNOLOGIES, YUMA, AZ. FILED 3-25-2009.

DESERT SAND

THE MARK CONSISTS OF STANDARD CHARACTERS WITHOUT CLAIM TO ANY PARTICULAR FONT, STYLE, SIZE, OR COLOR.

NO CLAIM IS MADE TO THE EXCLUSIVE RIGHT TO USE "SAND", APART FROM THE MARK AS SHOWN.
FOR CAT LITTER (U.S. CLS. 1 AND 46).
MARK SPARACINO, EXAMINING ATTORNEY

CLASS 31—(Continued).

SN 77-712,033. NN INTELLECTUAL RESERVES LLC, DRAPER, UT. FILED 4-11-2009.

AVIAN ADVANTAGE

THE MARK CONSISTS OF STANDARD CHARACTERS WITHOUT CLAIM TO ANY PARTICULAR FONT, STYLE, SIZE, OR COLOR.

NO CLAIM IS MADE TO THE EXCLUSIVE RIGHT TO USE "AVIAN", APART FROM THE MARK AS SHOWN.

FOR ANIMAL BEVERAGES, ANIMAL FEED; ANIMAL FEED ADDITIVES FOR NON-NUTRITIONAL PURPOSES FOR USE AS INGREDIENT OR FILLER; BIRD FOOD; PET FOOD, LIVE ANIMALS; LIVE BIRDS, NAMELY, BREEDER AND PET BIRDS; AND LIVE HATCHING EGGS (U.S. CLS. 1 AND 46).

FIRST USE 3-31-2009; IN COMMERCE 3-31-2009.
RENEE MCCRAY, EXAMINING ATTORNEY

CLASS 31—(Continued).

EACH ONION IS A DIFFERENT SIZE AND DIFFERENT COLOR (WHITE, PURPLE, AND BROWN), AND EACH ONION HAS THREE GREEN LEAVES SPROUTING FROM ITS TOP. THE WHITE ONION AND PURPLE ONION ARE IN THE FRONT AND THE BROWN ONION IS IMMEDIATELY BEHIND THEM IN A TRIANGULAR FORMATION. THE WHITE ONION HAS WHITE LEGS, WHITE FEET, WHITE ARMS, WHITE HANDS, AND ONE EYE WINKING. THE WHITE ONION'S RIGHT ARM IS OUTSTRETCHED, HIS RIGHT HAND IS IN A THUMBS-UP FORMATION, AND IN HIS WHITE THUMB ARE THE INITIALS "F.C." IN RED INK. THE WHITE ONION HAS HIS ARM AROUND THE PURPLE ONION, WHICH IS TO THE LEFT OF THE WHITE ONION. THE PURPLE ONION HAS PURPLE ARMS, PURPLE LEGS, PURPLE FEET, AND A WHITE HAND. THE PURPLE ONION'S LEFT HAND IS OUTSTRETCHED. THE BROWN ONION HAS BROWN LEGS, GREEN ARMS, AND WHITE HANDS. THE BROWN ONION HAS HIS TWO ARMS OUTSTRETCHED AND RAISED IN A "V" FORMATION.

FOR FRESH ONIONS; RAW ONIONS; UNPROCESSED ONIONS (U.S. CLS. 1 AND 46).

ROBERT C. CLARK JR., EXAMINING ATTORNEY

SN 77-714,554. NORTH GEORGIA TURF, INC., WHITESBURG, GA. FILED 4-15-2009.



NO CLAIM IS MADE TO THE EXCLUSIVE RIGHT TO USE "TURF", APART FROM THE MARK AS SHOWN.

THE MARK CONSISTS OF THE LETTERS "N" AND "G" AND THE WORD "TURF" TOGETHER WITH A PICTURE OF A GRASS PATCH.

FOR TURF GRASS; SOD (U.S. CLS. 1 AND 46).
FIRST USE 3-0-2005; IN COMMERCE 3-0-2005.
ANGELA DUONG, EXAMINING ATTORNEY

SN 77-718,185. GREEN CIRCLE GROWERS, INC., OBERLIN, OH. FILED 4-21-2009.



NO CLAIM IS MADE TO THE EXCLUSIVE RIGHT TO USE "ORCHIDS" AND THE DESIGN OF AN ORCHID, APART FROM THE MARK AS SHOWN.

THE MARK CONSISTS OF A FLOWER DESIGN ABOVE THE SCRIPT WORDS "JUST ADD ICE" ABOVE THE WORD "ORCHIDS" IN CAPITAL LETTERS.

FOR LIVE ORCHIDS (U.S. CLS. 1 AND 46).
LESLEY LAMOTHE, EXAMINING ATTORNEY

SN 77-716,329. FOUR CEES, INC., UNION, NJ. FILED 4-17-2009.



NO CLAIM IS MADE TO THE EXCLUSIVE RIGHT TO USE "ONIONS", APART FROM THE MARK AS SHOWN.

THE COLOR(S) RED, WHITE, GREEN, BROWN, PINK, AND PURPLE IS/ARE CLAIMED AS A FEATURE OF THE MARK.

THE MARK CONSISTS OF A BANNER WITH THREE VERTICAL PANELS. THE TOP PANEL IS A RED BANNER WITH THE WORDS "OKIE DOKIE ONIONS" IN WHITE CURSIVE FONT REPEATED MULTIPLE TIMES. THE BOTTOM PANEL IS A RED BANNER. THE MIDDLE PANEL CONSISTS OF A BANNER OF GREEN GRASS WITH A REPEATED IMAGE OF THREE STYLIZED ONIONS WITH HANDS, ARMS, LEGS, FEET, EYES, AND OPEN SMILING MOUTHS SHOWING PINK TONGUES.

SN 77-718,321. AFFILIATED FOODS, INC., AMARILLO, TX. FILED 4-21-2009.

POTATO PRIDE

THE MARK CONSISTS OF STANDARD CHARACTERS WITHOUT CLAIM TO ANY PARTICULAR FONT, STYLE, SIZE, OR COLOR.

NO CLAIM IS MADE TO THE EXCLUSIVE RIGHT TO USE "POTATO", APART FROM THE MARK AS SHOWN.

FOR FRESH POTATOES; UNPROCESSED POTATOES (U.S. CLS. 1 AND 46).

FIRST USE 11-26-1993; IN COMMERCE 11-26-1993.
MICHAEL WEBSTER, EXAMINING ATTORNEY

CLASS 31—(Continued).

SN 77-721,007. MARS, INCORPORATED, MCLEAN, VA.
FILED 4-23-2009.

MEATY MIXERS

THE MARK CONSISTS OF STANDARD CHARACTERS
WITHOUT CLAIM TO ANY PARTICULAR FONT, STYLE,
SIZE, OR COLOR.

NO CLAIM IS MADE TO THE EXCLUSIVE RIGHT TO
USE "MEATY", APART FROM THE MARK AS SHOWN.
FOR PET FOOD (U.S. CLS. 1 AND 46).
BRENDAN MCCAULEY, EXAMINING ATTORNEY

CLASS 31—(Continued).

SN 77-723,938. CARISHMA KHUBANI, SADDLE RIVER, NJ.
FILED 4-28-2009.

LAP IT UP

THE MARK CONSISTS OF STANDARD CHARACTERS
WITHOUT CLAIM TO ANY PARTICULAR FONT, STYLE,
SIZE, OR COLOR.

FOR DIETARY BEVERAGES FOR PETS (U.S. CLS. 1
AND 46).
JOHN WILKE, EXAMINING ATTORNEY

SN 77-723,155. SAKATA SEED AMERICA, INC., MORGAN
HILL, CA. FILED 4-27-2009.

POWER TO GROW

THE MARK CONSISTS OF STANDARD CHARACTERS
WITHOUT CLAIM TO ANY PARTICULAR FONT, STYLE,
SIZE, OR COLOR.

FOR PLANT SEEDS; LIVE PLANTS; PLANT CUT-
TINGS FOR HORTICULTURAL AND VEGETATIVE
PURPOSES (U.S. CLS. 1 AND 46).
NAAKWAMA ANKRAH, EXAMINING ATTORNEY

SN 77-724,286. SMG BRANDS, INC., WILMINGTON, DE.
FILED 4-28-2009.

MORNING SONG

THE MARK CONSISTS OF STANDARD CHARACTERS
WITHOUT CLAIM TO ANY PARTICULAR FONT, STYLE,
SIZE, OR COLOR.

OWNER OF U.S. REG. NOS. 2,255,270 AND 2,457,069.
FOR WILD BIRD FOOD (U.S. CLS. 1 AND 46).
FIRST USE 5-15-1985; IN COMMERCE 5-15-1985.
ROBIN MITTLER, EXAMINING ATTORNEY

SN 77-723,424. SMG BRANDS, INC., WILMINGTON, DE.
FILED 4-27-2009.

WILD BIRD ATTRACTIONS

THE MARK CONSISTS OF STANDARD CHARACTERS
WITHOUT CLAIM TO ANY PARTICULAR FONT, STYLE,
SIZE, OR COLOR.

NO CLAIM IS MADE TO THE EXCLUSIVE RIGHT TO
USE "WILD BIRD", APART FROM THE MARK AS SHOWN.
FOR WILD BIRD FOOD (U.S. CLS. 1 AND 46).
ROBIN MITTLER, EXAMINING ATTORNEY

SN 77-724,545. ESMERALDA FARMS, INC., DORAL, FL.
FILED 4-28-2009.

GO BANANAS

THE MARK CONSISTS OF STANDARD CHARACTERS
WITHOUT CLAIM TO ANY PARTICULAR FONT, STYLE,
SIZE, OR COLOR.

FOR FRESH CUT FLOWERS, NAMELY, ROSES (U.S.
CLS. 1 AND 46).
GENE MACIOL, EXAMINING ATTORNEY

CLASS 31—(Continued).

SN 77-725,868. COLUMBIA SEEDS, LLC, CORVALLIS, OR. FILED 4-30-2009.

AT

THE MARK CONSISTS OF STANDARD CHARACTERS WITHOUT CLAIM TO ANY PARTICULAR FONT, STYLE, SIZE, OR COLOR.
FOR AGRICULTURAL SEEDS; GRASS SEED (U.S. CLS. 1 AND 46).
FIRST USE 1-12-2009; IN COMMERCE 1-14-2009.
CHRISTINA SOBRAL, EXAMINING ATTORNEY

SN 77-726,253. GOLDEN EGG OPPORTUNITIES LLC, DBA CHOW-WOW, NEW YORK, NY. FILED 4-30-2009.



THE MARK CONSISTS OF A LOGO OF A HEART WITHIN TWO CIRCLES WITHIN A HOUSE WITH A SMOKESTACK AND A STAR, CIRCLE AND TRIANGLE FOLLOWED BY STYLIZED LETTERS SPELLING OUT THE WORDS CHOW-WOW.
FOR DOG FOOD; FOOD FOR ANIMALS; PET FOOD; PET TREATS (U.S. CLS. 1 AND 46).
SALLY SHIH, EXAMINING ATTORNEY

SN 77-726,372. SOUTH DAKOTA OILSEED PROCESSORS, LLC, MILLER, SD. FILED 4-30-2009.

Soy-XTRA

THE MARK CONSISTS OF STANDARD CHARACTERS WITHOUT CLAIM TO ANY PARTICULAR FONT, STYLE, SIZE, OR COLOR.
FOR SOYBEAN MEAL (U.S. CLS. 1 AND 46).
LAURA HAMMEL, EXAMINING ATTORNEY

CLASS 31—(Continued).

SN 77-726,506. ARTHUR DOGSWELL, LLC, AKA DOGSWELL, LOS ANGELES, CA. FILED 4-30-2009.

NUTRISCA

THE MARK CONSISTS OF STANDARD CHARACTERS WITHOUT CLAIM TO ANY PARTICULAR FONT, STYLE, SIZE, OR COLOR.
FOR PET FOOD AND PET TREATS (U.S. CLS. 1 AND 46).
BARBARA BROWN, EXAMINING ATTORNEY

SN 77-727,582. DCL INC., HONOLULU, HI. FILED 5-1-2009.

HAWAIIAN HARVEST

THE MARK CONSISTS OF STANDARD CHARACTERS WITHOUT CLAIM TO ANY PARTICULAR FONT, STYLE, SIZE, OR COLOR.
NO CLAIM IS MADE TO THE EXCLUSIVE RIGHT TO USE "HAWAIIAN", APART FROM THE MARK AS SHOWN.
FOR FRESH FRUIT AND VEGETABLES (U.S. CLS. 1 AND 46).
BARBARA GAYNOR, EXAMINING ATTORNEY

SN 77-735,519. GERAWAN FARMING, INC., SANGER, CA. FILED 5-12-2009.



THE MARK CONSISTS OF THE STYLIZED WORDS "MARKS & BRAND" SURROUNDED BY AN OVAL.
FOR FRESH FRUITS (U.S. CLS. 1 AND 46).
FIRST USE 5-12-2009; IN COMMERCE 5-12-2009.
YAT SYE, LEE, EXAMINING ATTORNEY

SN 78-782,670. PACIFIC TOMATO GROWERS, LTD., PALMETTO, FL. FILED 12-29-2005.

SUNCOAST

THE MARK CONSISTS OF STANDARD CHARACTERS WITHOUT CLAIM TO ANY PARTICULAR FONT, STYLE, SIZE, OR COLOR.
FOR FRESH FRUITS AND VEGETABLES (U.S. CLS. 1 AND 46).
FIRST USE 6-4-2002; IN COMMERCE 6-4-2002.
MICHAEL WEBSTER, EXAMINING ATTORNEY

CLASS 31—(Continued).

SN 78-930,659. SIX L'S PACKING COMPANY, INC., IMMO-KALEE, FL. FILED 7-17-2006.

RUSKIN VELVET

THE MARK CONSISTS OF STANDARD CHARACTERS WITHOUT CLAIM TO ANY PARTICULAR FONT, STYLE, SIZE, OR COLOR.

NO CLAIM IS MADE TO THE EXCLUSIVE RIGHT TO USE "RUSKIN", APART FROM THE MARK AS SHOWN.

FOR FRESH TOMATOES (U.S. CLS. 1 AND 46).

FIRST USE 4-4-1997; IN COMMERCE 4-4-1997.

MARY CRAWFORD, EXAMINING ATTORNEY

SN 79-065,600. HAMER BLOEMZADEN B.V., NETHERLANDS, FILED 12-23-2008.

GALLO

THE MARK CONSISTS OF STANDARD CHARACTERS WITHOUT CLAIM TO ANY PARTICULAR FONT, STYLE, SIZE, OR COLOR.

PRIORITY DATE OF 7-11-2008 IS CLAIMED.

OWNER OF INTERNATIONAL REGISTRATION 0994100 DATED 12-23-2008, EXPIRES 12-23-2018.

THE ENGLISH TRANSLATION OF "GALLO" IS ROOSTER.

FOR LIVE ORNAMENTAL PLANTS AND FLOWERS, EXCLUDING LIVE CORN AND WHEAT, AS WELL AS PLANT CUTTINGS AND PLANT SEEDS, EXCLUDING CORN AND WHEAT CUTTINGS AND SEEDS, FLOWER SEEDS; SEEDS FOR SOWING, EXCLUDING CORN AND WHEAT SEEDS FOR SOWING (U.S. CLS. 1 AND 46).

ALLISON SCHRODY, EXAMINING ATTORNEY

CLASS 31—(Continued).

SN 79-065,660. MARUKYU CO., LTD., SAITAMA-KEN 363-8509, JAPAN, FILED 12-26-2008.



PRIORITY DATE OF 12-22-2008 IS CLAIMED.
OWNER OF INTERNATIONAL REGISTRATION 0994300 DATED 12-26-2008, EXPIRES 12-26-2018.

THE MARK CONSISTS OF A STYLIZED DEPICTION OF A BOY HOLDING A FISHING ROD AND A FISH AND WEARING A BASEBALL CAP DISPLAYING THE WORD "MARUKYU". THE BOY APPEARS TO THE RIGHT OF A DIVIDED RECTANGLE CONTAINING A CIRCLE, JAPANESE CHARACTERS THAT TRANSLITERATE TO "MARUKYU" AND A STYLIZED DEPICTION OF A FISH FORMED BY A DIAMOND AND OVAL.

THE ENGLISH TRANSLATION OF "MARUKYU" IN THE MARK IS ROUND NINE.

THE NON-LATIN CHARACTERS IN THE MARK TRANSLITERATE TO "MARUKYU" AND THIS MEANS ROUND NINE IN ENGLISH.

FOR FOODSTUFFS FOR FISH, NAMELY, PROCESSED NATURAL PRODUCTS IN POWDER, PELLET OR BLOCK FORM FOR USE AS FISHING BAIT (U.S. CLS. 1 AND 46).

ROBERT LAVACHE, EXAMINING ATTORNEY

CLASS 32—LIGHT BEVERAGES

SN 77-127,648. D&S BEVERAGES DISTRIBUTORS INC., DEER PARK, NY. FILED 3-10-2007.



THE COLOR(S) ,RED, WHITE, AND BLUE, IS/ARE CLAIMED AS A FEATURE OF THE MARK.

THE MARK CONSISTS OF THE NUMBER, "4", IS IN RED AND THE WORD, "KICK", IS IN WHITE.

FOR ENERGY DRINKS (U.S. CLS. 45, 46 AND 48).
FIRST USE 10-1-2002; IN COMMERCE 2-5-2007.

RICHARD A. STRASER, EXAMINING ATTORNEY

CLASS 32—(Continued).

SN 77-386,062. JONES SODA CO. (USA) INC., SEATTLE, WA. FILED 1-31-2008.

JONES ORGANICS

THE MARK CONSISTS OF STANDARD CHARACTERS WITHOUT CLAIM TO ANY PARTICULAR FONT, STYLE, SIZE, OR COLOR.

OWNER OF U.S. REG. NOS. 2,541,825, 2,790,050 AND OTHERS.

NO CLAIM IS MADE TO THE EXCLUSIVE RIGHT TO USE "ORGANICS", APART FROM THE MARK AS SHOWN. SEC. 2(F) AS TO "JONES".

FOR ORGANIC BEVERAGES, NAMELY, NON-ALCOHOLIC NON-CARBONATED BEVERAGES, NAMELY, TEA FLAVORED DRINKS AND FRUIT JUICES FLAVORED WITH TEA (U.S. CLS. 45, 46 AND 48).
EUGENIA MARTIN, EXAMINING ATTORNEY

CLASS 32—(Continued).

SN 77-482,520. ESSENTIA WATER, INC., BOTHELL, WA. FILED 5-23-2008.

ESSENTIA WATER IS A PRESCRIPTION FOR LIFE!

THE MARK CONSISTS OF STANDARD CHARACTERS WITHOUT CLAIM TO ANY PARTICULAR FONT, STYLE, SIZE, OR COLOR.

FOR BOTTLED WATER (U.S. CLS. 45, 46 AND 48).
FIRST USE 4-1-2004; IN COMMERCE 4-1-2004.

BONNIE LUKEN, EXAMINING ATTORNEY

SN 77-441,163. TORRES, TORAH, OAKVIEW, CA. FILED 4-7-2008.

H209

THE MARK CONSISTS OF STANDARD CHARACTERS WITHOUT CLAIM TO ANY PARTICULAR FONT, STYLE, SIZE, OR COLOR.

FOR BOTTLED WATER; FLAVORED BOTTLED WATER; SPARKLING WATER (U.S. CLS. 45, 46 AND 48).
LESLIE RICHARDS, EXAMINING ATTORNEY

SN 77-529,363. OCEAN SPRAY CRANBERRIES, INC., LAKEVILLE-MIDDLEBORO, MA. FILED 7-23-2008.

CRANESSENCE

THE MARK CONSISTS OF STANDARD CHARACTERS WITHOUT CLAIM TO ANY PARTICULAR FONT, STYLE, SIZE, OR COLOR.

OWNER OF U.S. REG. NO. 3,419,838.

FOR BOTTLED WATER ENHANCED WITH VITAMINS AND MINERALS, FRUIT JUICES AND JUICE DRINKS, NAMELY, FRUIT DRINKS (U.S. CLS. 45, 46 AND 48).

ROBERT STRUCK, EXAMINING ATTORNEY

SN 77-450,745. EARNEST, AVERY, LOS ANGELES, CA. FILED 4-17-2008.

Radicalizer

THE MARK CONSISTS OF STANDARD CHARACTERS WITHOUT CLAIM TO ANY PARTICULAR FONT, STYLE, SIZE, OR COLOR.

FOR FRUIT FLAVORED DRINKS; SPORTS DRINKS (U.S. CLS. 45, 46 AND 48).

SARA THOMAS, EXAMINING ATTORNEY

SN 77-588,494. YIASOU, LLC, FORT WAYNE, IN. FILED 10-8-2008.

ARŌ the aronia berry brand

NO CLAIM IS MADE TO THE EXCLUSIVE RIGHT TO USE "THE ARONIA BERRY BRAND", APART FROM THE MARK AS SHOWN.

THE MARK CONSISTS OF CAPITAL LETTERS "A" AND "R" WITH A LOWERCASE LETTER "O" WITH A LINE ABOVE THE LETTER "O" WITH THE WORDS "THE ARONIA BERRY BRAND" UNDERNEATH THE LETTERS "A", "R", AND "O".

FOR FRUIT BEVERAGES (U.S. CLS. 45, 46 AND 48).

KAREN K. BUSH, EXAMINING ATTORNEY

CLASS 32—(Continued).

SN 77-596,427. NANZA GROUP LLC, LOS ANGELES, CA. FILED 10-20-2008.

URGE

THE MARK CONSISTS OF STANDARD CHARACTERS WITHOUT CLAIM TO ANY PARTICULAR FONT, STYLE, SIZE, OR COLOR.

FOR FRUIT JUICES, NAMELY, GOGI STRAWBERRY JUICE, VEGETABLE BEET JUICE, GOJI BERRY JUICE, APPLE JUICE, PEAR JUICE, STRAWBERRY JUICE, PINEAPPLE PASSION FRUIT JUICE; JUICE CONTAINING VITAMINS B3, B5, B6 AND B13, LAVENDER, ROSE HIP EXTRACTS, ASIOHIOAGHANDRA ROOT EXTRACT, GREEN TEA EXTRACT, YERBA MYRTLE EXTRACT AND RIBOSE EXTRACT; FRUIT JUICE CONCENTRATES; ENERGY DRINKS; SPORTS DRINKS; AND LEMONADE (U.S. CLS. 45, 46 AND 48).

GIANCARLO CASTRO, EXAMINING ATTORNEY

SN 77-596,513. HOWE SOUND BREWING COMPANY LTD., SQUAMISH, B.C., CANADA, FILED 10-20-2008.

Bailout Bitter

THE MARK CONSISTS OF STANDARD CHARACTERS WITHOUT CLAIM TO ANY PARTICULAR FONT, STYLE, SIZE, OR COLOR.

PRIORITY CLAIMED UNDER SEC. 44(D) ON CANADA APPLICATION NO. 1415012, FILED 10-20-2008.

NO CLAIM IS MADE TO THE EXCLUSIVE RIGHT TO USE "BITTER", APART FROM THE MARK AS SHOWN. FOR BEER, ALE, AND LAGER (U.S. CLS. 45, 46 AND 48).

THEODORE MCBRIDE, EXAMINING ATTORNEY

SN 77-613,152. OREGON BREWING COMPANY, NEWPORT, OR. FILED 11-12-2008.

ROGUE SESQUICENTENNIAL

THE MARK CONSISTS OF STANDARD CHARACTERS WITHOUT CLAIM TO ANY PARTICULAR FONT, STYLE, SIZE, OR COLOR.

OWNER OF U.S. REG. NOS. 1,625,318, 2,913,861 AND OTHERS.

FOR BEER (U.S. CLS. 45, 46 AND 48).

CHARLOTTE CORWIN, EXAMINING ATTORNEY

CLASS 32—(Continued).

SN 77-613,887. LIQUID LIGHTNING CORPORATION, POMPTON LAKES, NJ. FILED 11-13-2008.

First Real Beverage

THE MARK CONSISTS OF STANDARD CHARACTERS WITHOUT CLAIM TO ANY PARTICULAR FONT, STYLE, SIZE, OR COLOR.

NO CLAIM IS MADE TO THE EXCLUSIVE RIGHT TO USE "BEVERAGE", APART FROM THE MARK AS SHOWN. FOR ENERGY DRINKS (U.S. CLS. 45, 46 AND 48).

KRISTIN DAHLING, EXAMINING ATTORNEY

SN 77-621,010. JOHN BARRITT & SON LIMITED, SMITH'S PARISH, BERMUDA, FILED 11-24-2008.

BARRITTS

THE MARK CONSISTS OF STANDARD CHARACTERS WITHOUT CLAIM TO ANY PARTICULAR FONT, STYLE, SIZE, OR COLOR.

OWNER OF U.S. REG. NOS. 1,427,700 AND 1,564,932.

SEC. 2(F).

FOR NON-ALCOHOLIC BEVERAGES, NAMELY, GINGER BEER (U.S. CLS. 45, 46 AND 48).

FIRST USE 0-0-1874; IN COMMERCE 0-0-1998.

TOBY BULLOFF, EXAMINING ATTORNEY

SN 77-625,593. C.H.I.C. LLC, DBA VILLAGE PUB, PALM SPRINGS, CA. FILED 12-3-2008.

LA VIE

THE MARK CONSISTS OF STANDARD CHARACTERS WITHOUT CLAIM TO ANY PARTICULAR FONT, STYLE, SIZE, OR COLOR.

THE ENGLISH TRANSLATION OF "LA VIE" IS THE LIFE.

FOR DRINKING WATER (U.S. CLS. 45, 46 AND 48).

MATTHEW KLINE, EXAMINING ATTORNEY

CLASS 32—(Continued).

SN 77-625,602. C.H.I.C. LLC, DBA VILLAGE PUB, PALM SPRINGS, CA. FILED 12-3-2008.

LA VIE ROSE

THE MARK CONSISTS OF STANDARD CHARACTERS WITHOUT CLAIM TO ANY PARTICULAR FONT, STYLE, SIZE, OR COLOR.

NO CLAIM IS MADE TO THE EXCLUSIVE RIGHT TO USE "ROSE", APART FROM THE MARK AS SHOWN.

THE ENGLISH TRANSLATION OF "LA VIE ROSE" IS PINK LIFE.

FOR ROSE FLAVORED DRINKING WATER (U.S. CLS. 45, 46 AND 48).

MATTHEW KLINE, EXAMINING ATTORNEY

SN 77-650,944. OREGON BREWING COMPANY, NEWPORT, OR. FILED 1-16-2009.

ROGUE

THE MARK CONSISTS OF STANDARD CHARACTERS WITHOUT CLAIM TO ANY PARTICULAR FONT, STYLE, SIZE, OR COLOR.

OWNER OF U.S. REG. NOS. 1,625,132, 2,913,861 AND OTHERS.

FOR BEER (U.S. CLS. 45, 46 AND 48).

CHARLOTTE CORWIN, EXAMINING ATTORNEY

SN 77-655,103. SOCIEDAD ANONIMA DAMM, BARCELONA, SPAIN, FILED 1-23-2009.

DAMM INEDIT

THE MARK CONSISTS OF STANDARD CHARACTERS WITHOUT CLAIM TO ANY PARTICULAR FONT, STYLE, SIZE, OR COLOR.

OWNER OF U.S. REG. NOS. 3,204,372, 3,463,924 AND 3,518,133.

THE ENGLISH TRANSLATION OF "INEDIT" IN THE MARK IS UNPUBLISHED, NOVEL.

FOR BEER (U.S. CLS. 45, 46 AND 48).

KATHERINE CHANG, EXAMINING ATTORNEY

CLASS 32—(Continued).

SN 77-658,333. SOCIEDAD ANONIMA DAMM, BARCELONA, SPAIN, FILED 1-28-2009.

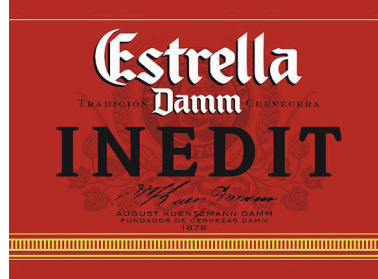

OWNER OF SPAIN REG. NO. 2805437, DATED 5-12-2008, EXPIRES 12-19-2017.

OWNER OF U.S. REG. NOS. 3,204,372, 3,463,924 AND 3,518,133.

NO CLAIM IS MADE TO THE EXCLUSIVE RIGHT TO USE "CEVECERA," "FUNDADOR DE CERVEZAS" OR "1876", APART FROM THE MARK AS SHOWN.

THE NAME(S), PORTRAIT(S), AND/OR SIGNATURE(S) SHOWN IN THE MARK DOES NOT IDENTIFY A PARTICULAR LIVING INDIVIDUAL.

THE COLOR(S) WHITE, BLACK, RED AND YELLOW IS/ARE CLAIMED AS A FEATURE OF THE MARK.

THE MARK CONSISTS OF THE STYLIZED WORDING "ESTRELLA DAMM" IN WHITE, THE WORDS "TRADICION CERVECERA INEDIT AUGUST KUENTZMANN DAMM FUNDADOR DE CERVEZAS DAMM 1876" IN BLACK, YELLOW HORIZONTAL TRIM ON THE TOP AND BOTTOM OF THE MARK, A BLACK EMBLEM OF AUGUST DAMM IN THE BACKGROUND, ALL IN A RED BACKGROUND.

THE ENGLISH TRANSLATION OF THE WORDS "ESTRELLA," "TRADICION," "CERVECERA," "INEDIT," AND "FUNDADOR DE CERVEZAS DAMM" IN THE MARK IS "STAR," "BREWING," "TRADITION," "UNPUBLISHED, NOVEL," AND "FOUNDER OF DAMM BEER." THE WORDING DAMM HAS NO MEANING IN A FOREIGN LANGUAGE.

FOR BEER (U.S. CLS. 45, 46 AND 48).

KATHERINE CHANG, EXAMINING ATTORNEY

SN 77-660,770. GLOBAL BEVERAGES TRADING COMPANY, LLC, GREAT NECK, NY. FILED 1-31-2009.

Global Dominican Power

THE MARK CONSISTS OF STANDARD CHARACTERS WITHOUT CLAIM TO ANY PARTICULAR FONT, STYLE, SIZE, OR COLOR.

NO CLAIM IS MADE TO THE EXCLUSIVE RIGHT TO USE "GLOBAL" AND "DOMINICAN", APART FROM THE MARK AS SHOWN.

FOR ENERGY DRINKS; ENERGY SHOTS, NAMELY, ENERGY DRINKS; DRINKING WATER CONTAINING VITAMIN OR PROTEIN; FLAVORED WATER; NON-ALCOHOLIC BEVERAGES, NAMELY, SPORTS DRINKS, DRINKING WATER CONTAINING PROTEIN, FRUIT DRINK, CARBONATED WATER, FRUIT JUICE CONCENTRATES, AND ENERGY SHOTS, NAMELY, ENERGY DRINKS (U.S. CLS. 45, 46 AND 48).

STEVEN R. FINE, EXAMINING ATTORNEY

CLASS 32—(Continued).

SN 77-686,779. GT BEVERAGE COMPANY, LLC, LAGUNA NIGUEL, CA. FILED 3-9-2009.



THE MARK CONSISTS OF A THREE-DIMENSIONAL CONFIGURATION OF THE PACKAGING FOR THE GOODS, NAMELY, A BEVERAGE CONTAINER FEATURING A GLOBULAR BOTTLE SHAPE RESEMBLING A BASKETBALL. THE BROKEN LINES IN THE BOTTOM OF THE BOTTLE AND IN THE NECK AND CAP OF THE BOTTLE ARE NOT CLAIMED AS PART OF THE MARK BUT ARE INSTEAD FOR CONTEXT AND TO SHOW PLACEMENT OF THE MARK ON THE BEVERAGE CONTAINER.

FOR SPORTS DRINKS (U.S. CLS. 45, 46 AND 48).
FIRST USE 5-0-2008; IN COMMERCE 5-0-2008.
MAUREEN DALL, EXAMINING ATTORNEY

SN 77-695,474. PHUSION PROJECTS, LLC, CHICAGO, IL.
FILED 3-20-2009.



NO CLAIM IS MADE TO THE EXCLUSIVE RIGHT TO USE "HIGH GRAVITY LAGER", APART FROM THE MARK AS SHOWN.

THE MARK CONSISTS OF THE WORDING "QUAKE" WITH NUMEROUS LINES CRISS-CROSSING THROUGH IT AND WITH THE WORDS "HIGH GRAVITY LAGER" ABOVE WITH THE LETTERS "I", "A" AND "E" UNDERLINED.

FOR BEER (U.S. CLS. 45, 46 AND 48).
LESLIE RICHARDS, EXAMINING ATTORNEY

CLASS 32—(Continued).

SN 77-708,023. SUNSTEEN LLC, SOUTH EL MONTE, CA, CA.
FILED 4-6-2009.



THE COLOR(S) THE COLORS GOLD, LIGHT GREEN, GREEN, DARK GREEN, LIGHT PURPLE, PURPLE, DARK PURPLE ORANGE, YELLOW, BEIGE TAN IS/ARE CLAIMED AS A FEATURE OF THE MARK.

THE MARK CONSISTS OF A GRAPHIC RESEMBLING THE OUTSIDE OF A MANGOSTEEN FRUIT ALONGSIDE A GRAPHIC REPRESENTING THE INSIDE OF A MANGOSTEEN FRUIT WITH LITERAL ELEMENT ABOVE. THE GRAPHIC REPRESENTING THE OUTSIDE OF THE MANGOSTEEN FRUIT HAS GREEN LEAVES, GREEN STEM, AND BODY OF FRUIT IS A LIGHT PURPLE GRADIENT OUTLINED BY PURPLE. THE GRAPHIC REPRESENTING THE INSIDE OF THE MANGOSTEEN FRUIT HAS A PULP THAT IS BEIGE OUTLINED BY TAN, YELLOW AND ORANGE BORDERING THE PULP AND A PURPLE OUTER SHELL.

FOR CONCENTRATED FRUIT JUICE; FRUIT DRINKS AND JUICES; FRUIT JUICES; MIXED FRUIT JUICE; NON-ALCOHOLIC BEVERAGES CONTAINING FRUIT JUICES; NON-ALCOHOLIC FRUIT JUICE BEVERAGES (U.S. CLS. 45, 46 AND 48).

FIRST USE 3-14-2008; IN COMMERCE 3-14-2008.
DAVON HATCHETT, EXAMINING ATTORNEY

SN 77-721,504. NIRVANA, INC., FORESTPORT, NY. FILED
4-24-2009.

6° LIQUID HARMONY

THE MARK CONSISTS OF STANDARD CHARACTERS WITHOUT CLAIM TO ANY PARTICULAR FONT, STYLE, SIZE, OR COLOR.

FOR BOTTLED WATER (U.S. CLS. 45, 46 AND 48).
KRISTINA MORRIS, EXAMINING ATTORNEY

CLASS 32—(Continued).

SN 77-722,231. PYRAMID IP, LLC, SEATTLE, WA. FILED 4-24-2009.

JUGGERNAUT

THE MARK CONSISTS OF STANDARD CHARACTERS WITHOUT CLAIM TO ANY PARTICULAR FONT, STYLE, SIZE, OR COLOR.

FOR BREWED MALT-BASED ALCOHOLIC BEVERAGE IN THE NATURE OF A BEER; MALT LIQUOR (U.S. CLS. 45, 46 AND 48).

ELIZABETH KAJUBI, EXAMINING ATTORNEY

SN 77-722,446. IW HOLDINGS CORPORATION, NORTH MIAMI BEACH, FL. FILED 4-25-2009.

THE MARK CONSISTS OF HYDRATE 2 "DONATE", INCORPORATING THE ELEMENT SYMBOL FOR WATER "H2O" BY BEGINNING THE FIRST WORD HYDRATE WITH A CAPITAL "H", FOLLOWED BY THE REMAINING LETTERS TO COMPLETE THE WORD "HYDRATE" AT THE CENTER TOP OF THE MARK, THE NUMBER "2", (POSITIONED BETWEEN THE CAPITAL "H" AND THE LOWER CASE "D") FOLLOWED BY THE SECOND WORD "DONATE", BEGINNING WITH A LOWER CASE "D" FOLLOWED BY AN OVERSIZED CAPITAL LETTER "O" AND THE REMAINING LETTERS TO COMPLETE THE WORD "DONATE" AT CENTER BOTTOM, ALL COLLECTIVELY COMPLETE THE MARK AND THE SYMBOL FOR WATER.

FOR BOTTLED WATER (U.S. CLS. 45, 46 AND 48).
ESTHER BELENKER, EXAMINING ATTORNEY

SN 77-723,588. GINSBERG, AVI, FORMERLY AVRAHAM MOSHE GINSBERG, HOUSTON, TX. FILED 4-28-2009.

COTTONMOUTH

THE MARK CONSISTS OF STANDARD CHARACTERS WITHOUT CLAIM TO ANY PARTICULAR FONT, STYLE, SIZE, OR COLOR.

FOR SPORTS DRINKS, NAMELY, ENERGY DRINKS (U.S. CLS. 45, 46 AND 48).

COLLEEN DOMBROW, EXAMINING ATTORNEY

CLASS 32—(Continued).

SN 77-723,759. HAYWARD ENTERPRISES, INC., NAPA, CA. FILED 4-28-2009.

EVERY GLASS IS A LIQUID CANVAS

THE MARK CONSISTS OF STANDARD CHARACTERS WITHOUT CLAIM TO ANY PARTICULAR FONT, STYLE, SIZE, OR COLOR.

FOR NON-ALCOHOLIC COCKTAIL MIXES (U.S. CLS. 45, 46 AND 48).

FIRST USE 4-20-2009; IN COMMERCE 4-20-2009.
MICHAEL ENGEL, EXAMINING ATTORNEY

SN 77-723,763. BLUE LOTUS LIFESTYLE, LLC, INDIAN WELLS, CA. FILED 4-28-2009.

Blue Lotus Lifestyle

THE MARK CONSISTS OF STANDARD CHARACTERS WITHOUT CLAIM TO ANY PARTICULAR FONT, STYLE, SIZE, OR COLOR.

FOR ENERGY DRINKS (U.S. CLS. 45, 46 AND 48).
FIRST USE 2-28-2008; IN COMMERCE 2-28-2008.

ANDREA K. NADELMAN, EXAMINING ATTORNEY

SN 77-723,845. SUNKIST GROWERS, INC., SHERMAN OAKS, CA. FILED 4-28-2009.

SUNKIST JUICY WATER

THE MARK CONSISTS OF STANDARD CHARACTERS WITHOUT CLAIM TO ANY PARTICULAR FONT, STYLE, SIZE, OR COLOR.

OWNER OF U.S. REG. NOS. 301,281, 1,215,135 AND OTHERS.

NO CLAIM IS MADE TO THE EXCLUSIVE RIGHT TO USE "WATER", APART FROM THE MARK AS SHOWN.

FOR FLAVORED WATERS (U.S. CLS. 45, 46 AND 48).
MARK PILARO, EXAMINING ATTORNEY

CLASS 32—(Continued).

SN 77-724,030. POMWONDERFUL LLC, LOS ANGELES, CA. FILED 4-28-2009.

POMx AID

THE MARK CONSISTS OF STANDARD CHARACTERS WITHOUT CLAIM TO ANY PARTICULAR FONT, STYLE, SIZE, OR COLOR.

FOR NON-ALCOHOLIC FRUIT EXTRACTS USED IN PREPARATION OF BEVERAGES; FRUIT FLAVORED BEVERAGES; NON-ALCOHOLIC BEVERAGES CONTAINING FRUIT JUICES; LOW CALORIE FRUIT FLAVORED BEVERAGES; LOW CALORIE FRUIT JUICE DRINKS; FRUIT JUICES; FRUIT DRINKS; FRUIT JUICE CONCENTRATES; NON-CARBONATED SOFT DRINKS; LOW CALORIE SOFT DRINK AND CONCENTRATES FOR MAKING SOFT DRINKS; FRUIT FLAVORED SOFT DRINKS; POWDERS, SYRUPS FOR USE IN MAKING SOFT DRINKS (U.S. CLS. 45, 46 AND 48).
JANICE KIM, EXAMINING ATTORNEY

SN 77-724,036. POMWONDERFUL LLC, LOS ANGELES, CA. FILED 4-28-2009.

POM AID

THE MARK CONSISTS OF STANDARD CHARACTERS WITHOUT CLAIM TO ANY PARTICULAR FONT, STYLE, SIZE, OR COLOR.

FOR FRUIT FLAVORED BEVERAGES; NON-ALCOHOLIC BEVERAGES CONTAINING FRUIT JUICES; LOW CALORIE FRUIT FLAVORED BEVERAGES; LOW CALORIE FRUIT JUICE DRINKS; FRUIT JUICES; FRUIT DRINKS; FRUIT JUICE CONCENTRATES; NON-CARBONATED SOFT DRINKS; LOW CALORIE SOFT DRINK AND CONCENTRATES FOR MAKING SOFT DRINKS; FRUIT FLAVORED SOFT DRINKS; POWDERS, SYRUPS FOR USE IN MAKING SOFT DRINKS (U.S. CLS. 45, 46 AND 48).
JANICE KIM, EXAMINING ATTORNEY

SN 77-724,145. AMAZON PRESERVATION PARTNERS, DBA ZOLA ACAI, SAN FRANCISCO, CA. FILED 4-28-2009.

Drink Zola. Live Better.

THE MARK CONSISTS OF STANDARD CHARACTERS WITHOUT CLAIM TO ANY PARTICULAR FONT, STYLE, SIZE, OR COLOR.

FOR FRUIT DRINKS AND FRUIT JUICES; SMOOTHIES (U.S. CLS. 45, 46 AND 48).
FIRST USE 3-5-2009; IN COMMERCE 3-5-2009.
RENEE MCCRAY, EXAMINING ATTORNEY

CLASS 32—(Continued).

SN 77-724,436. EXSTA BEVERAGE COMPANY, CORONA-DO, CA. FILED 4-28-2009.



NO CLAIM IS MADE TO THE EXCLUSIVE RIGHT TO USE "ENERGY", APART FROM THE MARK AS SHOWN.

THE MARK CONSISTS OF THE DESIGN OF HALF OF A HELMET TO THE LEFT OF THE WORDING "AGOGE ENERGY".

FOR ENERGY DRINKS (U.S. CLS. 45, 46 AND 48).
AISHA SALEM, EXAMINING ATTORNEY

SN 77-724,769. SHEETZ OF DELAWARE, INC., WILMINGTON, DE. FILED 4-29-2009.

ATOMIC BURST

THE MARK CONSISTS OF STANDARD CHARACTERS WITHOUT CLAIM TO ANY PARTICULAR FONT, STYLE, SIZE, OR COLOR.

FOR ENERGY DRINKS (U.S. CLS. 45, 46 AND 48).
GEORGE LORENZO, EXAMINING ATTORNEY

CLASS 32—(Continued).

SN 77-725,045. VITALON FOODS CO., LTD., TAICHUNG, TAIWAN, FILED 4-29-2009.



OWNER OF U.S. REG. NOS. 1,740,653 AND 2,790,791.
THE COLOR(S) BLUE, GREEN, INDIGO AND WHITE IS/ARE CLAIMED AS A FEATURE OF THE MARK.

THE MARK CONSISTS OF A WOMAN ATHLETE IN WHITE WITH CHINESE CHARACTERS, THE WORDS "SUPER SUPAU" AND A LIGHTING STRIKE IN WHITE ALL OUTLINED IN THE COLOR INDIGO WITH A BLUE, GREEN AND WHITE BACKGROUND.

THE NON-LATIN CHARACTERS IN THE MARK TRANSLITERATE TO SU AND PAU AND THIS MEANS COMFORTABLE, RELAXED, LEISURELY AND RUN IN ENGLISH.

FOR AERATED WATER; DRINKING WATER; SPORTS DRINKS CONSISTING OF SUGAR, VITAMINS, MINERALS, ACIDS, SALT AND FRUIT FLAVORING; SOFT DRINKS, NAMELY, COLAS; FRUIT DRINKS; FRUIT JUICES; MIXED FRUIT JUICES; FRUIT PUNCHES; FRUIT-BASED SOFT DRINKS FLAVORED WITH TEA; TOMATO JUICES; AERATED FRUIT JUICES; VEGETABLE JUICES; FRUIT JUICES IN GENERAL; LEMONADE; MALT WORT; MINERAL WATER; SELTZER WATER; SODA WATER; FRUIT FLAVORED SOFT DRINKS; SYRUPS FOR MAKING SOFT DRINKS; SARSAPARILLA; NON-ALCOHOLIC PUNCHES; AND NON-ALCOHOLIZED WINES (U.S. CLS. 45, 46 AND 48).

FIRST USE 3-26-2009; IN COMMERCE 4-11-2009.
MIDGE BUTLER, EXAMINING ATTORNEY

SN 77-725,941. SKINNY MIXES, LLC, LARGO, FL. FILED 4-30-2009.

Jordan's Skinny Mixes

THE MARK CONSISTS OF STANDARD CHARACTERS WITHOUT CLAIM TO ANY PARTICULAR FONT, STYLE, SIZE, OR COLOR.

NO CLAIM IS MADE TO THE EXCLUSIVE RIGHT TO USE "MIXES", APART FROM THE MARK AS SHOWN.

FOR NON-ALCOHOLIC FLAVORED COCKTAIL MIXES USED TO MAKE ALCOHOLIC BEVERAGES (U.S. CLS. 45, 46 AND 48).

CHARLES L. JENKINS, EXAMINING ATTORNEY

CLASS 32—(Continued).

SN 77-725,988. ENERTIA BEVERAGE LLC, DBA ENERTIA BEVERAGE, PITTSFORD, NY. FILED 4-30-2009.

vital energy

THE MARK CONSISTS OF STANDARD CHARACTERS WITHOUT CLAIM TO ANY PARTICULAR FONT, STYLE, SIZE, OR COLOR.

NO CLAIM IS MADE TO THE EXCLUSIVE RIGHT TO USE "ENERGY", APART FROM THE MARK AS SHOWN.

FOR DRINKING WATER WITH VITAMINS (U.S. CLS. 45, 46 AND 48).

ERNEST SHOSHO, EXAMINING ATTORNEY

SN 77-726,676. ROBERT W. GREGORY, AUSTIN, TX. FILED 5-1-2009.

Skidmark Beer

THE MARK CONSISTS OF STANDARD CHARACTERS WITHOUT CLAIM TO ANY PARTICULAR FONT, STYLE, SIZE, OR COLOR.

NO CLAIM IS MADE TO THE EXCLUSIVE RIGHT TO USE "BEER", APART FROM THE MARK AS SHOWN.

FOR BEER, ALE AND LAGER (U.S. CLS. 45, 46 AND 48).

WILLIAM VERHOSEK, EXAMINING ATTORNEY

SN 77-727,488. MACTARNAHAN'S IP, LLC, PORTLAND, OR. FILED 5-1-2009.

LIP STINGER

THE MARK CONSISTS OF STANDARD CHARACTERS WITHOUT CLAIM TO ANY PARTICULAR FONT, STYLE, SIZE, OR COLOR.

FOR BREWED MALT-BASED ALCOHOLIC BEVERAGE IN THE NATURE OF A BEER; MALT LIQUOR (U.S. CLS. 45, 46 AND 48).

ZACHARY BELLO, EXAMINING ATTORNEY

CLASS 32—(Continued).

SN 77-727,584. WRANGYER BEVERAGE (2008) CO., LTD.,
BANGKOK, THAILAND, FILED 5-1-2009.



THE COLOR(S) BLACK, WHITE, BROWN, RED, GOLD IS/
ARE CLAIMED AS A FEATURE OF THE MARK.

THE MARK CONSISTS OF THE WORD "WRANGYER" IN
BLACK WITH A WHITE BACKGROUND PARTIALLY
COVERING A TIGER IN BLACK AND BROWN WITH A
RED TONGUE AND WHITE TEETH AND GOLD MANE
PARTIALLY COVERING GOLD RAYS OF A SUN, ALL
WITHIN A RED RECTANGLE.

FOR ENERGY DRINKS (U.S. CLS. 45, 46 AND 48).
TEJBIR SINGH, EXAMINING ATTORNEY

CLASS 32—(Continued).

SN 78-708,937. MOUNT EVEREST LIMITED, HONG KONG,
CHINA, FILED 9-8-2005.

QOMOLUNGMA

THE MARK CONSISTS OF STANDARD CHARACTERS
WITHOUT CLAIM TO ANY PARTICULAR FONT, STYLE,
SIZE, OR COLOR.

OWNER OF HONG KONG REG. NO. 300477199, DATED 8-
15-2005, EXPIRES 8-15-2015.

THE FOREIGN WORDING IN THE MARK TRANSLATES
INTO ENGLISH AS PEARL, SOFT, BRIGHT, AND AGATE.
FOR MINERAL WATER, SPRING WATER, DRINK-
ING WATER, FLAVORED WATERS, SELTZER WATER,
SODA WATER, SPARKLING WATER (U.S. CLS. 45, 46
AND 48).

REBECCA SMITH, EXAMINING ATTORNEY

SN 77-728,347. HOME BOX OFFICE, INC., NEW YORK, NY.
FILED 5-4-2009.

BOARDWALK EMPIRE

THE MARK CONSISTS OF STANDARD CHARACTERS
WITHOUT CLAIM TO ANY PARTICULAR FONT, STYLE,
SIZE, OR COLOR.

FOR NON-ALCOHOLIC BEVERAGES, NAMELY,
FRUIT DRINKS, FRUIT JUICES, CARBONATED BEV-
ERAGES; NON-ALCOHOLIC BEER; ALCOHOLIC BEV-
ERAGES, NAMELY, BEER, ALE, LAGER, STOUT,
PORTER AND SHANDY; SYRUPS FOR MAKING NON-
ALCOHOLIC CARBONATED BEVERAGES; AND BEV-
ERAGE POWDER PREPARATIONS FOR FRUIT AND
SPORTS DRINKS (U.S. CLS. 45, 46 AND 48).

STEVEN JACKSON, EXAMINING ATTORNEY

CLASS 33—WINES AND SPIRITS

SN 76-496,632. FINE WINE OF AUSTRALIA PTY. LTD.,
MIRANDA, N.S.W. 2228, AUSTRALIA, FILED 3-11-2003.



NO CLAIM IS MADE TO THE EXCLUSIVE RIGHT TO
USE "RESERVE", APART FROM THE MARK AS SHOWN.
FOR ALCOHOLIC BEVERAGES, NAMELY, WINE
(U.S. CLS. 47 AND 49).

FIRST USE 2-24-2003; IN COMMERCE 2-24-2003.

VIVIAN MICZNIK FIRST, EXAMINING ATTORNEY

CLASS 33—(Continued).

SN 76-694,175. LOVE, KELVIN A., UNIVERSAL CITY, CA. FILED 11-12-2008.

EAU DE VIE VODKA WATER OF LIFE

THE MARK CONSISTS OF STANDARD CHARACTERS WITHOUT CLAIM TO ANY PARTICULAR FONT, STYLE, SIZE, OR COLOR.

NO CLAIM IS MADE TO THE EXCLUSIVE RIGHT TO USE "VODKA" AND "EAU DE VIE", APART FROM THE MARK AS SHOWN.

THE ENGLISH TRANSLATION OF "EAU DE VIE" IN THE MARK IS "WATER OF LIFE."

FOR ALCOHOLIC BEVERAGES, NAMELY, VODKA (U.S. CLS. 47 AND 49).

NAPOLEON SHARMA, EXAMINING ATTORNEY



SN 77-015,739. VINSKA KLET GORISKA BRDA, Z.O.O., DOBROVO, SLOVENIA, FILED 10-6-2006.



THE MARK CONSISTS OF STANDARD CHARACTERS WITHOUT CLAIM TO ANY PARTICULAR FONT, STYLE, SIZE, OR COLOR.

FOR WINE (U.S. CLS. 47 AND 49).

KAREN SEVERSON, EXAMINING ATTORNEY

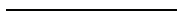

SN 77-162,106. AZIENDA VINICOLA UMANI RONCHI S.P.A., OSIMO (ANCONA), ITALY, FILED 4-20-2007.



OWNER OF ITALY REG. NO. 1176871, DATED 3-10-2009, EXPIRES 11-9-2016.

THE MARK CONSISTS OF A STYLIZED EXCLAMATION POINT.

FOR WINES AND ALCOHOLIC SPIRITS, NAMELY, BRANDY, WINE COOLERS, RUM, VODKA, AND LIQUEURS (U.S. CLS. 47 AND 49).

ELLEN B. AWRICH, EXAMINING ATTORNEY

CLASS 33—(Continued).

SN 77-285,204. DOUGLAS LAING & CO LIMITED, GLASGOW, UNITED KINGDOM, FILED 9-20-2007.

KING OF SCOTS

THE MARK CONSISTS OF STANDARD CHARACTERS WITHOUT CLAIM TO ANY PARTICULAR FONT, STYLE, SIZE, OR COLOR.

OWNER OF ERPN CMNTY TM OFC REG. NO. 000053215, DATED 11-9-1998, EXPIRES 4-1-2016.

FOR SPIRITS; BRANDY; PREPARED ALCOHOLIC COCKTAILS; LIQUEURS; WHISKY (U.S. CLS. 47 AND 49).

TINA BROWN, EXAMINING ATTORNEY



SN 77-360,301. BODEGA CAN BONASTRE, S.L.U., MASQUEFA, BARCELONA, SPAIN, FILED 12-27-2007.

NARA

THE MARK CONSISTS OF STANDARD CHARACTERS WITHOUT CLAIM TO ANY PARTICULAR FONT, STYLE, SIZE, OR COLOR.

OWNER OF SPAIN REG. NO. 2.755.446, DATED 2-15-2007, EXPIRES 2-15-2017.

THE ENGLISH TRANSLATION OF "NARA" IN THE MARK IS "NATION".

FOR WINES, SPARKLING WINES (U.S. CLS. 47 AND 49).

RONALD AIKENS, EXAMINING ATTORNEY



SN 77-429,144. MARTIGNETTI, THOMAS J., NEW YORK, NY. FILED 3-23-2008.

DUTCH COURAGE GIN

THE MARK CONSISTS OF STANDARD CHARACTERS WITHOUT CLAIM TO ANY PARTICULAR FONT, STYLE, SIZE, OR COLOR.

NO CLAIM IS MADE TO THE EXCLUSIVE RIGHT TO USE "GIN", APART FROM THE MARK AS SHOWN.

FOR GIN (U.S. CLS. 47 AND 49).

PRISCILLA MILTON, EXAMINING ATTORNEY

CLASS 33—(Continued).

SN 77-514,140. PARK AVENUE IMPORTS, LLC, WILMINGTON, DE. FILED 7-2-2008.

La Sorrentina

THE MARK CONSISTS OF STANDARD CHARACTERS WITHOUT CLAIM TO ANY PARTICULAR FONT, STYLE, SIZE, OR COLOR.

THE ENGLISH TRANSLATION OF "LA SORRENTINA" IN THE MARK IS THE SORRENTINE WOMEN.

FOR ALCOHOLIC BEVERAGES EXCEPT BEERS (U.S. CLS. 47 AND 49).

SHAUNIA CARLYLE, EXAMINING ATTORNEY

CLASS 33—(Continued).

SN 77-557,795. HEINEN'S FINE FOODS, WARRENSVILLE HEIGHTS, OH. FILED 8-28-2008.



NO CLAIM IS MADE TO THE EXCLUSIVE RIGHT TO USE "VIN" "GREAT WINES, GREAT SAVINGS, AND BIG DISCOUNTS" AND "FINE FOODS", APART FROM THE MARK AS SHOWN.

THE MARK CONSISTS OF A RECTANGLE WITH A BORDER, INSIDE THE RECTANGLE APPEARS A BOX COVERING THE TOP ONE-THIRD OF THE RECTANGLE, INSIDE THE BOX APPEARS THE WORDING "VIN HUNTER'S EXCLUSIVES!". BELOW THE BOX ON THE RIGHT APPEARS A VERTICAL BOX SPLIT INTO TWO SMALLER RECTANGLES COVERING THE ONE-THIRD OF THE LOWER SPACE, THE UPPER RECTANGLE CONTAINS A PICTURE OF A CLOTHED PERSON WEARING A HAT AND HOLDING A CORK SCREW LEANING ON A BOTTLE OF WINE, ABOVE THE CHARACTER APPEARS THE WORDING "GREAT WINES, GREAT SAVINGS, AND BIG DISCOUNTS. I ASK YOU, WHAT MORE COULD YOU WANT?" - "VIN" IN THE LOWER BOX APPEAR THREE DIAMONDS IN A VERTICAL ROW, BELOW THE DIAMONDS IS THE WORD "HEINEN'S" AND BELOW THAT APPEARS THE WORD "FINE FOODS".

THE ENGLISH TRANSLATION OF "VIN" IN THE MARK IS "WINE".

FOR WINES (U.S. CLS. 47 AND 49).
JEFF DEFORD, EXAMINING ATTORNEY

SN 77-525,478. ALT WIENER SCHNAPSMUSEUM GMBH, VIENNA, AUSTRIA, FILED 7-17-2008.

MYSTIQ

THE MARK CONSISTS OF STANDARD CHARACTERS WITHOUT CLAIM TO ANY PARTICULAR FONT, STYLE, SIZE, OR COLOR.

FOR ABSINTHE (U.S. CLS. 47 AND 49).

KAPIL BHANOT, EXAMINING ATTORNEY

SN 77-544,697. GENERATIONS OF SONOMA, LLC, DBA HIGHWAY 12 VINEYARDS AND WINERY, SONOMA, CA. AND OFFENBACHER, DOUG, SANTA ROSA, CA. FILED 8-12-2008.

TAPPO ROSSO

THE MARK CONSISTS OF STANDARD CHARACTERS WITHOUT CLAIM TO ANY PARTICULAR FONT, STYLE, SIZE, OR COLOR.

NO CLAIM IS MADE TO THE EXCLUSIVE RIGHT TO USE "ROSSO", APART FROM THE MARK AS SHOWN.

THE ENGLISH TRANSLATION OF "TAPPO ROSSO" IN THE MARK IS RED CAP.

FOR WINE (U.S. CLS. 47 AND 49).

KELLY CHOE, EXAMINING ATTORNEY

SN 77-566,914. BAREFOOT WINERY, TA CATHERINE MARSHALL WINES, STELLENBOSCH, SOUTH AFRICA, FILED 9-10-2008.

CATHERINE MARSHALL

THE MARK CONSISTS OF STANDARD CHARACTERS WITHOUT CLAIM TO ANY PARTICULAR FONT, STYLE, SIZE, OR COLOR.

THE NAME "CATHERINE MARSHALL" IDENTIFIES A LIVING INDIVIDUAL WHOSE CONSENT IS OF RECORD.

FOR APERITIF WINES; GRAPE WINE; NATURAL SPARKLING WINES; PORT WINES; RED WINES; SPARKLING WINES; SWEET WINES; TABLE WINES; WHITE WINE; WINE; WINES; WINES AND FORTIFIED WINES; WINES AND LIQUEURS; WINES AND SPARKLING WINES (U.S. CLS. 47 AND 49).

FIRST USE 1-9-2006; IN COMMERCE 1-9-2006.

REBECCA POVARCHUK, EXAMINING ATTORNEY

CLASS 33—(Continued).

SN 77-571,117. LIDESTRI FOODS, INC., FAIRPORT, NY.
FILED 9-16-2008.

LIDESTRI'S TUTTOBELLO

THE MARK CONSISTS OF STANDARD CHARACTERS
WITHOUT CLAIM TO ANY PARTICULAR FONT, STYLE,
SIZE, OR COLOR.

THE ENGLISH TRANSLATION OF THE WORD "TUTTO-
BELLO" IN THE MARK IS EVERYTHING BEAUTIFUL.
FOR ALCOHOLIC BEVERAGES EXCEPT BEERS (U.S.
CLS. 47 AND 49).

FIRST USE 6-27-2008; IN COMMERCE 6-27-2008.
NAPOLEON SHARMA, EXAMINING ATTORNEY

CLASS 33—(Continued).

SN 77-592,847. VIRIDIAN SPIRITS LLC, NEW YORK, NY.
FILED 10-15-2008.

SMASHING SHAMROCK

THE MARK CONSISTS OF STANDARD CHARACTERS
WITHOUT CLAIM TO ANY PARTICULAR FONT, STYLE,
SIZE, OR COLOR.

FOR PREPARED ALCOHOLIC COCKTAILS (U.S. CLS.
47 AND 49).

MARY CRAWFORD, EXAMINING ATTORNEY

SN 77-592,116. SERESIN ESTATE LIMITED, RENWICK,
NEW ZEALAND, FILED 10-14-2008.

CHIAROSCURO

THE MARK CONSISTS OF STANDARD CHARACTERS
WITHOUT CLAIM TO ANY PARTICULAR FONT, STYLE,
SIZE, OR COLOR.

PRIORITY CLAIMED UNDER SEC. 44(D) ON NEW
ZEALAND APPLICATION NO. 797311, FILED 10-8-2008,
REG. NO. 797311, DATED 10-8-2008, EXPIRES 10-8-2018.

FOR WINE (U.S. CLS. 47 AND 49).
JENNIFER MARTIN, EXAMINING ATTORNEY

SN 77-596,246. PLATINUM BRANDS, INC., BALTIMORE,
MD. FILED 10-20-2008.

NUDO

THE MARK CONSISTS OF STANDARD CHARACTERS
WITHOUT CLAIM TO ANY PARTICULAR FONT, STYLE,
SIZE, OR COLOR.

THE ENGLISH TRANSLATION OF "NUDO" IN THE
MARK IS "KNOT".

FOR WINE (U.S. CLS. 47 AND 49).
GEORGE LORENZO, EXAMINING ATTORNEY

SN 77-592,167. CHAMISAL VINEYARDS, LLC, NAPA, CA.
FILED 10-14-2008.

DOMAINE ALFRED

THE MARK CONSISTS OF STANDARD CHARACTERS
WITHOUT CLAIM TO ANY PARTICULAR FONT, STYLE,
SIZE, OR COLOR.

NO CLAIM IS MADE TO THE EXCLUSIVE RIGHT TO
USE "DOMAINE", APART FROM THE MARK AS SHOWN.
THE ENGLISH TRANSLATION OF "DOMAINE" IN THE
MARK IS ESTATE.

FOR WINE (U.S. CLS. 47 AND 49).
FIRST USE 4-30-1998; IN COMMERCE 4-30-1998.
PAUL MORENO, EXAMINING ATTORNEY

SN 77-607,959. EVENSTAD, KENNETH L., NAPLES, FL.
FILED 11-5-2008.

GRAND CHEVAL

THE MARK CONSISTS OF STANDARD CHARACTERS
WITHOUT CLAIM TO ANY PARTICULAR FONT, STYLE,
SIZE, OR COLOR.

THE ENGLISH TRANSLATION OF "CHEVAL" IN THE
MARK IS HORSE.

FOR WINE (U.S. CLS. 47 AND 49).
JEAN IM, EXAMINING ATTORNEY

CLASS 33—(Continued).

SN 77-610,893. BODEGAS MARQUÉS DE VITORIA, S.A., OYÓN (ALAVA), SPAIN, FILED 11-10-2008.

FINCA 10

THE MARK CONSISTS OF STANDARD CHARACTERS WITHOUT CLAIM TO ANY PARTICULAR FONT, STYLE, SIZE, OR COLOR.

PRIORITY CLAIMED UNDER SEC. 44(D) ON ERPN CMNTY TM OFC APPLICATION NO. 7344931, FILED 10-27-2008, REG. NO. 7344931, DATED 5-20-2009, EXPIRES 10-27-2018.

NO CLAIM IS MADE TO THE EXCLUSIVE RIGHT TO USE "FINCA", APART FROM THE MARK AS SHOWN.

THE FOREIGN WORDING IN THE MARK TRANSLATES INTO ENGLISH AS PROPERTY OR ESTATE.

FOR WINES (U.S. CLS. 47 AND 49).
KELLY BOULTON, EXAMINING ATTORNEY

SN 77-614,074. BRB TRADEMARK HOLDINGS COMPANY, LLC, WHITE PLAINS, NY. FILED 11-13-2008.

CRUZ DE ALBA

THE MARK CONSISTS OF STANDARD CHARACTERS WITHOUT CLAIM TO ANY PARTICULAR FONT, STYLE, SIZE, OR COLOR.

THE NAME "CRUZ DE ALBA" DOES NOT IDENTIFY A LIVING INDIVIDUAL.

THE ENGLISH TRANSLATION OF "CRUZ DE ALBA" IN THE MARK IS CROSS OF DAWN.

FOR WINES (U.S. CLS. 47 AND 49).
FIRST USE 11-30-2006; IN COMMERCE 6-5-2008.
HAI-LY LAM, EXAMINING ATTORNEY

CLASS 33—(Continued).

SN 77-615,948. MOET HENNESSY USA, INC., NEW YORK, NY. FILED 11-17-2008.



OWNER OF U.S. REG. NOS. 868,468, 3,286,783 AND OTHERS.

THE MARK CONSISTS OF AN ARM HOLDING A BATTLE AXE ABOVE THE WORDS "HENNESSY BLACK." THERE IS A STYLIZED LINE DESIGN ON BOTH SIDES OF THE WORD "BLACK".

FOR ALCOHOLIC BEVERAGES EXCEPT BEERS (U.S. CLS. 47 AND 49).

AMY HELLA, EXAMINING ATTORNEY

SN 77-618,276. SAZERAC COMPANY, INC., NEW ORLEANS, LA. FILED 11-20-2008.

TASTES LIKE HEAVEN. BURNS LIKE HELL.

THE MARK CONSISTS OF STANDARD CHARACTERS WITHOUT CLAIM TO ANY PARTICULAR FONT, STYLE, SIZE, OR COLOR.

FOR WHISKEY (U.S. CLS. 47 AND 49).

FIRST USE 4-0-2007; IN COMMERCE 4-0-2007.

RONALD DELGIZZI, EXAMINING ATTORNEY

SN 77-648,560. VINOS DE LOS HEREDEROS DEL MARQUES DE RISCAL, S.A., ELCIEGO, SPAIN, FILED 1-13-2009.

RISCAL 2000

THE MARK CONSISTS OF STANDARD CHARACTERS WITHOUT CLAIM TO ANY PARTICULAR FONT, STYLE, SIZE, OR COLOR.

OWNER OF SPAIN REG. NO. 2327491, DATED 1-5-2001, EXPIRES 6-22-2010.

OWNER OF U.S. REG. NOS. 825,409, 2,806,906 AND OTHERS.

NO CLAIM IS MADE TO THE EXCLUSIVE RIGHT TO USE "2000", APART FROM THE MARK AS SHOWN.

THE WORDING "RISCAL" HAS NO MEANING IN A FOREIGN LANGUAGE.

FOR WINES (U.S. CLS. 47 AND 49).

MAUREEN DALL, EXAMINING ATTORNEY

CLASS 33—(Continued).

SN 77-657,401. ZEN VILLAGE, INC., DANIA, FL. FILED 1-27-2009.



THE COLOR(S) RED, BLACK, GRAY, YELLOWISH GREEN, WHITE IS/ARE CLAIMED AS A FEATURE OF THE MARK.

THE MARK CONSISTS OF A DRAGON THAT IS RUNNING FROM THE BOTTOM LEFT CORNER UPWARDS THEN TO THE RIGHT TO THE RIGHT UPPER CORNER. THE COLOR OF THE DRAGON IS FROM BLACK AND LIGHTENS UP TO A LIGHT GRAY, WITH A YELLOWISH GREEN SHADOW. IN THE MIDDLE OF THE DRAGON IS THE CHINESE CHARACTER FOR "ZEN" IN RED, WITH A YELLOWISH GREEN SHADOW AND THE WORDS "ZEN" IS TO THE RIGHT OF IT WITH THE COLOR BEING SHADES OF GRAY WITH A YELLOWISH GREEN SHADOW. THE WORD "VILLAGE" IS RIGHT BELOW IT IN SHADES OF GRAY AND BLACK WITH A SHADOW OF YELLOWISH GREEN. TO THE RIGHT OF THE "N" OF THE WORD "ZEN" IS A RED MARK POINTED HORIZONTALLY TO THE RIGHT FROM THICK TO THIN. ALL OF THE ABOVE ARE IN A WHITE BACKGROUND.

THE NON-LATIN CHARACTERS IN THE MARK TRANSLITERATE TO "SIN" IN CANTONESE CHINESE AND "XIAN" IN MANDARIN CHINESE, AND THIS CAPTURES THE ESSENCE OF "ZEN", WHICH IS THE ATTAINMENT OF ENLIGHTENMENT THROUGH MEDIATION.

FOR FRUIT WINE; WINE; WINES (U.S. CLS. 47 AND 49).

MELVIN AXILBUND, EXAMINING ATTORNEY

SN 77-660,816. E. & J. GALLO WINERY, MODESTO, CA. FILED 1-31-2009.



OWNER OF U.S. REG. NOS. 1,657,573, 2,022,845 AND OTHERS.

NO CLAIM IS MADE TO THE EXCLUSIVE RIGHT TO USE "WINE", APART FROM THE MARK AS SHOWN. FOR WINES (U.S. CLS. 47 AND 49).

WENDY GOODMAN, EXAMINING ATTORNEY

CLASS 33—(Continued).

SN 77-682,193. INNOVATIVE LIQUORS, LLC, HOLLYWOOD, FL. FILED 3-3-2009.

SHANNON

THE MARK CONSISTS OF STANDARD CHARACTERS WITHOUT CLAIM TO ANY PARTICULAR FONT, STYLE, SIZE, OR COLOR.

FOR ALCOHOLIC BEVERAGES, NAMELY, LIQUEURS (U.S. CLS. 47 AND 49).

COLLEEN DOMBROW, EXAMINING ATTORNEY

SN 77-690,349. DE BORTOLI WINES PTY LTD, BILBUL, AUSTRALIA, FILED 3-13-2009.

COOPERS CROSSING

THE MARK CONSISTS OF STANDARD CHARACTERS WITHOUT CLAIM TO ANY PARTICULAR FONT, STYLE, SIZE, OR COLOR.

FOR WINES, SPARKLING WINES, DESSERT WINES, FORTIFIED WINES, SPIRITS, LIQUEURS, ALCOHOLIC BEVERAGES EXCLUDING BEER (U.S. CLS. 47 AND 49).

AMY C. KEAN, EXAMINING ATTORNEY

SN 77-691,313. MARNA INCORPORATED, DBA REFERENT VODKA, SAINT PAUL, MN. FILED 3-15-2009.

REFERENT

THE MARK CONSISTS OF THE WORD "REFERENT" STYLIZED IN DESDEMONA FONT AND SPELLED OUT IN ALL CAPITAL LETTERS.

FOR VODKA (U.S. CLS. 47 AND 49).

ROBERT STRUCK, EXAMINING ATTORNEY

SN 77-696,642. SIDNEY FRANK IMPORTING CO., INC., NEW ROCHELLE, NY. FILED 3-23-2009.

TIPPET

THE MARK CONSISTS OF STANDARD CHARACTERS WITHOUT CLAIM TO ANY PARTICULAR FONT, STYLE, SIZE, OR COLOR.

FOR IRISH WHISKEY (U.S. CLS. 47 AND 49).

BARBARA A. GOLD, EXAMINING ATTORNEY

CLASS 33—(Continued).

SN 77-700,682. VINEDOS Y BODEGAS CORPORA S.A.,
VITACURA, SANTIAGO, CHILE, FILED 3-27-2009.

Travesia Sur

THE MARK CONSISTS OF STANDARD CHARACTERS
WITHOUT CLAIM TO ANY PARTICULAR FONT, STYLE,
SIZE, OR COLOR.

THE ENGLISH TRANSLATION OF "TRAVESIA SUR" IN
THE MARK IS "SOUTH PASSAGE".
FOR WINES (U.S. CLS. 47 AND 49).
MAUREEN DALL, EXAMINING ATTORNEY

CLASS 33—(Continued).

SN 77-700,713. VINEDOS Y BODEGAS CORPORA S.A.,
VITACURA, SANTIAGO, CHILE, FILED 3-27-2009.

Explorasur

THE MARK CONSISTS OF STANDARD CHARACTERS
WITHOUT CLAIM TO ANY PARTICULAR FONT, STYLE,
SIZE, OR COLOR.

THE ENGLISH TRANSLATIONS OF "EXPLORA" AND
"SUR" IN THE MARK ARE "EXPLORE" AND "SOUTH"
RESPECTIVELY. THE WORDING "EXPLORASUR" AS A
WHOLE HAS NO MEANING IN A FOREIGN LANGUAGE.
FOR WINES (U.S. CLS. 47 AND 49).
MAUREEN DALL, EXAMINING ATTORNEY

SN 77-700,688. VINEDOS Y BODEGAS CORPORA S.A.,
VITACURA, SANTIAGO, CHILE, FILED 3-27-2009.

Remota

THE MARK CONSISTS OF STANDARD CHARACTERS
WITHOUT CLAIM TO ANY PARTICULAR FONT, STYLE,
SIZE, OR COLOR.

THE ENGLISH TRANSLATION OF "REMOTA" IN THE
MARK IS "REMOTE".
FOR WINES (U.S. CLS. 47 AND 49).
MAUREEN DALL, EXAMINING ATTORNEY

SN 77-701,095. VINEDOS Y BODEGAS CORPORA S.A.,
VITACURA, SANTIAGO, CHILE, FILED 3-27-2009.

Remote

THE MARK CONSISTS OF STANDARD CHARACTERS
WITHOUT CLAIM TO ANY PARTICULAR FONT, STYLE,
SIZE, OR COLOR.

FOR WINES (U.S. CLS. 47 AND 49).
MAUREEN DALL, EXAMINING ATTORNEY

SN 77-700,696. VINEDOS Y BODEGAS CORPORA S.A.,
VITACURA, SANTIAGO, CHILE, FILED 3-27-2009.

Remoto Sur

THE MARK CONSISTS OF STANDARD CHARACTERS
WITHOUT CLAIM TO ANY PARTICULAR FONT, STYLE,
SIZE, OR COLOR.

THE ENGLISH TRANSLATION OF "REMOTO SUR" IN
THE MARK IS "REMOTE SOUTH".
FOR WINES (U.S. CLS. 47 AND 49).
MAUREEN DALL, EXAMINING ATTORNEY

SN 77-701,113. VINEDOS Y BODEGAS CORPORA S.A.,
VITACURA, SANTIAGO, CHILE, FILED 3-27-2009.

GIASUR

THE MARK CONSISTS OF STANDARD CHARACTERS
WITHOUT CLAIM TO ANY PARTICULAR FONT, STYLE,
SIZE, OR COLOR.

THE WORDING "GIASUR" HAS NO MEANING IN A
FOREIGN LANGUAGE.
FOR WINES (U.S. CLS. 47 AND 49).
MAUREEN DALL, EXAMINING ATTORNEY

CLASS 33—(Continued).

SN 77-701,121. VINEDOS Y BODEGAS CORPORA S.A., VITACURA, SANTIAGO, CHILE, FILED 3-27-2009.

Guia

THE MARK CONSISTS OF STANDARD CHARACTERS WITHOUT CLAIM TO ANY PARTICULAR FONT, STYLE, SIZE, OR COLOR.

THE ENGLISH TRANSLATION OF "GUIA" IN THE MARK IS GUIDE.

FOR WINES (U.S. CLS. 47 AND 49).
INGRID C. EULIN, EXAMINING ATTORNEY

SN 77-706,171. ITS IN THE BOTTLE, INC., HUNTINGTON BAY, NY. FILED 4-3-2009.



NO CLAIM IS MADE TO THE EXCLUSIVE RIGHT TO USE "VODKA", APART FROM THE MARK AS SHOWN. THE STIPLING IS FOR SHADING PURPOSES ONLY.

THE MARK CONSISTS OF THE STYLIZED TEXT "ROCK'N VODKA LET IT ROCK" INSIDE A RECTANGLE DESIGN. THE WORD "ROCK N" IS IN LARGE LETTERS WITH THE WORD "VODKA" ON THE LEFT SIDE AND PERPENDICULAR TO THE LETTER "R". THE WORDING "LET IT ROCK" IS TO THE LEFT OF THE WORD "VODKA".

FOR DISTILLED SPIRITS (U.S. CLS. 47 AND 49).
LINDA ORNDORFF, EXAMINING ATTORNEY

SN 77-707,811. TREANA WINERY LLC, DBA HOPE FAMILY WINES, PASO ROBLES, CA. FILED 4-6-2009.

HOPE FAMILY WINES

THE MARK CONSISTS OF STANDARD CHARACTERS WITHOUT CLAIM TO ANY PARTICULAR FONT, STYLE, SIZE, OR COLOR.

NO CLAIM IS MADE TO THE EXCLUSIVE RIGHT TO USE "FAMILY WINES", APART FROM THE MARK AS SHOWN.

FOR WINE (U.S. CLS. 47 AND 49).
FIRST USE 2-1-2009; IN COMMERCE 4-6-2009.
MARY BOAGNI, EXAMINING ATTORNEY

CLASS 33—(Continued).

SN 77-714,015. EMPRESA DE LICORES DE CUNDINAMARCA, BOGOTA D.C., COLOMBIA, FILED 4-15-2009.

Aguardiente 180° Grados

THE MARK CONSISTS OF STANDARD CHARACTERS WITHOUT CLAIM TO ANY PARTICULAR FONT, STYLE, SIZE, OR COLOR.

OWNER OF U.S. REG. NO. 2,439,736.

NO CLAIM IS MADE TO THE EXCLUSIVE RIGHT TO USE "AGUARDIENTE", APART FROM THE MARK AS SHOWN.

THE ENGLISH TRANSLATION OF "GRADOS" IN THE MARK IS DEGREES.

FOR DISTILLED SPIRITS, NAMELY, COLOMBIAN AGUARDIENTE (U.S. CLS. 47 AND 49).

COURTNEY MCCORMICK, EXAMINING ATTORNEY

SN 77-720,955. TOP BRASS DISTILLERIES LLC, NEWARK, NJ. FILED 4-23-2009.

NO CLAIM IS MADE TO THE EXCLUSIVE RIGHT TO USE "BLOODY MARTINI", APART FROM THE MARK AS SHOWN.

THE COLOR(S) BROWN, GREEN, AND RED IS/ARE CLAIMED AS A FEATURE OF THE MARK.

THE MARK CONSISTS OF THE TERM "TOP BRASS" IN BROWN WITH GREEN HIGHLIGHTING AND RED SHADOWING ABOVE THE TERM "BLOODY MARTINI" IN RED. THE BACKGROUND OF THE ENTIRE MARK IS TRANSLUCENT.

FOR ALCOHOLIC COCKTAIL MIXES CONTAINING VODKA FOR MAKING BLOODY MARTINIS (U.S. CLS. 47 AND 49).

JIM RINGLE, EXAMINING ATTORNEY

CLASS 33—(Continued).

SN 77-720,974. TOP BRASS DISTILLERIES LLC, NEWARK, NJ. FILED 4-23-2009.

TOP BRASS
Cooked Apple Gin

NO CLAIM IS MADE TO THE EXCLUSIVE RIGHT TO USE "COOKED APPLE GIN", APART FROM THE MARK AS SHOWN.

THE COLOR(S) BROWN, RED, AND GREEN IS/ARE CLAIMED AS A FEATURE OF THE MARK.

THE MARK CONSISTS OF THE TERM "TOP BRASS" IN BROWN WITH GREEN HIGHLIGHTING AND RED SHADOWING ABOVE THE TERM "COOKED APPLE GIN" IN GREEN. THE BACKGROUND OF THE ENTIRE MARK IS TRANSLUCENT.

FOR GIN (U.S. CLS. 47 AND 49).
JIM RINGLE, EXAMINING ATTORNEY

SN 77-722,031. LAV-COR AGRICULTURAL, INC., DBA PECONIC BAY WINERY, CUTCHOGUE, NY. FILED 4-24-2009.

POLARIS

THE MARK CONSISTS OF STANDARD CHARACTERS WITHOUT CLAIM TO ANY PARTICULAR FONT, STYLE, SIZE, OR COLOR.

FOR WINES (U.S. CLS. 47 AND 49).
FIRST USE 10-10-2000; IN COMMERCE 10-10-2000.
LESLEY LAMOTHE, EXAMINING ATTORNEY

SN 77-722,033. CO.GE.VI, 51160 AY CHAMPAGNE, FRANCE, FILED 4-24-2009.

CHAMPAGNE COLLET ROSE

THE MARK CONSISTS OF STANDARD CHARACTERS WITHOUT CLAIM TO ANY PARTICULAR FONT, STYLE, SIZE, OR COLOR.

NO CLAIM IS MADE TO THE EXCLUSIVE RIGHT TO USE "CHAMPAGNE" AND "ROSE", APART FROM THE MARK AS SHOWN.

FOR CHAMPAGNE (U.S. CLS. 47 AND 49).
WON TEAK OH, EXAMINING ATTORNEY

CLASS 33—(Continued).

SN 77-723,592. CALEB FOSTER WINES, L.L.C., WALLA WALLA, WA. FILED 4-28-2009.

LE BEAST

THE MARK CONSISTS OF STANDARD CHARACTERS WITHOUT CLAIM TO ANY PARTICULAR FONT, STYLE, SIZE, OR COLOR.

OWNER OF U.S. REG. NO. 3,011,390.
FOR WINES (U.S. CLS. 47 AND 49).
COLLEEN DOMBROW, EXAMINING ATTORNEY

SN 77-723,617. LAV-COR AGRICULTURAL, INC., DBA PECONIC BAY WINERY, CUTCHOGUE, NY. FILED 4-28-2009.

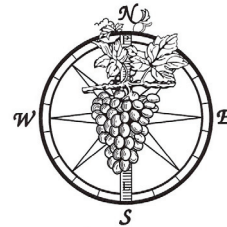

Polaris

THE MARK CONSISTS OF THE WORD "POLARIS" AND A DESIGN OF A BUNCH OF GRAPES IN FRONT OF A COMPASS.

FOR WINES (U.S. CLS. 47 AND 49).
FIRST USE 10-10-2000; IN COMMERCE 10-10-2000.
LESLEY LAMOTHE, EXAMINING ATTORNEY

SN 77-723,713. STONE DISTILLERY LLC, SEATTLE, WA. FILED 4-28-2009.

Stone Distillery

THE MARK CONSISTS OF STANDARD CHARACTERS WITHOUT CLAIM TO ANY PARTICULAR FONT, STYLE, SIZE, OR COLOR.

NO CLAIM IS MADE TO THE EXCLUSIVE RIGHT TO USE "DISTILLERY", APART FROM THE MARK AS SHOWN.

FOR DISTILLED SPIRITS (U.S. CLS. 47 AND 49).
DAVID H. STINE, EXAMINING ATTORNEY

CLASS 33—(Continued).

SN 77-723,964. THE STANDISH WINE COMPANY PTY LTD, LYNDPOCH SA 5351, AUSTRALIA, FILED 4-28-2009.

THE RELIC

THE MARK CONSISTS OF STANDARD CHARACTERS WITHOUT CLAIM TO ANY PARTICULAR FONT, STYLE, SIZE, OR COLOR.
 FOR WINES FROM AUSTRALIA (U.S. CLS. 47 AND 49).
 FIRST USE 4-17-2004; IN COMMERCE 4-17-2004.
 GINA HAYES, EXAMINING ATTORNEY

SN 77-724,506. CHANG, JEFF R., DIAMOND BAR, CA. FILED 4-28-2009.



OWNER OF U.S. REG. NO. 2,898,783.
 NO CLAIM IS MADE TO THE EXCLUSIVE RIGHT TO USE THE WORDING "MICHIU", THE CHINESE CHARACTERS THAT TRANSLITERATE TO "TAIWAN MICHIU" AND TRANSLATE INTO ENGLISH AS "TAIWAN RICE WINE OR SPIRIT", AND THE DESIGN OF THE ISLAND OF TAIWAN, APART FROM THE MARK AS SHOWN.
 THE COLOR(S) RED, PINK AND WHITE IS/ARE CLAIMED AS A FEATURE OF THE MARK.
 THE MARK CONSISTS OF THE TERM "MICHIU" IN STYLIZED ENGLISH CHARACTERS, TWO CHINESE CHARACTERS POSITIONED SIDE BY SIDE (WHICH TRANSLITERATE TO "TAI WAN"), ANOTHER PAIR OF CHINESE CHARACTERS ARRANGED VERTICALLY (WHICH TRANSLITERATE TO "MI CHIU"), A THIRD PAIR OF CHINESE CHARACTERS ARRANGED VERTICALLY (WHICH TRANSLITERATE TO "HONG BIAU"), A DRAWING IN THE SHAPE OF THE ISLAND OF TAIWAN, AND A RICE PLANT. "MICHIU" IS IN RED COLOR AND APPEARS AT THE BOTTOM OF THE MARK. ON TOP OF "MICHIU" AND IN RED COLOR ARE THE TWO CHINESE CHARACTERS PHONETICALLY SPELLED "MI CHIU". ON THE TOP OF "MI CHIU" (CHINESE CHARACTERS) AND IN RED COLOR ARE THE TWO CHINESE CHARACTERS

CLASS 33—(Continued).

PHONETICALLY SPELLED "TAI WAN". THE ISLAND DRAWING, WHOSE INSIDE AREA IS RED AND BORDER IS WHITE, APPEARS TO THE LEFT OF THE CHINESE CHARACTER PHONETICALLY SPELLED "MI". INSIDE THE ISLAND ARE THE TWO CHINESE CHARACTERS PHONETICALLY SPELLED "HONG BIAU" IN WHITE COLOR. THE RICE PLANT IS WHITE AND APPEARS PARTIALLY BEHIND "MI CHIU" (CHINESE CHARACTERS). THE BACKGROUND OF THE ENTIRE MARK IS PINK.
 THE ENGLISH TRANSLATION OF "MICHIU" IN THE MARK IS "RICE WINE OR SPIRIT".
 THE NON-LATIN CHARACTERS IN THE MARK TRANSLITERATE TO "TAI WAN MI CHIU" AND "HONG BIAU" AND THIS MEANS "TAIWAN RICE WINE OR SPIRIT" AND "RED MARK" IN ENGLISH.
 FOR CHINESE BREWED LIQUOR; CHINESE MIXED LIQUOR; CHINESE SPIRIT OF SORGHUM; CHINESE WHITE LIQUOR; COOKING WINE; DISTILLED SPIRITS; DISTILLED SPIRITS OF RICE, CORN, AND BARLEY; DISTILLED SPIRITS OF SORGHUM, SOYBEAN, BLACK BEAN, AND SUGAR CANE; FORTIFIED WINES; HERB LIQUEURS; JAPANESE SHOCHUH-BASED MIXED LIQUOR; JAPANESE WHITE LIQUOR (SHOCHU); LIQUEURS; POTABLE SPIRITS; RICE WINE; SAKE; SPARKLING WINES; SPIRITS AND LIQUEURS; WINES AND FORTIFIED WINES; WINES AND LIQUEURS; AND WINES AND SPARKLING WINES (U.S. CLS. 47 AND 49).
 FIRST USE 1-1-2003; IN COMMERCE 1-1-2003.
 WILLIAM P. SHANAHAN, EXAMINING ATTORNEY

SN 77-725,131. SOLOMON, ERIC, CHARLOTTE, NC. FILED 4-29-2009.

SABREGO

THE MARK CONSISTS OF STANDARD CHARACTERS WITHOUT CLAIM TO ANY PARTICULAR FONT, STYLE, SIZE, OR COLOR.
 FOR ALCOHOLIC BEVERAGES, NAMELY, WINE (U.S. CLS. 47 AND 49).
 CAROLINE WOOD, EXAMINING ATTORNEY

SN 77-725,189. STEFFANCI, TOM, NAPA, CA. FILED 4-29-2009.

BOYANCI InSpire

THE MARK CONSISTS OF STANDARD CHARACTERS WITHOUT CLAIM TO ANY PARTICULAR FONT, STYLE, SIZE, OR COLOR.
 OWNER OF U.S. REG. NO. 3,599,706.
 FOR WINE (U.S. CLS. 47 AND 49).
 DAVID C. REIHNER, EXAMINING ATTORNEY

CLASS 33—(Continued).

SN 77-725,422. HECKENLAIBLE, VICKI, LODI, CA. AND HECKENLAIBLE, DWAYNE, LODI, CA. FILED 4-29-2009.

BEYADA BAY

THE MARK CONSISTS OF STANDARD CHARACTERS WITHOUT CLAIM TO ANY PARTICULAR FONT, STYLE, SIZE, OR COLOR.
FOR WINES (U.S. CLS. 47 AND 49).
FIRST USE 7-1-2008; IN COMMERCE 7-1-2008.
ROBERT C. CLARK JR., EXAMINING ATTORNEY

SN 77-725,489. ANTHONY LOUIS MOORE, BLENHEIM, NEW ZEALAND, FILED 4-29-2009.

K1W1

THE MARK CONSISTS OF STANDARD CHARACTERS WITHOUT CLAIM TO ANY PARTICULAR FONT, STYLE, SIZE, OR COLOR.
FOR WINE (U.S. CLS. 47 AND 49).
NAAKWAMA ANKRAH, EXAMINING ATTORNEY

SN 77-725,572. ROCKS LIQUOR, BASKING RIDGE, NJ. FILED 4-29-2009.



THE MARK CONSISTS OF A STYLIZED G.
FOR VODKA (U.S. CLS. 47 AND 49).
ELIZABETH KAJUBI, EXAMINING ATTORNEY

CLASS 33—(Continued).

SN 77-725,856. VINA MAYU, LTDA, VICUNA, CHILE, FILED 4-30-2009.

ELKI

THE MARK CONSISTS OF STANDARD CHARACTERS WITHOUT CLAIM TO ANY PARTICULAR FONT, STYLE, SIZE, OR COLOR.
FOR WINES (U.S. CLS. 47 AND 49).
FIRST USE 2-28-2009; IN COMMERCE 4-30-2009.
AMOS T. MATTHEWS, JR., EXAMINING ATTORNEY

SN 77-725,955. HUNEEUS VINTNERS LLC, RUTHERFORD, CA. FILED 4-30-2009.

Q BLOCK

THE MARK CONSISTS OF STANDARD CHARACTERS WITHOUT CLAIM TO ANY PARTICULAR FONT, STYLE, SIZE, OR COLOR.
OWNER OF U.S. REG. NO. 3,598,558.
FOR WINE (U.S. CLS. 47 AND 49).
GEORGE LORENZO, EXAMINING ATTORNEY

SN 77-726,047. DUCKHORN WINE COMPANY, ST. HELENA, CA. FILED 4-30-2009.

THE DISCUSSION

THE MARK CONSISTS OF STANDARD CHARACTERS WITHOUT CLAIM TO ANY PARTICULAR FONT, STYLE, SIZE, OR COLOR.
FOR WINES (U.S. CLS. 47 AND 49).
JAMES LOVELACE, EXAMINING ATTORNEY

CLASS 33—(Continued).

SN 77-726,446. HUNEEUS VINTNERS LLC, RUTHERFORD, CA. FILED 4-30-2009.

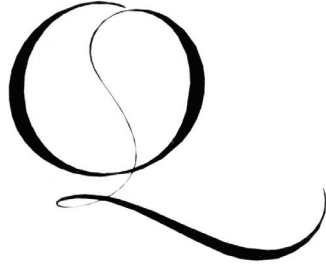

OWNER OF U.S. REG. NO. 3,598,558.
THE MARK CONSISTS OF THE STYLIZED LETTER "Q".
FOR WINE (U.S. CLS. 47 AND 49).
FIRST USE 1-4-1995; IN COMMERCE 1-4-1995.
GEORGE LORENZO, EXAMINING ATTORNEY

SN 77-726,448. NATURAL DRINKS S.A., SAO PAULO, SP, BRAZIL, FILED 4-30-2009.



THE MARK CONSISTS OF THE WORD "CAIPIONE" IN STYLIZED LETTERS.
THE WORDING "CAIPIONE" HAS NO MEANING IN A FOREIGN LANGUAGE.
FOR ALCOHOLIC BEVERAGES EXCEPT BEERS; DISTILLED SPIRITS (U.S. CLS. 47 AND 49).
MARGERY A. TIERNEY, EXAMINING ATTORNEY

SN 77-726,454. ASTROLABE WINES LIMITED, BLENHEIM, NEW ZEALAND, FILED 4-30-2009.



THE MARK CONSISTS OF STANDARD CHARACTERS WITHOUT CLAIM TO ANY PARTICULAR FONT, STYLE, SIZE, OR COLOR.
FOR WINE (U.S. CLS. 47 AND 49).
JAMES STEIN, EXAMINING ATTORNEY

CLASS 33—(Continued).

SN 77-726,498. NATURAL DRINKS S.A., SAO PUALO, SP, BRAZIL, FILED 4-30-2009.



THE MARK CONSISTS OF THE WORD "CAIPIONE" IN STYLIZED LETTERS.
THE WORDING "CAIPIONE" HAS NO MEANING IN A FOREIGN LANGUAGE.
FOR ALCOHOLIC BEVERAGES EXCEPT BEERS; DISTILLED SPIRITS (U.S. CLS. 47 AND 49).
MARGERY A. TIERNEY, EXAMINING ATTORNEY

SN 77-726,968. JEAN-CLAUDE BOISSET WINES USA, INC., SAUSALITO, CA. FILED 5-1-2009.



THE MARK CONSISTS OF STANDARD CHARACTERS WITHOUT CLAIM TO ANY PARTICULAR FONT, STYLE, SIZE, OR COLOR.
FOR WINES (U.S. CLS. 47 AND 49).
GEORGE LORENZO, EXAMINING ATTORNEY

SN 77-727,452. DRINKWARD, LISA, ST. HELENA, CA. AND BEHRENS, LES, ST. HELENA, CA. FILED 5-1-2009.



THE MARK CONSISTS OF STANDARD CHARACTERS WITHOUT CLAIM TO ANY PARTICULAR FONT, STYLE, SIZE, OR COLOR.
FOR WINE (U.S. CLS. 47 AND 49).
FIRST USE 11-1-2003; IN COMMERCE 7-1-2005.
ANGELA DUONG, EXAMINING ATTORNEY

CLASS 33—(Continued).

SN 77-728,264. SHANNON RIDGE, INC., CLEARLAKE OAKS, CA. FILED 5-4-2009.

Highland Ranch

THE MARK CONSISTS OF STANDARD CHARACTERS WITHOUT CLAIM TO ANY PARTICULAR FONT, STYLE, SIZE, OR COLOR.

FOR WINES (U.S. CLS. 47 AND 49).
DANIEL CAPSHAW, EXAMINING ATTORNEY

SN 77-728,296. SHANNON RIDGE, INC., CLEARLAKE OAKS, CA. FILED 5-4-2009.

Cross Springs

THE MARK CONSISTS OF STANDARD CHARACTERS WITHOUT CLAIM TO ANY PARTICULAR FONT, STYLE, SIZE, OR COLOR.

FOR WINES (U.S. CLS. 47 AND 49).
DANIEL CAPSHAW, EXAMINING ATTORNEY

SN 77-728,563. HEARTSMART WINE, LLC, LONG BEACH, CA. FILED 5-4-2009.

GREAT DANE

THE MARK CONSISTS OF STANDARD CHARACTERS WITHOUT CLAIM TO ANY PARTICULAR FONT, STYLE, SIZE, OR COLOR.

FOR WINE (U.S. CLS. 47 AND 49).
JAY FLOWERS, EXAMINING ATTORNEY

SN 77-729,282. SHANNON RIDGE, INC., CLEARLAKE OAKS, CA. FILED 5-5-2009.

Vigilance

THE MARK CONSISTS OF STANDARD CHARACTERS WITHOUT CLAIM TO ANY PARTICULAR FONT, STYLE, SIZE, OR COLOR.

FOR WINES (U.S. CLS. 47 AND 49).
DANIEL CAPSHAW, EXAMINING ATTORNEY

CLASS 33—(Continued).

SN 77-738,377. THIRTEENTH COLONY DISTILLERIES, LLC, AMERICUS, GA. FILED 5-15-2009.

Morning Glory

THE MARK CONSISTS OF STANDARD CHARACTERS WITHOUT CLAIM TO ANY PARTICULAR FONT, STYLE, SIZE, OR COLOR.

FOR DISTILLED SPIRITS (U.S. CLS. 47 AND 49).
KARANENDRA S. CHHINA, EXAMINING ATTORNEY

SN 77-757,033. SOLOMON SPIRITS CORPORATION, AVON, CT. FILED 6-11-2009.

BAMAKA

THE MARK CONSISTS OF STANDARD CHARACTERS WITHOUT CLAIM TO ANY PARTICULAR FONT, STYLE, SIZE, OR COLOR.

FOR SPIRITS AND LIQUEURS (U.S. CLS. 47 AND 49).
LINDSEY RUBIN, EXAMINING ATTORNEY

SN 77-763,489. ENTERTAINMENT BEVERAGES DISTILLERS, LLC, NORWOOD, MA. FILED 6-18-2009.

BLACK FLY

THE MARK CONSISTS OF STANDARD CHARACTERS WITHOUT CLAIM TO ANY PARTICULAR FONT, STYLE, SIZE, OR COLOR.

FOR ALCOHOLIC BEVERAGES EXCLUDING BEERS; ALCOHOLIC ENERGY DRINKS; WINES; WINE-BASED ENERGY DRINKS (U.S. CLS. 47 AND 49).
ELIZABETH HUGHITT, EXAMINING ATTORNEY

SN 77-763,776. ROCLAND WINE IMPORTS, SAN FRANCISCO, CA. FILED 6-19-2009.

SITTING DUCKS

THE MARK CONSISTS OF STANDARD CHARACTERS WITHOUT CLAIM TO ANY PARTICULAR FONT, STYLE, SIZE, OR COLOR.

FOR WINE (U.S. CLS. 47 AND 49).
SUE LAWRENCE, EXAMINING ATTORNEY

CLASS 33—(Continued).

SN 77-782,327. THIRTEENTH COLONY DISTILLERIES, LLC, AMERICUS, GA. FILED 7-16-2009.

Jezebel

THE MARK CONSISTS OF STANDARD CHARACTERS WITHOUT CLAIM TO ANY PARTICULAR FONT, STYLE, SIZE, OR COLOR.

FOR DISTILLED SPIRITS (U.S. CLS. 47 AND 49).
KARANENDRA S. CHHINA, EXAMINING ATTORNEY

SN 77-785,979. THIRTEENTH COLONY DISTILLERIES, LLC, AMERICUS, GA. FILED 7-21-2009.

Magic

THE MARK CONSISTS OF STANDARD CHARACTERS WITHOUT CLAIM TO ANY PARTICULAR FONT, STYLE, SIZE, OR COLOR.

FOR DISTILLED SPIRITS (U.S. CLS. 47 AND 49).
KARANENDRA S. CHHINA, EXAMINING ATTORNEY

SN 79-059,167. CHATEAU DE PONCIE, FRANCE, FILED 9-5-2008.

CHATEAU DE PONCIE

THE MARK CONSISTS OF STANDARD CHARACTERS WITHOUT CLAIM TO ANY PARTICULAR FONT, STYLE, SIZE, OR COLOR.

OWNER OF INTERNATIONAL REGISTRATION 0978070 DATED 9-5-2008, EXPIRES 9-5-2018.

NO CLAIM IS MADE TO THE EXCLUSIVE RIGHT TO USE "CHATEAU", APART FROM THE MARK AS SHOWN.

THE ENGLISH TRANSLATION OF "CHATEAU DE PONCIE" IN THE MARK IS CASTLE OF PONCIE.

FOR WINES OF GUARANTEED LABEL OF ORIGIN FROM THE WINE-MAKING ESTATE CALLED CHATEAU DE PONCIE (U.S. CLS. 47 AND 49).

CAROL SPILS, EXAMINING ATTORNEY

SN 79-061,701. LIDL STIFTUNG & CO. KG, FED REP GERMANY, FILED 9-29-2008.

Goldhauch

THE MARK CONSISTS OF STANDARD CHARACTERS WITHOUT CLAIM TO ANY PARTICULAR FONT, STYLE, SIZE, OR COLOR.

OWNER OF INTERNATIONAL REGISTRATION 0771434 DATED 10-24-2001, EXPIRES 10-24-2011.

THE ENGLISH TRANSLATION OF "GOLDHAUCH" IN THE MARK IS GOLD BREATH.

FOR DISTILLED SPIRITS (U.S. CLS. 47 AND 49).

JANET LEE, EXAMINING ATTORNEY

CLASS 33—(Continued).

SN 79-063,225. CASA VINICOLA LUIGI CECCHI & FIGLI S.R.L., ITALY, FILED 9-30-2008.

ZONA OTTO

THE MARK CONSISTS OF STANDARD CHARACTERS WITHOUT CLAIM TO ANY PARTICULAR FONT, STYLE, SIZE, OR COLOR.

OWNER OF INTERNATIONAL REGISTRATION 0987831 DATED 9-30-2008, EXPIRES 9-30-2018.

THE ENGLISH TRANSLATION OF "ZONA OTTO" IN THE MARK IS ZONE EIGHT.

FOR WINE (U.S. CLS. 47 AND 49).

KIM MONINGHOFF, EXAMINING ATTORNEY

SN 79-063,302. MANUEL SANCHO LABARTA, SPAIN, FILED 10-17-2008.



OWNER OF INTERNATIONAL REGISTRATION 0578740 DATED 11-15-1991, EXPIRES 11-15-2011.

THE LINING IS A FEATURE OF THE MARK AND DOES NOT INDICATE COLOR.

FOR SPARKLING WINES, WINES, SPIRITS, LIQUEURS, EAUX-DE-VIE (BRANDY) AND OTHER ALCOHOLIC BEVERAGES (EXCEPT BEERS) (U.S. CLS. 47 AND 49).

JOHN E. MICHOS, EXAMINING ATTORNEY

SN 79-064,629. GLAETZER WINES PTY LTD, AUSTRALIA, FILED 12-18-2008.



BISHOP

PRIORITY DATE OF 7-21-2008 IS CLAIMED. OWNER OF INTERNATIONAL REGISTRATION 0991483 DATED 12-18-2008, EXPIRES 12-18-2018.

FOR WINE (U.S. CLS. 47 AND 49).

JESSICA FATHY, EXAMINING ATTORNEY

CLASS 33—(Continued).

SN 79-065,097. INCORPORATED BEVERAGES (JERSEY) LIMITED, UNITED KINGDOM, FILED 1-27-2009.

ZAMARETTO

OWNER OF INTERNATIONAL REGISTRATION 0992651 DATED 1-27-2009, EXPIRES 1-27-2019.

THE MARK CONSISTS OF THE WORDING "ZAMARETTO" IN STYLIZED FONT.

FOR ALCOHOLIC BEVERAGES, NAMELY, LIQUEURS (U.S. CLS. 47 AND 49).

DANIEL CAPSHAW, EXAMINING ATTORNEY

SN 79-067,454. ANGULLONG MANAGEMENT PTY LTD, AUSTRALIA, FILED 11-6-2008.

ANGULLONG

THE MARK CONSISTS OF STANDARD CHARACTERS WITHOUT CLAIM TO ANY PARTICULAR FONT, STYLE, SIZE, OR COLOR.

OWNER OF INTERNATIONAL REGISTRATION 0999242 DATED 11-6-2008, EXPIRES 11-6-2018.

THE ENGLISH TRANSLATION OF "ANGULLONG" IN THE MARK IS RUNNING WATER.

FOR WINE (U.S. CLS. 47 AND 49).

FRED CARL, EXAMINING ATTORNEY

SN 79-068,881. GIANNI GAGLIARDO VILLA MONTISEL SRL, ITALY, FILED 4-27-2009.

villa M

PRIORITY DATE OF 3-5-2009 IS CLAIMED.
OWNER OF INTERNATIONAL REGISTRATION 1002883 DATED 4-27-2009, EXPIRES 4-27-2019.
FOR WINES (U.S. CLS. 47 AND 49).
CHARISMA HAMPTON, EXAMINING ATTORNEY

CLASS 33—(Continued).

SN 79-069,629. MITOLO WINES AUST PTY LTD, AUSTRALIA, FILED 4-6-2009.

7th son

THE MARK CONSISTS OF STANDARD CHARACTERS WITHOUT CLAIM TO ANY PARTICULAR FONT, STYLE, SIZE, OR COLOR.

PRIORITY DATE OF 1-29-2009 IS CLAIMED.

OWNER OF INTERNATIONAL REGISTRATION 1004649 DATED 4-6-2009, EXPIRES 4-6-2019.

FOR WINE; ALCOHOLIC BEVERAGES EXCEPT BEER (U.S. CLS. 47 AND 49).

CHARISMA HAMPTON, EXAMINING ATTORNEY

SN 79-069,953. ELVIWINES, S.L., SPAIN, FILED 4-28-2009.

ELVIWINES

THE MARK CONSISTS OF STANDARD CHARACTERS WITHOUT CLAIM TO ANY PARTICULAR FONT, STYLE, SIZE, OR COLOR.

OWNER OF INTERNATIONAL REGISTRATION 1005441 DATED 4-28-2009, EXPIRES 4-28-2019.

FOR WINE, SPARKLING WINE; SANGRIA; BRANDY (U.S. CLS. 47 AND 49).

TINA L. SNAPP, EXAMINING ATTORNEY

CLASS 34—SMOKERS' ARTICLES

SN 77-441,564. FUENTE MARKETING LTD., TORTOLA, BR. VIRGIN ISLANDS, FILED 4-7-2008.

CARLOS

THE MARK CONSISTS OF STANDARD CHARACTERS WITHOUT CLAIM TO ANY PARTICULAR FONT, STYLE, SIZE, OR COLOR.

OWNER OF U.S. REG. NOS. 2,330,649, 3,144,715 AND OTHERS.

FOR CIGARS (U.S. CLS. 2, 8, 9 AND 17).

KAREN SEVERSON, EXAMINING ATTORNEY

CLASS 34—(Continued).

SN 77-441,570. FUENTE MARKETING LTD., TORTOLA, BR.VIRGIN ISLANDS, FILED 4-7-2008.

CLASS 34—(Continued).

SN 77-441,597. FUENTE MARKETING LTD., TORTOLA, BR.VIRGIN ISLANDS, FILED 4-7-2008.

CARLOS I

THE MARK CONSISTS OF STANDARD CHARACTERS WITHOUT CLAIM TO ANY PARTICULAR FONT, STYLE, SIZE, OR COLOR.
OWNER OF U.S. REG. NOS. 2,330,649, 3,144,715 AND OTHERS.
FOR CIGARS (U.S. CLS. 2, 8, 9 AND 17).
KAREN SEVERSON, EXAMINING ATTORNEY

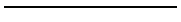

SN 77-441,581. FUENTE MARKETING LTD., TORTOLA, BR.VIRGIN ISLANDS, FILED 4-7-2008.

CARLOS II

THE MARK CONSISTS OF STANDARD CHARACTERS WITHOUT CLAIM TO ANY PARTICULAR FONT, STYLE, SIZE, OR COLOR.
OWNER OF U.S. REG. NOS. 2,330,649, 3,144,715 AND OTHERS.
FOR CIGARS (U.S. CLS. 2, 8, 9 AND 17).
KAREN SEVERSON, EXAMINING ATTORNEY

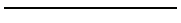

SN 77-441,585. FUENTE MARKETING LTD., TORTOLA, BR.VIRGIN ISLANDS, FILED 4-7-2008.

CARLOS III

THE MARK CONSISTS OF STANDARD CHARACTERS WITHOUT CLAIM TO ANY PARTICULAR FONT, STYLE, SIZE, OR COLOR.
OWNER OF U.S. REG. NOS. 2,330,649, 3,144,715 AND OTHERS.
FOR CIGARS (U.S. CLS. 2, 8, 9 AND 17).
KAREN SEVERSON, EXAMINING ATTORNEY

CARLOS IV

THE MARK CONSISTS OF STANDARD CHARACTERS WITHOUT CLAIM TO ANY PARTICULAR FONT, STYLE, SIZE, OR COLOR.
OWNER OF U.S. REG. NOS. 2,330,649, 3,144,715 AND OTHERS.
FOR CIGARS (U.S. CLS. 2, 8, 9 AND 17).
KAREN SEVERSON, EXAMINING ATTORNEY

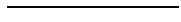

SN 77-616,946. MAX ROHR, INC., WILMINGTON, DE. FILED 11-18-2008.

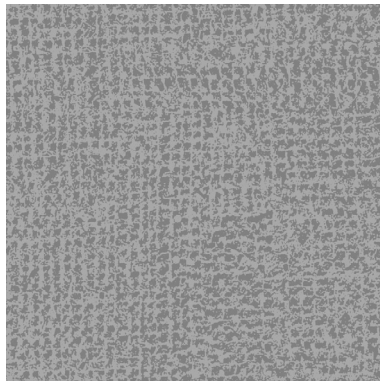

THE MARK CONSISTS OF A SIMULATED BURLAP DESIGN COMPRISED OF A RANDOM PATTERN OF DARKER IRREGULAR SHAPES AGAINST A LIGHTER SOLID BACKGROUND GIVING THE ILLUSION OF A WOVEN TEXTURE WHICH COMPLETELY COVERS THE OUTSIDE OF CIGAR AND TOBACCO PRODUCT PACKAGING.
SEC. 2(F).
FOR CIGARS; TOBACCO POUCHES; CIGAR AND CIGARETTE CASES NOT OF PRECIOUS METAL (U.S. CLS. 2, 8, 9 AND 17).
FIRST USE 5-2-1979; IN COMMERCE 5-2-1979.
THOMAS MANOR, EXAMINING ATTORNEY

CLASS 34—(Continued).

SN 77-632,879. ROYAL DISTRIBUTION TABAC DITRIB
NORD, 59000 LILLE, FRANCE, FILED 12-15-2008.

SENSKY

THE MARK CONSISTS OF STANDARD CHARACTERS
WITHOUT CLAIM TO ANY PARTICULAR FONT, STYLE,
SIZE, OR COLOR.

PRIORITY CLAIMED UNDER SEC. 44(D) ON FRANCE
APPLICATION NO. 083590848, FILED 7-25-2008.

OWNER OF FRANCE REG. NO. 083590848, DATED 7-25-
2008, EXPIRES 7-25-2018.

FOR TOBACCO, SMOKER'S ARTICLES, NAMELY,
PIPE TAMPERS, CIGAR CUTTERS, CIGAR AND CI-
GARETTE HOLDERS, TOBACCO FILTERS, TOBACCO
JARS, TOBACCO PIPE CLEANERS, MATCHES, CIGARS,
CIGARETTES, CIGARETTE PAPER, SMOKING PIPES,
LIGHTERS FOR SMOKERS, CIGAR AND CIGARETTE
CASES, ASHTRAYS (U.S. CLS. 2, 8, 9 AND 17).

HEATHER BIDDULPH, EXAMINING ATTORNEY

CLASS 34—(Continued).

SN 77-692,927. MAX ROHR, INC., WILMINGTON, DE.
FILED 3-17-2009.

BACKGAMMON

THE MARK CONSISTS OF STANDARD CHARACTERS
WITHOUT CLAIM TO ANY PARTICULAR FONT, STYLE,
SIZE, OR COLOR.

FOR CIGARS, LITTLE CIGARS, ROLL-YOUR-OWN
TOBACCO, PIPE TOBACCO AND SMOKELESS TOBAC-
CO, AND RELATED ACCESSORIES IN THE NATURE
OF ASHTRAYS, CIGAR BOXES, CIGAR CUTTERS,
CIGAR CASES, CIGAR HOLDERS, HUMIDORS, LIGHT-
ERS FOR SMOKERS, TOBACCO PIPES, TOBACCO
POUCHES, TOBACCO PUNCHES, AND TOBACCO TINS
(U.S. CLS. 2, 8, 9 AND 17).

JACLYN KIDWELL, EXAMINING ATTORNEY

SN 77-673,567. MAX ROHR, INC., WILMINGTON, DE.
FILED 2-19-2009.

GENIOS

THE MARK CONSISTS OF STANDARD CHARACTERS
WITHOUT CLAIM TO ANY PARTICULAR FONT, STYLE,
SIZE, OR COLOR.

THE ENGLISH TRANSLATION OF "GENIOS" IS "GEN-
IUSES".

FOR CIGARS (U.S. CLS. 2, 8, 9 AND 17).

JACLYN KIDWELL, EXAMINING ATTORNEY

SN 77-724,619. AMERICAN CIGARETTE COMPANY, INC.,
FT. LAUDERDALE, FL. FILED 4-29-2009.

UNIQUE

THE MARK CONSISTS OF STANDARD CHARACTERS
WITHOUT CLAIM TO ANY PARTICULAR FONT, STYLE,
SIZE, OR COLOR.

FOR CIGARETTES (U.S. CLS. 2, 8, 9 AND 17).

JULIE WATSON, EXAMINING ATTORNEY

SN 77-673,590. MAX ROHR, INC., WILMINGTON, DE.
FILED 2-19-2009.

SECRETOS

THE MARK CONSISTS OF STANDARD CHARACTERS
WITHOUT CLAIM TO ANY PARTICULAR FONT, STYLE,
SIZE, OR COLOR.

THE ENGLISH TRANSLATION OF "SECRETOS" IS
"SECRETS".

FOR CIGARS (U.S. CLS. 2, 8, 9 AND 17).

JACLYN KIDWELL, EXAMINING ATTORNEY

SN 77-724,638. FUENTE MARKETING LTD., TORTOLA,
BR. VIRGIN ISLANDS, FILED 4-29-2009.

OPUS

THE MARK CONSISTS OF STANDARD CHARACTERS
WITHOUT CLAIM TO ANY PARTICULAR FONT, STYLE,
SIZE, OR COLOR.

FOR CIGARS (U.S. CLS. 2, 8, 9 AND 17).

MELVIN AXILBUND, EXAMINING ATTORNEY

CLASS 34—(Continued).

SN 79-066,812. NINGBO XINHAI ELECTRIC CO., LTD., CHINA, FILED 12-29-2008.



OWNER OF INTERNATIONAL REGISTRATION 0997530 DATED 12-29-2008, EXPIRES 12-29-2018.

THE COLOR(S) BLACK AND RED IS/ARE CLAIMED AS A FEATURE OF THE MARK.

THE MARK CONSISTS OF THE WORD "EXALT" IN BLACK AND A DEVICE OF AN ELLIPSE IN RED.

FOR CIGARETTE LIGHTERS NOT FOR LAND VEHICLES; LIGHTERS FOR SMOKERS; FIRESTONES; CIGARETTE PIPES; ASHTRAYS; GAS CONTAINERS FOR CIGAR LIGHTERS; BUTANE LIGHTERS FOR SMOKING PURPOSE; GAS CONTAINERS FOR CIGARETTE LIGHTERS; HOLDERS FOR USED MATCHES; TINS FOR TOBACCO (U.S. CLS. 2, 8, 9 AND 17).

DOMINIC FATHY, EXAMINING ATTORNEY

CLASS 35—(Continued).

SN 76-661,218. AMR CORPORATION, FORT WORTH, TX, FILED 6-7-2006.



FOR BUSINESS MANAGEMENT CONSULTING SERVICES IN THE AVIATION AND TRANSPORTATION INDUSTRIES (U.S. CLS. 100, 101 AND 102).

FIRST USE 3-15-1990; IN COMMERCE 3-15-1990.

JENNY PARK, EXAMINING ATTORNEY

SN 76-692,250. MARTIN, ROSEMARY M., VOORHEES, NJ, FILED 8-12-2008.

SERVICE MARKS
**CLASS 35—ADVERTISING AND BUSINESS**

SN 75-928,385. CRESCENT MARKETING, INC., NORTH OLMSTED, OH. FILED 2-25-2000.

GAME QUEST

NO CLAIM IS MADE TO THE EXCLUSIVE RIGHT TO USE "GAME", APART FROM THE MARK AS SHOWN.

FOR RETAIL STORE SERVICES FEATURING VIDEO GAMES, COMPUTER SOFTWARE, HARDWARE AND RELATED ACCESSORIES FOR THE FOREGOING (U.S. CLS. 100, 101 AND 102).

FIRST USE 6-0-1994; IN COMMERCE 11-0-1999.

SHANNON TWOHIG, EXAMINING ATTORNEY

NO CLAIM IS MADE TO THE EXCLUSIVE RIGHT TO USE "HUMAN DYNAMICS", APART FROM THE MARK AS SHOWN.

THE COLOR(S) BLACK, WHITE, BLUE AND GRAY IS/ARE CLAIMED AS A FEATURE OF THE MARK.

THE MARK CONSISTS OF THE STYLIZED PHRASE "HUMAN DYNAMICS" ABOVE THE STYLIZED PHRASE "INNOVATION IN EMPLOYEE COMMUNICATIONS" ALL SUPERIMPOSED ON A LARGE TRIANGLE, WHICH IS SUPERIMPOSED ON A SMALLER TRIANGLE; THE COLOR BLACK APPEARS IN THE PHRASE "INNOVATION IN EMPLOYEE COMMUNICATIONS", AND IN THE BORDERS AROUND THE TRIANGLES; THE COLOR BLUE APPEARS IN THE PHRASE "HUMAN DYNAMICS" AND IN THE BACKGROUND IN THE SMALLER TRIANGLE; THE COLOR GRAY APPEARS IN THE BACKGROUND OF THE LARGER TRIANGLE; THE COLOR WHITE APPEARS IN THE SHADING ON BOTH TRIANGLES.

FOR CONSULTING SERVICES IN THE FIELD OF HUMAN RESOURCES DEVELOPMENT, NAMELY, FOR THE PROMOTION OF EMPLOYEES AND EMPLOYERS BY PROVIDING FEEDBACK TO MANAGEMENT TO IDENTIFY AND CORRECT PROBLEMS IN THE WORK ENVIRONMENT AND ENHANCE EMPLOYEE JOB SATISFACTION THROUGH THE USE OF A NEW AND DIFFERENT EMPLOYEE SURVEY EVALUATION OF WORKPLACE HUMAN DYNAMICS' BEHAVIORS (U.S. CLS. 100, 101 AND 102).

MYRIAH HABEEB, EXAMINING ATTORNEY

CLASS 35—(Continued).

SN 76-694,380. WORLD 50, INC., ATLANTA, GA. FILED 11-21-2008.

SUPPLY CHAIN 50

THE MARK CONSISTS OF STANDARD CHARACTERS WITHOUT CLAIM TO ANY PARTICULAR FONT, STYLE, SIZE, OR COLOR.

NO CLAIM IS MADE TO THE EXCLUSIVE RIGHT TO USE "SUPPLY CHAIN", APART FROM THE MARK AS SHOWN.

FOR BUSINESS ADMINISTRATION AND MANAGEMENT, NAMELY, PROVIDING, ORGANIZING, AND OPERATING AN EXCLUSIVE ORGANIZATION OF SUPPLY CHAIN EXECUTIVES FOR THE PURPOSE OF NETWORKING ACTIVITIES WHICH IS COMPOSED OF GLOBAL MEMBERS FROM A VARIETY OF FIELDS AND INDUSTRY SECTORS (U.S. CLS. 100, 101 AND 102).

FIRST USE 3-1-2007; IN COMMERCE 3-1-2007.
ELLEN PERKINS, EXAMINING ATTORNEY

CLASS 35—(Continued).

SN 76-694,382. WORLD 50, INC., ATLANTA, GA. FILED 11-21-2008.

HUMAN RESOURCE 50

THE MARK CONSISTS OF STANDARD CHARACTERS WITHOUT CLAIM TO ANY PARTICULAR FONT, STYLE, SIZE, OR COLOR.

NO CLAIM IS MADE TO THE EXCLUSIVE RIGHT TO USE "HUMAN RESOURCE", APART FROM THE MARK AS SHOWN.

FOR BUSINESS ADMINISTRATION AND MANAGEMENT, NAMELY, PROVIDING, ORGANIZING, AND OPERATING AN EXCLUSIVE ORGANIZATION OF HUMAN RESOURCE EXECUTIVES FOR THE PURPOSE OF NETWORKING ACTIVITIES WHICH IS COMPOSED OF GLOBAL MEMBERS FROM A VARIETY OF FIELDS AND INDUSTRY SECTORS (U.S. CLS. 100, 101 AND 102).

FIRST USE 2-1-2005; IN COMMERCE 2-1-2005.
ELLEN PERKINS, EXAMINING ATTORNEY

SN 76-694,381. WORLD 50, INC., ATLANTA, GA. FILED 11-21-2008.

MARKETING 50

THE MARK CONSISTS OF STANDARD CHARACTERS WITHOUT CLAIM TO ANY PARTICULAR FONT, STYLE, SIZE, OR COLOR.

NO CLAIM IS MADE TO THE EXCLUSIVE RIGHT TO USE "MARKETING", APART FROM THE MARK AS SHOWN.

FOR BUSINESS ADMINISTRATION AND MANAGEMENT, NAMELY, PROVIDING, ORGANIZING, AND OPERATING AN EXCLUSIVE ORGANIZATION OF MARKETING EXECUTIVES FOR THE PURPOSE OF NETWORKING ACTIVITIES WHICH IS COMPOSED OF GLOBAL MEMBERS FROM A VARIETY OF FIELDS AND INDUSTRY SECTORS (U.S. CLS. 100, 101 AND 102).

FIRST USE 1-1-2004; IN COMMERCE 1-1-2004.
ELLEN PERKINS, EXAMINING ATTORNEY

SN 76-694,422. WORLD 50, INC., ATLANTA, GA. FILED 11-24-2008.

REVENUE 50

THE MARK CONSISTS OF STANDARD CHARACTERS WITHOUT CLAIM TO ANY PARTICULAR FONT, STYLE, SIZE, OR COLOR.

NO CLAIM IS MADE TO THE EXCLUSIVE RIGHT TO USE REVENUE, APART FROM THE MARK AS SHOWN.

FOR BUSINESS ADMINISTRATION AND MANAGEMENT, NAMELY, PROVIDING, ORGANIZING, AND OPERATING AN EXCLUSIVE ORGANIZATION OF SALES AND REVENUE FOCUSED EXECUTIVES FOR THE PURPOSE OF NETWORKING ACTIVITIES WHICH IS COMPOSED OF GLOBAL MEMBERS FROM A VARIETY OF FIELDS AND INDUSTRY SECTORS (U.S. CLS. 100, 101 AND 102).

FIRST USE 8-1-2008; IN COMMERCE 8-1-2008.
ELLEN PERKINS, EXAMINING ATTORNEY

CLASS 35—(Continued).

SN 76-694,423. WORLD 50, INC., ATLANTA, GA. FILED 11-24-2008.

BRAND 50

THE MARK CONSISTS OF STANDARD CHARACTERS WITHOUT CLAIM TO ANY PARTICULAR FONT, STYLE, SIZE, OR COLOR.

NO CLAIM IS MADE TO THE EXCLUSIVE RIGHT TO USE "BRAND", APART FROM THE MARK AS SHOWN.

FOR BUSINESS ADMINISTRATION AND MANAGEMENT, NAMELY, PROVIDING, ORGANIZING, AND OPERATING AN EXCLUSIVE ORGANIZATION OF GLOBAL BRAND EXECUTIVES FOR THE PURPOSE OF NETWORKING ACTIVITIES WHICH IS COMPOSED OF MEMBERS FROM A VARIETY OF FIELDS AND INDUSTRY SECTORS (U.S. CLS. 100, 101 AND 102).

FIRST USE 3-1-2006; IN COMMERCE 3-1-2006.
ELLEN PERKINS, EXAMINING ATTORNEY

CLASS 35—(Continued).

SN 76-694,425. WORLD 50, INC., ATLANTA, GA. FILED 11-24-2008.

SUSTAINABILITY 50

THE MARK CONSISTS OF STANDARD CHARACTERS WITHOUT CLAIM TO ANY PARTICULAR FONT, STYLE, SIZE, OR COLOR.

NO CLAIM IS MADE TO THE EXCLUSIVE RIGHT TO USE "SUSTAINABILITY", APART FROM THE MARK AS SHOWN.

FOR BUSINESS ADMINISTRATION AND MANAGEMENT, NAMELY, PROVIDING, ORGANIZING, AND OPERATING AN EXCLUSIVE ORGANIZATION OF SUSTAINABILITY AND CORPORATE RESPONSIBILITY EXECUTIVES FOR THE PURPOSE OF NETWORKING ACTIVITIES WHICH IS COMPOSED OF GLOBAL MEMBERS FROM A VARIETY OF FIELDS AND INDUSTRY SECTORS (U.S. CLS. 100, 101 AND 102).

FIRST USE 10-1-2007; IN COMMERCE 10-1-2007.
ELLEN PERKINS, EXAMINING ATTORNEY

SN 76-694,424. WORLD 50, INC., ATLANTA, GA. FILED 11-24-2008.

GLOBAL 50

THE MARK CONSISTS OF STANDARD CHARACTERS WITHOUT CLAIM TO ANY PARTICULAR FONT, STYLE, SIZE, OR COLOR.

NO CLAIM IS MADE TO THE EXCLUSIVE RIGHT TO USE "GLOBAL", APART FROM THE MARK AS SHOWN.

FOR BUSINESS ADMINISTRATION AND MANAGEMENT, NAMELY, PROVIDING, ORGANIZING, AND OPERATING AN EXCLUSIVE ORGANIZATION OF GLOBAL EXECUTIVES FOR THE PURPOSE OF NETWORKING ACTIVITIES WHICH IS COMPOSED OF MEMBERS FROM A VARIETY OF FIELDS AND INDUSTRY SECTORS, NAMELY, PRESIDENTS, COOS AND DIVISION CEO PEERS (U.S. CLS. 100, 101 AND 102).

FIRST USE 4-1-2005; IN COMMERCE 4-1-2005.
ELLEN PERKINS, EXAMINING ATTORNEY

SN 76-694,717. WORLD 50, INC., ATLANTA, GA. FILED 12-9-2008.

HR 50

THE MARK CONSISTS OF STANDARD CHARACTERS WITHOUT CLAIM TO ANY PARTICULAR FONT, STYLE, SIZE, OR COLOR.

NO CLAIM IS MADE TO THE EXCLUSIVE RIGHT TO USE "HR", APART FROM THE MARK AS SHOWN.

FOR BUSINESS ADMINISTRATION AND MANAGEMENT, NAMELY, PROVIDING, ORGANIZING, AND OPERATING AN EXCLUSIVE ORGANIZATION OF HUMAN RESOURCE EXECUTIVES FOR THE PURPOSE OF NETWORKING ACTIVITIES WHICH IS COMPOSED OF GLOBAL MEMBERS FROM A VARIETY OF FIELDS AND INDUSTRY SECTORS (U.S. CLS. 100, 101 AND 102).

FIRST USE 2-1-2005; IN COMMERCE 2-1-2005.
ELLEN PERKINS, EXAMINING ATTORNEY

CLASS 35—(Continued).

SN 76-695,370. WANG, HENRY, MASPETH, NY. FILED 1-21-2009.



THE NON-LATIN CHARACTERS IN THE MARK TRANSLITERATE TO "DONG NAN" AND THIS MEANS "SOUTH-EAST" IN ENGLISH.

FOR DISTRIBUTORSHIPS IN THE FIELD OF FRESH FRUIT AND VEGETABLES (U.S. CLS. 100, 101 AND 102).
FIRST USE 1-1-1995; IN COMMERCE 1-1-1995.
MATTHEW MCDOWELL, EXAMINING ATTORNEY

CLASS 35—(Continued).

SN 76-695,995. LAMM PRODUCTS INC., RICHMOND HTS, OH. FILED 2-26-2009.



THE MARK CONSISTS OF THE WORDING "BOTTOMS UP" WITH TWO INCOMPLETE OVALS CURVING AWAY AND UP FROM THE WORDING. THERE ARE TWO EXCLAMATION POINTS AFTER THE WORDING WITH ONE UPSIDE DOWN.

FOR RETAIL STORE SERVICES FEATURING PRE-PACKAGED GELATIN SHOT CUPS (U.S. CLS. 100, 101 AND 102).

FIRST USE 10-1-2008; IN COMMERCE 10-1-2008.
AMY HELLA, EXAMINING ATTORNEY

SN 76-695,555. PENNSYLVANIA HISTORICAL AND MUSEUM COMMISSION, HARRISBURG, PA. FILED 2-2-2009.



NO CLAIM IS MADE TO THE EXCLUSIVE RIGHT TO USE "PABOOKSTORE.COM", APART FROM THE MARK AS SHOWN.

FOR ADVERTISING AND BUSINESS SERVICES RELATING TO BOOKSTORE INDUSTRIES (U.S. CLS. 100, 101 AND 102).

FIRST USE 0-0-2006; IN COMMERCE 0-0-2006.
ZACHARY BELLO, EXAMINING ATTORNEY

SN 76-696,789. XSE GROUP, INC., MIDDLETOWN, CT. FILED 4-9-2009.



OWNER OF U.S. REG. NOS. 2,339,106 AND 2,386,992.
FOR DISTRIBUTORSHIP SERVICES IN THE FIELD OF OFFICE PRODUCTS AND COMPUTER SUPPLIES (U.S. CLS. 100, 101 AND 102).

FIRST USE 1-0-1999; IN COMMERCE 1-0-1999.
ANGELA M. MICHELI, EXAMINING ATTORNEY

SN 76-695,556. PENNSYLVANIA HISTORICAL AND MUSEUM COMMISSION, HARRISBURG, PA. FILED 2-2-2009.

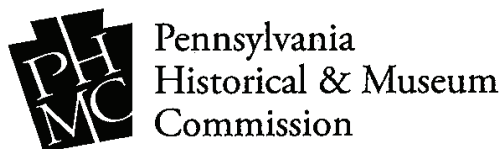

NO CLAIM IS MADE TO THE EXCLUSIVE RIGHT TO USE "PENNSYLVANIA HISTORICAL & MUSEUM COMMISSION", APART FROM THE MARK AS SHOWN.

FOR ADVERTISING AND BUSINESS SERVICES RELATING TO BOOKSTORE INDUSTRIES (U.S. CLS. 100, 101 AND 102).

FIRST USE 0-0-2006; IN COMMERCE 0-0-2006.
ZACHARY BELLO, EXAMINING ATTORNEY

SN 77-122,797. EUREKA PUZZLES INC., BROOKLINE, MA. FILED 3-5-2007.

EUREKA

THE MARK CONSISTS OF STANDARD CHARACTERS WITHOUT CLAIM TO ANY PARTICULAR FONT, STYLE, SIZE, OR COLOR.

FOR WHOLESALE STORES FEATURING GAMES, GIFTS, PUZZLES, JIGSAW PUZZLES, MECHANICAL PUZZLES, TOYS, SOUVENIRS; RETAIL STORES FEATURING GAMES, GIFTS, PUZZLES, JIGSAW PUZZLES, MECHANICAL PUZZLES, TOYS, SOUVENIRS; ON-LINE RETAIL STORE SERVICES FEATURING GAMES, GIFTS, PUZZLES, JIGSAW PUZZLES, MECHANICAL PUZZLES, TOYS, SOUVENIRS (U.S. CLS. 100, 101 AND 102).

FIRST USE 9-0-2004; IN COMMERCE 9-0-2004.
ALEX KEAM, EXAMINING ATTORNEY

CLASS 35—(Continued).

SN 77-189,852. CHICAGO ASSOCIATION FOR RESEARCH AND EDUCATION IN SCIENCE, HINES, IL. FILED 5-24-2007.

CARES

THE MARK CONSISTS OF STANDARD CHARACTERS WITHOUT CLAIM TO ANY PARTICULAR FONT, STYLE, SIZE, OR COLOR.

FOR ASSOCIATION SERVICES, NAMELY, PROMOTING THE INTERESTS OF VETERANS (U.S. CLS. 100, 101 AND 102).

FIRST USE 8-1-1986; IN COMMERCE 8-1-1986.
ALICIA COLLINS, EXAMINING ATTORNEY

SN 77-212,343. CHAMBERTV, INC., FORMERLY CHAMBERTV, EL DORADO HILLS, CA. FILED 6-21-2007.

ChamberTV

THE MARK CONSISTS OF STANDARD CHARACTERS WITHOUT CLAIM TO ANY PARTICULAR FONT, STYLE, SIZE, OR COLOR.

FOR PROVIDING A SEARCHABLE ONLINE ADVERTISING GUIDE FEATURING THE GOODS AND SERVICES OF OTHER ON-LINE VENDORS ON THE INTERNET; ADVERTISING AND COMMERCIAL INFORMATION SERVICES, VIA THE INTERNET (U.S. CLS. 100, 101 AND 102).

FIRST USE 5-18-2007; IN COMMERCE 5-18-2007.
JULIE WATSON, EXAMINING ATTORNEY

SN 77-224,775. HAMPTON ROADS TECHNOLOGY COUNCIL, HAMPTON, VA. FILED 7-9-2007.

SENSORS WORLD

THE MARK CONSISTS OF STANDARD CHARACTERS WITHOUT CLAIM TO ANY PARTICULAR FONT, STYLE, SIZE, OR COLOR.

NO CLAIM IS MADE TO THE EXCLUSIVE RIGHT TO USE "SENSORS", APART FROM THE MARK AS SHOWN.

FOR PROMOTING, ARRANGING AND CONDUCTING BUSINESS CONFERENCES AND TRADE SHOWS FOR SENSOR MANUFACTURERS AND OTHERS IN THE FIELD OF SENSOR TECHNOLOGY (U.S. CLS. 100, 101 AND 102).

FIRST USE 12-12-2007; IN COMMERCE 12-12-2007.
H. M. FISHER, EXAMINING ATTORNEY

CLASS 35—(Continued).

SN 77-239,809. TRINITY TECHNOLOGY GROUP, INC., FAIRFAX, VA. FILED 7-26-2007.

C.R.I.S.I.S. - CONTINGENCY READINESS & INFRASTRUCTURE SECURITY INFORMATION SYSTEM

THE MARK CONSISTS OF STANDARD CHARACTERS WITHOUT CLAIM TO ANY PARTICULAR FONT, STYLE, SIZE, OR COLOR.

NO CLAIM IS MADE TO THE EXCLUSIVE RIGHT TO USE "CONTINGENCY READINESS & INFRASTRUCTURE SECURITY INFORMATION SYSTEM", APART FROM THE MARK AS SHOWN.

FOR BUSINESS MANAGEMENT CONSULTING AND ADVISORY SERVICES; BUSINESS CONSULTING, MANAGEMENT, PLANNING AND SUPERVISION; BUSINESS CONSULTATION SERVICES ON THE SUBJECTS OF BUSINESS PLANNING AND BUSINESS REENGINEERING; PROVIDING INFORMATION OVER GLOBAL, LOCAL AND INTERNAL COMPUTER NETWORKS ON THE SUBJECTS OF BUSINESS PLANNING AND BUSINESS PROCESS REENGINEERING; PROVIDING BUSINESS INFORMATION VIA THE INTERNET ON THE SUBJECTS OF BUSINESS PLANNING AND BUSINESS PROCESS REENGINEERING (U.S. CLS. 100, 101 AND 102).

FIRST USE 6-27-2006; IN COMMERCE 6-27-2006.
SIMON TENG, EXAMINING ATTORNEY

SN 77-239,834. TRINITY TECHNOLOGY GROUP, INC., FAIRFAX, VA. FILED 7-26-2007.

C.R.I.S.I.S.

THE MARK CONSISTS OF STANDARD CHARACTERS WITHOUT CLAIM TO ANY PARTICULAR FONT, STYLE, SIZE, OR COLOR.

FOR BUSINESS MANAGEMENT CONSULTING AND ADVISORY SERVICES; BUSINESS CONSULTING, MANAGEMENT, PLANNING AND SUPERVISION; BUSINESS CONSULTATION SERVICES ON THE SUBJECTS OF BUSINESS PLANNING AND BUSINESS REENGINEERING; PROVIDING INFORMATION OVER GLOBAL, LOCAL AND INTERNAL COMPUTER NETWORKS ON THE SUBJECTS OF BUSINESS PLANNING AND BUSINESS PROCESS REENGINEERING; PROVIDING BUSINESS INFORMATION VIA THE INTERNET ON THE SUBJECTS OF BUSINESS PLANNING AND BUSINESS PROCESS REENGINEERING (U.S. CLS. 100, 101 AND 102).

FIRST USE 6-27-2006; IN COMMERCE 6-27-2006.
SIMON TENG, EXAMINING ATTORNEY

CLASS 35—(Continued).

SN 77-283,171. CANOLA COUNCIL OF CANADA, WINNIPEG, MANITOBA, CANADA, FILED 9-19-2007.



PRIORITY CLAIMED UNDER SEC. 44(D) ON CANADA APPLICATION NO. 1363029, FILED 9-10-2007, REG. NO. 1363029, DATED 9-10-2007, EXPIRES 9-10-2022.

NO CLAIM IS MADE TO THE EXCLUSIVE RIGHT TO USE "CANOLA BIODIESEL", APART FROM THE MARK AS SHOWN.

THE MARK CONSISTS OF THE WORDING "CANOLA-BIODIESEL" BELOW A TEARDROP-SHAPED COMPONENT WITH A CLOUD SHAPE OVER CRESCENT ELEMENTS WITHIN THE TEARDROP-SHAPED COMPONENT.

FOR PROMOTION OF THE USE OF CANOLA IN THE MANUFACTURE OF BIODIESEL FUELS THROUGH INFORMATIONAL CAMPAIGNS, SEMINARS, WORKSHOPS, TRADE MISSIONS AND CONFERENCES, THE DISTRIBUTION OF PRINTED BROCHURES, PAMPHLETS, BOOKLETS, LEAFLETS, THE PLACEMENT OF ADVERTISEMENTS IN VARIOUS MEDIA FORMATS AND THE OPERATION OF A WEB SITE FOR OTHERS (U.S. CLS. 100, 101 AND 102).

BENJAMIN OKEKE, EXAMINING ATTORNEY

SN 77-285,399. CANOLA COUNCIL OF CANADA, WINNIPEG, MANITOBA, CANADA, FILED 9-21-2007.

GROWING FUEL. FUELING
GROWTH.

THE MARK CONSISTS OF STANDARD CHARACTERS WITHOUT CLAIM TO ANY PARTICULAR FONT, STYLE, SIZE, OR COLOR.

PRIORITY CLAIMED UNDER SEC. 44(D) ON CANADA APPLICATION NO. 1363464, FILED 9-13-2007, REG. NO. 1363464, DATED 9-13-2007, EXPIRES 9-13-2022.

FOR PROMOTION OF THE USE OF CANOLA IN THE MANUFACTURE OF BIODIESEL FUELS THROUGH INFORMATIONAL CAMPAIGNS, SEMINARS, WORKSHOPS, TRADE MISSIONS AND CONFERENCES, THE DISTRIBUTION OF PRINTED BROCHURES, PAMPHLETS, BOOKLETS, LEAFLETS, THE PLACEMENT OF ADVERTISEMENTS IN VARIOUS MEDIA FORMATS AND THE OPERATION OF A WEB SITE FOR OTHERS (U.S. CLS. 100, 101 AND 102).

BENJAMIN OKEKE, EXAMINING ATTORNEY

CLASS 35—(Continued).

SN 77-294,295. INTERNATIONAL STORES CORP., PANAMA CITY, PANAMA, FILED 10-2-2007.



attenza

OWNER OF PANAMA REG. NO. 16530201, DATED 9-27-2007, EXPIRES 9-27-2017.

THE MARK CONSISTS OF FIVE SHOPPING BAGS ARRANGED TO BE A FIVE-POINTED STAR.

FOR ADVERTISING CONSULTATION; BUSINESS MANAGEMENT; BUSINESS ADMINISTRATION CONSULTANCY; OFFICE FUNCTIONS (U.S. CLS. 100, 101 AND 102).

WARREN L. OLANDRIA, EXAMINING ATTORNEY

SN 77-294,384. INTERNATIONAL STORES CORP., PANAMA CITY, PANAMA, FILED 10-2-2007.



attenza

LA MEJOR ATENCION

OWNER OF PANAMA REG. NO. 16529801, DATED 9-27-2007, EXPIRES 9-27-2017.

NO CLAIM IS MADE TO THE EXCLUSIVE RIGHT TO USE "LA MEJOR ATENCION", APART FROM THE MARK AS SHOWN.

THE MARK CONSISTS OF FIVE SHOPPING BAGS ARRANGED TO BE A FIVE-POINTED STAR.

THE FOREIGN WORDING IN THE MARK TRANSLATES INTO ENGLISH AS "BEST CARE".

FOR ADVERTISING CONSULTATION; BUSINESS MANAGEMENT; BUSINESS ADMINISTRATION CONSULTANCY; OFFICE FUNCTIONS (U.S. CLS. 100, 101 AND 102).

WARREN L. OLANDRIA, EXAMINING ATTORNEY

CLASS 35—(Continued).

SN 77-338,240. KRB MANAGEMENT, INC., DBA AMERICAN UNDERWRITING MANAGERS, SOUTHLAKE, TX. FILED 11-27-2007.



THE COLOR(S) PURPLE, BLUE, BLACK, RED, YELLOW AND GREEN IS/ARE CLAIMED AS A FEATURE OF THE MARK.

THE MARK CONSISTS OF THE WORDING "R.O.B.O.T. RATE ONLINE BE ON TIME" AND A STICK FIGURE HOLDING A WHIRLING GLOBE WITH FOUR SPINDLES. THE COLOR PURPLE APPEARS IN THE WORDING "R.O.B.O.T." AND THE FIRST LETTER OF EACH OF THE WORDS "RATE ONLINE BE ON TIME". THE COLOR BLUE APPEARS IN THE LETTERS "ATE," "NLINE," "E," "N" AND "IME" IN THE WORDING "RATE ONLINE BE ON TIME". THE COLOR BLACK APPEARS IN THE STICK FIGURE AND THE OUTLINE OF THE GLOBE. THE COLORS RED, BLUE, YELLOW AND GREEN APPEAR IN THE SPINDLES ON THE GLOBE FROM TOP TO BOTTOM.

FOR INSURANCE LEAD COLLECTION AND MATCHING SERVICES, NAMELY, MATCHING CONSUMER REQUESTS FOR INSURANCE POLICY QUOTES COLLECTED OVER THE INTERNET TO PRE-QUALIFIED INSURANCE BROKERS, AGENTS AND AGENCIES INTERESTED IN THOSE REQUESTS; MANAGING THE OPERATIONS OF INSURANCE AGENCIES AND BROKERS ON AN OUTSOURCING BASIS; PROMOTION OF FINANCIAL AND INSURANCE SERVICES, ON BEHALF OF THIRD PARTIES (U.S. CLS. 100, 101 AND 102).

TINA BROWN, EXAMINING ATTORNEY

SN 77-341,750. CHAN SEK CHIO, EDF.CHI FU COURT, MACAO, FILED 11-30-2007.



THE COLOR(S) BLUE AND ORANGE IS/ARE CLAIMED AS A FEATURE OF THE MARK.

THE MARK CONSISTS OF THE WORD "JUBERRY" IN BLUE COLOR BENEATH A FEMALE PROFILE IN ORANGE COLOR WHICH IS SURROUNDED BY TWO INCOMPLETE CONCENTRIC CIRCLES SHAPED LIKE A FLOWER IN BLUE COLOR.

FOR WHOLESALE DISTRIBUTORSHIP AND EXPORT AGENCIES, BOTH IN THE FIELD OF DIETARY SUPPLEMENTS AND VITAMINS (U.S. CLS. 100, 101 AND 102).

FIRST USE 5-12-2006; IN COMMERCE 5-12-2006.
ANDREA SAUNDERS, EXAMINING ATTORNEY

CLASS 35—(Continued).

SN 77-346,871. THE KELLY SUPPLY COMPANY, GRAND ISLAND, NE. FILED 12-7-2007.



NO CLAIM IS MADE TO THE EXCLUSIVE RIGHT TO USE "DIRECT" AND "SUPPLYING THE MRO NEEDS OF AMERICAN TRADESMEN SINCE 1903", APART FROM THE MARK AS SHOWN.

THE MARK CONSISTS OF LETTERS "KSC" FOLLOWED BY A CIRCLE CONTAINING THE UPPER PORTION AS A PROFILE OF A MAN HOLDING A WRENCH WITH TWO STARS ON THE UPPER EDGE OF THE CIRCLE, FOLLOWED BY THE WORD "DIRECT", TO INCLUDE A TAGLINE DIRECTLY BELOW THE LOGO THAT READS "SUPPLYING THE MRO NEEDS OF AMERICAN TRADESMEN SINCE 1903".

FOR ON-LINE STORE FEATURING INDUSTRIAL PRODUCTS, NAMELY, MAINTENANCE AND REPAIR PARTS, TOOLS, PLUMBING, ELECTRICAL, CHEMICALS, LUBRICANTS, SAFETY EQUIPMENT AND PRODUCTS, HVAC PRODUCTS, AGRICULTURAL PRODUCTS, HYDRONICS, HYDRAULICS, PNEUMATICS, BEARINGS, POWER TRANSMISSION PRODUCTS, PIPE, VALVES, FITTINGS, PUMPS (U.S. CLS. 100, 101 AND 102).

FIRST USE 9-27-2000; IN COMMERCE 1-31-2006.
LEIGH CAROLINE CASE, EXAMINING ATTORNEY

SN 77-355,097. SIMPLEVIEW, INC., TUCSON, CA. FILED 12-18-2007.

DESTINATION TRAVEL NETWORK

THE MARK CONSISTS OF STANDARD CHARACTERS WITHOUT CLAIM TO ANY PARTICULAR FONT, STYLE, SIZE, OR COLOR.

NO CLAIM IS MADE TO THE EXCLUSIVE RIGHT TO USE "TRAVEL NETWORK", APART FROM THE MARK AS SHOWN.

FOR PROVIDING SPACE AT A WEBSITE FOR THE ADVERTISEMENT OF THE GOODS AND SERVICES OF OTHERS (U.S. CLS. 100, 101 AND 102).

FIRST USE 10-1-2007; IN COMMERCE 10-1-2007.
JENNIFER MARTIN, EXAMINING ATTORNEY

CLASS 35—(Continued).

SN 77-374,510. HEWO SDN. BHD., 47100 PUCHONG, MALAYSIA, FILED 1-17-2008.

HEWO

THE MARK CONSISTS OF STANDARD CHARACTERS WITHOUT CLAIM TO ANY PARTICULAR FONT, STYLE, SIZE, OR COLOR.

PRIORITY CLAIMED UNDER SEC. 44(D) ON MALAYSIA APPLICATION NO. 07019568, FILED 10-4-2007, REG. NO. 07019568, DATED 10-4-2007, EXPIRES 10-4-2017.

FOR ADVERTISING AND ADVERTISEMENT SERVICES; BUSINESS ADMINISTRATION AND MANAGEMENT; OFFICE ADMINISTRATION SERVICES; CUSTOMER LOYALTY SERVICES AND CUSTOMER CLUB SERVICES, FOR COMMERCIAL, PROMOTIONAL AND/OR ADVERTISING PURPOSES; CONTESTS AND INCENTIVE AWARD PROGRAMS TO PROMOTE THE SALE OF PRODUCTS AND SERVICES OF OTHERS; PRODUCTION AND DISTRIBUTION OF RADIO AND TELEVISION COMMERCIALS (U.S. CLS. 100, 101 AND 102).

YAT SYE, LEE, EXAMINING ATTORNEY

SN 77-380,707. IN-SYNC CONSUMER INSIGHT CORP., TORONTO, CANADA, FILED 1-25-2008.

BI-VOCAL ETHNOGRAPHY

THE MARK CONSISTS OF STANDARD CHARACTERS WITHOUT CLAIM TO ANY PARTICULAR FONT, STYLE, SIZE, OR COLOR.

PRIORITY CLAIMED UNDER SEC. 44(D) ON CANADA APPLICATION NO. 1373401, FILED 11-23-2007, REG. NO. TMA729259, DATED 11-24-2008, EXPIRES 11-24-2023.

NO CLAIM IS MADE TO THE EXCLUSIVE RIGHT TO USE "ETHNOGRAPHY", APART FROM THE MARK AS SHOWN.

FOR CONDUCTING, PROCESSING AND ANALYZING BUSINESS AND MARKET RESEARCH (U.S. CLS. 100, 101 AND 102).

CYNTHIA SLOAN, EXAMINING ATTORNEY

CLASS 35—(Continued).

SN 77-384,149. DAVIDOFF COMMUNICATIONS, LLC, CHICAGO, IL. FILED 1-30-2008.

MISSION-DRIVEN MARKETING

THE MARK CONSISTS OF STANDARD CHARACTERS WITHOUT CLAIM TO ANY PARTICULAR FONT, STYLE, SIZE, OR COLOR.

NO CLAIM IS MADE TO THE EXCLUSIVE RIGHT TO USE "MARKETING", APART FROM THE MARK AS SHOWN.

FOR MARKETING PLAN DEVELOPMENT (U.S. CLS. 100, 101 AND 102).

BERYL GARDNER, EXAMINING ATTORNEY

SN 77-402,095. THE COTTON MARKET, LTD., CALVERTON, NY. FILED 2-20-2008.

THE COTTON MARKET

THE MARK CONSISTS OF STANDARD CHARACTERS WITHOUT CLAIM TO ANY PARTICULAR FONT, STYLE, SIZE, OR COLOR.

NO CLAIM IS MADE TO THE EXCLUSIVE RIGHT TO USE "MARKET", APART FROM THE MARK AS SHOWN.

SEC. 2(F).

FOR RETAIL STORE SERVICES IN THE FIELDS OF CLOTHING, CLOTHING ACCESSORIES, HEADWEAR, AND FOOTWEAR, ALL MADE IN WHOLE OR PART OF COTTON (U.S. CLS. 100, 101 AND 102).

FIRST USE 8-3-2007; IN COMMERCE 8-3-2007.

JEAN IM, EXAMINING ATTORNEY

SN 77-402,563. ATTENSITY CORPORATION, PALO ALTO, CA. FILED 2-21-2008.

FIRST PERSON INTELLIGENCE

THE MARK CONSISTS OF STANDARD CHARACTERS WITHOUT CLAIM TO ANY PARTICULAR FONT, STYLE, SIZE, OR COLOR.

FOR BUSINESS RESEARCH AND CONSULTATION SERVICES FOR OTHERS, NAMELY, PROVIDING ANALYSIS OF CUSTOMER FEEDBACK (U.S. CLS. 100, 101 AND 102).

FIRST USE 12-31-2007; IN COMMERCE 12-31-2007.

CIMMERIAN COLEMAN, EXAMINING ATTORNEY

CLASS 35—(Continued).

SN 77-408,369. ECOIST, LLC, MIAMI, FL. FILED 2-28-2008.

ECOIST

THE MARK CONSISTS OF STANDARD CHARACTERS WITHOUT CLAIM TO ANY PARTICULAR FONT, STYLE, SIZE, OR COLOR.

OWNER OF U.S. REG. NOS. 3,070,679 AND 3,223,355.
FOR RETAIL STORE SERVICES FEATURING CLOTHING, HANDBAGS, HOME ACCESSORIES (U.S. CLS. 100, 101 AND 102).
LINDSEY RUBIN, EXAMINING ATTORNEY

SN 77-408,478. ECOIST, LLC, MIAMI, FL. FILED 2-28-2008.

ECOIST

THE MARK CONSISTS OF STANDARD CHARACTERS WITHOUT CLAIM TO ANY PARTICULAR FONT, STYLE, SIZE, OR COLOR.

OWNER OF U.S. REG. NOS. 3,070,679 AND 3,223,355.
FOR ONLINE RETAIL STORE FEATURING HANDBAGS AND HOME ACCESSORIES (U.S. CLS. 100, 101 AND 102).
FIRST USE 0-0-2004; IN COMMERCE 0-0-2004.
LINDSEY RUBIN, EXAMINING ATTORNEY

SN 77-414,675. FLYAWAY CIRCUS, INC., INDIANAPOLIS, IN. FILED 3-6-2008.



THE MARK CONSISTS OF STAR WITHIN DOUBLE RINGS WITH FLAMES ON TOP.

FOR CONSULTING SERVICES IN THE FIELD OF GLOBAL SPORTS ASSET MANAGEMENT, NAMELY, CONSULTATION IN THE FIELD OF BRAND STRATEGY AND PROFESSIONAL ATHLETE PROMOTIONAL SPONSORSHIP (U.S. CLS. 100, 101 AND 102).
MARY CRAWFORD, EXAMINING ATTORNEY

CLASS 35—(Continued).

SN 77-418,611. KOZIOL, PETER A., HONOLULU, HI. FILED 3-11-2008.

CULTURIZATION

THE MARK CONSISTS OF STANDARD CHARACTERS WITHOUT CLAIM TO ANY PARTICULAR FONT, STYLE, SIZE, OR COLOR.

FOR PLANNING AND MANAGING ADVERTISING PROGRAMS FOR OTHERS, PROMOTING SUPPORT OF THE ARTS, PROMOTIONAL SERVICES, NAMELY, PROMOTING THE CHARITIES OF OTHERS, NEW BUSINESS VENTURE DEVELOPMENT AND FORMATION CONSULTATION SERVICES (U.S. CLS. 100, 101 AND 102).
MELVIN AXILBUND, EXAMINING ATTORNEY

SN 77-429,201. KURT SALMON ASSOCIATES, INC., ATLANTA, GA. FILED 3-24-2008.

SYMPHONIE ORCHESTRATING YOUR BUILDING'S DEBUT

THE MARK CONSISTS OF STANDARD CHARACTERS WITHOUT CLAIM TO ANY PARTICULAR FONT, STYLE, SIZE, OR COLOR.

FOR BUSINESS CONSULTING, MANAGEMENT, PLANNING AND OVERSIGHT SERVICES FOR HEALTH CARE FACILITIES RELATING TO NEW BUILDING ACTIVATION SERVICES, INCLUDING, INTEGRATED ACTIVATION SCHEDULE DEVELOPMENT SERVICES; BUSINESS PLANNING SERVICES IN THE FIELD OF FACILITY ACTIVATION; BUSINESS PLANNING SERVICES IN THE FIELD OF FACILITY TRANSITION; BUSINESS SERVICES IN THE NATURE OF FACILITIES MANAGEMENT OF TECHNICAL OPERATIONS, NAMELY, FACILITY OPERATIONAL AND STRATEGIC PLANNING SERVICES; AND BUSINESS CONSULTING SERVICES DESIGNED TO REDUCE RISKS AND COSTS OF OPENING, TRANSITIONING INTO, AND OPERATING NEW HEALTH CARE FACILITIES (U.S. CLS. 100, 101 AND 102).
FIRST USE 1-15-2008; IN COMMERCE 1-15-2008.
TINA BROWN, EXAMINING ATTORNEY

CLASS 35—(Continued).

SN 77-449,906. J'S MOBILE INTERACTIONS, LLC, DALLAS, TX. FILED 4-16-2008.



THE COLOR(S) BLACK AND NEON GREEN IS/ARE CLAIMED AS A FEATURE OF THE MARK.

THE MARK CONSISTS OF A STYLIZED "X" THAT IS IN 4 SEGMENTS WITH A SPACE RUNNING THROUGH IT AND IS IN THE COLOR NEON GREEN AND OUTLINED IN BLACK AND THE WORDING "AMPMOBILEMARKETING" WHICH IS IN THE COLOR NEON GREEN AND OUTLINED IN BLACK. THE COLOR WHITE IS NOT BEING CLAIMED AS A FEATURE OF THE MARK AND MERELY REPRESENTS BACKGROUND AND/OR TRANSPARENT AREAS WHICH ARE NOT PART OF THE MARK.

FOR ADVERTISING, MARKETING AND PROMOTIONAL SERVICES RELATED TO ALL INDUSTRIES FOR THE PURPOSE OF FACILITATING NETWORKING AND SOCIALIZING OPPORTUNITIES FOR BUSINESS PURPOSES (U.S. CLS. 100, 101 AND 102).

BARBARA RUTLAND, EXAMINING ATTORNEY

SN 77-451,102. HEART OF AMERICA E-COMMERCE, L.L.C., LAWRENCE, KS. FILED 4-17-2008.

COOL PRODUCTS

THE MARK CONSISTS OF STANDARD CHARACTERS WITHOUT CLAIM TO ANY PARTICULAR FONT, STYLE, SIZE, OR COLOR.

NO CLAIM IS MADE TO THE EXCLUSIVE RIGHT TO USE "PRODUCTS", APART FROM THE MARK AS SHOWN.

FOR COMPUTERIZED ON-LINE ORDERING FEATURING GENERAL MERCHANDISE AND GENERAL CONSUMER GOODS (U.S. CLS. 100, 101 AND 102).

FIRST USE 4-5-2008; IN COMMERCE 4-5-2008.
MICHAEL LITZAU, EXAMINING ATTORNEY

CLASS 35—(Continued).

SN 77-451,162. GLOBAL COLLABORATIVE CONNECTIONS, LLC, SOLOON, OH. FILED 4-17-2008.

GLOBAL COLLABORATIVE CONNECTIONS

THE MARK CONSISTS OF STANDARD CHARACTERS WITHOUT CLAIM TO ANY PARTICULAR FONT, STYLE, SIZE, OR COLOR.

NO CLAIM IS MADE TO THE EXCLUSIVE RIGHT TO USE "GLOBAL COLLABORATIVE", APART FROM THE MARK AS SHOWN.

FOR BUSINESS AND ADVERTISING SERVICES, NAMELY, PROMOTING AND MARKETING THE GOODS AND SERVICES OF OTHERS IN THE FIELD OF WORKPLACE SKILLS ASSESSMENTS, WORKPLACE PERFORMANCE AND JOB-FIT, WORKFORCE TRAINING, CUSTOMER SERVICE TRAINING, MANAGEMENT AND LEADERSHIP DEVELOPMENT, ALL ON A NATIONAL AND GLOBAL LEVEL (U.S. CLS. 100, 101 AND 102).

MICHELE SWAIN, EXAMINING ATTORNEY

SN 77-462,879. AUTOTRADER.COM, INC., ATLANTA, GA. FILED 5-1-2008.

TURN 2

THE MARK CONSISTS OF STANDARD CHARACTERS WITHOUT CLAIM TO ANY PARTICULAR FONT, STYLE, SIZE, OR COLOR.

FOR ORGANIZING AND CONDUCTING BASEBALL-THEMED PROMOTIONS OF ONLINE DIRECTORY AND CLASSIFIED ADVERTISING SERVICES FOR THE SALE OF AUTOMOBILES, IN STADIUM VENUES, IN PRINT AND ONLINE (U.S. CLS. 100, 101 AND 102).

FIRST USE 4-18-2007; IN COMMERCE 4-18-2007.
APRIL HESIK, EXAMINING ATTORNEY

SN 77-462,911. INGENEX, LLC, ANN ARBOR, MI. FILED 5-1-2008.

Ingenex

THE MARK CONSISTS OF STANDARD CHARACTERS WITHOUT CLAIM TO ANY PARTICULAR FONT, STYLE, SIZE, OR COLOR.

FOR ADVERTISING SERVICES (U.S. CLS. 100, 101 AND 102).

FIRST USE 5-1-2006; IN COMMERCE 7-1-2006.
JERI J. FICKES, EXAMINING ATTORNEY

CLASS 35—(Continued).

SN 77-470,704. UNIVISION COMMUNICATIONS INC., LOS ANGELES, CA. FILED 5-9-2008.

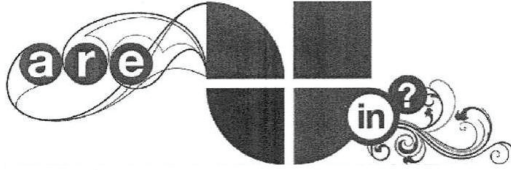

OWNER OF U.S. REG. NOS. 1,672,807 AND 3,393,854.
THE MARK CONSISTS OF THE WORDING "ARE U IN?" FLANKED BY DECORATIVE SCROLLWORK DESIGNS; THREE HORIZONTALLY-ALIGNED CIRCLES APPEAR AT THE LEFT EDGE OF THE MARK WITH THE WORDING "ARE" SUPERIMPOSED THEREON, WITH ONE LETTER APPEARING ON EACH CIRCLE; THE "U" IS FORMED OF GEOMETRIC SHAPES IN THE NATURE OF A SQUARE AND THREE ONE-QUARTER CIRCLES; AT THE RIGHT OF THE LETTER "U" APPEARS THE WORDING "IN" SUPERIMPOSED ON A CIRCLE AND A QUESTION MARK SUPERIMPOSED ON A SECOND CIRCLE TO THE RIGHT OF THE WORDING "IN"; A SINGLE HORIZONTAL LINE APPEARS BENEATH THE AFOREMENTIONED ELEMENTS OF THE MARK.

FOR ADVERTISING SERVICES FOR OTHERS, NAMELY, PRODUCTION AND DISTRIBUTION OF TELEVISION AND RADIO COMMERCIALS FOR OTHERS (U.S. CLS. 100, 101 AND 102).

KEVIN CORWIN, EXAMINING ATTORNEY

SN 77-472,140. GREENPAK DEVELOPMENT, INC., PARKERSBURG, WV. FILED 5-12-2008.



NO CLAIM IS MADE TO THE EXCLUSIVE RIGHT TO USE DEFENSE OPTIMIZED TRACKING SYSTEM, APART FROM THE MARK AS SHOWN.

THE COLOR(S) GREEN, BLUE, RED, YELLOW AND BLACK IS/ARE CLAIMED AS A FEATURE OF THE MARK.

THE MARK CONSISTS OF A THE WORD "DOTS" IN BLACK, A GREEN DOT WITH A SUPERPOSED "D", A BLUE DOT WITH A SUPERPOSED "O", A RED DOT WITH A SUPERPOSED "T", AND A YELLOW DOT WITH A SUPERPOSED "S" ALL CONNECTED BY A BLACK LINE IN A ZIG ZAG PATTERN AND SUPERPOSED OVER THE WORDS "DEFENSE OPTIMIZED TRACKING SYSTEM" IN BLACK.

FOR TRANSPORTATION LOGISTICS SERVICES, NAMELY, ARRANGING THE TRANSPORTATION OF GOODS FOR OTHERS; TRANSPORTATION LOGISTICS SERVICES, NAMELY, PLANNING AND SCHEDULING SHIPMENTS FOR USERS OF TRANSPORTATION SERVICES; LOGISTICS MANAGEMENT IN THE FIELD OF WAREHOUSING, TRANSPORTATION, RESOURCE ALLOCATION, UTILIZATION, AND CONTROL OF INVENTORY PARTICULARLY DIRECTED TO DEPARTMENT OF DEFENSE REQUIREMENTS (U.S. CLS. 100, 101 AND 102).

FIRST USE 1-3-2008; IN COMMERCE 1-3-2008.
STEPHANIE ALI, EXAMINING ATTORNEY

CLASS 35—(Continued).

SN 77-475,805. MARS, INCORPORATED, MCLEAN, VA. FILED 5-15-2008.



NO CLAIM IS MADE TO THE EXCLUSIVE RIGHT TO USE "VOLUNTEER PROGRAM", APART FROM THE MARK AS SHOWN.

THE COLOR(S) BLUE, BLACK, PURPLE, TEAL, ORANGE AND GREEN IS/ARE CLAIMED AS A FEATURE OF THE MARK.

THE MARK CONSISTS OF THE WORDING "MVP" IN BLUE, ABOVE THE WORDING "MARS VOLUNTEER PROGRAM" IN BLACK LOWER CASE LETTERING, ABOVE FOUR HORIZONTAL SETS OF HAND PRINTS, IN PURPLE, TEAL, ORANGE AND GREEN, ALL ABOVE THE WORDING "A SHOW OF HANDS IN OUR COMMUNITY", IN PURPLE LOWER CASE LETTERING.

FOR CHARITABLE SERVICES, NAMELY, ORGANIZING AND CONDUCTING VOLUNTEER PROGRAMS AND COMMUNITY SERVICE PROJECTS, CHARITABLE SERVICES, NAMELY, ORGANIZING AND CONDUCTING VOLUNTEER PROGRAMS AND COMMUNITY SERVICE PROJECTS AIMED AT INCREASING SUPPORT AND MORALE WITHIN THE COMMUNITY; ORGANIZING VOLUNTEER ACTIVITIES, NAMELY, DEVELOPING AND COORDINATING VOLUNTEER PROJECTS FOR CHARITABLE ORGANIZATIONS; CHARITABLE SERVICES, NAMELY, PROVIDING OFFICE EQUIPMENT TO THOSE IN NEED (U.S. CLS. 100, 101 AND 102).

ELISSA GARBER KON, EXAMINING ATTORNEY

SN 77-478,679. OPERATION ORGANIZATION, INC., VAN NUYS, CA. FILED 5-20-2008.

OPERATION ORGANIZATION

THE MARK CONSISTS OF STANDARD CHARACTERS WITHOUT CLAIM TO ANY PARTICULAR FONT, STYLE, SIZE, OR COLOR.

NO CLAIM IS MADE TO THE EXCLUSIVE RIGHT TO USE "ORGANIZATION", APART FROM THE MARK AS SHOWN.

FOR BUSINESS CONSULTING AND INFORMATION SERVICES; ORGANIZATIONAL SERVICES FOR BUSINESS PURPOSES; PROVIDING ORGANIZING SERVICES FOR BELONGINGS AND SPACES IN A RESIDENCE, OFFICE OR BUSINESS ESTABLISHMENT, SUCH AS PAPERS AND TIME; PROVIDING ORGANIZING SERVICES FOR INDIVIDUALS AT HOME, IN HOME OFFICES AND IN BUSINESS OFFICES, THAT PROVIDES HELP WITH TIME AND PAPER MANAGEMENT; COMPUTERIZED AND NON-COMPUTERIZED BUSINESS FILE AND DOCUMENT MANAGEMENT IN THE NATURE OF PAPER SORTING, FILING AND ELECTRONIC FILE CATEGORIZING SERVICES; INVENTORY MANAGEMENT (U.S. CLS. 100, 101 AND 102).

NELSON SNYDER, EXAMINING ATTORNEY

CLASS 35—(Continued).

SN 77-509,642. EQUIP INTERNATIONAL MINISTRIES, INC.,
JOHNS CREEK, GA. FILED 6-27-2008.

LEADERSHIP MOMENT

THE MARK CONSISTS OF STANDARD CHARACTERS WITHOUT CLAIM TO ANY PARTICULAR FONT, STYLE, SIZE, OR COLOR.

NO CLAIM IS MADE TO THE EXCLUSIVE RIGHT TO USE "LEADERSHIP", APART FROM THE MARK AS SHOWN.

FOR PROVIDING INFORMATION VIA A GLOBAL COMMUNICATIONS NETWORK IN THE FIELDS OF BUSINESS AND NONPROFIT LEADERSHIP DEVELOPMENT, AND BUSINESS AND NONPROFIT ORGANIZATIONAL DEVELOPMENT (U.S. CLS. 100, 101 AND 102).

FIRST USE 1-1-2008; IN COMMERCE 1-1-2008.
CAROL SPILS, EXAMINING ATTORNEY

SN 77-514,877. CMS PEOPLE CORP, CORAL GABLES, FL.
FILED 7-3-2008.



NO CLAIM IS MADE TO THE EXCLUSIVE RIGHT TO USE "CREDIT MANAGEMENT SOLUTIONS", APART FROM THE MARK AS SHOWN.

THE COLOR(S) BLUE, ORANGE AND WHITE IS/ARE CLAIMED AS A FEATURE OF THE MARK.

THE MARK CONSISTS OF THE LITERAL ELEMENTS "CMS" AND "CREDIT MANAGEMENT SOLUTIONS" SEPARATED BY A VERTICAL LINE WITH AN ASSOCIATED DESIGN. THE LITERAL ELEMENT AND VERTICAL LINE IS IN BLUE. THE DESIGN CONSISTS OF THREE SPHERES IN INCREASING SIZE ABOVE THE LITERAL ELEMENT. THE SPHERES ARE ORANGE WITH A WHITE SPOT IN THE UPPER LEFT PORTION REPRESENTING SHININESS. FOR ARRANGING AND CONDUCTING BUSINESS CONFERENCES (U.S. CLS. 100, 101 AND 102).

FIRST USE 1-1-2002; IN COMMERCE 1-1-2002.
SANI KHOURI, EXAMINING ATTORNEY

CLASS 35—(Continued).

SN 77-514,928. CMS PEOPLE CORP, CORAL GABLES, FL.
FILED 7-3-2008.

CCSA
CREDIT & COLLECTION
SYMPOSIUM OF THE AMERICAS

THE MARK CONSISTS OF STANDARD CHARACTERS WITHOUT CLAIM TO ANY PARTICULAR FONT, STYLE, SIZE, OR COLOR.

NO CLAIM IS MADE TO THE EXCLUSIVE RIGHT TO USE "CREDIT & COLLECTION SYMPOSIUM OF THE AMERICAS", APART FROM THE MARK AS SHOWN.

FOR ARRANGING AND CONDUCTING BUSINESS CONFERENCES IN THE FIELD OF CREDIT AND COLLECTIONS (U.S. CLS. 100, 101 AND 102).

FIRST USE 1-1-2008; IN COMMERCE 1-1-2008.
SANI KHOURI, EXAMINING ATTORNEY

SN 77-520,533. SILENTWHISTLE, INC., DBA ALLEGIANCE,
INC., SOUTH JORDAN, UT. FILED 7-11-2008.

TOTALENGAGE

THE MARK CONSISTS OF STANDARD CHARACTERS WITHOUT CLAIM TO ANY PARTICULAR FONT, STYLE, SIZE, OR COLOR.

FOR BUSINESS CONSULTING SERVICES RELATING TO ALLOWING BUSINESS ENTERPRISES TO CAPITALIZE ON THE BUSINESS OPPORTUNITY OF ENGAGEMENT BY MAKING FASTER AND BETTER INFORMED DECISIONS, GAINING REAL-TIME INSIGHT INTO OPINIONS, IDEAS AND DYNAMICS OF CUSTOMERS AND EMPLOYEES, AND MEASURING, MANAGING AND ACTING UPON ENGAGEMENT AND LOYALTY (U.S. CLS. 100, 101 AND 102).

FIRST USE 9-17-2007; IN COMMERCE 9-17-2007.
REBECCA GILBERT, EXAMINING ATTORNEY

SN 77-520,555. SILENTWHISTLE, INC., DBA ALLEGIANCE,
INC., SOUTH JORDAN, UT. FILED 7-11-2008.

CUSTOMERENGAGE

THE MARK CONSISTS OF STANDARD CHARACTERS WITHOUT CLAIM TO ANY PARTICULAR FONT, STYLE, SIZE, OR COLOR.

FOR BUSINESS CONSULTING SERVICES RELATING TO ALLOWING BUSINESS ENTERPRISES TO CAPITALIZE ON THE BUSINESS OPPORTUNITY OF ENGAGEMENT BY MAKING FASTER AND BETTER INFORMED DECISIONS, GAINING REAL-TIME INSIGHT INTO OPINIONS, IDEAS AND DYNAMICS OF CUSTOMERS AND EMPLOYEES, AND MEASURING, MANAGING AND ACTING UPON ENGAGEMENT AND LOYALTY (U.S. CLS. 100, 101 AND 102).

FIRST USE 9-17-2007; IN COMMERCE 9-17-2007.
REBECCA GILBERT, EXAMINING ATTORNEY

CLASS 35—(Continued).

SN 77-520,574. SILENTWHISTLE, INC., DBA ALLEGIANCE, INC., SOUTH JORDAN, UT. FILED 7-11-2008.

EMPLOYEEENGAGE

THE MARK CONSISTS OF STANDARD CHARACTERS WITHOUT CLAIM TO ANY PARTICULAR FONT, STYLE, SIZE, OR COLOR.

FOR BUSINESS CONSULTING SERVICES RELATING TO ALLOWING BUSINESS ENTERPRISES TO CAPITALIZE ON THE BUSINESS OPPORTUNITY OF ENGAGEMENT BY MAKING FASTER AND BETTER INFORMED DECISIONS, GAINING REAL-TIME INSIGHT INTO OPINIONS, IDEAS AND DYNAMICS OF CUSTOMERS AND EMPLOYEES, AND MEASURING, MANAGING AND ACTING UPON ENGAGEMENT AND LOYALTY (U.S. CLS. 100, 101 AND 102).

FIRST USE 9-17-2007; IN COMMERCE 9-17-2007.
REBECCA GILBERT, EXAMINING ATTORNEY

SN 77-542,705. ELIZABETH L. MUMFORD, GRIFFIN, IN. FILED 8-8-2008.

UNDER THE BEAMS

THE MARK CONSISTS OF STANDARD CHARACTERS WITHOUT CLAIM TO ANY PARTICULAR FONT, STYLE, SIZE, OR COLOR.

FOR PROVIDING MARKETING AND PROMOTION OF SPECIAL EVENTS (U.S. CLS. 100, 101 AND 102).

FIRST USE 5-1-2001; IN COMMERCE 5-1-2001.
BRIAN PINO, EXAMINING ATTORNEY

SN 77-552,169. UNDERCURRENT LLC, BOULDER, CO. FILED 8-21-2008.

Social Life

THE MARK CONSISTS OF STANDARD CHARACTERS WITHOUT CLAIM TO ANY PARTICULAR FONT, STYLE, SIZE, OR COLOR.

FOR ADVERTISING AND MARKETING (U.S. CLS. 100, 101 AND 102).

FIRST USE 6-1-2008; IN COMMERCE 6-19-2008.
FLORENTINA BLANDU, EXAMINING ATTORNEY

CLASS 35—(Continued).

SN 77-563,015. FL FOOD LION, INC., SALISBURY, NC. FILED 9-5-2008.

BLOOM BREEZE BUDDY

THE MARK CONSISTS OF STANDARD CHARACTERS WITHOUT CLAIM TO ANY PARTICULAR FONT, STYLE, SIZE, OR COLOR.

OWNER OF U.S. REG. NOS. 2,949,391, 3,252,566 AND OTHERS.

FOR COMPUTERIZED SHOPPING INFORMATIONAL SYSTEM COMPRISING OF COMPUTERIZED TRACKING OF PURCHASES IN TRANSIT AND PROVIDING INFORMATION IN THE FIELD OF CONSUMER PRODUCTS AND SERVICES FOR RETAIL GROCERY STORES, NAMELY, NUTRITION, PRICES, PROMOTIONAL OFFERS, DISCOUNT INFORMATION, AND OTHER INFORMATION HELPFUL TO GROCERY SHOPPERS (U.S. CLS. 100, 101 AND 102).

ERIN FALK, EXAMINING ATTORNEY

SN 77-565,308. ROSEWOOD HOTELS AND RESORTS, LLC, DALLAS, TX. FILED 9-9-2008.

VERDES

THE MARK CONSISTS OF STANDARD CHARACTERS WITHOUT CLAIM TO ANY PARTICULAR FONT, STYLE, SIZE, OR COLOR.

THE ENGLISH TRANSLATION OF "VERDES" IN THE MARK IS GREEN.

FOR HOTEL MANAGEMENT PROGRAM FOR OPERATION OF HOTELS FOR OTHERS WITH AN ENVIRONMENTALLY RESPONSIBLE PHILOSOPHY AND BUSINESS PRACTICE (U.S. CLS. 100, 101 AND 102).

SHANNON TWOHIG, EXAMINING ATTORNEY

SN 77-565,345. ROSEWOOD HOTELS AND RESORTS, LLC, DALLAS, TX. FILED 9-9-2008.



THE COLOR(S) GREEN IS/ARE CLAIMED AS A FEATURE OF THE MARK.

THE MARK CONSISTS OF THE TERM "VERDES" IN GREEN LOWER-CASE LETTERS WITH GREEN STYLIZED LEAVES ON TOP OF THE LETTER "D".

THE ENGLISH TRANSLATION OF "VERDES" IN THE MARK IS GREEN.

FOR HOTEL MANAGEMENT PROGRAM FOR OPERATION OF HOTELS FOR OTHERS WITH AN ENVIRONMENTALLY RESPONSIBLE PHILOSOPHY AND BUSINESS PRACTICE (U.S. CLS. 100, 101 AND 102).

SHANNON TWOHIG, EXAMINING ATTORNEY

CLASS 35—(Continued).

SN 77-565,958. NATIONAL JOINT UTILITIES NOTIFICATION SYSTEMS, INC., CARROLLTON, GA. FILED 9-9-2008.



OWNER OF U.S. REG. NO. 2,297,802.
NO CLAIM IS MADE TO THE EXCLUSIVE RIGHT TO USE "EFFECTIVE UTILITY COMMUNICATION", APART FROM THE MARK AS SHOWN.

THE MARK CONSISTS OF A STYLIZED "N" WITH SHADOWING TO THE LEFT OF SAID STYLIZED "N" AND THE WORDS "EFFICIENT UTILITY COMMUNICATION" DIRECTLY BELOW THE "UNS" IN "NJUNS".

FOR PROVIDING AN INTERACTIVE DATABASE TO UTILITIES PROVIDERS ACCESSIBLE VIA A GLOBAL COMPUTER NETWORK FEATURING INFORMATION TO FACILITATE OPERATION AND ADMINISTRATION OF JOINT ACTIVITIES (U.S. CLS. 100, 101 AND 102).

FIRST USE 1-1-2008; IN COMMERCE 1-1-2008.
CURTIS FRENCH, EXAMINING ATTORNEY

SN 77-568,287. CALLCENTRIC WHOLESALE, INC., FORMERLY ACCATEL, INC., NEW YORK, NY. FILED 9-11-2008.

Accatel

THE MARK CONSISTS OF STANDARD CHARACTERS WITHOUT CLAIM TO ANY PARTICULAR FONT, STYLE, SIZE, OR COLOR.

FOR WHOLESALE AND RETAIL STORE SERVICES FEATURING TELECOMMUNICATIONS SERVICE PLANS AND TELECOMMUNICATIONS SERVICE ACTIVATION (U.S. CLS. 100, 101 AND 102).

ANGELA DUONG, EXAMINING ATTORNEY

SN 77-568,422. PROVOST, CRAIG, BOSTON, MA. FILED 9-12-2008.

FUTURE PEOPLES

THE MARK CONSISTS OF STANDARD CHARACTERS WITHOUT CLAIM TO ANY PARTICULAR FONT, STYLE, SIZE, OR COLOR.

FOR BUSINESS CONSULTING; BUSINESS RESEARCH AND ANALYSIS IN THE FIELD OF SUSTAINABILITY; CONSULTING IN THE FIELD OF SUSTAINABLE BUSINESS SOLUTIONS (U.S. CLS. 100, 101 AND 102).

JAMES GRIFFIN, EXAMINING ATTORNEY

CLASS 35—(Continued).

SN 77-568,635. FROST ELECTRIC SUPPLY COMPANY, MARYLAND HEIGHTS, MO. FILED 9-12-2008.



NO CLAIM IS MADE TO THE EXCLUSIVE RIGHT TO USE "SUPPLY", "SUPPORT" AND "SERVICE", APART FROM THE MARK AS SHOWN.

THE COLOR(S) ORANGE, WHITE AND CHARCOAL GRAY IS/ARE CLAIMED AS A FEATURE OF THE MARK.

THE MARK CONSISTS OF AN ORANGE SQUARE IN WHICH TWO WHITE LINES PARALLEL TO EACH OTHER EXTEND UPWARD FROM THE BOTTOM OF THE SQUARE AND THEN MAKE A NINETY-DEGREE ANGLE TO THE RIGHT BEFORE STOPPING, WITH THE UPPER WHITE LINE EXTENDING FURTHER THAN THE LOWER WHITE LINE, BOTH LINES ENDING WITH A CIRCLE SLIGHTLY LARGER THAN THE WIDTH OF THE LINE, FORMING A STYLIZED CAPITAL "F" DRAWN TO RESEMBLE A WIRING DIAGRAM; WITH THE WORD "FROST" IN CHARCOAL GRAY CAPITAL LETTERS BELOW THE SQUARE AND THE WORDS "SUPPLY. SUPPORT. SERVICE." IN SMALLER CHARCOAL GRAY CAPITAL LETTERS BELOW THE WORD "FROST".

FOR WHOLESALE AND RETAIL STORE, MAIL ORDER CATALOG, AND ELECTRONIC ON-LINE ORDERING SERVICES, ALL FEATURING ELECTRICAL WIRE, DATA AND COMMUNICATION TRANSMISSION WIRE, EQUIPMENT AND PARTS, LIGHTING FIXTURES, LIGHT BULBS, ELECTRICIAN TOOLS, POWER TOOLS, TESTING AND MEASURING TOOLS, JOBSITE SAFETY EQUIPMENT, FACTORY AUTOMATION AND INDUSTRIAL CONTROL EQUIPMENT (U.S. CLS. 100, 101 AND 102).

FIRST USE 8-20-2008; IN COMMERCE 8-20-2008.
ANDREA K. NADELMAN, EXAMINING ATTORNEY

SN 77-569,828. HALCYON BUSINESS PUBLICATIONS, INC., WESTBURY, CT. FILED 9-15-2008.

LOCATION USA

THE MARK CONSISTS OF STANDARD CHARACTERS WITHOUT CLAIM TO ANY PARTICULAR FONT, STYLE, SIZE, OR COLOR.

OWNER OF U.S. REG. NO. 2,216,149.

NO CLAIM IS MADE TO THE EXCLUSIVE RIGHT TO USE "USA", APART FROM THE MARK AS SHOWN.

FOR ARRANGING AND CONDUCTING BUSINESS CONFERENCES FOR EXECUTIVES OF INSOURCING COMPANIES RELATING TO REAL ESTATE SITE SELECTION (U.S. CLS. 100, 101 AND 102).

FIRST USE 9-7-2008; IN COMMERCE 9-7-2008.

ERIN FALK, EXAMINING ATTORNEY

CLASS 35—(Continued).

SN 77-574,734. THE COMPUTING TECHNOLOGY INDUSTRY ASSOCIATION, INC., OAKBROOK TERRACE, IL. FILED 9-19-2008.

CLASS 35—(Continued).

SN 77-579,024. ELECTRICAL SOUTH, INC., GREENSBORO, NC. FILED 9-25-2008.

FocusOnMSP

THE MARK CONSISTS OF STANDARD CHARACTERS WITHOUT CLAIM TO ANY PARTICULAR FONT, STYLE, SIZE, OR COLOR.

FOR PROVIDING A WEB SITE FEATURING BUSINESS MANAGEMENT INFORMATION IN THE FORM OF AUDIO AND VIDEO INTERVIEWS, TRANSCRIPTS AND OTHER EDUCATIONAL MATERIALS (U.S. CLS. 100, 101 AND 102).

FIRST USE 2-1-2008; IN COMMERCE 2-1-2008.
LINDA ORNDORFF, EXAMINING ATTORNEY

REMAN ELECTRONICS

SN 77-575,847. OFFICE SOURCE USA, INC., DBA AMERICA'S OFFICE SOURCE, ALTAMONTE SPRINGS, FL. FILED 9-22-2008.



NO CLAIM IS MADE TO THE EXCLUSIVE RIGHT TO USE "DEALER MEMBER NETWORK AMERICA'S OFFICE", APART FROM THE MARK AS SHOWN.

THE MARK CONSISTS OF THE WORDS "DEALER MEMBER NETWORK" IN SMALL, ITALICIZED FONT, ABOVE THE WORD "AMERICA'S" IN ENLARGED, ITALICIZED FONT WITH AN EAGLE DOTTING THE LETTER "I" AND A LINE UNDER THE LETTERS "ERICA'S". ALL ABOVE THE WORDS "OFFICE SOURCE" IN SMALL CAPITALIZED BLOCK LETTERS.

FOR WHOLESALE AND RETAIL STORE SERVICES FEATURING OFFICE PRODUCTS, NAMELY, OFFICE SUPPLIES, COMPUTER ACCESSORIES, JANITORIAL SUPPLIES, CLEANING AND BREAK ROOM SUPPLIES, PRINTERS AND PRINTING SUPPLIES, OFFICE FURNITURE, NAMELY, FILING SYSTEMS AND COMPUTER RACKS, BUSINESS FORMS AND CARDS, AND PROMOTIONAL APPAREL (U.S. CLS. 100, 101 AND 102).

FIRST USE 12-1-2008; IN COMMERCE 12-1-2008.
TRACY CROSS, EXAMINING ATTORNEY

THE MARK CONSISTS OF STANDARD CHARACTERS WITHOUT CLAIM TO ANY PARTICULAR FONT, STYLE, SIZE, OR COLOR.

NO CLAIM IS MADE TO THE EXCLUSIVE RIGHT TO USE "ELECTRONICS", APART FROM THE MARK AS SHOWN.

SEC. 2(F).

FOR ONLINE RETAIL STORE SERVICES FEATURING DC DRIVES, AC DRIVES, AC AND DC SERVO DRIVES, VECTOR DRIVES, ELECTRONIC TESTING EQUIPMENT, TIMERS, COUNTERS, ENCODERS, TEMPERATURE CONTROLLERS, PRESSURE CONTROLLERS, TEMPERATURE INDICATORS, PRESSURE INDICATORS, SINGLE POINT PROCESS CONTROLLERS, PROCESS CONTROLLERS, PHOTOELECTRIC CONTROLS, METERS, FLOW CONTROLLERS, LEVEL CONTROLLERS, VALVE POSITIONERS, FIELD REGULATORS, TURBINE CONTROLS, PROGRAMMABLE LOGIC CONTROLLERS, MACHINE TOOL CONTROLS, NUMERICAL CONTROLS, ROBOTIC CONTROLS, VIDEO MONITORS, SIGNAL CONDITIONERS, BARCODE SCANNERS, BARCODE PRINTERS, LASER THERMAL PRINTERS, LINE PRINTERS, DOT MATRIX PRINTERS, ELECTRICAL LINEAR POWER SUPPLIES, SWITCHING POWER SUPPLIES, UPS SYSTEMS, SOFTSTART CONTROLS, ELECTRONIC BRAKES, SOLID STATE STARTERS, VOLTAGE REGULATORS, ALPHA NUMERIC DISPLAYS, ASR CONTROLLERS, STATUS MONITORS, EDDY CURRENT DRIVES, PROGRAMMERS DISTRIBUTED CONTROLS, WELDER CONTROLS, GENERATOR CONTROLS, MOTION CONTROLLERS, RECORDERS, MOTION DETECTORS, STEPPER CONTROLS AND CALIBRATORS (U.S. CLS. 100, 101 AND 102).

FIRST USE 9-7-2000; IN COMMERCE 9-7-2000.
ELIZABETH KAJUBI, EXAMINING ATTORNEY

CLASS 35—(Continued).

SN 77-579,404. SHORT, THOMAS H., INDIANA, PA. FILED 9-26-2008.

Got Data?

THE MARK CONSISTS OF STANDARD CHARACTERS WITHOUT CLAIM TO ANY PARTICULAR FONT, STYLE, SIZE, OR COLOR.

NO CLAIM IS MADE TO THE EXCLUSIVE RIGHT TO USE "DATA", APART FROM THE MARK AS SHOWN.

FOR BUSINESS MANAGEMENT CONSULTING WITH RELATION TO STRATEGY, MARKETING, SALES, OPERATION, PRODUCT DESIGN PARTICULARLY SPECIALIZING IN THE USE OF ANALYTIC AND STATISTIC MODELS FOR THE UNDERSTANDING AND PREDICTING OF CONSUMERS, BUSINESSES, AND MARKET TRENDS AND ACTIONS; COMPILATION AND PROVISION OF TRADE AND BUSINESS PRICE AND STATISTICAL INFORMATION; COMPILATION OF STATISTICS; PROVIDING STATISTICAL EVALUATION OF INSURANCE CLAIMS PERFORMANCE MEASURES FOR OTHERS; PROVIDING STATISTICAL INFORMATION; PROVIDING STATISTICAL INFORMATION AND INDEXES OF MORTGAGES, INTERESTS, AND PRICES FOR OTHERS; SERVICES COMPRISING THE RECORDING, TRANSCRIPTION, COMPOSITION, COMPILATION AND SYSTEMATIZATION OF WRITTEN COMMUNICATIONS AND RECORDINGS, AS WELL AS THE COMPILATION OF MATHEMATICAL OR STATISTICAL DATA; STATISTICAL ANALYSIS AND REPORTING SERVICES FOR BUSINESS PURPOSES; STATISTICAL EVALUATIONS OF MARKETING DATA (U.S. CLS. 100, 101 AND 102).

COLLEEN KEARNEY, EXAMINING ATTORNEY

SN 77-579,685. GATEWAY SOLUTIONS, VALLEY STREAM, NY. FILED 9-26-2008.

GATEWAY solutions

THE MARK CONSISTS OF STANDARD CHARACTERS WITHOUT CLAIM TO ANY PARTICULAR FONT, STYLE, SIZE, OR COLOR.

NO CLAIM IS MADE TO THE EXCLUSIVE RIGHT TO USE "SOLUTIONS", APART FROM THE MARK AS SHOWN.

FOR FINANCIAL RECORDS MANAGEMENT (U.S. CLS. 100, 101 AND 102).

FIRST USE 9-2-2008; IN COMMERCE 9-2-2008.

SAMUEL E. SHARPER JR., EXAMINING ATTORNEY

CLASS 35—(Continued).

SN 77-579,738. NONPROFIT ENTERPRISE AND SELF-SUSTAINABILITY TEAM, INC., TURLOCK, CA. FILED 9-26-2008.

BROWNPAGES

THE MARK CONSISTS OF STANDARD CHARACTERS WITHOUT CLAIM TO ANY PARTICULAR FONT, STYLE, SIZE, OR COLOR.

FOR PROMOTING THE GOODS AND SERVICES OF SOCIALLY RESPONSIBLE ENTERPRISES AND NON-PROFIT ORGANIZATIONS BY PROVIDING A SEARCHABLE WEB PAGE FEATURING LINKS TO THE RETAIL WEBSITE PAGES OF SAID ENTERPRISES AND ORGANIZATIONS; ONLINE RETAIL STORE SERVICES FEATURING A WIDE VARIETY OF GOODS AND SERVICES PROVIDED BY SOCIALLY RESPONSIBLE ENTERPRISES AND NON-PROFIT ORGANIZATIONS (U.S. CLS. 100, 101 AND 102).

BARBARA A. GOLD, EXAMINING ATTORNEY

SN 77-580,090. ELEPHANT GROUP, INC., FORT LAUDERDALE, FL. FILED 9-26-2008.

We Compare, You Save

THE MARK CONSISTS OF STANDARD CHARACTERS WITHOUT CLAIM TO ANY PARTICULAR FONT, STYLE, SIZE, OR COLOR.

FOR PROVIDING INFORMATION ABOUT THE GOODS AND SERVICES OF OTHERS VIA A GLOBAL NETWORK FEATURING A COMPILATION OF PRODUCTS AND SERVICES WITH REAL TIME PRICE COMPARISONS (U.S. CLS. 100, 101 AND 102).

FIRST USE 6-27-2008; IN COMMERCE 7-28-2008.

MARLENE BELL, EXAMINING ATTORNEY

CLASS 35—(Continued).

SN 77-581,566. RELIANT ENERGY RETAIL HOLDINGS, LLC, HOUSTON, TX. FILED 9-29-2008.

e-Sense

THE MARK CONSISTS OF LOWER CASE "E" FOLLOWED BY A DASH THE CAPITALIZED WORD "SENSE".

FOR ENERGY USAGE MANAGEMENT SERVICES, NAMELY, PROVIDING CUSTOMERS WITH INFORMATION TO MAKE AND EXECUTE INFORMED DECISIONS ABOUT THEIR POWER CONSUMPTION, POWER GENERATION, AND ENVIRONMENTAL IMPACT; ENERGY PRICE AND PEER USAGE COMPARISON SERVICES; ENERGY USAGE MANAGEMENT INFORMATION SERVICES; INFORMATION IN THE FIELD OF ENERGY EFFICIENCY; UTILITY BILL MANAGEMENT SERVICES, NAMELY, TRACKING, REPORTING, ANALYZING AND DELIVERING ENERGY INFORMATION IN THE FORM OF UTILITY BILLS AND UTILITY METER DATA RATE SCHEDULES; CONSULTATION AND INFORMATION IN THE FIELD OF ENERGY EFFICIENCY; CONSULTATION AND INFORMATION IN THE FIELD OF ENERGY COST AND USAGE MONITORING AND ANALYSIS SERVICES; CONSULTATION AND INFORMATION IN THE FIELD OF ENERGY USAGE MANAGEMENT, NAMELY, DEMAND RESPONSE CONTROLS; PROVIDING A WEB SITE FEATURING INFORMATION IN THE FIELD OF ENERGY USE MANAGEMENT, NAMELY, POWER CONSUMPTION AND GENERATION, ENVIRONMENTAL CONDITIONS AND IMPACT, AND ENERGY UTILIZATION (U.S. CLS. 100, 101 AND 102).

JOHN SCHUYLER YARD, EXAMINING ATTORNEY

CLASS 35—(Continued).

SN 77-584,004. CENTER FOR RURAL OUTREACH & PUBLIC SERVICES, INC., KNOX, IN. FILED 10-2-2008.

Growing Rural

THE MARK CONSISTS OF STANDARD CHARACTERS WITHOUT CLAIM TO ANY PARTICULAR FONT, STYLE, SIZE, OR COLOR.

NO CLAIM IS MADE TO THE EXCLUSIVE RIGHT TO USE "RURAL", APART FROM THE MARK AS SHOWN.

FOR CONSULTING SERVICES FOR IMPLEMENTING A YOUTH-LED RURAL BUSINESS VENTURE AND MARKETING DEVELOPMENT PROGRAM; CONSULTING SERVICES FOR IMPLEMENTING A YOUTH-LED RURAL DEVELOPMENT ECONOMIC DEVELOPMENT PROGRAM, NAMELY, PROMOTING RURAL ECONOMIC DEVELOPMENT IN THE UNITED STATES (U.S. CLS. 100, 101 AND 102).

MARK PILARO, EXAMINING ATTORNEY

SN 77-582,338. LEE COUNTY BOARD OF COUNTY COMMISSIONERS, FORT MYERS, FL. FILED 9-30-2008.

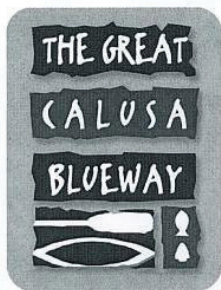

**Lee County
Paddling Trail**

NO CLAIM IS MADE TO THE EXCLUSIVE RIGHT TO USE "BLUEWAY" AND "LEE COUNTY PADDLING TRAIL", APART FROM THE MARK AS SHOWN.

THE MARK CONSISTS OF THE WORDS "THE GREAT CALUSA BLUEWAY" AND THE STYLIZED DESIGNS OF A CANOE, OAR AND FISH AGAINST DARK BANNERS AND A LIGHTER RECTANGULAR BACKGROUND. THE WORDS "LEE COUNTY PADDLING TRAIL" APPEAR BELOW THE DESIGN.

FOR PROMOTING RECREATION AND TOURISM IN LEE COUNTY, FLORIDA (U.S. CLS. 100, 101 AND 102).

FIRST USE 12-31-2003; IN COMMERCE 12-31-2003.

AMY C. KEAN, EXAMINING ATTORNEY

SN 77-585,904. TARGET BRANDS, INC., MINNEAPOLIS, MN. FILED 10-6-2008.

CHEAP & CHEERFUL BASICS

THE MARK CONSISTS OF STANDARD CHARACTERS WITHOUT CLAIM TO ANY PARTICULAR FONT, STYLE, SIZE, OR COLOR.

NO CLAIM IS MADE TO THE EXCLUSIVE RIGHT TO USE "CHEAP" AND "BASICS", APART FROM THE MARK AS SHOWN.

FOR RETAIL STORE AND ONLINE RETAIL STORE SERVICES FEATURING A WIDE VARIETY OF CONSUMER GOODS (U.S. CLS. 100, 101 AND 102).

BONNIE LUKEN, EXAMINING ATTORNEY

CLASS 35—(Continued).

SN 77-587,636. HOME JUNCTION, INC., LA JOLLA, CA.
FILED 10-7-2008.



NO CLAIM IS MADE TO THE EXCLUSIVE RIGHT TO USE "WIKI PROPERTY", APART FROM THE MARK AS SHOWN.

THE COLOR(S) BLUE, BLACK AND GREY IS/ARE CLAIMED AS A FEATURE OF THE MARK.

THE MARK CONSISTS OF THE TERM "WIKIPROPERTY" IN BLACK EXCEPT THE LETTER "O" IN "PROPERTY" WHICH IS BLUE; DISPLAYED TO THE LEFT OF THIS TERM IS THE DESIGN OF A BLUE REAL ESTATE SIGN WITH GREY SHADOWING. THE BACKGROUND OF THE MARK IS TRANSLUCENT.

FOR PROVIDING AN ON-LINE MARKETPLACE FOR REAL ESTATE AND REAL ESTATE-RELATED SERVICES (U.S. CLS. 100, 101 AND 102).

JIM RINGLE, EXAMINING ATTORNEY

SN 77-588,934. ARTASCOPE PLAYWORKS, LLC, SOUTH PORTLAND, ME. FILED 10-8-2008.

LIVE... LAUGH... CREATE

THE MARK CONSISTS OF STANDARD CHARACTERS WITHOUT CLAIM TO ANY PARTICULAR FONT, STYLE, SIZE, OR COLOR.

FOR ON-LINE AUCTION SERVICES; ON-LINE BUSINESS NETWORKING SERVICES; ON-LINE RETAIL STORE SERVICES FEATURING ART EDUCATION MATERIALS AND SUPPLIES; OPERATING AN ON-LINE SHOPPING SITE IN THE FIELD OF ART EDUCATION MATERIALS AND SUPPLIES; OPERATING ON-LINE MARKETPLACES FOR SELLERS OF GOODS AND/OR SERVICES; PROVIDING A WEB SITE WHERE USERS CAN POST RATINGS, REVIEWS AND RECOMMENDATIONS ON PRODUCTS AND SERVICES; PROVIDING CONSUMER INFORMATION IN THE FIELD OF ART EDUCATION MATERIALS AND SUPPLIES; PROVIDING HOME SHOPPING SERVICES IN THE FIELD OF ART EDUCATION MATERIALS AND SUPPLIES BY MEANS OF TELEVISION (U.S. CLS. 100, 101 AND 102).

FIRST USE 2-15-2001; IN COMMERCE 5-15-2003.

SIMON TENG, EXAMINING ATTORNEY

CLASS 35—(Continued).

SN 77-589,760. ACORN PRODUCTS CO., LLC, LEWISTON, ME. FILED 10-9-2008.

COMFORT ON EARTH

THE MARK CONSISTS OF STANDARD CHARACTERS WITHOUT CLAIM TO ANY PARTICULAR FONT, STYLE, SIZE, OR COLOR.

OWNER OF U.S. REG. NOS. 2,763,070, 2,874,173 AND OTHERS.

FOR RETAIL STORE AND ON-LINE RETAIL STORE SERVICES FEATURING FOOTWEAR, CLOTHING AND CLOTHING ACCESSORIES (U.S. CLS. 100, 101 AND 102).

FIRST USE 5-30-2007; IN COMMERCE 5-30-2007.

TRACY FLETCHER, EXAMINING ATTORNEY

SN 77-589,796. DIRECT MARKETING ASSOCIATION, INC., NEW YORK, NY. FILED 10-9-2008.

DMACHOICE

THE MARK CONSISTS OF STANDARD CHARACTERS WITHOUT CLAIM TO ANY PARTICULAR FONT, STYLE, SIZE, OR COLOR.

OWNER OF U.S. REG. NO. 3,420,116.

FOR COMPILATION OF DATABASE OF NAMES OF CONSUMERS WHO DO NOT WISH TO RECEIVE UNSOLICITED PROMOTIONAL MESSAGES THROUGH THE MAIL OR OTHER MEDIA; MAINTAINING A DATABASE REGISTRY OF NAMES OF CONSUMERS WHO DO NOT WISH TO RECEIVE UNSOLICITED PROMOTIONAL MESSAGES THROUGH THE MAIL OR OTHER MEDIA; MAINTENANCE OF CONSUMER DO-NOT-MAIL, E-MAIL OR OTHERWISE SOLICIT REGISTRY INFORMATION; SUBSCRIPTION SERVICE PROVIDING MARKETERS WITH NAMES OF CONSUMER DO-NOT-MAIL, E-MAIL OR OTHERWISE SOLICIT FILES; PROVIDING A WEBSITE WHICH ALLOWS CONSUMERS TO REGISTER TO OPT-OUT OF UNSOLICITED COMMERCIAL SOLICITATIONS; PROVIDING A WEB SITE WHICH ALLOWS CONSUMERS TO REGISTER TO RECEIVE COMMERCIAL SOLICITATIONS FROM SPECIFIC MARKETERS; PROVIDING CONSUMER INFORMATION IN THE FIELD OF DIRECT MARKETING PREFERENCES; PROVIDING A WEB SITE WHICH ALLOWS MARKETERS TO PROVIDE CONSUMERS WITH SPECIAL OFFERS AND BENEFITS BASED ON THEIR INTERACTION WITH THIS SITE (U.S. CLS. 100, 101 AND 102).

DAVID MILLER, EXAMINING ATTORNEY

CLASS 35—(Continued).

SN 77-589,798. DIRECT MARKETING ASSOCIATION, INC.,
NEW YORK, NY. FILED 10-9-2008.

DMACHOICE.ORG

CLASS 35—(Continued).

SN 77-590,357. DIRECT MARKETING ASSOCIATION, INC.,
NEW YORK, NY. FILED 10-10-2008.

GIVE YOUR MAILBOX A MAKEOVER

THE MARK CONSISTS OF STANDARD CHARACTERS WITHOUT CLAIM TO ANY PARTICULAR FONT, STYLE, SIZE, OR COLOR.

FOR COMPILATION OF DATABASE OF NAMES OF CONSUMERS WHO DO NOT WISH TO RECEIVE UNSOLICITED PROMOTIONAL MESSAGES THROUGH THE MAIL OR OTHER MEDIA; MAINTAINING A DATABASE REGISTRY OF NAMES OF CONSUMERS WHO DO NOT WISH TO RECEIVE UNSOLICITED PROMOTIONAL MESSAGES THROUGH THE MAIL OR OTHER MEDIA; MAINTENANCE OF CONSUMER DO-NOT-MAIL, E-MAIL OR OTHERWISE SOLICIT REGISTRY INFORMATION; SUBSCRIPTION SERVICE PROVIDING MARKETERS WITH NAMES OF CONSUMER DO-NOT-MAIL, E-MAIL OR OTHERWISE SOLICIT FILES; PROVIDING A WEBSITE WHICH ALLOWS CONSUMERS TO REGISTER TO OPT-OUT OF UNSOLICITED COMMERCIAL SOLICITATIONS; PROVIDING A WEB SITE WHICH ALLOWS CONSUMERS TO REGISTER TO RECEIVE COMMERCIAL SOLICITATIONS FROM SPECIFIC MARKETERS; PROVIDING CONSUMER INFORMATION IN THE FIELD OF DIRECT MARKETING PREFERENCES; PROVIDING A WEB SITE WHICH ALLOWS MARKETERS TO PROVIDE CONSUMERS WITH SPECIAL OFFERS AND BENEFITS BASED ON THEIR INTERACTION WITH THIS SITE (U.S. CLS. 100, 101 AND 102).

DAVID MILLER, EXAMINING ATTORNEY

THE MARK CONSISTS OF STANDARD CHARACTERS WITHOUT CLAIM TO ANY PARTICULAR FONT, STYLE, SIZE, OR COLOR.

OWNER OF U.S. REG. NO. 3,420,116.

FOR COMPILATION OF DATABASE OF NAMES OF CONSUMERS WHO DO NOT WISH TO RECEIVE UNSOLICITED PROMOTIONAL MESSAGES THROUGH THE MAIL OR OTHER MEDIA; MAINTAINING A DATABASE REGISTRY OF NAMES OF CONSUMERS WHO DO NOT WISH TO RECEIVE UNSOLICITED PROMOTIONAL MESSAGES THROUGH THE MAIL OR OTHER MEDIA; MAINTENANCE OF CONSUMER DO-NOT-MAIL, E-MAIL OR OTHERWISE SOLICIT REGISTRY INFORMATION; SUBSCRIPTION SERVICE PROVIDING MARKETERS WITH NAMES OF CONSUMERS DO-NOT-MAIL, E-MAIL OR OTHERWISE SOLICIT FILES; PROVIDING A WEB SITE WHICH ALLOWS CONSUMERS TO REGISTER TO OPT-OUT OF UNSOLICITED COMMERCIAL SOLICITATIONS; PROVIDING A WEB SITE WHICH ALLOWS CONSUMERS TO REGISTER TO RECEIVE COMMERCIAL SOLICITATIONS FROM SPECIFIC MARKETERS; PROVIDING CONSUMER INFORMATION IN THE FIELD OF DIRECT MARKETING PREFERENCES; PROVIDING A WEB SITE WHICH ALLOWS MARKETERS TO PROVIDE CONSUMERS WITH SPECIAL OFFERS AND BENEFITS BASED ON THEIR INTERACTION WITH THIS SITE (U.S. CLS. 100, 101 AND 102).

DAVID MILLER, EXAMINING ATTORNEY

SN 77-593,938. PETRA BENEFITS MANAGEMENT CO.,
TOMBALL, TX. FILED 10-16-2008.

PETRA BENEFITS

THE MARK CONSISTS OF STANDARD CHARACTERS WITHOUT CLAIM TO ANY PARTICULAR FONT, STYLE, SIZE, OR COLOR.

NO CLAIM IS MADE TO THE EXCLUSIVE RIGHT TO USE "BENEFITS", APART FROM THE MARK AS SHOWN. FOR BUSINESS SUCCESSION PLANNING (U.S. CLS. 100, 101 AND 102).

DAVID HOFFMAN, EXAMINING ATTORNEY

CLASS 35—(Continued).

SN 77-594,477. S&S CONNECTIONS, INC., NEW YORK, NY. FILED 10-16-2008.



NO CLAIM IS MADE TO THE EXCLUSIVE RIGHT TO USE "N Y", APART FROM THE MARK AS SHOWN.

THE MARK CONSISTS OF THE MARK CONSISTS OF A COAT OF ARMS DESIGN FEATURING A KNIGHT'S HELMET WITH A CROWN ON TOP ABOVE A SHIELD. THE SHIELD DISPLAYS THE WORDING "DA CHOZEN ONEZ" ON A RIBBON-LIKE BANNER WRAPPED AROUND A FLEUR-DE-LIS-LIKE FIGURATIVE ELEMENT. A PORTION OF A STYLIZED MOTORCYCLE APPEARS IN THE UPPER RIGHT HAND CORNER OF THE SHIELD, AND A PORTION OF A STYLIZED AUTOMOBILE APPEARS IN THE LOWER LEFT HAND PORTION OF THE SHIELD. THE COAT OF ARMS DESIGN IS SURROUNDED BY RIBBON-LIKE BANNERS DISPLAYING THE LETTERS "M A S C" AND "N Y" REFERRING TO "NEW YORK". THE TERM "L'GENDARY" APPEARS IN STYLIZED FORM ABOVE THE COAT OF ARMS DESIGN, AND THE TERM "MOV'MENTS" APPEARS IN STYLIZED FORM BELOW THE COAT OF ARMS DESIGN. THE RECTANGULAR SHAPE OF THE BACKGROUND SHOWN IN THE DRAWING OF THE MARK IS NOT CLAIMED AS A FEATURE OF THE MARK.

FOR ASSOCIATION SERVICES, NAMELY, PROMOTING THE INTERESTS OF MOTORCYCLE RIDERS AND AUTOMOBILE ENTHUSIASTS (U.S. CLS. 100, 101 AND 102).

FIRST USE 10-1-2007; IN COMMERCE 10-1-2007. ZHALEH DELANEY, EXAMINING ATTORNEY

SN 77-594,982. PMA MARKETING ONLINE LLC, DBA PRO MA MARKETING, TAMPA, FL. FILED 10-17-2008.

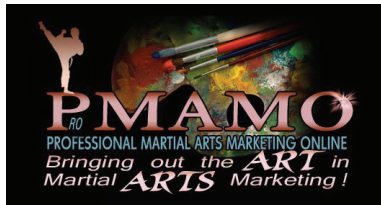

NO CLAIM IS MADE TO THE EXCLUSIVE RIGHT TO USE "PROFESSIONAL MARTIAL ARTS MARKETING ONLINE", APART FROM THE MARK AS SHOWN.

THE COLOR(S) BRONZE, LIGHT BLUE, WHITE, SILVER, YELLOW, ORANGE, GREEN, DARK BLUE AND BROWN IS/ARE CLAIMED AS A FEATURE OF THE MARK.

THE MARK CONSISTS OF THE COLOR BRONZE APPEARING IN THE LETTERING "PMA MO" AND IN THE MARTIAL ARTS FIGURE. THE COLOR LIGHT BLUE APPEARS IN THE LETTERING "RO" (AS PART OF "PROMAMO") AND IN THE WORDING "PROFESSIONAL MARTIAL ARTS MARKETING ONLINE". THE COLOR

CLASS 35—(Continued).

WHITE APPEARS IN THE WORDING "BRINGING OUT THE ART IN MARTIAL ARTS MARKETING!" AND IN THE EASEL DESIGN. THE COLOR SILVER APPEARS IN THE PAINTBRUSHES DESIGN. THE COLOR YELLOW APPEARS IN THE PAINTBRUSHES AND EASEL DESIGNS. THE COLOR ORANGE APPEARS IN THE PAINTBRUSHES AND EASEL DESIGNS. THE COLOR GREEN APPEARS IN THE EASEL DESIGN. THE COLOR DARK BLUE APPEARS IN THE PAINTBRUSHES DESIGN. THE COLOR BROWN APPEARS IN THE PAINTBRUSHES AND EASEL DESIGNS. FOR ADVERTISING, MARKETING AND PROMOTION SERVICES (U.S. CLS. 100, 101 AND 102).

FIRST USE 10-13-2008; IN COMMERCE 10-13-2008. TIMOTHY FINNEGAN, EXAMINING ATTORNEY

SN 77-595,808. NTEC FOR TECHNOLOGY, INC., DBA NTEC, INC. OR DBA THE NORTH TEXAS ENTERPRISE CENTER FOR MEDICAL TECHNOLOGY, FRISCO, TX. FILED 10-20-2008.

INNOVATION. ACCELERATED.

THE MARK CONSISTS OF STANDARD CHARACTERS WITHOUT CLAIM TO ANY PARTICULAR FONT, STYLE, SIZE, OR COLOR.

FOR BUSINESS DEVELOPMENT SERVICES, NAMELY, PROVIDING START-UP SUPPORT FOR BUSINESSES OF OTHERS, NAMELY, MEDICAL TECHNOLOGY COMPANIES (U.S. CLS. 100, 101 AND 102).

GENE MACIOL, EXAMINING ATTORNEY

SN 77-596,362. SEDER, SCOTT, PHOENIX, AZ. FILED 10-20-2008.



THE COLOR(S) TAN, BLACK, WHITE, GREY, BLUE AND RED IS/ARE CLAIMED AS A FEATURE OF THE MARK.

THE MARK CONSISTS OF ROCKER ON TOP IN TAN WITH BLACK TEXT: "JUST US", CENTER LOGO IS WHITE/GREY SKULL WITH BLUE SHERIFF STAR PUPIL IN LEFT EYE SOCKET, RED MALTESE CROSS IN RIGHT EYE SOCKET, POLICE BATON AND PIKE POLE CROSSED BEHIND SKULL; BOX TO RIGHT OF SKULL WITH "PSMC" IN BLACK ON TAN BACKGROUND.

FOR ASSOCIATION SERVICES, NAMELY, PROMOTING THE INTERESTS OF MEMBERS IN A MOTORCYCLE CLUB (U.S. CLS. 100, 101 AND 102).

DAWN FELDMAN, EXAMINING ATTORNEY

CLASS 35—(Continued).

SN 77-597,294. TIE RACK TRADING LIMITED, BRENTFORD, MIDDLESEX, UNITED KINGDOM, FILED 10-21-2008.



PRIORITY CLAIMED UNDER SEC. 44(D) ON UNITED KINGDOM APPLICATION NO. 2497492, FILED 9-11-2008. OWNER OF U.S. REG. NOS. 1,484,209, 2,855,493 AND OTHERS.

NO CLAIM IS MADE TO THE EXCLUSIVE RIGHT TO USE "TIE" AND "LONDON", APART FROM THE MARK AS SHOWN.

THE COLOR(S) BROWN, ORANGE, AND WHITE IS/ARE CLAIMED AS A FEATURE OF THE MARK.

THE MARK CONSISTS OF A BROWN RECTANGULAR BOX WITH AN ORANGE BORDER. INSIDE THE BOX, ON THE FIRST LINE, THE WORDS "TIE RACK" APPEAR CENTERED, IN ALL CAPITAL WHITE LETTERS. DIRECTLY BELOW THE WORDS "TIE RACK" THE WORD "LONDON" APPEARS CENTERED, IN ALL CAPITAL WHITE LETTERS.

FOR RETAIL CLOTHES AND FASHION ACCESSORY STORES FEATURING JEWELRY, CLOTHING, AND FASHION ACCESSORIES; ON-LINE RETAIL STORE SERVICES FEATURING JEWELRY, CLOTHING, AND FASHION ACCESSORY GOODS, WHICH ALLOW CONSUMERS TO CONVENIENTLY VIEW AND PURCHASE JEWELRY, CLOTHING, AND FASHION ACCESSORY GOODS BY MEANS OF AN INTERNET WEBSITE; THE BRINGING TOGETHER, FOR THE BENEFIT OF OTHERS, OF A VARIETY OF GOODS, ENABLING CUSTOMERS TO CONVENIENTLY VIEW AND PURCHASE THOSE GOODS IN THE FIELD OF CLOTHING, JEWELRY, AND FASHION ACCESSORIES BY MEANS OF TELECOMMUNICATIONS (U.S. CLS. 100, 101 AND 102).

MICHAEL GAAFAR, EXAMINING ATTORNEY

SN 77-598,081. NRI, INC., WASHINGTON, DC. FILED 10-22-2008.

NRI LEGAL RESOURCES

THE MARK CONSISTS OF STANDARD CHARACTERS WITHOUT CLAIM TO ANY PARTICULAR FONT, STYLE, SIZE, OR COLOR.

OWNER OF U.S. REG. NOS. 1,596,752 AND 1,993,844.

NO CLAIM IS MADE TO THE EXCLUSIVE RIGHT TO USE "LEGAL", APART FROM THE MARK AS SHOWN. SEC. 2(F) AS TO "RESOURCES".

FOR TEMPORARY EMPLOYMENT AGENCY SERVICES; PERSONNEL PLACEMENT AND RECRUITMENT SERVICES; CONTRACT STAFFING SERVICES (U.S. CLS. 100, 101 AND 102).

FIRST USE 12-31-1975; IN COMMERCE 12-31-1975.

BRIAN NEVILLE, EXAMINING ATTORNEY

CLASS 35—(Continued).

SN 77-598,086. NRI, INC., WASHINGTON, DC. FILED 10-22-2008.

NRI ACCOUNTING RESOURCES

THE MARK CONSISTS OF STANDARD CHARACTERS WITHOUT CLAIM TO ANY PARTICULAR FONT, STYLE, SIZE, OR COLOR.

OWNER OF U.S. REG. NOS. 1,596,752 AND 1,993,844.

NO CLAIM IS MADE TO THE EXCLUSIVE RIGHT TO USE "ACCOUNTING", APART FROM THE MARK AS SHOWN.

SEC. 2(F) AS TO "RESOURCES".

FOR TEMPORARY EMPLOYMENT AGENCY SERVICES; PERSONNEL PLACEMENT AND RECRUITMENT SERVICES; CONTRACT STAFFING SERVICES (U.S. CLS. 100, 101 AND 102).

FIRST USE 10-2-1972; IN COMMERCE 10-2-1972.

BRIAN NEVILLE, EXAMINING ATTORNEY

SN 77-598,096. NRI, INC., WASHINGTON, DC. FILED 10-22-2008.

NRI HEALTHCARE

THE MARK CONSISTS OF STANDARD CHARACTERS WITHOUT CLAIM TO ANY PARTICULAR FONT, STYLE, SIZE, OR COLOR.

OWNER OF U.S. REG. NOS. 1,596,752 AND 1,993,844.

NO CLAIM IS MADE TO THE EXCLUSIVE RIGHT TO USE "HEALTHCARE", APART FROM THE MARK AS SHOWN.

FOR TEMPORARY EMPLOYMENT AGENCY SERVICES; PERSONNEL PLACEMENT AND RECRUITMENT SERVICES; CONTRACT STAFFING SERVICES (U.S. CLS. 100, 101 AND 102).

FIRST USE 12-31-1995; IN COMMERCE 12-31-1995.

BRIAN NEVILLE, EXAMINING ATTORNEY

CLASS 35—(Continued).

SN 77-598,102. NRI, INC., WASHINGTON, DC. FILED 10-22-2008.

NRI STAFFING RESOURCES

THE MARK CONSISTS OF STANDARD CHARACTERS WITHOUT CLAIM TO ANY PARTICULAR FONT, STYLE, SIZE, OR COLOR.

OWNER OF U.S. REG. NOS. 1,596,752 AND 1,993,844.

NO CLAIM IS MADE TO THE EXCLUSIVE RIGHT TO USE "STAFFING", APART FROM THE MARK AS SHOWN. SEC. 2(F) AS TO "RESOURCES".

FOR TEMPORARY EMPLOYMENT AGENCY SERVICES; PERSONNEL PLACEMENT AND RECRUITMENT SERVICES; CONTRACT STAFFING SERVICES (U.S. CLS. 100, 101 AND 102).

FIRST USE 10-2-1972; IN COMMERCE 10-2-1972.

BRIAN NEVILLE, EXAMINING ATTORNEY

SN 77-599,207. TARGETRX, INC., HORSHAM, PA. FILED 10-23-2008.

FIELDPERFORMANCEADVANTAGE

THE MARK CONSISTS OF STANDARD CHARACTERS WITHOUT CLAIM TO ANY PARTICULAR FONT, STYLE, SIZE, OR COLOR.

FOR DATA COLLECTION AND STATISTICAL ANALYSIS AND REPORTING SERVICES FOR BUSINESS PURPOSES REGARDING HEALTHCARE COMPANY SALES AND MARKETING EFFECTIVENESS (U.S. CLS. 100, 101 AND 102).

ALLISON SCHRODY, EXAMINING ATTORNEY

SN 77-599,596. LME INVESTMENTS, LLC, WATERLOO, WI. FILED 10-23-2008.

LME

THE MARK CONSISTS OF STANDARD CHARACTERS WITHOUT CLAIM TO ANY PARTICULAR FONT, STYLE, SIZE, OR COLOR.

FOR MATCHING CONSUMERS AND/OR POTENTIAL SELLERS TO REAL ESTATE PROFESSIONALS IN THE FIELD OF REAL ESTATE SERVICES (U.S. CLS. 100, 101 AND 102).

FIRST USE 11-1-2007; IN COMMERCE 11-1-2007.

DAVID H. STINE, EXAMINING ATTORNEY

CLASS 35—(Continued).

SN 77-600,463. CALIFORNIA ENERGY INITIATIVES, LLC, WATSONVILLE, CA. FILED 10-24-2008.

CALIFORNIA WARMING

THE MARK CONSISTS OF STANDARD CHARACTERS WITHOUT CLAIM TO ANY PARTICULAR FONT, STYLE, SIZE, OR COLOR.

NO CLAIM IS MADE TO THE EXCLUSIVE RIGHT TO USE "CALIFORNIA", APART FROM THE MARK AS SHOWN.

FOR CONSULTATION SERVICES FEATURING ENERGY EFFICIENCY PLANNING, ENERGY MANAGEMENT AND ECONOMIC POLICY (U.S. CLS. 100, 101 AND 102).

ZACHARY BELLO, EXAMINING ATTORNEY

SN 77-600,494. CALIFORNIA ENERGY INITIATIVES, LLC, WATSONVILLE, CA. FILED 10-24-2008.



THE COLOR(S) ORANGE, RED AND YELLOW IS/ARE CLAIMED AS A FEATURE OF THE MARK.

THE MARK CONSISTS OF THE LETTER "C" IN YELLOW, A LOWER CASE "E" IN A SWIRLING PATTERN OF RED, ORANGE AND YELLOW, AND THE LETTER "I" IN YELLOW.

FOR CONSULTATION SERVICES FEATURING ENERGY EFFICIENCY PLANNING, ENERGY MANAGEMENT AND ECONOMIC POLICY (U.S. CLS. 100, 101 AND 102).

ZACHARY BELLO, EXAMINING ATTORNEY

SN 77-602,441. ZANTMAN ART GALLERIES, LTD., CARMEL, CA. FILED 10-28-2008.

ZANTMAN ART GALLERIES

THE MARK CONSISTS OF STANDARD CHARACTERS WITHOUT CLAIM TO ANY PARTICULAR FONT, STYLE, SIZE, OR COLOR.

NO CLAIM IS MADE TO THE EXCLUSIVE RIGHT TO USE "ART GALLERIES", APART FROM THE MARK AS SHOWN.

SEC. 2(F).

FOR ART GALLERIES (U.S. CLS. 100, 101 AND 102).

FIRST USE 1-1-1959; IN COMMERCE 1-1-1959.

RONALD MCMORROW, EXAMINING ATTORNEY

CLASS 35—(Continued).

SN 77-602,775. T T OF ORANGE PARK, INC., JACKSONVILLE, FL. FILED 10-29-2008.

WHERE YOU'RE #1

THE MARK CONSISTS OF STANDARD CHARACTERS WITHOUT CLAIM TO ANY PARTICULAR FONT, STYLE, SIZE, OR COLOR.

FOR DEALERSHIPS IN THE FIELD OF NEW AND USED AUTOMOBILES; PROVIDING INFORMATION ABOUT AUTOMOBILES FOR SALE BY MEANS OF THE INTERNET; RETAIL STORE SERVICES FEATURING NEW AND USED AUTOMOBILES AND AUTOMOBILE PARTS (U.S. CLS. 100, 101 AND 102).

FIRST USE 10-29-2008; IN COMMERCE 10-29-2008.
PAUL F. GAST, EXAMINING ATTORNEY

SN 77-603,368. KORE EXTREME LLC, CHICAGO, IL. FILED 10-29-2008.

KoreExtreme

THE MARK CONSISTS OF STANDARD CHARACTERS WITHOUT CLAIM TO ANY PARTICULAR FONT, STYLE, SIZE, OR COLOR.

FOR RETAIL STORE SERVICES FEATURING EXERCISE, FITNESS, REHABILITATION AND THERAPY PRODUCTS; ON-LINE RETAIL AND WHOLESALE STORE SERVICES FEATURING EXERCISE, FITNESS, REHABILITATION AND THERAPY PRODUCTS; DISTRIBUTORSHIPS FEATURING EXERCISE, FITNESS, REHABILITATION AND THERAPY PRODUCTS (U.S. CLS. 100, 101 AND 102).

BILL DAWE, EXAMINING ATTORNEY

SN 77-603,411. KORE EXTREME LLC, CHICAGO, IL. FILED 10-29-2008.

Pure Balance

THE MARK CONSISTS OF STANDARD CHARACTERS WITHOUT CLAIM TO ANY PARTICULAR FONT, STYLE, SIZE, OR COLOR.

FOR RETAIL STORE SERVICES FEATURING EXERCISE, FITNESS, REHABILITATION AND THERAPY PRODUCTS; ON-LINE RETAIL AND WHOLESALE STORE SERVICES FEATURING EXERCISE, FITNESS, REHABILITATION AND THERAPY PRODUCTS; DISTRIBUTORSHIPS FEATURING EXERCISE, FITNESS, REHABILITATION AND THERAPY PRODUCTS (U.S. CLS. 100, 101 AND 102).

BILL DAWE, EXAMINING ATTORNEY

CLASS 35—(Continued).

SN 77-603,423. KORE EXTREME LLC, CHICAGO, IL. FILED 10-29-2008.

Make You Better Today

THE MARK CONSISTS OF STANDARD CHARACTERS WITHOUT CLAIM TO ANY PARTICULAR FONT, STYLE, SIZE, OR COLOR.

FOR RETAIL STORE SERVICES FEATURING EXERCISE, FITNESS, REHABILITATION AND THERAPY PRODUCTS; ON-LINE RETAIL AND WHOLESALE STORE SERVICES FEATURING EXERCISE, FITNESS, REHABILITATION AND THERAPY PRODUCTS; DISTRIBUTORSHIPS FEATURING EXERCISE, FITNESS, REHABILITATION AND THERAPY PRODUCTS (U.S. CLS. 100, 101 AND 102).

BILL DAWE, EXAMINING ATTORNEY

SN 77-604,383. R.L. JORDAN OIL COMPANY OF NORTH CAROLINA, INC., SPARTANBURG, SC. FILED 10-30-2008.



NO CLAIM IS MADE TO THE EXCLUSIVE RIGHT TO USE "JAVA", APART FROM THE MARK AS SHOWN.

THE MARK CONSISTS OF THE WORDS "JAVA SPOT". FOR RETAIL STORE SERVICES FEATURING CONVENIENCE STORE ITEMS AND GASOLINE (U.S. CLS. 100, 101 AND 102).

FIRST USE 3-1-2007; IN COMMERCE 3-1-2007.
TRACY FLETCHER, EXAMINING ATTORNEY

SN 77-605,363. SEARS BRANDS, LLC, HOFFMAN ESTATES, IL. FILED 10-31-2008.

LET'S STAY FIT AMERICA

THE MARK CONSISTS OF STANDARD CHARACTERS WITHOUT CLAIM TO ANY PARTICULAR FONT, STYLE, SIZE, OR COLOR.

FOR RETAIL STORE SERVICES FEATURING FITNESS EQUIPMENT; PROMOTING PUBLIC AWARENESS OF THE BENEFITS OF WEIGHT LOSS THROUGH AN INCENTIVE AWARD PROGRAM TO PROMOTE THE SALE OF EXERCISE EQUIPMENT AND FITNESS PROGRAMS OF OTHERS; ADMINISTRATION OF A PROGRAM FOR ENABLING PARTICIPANTS TO OBTAIN DISCOUNTS ON EXERCISE EQUIPMENT, FITNESS PROGRAMS, AND GIFT CARDS; PROVIDING INCENTIVE AWARD PROGRAMS FOR CUSTOMERS AND EMPLOYEES THROUGH THE DISTRIBUTION OF PREPAID STORED VALUE CARDS FOR THE PURPOSE OF PROMOTING AND REWARDING LOYALTY (U.S. CLS. 100, 101 AND 102).

BARBARA GAYNOR, EXAMINING ATTORNEY

CLASS 35—(Continued).

SN 77-607,852. TARGETRX, INC., HORSHAM, PA. FILED 11-5-2008.

TARGETADVANTAGE

THE MARK CONSISTS OF STANDARD CHARACTERS WITHOUT CLAIM TO ANY PARTICULAR FONT, STYLE, SIZE, OR COLOR.

FOR DATA COLLECTION AND STATISTICAL ANALYSIS AND REPORTING SERVICES FOR BUSINESS PURPOSES FOR PROFILING AND MATCHING HEALTHCARE PROFESSIONALS WITH PHARMACEUTICAL REPRESENTATIVES AND FOR PROFILING, SEGMENTING AND PRIORITIZING PHYSICIANS TO REACH WITH PROMOTION; BUSINESS CONSULTATION IN THE NATURE OF OPTIMIZATION SERVICES, NAMELY, EFFECTIVELY SIZING AND ALIGNING PHARMACEUTICAL REPRESENTATIVE ORGANIZATIONS (U.S. CLS. 100, 101 AND 102).

ALLISON SCHRODY, EXAMINING ATTORNEY

SN 77-608,281. LEAPFISH, INC., PLEASANTON, CA. FILED 11-5-2008.

Leapfish

THE MARK CONSISTS OF STANDARD CHARACTERS WITHOUT CLAIM TO ANY PARTICULAR FONT, STYLE, SIZE, OR COLOR.

FOR ONLINE ADVERTISING AND MARKETING SERVICES (U.S. CLS. 100, 101 AND 102).

FIRST USE 8-1-2008; IN COMMERCE 8-1-2008.

MARK T. MULLEN, EXAMINING ATTORNEY

SN 77-609,039. CIMARRON LUMBER AND SUPPLY COMPANY, KANSAS CITY, MO. FILED 11-6-2008.

CIMARRON LUMBER & SUPPLY COMPANY

THE MARK CONSISTS OF STANDARD CHARACTERS WITHOUT CLAIM TO ANY PARTICULAR FONT, STYLE, SIZE, OR COLOR.

OWNER OF U.S. REG. NO. 3,229,689.

NO CLAIM IS MADE TO THE EXCLUSIVE RIGHT TO USE "LUMBER & SUPPLY COMPANY", APART FROM THE MARK AS SHOWN.

FOR WHOLESALE DISTRIBUTORSHIP FEATURING LUMBER, BUILDING SUPPLIES AND HOME IMPROVEMENT PRODUCTS (U.S. CLS. 100, 101 AND 102).

FIRST USE 12-31-1982; IN COMMERCE 12-31-1982.

BRENDAN MCCAULEY, EXAMINING ATTORNEY

CLASS 35—(Continued).

SN 77-616,371. PROUDFOOT CONSULTING COMPANY, ATLANTA, GA. FILED 11-18-2008.

PROUDFOOT

THE MARK CONSISTS OF STANDARD CHARACTERS WITHOUT CLAIM TO ANY PARTICULAR FONT, STYLE, SIZE, OR COLOR.

OWNER OF U.S. REG. NOS. 1,521,213 AND 2,392,856.

SEC. 2(F).

FOR BUSINESS MANAGEMENT CONSULTING SERVICES (U.S. CLS. 100, 101 AND 102).

FIRST USE 3-1-1988; IN COMMERCE 3-1-1988.

ANNE FARRELL, EXAMINING ATTORNEY

SN 77-618,861. EVANGELICAL COUNCIL FOR FINANCIAL ACCOUNTABILITY, WINCHESTER, VA. FILED 11-20-2008.

SERVANTMATCH

THE MARK CONSISTS OF STANDARD CHARACTERS WITHOUT CLAIM TO ANY PARTICULAR FONT, STYLE, SIZE, OR COLOR.

FOR PROVIDING AN ON-LINE SEARCHABLE DATABASE THROUGH WHICH DONORS CAN FIND AND SELECT CHARITABLE AND NONPROFIT ORGANIZATIONS, PROJECTS, AND CHRISTIAN MINISTRIES FOR THE PURPOSE OF PROVIDING CHARITABLE DONATIONS (U.S. CLS. 100, 101 AND 102).

JAMES A. RAUEN, EXAMINING ATTORNEY

CLASS 35—(Continued).

SN 77-623,920. CATALINA MARKETING CORPORATION, ST. PETERSBURG, FL. FILED 12-1-2008.



OWNER OF U.S. REG. NOS. 2,461,395, 2,860,092 AND OTHERS.

NO CLAIM IS MADE TO THE EXCLUSIVE RIGHT TO USE "MEDIA NETWORK", APART FROM THE MARK AS SHOWN.

THE MARK CONSISTS OF THE WORDS "POINTER MEDIA NETWORK POWERED BY CATALINA", WHEREIN THE "I" IN "POINTER" IS REPLACED BY A DESIGN OF AN ARROW WITH A DOT ON TOP THAT LOOKS LIKE A PERSON.

FOR ADVERTISING AND BUSINESS SERVICES, NAMELY, PROVIDING CONSUMER INSIGHT AND BRAND MARKETING STRATEGY TO CONSUMER PACKAGED GOODS MANUFACTURERS AND OTHERS, PROVIDING BUSINESS CONSULTATION FOR THE UNDERSTANDING AND PREDICTING OF CONSUMERS, MARKET TRENDS AND ACTIONS, AND CONDUCTING CONSUMER TRACKING BEHAVIOR RESEARCH AND CONSUMER TREND ANALYSIS (U.S. CLS. 100, 101 AND 102).

ALLISON SCHRODY, EXAMINING ATTORNEY

CLASS 35—(Continued).

SN 77-627,057. KOOSHAREM CORPORATION, SANTA BARBARA, CA. FILED 12-5-2008.



THE MARK CONSISTS OF STANDARD CHARACTERS WITHOUT CLAIM TO ANY PARTICULAR FONT, STYLE, SIZE, OR COLOR.

FOR ANALYSIS OF MANAGEMENT NEEDS IN THE NATURE OF BUSINESS MANAGEMENT CONSULTATION, MAINTENANCE OF TIMEKEEPING DATA, NAMELY, BUSINESS RECORDS MANAGEMENT, PREPARING CUSTOMIZED BUSINESS REPORTS REGARDING WORKFORCE MANAGEMENT ALL PERFORMED IN THE FIELDS OF MANUFACTURING, FREIGHT AND TRANSPORTATION, APPAREL, HEALTH AND PERSONAL CARE, FINANCE AND ACCOUNTING, IT, AND SCIENTIFIC AND ENGINEERING INDUSTRIES (U.S. CLS. 100, 101 AND 102).

FIRST USE 4-15-2001; IN COMMERCE 4-15-2001.
JESSICA A. POWERS, EXAMINING ATTORNEY

SN 77-625,924. VEGAS.COM, LLC, HENDERSON, NV. FILED 12-3-2008.



THE MARK CONSISTS OF A FIGURE RESEMBLING A HEXAGON SURROUNDED BY THREE PARTIAL HEXAGONS TO THE LEFT OF THE TEXT "CYLLENIUS".

FOR BUSINESS CONSULTATION; BUSINESS MANAGEMENT AND CONSULTING SERVICES IN THE FIELD OF INFORMATION TECHNOLOGY (U.S. CLS. 100, 101 AND 102).

FIRST USE 10-22-2007; IN COMMERCE 10-22-2007.
MATTHEW KLINE, EXAMINING ATTORNEY

SN 77-628,771. TRADECARD, INC., NEW YORK, NY. FILED 12-8-2008.



THE MARK CONSISTS OF STANDARD CHARACTERS WITHOUT CLAIM TO ANY PARTICULAR FONT, STYLE, SIZE, OR COLOR.

NO CLAIM IS MADE TO THE EXCLUSIVE RIGHT TO USE "FACTORY", APART FROM THE MARK AS SHOWN.

FOR BUSINESS MANAGEMENT SERVICES FOR USE IN FACILITATING BUSINESS-TO-BUSINESS TRANSACTIONS, NAMELY, PROVIDING TO OTHERS COMPUTERIZED MONITORING OF THE STATUS OF BUY/SELL TRANSACTIONS AT THE PRODUCTION LEVEL (U.S. CLS. 100, 101 AND 102).

ROBIN CHOSID, EXAMINING ATTORNEY

CLASS 35—(Continued).

SN 77-630,193. ACCESSORIES BY JOANN HUTH, INC., BRYN MAWR, PA. FILED 12-10-2008.

Accessories by JoAnn Huth

THE MARK CONSISTS OF STANDARD CHARACTERS WITHOUT CLAIM TO ANY PARTICULAR FONT, STYLE, SIZE, OR COLOR.

NO CLAIM IS MADE TO THE EXCLUSIVE RIGHT TO USE "ACCESSORIES", APART FROM THE MARK AS SHOWN.

THE NAME(S), PORTRAIT(S), AND/OR SIGNATURE(S) SHOWN IN THE MARK IDENTIFIES "JOANN HUTH", WHOSE CONSENT(S) TO REGISTER IS MADE OF RECORD.

FOR ON-LINE RETAIL STORE SERVICES FEATURING HANDBAGS AND ACCESSORIES FOR WOMEN (U.S. CLS. 100, 101 AND 102).

FIRST USE 10-1-2007; IN COMMERCE 10-1-2007.
MICHAEL WEBSTER, EXAMINING ATTORNEY

SN 77-631,088. SWEET LIVING COFFEE LLC, OREGON CITY, OR. FILED 12-11-2008.



THE MARK CONSISTS OF THE WORDS "BARISTABEE" REPRESENTED IN STYLIZED FONT UNDERLINED AND WITH THE WORDS "YOUR HOME BARISTA SOLUTION" UNDERNEATH REPRESENTED IN STYLIZED FONT APPEARING BELOW A STYLIZED DESIGN OF A BEE CARRYING A COFFEE MUG.

FOR ON-LINE RETAIL STORE SERVICES FEATURING COFFEES, TEAS, COFFEE MAKERS, SHOT GLASS, STEAM PITCHER, MUGS (U.S. CLS. 100, 101 AND 102).

FIRST USE 2-1-2008; IN COMMERCE 2-1-2008.
WARREN L. OLANDRIA, EXAMINING ATTORNEY

CLASS 35—(Continued).

SN 77-632,012. ASOCIACION COLOMBIANA DE EXPORTADORES DE FLORES ASOCOLFLORES, BOGOTA, COLOMBIA, FILED 12-12-2008.



THE COLOR(S) YELLOW, RED, BLUE, GREEN IS/ARE CLAIMED AS A FEATURE OF THE MARK.

THE MARK CONSISTS OF A SERIES OF ROUGH BRUSH-STROKE CIRCLES, 3 YELLOW, 1 BLUE AND 1 RED, ALL SUGGESTING THE PETALS OF A SINGLE FLOWER AND SURROUNDING THE MIDDLE OF THE LOGO WHICH IS A BLUE BRUSH-STROKED CIRCLE REPRESENTING THE EYE OF THE FLOWER, WITHIN WHICH IS WRITTEN THE WORD "PROFLORA" IN THE COLOR BLUE, ABOVE WHICH ARE 5 GREENED-STEMMED FLOWERS, 2 WITH YELLOW HEADS, 2 WITH RED HEADS AND 1 WITH A BLUE HEAD. UNDERNEATH THE WORD "PROFLORA" IS A GREEN BANNER.

FOR ORGANIZATION OF TRADE FAIRS FOR COMMERCIAL OR ADVERTISING PURPOSES (U.S. CLS. 100, 101 AND 102).

KATHLEEN M. VANSTON, EXAMINING ATTORNEY

SN 77-633,392. URBAYN, INC., CHANDLER, AZ. FILED 12-15-2008.

URBAYN

THE MARK CONSISTS OF STANDARD CHARACTERS WITHOUT CLAIM TO ANY PARTICULAR FONT, STYLE, SIZE, OR COLOR.

FOR MAIL ORDER CATALOG SERVICES FEATURING HOUSEWARES, GLASSWARE, TABLEWARE, FLATWARE, PILLOWS, SLIPCOVERS, RUGS, LAMPS AND LIGHTING FIXTURES, CURTAINS, CURTAIN RODS, TABLE LINENS, BED LINENS, BATH LINENS, FRAGRANCE OILS, POTPOURRI, CANDLE HOLDERS, VASES, BASKETS MADE OF WICKER, WALL COVERINGS, WINDOW COVERINGS, WINDOW SHADES, FABRIC, UPHOLSTERY FABRIC, AND FABRIC MADE OF GAUZE; RETAIL DEPARTMENT STORES; RETAIL GIFT SHOPS; RETAIL JEWELRY STORES (U.S. CLS. 100, 101 AND 102).

FIRST USE 12-1-2003; IN COMMERCE 12-1-2003.
AARON BRODSKY, EXAMINING ATTORNEY

CLASS 35—(Continued).

SN 77-635,660. DEALCURIOUS, LLC, WARREN, MI. FILED 12-18-2008.

DEALCURIOUS

THE MARK CONSISTS OF STANDARD CHARACTERS WITHOUT CLAIM TO ANY PARTICULAR FONT, STYLE, SIZE, OR COLOR.

FOR PROVIDING A WEBSITE FOR CONNECTING SELLERS WITH BUYERS, NAMELY, AN ON-LINE PLATFORM FOR BUYERS TO PURCHASE PRODUCTS OR SERVICES AND TO INITIATE NEGOTIATIONS FOR THE DESIRED PRODUCTS OR SERVICES ON THE INTERNET (U.S. CLS. 100, 101 AND 102).

CYNTHIA TRIPI, EXAMINING ATTORNEY

CLASS 35—(Continued).

SN 77-642,833. BOSTON LIGHT SOURCE, INC., BOSTON, MA. FILED 1-3-2009.

SUSTAINABLE LIGHTING RESOURCES

THE MARK CONSISTS OF STANDARD CHARACTERS WITHOUT CLAIM TO ANY PARTICULAR FONT, STYLE, SIZE, OR COLOR.

NO CLAIM IS MADE TO THE EXCLUSIVE RIGHT TO USE "SUSTAINABLE LIGHTING", APART FROM THE MARK AS SHOWN.

FOR CONSULTATION IN THE FIELD OF ENERGY EFFICIENCY; ENERGY AUDITING; ENERGY USAGE MANAGEMENT; INFORMATION IN THE FIELD OF ENERGY EFFICIENCY; PROMOTING THE BENEFITS OF ENERGY EFFICIENT LIGHTING TECHNOLOGIES TO PROFESSIONALS IN THE LIGHTING FIELD (U.S. CLS. 100, 101 AND 102).

FIRST USE 5-1-2008; IN COMMERCE 5-1-2008.

BRIAN NEVILLE, EXAMINING ATTORNEY

SN 77-641,539. ORTHO MOLECULAR PRODUCTS, INC., STEVENS POINT, WI. FILED 12-30-2008.

EFFICACY THE POWER OF E

THE MARK CONSISTS OF STANDARD CHARACTERS WITHOUT CLAIM TO ANY PARTICULAR FONT, STYLE, SIZE, OR COLOR.

FOR ONLINE AND CATALOG RETAIL SERVICES FEATURING NUTRACEUTICAL DIETARY SUPPLEMENTS, NAMELY, AMINO ACID SUPPLEMENTS, BOTANICAL EXTRACT SUPPLEMENTS, CHILDREN'S FORMULA SUPPLEMENTS, ENDOCRINE MODULATOR SUPPLEMENTS, SUPPLEMENTS TO INCREASE GLANDULAR FUNCTIONS, MINERAL SUPPLEMENTS, SUPPLEMENTS CONTAINING NATURAL OILS, SUPPLEMENTS TO INCREASE NERVE RESPONSE, AND SPECIALTY FORMULA SUPPLEMENTS AND VITAMINS (U.S. CLS. 100, 101 AND 102).

FIRST USE 7-1-2009; IN COMMERCE 7-1-2009.

SHAUNIA CARLYLE, EXAMINING ATTORNEY

SN 77-643,615. CHRISTOPHER KONTAKIS, PHOENIX, AZ. FILED 1-5-2009.



NO CLAIM IS MADE TO THE EXCLUSIVE RIGHT TO USE "TEXT MAILER PAPERLESS ADVERTISING", APART FROM THE MARK AS SHOWN.

THE MARK CONSISTS OF THE WORDS "TXTMAILER PAPERLESS ADVERTISING" WITHIN A BUBBLE COMMENT SHAPE.

FOR ADVERTISING VIA ELECTRONIC MEDIA AND SPECIFICALLY THE INTERNET (U.S. CLS. 100, 101 AND 102).

KHANH LE, EXAMINING ATTORNEY

CLASS 35—(Continued).

SN 77-644,094. REICH, KELLY, CANTON, MI. FILED 1-6-2009.



THE COLOR(S) LIME GREEN, GRAY AND REDDISH-ORANGE IS/ARE CLAIMED AS A FEATURE OF THE MARK.

THE MARK CONSISTS OF THE TERMS "DESIGN LOOP". THE TERM "DESIGN" APPEARS IN REDDISH-ORANGE. THE TERM "LOOP" APPEARS IN LIME GREEN. THERE IS A GRAY RECTANGLE SURROUNDING THE WORDS AND A GRAY DOTTED LINE CONNECTING THE TOP OF THE "D" IN "DESIGN" WITH THE BOTTOM OF THE "L" IN "LOOP".

FOR PROVIDING A FREE AND FEE-BASED ONLINE DIRECTORY INFORMATION SERVICE FEATURING INFORMATION REGARDING REAL ESTATE DESIGN, REAL ESTATE SUPPLY MANUFACTURERS AND REAL ESTATE CONSTRUCTION COMMUNITY; AND PROVIDING A FREE AND FEE-BASED INTERNET WEBSITE TO PROMOTE LOCAL EVENTS RELATING TO THE REAL ESTATE DESIGN, REAL ESTATE SUPPLY MANUFACTURERS AND REAL ESTATE CONSTRUCTION COMMUNITY (U.S. CLS. 100, 101 AND 102).

PAULA MAHONEY, EXAMINING ATTORNEY

CLASS 35—(Continued).

SN 77-648,498. SIRIUS PRODUCTS, INC., LONGMONT, CO. FILED 1-13-2009.

THE GREAT IDEA NETWORK

THE MARK CONSISTS OF STANDARD CHARACTERS WITHOUT CLAIM TO ANY PARTICULAR FONT, STYLE, SIZE, OR COLOR.

FOR BUSINESS MARKETING CONSULTATION; PROVIDING ONLINE BUSINESS INFORMATION RELATED TO ORGANIZING AND OPERATING A NEW BUSINESS; PROVIDING ENTREPRENEURIAL BUSINESS ASSISTANCE TO STARTUP AND EMERGING COMPANIES, NAMELY, MARKETING CONCEPT DEVELOPMENT, BUSINESS PROJECT MANAGEMENT FOR OTHERS, PRODUCT MARKETING, ORGANIZATIONAL STRATEGY, BUSINESS MANAGEMENT AND FACILITATING FINANCING IN THE NATURE OF MATCHING INVESTORS WITH STARTUP COMPANIES; BUSINESS CONSULTATION AND MANAGEMENT REGARDING MARKETING ACTIVITIES AND LAUNCHING OF NEW PRODUCTS; ADVERTISING, NAMELY, CREATING CORPORATE AND BRAND IDENTITY FOR OTHERS; CONSULTING IN THE FIELD OF BUSINESS PARTNER RELATIONSHIP MANAGEMENT; BUSINESS ADVISORY SERVICES IN THE NATURE OF NEW VENTURE DEVELOPMENT AND FORMATION CONSULTING SERVICES, NAMELY, ADVISING OTHERS WITH STARTUP INITIATIVES IN ALL BUSINESS FIELDS ON INDUSTRY AND MARKET ANALYSIS, PRODUCT DEVELOPMENT, VALUE PROPOSITION, BUSINESS PLANNING, MARKETING, RECOURSE ACQUISITION, VALUATION, MERGER AND ACQUISITION, ALLIANCE AND JOINT VENTURE OPPORTUNITIES; BUSINESS MANAGEMENT SERVICES, NAMELY, ASSISTING OTHERS IN ENTERING INTO JOINT VENTURE PARTNERSHIP PROJECTS WITH ENTREPRENEURS (U.S. CLS. 100, 101 AND 102).

SANJEEV VOHRA, EXAMINING ATTORNEY

SN 77-649,619. WAKEFERN FOOD CORP., KEASBEY, NJ. FILED 1-14-2009.



OWNER OF U.S. REG. NOS. 2,938,720, 3,258,445 AND OTHERS.

THE MARK CONSISTS OF A CIRCULAR LOGO CONTAINING A SUNBURST DESIGN, A GROCERY CART AND A BANNER BEARING THE TERM "SHOPRITE".

FOR SUPERMARKETS, DISTRIBUTORSHIP SERVICES IN THE FIELD OF GROCERIES, RETAIL GASOLINE SUPPLY SERVICES (U.S. CLS. 100, 101 AND 102). FIRST USE 2-6-2003; IN COMMERCE 2-6-2003.

CAROL SPILS, EXAMINING ATTORNEY

CLASS 35—(Continued).

SN 77-650,197. THE GOYAK GROUP, LAS VEGAS, NV.
FILED 1-15-2009.



NO CLAIM IS MADE TO THE EXCLUSIVE RIGHT TO USE "GROUP", APART FROM THE MARK AS SHOWN.

THE COLOR(S) BLUE, GOLD AND WHITE IS/ARE CLAIMED AS A FEATURE OF THE MARK.

THE MARK CONSISTS OF THE STYLIZED GOLD WORDS "THE GOYAK GROUP" UNDER A BLUE AND GOLD RECTANGLE, WITHIN A WHITE CIRCULAR DESIGN REPRESENT THE PLANET EARTH SURROUNDED WITH A WHITE NARROW BORDER ENCASED BY ANOTHER BLUE AND GOLD NARROW BORDER.

FOR BUSINESS CONSULTING AND INFORMATION SERVICES; BUSINESS MANAGEMENT PLANNING; BUSINESS MANAGEMENT SUPERVISION (U.S. CLS. 100, 101 AND 102).

FIRST USE 1-0-2008; IN COMMERCE 2-0-2008.

TRACY FLETCHER, EXAMINING ATTORNEY

CLASS 35—(Continued).

SN 77-652,137. BACKFLOW SOLUTIONS, INC., ALSIP, IL.
FILED 1-19-2009.

BSI ONLINE

THE MARK CONSISTS OF STANDARD CHARACTERS WITHOUT CLAIM TO ANY PARTICULAR FONT, STYLE, SIZE, OR COLOR.

NO CLAIM IS MADE TO THE EXCLUSIVE RIGHT TO USE "ONLINE", APART FROM THE MARK AS SHOWN.

FOR MANAGING AND ADMINISTERING A CROSS-CONNECTION CONTROL AND BACKFLOW PREVENTION PROGRAM FOR PUBLIC AND PRIVATE WATER SYSTEMS (U.S. CLS. 100, 101 AND 102).

FIRST USE 12-12-2008; IN COMMERCE 12-12-2008.

ANGELA M. MICHELI, EXAMINING ATTORNEY

SN 77-652,264. CHESSEN, CHRISTINE, SAN FRANCISCO, CA. FILED 1-19-2009.

SN 77-651,140. PEPCO HOLDINGS, INC., WASHINGTON, DC. FILED 1-16-2009.

EnergyAssist



NO CLAIM IS MADE TO THE EXCLUSIVE RIGHT TO USE "CREMA", APART FROM THE MARK AS SHOWN.

THE COLOR(S) RED, GREEN, WHITE, AND BLUE IS/ARE CLAIMED AS A FEATURE OF THE MARK.

THE MARK CONSISTS OF THE WORD "CREMA" IN RED, SUPERIMPOSED OVER A WHITE MILK BOTTLE WHICH IS OUTLINED IN BLUE AND SUPERIMPOSED ON A MAP OF CALIFORNIA IN GREEN.

THE ENGLISH TRANSLATION OF "CREMA" IN THE MARK IS "CREAM".

FOR PROVIDING CONSUMER INFORMATION AND RELATED NEWS IN THE FIELD OF RAW MILK AND DAIRY PRODUCTS; PUBLIC ADVOCACY TO PROMOTE AWARENESS OF RAW MILK AND DAIRY PRODUCTS (U.S. CLS. 100, 101 AND 102).

FIRST USE 1-16-2009; IN COMMERCE 1-16-2009.

LAURA KOVALSKY, EXAMINING ATTORNEY

THE MARK CONSISTS OF STANDARD CHARACTERS WITHOUT CLAIM TO ANY PARTICULAR FONT, STYLE, SIZE, OR COLOR.

FOR PROVIDING A WEBSITE AT WHICH CUSTOMERS CAN OBTAIN ELECTRIC USAGE AND BILLING INFORMATION FROM THEIR ELECTRICAL UTILITY COMPANY; PROVIDING AN INTERNET WEBSITE PORTAL THROUGH WHICH CUSTOMERS CAN OBTAIN ELECTRIC USAGE AND BILLING INFORMATION FROM THEIR ELECTRICAL UTILITY COMPANY (U.S. CLS. 100, 101 AND 102).

DAVID TOOLEY, EXAMINING ATTORNEY

CLASS 35—(Continued).

SN 77-654,480. NATIONAL SOCIETY OF PROFESSIONAL ENGINEERS CORPORATION, ALEXANDRIA, VA. FILED 1-22-2009.



OWNER OF U.S. REG. NOS. 2,720,316, 3,566,821 AND 3,566,822.

NO CLAIM IS MADE TO THE EXCLUSIVE RIGHT TO USE "SOCIETY OF PROFESSIONAL ENGINEERS FOUNDED 1934", APART FROM THE MARK AS SHOWN.

THE MARK CONSISTS OF THE TERMS, "NATIONAL SOCIETY OF PROFESSIONAL ENGINEERS FOUNDED 1934", INSIDE THE DESIGN OF A SHIELD CONSISTING OF A CIRCLE CONNECTED ON THREE SIDES TO A ROUND EDGED TRIANGLE DESIGN COMPRISED OF TWO CONCENTRIC ROUND EDGED TRIANGLES.

SEC. 2(F) AS TO "NATIONAL SOCIETY OF PROFESSIONAL ENGINEERS".

FOR ASSOCIATION SERVICES, NAMELY, PROMOTING THE INTERESTS OF ENGINEERS AND ADVANCING DIVERSITY IN THE FIELD OF ENGINEERING (U.S. CLS. 100, 101 AND 102).

FIRST USE 12-10-1934; IN COMMERCE 12-10-1934.
BARBARA A. GOLD, EXAMINING ATTORNEY

CLASS 35—(Continued).

SN 77-654,595. WAKEFERN FOOD CORP., KEASBEY, NJ. FILED 1-22-2009.



OWNER OF U.S. REG. NOS. 2,938,720, 3,063,282 AND 3,258,445.

THE COLOR(S) RED, YELLOW, BLACK, WHITE IS/ARE CLAIMED AS A FEATURE OF THE MARK.

THE MARK CONSISTS OF A CIRCULAR LOGO OUTLINED IN BLACK, CONTAINING A BLACK GROCERY CART AND A RED BANNER BEARING THE TERM "SHOPRITE" IN WHITE, ATOP A YELLOW BACKGROUND CONTAINING A WHITE SUNBURST DESIGN.

FOR SUPERMARKETS, DISTRIBUTORSHIP SERVICES IN THE FIELD OF GROCERIES, RETAIL GASOLINE SUPPLY SERVICES (U.S. CLS. 100, 101 AND 102).

FIRST USE 2-6-2003; IN COMMERCE 2-6-2003.
CAROL SPILS, EXAMINING ATTORNEY

SN 77-658,654. CHRIS W. CAMPBELL, SAN JOSE, CA. FILED 1-28-2009.

GUITAR ADDICT

THE MARK CONSISTS OF STANDARD CHARACTERS WITHOUT CLAIM TO ANY PARTICULAR FONT, STYLE, SIZE, OR COLOR.

NO CLAIM IS MADE TO THE EXCLUSIVE RIGHT TO USE "GUITAR", APART FROM THE MARK AS SHOWN.

FOR RETAIL STORE SERVICES, ON-LINE RETAIL STORE SERVICES AND MAIL ORDER CATALOG SERVICES FEATURING MUSICAL INSTRUMENTS, ACCESSORIES AND SUPPLIES (U.S. CLS. 100, 101 AND 102).

GIANCARLO CASTRO, EXAMINING ATTORNEY

CLASS 35—(Continued).

SN 77-659,813. MILLENNIUM GROUP WORLDWIDE, INC.,
ST. AUGUSTINE, FL. FILED 1-30-2009.



NO CLAIM IS MADE TO THE EXCLUSIVE RIGHT TO USE "GROUP WORLDWIDE INC.", APART FROM THE MARK AS SHOWN.

THE COLOR(S) BLACK, GOLD IS/ARE CLAIMED AS A FEATURE OF THE MARK.

THE MARK CONSISTS OF A CIRCLE WITH THE LEFT HALF BEING GOLD AND THE RIGHT HALF BEING BLACK. CENTERED IN THE CIRCLE ARE THE STYLIZED LETTERS "MGW". UNDERNEATH THE CIRCLE ARE THE WORDS "MILLENNIUM GROUP WORLDWIDE INC." STYLIZED AND IN ALL CAPS. THESE WORDS ARE IN BLACK. THE COLOR WHITE REPRESENTS BACKGROUND AND IS NOT PART OF THE MARK.

FOR PROMOTING THE ECONOMIC DEVELOPMENT IN THE CARIBBEAN AND CONTINENT OF AFRICA IN THE FIELDS OF INFRASTRUCTURE DEVELOPMENT AND THE CREATION OF SUSTAINABLE BUSINESSES TO SUPPORT SOCIAL NEEDS (U.S. CLS. 100, 101 AND 102).

FIRST USE 3-15-2006; IN COMMERCE 3-15-2006.
DOUGLAS LEE, EXAMINING ATTORNEY

CLASS 35—(Continued).

SN 77-667,072. SCHEELS ALL SPORTS, INC., FARGO, ND.
FILED 2-10-2009.

SCHEELS
gear. passion. sports.

OWNER OF U.S. REG. NO. 2,814,941.

NO CLAIM IS MADE TO THE EXCLUSIVE RIGHT TO USE "GEAR" AND "SPORTS", APART FROM THE MARK AS SHOWN.

THE MARK CONSISTS OF THE WORD "SCHEELS" WITH "GEAR. PASSION. SPORTS" DIRECTLY BELOW IT.

FOR RETAIL STORE SERVICES FEATURING SPORTING GOODS, CLOTHING, AND SHOES (U.S. CLS. 100, 101 AND 102).

FIRST USE 12-1-2005; IN COMMERCE 12-1-2005.
GINA FINK, EXAMINING ATTORNEY

SN 77-665,932. CHUNG, JIYOUNG, IN CHEON, REPUBLIC
OF KOREA, FILED 2-9-2009.

Chamerica

THE MARK CONSISTS OF STANDARD CHARACTERS WITHOUT CLAIM TO ANY PARTICULAR FONT, STYLE, SIZE, OR COLOR.

FOR PROMOTING THE GOODS AND SERVICES OF OTHERS BY PROVIDING HYPERTEXT LINKS TO THE WEB SITES OF OTHERS (U.S. CLS. 100, 101 AND 102).

FIRST USE 1-12-2007; IN COMMERCE 1-12-2007.
STEVEN R. FINE, EXAMINING ATTORNEY

SN 77-672,255. ADVANCED GROUNDING CONCEPTS INC.,
AKA AGC, ATLANTA, GA. FILED 2-17-2009.

Smart Ground

THE MARK CONSISTS OF STANDARD CHARACTERS WITHOUT CLAIM TO ANY PARTICULAR FONT, STYLE, SIZE, OR COLOR.

FOR BUSINESS CONSULTING SERVICES FOR THE ELECTRIC ENERGY INDUSTRY (U.S. CLS. 100, 101 AND 102).

FIRST USE 1-1-2006; IN COMMERCE 1-1-2006.
SIMON TENG, EXAMINING ATTORNEY

CLASS 35—(Continued).

SN 77-677,247. EXEMPLAR COMPANIES INC., BOSTON, MA. FILED 2-24-2009.

Flexpertise

THE MARK CONSISTS OF STANDARD CHARACTERS WITHOUT CLAIM TO ANY PARTICULAR FONT, STYLE, SIZE, OR COLOR.

FOR ADVICE RELATING TO THE ORGANIZATION AND MANAGEMENT OF BUSINESS; ADVISORY SERVICES RELATING TO BUSINESS MANAGEMENT AND BUSINESS OPERATIONS; ASSISTANCE WITH BUSINESS MANAGEMENT AND PLANNING; ASSISTANCE, ADVISORY SERVICES AND CONSULTANCY WITH REGARD TO BUSINESS PLANNING, BUSINESS ANALYSIS, BUSINESS MANAGEMENT, AND BUSINESS ORGANIZATION; BUSINESS ACQUISITION AND MERGER CONSULTATION; BUSINESS CONSULTATION IN THE FIELD OF ENTREPRENEURIAL-BASED BUSINESSES; BUSINESS CONSULTING SERVICES, NAMELY, PROVIDING ASSISTANCE IN DEVELOPMENT OF BUSINESS STRATEGIES AND CREATIVE IDEATION; BUSINESS MANAGEMENT CONSULTING; BUSINESS ORGANIZATION AND MANAGEMENT CONSULTING SERVICES; BUSINESS RISK MANAGEMENT CONSULTATION; BUSINESS SERVICES, NAMELY, ASSISTING OTHERS IN THE ESTABLISHMENT OF CHARITABLE ORGANIZATION; CONSULTING SERVICES IN THE AREA OF SUSTAINABLE BUSINESS SOLUTIONS; CONSULTING SERVICES IN THE FIELD OF MANAGING INTELLECTUAL PROPERTIES; BUSINESS CONSULTATION IN THE FIELD OF ENTREPRENEURIAL-BASED BUSINESS, NAMELY, PROVIDING CORPORATE MANAGEMENT AND CONSULTING SERVICES IN THE AREA OF SUSTAINABLE BUSINESS SOLUTIONS; PROFESSIONAL SERVICES TO CLIENTS IN THE ENTERTAINMENT FIELD, NAMELY, BUSINESS CONSULTING AND BUSINESS MANAGEMENT CONSULTING FOR THE FILM, MUSIC, TELEVISION AND THEATER INDUSTRIES (U.S. CLS. 100, 101 AND 102).

FIRST USE 6-1-2008; IN COMMERCE 6-1-2008.
SHARON MEIER, EXAMINING ATTORNEY

CLASS 35—(Continued).

SN 77-682,356. LEASE SENTRY, INC., PANAMA CITY, FL. FILED 3-3-2009.



Lease Sentry, Inc.

www.lease-sentry.com

NO CLAIM IS MADE TO THE EXCLUSIVE RIGHT TO USE "LEASE" AND "INC.", APART FROM THE MARK AS SHOWN.

THE COLOR(S) BURGANDY, LIGHT GRAY, AND WHITE IS/ARE CLAIMED AS A FEATURE OF THE MARK. THE MARK CONSISTS OF A BURGANDY CIRCLE WITH A HELMET INSIDE THAT IS ALSO BURGANDY. THE BACKGROUND INSIDE THE CIRCLE IS LIGHT GRAY AT THE TOP AND FADES TO WHITE. UNDER THE CIRCLE ARE THE WORDS "LEASE SENTRY, INC." IN BURGANDY AND UNDER THAT ARE THE WORDS "WWW.LEASE-SENTRY.COM" ALSO IN BURGANDY.

FOR BUSINESS SERVICES, NAMELY, MONITORING OF TENANT BEHAVIOR AND RENTAL HISTORY (U.S. CLS. 100, 101 AND 102).

FIRST USE 3-15-2006; IN COMMERCE 3-15-2006.
JEFF DEFORD, EXAMINING ATTORNEY

SN 77-682,419. TAX-TALENT.COM, INC, MT. PLEASANT, SC. FILED 3-3-2009.

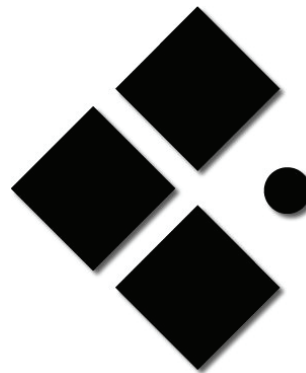

THE MARK CONSISTS OF THREE QUADRILATERAL SHAPES ARRANGED IN A LEFT POINTING ARROW SHAPE, WITH A SMALLER CIRCLE TO THE RIGHT OF THE THREE QUADRILATERALS.

FOR CAREER PLACEMENT SERVICES, EMPLOYMENT COUNSELING AND RECRUITING SERVICES, OUTPLACEMENT SERVICES, AND TEMPORARY EMPLOYMENT SERVICES ALL FOR TAX PROFESSIONS AND ALL OFFERED VIA THE INTERNET (U.S. CLS. 100, 101 AND 102).

FIRST USE 5-31-2008; IN COMMERCE 5-31-2008.
CYNTHIA TRIPI, EXAMINING ATTORNEY

CLASS 35—(Continued).

SN 77-687,124. PRESLEY, DEBORAH, PEACHTREE CITY, GA. FILED 3-10-2009.



OWNER OF U.S. REG. NO. 3,547,978.
NO CLAIM IS MADE TO THE EXCLUSIVE RIGHT TO USE "DIGEST", APART FROM THE MARK AS SHOWN.

THE MARK CONSISTS OF THE STYLIZED WORDS AND NUMBER "JUST 4 FAMILIES DIGEST". AN IMAGE OF AN ANIMATED CHARACTER HANGING FROM THE LETTER "J". AN IMAGE OF AN ANIMATED CHARACTER STANDING ABOVE THE LETTER "M". AN IMAGE OF AN ANIMATED CHARACTER STANDING ABOVE THE LETTERS "L" AND "I".

FOR PROVIDING ADVERTISING SERVICES FOR ONLINE AND PRINTED PUBLICATION FEATURING PARENTS' AND CHILDREN'S PRODUCTS AND SERVICES (U.S. CLS. 100, 101 AND 102).

FIRST USE 11-11-2008; IN COMMERCE 11-11-2008.
AISHA CLARKE, EXAMINING ATTORNEY

CLASS 35—(Continued).

SN 77-690,316. THAMES, ROBERT E., BROOKHAVEN, MS. FILED 3-13-2009.

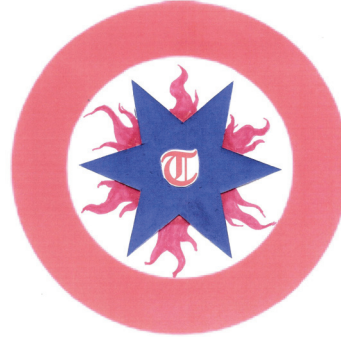

THE COLOR(S) RED, WHITE, AND BLUE IS/ARE CLAIMED AS A FEATURE OF THE MARK.

THE MARK CONSISTS OF LARGE RED OUTER CIRCLE WITH SIX POINTED BLUE STAR IN CENTER WITH RED FLAMES BETWEEN EACH POINT AND THE CAPITOL LETTER "T" IN OLD ENGLISH AT THE CENTER OF THE STAR. ALL ON A WHITE BACKGROUND.

FOR BUSINESS MANAGEMENT CONSULTING WITH RELATION TO STRATEGY, MARKETING, PRODUCTION, PERSONNEL AND RETAIL SALE MATTERS (U.S. CLS. 100, 101 AND 102).

JANICE KIM, EXAMINING ATTORNEY

SN 77-687,871. CASTANEDA, AKIMA, DBA AKIMA'S CASTING, VENTURA, CA. FILED 3-10-2009.

AKIMA

THE MARK CONSISTS OF STANDARD CHARACTERS WITHOUT CLAIM TO ANY PARTICULAR FONT, STYLE, SIZE, OR COLOR.

THE ENGLISH TRANSLATION OF "AKIMA" IN THE MARK IS BLACK.

FOR TALENT CASTING IN THE NATURE OF ARRANGING PERSONAL APPEARANCES FOR AUDITIONS BY PERSONS WORKING IN THE FIELD OF FILM, MUSIC, TELEVISION, AND ENTERTAINMENT (U.S. CLS. 100, 101 AND 102).

FIRST USE 9-9-2008; IN COMMERCE 9-9-2008.
STEVEN R. FINE, EXAMINING ATTORNEY

SN 77-692,599. CUSTOMMADE VENTURES, CORP., BOSTON, MA. FILED 3-17-2009.

 **CustomMade**

NO CLAIM IS MADE TO THE EXCLUSIVE RIGHT TO USE "CUSTOMMADE", APART FROM THE MARK AS SHOWN.

THE COLOR(S) MAROON IS/ARE CLAIMED AS A FEATURE OF THE MARK.

THE MARK CONSISTS OF THE WORD "CUSTOMMADE" IN A MAROON NON-STANDARD FONT WITH A MAROON IMAGE IN A SQUARE TO THE LEFT OF THE WORDS THAT REPRESENTS A FINGERPRINT AND ALSO REPRESENTS GRAINS OF WOOD.

FOR PROVIDING A SEARCHABLE ONLINE ADVERTISING GUIDE FEATURING THE GOODS AND SERVICES OF OTHER ON-LINE VENDORS ON THE INTERNET (U.S. CLS. 100, 101 AND 102).

FIRST USE 3-1-2009; IN COMMERCE 3-1-2009.
HEATHER SAPP, EXAMINING ATTORNEY

CLASS 35—(Continued).

SN 77-692,994. ZIELARZ CORPORATION, RIVER GROVE, IL. FILED 3-17-2009.



NO CLAIM IS MADE TO THE EXCLUSIVE RIGHT TO USE "CORPORATION", APART FROM THE MARK AS SHOWN.

THE MARK CONSISTS OF FIRST WORD "ZIELARZ" - CAPITAL LETTERS IN ARIAL WHITE FONTS, RIGHT BELOW SECOND WORD "CORPORATION" - CAPITAL LETTERS IN ARIAL WHITE FONTS ADEQUATELY SMALLER SIZE AND DOUBLE SPACING BETWEEN THE LETTERS TO KEEP THE SAME WIDTH, ON A BLACK BACKGROUND IN A WHITE FRAME WITH ROUNDED CORNERS. EVERYTHING INSIDE AND WITH FRAME MAKES UP THE LOGO.

THE ENGLISH TRANSLATION OF "ZIELARZ" IN THE MARK IS "HERBALIST".

FOR INTERNATIONAL TRADING IN NATURE OF ARRANGING OF TRADING TRANSACTION AND COMMERCIAL CONTRACTS, BUSINESS MARKETING AND BUSINESS CONSULTING SERVICES, ALL IN THE FIELD OF CONNECTING DIFFERENT BUSINESSES FOR SUCCESSFUL AND PROFITABLE COOPERATION (U.S. CLS. 100, 101 AND 102).

FIRST USE 9-1-1989; IN COMMERCE 6-1-2008.
ERNEST SHOSHO, EXAMINING ATTORNEY

SN 77-693,007. ZIELARZ CORPORATION, RIVER GROVE, IL. FILED 3-17-2009.

Zielarz Corporation

THE MARK CONSISTS OF STANDARD CHARACTERS WITHOUT CLAIM TO ANY PARTICULAR FONT, STYLE, SIZE, OR COLOR.

NO CLAIM IS MADE TO THE EXCLUSIVE RIGHT TO USE "CORPORATION", APART FROM THE MARK AS SHOWN.

THE ENGLISH TRANSLATION OF "ZIELARZ" IN THE MARK IS "HERBALIST".

FOR INTERNATIONAL TRADING IN NATURE OF ARRANGING OF TRADING TRANSACTION AND COMMERCIAL CONTRACTS, BUSINESS MARKETING AND BUSINESS CONSULTING SERVICES, ALL IN THE FIELD OF CONNECTING DIFFERENT BUSINESSES FOR SUCCESSFUL AND PROFITABLE COOPERATION (U.S. CLS. 100, 101 AND 102).

FIRST USE 9-1-1989; IN COMMERCE 6-12-2008.
ERNEST SHOSHO, EXAMINING ATTORNEY

CLASS 35—(Continued).

SN 77-696,583. MARSHALLS OF NEVADA, INC., NORTH LAS VEGAS, NV. FILED 3-23-2009.

DEPT 22

THE MARK CONSISTS OF STANDARD CHARACTERS WITHOUT CLAIM TO ANY PARTICULAR FONT, STYLE, SIZE, OR COLOR.

NO CLAIM IS MADE TO THE EXCLUSIVE RIGHT TO USE "DEPT", APART FROM THE MARK AS SHOWN.

FOR RETAIL DEPARTMENT STORE SERVICES (U.S. CLS. 100, 101 AND 102).

LESLIE RICHARDS, EXAMINING ATTORNEY

SN 77-696,984. MARITZ HOLDINGS INC., FENTON, MO. FILED 3-23-2009.

RECOGNITIONMANAGER

THE MARK CONSISTS OF STANDARD CHARACTERS WITHOUT CLAIM TO ANY PARTICULAR FONT, STYLE, SIZE, OR COLOR.

OWNER OF U.S. REG. NO. 2,857,077.

SEC. 2(F).

FOR BUSINESS INFORMATION, NAMELY, PROVIDING INFORMATION FOR OTHERS IN THE FIELD OF MOTIVATION AND PERFORMANCE IMPROVEMENT PROGRAMS FOR CLIENT COMPANY'S EMPLOYEES, DEALERS, SUPPLIERS AND DISTRIBUTORS; BUSINESS CONSULTATION FOR OTHERS IN THE FIELD OF MOTIVATION AND PERFORMANCE IMPROVEMENT PROGRAMS FOR CLIENT COMPANY'S EMPLOYEES, DEALERS, SUPPLIERS AND DISTRIBUTORS; PROMOTING, CONDUCTING AND ADMINISTERING MOTIVATION AND PERFORMANCE IMPROVEMENT PROGRAMS FOR OTHERS FOR CLIENT COMPANY'S EMPLOYEES, DEALERS, SUPPLIERS AND DISTRIBUTORS (U.S. CLS. 100, 101 AND 102).

FIRST USE 2-23-2004; IN COMMERCE 2-23-2004.
SAIMA MAKHDOOM, EXAMINING ATTORNEY

SN 77-697,014. CRYSTAL WORLD INC., SOUTH HACKENSACK, NJ. FILED 3-23-2009.

Crystal Optics

THE MARK CONSISTS OF STANDARD CHARACTERS WITHOUT CLAIM TO ANY PARTICULAR FONT, STYLE, SIZE, OR COLOR.

NO CLAIM IS MADE TO THE EXCLUSIVE RIGHT TO USE "OPTICS", APART FROM THE MARK AS SHOWN.

FOR RETAIL STORES FEATURING OPTICAL GOODS (U.S. CLS. 100, 101 AND 102).

FIRST USE 4-1-2008; IN COMMERCE 6-1-2008.
KRISTIN CARLSON, EXAMINING ATTORNEY

CLASS 35—(Continued).

SN 77-697,320. ADVANCE PROMOTIONS LLC, PORTLAND, OR. FILED 3-23-2009.



THE MARK CONSISTS OF THE TEXT "ECOSWAG.COM" IN ALL LOWER-CASE LETTERS, IN A CUSTOM FONT. A LEAF ELEMENT IS PART OF THE LETTER "O" IN THE WORD "ECOSWAG".

FOR ON-LINE RETAIL STORE SERVICES FEATURING ECOLOGICALLY PREFERABLE CUSTOM-DECORATED ADVERTISING SPECIALTIES IN THE NATURE OF GENERAL MERCHANDISE, AWARDS AND BUSINESS APPAREL (U.S. CLS. 100, 101 AND 102).

FIRST USE 4-22-2009; IN COMMERCE 4-22-2009.
KRISTIN DAHLING, EXAMINING ATTORNEY

CLASS 35—(Continued).

SN 77-699,111. MILLENNIA INFORMATION SYSTEMS L.P., DENISON, TX. FILED 3-25-2009.



THE COLOR(S) BLACK AND RED IS/ARE CLAIMED AS A FEATURE OF THE MARK.

THE MARK CONSISTS OF THE CAPITAL LETTER "A" WITH THE MIDDLE BAR BEING ALTERED SHOWING AN ARTISTS DEPICTION OF A "ROENTGEN TUBE" PRODUCING X-RAYS WHICH ARE BEING COLLIMATED BY THE "FEET" OF THE LETTER "A". THE LETTER "A" IS BLACK WITH THE X-RAYS BEING DEPICTED AS A RED "ARROW" POINTING UPWARD.

FOR MEDICAL BILLING SUPPORT SERVICES (U.S. CLS. 100, 101 AND 102).

FIRST USE 10-10-2007; IN COMMERCE 10-10-2007.
HEATHER THOMPSON, EXAMINING ATTORNEY

SN 77-697,772. FUND ACCOUNTING SOLUTION TECHNOLOGIES, INC, DBA RENTFROG.COM, LUBBOCK, TX. FILED 3-24-2009.



THE COLOR(S) GREEN, YELLOW, PURPLE, PINK, BLACK AND WHITE IS/ARE CLAIMED AS A FEATURE OF THE MARK.

THE MARK CONSISTS OF THE FOLLOWING: A GREEN AND YELLOW FROG WITH WHITE EYES, BLACK PUPILS AND PINK TONGUE; STYLIZED GREEN PAPER MONEY WITH WHITE DOLLAR SIGNS; AND THE WORDING "RENTFROG.COM" IN PURPLE AND OUTLINED IN WHITE AND BLACK.

FOR PROVISION OF SPACE ON WEBSITES FOR ADVERTISING GOODS AND SERVICES (U.S. CLS. 100, 101 AND 102).

FIRST USE 8-1-2008; IN COMMERCE 1-5-2009.
MARIA-VICTORIA SUAREZ, EXAMINING ATTORNEY

SN 77-699,453. VANIR GROUP OF COMPANIES, INC., SACRAMENTO, CA. FILED 3-25-2009.



OWNER OF U.S. REG. NOS. 1,956,987, 3,333,606 AND 3,342,789.

NO CLAIM IS MADE TO THE EXCLUSIVE RIGHT TO USE "ENERGY", APART FROM THE MARK AS SHOWN.

THE MARK CONSISTS OF THE STYLIZED LETTER COMBINATION OF "VE" FOLLOWED BY A STRAIGHT LINE FOLLOWED BY "VANIR ENERGY".

FOR WHOLESALE DISTRIBUTORSHIPS IN THE FIELD OF PETROLEUM PRODUCTS; RETAIL STORES IN THE FIELD OF PETROLEUM PRODUCTS (U.S. CLS. 100, 101 AND 102).

TRACY FLETCHER, EXAMINING ATTORNEY

SN 77-698,973. MILLENNIA INFORMATION SYSTEMS L.P., DENISON, TX. FILED 3-25-2009.



THE MARK CONSISTS OF STANDARD CHARACTERS WITHOUT CLAIM TO ANY PARTICULAR FONT, STYLE, SIZE, OR COLOR.

FOR MEDICAL BILLING SUPPORT SERVICES (U.S. CLS. 100, 101 AND 102).

FIRST USE 2-9-2009; IN COMMERCE 2-9-2009.
HEATHER THOMPSON, EXAMINING ATTORNEY

CLASS 35—(Continued).

SN 77-699,531. MED ASSOCIATES, INC., ST. ALBANS, VT.
FILED 3-26-2009.



NO CLAIM IS MADE TO THE EXCLUSIVE RIGHT TO USE "DISCOUNT DISPOSABLES", APART FROM THE MARK AS SHOWN.

THE MARK CONSISTS OF A STYLIZED MEDICAL ELECTRODE COLLAR AND THE WORDING "DISCOUNT DISPOSABLES". A SHADED RECTANGLE APPEARS BEHIND THE MARK WITH A SECOND RECTANGLE APPEARING BEHIND THE WORDING.

FOR COMPUTERIZED ON-LINE ORDERING SERVICES IN THE FIELD OF MEDICAL TESTING AND DIAGNOSTIC PRODUCTS; ON-LINE RETAIL STORE SERVICES FEATURING ELECTRODES, ELECTRODE COLLARS, REUSABLE ELECTRODES, GROUND STRAPS, TOOLS, CONNECTORS, ADAPTERS, WIRES, LEAD WIRES, CLIPS, PADS, SPONGES, CREAMS, GELS, PASTES, SPRAYS (U.S. CLS. 100, 101 AND 102).

FIRST USE 3-11-2003; IN COMMERCE 3-27-2003.
MARTHA FROMM, EXAMINING ATTORNEY

SN 77-701,300. GOAHEAD SOLUTIONS, LLC, SOUTH SAN FRANCISCO, CA. FILED 3-27-2009.

GOAHEAD SOLUTIONS

THE MARK CONSISTS OF STANDARD CHARACTERS WITHOUT CLAIM TO ANY PARTICULAR FONT, STYLE, SIZE, OR COLOR.

NO CLAIM IS MADE TO THE EXCLUSIVE RIGHT TO USE "SOLUTIONS", APART FROM THE MARK AS SHOWN.

FOR TEMPORARY AND PERMANENT EMPLOYMENT AGENCY SERVICES; PROVISION OF ON-SITE STAFFING MANAGEMENT SERVICES; ON-SITE EMPLOYEE RECRUITING, HIRING, STAFFING, HUMAN RESOURCES CONSULTING; BUSINESS MANAGEMENT CONSULTANCY; ADVICE IN THE FIELD OF BUSINESS MANAGEMENT; ASSISTANCE IN MANAGEMENT OF BUSINESS ACTIVITIES; ASSISTANCE WITH BUSINESS MANAGEMENT AND PLANNING; BUSINESS EVALUATION OF HUMAN RESOURCES NEEDS, BUSINESS MANAGEMENT, AND BUSINESS ORGANIZATION CONSULTING; TECHNOLOGY CONSULTING, NAMELY, BUSINESS CONSULTING SERVICES RELATING TO THE INTEGRATION OF THE AREAS OF BUSINESS PROCESS TECHNOLOGY, ORGANIZATION LEARNING, CHANGE MANAGEMENT, AND OPERATIONAL SUSTAINABILITY; BUSINESS CONSULTING SERVICES RELATING TO OPERATIONS MANAGEMENT SERVICES LOGISTICS, REVERSE LOGISTICS, SUPPLY CHAIN, AND PRODUCTION SYSTEMS AND DISTRIBUTION SOLUTIONS (U.S. CLS. 100, 101 AND 102).

FIRST USE 8-1-2001; IN COMMERCE 8-1-2001.
SHARON MEIER, EXAMINING ATTORNEY

CLASS 35—(Continued).

SN 77-702,210. RME, LLC, TAMPA, FL. FILED 3-30-2009.

RME

THE MARK CONSISTS OF STANDARD CHARACTERS WITHOUT CLAIM TO ANY PARTICULAR FONT, STYLE, SIZE, OR COLOR.

OWNER OF U.S. REG. NOS. 2,863,639, 2,933,975 AND 3,048,121.

FOR DIRECT MAIL ADVERTISING SERVICES; OPERATION OF TELEPHONE CALL CENTERS FOR OTHERS; DIRECT MARKETING ADVERTISING FOR OTHERS (U.S. CLS. 100, 101 AND 102).

FIRST USE 8-1-1996; IN COMMERCE 8-1-1996.
BARBARA GAYNOR, EXAMINING ATTORNEY

SN 77-703,236. TRISTAR PRODUCTS, INC., FAIRFIELD, NJ.
FILED 3-31-2009.

BEAUTY DISCOVERIES

THE MARK CONSISTS OF STANDARD CHARACTERS WITHOUT CLAIM TO ANY PARTICULAR FONT, STYLE, SIZE, OR COLOR.

NO CLAIM IS MADE TO THE EXCLUSIVE RIGHT TO USE "BEAUTY", APART FROM THE MARK AS SHOWN.

FOR PROVIDING HOME SHOPPING SERVICES IN THE FIELD OF A WIDE VARIETY OF COSMETIC, HAIR CARE AND SKIN CARE PRODUCTS OF OTHERS BY MEANS OF TELEVISION; ON-GOING TELEVISION PROGRAMS FEATURING CONSUMER PRODUCT INFORMATION AND ADVERTISING IN THE FIELD OF FIELD OF COSMETIC, HAIR CARE AND SKIN CARE PRODUCTS (U.S. CLS. 100, 101 AND 102).

EVELYN BRADLEY, EXAMINING ATTORNEY

CLASS 35—(Continued).

SN 77-703,509. SUTTLE & STALNAKER, PLLC, CHARLESTON, WV. FILED 3-31-2009.

**CLASS 35—(Continued).**

SN 77-704,471. SUPERSTATION, INC., ATLANTA, GA. FILED 4-1-2009.



NO CLAIM IS MADE TO THE EXCLUSIVE RIGHT TO USE "CERTIFIED PUBLIC ACCOUNTANTS", APART FROM THE MARK AS SHOWN.

THE COLOR(S) GREEN IS/ARE CLAIMED AS A FEATURE OF THE MARK.

THE MARK CONSISTS OF TWO STYLIZED LETTERS "S", SURROUNDING AN AMPERSAND INSIDE A GREEN SQUARE WHICH APPEARS TO THE LEFT OF THE WORDING "SUTTLE & STALNAKER", IN GREEN LETTERING, ALL OF WHICH IS ABOVE THE WORDING "CERTIFIED PUBLIC ACCOUNTANTS", IN GREEN LETTERING. THE COLOR WHITE REPRESENTS A TRANSPARENT AREA AND IS NOT PART OF THE MARK.

FOR ACCOUNT AUDITING; ACCOUNTANCY SERVICES; ACCOUNTING CONSULTATION; ACCOUNTING SERVICES; AUDIT SUPPORT SERVICES, NAMELY, REVIEW AND ANALYSIS OF A COMPANY'S SALES, AS WELL AS THE PREPARATION, ORGANIZATION AND PRESENTATION OF THE DOCUMENTS AND DATA REQUESTED BY A GOVERNMENT BODY, AND ADVICE ON GOVERNMENT AUDIT PROCESSES, POLICIES AND STRATEGY; BUSINESS AUDITING; ESTATE MANAGEMENT, NAMELY, ASSISTANCE IN THE GATHERING AND ORGANIZATION OF PERSONAL VITAL AND FINANCIAL RECORDS IN CONJUNCTION WITH INSTRUCTIONS FOR HANDLING OF SUCH DOCUMENTS BY OTHERS, INCLUDING EXECUTORS AND ATTORNEYS, UPON DEATH OR WHEN OTHERWISE NECESSARY; FINANCIAL STATEMENT PREPARATION AND ANALYSIS FOR BUSINESSES; INCOME TAX CONSULTATION; INCOME TAX PREPARATION; MANAGEMENT OF TAX FILES; TAX ADVISORY SERVICES; TAX CONSULTATION; TAX PREPARATION (U.S. CLS. 100, 101 AND 102).

FIRST USE 1-1-1980; IN COMMERCE 1-1-1980.

WENDY GOODMAN, EXAMINING ATTORNEY

OWNER OF U.S. REG. NOS. 3,030,533 AND 3,225,560.
NO CLAIM IS MADE TO THE EXCLUSIVE RIGHT TO USE "SHOP", APART FROM THE MARK AS SHOWN.

THE MARK CONSISTS OF THE WORDS "SHOP" AND "TBS & DESIGN" ENCLOSED IN DRAWING OF A SHOPPING BAG.

FOR ON-LINE RETAIL STORE SERVICES FEATURING, CLOTHING, NAMELY, HATS, T-SHIRTS AND SWEATSHIRTS; PLASTIC WATER BOTTLES, MUGS, BEVERAGE GLASSWARE; PLASTIC AND METAL KEY CHAINS, MAGNETS, PAPER WEIGHTS; PRINTED MATERIAL, NAMELY, COMPOSITION BOOKS, JOURNALS, GREETING CARDS, POSTERS AND PAPER CUBES; FLASHLIGHTS, LIGHTERS, BOTTLE OPENERS; BAGS AND BACKPACKS; MOUSE PADS, PROJECTOR PENS; USB DRIVES, PORTABLE MUSIC AND VIDEO PLAYERS; GAMES AND PLAY THINGS, NAMELY, PLUSH TOYS, PUZZLES, FIGURINES AND ACTION FIGURES; PRE-RECORDED DVDS FEATURING TELEVISION SHOWS AND MOVIES, PRE-RECORDED COMPACT DISC FEATURING SOUNDTRACKS AND MUSIC; JEWELRY, NAMELY, WATCHES, BUTTONS AND LAPEL PINS (U.S. CLS. 100, 101 AND 102).

FIRST USE 2-19-2009; IN COMMERCE 2-19-2009.

RONALD AIKENS, EXAMINING ATTORNEY

CLASS 35—(Continued).

SN 77-704,480. TURNER NETWORK TELEVISION, INC., ATLANTA, GA. FILED 4-1-2009.



OWNER OF U.S. REG. NOS. 2,679,935, 2,845,431 AND 3,575,919.

NO CLAIM IS MADE TO THE EXCLUSIVE RIGHT TO USE "STORE", APART FROM THE MARK AS SHOWN.

THE MARK CONSISTS OF THE WORD "TNT" ENCLOSED IN A CIRCLE NEXT TO THE WORD "STORE".

FOR ON-LINE RETAIL STORE SERVICES FEATURING, CLOTHING, NAMELY, HATS, T-SHIRTS AND SWEATSHIRTS; PLASTIC WATER BOTTLES, MUGS, BEVERAGE GLASSWARE; PLASTIC AND METAL KEY CHAINS, MAGNETS, PAPER WEIGHTS; PRINTED MATERIAL, NAMELY, COMPOSITION BOOKS, JOURNALS, GREETING CARDS, POSTERS AND PAPER CUBES; FLASHLIGHTS, LIGHTERS, BOTTLE OPENERS; BAGS AND BACKPACKS; MOUSE PADS, PROJECTOR PENS; USB DRIVES, PORTABLE MUSIC AND VIDEO PLAYERS; GAMES AND PLAY THINGS, NAMELY, PLUSH TOYS, PUZZLES, FIGURINES AND ACTION FIGURES; PRE-RECORDED DVDS FEATURING TELEVISION SHOWS AND MOVIES, PRE-RECORDED COMPACT DISC FEATURING SOUNDTRACKS AND MUSIC; JEWELRY, NAMELY, WATCHES, BUTTONS AND LABEL PINS (U.S. CLS. 100, 101 AND 102).

FIRST USE 3-16-2009; IN COMMERCE 3-16-2009.

RONALD AIKENS, EXAMINING ATTORNEY

CLASS 35—(Continued).

SN 77-705,129. GARY, FAYE A., OCALA, FL. AND DAVIS-LEWIS, BETTYE, HOUSTON, TX. FILED 4-2-2009.

Institute of Excellence

THE MARK CONSISTS OF STANDARD CHARACTERS WITHOUT CLAIM TO ANY PARTICULAR FONT, STYLE, SIZE, OR COLOR.

NO CLAIM IS MADE TO THE EXCLUSIVE RIGHT TO USE "INSTITUTE", APART FROM THE MARK AS SHOWN.

FOR PROMOTING COLLABORATION WITHIN THE SCIENTIFIC, RESEARCH AND MEDICAL COMMUNITIES TO ACHIEVE ADVANCES IN THE FIELD OF HEALTHCARE; PROMOTING TECHNICAL AND SCIENTIFIC INVESTIGATION, RESEARCH, AND EXPERIMENTATION IN THE FIELD OF ADVANCEMENT OF THE APPLICATION OF SCIENTIFIC DISCOVERY FOR THE BETTERMENT OF HUMANKIND THROUGH SUPPORT OF EDUCATIONAL INSTITUTIONS AND SCIENTIFIC ORGANIZATIONS; PROMOTING THE EXCHANGE OF INFORMATION AND RESOURCES WITHIN THE SCIENTIFIC RESEARCH AND MEDICAL COMMUNITIES TO ACHIEVE ADVANCES IN THE FIELD OF HEALTHCARE; PROMOTING THE EXCHANGE OF INFORMATION AND RESOURCES WITHIN THE SCIENTIFIC RESEARCH COMMUNITIES TO ACHIEVE ADVANCES IN THE FIELD OF 21ST CENTURY TRANSFORMATIONAL SCIENCE (U.S. CLS. 100, 101 AND 102).

FIRST USE 8-0-2006; IN COMMERCE 8-0-2006.

KATHLEEN LORENZO, EXAMINING ATTORNEY

SN 77-707,462. JOHNSON, SAMYE J., DBA PINTO PONY COOKIE FACTORY, SAN AUGUSTINE, TX. FILED 4-6-2009.

SN 77-704,563. UNISOURCE WORLDWIDE, INC., NORCROSS, GA. FILED 4-1-2009.



OWNER OF U.S. REG. NOS. 3,325,554, 3,443,464 AND OTHERS.

NO CLAIM IS MADE TO THE EXCLUSIVE RIGHT TO USE ".COM", APART FROM THE MARK AS SHOWN.

THE COLOR(S) RED, BLACK, GRAY, AND WHITE IS/ARE CLAIMED AS A FEATURE OF THE MARK.

THE MARK CONSISTS OF RED UPPERCASE "U" WITH RED STRIPED SHADOW AND WHITE STRIPES; THE LITERAL ELEMENT "UNISOURCE" IN SOLID BLACK; THE LITERAL ELEMENT "DIRECT" IN BLACK, GRAY AND WHITE STRIPES, AND THE LITERAL ELEMENT ".COM" IN GRAY.

FOR ONLINE WHOLESALE DISTRIBUTORSHIP SERVICES IN THE FIELD OF PAPER AND INDUSTRIAL SUPPLIES, NAMELY, OFFICE AND STATIONERY PRODUCTS, MAINTENANCE AND CLEANING PREPARATIONS, FOOD SERVICE DISPOSABLES, SANITARY AND HEALTH CARE PRODUCTS, AND PACKAGING MATERIALS AND PACKAGING EQUIPMENT (U.S. CLS. 100, 101 AND 102).

SKYE YOUNG, EXAMINING ATTORNEY



NO CLAIM IS MADE TO THE EXCLUSIVE RIGHT TO USE "COOKIE FACTORY", APART FROM THE MARK AS SHOWN.

THE MARK CONSISTS OF THE STYLIZED WORDS "PINTO PONY COOKIE FACTORY". TO THE LEFT OF THE STYLIZED WORDS "PINTO PONY" IS AN IMAGE OF A HORSE'S HEAD FACING LEFT WITH FLOWING MANE.

FOR RETAIL STORE SERVICES FEATURING HOMEMADE COOKIES AVAILABLE IN GIFT BAGS, HAND CRAFTED TINS/BOXES AND T-SHIRTS AND BALL CAPS (U.S. CLS. 100, 101 AND 102).

FIRST USE 9-1-2007; IN COMMERCE 11-1-2007.

KIM SAITO, EXAMINING ATTORNEY

CLASS 35—(Continued).

SN 77-708,296. TAIGAN, LLC, NASHVILLE, TN. FILED 4-7-2009.

TAIGAN

THE MARK CONSISTS OF STANDARD CHARACTERS WITHOUT CLAIM TO ANY PARTICULAR FONT, STYLE, SIZE, OR COLOR.
 FOR ON-LINE RETAIL STORE SERVICES FEATURING FOOD, COLLECTIBLES, HOME DECOR, CLOTHING AND ARTWORK; PROMOTING THE GOODS AND SERVICES OF OTHERS VIA A GLOBAL COMPUTER NETWORK (U.S. CLS. 100, 101 AND 102).
 SKYE YOUNG, EXAMINING ATTORNEY

SN 77-708,571. JENCKS, ERIC, DBA VIRIDIAN, VISTA, CA. FILED 4-7-2009.



VIRIDIAN

I PROSPER | ENJOY | REPLENISH

THE COLOR(S) GREEN AND AQUA IS/ARE CLAIMED AS A FEATURE OF THE MARK.
 THE MARK CONSISTS OF A DESIGN OF SIX CIRCLE OVERLAPPING OR INTERLOCKING IN THE UPPER RIGHT PORTION OF THE MARK. BELOW THE DESIGN, CENTERED IN UPPERCASE STYLIZED FONT IS THE WORD "VIRIDIAN". BELOW THE WORD "VIRIDIAN" CENTERED IN UPPERCASE STYLIZED FONT ARE THE WORDS "I PROSPER | ENJOY | REPLENISH". THE COLOR GREEN IS LOCATED ON THE LETTERS "V", "R", "D", "A" AND "N" IN THE WORD "VIRIDIAN", AND ON THE WORDS "PROSPER", "ENJOY" AND "REPLENISH". THE COLOR AQUA APPEARS ON THE DESIGN, AND ON THE LETTER "I" THROUGHOUT THE MARK.
 FOR MANAGEMENT AND BUSINESS CONSULTING SERVICES IN THE FIELD OF PRACTICES AND POLICIES TO REDUCE THE ENVIRONMENTAL FOOTPRINT OF BUSINESS OPERATIONS AND STRUCTURES AND PRACTICES AND POLICIES CONCERNING THE MANAGEMENT OF NATURAL RESOURCES, THE DISPOSAL OF WASTE (U.S. CLS. 100, 101 AND 102).
 FIRST USE 10-0-2007; IN COMMERCE 10-0-2007.
 ANGELA M. MICHELI, EXAMINING ATTORNEY

CLASS 35—(Continued).

SN 77-709,980. LONGEVITY & WELLNESS ASSOCIATION, DILLON, SC. FILED 4-8-2009.



NO CLAIM IS MADE TO THE EXCLUSIVE RIGHT TO USE "WELLNESS ASSOCIATION" AND THE CADUCEUS SYMBOL, APART FROM THE MARK AS SHOWN.
 THE MARK CONSISTS OF THE STYLIZED TEXT "LONGEVITY & WELLNESS ASSOCIATION LIVE WELL. LIVE PROTECTED." WITH THE STYLIZED TEXT "LONGEVITY & WELLNESS ASSOCIATION" INSIDE A SHIELD. INSIDE THE SHIELD THERE IS ALSO A CADUCEUS SYMBOL.
 FOR MEMBERSHIP CLUB SERVICES PROVIDING DISCOUNTS AND PROCESSING REBATES FOR THE SERVICES OF OTHERS (U.S. CLS. 100, 101 AND 102).
 FIRST USE 6-1-2002; IN COMMERCE 6-1-2004.
 G. MAYERSCHOFF, EXAMINING ATTORNEY

SN 77-710,448. JADARA GROUP, SACRAMENTO, CA. FILED 4-9-2009.



JADARA GROUP

NO CLAIM IS MADE TO THE EXCLUSIVE RIGHT TO USE "GROUP", APART FROM THE MARK AS SHOWN.
 THE MARK CONSISTS OF THE STYLIZED WORDS "JADARA GROUP". ABOVE THE STYLIZED WORDS IS AN IMAGE OF AN ABSTRACT DESIGN IN THE FIGURE OF A MAN.
 FOR BUSINESS MANAGEMENT CONSULTANCY AS WELL AS DEVELOPMENT OF PROCESSES FOR THE ANALYSIS AND THE IMPLEMENTATION OF STRATEGY PLANS AND MANAGEMENT PROJECTS (U.S. CLS. 100, 101 AND 102).
 SHARON MEIER, EXAMINING ATTORNEY

CLASS 35—(Continued).

SN 77-711,019. XXTRAS ACCESSORIES INC., HUNTINGTON, NY. FILED 4-9-2009.



THE STIPPLING IS FOR SHADING PURPOSES ONLY. THE MARK CONSISTS OF THE WORD "XTRA'S" WITH A SECOND LARGE "X" IN THE BACKGROUND. FOR ON-LINE RETAIL STORE SERVICES FEATURING WOMEN'S CLOTHING AND FASHION ACCESSORIES (U.S. CLS. 100, 101 AND 102).
AISHA CLARKE, EXAMINING ATTORNEY

SN 77-711,881. HOME CARE PULSE, LLC, REXBURG, ID. FILED 4-10-2009.

**HOME
CARE
PULSE**

NO CLAIM IS MADE TO THE EXCLUSIVE RIGHT TO USE "HOME CARE", APART FROM THE MARK AS SHOWN.

THE MARK CONSISTS OF THE STYLIZED WORDING "HOME CARE PULSE" WITH A ZIG ZAG LINE SUGGESTIVE OF HEART MONITOR LINE FORMING THE LETTER A IN THE WORD "CARE" AND UNDERLINING THE WORD "CARE".

FOR CONDUCTING QUALITY ASSURANCE SURVEYS IN THE FIELD OF HOME HEALTH CARE SERVICES TO DETERMINE SERVICES QUALITY AND EMPLOYEE SATISFACTION; PROVIDING INFORMATION ON THE TOPIC OF PROVIDING JOB SATISFACTION (U.S. CLS. 100, 101 AND 102).

FIRST USE 4-1-2008; IN COMMERCE 2-26-2009.
JOHN SCHUYLER YARD, EXAMINING ATTORNEY

CLASS 35—(Continued).

SN 77-712,160. SHANNON T. PIRO, DBA SKINNY MATERNITY, SAN FRANCISCO, CA. FILED 4-12-2009.

Skinny Maternity

THE MARK CONSISTS OF STANDARD CHARACTERS WITHOUT CLAIM TO ANY PARTICULAR FONT, STYLE, SIZE, OR COLOR.

NO CLAIM IS MADE TO THE EXCLUSIVE RIGHT TO USE "MATERNITY", APART FROM THE MARK AS SHOWN.

FOR ARRANGING AND CONDUCTING SWAP MEETS IN THE FIELD OF NEW/USED MATERNITY AND BABY CLOTHES AND ACCESSORIES; ON-LINE CONSIGNMENT SERVICES WHEREBY GOODS ARE RECEIVED ON CONSIGNMENT IN ON-LINE RETAIL STORES FEATURING NEW/USED MATERNITY AND BABY CLOTHES AND ACCESSORIES; ON-LINE RETAIL CONSIGNMENT STORES FEATURING NEW/USED MATERNITY AND BABY CLOTHES AND ACCESSORIES; RETAIL CONSIGNMENT STORES IN THE FIELD OF NEW/USED MATERNITY AND BABY CLOTHES AND ACCESSORIES (U.S. CLS. 100, 101 AND 102).

FIRST USE 3-1-2008; IN COMMERCE 1-1-2009.
GINA FINK, EXAMINING ATTORNEY

SN 77-713,037. INTUITIVE MINDS INC., CHAPEL HILL, NC. FILED 4-13-2009.



INTUITIVEMINDS

THE COLOR(S) BLUE, ORANGE, AND YELLOW IS/ARE CLAIMED AS A FEATURE OF THE MARK.

THE MARK CONSISTS OF THE WORDING "INTUITIVE MINDS" DEPICTED IN BLUE, WHICH APPEARS TO THE LEFT AND UNDERNEATH A YELLOW AND ORANGE SILHOUETTE DESIGN OF THE SIDE OF A MAN'S HEAD ENCLOSED IN A CIRCLE WITH A YELLOW AND ORANGE BACKGROUND, AND INSIDE THE SILHOUETTE HEAD DESIGN ARE THREE MACHINE COGS WHICH ARE ORANGE IN COLOR.

FOR (BASED ON USE IN COMMERCE) ADVERTISING AGENCY SPECIALIZING IN THE DESIGN AND EXECUTION OF WORD OF MOUTH, VIRAL, BUZZ AND EXPERIENTIAL MARKETING PROGRAMS; ADVERTISING AND MARKETING; ADVERTISING AND MARKETING SERVICES, NAMELY, PROMOTING THE GOODS AND SERVICES OF OTHERS; ADVERTISING, MARKETING AND PROMOTION SERVICES; ADVERTISING, PROMOTION AND MARKETING SERVICES IN THE NATURE OF E-MAIL BLAST CAMPAIGNS FOR OTHERS; ADVICE IN THE FIELD OF BUSINESS MANAGEMENT AND MARKETING; ARRANGING SUBSCRIPTIONS OF THE ONLINE PUBLICATIONS OF OTHERS; ASSISTANCE, ADVISORY SERVICES AND CONSULTANCY WITH REGARD TO BUSINESS PLANNING, BUSINESS ANALYSIS, BUSINESS MANAGEMENT, BUSINESS ORGANIZATION, MARKETING AND CUSTOMER ANALYSIS; BRANDING SERVICES, NAMELY, CONSULTING, DEVELOPMENT, MANAGEMENT AND MARKETING OF BRANDS FOR BUSI-

CLASS 35—(Continued).

NESSSES; BUSINESS CONSULTATION AND MANAGEMENT REGARDING MARKETING ACTIVITIES AND LAUNCHING OF NEW PRODUCTS; BUSINESS MANAGEMENT CONSULTING WITH RELATION TO STRATEGY, MARKETING, PRODUCTION, PERSONNEL AND RETAIL SALE MATTERS; BUSINESS MANAGEMENT CONSULTING WITH RELATION TO STRATEGY, MARKETING, SALES, OPERATION, PRODUCT DESIGN PARTICULARLY SPECIALIZING IN THE USE OF ANALYTIC AND STATISTIC MODELS FOR THE UNDERSTANDING AND PREDICTING OF CONSUMERS, BUSINESSES, AND MARKET TRENDS AND ACTIONS; BUSINESS MARKETING AND DIRECT MAIL CONSULTING SERVICES; BUSINESS MARKETING CONSULTING SERVICES; BUSINESS MARKETING SERVICES; BUSINESS TO BUSINESS DIRECT MARKETING SERVICES; CONDUCTING MARKETING STUDIES; CREATION OF MARKETING TOOLS DESIGNED TO INCREASE A CLIENT COMPANY'S KNOWLEDGE OF CUSTOMER NEEDS, AND ITS COMPETITORS' PRODUCTS AND SERVICES, PRICING, ADVERTISING STRATEGY AND SALES STRATEGY; CREATIVE MARKETING DESIGN SERVICES; DEVELOPMENT OF MARKETING STRATEGIES AND CONCEPTS; DIRECT MARKETING ADVERTISING FOR OTHERS; DIRECT MARKETING CONSULTING SERVICES; DIRECT MARKETING SERVICES; IMPLEMENTATION AND FOLLOW-UP OF ADVICE IN THE FIELDS OF MARKETING; INFORMATION OR ENQUIRIES ON BUSINESS AND MARKETING; MARKETING ANALYSIS SERVICES; MARKETING AND BRANDING SERVICES, NAMELY, PERFORMING CONSUMER INSIGHT AND BRAND STRATEGY OF COMPANY LOGOS; MARKETING CONSULTING; MARKETING PLAN DEVELOPMENT; MARKETING SERVICES IN THE FIELD OF PLANNED-GIVING FOR NON-PROFIT AND CHARITABLE ORGANIZATIONS; MARKETING SERVICES, NAMELY, CONDUCTING CONSUMER TRACKING BEHAVIOR RESEARCH AND CONSUMER TREND ANALYSIS; MARKETING SERVICES, NAMELY, CONSUMER MARKETING RESEARCH; MARKETING SERVICES, NAMELY, PROVIDING INFORMATIONAL WEB PAGES DESIGNED TO GENERATE SALES TRAFFIC VIA HYPERLINKS TO OTHER WEB SITES; MEDIA PLANNING, NAMELY, ADVISING THE CLIENT ON THE CORRECT TIMES AND STATIONS TO ADVERTISE BASED ON MEDIA ANALYSIS OF THE MARKET FOR THAT MEDIA; ON-LINE ADVERTISING AND MARKETING SERVICES; PROMOTING, ADVERTISING AND MARKETING OF THE ON-LINE WEB SITES OF OTHERS; PROMOTION AND MARKETING SERVICES AND RELATED CONSULTING; PROMOTION, ADVERTISING AND MARKETING OF ON-LINE WEBSITES; PROMOTIONAL SERVICES, NAMELY, GUERRILLA MARKETING SERVICES; PROVIDING INFORMATION IN THE FIELD OF MARKETING AND ON-LINE MARKETING MEDIA VIA THE INTERNET; PROVIDING ONLINE BUSINESS MANAGEMENT SERVICES INCLUDING ACCOUNTING, MARKETING, BUSINESS PROJECT MANAGEMENT, AND BUSINESS DEVELOPMENT; PROVIDING PROMOTIONAL MARKETING SERVICES TO BUSINESSES IN THE BROADBAND AND MEDIA INDUSTRIES; SOCIAL MEDIA STRATEGY AND MARKETING CONSULTANCY FOCUSING ON HELPING CLIENTS CREATE AND EXTEND THEIR PRODUCT AND BRAND STRATEGIES BY BUILDING VIRALLY ENGAGING MARKETING SOLUTIONS; STATISTICAL EVALUATIONS OF MARKETING DATA(BASED ON INTENT TO USE) ADVERTISING AND DIRECTORY SERVICES, NAMELY, PROMOTING THE SERVICES OF OTHERS BY PROVIDING A WEB PAGE FEATURING LINKS TO THE WEBSITES OF OTHERS; ADVERTISING SERVICES, NAMELY, PROMOTING AND MARKETING THE GOODS AND SERVICES OF OTHERS IN THE FIELD OF UPSCALE CHOICES SUCH AS CULTURAL EVENTS, RESTAURANTS, SHOPPING, AND TRAVEL VIA PRINT AND ELECTRONIC MEDIA; ADVERTISING SERVICES, NAMELY, PROMOTING AND MARKETING THE GOODS AND SERVICES OF OTHERS THROUGH ALL PUBLIC COMMUNICATION MEANS; ADVERTISING SERVICES, PUBLIC RELATIONS AND MARKETING SERVICES, NAMELY, PROMOTING AND MARKETING THE GOODS AND SERVICES OF OTHERS THROUGH ALL PUBLIC COMMUNICATION MEANS; ADVERTISING, MARKETING AND PROMOTIONAL SERVICES FOR AUTOMOTIVE DEALERSHIPS; ADVERTISING, MARKETING AND PROMOTIONAL SERVICES

CLASS 35—(Continued).

RELATED TO ALL INDUSTRIES FOR THE PURPOSE OF FACILITATING NETWORKING AND SOCIALIZING OPPORTUNITIES FOR BUSINESS PURPOSES; ARRANGING AND CONDUCTING MARKETING PROMOTIONAL EVENTS FOR OTHERS; BUSINESS MANAGEMENT AND CONSULTING SERVICES FOR THE HEALTH CARE INDUSTRY, NAMELY, CUSTOMER SERVICE, ACCOUNTING SERVICES, AND WEB-BASED ADVERTISING AND MARKETING SERVICES; BUSINESS MANAGEMENT CONSULTING WITH RELATION TO STRATEGY, FINANCING, MARKETING, PRODUCTION, PERSONNEL AND SALE MATTERS FOR COMPANIES INVOLVED WITH THIN FILM AND NANO TECHNOLOGIES AND PLASMA PROCESSES; BUSINESS MARKETING CONSULTING SERVICES TO CHILD-CARE ORGANIZATIONS; COMMERCIAL INFORMATION AGENCIES; CONSULTING SERVICES IN THE FIELD OF MARKETING OF EDUCATIONAL TRAINING; COOPERATIVE ADVERTISING AND MARKETING; COOPERATIVE ADVERTISING AND MARKETING SERVICES BY WAY OF SOLICITATION, CUSTOMER SERVICE AND PROVIDING MARKETING INFORMATION VIA WEB SITES ON A GLOBAL COMPUTER NETWORK; CUSTOM WRITING SERVICES COMPRISING PUBLIC RELATIONS AND MARKETING MATERIALS FOR THE AUDIO, VIDEO AND TECHNOLOGY INDUSTRIES; MARKETING AND ADVERTISING SERVICES FOR AUTOMOBILE DEALERSHIPS; MARKETING SERVICES, NAMELY, PROVIDING ON-LINE NON-DOWNLOADABLE VIDEOS TO PROMOTE DOCTORS AND MEDICAL PRACTICES; MARKETING, ADVERTISING AND PROMOTING THE GOODS AND SERVICES OF OTHERS IN THE FIELD OF TRAVEL AND TOURISM, NAMELY, PROVIDING INFORMATION VIA MAIL AND ELECTRONIC MAIL; MARKETING, ADVERTISING, AND PROMOTING THE RETAIL GOODS AND SERVICES OF OTHERS TO WIRELESS ELECTRONIC DEVICES; MARKETING, PROMOTIONAL AND ADVERTISING SERVICES PROVIDED BY MOBILE TELEPHONE CONNECTIONS; ON-LINE CONSIGNMENT SERVICES WHEREBY GOODS ARE RECEIVED ON CONSIGNMENT FOR AUCTION ON AN ONLINE AUCTION SITE; OUTSOURCING IN THE FIELD OF SALES AND MARKETING OF COMPUTER SOFTWARE; PROMOTING AND MARKETING THE DELIVERY OF WATER WITHOUT GREENHOUSE GAS EMISSIONS; PROMOTIONAL MARKETING AND REPRESENTATION SERVICES FOR SALES TO THE PUBLIC SECTOR; PROVIDING A SEARCHABLE ONLINE ADVERTISING GUIDE FEATURING THE GOODS AND SERVICES OF OTHER ON-LINE VENDORS ON THE INTERNET; PROVIDING A WEB SITE THAT FEATURES AN ON-LINE MARKET FOR USERS TO LIST OFFERED OR WANTED PERSONAL AND BUSINESS ASSETS AND SKILLS FOR HIRE, RENT, SALE OR AUCTION TRANSACTION ON THE BASIS OF PREDEFINED PERFORMANCE AND CLOSING TERMS AND CONDITIONS; PROVIDING ADVERTISING, MARKETING AND PROMOTIONAL SERVICES FOR THE PHARMACEUTICAL AND MEDICAL INDUSTRY; PROVIDING ADVERTISING, MARKETING AND PROMOTIONAL SERVICES FOR THE PHARMACEUTICAL AND MEDICAL PRODUCTS OF OTHERS; PROVIDING BUSINESS MARKETING INFORMATION; PROVIDING MARKETING AND PROMOTION OF SPECIAL EVENTS; PROVIDING ON-LINE DIRECTORY INFORMATION SERVICES ALSO FEATURING HYPERLINKS TO OTHER WEB SITES; PUBLIC RELATIONS, ADVERTISING AND MARKETING SERVICES FOR THE TOURISM AND CONVENTION INDUSTRY, NAMELY, ORGANIZING AND HOSTING SITE INSPECTIONS AND FAMILIARIZATION TOURS FOR WHOLESALERS, TOUR OPERATORS, TRAVEL AGENTS, MEETING AND INCENTIVE TRAVEL PLANNERS AND TRAVEL MEDIA; REAL ESTATE MARKETING SERVICES, NAMELY, ON-LINE SERVICES FEATURING THE PROMOTION OF RESIDENTIAL NEW CONSTRUCTION, WHICH ALSO CONTAINS BACK OFFICE SOLUTIONS FOR BUILDERS; REAL

CLASS 35—(Continued).

ESTATE MARKETING SERVICES, NAMELY, ON-LINE SERVICES FEATURING TOURS OF RESIDENTIAL AND COMMERCIAL REAL ESTATE; RENTAL OF ALL PUBLICITY AND MARKETING PRESENTATION MATERIALS; THE BRINGING TOGETHER, FOR THE BENEFIT OF OTHERS, OF A VARIETY OF GOODS AND SERVICES, ENABLING CUSTOMERS TO CONVENIENTLY VIEW AND PURCHASE THOSE GOODS AND SERVICES FROM AN INTERNET WEB SITE PARTICULARLY SPECIALIZING IN THE MARKETING OF THE SALE OF GOODS AND SERVICES OF OTHERS (U.S. CLS. 100, 101 AND 102).

FIRST USE 10-27-2007; IN COMMERCE 10-27-2007.
TINA L. SNAPP, EXAMINING ATTORNEY

CLASS 35—(Continued).

SN 77-714,781. OVERSTOCK.COM, INC., SALT LAKE CITY, UT. FILED 4-15-2009.

WORLDSTOCK FAIR TRADE

THE MARK CONSISTS OF STANDARD CHARACTERS WITHOUT CLAIM TO ANY PARTICULAR FONT, STYLE, SIZE, OR COLOR.

OWNER OF U.S. REG. NOS. 2,945,081 AND 2,945,082.

NO CLAIM IS MADE TO THE EXCLUSIVE RIGHT TO USE "FAIR TRADE", APART FROM THE MARK AS SHOWN.

FOR ON-LINE WHOLESALE AND RETAIL STORE SERVICES FEATURING GENERAL CONSUMER MERCHANDISE THAT MEET FAIR TRADE STANDARDS (U.S. CLS. 100, 101 AND 102).

FONG HSU, EXAMINING ATTORNEY

SN 77-713,066. VICTOR POON, ROSEMEAD, CA. FILED 4-14-2009.



THE COLOR(S) WHITE, BLACK, BLUE IS/ARE CLAIMED AS A FEATURE OF THE MARK.

THE MARK CONSISTS OF A BLACK SPACE FIGHTER WITH WHITE EDGE LINES IS FLYING OUT OF THE TOP RIGHT HAND CORNER OF A ROUNDED RECTANGULAR BOX. SHOOTING OUT OF THE BACK OF THE FIGHTER IS A WHITE ENGINE BURST. UNDERNEATH THE SPACE FIGHTER IS THE WORD "DREAM" WHICH IS IN BLUE WITH EACH LETTER OUTLINED WITH A BLACK AND WHITE BORDER.

FOR BUSINESS CONSULTING SERVICES, NAMELY, PROVIDING ASSISTANCE IN DEVELOPMENT OF BUSINESS STRATEGIES AND CREATIVE IDEATION (U.S. CLS. 100, 101 AND 102).

FIRST USE 6-1-2007; IN COMMERCE 11-1-2007.
JOHN SCHUYLER YARD, EXAMINING ATTORNEY

SN 77-714,791. OVERSTOCK.COM, INC., SALT LAKE CITY, UT. FILED 4-15-2009.



OWNER OF U.S. REG. NOS. 2,945,081 AND 2,945,082.

NO CLAIM IS MADE TO THE EXCLUSIVE RIGHT TO USE "FAIR TRADE", APART FROM THE MARK AS SHOWN.

THE MARK CONSISTS OF THE WORDS "WORLDSTOCK FAIR TRADE" AND A DESIGN OF A COMPASS.

FOR ON-LINE WHOLESALE AND RETAIL STORE SERVICES FEATURING GENERAL CONSUMER MERCHANDISE THAT MEET FAIR TRADE STANDARDS (U.S. CLS. 100, 101 AND 102).

FONG HSU, EXAMINING ATTORNEY

CLASS 35—(Continued).

SN 77-714,797. OVERSTOCK.COM, INC., SALT LAKE CITY, UT. FILED 4-15-2009.



OWNER OF U.S. REG. NOS. 2,945,081 AND 2,945,082.
NO CLAIM IS MADE TO THE EXCLUSIVE RIGHT TO USE "FAIR TRADE", APART FROM THE MARK AS SHOWN.

THE MARK CONSISTS OF THE WORDS "WORLDSTOCK FAIR TRADE" AND A DESIGN OF A BRANCH.

FOR ON-LINE WHOLESALE AND RETAIL STORE SERVICES FEATURING GENERAL CONSUMER MERCHANDISE THAT MEET FAIR TRADE STANDARDS (U.S. CLS. 100, 101 AND 102).

FONG HSU, EXAMINING ATTORNEY

SN 77-715,002. OUTDOOR SPORTS PRODUCTS, LLC, SPOKANE, WA. FILED 4-16-2009.



NO CLAIM IS MADE TO THE EXCLUSIVE RIGHT TO USE "OUTDOOR SPORTS PRODUCTS.COM", APART FROM THE MARK AS SHOWN.

THE COLOR(S) RED, WHITE, AND BLACK IS/ARE CLAIMED AS A FEATURE OF THE MARK.

THE MARK CONSISTS OF THE WORDS "OUTDOOR SPORTS PRODUCTS.COM" WRITTEN IN SMALL RED CAPITAL LETTERS, EXCEPT FOR THE ".COM" PORTION IS WRITTEN IN BLACK. THERE IS A SMALL WHITE LINE RUNNING HORIZONTALLY THROUGH THE UPPER PORTION OF THE LETTERING. ABOVE THE LEFT SIDE OF "OUTDOOR SPORTS PRODUCTS.COM" THE LETTERS "OSP" ARE WRITTEN IN LARGE BLACK CAPITAL LETTERING. THERE IS A WHITE LINE RUNNING HORIZONTALLY THROUGH THE TOP PORTION OF THE LETTERING. WITHIN THE "O" THERE IS A RED DOT.

FOR WHOLESALE DISTRIBUTORSHIPS FEATURING ARCHERY EQUIPMENT, CAMPING GEAR, GUNS, SPORTING GOODS, CLOTHING, OUTDOOR COOKING PRODUCTS (U.S. CLS. 100, 101 AND 102).

FIRST USE 1-1-2009; IN COMMERCE 1-1-2009.
JORDAN BAKER, EXAMINING ATTORNEY

CLASS 35—(Continued).

SN 77-715,753. WASHINGTON, RICHARD CHARLES, TEMPE, AZ. FILED 4-16-2009.



NO CLAIM IS MADE TO THE EXCLUSIVE RIGHT TO USE "OFFICIAL" AND "MADE IN ARIZONA", APART FROM THE MARK AS SHOWN.

THE NAME "DOK WASHINGTON" IDENTIFIES THE NICKNAME OF RICHARD CHARLES WASHINGTON, A LIVING INDIVIDUAL WHOSE CONSENT IS OF RECORD.

THE COLOR(S) RED AND BLACK IS/ARE CLAIMED AS A FEATURE OF THE MARK.

THE MARK CONSISTS OF A RED RECTANGULAR BACKGROUND WITH THE STYLIZED BLACK WORDS "THE RED RAGS OF RAGE" CENTERED ON THE RECTANGLE. ABOVE THE RED RAGS OF RAGE ARE THE STYLIZED BLACK WORDS "DOK WASHINGTON'S OFFICIAL" AND BELOW ARE THE STYLIZED BLACK WORDS "MADE IN ARIZONA".

FOR PROVIDING ADVERTISING, MARKETING AND PROMOTIONAL SERVICES, NAMELY, DEVELOPMENT OF ADVERTISING CAMPAIGNS FOR SPORTING EVENTS; PUBLISHING OF ADVERTISING TEXTS; SPECIALTY MERCHANDISING SERVICES, NAMELY, PROMOTING THE GOODS AND SERVICES OF OTHERS THROUGH THE DISTRIBUTION OF CUSTOMIZED ADVERTISING MATERIALS, NAMELY, TOWELS (U.S. CLS. 100, 101 AND 102).

KOURTNEE HODGES, EXAMINING ATTORNEY

SN 77-716,319. DATA SOURCE OF LOUDOUN, INC., LEESBURG, VA. FILED 4-17-2009.

EMPLOYER FIND

THE MARK CONSISTS OF STANDARD CHARACTERS WITHOUT CLAIM TO ANY PARTICULAR FONT, STYLE, SIZE, OR COLOR.

NO CLAIM IS MADE TO THE EXCLUSIVE RIGHT TO USE "EMPLOYER", APART FROM THE MARK AS SHOWN.

FOR PROVIDING AN ON-LINE COMMERCIAL INFORMATION DIRECTORY ON THE INTERNET; PROVIDING AN ON-LINE COMPUTER DATABASE FEATURING TRADE INFORMATION IN THE FIELD OF IDENTIFICATION OF EMPLOYERS AND EMPLOYER INFORMATION FOR INDIVIDUAL DONORS TO NON-PROFIT ORGANIZATIONS; PROVIDING AN ON-LINE DIRECTORY INFORMATION SERVICE FEATURING INFORMATION REGARDING IDENTIFICATION OF EMPLOYERS AND EMPLOYER INFORMATION FOR INDIVIDUAL DONORS TO NON-PROFIT ORGANIZATIONS; PROVIDING BUSINESS INFORMATION, ALSO VIA INTERNET, THE CABLE NETWORK OR OTHER FORMS OF DATA TRANSFER (U.S. CLS. 100, 101 AND 102).

FIRST USE 3-5-2009; IN COMMERCE 3-5-2009.
KATHERINE CONNOLLY, EXAMINING ATTORNEY

CLASS 35—(Continued).

SN 77-716,950. ECOGEE, INC., AURORA, CO. FILED 4-18-2009.



THE COLOR(S) GREEN, DARK BLUE AND LIGHT BLUE IS/ARE CLAIMED AS A FEATURE OF THE MARK.

THE MARK CONSISTS OF THE TERM "ECOGEE" IN GREEN WITH THE LETTER "O" REPRESENTED BY A LIGHT BLUE GLOBE WITH GREEN CONTINENTS; THE SLOGAN "EMPOWERING PEOPLE WITH POWER" APPEARS IN DARK BLUE BELOW "ECOGEE".

FOR ENERGY MANAGEMENT SERVICES, NAMELY, PROVIDING A SERVICE THAT ALLOWS CUSTOMERS TO PURCHASE ENERGY, NAMELY, ELECTRICITY, NATURAL GAS AND RENEWABLE ENERGY, AT A FIXED PRICE (U.S. CLS. 100, 101 AND 102).

FIRST USE 2-12-2009; IN COMMERCE 3-1-2009.
G. MAYERSCHOFF, EXAMINING ATTORNEY

CLASS 35—(Continued).

SN 77-717,547. GREEN IS GOLDEN MARKETING, INC., PEMBROKE PINES, FL. FILED 4-20-2009.

GREEN IS GOLDEN MARKETING,
INC.

THE MARK CONSISTS OF STANDARD CHARACTERS WITHOUT CLAIM TO ANY PARTICULAR FONT, STYLE, SIZE, OR COLOR.

NO CLAIM IS MADE TO THE EXCLUSIVE RIGHT TO USE "MARKETING, INC.", APART FROM THE MARK AS SHOWN.

FOR ADVERTISING SERVICES, NAMELY, MARKETING, PROMOTIONS, PUBLIC RELATIONS (U.S. CLS. 100, 101 AND 102).

FIRST USE 2-2-2009; IN COMMERCE 2-7-2009.
FRANK LATTUCA, EXAMINING ATTORNEY

SN 77-717,471. CLICK3C.COM, LLC, DAYTONA BEACH, FL. FILED 4-20-2009.



THE MARK CONSISTS OF A CIRCLE WITH THE WORDING "WWW.CLICK3C.COM" ON TOP OF THE PERIMETER OF A CIRCLE AND THE WORDING "COMPLIMENT" SEPARATED BY AN ARROW FROM "COMPLIMENT" BELOW THE PERIMETER OF THE CIRCLE, THE INTERIOR OF THE CIRCLE CONTAINING A SINGLE FIVE POINTED STAR CONNECTED TO TWO CIRCLES.

FOR PROVIDING A WEB SITE FOR INDIVIDUALS TO SUBMIT COMPLAINTS, COMPLIMENTS, AND SUGGESTIONS TO ALL TYPES OF BUSINESSES AND GOVERNMENTAL ENTITIES (U.S. CLS. 100, 101 AND 102).

RAUL CORDOVA, EXAMINING ATTORNEY

SN 77-717,761. RETIRELIFE, INC., BROOKLINE, MA. FILED 4-20-2009.

RetireLife

THE MARK CONSISTS OF STANDARD CHARACTERS WITHOUT CLAIM TO ANY PARTICULAR FONT, STYLE, SIZE, OR COLOR.

FOR PROMOTING THE GOODS AND SERVICES OF OTHERS BY PROVIDING A WEB SITE AT WHICH USERS CAN LINK TO INFORMATION ABOUT PRODUCTS AND SERVICES OF INTEREST TO SENIOR CITIZENS, NAMELY, RETIREMENT HOMES, ASSISTED LIVING COMMUNITIES, ADULT COMMUNITIES, NURSING HOMES, IN-HOME NURSING CARE, COMPANIONSHIP SERVICES, TRANSPORTATION SERVICES, ADULT DAY CARE SERVICES, PHYSICAL FITNESS, EXERCISE, OUTDOOR ACTIVITIES, AND MEDICAL EQUIPMENT PRODUCTS AND SERVICES (U.S. CLS. 100, 101 AND 102).

MELVIN AXILBUND, EXAMINING ATTORNEY

CLASS 35—(Continued).

SN 77-718,653. THE COOK'S WAREHOUSE, INC., ATLANTA, GA. FILED 4-21-2009.

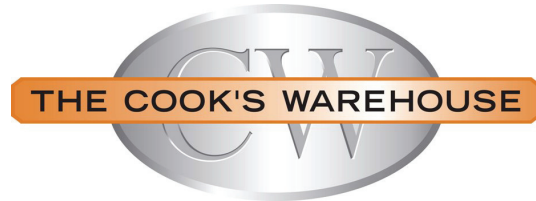

NO CLAIM IS MADE TO THE EXCLUSIVE RIGHT TO USE "COOK'S WAREHOUSE", APART FROM THE MARK AS SHOWN.

THE COLOR(S) BLACK, WHITE, GRAY, ORANGE, LIGHT GRAY AND LIGHT ORANGE IS/ARE CLAIMED AS A FEATURE OF THE MARK.

THE MARK CONSISTS OF A BANNER WITH THE WORDS "THE COOK'S WAREHOUSE" IN BLACK, THE BANNER BEING ORANGE ON THE ENDS AND LIGHT ORANGE IN THE MIDDLE, AND UNDER THE BANNER IS A CIRCLE WITH THE LETTERS "CW" IN GRAY, THE CIRCLE BEING GRAY ON THE ENDS AND LIGHT GRAY IN THE MIDDLE, AND THE BANNER AND CIRCLE ARE ON A WHITE BACKGROUND.

FOR RETAIL STORE SERVICES AND ON-LINE RETAIL STORE SERVICES IN THE FIELD OF COOKWARE, KITCHEN SUPPLIES, COOKING UTENSILS, KITCHEN APPLIANCES, GOURMET FOOD PRODUCTS, BAR ACCESSORIES, GLASSWARE, TABLEWARE, JACKETS, APRONS, HATS AND SHOES (U.S. CLS. 100, 101 AND 102).

FIRST USE 12-0-1994; IN COMMERCE 3-0-1995.
KATHLEEN M. VANSTON, EXAMINING ATTORNEY

SN 77-719,062. LZ DELTA, LLC, SCOTTSDALE, AZ. FILED 4-21-2009.



NO CLAIM IS MADE TO THE EXCLUSIVE RIGHT TO USE "AZ MOTORCYCLES", APART FROM THE MARK AS SHOWN.

THE COLOR(S) BLACK, BLUE, BROWN, RED, YELLOW AND WHITE IS/ARE CLAIMED AS A FEATURE OF THE MARK.

THE MARK CONSISTS OF A TRIANGULAR SHIELD WITH CURVED SIDES FORMED BY BROWN AND WHITE LINES. A BROWN, FIVE-POINT STAR IS IN THE MIDDLE OF THE SHIELD. RED AND YELLOW LINES RADIATE FROM THE TOP OF THE STAR. A BLUE BACKGROUND IS BEHIND THE LOWER HALF OF THE STAR. THE WORDING, "GO AZ MOTORCYCLES" IS CENTERED IN BLACK OVER THE LOWER THIRD OF THE SHIELD.

FOR ON-LINE RETAIL STORE AND RETAIL STORE SERVICES FEATURING MOTORCYCLES, MOTORCYCLE ACCESSORIES AND PARTS (U.S. CLS. 100, 101 AND 102).

FIRST USE 6-26-2008; IN COMMERCE 6-26-2008.
IRA J. GOODSAD, EXAMINING ATTORNEY

CLASS 35—(Continued).

SN 77-719,738. SKY RESORT MANAGEMENT, LLC, ORLANDO, FL. FILED 4-22-2009.

Palisades Resort

THE MARK CONSISTS OF STANDARD CHARACTERS WITHOUT CLAIM TO ANY PARTICULAR FONT, STYLE, SIZE, OR COLOR.

NO CLAIM IS MADE TO THE EXCLUSIVE RIGHT TO USE "RESORT", APART FROM THE MARK AS SHOWN, FOR MANAGING AND OPERATING RESORT HOTELS AND BUSINESS CONFERENCE CENTERS OF OTHERS (U.S. CLS. 100, 101 AND 102).

FIRST USE 1-15-2008; IN COMMERCE 1-15-2008.
ALEX KEAM, EXAMINING ATTORNEY

SN 77-720,003. COMMUNITY SHOPPER, LLC, MALIBU, CA. FILED 4-22-2009.



NO CLAIM IS MADE TO THE EXCLUSIVE RIGHT TO USE "COMMUNITY SHOPPER", APART FROM THE MARK AS SHOWN.

FOR ONLINE TRADING SERVICES TO FACILITATE THE SALE OF GOODS AND SERVICES BY OTHERS VIA A COMPUTER NETWORK (U.S. CLS. 100, 101 AND 102).
MARK SPARACINO, EXAMINING ATTORNEY

SN 77-720,086. TABLE BAY FINANCIAL NETWORK, INC., WOODLAND HILLS, CA. FILED 4-22-2009.

CPA ADVANTAGE EDGE PROGRAM

THE MARK CONSISTS OF STANDARD CHARACTERS WITHOUT CLAIM TO ANY PARTICULAR FONT, STYLE, SIZE, OR COLOR.

NO CLAIM IS MADE TO THE EXCLUSIVE RIGHT TO USE "CPA" AND "PROGRAM", APART FROM THE MARK AS SHOWN.

FOR MARKETING STRATEGY SERVICES (U.S. CLS. 100, 101 AND 102).
FIRST USE 1-1-2004; IN COMMERCE 1-1-2004.
RAUL CORDOVA, EXAMINING ATTORNEY

CLASS 35—(Continued).

SN 77-720,335. FBD PARTNERSHIP, LP, SAN ANTONIO, TX. FILED 4-23-2009.

OUR EXPERTISE IS FROZEN

THE MARK CONSISTS OF STANDARD CHARACTERS WITHOUT CLAIM TO ANY PARTICULAR FONT, STYLE, SIZE, OR COLOR.

FOR WHOLESALE ORDERING SERVICES FEATURING DISPENSING UNITS FOR FROZEN BEVERAGES AND DESSERTS, AND CARTS FOR USE THEREWITH; WHOLESALE ORDERING SERVICES FEATURING DISPENSERS FOR CUPS AND STRAWS; RETAIL SERVICES BY DIRECT SOLICITATION BY SALES AGENTS FEATURING DISPENSING UNITS FOR FROZEN BEVERAGES AND DESSERTS, AND CARTS FOR USE THEREWITH; RETAIL SERVICES BY DIRECT SOLICITATION BY SALES AGENTS FEATURING DISPENSERS FOR CUPS AND STRAWS (U.S. CLS. 100, 101 AND 102). FIRST USE 8-6-2006; IN COMMERCE 8-6-2006.

ALICE BENMAMAN, EXAMINING ATTORNEY

SN 77-720,439. TRACY WILLIAMS, RENO, NV. FILED 4-23-2009.

IPPIDY

THE MARK CONSISTS OF STANDARD CHARACTERS WITHOUT CLAIM TO ANY PARTICULAR FONT, STYLE, SIZE, OR COLOR.

FOR ADVERTISING SERVICES VIA THE INTERNET THROUGH AN INTERACTIVE PORTAL TO PROMOTE BRAND LOYALTY AND INFLUENCE OTHER USERS OF THE PORTAL TOWARD LOYALTY TO CERTAIN BRANDS WHEREBY USERS OF THE PORTAL ARE ELIGIBLE FOR DIRECT COMPENSATION FROM THE PORTAL COMPANY AS WELL AS PROMOTIONAL ITEMS, REBATES, DISCOUNTS, AND SPECIAL OFFERINGS ON GOODS AND/OR SERVICES (U.S. CLS. 100, 101 AND 102).

ESTHER A. BORSUK, EXAMINING ATTORNEY

CLASS 35—(Continued).

SN 77-720,860. AITCHISON, ERIC W, DBA HEARTLAND WASTE SOLUTIONS, IOWA CITY, IA. FILED 4-23-2009.

Heartland Waste Solutions

THE MARK CONSISTS OF STANDARD CHARACTERS WITHOUT CLAIM TO ANY PARTICULAR FONT, STYLE, SIZE, OR COLOR.

NO CLAIM IS MADE TO THE EXCLUSIVE RIGHT TO USE "WASTE SOLUTIONS", APART FROM THE MARK AS SHOWN.

FOR BUSINESS CONSULTATION IN THE FIELD OF WASTE DISPOSAL AND RECYCLING (U.S. CLS. 100, 101 AND 102).

FIRST USE 6-23-2004; IN COMMERCE 10-13-2004.

MICHELE SWAIN, EXAMINING ATTORNEY

SN 77-720,882. THE MACHINE GROUP, LLC, TAMPA, FL. FILED 4-23-2009.

LawMachine

THE MARK CONSISTS OF STANDARD CHARACTERS WITHOUT CLAIM TO ANY PARTICULAR FONT, STYLE, SIZE, OR COLOR.

FOR PROVIDING AN ONLINE DIRECTORY OF LAWYERS AND LEGAL SERVICES, FEATURING PROFILES OF LEGAL PROFESSIONALS RENDERING LEGAL SERVICES; PROVIDING A WEBSITE WHEREBY LAWYERS CAN BID TO WORK ON PENDING LEGAL MATTERS (U.S. CLS. 100, 101 AND 102).

LAURA KOVALSKY, EXAMINING ATTORNEY

SN 77-720,903. AARP, WASHINGTON, DC. FILED 4-23-2009.

VITALITY PROJECT

THE MARK CONSISTS OF STANDARD CHARACTERS WITHOUT CLAIM TO ANY PARTICULAR FONT, STYLE, SIZE, OR COLOR.

NO CLAIM IS MADE TO THE EXCLUSIVE RIGHT TO USE "PROJECT", APART FROM THE MARK AS SHOWN.

FOR PROMOTING PUBLIC AWARENESS OF THE NEED FOR HEALTH CARE IMPROVEMENTS AND HEALTHY URBAN POPULATIONS; BUSINESS ADMINISTRATION AND MANAGEMENT SERVICES, NAMELY, ADMINISTRATION OF PROGRAMS IN THE FIELD OF HEALTH CARE IMPROVEMENTS AND HEALTHY URBAN POPULATIONS (U.S. CLS. 100, 101 AND 102).

STEVEN R. FINE, EXAMINING ATTORNEY

CLASS 35—(Continued).

SN 77-721,059. SPHERION ATLANTIC ENTERPRISES LLC, FT. LAUDERDALE, FL. FILED 4-23-2009.

Provali Group

THE MARK CONSISTS OF STANDARD CHARACTERS WITHOUT CLAIM TO ANY PARTICULAR FONT, STYLE, SIZE, OR COLOR.

NO CLAIM IS MADE TO THE EXCLUSIVE RIGHT TO USE "GROUP", APART FROM THE MARK AS SHOWN.

FOR OUTSOURCING IN THE FIELD OF INFORMATION TECHNOLOGY (U.S. CLS. 100, 101 AND 102).

FIRST USE 4-1-2009; IN COMMERCE 4-1-2009.

JEFFREY LOOK, EXAMINING ATTORNEY

SN 77-721,084. HEB GROCERY COMPANY, LP, SAN ANTONIO, TX. FILED 4-23-2009.

CARTS MARKET

THE MARK CONSISTS OF STANDARD CHARACTERS WITHOUT CLAIM TO ANY PARTICULAR FONT, STYLE, SIZE, OR COLOR.

NO CLAIM IS MADE TO THE EXCLUSIVE RIGHT TO USE "MARKET", APART FROM THE MARK AS SHOWN.

FOR RETAIL GROCERY STORE SERVICES (U.S. CLS. 100, 101 AND 102).

LAKEISHA LEWIS, EXAMINING ATTORNEY

SN 77-721,109. ARCA BIOPHARMA, INC., BROOMFIELD, CO. FILED 4-23-2009.

GEN4HF
The Integrated Genetics Registry
for Heart Failure

NO CLAIM IS MADE TO THE EXCLUSIVE RIGHT TO USE "THE INTEGRATED GENETICS REGISTRY FOR HEART FAILURE", APART FROM THE MARK AS SHOWN.

THE MARK CONSISTS OF "GEN4HF" PRINTED LARGER AND ABOVE "THE INTEGRATED GENETICS REGISTRY FOR HEART FAILURE" WORDS.

FOR MAINTAINING AN ONLINE GENETIC REGISTRY FOR USE IN THE FIELD OF THERAPEUTIC MANAGEMENT OF CARDIOVASCULAR DISEASE (U.S. CLS. 100, 101 AND 102).

KHANH LE, EXAMINING ATTORNEY

CLASS 35—(Continued).

SN 77-721,459. AYDIN, SELMA, DBA LOVEANDCHIC, ANKARA, TURKEY, FILED 4-24-2009.

LoveAndChic

THE MARK CONSISTS OF STANDARD CHARACTERS WITHOUT CLAIM TO ANY PARTICULAR FONT, STYLE, SIZE, OR COLOR.

FOR COMPUTERIZED ON-LINE RETAIL STORE SERVICES IN THE FIELD OF APPAREL AND FOOTWEAR (U.S. CLS. 100, 101 AND 102).

FIRST USE 4-16-2007; IN COMMERCE 4-16-2007.

JAMES LOVELACE, EXAMINING ATTORNEY

SN 77-721,897. TRIPLE X DIAMONDS CORP., NEW YORK, NY. FILED 4-24-2009.

DIAMOND FLIP

THE MARK CONSISTS OF STANDARD CHARACTERS WITHOUT CLAIM TO ANY PARTICULAR FONT, STYLE, SIZE, OR COLOR.

NO CLAIM IS MADE TO THE EXCLUSIVE RIGHT TO USE "DIAMOND", APART FROM THE MARK AS SHOWN.

FOR ON-LINE TRADING SERVICES TO FACILITATE THE SALE OF JEWELRY, GEMSTONES, DIAMONDS AND WATCHES BY OTHERS VIA A COMPUTER NETWORK AND PROVIDING EVALUATIVE FEEDBACK AND RATINGS OF SELLERS' GOODS AND SERVICES, THE VALUE AND PRICES OF SELLERS' GOODS, BUYERS' AND SELLERS' PERFORMANCE, DELIVERY, AND OVERALL TRADING EXPERIENCE IN CONNECTION THEREWITH (U.S. CLS. 100, 101 AND 102).

CHARLES L. JENKINS, EXAMINING ATTORNEY

SN 77-722,444. APP, MARK T, BEAVERCREEK, OH. FILED 4-25-2009.

Lucky Visit

THE MARK CONSISTS OF STANDARD CHARACTERS WITHOUT CLAIM TO ANY PARTICULAR FONT, STYLE, SIZE, OR COLOR.

FOR ADVERTISING SERVICES, NAMELY, COST-PER-ACTION ON-LINE ADVERTISING; DESIGN OF INTERNET ADVERTISING; INTERNET ADVERTISING SERVICES; ON-LINE ADVERTISING AND MARKETING SERVICES; ON-LINE ADVERTISING ON COMPUTER COMMUNICATION NETWORKS (U.S. CLS. 100, 101 AND 102).

ESTHER BELENKER, EXAMINING ATTORNEY

CLASS 35—(Continued).

SN 77-722,556. YOUMANS, BENJAMIN, ROCHESTER, MN.
FILED 4-26-2009.



Hydroponics Hut
Indoor Growing Supplies

NO CLAIM IS MADE TO THE EXCLUSIVE RIGHT TO USE "HYDROPONICS" AND "INDOOR GROWING SUPPLIES", APART FROM THE MARK AS SHOWN.

THE MARK CONSISTS OF THE STYLIZED TEXT "HYDROPONICS HUT INDOOR GROWING SUPPLIES" WITH A PLANT PARTIALLY ENCLOSED IN A CIRCLE ON THE LEFT.

FOR RETAIL STORE AND ON-LINE RETAIL STORE SERVICES FEATURING HYDROPONIC GARDENING SUPPLIES AND INDOOR GROW LIGHTING (U.S. CLS. 100, 101 AND 102).

FIRST USE 4-18-2009; IN COMMERCE 4-18-2009.
CYNTHIA SLOAN, EXAMINING ATTORNEY

CLASS 35—(Continued).

SN 77-722,674. FOUNDATION FOR INTERNATIONAL MEDICAL RELIEF OF CHILDREN, PHILADELPHIA, PA. FILED 4-27-2009.

ONE VISION... MANY
PATHS... A CELEBRATION OF
HUMANITY...

THE MARK CONSISTS OF STANDARD CHARACTERS WITHOUT CLAIM TO ANY PARTICULAR FONT, STYLE, SIZE, OR COLOR.

FOR CHARITABLE SERVICES, NAMELY, ORGANIZING AND CONDUCTING VOLUNTEER PROGRAMS AND COMMUNITY SERVICE PROJECTS IN THE FIELD OF MEDICAL CARE; AND PROMOTING PUBLIC AWARENESS OF THE NEED FOR INTERNATIONAL MEDICAL CARE AND THE NEED FOR MONETARY SUPPORT FOR INTERNATIONAL MEDICAL CARE PROJECTS (U.S. CLS. 100, 101 AND 102).

FIRST USE 0-0-2003; IN COMMERCE 0-0-2003.
GIANCARLO CASTRO, EXAMINING ATTORNEY

SN 77-722,788. NAV N GO KFT, BUDAPEST, HUNGARY,
FILED 4-27-2009.

NAVIEXTRAS.COM

SN 77-722,574. KIZOREK, INC., DBA THE VIRAL PULSE,
DANIA BEACH, FL. FILED 4-26-2009.

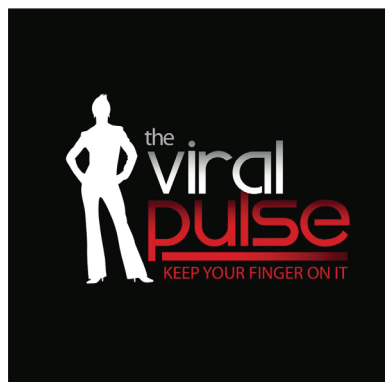

THE MARK CONSISTS OF STANDARD CHARACTERS WITHOUT CLAIM TO ANY PARTICULAR FONT, STYLE, SIZE, OR COLOR.

FOR ON-LINE RETAIL STORE SERVICES FEATURING COMPUTER SOFTWARE IN THE FIELD OF NAVIGATION (U.S. CLS. 100, 101 AND 102).

FIRST USE 7-4-2008; IN COMMERCE 7-4-2008.
JUSTINE D. PARKER, EXAMINING ATTORNEY

SN 77-722,826. INTELLECT HOLDINGS, INC., TAMPA, FL.
FILED 4-27-2009.

BELL CURVE HIRING

NO CLAIM IS MADE TO THE EXCLUSIVE RIGHT TO USE VIRAL, APART FROM THE MARK AS SHOWN.

THE COLOR(S) BLACK, WHITE AND RED IS/ARE CLAIMED AS A FEATURE OF THE MARK.

THE MARK CONSISTS OF BLACK BACKGROUND, WHITE SILHOUETTE, WHITE LETTERS "THE VIRAL," RED LETTERS "PULSE" AND "KEEP YOUR FINGER ON IT".

FOR ADVERTISING AND MARKETING (U.S. CLS. 100, 101 AND 102).

FIRST USE 12-16-2008; IN COMMERCE 3-1-2009.
CYNTHIA SLOAN, EXAMINING ATTORNEY

THE MARK CONSISTS OF STANDARD CHARACTERS WITHOUT CLAIM TO ANY PARTICULAR FONT, STYLE, SIZE, OR COLOR.

NO CLAIM IS MADE TO THE EXCLUSIVE RIGHT TO USE "HIRING", APART FROM THE MARK AS SHOWN.

FOR EXECUTIVE RECRUITING SERVICES AND EMPLOYMENT STAFFING SERVICES IN THE FIELD OF INFORMATION TECHNOLOGY (U.S. CLS. 100, 101 AND 102).

FIRST USE 4-20-2009; IN COMMERCE 4-20-2009.
ALEX KEAM, EXAMINING ATTORNEY

CLASS 35—(Continued).

SN 77-722,946. KERR DRUG, INC., RALEIGH, NC. FILED 4-27-2009.



THE MARK CONSISTS OF THE WORD "NATURALLY", WITH ONLY THE "N" CAPITALIZED AND A VINE FORMING THE LETTER "T," OVER THE WORD "KERR" IN A BLOCK, ALL-CAPITAL LETTERS FONT.
 FOR RETAIL DRUG STORE SERVICES FEATURING NATURAL, ORGANIC, AND HOMEOPATHIC PRODUCTS (U.S. CLS. 100, 101 AND 102).
 FIRST USE 4-1-2009; IN COMMERCE 4-1-2009.
 ZACHARY BELLO, EXAMINING ATTORNEY

CLASS 35—(Continued).

SN 77-723,134. U.S.G. ENTERPRISES, INC., MARINA DEL REY, CA. FILED 4-27-2009.



THE MARK CONSISTS OF STANDARD CHARACTERS WITHOUT CLAIM TO ANY PARTICULAR FONT, STYLE, SIZE, OR COLOR.
 FOR ELECTRONIC COMMERCE SERVICES, NAMELY, PROVIDING INFORMATION ABOUT SERVICES AND PRODUCTS VIA TELECOMMUNICATION NETWORKS FOR MARKETING, ADVERTISING AND SALES PURPOSES (U.S. CLS. 100, 101 AND 102).
 SHAUNIA CARLYLE, EXAMINING ATTORNEY

SN 77-723,028. NEWTOWN MACON, INC., MACON, GA. FILED 4-27-2009.

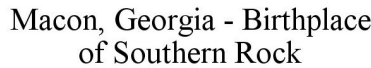

THE MARK CONSISTS OF STANDARD CHARACTERS WITHOUT CLAIM TO ANY PARTICULAR FONT, STYLE, SIZE, OR COLOR.
 NO CLAIM IS MADE TO THE EXCLUSIVE RIGHT TO USE "MACON, GEORGIA" AND "SOUTHERN ROCK", APART FROM THE MARK AS SHOWN.
 FOR MARKETING, ADVERTISING AND PROMOTING THE GOODS AND SERVICES OF OTHERS RELATED TO THE MUSIC HERITAGE AND INDUSTRY OF MACON, GEORGIA (U.S. CLS. 100, 101 AND 102).
 JAMES LOVELACE, EXAMINING ATTORNEY

SN 77-723,306. ATS SERVICES, LLC, JACKSONVILLE, FL. FILED 4-27-2009.



THE MARK CONSISTS OF STANDARD CHARACTERS WITHOUT CLAIM TO ANY PARTICULAR FONT, STYLE, SIZE, OR COLOR.
 FOR EMPLOYMENT HIRING, RECRUITING, PLACEMENT, STAFFING AND CAREER NETWORKING SERVICES (U.S. CLS. 100, 101 AND 102).
 TINA KUAN, EXAMINING ATTORNEY

SN 77-723,072. HEARST BUSINESS COMMUNICATIONS, INC., NEW YORK, NY. FILED 4-27-2009.



THE MARK CONSISTS OF STANDARD CHARACTERS WITHOUT CLAIM TO ANY PARTICULAR FONT, STYLE, SIZE, OR COLOR.
 OWNER OF U.S. REG. NO. 1,117,235.
 NO CLAIM IS MADE TO THE EXCLUSIVE RIGHT TO USE "IC", APART FROM THE MARK AS SHOWN.
 FOR PROVIDING AN ON-LINE COMPUTER DATABASE FEATURING TRADE INFORMATION IN THE FIELD OF ELECTRICAL PRODUCTS AND COMPONENTS, NAMELY, SEMICONDUCTORS, PASSIVES, POWER, ELECTROMECHANICAL AND INTERCONNECTS (U.S. CLS. 100, 101 AND 102).
 FIRST USE 1-1-1998; IN COMMERCE 1-1-1998.
 AMY KERTGATE, EXAMINING ATTORNEY

SN 77-723,386. MAIN STREET POWER COMPANY, INC., DBA MAINSTREET POWER, BOULDER, CO. FILED 4-27-2009.



THE MARK CONSISTS OF STANDARD CHARACTERS WITHOUT CLAIM TO ANY PARTICULAR FONT, STYLE, SIZE, OR COLOR.
 NO CLAIM IS MADE TO THE EXCLUSIVE RIGHT TO USE "POWER", APART FROM THE MARK AS SHOWN.
 FOR ENERGY MANAGEMENT SERVICES, NAMELY, PROVIDING A SERVICE THAT ALLOWS CUSTOMERS TO PURCHASE ENERGY, NAMELY, ELECTRICITY, NATURAL GAS AND RENEWABLE ENERGY, AT A FIXED PRICE (U.S. CLS. 100, 101 AND 102).
 FIRST USE 11-1-2008; IN COMMERCE 11-1-2008.
 RENEE SERVANCE, EXAMINING ATTORNEY

CLASS 35—(Continued).

SN 77-723,458. FIRST FINANCIAL EMPLOYEE LEASING, INC., PT. CHARLOTTE, FL. FILED 4-27-2009.



THE MARK CONSISTS OF AN IMAGE OF A SHIP STEERING WHEEL WITH A STYLIZED COMPASS ROSE IN THE MIDDLE. THE STYLIZED WORD "CREW" ACROSS THE STEERING WHEEL. THE STYLIZED WORDS "CLIENTS RETURNING" IS ABOVE. THE STYLIZED WORDS "EMPLOYEES TO WORK" IS BELOW.

FOR HUMAN RESOURCES MANAGEMENT; PAY-ROLL PROCESSING SERVICES (U.S. CLS. 100, 101 AND 102).

FIRST USE 9-1-2008; IN COMMERCE 10-1-2008.
BRIAN NEVILLE, EXAMINING ATTORNEY

CLASS 35—(Continued).

SN 77-723,697. OSCODA AREA CONVENTION AND VISITORS BUREAU, OSCODA, MI. FILED 4-28-2009.

Oscoda Naturally

THE MARK CONSISTS OF STANDARD CHARACTERS WITHOUT CLAIM TO ANY PARTICULAR FONT, STYLE, SIZE, OR COLOR.

NO CLAIM IS MADE TO THE EXCLUSIVE RIGHT TO USE "OSCODA", APART FROM THE MARK AS SHOWN.

FOR CONVENTION AND VISITORS BUREAU SERVICES, NAMELY, PROMOTING BUSINESS AND TOURISM IN THE NORTHERN MICHIGAN AREA; CONVENTION AND VISITORS BUREAU SERVICES, NAMELY, PROMOTING BUSINESS, TOURISM AND THE HOLDING OF CONVENTIONS IN THE NORTHERN MICHIGAN AREA; CONVENTION AND VISITORS BUREAU SERVICES, NAMELY, PROMOTING CONVENTIONS AND TOURISM IN THE NORTHERN MICHIGAN AREA; CONVENTION AND VISITORS BUREAU SERVICES, NAMELY, PROMOTING TOURISM, BUSINESS AND CONVENTIONS IN AND AROUND THE NORTHERN MICHIGAN AREA (U.S. CLS. 100, 101 AND 102).

FIRST USE 3-1-1996; IN COMMERCE 3-1-1996.
JUDITH HELFMAN, EXAMINING ATTORNEY

SN 77-723,686. FLASHPOINT MEDICA, LLC, NEW YORK, NY. FILED 4-28-2009.

FLASHPOINT WEST

THE MARK CONSISTS OF STANDARD CHARACTERS WITHOUT CLAIM TO ANY PARTICULAR FONT, STYLE, SIZE, OR COLOR.

OWNER OF U.S. REG. NO. 3,079,708.

FOR CONDUCTING MARKETING ANALYSIS, MARKETING STUDIES, MARKETING RESEARCH, AND PREPARATION OF MARKETING STRATEGIES, AND RELATED MARKETING MATERIALS AND BROCHURES FOR OTHERS IN THE MEDICAL, PHARMACEUTICAL AND HEALTHCARE FIELDS; PROVIDING BUSINESS MARKETING CONSULTATION SERVICES TO THOSE IN MEDICAL, PHARMACEUTICAL AND HEALTHCARE MARKETING FIELDS (U.S. CLS. 100, 101 AND 102).

MICHAEL ENGEL, EXAMINING ATTORNEY

SN 77-723,723. SCRUB WEAR HOUSE INCORPORATED, ROCKY HILL, CT. FILED 4-28-2009.



NO CLAIM IS MADE TO THE EXCLUSIVE RIGHT TO USE "SCRUB WEAR", APART FROM THE MARK AS SHOWN.

THE MARK CONSISTS OF THE STYLIZED WORDS "SCRUB WEAR HOUSE" POSITIONED SLIGHTLY TO THE LEFT, AND ON TOP OF AN IMAGE OF A SCRUB T-SHIRT ALL ATOP A COMPLETELY SHADED OVAL.

FOR RETAIL STORE AND ON-LINE RETAIL STORE SERVICES FEATURING SCRUBS, CLOTHING, STETHOSCOPES, BLOOD PRESSURE CUFFS, SCISSORS, PROTECTIVE EYE WEAR, PENS, GAIT TRANSFER BELTS, ELECTROCARDIOGRAM CALIPERS, ORGANIZERS, TOTE BAGS, LANYARDS, WATCHES, PENLIGHTS, PUPIL GAUGES, BADGE HOLDERS, AND EMBLEM PENS (U.S. CLS. 100, 101 AND 102).

FIRST USE 10-4-2002; IN COMMERCE 10-4-2002.
SANDRA MANIOS, EXAMINING ATTORNEY

CLASS 35—(Continued).

SN 77-723,729. BODYMEDIA, INC., PITTSBURGH, PA. FILED 4-28-2009.

BODYMEDIA

THE MARK CONSISTS OF STANDARD CHARACTERS WITHOUT CLAIM TO ANY PARTICULAR FONT, STYLE, SIZE, OR COLOR.

OWNER OF U.S. REG. NOS. 2,570,373, 3,387,020 AND OTHERS.

FOR DISTRIBUTORSHIPS AND ONLINE RETAIL STORE SERVICES FEATURING MONITORING DEVICES FOR DETECTING, STORING AND REPORTING HUMAN PHYSIOLOGICAL AND ENVIRONMENTAL PARAMETERS; PROMOTING THE GOODS AND SERVICES OF OTHERS IN THE FIELDS OF HUMAN PHYSIOLOGY AND HEALTH AND FITNESS BY DISTRIBUTING PRINTED MATERIALS AND BY PROVIDING PROMOTIONAL INFORMATION OVER THE INTERNET (U.S. CLS. 100, 101 AND 102).

FIRST USE 11-3-2008; IN COMMERCE 11-3-2008. JUDITH HELFMAN, EXAMINING ATTORNEY

CLASS 35—(Continued).

SN 77-723,915. PEARSON DENTAL SUPPLIES, INC., SYLMAR, CA. FILED 4-28-2009.

Pearson Preferred Rewards

THE MARK CONSISTS OF STANDARD CHARACTERS WITHOUT CLAIM TO ANY PARTICULAR FONT, STYLE, SIZE, OR COLOR.

NO CLAIM IS MADE TO THE EXCLUSIVE RIGHT TO USE "PREFERRED REWARDS", APART FROM THE MARK AS SHOWN.

FOR RETAIL STORE SERVICES IN THE FIELD OF DENTAL EQUIPMENT AND SUPPLIES FEATURING A BONUS INCENTIVE PROGRAM FOR CUSTOMERS; WHOLESALE AND RETAIL STORE SERVICES AND ON-LINE RETAIL AND WHOLESALE STORE SERVICES FEATURING DENTAL EQUIPMENT AND SUPPLIES (U.S. CLS. 100, 101 AND 102).

JUSTINE D. PARKER, EXAMINING ATTORNEY

SN 77-724,127. CHAD REA, NEW YORK, NY. FILED 4-28-2009.

ECOPOP

THE MARK CONSISTS OF STANDARD CHARACTERS WITHOUT CLAIM TO ANY PARTICULAR FONT, STYLE, SIZE, OR COLOR.

FOR BRAND CONCEPT AND BRAND DEVELOPMENT SERVICES; BRAND CONSULTING SERVICES; ADVERTISING AND MARKETING SERVICES (U.S. CLS. 100, 101 AND 102).

JAMES A. RAUEN, EXAMINING ATTORNEY

SN 77-723,760. WILKERSON, CARRIE D, SPRINGTOWN, TX. FILED 4-28-2009.

Carrie Wilkerson

SN 77-724,133. IDC, LTD., AKA IDC, HENDERSON, NV. FILED 4-28-2009.

PGCall

THE MARK CONSISTS OF STANDARD CHARACTERS WITHOUT CLAIM TO ANY PARTICULAR FONT, STYLE, SIZE, OR COLOR.

FOR PROVIDING A WEB SITE FEATURING BUSINESS INFORMATION IN THE FORM OF AUDIO AND VIDEO INTERVIEWS, TRANSCRIPTS AND OTHER EDUCATIONAL MATERIALS (U.S. CLS. 100, 101 AND 102).

FIRST USE 3-23-1972; IN COMMERCE 8-1-2007. ANDREA K. NADELMAN, EXAMINING ATTORNEY

THE MARK CONSISTS OF STANDARD CHARACTERS WITHOUT CLAIM TO ANY PARTICULAR FONT, STYLE, SIZE, OR COLOR.

FOR MARKETING SERVICES IN THE FIELD OF PLANNED-GIVING FOR NON-PROFIT AND CHARITABLE ORGANIZATIONS (U.S. CLS. 100, 101 AND 102).

FIRST USE 2-1-2007; IN COMMERCE 2-1-2007. REBECCA GILBERT, EXAMINING ATTORNEY

CLASS 35—(Continued).

SN 77-724,136. PEARSON DENTAL SUPPLIES, INC., SYLMAR, CA. FILED 4-28-2009.

We Take the Pain Out of Buying Dental Supplies

THE MARK CONSISTS OF STANDARD CHARACTERS WITHOUT CLAIM TO ANY PARTICULAR FONT, STYLE, SIZE, OR COLOR.

FOR CATALOG ORDERING SERVICE FEATURING DENTAL EQUIPMENT AND SUPPLIES; ELECTRONIC CATALOG SERVICES FEATURING DENTAL EQUIPMENT AND SUPPLIES; MAIL ORDER CATALOG SERVICES FEATURING DENTAL EQUIPMENT AND SUPPLIES; RETAIL STORE AND ON-LINE RETAIL STORE SERVICES FEATURING DENTAL EQUIPMENT AND SUPPLIES; WHOLESALE AND RETAIL STORE SERVICES AND ON-LINE RETAIL AND WHOLESALE STORE SERVICES FEATURING DENTAL EQUIPMENT AND SUPPLIES; WHOLESALE AND RETAIL STORE SERVICES FEATURING DENTAL EQUIPMENT AND SUPPLIES (U.S. CLS. 100, 101 AND 102).

JUSTINE D. PARKER, EXAMINING ATTORNEY

CLASS 35—(Continued).

SN 77-724,203. THE CHRISTMAS TREE COMPANY, LAKE BLUFF, IL. FILED 4-28-2009.

DELIVER STAR

SN 77-724,159. ONEIR REALTY, LLC, TAMPA, FL. FILED 4-28-2009.

ONEIR

THE MARK CONSISTS OF STANDARD CHARACTERS WITHOUT CLAIM TO ANY PARTICULAR FONT, STYLE, SIZE, OR COLOR.

"ONEIR" HAS NO MEANING IN A FOREIGN LANGUAGE.

FOR REAL ESTATE SALES MANAGEMENT (U.S. CLS. 100, 101 AND 102).

MATTHEW PAPPAS, EXAMINING ATTORNEY

SN 77-724,184. ONEIR REALTY, LLC, TAMPA, FL. FILED 4-28-2009.

ONEIR REALTY

THE MARK CONSISTS OF STANDARD CHARACTERS WITHOUT CLAIM TO ANY PARTICULAR FONT, STYLE, SIZE, OR COLOR.

NO CLAIM IS MADE TO THE EXCLUSIVE RIGHT TO USE "REALTY", APART FROM THE MARK AS SHOWN.

"ONEIR" HAS NO MEANING IN A FOREIGN LANGUAGE.

FOR REAL ESTATE SALES MANAGEMENT (U.S. CLS. 100, 101 AND 102).

MATTHEW PAPPAS, EXAMINING ATTORNEY

THE MARK CONSISTS OF STANDARD CHARACTERS WITHOUT CLAIM TO ANY PARTICULAR FONT, STYLE, SIZE, OR COLOR.

OWNER OF U.S. REG. NO. 3,547,719.

FOR ONLINE WHOLESALE AND RETAIL STORE SERVICES FEATURING GIFTING PRODUCTS IN THE NATURE OF SOAPS, MOISTURIZERS, SHOWER GELS, SHAMPOO, BODY LOTION, FACIAL CREAM AND RELATED SKIN PRODUCTS, BODY MIST, COLOGNE, PERFUME, SCENTED CANDLES, BODY SCRUB, BODY POWDER, BODY TONIC, BODY OIL, AND LOOFAH, BASKET AND PACKAGING MATERIALS IN THE NATURE OF GIFT BOXES, WICKER BASKETS, METAL BASKETS, METAL CHAMPAGNE CHILLERS, ICE BUCKETS, AND SACKS, GLASS WARE IN THE NATURE OF FLUTES, CRYSTAL, ORNAMENTS, COASTERS, AND TRINKETS, PET ITEMS IN THE NATURE OF SQUEEZE TOYS, BANDANAS, DOGGY BLANKETS, CHEWABLE TOYS, AND DOG-COOKIES, BABY ITEMS IN THE NATURE OF DIAPERS, WIPES, MOISTURIZERS, BABY POWDER, CLOTHING, SOCKS, BLANKETS, SHIRTS, PAJAMAS, JUMPERS, PLASTIC WARE, SIPPY CUPS, FORKS, SPOONS, SOAPS, BABY HYGIENE PRODUCTS, AND MEDICAL FIRST AID KITS, FOOD AND BEVERAGE ITEMS IN THE NATURE OF FRUITS, JAMS, COOKIES, CRACKERS, CHOCOLATE, CHEESE, CANDY, NUTS, PRETZELS, CHIPS, CAKES, BREAD, NUTRITION BARS, WINE, CHAMPAGNE, WHISKY, BEER, CIDER, COFFEE, ESPRESSO, BOTTLED WATER, SPARKLING WATER, AND SOFT DRINKS, CLOTHING AND ACCESSORIES, CHRISTMAS TREES, WREATHS, SEASONAL GREENERY, ROPING, TREE STANDS, IN-HOME AND GARDEN DECOR, SEASONAL ACCESSORIES, AND HOLIDAY GREETING SERVICES IN THE NATURE OF MESSAGES OR COMMUNICATIONS SENT ELECTRONICALLY OR BY OTHER MEANS TO OTHERS, AND STATIONERY (U.S. CLS. 100, 101 AND 102).

JASON BLAIR, EXAMINING ATTORNEY

CLASS 35—(Continued).

SN 77-724,214. PEARSON DENTAL SUPPLIES, INC., SYLMAR, CA. FILED 4-28-2009.

We Take The Pain Out Of Buying Medical Supplies

THE MARK CONSISTS OF STANDARD CHARACTERS WITHOUT CLAIM TO ANY PARTICULAR FONT, STYLE, SIZE, OR COLOR.

FOR CATALOG ORDERING SERVICE FEATURING MEDICAL AND DENTAL EQUIPMENT AND SUPPLIES; ELECTRONIC CATALOG SERVICES FEATURING MEDICAL AND DENTAL EQUIPMENT AND SUPPLIES; MAIL ORDER CATALOG SERVICES FEATURING MEDICAL AND DENTAL EQUIPMENT AND SUPPLIES; RETAIL STORE AND ON-LINE RETAIL STORE SERVICES FEATURING MEDICAL AND DENTAL EQUIPMENT AND SUPPLIES; WHOLESALE AND RETAIL STORE SERVICES AND ON-LINE RETAIL AND WHOLESALE STORE SERVICES FEATURING MEDICAL AND DENTAL EQUIPMENT AND SUPPLIES; WHOLESALE AND RETAIL STORE SERVICES FEATURING MEDICAL AND DENTAL EQUIPMENT AND SUPPLIES (U.S. CLS. 100, 101 AND 102).

JUSTINE D. PARKER, EXAMINING ATTORNEY

SN 77-724,274. FLIXYA ENTERTAINMENT, LLC, SAN FRANCISCO, CA. FILED 4-28-2009.

Openstock

THE MARK CONSISTS OF STANDARD CHARACTERS WITHOUT CLAIM TO ANY PARTICULAR FONT, STYLE, SIZE, OR COLOR.

FOR COMMERCIAL ADMINISTRATION OF THE LICENSING OF RIGHTS TO DOWNLOAD, USE, DISTRIBUTE, REPRODUCE, AND OTHERWISE EXPLOIT THE DIGITAL PHOTOGRAPHS AND OTHER DIGITAL MEDIA OF OTHERS (U.S. CLS. 100, 101 AND 102).

FIRST USE 4-24-2009; IN COMMERCE 4-24-2009.
LINDA LAVACHE, EXAMINING ATTORNEY

SN 77-724,475. VANITY SHOP OF GRAND FORKS, INC., FARGO, ND. FILED 4-28-2009.

Vanity

OWNER OF U.S. REG. NOS. 1,780,669, 1,851,806 AND OTHERS.

FOR RETAIL STORE SERVICES FEATURING JEWELRY (U.S. CLS. 100, 101 AND 102).

FIRST USE 11-3-2003; IN COMMERCE 11-3-2003.
SETH A. RAPPAPORT, EXAMINING ATTORNEY

CLASS 35—(Continued).

SN 77-724,480. IDEA COUTURE INC., WASHINGTON, DC. FILED 4-28-2009.

D-School + B-School

THE MARK CONSISTS OF STANDARD CHARACTERS WITHOUT CLAIM TO ANY PARTICULAR FONT, STYLE, SIZE, OR COLOR.

FOR BUSINESS CONSULTING SERVICES, NAMELY, PROVIDING ASSISTANCE IN DEVELOPMENT OF BUSINESS STRATEGIES AND CREATIVE IDEATION; CONSULTANCY SERVICES REGARDING BUSINESS STRATEGIES; CREATIVE MARKETING DESIGN SERVICES; PROVIDING INFORMATION IN THE FIELDS OF BUSINESS INNOVATION PROCESS, BUSINESS MANAGEMENT AND BUSINESS OPPORTUNITIES (U.S. CLS. 100, 101 AND 102).

FIRST USE 8-3-2007; IN COMMERCE 8-3-2007.
NAKIA HENRY, EXAMINING ATTORNEY

Vanity

OWNER OF U.S. REG. NOS. 1,780,669, 1,851,806 AND OTHERS.

FOR RETAIL STORE SERVICES FEATURING BODY BUTTER, BODY GLIMMER, BODY SPRAYS, FRAGRANCES FOR PERSONAL USE, LIP GLOSS, AND NAIL POLISH (U.S. CLS. 100, 101 AND 102).

FIRST USE 10-19-2005; IN COMMERCE 10-19-2005.
SETH A. RAPPAPORT, EXAMINING ATTORNEY

CLASS 35—(Continued).

SN 77-724,513. VANITY SHOP OF GRAND FORKS, INC.,
FARGO, ND. FILED 4-28-2009.



OWNER OF U.S. REG. NOS. 1,800,825, 1,891,144 AND
OTHERS.

FOR RETAIL STORE SERVICES FEATURING BELTS,
BOOTS, BRAS, CAPRIS, COATS, CORSETS, DRESSES,
FLIP FLOPS, GLOVES, HATS, HEADBANDS, HEAD
WRAPS, HOODED SWEATSHIRTS, HOSIERY, JACKETS,
JEANS, JUMPSUITS, KNIT TOPS, LEGGINGS, MINIS-
KIRTS, MITTENS, PANTS, ROBES, SANDALS,
SCARVES, SHIRTS, SHOES, SHORTS, SKIRTS, SLACKS,
SLEEPWEAR, SLIPPERS, SOCKS, SWEATERS, SWIM-
WEAR, T-SHIRTS, TOPS, UNDERWEAR, AND OUTER-
WEAR, NAMELY, VESTS (U.S. CLS. 100, 101 AND 102).

FIRST USE 11-2-2003; IN COMMERCE 11-2-2003.
SETH A. RAPPAPORT, EXAMINING ATTORNEY

SN 77-724,517. VANITY SHOP OF GRAND FORKS, INC.,
FARGO, ND. FILED 4-28-2009.



OWNER OF U.S. REG. NOS. 1,780,669, 1,851,806 AND
OTHERS.

FOR RETAIL STORE SERVICES FEATURING
PURSES, TOTE BAGS, AND WALLETS (U.S. CLS. 100,
101 AND 102).

FIRST USE 11-2-2003; IN COMMERCE 11-2-2003.
SETH A. RAPPAPORT, EXAMINING ATTORNEY

SN 77-724,522. VANITY SHOP OF GRAND FORKS, INC.,
FARGO, ND. FILED 4-28-2009.



OWNER OF U.S. REG. NOS. 1,800,825, 1,891,144 AND
OTHERS.

FOR RETAIL STORE SERVICES FEATURING SUN-
GLASSES (U.S. CLS. 100, 101 AND 102).

FIRST USE 4-12-2004; IN COMMERCE 4-12-2004.
SETH A. RAPPAPORT, EXAMINING ATTORNEY

CLASS 35—(Continued).

SN 77-724,525. VANITY SHOP OF GRAND FORKS, INC.,
FARGO, ND. FILED 4-28-2009.



OWNER OF U.S. REG. NOS. 1,800,825, 1,891,144 AND
OTHERS.

FOR RETAIL STORE SERVICES FEATURING BARR-
ETTES, HAIR CLIPS, HAIR ELASTICS, AND HAIR TIES
(U.S. CLS. 100, 101 AND 102).

FIRST USE 11-8-2003; IN COMMERCE 11-8-2003.
SETH A. RAPPAPORT, EXAMINING ATTORNEY

SN 77-724,529. VANITY SHOP OF GRAND FORKS, INC.,
FARGO, ND. FILED 4-28-2009.



OWNER OF U.S. REG. NOS. 1,800,825, 1,891,144 AND
OTHERS.

FOR RETAIL STORES SERVICES FEATURING CAN-
DLES (U.S. CLS. 100, 101 AND 102).

FIRST USE 11-7-2006; IN COMMERCE 11-7-2006.
SETH A. RAPPAPORT, EXAMINING ATTORNEY

SN 77-724,559. NGENIUS MEDIA INC., BELTON, MO. FILED
4-29-2009.

Girlvivalist

THE MARK CONSISTS OF STANDARD CHARACTERS
WITHOUT CLAIM TO ANY PARTICULAR FONT, STYLE,
SIZE, OR COLOR.

FOR MARKETING SERVICES, NAMELY, PROVIDING
INFORMATIONAL WEB PAGES DESIGNED TO GEN-
ERATE SALES TRAFFIC VIA HYPERLINKS TO OTHER
WEB SITES; PROMOTING THE GOODS AND SERVICES
OF OTHERS BY PROVIDING A WEB SITE AT WHICH
USERS CAN LINK TO SURVIVALISM INFORMATION.;
THE BRINGING TOGETHER, FOR THE BENEFIT OF
OTHERS, OF A VARIETY OF GOODS AND SERVICES,
ENABLING CUSTOMERS TO CONVENIENTLY VIEW
AND PURCHASE THOSE GOODS AND SERVICES
FROM AN INTERNET WEB SITE PARTICULARLY
SPECIALIZING IN THE MARKETING OF THE SALE
OF GOODS AND SERVICES OF OTHERS (U.S. CLS. 100,
101 AND 102).

FIRST USE 4-5-2009; IN COMMERCE 4-10-2009.
DANNEAN HETZEL, EXAMINING ATTORNEY

CLASS 35—(Continued).

SN 77-724,613. PEARSON DENTAL SUPPLIES, INC., SYLMAR, CA. FILED 4-29-2009.

Are You Getting The Most Out Of Your Dental Supplier?

THE MARK CONSISTS OF STANDARD CHARACTERS WITHOUT CLAIM TO ANY PARTICULAR FONT, STYLE, SIZE, OR COLOR.

FOR CATALOG ORDERING SERVICE FEATURING DENTAL EQUIPMENT AND SUPPLIES; ELECTRONIC CATALOG SERVICES FEATURING DENTAL EQUIPMENT AND SUPPLIES; MAIL ORDER CATALOG SERVICES FEATURING DENTAL EQUIPMENT AND SUPPLIES; RETAIL STORE AND ON-LINE RETAIL STORE SERVICES FEATURING DENTAL EQUIPMENT AND SUPPLIES; WHOLESALE AND RETAIL STORE SERVICES AND ON-LINE RETAIL AND WHOLESALE STORE SERVICES FEATURING DENTAL EQUIPMENT AND SUPPLIES; WHOLESALE AND RETAIL STORE SERVICES FEATURING DENTAL EQUIPMENT AND SUPPLIES (U.S. CLS. 100, 101 AND 102).

JUSTINE D. PARKER, EXAMINING ATTORNEY

SN 77-724,650. MAIN STREET INITIATIVE, LLC, MONTCLAIR, VA. FILED 4-29-2009.

MAIN STREET INITIATIVE

THE MARK CONSISTS OF STANDARD CHARACTERS WITHOUT CLAIM TO ANY PARTICULAR FONT, STYLE, SIZE, OR COLOR.

FOR BUSINESS CONSULTING SERVICES (U.S. CLS. 100, 101 AND 102).

TINA L. SNAPP, EXAMINING ATTORNEY

SN 77-724,672. BATTERIES PLUS, LLC, HARTLAND, WI. FILED 4-29-2009.



NO CLAIM IS MADE TO THE EXCLUSIVE RIGHT TO USE "BULBS", APART FROM THE MARK AS SHOWN.

THE MARK CONSISTS OF THE WORDS "BULBS" AND "PLUS" SEPARATED BY A LIGHT BULB DESIGN.

FOR FRANCHISING, NAMELY, OFFERING TECHNICAL ASSISTANCE IN THE ESTABLISHMENT AND/OR OPERATION OF RETAIL STORES FEATURING LIGHT BULBS; RETAIL STORE SERVICES FEATURING LIGHT BULBS (U.S. CLS. 100, 101 AND 102).

YAT SYE, LEE, EXAMINING ATTORNEY

CLASS 35—(Continued).

SN 77-724,681. LMM COMMUNICATIONS, INC., MILWAUKEE, WI. FILED 4-29-2009.

SERVE 60

THE MARK CONSISTS OF STANDARD CHARACTERS WITHOUT CLAIM TO ANY PARTICULAR FONT, STYLE, SIZE, OR COLOR.

FOR CHARITABLE SERVICES, NAMELY, ORGANIZING AND CONDUCTING VOLUNTEER PROGRAMS AND COMMUNITY SERVICE PROJECTS (U.S. CLS. 100, 101 AND 102).

NAAKWAMA ANKRAH, EXAMINING ATTORNEY

SN 77-724,724. PLAYPUMPS INTERNATIONAL, INC., WASHINGTON, DC. FILED 4-29-2009.

PLAYPUMPS

THE MARK CONSISTS OF STANDARD CHARACTERS WITHOUT CLAIM TO ANY PARTICULAR FONT, STYLE, SIZE, OR COLOR.

FOR PROMOTING PUBLIC AWARENESS OF THE NEED FOR CLEAN WATER; PROMOTING PUBLIC AWARENESS OF PUBLIC HEALTH ISSUES IN DISADVANTAGED COUNTRIES AND UNDERPRIVILEGED POPULATIONS (U.S. CLS. 100, 101 AND 102).

FIRST USE 4-4-2006; IN COMMERCE 4-4-2006.
B. PARADEWELAI, EXAMINING ATTORNEY

SN 77-724,725. PLAYPUMPS INTERNATIONAL, INC., WASHINGTON, DC. FILED 4-29-2009.

PLAYPUMPS INTERNATIONAL

THE MARK CONSISTS OF STANDARD CHARACTERS WITHOUT CLAIM TO ANY PARTICULAR FONT, STYLE, SIZE, OR COLOR.

NO CLAIM IS MADE TO THE EXCLUSIVE RIGHT TO USE "INTERNATIONAL", APART FROM THE MARK AS SHOWN.

FOR PROMOTING PUBLIC AWARENESS OF THE NEED FOR CLEAN WATER; PROMOTING PUBLIC AWARENESS OF PUBLIC HEALTH ISSUES IN DISADVANTAGED COUNTRIES AND UNDERPRIVILEGED POPULATIONS (U.S. CLS. 100, 101 AND 102).

FIRST USE 4-4-2006; IN COMMERCE 4-4-2006.
B. PARADEWELAI, EXAMINING ATTORNEY

CLASS 35—(Continued).

SN 77-724,749. ASHLEY O'ROURKE, TOPANGA, CA. FILED 4-29-2009.

ZGLOBALMART

THE MARK CONSISTS OF STANDARD CHARACTERS WITHOUT CLAIM TO ANY PARTICULAR FONT, STYLE, SIZE, OR COLOR.

FOR ON-LINE VIRTUAL TRADE SHOW FOR THE FASHION INDUSTRY; WHOLESALE B2B STORE SERVICES FEATURING WOMEN'S, MEN'S AND YOUTH CLOTHING, HOME ACCESSORIES, FASHION ACCESSORIES (U.S. CLS. 100, 101 AND 102).

GINA HAYES, EXAMINING ATTORNEY

CLASS 35—(Continued).

SN 77-724,822. E1 ENTERTAINMENT U.S. LP, PORT WASHINGTON, NY. FILED 4-29-2009.

THE MAJOR ALTERNATIVE

THE MARK CONSISTS OF STANDARD CHARACTERS WITHOUT CLAIM TO ANY PARTICULAR FONT, STYLE, SIZE, OR COLOR.

OWNER OF U.S. REG. NO. 2,674,274.
FOR DISTRIBUTORSHIP SERVICES IN THE FIELD OF MUSIC, MOTION PICTURES AND TELEVISION PROGRAMS (U.S. CLS. 100, 101 AND 102).

FIRST USE 3-15-1995; IN COMMERCE 3-15-1995.
FRANK LATTUCA, EXAMINING ATTORNEY

SN 77-724,779. E1 ENTERTAINMENT U.S. LP, PORT WASHINGTON, NY. FILED 4-29-2009.

THE GLOBAL INDEPENDENT

THE MARK CONSISTS OF STANDARD CHARACTERS WITHOUT CLAIM TO ANY PARTICULAR FONT, STYLE, SIZE, OR COLOR.

OWNER OF U.S. REG. NO. 2,658,708.
FOR DISTRIBUTORSHIP SERVICES IN THE FIELD OF MUSIC, MOTION PICTURES AND TELEVISION PROGRAMS (U.S. CLS. 100, 101 AND 102).

FIRST USE 8-16-2001; IN COMMERCE 8-16-2001.
FRANK LATTUCA, EXAMINING ATTORNEY

SN 77-724,850. CONI-SEAL, INC., LAKEWOOD, NJ. FILED 4-29-2009.

DO A BETTER JOB FASTER

THE MARK CONSISTS OF STANDARD CHARACTERS WITHOUT CLAIM TO ANY PARTICULAR FONT, STYLE, SIZE, OR COLOR.

FOR ADVERTISING, MARKETING AND PROMOTION SERVICES (U.S. CLS. 100, 101 AND 102).

PAM WILLIS, EXAMINING ATTORNEY

SN 77-724,794. E1 ENTERTAINMENT U.S. LP, PORT WASHINGTON, NY. FILED 4-29-2009.

THE MAJOR INDEPENDENT

THE MARK CONSISTS OF STANDARD CHARACTERS WITHOUT CLAIM TO ANY PARTICULAR FONT, STYLE, SIZE, OR COLOR.

OWNER OF U.S. REG. NO. 2,713,483.
FOR DISTRIBUTORSHIP SERVICES IN THE FIELD OF MUSIC, MOTION PICTURES AND TELEVISION PROGRAMS (U.S. CLS. 100, 101 AND 102).

FIRST USE 7-12-2000; IN COMMERCE 7-12-2000.
FRANK LATTUCA, EXAMINING ATTORNEY

SN 77-724,887. NATIONAL PARK TRUST INC., ROCKVILLE, MD. FILED 4-29-2009.

WHERE'S BUDDY BISON BEEN?

THE MARK CONSISTS OF STANDARD CHARACTERS WITHOUT CLAIM TO ANY PARTICULAR FONT, STYLE, SIZE, OR COLOR.

FOR PROMOTING PUBLIC AWARENESS OF PARKS TO CHILDREN FOR CULTIVATING INTEREST IN YOUTHS PERTAINING TO CONSERVATIONISM AND THE ENVIRONMENT (U.S. CLS. 100, 101 AND 102).

FIRST USE 9-0-2008; IN COMMERCE 9-0-2008.
JAMES STEIN, EXAMINING ATTORNEY

CLASS 35—(Continued).

SN 77-724,935. PUBLISHERS CLEARING HOUSE LLC, PORT WASHINGTON, NY. FILED 4-29-2009.

WHERE AMERICA PLAYS TO WIN

THE MARK CONSISTS OF STANDARD CHARACTERS WITHOUT CLAIM TO ANY PARTICULAR FONT, STYLE, SIZE, OR COLOR.

FOR INTERNET ADVERTISING AND MARKETING SERVICES, NAMELY, ONLINE ADVERTISING IN THE FORM OF BANNER ADS, CLICK THROUGH CAMPAIGNS, AND AFFILIATE PROGRAMS FOR OTHERS; DISSEMINATION OF ADVERTISING FOR OTHERS VIA THE INTERNET, DIRECT MARKETING ADVERTISING FOR OTHERS; PREPARING AND PLACING ADVERTISING FOR OTHERS (U.S. CLS. 100, 101 AND 102).

FIRST USE 4-6-2009; IN COMMERCE 4-6-2009.
SETH A. RAPPAPORT, EXAMINING ATTORNEY

SN 77-724,951. ARDEN CORPORATION, SOUTHFIELD, MI. FILED 4-29-2009.

VIVA PARADISE

THE MARK CONSISTS OF STANDARD CHARACTERS WITHOUT CLAIM TO ANY PARTICULAR FONT, STYLE, SIZE, OR COLOR.

OWNER OF U.S. REG. NOS. 3,146,958 AND 3,227,632.
FOR ON-LINE RETAIL STORE SERVICES FEATURING FABRIC FOR OUTDOOR PRODUCT USES, OUTDOOR FURNITURE, CUSHIONS FOR USE WITH OUTDOOR FURNITURE, COVERS FOR OUTDOOR CUSHIONS, FABRIC CHAIR COVERS, ARM COVERS FOR CHAIRS, FABRIC STORAGE BAGS FOR CUSHIONS, WATER FOUNTAINS, UMBRELLAS, UMBRELLA BASES, AND DECORATIVE URNS (U.S. CLS. 100, 101 AND 102).

SALLY SHIH, EXAMINING ATTORNEY

SN 77-724,968. E & H DISTRIBUTING CO., NORTH LAS VEGAS, NV. FILED 4-29-2009.

EL PASADO

THE MARK CONSISTS OF STANDARD CHARACTERS WITHOUT CLAIM TO ANY PARTICULAR FONT, STYLE, SIZE, OR COLOR.

OWNER OF U.S. REG. NOS. 2,164,286 AND 3,188,699.
THE ENGLISH TRANSLATION OF "EL PASADO" IN THE MARK IS "THE PAST".

FOR WHOLESALE FOOD DISTRIBUTORSHIP SERVICES (U.S. CLS. 100, 101 AND 102).

FIRST USE 1-0-2009; IN COMMERCE 1-0-2009.
ALICE BENMAMAN, EXAMINING ATTORNEY

CLASS 35—(Continued).

SN 77-724,996. NATIONAL CRIME PREVENTION COUNCIL, INC., ARLINGTON, VA. FILED 4-29-2009.

CIRCLE OF RESPECT

THE MARK CONSISTS OF STANDARD CHARACTERS WITHOUT CLAIM TO ANY PARTICULAR FONT, STYLE, SIZE, OR COLOR.

FOR PROMOTING PUBLIC AWARENESS OF, AND UNDERSTANDING OF, THE NEGATIVE EFFECTS OF BULLYING, CYBERBULLYING AND RELATED NEGATIVE BEHAVIOR THROUGH A PUBLIC SERVICE ADVERTISING AND EDUCATIONAL CAMPAIGN DESIGNED TO PROMOTE GOOD BEHAVIOR AND PREVENTION OF BULLYING, CYBERBULLYING AND RELATED NEGATIVE BEHAVIOR (U.S. CLS. 100, 101 AND 102).

JAMES A. RAUEN, EXAMINING ATTORNEY

SN 77-725,004. VIEWPOINT COMPUTER ANIMATION, INCORPORATED, NEEDHAM, MA. FILED 4-29-2009.

VIEWPOINT CREATIVE

THE MARK CONSISTS OF STANDARD CHARACTERS WITHOUT CLAIM TO ANY PARTICULAR FONT, STYLE, SIZE, OR COLOR.

NO CLAIM IS MADE TO THE EXCLUSIVE RIGHT TO USE "CREATIVE", APART FROM THE MARK AS SHOWN.
FOR CREATIVE MARKETING DESIGN SERVICES; ADVERTISING SERVICES; DESIGN AND PRODUCTION OF ADVERTISING AND PROMOTIONAL MATERIALS FOR OTHERS (U.S. CLS. 100, 101 AND 102).

FIRST USE 9-24-2003; IN COMMERCE 9-24-2003.
MIDGE BUTLER, EXAMINING ATTORNEY

SN 77-725,015. VIEWPOINT COMPUTER ANIMATION, INCORPORATED, NEEDHAM, MA. FILED 4-29-2009.

VIEWPOINT LIFESTYLE

THE MARK CONSISTS OF STANDARD CHARACTERS WITHOUT CLAIM TO ANY PARTICULAR FONT, STYLE, SIZE, OR COLOR.

FOR CREATIVE MARKETING DESIGN SERVICES; ADVERTISING SERVICES; DESIGN AND PRODUCTION OF ADVERTISING AND PROMOTIONAL MATERIALS FOR OTHERS (U.S. CLS. 100, 101 AND 102).

FIRST USE 3-15-2009; IN COMMERCE 3-15-2009.
MIDGE BUTLER, EXAMINING ATTORNEY

CLASS 35—(Continued).

SN 77-725,029. E & H DISTRIBUTING CO., NORTH LAS VEGAS, NV. FILED 4-29-2009.



OWNER OF U.S. REG. NOS. 2,164,286 AND 3,188,699. THE STIPPLING IS A FEATURE OF THE MARK AND DOES NOT INDICATE COLOR.

THE MARK CONSISTS OF THE PHRASE "EL PASADO" BORDERED BY NOTCHED LINES AND FEATURING THE DESIGN OF A CHILI PEPPER.

THE ENGLISH TRANSLATION OF "EL PASADO" IN THE MARK IS "THE PAST".

FOR WHOLESALE FOOD DISTRIBUTORSHIP SERVICES (U.S. CLS. 100, 101 AND 102).

FIRST USE 1-0-2009; IN COMMERCE 1-0-2009.

ALICE BENMAMAN, EXAMINING ATTORNEY

SN 77-725,089. FORD MOTOR COMPANY, DEARBORN, MI. FILED 4-29-2009.

QUICK LANE

THE MARK CONSISTS OF STANDARD CHARACTERS WITHOUT CLAIM TO ANY PARTICULAR FONT, STYLE, SIZE, OR COLOR.

OWNER OF U.S. REG. NO. 2,241,002.

FOR RETAIL STORE SERVICES IN THE FIELD OF AUTOMOTIVE PARTS (U.S. CLS. 100, 101 AND 102).

FIRST USE 5-15-1997; IN COMMERCE 5-15-1997.

EVELYN BRADLEY, EXAMINING ATTORNEY

SN 77-725,127. SLAVET, KAYE H, SAN MATEO, CA. FILED 4-29-2009.

little earthkeepers

THE MARK CONSISTS OF STANDARD CHARACTERS WITHOUT CLAIM TO ANY PARTICULAR FONT, STYLE, SIZE, OR COLOR.

FOR DEVELOPING AND COORDINATING VOLUNTEER PROJECTS FOR CHARITABLE ORGANIZATIONS (U.S. CLS. 100, 101 AND 102).

CAROLINE WOOD, EXAMINING ATTORNEY

CLASS 35—(Continued).

SN 77-725,143. MILENIA AGRO CIÊNCIAS S.A., LONDRI-NA/PR, BRAZIL, FILED 4-29-2009.

MS BIOSOLUTIONS

THE MARK CONSISTS OF STANDARD CHARACTERS WITHOUT CLAIM TO ANY PARTICULAR FONT, STYLE, SIZE, OR COLOR.

FOR ON-LINE RETAIL STORE SERVICES FEATURING INSECT AND DISEASES CONTROL PRODUCTS FOR AGRICULTURAL USE IN GARDENING, THE PROTECTION AND NUTRITION OF PLANTS, VETERINARY PRODUCTS, SANITARY PRODUCTS INCLUDING DETERGENTS AND SOAPS, PRODUCTS FOR KILLING WEEDS AND DESTROYING VERMIN AND INSECTS; WHOLESALE ORDERING SERVICES IN THE FIELD OF INSECT AND DISEASE CONTROL PRODUCTS FOR AGRICULTURAL USE IN GARDENING, THE PROTECTION AND NUTRITION OF PLANTS, VETERINARY PRODUCTS, SANITARY PRODUCTS INCLUDING DETERGENTS AND SOAPS, PRODUCTS FOR KILLING WEEDS AND DESTROYING VERMIN AND INSECTS; WHOLESALE DISTRIBUTORSHIPS FEATURING INSECT AND DISEASE CONTROL PRODUCTS FOR AGRICULTURAL USE IN GARDENING, THE PROTECTION AND NUTRITION OF PLANTS, VETERINARY PRODUCTS, SANITARY PRODUCTS INCLUDING DETERGENTS AND SOAPS, PRODUCTS FOR KILLING WEEDS AND DESTROYING VERMIN AND INSECTS; ON-LINE ORDERING SERVICES FEATURING INSECT AND DISEASE CONTROL PRODUCTS FOR AGRICULTURAL USE IN GARDENING, THE PROTECTION AND NUTRITION OF PLANTS, VETERINARY PRODUCTS, SANITARY PRODUCTS INCLUDING DETERGENTS AND SOAPS, PRODUCTS FOR KILLING WEEDS AND DESTROYING VERMIN AND INSECTS (U.S. CLS. 100, 101 AND 102).

CAROLINE WOOD, EXAMINING ATTORNEY

SN 77-725,218. BEKEN, LAURA, DBA HANDBOOKLIVE, SAN MARCOS, CA. AND SMITH, SIMON F., DBA HANDBOOKLIVE, SAN MARCOS, CA. FILED 4-29-2009.

We help you Choose it and
Use it!

THE MARK CONSISTS OF STANDARD CHARACTERS WITHOUT CLAIM TO ANY PARTICULAR FONT, STYLE, SIZE, OR COLOR.

FOR ADVERTISING AND PUBLICITY SERVICES, NAMELY, PROMOTING THE GOODS, SERVICES, BRAND IDENTITY AND COMMERCIAL INFORMATION AND NEWS OF THIRD PARTIES THROUGH PRINT, AUDIO, VIDEO, DIGITAL AND ON-LINE MEDIUM (U.S. CLS. 100, 101 AND 102).

FIRST USE 4-21-2009; IN COMMERCE 4-27-2009.

KIMBERLY FRYE, EXAMINING ATTORNEY

CLASS 35—(Continued).

SN 77-725,221. BAKER, MEGHAN A., PHILADELPHIA, PA. FILED 4-29-2009.

Baby Planit

THE MARK CONSISTS OF STANDARD CHARACTERS WITHOUT CLAIM TO ANY PARTICULAR FONT, STYLE, SIZE, OR COLOR.

NO CLAIM IS MADE TO THE EXCLUSIVE RIGHT TO USE "BABY", APART FROM THE MARK AS SHOWN.

FOR CONSULTING SERVICES, NAMELY, PROVIDING EXPECTANT PARENTS WITH CONSUMER INFORMATION ON ALL TYPES OF BABY PRODUCTS AND SERVICES (U.S. CLS. 100, 101 AND 102).

CHRISTINA SOBRAL, EXAMINING ATTORNEY

CLASS 35—(Continued).

SN 77-725,267. THE LEADERSHIP COUNCIL ON LEGAL DIVERSITY, INC., PITTSBURGH, PA. FILED 4-29-2009.

LCLD

THE MARK CONSISTS OF STANDARD CHARACTERS WITHOUT CLAIM TO ANY PARTICULAR FONT, STYLE, SIZE, OR COLOR.

FOR PROMOTING PUBLIC AWARENESS OF DIVERSITY ISSUES SURROUNDING THE LEGAL SERVICES INDUSTRY AND INCREASING EMPLOYMENT OPPORTUNITIES FOR MINORITIES AND WOMEN IN THE LEGAL SERVICES INDUSTRY (U.S. CLS. 100, 101 AND 102).

MICHAEL WIENER, EXAMINING ATTORNEY

SN 77-725,229. MY MARKETING DEPARTMENT, INC., SEMINOLE, FL. FILED 4-29-2009.

MY MARKETING DEPARTMENT

THE MARK CONSISTS OF STANDARD CHARACTERS WITHOUT CLAIM TO ANY PARTICULAR FONT, STYLE, SIZE, OR COLOR.

NO CLAIM IS MADE TO THE EXCLUSIVE RIGHT TO USE "MARKETING DEPARTMENT", APART FROM THE MARK AS SHOWN.

FOR ADVERTISING AND MARKETING (U.S. CLS. 100, 101 AND 102).

FIRST USE 5-14-2007; IN COMMERCE 5-30-2007.
EMILY CHUO, EXAMINING ATTORNEY

SN 77-725,328. COFFEE EUPHORIA INC., CAPE CORAL, FL. FILED 4-29-2009.

Coffee Euphoria

THE MARK CONSISTS OF STANDARD CHARACTERS WITHOUT CLAIM TO ANY PARTICULAR FONT, STYLE, SIZE, OR COLOR.

NO CLAIM IS MADE TO THE EXCLUSIVE RIGHT TO USE "COFFEE", APART FROM THE MARK AS SHOWN.

FOR ON-LINE WHOLESALE AND RETAIL STORE SERVICES FEATURING GOURMET ROASTED COFFEE, ESPRESSO MACHINES, BREWING EQUIPMENT, COFFEE SYRUPS AND SMOOTHIE MIX (U.S. CLS. 100, 101 AND 102).

FIRST USE 2-21-2007; IN COMMERCE 2-21-2007.
JAY BESCH, EXAMINING ATTORNEY

SN 77-725,254. THE LEADERSHIP COUNCIL ON LEGAL DIVERSITY, INC., PITTSBURGH, PA. FILED 4-29-2009.

LEADERSHIP COUNCIL ON LEGAL DIVERSITY

THE MARK CONSISTS OF STANDARD CHARACTERS WITHOUT CLAIM TO ANY PARTICULAR FONT, STYLE, SIZE, OR COLOR.

FOR PROMOTING PUBLIC AWARENESS OF DIVERSITY ISSUES SURROUNDING THE LEGAL SERVICES INDUSTRY AND INCREASING EMPLOYMENT OPPORTUNITIES FOR MINORITIES AND WOMEN IN THE LEGAL SERVICES INDUSTRY (U.S. CLS. 100, 101 AND 102).

MICHAEL WIENER, EXAMINING ATTORNEY

SN 77-725,331. NETCHANNEL, INC., ALBUQUERQUE, NM. FILED 4-29-2009.

NetChannel

THE MARK CONSISTS OF STANDARD CHARACTERS WITHOUT CLAIM TO ANY PARTICULAR FONT, STYLE, SIZE, OR COLOR.

FOR ON-LINE WHOLESALE AND RETAIL STORE SERVICES FEATURING HOME AND OFFICE DECOR ITEMS CONSISTING OF RUGS, RUG PADS, PILLOWS, PAINTINGS (U.S. CLS. 100, 101 AND 102).

FIRST USE 2-16-1999; IN COMMERCE 5-21-2001.
LINDA ORNDORFF, EXAMINING ATTORNEY

CLASS 35—(Continued).

SN 77-725,399. MAXXUS GROUP INTERNATIONAL, LLC, CHICAGO, IL. FILED 4-29-2009.

GMS Hotels

THE MARK CONSISTS OF STANDARD CHARACTERS WITHOUT CLAIM TO ANY PARTICULAR FONT, STYLE, SIZE, OR COLOR.

NO CLAIM IS MADE TO THE EXCLUSIVE RIGHT TO USE "HOTELS", APART FROM THE MARK AS SHOWN, FOR ADMINISTRATIVE HOTEL MANAGEMENT (U.S. CLS. 100, 101 AND 102).
THEODORE MCBRIDE, EXAMINING ATTORNEY

SN 77-725,412. GET YOWZA, LLC, DBA YOWZA!!, LOS ANGELES, CA. FILED 4-29-2009.

YOWZA!!

THE MARK CONSISTS OF STANDARD CHARACTERS WITHOUT CLAIM TO ANY PARTICULAR FONT, STYLE, SIZE, OR COLOR.

FOR PROMOTING THE GOODS AND SERVICES OF OTHERS, NAMELY, PROVIDING COUPONS, REBATES AND VOUCHERS FOR THE GOODS AND SERVICES OF OTHERS (U.S. CLS. 100, 101 AND 102).

FIRST USE 4-14-2009; IN COMMERCE 4-14-2009.
CHARLES L. JENKINS, EXAMINING ATTORNEY

SN 77-725,423. NAUGHTYXOXO, LLC, ORLANDO, FL. FILED 4-29-2009.



THE STIPPLING IS FOR SHADING PURPOSES ONLY. THE MARK CONSISTS OF THE STYLIZED WORDS "NAUGHTYXOXO". THE LETTERS "O"'S ARE IN THE FORM OF A HANDCUFF. AN IMAGE OF A LIP PRINT IS IN THE BACKGROUND OF THE LETTERS "NAU" OF THE WORD "NAUGHTY".

FOR ON-LINE RETAIL STORE SERVICES FEATURING ADULT RETAIL ITEMS SUCH AS LOTIONS, CREAMS, LINGERIE, VIBRATORS, ADULT SWINGS, STRICTLY ADULT SEXUAL ITEMS SOLD OVER THE INTERNET (U.S. CLS. 100, 101 AND 102).

ROBERT C. CLARK JR., EXAMINING ATTORNEY

CLASS 35—(Continued).

SN 77-725,486. JODUG LLC, LAS VEGAS, NV. FILED 4-29-2009.

JoDug

THE MARK CONSISTS OF STANDARD CHARACTERS WITHOUT CLAIM TO ANY PARTICULAR FONT, STYLE, SIZE, OR COLOR.

FOR OPERATING ON-LINE MARKETPLACES FEATURING MATCHMAKING SERVICES BETWEEN SERVICE PROVIDERS AND CUSTOMERS (U.S. CLS. 100, 101 AND 102).

NAKWAMA ANKRAH, EXAMINING ATTORNEY

SN 77-725,501. STAR MANAGEMENT SERVICES, LLC, DBA WALK HAPPY, BINGHAM FARMS, MI. FILED 4-29-2009.

WALK HAPPY

THE MARK CONSISTS OF STANDARD CHARACTERS WITHOUT CLAIM TO ANY PARTICULAR FONT, STYLE, SIZE, OR COLOR.

FOR RETAIL STORE SERVICES IN THE FIELD OF SHOES, SHOE SUPPORTS, SHOE CUSHIONS, ARCH SUPPORTS AND FOOT ORTHOTICS; RETAIL STORE SERVICES IN THE FIELD OF CUSTOM SUPPORTS FOR SHOES, CUSTOM CUSHIONS FOR SHOES, CUSTOM ARCH SUPPORTS AND CUSTOM FOOT ORTHOTICS; DISTRIBUTORSHIPS IN THE FIELD OF SHOE SUPPORTS, CUSTOM ARCH SUPPORTS, FOOT ORTHOTICS AND CUSTOM FOOT ORTHOTICS; AND RETAIL STORE SERVICES IN THE FIELD OF CUSTOM FOOT ORTHOTICS, CUSTOM ARCH SUPPORTS AND CUSTOM CUSHIONS FOR SHOES THAT ARE CUSTOMIZED THROUGH THE USE OF MANUAL AND COMPUTERIZED FOOT SCANNING TECHNOLOGY (U.S. CLS. 100, 101 AND 102).

FIRST USE 9-20-2008; IN COMMERCE 9-20-2008.
WON TEAK OH, EXAMINING ATTORNEY

SN 77-725,515. LAGOTTI, STEFANO, WESTON, FL. AND ARRASATE, CAROL, WESTON, FL. FILED 4-29-2009.

under ground fighters

THE MARK CONSISTS OF STANDARD CHARACTERS WITHOUT CLAIM TO ANY PARTICULAR FONT, STYLE, SIZE, OR COLOR.

FOR ADVERTISING AND MARKETING (U.S. CLS. 100, 101 AND 102).

FIRST USE 1-1-2009; IN COMMERCE 1-1-2009.
LINDA ORNDORFF, EXAMINING ATTORNEY

CLASS 35—(Continued).

SN 77-725,581. ONCARD MARKETING, INC., DBA REVTRAX, NEW YORK, NY. FILED 4-29-2009.

REVTRAX

THE MARK CONSISTS OF STANDARD CHARACTERS WITHOUT CLAIM TO ANY PARTICULAR FONT, STYLE, SIZE, OR COLOR.

FOR ADVERTISING, MARKETING AND BUSINESS MANAGEMENT SERVICES, NAMELY, DEVELOPMENT, MANAGEMENT, OPTIMIZATION AND ANALYSIS OF MARKETING STRATEGIES AND MARKETING AND ADVERTISING CAMPAIGNS FOR OTHERS; ADVERTISING AND MARKETING SERVICES, SEARCH ENGINE MARKETING, NAMELY, PROMOTING THE GOODS AND SERVICES OF OTHERS THROUGH SEARCH ENGINE REFERRAL TRAFFIC ANALYSIS AND REPORTING AND E-MAIL MARKETING SERVICES IN THE NATURE OF E-MAIL BLAST CAMPAIGNS FOR OTHERS; AFFILIATE MARKETING SERVICES, NAMELY, FACILITATING PARTNERSHIPS BETWEEN AFFILIATES AND MERCHANTS IN CONNECTION WITH MARKETING CAMPAIGNS AND TRANSACTIONS; COLLECTING, ANALYZING AND REPORTING DATA CONCERNING BUSINESS-TO-CONSUMER AND BUSINESS-TO-BUSINESS COMMERCIAL TRANSACTIONS; INTEGRATED TRACKING AND MANAGEMENT OF BUSINESS-TO-CONSUMER AND BUSINESS-TO-BUSINESS COMMERCIAL TRANSACTIONS; BUSINESS MANAGEMENT SERVICES, NAMELY, COMPUTER-BASED SERVICES IN THE NATURE OF MAINTAINING AND ADMINISTERING AN AFFILIATE MARKETING NETWORK (U.S. CLS. 100, 101 AND 102). FIRST USE 7-10-2008; IN COMMERCE 7-10-2008. DEBRA LEE, EXAMINING ATTORNEY

SN 77-725,603. INTRATOR, DAVID, DBA DAVID INTRATOR COMMUNICATIONS, NEW YORK, NY. FILED 4-29-2009.

There's a story in every strategy

THE MARK CONSISTS OF STANDARD CHARACTERS WITHOUT CLAIM TO ANY PARTICULAR FONT, STYLE, SIZE, OR COLOR.

FOR ADMINISTRATION AND MANAGEMENT OF RESEARCH GRANTS; ADVERTISING AGENCY SPECIALIZING IN THE DESIGN AND EXECUTION OF WORD OF MOUTH, VIRAL, BUZZ AND EXPERIENTIAL MARKETING PROGRAMS; ADVERTISING AND MARKETING; ADVERTISING AND MARKETING SERVICES, NAMELY, PROMOTING THE GOODS AND SERVICES OF OTHERS; ADVERTISING SERVICES, NAMELY, PROMOTING AND MARKETING THE GOODS AND SERVICES OF OTHERS THROUGH ALL PUBLIC COMMUNICATION MEANS; ADVERTISING SERVICES, PUBLIC RELATIONS AND MARKETING SERVICES, NAMELY, PROMOTING AND MARKETING THE GOODS AND SERVICES OF OTHERS THROUGH ALL PUBLIC COMMUNICATION MEANS; ADVERTISING, MARKETING AND PROMOTING THE GOODS AND SERVICES OF OTHERS USING KIOSKS; ADVER-

CLASS 35—(Continued).

TISING, MARKETING AND PROMOTION SERVICES; ADVERTISING, MARKETING AND PROMOTIONAL SERVICES FOR AUTOMOTIVE DEALERSHIPS; ADVERTISING, MARKETING AND PROMOTIONAL SERVICES FOR LIGHT AND HEAVY EQUIPMENT DEALERSHIPS; ADVERTISING, MARKETING AND PROMOTIONAL SERVICES FOR THE DONATION OF HUMAN BLOOD THAT EXACTLY MATCHES THE BLOOD TYPE OF INDIVIDUALS NEEDING TRANSFUSIONS; ADVERTISING, MARKETING AND PROMOTIONAL SERVICES RELATED TO ALL INDUSTRIES FOR THE PURPOSE OF FACILITATING NETWORKING AND SOCIALIZING OPPORTUNITIES FOR BUSINESS PURPOSES; ADVERTISING, PROMOTION AND MARKETING SERVICES IN THE NATURE OF E-MAIL BLAST CAMPAIGNS FOR OTHERS; ADVICE CONCERNING CHEMICAL PRODUCT MARKETING; ADVICE IN THE FIELD OF BUSINESS MANAGEMENT AND MARKETING; ANALYZING AND COMPILING DATA FOR MEASURING THE PERFORMANCE OF FINANCIAL MARKETS; ARRANGING AND CONDUCTING MARKETING PROMOTIONAL EVENTS FOR OTHERS; ASSISTANCE, ADVISORY SERVICES AND CONSULTANCY WITH REGARD TO BUSINESS PLANNING, BUSINESS ANALYSIS, BUSINESS MANAGEMENT, BUSINESS ORGANIZATION, MARKETING AND CUSTOMER ANALYSIS; BRANDING SERVICES, NAMELY, CONSULTING, DEVELOPMENT, MANAGEMENT AND MARKETING OF BRANDS FOR BUSINESSES; BUSINESS CONSULTATION AND MANAGEMENT REGARDING MARKETING ACTIVITIES AND LAUNCHING OF NEW PRODUCTS; BUSINESS CONSULTING AND MANAGEMENT IN THE FIELD OF CLINICAL TRIALS, NAMELY, CLINICAL DATA AND REGULATORY SUBMISSION MANAGEMENT ON BEHALF OF MEDICAL, BIOPHARMACEUTICAL AND BIOTECHNOLOGY COMPANIES TO ASSIST THEM WITH CLINICAL RESEARCH, CLINICAL TRIALS AND APPLICATIONS FOR DRUG APPROVAL; BUSINESS INFORMATION MANAGEMENT, NAMELY, ELECTRONIC REPORTING OF BUSINESS INFORMATION, BUSINESS ANALYTICS, NAMELY, BUSINESS INVESTIGATIONS, EVALUATIONS, EXPERT APPRAISALS, INFORMATION AND RESEARCH, TRADE SPEND BUSINESS MANAGEMENT; BUSINESS INVESTIGATIONS, EVALUATIONS, EXPERT APPRAISALS, INFORMATION AND RESEARCH; BUSINESS MANAGEMENT AND CONSULTING SERVICES FOR THE HEALTH CARE INDUSTRY, NAMELY, CUSTOMER SERVICE, ACCOUNTING SERVICES, AND WEB-BASED ADVERTISING AND MARKETING SERVICES; BUSINESS MANAGEMENT CONSULTING WITH RELATION TO STRATEGY, FINANCING, MARKETING, PRODUCTION, PERSONNEL AND SALE MATTERS FOR COMPANIES INVOLVED WITH THIN FILM AND NANO TECHNOLOGIES AND PLASMA PROCESSES; BUSINESS MANAGEMENT CONSULTING WITH RELATION TO STRATEGY, MARKETING, PRODUCTION, PERSONNEL AND RETAIL SALE MATTERS; BUSINESS MANAGEMENT CONSULTING WITH RELATION TO STRATEGY, MARKETING, SALES, OPERATION, PRODUCT DESIGN PARTICULARLY SPECIALIZING IN THE USE OF ANALYTIC AND STATISTIC MODELS FOR THE UNDERSTANDING AND PREDICTING OF CONSUMERS, BUSINESSES, AND MARKET TRENDS AND ACTIONS; BUSINESS MARKETING AND DIRECT MAIL CONSULTING SERVICES; BUSINESS MARKETING CONSULTING SERVICES; BUSINESS MARKETING CONSULTING SERVICES TO CHILDCARE ORGANIZATIONS; BUSINESS MARKETING SERVICES; BUSINESS RESEARCH; BUSINESS RESEARCH AND SURVEYS; BUSINESS RESEARCH CONSULTATION; BUSINESS RESEARCH SERVICES, NAMELY, PROVIDING ANALYSIS OF RETAIL DATA ON SPECIFIC BUSINESS LOCATIONS; BUSINESS RESEARCH USING FOCUS GROUPS; BUSINESS TO BUSINESS DIRECT MARKETING SERVICES; COMMERCIAL INFORMATION AGENCIES; CONDUCTING BUSINESS AND MARKET RESEARCH SURVEYS; CONDUCTING BUSINESS RESEARCH AND SURVEYS; CONDUCTING MARKETING STUDIES; CONDUCTING ON-LINE BUSINESS MANAGEMENT RESEARCH SURVEYS; CONSULTATION SERVICES IN THE FIELD OF COMPANY, BUSINESS SECTOR AND INDUSTRY DATA AND RESEARCH; CONSULTING SERVICES IN THE FIELD OF MARKETING OF EDUCATIONAL TRAINING; CONSUMER RESEARCH; COOPERATIVE ADVERTISING AND MARKETING; COOPERATIVE ADVERTISING AND MARKETING SER-

CLASS 35—(Continued).

VICES BY WAY OF SOLICITATION, CUSTOMER SERVICE AND PROVIDING MARKETING INFORMATION VIA WEB SITES ON A GLOBAL COMPUTER NETWORK; CREATION OF MARKETING TOOLS DESIGNED TO INCREASE A CLIENT COMPANY'S KNOWLEDGE OF CUSTOMER NEEDS, AND ITS COMPETITORS' PRODUCTS AND SERVICES, PRICING, ADVERTISING STRATEGY AND SALES STRATEGY; CREATIVE MARKETING DESIGN SERVICES; CUSTOM WRITING SERVICES COMPRISING PUBLIC RELATIONS AND MARKETING MATERIALS FOR THE AUDIO, VIDEO AND TECHNOLOGY INDUSTRIES; DEVELOPMENT OF MARKETING STRATEGIES AND CONCEPTS; DIRECT MARKETING ADVERTISING FOR OTHERS; DIRECT MARKETING CONSULTING SERVICES; DIRECT MARKETING SERVICES; ENTERTAINMENT MARKETING SERVICES, NAMELY, MARKETING, PROMOTION AND ADVERTISING FOR INDEPENDENT RECORDING ARTISTS; FLEA MARKETS; GENERAL BUSINESS MERCHANDISING SERVICES, NAMELY, MARKETING; INFORMATION OR ENQUIRIES ON BUSINESS AND MARKETING; MARKET ANALYSIS; MARKET ANALYSIS AND RESEARCH SERVICES; MARKET MANIPULATION, RESEARCH AND ANALYSIS, WHETHER OR NOT VIA THE INTERNET; MARKET OPINION POLLING STUDIES; MARKET REPORTS AND STUDIES; MARKET RESEARCH; MARKET RESEARCH AND MARKET INTELLIGENCE SERVICES; MARKET RESEARCH CONSULTATION; MARKET RESEARCH SERVICES; MARKET RESEARCH STUDIES; MARKET SEGMENTATION CONSULTATION; MARKET STUDY AND ANALYSIS OF MARKET STUDIES; MARKETING ANALYSIS SERVICES; MARKETING AND ADVERTISING SERVICES FOR AUTOMOBILE DEALERSHIPS; MARKETING AND BRANDING SERVICES, NAMELY, PERFORMING CONSUMER INSIGHT AND BRAND STRATEGY OF COMPANY LOGOS; MARKETING CONSULTING; MARKETING PLAN DEVELOPMENT; MARKETING SERVICES IN THE FIELD OF PLANNED-GIVING FOR NON-PROFIT AND CHARITABLE ORGANIZATIONS; MARKETING SERVICES, NAMELY, CONDUCTING CONSUMER TRACKING BEHAVIOR RESEARCH AND CONSUMER TREND ANALYSIS; MARKETING SERVICES, NAMELY, CONSUMER MARKETING RESEARCH; MARKETING SERVICES, NAMELY, PROVIDING INFORMATIONAL WEB PAGES DESIGNED TO GENERATE SALES TRAFFIC VIA HYPERLINKS TO OTHER WEB SITES; MARKETING SERVICES, NAMELY, PROVIDING ON-LINE NON-DOWNLOADABLE VIDEOS TO PROMOTE DOCTORS AND MEDICAL PRACTICES; MARKETING, ADVERTISING AND PROMOTING THE GOODS AND SERVICES OF OTHERS IN THE FIELD OF TRAVEL AND TOURISM, NAMELY, PROVIDING INFORMATION VIA MAIL AND ELECTRONIC MAIL; MARKETING, ADVERTISING, AND PROMOTING THE RETAIL GOODS AND SERVICES OF OTHERS TO WIRELESS ELECTRONIC DEVICES; MARKETING, PROMOTIONAL AND ADVERTISING SERVICES PROVIDED BY MOBILE TELEPHONE CONNECTIONS; MEDIA PLANNING, NAMELY, ADVISING THE CLIENT ON THE CORRECT TIMES AND STATIONS TO ADVERTISE BASED ON MEDIA ANALYSIS OF THE MARKET FOR THAT MEDIA; MULTI-LEVEL MARKETING BUSINESS SERVICES; ON-LINE ADVERTISING AND MARKETING SERVICES; ON-LINE BUSINESS RESEARCH SERVICE THAT ALLOWS THE USER TO ANALYZE OPINION TRENDS CONTAINED IN DOCUMENTS ON THE INTERNET; PROMOTING COLLABORATION WITHIN THE SCIENTIFIC, RESEARCH AND MEDICAL COMMUNITIES TO ACHIEVE ADVANCES IN THE FIELD OF HEALTHCARE; PROMOTING TECHNICAL AND SCIENTIFIC INVESTIGATION, RESEARCH, AND EXPERIMENTATION IN THE FIELD OF ADVANCEMENT OF THE APPLICATION OF SCIENTIFIC DISCOVERY FOR THE BETTERMENT OF HUMANKIND THROUGH SUPPORT OF EDUCATIONAL INSTITUTIONS AND SCIENTIFIC ORGANIZATIONS; PROMOTING THE EXCHANGE OF INFORMATION AND RESOURCES WITHIN THE SCIENTIFIC RESEARCH AND MEDICAL COMMUNITIES TO ACHIEVE ADVANCES IN THE FIELD OF HEALTHCARE; PROMOTING, ADVERTISING AND MARKETING OF THE ON-LINE WEB SITES OF OTHERS; PROMOTION AND MARKETING SERVICES AND RELATED CONSULTING; PROMOTION, ADVERTISING AND MARKETING OF ON-LINE WEBSITES; PROMOTIONAL MARKETING AND REPRESENTATION SERVICES FOR SALES TO THE PUBLIC

CLASS 35—(Continued).

SECTOR; PROMOTIONAL SERVICES, NAMELY, GUERRILLA MARKETING SERVICES; PROVIDING A WEB SITE THAT FEATURES AN ON-LINE MARKET FOR USERS TO LIST OFFERED OR WANTED PERSONAL AND BUSINESS ASSETS AND SKILLS FOR HIRE, RENT, SALE OR AUCTION TRANSACTED ON THE BASIS OF PREDEFINED PERFORMANCE AND CLOSING TERMS AND CONDITIONS; PROVIDING ADVERTISING, MARKETING AND PROMOTIONAL SERVICES FOR THE PHARMACEUTICAL AND MEDICAL INDUSTRY; PROVIDING ADVERTISING, MARKETING AND PROMOTIONAL SERVICES FOR THE PHARMACEUTICAL AND MEDICAL PRODUCTS OF OTHERS; PROVIDING BUSINESS MARKETING INFORMATION; PROVIDING BUSINESS RESEARCH SERVICES, NAMELY, RESEARCHING DENTAL PATIENT INSURANCE INFORMATION FOR DENTAL OFFICES; PROVIDING FINANCIAL INDICES OF SELECT BONDS TO ENABLE CONSUMERS TO EVALUATE INVESTMENTS AND MARKET TRENDS IN THE BOND MARKET; PROVIDING INFORMATION IN THE FIELD OF MARKETING AND ON-LINE MARKETING MEDIA VIA THE INTERNET; PROVIDING MARKETING AND PROMOTION OF SPECIAL EVENTS; PROVIDING ONLINE BUSINESS MANAGEMENT SERVICES INCLUDING ACCOUNTING, MARKETING, BUSINESS PROJECT MANAGEMENT, AND BUSINESS DEVELOPMENT; PROVIDING PROMOTIONAL MARKETING SERVICES TO BUSINESSES IN THE BROADBAND AND MEDIA INDUSTRIES; PROVIDING PUBLIC SECTOR BUSINESS AND MARKET INTELLIGENCE; PROVIDING PUBLIC SECTOR GO-TO-MARKET ADVICE AND STRATEGIES; PROVIDING TECHNICAL CONSULTING SERVICES AND INFORMATION MANAGEMENT SERVICES, NAMELY, CLINICAL DATA AND REGULATORY SUBMISSION MANAGEMENT TO MEDICAL, BIOPHARMACEUTICAL AND BIOTECHNOLOGY COMPANIES TO ASSIST THEM WITH CLINICAL RESEARCH, CLINICAL TRIALS AND APPLICATIONS FOR DRUG APPROVAL; PUBLIC POLICY RESEARCH SERVICES; PUBLIC RELATIONS, ADVERTISING AND MARKETING SERVICES FOR THE TOURISM AND CONVENTION INDUSTRY, NAMELY, ORGANIZING AND HOSTING SITE INSPECTIONS AND FAMILIARIZATION TOURS FOR WHOLESALE, TOUR OPERATORS, TRAVEL AGENTS, MEETING AND INCENTIVE TRAVEL PLANNERS AND TRAVEL MEDIA; REAL ESTATE MARKETING SERVICES, NAMELY, ON-LINE SERVICES FEATURING THE PROMOTION OF RESIDENTIAL NEW CONSTRUCTION, WHICH ALSO CONTAINS BACK OFFICE SOLUTIONS FOR BUILDERS; REAL ESTATE MARKETING SERVICES, NAMELY, ON-LINE SERVICES FEATURING TOURS OF RESIDENTIAL AND COMMERCIAL REAL ESTATE; RENTAL OF ALL PUBLICITY AND MARKETING PRESENTATION MATERIALS; SHOPPING BY RESEARCHERS WHO POSE AS CUSTOMERS TO EVALUATE THE QUALITY OF SERVICE DELIVERED; SOCIAL MEDIA STRATEGY AND MARKETING CONSULTANCY FOCUSING ON HELPING CLIENTS CREATE AND EXTEND THEIR PRODUCT AND BRAND STRATEGIES BY BUILDING VIRALLY ENGAGING MARKETING SOLUTIONS; STATISTICAL EVALUATIONS OF MARKETING DATA; THE BRINGING TOGETHER, FOR THE BENEFIT OF OTHERS, OF A VARIETY OF GOODS AND SERVICES, ENABLING CUSTOMERS TO CONVENIENTLY VIEW AND PURCHASE THOSE GOODS AND SERVICES FROM AN INTERNET WEB SITE PARTICULARLY SPECIALIZING IN THE MARKETING OF THE SALE OF GOODS AND SERVICES OF OTHERS (U.S. CLS. 100, 101 AND 102).

FIRST USE 6-6-2005; IN COMMERCE 6-6-2005.

ELLEN BURNS, EXAMINING ATTORNEY

CLASS 35—(Continued).

SN 77-725,641. MADDOX, ANTHONY BERNARD, LOS ANGELES, CA. FILED 4-30-2009.

Perfect Competition

THE MARK CONSISTS OF STANDARD CHARACTERS WITHOUT CLAIM TO ANY PARTICULAR FONT, STYLE, SIZE, OR COLOR.

FOR NEW BUSINESS VENTURE DEVELOPMENT AND FORMATION CONSULTING SERVICES (U.S. CLS. 100, 101 AND 102).

TARAH HARDY, EXAMINING ATTORNEY

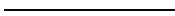

SN 77-725,684. BRANDT, JANE C., STEWARTSVILLE, NJ. FILED 4-30-2009.

Door-To-Door Secretary

THE MARK CONSISTS OF STANDARD CHARACTERS WITHOUT CLAIM TO ANY PARTICULAR FONT, STYLE, SIZE, OR COLOR.

NO CLAIM IS MADE TO THE EXCLUSIVE RIGHT TO USE "SECRETARY", APART FROM THE MARK AS SHOWN.

FOR BUSINESS OPERATION, BUSINESS ADMINISTRATION AND OFFICE FUNCTIONS (U.S. CLS. 100, 101 AND 102).

KIM MONINGHOFF, EXAMINING ATTORNEY

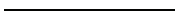

SN 77-725,751. BATTERIES PLUS, LLC, HARTLAND, WI. FILED 4-30-2009.



NO CLAIM IS MADE TO THE EXCLUSIVE RIGHT TO USE "BULB", APART FROM THE MARK AS SHOWN.

THE MARK CONSISTS OF THE WORDS "BULB" AND "SQUAD" SEPARATED BY A LIGHT BULB DESIGN.

FOR FRANCHISING, NAMELY, OFFERING TECHNICAL ASSISTANCE IN THE ESTABLISHMENT AND/OR OPERATION OF RETAIL STORES FEATURING LIGHT BULBS; RETAIL STORE SERVICES FEATURING LIGHT BULBS (U.S. CLS. 100, 101 AND 102).

YAT SYE, LEE, EXAMINING ATTORNEY

CLASS 35—(Continued).

SN 77-725,776. BATTERIES PLUS, LLC, HARTLAND, WI. FILED 4-30-2009.



OWNER OF U.S. REG. NOS. 1,697,440 AND 3,322,549. THE COLOR(S) GREEN AND ORANGE IS/ARE CLAIMED AS A FEATURE OF THE MARK.

THE MARK CONSISTS OF THE WORD "BATTERIES" IN GREEN, THE WORD "PLUS" IN ORANGE AND A GREEN AND ORANGE PLUS SYMBOL IN THE SHAPE OF A PERSON.

FOR FRANCHISING, NAMELY, OFFERING TECHNICAL ASSISTANCE IN THE ESTABLISHMENT AND/OR OPERATION OF RETAIL STORES FEATURING BATTERIES; RETAIL STORE SERVICES FEATURING BATTERIES (U.S. CLS. 100, 101 AND 102).

FIRST USE 6-16-2003; IN COMMERCE 6-16-2003.

YAT SYE, LEE, EXAMINING ATTORNEY



SN 77-725,808. HAIRY WINSTON, LLC, MT. PLEASANT, SC. FILED 4-30-2009.

The B*tches Love Us!

THE MARK CONSISTS OF STANDARD CHARACTERS WITHOUT CLAIM TO ANY PARTICULAR FONT, STYLE, SIZE, OR COLOR.

FOR RETAIL STORES FEATURING PET SUPPLIES (U.S. CLS. 100, 101 AND 102).

FIRST USE 8-25-2008; IN COMMERCE 10-2-2008.

DOMINICK J. SALEMI, EXAMINING ATTORNEY



SN 77-726,045. STUDENT VOLUNTEER FOUNDATION, MINNEAPOLIS, MN. FILED 4-30-2009.

SPARK MARKET

THE MARK CONSISTS OF STANDARD CHARACTERS WITHOUT CLAIM TO ANY PARTICULAR FONT, STYLE, SIZE, OR COLOR.

NO CLAIM IS MADE TO THE EXCLUSIVE RIGHT TO USE "MARKET", APART FROM THE MARK AS SHOWN.

FOR PROVIDING A WEBSITE FOR INDIVIDUALS OR GROUPS TO REQUEST FUNDING FOR VOLUNTEER PROJECTS (U.S. CLS. 100, 101 AND 102).

JAMES LOVELACE, EXAMINING ATTORNEY

CLASS 35—(Continued).

SN 77-726,046. REED ELSEVIER PROPERTIES INC., WILMINGTON, DE. FILED 4-30-2009.

MARTINDALE-HUBBELL

THE MARK CONSISTS OF STANDARD CHARACTERS WITHOUT CLAIM TO ANY PARTICULAR FONT, STYLE, SIZE, OR COLOR.

OWNER OF U.S. REG. NOS. 2,057,030, 2,989,601 AND OTHERS.

FOR MARKETING SERVICES, NAMELY, PROVIDING ON-LINE NON-DOWNLOADABLE VIDEOS TO PROMOTE LAWYERS AND LAW FIRM PRACTICES; PROVIDING AN ONLINE VIDEO BUSINESS DIRECTORY FOR LEGAL PROFESSIONALS (U.S. CLS. 100, 101 AND 102).

JAMES LOVELACE, EXAMINING ATTORNEY

SN 77-726,053. STACY PASSERI, DANVILLE, CA. FILED 4-30-2009.

KITETALE

THE MARK CONSISTS OF STANDARD CHARACTERS WITHOUT CLAIM TO ANY PARTICULAR FONT, STYLE, SIZE, OR COLOR.

FOR DATABASE MANAGEMENT (U.S. CLS. 100, 101 AND 102).

ERIN FALK, EXAMINING ATTORNEY

SN 77-726,081. AMERICAN SIGNATURE, INC., COLUMBUS, OH. FILED 4-30-2009.

FIT FOR A KING

THE MARK CONSISTS OF STANDARD CHARACTERS WITHOUT CLAIM TO ANY PARTICULAR FONT, STYLE, SIZE, OR COLOR.

FOR RETAIL STORE SERVICES FEATURING FURNITURE (U.S. CLS. 100, 101 AND 102).

JEFFREY LOOK, EXAMINING ATTORNEY

CLASS 35—(Continued).

SN 77-726,111. LOYALTYONE US, INC., WILMINGTON, DE. FILED 4-30-2009.

LIFE. REWARDED.

THE MARK CONSISTS OF STANDARD CHARACTERS WITHOUT CLAIM TO ANY PARTICULAR FONT, STYLE, SIZE, OR COLOR.

FOR ORGANIZATION, OPERATION AND ADMINISTRATION OF LOYALTY PROGRAMS AND PROMOTIONAL INCENTIVE SCHEMES TO PROMOTE THE GOODS AND SERVICES OF OTHERS; COOPERATIVE ADVERTISING, MARKETING AND PROMOTION OF GOODS AND SERVICES OF OTHERS (U.S. CLS. 100, 101 AND 102).

REBECCA GILBERT, EXAMINING ATTORNEY

SN 77-726,157. ZIMPLE, INC., AKA ZIMPLEMONEY, COSTA MESA, CA. FILED 4-30-2009.

Zimple

THE MARK CONSISTS OF STANDARD CHARACTERS WITHOUT CLAIM TO ANY PARTICULAR FONT, STYLE, SIZE, OR COLOR.

FOR PROVIDING AN ON-LINE COMPUTER WEB SITE THAT PROVIDES COMMERCIAL FINANCIAL TRANSACTION DATA, ACCOUNT MANAGEMENT, FINANCIAL REPORTING, ACCOUNTING FEATURES AND RELATED REFERENCE INFORMATION (U.S. CLS. 100, 101 AND 102).

NAKIA HENRY, EXAMINING ATTORNEY

SN 77-726,170. O'REILLY AUTOMOTIVE, INC., SPRINGFIELD, MO. FILED 4-30-2009.

Serious about your car...So are we!

THE MARK CONSISTS OF STANDARD CHARACTERS WITHOUT CLAIM TO ANY PARTICULAR FONT, STYLE, SIZE, OR COLOR.

FOR RETAIL STORES AND ONLINE RETAIL STORES FEATURING AUTOMOBILE PARTS AND ACCESSORIES (U.S. CLS. 100, 101 AND 102).

RONALD MCMORROW, EXAMINING ATTORNEY

CLASS 35—(Continued).

SN 77-726,192. TURNING POINT MINISTRIES INTERNATIONAL, HOUSTON, TX. FILED 4-30-2009.

Somebody Cares

THE MARK CONSISTS OF STANDARD CHARACTERS WITHOUT CLAIM TO ANY PARTICULAR FONT, STYLE, SIZE, OR COLOR.

OWNER OF U.S. REG. NO. 2,083,594.
 FOR CHARITABLE SERVICES, NAMELY, ORGANIZING AND CONDUCTING VOLUNTEER PROGRAMS AND COMMUNITY SERVICE PROJECTS; CHARITABLE SERVICES, NAMELY, ORGANIZING YOUTH GROUPS TO UNDERTAKE CHARITABLE PROJECTS IN THE FIELD OF DISASTER RESPONSE (U.S. CLS. 100, 101 AND 102).

FIRST USE 6-1-1994; IN COMMERCE 6-1-1994.
 SALLY SHIH, EXAMINING ATTORNEY

SN 77-726,235. SAGE GROUP INTERNATIONAL, LLC, DENVER, CO. FILED 4-30-2009.

TEA RANCH

THE MARK CONSISTS OF STANDARD CHARACTERS WITHOUT CLAIM TO ANY PARTICULAR FONT, STYLE, SIZE, OR COLOR.

OWNER OF U.S. REG. NO. 3,497,233.
 NO CLAIM IS MADE TO THE EXCLUSIVE RIGHT TO USE "TEA", APART FROM THE MARK AS SHOWN.
 FOR RETAIL STORE SERVICES FEATURING BEVERAGES (U.S. CLS. 100, 101 AND 102).
 SALLY SHIH, EXAMINING ATTORNEY

SN 77-726,458. MYBRANDSTAND, LLC, BELLEVUE, WA. FILED 4-30-2009.

MEOSIC

THE MARK CONSISTS OF STANDARD CHARACTERS WITHOUT CLAIM TO ANY PARTICULAR FONT, STYLE, SIZE, OR COLOR.

FOR ADVERTISING SERVICES, NAMELY, FACILITATING ADVERTISEMENT MANAGEMENT FOR OTHERS BY FACILITATING USER-INITIATED PLACEMENT OF ADVERTISING AND MAXIMIZING RELATED REVENUE VIA A GLOBAL COMPUTER NETWORK (U.S. CLS. 100, 101 AND 102).

FIRST USE 4-23-2009; IN COMMERCE 4-30-2009.
 VIVIAN MICZNIK FIRST, EXAMINING ATTORNEY

CLASS 35—(Continued).

SN 77-726,485. MYBRANDSTAND, LLC, BELLEVUE, WA. FILED 4-30-2009.

meosic [myoo-zik] orchestrate your brand

THE MARK CONSISTS OF STYLIZED FORM OF THE WORDS MEOSIC [MYOO-ZIK] ORCHESTRATE YOUR BRAND.

FOR ADVERTISING SERVICES, NAMELY, FACILITATING ADVERTISEMENT MANAGEMENT FOR OTHERS BY FACILITATING USER-INITIATED PLACEMENT OF ADVERTISING AND MAXIMIZING RELATED REVENUE VIA A GLOBAL COMPUTER NETWORK (U.S. CLS. 100, 101 AND 102).

FIRST USE 4-23-2009; IN COMMERCE 4-30-2009.
 VIVIAN MICZNIK FIRST, EXAMINING ATTORNEY

SN 77-726,504. DILEMIO INC., LONGWOOD, FL. FILED 4-30-2009.

Dilemio

THE STIPPLING IS FOR SHADING PURPOSES ONLY. THE MARK CONSISTS OF THE STYLIZED TEXT "DILEMIO".

FOR CONDUCTING PUBLIC OPINION POLLS (U.S. CLS. 100, 101 AND 102).

BARBARA BROWN, EXAMINING ATTORNEY

SN 77-726,511. ALJA INC., BROOKLYN PARK, MN. FILED 4-30-2009.



SUNNY'S

THE MARK CONSISTS OF THE STYLIZED TEXT "S" INSIDE A RECTANGLE WITH THE STYLIZED TEXT "SUNNY'S" AT THE BOTTOM.

FOR RETAIL STORE SERVICES FEATURING WIGS, HAIR EXTENSIONS, HAIR PIECES, HAIR AND SKIN PRODUCTS, ARTIFICIAL EYELASHES, AND PONYTAILS (U.S. CLS. 100, 101 AND 102).

KIMBERLY FRYE, EXAMINING ATTORNEY

CLASS 35—(Continued).

SN 77-726,557. MOOBIL MEDIA, LLC., FORT WORTH, TX. FILED 4-30-2009.

MooBilAds

THE MARK CONSISTS OF STANDARD CHARACTERS WITHOUT CLAIM TO ANY PARTICULAR FONT, STYLE, SIZE, OR COLOR.

FOR (BASED ON USE IN COMMERCE) ADVERTISING AGENCY SPECIALIZING IN THE DESIGN AND EXECUTION OF WORD OF MOUTH, VIRAL, BUZZ AND EXPERIENTIAL MARKETING PROGRAMS; ADVERTISING AND PUBLICITY SERVICES, NAMELY, PROMOTING THE GOODS, SERVICES, BRAND IDENTITY AND COMMERCIAL INFORMATION AND NEWS OF THIRD PARTIES THROUGH PRINT, AUDIO, VIDEO, DIGITAL AND ON-LINE MEDIUM; OUT-OF-HOME ADVERTISING SERVICES, NAMELY, RENTAL OF ADVERTISING SPACE, AND PREPARING AND PLACING ADVERTISEMENTS FOR OTHERS (BASED ON INTENT TO USE) ADVERTISING SERVICES, NAMELY, PROMOTING AND MARKETING THE GOODS AND SERVICES OF OTHERS THROUGH ALL PUBLIC COMMUNICATION MEANS; ELECTRONIC BILLBOARD ADVERTISING; PROVIDING ADVERTISING SPACE ON BILLBOARDS AND IN KIOSKS (U.S. CLS. 100, 101 AND 102).

FIRST USE 2-27-2009; IN COMMERCE 4-20-2009.
LEIGH CAROLINE CASE, EXAMINING ATTORNEY

SN 77-726,573. CREATIVESCALE, LLC, WINNETKA, IL. FILED 4-30-2009.

CreativeScale

THE MARK CONSISTS OF STANDARD CHARACTERS WITHOUT CLAIM TO ANY PARTICULAR FONT, STYLE, SIZE, OR COLOR.

FOR ADVERTISING, MARKETING AND PROMOTION SERVICES; BRANDING SERVICES, NAMELY, CONSULTING, DEVELOPMENT, MANAGEMENT AND MARKETING OF BRANDS FOR BUSINESSES; ON-LINE ADVERTISING AND MARKETING SERVICES (U.S. CLS. 100, 101 AND 102).

JUDITH HELFMAN, EXAMINING ATTORNEY

CLASS 35—(Continued).

SN 77-726,640. SUSAN SEARS & ASSOCIATES, LLC, DBA SSA PUBLIC RELATIONS, PHOENIX, AZ. FILED 4-30-2009.

INVIEW COMMUNICATIONS

THE MARK CONSISTS OF STANDARD CHARACTERS WITHOUT CLAIM TO ANY PARTICULAR FONT, STYLE, SIZE, OR COLOR.

NO CLAIM IS MADE TO THE EXCLUSIVE RIGHT TO USE "COMMUNICATIONS", APART FROM THE MARK AS SHOWN.

FOR PUBLIC RELATIONS (U.S. CLS. 100, 101 AND 102).

KIMBERLY FRYE, EXAMINING ATTORNEY

SN 77-726,789. WHITNEY, ROB, HARRISONBURG, VA. FILED 5-1-2009.

ScholarPower.net

THE COLOR(S) BLACK AND PURPLE IS/ARE CLAIMED AS A FEATURE OF THE MARK.

THE MARK CONSISTS OF THE STYLIZED LETTERING OF "SCHOLARPOWER.NET" WITH THE WORDS "SCHOLAR" AND ".NET" IN BLACK AND THE WORD "POWER" IS IN PURPLE LETTERING. THE ".NET" IS IN THE UPPER RIGHT.

FOR ADVERTISING AND COMMERCIAL INFORMATION SERVICES, VIA THE INTERNET; ADVERTISING SERVICES, NAMELY, PROVIDING INFORMATION AS TO THE AVAILABILITY OF GOODS AND SERVICES OFFERED BY BUSINESSES TO COLLEGE STUDENTS FOR RENT OR PURCHASE (U.S. CLS. 100, 101 AND 102).

HENRY S. ZAK, EXAMINING ATTORNEY

SN 77-726,809. TOYA, HIROSHI, CARSON, CA. FILED 5-1-2009.

RUGBY IS THE BEST SPORT.

THE MARK CONSISTS OF STANDARD CHARACTERS WITHOUT CLAIM TO ANY PARTICULAR FONT, STYLE, SIZE, OR COLOR.

NO CLAIM IS MADE TO THE EXCLUSIVE RIGHT TO USE "RUGBY", APART FROM THE MARK AS SHOWN.

FOR RETAIL STORES FEATURING RUGBY GOODS AND EQUIPMENT (U.S. CLS. 100, 101 AND 102).

GISELLE AGOSTO, EXAMINING ATTORNEY

CLASS 35—(Continued).

SN 77-726,816. TIME INC., NEW YORK, NY. FILED 5-1-2009.

ALL YOU

THE MARK CONSISTS OF STANDARD CHARACTERS WITHOUT CLAIM TO ANY PARTICULAR FONT, STYLE, SIZE, OR COLOR.

FOR ONLINE AND MAIL ORDER BOOK CLUB SERVICES (U.S. CLS. 100, 101 AND 102).
FIRST USE 10-31-2008; IN COMMERCE 10-31-2008.
ZACHARY BELLO, EXAMINING ATTORNEY

SN 77-726,951. PROPHET BRAND STRATEGY, SAN FRANCISCO, CA. FILED 5-1-2009.

INSPIRATION. REALIZED.

THE MARK CONSISTS OF STANDARD CHARACTERS WITHOUT CLAIM TO ANY PARTICULAR FONT, STYLE, SIZE, OR COLOR.

FOR STRATEGIC BUSINESS PLANNING; BUSINESS MARKETING CONSULTING SERVICES; BUSINESS CONSULTATION SERVICES; BUSINESS MANAGEMENT CONSULTING; BRANDING SERVICES, NAMELY, CONSULTING, DEVELOPMENT, MANAGEMENT AND MARKETING OF BRANDS FOR BUSINESSES (U.S. CLS. 100, 101 AND 102).
FIRST USE 1-16-2008; IN COMMERCE 1-16-2008.
LESLIE RICHARDS, EXAMINING ATTORNEY

SN 77-726,991. ROMAIN INVESTMENT, CORP., DORAL, FL. FILED 5-1-2009.

CHICBERRY

THE MARK CONSISTS OF STANDARD CHARACTERS WITHOUT CLAIM TO ANY PARTICULAR FONT, STYLE, SIZE, OR COLOR.

FOR RETAIL STORE SERVICES FEATURING FROZEN YOGURT, SMOOTHIES, MUFFINS, COFFEE, WATER (U.S. CLS. 100, 101 AND 102).
GEORGE LORENZO, EXAMINING ATTORNEY

CLASS 35—(Continued).

SN 77-727,036. ZEPHYRSP, LLC, DBA ZEPHYR SOLUTIONS AND PRODUCTIONS, ATLANTA, GA. FILED 5-1-2009.

ZEPHYR SOLUTIONS AND PRODUCTIONS

THE MARK CONSISTS OF STANDARD CHARACTERS WITHOUT CLAIM TO ANY PARTICULAR FONT, STYLE, SIZE, OR COLOR.

NO CLAIM IS MADE TO THE EXCLUSIVE RIGHT TO USE "SOLUTIONS" AND "PRODUCTIONS", APART FROM THE MARK AS SHOWN.

FOR BUSINESS CONSULTATION IN THE FIELD OF MARKETING, MANAGEMENT, AND STRATEGY IN THE AREA OF TELECOMMUNICATIONS AND DEFENSE (U.S. CLS. 100, 101 AND 102).
JOHN WILKE, EXAMINING ATTORNEY

SN 77-727,497. VON BUREN, JOHN, DBA PAPA RAZZINC, PALM SPRINGS, CA. FILED 5-1-2009.

PAPA RAZZINC

THE COLOR(S) BLACK IS/ARE CLAIMED AS A FEATURE OF THE MARK.

THE MARK CONSISTS OF THE WORDING "PAPA RAZZINC" IN BLACK COLOR AND STYLIZED FONT.

FOR RETAIL STORE SERVICES IN THE FIELD OF CELEBRITY MEMORABILIA (U.S. CLS. 100, 101 AND 102).
TEJBIR SINGH, EXAMINING ATTORNEY

SN 77-727,508. POOL WATER PRODUCTS, INC., IRVINE, CA. FILED 5-1-2009.



NO CLAIM IS MADE TO THE EXCLUSIVE RIGHT TO USE "POOL WATER PRODUCTS", APART FROM THE MARK AS SHOWN.

THE MARK CONSISTS OF THE LETTERS "PWP" RESTING ON TOP OF A WATERLINE/WAVES WITH THE WORDS "POOL WATER PRODUCTS" BELOW, ALL ENCLOSED IN A RECTANGULAR BOX.

FOR WHOLESALE AND RETAIL STORE SERVICES FEATURING SWIMMING POOL AND SPA EQUIPMENT AND SUPPLIES (U.S. CLS. 100, 101 AND 102).
FIRST USE 5-15-1964; IN COMMERCE 5-15-1964.
STEVEN R. FOSTER, EXAMINING ATTORNEY

CLASS 35—(Continued).

SN 77-727,543. WEST, MIKE, ANCHORAGE, AK. FILED 5-1-2009.

CAKESATIONS

THE MARK CONSISTS OF STANDARD CHARACTERS WITHOUT CLAIM TO ANY PARTICULAR FONT, STYLE, SIZE, OR COLOR.

FOR RETAIL BAKERY SHOPS (U.S. CLS. 100, 101 AND 102).

FIRST USE 4-1-2008; IN COMMERCE 4-1-2008.
MAYUR VAGHANI, EXAMINING ATTORNEY

SN 77-727,649. COZBY, JAMIE D., HAMILTON, TX. FILED 5-2-2009.

Punchy Cowgirl

THE MARK CONSISTS OF STANDARD CHARACTERS WITHOUT CLAIM TO ANY PARTICULAR FONT, STYLE, SIZE, OR COLOR.

FOR ELECTRONIC RETAIL STORE SERVICES VIA THE COMPUTER AND ONLINE RETAIL STORE SERVICES FEATURING JEWELRY, BRACELETS, PENDANTS, EARRINGS, NECKLACES, RINGS, APPAREL, BELTS, BELT BUCKLES, T-SHIRTS, DRESSES, LEGGINGS, HATS, BASEBALL CAPS, HANDBAGS, PURSES, WALLET, CELL PHONE HOLDERS, FLIP FLOP SANDALS, COMFORTERS, CURTAINS, TOWELS, SHEETS, CANDLE HOLDERS, METAL CANNISTERS FOR CANDLES, WALL ART, AND HOME DECORATIONS (U.S. CLS. 100, 101 AND 102).

MICHAEL SOUDERS, EXAMINING ATTORNEY

SN 77-727,867. FAITHFUL ORGANIZERS, DBA FAITHFUL ORGANIZERS, HOUSTON, TX. FILED 5-3-2009.

FAITHFUL ORGANIZERS

THE MARK CONSISTS OF STANDARD CHARACTERS WITHOUT CLAIM TO ANY PARTICULAR FONT, STYLE, SIZE, OR COLOR.

NO CLAIM IS MADE TO THE EXCLUSIVE RIGHT TO USE "ORGANIZERS", APART FROM THE MARK AS SHOWN.

FOR ASSOCIATION SERVICES, NAMELY, PROMOTING THE INTERESTS OF PROFESSIONAL ORGANIZERS OF FAITH (U.S. CLS. 100, 101 AND 102).

FIRST USE 1-23-2001; IN COMMERCE 1-23-2001.
FRED MANDIR, EXAMINING ATTORNEY

CLASS 35—(Continued).

SN 77-728,344. BATTLE BORN GAMING, INC., VICTORIA, SEYCHELLES, FILED 5-4-2009.

SATAN IS MY CO-PILOT

THE MARK CONSISTS OF STANDARD CHARACTERS WITHOUT CLAIM TO ANY PARTICULAR FONT, STYLE, SIZE, OR COLOR.

FOR ADVERTISING AND PROMOTIONAL SERVICES (U.S. CLS. 100, 101 AND 102).

MARK SPARACINO, EXAMINING ATTORNEY

SN 77-728,349. BATTLE BORN GAMING, INC., VICTORIA, SEYCHELLES, FILED 5-4-2009.

WHAT WOULD SATAN DO?

THE MARK CONSISTS OF STANDARD CHARACTERS WITHOUT CLAIM TO ANY PARTICULAR FONT, STYLE, SIZE, OR COLOR.

FOR ADVERTISING AND PROMOTIONAL SERVICES (U.S. CLS. 100, 101 AND 102).

MARK SPARACINO, EXAMINING ATTORNEY

SN 77-728,353. BATTLE BORN GAMING, INC., VICTORIA, SEYCHELLES, FILED 5-4-2009.

WHAT WOULD SATAN DRINK?

THE MARK CONSISTS OF STANDARD CHARACTERS WITHOUT CLAIM TO ANY PARTICULAR FONT, STYLE, SIZE, OR COLOR.

FOR ADVERTISING AND PROMOTIONAL SERVICES (U.S. CLS. 100, 101 AND 102).

MARK SPARACINO, EXAMINING ATTORNEY

CLASS 35—(Continued).

SN 77-728,356. BATTLE BORN GAMING, INC., VICTORIA, SEYCHELLES, FILED 5-4-2009.

CLASS 35—(Continued).

SN 77-728,447. LANCASTER, MICHELLE, SANTA MONICA, CA. FILED 5-4-2009.

SATAN'S GOT ME BY THE BALLS

Conscious Footprint

THE MARK CONSISTS OF STANDARD CHARACTERS WITHOUT CLAIM TO ANY PARTICULAR FONT, STYLE, SIZE, OR COLOR.
FOR ADVERTISING AND PROMOTIONAL SERVICES (U.S. CLS. 100, 101 AND 102).
MARK SPARACINO, EXAMINING ATTORNEY

THE MARK CONSISTS OF STANDARD CHARACTERS WITHOUT CLAIM TO ANY PARTICULAR FONT, STYLE, SIZE, OR COLOR.
FOR BUSINESS CONSULTATION SERVICES (U.S. CLS. 100, 101 AND 102).
LAURIE MAYES, EXAMINING ATTORNEY

SN 77-728,429. LUCKY BRAND DUNGAREES, INC., VERNON, CA. FILED 5-4-2009.

SN 77-728,552. HUMAN RESOURCE DEVELOPMENT SERVICES INC., DBA HRDS INC., PARK RIDGE, IL. FILED 5-4-2009.

LIVE IN LOVE

Where You Achieve More

THE MARK CONSISTS OF STANDARD CHARACTERS WITHOUT CLAIM TO ANY PARTICULAR FONT, STYLE, SIZE, OR COLOR.
FOR RETAIL STORE AND ON-LINE RETAIL STORE SERVICES FEATURING APPAREL, LEATHER GOODS, EYEWEAR, FASHION ACCESSORIES AND JEWELRY (U.S. CLS. 100, 101 AND 102).
MICHAEL WEBSTER, EXAMINING ATTORNEY

THE MARK CONSISTS OF STANDARD CHARACTERS WITHOUT CLAIM TO ANY PARTICULAR FONT, STYLE, SIZE, OR COLOR.
FOR CONSULTING SERVICES IN THE FIELD OF HIGHER EDUCATION ADMINISTRATION (U.S. CLS. 100, 101 AND 102).
TINA KUAN, EXAMINING ATTORNEY

SN 77-728,440. AVERY, CLAUDIA, WICHITA, KS. FILED 5-4-2009.

SN 77-728,584. WERNER RELOCATION SOLUTIONS, LLC, HOBOKEN, NJ. FILED 5-4-2009.

Blessing Box Cottage

I'LL MOVE YOUR MOM!

THE MARK CONSISTS OF STANDARD CHARACTERS WITHOUT CLAIM TO ANY PARTICULAR FONT, STYLE, SIZE, OR COLOR.
FOR RETAIL GIFT SHOPS (U.S. CLS. 100, 101 AND 102).
PATRICIA EVANKO, EXAMINING ATTORNEY

THE MARK CONSISTS OF STANDARD CHARACTERS WITHOUT CLAIM TO ANY PARTICULAR FONT, STYLE, SIZE, OR COLOR.
FOR MOVING AND RELOCATION SERVICES, NAMELY, CONSULTING, PLANNING, COORDINATING, PROJECT OVERSIGHT, AND IMPLEMENTING MOVES OF HOMES AND OFFICES (U.S. CLS. 100, 101 AND 102).
TARAH HARDY, EXAMINING ATTORNEY

CLASS 35—(Continued).

SN 77-728,745. IMAGING TECHNOLOGIES DIRECT LLC, LOS ANGELES, CA. FILED 5-4-2009.

IT'S TOUGH TO BEAT A RHINO

THE MARK CONSISTS OF STANDARD CHARACTERS WITHOUT CLAIM TO ANY PARTICULAR FONT, STYLE, SIZE, OR COLOR.

FOR WHOLESALE AND RETAIL STORE SERVICES FEATURING INK JET CARTRIDGES, TONER CARTRIDGES, AND OTHER COMPUTER AND PRINTER PRODUCTS (U.S. CLS. 100, 101 AND 102).

FIRST USE 8-1-1997; IN COMMERCE 8-1-1997.
DAVID H. STINE, EXAMINING ATTORNEY

SN 77-728,809. RESOURCEFUL MOMMY MEDIA, LLC, OLNEY, MD. FILED 5-4-2009.

Momfluence

THE MARK CONSISTS OF STANDARD CHARACTERS WITHOUT CLAIM TO ANY PARTICULAR FONT, STYLE, SIZE, OR COLOR.

FOR ADVERTISING SERVICES, PUBLIC RELATIONS AND MARKETING SERVICES, NAMELY, PROMOTING AND MARKETING THE GOODS AND SERVICES OF OTHERS THROUGH ALL PUBLIC COMMUNICATION MEANS, SOCIAL MEDIA STRATEGY AND MARKETING CONSULTANCY FOCUSING ON HELPING CLIENTS CREATE AND EXTEND THEIR PRODUCT AND BRAND STRATEGIES BY BUILDING VIRALLY ENGAGING MARKETING SOLUTIONS (U.S. CLS. 100, 101 AND 102).

FIRST USE 2-10-2009; IN COMMERCE 2-19-2009.
DAVID HOFFMAN, EXAMINING ATTORNEY

SN 77-729,508. JULIANNA DELIGANS, OKLAHOMA CITY, OK. FILED 5-5-2009.

BARELY BENEATH

THE MARK CONSISTS OF STANDARD CHARACTERS WITHOUT CLAIM TO ANY PARTICULAR FONT, STYLE, SIZE, OR COLOR.

FOR RETAIL STORE AND ON-LINE RETAIL STORE SERVICES FEATURING INTIMATE APPAREL (U.S. CLS. 100, 101 AND 102).

GIANCARLO CASTRO, EXAMINING ATTORNEY

CLASS 35—(Continued).

SN 77-729,602. BUCK CONSULTANTS, LLC, NEW YORK, NY. FILED 5-5-2009.

MY MEDICARE ADVOCATE

THE MARK CONSISTS OF STANDARD CHARACTERS WITHOUT CLAIM TO ANY PARTICULAR FONT, STYLE, SIZE, OR COLOR.

NO CLAIM IS MADE TO THE EXCLUSIVE RIGHT TO USE "MEDICARE", APART FROM THE MARK AS SHOWN. FOR BUSINESS CONSULTING RELATING TO COMPANY AND GOVERNMENTAL HEALTH BENEFITS FOR EMPLOYEES AND RETIREES (U.S. CLS. 100, 101 AND 102).

ZHALEH DELANEY, EXAMINING ATTORNEY

SN 77-729,621. BUCK CONSULTANTS, LLC, NEW YORK, NY. FILED 5-5-2009.

HELPING YOU MAKE THE RIGHT DECISIONS

THE MARK CONSISTS OF STANDARD CHARACTERS WITHOUT CLAIM TO ANY PARTICULAR FONT, STYLE, SIZE, OR COLOR.

FOR BUSINESS CONSULTING RELATING TO COMPANY AND GOVERNMENTAL HEALTH BENEFITS FOR EMPLOYEES AND RETIREES (U.S. CLS. 100, 101 AND 102).

ZHALEH DELANEY, EXAMINING ATTORNEY

SN 77-731,475. SENGSTAKEN ENTERPRISES, INC., OXNARD, CA. FILED 5-7-2009.

STYLE WEST

THE MARK CONSISTS OF STANDARD CHARACTERS WITHOUT CLAIM TO ANY PARTICULAR FONT, STYLE, SIZE, OR COLOR.

FOR DISTRIBUTORSHIP SERVICES IN THE FIELD OF CLOTHING, FOOTWEAR AND CLOTHING ACCESSORIES (U.S. CLS. 100, 101 AND 102).

C. DIONNE CLYBURN, EXAMINING ATTORNEY

CLASS 35—(Continued).

SN 77-732,828. JACKSON NATIONAL LIFE INSURANCE COMPANY, LANSING, MI. FILED 5-8-2009.

JACKSON OF NY

THE MARK CONSISTS OF STANDARD CHARACTERS WITHOUT CLAIM TO ANY PARTICULAR FONT, STYLE, SIZE, OR COLOR.

OWNER OF U.S. REG. NOS. 2,906,958, 3,578,110 AND OTHERS.

NO CLAIM IS MADE TO THE EXCLUSIVE RIGHT TO USE "NY", APART FROM THE MARK AS SHOWN.

FOR INSURANCE MARKETING CONSULTING SERVICES FOR AGENTS AND BROKERS (U.S. CLS. 100, 101 AND 102).

EMILY CARLSEN, EXAMINING ATTORNEY

SN 77-735,755. PRIORITY ENERGY, LLC, CHICAGO, IL. FILED 5-13-2009.



NO CLAIM IS MADE TO THE EXCLUSIVE RIGHT TO USE "ENERGY" AND "ENERGY PLANNING", APART FROM THE MARK AS SHOWN.

THE COLOR(S) GREEN AND BLUE IS/ARE CLAIMED AS A FEATURE OF THE MARK.

THE MARK CONSISTS OF THE STYLIZED WORD "PRIORITY" IN GREEN WITH THE "O" BEING AN ARTISTIC RENDERING OF THE PLANET EARTH, WITH A BLUE CIRCULAR ARROW SURROUNDING THE EARTH. THERE IS A THICK BLUE UNDERLINE UNDER THE LETTERS "PRI" OF THE WORD "PRIORITY" WITH A THIN BLUE UNDERLINE APPEARING BELOW THE THICK BLUE UNDERLINE AND RUNNING THE LENGTH OF THE WORD "PRIORITY". UNDER THE "RITY" OF "PRIORITY" IS THE STYLIZED WORD "ENERGY" IN BLUE. UNDER THE THIN BLUE UNDERLINE IS THE STYLIZED WORDING "PRIORITY ENERGY PLANNING" IN GREEN.

FOR ENERGY ASSESSMENT SERVICES FOR THE PURPOSE OF DETERMINING ENERGY EFFICIENCY OR USAGE MANAGEMENT (U.S. CLS. 100, 101 AND 102).

FIRST USE 4-9-2009; IN COMMERCE 4-9-2009.
HENRY S. ZAK, EXAMINING ATTORNEY

CLASS 35—(Continued).

SN 77-738,136. CHAPIN MANUFACTURING, INC., BATAVIA, NY. FILED 5-15-2009.



THE MARK CONSISTS OF A STAR IN A SLANTED SQUARE AND TWO BARS.

FOR ON-LINE RETAIL STORE SERVICES FEATURING FLAGS, FLAG POLES, FLAG AND FLAG POLE ACCESSORIES AND HARDWARE, AND FLAG POLE KITS COMPRISED OF FLAG, FLAG POLE, FLAG POLE BRACKETS AND FLAG-TO-POLE ATTACHMENTS (U.S. CLS. 100, 101 AND 102).

MARK SPARACINO, EXAMINING ATTORNEY

SN 77-739,006. E & H DISTRIBUTING CO., NORTH LAS VEGAS, NV. FILED 5-18-2009.

DEALS TO GROW

THE MARK CONSISTS OF STANDARD CHARACTERS WITHOUT CLAIM TO ANY PARTICULAR FONT, STYLE, SIZE, OR COLOR.

FOR WHOLESALE DISTRIBUTORSHIPS FEATURING FOOD, PAPER PRODUCTS, SUPPLIES AND EQUIPMENT RELATED TO THE FOOD SERVICE INDUSTRY (U.S. CLS. 100, 101 AND 102).

ALICE BENMAMAN, EXAMINING ATTORNEY

SN 77-739,010. E & H DISTRIBUTING CO., NORTH LAS VEGAS, NV. FILED 5-18-2009.



THE MARK CONSISTS OF THE PHRASE "DEALS TO GROW", WITH AN ARROW DESIGN EXTENDING UPWARD FROM THE "W" IN "GROW".

FOR WHOLESALE DISTRIBUTORSHIPS FEATURING FOOD, PAPER PRODUCTS, SUPPLIES AND EQUIPMENT RELATED TO THE FOOD SERVICE INDUSTRY (U.S. CLS. 100, 101 AND 102).

ALICE BENMAMAN, EXAMINING ATTORNEY

CLASS 35—(Continued).

SN 77-739,998. BUCK CONSULTANTS, LLC, NEW YORK, NY. FILED 5-19-2009.

ADVOCATE CONNECTOR

THE MARK CONSISTS OF STANDARD CHARACTERS WITHOUT CLAIM TO ANY PARTICULAR FONT, STYLE, SIZE, OR COLOR.

FOR MANAGEMENT AND OPERATION OF TELEPHONE CALL CENTERS FOR OTHERS AND TECHNICAL ASSISTANCE IN THE ESTABLISHMENT OF TELEPHONE CALL CENTERS TO BE MANAGED AND OPERATED BY OTHERS (U.S. CLS. 100, 101 AND 102).
ZHALEH DELANEY, EXAMINING ATTORNEY

SN 77-743,292. GREATER ROCHESTER ENTERPRISE, INC., ROCHESTER, NY. FILED 5-22-2009.



THE COLOR(S) BLUE, GREEN, AND WHITE IS/ARE CLAIMED AS A FEATURE OF THE MARK.

THE MARK CONSISTS OF THE LOWER CASE LETTER "I" IN BLUE WITH A GREEN DOT, THE LOWER CASE LETTER "D" IN BLUE WITH WHITE INSIDE, AND THE UPPER CASE LETTER "Q" IN GREEN WITH WHITE INSIDE AND A BLUE RECTANGLE AT AN ANGLE AT THE LOWER RIGHT EDGE OF THE "Q".

FOR PROMOTING BUSINESS AND ECONOMIC DEVELOPMENT IN THE CITY OF ROCHESTER, NEW YORK AND IN THE SURROUNDING AREAS, NAMELY, ORLEANS, GENESEE, WYOMING, MONROE, LIVINGSTON, WAYNE, ONTARIO, SENECA, AND YATES COUNTIES (U.S. CLS. 100, 101 AND 102).
STEVEN R. FINE, EXAMINING ATTORNEY

CLASS 35—(Continued).

SN 77-744,265. MYBRANDSTAND, LLC, BELLEVUE, WA. FILED 5-26-2009.

MEOSICNOTE

THE MARK CONSISTS OF STANDARD CHARACTERS WITHOUT CLAIM TO ANY PARTICULAR FONT, STYLE, SIZE, OR COLOR.

FOR ADVERTISING SERVICES, NAMELY, FACILITATING ADVERTISEMENT MANAGEMENT FOR OTHERS BY FACILITATING USER-INITIATED PLACEMENT OF ADVERTISING AND MAXIMIZING RELATED REVENUE VIA A GLOBAL COMPUTER NETWORK (U.S. CLS. 100, 101 AND 102).

FIRST USE 4-23-2009; IN COMMERCE 4-30-2009.

VIVIAN MICZNIK FIRST, EXAMINING ATTORNEY

SN 77-747,826. BICKMORE & ASSOCIATES, INC., DBA BICKMORE RISK SERVICES, SACRAMENTO, CA. FILED 5-29-2009.

**Bickmore Risk Services**

NO CLAIM IS MADE TO THE EXCLUSIVE RIGHT TO USE "RISK SERVICES", APART FROM THE MARK AS SHOWN.

THE COLOR(S) BLUE IS/ARE CLAIMED AS A FEATURE OF THE MARK.

THE MARK CONSISTS OF THE WORDING "BRS BICKMORE RISK SERVICES" IN BLUE, AND THE TERM "BRS" HAS A SWOOSH DESIGN.

FOR BUSINESS RISK MANAGEMENT CONSULTATION (U.S. CLS. 100, 101 AND 102).

FIRST USE 9-1-2007; IN COMMERCE 9-1-2007.

TEJBIR SINGH, EXAMINING ATTORNEY

SN 77-747,855. BICKMORE & ASSOCIATES, INC., DBA BICKMORE RISK SERVICES, SACRAMENTO, CA. FILED 5-29-2009.

SIIMS (Secure Insurance Information Management System)

THE MARK CONSISTS OF STANDARD CHARACTERS WITHOUT CLAIM TO ANY PARTICULAR FONT, STYLE, SIZE, OR COLOR.

NO CLAIM IS MADE TO THE EXCLUSIVE RIGHT TO USE "SECURE INSURANCE INFORMATION MANAGEMENT SYSTEM", APART FROM THE MARK AS SHOWN.

FOR COMPUTERIZED DATABASE MANAGEMENT (U.S. CLS. 100, 101 AND 102).

TEJBIR SINGH, EXAMINING ATTORNEY

CLASS 35—(Continued).

SN 77-750,089. CITY HARVEST, INC., NEW YORK, NY.
FILED 6-2-2009.

STREET FLEET

THE MARK CONSISTS OF STANDARD CHARACTERS WITHOUT CLAIM TO ANY PARTICULAR FONT, STYLE, SIZE, OR COLOR.

FOR CHARITABLE SERVICES, NAMELY, COORDINATION OF THE PROCUREMENT AND DISTRIBUTION OF FOOD DONATIONS FROM RESTAURANTS TO ORGANIZATIONS PROVIDING FOOD TO PEOPLE IN NEED (U.S. CLS. 100, 101 AND 102).

FIRST USE 3-31-2003; IN COMMERCE 3-31-2003.
PAM WILLIS, EXAMINING ATTORNEY

SN 77-750,542. CODDINGTON FINANCE CORPORATION PTY LTD, GLADESVILLE NSW, AUSTRALIA, FILED 6-2-2009.

Communication DNA

THE MARK CONSISTS OF STANDARD CHARACTERS WITHOUT CLAIM TO ANY PARTICULAR FONT, STYLE, SIZE, OR COLOR.

NO CLAIM IS MADE TO THE EXCLUSIVE RIGHT TO USE "COMMUNICATION", APART FROM THE MARK AS SHOWN.

FOR BUSINESS CONSULTING AND INFORMATION SERVICES (U.S. CLS. 100, 101 AND 102).

FIRST USE 9-1-2008; IN COMMERCE 9-1-2008.
ERNEST SHOSHO, EXAMINING ATTORNEY

CLASS 35—(Continued).

SN 77-750,956. NATIONAL CRIME PREVENTION COUNCIL, INC., ARLINGTON, VA. FILED 6-3-2009.



THE MARK CONSISTS OF THE MARK CONSISTS OF 4 CONCENTRIC CIRCLES OR RINGS OF VARYING WIDTHS WITH A STYLIZED LETTER "R" IN THE CENTER OF THE CONCENTRIC CIRCLES. A DOT OR CIRCLE APPEARS ABOVE THE STYLIZED "R". WITHIN THE CONCENTRIC CIRCLES. THE COMBINATION OF THE DOT AND STYLIZED "R" ALSO CAN BE VIEWED AS A STYLIZED HUMAN FIGURE. COLOR IS NOT CLAIMED AS A FEATURE OF THE MARK.

FOR PROMOTING PUBLIC AWARENESS OF, AND UNDERSTANDING OF, THE NEGATIVE EFFECTS OF BULLYING, CYBERBULLYING AND RELATED NEGATIVE BEHAVIOR THROUGH A PUBLIC SERVICE ADVERTISING AND EDUCATIONAL CAMPAIGN DESIGNED TO PROMOTE GOOD BEHAVIOR AND PREVENTION OF BULLYING, CYBERBULLYING AND RELATED NEGATIVE BEHAVIOR (U.S. CLS. 100, 101 AND 102).

JAMES A. RAUEN, EXAMINING ATTORNEY

SN 77-759,564. NYP HOLDINGS, INC., NEW YORK, NY.
FILED 6-15-2009.

SEARCH MILLIONS, FIND THE ONE

THE MARK CONSISTS OF STANDARD CHARACTERS WITHOUT CLAIM TO ANY PARTICULAR FONT, STYLE, SIZE, OR COLOR.

OWNER OF U.S. REG. NOS. 1,526,818, 2,213,076 AND OTHERS.

FOR PROVIDING AN ONLINE SEARCHABLE DATABASE FEATURING CLASSIFIED AD LISTINGS (U.S. CLS. 100, 101 AND 102).

SAIMA MAKHDOOM, EXAMINING ATTORNEY

CLASS 35—(Continued).

SN 77-776,833. AFFECTIVA, INC, NEWTONVILLE, MA.
FILED 7-8-2009.

AFFECTIVA

THE MARK CONSISTS OF STANDARD CHARACTERS WITHOUT CLAIM TO ANY PARTICULAR FONT, STYLE, SIZE, OR COLOR.

FOR BUSINESS MANAGEMENT CONSULTING AND BUSINESS MARKETING CONSULTING SERVICES FEATURING DEMONSTRATIVE DATA FROM PHYSIOLOGICAL EXPRESSIONS AND SIGNALS (U.S. CLS. 100, 101 AND 102).

MICHAEL TANNER, EXAMINING ATTORNEY

SN 78-780,832. BRIGHTPOINT, INC., PLAINFIELD, IN.
FILED 12-27-2005.

fono

FOR RETAIL STORES IN THE FIELD OF WIRELESS TELEPHONE HANDSETS, SUBSCRIPTION TO A WIRELESS NETWORK, AND ACCESSORIES THEREFORE, NAMELY, BATTERIES, CARRYING CASES AND CHARGERS FOR WIRELESS TELEPHONE HANDSETS (U.S. CLS. 100, 101 AND 102).

FIRST USE 11-25-2005; IN COMMERCE 11-25-2005.
HOWARD SMIGA, EXAMINING ATTORNEY

CLASS 35—(Continued).

SN 79-062,783. DAINESE S.P.A., ITALY, FILED 9-17-2008.



PRIORITY DATE OF 8-7-2008 IS CLAIMED.
OWNER OF INTERNATIONAL REGISTRATION 0986729
DATED 9-17-2008, EXPIRES 9-17-2018.

THE MARK CONSISTS OF THE WORD "DAINESE" AND A STYLIZED TRIANGULAR DEVIL'S FACE.

THE WORDING "DAINESE" HAS NO MEANING IN A FOREIGN LANGUAGE.

FOR WHOLESALE STORE, RETAIL STORE, MAIL ORDER, AND ONLINE STORE SERVICES VIA WEB SITES, AND RETAIL STORE SERVICES VIA TELESOPPING, ALL IN THE FIELD OF PROTECTIVE CLOTHING FOR SPORTS, PROTECTIVE HELMETS FOR SPORTS, EYEWEAR, SPORTS EYEWEAR, DIVING EQUIPMENT, TRIGGERING SOFTWARE FOR INFLATABLE PROTECTIVE DEVICES, BAGS, BACKPACKS, LEATHER AND IMITATION LEATHER ARTICLES, JACKETS, TROUSERS AND OVERALLS FOR MOTORCYCLING AND OTHER SPORTS, CLOTHING, HEADGEAR, FOOTWEAR, PROTECTIVE PADS, MOTORCYCLE GLOVES, SKI GLOVES, DIVING GLOVES, GYMNASTIC AND SPORTING ARTICLES (U.S. CLS. 100, 101 AND 102).

DOUGLAS LEE, EXAMINING ATTORNEY

CLASS 36—INSURANCE AND FINANCIAL

SN 75-769,258. HORNBLOWER FISCHER AG, 60313 FRANKFURT AM MAIN, FED REP GERMANY, FILED 8-6-1999.

HORNBLOWER

OWNER OF FED REP GERMANY REG. NO. 2037513,
DATED 6-3-1993, EXPIRES 6-3-2013.
SEC. 2(F).

FOR FINANCIAL SERVICES, PRIMARILY INVESTMENT BANKING, BROKERAGE AND TRADING SERVICES (U.S. CLS. 100, 101 AND 102).

H. M. FISHER, EXAMINING ATTORNEY

SN 76-595,551. RISING, GERALD R., JR, CENTENNIAL, CO.
FILED 6-4-2004.

EXCELL HEALTH PLANS

THE MARK CONSISTS OF STANDARD CHARACTERS WITHOUT CLAIM TO ANY PARTICULAR FONT, STYLE, SIZE, OR COLOR.

NO CLAIM IS MADE TO THE EXCLUSIVE RIGHT TO USE "HEALTH PLANS", APART FROM THE MARK AS SHOWN.

FOR ORGANIZATION AND ADMINISTRATION OF PRE-PAID HEALTH CARE PLANS (U.S. CLS. 100, 101 AND 102).

BARBARA RUTLAND, EXAMINING ATTORNEY

CLASS 36—(Continued).

SN 76-695,707. RIALTO CAPITAL MANAGEMENT, LLC, MIAMI, FL. FILED 2-9-2009.



NO CLAIM IS MADE TO THE EXCLUSIVE RIGHT TO USE "CAPITAL MANAGEMENT", APART FROM THE MARK AS SHOWN.

THE MARK CONSISTS OF THE WORDING "RIALTO" ABOVE THE WORDING "CAPITAL MANAGEMENT" WITH A HORIZONTAL LINE SEPARATING THE WORDING AND THE DESIGN OF A BRIDGE TO THE RIGHT OF THE WORDING "RIALTO".

FOR CREATION AND MANAGEMENT OF INVESTMENT FUNDS; CAPITAL INVESTMENT, CAPITAL INVESTMENT MANAGEMENT AND FINANCIAL ASSET MANAGEMENT; AND ADVISORY SERVICES IN THE FIELD OF CREATING AND MANAGING INVESTMENT FUNDS AND FINANCIAL ASSET MANAGEMENT (U.S. CLS. 100, 101 AND 102).

WILLIAM BRECKENFELD, EXAMINING ATTORNEY

CLASS 36—(Continued).

SN 76-696,867. THREE SEAS CAPITAL, LLC, DALLAS, TX. FILED 4-15-2009.

THREE SEAS CAPITAL

THE MARK CONSISTS OF STANDARD CHARACTERS WITHOUT CLAIM TO ANY PARTICULAR FONT, STYLE, SIZE, OR COLOR.

NO CLAIM IS MADE TO THE EXCLUSIVE RIGHT TO USE "CAPITAL", APART FROM THE MARK AS SHOWN.

FOR FINANCIAL CONSULTING SERVICES; INVESTMENT MANAGEMENT SERVICES; INVESTMENT ADVISORY SERVICES (U.S. CLS. 100, 101 AND 102).

FIRST USE 2-13-2009; IN COMMERCE 2-13-2009.
DAVID C. REIHNER, EXAMINING ATTORNEY

SN 76-696,375. A.G.I.A., INC., CARPINTERIA, CA. FILED 3-18-2009.



CREDIT ONE FINANCIAL SOLUTIONS

THE COLOR(S) BLUE AND BLACK IS/ARE CLAIMED AS A FEATURE OF THE MARK.

THE MARK CONSISTS OF A STYLIZED IMAGE IN BLACK OF A BALD EAGLE WITH OUTSTRETCHED WINGS, WHICH IS IN FRONT OF A BLUE CIRCLE DESIGN IN WHICH A CIRCLE OF BLUE STARS IS ENCLOSED BY THE INNER AND OUTER BLUE RINGS OF THE CIRCLE.

FOR BROKERAGE AND ADMINISTRATION OF ALL TYPES OF INSURANCE (U.S. CLS. 100, 101 AND 102).

FIRST USE 6-1-1983; IN COMMERCE 6-1-1983.
ANDREW LEASER, EXAMINING ATTORNEY

THE MARK CONSISTS OF STANDARD CHARACTERS WITHOUT CLAIM TO ANY PARTICULAR FONT, STYLE, SIZE, OR COLOR.

NO CLAIM IS MADE TO THE EXCLUSIVE RIGHT TO USE "CREDIT" AND "FINANCIAL SOLUTIONS", APART FROM THE MARK AS SHOWN.

FOR FINANCIAL SERVICES, NAMELY, PROVIDING LINES OF CREDIT; ORIGINATING, ACQUIRING, MANAGING, COLLECTING OF DEBTS FOR AND BROKERAGE OF UNSECURED CONSUMER AND BUSINESS LOANS, LINES OF CREDIT AND RESIDENTIAL MORTGAGE LOANS (U.S. CLS. 100, 101 AND 102).

HEATHER BIDDULPH, EXAMINING ATTORNEY

CLASS 36—(Continued).

SN 77-211,000. FOCUS PROPERTY GROUP, LLC, LAS VEGAS, NV. FILED 6-20-2007.



NO CLAIM IS MADE TO THE EXCLUSIVE RIGHT TO USE "PROPERTY GROUP", APART FROM THE MARK AS SHOWN.

THE COLOR(S) GREY, BLUE, RED, WHITE AND BLACK IS/ARE CLAIMED AS A FEATURE OF THE MARK.

THE MARK CONSISTS OF A RED SQUARE SUPERIMPOSED OVER THE CORNER OF A LARGER WHITE SQUARE, SUPERIMPOSED OVER THE CORNER OF A LARGER BLUE SQUARE, SUPERIMPOSED OVER A GREY SQUARE, WITH THE WORD "FOCUS" ABOVE THE WORDS "PROPERTY GROUP", WRITTEN IN BLACK.

FOR REAL ESTATE LISTING, LEASING, AND BROKERAGE SERVICES (U.S. CLS. 100, 101 AND 102).

FIRST USE 6-10-2002; IN COMMERCE 6-10-2002.

TRACY CROSS, EXAMINING ATTORNEY

SN 77-255,508. LOCKWOOD CAPITAL MANAGEMENT, INC., MALVERN, PA. FILED 8-15-2007.

LIS²

THE MARK CONSISTS OF THE WORDING "LIS²" WHERE THE NUMBER "2" APPEARS AS A SUPERSCRIP.

FOR FINANCIAL MANAGEMENT AND INVESTMENT ADVISORY SERVICES, NAMELY, PROVIDING INVESTMENT PROFESSIONALS AND BROKER/DEALERS WITH OFFERS OF VARIABLE INSURANCE AND ANNUITIES FOR ITS CLIENTS (U.S. CLS. 100, 101 AND 102).

TINA BROWN, EXAMINING ATTORNEY

CLASS 36—(Continued).

SN 77-262,933. VALU PAYMENTS B.V., AMSTERDAM, NETHERLANDS, FILED 8-23-2007.

ValU

THE MARK CONSISTS OF STANDARD CHARACTERS WITHOUT CLAIM TO ANY PARTICULAR FONT, STYLE, SIZE, OR COLOR.

PRIORITY CLAIMED UNDER SEC. 44(D) ON ERPNTY TM OFC APPLICATION NO. 005740147, FILED 2-23-2007.

FOR FINANCIAL SERVICES, NAMELY, PAYMENT CLUBS FEATURING ELECTRONIC CREDIT AND DEBIT TRANSACTIONS PROCESSED OVER MOBILE PHONE AND INTERNET NETWORKS, CASH DISBURSEMENTS, NAMELY, AUTHORIZING CASH ADVANCES OVER MOBILE PHONE AND INTERNET NETWORKS, CASH REPLACEMENT RENDERED BY CREDIT AND DEBIT ACCOUNTS OVER MOBILE PHONE AND INTERNET NETWORKS, ELECTRONIC CASH TRANSACTIONS, DEPOSIT ACCESS, NAMELY, ELECTRONIC REMOTE CHECK DEPOSIT SERVICES RENDERED VIA MOBILE PHONE AND INTERNET NETWORKS AND AUTOMATED TELLER MACHINE SERVICES, POINT OF SALE AND POINT OF TRANSACTION SERVICES, TRANSACTION AUTHORIZATION AND SETTLEMENT SERVICES, ELECTRONIC PAYMENT PROCESSING SERVICES, CREDIT CARD AND DEBIT ACCOUNT VERIFICATION, PAYMENT TRANSACTION AUTHENTICATION AND VERIFICATION SERVICES, FACILITATING PERSON-TO-PERSON PAYMENT SERVICES THROUGH ELECTRONIC MEANS VIA A PLURALITY OF NETWORKS, NAMELY, MOBILE PHONE AND INTERNET NETWORKS; VALUE EXCHANGE SERVICES, NAMELY, SECURE ELECTRONIC CASH TRANSACTIONS AND ELECTRONIC CASH EXCHANGE TRANSACTIONS OVER MOBILE PHONE AND INTERNET NETWORKS TO FACILITATE ELECTRONIC AND/OR MOBILE COMMERCE; ELECTRONIC FUNDS TRANSFER, STORED VALUE SERVICES AND ELECTRONIC CASH SERVICES, NAMELY, CURRENCY EXCHANGE IN A SECURE ENVIRONMENT OVER A PLURALITY OF COMMUNICATIONS NETWORKS, PROVIDING FINANCIAL INFORMATION, NAMELY, CREDIT AND DEBIT CARD DATA AND REPORTS (U.S. CLS. 100, 101 AND 102).

FIRST USE 2-14-2007; IN COMMERCE 2-14-2007.

GENE MACIOL, EXAMINING ATTORNEY

CLASS 36—(Continued).

SN 77-262,956. VALU PAYMENTS B.V., AMSTERDAM, NETHERLANDS, FILED 8-23-2007.

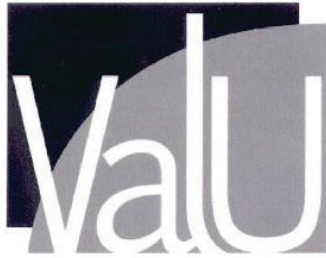

CLASS 36—(Continued).

SN 77-294,297. INTERNATIONAL STORES CORP., PANAMA CITY, PANAMA, FILED 10-2-2007.



attenza

OWNER OF PANAMA REG. NO. 16530301, DATED 9-27-2007, EXPIRES 9-27-2017.

THE MARK CONSISTS OF FIVE SHOPPING BAGS ARRANGED TO BE A FIVE-POINTED STAR.

FOR INSURANCE AGENCIES; FINANCIAL ADVICE AND CONSULTANCY; MONETARY EXCHANGE; AND REAL ESTATE CONSULTANCY (U.S. CLS. 100, 101 AND 102).

WARREN L. OLANDRIA, EXAMINING ATTORNEY

PRIORITY CLAIMED UNDER SEC. 44(D) ON ERPN CMNTY TM OFC APPLICATION NO. 005743588, FILED 2-23-2007.

FOR FINANCIAL SERVICES, NAMELY, PAYMENT CLUBS FEATURING ELECTRONIC CREDIT AND DEBIT TRANSACTIONS PROCESSED OVER MOBILE PHONE AND INTERNET NETWORKS, CASH DISBURSEMENTS, NAMELY, AUTHORIZING CASH ADVANCES OVER MOBILE PHONE AND INTERNET NETWORKS, CASH REPLACEMENT RENDERED BY CREDIT AND DEBIT ACCOUNTS OVER MOBILE PHONE AND INTERNET NETWORKS, ELECTRONIC CASH TRANSACTIONS, DEPOSIT ACCESS, NAMELY, ELECTRONIC REMOTE CHECK DEPOSIT SERVICES RENDERED VIA MOBILE PHONE AND INTERNET NETWORKS AND AUTOMATED TELLER MACHINE SERVICES, POINT OF SALE AND POINT OF TRANSACTION SERVICES, TRANSACTION AUTHORIZATION AND SETTLEMENT SERVICES, ELECTRONIC PAYMENT PROCESSING SERVICES, CREDIT CARD AND DEBIT ACCOUNT VERIFICATION, PAYMENT TRANSACTION AUTHENTICATION AND VERIFICATION SERVICES, FACILITATING PERSON-TO-PERSON PAYMENT SERVICES THROUGH ELECTRONIC MEANS VIA A PLURALITY OF NETWORKS, NAMELY, MOBILE PHONE AND INTERNET NETWORKS; VALUE EXCHANGE SERVICES, NAMELY, SECURE ELECTRONIC CASH TRANSACTIONS AND ELECTRONIC CASH EXCHANGE TRANSACTIONS OVER MOBILE PHONE AND INTERNET NETWORKS TO FACILITATE ELECTRONIC AND/OR MOBILE COMMERCE; ELECTRONIC FUNDS TRANSFER, STORED VALUE SERVICES AND ELECTRONIC CASH SERVICES, NAMELY, CURRENCY EXCHANGE IN A SECURE ENVIRONMENT OVER A PLURALITY OF COMMUNICATIONS NETWORKS, PROVIDING FINANCIAL INFORMATION, NAMELY, CREDIT AND DEBIT CARD DATA AND REPORTS (U.S. CLS. 100, 101 AND 102).

FIRST USE 2-14-2007; IN COMMERCE 2-14-2007.
GENE MACIOL, EXAMINING ATTORNEY

SN 77-294,354. INTERNATIONAL STORES CORP., PANAMA CITY, PANAMA, FILED 10-2-2007.



attenza

DUTY FREE

OWNER OF PANAMA REG. NO. 16531001, DATED 9-27-2007, EXPIRES 9-27-2017.

NO CLAIM IS MADE TO THE EXCLUSIVE RIGHT TO USE "DUTY FREE", APART FROM THE MARK AS SHOWN.

THE MARK CONSISTS OF FIVE SHOPPING BAGS ARRANGED TO BE A FIVE-POINTED STAR.

FOR INSURANCE AGENCIES; FINANCIAL ADVICE AND CONSULTANCY; MONETARY EXCHANGE; AND REAL ESTATE CONSULTANCY (U.S. CLS. 100, 101 AND 102).

WARREN L. OLANDRIA, EXAMINING ATTORNEY

CLASS 36—(Continued).

SN 77-294,388. INTERNATIONAL STORES CORP., PANAMA CITY, PANAMA, FILED 10-2-2007.



LA MEJOR ATENCION

OWNER OF PANAMA REG. NO. 16529901, DATED 9-27-2007, EXPIRES 9-27-2017.

NO CLAIM IS MADE TO THE EXCLUSIVE RIGHT TO USE "LA MEJOR ATENCION", APART FROM THE MARK AS SHOWN.

THE MARK CONSISTS OF FIVE SHOPPING BAGS ARRANGED TO BE A FIVE-POINTED STAR.

THE FOREIGN WORDING IN THE MARK TRANSLATES INTO ENGLISH AS "BEST CARE".

FOR INSURANCE AGENCIES; FINANCIAL ADVICE AND CONSULTANCY; MONETARY EXCHANGE; AND REAL ESTATE CONSULTANCY (U.S. CLS. 100, 101 AND 102).

WARREN L. OLANDRIA, EXAMINING ATTORNEY

SN 77-336,994. GUIDESTONE FINANCIAL RESOURCES OF THE SOUTHERN BAPTIST CONVENTION, DALLAS, TX. FILED 11-26-2007.

GUIDESTONE FUNDS RIGHTCHOICE IRA

THE MARK CONSISTS OF STANDARD CHARACTERS WITHOUT CLAIM TO ANY PARTICULAR FONT, STYLE, SIZE, OR COLOR.

OWNER OF U.S. REG. NOS. 2,954,597, 2,982,743 AND 3,242,186.

NO CLAIM IS MADE TO THE EXCLUSIVE RIGHT TO USE "FUNDS" AND "IRA", APART FROM THE MARK AS SHOWN.

FOR FINANCIAL SERVICES, NAMELY, DIRECTLY AND INDIRECTLY PROVIDING INVESTMENT AND EMPLOYEE BENEFIT PROGRAMS, NAMELY, ADMINISTERING RETIREMENT, DEFERRED COMPENSATION AND SEVERANCE PAY PLANS AND PROGRAMS; UNDERWRITING AND ADMINISTRATION OF DISABILITY, LIFE, ACCIDENT AND PROPERTY AND CASUALTY INSURANCE; INVESTMENT OF FUNDS FOR OTHERS, NAMELY, PARTICIPANTS AND THEIR DEPENDENTS; AND ADMINISTRATION OF BENEFIT PLANS DESIGNED TO PROVIDE ADDITIONAL FINANCIAL RESOURCES TO INDIVIDUALS WITH LIMITED FINANCIAL RESOURCES AND SPECIAL NEEDS (U.S. CLS. 100, 101 AND 102).

PAUL MORENO, EXAMINING ATTORNEY

CLASS 36—(Continued).

SN 77-344,625. ALLIED SOVEREIGN AND EQUITABLE ASSURANCE COMPANY LTD., CHRIST CHURCH, BARBADOS, FILED 12-5-2007.

ALLIED SOVEREIGN AND EQUITABLE ASSURANCE

THE MARK CONSISTS OF STANDARD CHARACTERS WITHOUT CLAIM TO ANY PARTICULAR FONT, STYLE, SIZE, OR COLOR.

PRIORITY CLAIMED UNDER SEC. 44(D) ON CANADA APPLICATION NO. 1350697, FILED 6-7-2007.

NO CLAIM IS MADE TO THE EXCLUSIVE RIGHT TO USE "EQUITABLE ASSURANCE", APART FROM THE MARK AS SHOWN.

FOR INSURANCE SERVICES, NAMELY, ADMINISTRATION AND MANAGEMENT OF PERSONAL WEALTH AND ASSET PROTECTION IN THE FORM OF ESTATE PLANNING, SUCCESSION STRUCTURE, CUSTODIAL ACCOUNTS AND INVESTMENT MANAGEMENT (U.S. CLS. 100, 101 AND 102).

AMY ALFIERI, EXAMINING ATTORNEY

SN 77-376,007. BLUELINE ENTERPRISES, LLC, COEUR D'ALENE, ID. FILED 1-19-2008.

INSURLINK

THE MARK CONSISTS OF STANDARD CHARACTERS WITHOUT CLAIM TO ANY PARTICULAR FONT, STYLE, SIZE, OR COLOR.

FOR PROVIDING TEMPORARY LOANS TO THIRD PARTIES THAT WORK WITH INSURANCE PROVIDERS AND THE LIKE IN ORDER TO RECEIVE PAYMENT FOR SALE OF THEIR GOODS AND/OR SERVICES TO INSUREES (U.S. CLS. 100, 101 AND 102).

FIRST USE 7-23-2007; IN COMMERCE 7-23-2007.

WILLIAM ROSSMAN, EXAMINING ATTORNEY

CLASS 36—(Continued).

SN 77-395,820. LIFELINE FUNDING, LLC, WILMINGTON, DE. FILED 2-13-2008.

USCLAIMS

THE MARK CONSISTS OF STANDARD CHARACTERS WITHOUT CLAIM TO ANY PARTICULAR FONT, STYLE, SIZE, OR COLOR.

SEC. 2(F).
FOR FINANCIAL FACTORING SERVICES, NAMELY, PURCHASING OF DEFERRED PAYMENT STREAMS IN THE NATURE OF STRUCTURED SETTLEMENTS OF LEGAL CLAIMS, PURCHASING PAYMENTS FROM SETTLEMENTS OF LEGAL CLAIMS AND PRE-SETTLEMENT FUNDING, NAMELY, PROVIDING WORKING CAPITAL TO FUND LEGAL CLAIMS PRIOR TO SETTLEMENT (U.S. CLS. 100, 101 AND 102).

FIRST USE 7-15-1996; IN COMMERCE 7-15-1996.
EDWARD FENNESSY, EXAMINING ATTORNEY

SN 77-408,222. NEW YORK LIFE INSURANCE COMPANY, NEW YORK, NY. FILED 2-28-2008.



THE MARK CONSISTS OF AN ARCH DESIGN APPEARING OVER THE WORDS "WEALTH MATTERS" WHICH IS ABOVE THE WORDS "FOR YOUR LIFE".

FOR FINANCIAL INFORMATION AND ADVISORY SERVICES; FINANCIAL INFORMATION AND ADVISORY SERVICES REGARDING RETIREMENT, INVESTMENTS, FINANCIAL PLANNING, FINANCIAL MANAGEMENT, INSURANCE, LIFE ORGANIZATION AND LIFE EVENTS (U.S. CLS. 100, 101 AND 102).

FIRST USE 4-2-2007; IN COMMERCE 4-2-2007.
AMY C. KEAN, EXAMINING ATTORNEY

SN 77-408,230. NEW YORK LIFE INSURANCE COMPANY, NEW YORK, NY. FILED 2-28-2008.



THE MARK CONSISTS OF AN ARCH DESIGN APPEARING OVER THE WORDS "WEALTH MATTERS" WHICH IS ABOVE THE WORDS "FOR YOUR BUSINESS".

FOR FINANCIAL INFORMATION AND ADVISORY SERVICES; FINANCIAL INFORMATION AND ADVISORY SERVICES REGARDING RETIREMENT, INVESTMENTS, FINANCIAL PLANNING, FINANCIAL MANAGEMENT, INSURANCE, LIFE ORGANIZATION AND LIFE EVENTS (U.S. CLS. 100, 101 AND 102).

FIRST USE 4-2-2007; IN COMMERCE 4-2-2007.
AMY C. KEAN, EXAMINING ATTORNEY

CLASS 36—(Continued).

SN 77-408,345. NEW YORK LIFE INSURANCE COMPANY, NEW YORK, NY. FILED 2-28-2008.



THE MARK CONSISTS OF AN ARCH DESIGN APPEARING OVER THE WORDS "WEALTH MATTERS" WHICH IS ABOVE THE WORDS "FOR YOUR RETIREMENT".

FOR FINANCIAL INFORMATION AND ADVISORY SERVICES; FINANCIAL INFORMATION AND ADVISORY SERVICES REGARDING RETIREMENT, INVESTMENT, FINANCIAL PLANNING, FINANCIAL MANAGEMENT, INSURANCE, LIFE ORGANIZATION AND LIFE EVENTS (U.S. CLS. 100, 101 AND 102).

FIRST USE 4-2-2007; IN COMMERCE 4-2-2007.
AMY C. KEAN, EXAMINING ATTORNEY

SN 77-426,412. OOBA (PROPRIETARY) LIMITED, CAPE TOWN, SOUTH AFRICA, FILED 3-19-2008.

OOBA

THE MARK CONSISTS OF STANDARD CHARACTERS WITHOUT CLAIM TO ANY PARTICULAR FONT, STYLE, SIZE, OR COLOR.

OWNER OF SOUTH AFRICA REG. NO. 2006/08159, DATED 4-11-2006, EXPIRES 4-11-2016.

FOR MORTGAGE PROCUREMENT FOR OTHERS; MORTGAGE BROKERAGE, MORTGAGE ORIGINATION, MORTGAGE LENDING, MORTGAGE SERVICES, NAMELY, VETTING ELLIGIBILITY OF HOME BUYERS AND COMPLIANCE WITH FINANCIAL REQUIREMENTS FOR MORTGAGE LENDERS; MORTGAGE PLANNING AND SERVICING OF MORTGAGE LOANS; REAL ESTATE LISTINGS; HOME INSURANCE AND BROKERAGE IN THE FIELD OF HOME INSURANCE; ADVISORY SERVICES AND CONSULTATION IN THE FIELDS OF HOME PURCHASES, LOANS FOR HOME PURCHASES AND HOME INSURANCE; CREDIT CARD SERVICES; DEBIT CARD AND DISCOUNT CARD SERVICES; PROVISION OF INFORMATION IN CONNECTION WITH THE AFOREGOING AND IN CONNECTION WITH REAL ESTATE (U.S. CLS. 100, 101 AND 102).

SHAUNIA CARLYLE, EXAMINING ATTORNEY

CLASS 36—(Continued).

SN 77-426,414. OOBA (PROPRIETARY) LIMITED, CAPE TOWN, SOUTH AFRICA, FILED 3-19-2008.



OWNER OF SOUTH AFRICA REG. NO. 200717845, DATED 8-10-2007, EXPIRES 8-10-2017.

THE COLOR(S) GREEN, GREY AND WHITE IS/ARE CLAIMED AS A FEATURE OF THE MARK.

THE MARK CONSISTS OF THE COLOR GREEN IN THE WORD "OOBA" AND IN THE CENTER CIRCLE OF THE DESIGN; THE COLOR GREY IN THE OUTER RING OF THE DESIGN; AND WHITE IN THE INNER RING OF THE DESIGN.

FOR MORTGAGE PROCUREMENT FOR OTHERS; MORTGAGE BROKERAGE, MORTGAGE ORIGINATION, MORTGAGE LENDING, MORTGAGE SERVICES, NAMELY, VETTING ELIGIBILITY OF HOME BUYERS AND COMPLIANCE WITH FINANCIAL REQUIREMENTS FOR MORTGAGE LENDERS; MORTGAGE PLANNING AND SERVICING OF MORTGAGE LOANS; REAL ESTATE LISTINGS; HOME INSURANCE AND BROKERAGE IN THE FIELD OF HOME INSURANCE; ADVISORY SERVICES AND CONSULTATION IN THE FIELDS OF HOME PURCHASES, LOANS FOR HOME PURCHASES AND HOME INSURANCE; CREDIT CARD SERVICES; DEBIT CARD AND DISCOUNT CARD SERVICES; PROVISION OF INFORMATION IN CONNECTION WITH THE AFOREGOING AND IN CONNECTION WITH REAL ESTATE (U.S. CLS. 100, 101 AND 102).

SHAUNIA CARLYLE, EXAMINING ATTORNEY

SN 77-445,366. HARBORSTONE CREDIT UNION, LAKEWOOD, WA. FILED 4-10-2008.

NO ONE TAKES BETTER CARE
OF YOU

THE MARK CONSISTS OF STANDARD CHARACTERS WITHOUT CLAIM TO ANY PARTICULAR FONT, STYLE, SIZE, OR COLOR.

FOR CREDIT UNION AND BANKING SERVICES, NAMELY, CHECKING, SAVINGS AND MONEY MARKET ACCOUNTS, DIRECT DEPOSIT, CASH MACHINE ACCESS, SAFE DEPOSIT BOXES, TELEPHONE BANKING AND ELECTRONIC BANKING VIA A GLOBAL COMPUTER NETWORK, CERTIFICATES OF DEPOSIT, IRAS, TRAVELERS CHECKS, OVERDRAFT PROTECTION, CREDIT CARDS, DEBIT CARDS, AUTO LOANS, HOME LOANS, INVESTMENT OF FUNDS FOR OTHERS; INSURANCE ADMINISTRATION SERVICES, IN THE FIELD OF LIFE, DISABILITY, PROPERTY AND CASUALTY, AND DEPOSIT, CREDIT AND LIFE SAVINGS INSURANCE; INSURANCE INFORMATION AND CONSULTANCY IN THE FIELD OF LIFE, DISABILITY, PROPERTY AND CASUALTY, AND DEPOSIT, CREDIT AND LIFE SAVINGS INSURANCE; FINANCIAL EVA-

CLASS 36—(Continued).

LUATION FOR INSURANCE PURPOSES IN THE FIELD OF LIFE, DISABILITY, PROPERTY AND CASUALTY, AND DEPOSIT, CREDIT AND LIFE SAVINGS INSURANCE; INSURANCE CLAIMS ADMINISTRATION, ADJUSTMENT AND PROCESSING IN THE FIELD OF LIFE, DISABILITY, PROPERTY AND CASUALTY, AND DEPOSIT, CREDIT AND LIFE SAVINGS INSURANCE; FINANCIAL INVESTMENT SERVICES IN THE FIELD OF STOCKS, BONDS, MUTUAL FUNDS, TRUSTS, FINANCIAL PLANNING AND FEE-BASED ASSET MANAGEMENT, FINANCIAL INVESTMENT SERVICES IN THE FIELD OF STOCKS AND BONDS BROKERAGE, MUTUAL FUND INVESTMENT, FINANCIAL PLANNING, FEE-BASED FINANCIAL PORTFOLIO MANAGEMENT, TRUSTEESHIP REPRESENTATIVES, AND ESTATE TRUST MANAGEMENT; COMMERCIAL LENDING SERVICES; COMMERCIAL BANKING SERVICES; REAL ESTATE LENDING SERVICES; MORTGAGE LENDING SERVICES; MORTGAGE BANKING SERVICES; MAINTAINING MORTGAGE ESCROW ACCOUNTS; LOAN UNDERWRITING SERVICES; FUNDING SERVICES, NAMELY, PROVIDING LOAN FINANCING TO OTHERS AND PROVIDING WORKING CAPITAL FINANCING TO BUSINESSES AND BUSINESS OWNERS; COLLECTION SERVICES, NAMELY, COLLECTION OF DEBTS (U.S. CLS. 100, 101 AND 102).

FIRST USE 7-31-2006; IN COMMERCE 7-31-2006.

ALICE BENMAMAN, EXAMINING ATTORNEY

SN 77-448,842. THOMPSON, BRIAN, GLEN ARM, MD. FILED 4-15-2008.

WAY2PAY

THE MARK CONSISTS OF STANDARD CHARACTERS WITHOUT CLAIM TO ANY PARTICULAR FONT, STYLE, SIZE, OR COLOR.

FOR CREDIT CARD AND DEBIT CARD SERVICES; CREDIT CARD AND PAYMENT CARD SERVICES; CREDIT CARD PAYMENT PROCESSING SERVICES; CREDIT CARD SERVICES; CREDIT CARD TRANSACTION PROCESSING SERVICES (U.S. CLS. 100, 101 AND 102).

JOHN DWYER, EXAMINING ATTORNEY

CLASS 36—(Continued).

SN 77-461,933. NEW YORK LIFE INSURANCE COMPANY, NEW YORK, NY. FILED 4-30-2008.



THE MARK CONSISTS OF THE TERM "SELF" APPEARING OVER THE TERM "LESS" APPEARING OVER THE TERM "GIFT" WITH ALL OF THE AFOREMENTIONED APPEARING OVER THE BACKGROUND DESIGN OF A SQUARE WITH CURVED CORNERS.

SEC. 2(F) AS TO "GIFT".

FOR LIFE AND HEALTH INSURANCE AND ANNUITY UNDERWRITING SERVICES; FINANCIAL ANALYSIS AND CONSULTING SERVICES; FINANCIAL PLANNING SERVICES; INVESTMENT ADVISORY SERVICES; MUTUAL FUND INVESTMENT SERVICES; MUTUAL FUND DISTRIBUTION; FUND INVESTMENT CONSULTATION; INVESTMENT MANAGEMENT; FINANCIAL INVESTMENT AND MANAGEMENT SERVICES, NAMELY, DISTRIBUTION AND ADMINISTRATION OF MUTUAL FUNDS FOR OTHERS; FINANCIAL INVESTMENT MANAGEMENT OF RETIREMENT FUNDS; RETIREMENT INVESTMENT CONSULTATION; FINANCIAL PLANNING SERVICES; MUTUAL FUND DISTRIBUTION; INVESTMENT MANAGEMENT, NAMELY, ASSET MANAGEMENT (U.S. CLS. 100, 101 AND 102).

FIRST USE 1-7-2008; IN COMMERCE 1-7-2008.
AMY C. KEAN, EXAMINING ATTORNEY

SN 77-551,405. USI INSURANCE SERVICES LLC, BRIARCLIFF MANOR, NY. FILED 8-20-2008.

PREMIER PROPERTIES

THE MARK CONSISTS OF STANDARD CHARACTERS WITHOUT CLAIM TO ANY PARTICULAR FONT, STYLE, SIZE, OR COLOR.

NO CLAIM IS MADE TO THE EXCLUSIVE RIGHT TO USE "PROPERTIES", APART FROM THE MARK AS SHOWN.

FOR GROUP INSURANCE PROGRAMS FOR COMMERCIAL REAL ESTATE, NAMELY, INSURANCE UNDERWRITING AND PLACEMENT SERVICES (U.S. CLS. 100, 101 AND 102).

MATTHEW KLINE, EXAMINING ATTORNEY

CLASS 36—(Continued).

SN 77-561,094. CAPRICORN INVESTMENT GROUP, LLC, PALO ALTO, CA. FILED 9-3-2008.



NO CLAIM IS MADE TO THE EXCLUSIVE RIGHT TO USE "INVESTMENT GROUP" AND "INVESTMENT MANAGEMENT", APART FROM THE MARK AS SHOWN.

THE COLOR(S) CRIMSON, GREY AND BLACK IS/ARE CLAIMED AS A FEATURE OF THE MARK.

THE MARK CONSISTS OF A SQUARE CRIMSON BLOCK OVER WHICH AN ABSTRACT SIDE ANGLE IMAGE OF A WHITE AND BLACK SAIL OR SHEET IS SUPERIMPOSED. THE WORD "CAPRICORN" IS DISPLAYED OVER A SOLID CRIMSON LINE UNDERNEATH WHICH APPEAR THE WORDS "INVESTMENT GROUP PRINCIPLED INVESTMENT MANAGEMENT".

FOR INVESTMENT MANAGEMENT AND ADVICE PROVIDED TO FOUNDATIONS, INSTITUTIONS AND HIGH NET WORTH INDIVIDUALS (U.S. CLS. 100, 101 AND 102).

SUZANNE BLANE, EXAMINING ATTORNEY

SN 77-565,041. VITRUVIAN PARTNERS LLP, LONDON, UNITED KINGDOM, FILED 9-8-2008.

VITRUVIAN

THE MARK CONSISTS OF STANDARD CHARACTERS WITHOUT CLAIM TO ANY PARTICULAR FONT, STYLE, SIZE, OR COLOR.

OWNER OF ERPN CMNTY TM OFC REG. NO. 5162938, DATED 5-24-2007, EXPIRES 6-27-2016.

FOR FINANCIAL SERVICES, NAMELY, THE PROVISION AND DISSEMINATION OF FINANCIAL INFORMATION AND INDICES; FINANCIAL INFORMATION SERVICES; FINANCIAL SERVICES, NAMELY, MANAGEMENT OF FUNDS AND OF INVESTMENTS OF OTHERS; FINANCIAL SERVICES, NAMELY, PRIVATE PLACEMENTS OF PRIVATE EQUITY FUNDS/SECURITIES/DERIVATIVES FOR OTHERS; ADVISORY SERVICES RELATING TO INVESTMENTS; INVESTMENT FUND BROKERAGE, DISTRIBUTION AND INVESTMENT; DERIVATIVE SECURITIES INVESTMENT; FINANCING SERVICES; FINANCIAL CONSULTING SERVICES RELATING TO ALL THE FOREGOING SERVICES (U.S. CLS. 100, 101 AND 102).

KOURTNEE HODGES, EXAMINING ATTORNEY

CLASS 36—(Continued).

SN 77-569,877. NARRAGANSETT BAY INSURANCE COMPANY, PAWTUCKET, RI. FILED 9-15-2008.

NARRAGANSETT BAY INSURANCE

THE MARK CONSISTS OF STANDARD CHARACTERS WITHOUT CLAIM TO ANY PARTICULAR FONT, STYLE, SIZE, OR COLOR.

NO CLAIM IS MADE TO THE EXCLUSIVE RIGHT TO USE "INSURANCE", APART FROM THE MARK AS SHOWN.

SEC. 2(F).

FOR APPRAISALS FOR INSURANCE CLAIMS OF PERSONAL PROPERTY AND REAL ESTATE (U.S. CLS. 100, 101 AND 102).

KIMBERLY PERRY, EXAMINING ATTORNEY

SN 77-577,359. THE MEDICAL PROTECTIVE COMPANY, FORT WAYNE, IN. FILED 9-24-2008.

ATTORNEY PROTECTIVE

THE MARK CONSISTS OF STANDARD CHARACTERS WITHOUT CLAIM TO ANY PARTICULAR FONT, STYLE, SIZE, OR COLOR.

OWNER OF U.S. REG. NOS. 2,011,673 AND 3,247,595.

NO CLAIM IS MADE TO THE EXCLUSIVE RIGHT TO USE "ATTORNEY", APART FROM THE MARK AS SHOWN.

FOR INSURANCE SERVICES, NAMELY, UNDERWRITING, ISSUING AND ADMINISTRATION OF PROFESSIONAL LIABILITY INSURANCE (U.S. CLS. 100, 101 AND 102).

JEAN IM, EXAMINING ATTORNEY

CLASS 36—(Continued).

SN 77-577,581. FERRARI S.P.A., MODENA, ITALY, FILED 9-24-2008.

PERSONAL  SERVICES

OWNER OF ERPN CMNTY TM OFC REG. NO. 1546977, DATED 3-29-2001, EXPIRES 3-8-2010.

OWNER OF U.S. REG. NOS. 2,623,076, 3,335,166 AND OTHERS.

NO CLAIM IS MADE TO THE EXCLUSIVE RIGHT TO USE "PERSONAL SERVICES", APART FROM THE MARK AS SHOWN.

THE MARK CONSISTS OF THE WORDS "PERSONAL SERVICES" IN STYLIZED LETTERS. BETWEEN SUCH WORDS THERE IS A RECTANGULAR BORDER HAVING THREE STRIPES AT THE TOP AND CONTAINING THE PRANCING HORSE DESIGN ABOVE THE WORD "FERRARI" IN STYLIZED LETTERING. A HORIZONTAL LINE APPEARS ABOVE THE LAST SEVEN LETTERS OF "PERSONAL" AND ABOVE THE FIRST SEVEN LETTERS OF "SERVICES" ON EACH SIDE OF THE RECTANGULAR BORDER.

FOR FINANCIAL SERVICES, NAMELY, FINANCING THE LEASING OF NEW AND USED AUTOMOBILES; FINANCIAL VALUATION SERVICES, NAMELY, VALUATION OF NEW AND USED AUTOMOBILES; FINANCING SERVICES; AUTOMOTIVE INSTALLMENT LOAN SERVICES AND WARRANTY PROGRAM SERVICES, NAMELY, PROVIDING EXTENDED WARRANTIES ON AUTOMOBILES; CREDIT SERVICES, NAMELY, CREDIT CARD, DEBIT CARD AND CHARGE CARD SERVICES; AUTOMOBILE INSURANCE SERVICES, NAMELY, AUTOMOBILE INSURANCE UNDERWRITING AND AUTOMOBILE INSURANCE BROKERAGE SERVICES (U.S. CLS. 100, 101 AND 102).

GINA FINK, EXAMINING ATTORNEY

SN 77-581,818. CEDAR SHOPPING CENTERS PARTNERSHIP, L.P., PORT WASHINGTON, NY. FILED 9-30-2008.

bread & butter

THE MARK CONSISTS OF STANDARD CHARACTERS WITHOUT CLAIM TO ANY PARTICULAR FONT, STYLE, SIZE, OR COLOR.

FOR REAL ESTATE MANAGEMENT SERVICES IN THE FIELD OF SUPERMARKET-ANCHORED SHOPPING CENTERS AND DRUG STORE-ANCHORED CONVENIENCE CENTERS (U.S. CLS. 100, 101 AND 102).

FIRST USE 5-1-2008; IN COMMERCE 5-1-2008.

STEVEN PEREZ, EXAMINING ATTORNEY

CLASS 36—(Continued).

SN 77-589,752. CREDIT INFONET, INC., DAYTON, OH. FILED 10-9-2008.

myHorizon

THE MARK CONSISTS OF STANDARD CHARACTERS WITHOUT CLAIM TO ANY PARTICULAR FONT, STYLE, SIZE, OR COLOR.
FOR CREDIT REPORTING SERVICES (U.S. CLS. 100, 101 AND 102).
FIRST USE 9-0-2007; IN COMMERCE 9-0-2007.
TEJBIR SINGH, EXAMINING ATTORNEY

SN 77-589,766. CREDIT INFONET, INC., DAYTON, OH. FILED 10-9-2008.

CIN Online

THE MARK CONSISTS OF STANDARD CHARACTERS WITHOUT CLAIM TO ANY PARTICULAR FONT, STYLE, SIZE, OR COLOR.
NO CLAIM IS MADE TO THE EXCLUSIVE RIGHT TO USE "ONLINE", APART FROM THE MARK AS SHOWN.
FOR CREDIT REPORTING SERVICES (U.S. CLS. 100, 101 AND 102).
FIRST USE 4-0-2005; IN COMMERCE 4-0-2005.
TEJBIR SINGH, EXAMINING ATTORNEY

SN 77-591,548. RANGER CAPITAL GROUP HOLDINGS, L.P., DALLAS, TX. FILED 10-13-2008.

Ranger Investments

THE MARK CONSISTS OF STANDARD CHARACTERS WITHOUT CLAIM TO ANY PARTICULAR FONT, STYLE, SIZE, OR COLOR.
NO CLAIM IS MADE TO THE EXCLUSIVE RIGHT TO USE "INVESTMENTS", APART FROM THE MARK AS SHOWN.
FOR INVESTMENT ADVISORY SERVICES (U.S. CLS. 100, 101 AND 102).
FIRST USE 0-0-2002; IN COMMERCE 0-0-2002.
MARK RADEMACHER, EXAMINING ATTORNEY

CLASS 36—(Continued).

SN 77-591,559. RANGER CAPITAL GROUP HOLDINGS, L.P., DALLAS, TX. FILED 10-13-2008.

Ranger Advisors

THE MARK CONSISTS OF STANDARD CHARACTERS WITHOUT CLAIM TO ANY PARTICULAR FONT, STYLE, SIZE, OR COLOR.
NO CLAIM IS MADE TO THE EXCLUSIVE RIGHT TO USE "ADVISORS", APART FROM THE MARK AS SHOWN.
FOR INVESTMENT ADVISORY SERVICES (U.S. CLS. 100, 101 AND 102).
FIRST USE 0-0-2002; IN COMMERCE 0-0-2002.
MARK RADEMACHER, EXAMINING ATTORNEY

SN 77-591,620. RANGER CAPITAL GROUP HOLDINGS, L.P., DALLAS, TX. FILED 10-13-2008.

Ranger Alternatives

THE MARK CONSISTS OF STANDARD CHARACTERS WITHOUT CLAIM TO ANY PARTICULAR FONT, STYLE, SIZE, OR COLOR.
NO CLAIM IS MADE TO THE EXCLUSIVE RIGHT TO USE "ALTERNATIVES", APART FROM THE MARK AS SHOWN.
FOR INVESTMENT ADVISORY SERVICES (U.S. CLS. 100, 101 AND 102).
FIRST USE 1-1-2008; IN COMMERCE 1-1-2008.
MARK RADEMACHER, EXAMINING ATTORNEY

SN 77-592,834. INSURANCE COMPANY OF THE WEST, SAN DIEGO, CA. FILED 10-15-2008.



OWNER OF U.S. REG. NOS. 3,187,304 AND 3,187,305.
NO CLAIM IS MADE TO THE EXCLUSIVE RIGHT TO USE "INSURANCE COMPANIES", APART FROM THE MARK AS SHOWN.
THE COLOR(S) RED, BLUE, GREEN AND GRAY IS/ARE CLAIMED AS A FEATURE OF THE MARK.
THE MARK CONSISTS OF DESIGNS ABOVE THE WORDING "ICWGROUP," WHICH ITSELF APPEARS ABOVE THE WORDING "INSURANCE COMPANIES". THE DESIGN ELEMENT CONSISTS OF THREE SOLID DOTS ARRANGED HORIZONTALLY AT THE UPPER LEFT

CLASS 36—(Continued).

OF THE MARK, ABOVE THE WORDING. THE DOT ON THE LEFT IS RED, THE DOT IN THE MIDDLE IS BLUE, AND THE DOT ON THE RIGHT IS GREEN. THE INITIALS "ICW" ARE SHOWN IN A THICK GRAY FONT, AND THE "C" IS STYLIZED BY BEING CUT OFF TO ACCOMMODATE THE "W" NEXT TO IT. NEXT TO THE INITIALS "ICW", THE TERM "GROUP" APPEARS IN ALL CAPITAL LETTERS IN A THINNER GRAY FONT. AT THE BOTTOM OF THE MARK, THE WORDING "INSURANCE COMPANIES", ALSO APPEARS IN GRAY.

FOR INSURANCE SERVICES, NAMELY, WRITING COMMERCIAL PROPERTY AND CASUALTY INSURANCE (U.S. CLS. 100, 101 AND 102).

CORY BOONE, EXAMINING ATTORNEY

SN 77-593,933. PETRA BENEFITS MANAGEMENT CO., TOMBALL, TX. FILED 10-16-2008.

PETRA BENEFITS

THE MARK CONSISTS OF STANDARD CHARACTERS WITHOUT CLAIM TO ANY PARTICULAR FONT, STYLE, SIZE, OR COLOR.

NO CLAIM IS MADE TO THE EXCLUSIVE RIGHT TO USE "BENEFITS", APART FROM THE MARK AS SHOWN.

FOR PROVIDING FINANCIAL SERVICES FOR INDIVIDUALS AND SMALL BUSINESSES, NAMELY, FINANCIAL PLANNING, INVESTMENT MANAGEMENT, RETIREMENT PLANNING IN THE NATURE OF DISTRIBUTION STRATEGIES, ESTATE PLANNING, LIFE AND HEALTH INSURANCE BROKERAGE AND CONSULTING SERVICES, CONSULTING SERVICES ON EMPLOYEE BENEFIT PACKAGES (U.S. CLS. 100, 101 AND 102).

DAVID HOFFMAN, EXAMINING ATTORNEY

SN 77-595,249. NORTHWEST COMMUNITY CREDIT UNION, SPRINGFIELD, OR. FILED 10-17-2008.

NORTHWEST OF BANKING

THE MARK CONSISTS OF STANDARD CHARACTERS WITHOUT CLAIM TO ANY PARTICULAR FONT, STYLE, SIZE, OR COLOR.

NO CLAIM IS MADE TO THE EXCLUSIVE RIGHT TO USE "BANKING", APART FROM THE MARK AS SHOWN.

FOR BANKING AND FINANCIAL SERVICES, NAMELY, SAVINGS, CHECKING, INDIVIDUAL RETIREMENT ACCOUNT SERVICES, SECURED AND UNSECURED LOAN FINANCING SERVICES, INVESTMENT ADVISORY SERVICES AND CREDIT CARD SERVICES (U.S. CLS. 100, 101 AND 102).

RONALD MCMORROW, EXAMINING ATTORNEY

CLASS 36—(Continued).

SN 77-596,263. RANGER CAPITAL GROUP HOLDINGS, L.P., DALLAS, TX. FILED 10-20-2008.

Ranger Funds

THE MARK CONSISTS OF STANDARD CHARACTERS WITHOUT CLAIM TO ANY PARTICULAR FONT, STYLE, SIZE, OR COLOR.

NO CLAIM IS MADE TO THE EXCLUSIVE RIGHT TO USE "FUNDS", APART FROM THE MARK AS SHOWN.

FOR INVESTMENT ADVISORY SERVICES; INVESTMENT MANAGEMENT; MANAGEMENT OF PORTFOLIOS COMPRISING SECURITIES (U.S. CLS. 100, 101 AND 102).

FIRST USE 0-0-2000; IN COMMERCE 0-0-2000.

MARK RADEMACHER, EXAMINING ATTORNEY

SN 77-597,600. HBI PAYMENTS, LTD., COLUMBUS, OH. FILED 10-22-2008.

ITEMAGE EXPRESS

THE MARK CONSISTS OF STANDARD CHARACTERS WITHOUT CLAIM TO ANY PARTICULAR FONT, STYLE, SIZE, OR COLOR.

FOR PROVIDING REMITTANCE PROCESSING, CHECK PROCESSING AND ELECTRONIC PROCESSING AND TRANSMISSION OF BILL PAYMENT DATA WITHIN THE PAYMENTS SECTOR OF THE FINANCIAL SERVICES INDUSTRY TO BUSINESSES, GOVERNMENTS AND NONPROFIT ORGANIZATIONS; LOCK BOX DEPOSIT AND PROCESSING SERVICES; UTILITY, TELECOMMUNICATIONS AND MORTGAGE PAYMENT PROCESSING SERVICES; CREDIT CARD PAYMENT PROCESSING SERVICES (U.S. CLS. 100, 101 AND 102).

FIRST USE 10-18-2008; IN COMMERCE 10-18-2008.

LAKEISHA LEWIS, EXAMINING ATTORNEY

SN 77-599,966. NATIONWIDE MUTUAL INSURANCE COMPANY, COLUMBUS, OH. FILED 10-24-2008.

NATIONWIDE RETIRECLEAR

THE MARK CONSISTS OF STANDARD CHARACTERS WITHOUT CLAIM TO ANY PARTICULAR FONT, STYLE, SIZE, OR COLOR.

OWNER OF U.S. REG. NOS. 854,888, 2,017,147 AND 3,328,989.

FOR FINANCIAL SERVICES, NAMELY, ADMINISTRATION, AND DISTRIBUTION OF INVESTMENTS; INVESTMENT ADVISORY AND ASSET ALLOCATION SERVICES; TRUST AND CUSTODIAL SERVICES (U.S. CLS. 100, 101 AND 102).

SCOTT BIBB, EXAMINING ATTORNEY

CLASS 36—(Continued).

SN 77-599,969. NATIONWIDE MUTUAL INSURANCE COMPANY, COLUMBUS, OH. FILED 10-24-2008.

**NATIONWIDE RETIREMENT
CLEAR ADVANTAGE**

THE MARK CONSISTS OF STANDARD CHARACTERS WITHOUT CLAIM TO ANY PARTICULAR FONT, STYLE, SIZE, OR COLOR.

OWNER OF U.S. REG. NOS. 854,888, 2,017,147 AND 3,328,989.

NO CLAIM IS MADE TO THE EXCLUSIVE RIGHT TO USE "RETIREMENT", APART FROM THE MARK AS SHOWN.

FOR FINANCIAL SERVICES, NAMELY, ADMINISTRATION, AND DISTRIBUTION OF INVESTMENTS; INVESTMENT ADVISORY AND ASSET ALLOCATION SERVICES; TRUST AND CUSTODIAL SERVICES (U.S. CLS. 100, 101 AND 102).

SCOTT BIBB, EXAMINING ATTORNEY



SN 77-600,263. SINVIN REALTY, LLC, NEW YORK, NY. FILED 10-24-2008.

Sinvin is Downtown

THE MARK CONSISTS OF STANDARD CHARACTERS WITHOUT CLAIM TO ANY PARTICULAR FONT, STYLE, SIZE, OR COLOR.

FOR COMMERCIAL AND RESIDENTIAL REAL ESTATE AGENCY SERVICES (U.S. CLS. 100, 101 AND 102). FIRST USE 12-21-2007; IN COMMERCE 12-21-2007.

MICHAEL TANNER, EXAMINING ATTORNEY



SN 77-601,483. THE TORONTO-DOMINION BANK, TORONTO, CANADA, FILED 10-27-2008.

CHECK VIEW

THE MARK CONSISTS OF STANDARD CHARACTERS WITHOUT CLAIM TO ANY PARTICULAR FONT, STYLE, SIZE, OR COLOR.

OWNER OF U.S. REG. NO. 2,831,145.

FOR BANKING SERVICES, NAMELY, PROVIDING CUSTOMERS WITH BANK STATEMENTS CONTAINING IMAGES OF THEIR CHECKS RATHER THAN THE ACTUAL CHECKS (U.S. CLS. 100, 101 AND 102).

DAVID YONTEF, EXAMINING ATTORNEY

CLASS 36—(Continued).

SN 77-605,102. FLAGSTONE REINSURANCE HOLDINGS LTD., HAMILTON HM11, BERMUDA, FILED 10-31-2008.

MOSAIC INSURANCE

THE MARK CONSISTS OF STANDARD CHARACTERS WITHOUT CLAIM TO ANY PARTICULAR FONT, STYLE, SIZE, OR COLOR.

NO CLAIM IS MADE TO THE EXCLUSIVE RIGHT TO USE "INSURANCE", APART FROM THE MARK AS SHOWN.

FOR INSURANCE SERVICES, NAMELY, WRITING PROPERTY AND CASUALTY INSURANCE; REINSURANCE UNDERWRITING (U.S. CLS. 100, 101 AND 102).

FRANK LATTUCA, EXAMINING ATTORNEY



SN 77-612,494. REAL ESTATE ADVISORS, INC., PLANO, TX. FILED 11-12-2008.

Leasing 2.0

THE MARK CONSISTS OF STANDARD CHARACTERS WITHOUT CLAIM TO ANY PARTICULAR FONT, STYLE, SIZE, OR COLOR.

NO CLAIM IS MADE TO THE EXCLUSIVE RIGHT TO USE "LEASING", APART FROM THE MARK AS SHOWN.

FOR REAL ESTATE CONSULTANCY (U.S. CLS. 100, 101 AND 102).

FIRST USE 3-1-2008; IN COMMERCE 4-1-2008.

STEVEN R. FINE, EXAMINING ATTORNEY

CLASS 36—(Continued).

SN 77-615,136. IXE GRUPO FINANCIERO S.A.B. DE C.V., MEXICO CITY, MEXICO, FILED 11-14-2008.

CLASS 36—(Continued).

SN 77-622,118. GIRLING, DAVID W., DBA GIRLING REAL ESTATE INVESTMENT GROUP, NEWPORT BEACH, CA. FILED 11-26-2008.

EL
BAN
CODE
UNO

Balboa Island Price Index ("BIPI")

THE MARK CONSISTS OF STANDARD CHARACTERS WITHOUT CLAIM TO ANY PARTICULAR FONT, STYLE, SIZE, OR COLOR.

NO CLAIM IS MADE TO THE EXCLUSIVE RIGHT TO USE "BALBOA ISLAND PRICE INDEX", APART FROM THE MARK AS SHOWN.

FOR (BASED ON USE IN COMMERCE) PROVIDING A DATABASE OF INFORMATION ABOUT RESIDENTIAL REAL ESTATE LISTINGS IN DIFFERENT NEIGHBORHOODS AND COMMUNITIES; REAL ESTATE INVESTMENT SERVICES IN THE NATURE OF PURCHASING AND SELLING OF REAL ESTATE FOR OTHERS (BASED ON INTENT TO USE) FINANCIAL VALUATION OF PERSONAL PROPERTY AND REAL ESTATE (U.S. CLS. 100, 101 AND 102).

FIRST USE 11-20-2008; IN COMMERCE 11-20-2008.
HEATHER SAPP, EXAMINING ATTORNEY

SN 77-622,821. PPCLOAN.COM, LLC, THE WOODLANDS, TX. FILED 11-26-2008.

OWNER OF MEXICO REG. NO. 1054537, DATED 8-15-2008, EXPIRES 3-14-2018.

THE MARK CONSISTS OF THE FOUR WORDS STACKED IN FOUR LINES ON TOP OF EACH OTHER.

THE FOREIGN WORDING IN THE MARK TRANSLATES INTO ENGLISH AS ONE'S BANK.

FOR FINANCIAL ADMINISTRATION, REAL ESTATE LEASING AGENCIES, SAVING ACCOUNT SERVICES, FINANCIAL INVESTMENT SERVICES, NAMELY, INVESTMENT OF FUNDS AND RETIREMENT FUNDS AND BUYING AND SELLING OF STOCKS; REAL ESTATE AGENCY SERVICES; INSURANCE AGENCY SERVICES; FINANCIAL CONSULTING SERVICES; FOREIGN CURRENCY EXCHANGE SERVICES; FINANCING SERVICES, TRUST SERVICES, NAMELY, INVESTMENT AND TRUST COMPANY SERVICES; FINANCIAL SERVICES, NAMELY, ADMINISTRATION OF TRANSACTIONS INVOLVING FUNDS DRAWN FROM SECURITIES, STOCKS, FUNDS, EQUITIES, BONDS, CASH, OR OTHER TYPES OF FINANCIAL INVESTMENTS IN RETIREMENT PLANS USING A CREDIT OR DEBIT CARD OVER A GLOBAL DATA NETWORK; FINANCIAL ANALYSIS AND CONSULTING; REAL ESTATE SERVICES, NAMELY, TAX APPRAISALS; ELECTRONIC TRANSFER OF FUNDS; MORTGAGE LENDING AND COMMERCIAL LENDING SERVICES; AND BANKING SERVICES (U.S. CLS. 100, 101 AND 102).
JOHN E. MICHOS, EXAMINING ATTORNEY

PPCLOAN

THE MARK CONSISTS OF STANDARD CHARACTERS WITHOUT CLAIM TO ANY PARTICULAR FONT, STYLE, SIZE, OR COLOR.

OWNER OF U.S. REG. NOS. 2,259,481 AND 2,290,007.
FOR FINANCIAL SERVICES, NAMELY, ASSISTING PROFESSIONALS IN OBTAINING FINANCING RELATED TO PRACTICE ACQUISITION AND EXPANSION (U.S. CLS. 100, 101 AND 102).
TRACY CROSS, EXAMINING ATTORNEY

CLASS 36—(Continued).

SN 77-631,415. ALLIED WORLD ASSURANCE COMPANY (U.S.) INC., BOSTON, MA. FILED 12-11-2008.



OWNER OF U.S. REG. NOS. 3,401,036 AND 3,525,022.
NO CLAIM IS MADE TO THE EXCLUSIVE RIGHT TO USE "BROKERAGE", APART FROM THE MARK AS SHOWN.

THE MARK CONSISTS OF THE WORDS "AW" ALONG WITH THE WORDS "ALLIED WORLD BROKERAGE".

FOR INSURANCE SERVICES, NAMELY, INSURANCE ADMINISTRATION AND UNDERWRITING IN THE FIELDS OF PROPERTY INSURANCE, LIABILITY INSURANCE, CASUALTY INSURANCE, PROFESSIONAL LIABILITY INSURANCE AND HEALTHCARE LIABILITY INSURANCE; REINSURANCE UNDERWRITING (U.S. CLS. 100, 101 AND 102).

FIRST USE 8-14-2008; IN COMMERCE 8-14-2008.
HOWARD SMIGA, EXAMINING ATTORNEY

SN 77-634,461. HUNTSMAN GAY GLOBAL CAPITAL, LLC, PALO ALTO, CA. FILED 12-16-2008.

HUNTSMAN GAY GLOBAL CAPITAL

THE MARK CONSISTS OF STANDARD CHARACTERS WITHOUT CLAIM TO ANY PARTICULAR FONT, STYLE, SIZE, OR COLOR.

NO CLAIM IS MADE TO THE EXCLUSIVE RIGHT TO USE "GLOBAL CAPITAL", APART FROM THE MARK AS SHOWN.

FOR FINANCIAL SERVICES, NAMELY, INVESTMENT ADVICE, INVESTMENT MANAGEMENT, INVESTMENT CONSULTATION AND INVESTMENT OF FUNDS FOR OTHERS (U.S. CLS. 100, 101 AND 102).

FIRST USE 12-19-2008; IN COMMERCE 12-19-2008.
PAM WILLIS, EXAMINING ATTORNEY

SN 77-638,989. PREMIER COMMERCIAL BANCORP, ANAHEIM, CA. FILED 12-23-2008.

PREMIER COMMERCIAL BANCORP

THE MARK CONSISTS OF STANDARD CHARACTERS WITHOUT CLAIM TO ANY PARTICULAR FONT, STYLE, SIZE, OR COLOR.

OWNER OF U.S. REG. NOS. 3,383,562, 3,559,651 AND OTHERS.

NO CLAIM IS MADE TO THE EXCLUSIVE RIGHT TO USE "BANCORP", APART FROM THE MARK AS SHOWN. SEC. 2(F).

FOR BANKING AND FINANCING SERVICES (U.S. CLS. 100, 101 AND 102).

FIRST USE 6-30-2004; IN COMMERCE 6-30-2004.
LAURIE KAUFMAN, EXAMINING ATTORNEY

CLASS 36—(Continued).

SN 77-641,337. ALISA BENAY LLC, DBA ALISA BENAY BRIDAL COUTURE, COLORADO SPRINGS, CO. FILED 12-30-2008.

100 Brides for 100 K

THE MARK CONSISTS OF STANDARD CHARACTERS WITHOUT CLAIM TO ANY PARTICULAR FONT, STYLE, SIZE, OR COLOR.

FOR CHARITABLE FUNDRAISING SERVICES, NAMELY, ORGANIZING FUNDRAISING SALES EVENTS TO RAISE FUNDS FOR BREAST CANCER RESEARCH (U.S. CLS. 100, 101 AND 102).

KEVON CHISOLM, EXAMINING ATTORNEY

SN 77-645,825. STARKE AGENCY, INC., MONTGOMERY, AL. FILED 1-8-2009.



THE MARK CONSISTS OF WAVE DESIGN FOLLOWED BY THE WORD "STARKE".

FOR INSURANCE SERVICES, NAMELY, BROKERAGE IN THE FIELD OF INSURANCE, INSURANCE AGENCY AND BROKERAGE, INSURANCE CONSULTANCY SERVICES, NAMELY, PROVIDING ADVICE IN THE FIELD OF PROPERTY AND CASUALTY INSURANCE, LIFE INSURANCE BROKERAGE, AND INSURANCE BROKERAGE IN THE FIELD OF EMPLOYEE BENEFITS, FINANCIAL SERVICES, NAMELY, FINANCIAL CONSULTANCY AND INSURANCE CONSULTANCY AND PROVIDING AN INVESTMENT OPTION AVAILABLE FOR VARIABLE ANNUITY, VARIABLE LIFE INSURANCE PRODUCTS, AND 401(K) PLANS (U.S. CLS. 100, 101 AND 102).

FIRST USE 12-18-2008; IN COMMERCE 12-18-2008.
LAURIE KAUFMAN, EXAMINING ATTORNEY

SN 77-645,848. JPMORGAN CHASE & CO., NEW YORK, NY. FILED 1-8-2009.

CHASE HEALTH GRAD PLUS LOAN

THE MARK CONSISTS OF STANDARD CHARACTERS WITHOUT CLAIM TO ANY PARTICULAR FONT, STYLE, SIZE, OR COLOR.

NO CLAIM IS MADE TO THE EXCLUSIVE RIGHT TO USE "HEALTH GRAD" AND "LOAN", APART FROM THE MARK AS SHOWN.

FOR BANKING AND FINANCIAL SERVICES, NAMELY, LOAN SERVICES FOR MEDICAL EDUCATION (U.S. CLS. 100, 101 AND 102).

FIRST USE 1-23-2008; IN COMMERCE 1-23-2008.
BRIAN NEVILLE, EXAMINING ATTORNEY

CLASS 36—(Continued).

SN 77-649,536. GEORGIA FORECLOSURE INC, ATLANTA, GA. FILED 1-14-2009.



NO CLAIM IS MADE TO THE EXCLUSIVE RIGHT TO USE "GEORGIA FORECLOSURE INC.", APART FROM THE MARK AS SHOWN.

THE COLOR(S) WHITE, GOLD AND BLACK IS/ARE CLAIMED AS A FEATURE OF THE MARK.

THE MARK CONSISTS OF THE WORD "GEORGIA" IN BLACK FONT. THE WORD "FORECLOSURE" IS IN GOLD FONT AND DIRECTLY UNDER THE WORD "GEORGIA". THE SUFFIX "INC" IS IN BLACK AND TO THE RIGHT OF "FORECLOSURE". THE WORDS "FINDING PROPERTIES JUST GOT EASIER" ARE IN BLACK AND JUST BELOW THE WORD "FORECLOSURE". TO THE LEFT OF THE WORDS IS A SQUARE GOLD COLORED IMAGE WITH LINES OF WHITE AND DARK GOLD DEPICTING AN ANGLE WITHIN THE SQUARE.

FOR PROVIDING REAL ESTATE LISTINGS AND REAL ESTATE INFORMATION VIA THE INTERNET (U.S. CLS. 100, 101 AND 102).

FIRST USE 11-1-1999; IN COMMERCE 11-1-1999.
DOMINIC J. FERRAIUOLO, EXAMINING ATTORNEY

SN 77-651,437. TRI CLIFF LLC, CHICAGO, IL. FILED 1-16-2009.



THE COLOR(S) GREEN IS/ARE CLAIMED AS A FEATURE OF THE MARK.

THE MARK CONSISTS OF THE LETTERS "CCP" IN A STYLIZED DESIGN OF A FROG.

FOR FINANCIAL SERVICES, NAMELY, INVESTMENT OF FUNDS IN COMMERCIAL OFFICE AND RETAIL BUILDINGS, PORTFOLIO AND ASSET MANAGEMENT; PROPERTY MANAGEMENT SERVICES OF COMMERCIAL OFFICE AND RETAIL BUILDINGS, REAL ESTATE MANAGEMENT, REAL ESTATE LEASING (U.S. CLS. 100, 101 AND 102).

JASON BLAIR, EXAMINING ATTORNEY

CLASS 36—(Continued).

SN 77-651,458. TRI CLIFF LLC, CHICAGO, IL. FILED 1-16-2009.

CCP

THE MARK CONSISTS OF STANDARD CHARACTERS WITHOUT CLAIM TO ANY PARTICULAR FONT, STYLE, SIZE, OR COLOR.

FOR FINANCIAL SERVICES, NAMELY, INVESTMENT OF FUNDS IN COMMERCIAL OFFICE AND RETAIL BUILDINGS, PORTFOLIO AND ASSET MANAGEMENT; PROPERTY MANAGEMENT SERVICES OF COMMERCIAL OFFICE AND RETAIL BUILDINGS, REAL ESTATE MANAGEMENT, REAL ESTATE LEASING (U.S. CLS. 100, 101 AND 102).

JASON BLAIR, EXAMINING ATTORNEY

SN 77-657,171. ARROWHAWK CAPITAL PARTNERS, LLC, DARIEN, CT. FILED 1-27-2009.

ARROWHAWK DURABLE ALPHA

THE MARK CONSISTS OF STANDARD CHARACTERS WITHOUT CLAIM TO ANY PARTICULAR FONT, STYLE, SIZE, OR COLOR.

NO CLAIM IS MADE TO THE EXCLUSIVE RIGHT TO USE "DURABLE ALPHA", APART FROM THE MARK AS SHOWN.

FOR FINANCIAL SERVICES, NAMELY, INVESTMENT MANAGEMENT AND ADVISORY SERVICES (U.S. CLS. 100, 101 AND 102).

SALLY SHIH, EXAMINING ATTORNEY

SN 77-661,668. RETIREMENT BENCHMARK LLC, LEAWOOD, KS. FILED 2-2-2009.

Retirement Benchmark

THE MARK CONSISTS OF STANDARD CHARACTERS WITHOUT CLAIM TO ANY PARTICULAR FONT, STYLE, SIZE, OR COLOR.

NO CLAIM IS MADE TO THE EXCLUSIVE RIGHT TO USE "RETIREMENT", APART FROM THE MARK AS SHOWN.

FOR FINANCIAL PLANNING AND INVESTMENT ADVISORY SERVICES (U.S. CLS. 100, 101 AND 102).

FIRST USE 11-6-2008; IN COMMERCE 11-6-2008.

KIMBERLY FRYE, EXAMINING ATTORNEY

CLASS 36—(Continued).

SN 77-667,552. PSYCHIATRISTS' PURCHASING GROUP, INC., TUCSON, AZ. FILED 2-10-2009.



THE COLOR(S) DARK BLUE AND LIGHT BLUE IS/ARE CLAIMED AS A FEATURE OF THE MARK.
 THE MARK CONSISTS OF A LIGHT BLUE SQUARE WITH A BLUE LIGHTHOUSE IN THE CENTER OF A DARK BLUE CIRCLE. THE LETTERS "PPG" ARE LOCATED IN A DARK BLUE RECTANGLE DIRECTLY BELOW THE SQUARE DESIGN. THE LETTERS "PPG" ARE LIGHT BLUE AND THE STRIPES IN THE LIGHTHOUSE ARE DARK BLUE WHICH MATCH THE CIRCLE.

FOR INSURANCE ADMINISTRATION; INSURANCE CONSULTANCY SERVICES, NAMELY, PROVIDING ADVICE IN THE FIELD OF PROPERTY AND CASUALTY INSURANCE; INSURANCE INFORMATION; INSURANCE UNDERWRITING CONSULTATION; INSURANCE UNDERWRITING IN THE FIELD OF PSYCHIATRIC MALPRACTICE CLAIMS; PROVIDING INFORMATION IN INSURANCE MATTERS (U.S. CLS. 100, 101 AND 102).

FIRST USE 10-10-2000; IN COMMERCE 10-10-2000.
 DAVID COLLIER, EXAMINING ATTORNEY

CLASS 36—(Continued).

SN 77-675,347. HOME LOAN INVESTMENT BANK, FSB, WARWICK, RI. FILED 2-21-2009.

Ashborn

THE MARK CONSISTS OF STANDARD CHARACTERS WITHOUT CLAIM TO ANY PARTICULAR FONT, STYLE, SIZE, OR COLOR.

FOR BANKING, BANKING SERVICES, CAPITAL INVESTMENT CONSULTATION, CAPITAL INVESTMENT SERVICES, FINANCIAL ADVICE AND CONSULTANCY SERVICES, FINANCIAL ASSET MANAGEMENT, FINANCIAL CONSULTANCY AND INSURANCE CONSULTANCY, FINANCIAL MANAGEMENT, FINANCIAL CONSULTING, FINANCIAL PORTFOLIO MANAGEMENT, INVESTMENT MANAGEMENT, MORTGAGE BANKING, PRIVATE EQUITY FUND INVESTMENT SERVICES, PRIVATE WEALTH MANAGEMENT, VENTURE CAPITAL SERVICES, SAVINGS AND LOAN ASSOCIATIONS, SAVINGS AND LOAN SERVICES, SAVINGS BANK SERVICES, INVESTMENT BANKING SERVICES, REAL ESTATE ACQUISITION, REAL ESTATE INVESTMENT, REAL ESTATE MANAGEMENT, INSURANCE ADMINISTRATION, ARRANGING AND PROVISION OF CREDIT, LOANS, INSURANCE, CURRENCY EXCHANGE AND TRAVELERS CHEQUES, BROKERAGE IN THE FIELD OF INSURANCE, CONSULTING AND INFORMATION CONCERNING INSURANCE, FINANCIAL EVALUATION FOR INSURANCE PURPOSES, INSURANCE AGENCIES, INSURANCE AGENCY AND BROKERAGE, INSURANCE SERVICES, NAMELY, WRITING PROPERTY AND CASUALTY INSURANCE, INSURANCE SERVICES, NAMELY, UNDERWRITING, ISSUING AND ADMINISTRATION OF LIFE INSURANCE, PROVIDING INFORMATION ON INSURANCE MATTERS, INSURANCE ADMINISTRATION, INSURANCE CONSULTANCY (U.S. CLS. 100, 101 AND 102).
 CHRIS WELLS, EXAMINING ATTORNEY

SN 77-671,117. WINICK, JON, CHICAGO, IL. FILED 2-16-2009.



NO CLAIM IS MADE TO THE EXCLUSIVE RIGHT TO USE "CAPITAL", APART FROM THE MARK AS SHOWN.
 THE COLOR(S) BLACK AND BLUE IS/ARE CLAIMED AS A FEATURE OF THE MARK.

THE MARK CONSISTS OF THE WORDS "CLARK STREET" WRITTEN IN BLACK. ON THE LEFT OF THE MARK IS A BLACK SQUARE OUTLINE CONTAINING A BLUE SOLID SQUARE FADING FROM DARK TO LIGHT BLUE FROM THE RIGHT TO LEFT. WITHIN THE BLUE SQUARE IS A BLACK BRIDGE. A PORTION OF THE BRIDGE EXTENDS OUTSIDE THE BOX AND UNDERLINES THE WORDS "CLARK STREET". BELOW THE UNDERLINING IS THE WORD "CAPITAL" WRITTEN IN BLUE.

SEC. 2(F).
 FOR MANAGEMENT OF PRIVATE EQUITY FUNDS (U.S. CLS. 100, 101 AND 102).
 CYNTHIA TRIPI, EXAMINING ATTORNEY

SN 77-682,591. HOUSESAVVY USA, LLC, NORWELL, MA. FILED 3-3-2009.

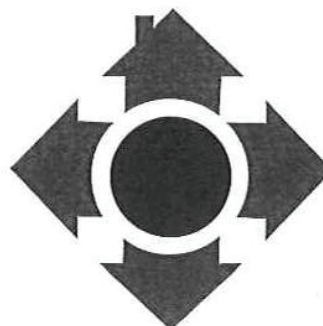

THE MARK CONSISTS OF FOUR HOUSES AROUND A SUN.

FOR REAL ESTATE LISTING SERVICES; REAL ESTATE BROKERAGE SERVICES; CONSULTING SERVICES FOR BUYERS AND SELLERS OF REAL ESTATE (U.S. CLS. 100, 101 AND 102).
 VERA BETH RIRIE, EXAMINING ATTORNEY

CLASS 36—(Continued).

SN 77-682,853. INAMDAR, RAJ S., NEW YORK, NY. FILED 3-4-2009.

Sorani

THE MARK CONSISTS OF STANDARD CHARACTERS WITHOUT CLAIM TO ANY PARTICULAR FONT, STYLE, SIZE, OR COLOR.

FOR ACCEPTING AND ADMINISTERING MONETARY CHARITABLE CONTRIBUTIONS; ACCEPTING AND ADMINISTERING MONETARY CHARITABLE CONTRIBUTIONS TO FUND MEDICAL RESEARCH; BANKING AND FINANCING SERVICES; CHARITABLE FOUNDATION SERVICES, NAMELY, PROVIDING FUND RAISING ACTIVITIES TO SUPPORT MEDICAL RESEARCH AND PROCEDURES FOR THOSE IN NEED; CHARITABLE FUND RAISING; CHARITABLE FUNDRAISING SERVICES; CHARITABLE SERVICES, NAMELY, GRANTING FUNDS TO SCHOOLS; CHARITABLE SERVICES, NAMELY, PROVIDING FINANCIAL ASSISTANCE TO MEET THE PHYSICAL, PSYCHOLOGICAL, SOCIAL AND OTHER SPECIAL NEEDS OF CHILDREN; CHARITABLE SERVICES, NAMELY, PROVIDING FINANCIAL SUPPORT TO PEOPLE FROM DISADVANTAGED COUNTRIES FOR THE PURPOSE OF FACILITATING EDUCATIONAL OPPORTUNITIES; FINANCIAL ADVISORY AND CONSULTANCY SERVICES RELATING TO MICRO CREDITS, MICRO FINANCE AND ENERGY PRODUCTS; FINANCIAL CONSULTING SERVICES IN THE FIELD OF PLANNED GIVING FOR NON-PROFIT AND CHARITABLE ORGANIZATIONS; FINANCING MEDICAL RESEARCH OF OTHERS; FINANCING OF REAL ESTATE DEVELOPMENT PROJECTS; HOUSING SERVICES, NAMELY, REAL PROPERTY ACQUISITION AND CONSUMER FINANCING TO FACILITATE HOME OWNERSHIP; LEASING OF REAL ESTATE; MORTGAGE BANKING SERVICES, NAMELY, ORIGINATION, ACQUISITION, SERVICING, SECURITIZATION AND BROKERAGE OF MORTGAGE LOANS; MORTGAGE FORECLOSURE MITIGATION AND LOAN DEFAULT MITIGATION SERVICES, NAMELY, ACQUISITION AND LEASE-BACK OF REAL ESTATE; PROVIDING EDUCATIONAL SCHOLARSHIPS; PROVIDING WORKING CAPITAL FINANCING TO SMALL BUSINESSES AND SMALL BUSINESS OWNERS; REAL ESTATE ACQUISITION SERVICES; REAL ESTATE BROKERAGE; REAL ESTATE FINANCING SERVICES; REAL ESTATE INSURANCE UNDERWRITING SERVICES; REAL ESTATE INVESTMENT; REAL ESTATE LENDING SERVICES; REAL ESTATE MANAGEMENT; VENTURE CAPITAL SERVICES, NAMELY, PROVIDING FINANCING TO EMERGING AND START-UP COMPANIES (U.S. CLS. 100, 101 AND 102).

KATINA MISTER, EXAMINING ATTORNEY

CLASS 36—(Continued).

SN 77-683,899. KABUSHIKI KAISHA SQUARE ENIX, AKA SQUARE ENIX CO., LTD., TOKYO, JAPAN, FILED 3-5-2009.

CRYSTA

THE MARK CONSISTS OF STANDARD CHARACTERS WITHOUT CLAIM TO ANY PARTICULAR FONT, STYLE, SIZE, OR COLOR.

PRIORITY CLAIMED UNDER SEC. 44(D) ON JAPAN APPLICATION NO. 2008-092746, FILED 10-31-2008, REG. NO. 5246672, DATED 7-10-2009, EXPIRES 7-10-2019.

FOR ELECTRONIC FUNDS TRANSFER; TRANSFER OF ELECTRONIC MONEY VIA THE INTERNET; ISSUING CREDIT CARDS; CASH CARD SERVICES; CREDIT CARD SERVICES; DEBIT CARD SERVICES; ACQUISITION AND TRANSFER OF MONETARY CLAIMS; PROVIDING INFORMATION ABOUT ACQUISITION AND TRANSFER OF MONETARY CLAIMS; MONEY COLLECTION AGENCIES; ELECTRONIC FUNDS TRANSFER SERVICES; ISSUE OF TOKENS OF VALUE; PREPAID PURCHASE CARD SERVICES, NAMELY, PROCESSING ELECTRONIC PAYMENTS MADE THROUGH PREPAID CARDS (U.S. CLS. 100, 101 AND 102).

DORITT L. CARROLL, EXAMINING ATTORNEY

SN 77-692,445. MASSACHUSETTS MUTUAL LIFE INSURANCE COMPANY, SPRINGFIELD, MA. FILED 3-17-2009.

Vantage Term

THE MARK CONSISTS OF STANDARD CHARACTERS WITHOUT CLAIM TO ANY PARTICULAR FONT, STYLE, SIZE, OR COLOR.

NO CLAIM IS MADE TO THE EXCLUSIVE RIGHT TO USE "TERM", APART FROM THE MARK AS SHOWN.

FOR INSURANCE SERVICES, NAMELY, UNDERWRITING, ISSUING AND ADMINISTRATION OF LIFE INSURANCE (U.S. CLS. 100, 101 AND 102).

CHERYL CLAYTON, EXAMINING ATTORNEY

CLASS 36—(Continued).

SN 77-693,392. THE PROPERTY GAUGE, LLC, LATHAM, NY. FILED 3-18-2009.



NO CLAIM IS MADE TO THE EXCLUSIVE RIGHT TO USE "PROPERTY", APART FROM THE MARK AS SHOWN. THE MARK CONSISTS OF THE WORDS "THE PROPERTY GAUGE" IN AN OVAL.

FOR MORTGAGE LENDING CONSULTING SERVICES, NAMELY, IDENTIFYING POTENTIAL DEFAULT RISK IN MULTIFAMILY MORTGAGE LENDING (U.S. CLS. 100, 101 AND 102).

MARK SPARACINO, EXAMINING ATTORNEY

CLASS 36—(Continued).

SN 77-697,756. DAHL CAPITAL VENTURES, LLC, CHICAGO, IL. FILED 3-24-2009.



NO CLAIM IS MADE TO THE EXCLUSIVE RIGHT TO USE "FUTURES TRADING ADVISORIES & EDUCATION", APART FROM THE MARK AS SHOWN.

THE COLOR(S) DARK PURPLE, LIGHT PURPLE AND GOLD IS/ARE CLAIMED AS A FEATURE OF THE MARK.

THE MARK CONSISTS OF A DESIGN OF A DARK PURPLE FIGURE SPEAKING TO A GOLD FIGURE, ABOVE DARK PURPLE AND GOLD CURVED LINES, WHICH ARE ABOVE THE TERM "CANDIDCOMMODITIES" IN DARK PURPLE, WHICH IS ABOVE THE TERM "FUTURES TRADING ADVISORIES & EDUCATION" IN LIGHT PURPLE, WHICH IS ABOVE DARK PURPLE AND GOLD CURVED LINES.

FOR FINANCIAL AND INVESTMENT SERVICES, NAMELY, MANAGEMENT AND BROKERAGE IN THE FIELDS OF STOCKS, BONDS, OPTIONS, COMMODITIES, FUTURES AND OTHER SECURITIES, AND THE INVESTMENT OF FUNDS OF OTHERS (U.S. CLS. 100, 101 AND 102).

TARA PATE, EXAMINING ATTORNEY

SN 77-702,028. KIMC INVESTMENTS, INC., WEST PALM BEACH, FL. FILED 3-30-2009.

SCRUBS FOR A CAUSE

THE MARK CONSISTS OF STANDARD CHARACTERS WITHOUT CLAIM TO ANY PARTICULAR FONT, STYLE, SIZE, OR COLOR.

FOR CHARITABLE FUNDRAISING SERVICES; ORGANIZING AND CONDUCTING SPECIAL EVENTS FOR CHARITABLE FUNDRAISING PURPOSES (U.S. CLS. 100, 101 AND 102).

TRACY WHITTAKER-BROWN, EXAMINING ATTORNEY

SN 77-697,124. DAHL CAPITAL VENTURES, CHICAGO, IL. FILED S.R. 3-23-2009; AM. P.R. 6-24-2009.



NO CLAIM IS MADE TO THE EXCLUSIVE RIGHT TO USE "CAPITAL VENTURES" AND "ALTERNATIVE INVESTMENTS & TRADING SYSTEMS", APART FROM THE MARK AS SHOWN.

THE COLOR(S) BLUE, GREEN, GREY IS/ARE CLAIMED AS A FEATURE OF THE MARK.

THE MARK CONSISTS OF THE TERM "DAHL" IN BLUE, UNDERLINED BY A GREEN ARROW THAT INTERSECTS A GREEN TRIANGLE AND BLUE SEMI-CIRCLE DESIGN, WHICH IS TO THE LEFT OF THE UNDERLINED TERM "CAPITAL VENTURES" IN GREEN, ALL ABOVE THE TERM "ALTERNATIVE INVESTMENTS & TRADING SYSTEMS" IN GREY.

FOR AGENCIES IN THE FIELD OF BONDS AND OTHER SECURITIES (U.S. CLS. 100, 101 AND 102).

FIRST USE 11-1-2008; IN COMMERCE 11-1-2008.

TARA PATE, EXAMINING ATTORNEY

SN 77-702,329. LIZARD INVESTORS LLC, CHICAGO, IL. FILED 3-30-2009.

LIZARDinvestors



NO CLAIM IS MADE TO THE EXCLUSIVE RIGHT TO USE "INVESTORS", APART FROM THE MARK AS SHOWN. THE MARK CONSISTS OF THE WORDS "LIZARD INVESTORS" AND TO THE RIGHT A LIZARD TAIL IN WHITE IN A BLACK SQUARE.

FOR INVESTMENT MANAGEMENT SERVICES (U.S. CLS. 100, 101 AND 102).

DAVID MURRAY, EXAMINING ATTORNEY

CLASS 36—(Continued).

SN 77-702,978. MEM PROPERTY MANAGEMENT CO, INC., JERSEY CITY, NJ. FILED 3-31-2009.



NO CLAIM IS MADE TO THE EXCLUSIVE RIGHT TO USE "PROPERTY MANAGEMENT", APART FROM THE MARK AS SHOWN.

THE COLOR(S) BLUE, BLACK AND WHITE IS/ARE CLAIMED AS A FEATURE OF THE MARK.

THE MARK CONSISTS OF THE ARTISTIC RENDERING OF TWO BUILDINGS IN BLUE AND WHITE. EXTENDING FROM THE BASE OF THE BUILDINGS IS A SEMI CIRCLE IN BLACK. IN THE SEMI CIRCLE THE STYLIZED LETTERS "MEM" IN BLACK APPEAR OVER THE STYLIZED WORDS "PROPERTY MANAGEMENT" IN BLUE. THE REMAINING WHITE IN THE MARK IS INTENDED TO REPRESENT BACKGROUND ONLY AND IS NOT CLAIMED AS A FEATURE OF THE MARK.

FOR REAL ESTATE SERVICES, NAMELY, CONDOMINIUM MANAGEMENT SERVICES (U.S. CLS. 100, 101 AND 102).

FIRST USE 2-1-2008; IN COMMERCE 2-1-2008.
AMY ALFIERI, EXAMINING ATTORNEY

SN 77-707,754. GUTTMACHER INSTITUTE, INC., FORMERLY THE ALAN GUTTMACHER INSTITUTE, INC., NEW YORK, NY. FILED 4-6-2009.



OWNER OF U.S. REG. NOS. 2,768,957 AND 2,793,970.

NO CLAIM IS MADE TO THE EXCLUSIVE RIGHT TO USE "INSTITUTE", APART FROM THE MARK AS SHOWN.

THE MARK CONSISTS OF THE BOTTOM HALF OF A THREE DIMENSIONAL LETTER "G", WITH THE WORDS "GUTTMACHER INSTITUTE" BENEATH.

FOR CHARITABLE FUND RAISING SERVICES RELATING TO RESEARCH INVOLVING FAMILY PLANNING ISSUES (U.S. CLS. 100, 101 AND 102).

FIRST USE 7-1-2005; IN COMMERCE 7-1-2005.
INGRID C. EULIN, EXAMINING ATTORNEY

CLASS 36—(Continued).

SN 77-710,643. ORT AMERICA, INC., NEW YORK, NY. FILED 4-9-2009.

ORGANIZATION FOR REHABILITATION THROUGH TRAINING

THE MARK CONSISTS OF STANDARD CHARACTERS WITHOUT CLAIM TO ANY PARTICULAR FONT, STYLE, SIZE, OR COLOR.

NO CLAIM IS MADE TO THE EXCLUSIVE RIGHT TO USE "ORGANIZATION", APART FROM THE MARK AS SHOWN.

FOR CHARITABLE FUNDRAISING SERVICES (U.S. CLS. 100, 101 AND 102).

FIRST USE 0-0-1956; IN COMMERCE 0-0-1956.
MARIA-VICTORIA SUAREZ, EXAMINING ATTORNEY

SN 77-710,722. BANK OF MONTREAL, TORONTO, ONTARIO, CANADA, FILED 4-9-2009.

BMO APPROVE2PAY

THE MARK CONSISTS OF STANDARD CHARACTERS WITHOUT CLAIM TO ANY PARTICULAR FONT, STYLE, SIZE, OR COLOR.

OWNER OF U.S. REG. NOS. 2,615,684 AND 2,615,685.
FOR FINANCIAL SERVICES, NAMELY, ELECTRONIC BILL PAYMENT TRANSACTION PROGRAM FOR CUSTOMERS AND SUPPLIERS (U.S. CLS. 100, 101 AND 102).
JOHN E. MICHOS, EXAMINING ATTORNEY

SN 77-712,010. UNITED POLES FEDERAL CREDIT UNION, PERTH AMBOY, NJ. FILED 4-11-2009.

UNITED POLES

THE MARK CONSISTS OF STANDARD CHARACTERS WITHOUT CLAIM TO ANY PARTICULAR FONT, STYLE, SIZE, OR COLOR.

NO CLAIM IS MADE TO THE EXCLUSIVE RIGHT TO USE "POLES", APART FROM THE MARK AS SHOWN.

FOR FINANCIAL SERVICES, NAMELY, CREDIT UNION SERVICES, CREDIT CARD SERVICES, BANKING SERVICES, CONSUMER AND COMMERCIAL LENDING SERVICES, BILL PAYMENT SERVICES, FINANCIAL CONSULTATION SERVICES, FINANCIAL PLANNING SERVICES, FINANCIAL RETIREMENT PLANNING SERVICES (U.S. CLS. 100, 101 AND 102).

FIRST USE 12-31-1964; IN COMMERCE 12-31-1973.
NANCY CLARKE, EXAMINING ATTORNEY

CLASS 36—(Continued).

SN 77-712,018. UNITED POLES FEDERAL CREDIT UNION, PERTH AMBOY, NJ. FILED 4-11-2009.



THE MARK CONSISTS OF A CIRCLE DIVIDED INTO TWO HALVES BY A HORIZONTAL LINE, WITH THE UPPER HALF BEING OPEN AND THE LOWER HALF BEING FILLED IN, AND WITH A PAIR OF DIAMETRICALLY OPPOSED EXTERNAL ARCS EACH EXTENDING CLOCKWISE APPROXIMATELY ONE HUNDRED THIRTY FIVE (135) DEGREES FROM THE HORIZONTAL DIVIDING LINE, AND WITH EACH ARC TAPERING TO A POINT FROM ITS BEGINNING AT THE HORIZONTAL DIVIDING LINE.

FOR FINANCIAL SERVICES, NAMELY, CREDIT UNION SERVICES, CREDIT CARD SERVICES, BANKING SERVICES, CONSUMER AND COMMERCIAL LENDING SERVICES, BILL PAYMENT SERVICES, FINANCIAL CONSULTATION SERVICES, FINANCIAL PLANNING SERVICES, FINANCIAL RETIREMENT PLANNING SERVICES (U.S. CLS. 100, 101 AND 102).

FIRST USE 4-9-2009; IN COMMERCE 4-9-2009.
NANCY CLARKE, EXAMINING ATTORNEY

SN 77-712,522. HAITIAN EDUCATION AND LEADERSHIP PROGRAM, NEW YORK, NY. FILED 4-13-2009.

From Poverty to Prosperity
Through Education

THE MARK CONSISTS OF STANDARD CHARACTERS WITHOUT CLAIM TO ANY PARTICULAR FONT, STYLE, SIZE, OR COLOR.

FOR CHARITABLE FUND RAISING AND EDUCATIONAL SCHOLARSHIP SERVICES (U.S. CLS. 100, 101 AND 102).

FIRST USE 12-31-2007; IN COMMERCE 12-31-2007.
BONNIE LUKEN, EXAMINING ATTORNEY

CLASS 36—(Continued).

SN 77-712,524. HAITIAN EDUCATION AND LEADERSHIP PROGRAM, NEW YORK, NY. FILED 4-13-2009.

Capacité + Volonté +
Opportunité = Succès

THE MARK CONSISTS OF STANDARD CHARACTERS WITHOUT CLAIM TO ANY PARTICULAR FONT, STYLE, SIZE, OR COLOR.

THE ENGLISH TRANSLATION OF "CAPACITÉ", "VOLONTÉ", "OPPORTUNITÉ", AND "SUCCÈS" IS "CAPABILITY", "WILL", "OPPORTUNITY" AND "SUCCESS".

FOR CHARITABLE FUNDRAISING SERVICES AND PROVIDING EDUCATIONAL SCHOLARSHIPS (U.S. CLS. 100, 101 AND 102).

FIRST USE 4-30-2004; IN COMMERCE 4-30-2004.
BONNIE LUKEN, EXAMINING ATTORNEY

SN 77-712,586. BLUE RIDGE ASSET MANAGEMENT, LLC, RALEIGH, NC. FILED 4-13-2009.

PARK RIDGE ASSET MANAGEMENT

THE MARK CONSISTS OF STANDARD CHARACTERS WITHOUT CLAIM TO ANY PARTICULAR FONT, STYLE, SIZE, OR COLOR.

NO CLAIM IS MADE TO THE EXCLUSIVE RIGHT TO USE "ASSET MANAGEMENT", APART FROM THE MARK AS SHOWN.

FOR FINANCIAL SERVICES, NAMELY, INVESTMENT ADVISORY SERVICES, INVESTMENT MANAGEMENT SERVICES AND ASSET MANAGEMENT SERVICES (U.S. CLS. 100, 101 AND 102).

ROBIN CHOSID, EXAMINING ATTORNEY

SN 77-714,098. ABUNDANCE TECHNOLOGIES, INC., CINCINNATI, OH. FILED 4-15-2009.

MATSONMONEY

THE MARK CONSISTS OF STANDARD CHARACTERS WITHOUT CLAIM TO ANY PARTICULAR FONT, STYLE, SIZE, OR COLOR.

OWNER OF U.S. REG. NO. 3,504,840.

FOR FINANCIAL ADVISORY AND CONSULTANCY SERVICES; FINANCIAL ANALYSES; FINANCIAL ASSET MANAGEMENT; FINANCIAL PLANNING, NAMELY, THE CREATION OF PERSONALIZED STRATEGIES TO ACHIEVE FINANCIAL INDEPENDENCE; FINANCIAL PORTFOLIO ANALYSIS SERVICES (U.S. CLS. 100, 101 AND 102).

FIRST USE 3-11-2009; IN COMMERCE 3-11-2009.
GENE MACIOL, EXAMINING ATTORNEY

CLASS 36—(Continued).

SN 77-714,674. ALLEN CREDIT AND DEBT COUNSELING AGENCY, WESSINGTON, SD. FILED 4-15-2009.

My Financial Management

THE MARK CONSISTS OF STANDARD CHARACTERS WITHOUT CLAIM TO ANY PARTICULAR FONT, STYLE, SIZE, OR COLOR.

NO CLAIM IS MADE TO THE EXCLUSIVE RIGHT TO USE "FINANCIAL MANAGEMENT", APART FROM THE MARK AS SHOWN.

FOR PROVIDING A WEB SITE FEATURING PERSONAL FINANCIAL INFORMATION FOR VIEWING ACCOUNT INFORMATION OF MULTIPLE FINANCIAL ACCOUNTS, PROVIDING SUMMARY GRAPHS AND CHARTS FOR VIEWING SPENDING HABITS, CALCULATING PERSONAL BUDGETS AND RECEIVING DAILY ACCOUNT UPDATES VIA EMAIL AND TEXT MESSAGE (U.S. CLS. 100, 101 AND 102).

JENNIFER DIXON, EXAMINING ATTORNEY

SN 77-716,008. HOPKINS FINANCIAL CORPORATION, MITCHELL, SD. FILED 4-17-2009.

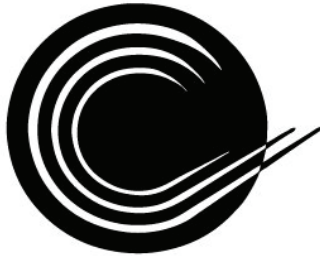

OWNER OF U.S. REG. NO. 2,229,788.

THE MARK CONSISTS OF A HIGHLY STYLIZED LETTER "C", COMPRISED OF THREE PARALLEL ARCS, APPEARING WITHIN AND EXTENDING BEYOND THE OUTSIDE OF A CIRCLE.

FOR BANKING SERVICES; FINANCING AND LOAN SERVICES; FINANCIAL TRUST OPERATIONS; INSURANCE AGENCIES; ACCOUNTS RECEIVABLES FINANCING; BILL PAYMENT SERVICES PROVIDED THROUGH A WEBSITE; ATM BANKING SERVICES; HOME BANKING SERVICES; ON-LINE BANKING SERVICES; AUTOMATED BANKING PROVIDED BY TELEPHONE; ELECTRONIC FUNDS TRANSFER; FINANCIAL AND BANKING SERVICES, NAMELY, THE OFFERING OF SAVINGS AND CHECKING ACCOUNTS, DEBIT CARDS, CREDIT CARDS, OVERDRAFT PROTECTION; ARRANGING OF CONSUMER LOANS, MORTGAGE LOANS, COMMERCIAL LOANS, AGRICULTURE LOANS, AUTO LOANS, HOME IMPROVEMENT LOANS, BOAT LOANS, RV LOANS, AND HOME EQUITY LOANS; INDIVIDUAL RETIREMENT ACCOUNT SERVICES; AND PROVIDING FINANCIAL AND BANKING-RELATED INFORMATION BY MEANS OF A GLOBAL COMPUTER NETWORK (U.S. CLS. 100, 101 AND 102).

FIRST USE 7-1-1993; IN COMMERCE 7-1-1993.

TEJBIR SINGH, EXAMINING ATTORNEY

CLASS 36—(Continued).

SN 77-716,523. HOMELOVERS, LLC, GLENDALE, AZ. FILED 4-17-2009.

HOME LOVERS

THE MARK CONSISTS OF STANDARD CHARACTERS WITHOUT CLAIM TO ANY PARTICULAR FONT, STYLE, SIZE, OR COLOR.

NO CLAIM IS MADE TO THE EXCLUSIVE RIGHT TO USE "HOME", APART FROM THE MARK AS SHOWN.

FOR REAL ESTATE BROKERAGE; REAL ESTATE MANAGEMENT (U.S. CLS. 100, 101 AND 102).

FIRST USE 7-17-2008; IN COMMERCE 7-17-2008.

YAT SYE, LEE, EXAMINING ATTORNEY

SN 77-716,552. MEDIA IMAGING COMPANY, INC, DBA LIVINGSEEKER, NORTH HOLLYWOOD, CA. FILED 4-17-2009.



THE COLOR(S) BLUE, LIGHT BLUE, PALE BLUE AND DARK BLUE IS/ARE CLAIMED AS A FEATURE OF THE MARK.

THE MARK CONSISTS OF DESIGN PLUS WORDS. THREE TRIANGLES, OVERLAPPING ARE AT THE UPPER LEFT OF THE MARK. BELOW THE TRIANGLES IS THE WORD "LIVING" IN UPPERCASE, STYLIZED FONT. CENTERED BELOW THE WORD "LIVING" IN STYLIZED SCRIPT FONT IS THE WORD "SEEKER" IN PROPER CASE. THE "S" AND "K" IN THE WORD "SEEKER" INTERTWINE WITH THE LETTERS "V" AND "N" IN THE WORD "LIVING". THE BLUE APPEARS ON THE FOREMOST TRIANGLE, AND THE WORD "LIVING". THE COLOR LIGHT BLUE APPEARS ON THE MIDDLE TRIANGLE, AND THE COLOR PALE BLUE APPEARS ON THE BACK TRIANGLE. THE COLOR DARK BLUE APPEARS ON THE WORD "SEEKER".

FOR PROVIDING INFORMATION IN THE FIELD OF REAL ESTATE VIA THE INTERNET WHICH ALLOWS USERS TO OBTAIN REAL ESTATE INFORMATION IN GEOGRAPHICAL AREAS USING AN INTERACTIVE MAP INTERFACE (U.S. CLS. 100, 101 AND 102).

FIRST USE 1-3-2007; IN COMMERCE 1-3-2007.

BRENDAN MCCAULEY, EXAMINING ATTORNEY

CLASS 36—(Continued).

SN 77-716,750. STATE FUND INSURANCE AGENCY, INC., BOSTON, MA. FILED 4-17-2009.



NO CLAIM IS MADE TO THE EXCLUSIVE RIGHT TO USE "STATE FUND INSURANCE", APART FROM THE MARK AS SHOWN.

THE COLOR(S) BLUE, GREEN AND GRAY IS/ARE CLAIMED AS A FEATURE OF THE MARK.

THE MARK CONSISTS OF A BLUE PARENT AND CHILD DESIGN UNDER A BLUE ROOF, ALL TO THE LEFT OF THE TERM "STATE FUND" IN BLUE ABOVE THE TERMS "INSURANCE" IN GREEN AND "FOR YOUR LIFE" IN GRAY.

FOR INSURANCE BROKERAGE SERVICES AND INVESTMENT BROKERAGE SERVICES (U.S. CLS. 100, 101 AND 102).

FIRST USE 11-1-1997; IN COMMERCE 11-1-1997.
TARA PATE, EXAMINING ATTORNEY

CLASS 36—(Continued).

SN 77-717,919. LIVE HOLDINGS LLC, RENO, NV. FILED 4-20-2009.

LIFE CARD

THE MARK CONSISTS OF STANDARD CHARACTERS WITHOUT CLAIM TO ANY PARTICULAR FONT, STYLE, SIZE, OR COLOR.

NO CLAIM IS MADE TO THE EXCLUSIVE RIGHT TO USE "CARD", APART FROM THE MARK AS SHOWN.

FOR MONEY TRANSFER SERVICES; CREDIT CARD AND DEBIT CARD SERVICES (U.S. CLS. 100, 101 AND 102).

ODESSA BIBBINS, EXAMINING ATTORNEY

SN 77-720,285. HORIZON FUNDS MANAGEMENT, LLC, ATLANTA, GA. FILED 4-23-2009.

Dividend Champions

THE MARK CONSISTS OF STANDARD CHARACTERS WITHOUT CLAIM TO ANY PARTICULAR FONT, STYLE, SIZE, OR COLOR.

NO CLAIM IS MADE TO THE EXCLUSIVE RIGHT TO USE "DIVIDEND", APART FROM THE MARK AS SHOWN.

FOR INVESTMENT OF FUNDS FOR OTHERS (U.S. CLS. 100, 101 AND 102).

SAIMA MAKHDOOM, EXAMINING ATTORNEY

SN 77-717,265. LITTON LOAN SERVICING LP, HOUSTON, TX. FILED 4-20-2009.

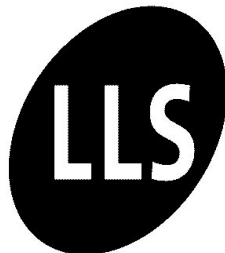

THE MARK CONSISTS OF AN OVAL ON A DIAGONAL WITH THE LETTERS "LLS" INSIDE THE OVAL FOR LOAN SERVICING SERVICES (U.S. CLS. 100, 101 AND 102).

FIRST USE 12-0-2005; IN COMMERCE 12-0-2005.
GRETTA YAO, EXAMINING ATTORNEY

SN 77-720,309. AFFINITY INSURANCE SERVICES, INC., CHICAGO, IL. FILED 4-23-2009.

CPA EMPLOYERGARD

THE MARK CONSISTS OF STANDARD CHARACTERS WITHOUT CLAIM TO ANY PARTICULAR FONT, STYLE, SIZE, OR COLOR.

OWNER OF U.S. REG. NO. 2,355,158.

NO CLAIM IS MADE TO THE EXCLUSIVE RIGHT TO USE "CPA", APART FROM THE MARK AS SHOWN.

FOR CLAIMS ADMINISTRATION AND BROKERAGE OF EMPLOYMENT PRACTICES LIABILITY INSURANCE FOR CERTIFIED PUBLIC ACCOUNTANTS (U.S. CLS. 100, 101 AND 102).

FIRST USE 1-18-1999; IN COMMERCE 1-18-1999.
SAIMA MAKHDOOM, EXAMINING ATTORNEY

CLASS 36—(Continued).

SN 77-720,600. RCG CAPITAL CORP., SAN DIEGO, CA.
FILED 4-23-2009.

Freedom Asset Manager

THE MARK CONSISTS OF STANDARD CHARACTERS WITHOUT CLAIM TO ANY PARTICULAR FONT, STYLE, SIZE, OR COLOR.

NO CLAIM IS MADE TO THE EXCLUSIVE RIGHT TO USE "ASSET MANAGER", APART FROM THE MARK AS SHOWN.

FOR FINANCIAL SERVICES, NAMELY, MORTGAGE PLANNING (U.S. CLS. 100, 101 AND 102).

FIRST USE 6-1-2008; IN COMMERCE 6-1-2008.
EDWARD NELSON, EXAMINING ATTORNEY

CLASS 36—(Continued).

SN 77-721,464. OLD NATIONAL BANCORP, EVANSVILLE, IN. FILED 4-24-2009.

OLD NATIONAL INSURANCE

THE MARK CONSISTS OF STANDARD CHARACTERS WITHOUT CLAIM TO ANY PARTICULAR FONT, STYLE, SIZE, OR COLOR.

OWNER OF U.S. REG. NOS. 1,287,233, 3,526,791 AND OTHERS.

NO CLAIM IS MADE TO THE EXCLUSIVE RIGHT TO USE "INSURANCE", APART FROM THE MARK AS SHOWN.

FOR INSURANCE AGENCY SERVICES (U.S. CLS. 100, 101 AND 102).

FIRST USE 10-1-2007; IN COMMERCE 10-1-2007.
JAMES LOVELACE, EXAMINING ATTORNEY

SN 77-720,796. SCOTT, LAURIAN LEE, FRANKLIN, TN.
FILED 4-23-2009.

A MIGHTY VOICE

THE MARK CONSISTS OF STANDARD CHARACTERS WITHOUT CLAIM TO ANY PARTICULAR FONT, STYLE, SIZE, OR COLOR.

FOR ORGANIZING AND CONDUCTING CHARITABLE FUNDRAISING EVENTS (U.S. CLS. 100, 101 AND 102).

FIRST USE 5-31-2008; IN COMMERCE 5-31-2008.
ELIZABETH HUGHITT, EXAMINING ATTORNEY

SN 77-721,466. OCEAN CITY HOME BANK, OCEAN CITY, NJ. FILED 4-24-2009.

The Bank People Trust

THE MARK CONSISTS OF STANDARD CHARACTERS WITHOUT CLAIM TO ANY PARTICULAR FONT, STYLE, SIZE, OR COLOR.

FOR ATM BANKING SERVICES; BANKING; BANKING AND FINANCING SERVICES; BANKING SERVICES (U.S. CLS. 100, 101 AND 102).

FIRST USE 10-10-2008; IN COMMERCE 10-10-2008.
BRIAN PINO, EXAMINING ATTORNEY

SN 77-721,047. TRILANTIC CAPITAL MANAGEMENT LLC, NEW YORK, NY. FILED 4-23-2009.

TRILANTIC CAPITAL PARTNERS

THE MARK CONSISTS OF STANDARD CHARACTERS WITHOUT CLAIM TO ANY PARTICULAR FONT, STYLE, SIZE, OR COLOR.

NO CLAIM IS MADE TO THE EXCLUSIVE RIGHT TO USE "CAPITAL PARTNERS", APART FROM THE MARK AS SHOWN.

FOR FINANCIAL SERVICES, NAMELY, CAPITAL INVESTMENT SERVICES; EQUITY CAPITAL INVESTMENT; FUNDS INVESTMENT; FINANCIAL AND INVESTMENT MANAGEMENT AND ADVISORY SERVICES; INVESTMENT OF FUNDS FOR OTHERS; MERCHANT BANKING; INVESTMENT BANKING SERVICES; PRIVATE EQUITY FUND INVESTMENT SERVICES; LEVERAGED BUY OUTS AND INVESTMENTS IN FINANCIALLY DISTRESSED OR UNDERPERFORMING COMPANIES (U.S. CLS. 100, 101 AND 102).

CHARLES L. JENKINS, EXAMINING ATTORNEY

SN 77-721,839. ARIZONA GRAND RESORT, LLC, PHOENIX, AZ. FILED 4-24-2009.



OWNER OF U.S. REG. NOS. 3,645,731 AND 3,645,733.
NO CLAIM IS MADE TO THE EXCLUSIVE RIGHT TO USE "ARIZONA" AND "VILLAS", APART FROM THE MARK AS SHOWN.

THE COLOR(S) BLUE, ORANGE AND GREEN IS/ARE CLAIMED AS A FEATURE OF THE MARK.

THE MARK CONSISTS OF THREE PALM TREES OVER THE WORDING "ARIZONA GRAND VILLAS". THE WORDING "ARIZONA GRAND VILLAS" AND THE LEFT PALM TREE ARE BLUE. THE MIDDLE PALM TREE IS ORANGE. THE RIGHT PALM TREE IS GREEN.

FOR REAL ESTATE SERVICES, NAMELY, LISTING, LEASING, BROKERAGE, AND MANAGEMENT OF RESIDENTIAL UNITS, VACATION CONDOMINIUMS, APARTMENTS, AND SHORT-TERM FURNISHED APARTMENTS (U.S. CLS. 100, 101 AND 102).

FIRST USE 11-1-2007; IN COMMERCE 11-1-2007.
CURTIS FRENCH, EXAMINING ATTORNEY

CLASS 36—(Continued).

SN 77-722,200. TORRELLO, LINDA M. TORRELLO, JOSEPH M., DBA FUNDRAISING CORNER, SAN JOSE, CA. FILED 4-24-2009.

FUNDRAISING CORNER

THE MARK CONSISTS OF STANDARD CHARACTERS WITHOUT CLAIM TO ANY PARTICULAR FONT, STYLE, SIZE, OR COLOR.

NO CLAIM IS MADE TO THE EXCLUSIVE RIGHT TO USE "FUNDRAISING", APART FROM THE MARK AS SHOWN.

FOR FUNDRAISING CONSULTATION FOR SCHOOLS AND CIVIC ORGANIZATIONS, NAMELY, PROVIDING CONSULTATION TO STUDENTS AND MEMBERS ON HOW TO MENTOR OTHER PARTICIPATING STUDENTS AND MEMBERS IN HOW TO FUNDRAISE; FUNDRAISING SERVICES BY MEANS OF SUPPLYING MERCHANDISE TO SCHOOLS AND CIVIC ORGANIZATIONS IN CONNECTION WITH FUNDRAISING CAMPAIGNS, NAMELY, PROVIDING SCHOOLS AND CIVIC ORGANIZATIONS WITH MERCHANDISE ORDER FORMS, TAKING ORDERS FOR MERCHANDISE FROM STUDENTS OF SCHOOLS AND MEMBERS OF CIVIC ORGANIZATIONS, AND DELIVERING ORDERED MERCHANDISE TO THE SCHOOLS AND THEIR STUDENTS AND TO CIVIC ORGANIZATIONS AND THEIR MEMBERS (U.S. CLS. 100, 101 AND 102).

JOHN KELLY, EXAMINING ATTORNEY

SN 77-722,500. ALYSSA, PAZDAN H, BARRINGTON, IL. FILED 4-26-2009.

Kids Feeding Kids

THE MARK CONSISTS OF STANDARD CHARACTERS WITHOUT CLAIM TO ANY PARTICULAR FONT, STYLE, SIZE, OR COLOR.

FOR CHARITABLE FUNDRAISING SERVICES (U.S. CLS. 100, 101 AND 102).

PATRICIA EVANKO, EXAMINING ATTORNEY

SN 77-722,766. GENERAL MILLS, INC, MINNEAPOLIS, MN. FILED 4-27-2009.

SHOW YOUR HELPING HAND

THE MARK CONSISTS OF STANDARD CHARACTERS WITHOUT CLAIM TO ANY PARTICULAR FONT, STYLE, SIZE, OR COLOR.

OWNER OF U.S. REG. NO. 1,918,186.

FOR CHARITABLE FUND RAISING (U.S. CLS. 100, 101 AND 102).

JEFF DEFORD, EXAMINING ATTORNEY

CLASS 36—(Continued).

SN 77-722,807. DREAMS TO REALTY, LLC, AUSTIN, TX. FILED S.R. 4-27-2009; AM. P.R. 7-23-2009.



NO CLAIM IS MADE TO THE EXCLUSIVE RIGHT TO USE "REALTY", APART FROM THE MARK AS SHOWN.

THE MARK CONSISTS OF THE WORDS "DREAMS TO REALTY" AND A DESIGN DEPICTING A HOUSE AND AN OUTLINE OF A HOUSE AMIDST CLOUDS.

FOR REAL ESTATE AGENCIES; REAL ESTATE BROKERAGE; REAL ESTATE INVESTMENT SERVICES IN THE NATURE OF PURCHASING AND SELLING OF REAL ESTATE FOR OTHERS; REAL ESTATE LISTING; REAL ESTATE LISTING SERVICES FOR THE HOUSING RENTALS AND APARTMENT RENTALS (U.S. CLS. 100, 101 AND 102).

FIRST USE 7-31-2001; IN COMMERCE 7-31-2001.

MARGERY A. TIERNEY, EXAMINING ATTORNEY

SN 77-722,909. NATIONAL COSMETOLOGY ASSOCIATION, INC., CHICAGO, IL. FILED 4-27-2009.

LEGENDS & ICONS

THE MARK CONSISTS OF STANDARD CHARACTERS WITHOUT CLAIM TO ANY PARTICULAR FONT, STYLE, SIZE, OR COLOR.

FOR CHARITABLE FUND RAISING SERVICES TO PROVIDE FINANCIAL ASSISTANCE (U.S. CLS. 100, 101 AND 102).

ALEX KEAM, EXAMINING ATTORNEY

CLASS 36—(Continued).

SN 77-722,971. AMERICAN FUNDS DISTRIBUTORS, INC., LOS ANGELES, CA. FILED 4-27-2009.

**American Funds Retirement
Roadmap**

THE MARK CONSISTS OF STANDARD CHARACTERS WITHOUT CLAIM TO ANY PARTICULAR FONT, STYLE, SIZE, OR COLOR.

OWNER OF U.S. REG. NOS. 3,264,149, 3,279,516 AND 3,563,152.

NO CLAIM IS MADE TO THE EXCLUSIVE RIGHT TO USE "RETIREMENT ROADMAP", APART FROM THE MARK AS SHOWN.

SEC. 2(F) AS TO "AMERICAN FUNDS".
FOR FINANCIAL SERVICES, NAMELY, FINANCIAL ANALYSIS, EVALUATION AND CONSULTATION; INVESTMENT MANAGEMENT AND ADVICE; MUTUAL FUND INVESTMENT MANAGEMENT AND DISTRIBUTION; ANNUITY SERVICES, NAMELY, INVESTMENT MANAGEMENT AND DISTRIBUTION OF VARIABLE ANNUITIES; FIDUCIARY SERVICES, NAMELY, SERVING AS TRUSTEE FOR DIRECTED AND DISCRETIONARY TRUST ACCOUNTS; ESTATE PLANNING; AND ADMINISTRATION OF EMPLOYEE BENEFIT, PENSION AND RETIREMENT PLANS IN CONNECTION WITH THE AFOREMENTIONED SERVICES (U.S. CLS. 100, 101 AND 102).

FIRST USE 4-24-2009; IN COMMERCE 4-24-2009.
HELENE LIWINSKI, EXAMINING ATTORNEY

SN 77-723,632. BAY CITIES BANK, TAMPA, FL. FILED 4-28-2009.

**When Your Business
Outgrows the Large Bank**

THE MARK CONSISTS OF STANDARD CHARACTERS WITHOUT CLAIM TO ANY PARTICULAR FONT, STYLE, SIZE, OR COLOR.

NO CLAIM IS MADE TO THE EXCLUSIVE RIGHT TO USE "BANK", APART FROM THE MARK AS SHOWN.

FOR ATM BANKING SERVICES; BANKING AND FINANCING SERVICES; CHECKING ACCOUNT SERVICES; COMMERCIAL LENDING SERVICES; CONSUMER LENDING SERVICES; ELECTRONIC BANKING VIA A GLOBAL COMPUTER NETWORK; LOAN FINANCING; ON-LINE BANKING SERVICES; SAVINGS ACCOUNT SERVICES (U.S. CLS. 100, 101 AND 102).

KAREN BRACEY, EXAMINING ATTORNEY

CLASS 36—(Continued).

SN 77-723,688. SHAW REAL ESTATE SERVICES LLC, MT. PLEASANT, SC. FILED 4-28-2009.

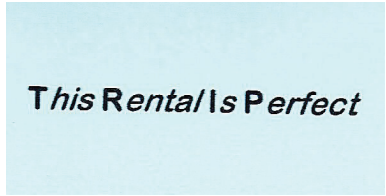

THE COLOR(S) BLUE, BLACK IS/ARE CLAIMED AS A FEATURE OF THE MARK.

THE MARK CONSISTS OF A BLUE RECTANGLE WITH BLACK LETTERING THAT HAS THE FIRST LETTER OF EACH SEPARATE WORD CAPITALIZED FOLLOWED BY ITALICIZED LOWER-CASE LETTERS.

FOR REAL ESTATE SERVICES, NAMELY, RENTAL OF VACATION HOMES, CONDOMINIUMS, CABINS, AND VILLAS USING PAY PER CLICK ADVERTISING ON A GLOBAL COMPUTER NETWORK; REAL ESTATE SERVICES, NAMELY, VACATION HOME RENTAL MANAGEMENT SERVICES (U.S. CLS. 100, 101 AND 102).
MARC LEIPZIG, EXAMINING ATTORNEY

SN 77-723,758. AMERICAN FINANCIAL & AUTOMOTIVE SERVICES, INC., THE WOODLANDS, TX. FILED 4-28-2009.



THE MARK CONSISTS OF THREE SWOOSH MARKS SUGGESTING A ROUNDED TRIANGLE.

FOR INSURANCE AGENCY AND BROKERAGE (U.S. CLS. 100, 101 AND 102).

FIRST USE 11-17-2008; IN COMMERCE 11-17-2008.
KRISTINA MORRIS, EXAMINING ATTORNEY

CLASS 36—(Continued).

SN 77-723,880. GTE FEDERAL CREDIT UNION, TAMPA, FL. FILED 4-28-2009.

U22

THE MARK CONSISTS OF STANDARD CHARACTERS WITHOUT CLAIM TO ANY PARTICULAR FONT, STYLE, SIZE, OR COLOR.

FOR CREDIT UNION SERVICES, NAMELY, CHECKING ACCOUNT, SAVING ACCOUNT, DEBIT CARD, AND CREDIT CARD SERVICES (U.S. CLS. 100, 101 AND 102).

BARBARA RUTLAND, EXAMINING ATTORNEY

SN 77-723,885. CLEARVIEW CORRESPONDENT SERVICES, LLC, RICHMOND, VA. FILED 4-28-2009.

FP&S EMPOWER

THE MARK CONSISTS OF STANDARD CHARACTERS WITHOUT CLAIM TO ANY PARTICULAR FONT, STYLE, SIZE, OR COLOR.

FOR FINANCIAL SERVICES, NAMELY, PROVIDING INFORMATION AND ADVICE TO ALIGN PERSONAL FINANCIAL STRATEGIES AND PLANNING WITH LIFE GOALS, FINANCIAL PLANNING, FINANCIAL FORECASTING, PERSONAL FINANCIAL SITUATION ASSESSMENT AND EVALUATION, AND IMPLEMENTING AND MONITORING FINANCIAL PLANNING STRATEGIES TO ACHIEVE LIFE GOALS (U.S. CLS. 100, 101 AND 102).

BARBARA RUTLAND, EXAMINING ATTORNEY

SN 77-724,053. CROSSCUT VENTURES MANAGEMENT, LLC, DBA CROSSCUT VENTURES, MANHATTAN BEACH, CA. FILED 4-28-2009.

CROSSCUT

THE MARK CONSISTS OF STANDARD CHARACTERS WITHOUT CLAIM TO ANY PARTICULAR FONT, STYLE, SIZE, OR COLOR.

FOR VENTURE CAPITAL SERVICES, NAMELY, PROVIDING FINANCING TO EMERGING AND START-UP COMPANIES (U.S. CLS. 100, 101 AND 102).

FIRST USE 6-15-2008; IN COMMERCE 6-15-2008. MICHAEL SOUDERS, EXAMINING ATTORNEY

CLASS 36—(Continued).

SN 77-724,059. DENALI CAPITAL LLC, OAK BROOK, IL. FILED 4-28-2009.

DENALI CAPITAL

THE MARK CONSISTS OF STANDARD CHARACTERS WITHOUT CLAIM TO ANY PARTICULAR FONT, STYLE, SIZE, OR COLOR.

NO CLAIM IS MADE TO THE EXCLUSIVE RIGHT TO USE "CAPITAL", APART FROM THE MARK AS SHOWN.

THE ENGLISH TRANSLATION OF "DENALI" IN THE MARK IS THE GREAT ONE.

FOR FINANCIAL INVESTMENT MANAGEMENT SERVICES, NAMELY, MANAGEMENT OF SPECIALIZED ASSET PORTFOLIOS (U.S. CLS. 100, 101 AND 102).

FIRST USE 4-1-2001; IN COMMERCE 10-1-2001. CHRISTINA SOBRAL, EXAMINING ATTORNEY

SN 77-724,079. NORTH AMERICAN INSURANCE AGENCY, INC., OKLAHOMA CITY, OK. FILED 4-28-2009.

INSURICA.COM

THE MARK CONSISTS OF STANDARD CHARACTERS WITHOUT CLAIM TO ANY PARTICULAR FONT, STYLE, SIZE, OR COLOR.

FOR INSURANCE SERVICES, NAMELY, UNDERWRITING PROPERTY AND CASUALTY, LIFE AND HEALTH INSURANCE AND ADMINISTRATION OF EMPLOYEE BENEFIT PLANS CONCERNING INSURANCE AND FINANCE (U.S. CLS. 100, 101 AND 102).

KATHERINE CONNOLLY, EXAMINING ATTORNEY

SN 77-724,110. SOUTHERN COMMUNITY BANK AND TRUST, WINSTON-SALEM, NC. FILED 4-28-2009.

READY SAVER

THE MARK CONSISTS OF STANDARD CHARACTERS WITHOUT CLAIM TO ANY PARTICULAR FONT, STYLE, SIZE, OR COLOR.

FOR ONLINE BANKING SERVICES (U.S. CLS. 100, 101 AND 102).

KRISTIN DAHLING, EXAMINING ATTORNEY

CLASS 36—(Continued).

SN 77-724,179. JACKSON NATIONAL LIFE INSURANCE COMPANY, LANSING, MI. FILED 4-28-2009.

LIFEGUARD FREEDOM 6

THE MARK CONSISTS OF STANDARD CHARACTERS WITHOUT CLAIM TO ANY PARTICULAR FONT, STYLE, SIZE, OR COLOR.

OWNER OF U.S. REG. NOS. 3,083,645 AND 3,086,409. FOR ANNUITY UNDERWRITING SERVICES, NAMELY, A GUARANTEED MINIMUM WITHDRAWAL BENEFIT THAT CAN BE ELECTED IN CONJUNCTION WITH AN ANNUITY (U.S. CLS. 100, 101 AND 102). EMILY CARLSEN, EXAMINING ATTORNEY

SN 77-724,199. SOX, ALECIA DIANE, RICHMOND, VA. FILED 4-28-2009.

SHOW CANCER WHO'S BOSS

THE MARK CONSISTS OF STANDARD CHARACTERS WITHOUT CLAIM TO ANY PARTICULAR FONT, STYLE, SIZE, OR COLOR.

FOR CHARITABLE FUNDRAISING SERVICES (U.S. CLS. 100, 101 AND 102). FIRST USE 3-28-2009; IN COMMERCE 3-28-2009. NATALIE POLZER, EXAMINING ATTORNEY

SN 77-724,205. NORTH AMERICAN INSURANCE AGENCY, INC., OKLAHOMA CITY, OK. FILED 4-28-2009.

SIRPRO

THE MARK CONSISTS OF STANDARD CHARACTERS WITHOUT CLAIM TO ANY PARTICULAR FONT, STYLE, SIZE, OR COLOR.

FOR INSURANCE SERVICES, NAMELY, UNDERWRITING PROPERTY AND CASUALTY INSURANCE AND ADMINISTRATION OF EMPLOYEE BENEFIT PLANS CONCERNING INSURANCE AND FINANCE (U.S. CLS. 100, 101 AND 102). KATHERINE CONNOLLY, EXAMINING ATTORNEY

CLASS 36—(Continued).

SN 77-724,338. UNITED STATES FIRE INSURANCE COMPANY, MORRISTOWN, NJ. FILED 4-28-2009.

SUITE 16

THE MARK CONSISTS OF STANDARD CHARACTERS WITHOUT CLAIM TO ANY PARTICULAR FONT, STYLE, SIZE, OR COLOR.

FOR INSURANCE SERVICES, NAMELY, UNDERWRITING INSURANCE COVERAGE IN THE FIELDS OF EMPLOYMENT PRACTICES LIABILITY AND DIRECTOR AND OFFICER LIABILITY (U.S. CLS. 100, 101 AND 102).

FIRST USE 2-2-2009; IN COMMERCE 2-2-2009. VIVIAN MICZNIK FIRST, EXAMINING ATTORNEY

SN 77-724,426. NEXTAID, INC., LOS ANGELES, CA. FILED 4-28-2009.

NEXTAID

THE MARK CONSISTS OF STANDARD CHARACTERS WITHOUT CLAIM TO ANY PARTICULAR FONT, STYLE, SIZE, OR COLOR.

FOR CHARITABLE FUND RAISING SERVICES; PROVIDING FUNDING AND GRANTS FOR COMMUNITY-DRIVEN, ENVIRONMENTALLY SUSTAINABLE, ECONOMICALLY AND SOCIALLY EMPOWERING SOLUTIONS TO THE AIDS ORPHAN PANDEMIC; CHARITABLE FUND RAISING SERVICES BY MEANS OF ORGANIZING AND PROMOTING CHARITY CONCERTS; PROVIDING INDIVIDUALS WITH THE INFORMATION AND OPPORTUNITY TO MAKE MONETARY DONATIONS TO THEIR FAVORITE CHARITY (U.S. CLS. 100, 101 AND 102).

FIRST USE 3-26-2002; IN COMMERCE 3-26-2002. CHRISTOPHER BUONGIORNO, EXAMINING ATTORNEY

CLASS 36—(Continued).

SN 77-724,430. NEXTAID, INC., LOS ANGELES, CA. FILED 4-28-2009.



THE MARK CONSISTS OF TWO FIGURES INSIDE A CIRCLE.

FOR CHARITABLE FUND RAISING SERVICES; PROVIDING FUNDING AND GRANTS FOR COMMUNITY-DRIVEN, ENVIRONMENTALLY SUSTAINABLE, ECONOMICALLY AND SOCIALLY EMPOWERING SOLUTIONS TO THE AIDS ORPHAN PANDEMIC; CHARITABLE FUND RAISING SERVICES BY MEANS OF ORGANIZING AND PROMOTING CHARITY CONCERTS; PROVIDING INDIVIDUALS WITH THE INFORMATION AND OPPORTUNITY TO MAKE MONETARY DONATIONS TO THEIR FAVORITE CHARITY (U.S. CLS. 100, 101 AND 102).

FIRST USE 10-8-2003; IN COMMERCE 10-8-2003.
CHRISTOPHER BUONGIORNO, EXAMINING ATTORNEY

CLASS 36—(Continued).

SN 77-724,434. NEXTAID, INC., LOS ANGELES, CA. FILED 4-28-2009.

BEATS BUILD HOPE

THE MARK CONSISTS OF STANDARD CHARACTERS WITHOUT CLAIM TO ANY PARTICULAR FONT, STYLE, SIZE, OR COLOR.

FOR CHARITABLE FUND RAISING SERVICES; PROVIDING FUNDING AND GRANTS FOR COMMUNITY-DRIVEN, ENVIRONMENTALLY SUSTAINABLE, ECONOMICALLY AND SOCIALLY EMPOWERING SOLUTIONS TO THE AIDS ORPHAN PANDEMIC; CHARITABLE FUND RAISING SERVICES BY MEANS OF ORGANIZING AND PROMOTING CHARITY CONCERTS; PROVIDING INDIVIDUALS WITH THE INFORMATION AND OPPORTUNITY TO MAKE MONETARY DONATIONS TO THEIR FAVORITE CHARITY (U.S. CLS. 100, 101 AND 102).

FIRST USE 2-23-2006; IN COMMERCE 2-23-2006.
CHRISTOPHER BUONGIORNO, EXAMINING ATTORNEY

SN 77-724,433. NEXTAID, INC., LOS ANGELES, CA. FILED 4-28-2009.



THE MARK CONSISTS OF IMAGE OF AFRICA WITH THE PROFILE OF A CHILD'S FACE ON THE LEFT SIDE.

FOR CHARITABLE FUND RAISING SERVICES; PROVIDING FUNDING AND GRANTS FOR COMMUNITY-DRIVEN, ENVIRONMENTALLY SUSTAINABLE, ECONOMICALLY AND SOCIALLY EMPOWERING SOLUTIONS TO THE AIDS ORPHAN PANDEMIC; CHARITABLE FUND RAISING SERVICES BY MEANS OF ORGANIZING AND PROMOTING CHARITY CONCERTS; PROVIDING INDIVIDUALS WITH THE INFORMATION AND OPPORTUNITY TO MAKE MONETARY DONATIONS TO THEIR FAVORITE CHARITY (U.S. CLS. 100, 101 AND 102).

FIRST USE 2-23-2006; IN COMMERCE 2-23-2006.
CHRISTOPHER BUONGIORNO, EXAMINING ATTORNEY

SN 77-724,679. RADIO SYSTEMS CORPORATION, KNOXVILLE, TN. FILED 4-29-2009.



OWNER OF U.S. REG. NOS. 3,167,345 AND 3,319,500.
NO CLAIM IS MADE TO THE EXCLUSIVE RIGHT TO USE "BRAND CONSERVATION FUND", APART FROM THE MARK AS SHOWN.

THE MARK CONSISTS OF AN OUTLINE OF A SHIELD SHAPE HAVING A PARTIAL OVAL UPPER PORTION, THE UPPER PORTION HAVING A PARTIAL OVAL PLACED THEREIN SURROUNDING AN OUTLINE OF AN UPPER PORTION OF A MAN WEARING A CAP AND HOLDING A SHOTGUN WITH THE WORDS "SPORTDOG BRAND" APPEARING BELOW THE MAN AND SHOTGUN, A BANNER APPEARING ACROSS THE SHIELD SHAPE WITH THE WORDS "CONSERVATION FUND" APPEARING THEREIN, AND AN OUTLINE OF TWO BIRDS APPEARING BELOW THE BANNER.

FOR PROVIDING PROJECT GRANTS FOR ENVIRONMENTAL AWARENESS, ENVIRONMENTAL CLEANUP, WILDLIFE MAINTENANCE, WILDLIFE DEVELOPMENT, AND WILDLIFE AWARENESS PROJECTS (U.S. CLS. 100, 101 AND 102).

FIRST USE 3-17-2008; IN COMMERCE 3-17-2008.
NAAKWAMA ANKRAH, EXAMINING ATTORNEY

CLASS 36—(Continued).

SN 77-724,726. PLAYPUMPS INTERNATIONAL, INC., WASHINGTON, DC. FILED 4-29-2009.

PLAYPUMPS INTERNATIONAL

THE MARK CONSISTS OF STANDARD CHARACTERS WITHOUT CLAIM TO ANY PARTICULAR FONT, STYLE, SIZE, OR COLOR.

NO CLAIM IS MADE TO THE EXCLUSIVE RIGHT TO USE "INTERNATIONAL", APART FROM THE MARK AS SHOWN.

FOR CHARITABLE FUNDRAISING SERVICES (U.S. CLS. 100, 101 AND 102).

FIRST USE 4-4-2006; IN COMMERCE 4-4-2006.
B. PARADEWELAI, EXAMINING ATTORNEY

SN 77-724,727. PLAYPUMPS INTERNATIONAL, INC., WASHINGTON, DC. FILED 4-29-2009.

PLAYPUMPS

THE MARK CONSISTS OF STANDARD CHARACTERS WITHOUT CLAIM TO ANY PARTICULAR FONT, STYLE, SIZE, OR COLOR.

FOR CHARITABLE FUNDRAISING SERVICES (U.S. CLS. 100, 101 AND 102).

FIRST USE 4-4-2006; IN COMMERCE 4-4-2006.
B. PARADEWELAI, EXAMINING ATTORNEY

SN 77-724,755. MERSCORP, INC., RESTON, VA. FILED 4-29-2009.

Process loans, not
paperwork.

THE MARK CONSISTS OF STANDARD CHARACTERS WITHOUT CLAIM TO ANY PARTICULAR FONT, STYLE, SIZE, OR COLOR.

FOR REAL ESTATE DATABASE SERVICES, NAMELY, PROVIDING AND MAINTAINING A REGISTRY OF THE TRANSFER OF MORTGAGE SERVICING RIGHTS, MORTGAGE OWNERSHIP, SECURITY INTERESTS IN MORTGAGES AND THE RELEASE OF MORTGAGES FOR USE BY THOSE IN THE MORTGAGE BANKING INDUSTRY (U.S. CLS. 100, 101 AND 102).

FIRST USE 1-10-2002; IN COMMERCE 1-10-2002.
GINA HAYES, EXAMINING ATTORNEY

CLASS 36—(Continued).

SN 77-724,892. NATIONAL PARK TRUST INC., ROCKVILLE, MD. FILED 4-29-2009.

WHERE'S BUDDY BISON BEEN?

THE MARK CONSISTS OF STANDARD CHARACTERS WITHOUT CLAIM TO ANY PARTICULAR FONT, STYLE, SIZE, OR COLOR.

FOR CHARITABLE FUNDRAISING SERVICES (U.S. CLS. 100, 101 AND 102).

FIRST USE 9-0-2008; IN COMMERCE 9-0-2008.
JAMES STEIN, EXAMINING ATTORNEY

SN 77-724,974. U.S. BANK, N.A., MINNEAPOLIS, MN. FILED 4-29-2009.



OWNER OF U.S. REG. NOS. 2,258,556, 2,268,771 AND OTHERS.

THE MARK CONSISTS OF A PAPER AIRPLANE WITH "US" ON ITS WINGS.

SEC. 2(F) AS TO "US".
FOR BANKING AND RELATED FINANCIAL SERVICES (U.S. CLS. 100, 101 AND 102).

FIRST USE 8-1-2008; IN COMMERCE 8-1-2008.
MAYUR VAGHANI, EXAMINING ATTORNEY

SN 77-725,065. WORLD HOPE INTERNATIONAL, INC., ALEXANDRIA, VA. FILED 4-29-2009.

ADELPHE AN INTERNATIONAL
COMMUNITY OF SISTERS

THE MARK CONSISTS OF STANDARD CHARACTERS WITHOUT CLAIM TO ANY PARTICULAR FONT, STYLE, SIZE, OR COLOR.

NO CLAIM IS MADE TO THE EXCLUSIVE RIGHT TO USE "INTERNATIONAL COMMUNITY", APART FROM THE MARK AS SHOWN.

FOR CHARITABLE FUND RAISING SERVICES (U.S. CLS. 100, 101 AND 102).

DAVID H. STINE, EXAMINING ATTORNEY

CLASS 36—(Continued).

SN 77-725,200. BIDCATION, L.L.C., ATLANTA, GA. FILED 4-29-2009.

Bidcation

THE MARK CONSISTS OF STANDARD CHARACTERS WITHOUT CLAIM TO ANY PARTICULAR FONT, STYLE, SIZE, OR COLOR.

FOR REAL ESTATE LISTING SERVICES FOR THE HOUSING RENTALS AND APARTMENT RENTALS; REAL ESTATE SERVICE, NAMELY, RENTAL PROPERTY MANAGEMENT; REAL ESTATE SERVICES, NAMELY, RENTAL OF VACATION HOMES; REAL ESTATE SERVICES, NAMELY, RENTAL OF VACATION HOMES, CONDOMINIUMS, CABINS, AND VILLAS USING PAY PER CLICK ADVERTISING ON A GLOBAL COMPUTER NETWORK; REAL ESTATE SERVICES, NAMELY, VACATION HOME RENTAL MANAGEMENT SERVICES (U.S. CLS. 100, 101 AND 102).

FIRST USE 3-16-2009; IN COMMERCE 4-17-2009.
DAVID C. REIHNER, EXAMINING ATTORNEY

CLASS 36—(Continued).

SN 77-725,462. INSURANCE SERVICES OFFICE, INC., JERSEY CITY, NJ. FILED 4-29-2009.

PROMETRIX

THE MARK CONSISTS OF STANDARD CHARACTERS WITHOUT CLAIM TO ANY PARTICULAR FONT, STYLE, SIZE, OR COLOR.

FOR PROVIDING INSURANCE UNDERWRITING AND INSURANCE RATING DATA VIA AN ONLINE DATABASE AVAILABLE ON THE INTERNET (U.S. CLS. 100, 101 AND 102).

DAVID H. STINE, EXAMINING ATTORNEY

SN 77-725,482. GEORGE, DAVID, HOUSTON, TX. FILED 4-29-2009.

PLAN YOUR LAYOFF

THE MARK CONSISTS OF STANDARD CHARACTERS WITHOUT CLAIM TO ANY PARTICULAR FONT, STYLE, SIZE, OR COLOR.

FOR FINANCIAL SERVICES, NAMELY, FINANCIAL ADVICE AND CONSULTANCY SERVICES, DEBT MANAGEMENT CONSULTATION AND COUNSELING SERVICES, CREDIT REPAIR AND RESTORATION (U.S. CLS. 100, 101 AND 102).

NAAKWAMA ANKRAH, EXAMINING ATTORNEY

SN 77-725,345. FSD INTERNATIONAL, INC., ATLANTA, GA. FILED 4-29-2009.



OWNER OF U.S. REG. NO. 3,650,866.
THE COLOR(S) BLUE AND WHITE IS/ARE CLAIMED AS A FEATURE OF THE MARK.

THE MARK CONSISTS OF A BLUE-COLORED DIAMOND HAVING THREE SHADES OF BLUE WITH THE LETTERS "F","S","D" WRITTEN IN A RAISED FONT IN THE CENTER OF THE DIAMOND AND THE LETTERS "F","S","D" ARE IN THE COLOR WHITE.

FOR BROKERAGE OF FOOD PRODUCTS TO RETAIL MERCHANTS AND FOOD SERVICE INDUSTRY (U.S. CLS. 100, 101 AND 102).

FIRST USE 7-31-2005; IN COMMERCE 7-31-2005.
KATHLEEN LORENZO, EXAMINING ATTORNEY

SN 77-725,599. WIDEBRIDGE GROUP LLC, NEW YORK, NY. FILED 4-29-2009.

WIDEBRIDGE

THE MARK CONSISTS OF STANDARD CHARACTERS WITHOUT CLAIM TO ANY PARTICULAR FONT, STYLE, SIZE, OR COLOR.

FOR INVESTMENT BANK (U.S. CLS. 100, 101 AND 102).

DORITT L. CARROLL, EXAMINING ATTORNEY

CLASS 36—(Continued).

SN 77-725,628. DEUTERONOMY 8:18, COSTA MESA, CA. FILED 4-30-2009.



THE COLOR(S) DARK BLUE, LIGHT BLUE GRAY AND WHITE IS/ARE CLAIMED AS A FEATURE OF THE MARK.

THE MARK CONSISTS OF THE A DARK BLUE CIRCLE CONTAINING THE WORDING "DEUTERONOMY 8:18" IN DARK BLUE ALONG THE UPPER PORTION OF THE CIRCLE AND HAVING TWO DARK BLUE LINES ALONG THE BOTTOM OF THE CIRCLE; IN THE MIDDLE OF THE CIRCLE IS A GLOBE DESIGN IN DARK BLUE HAVING A DIAMOND DESIGN OUTLINED IN THE COLOR GRAY WITH LIGHT BLUE RAYS OF LIGHT EMANATING FROM THE DIAMOND; AN OPEN BOOK APPEARS BELOW THE DIAMOND HAVING A DARK BLUE COVER AND GRAY PAGES; THE DESIGN HAS A WHITE BACKGROUND.

FOR FINANCIAL ASSET MANAGEMENT; INVESTMENT MANAGEMENT; INVESTMENT MANAGEMENT SERVICES IN THE FIELD OF ACQUIRING JOINT VENTURES; INVESTMENT SERVICES, NAMELY, ASSET ACQUISITION, CONSULTATION, DEVELOPMENT AND MANAGEMENT SERVICES; LAND ACQUISITION SERVICES; REAL ESTATE ACQUISITION SERVICES; REAL ESTATE INVESTMENT; REAL ESTATE SERVICES, NAMELY, RENTAL, BROKERAGE, LEASING AND MANAGEMENT OF COMMERCIAL PROPERTY, OFFICES AND OFFICE SPACE (U.S. CLS. 100, 101 AND 102).

DOMINIC FATHY, EXAMINING ATTORNEY

SN 77-726,036. STUDENT LOAN FINANCE CORPORATION, ABERDEEN, SD. FILED 4-30-2009.

THE BRIGHTEST AND BEST

THE MARK CONSISTS OF STANDARD CHARACTERS WITHOUT CLAIM TO ANY PARTICULAR FONT, STYLE, SIZE, OR COLOR.

FOR FINANCING FOR STUDENT LOANS AND STUDENT LOAN FOUNDATIONS, FINANCING FOR STUDENT EDUCATIONAL LOANS THROUGH AN ACADEMIC ACHIEVEMENT PROGRAM FOR TOP ACADEMIC PERFORMERS FROM LOCAL HIGH SCHOOL GRADUATING CLASSES (U.S. CLS. 100, 101 AND 102).

INGRID C. EULIN, EXAMINING ATTORNEY

CLASS 36—(Continued).

SN 77-726,043. AMERICAN INTERNATIONAL GROUP, INC., NEW YORK, NY. FILED 4-30-2009.

GLOBAL ACCESS FROM AIU HOLDINGS

THE MARK CONSISTS OF STANDARD CHARACTERS WITHOUT CLAIM TO ANY PARTICULAR FONT, STYLE, SIZE, OR COLOR.

OWNER OF U.S. REG. NOS. 598,896, 1,008,025 AND 3,471,828.

NO CLAIM IS MADE TO THE EXCLUSIVE RIGHT TO USE "GLOBAL" AND "HOLDINGS", APART FROM THE MARK AS SHOWN.

FOR INSURANCE UNDERWRITING IN THE FIELD OF ACCIDENT AND HEALTH (U.S. CLS. 100, 101 AND 102).

MARGARET POWER, EXAMINING ATTORNEY

SN 77-726,200. TAMALPAIS BANK, SAN RAFAEL, CA. FILED 4-30-2009.

Let's make your business stronger...together.

THE MARK CONSISTS OF STANDARD CHARACTERS WITHOUT CLAIM TO ANY PARTICULAR FONT, STYLE, SIZE, OR COLOR.

FOR BANKING SERVICES (U.S. CLS. 100, 101 AND 102).

MARLENE BELL, EXAMINING ATTORNEY

SN 77-726,244. MUTUAL OF OMAHA INSURANCE COMPANY, OMAHA, NE. FILED 4-30-2009.

PROUD SPONSOR OF LIFE'S AHA MOMENTS

THE MARK CONSISTS OF STANDARD CHARACTERS WITHOUT CLAIM TO ANY PARTICULAR FONT, STYLE, SIZE, OR COLOR.

FOR INSURANCE UNDERWRITING IN THE FIELD OF LIFE, HEALTH, DISABILITY, DENTAL, LONG-TERM CARE, MEDICARE SUPPLEMENT, CRITICAL ILLNESS, ACCIDENTAL DEATH AND DISMEMBERMENT, AND HOSPITAL INCOME INSURANCE; ANNUITY UNDERWRITING; FINANCIAL ADMINISTRATION OF RETIREMENT PLANS; MUTUAL FUND INVESTMENT (U.S. CLS. 100, 101 AND 102).

SALLY SHIH, EXAMINING ATTORNEY

CLASS 36—(Continued).

SN 77-726,252. MUTUAL OF OMAHA INSURANCE COMPANY, OMAHA, NE. FILED 4-30-2009.

OFFICIAL SPONSOR OF LIFE'S
AHA MOMENTS

THE MARK CONSISTS OF STANDARD CHARACTERS WITHOUT CLAIM TO ANY PARTICULAR FONT, STYLE, SIZE, OR COLOR.

FOR INSURANCE UNDERWRITING IN THE FIELD OF LIFE, HEALTH, DISABILITY, DENTAL, LONG-TERM CARE, MEDICARE SUPPLEMENT, CRITICAL ILLNESS, ACCIDENTAL DEATH AND DISMEMBERMENT, AND HOSPITAL INCOME INSURANCE; ANNUITY UNDERWRITING; FINANCIAL ADMINISTRATION OF RETIREMENT PLANS; MUTUAL FUND INVESTMENT (U.S. CLS. 100, 101 AND 102).

SALLY SHIH, EXAMINING ATTORNEY

SN 77-726,256. TURNING POINT MINISTRIES INTERNATIONAL, HOUSTON, TX. FILED 4-30-2009.

Somebody Cares

THE MARK CONSISTS OF STANDARD CHARACTERS WITHOUT CLAIM TO ANY PARTICULAR FONT, STYLE, SIZE, OR COLOR.

OWNER OF U.S. REG. NO. 2,083,594.
FOR ACCEPTING AND ADMINISTERING MONETARY CHARITABLE CONTRIBUTIONS; CHARITABLE FUNDRAISING SERVICES (U.S. CLS. 100, 101 AND 102).
FIRST USE 6-1-1994; IN COMMERCE 6-1-1994.
SALLY SHIH, EXAMINING ATTORNEY

SN 77-726,355. SHARE OUR STRENGTH, WASHINGTON, DC. FILED 4-30-2009.

SHARE OUR STRENGTH'S
PLEDGE TO END CHILDHOOD
HUNGER

THE MARK CONSISTS OF STANDARD CHARACTERS WITHOUT CLAIM TO ANY PARTICULAR FONT, STYLE, SIZE, OR COLOR.

OWNER OF U.S. REG. NO. 1,894,313.
FOR CHARITABLE FUND RAISING ACTIVITIES (U.S. CLS. 100, 101 AND 102).
ALICE SUE CARRUTHERS, EXAMINING ATTORNEY

CLASS 36—(Continued).

SN 77-726,435. OCEANCONNECT BROKING INC, WHITE PLAINS, NY. FILED 4-30-2009.

MyEex

THE MARK CONSISTS OF STANDARD CHARACTERS WITHOUT CLAIM TO ANY PARTICULAR FONT, STYLE, SIZE, OR COLOR.

FOR BROKERAGE OF CARBON DIOXIDE AND OTHER GREENHOUSE GAS EMISSION CREDITS, ALLOWANCES OR OFFSETS ON BEHALF OF OFFSET PRODUCERS (U.S. CLS. 100, 101 AND 102).

FIRST USE 6-2-2008; IN COMMERCE 3-2-2009.
DAVID TOOLEY, EXAMINING ATTORNEY

SN 77-726,467. PURE REALTY, INC., BEVERLY HILLS, CA. FILED 4-30-2009.

Pure Realty

THE MARK CONSISTS OF STANDARD CHARACTERS WITHOUT CLAIM TO ANY PARTICULAR FONT, STYLE, SIZE, OR COLOR.

NO CLAIM IS MADE TO THE EXCLUSIVE RIGHT TO USE "REALTY", APART FROM THE MARK AS SHOWN.
FOR COMMERCIAL AND RESIDENTIAL REAL ESTATE AGENCY SERVICES; FINANCIAL INVESTMENT IN THE FIELD OF REAL ESTATE; PROVIDING REAL ESTATE LISTINGS AND REAL ESTATE INFORMATION VIA THE INTERNET; REAL ESTATE BROKERAGE; REAL ESTATE CONSULTANCY; REAL ESTATE INVESTMENT (U.S. CLS. 100, 101 AND 102).

FIRST USE 12-28-1994; IN COMMERCE 12-28-1994.
MEGHAN REINHART, EXAMINING ATTORNEY

SN 77-726,545. ELFMONT, DANIEL, TORRANCE, CA. FILED 4-30-2009.

The Appraisal Depot

THE MARK CONSISTS OF STANDARD CHARACTERS WITHOUT CLAIM TO ANY PARTICULAR FONT, STYLE, SIZE, OR COLOR.

NO CLAIM IS MADE TO THE EXCLUSIVE RIGHT TO USE "APPRAISAL", APART FROM THE MARK AS SHOWN.
FOR HOME APPRAISAL SERVICES (U.S. CLS. 100, 101 AND 102).

HELENE LIWINSKI, EXAMINING ATTORNEY

CLASS 36—(Continued).

SN 77-726,560. JOHNSON, LUCAS, SANTA BARBARA, CA. FILED 4-30-2009.

ECOVALUATOR

THE MARK CONSISTS OF STANDARD CHARACTERS WITHOUT CLAIM TO ANY PARTICULAR FONT, STYLE, SIZE, OR COLOR.
FOR INVESTMENT ADVISORY SERVICES (U.S. CLS. 100, 101 AND 102).
LEIGH CAROLINE CASE, EXAMINING ATTORNEY

SN 77-726,910. HYPAN INC., SOUTH SALEM, NY. FILED 5-1-2009.



THE MARK CONSISTS OF "SOS" IN UPPER-CASE LETTERS WITH THREE CURVED LINES CONTAINED WITHIN THE LETTER "O".
FOR REAL ESTATE CONSULTANCY (U.S. CLS. 100, 101 AND 102).
FIRST USE 6-17-2008; IN COMMERCE 6-17-2008.
MICHELE SWAIN, EXAMINING ATTORNEY

SN 77-726,977. GEOFFREY BEENE, LLC, NEW YORK, NY. FILED 5-1-2009.

ROCK S.O.S

THE MARK CONSISTS OF STANDARD CHARACTERS WITHOUT CLAIM TO ANY PARTICULAR FONT, STYLE, SIZE, OR COLOR.
FOR PHILANTHROPIC SERVICES CONCERNING MONETARY DONATIONS (U.S. CLS. 100, 101 AND 102).
ALICE SUE CARRUTHERS, EXAMINING ATTORNEY

CLASS 36—(Continued).

SN 77-726,981. GEOFFREY BEENE, LLC, NEW YORK, NY. FILED 5-1-2009.

ROCK STARS OF SCIENCE

THE MARK CONSISTS OF STANDARD CHARACTERS WITHOUT CLAIM TO ANY PARTICULAR FONT, STYLE, SIZE, OR COLOR.
FOR PHILANTHROPIC SERVICES CONCERNING MONETARY DONATIONS (U.S. CLS. 100, 101 AND 102).
ALICE SUE CARRUTHERS, EXAMINING ATTORNEY

SN 77-726,985. GEOFFREY BEENE, LLC, NEW YORK, NY. FILED 5-1-2009.



THE MARK CONSISTS OF A SQUARE CONTAINING A LARGE LETTER "R" ABOVE THE WORDING "ROCK S. O. S"; TO THE RIGHT OF THE "R" ARE A GUITAR AND TWO DIAGONAL QUADRILATERALS COMPOSED OF ALTERNATING DARK AND LIGHT BARS.
FOR PHILANTHROPIC SERVICES CONCERNING MONETARY DONATIONS (U.S. CLS. 100, 101 AND 102).
ALICE SUE CARRUTHERS, EXAMINING ATTORNEY

SN 77-727,153. CONSUMER CREDIT COUNSELING SERVICE OF THE MIDWEST, INC., COLUMBUS, OH. FILED 5-1-2009.

WEBVISOR

THE MARK CONSISTS OF STANDARD CHARACTERS WITHOUT CLAIM TO ANY PARTICULAR FONT, STYLE, SIZE, OR COLOR.
FOR CONSUMER MONEY MANAGEMENT AND DEBT COUNSELING; PROVIDING ON-LINE INFORMATION IN THE FIELD OF CONSUMER MONEY AND CONSUMER DEBT MANAGEMENT (U.S. CLS. 100, 101 AND 102).
BRIDGETT SMITH, EXAMINING ATTORNEY

CLASS 36—(Continued).

SN 77-727,251. JPMORGAN CHASE & CO., NEW YORK, NY.
FILED 5-1-2009.

CLASS 36—(Continued).

SN 77-727,293. JPMORGAN CHASE & CO., NEW YORK, NY.
FILED 5-1-2009.

ALWAYS NEARBY MATTERS

THE MARK CONSISTS OF STANDARD CHARACTERS
WITHOUT CLAIM TO ANY PARTICULAR FONT, STYLE,
SIZE, OR COLOR.
FOR BANKING AND RELATED FINANCIAL SER-
VICES (U.S. CLS. 100, 101 AND 102).
JENNIFER DIXON, EXAMINING ATTORNEY

A GREAT RATE MATTERS

THE MARK CONSISTS OF STANDARD CHARACTERS
WITHOUT CLAIM TO ANY PARTICULAR FONT, STYLE,
SIZE, OR COLOR.
FOR BANKING AND RELATED FINANCIAL SER-
VICES (U.S. CLS. 100, 101 AND 102).
JENNIFER DIXON, EXAMINING ATTORNEY

SN 77-727,265. JPMORGAN CHASE & CO., NEW YORK, NY.
FILED 5-1-2009.

SN 77-727,301. JPMORGAN CHASE & CO., NEW YORK, NY.
FILED 5-1-2009.

ACCESS MATTERS

THE MARK CONSISTS OF STANDARD CHARACTERS
WITHOUT CLAIM TO ANY PARTICULAR FONT, STYLE,
SIZE, OR COLOR.
FOR BANKING AND RELATED FINANCIAL SER-
VICES (U.S. CLS. 100, 101 AND 102).
JENNIFER DIXON, EXAMINING ATTORNEY

24/7 MATTERS

THE MARK CONSISTS OF STANDARD CHARACTERS
WITHOUT CLAIM TO ANY PARTICULAR FONT, STYLE,
SIZE, OR COLOR.
FOR BANKING AND RELATED FINANCIAL SER-
VICES (U.S. CLS. 100, 101 AND 102).
JENNIFER DIXON, EXAMINING ATTORNEY

SN 77-727,279. JPMORGAN CHASE & CO., NEW YORK, NY.
FILED 5-1-2009.

SN 77-727,366. JPMORGAN CHASE & CO., NEW YORK, NY.
FILED 5-1-2009.

A GUARANTEED RETURN MATTERS

STUDENT LOANS MADE SIMPLE

THE MARK CONSISTS OF STANDARD CHARACTERS
WITHOUT CLAIM TO ANY PARTICULAR FONT, STYLE,
SIZE, OR COLOR.
FOR BANKING AND RELATED FINANCIAL SER-
VICES (U.S. CLS. 100, 101 AND 102).
JENNIFER DIXON, EXAMINING ATTORNEY

THE MARK CONSISTS OF STANDARD CHARACTERS
WITHOUT CLAIM TO ANY PARTICULAR FONT, STYLE,
SIZE, OR COLOR.
FOR BANKING AND FINANCIAL SERVICES,
NAMELY, STUDENT LOAN SERVICES (U.S. CLS. 100,
101 AND 102).
FIRST USE 1-0-2006; IN COMMERCE 1-0-2006.
JENNIFER DIXON, EXAMINING ATTORNEY

CLASS 36—(Continued).

SN 77-727,545. CITY OF BELLEVUE, BELLEVUE, WA.
FILED 5-1-2009.



NO CLAIM IS MADE TO THE EXCLUSIVE RIGHT TO USE "BY PHONE", APART FROM THE MARK AS SHOWN. THE MARK CONSISTS OF THE WORDS "MYUTILITY-BILL" ABOVE THE WORDS "BY PHONE" ALL TO THE RIGHT OF A KEYPAD OVERLAID BY A CURVED ARROW. FOR PROVIDING UTILITIES CUSTOMERS WITH FINANCIAL ACCOUNT INFORMATION BY TELEPHONE; TELEPHONE BILL PAYMENT SERVICES FOR UTILITIES CUSTOMERS (U.S. CLS. 100, 101 AND 102).
FRED MANDIR, EXAMINING ATTORNEY

SN 77-727,600. FATHEREE, JAMES L., HOUSTON, TX.
FILED 5-1-2009.

ACTIVOFIRST SAVINGS ASSOCIATION

THE MARK CONSISTS OF STANDARD CHARACTERS WITHOUT CLAIM TO ANY PARTICULAR FONT, STYLE, SIZE, OR COLOR.
NO CLAIM IS MADE TO THE EXCLUSIVE RIGHT TO USE "SAVINGS ASSOCIATION", APART FROM THE MARK AS SHOWN.
FOR SAVINGS AND LOAN SERVICES (U.S. CLS. 100, 101 AND 102).
TEJBIR SINGH, EXAMINING ATTORNEY

SN 77-727,687. REMEDY PAWN & JEWELRY, LLC, MELBOURNE, FL. FILED 5-2-2009.

REMEDY PAWN & JEWELRY

THE MARK CONSISTS OF STANDARD CHARACTERS WITHOUT CLAIM TO ANY PARTICULAR FONT, STYLE, SIZE, OR COLOR.
NO CLAIM IS MADE TO THE EXCLUSIVE RIGHT TO USE "PAWN & JEWELRY", APART FROM THE MARK AS SHOWN.
FOR PAWN SHOPS (U.S. CLS. 100, 101 AND 102).
JENNIFER VASQUEZ, EXAMINING ATTORNEY

CLASS 36—(Continued).

SN 77-728,202. REMEDY PAWN & JEWELRY, LLC, MELBOURNE, FL. FILED 5-4-2009.



NO CLAIM IS MADE TO THE EXCLUSIVE RIGHT TO USE "PAWN AND JEWELRY", APART FROM THE MARK AS SHOWN.
THE MARK CONSISTS OF THE WORDS "REMEDY PAWN" IN STYLIZED FORM WITH A HORIZONTAL LINE BELOW AND THE WORDS "AND JEWELRY" IN STYLIZED FORM BELOW THE HORIZONTAL LINE, ALL WITHIN A RECTANGULAR BOX.
FOR PAWN SHOPS (U.S. CLS. 100, 101 AND 102).
JENNIFER VASQUEZ, EXAMINING ATTORNEY

SN 77-728,207. REMEDY PAWN & JEWELRY, LLC, MELBOURNE, FL. FILED 5-4-2009.

REMEDY PAWN AND JEWELRY

THE MARK CONSISTS OF STANDARD CHARACTERS WITHOUT CLAIM TO ANY PARTICULAR FONT, STYLE, SIZE, OR COLOR.
NO CLAIM IS MADE TO THE EXCLUSIVE RIGHT TO USE "PAWN AND JEWELRY", APART FROM THE MARK AS SHOWN.
FOR PAWN SHOPS (U.S. CLS. 100, 101 AND 102).
JENNIFER VASQUEZ, EXAMINING ATTORNEY

SN 77-728,340. BANK 360, BERESFORD, SD. FILED 5-4-2009.

Bank 360

THE MARK CONSISTS OF STANDARD CHARACTERS WITHOUT CLAIM TO ANY PARTICULAR FONT, STYLE, SIZE, OR COLOR.
NO CLAIM IS MADE TO THE EXCLUSIVE RIGHT TO USE "BANK", APART FROM THE MARK AS SHOWN.
FOR BANKING AND FINANCING SERVICES; CHECKING ACCOUNT SERVICES; CONSUMER LENDING SERVICES; ELECTRONIC BANKING VIA A GLOBAL COMPUTER NETWORK; ELECTRONIC FUNDS TRANSFER; HOME EQUITY LOANS; MORTGAGE LENDING; SAFE DEPOSIT BOX SERVICES; SAVINGS ACCOUNT SERVICES (U.S. CLS. 100, 101 AND 102).
FIRST USE 1-1-2009; IN COMMERCE 1-1-2009.
LINDSEY RUBIN, EXAMINING ATTORNEY

CLASS 36—(Continued).

SN 77-728,358. BANK 360, BERESFORD, SD. FILED 5-4-2009.



NO CLAIM IS MADE TO THE EXCLUSIVE RIGHT TO USE "BANK", APART FROM THE MARK AS SHOWN.

THE MARK CONSISTS OF A RECTANGLE POSITIONED TO THE LEFT OF AND ADJOINING A CIRCLE WITH THE WORD "BANK" POSITIONED WITHIN THE RECTANGLE AND THE NUMBER "360" POSITIONED WITHIN THE CIRCLE.

FOR BANKING AND FINANCING SERVICES; CHECKING ACCOUNT SERVICES; CONSUMER LENDING SERVICES; CREDIT CARD AND DEBIT CARD SERVICES; ELECTRONIC BANKING VIA A GLOBAL COMPUTER NETWORK; ELECTRONIC FUNDS TRANSFER; HOME EQUITY LOANS; MORTGAGE LENDING; SAFE DEPOSIT BOX SERVICES; SAVINGS ACCOUNT SERVICES (U.S. CLS. 100, 101 AND 102).

FIRST USE 1-1-2009; IN COMMERCE 1-1-2009.
LINDSEY RUBIN, EXAMINING ATTORNEY

SN 77-728,517. KINGSBROOK PARTNERS LP, NEW ROCHELLE, NY. FILED 5-4-2009.

KINGSBROOK

THE MARK CONSISTS OF STANDARD CHARACTERS WITHOUT CLAIM TO ANY PARTICULAR FONT, STYLE, SIZE, OR COLOR.

FOR FINANCIAL SERVICES, NAMELY, INVESTMENT ADVISORY SERVICES, INVESTMENT MANAGEMENT SERVICES AND ASSET MANAGEMENT SERVICES (U.S. CLS. 100, 101 AND 102).

TINA KUAN, EXAMINING ATTORNEY

SN 77-729,604. BUCK CONSULTANTS, LLC, NEW YORK, NY. FILED 5-5-2009.

MY MEDICARE ADVOCATE

THE MARK CONSISTS OF STANDARD CHARACTERS WITHOUT CLAIM TO ANY PARTICULAR FONT, STYLE, SIZE, OR COLOR.

NO CLAIM IS MADE TO THE EXCLUSIVE RIGHT TO USE "MEDICARE", APART FROM THE MARK AS SHOWN.

FOR ADMINISTRATION OF EMPLOYEE AND RETIREE BENEFIT PLANS, NAMELY, ADMINISTRATION OF COMPANY AND GOVERNMENTAL HEALTH CARE BENEFIT PLANS, INCLUDING PRE-PAID HEALTH CARE BENEFIT PLANS (U.S. CLS. 100, 101 AND 102).

ZHALEH DELANEY, EXAMINING ATTORNEY

CLASS 36—(Continued).

SN 77-729,623. BUCK CONSULTANTS, LLC, NEW YORK, NY. FILED 5-5-2009.

HELPING YOU MAKE THE RIGHT DECISIONS

THE MARK CONSISTS OF STANDARD CHARACTERS WITHOUT CLAIM TO ANY PARTICULAR FONT, STYLE, SIZE, OR COLOR.

FOR ADMINISTRATION OF EMPLOYEE AND RETIREE BENEFIT PLANS, NAMELY, ADMINISTRATION OF COMPANY AND GOVERNMENTAL HEALTH CARE BENEFIT PLANS, INCLUDING PRE-PAID HEALTH CARE BENEFIT PLANS (U.S. CLS. 100, 101 AND 102).

ZHALEH DELANEY, EXAMINING ATTORNEY

SN 77-730,388. MUTUAL OF OMAHA INSURANCE COMPANY, OMAHA, NE. FILED 5-6-2009.

CELEBRATING LIFE'S AHA MOMENTS

THE MARK CONSISTS OF STANDARD CHARACTERS WITHOUT CLAIM TO ANY PARTICULAR FONT, STYLE, SIZE, OR COLOR.

FOR INSURANCE UNDERWRITING IN THE FIELD OF LIFE, HEALTH, DISABILITY, DENTAL, LONG-TERM CARE, MEDICARE SUPPLEMENT, CRITICAL ILLNESS, ACCIDENTAL DEATH AND DISMEMBERMENT, AND HOSPITAL INCOME INSURANCE; ANNUITY UNDERWRITING; FINANCIAL ADMINISTRATION OF RETIREMENT PLANS; MUTUAL FUND INVESTMENT (U.S. CLS. 100, 101 AND 102).

SALLY SHIH, EXAMINING ATTORNEY

SN 77-731,094. PRUDENTIAL INSURANCE COMPANY OF AMERICA, THE, NEWARK, NJ. FILED 5-7-2009.

HIGHEST DAILY LIFETIME

THE MARK CONSISTS OF STANDARD CHARACTERS WITHOUT CLAIM TO ANY PARTICULAR FONT, STYLE, SIZE, OR COLOR.

FOR ANNUITIES BROKERAGE SERVICES; UNDERWRITING AND INVESTMENT MANAGEMENT OF ANNUITIES AND DEFINED CONTRIBUTION PLANS; INVESTMENT MANAGEMENT AND ADVISORY SERVICES; ADMINISTRATION OF EMPLOYEE RETIREMENT PLANS; RETIREMENT PLANNING SERVICES; ESTATE PLANNING SERVICES; INSURANCE UNDERWRITING, ADMINISTRATION AND AGENCY SERVICES IN THE FIELDS OF LIFE, LONG TERM CARE AND DISABILITY INSURANCE; PROVIDING INSURANCE AND FINANCIAL INFORMATION AND RESEARCH BY MEANS OF A GLOBAL COMPUTER NETWORK (U.S. CLS. 100, 101 AND 102).

JANICE KIM, EXAMINING ATTORNEY

CLASS 36—(Continued).

SN 77-731,105. PRUDENTIAL INSURANCE COMPANY OF AMERICA, THE, NEWARK, NJ. FILED 5-7-2009.

HD LIFETIME

THE MARK CONSISTS OF STANDARD CHARACTERS WITHOUT CLAIM TO ANY PARTICULAR FONT, STYLE, SIZE, OR COLOR.

FOR ANNUITIES BROKERAGE SERVICES; UNDERWRITING AND INVESTMENT MANAGEMENT OF ANNUITIES AND DEFINED CONTRIBUTION PLANS; INVESTMENT MANAGEMENT AND ADVISORY SERVICES; ADMINISTRATION OF EMPLOYEE RETIREMENT PLANS; RETIREMENT PLANNING SERVICES; ESTATE PLANNING SERVICES; INSURANCE UNDERWRITING, ADMINISTRATION AND AGENCY SERVICES IN THE FIELDS OF LIFE, LONG TERM CARE AND DISABILITY INSURANCE; PROVIDING INSURANCE AND FINANCIAL INFORMATION AND RESEARCH BY MEANS OF A GLOBAL COMPUTER NETWORK (U.S. CLS. 100, 101 AND 102).

JANICE KIM, EXAMINING ATTORNEY

SN 77-731,112. JPMORGAN CHASE & CO., NEW YORK, NY. FILED 5-7-2009.

CHASE PICKS UP THE TAB

THE MARK CONSISTS OF STANDARD CHARACTERS WITHOUT CLAIM TO ANY PARTICULAR FONT, STYLE, SIZE, OR COLOR.

OWNER OF U.S. REG. NOS. 3,340,975, 3,347,861 AND 3,352,010.

FOR BANKING AND RELATED FINANCIAL SERVICES, NAMELY, DEBIT CARD SERVICES (U.S. CLS. 100, 101 AND 102).

FIRST USE 3-2-2009; IN COMMERCE 3-2-2009.
JENNIFER DIXON, EXAMINING ATTORNEY

CLASS 36—(Continued).

SN 77-732,747. AMERICAN INTERNATIONAL GROUP, INC., NEW YORK, NY. FILED 5-8-2009.

NOT-FOR-PROFIT PROTECTOR

THE MARK CONSISTS OF STANDARD CHARACTERS WITHOUT CLAIM TO ANY PARTICULAR FONT, STYLE, SIZE, OR COLOR.

OWNER OF U.S. REG. NOS. 2,269,660, 3,389,603 AND OTHERS.

NO CLAIM IS MADE TO THE EXCLUSIVE RIGHT TO USE NOT-FOR-PROFIT, APART FROM THE MARK AS SHOWN.

FOR INSURANCE UNDERWRITING IN THE FIELD OF DIRECTORS, OFFICERS, AND EMPLOYMENT PRACTICES LIABILITY INSURANCE (U.S. CLS. 100, 101 AND 102).

FIRST USE 3-1-1998; IN COMMERCE 3-1-1998.

MARGARET POWER, EXAMINING ATTORNEY

SN 77-732,798. JACKSON NATIONAL LIFE INSURANCE COMPANY, LANSING, MI. FILED 5-8-2009.

JACKSON OF NY

THE MARK CONSISTS OF STANDARD CHARACTERS WITHOUT CLAIM TO ANY PARTICULAR FONT, STYLE, SIZE, OR COLOR.

OWNER OF U.S. REG. NOS. 2,906,958, 3,578,110 AND OTHERS.

NO CLAIM IS MADE TO THE EXCLUSIVE RIGHT TO USE "NY", APART FROM THE MARK AS SHOWN.

FOR LIFE INSURANCE AND ANNUITY UNDERWRITING SERVICES (U.S. CLS. 100, 101 AND 102).

FIRST USE 4-25-2007; IN COMMERCE 4-25-2007.

EMILY CARLSEN, EXAMINING ATTORNEY

SN 77-739,037. JPMORGAN CHASE & CO., NEW YORK, NY. FILED 5-18-2009.

CHASE FREEDOM

THE MARK CONSISTS OF STANDARD CHARACTERS WITHOUT CLAIM TO ANY PARTICULAR FONT, STYLE, SIZE, OR COLOR.

OWNER OF U.S. REG. NOS. 3,340,975, 3,347,861 AND 3,352,010.

FOR CREDIT CARD SERVICES (U.S. CLS. 100, 101 AND 102).

FIRST USE 9-18-2006; IN COMMERCE 9-18-2006.

JENNIFER DIXON, EXAMINING ATTORNEY

CLASS 36—(Continued).

SN 77-745,137. BAY CITIES BANK, TAMPA, FL. FILED 5-27-2009.

When You've Outgrown the Big Banks

THE MARK CONSISTS OF STANDARD CHARACTERS WITHOUT CLAIM TO ANY PARTICULAR FONT, STYLE, SIZE, OR COLOR.

NO CLAIM IS MADE TO THE EXCLUSIVE RIGHT TO USE "BANK", APART FROM THE MARK AS SHOWN.

FOR ATM BANKING SERVICES; BANKING AND FINANCING SERVICES; CHECKING ACCOUNT SERVICES; COMMERCIAL LENDING SERVICES; CONSUMER LENDING SERVICES; ELECTRONIC BANKING VIA A GLOBAL COMPUTER NETWORK; LOAN FINANCING; ON-LINE BANKING SERVICES; SAVINGS ACCOUNT SERVICES (U.S. CLS. 100, 101 AND 102).
KAREN BRACEY, EXAMINING ATTORNEY

SN 77-745,154. BAY CITIES BANK, TAMPA, FL. FILED 5-27-2009.

When a Big Bank Won't Work

THE MARK CONSISTS OF STANDARD CHARACTERS WITHOUT CLAIM TO ANY PARTICULAR FONT, STYLE, SIZE, OR COLOR.

NO CLAIM IS MADE TO THE EXCLUSIVE RIGHT TO USE "BANK", APART FROM THE MARK AS SHOWN.

FOR ATM BANKING SERVICES; BANKING AND FINANCING SERVICES; CHECKING ACCOUNT SERVICES; COMMERCIAL LENDING SERVICES; CONSUMER LENDING SERVICES; ELECTRONIC BANKING VIA A GLOBAL COMPUTER NETWORK; LOAN FINANCING; ON-LINE BANKING SERVICES; SAVINGS ACCOUNT SERVICES (U.S. CLS. 100, 101 AND 102).
KAREN BRACEY, EXAMINING ATTORNEY

SN 77-745,163. BAY CITIES BANK, TAMPA, FL. FILED 5-27-2009.

When You've Outgrown the Large Banks

THE MARK CONSISTS OF STANDARD CHARACTERS WITHOUT CLAIM TO ANY PARTICULAR FONT, STYLE, SIZE, OR COLOR.

NO CLAIM IS MADE TO THE EXCLUSIVE RIGHT TO USE "BANKS", APART FROM THE MARK AS SHOWN.

FOR ATM BANKING SERVICES; BANKING AND FINANCING SERVICES; CHECKING ACCOUNT SERVICES; COMMERCIAL LENDING SERVICES; CONSUMER LENDING SERVICES; ELECTRONIC BANKING VIA A GLOBAL COMPUTER NETWORK; LOAN FINANCING; ON-LINE BANKING SERVICES; SAVINGS ACCOUNT SERVICES (U.S. CLS. 100, 101 AND 102).
KAREN BRACEY, EXAMINING ATTORNEY

CLASS 36—(Continued).

SN 77-746,510. BUCK CONSULTANTS, LLC, NEW YORK, NY. FILED 5-28-2009.

3B

THE MARK CONSISTS OF STANDARD CHARACTERS WITHOUT CLAIM TO ANY PARTICULAR FONT, STYLE, SIZE, OR COLOR.

FOR PROVIDING INFORMATION RELATING TO THE ADMINISTRATION OF EMPLOYEE BENEFIT PLANS OF OTHERS CONCERNING INSURANCE AND FINANCE; PROVIDING INFORMATION RELATING TO THE ADMINISTRATION OF EMPLOYEE HEALTH CARE BENEFIT PLANS OF OTHERS (U.S. CLS. 100, 101 AND 102).

FIRST USE 3-23-2009; IN COMMERCE 3-23-2009.
ZHALEH DELANEY, EXAMINING ATTORNEY

SN 77-746,514. BUCK CONSULTANTS, LLC, NEW YORK, NY. FILED 5-28-2009.

3B

THE MARK CONSISTS OF STANDARD CHARACTERS WITHOUT CLAIM TO ANY PARTICULAR FONT, STYLE, SIZE, OR COLOR.

FOR CONSULTING SERVICES IN THE FIELD OF EMPLOYEE BENEFIT PLANS; PROCESSING, ADMINISTERING, AND MANAGING EMPLOYEE BENEFIT PLANS CONCERNING INSURANCE AND FINANCE FOR OTHERS; PROCESSING, ADMINISTERING, AND MANAGING EMPLOYEE HEALTH CARE BENEFIT PLANS FOR OTHERS (U.S. CLS. 100, 101 AND 102).

FIRST USE 3-23-2009; IN COMMERCE 3-23-2009.
ZHALEH DELANEY, EXAMINING ATTORNEY

SN 77-749,166. MAYTAG CORPORATION, BENTON HARBOR, MI. FILED 6-1-2009.

DEPENDABILITY PLUS

THE MARK CONSISTS OF STANDARD CHARACTERS WITHOUT CLAIM TO ANY PARTICULAR FONT, STYLE, SIZE, OR COLOR.

FOR EXTENDED SERVICE PLANS PROVIDING WARRANTY COVERAGE EXTENSION FOR HOME APPLIANCES AND ELECTRONICS STARTING AFTER EXPIRATION OF ORIGINAL MANUFACTURER'S WARRANTY (U.S. CLS. 100, 101 AND 102).

DEIRDRE ROBERTSON, EXAMINING ATTORNEY

CLASS 36—(Continued).

SN 77-752,681. CNA FINANCIAL CORPORATION, CHICAGO, IL. FILED 6-4-2009.

EPACK EXTRA EZ

THE MARK CONSISTS OF STANDARD CHARACTERS WITHOUT CLAIM TO ANY PARTICULAR FONT, STYLE, SIZE, OR COLOR.

OWNER OF U.S. REG. NOS. 2,621,994 AND 3,455,809.
FOR INSURANCE UNDERWRITING SERVICES THAT COMBINE VARIOUS TYPES OF COVERAGE IN THE FIELDS OF EMPLOYMENT PRACTICES' LIABILITY, DIRECTORS' AND OFFICERS' LIABILITY, AND FIDUCIARY LIABILITY (U.S. CLS. 100, 101 AND 102).
JEAN IM, EXAMINING ATTORNEY

SN 77-753,186. BANK OF AMERICA CORPORATION, CHARLOTTE, NC. FILED 6-5-2009.

SHOW YOUR STRIPES

THE MARK CONSISTS OF STANDARD CHARACTERS WITHOUT CLAIM TO ANY PARTICULAR FONT, STYLE, SIZE, OR COLOR.

FOR BANKING AND RELATED FINANCIAL SERVICES (U.S. CLS. 100, 101 AND 102).
NAKIA HENRY, EXAMINING ATTORNEY

SN 77-754,938. THE BALTIMORE LIFE INSURANCE COMPANY, BALTIMORE, MD. FILED 6-9-2009.

GENERATION LEGACY

THE MARK CONSISTS OF STANDARD CHARACTERS WITHOUT CLAIM TO ANY PARTICULAR FONT, STYLE, SIZE, OR COLOR.

FOR ANNUITY UNDERWRITING; LIFE INSURANCE UNDERWRITING (U.S. CLS. 100, 101 AND 102).
DORITT L. CARROLL, EXAMINING ATTORNEY

CLASS 36—(Continued).

SN 77-754,995. AMERICAN AUTO GUARDIAN, INC., ARLINGTON HEIGHTS, IL. FILED 6-9-2009.

"We succeed only when you do!"

THE MARK CONSISTS OF STANDARD CHARACTERS WITHOUT CLAIM TO ANY PARTICULAR FONT, STYLE, SIZE, OR COLOR.

FOR PROVIDING EXTENDED WARRANTIES ON AUTOMOBILES, TRUCKS, SPORT VEHICLES, AND OTHER VEHICLES (U.S. CLS. 100, 101 AND 102).
FIRST USE 1-1-2004; IN COMMERCE 1-1-2004.
INGRID C. EULIN, EXAMINING ATTORNEY

SN 77-756,094. U.S. BANK, N.A., MINNEAPOLIS, MN. FILED 6-10-2009.

ESTAMOS TODOS PARA SERVIRTE

THE MARK CONSISTS OF STANDARD CHARACTERS WITHOUT CLAIM TO ANY PARTICULAR FONT, STYLE, SIZE, OR COLOR.

THE ENGLISH TRANSLATION OF "ESTAMOS TODOS PARA SERVIRTE" IN THE MARK IS ALL OF US SERVING YOU.

FOR BANKING SERVICES; FINANCIAL SERVICES IN THE NATURE OF ESTATE TRUST ADMINISTRATION AND MANAGEMENT SERVICES, TRUSTEESHIP REPRESENTATIVE SERVICES, INSTITUTIONAL, CORPORATE, AND PERSONAL TRUSTEE SERVICES, TRUSTEE SERVICES RELATING TO BOND INDENTURES OR OTHER DEBT OBLIGATIONS, ASSET CUSTODY SERVICES, EMPLOYER AND INDIVIDUAL RETIREMENT PLAN TRUSTEE SERVICES, TRANSFER AGENT SERVICES, PAYING AGENT SERVICES, ESCROW AGENT SERVICES, MORTGAGE LENDING SERVICES, LIFE INSURANCE UNDERWRITING, BROKERAGE, AND AGENCY SERVICES, INVESTMENT ADVISORY AND CONSULTATION SERVICES, FINANCIAL PORTFOLIO MANAGEMENT SERVICES, INVESTMENT MANAGEMENT SERVICES, INVESTMENT OF FUNDS FOR OTHERS, AND CREDIT CARD SERVICES (U.S. CLS. 100, 101 AND 102).
MAYUR VAGHANI, EXAMINING ATTORNEY

CLASS 36—(Continued).

SN 78-831,583. CITIZENS BANK OF NEVADA COUNTY,
GRASS VALLEY, CA. FILED 3-7-2006.

Your community. Your bank.

THE MARK CONSISTS OF STANDARD CHARACTERS WITHOUT CLAIM TO ANY PARTICULAR FONT, STYLE, SIZE, OR COLOR.

FOR BANKING AND FINANCIAL SERVICES, NAMELY, BUSINESS SAVINGS ACCOUNTS, CHECKING ACCOUNTS AND CASH MANAGEMENT SERVICES, PERSONAL SAVINGS ACCOUNTS, CHECKING ACCOUNTS AND ON-LINE BANKING SERVICES, COMMERCIAL AND RESIDENTIAL REAL ESTATE LOANS, NON-PROFIT SAVINGS ACCOUNTS, CHECKING ACCOUNTS AND CASH MANAGEMENT SERVICES, NON-PROFIT COMMERCIAL AND REAL ESTATE LOANS, BUSINESS LOANS FOR ACQUISITION, EXPANSION, EQUIPMENT, WORKING CAPITAL AND CREDIT CARDS, PERSONAL LOANS RELATED TO HOME EQUITY, AUTOMOBILES, CREDIT CARDS AND LINES OF CREDIT, AUTOMATED TELLER MACHINE SERVICES, ELECTRONIC REMOTE CHECK DEPOSIT SERVICES, HEALTH SAVINGS ACCOUNTS, AND SAFE DEPOSIT BOX SERVICES (U.S. CLS. 100, 101 AND 102).

FIRST USE 5-31-2004; IN COMMERCE 5-31-2004.
WILLIAM VERHOSEK, EXAMINING ATTORNEY

SN 79-064,249. M & G LIMITED, UNITED KINGDOM, FILED
12-16-2008.

INFRACAPITAL

THE MARK CONSISTS OF STANDARD CHARACTERS WITHOUT CLAIM TO ANY PARTICULAR FONT, STYLE, SIZE, OR COLOR.

PRIORITY DATE OF 7-8-2008 IS CLAIMED.

OWNER OF INTERNATIONAL REGISTRATION 0990406
DATED 12-16-2008, EXPIRES 12-16-2018.

FOR FINANCIAL MANAGEMENT; FINANCIAL SERVICES, NAMELY, FINANCIAL ADVISORY AND CONSULTANCY SERVICES, FINANCIAL ANALYSIS AND RESEARCH SERVICES, FINANCIAL FORECASTING, FINANCIAL PLANNING AND FINANCING SERVICES FOR THE SECURING OF FUNDS; INVESTMENT SERVICES, NAMELY, INVESTMENT MANAGEMENT AND CONSULTATION; CAPITAL INVESTMENT; PRIVATE EQUITY INVESTMENT; INVESTMENT IN INFRASTRUCTURE (U.S. CLS. 100, 101 AND 102).

ERNEST SHOSHO, EXAMINING ATTORNEY

CLASS 37—CONSTRUCTION AND REPAIR

SN 76-618,998. FIESTA PALMS, LLC, LAS VEGAS, NV.
FILED 11-1-2004.

PALMS PLACE A MALOOF
CONDOMINIUM HOTEL TOWER

THE MARK CONSISTS OF STANDARD CHARACTERS WITHOUT CLAIM TO ANY PARTICULAR FONT, STYLE, SIZE, OR COLOR.

OWNER OF U.S. REG. NOS. 2,646,679, 2,742,897 AND OTHERS.

NO CLAIM IS MADE TO THE EXCLUSIVE RIGHT TO USE "CONDOMINIUM HOTEL TOWER", APART FROM THE MARK AS SHOWN.

FOR REAL ESTATE DEVELOPMENT, NAMELY, THE DEVELOPMENT OF HOTELS AND CONDOMINIUMS FOR OTHERS (U.S. CLS. 100, 103 AND 106).

ANDREW RHIM, EXAMINING ATTORNEY

SN 76-695,524. DWYER FRANCHISING LLC, WACO, TX.
FILED 1-30-2009.

SIR PAINTER

THE MARK CONSISTS OF STANDARD CHARACTERS WITHOUT CLAIM TO ANY PARTICULAR FONT, STYLE, SIZE, OR COLOR.

APPLICANT REQUESTS THAT THE APPLICATION FOR REGISTRATION EXCLUDE THE FOLLOWING GEOGRAPHIC AREAS: THE STATE OF DELAWARE, THE MARYLAND COUNTIES OF KENT, QUEEN ANNE'S, TALBOT, CAROLINE, DORCHESTER, WICOMICO, WORCESTER AND SOMERSET AND THE VIRGINIA COUNTIES OF ACCOMACK AND NORTHAMPTON. THE CONCURRENT USER IS SIR-PAINTS-A-LOT OF 309 B SOUTH BAY DRIVE, OCEAN CITY, MD 21842.

FOR PAINTING SERVICES; NAMELY, PAINTING RESIDENTIAL AND COMMERCIAL BUILDINGS (U.S. CLS. 100, 103 AND 106).

JACQUELINE A. LAVINE, EXAMINING ATTORNEY

SN 76-697,160. BUG ZERO, INC., SPRINGFIELD, MO. FILED
5-1-2009.

INSECTA-SHIELD

THE MARK CONSISTS OF STANDARD CHARACTERS WITHOUT CLAIM TO ANY PARTICULAR FONT, STYLE, SIZE, OR COLOR.

FOR PEST CONTROL SERVICES (U.S. CLS. 100, 103 AND 106).

FIRST USE 5-1-2003; IN COMMERCE 5-1-2003.

MICHAEL KEATING, EXAMINING ATTORNEY

CLASS 37—(Continued).

SN 77-255,918. MOBILITY SUPPORT SYSTEMS, LLC, TEA, SD. FILED 8-15-2007.

ITS

THE MARK CONSISTS OF STANDARD CHARACTERS WITHOUT CLAIM TO ANY PARTICULAR FONT, STYLE, SIZE, OR COLOR.
FOR ROADSIDE ASSISTANCE SERVICES (U.S. CLS. 100, 103 AND 106).
CORY BOONE, EXAMINING ATTORNEY

SN 77-429,614. VOLVO GROUP CANADA INC., MONTRÉAL, QUÉBEC, CANADA, FILED 3-24-2008.

LFS ARTIC

THE MARK CONSISTS OF STANDARD CHARACTERS WITHOUT CLAIM TO ANY PARTICULAR FONT, STYLE, SIZE, OR COLOR.
PRIORITY CLAIMED UNDER SEC. 44(D) ON CANADA APPLICATION NO. 1377801, FILED 12-7-2007, REG. NO. TMA738417, DATED 4-21-2009, EXPIRES 4-21-2024.
OWNER OF U.S. REG. NOS. 2,699,741, 3,507,000 AND OTHERS.
NO CLAIM IS MADE TO THE EXCLUSIVE RIGHT TO USE "ARTIC", APART FROM THE MARK AS SHOWN.
SEC. 2(F) AS TO "LFS".
FOR MAINTENANCE AND REPAIR OF BUSES (U.S. CLS. 100, 103 AND 106).
ODESSA BIBBINS, EXAMINING ATTORNEY

SN 77-429,919. STICHA, THOMAS M, NORRIDGE, IL. FILED 3-24-2008.

GREENKLEEN

THE MARK CONSISTS OF STANDARD CHARACTERS WITHOUT CLAIM TO ANY PARTICULAR FONT, STYLE, SIZE, OR COLOR.
FOR CLEANING OF BUILDINGS; CLEANING OF EXTERNAL SURFACES OF BUILDINGS; CLEANING OF RESIDENTIAL HOUSES (U.S. CLS. 100, 103 AND 106).
RUDY R. SINGLETON, EXAMINING ATTORNEY

CLASS 37—(Continued).

SN 77-518,002. HOGLUNDS TOP SHOP INC, EVERETT, WA. FILED 7-9-2008.

Hoglunds

THE MARK CONSISTS OF STANDARD CHARACTERS WITHOUT CLAIM TO ANY PARTICULAR FONT, STYLE, SIZE, OR COLOR.
FOR REPAIR AND INSTALLATION OF VEHICLE PARTS, VEHICLE TOPS, VEHICLE SUNROOFS, AND VEHICLE UPHOLSTERY; UPHOLSTERY REPAIR (U.S. CLS. 100, 103 AND 106).
TEJBIR SINGH, EXAMINING ATTORNEY

SN 77-590,686. HOME IMPROVEMENTS 4 LESS, ONTARIO, CA. FILED 10-10-2008.



NO CLAIM IS MADE TO THE EXCLUSIVE RIGHT TO USE "HOME IMPROVEMENTS FOR LESS", APART FROM THE MARK AS SHOWN.
THE MARK CONSISTS OF A PARTIAL BLUE OUTLINE OF A STICK HOUSE WITH THE WORDS HOME IMPROVEMENTS IN GREEN AND "4 LESS" IN BLUE COMING OUT OF THE HOUSE. BELOW THESE WORDS IS A BLUE RECTANGLE CONTAINING THE WHITE WORDS YOUR PROJECT YOUR PRICE WITH A DOT IN THE CENTER.
FOR REMODELING OF HOUSE INTERIORS AND EXTERIORS (U.S. CLS. 100, 103 AND 106).
LINDA MICKLEBURGH, EXAMINING ATTORNEY

SN 77-591,473. THORNDALE CONSTRUCTION SERVICES, INC., OAKBROOK TERRACE, IL. FILED 10-13-2008.

Circle of Expertise

THE MARK CONSISTS OF STANDARD CHARACTERS WITHOUT CLAIM TO ANY PARTICULAR FONT, STYLE, SIZE, OR COLOR.
NO CLAIM IS MADE TO THE EXCLUSIVE RIGHT TO USE "EXPERTISE", APART FROM THE MARK AS SHOWN.
FOR BUILDING CONSTRUCTION SERVICES (U.S. CLS. 100, 103 AND 106).
FIRST USE 6-1-1999; IN COMMERCE 6-1-1999.
ELIZABETH HUGHITT, EXAMINING ATTORNEY

CLASS 37—(Continued).

SN 77-600,520. GIGASAVVY, CHINO HILLS, CA. FILED 10-24-2008.



THE MARK CONSISTS OF THE LETTER "G" AT A 45 DEGREE ANGLE WITH TWO DOTS ALONG THE FLAT SIDE OF THE "G".

FOR COMPUTER INSTALLATION AND REPAIR; INSTALLATION, MAINTENANCE AND REPAIR OF COMPUTER HARDWARE; INSTALLATION, REPAIR AND MAINTENANCE OF HOME THEATER EQUIPMENT, MOBILE AND PORTABLE ELECTRONICS; INSTALLATION, REPAIR AND MAINTENANCE OF TELEPHONE SYSTEMS FOR BUSINESSES; CONSULTATION RELATING TO INSTALLATION, MAINTENANCE AND REPAIR OF HOME THEATER EQUIPMENT, MOBILE AND PORTABLE ELECTRONICS (U.S. CLS. 100, 103 AND 106).

CHRISTINA SOBRAL, EXAMINING ATTORNEY

CLASS 37—(Continued).

SN 77-600,530. GIGASAVVY, CHINO HILLS, CA. FILED 10-24-2008.

GIGASAVVY

THE MARK CONSISTS OF STANDARD CHARACTERS WITHOUT CLAIM TO ANY PARTICULAR FONT, STYLE, SIZE, OR COLOR.

FOR COMPUTER INSTALLATION AND REPAIR; INSTALLATION, MAINTENANCE AND REPAIR OF COMPUTER HARDWARE; INSTALLATION, REPAIR AND MAINTENANCE OF HOME THEATER EQUIPMENT, MOBILE AND PORTABLE ELECTRONICS; INSTALLATION, REPAIR AND MAINTENANCE OF TELEPHONE SYSTEMS FOR BUSINESSES; CONSULTATION RELATING TO INSTALLATION, MAINTENANCE AND REPAIR OF HOME THEATER EQUIPMENT, MOBILE AND PORTABLE ELECTRONICS (U.S. CLS. 100, 103 AND 106).

CHRISTINA SOBRAL, EXAMINING ATTORNEY

SN 77-600,526. GIGASAVVY, CHINO HILLS, CA. FILED 10-24-2008.



GIGASAVVY

THE MARK CONSISTS OF THE LETTER "G" AT A 45 DEGREE ANGLE WITH TWO DOTS ALONG THE FLAT SIDE OF THE "G" UNDER THE LETTER IS THE WORD "GIGASAVVY".

FOR COMPUTER INSTALLATION AND REPAIR; INSTALLATION, MAINTENANCE AND REPAIR OF COMPUTER HARDWARE; INSTALLATION, REPAIR AND MAINTENANCE OF HOME THEATER EQUIPMENT, MOBILE AND PORTABLE ELECTRONICS; INSTALLATION, REPAIR AND MAINTENANCE OF TELEPHONE SYSTEMS FOR BUSINESSES; CONSULTATION RELATING TO INSTALLATION, MAINTENANCE AND REPAIR OF HOME THEATER EQUIPMENT, MOBILE AND PORTABLE ELECTRONICS (U.S. CLS. 100, 103 AND 106).

CHRISTINA SOBRAL, EXAMINING ATTORNEY

SN 77-606,354. LTS BUILDERS, LLC, EAST STROUDSBURG, PA. FILED 11-3-2008.

SELECTSITE

THE MARK CONSISTS OF STANDARD CHARACTERS WITHOUT CLAIM TO ANY PARTICULAR FONT, STYLE, SIZE, OR COLOR.

SEC. 2(F).
FOR CONSTRUCTION OF RESIDENTIAL REAL PROPERTY; LAND DEVELOPMENT SERVICES, NAMELY, PLANNING AND LAYING OUT OF RESIDENTIAL HOMES AND RESIDENTIAL COMMUNITIES (U.S. CLS. 100, 103 AND 106).

FIRST USE 5-1-1986; IN COMMERCE 5-1-1986.
SALLY SHIH, EXAMINING ATTORNEY

CLASS 37—(Continued).

SN 77-612,178. VOGEL SHEET METAL AND HEATING, INC., DBA VOGEL HEATING AND COOLING, ST. LOUIS, MO. FILED 11-11-2008.



NO CLAIM IS MADE TO THE EXCLUSIVE RIGHT TO USE "SINCE 1946", APART FROM THE MARK AS SHOWN. THE MARK CONSISTS OF THE WORD "VOGEL" WITH AN ELONGATED "V" OVER THE REMAINING LETTERS OF THE WORD AND "SINCE 1946" CONTAINED WITH THE ELONGATION.

FOR HVAC CONTRACTOR SERVICES; INSTALLATION, REPAIR AND MAINTENANCE OF HEATING EQUIPMENT; MECHANICAL CONTRACTOR SERVICES (U.S. CLS. 100, 103 AND 106).

FIRST USE 1-1-2006; IN COMMERCE 1-1-2006.
MATTHEW KLINE, EXAMINING ATTORNEY

SN 77-639,218. ATLANTIC CONTRACTING AND SPECIALTIES, LLC, FRANKLIN, MA. FILED 12-23-2008.



NO CLAIM IS MADE TO THE EXCLUSIVE RIGHT TO USE "CONTRACTING & SPECIALTIES", APART FROM THE MARK AS SHOWN.

THE MARK CONSISTS OF THE STYLIZED WORDS "ATLANTIC CONTRACTING & SPECIALTIES" WITH WAVE-LIKE DESIGN INSTEAD OF THE CROSSBAR IN THE "A" AND A SHADED BAR PROTRUDING FROM BEHIND THE LETTERS "IC" IN "ATLANTIC".

FOR INSTALLATION OF INSULATING MATERIALS FOR INDUSTRIAL APPLICATIONS, NAMELY, HIGH TEMPERATURE INSULATION; INSTALLATION OF INSULATING MATERIALS FOR MECHANICAL APPLICATIONS, NAMELY, TANKS, VESSELS, BOILER WORKS, BAGHOUSES, PRECIPITATORS, DUCTWORK AND PIPING; INSTALLATION OF INSULATING MATERIALS FOR THERMAL APPLICATIONS, NAMELY, PROCESS CONTROL, CONDENSATION CONTROL, ENERGY/HEAT CONVERSIONS; AND INSTALLATION OF INSULATING MATERIALS FOR ACOUSTICAL INSULATION FOR BUILDINGS AND SHIPS AND VESSELS; COMMERCIAL AND INDUSTRIAL ASBESTOS AND LEAD ABATEMENT SERVICES ON BUILDING RENOVATIONS AND MODIFICATIONS; HAZARDOUS WASTE DISPOSAL SERVICES; INSTALLATION OF INSULATION FOR FIRE STOPPING, STRUCTURAL FIRE-PROOFING, ELECTRICAL RACEWAY PROTECTION AND DUCTWORK PROTECTION; NOISE CONTROL SERVICES, NAMELY, INSTALLATION OF ACOUSTICAL ENCLOSURES OR BUILDINGS, ACOUSTIC BARRIERS, ACOUSTIC VENTILATION SYSTEMS, COMBUSTION AIR INTAKE AND EXHAUST SILENCERS, ACOUSTIC DOORS AND AUXILIARY BUILDING SYSTEMS (U.S. CLS. 100, 103 AND 106).

FIRST USE 6-16-2000; IN COMMERCE 6-16-2000.
MARCIE MILONE, EXAMINING ATTORNEY

CLASS 37—(Continued).

SN 77-666,158. AERO-COLOURS, INC., CHARLOTTE, NC. FILED 2-9-2009.



OWNER OF U.S. REG. NOS. 1,429,534 AND 1,748,877. NO CLAIM IS MADE TO THE EXCLUSIVE RIGHT TO USE "COLOURS" AND "AMERICA'S PAINT REPAIR SPECIALISTS", APART FROM THE MARK AS SHOWN.

THE MARK CONSISTS OF SIX TRIANGLES THAT FORM AN OCTAGON DESIGN, FOLLOWED BY THE WORDS "AERO COLOURS" IN A STYLIZED FORM. THE WORDS "AMERICA'S PAINT REPAIR SPECIALISTS" APPEAR BELOW THE WORDS "AERO COLOURS" IN A SMALLER STYLIZED FORM.

FOR PAINTING OF THE EXTERIORS OF AUTOMOBILES, MOTORCYCLES, AND VARIOUS SURFACES OF METAL, PLASTIC, WOOD, AND OTHER NON-POROUS MATERIALS; REPAIR OF EXTERIOR SURFACES OF AUTOMOBILES (U.S. CLS. 100, 103 AND 106).

FIRST USE 6-30-2008; IN COMMERCE 6-30-2008.
TARAH HARDY, EXAMINING ATTORNEY

SN 77-687,644. TOTAL HOME ENTERTAINMENT, LLC, ALPHARETTA, GA. FILED 3-10-2009.

WILLETT WIRING

THE MARK CONSISTS OF STANDARD CHARACTERS WITHOUT CLAIM TO ANY PARTICULAR FONT, STYLE, SIZE, OR COLOR.

NO CLAIM IS MADE TO THE EXCLUSIVE RIGHT TO USE "WIRING", APART FROM THE MARK AS SHOWN.

SEC. 2(F) AS TO "WILLETT".

FOR INSTALLATION OF LOW VOLTAGE WIRING FOR USE IN CONNECTION WITH AUDIO VISUAL EQUIPMENT, SECURITY SYSTEMS, LIGHTING SYSTEMS, CENTRAL VACUUM, ENVIRONMENTAL SYSTEMS, TELEPHONE AND DATA NETWORKING (U.S. CLS. 100, 103 AND 106).

FIRST USE 0-0-1986; IN COMMERCE 0-0-1986.
JASON TURNER, EXAMINING ATTORNEY

CLASS 37—(Continued).

SN 77-697,190. UNIVERSAL BUILDING MAINTENANCE LLC, SANTA ANA, CA. FILED 3-23-2009.



NO CLAIM IS MADE TO THE EXCLUSIVE RIGHT TO USE "BUILDING MAINTENANCE", "GREEN" AND THE REPRESENTATIONS OF THE RECYCLING SYMBOL, APART FROM THE MARK AS SHOWN.

THE COLOR(S) GREEN AND YELLOW IS/ARE CLAIMED AS A FEATURE OF THE MARK.

THE MARK CONSISTS OF THE LETTER "U" IN GREEN WITH THE ARCHED WORDING "UNIVERSAL BUILDING MAINTENANCE" IN GREEN APPEARING OVER THE LETTER "U"; THE ARCHED WORD "GREEN" IN GREEN APPEARS BELOW THE LETTER "U"; AND GREEN AND YELLOW RECYCLING SYMBOLS APPEAR ON THE LEFT AND RIGHT OF THE LOWER PORTION OF THE LETTER "U". THE COLORS BLACK, WHITE AND GRAY REPRESENT BACKGROUND, OUTLINING, SHADING AND/OR TRANSPARENT AREAS AND ARE NOT PART OF THE MARK.

FOR ENVIRONMENTALLY FRIENDLY JANITORIAL SERVICES (U.S. CLS. 100, 103 AND 106).

FIRST USE 3-15-2008; IN COMMERCE 3-15-2008.
MARIAM MAHMOUDI, EXAMINING ATTORNEY

SN 77-702,692. WOLD,SHANE,M, OAKGROVE, MN. FILED 3-30-2009.



OWNER OF U.S. REG. NO. 3,360,310.
NO CLAIM IS MADE TO THE EXCLUSIVE RIGHT TO USE "CLEAN CARPETS", APART FROM THE MARK AS SHOWN.

THE COLOR(S) GRAY, WHITE AND BLACK IS/ARE CLAIMED AS A FEATURE OF THE MARK.

THE MARK CONSISTS OF A FANCY LETTER "C" IN COLORS GRAY AND WHITE, EXTENDED LIKE A ROLL WITH 2 FANCY SLASHES BELOW IT, SPARKLES IN WHITE ACROSS IT, AND TEXT "CLEAN CARPETS & MORE" IN BLACK AND WHITE.

FOR CARPET AND UPHOLSTERY CLEANING SERVICES AND WATER DAMAGE RESTORATION SERVICES FOR CARPET AND UPHOLSTERY (U.S. CLS. 100, 103 AND 106).

FIRST USE 3-30-2009; IN COMMERCE 3-30-2009.
SOPHIA S. KIM, EXAMINING ATTORNEY

CLASS 37—(Continued).

SN 77-706,581. PARADIGM BUILDING GROUP, LLC, FAIRFAX, VA. FILED 4-3-2009.

PARADIGM

THE MARK CONSISTS OF STANDARD CHARACTERS WITHOUT CLAIM TO ANY PARTICULAR FONT, STYLE, SIZE, OR COLOR.

FOR RESIDENTIAL AND COMMERCIAL BUILDING CONSTRUCTION, RENOVATION OF BUILDINGS, AND GENERAL CONSTRUCTION CONTRACTING SERVICES (U.S. CLS. 100, 103 AND 106).

FIRST USE 2-0-2007; IN COMMERCE 2-0-2007.
TAMARA FRAZIER, EXAMINING ATTORNEY

SN 77-706,681. PARADIGM BUILDING GROUP, LLC, FAIRFAX, VA. FILED 4-3-2009.



NO CLAIM IS MADE TO THE EXCLUSIVE RIGHT TO USE "BUILDING GROUP, LLC", APART FROM THE MARK AS SHOWN.

THE COLOR(S) BLUE AND SILVER IS/ARE CLAIMED AS A FEATURE OF THE MARK.

THE MARK CONSISTS OF THE WORDING "PARADIGM" IN BLUE AND THE WORDING "BUILDING GROUP, LLC" IN SILVER, A STYLIZED SILVER ROOF DESIGN WITHIN A SILVER OVAL BORDER WITH BLUE SHADING INSIDE THE OVAL, A CIRCULAR SILVER SHADOW BELOW THE CARRIER, AND A SILVER LINE RUNNING UNDER THE TERM "PARADIGM" AND ABOVE THE WORDING "BUILDING GROUP, LLC".

FOR RESIDENTIAL AND COMMERCIAL BUILDING CONSTRUCTION, RENOVATION OF BUILDINGS, AND GENERAL CONSTRUCTION CONTRACTING SERVICES (U.S. CLS. 100, 103 AND 106).

FIRST USE 2-0-2007; IN COMMERCE 2-0-2007.
TAMARA FRAZIER, EXAMINING ATTORNEY

SN 77-713,096. FLEET WHOLESALE SUPPLY CO., INC., APPLETON, WI. FILED 4-14-2009.

MILLS SERVICE CENTER

THE MARK CONSISTS OF STANDARD CHARACTERS WITHOUT CLAIM TO ANY PARTICULAR FONT, STYLE, SIZE, OR COLOR.

NO CLAIM IS MADE TO THE EXCLUSIVE RIGHT TO USE "SERVICE CENTER", APART FROM THE MARK AS SHOWN.

FOR REPAIR OF SMALL ENGINES (U.S. CLS. 100, 103 AND 106).

TIMOTHY FINNEGAN, EXAMINING ATTORNEY

CLASS 37—(Continued).

SN 77-715,303. OSRAM SYLVANIA INC., DANVERS, MA.
FILED 4-16-2009.

SYLVANIA

THE MARK CONSISTS OF STANDARD CHARACTERS WITHOUT CLAIM TO ANY PARTICULAR FONT, STYLE, SIZE, OR COLOR.

OWNER OF U.S. REG. NOS. 1,325,543, 1,411,188 AND OTHERS.

FOR SERVICES IN THE FIELD OF LIGHTING, NAMELY, INSTALLATION AND REPLACEMENT OF LIGHTING BALLASTS AND FIXTURES (U.S. CLS. 100, 103 AND 106).

FIRST USE 1-0-1972; IN COMMERCE 1-0-1972.
ANDREW LEASER, EXAMINING ATTORNEY

SN 77-715,661. NATIVE STRUCTURES, INC., PROVIDENCE, RI. FILED 4-16-2009.

NATIVE STRUCTURES

THE MARK CONSISTS OF STANDARD CHARACTERS WITHOUT CLAIM TO ANY PARTICULAR FONT, STYLE, SIZE, OR COLOR.

NO CLAIM IS MADE TO THE EXCLUSIVE RIGHT TO USE "STRUCTURES", APART FROM THE MARK AS SHOWN.

FOR GENERAL CONSTRUCTION CONTRACTING (U.S. CLS. 100, 103 AND 106).

WON TEAK OH, EXAMINING ATTORNEY

SN 77-718,590. PARAGON BUILDERS INC., CARLSBAD, CA.
FILED 4-21-2009.

THE CONSTRUCTION INTERVENTIONIST

THE MARK CONSISTS OF STANDARD CHARACTERS WITHOUT CLAIM TO ANY PARTICULAR FONT, STYLE, SIZE, OR COLOR.

NO CLAIM IS MADE TO THE EXCLUSIVE RIGHT TO USE "CONSTRUCTION", APART FROM THE MARK AS SHOWN.

FOR GENERAL CONSTRUCTION CONTRACTING; CONSTRUCTION SERVICES, NAMELY, PLANNING, LAYING OUT AND CUSTOM CONSTRUCTION OF RESIDENTIAL AND COMMERCIAL BUILDINGS; CONSTRUCTION CONSULTING; COMMERCIAL BUILDING CONSTRUCTION; BUILDING CONSTRUCTION AND REPAIR; BUILDING CONSTRUCTION MANAGEMENT; BUILDING CONSTRUCTION SERVICES AS GENERAL CONTRACTORS (U.S. CLS. 100, 103 AND 106).

ANDREW LEASER, EXAMINING ATTORNEY

CLASS 37—(Continued).

SN 77-719,146. RENTING MEMORIES, LLC, DEWITT, NY.
FILED 4-21-2009.



NO CLAIM IS MADE TO THE EXCLUSIVE RIGHT TO USE "RENTING", APART FROM THE MARK AS SHOWN.

THE MARK CONSISTS OF THE STYLIZED WORDS "RENTING MEMORIES" WITH A DESIGN OF AN ARC THAT HAS A PAINT-BRUSHED EFFECT BELOW THE WORDS.

FOR RENTAL OF CONSTRUCTION EQUIPMENT (U.S. CLS. 100, 103 AND 106).

MARY CRAWFORD, EXAMINING ATTORNEY

SN 77-722,097. WHEELTIME NETWORK, LLC, PHILADELPHIA, PA. FILED 4-24-2009.

WHEELTIME HVT

THE MARK CONSISTS OF STANDARD CHARACTERS WITHOUT CLAIM TO ANY PARTICULAR FONT, STYLE, SIZE, OR COLOR.

OWNER OF U.S. REG. NO. 2,693,249.
FOR VEHICLE REPAIR AND MAINTENANCE (U.S. CLS. 100, 103 AND 106).

AMEEN IMAM, EXAMINING ATTORNEY

SN 77-722,107. WHEELTIME NETWORK, LLC, PHILADELPHIA, PA. FILED 4-24-2009.

WHEELTIME HYBRID VEHICLE TECHNICIAN

THE MARK CONSISTS OF STANDARD CHARACTERS WITHOUT CLAIM TO ANY PARTICULAR FONT, STYLE, SIZE, OR COLOR.

OWNER OF U.S. REG. NO. 2,693,249.
NO CLAIM IS MADE TO THE EXCLUSIVE RIGHT TO USE "HYBRID VEHICLE TECHNICIAN", APART FROM THE MARK AS SHOWN.

FOR VEHICLE REPAIR AND MAINTENANCE (U.S. CLS. 100, 103 AND 106).

AMEEN IMAM, EXAMINING ATTORNEY

CLASS 37—(Continued).

SN 77-722,842. CDC HOLDINGS INC., BOULDER, CO. FILED 4-27-2009.

SitePanel

THE MARK CONSISTS OF STANDARD CHARACTERS WITHOUT CLAIM TO ANY PARTICULAR FONT, STYLE, SIZE, OR COLOR.

FOR CARPENTRY; CARPENTRY CONTRACTOR SERVICES; FRAMING CONTRACTOR SERVICES; GENERAL CONTRACTOR SERVICES, NAMELY, PLUMBING, HEATING AND AIR CONDITIONING, CARPENTRY, DRYWALL, PAINTING, ELECTRICAL, BUILDING AND FRAMING CONTRACTOR SERVICES; SELF-PERFORM CONSTRUCTION SKILLED TRADES, NAMELY, CONCRETE WORK, CARPENTRY AND SELECTIVE DEMOLITION SERVICES (U.S. CLS. 100, 103 AND 106).
MEGHAN REINHART, EXAMINING ATTORNEY

SN 77-723,584. AHMED, MIAN, FREMONT, CA. FILED 4-28-2009.

MR. DRAIN

THE MARK CONSISTS OF STANDARD CHARACTERS WITHOUT CLAIM TO ANY PARTICULAR FONT, STYLE, SIZE, OR COLOR.

FOR PLUMBING SERVICES (U.S. CLS. 100, 103 AND 106).
FIRST USE 10-0-2008; IN COMMERCE 10-0-2008.
KATHERINE CONNOLLY, EXAMINING ATTORNEY

SN 77-724,439. PERRY, PREVYANT, MONTREAL, CANADA, FILED 4-28-2009.

Renovus

THE MARK CONSISTS OF STANDARD CHARACTERS WITHOUT CLAIM TO ANY PARTICULAR FONT, STYLE, SIZE, OR COLOR.

FOR BUILDING CONSTRUCTION AND REPAIR; BUILDING CONSTRUCTION SERVICES; BUILDING CONSTRUCTION SUPERVISION; BUILDING CONSTRUCTION, REMODELING AND REPAIR; CONSTRUCTING DECKS; CONSTRUCTING PORCHES; CONSTRUCTING SUNROOMS; CONSTRUCTION AND RENOVATION OF BUILDINGS; CONSTRUCTION AND REPAIR OF BUILDINGS; CONSTRUCTION CONSULTANCY; CONSTRUCTION CONSULTATION; CONSTRUCTION OF BUILDINGS; CONSTRUCTION SUPERVISION; CONSTRUCTION, MAINTENANCE AND RENOVATION OF PROPERTY; CUSTOM CONSTRUCTION AND BUILDING RENOVATION; CUSTOM CONSTRUCTION OF HOMES; GENERAL CONSTRUCTION CONTRACTING (U.S. CLS. 100, 103 AND 106).
BARBARA A. GOLD, EXAMINING ATTORNEY

CLASS 37—(Continued).

SN 77-725,302. J.E. DUNN CONSTRUCTION GROUP, INC., KANSAS CITY, MO. FILED 4-29-2009.

INTEGRITY + PERFORMANCE =
TRUST

THE MARK CONSISTS OF STANDARD CHARACTERS WITHOUT CLAIM TO ANY PARTICULAR FONT, STYLE, SIZE, OR COLOR.

FOR BUILDING CONSTRUCTION SERVICES (U.S. CLS. 100, 103 AND 106).
FONG HSU, EXAMINING ATTORNEY

SN 77-725,308. J.E. DUNN CONSTRUCTION GROUP, INC., KANSAS CITY, MO. FILED 4-29-2009.

IN PURSUIT OF BUILDING
PERFECTION

THE MARK CONSISTS OF STANDARD CHARACTERS WITHOUT CLAIM TO ANY PARTICULAR FONT, STYLE, SIZE, OR COLOR.

FOR BUILDING CONSTRUCTION SERVICES (U.S. CLS. 100, 103 AND 106).
FONG HSU, EXAMINING ATTORNEY

SN 77-726,783. HOWE, ERIC, KELLER, TX. FILED 5-1-2009.

OPTIC-KLEER

THE MARK CONSISTS OF STANDARD CHARACTERS WITHOUT CLAIM TO ANY PARTICULAR FONT, STYLE, SIZE, OR COLOR.

FOR MAINTENANCE AND/OR REPAIR OF AUTOMOBILE WINDSHIELDS (U.S. CLS. 100, 103 AND 106).
HENRY S. ZAK, EXAMINING ATTORNEY

CLASS 37—(Continued).

SN 77-726,814. CONKLIN COMPANY, INC., SHAKOPEE, MN. FILED 5-1-2009.

MR SYSTEM

THE MARK CONSISTS OF STANDARD CHARACTERS WITHOUT CLAIM TO ANY PARTICULAR FONT, STYLE, SIZE, OR COLOR.

NO CLAIM IS MADE TO THE EXCLUSIVE RIGHT TO USE "SYSTEM", APART FROM THE MARK AS SHOWN.

FOR INSTALLATION OF THERMOPLASTIC ROOFING SYSTEMS (U.S. CLS. 100, 103 AND 106).

FIRST USE 0-0-1998; IN COMMERCE 0-0-1998.
G. MAYERSCHOFF, EXAMINING ATTORNEY

SN 77-726,971. AFFORDABLE LOCKSMITH INC, NEW YORK, NY. FILED 5-1-2009.

LOCKBUSTERS

THE MARK CONSISTS OF STANDARD CHARACTERS WITHOUT CLAIM TO ANY PARTICULAR FONT, STYLE, SIZE, OR COLOR.

FOR LOCKSMITH SERVICES, NAMELY, REPAIR, MAINTENANCE, AND INSTALLATION OF LOCKS, GATES, WINDOW GUARDS, SAFES, AND DOORS (U.S. CLS. 100, 103 AND 106).

RICHARD WHITE, EXAMINING ATTORNEY

SN 77-728,740. SUNPOWER CORPORATION, SAN JOSE, CA. FILED 5-4-2009.

RE-VOLT

THE MARK CONSISTS OF STANDARD CHARACTERS WITHOUT CLAIM TO ANY PARTICULAR FONT, STYLE, SIZE, OR COLOR.

FOR INSTALLATION, REPAIR, AND MAINTENANCE OF SOLAR ENERGY SYSTEMS, SOLAR COLLECTORS AND SOLAR HEAT COLLECTION PANELS; INSTALLATION OF FACILITIES TO PRODUCE SOLAR ENERGY; INSTALLATION OF GROUND-MOUNTED AND ROOF-MOUNTED SOLAR PANEL PLANTS (U.S. CLS. 100, 103 AND 106).

ALICE BENMAMAN, EXAMINING ATTORNEY

CLASS 37—(Continued).

SN 77-728,765. SUNPOWER CORPORATION, SAN JOSE, CA. FILED 5-4-2009.

USE MORE SUN

THE MARK CONSISTS OF STANDARD CHARACTERS WITHOUT CLAIM TO ANY PARTICULAR FONT, STYLE, SIZE, OR COLOR.

FOR INSTALLATION, REPAIR, AND MAINTENANCE OF SOLAR ENERGY SYSTEMS, SOLAR COLLECTORS AND SOLAR HEAT COLLECTION PANELS; INSTALLATION OF FACILITIES TO PRODUCE SOLAR ENERGY; INSTALLATION OF GROUND-MOUNTED AND ROOF-MOUNTED SOLAR PANEL PLANTS (U.S. CLS. 100, 103 AND 106).

ALICE BENMAMAN, EXAMINING ATTORNEY

SN 77-728,780. PALMATIER, TIMOTHY ARTHUR, DBA PEST RX, RIVERSIDE, CA. FILED 5-4-2009.



NO CLAIM IS MADE TO THE EXCLUSIVE RIGHT TO USE "PEST", APART FROM THE MARK AS SHOWN.

THE COLOR(S) YELLOW, BLUE, BLACK IS/ARE CLAIMED AS A FEATURE OF THE MARK.

THE MARK CONSISTS OF THE WORD "PEST" IN YELLOW AND THE WORD "RX" IN BLACK WITH BLUE BACKGROUND FEATURING A STYLIZED MORTAR AND PESTLE; THIS IMAGE IS OUTLINED IN BLACK WITH THE TEXT "YOUR PEST CONTROL PRESCRIPTION" PRINTED BELOW IT IN BLACK.

FOR PEST CONTROL (U.S. CLS. 100, 103 AND 106).
FIRST USE 6-1-2007; IN COMMERCE 6-1-2007.
REBECCA SMITH, EXAMINING ATTORNEY

SN 77-729,968. BRENAMAN ELECTRICAL SERVICE, INC., MOUNT JOY, PA. FILED S.R. 5-6-2009; AM. P.R. 5-13-2009.

Brenaman Electrical Service, Inc.

THE MARK CONSISTS OF STANDARD CHARACTERS WITHOUT CLAIM TO ANY PARTICULAR FONT, STYLE, SIZE, OR COLOR.

NO CLAIM IS MADE TO THE EXCLUSIVE RIGHT TO USE "ELECTRICAL SERVICE, INC.", APART FROM THE MARK AS SHOWN.

SEC. 2(F) AS TO "BRENAMAN".
FOR ELECTRICAL CONTRACTOR SERVICES (U.S. CLS. 100, 103 AND 106).
FIRST USE 7-31-1981; IN COMMERCE 7-31-1981.
PAUL F. GAST, EXAMINING ATTORNEY

CLASS 37—(Continued).

SN 77-745,125. WHEELTIME NETWORK, LLC, PHILADELPHIA, PA. FILED 5-27-2009.

SOLUTIONS, NOT EXCUSES

THE MARK CONSISTS OF STANDARD CHARACTERS WITHOUT CLAIM TO ANY PARTICULAR FONT, STYLE, SIZE, OR COLOR.
FOR PROVIDING VEHICLE REPAIR AND MAINTENANCE (U.S. CLS. 100, 103 AND 106).
AMEEN IMAM, EXAMINING ATTORNEY

CLASS 38—(Continued).

SN 76-695,987. CAPROCK COMMUNICATIONS, INC., HOUSTON, TX. FILED 2-26-2009.



OWNER OF U.S. REG. NOS. 2,752,405, 3,447,322 AND OTHERS.
NO CLAIM IS MADE TO THE EXCLUSIVE RIGHT TO USE "GOVERNMENT SOLUTIONS", APART FROM THE MARK AS SHOWN.
THE MARK CONSISTS OF THE LETTER "C" FEATURING A PLANET WITH A FANCIFUL SATELLITE FORMING A RING AND UNDERLINED WORD "CAPROCK", AND WORDING "GOVERNMENT SOLUTIONS".
FOR PROVIDING SATELLITE-BASED COMMUNICATIONS TO GOVERNMENTAL ENTITIES (U.S. CLS. 100, 101 AND 104).
DAVID C. REIHNER, EXAMINING ATTORNEY

CLASS 38—COMMUNICATION

SN 76-694,577. GROUP KAITU, LLC, OAKLAND, CA. FILED 12-1-2008.

WWW.EROS-GUIDE.COM

THE MARK CONSISTS OF STANDARD CHARACTERS WITHOUT CLAIM TO ANY PARTICULAR FONT, STYLE, SIZE, OR COLOR.
FOR PROVIDING ONLINE CHAT ROOMS AND ELECTRONIC BULLETIN BOARDS FOR TRANSMISSIONS OF MESSAGES AMONG USERS IN THE FIELD OF ADULT-THEMED TOPICS, PRODUCTS, SERVICES AND ENTERTAINMENT; MOBILE MEDIA SERVICES IN THE NATURE OF ELECTRONIC TRANSMISSION OF ENTERTAINMENT, BUSINESS AND EDUCATIONAL MEDIA CONTENT IN THE FIELD OF ADULT-THEMED TOPICS, PRODUCTS, SERVICES AND ENTERTAINMENT (U.S. CLS. 100, 101 AND 104).
CHRISTINA SOBRAL, EXAMINING ATTORNEY

SN 77-242,426. MAVERICK NETWORKS INC., PLEASANTON, CA. FILED 7-30-2007.



NO CLAIM IS MADE TO THE EXCLUSIVE RIGHT TO USE "NETWORKS INC", APART FROM THE MARK AS SHOWN.
THE COLOR(S) BLACK, BLUE, WHITE AND GREY IS/ARE CLAIMED AS A FEATURE OF THE MARK.
THE MARK CONSISTS OF A BLUE, LIGHT BLUE AND WHITE SPHERE, WITH BLACK DEVILISH HORNS PROTRUDING FROM THE LEFT SIDE AND FROM THE RIGHT SIDE (PARTLY OCCULTED), ALL SURROUNDED BY TWO BLACK ORBITING RINGS THAT CROSS IN THE FORM OF AN "X" TO THE RIGHT OF THE SPHERE'S CENTER MAKING IT APPEAR AS THOUGH THE IMAGE IS BEING VIEWED FROM A POINT SLIGHTLY LEFT OF CENTER. THE SPHERE HOVERS ABOVE THE STYLIZED, LOWER-CASE, WORD "MAVERICK", WHICH APPEARS IN BLACK. IN TURN, THE WORD "MAVERICK" HOVERS JUST ABOVE THE STYLIZED, UPPER-CASE WORDS "NETWORKS" IN BLUE AND "INC" IN GREY, EACH OF WHICH APPEARING APPROXIMATELY HALF THE FONT SIZE OF THE WORD "MAVERICK" ABOVE THEM.
FOR LEASING OF TELECOMMUNICATION EQUIPMENT, NAMELY, TELEPHONES, TELEPHONE SYSTEMS, TELEPHONE LINES AND WIRELESS TELECOMMUNICATIONS PRODUCTS; PROVIDING ACCESS TO TELECOMMUNICATION NETWORKS; PROVIDING ELECTRONIC TELECOMMUNICATION CONNECTIONS; RENTAL OF TELECOMMUNICATION EQUIPMENT TELEPHONES, TELEPHONE SYSTEMS, TELEPHONE LINES AND WIRELESS TELECOMMUNICATIONS PRODUCTS (U.S. CLS. 100, 101 AND 104).
FIRST USE 1-1-2005; IN COMMERCE 1-1-2005.
KATHY DE JONGE, EXAMINING ATTORNEY

SN 76-695,985. CAPROCK COMMUNICATIONS, INC., HOUSTON, TX. FILED 2-26-2009.

CAPROCK GOVERNMENT SOLUTIONS

THE MARK CONSISTS OF STANDARD CHARACTERS WITHOUT CLAIM TO ANY PARTICULAR FONT, STYLE, SIZE, OR COLOR.
OWNER OF U.S. REG. NOS. 2,752,405, 3,447,322 AND OTHERS.
NO CLAIM IS MADE TO THE EXCLUSIVE RIGHT TO USE "GOVERNMENT SOLUTIONS", APART FROM THE MARK AS SHOWN.
FOR PROVIDING SATELLITE-BASED COMMUNICATIONS TO GOVERNMENTAL ENTITIES (U.S. CLS. 100, 101 AND 104).
DAVID C. REIHNER, EXAMINING ATTORNEY

CLASS 38—(Continued).

SN 77-408,304. ECOIST, LLC, MIAMI, FL. FILED 2-28-2008.

ECOIST

THE MARK CONSISTS OF STANDARD CHARACTERS WITHOUT CLAIM TO ANY PARTICULAR FONT, STYLE, SIZE, OR COLOR.

OWNER OF U.S. REG. NOS. 3,070,679 AND 3,223,355.

FOR TELEVISION BROADCASTING FEATURING CONSERVATION; INTERNET WEBSITE FEATURING CHATROOMS AND ELECTRONIC BULLETIN BOARDS FOR MEMBER POSTINGS RELATED TO CONSERVATION (U.S. CLS. 100, 101 AND 104).

LINDSEY RUBIN, EXAMINING ATTORNEY

SN 77-595,895. DJR HOLDINGS, LLC, NEW YORK, NY. FILED 10-20-2008.

DEF JAM MOBILE

THE MARK CONSISTS OF STANDARD CHARACTERS WITHOUT CLAIM TO ANY PARTICULAR FONT, STYLE, SIZE, OR COLOR.

OWNER OF U.S. REG. NOS. 1,790,763, 2,361,626 AND OTHERS.

NO CLAIM IS MADE TO THE EXCLUSIVE RIGHT TO USE "MOBILE", APART FROM THE MARK AS SHOWN.

FOR CELLULAR TELEPHONE SERVICES; TELEPHONE COMMUNICATION SERVICES; WIRELESS TELEPHONE SERVICES; LOCAL AND LONG DISTANCE TELEPHONE COMMUNICATION SERVICES; TELEPHONE COMMUNICATION SERVICES, NAMELY, PREPAID TELEPHONE SERVICES VIA THE INTERNET; PROVIDING TELECOMMUNICATIONS CONNECTIONS TO A GLOBAL COMPUTER NETWORK; TELECOMMUNICATIONS GATEWAY SERVICES; TELECOMMUNICATIONS SERVICES, NAMELY, ISDN SERVICES; TELECOMMUNICATION SERVICES, NAMELY, WIRELESS PBX SERVICES, WIRELESS DIGITAL MESSAGING SERVICES, AND WIRELESS FACSIMILE MAIL SERVICES; TELECOMMUNICATION SERVICES, NAMELY, PERSONAL COMMUNICATION SERVICES; TELECOMMUNICATION SERVICES, NAMELY, VOICE MAIL SERVICES; ELECTRONIC VOICE MESSAGING, NAMELY, THE RECORDING, STORAGE AND SUBSEQUENT TRANSMISSION OF VOICE MESSAGES BY TELEPHONE; ELECTRONIC MAIL SERVICES; ELECTRONIC STORE-AND-FORWARD MESSAGING SERVICES; CELLULAR-BASED DISPATCH COMMUNICATION SERVICES; PREPAID CELLULAR TELEPHONE SERVICES; VOICE-ACTIVATED CELLULAR TELEPHONE SERVICES; EMERGENCY CELLULAR TELEPHONE SERVICES; TRANSMISSION OF DATA VIA CELLULAR COMMUNICATION NETWORKS; PROVIDING PERSONAL IDENTIFICATION NUMBERS IN ASSOCIATION WITH CELLULAR TELECOMMUNICATIONS; FACSIMILE TRANSMISSIONS; ELECTRONIC TRANSMISSION OF DATA AND DOCUMENTS VIA COMPUTER TERMINALS; PAGING SERVICES; ELECTRONIC AND WIRELESS TRANSMISSION OF MESSAGES, VOICES AND DATA; PROVIDING MULTIPLE-USER ACCESS TO A GLOBAL COMPUTER INFORMATION NETWORK; PROVIDING ON-LINE CHAT ROOMS FOR TRANSMISSION OF MESSAGES AMONG COMPUTER USERS CONCERNING TELEVISION AND TELEVISION ACTORS, FILM, MOTION PICTURE, MOVIE ACTORS, THEATER AND THEATRICAL ACTORS, COMEDY

CLASS 38—(Continued).

AND COMEDIANS, MUSIC AND MUSICIANS, PERFORMANCE AND RECORDING ARTISTS, MUSICAL RECORDINGS IN ALL VARIETY FORMATS, MUSIC TOURS, SPORTS AND SPORTS CELEBRITIES, ARTS AND VARIETY ENTERTAINMENT, TRAVEL, LITERATURE, CLOTHING AND RELATED ACCESSORIES, NEWS AND POLITICS AND POLITICIANS, GOODS AND SERVICES ALL RELATING TO THE TELECOMMUNICATIONS AND COMPUTER INDUSTRIES, AND A WIDE RANGE OF OTHER TOPICS OF GENERAL INTEREST; PROVIDING ON-LINE ELECTRONIC BULLETIN BOARDS FOR TRANSMISSION OF MESSAGES AMONG COMPUTER USERS CONCERNING TELEVISION AND TELEVISION ACTORS, FILM, MOTION PICTURES, MOVIE ACTORS, THEATER AND THEATRICAL ACTORS, COMEDY AND COMEDIANS, MUSIC AND MUSICIANS, PERFORMANCE AND RECORDING ARTISTS, MUSICAL RECORDINGS IN ALL VARIETY FORMATS, MUSIC TOURS, SPORTS AND SPORTS CELEBRITIES, ARTS AND VARIETY ENTERTAINMENT, TRAVEL, LITERATURE, CLOTHING AND RELATED ACCESSORIES, NEWS, POLITICS AND POLITICIANS, GOODS AND SERVICES ALL RELATING TO THE TELECOMMUNICATIONS AND COMPUTER INDUSTRIES, AND A WIDE RANGE OF OTHER TOPICS OF GENERAL INTEREST (U.S. CLS. 100, 101 AND 104).

G. MAYERSCHOFF, EXAMINING ATTORNEY

SN 77-602,593. NUM LIP ENTERTAINMENT, INC., VAN NUYS, CA. FILED 10-28-2008.



NO CLAIM IS MADE TO THE EXCLUSIVE RIGHT TO USE "ENT", APART FROM THE MARK AS SHOWN.

THE COLOR(S) PINK, RED, PURPLE, BLACK AND GRAY IS/ARE CLAIMED AS A FEATURE OF THE MARK.

THE MARK CONSISTS OF THE WORD "NUM" IN PINK, WITH A RED STAR IN THE MIDDLE OF THE "U" WITH THE WORD "LIP" IN RED, UNDERNEATH, WITH THE SILHOUETTE OF A WOMAN IN PLACE OF THE LETTER "I" ALSO IN RED, WITH THE WORD "ENT" UNDERNEATH IN PURPLE, THE LETTERS OF THE LITERAL PORTIONS BEING SHADOWED IN BLACK AND GRAY, ALL ON A LIGHTLY STRIATED PINK BACKGROUND.

FOR STREAMING OF ADULT-THEMED VIDEO ENTERTAINMENT ON THE INTERNET; VIDEO-ON-DEMAND TRANSMISSION SERVICES VIA THE INTERNET FOR ADULT-THEMED ENTERTAINMENT (U.S. CLS. 100, 101 AND 104).

HANNO RITTNER, EXAMINING ATTORNEY

CLASS 38—(Continued).

SN 77-611,160. OLYMPIC SOCCER ACADEMY, LLC, SEATTLE, WA. FILED 11-10-2008.

CLASS 38—(Continued).

SN 77-612,790. OLYMPIC SOCCER ACADEMY, LLC, SEATTLE, WA. FILED 11-12-2008.

OSA SOCCER ACADEMY



NO CLAIM IS MADE TO THE EXCLUSIVE RIGHT TO USE "SOCCER ACADEMY", APART FROM THE MARK AS SHOWN.

THE MARK CONSISTS OF THE LETTERS "OSA" IN A STYLIZED CURSIVE FONT WITH THE LETTER "S" AROUND A SOCCER BALL, AND THE WORDS "SOCCER", WITH A BLACK BOX AROUND IT, AND "ACADEMY" STACKED BELOW "OSA" AND THE SOCCER BALL.

FOR SHORT TERM RENTAL SERVICES AND ONLINE RENTAL SERVICES OF CELLULAR TELEPHONES; INTERNET SERVICE PROVIDER AND ON-LINE SERVICE PROVIDER SERVICES, NAMELY, PROVIDING MULTIPLE USER ACCESS TO A GLOBAL COMPUTER INFORMATION NETWORK, THE INTERNET AND PRIVATE COMPUTER INFORMATION NETWORKS; TELECOMMUNICATION SERVICES, NAMELY, PROVIDING TELECOMMUNICATIONS CONNECTIONS THAT ALLOW USERS TO PERFORM ELECTRONIC PRIVATE AND BUSINESS TRANSACTIONS VIA PAGERS, CELLULAR TELEPHONES, TELEPHONES, PERSONAL DIGITAL ASSISTANTS, HANDHELD COMPUTERS, MOBILE DATA RECEIVERS AND VIA A GLOBAL COMPUTER INFORMATION NETWORK, THE INTERNET AND PRIVATE COMPUTER INFORMATION NETWORKS (U.S. CLS. 100, 101 AND 104).

TINA BROWN, EXAMINING ATTORNEY

THE MARK CONSISTS OF STANDARD CHARACTERS WITHOUT CLAIM TO ANY PARTICULAR FONT, STYLE, SIZE, OR COLOR.

NO CLAIM IS MADE TO THE EXCLUSIVE RIGHT TO USE "SOCCER ACADEMY", APART FROM THE MARK AS SHOWN.

FOR SHORT TERM RENTAL SERVICES AND ONLINE RENTAL SERVICES OF CELLULAR TELEPHONES; INTERNET SERVICE PROVIDER AND ON-LINE SERVICE PROVIDER SERVICES, NAMELY, PROVIDING MULTIPLE USER ACCESS TO A GLOBAL COMPUTER INFORMATION NETWORK, THE INTERNET AND PRIVATE COMPUTER INFORMATION NETWORKS; TELECOMMUNICATION SERVICES, NAMELY, PROVIDING TELECOMMUNICATIONS CONNECTIONS THAT ALLOW USERS TO PERFORM ELECTRONIC PRIVATE AND BUSINESS TRANSACTIONS VIA PAGERS, CELLULAR TELEPHONES, TELEPHONES, PERSONAL DIGITAL ASSISTANTS, HANDHELD COMPUTERS, MOBILE DATA RECEIVERS AND VIA A GLOBAL COMPUTER INFORMATION NETWORK, THE INTERNET AND PRIVATE COMPUTER INFORMATION NETWORKS (U.S. CLS. 100, 101 AND 104).

TINA BROWN, EXAMINING ATTORNEY

SN 77-623,754. POPSCREEN, INC., HOUSTON, TX. FILED 12-1-2008.

POPSCREEN

THE MARK CONSISTS OF STANDARD CHARACTERS WITHOUT CLAIM TO ANY PARTICULAR FONT, STYLE, SIZE, OR COLOR.

FOR PROVIDING AN ON-LINE FORUM FOR THE POSTING BY COMPUTER USERS OF VIDEOS IN THE FIELD OF GENERAL INTEREST AND THE TRANSMISSION OF MESSAGES AMONG COMPUTER USERS CONCERNING SUCH VIDEOS (U.S. CLS. 100, 101 AND 104).

LAURA KOVALSKY, EXAMINING ATTORNEY

CLASS 38—(Continued).

SN 77-632,873. FULL SAIL, INC., WINTER PARK, FL. FILED 12-15-2008.



OWNER OF U.S. REG. NOS. 2,025,339, 3,525,113 AND OTHERS.

NO CLAIM IS MADE TO THE EXCLUSIVE RIGHT TO USE "UNIVERSITY", APART FROM THE MARK AS SHOWN.

THE COLOR(S) ORANGE, WHITE AND SAGE IS/ARE CLAIMED AS A FEATURE OF THE MARK.

THE MARK CONSISTS OF A DESIGN OF AN AIRPLANE WITHIN A CIRCULAR DESIGN AND THE WORDS "FULL SAIL UNIVERSITY" BELOW THE DESIGN. THE AIRPLANE DESIGN IS IN WHITE, THE CIRCULAR DESIGN IS IN ORANGE AND THE WORDS "FULL SAIL UNIVERSITY" ARE IN SAGE.

FOR PROVIDING AN ONLINE PORTAL FOR STUDENTS AND INSTRUCTORS TO COMMUNICATE AND TRANSMIT INFORMATION, DATA, AND DIGITAL CONTENT PERTAINING TO EDUCATIONAL RESOURCES AND PROJECTS (U.S. CLS. 100, 101 AND 104).

AMEETA JORDAN, EXAMINING ATTORNEY

CLASS 38—(Continued).

SN 77-675,081. UNIVISION COMMUNICATIONS INC., LOS ANGELES, CA. FILED 2-20-2009.

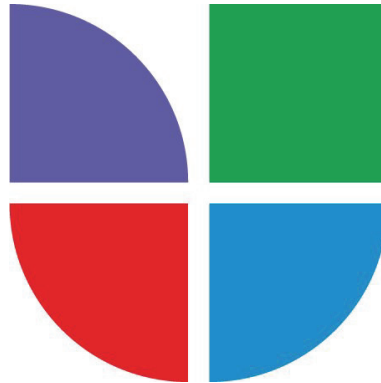

OWNER OF U.S. REG. NOS. 357,002, 1,672,807 AND 3,568,848.

THE COLOR(S) PURPLE, GREEN, BLUE AND RED IS/ARE CLAIMED AS A FEATURE OF THE MARK.

THE MARK CONSISTS OF A FANCIFUL DEPICTION OF A TULIP, INTENDED TO REPRESENT THE LETTER "U" IN APPLICANT'S CORPORATE NAME. THE COLORS PURPLE-(PANTONE 265 C), GREEN (PANTONE 354 C), BLUE (PANTONE 299 C) AND RED (PANTONE 1788 C) EACH FILLS ONE OF THE 3 QUARTER-CIRCLES AND THE ONE SQUARE THAT COMPRISE THE TULIP, AND ARE ALL CLAIMED AS A FEATURE OF THE MARK.

FOR TELEVISION BROADCASTING (U.S. CLS. 100, 101 AND 104).

FIRST USE 11-30-1989; IN COMMERCE 11-30-1989.

THOMAS MANOR, EXAMINING ATTORNEY

SN 77-675,040. UNIVISION COMMUNICATIONS INC., LOS ANGELES, CA. FILED 2-20-2009.

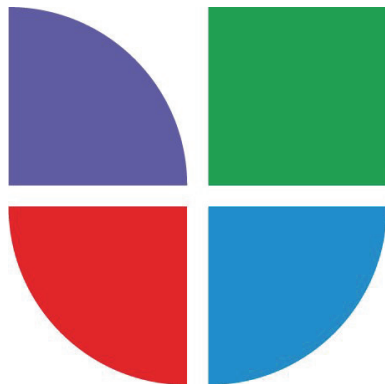

SN 77-724,152. DISH NETWORK L.L.C., ENGLEWOOD, CO. FILED 4-28-2009.

WHY WOULD YOU EVER PAY MORE FOR TV?

OWNER OF U.S. REG. NOS. 1,672,807, 3,568,848 AND 3,570,072.

THE COLOR(S) PURPLE, GREEN, BLUE AND RED IS/ARE CLAIMED AS A FEATURE OF THE MARK.

THE MARK CONSISTS OF A FANCIFUL DEPICTION OF A TULIP, INTENDED TO REPRESENT THE LETTER "U". THE COLORS PURPLE-(PANTONE 265 C), GREEN (PANTONE 354 C), BLUE (PANTONE 299 C) AND RED (PANTONE 1788 C) EACH FILLS ONE OF THE 3 QUARTER-CIRCLES AND THE ONE SQUARE THAT COMPRISE THE TULIP, AND ARE ALL CLAIMED AS A FEATURE OF THE MARK.

FOR RADIO BROADCASTING (U.S. CLS. 100, 101 AND 104).

FIRST USE 9-23-2003; IN COMMERCE 9-23-2003.

THOMAS MANOR, EXAMINING ATTORNEY

THE MARK CONSISTS OF STANDARD CHARACTERS WITHOUT CLAIM TO ANY PARTICULAR FONT, STYLE, SIZE, OR COLOR.

FOR BROADCASTING OF RADIO AND TELEVISION PROGRAMS; SUBSCRIPTION TELEVISION BROADCASTING; SATELLITE COMMUNICATION SERVICES; SATELLITE TELEVISION BROADCASTING SERVICES; RENTAL OF SET-TOP BOXES FOR USE WITH TELEVISIONS; TELEVISION TRANSMISSION SERVICES; TELECOMMUNICATION SERVICES, NAMELY, TRANSMISSION OF AUDIO, VIDEO, DATA AND IMAGES BY MEANS OF BROADBAND POWER LINE, WIRELESS NETWORKS AND FIBER OPTIC TELECOMMUNICATIONS NETWORKS (U.S. CLS. 100, 101 AND 104).

IRA J. GOODSaid, EXAMINING ATTORNEY

CLASS 38—(Continued).

SN 77-724,321. BAND CRASHERS LLC, ALPINE, UT. FILED 4-28-2009.

PARTY CRASHERS

THE MARK CONSISTS OF STANDARD CHARACTERS WITHOUT CLAIM TO ANY PARTICULAR FONT, STYLE, SIZE, OR COLOR.

FOR LIVE STREAMING ON THE INTERNET OF MUSIC, CONCERTS, MOVIES, PARTIES, SPORTS EVENTS AND ANY OTHER EVENTS; STREAMING OF AUDIO, VISUAL AND AUDIOVISUAL MATERIAL VIA GLOBAL COMPUTER NETWORKS; STREAMING OF VIDEO MATERIAL ON THE INTERNET (U.S. CLS. 100, 101 AND 104).

JOHN WILKE, EXAMINING ATTORNEY

SN 77-724,930. APPRISS INC., LOUISVILLE, KY. FILED 4-29-2009.

CJCONNECT

THE MARK CONSISTS OF STANDARD CHARACTERS WITHOUT CLAIM TO ANY PARTICULAR FONT, STYLE, SIZE, OR COLOR.

FOR PROVIDING USER ACCESS TO A DATABASE VIA A GLOBAL COMPUTER NETWORK WHICH ALLOWS USERS TO ACCESS RECORDS MANAGEMENT SYSTEMS OF OTHERS FOR PURPOSES OF INFORMATION SHARING (U.S. CLS. 100, 101 AND 104).

FIRST USE 4-0-2009; IN COMMERCE 4-0-2009.
HANNO RITTNER, EXAMINING ATTORNEY

SN 77-725,055. BLUEGRASS CELLULAR INC., ELIZABETH-TOWN, KY. FILED 4-29-2009.

TREATING CUSTOMERS LIKE GOOD FRIENDS

THE MARK CONSISTS OF STANDARD CHARACTERS WITHOUT CLAIM TO ANY PARTICULAR FONT, STYLE, SIZE, OR COLOR.

FOR WIRELESS COMMUNICATION SERVICES, NAMELY, WIRELESS TELEPHONE COMMUNICATIONS SERVICES AND CALLING PLANS; WIRELESS VOICE, DATA, AND PICTURE MESSAGING SERVICES; WIRELESS INTERNET CONNECTION SERVICES; AND PAGING SERVICES (U.S. CLS. 100, 101 AND 104).

DEBRA LEE, EXAMINING ATTORNEY

CLASS 38—(Continued).

SN 77-725,287. FIVE POINT NETWORKS, NEW YORK, NY. FILED 4-29-2009.

Xykast

THE MARK CONSISTS OF STANDARD CHARACTERS WITHOUT CLAIM TO ANY PARTICULAR FONT, STYLE, SIZE, OR COLOR.

FOR TRANSMISSION OF LIVE SOUND AND VIDEO FROM WEB CAMS, VIDEO CAMERAS OR MOBILE PHONES, ALL FEATURING LIVE, REAL-TIME CONTENT (U.S. CLS. 100, 101 AND 104).

FIRST USE 4-15-2005; IN COMMERCE 12-1-2008.
LINDA MICKLEBURGH, EXAMINING ATTORNEY

SN 77-726,634. TUCOWS (DELAWARE) INC., WILMINGTON, DE. FILED 4-30-2009.

BUTTERSCOTCH

THE MARK CONSISTS OF STANDARD CHARACTERS WITHOUT CLAIM TO ANY PARTICULAR FONT, STYLE, SIZE, OR COLOR.

FOR VIDEO BROADCASTING SERVICES OVER THE INTERNET OR OTHER COMMUNICATIONS NETWORK, NAMELY, SHOWING, DISPLAYING, AND ELECTRONICALLY TRANSMITTING VIDEO CLIPS (U.S. CLS. 100, 101 AND 104).

FIRST USE 9-0-2008; IN COMMERCE 9-0-2008.
ERNEST SHOSHO, EXAMINING ATTORNEY

CLASS 38—(Continued).

SN 77-728,776. LUNA, MARCUS A., HENDERSON, NV. FILED 5-4-2009.

MACHO TV

THE MARK CONSISTS OF STANDARD CHARACTERS WITHOUT CLAIM TO ANY PARTICULAR FONT, STYLE, SIZE, OR COLOR.

NO CLAIM IS MADE TO THE EXCLUSIVE RIGHT TO USE "TV", APART FROM THE MARK AS SHOWN.

FOR AUDIO AND VIDEO BROADCASTING SERVICES OVER THE INTERNET; BROADCAST OF CABLE TELEVISION PROGRAMMES; BROADCASTING OF TELEVISION PROGRAMMES; BROADCASTING OF VIDEO AND AUDIO PROGRAMMING OVER THE INTERNET; BROADCASTING PROGRAMS VIA A GLOBAL COMPUTER NETWORK; BROADCASTING SERVICES AND PROVISION OF TELECOMMUNICATION ACCESS TO FILMS AND TELEVISION PROGRAMMES PROVIDED VIA A VIDEO-ON-DEMAND SERVICE; BROADCASTING SERVICES AND PROVISION OF TELECOMMUNICATION ACCESS TO VIDEO AND AUDIO CONTENT PROVIDED VIA A VIDEO-ON-DEMAND SERVICE VIA THE INTERNET; CABLE TELEVISION BROADCASTING; INTERACTIVE DELIVERY OF VIDEO OVER DIGITAL NETWORKS; INTERNET BROADCASTING SERVICES (U.S. CLS. 100, 101 AND 104).

STEVEN R. FOSTER, EXAMINING ATTORNEY

SN 77-729,276. K & W DEVELOPMENT LLC, DBA NETWEDS, GARY, IN. FILED 5-5-2009.



THE MARK CONSISTS OF A DESIGN OF A HEART-SHAPED JEWELRY BOX CONTAINING TWO RINGS; TO THE RIGHT OF THE DESIGN IS THE STYLIZED TERM "NETWEDS".

FOR AUDIO AND VIDEO BROADCASTING SERVICES OVER THE INTERNET (U.S. CLS. 100, 101 AND 104).

BENJAMIN OKEKE, EXAMINING ATTORNEY

CLASS 39—TRANSPORTATION AND STORAGE

SN 76-694,926. MIDAMERICAN ENERGY COMPANY, DES MOINES, IA. FILED 12-23-2008.

ENERGY EFFICIENCY FROM YOUR ENERGY COMPANY

THE MARK CONSISTS OF STANDARD CHARACTERS WITHOUT CLAIM TO ANY PARTICULAR FONT, STYLE, SIZE, OR COLOR.

FOR PUBLIC UTILITY SERVICES IN THE NATURE OF THE TRANSMISSION AND DISTRIBUTION OF GAS AND ELECTRICITY (U.S. CLS. 100 AND 105).

FIRST USE 12-1-2008; IN COMMERCE 12-1-2008. DAVON HATCHETT, EXAMINING ATTORNEY

SN 77-201,871. EVERY CREATURE COUNTS, BYERS, CO. FILED 6-8-2007.

Every Creature Counts

THE MARK CONSISTS OF STANDARD CHARACTERS WITHOUT CLAIM TO ANY PARTICULAR FONT, STYLE, SIZE, OR COLOR.

FOR NON-PROFIT ANIMAL RESCUE (U.S. CLS. 100 AND 105).

FIRST USE 1-1-1995; IN COMMERCE 1-1-1995. NICHOLAS COLEMAN, EXAMINING ATTORNEY

SN 77-350,643. SILVER PLATTER DELIVERY, LLC, PLEASANT GROVE, UT. FILED 12-12-2007.

Silver Platter Delivery

THE MARK CONSISTS OF STANDARD CHARACTERS WITHOUT CLAIM TO ANY PARTICULAR FONT, STYLE, SIZE, OR COLOR.

NO CLAIM IS MADE TO THE EXCLUSIVE RIGHT TO USE "DELIVERY", APART FROM THE MARK AS SHOWN. FOR FOOD DELIVERY SERVICES (U.S. CLS. 100 AND 105).

FIRST USE 11-1-2007; IN COMMERCE 11-2-2007. RONALD AIKENS, EXAMINING ATTORNEY

CLASS 39—(Continued).

SN 77-371,702. JORGENSEN INDUSTRIES, LLC, LOUISVILLE, KY. FILED 1-15-2008.

Filco

THE MARK CONSISTS OF STANDARD CHARACTERS WITHOUT CLAIM TO ANY PARTICULAR FONT, STYLE, SIZE, OR COLOR.

FOR PACKAGING ARTICLES TO THE ORDER AND SPECIFICATION OF OTHERS (U.S. CLS. 100 AND 105). FIRST USE 1-27-2008; IN COMMERCE 1-27-2008. MICHELLE DUBOIS, EXAMINING ATTORNEY

CLASS 39—(Continued).

SN 77-541,985. HARRIS PROFESSIONAL CONSULTING, DBA FILEACCESS365.COM, DOUGLASVILLE, GA. FILED 8-7-2008.



"Your Files. Anytime...Anywhere!"

SN 77-385,516. KINGFISHER AIRLINES LIMITED, BANGALORE, INDIA, FILED 1-31-2008.



NO CLAIM IS MADE TO THE EXCLUSIVE RIGHT TO USE "FLY" FOR "AIR TRANSPORT SERVICES" AND "AIRLINE TRANSPORTATION SERVICES", APART FROM THE MARK AS SHOWN.

FOR AIR TRANSPORT SERVICES; PACKAGING ARTICLES FOR TRANSPORTATION AND STORAGE OF GOODS; COORDINATING TRAVEL ARRANGEMENTS FOR INDIVIDUALS AND GROUPS; AIRLINE TRANSPORTATION SERVICES (U.S. CLS. 100 AND 105). BARBARA GAYNOR, EXAMINING ATTORNEY

NO CLAIM IS MADE TO THE EXCLUSIVE RIGHT TO USE "FILE ACCESS", APART FROM THE MARK AS SHOWN.

THE COLOR(S) BLACK, GOLD, AND GRAY IS/ARE CLAIMED AS A FEATURE OF THE MARK.

THE MARK CONSISTS OF THE WORD "FILE" WRITTEN IN LARGE BLACK, BLOCKED LETTERS APPEARING ABOVE THE WORD "ACCESS", WHICH IS WRITTEN IN SMALLER BLACK, BLOCKED LETTERS, BUT OF EQUAL LENGTH TO THE ABOVE WORD. TO THE LEFT OF THE WORDS "FILE" AND "ACCESS" IS A PARTIALLY OPENED GOLD FILE FOLDER, WITH 2 (TWO) GOLD KEYS ON TOP OF THE FOLDER. TO THE RIGHT OF THE WORDS "FILE" AND "ACCESS" IS THE LIKENESS OF A BLACK/GRAY, FLIP-TYPE CALENDAR GRID PARTIALLY FLIPPED AT THE BOTTOM RIGHT CORNER OF THE CALENDAR'S LIKENESS WITH THE NUMBERS "365", IN GOLD, ACROSS THE FACE OF THE CALENDAR GRID. TO THE RIGHT OF THE CALENDAR GRID AND ON THE SAME LINE AS THE WORD "ACCESS", IS A PERIOD (.) BEFORE THE WORD "COM" WHICH IS IN SMALL BLACK, BLOCKED LETTERS AS WELL. THERE IS A LINE THE STRETCHES THROUGH THE ENTIRE IMAGE FROM LEFT TO RIGHT FADING AS IT GOES. THE LINE STARTS TO THE LEFT OF THE GOLD FILE FOLDER AND GOES BEHIND THE GOLD FOLDER AND THE 2 GOLD KEYS. THE LINE CONTINUES AS IT SEPARATES THE WORDS "FILE" AND "ACCESS" ("FILE" ABOVE THE LINE, "ACCESS" BELOW THE LINE), THE LINE CONTINUES AS IT BEGINS TO FADE, RUNNING BEHIND THE CALENDAR GRID AND ENDING JUST ABOVE THE TOP OF THE "M" IN ".COM" BELOW THE ABOVE IMAGES ARE THE FOLLOWING WORDS WRITTEN WITH QUOTATION MARKS AND STRETCHING THE LENGTH OF THE IMAGE: "YOUR FILES. ANYTIME. . . ANYWHERE!"

SN 77-510,032. YACHSERV, MOREHEAD CITY, NC. FILED 6-27-2008.



THE COLOR(S) BLUE IS/ARE CLAIMED AS A FEATURE OF THE MARK.

THE MARK CONSISTS OF THE COLOR BLUE APPEARING IN THE DESIGN OF THE SURROUNDING ROPE AND THE ANCHOR AND IN THE WORDS "YACHTSERV".

FOR MARINA SERVICES (U.S. CLS. 100 AND 105). CHARLES L. JENKINS, EXAMINING ATTORNEY

FOR ELECTRONIC STORAGE OF FILES AND DOCUMENTS; ELECTRONIC STORAGE OF ELECTRONIC FILES AND PROJECTS; PROVIDING A WEB SITE FOR THE ELECTRONIC STORAGE OF DIGITAL PHOTOGRAPHS AND VIDEOS; STORAGE OF ELECTRONIC MEDIA, NAMELY, IMAGES, TEXT AND AUDIO DATA; STORAGE SERVICES FOR ARCHIVING DATABASES, IMAGES AND OTHER ELECTRONIC DATA (U.S. CLS. 100 AND 105).

LESLEY LAMOTHE, EXAMINING ATTORNEY

CLASS 39—(Continued).

SN 77-568,189. UST INVESTMENTS, LLC, DES PLAINES, IL. FILED 9-11-2008.

TAXI TECH

THE MARK CONSISTS OF STANDARD CHARACTERS WITHOUT CLAIM TO ANY PARTICULAR FONT, STYLE, SIZE, OR COLOR.

NO CLAIM IS MADE TO THE EXCLUSIVE RIGHT TO USE "TECH", APART FROM THE MARK AS SHOWN.

FOR TRANSPORTING AIRCRAFT IN THE NATURE OF GROUND TRANSPORTATION WITH THE USE OF MACHINERY; TOWING OR PUSHING AIRCRAFT FROM ONE LOCATION TO ANOTHER LOCATION, NAMELY, TO AND FROM AIRPORTS, AIRPORT TERMINALS, AIRPORT RUNWAYS AND AIRPORT HANGARS; PROVIDING TRANSIT OF AIRCRAFT FOR THE PURPOSE OF ROUTINE REPAIR AND MAINTENANCE (U.S. CLS. 100 AND 105).

JULIE GUTTADAURO, EXAMINING ATTORNEY

SN 77-601,499. OAG WORLDWIDE LIMITED, DUNSTABLE, UNITED KINGDOM, FILED 10-27-2008.

LAND WITH A PLAN

THE MARK CONSISTS OF STANDARD CHARACTERS WITHOUT CLAIM TO ANY PARTICULAR FONT, STYLE, SIZE, OR COLOR.

FOR PROVIDING ON-LINE NEWS AND INFORMATION REGARDING AIRLINE FLIGHT ARRIVALS AND DEPARTURES WORLDWIDE; TRAVEL INFORMATION SERVICES PROVIDING VIA THE INTERNET FOR ACCESS BY COMPUTER OR MOBILE TELEPHONE PERMITTING VIEWING OF AIRLINE FLIGHT INFORMATION AND THE BOOKING OF AIRLINE FLIGHTS (U.S. CLS. 100 AND 105).

FIRST USE 10-1-2008; IN COMMERCE 10-1-2008.
KAREN K. BUSH, EXAMINING ATTORNEY

SN 77-611,164. OLYMPIC SOCCER ACADEMY, LLC, SEATTLE, WA. FILED 11-10-2008.

OSA SOCCER ACADEMY

THE MARK CONSISTS OF STANDARD CHARACTERS WITHOUT CLAIM TO ANY PARTICULAR FONT, STYLE, SIZE, OR COLOR.

NO CLAIM IS MADE TO THE EXCLUSIVE RIGHT TO USE "SOCCER ACADEMY", APART FROM THE MARK AS SHOWN.

FOR MAKING TRAVEL AND EXCURSION ARRANGEMENTS FOR INDIVIDUALS AND FOR GROUPS; TRANSPORTATION OF PASSENGERS AND PASSENGERS' LUGGAGE (U.S. CLS. 100 AND 105).

TINA BROWN, EXAMINING ATTORNEY

CLASS 39—(Continued).

SN 77-612,789. OLYMPIC SOCCER ACADEMY, LLC, SEATTLE, WA. FILED 11-12-2008.



NO CLAIM IS MADE TO THE EXCLUSIVE RIGHT TO USE "SOCCER ACADEMY", APART FROM THE MARK AS SHOWN.

THE MARK CONSISTS OF THE LETTERS "OSA" IN A STYLIZED CURSIVE FONT WITH THE LETTER "S" AROUND A SOCCER BALL, AND THE WORDS "SOCCER", WITH A BLACK BOX AROUND IT, AND "ACADEMY" STACKED BELOW "OSA" AND THE SOCCER BALL.

FOR MAKING TRAVEL AND EXCURSION ARRANGEMENTS FOR INDIVIDUALS AND FOR GROUPS; TRANSPORTATION OF PASSENGERS AND PASSENGERS' LUGGAGE (U.S. CLS. 100 AND 105).

TINA BROWN, EXAMINING ATTORNEY

SN 77-613,608. TRANSEXRESS, INC., MIAMI, FL. FILED 11-13-2008.



OWNER OF U.S. REG. NO. 3,501,026.
NO CLAIM IS MADE TO THE EXCLUSIVE RIGHT TO USE "GLOBAL E-COMMERCE LOGISTICS" AND "INTERNATIONAL ON-LINE PURCHASES DELIVERY SERVICE", APART FROM THE MARK AS SHOWN.

THE COLOR(S) BLUE AND RED IS/ARE CLAIMED AS A FEATURE OF THE MARK.

THE MARK CONSISTS OF THE WORDS "GLOBAL E-COMMERCE LOGISTICS" APPEARING IN BLUE ABOVE THE STYLIZED HYPHENATED WORDS "TRANS-EXRESS" APPEARING IN BLUE WITH THE BOTTOM OF THE "T" CURVING TO UNDERLINE THE WORDS UP UNTIL THE SECOND "E" IN "EXPRESS". BELOW THIS APPEARS THE STYLIZED SLOGAN "INTERNATIONAL ON-LINE PURCHASES DELIVERY SERVICE" IN RED.

FOR POSTAL SERVICES, NAMELY, PARCEL DELIVERY, PACKAGING ARTICLES FOR GLOBAL TRANSPORTATION, RENTAL OF MAIL BOXES (U.S. CLS. 100 AND 105).

FIRST USE 9-26-2008; IN COMMERCE 9-26-2008.
LINDA MICKLEBURGH, EXAMINING ATTORNEY

CLASS 39—(Continued).

SN 77-697,173. CHINA CYTS TOURS HOLDING CO., LTD, BEIJING, CHINA, FILED 3-23-2009.



THE MARK CONSISTS OF THE WORD "CYTS".
 FOR ARRANGING CRUISES; TRANSPORT OF TRAVELERS; TOURIST OFFICE SERVICES; ESCORTING FOR TRAVELERS; ORGANIZATION OF SIGHT SEEING TOURS; ARRANGEMENT OF TRAVEL; TRAVEL RESERVATION, NAMELY, RESERVATION AND BOOKING OF SEATS FOR TRAVEL, TRAVEL AND TOUR TICKET RESERVATION SERVICE; CHAUFFEUR SERVICES; COACH RENTAL (U.S. CLS. 100 AND 105).

KATHERINE E. HALMEN, EXAMINING ATTORNEY

SN 77-697,175. CHINA CYTS TOURS HOLDING CO., LTD, BEIJING, CHINA, FILED 3-23-2009.



THE MARK CONSISTS OF A CIRCLE WITH A MISCELLANEOUS DESIGN.

FOR ARRANGING CRUISES; TRANSPORT OF TRAVELERS; TOURIST OFFICE SERVICES; ESCORTING FOR TRAVELERS; ORGANIZATION OF SIGHT SEEING TOURS; ARRANGEMENT OF TRAVEL; TRAVEL RESERVATION, NAMELY, RESERVATION AND BOOKING OF SEATS FOR TRAVEL, TRAVEL AND TOUR TICKET RESERVATION SERVICE; CHAUFFEUR SERVICES; COACH RENTAL (U.S. CLS. 100 AND 105).

KATHERINE E. HALMEN, EXAMINING ATTORNEY

CLASS 39—(Continued).

SN 77-703,783. TIKI TRIPS, LLC, DBA TIKI TRIPS, DALLAS, TX, FILED 3-31-2009.



NO CLAIM IS MADE TO THE EXCLUSIVE RIGHT TO USE "TRIPS", APART FROM THE MARK AS SHOWN.

THE COLOR(S) RED, ORANGE, YELLOW, GREEN, BROWN, BLUE AND BLACK IS/ARE CLAIMED AS A FEATURE OF THE MARK.

THE MARK CONSISTS OF THE WORDING "TIKI TRIPS" IN RED AND BLACK OUTLINE, THE PALM FRONDS ON THE RIGHT SIDE OF THE MARK ARE GREEN WITH BROWN TRUNKS, THE TIKI HEAD ON THE LEFT SIDE OF THE MARK IS BLUE WITH A YELLOW AND BROWN MOUTH SIMULATING FLAMES, AND THE BACKGROUND IS DARK ORANGE AT THE TOP WHICH FADES TO LIGHT YELLOW MIDWAY THROUGH THE NAME "TIKI TRIPS". ALL OF THE AFOREMENTIONED APPEARING IN A RECTANGULAR DESIGN.

FOR TRAVEL BOOKING AGENCIES (U.S. CLS. 100 AND 105).

FIRST USE 4-25-2004; IN COMMERCE 5-21-2004.
 DAVID COLLIER, EXAMINING ATTORNEY

SN 77-712,995. FIRST CLASS EXECUTIVE LIMO, LLC, PHOENIX, AZ, FILED 4-13-2009.



NO CLAIM IS MADE TO THE EXCLUSIVE RIGHT TO USE "EXECUTIVE LIMO, LLC.", APART FROM THE MARK AS SHOWN.

THE MARK CONSISTS OF THE STYLIZED TEXT "FIRST CLASS EXECUTIVE LIMO, LLC.".

FOR LIMOUSINE AND EXECUTIVE HIRED CAR TRANSPORT SERVICES (U.S. CLS. 100 AND 105).

FIRST USE 8-1-2006; IN COMMERCE 8-1-2006.
 KIM SAITO, EXAMINING ATTORNEY

CLASS 39—(Continued).

SN 77-722,326. VOYLES, RICKY, WYNNE, AR. FILED 4-24-2009.

Snatch-A-Part

THE MARK CONSISTS OF STANDARD CHARACTERS WITHOUT CLAIM TO ANY PARTICULAR FONT, STYLE, SIZE, OR COLOR.

FOR AUTOMOBILE SALVAGE (U.S. CLS. 100 AND 105).

FONG HSU, EXAMINING ATTORNEY

SN 77-722,356. LARF, INC., LOS ANGELES, CA. FILED 4-24-2009.

Amazing Los Angeles Race

THE MARK CONSISTS OF STANDARD CHARACTERS WITHOUT CLAIM TO ANY PARTICULAR FONT, STYLE, SIZE, OR COLOR.

NO CLAIM IS MADE TO THE EXCLUSIVE RIGHT TO USE "LOS ANGELES RACE", APART FROM THE MARK AS SHOWN.

FOR ARRANGING EXCURSIONS FOR TOURISTS (U.S. CLS. 100 AND 105).

FIRST USE 3-1-2008; IN COMMERCE 3-1-2008.
SUE LAWRENCE, EXAMINING ATTORNEY

SN 77-723,679. SPIRIT AIRLINES, INC., MIRAMAR, FL. FILED 4-28-2009.



OWNER OF U.S. REG. NOS. 3,047,380, 3,536,946 AND OTHERS.

THE COLOR(S) BLUE AND RED IS/ARE CLAIMED AS A FEATURE OF THE MARK.

THE MARK CONSISTS OF A STYLIZED "SPIRIT" COMPRISED OF THE TEXT IN BLUE, EXCEPT FOR THE NON-VERTICAL PORTION OF THE "R" THAT IS RED.

FOR TRANSPORTATION OF GOODS, PASSENGERS AND TRAVELLERS BY AIR (U.S. CLS. 100 AND 105).

FIRST USE 9-26-2007; IN COMMERCE 9-26-2007.
BRIAN CALLAGHAN, EXAMINING ATTORNEY

CLASS 39—(Continued).

SN 77-724,482. MARGO BRANDANO LLC, KENSINGTON, NH. FILED 4-28-2009.



THE MARK CONSISTS OF A DEPICTION OF BENCH, FOR STORAGE SERVICES FOR ARCHIVING DATABASES OF VOICE RECORDINGS (U.S. CLS. 100 AND 105).

NAKIA HENRY, EXAMINING ATTORNEY

SN 77-724,786. FRANCES BLAKE WILLIAMS TAHA, EAST ELMHURST, NY. FILED 4-29-2009.

A FLEET OF WON

THE MARK CONSISTS OF STANDARD CHARACTERS WITHOUT CLAIM TO ANY PARTICULAR FONT, STYLE, SIZE, OR COLOR.

FOR LIMOUSINE SERVICES (U.S. CLS. 100 AND 105).

FRED MANDIR, EXAMINING ATTORNEY

SN 77-724,840. GRACE VAN POOL SERVICE, STAFFORD, VA. FILED 4-29-2009.

Grace Van Pool Service
"His grace is sufficient
for thee"

THE MARK CONSISTS OF STANDARD CHARACTERS WITHOUT CLAIM TO ANY PARTICULAR FONT, STYLE, SIZE, OR COLOR.

NO CLAIM IS MADE TO THE EXCLUSIVE RIGHT TO USE "VAN POOL SERVICE", APART FROM THE MARK AS SHOWN.

FOR TRANSPORTATION OF PASSENGERS AND/OR GOODS BY VAN (U.S. CLS. 100 AND 105).

FIRST USE 3-23-2009; IN COMMERCE 3-23-2009.
MARK RADEMACHER, EXAMINING ATTORNEY

CLASS 39—(Continued).

SN 77-724,912. ALLFR8 LOGISTICS, INC., JACKSONVILLE, FL. FILED 4-29-2009.



THE MARK CONSISTS OF THE STYLIZED LETTERS AND NUMBER "ALLFR8". AN IMAGE OF A SWOOSH-LIKE SYMBOL ABOVE THE STYLIZED LETTERS AND NUMBERS.
FOR FREIGHT BROKERAGE (U.S. CLS. 100 AND 105).
DEIRDRE ROBERTSON, EXAMINING ATTORNEY

SN 77-725,074. MID-ATLANTIC SERVICES GROUP, INC., DBA UNIPARK, SILVER SPRING, MD. FILED 4-29-2009.

UNIPARK

THE MARK CONSISTS OF STANDARD CHARACTERS WITHOUT CLAIM TO ANY PARTICULAR FONT, STYLE, SIZE, OR COLOR.
FOR PARKING LOT SERVICES; TRANSPORTATION OF PASSENGERS AND/OR GOODS BY VEHICLE; VALET PARKING (U.S. CLS. 100 AND 105).
FIRST USE 12-31-1965; IN COMMERCE 12-31-1965.
MICHAEL ENGEL, EXAMINING ATTORNEY

SN 77-726,258. NORTH STATE STORAGE, LLC, DURHAM, NC. FILED 4-30-2009.

NORTH STATE STORAGE

THE MARK CONSISTS OF STANDARD CHARACTERS WITHOUT CLAIM TO ANY PARTICULAR FONT, STYLE, SIZE, OR COLOR.
OWNER OF U.S. REG. NO. 2,724,601.
NO CLAIM IS MADE TO THE EXCLUSIVE RIGHT TO USE "STORAGE", APART FROM THE MARK AS SHOWN.
FOR PROVIDING SELF-STORAGE FACILITIES FOR OTHERS (U.S. CLS. 100 AND 105).
FIRST USE 6-30-1999; IN COMMERCE 6-30-2001.
SALLY SHIH, EXAMINING ATTORNEY

CLASS 39—(Continued).

SN 77-726,553. PRICE SELF STORAGE HOLDINGS, LLC, SAN DIEGO, CA. FILED 4-30-2009.

Best Price Self Storage

THE MARK CONSISTS OF STANDARD CHARACTERS WITHOUT CLAIM TO ANY PARTICULAR FONT, STYLE, SIZE, OR COLOR.
OWNER OF U.S. REG. NO. 2,833,449.
NO CLAIM IS MADE TO THE EXCLUSIVE RIGHT TO USE "SELF STORAGE", APART FROM THE MARK AS SHOWN.
SEC. 2(F).
FOR PROVIDING SELF-STORAGE FACILITIES FOR OTHERS (U.S. CLS. 100 AND 105).
FIRST USE 1-2-2003; IN COMMERCE 1-2-2003.
JULIE WATSON, EXAMINING ATTORNEY

SN 77-754,226. MID-ATLANTIC SERVICES GROUP, INC., DBA UNIPARK, SILVER SPRING, MD. FILED 6-8-2009.



THE MARK CONSISTS OF "UNIPARK" AND A CURVED ROAD WITH LANE STRIPING.
FOR PARKING LOT SERVICES; TRANSPORTATION OF PASSENGERS AND/OR GOODS BY VEHICLE; VALET PARKING (U.S. CLS. 100 AND 105).
FIRST USE 12-31-1965; IN COMMERCE 12-31-1965.
MICHAEL ENGEL, EXAMINING ATTORNEY

SN 77-757,539. UNION DEVELOPMENT FINANCIAL, INC., CERRITOS, CA. FILED 6-11-2009.

**SOLVING YOUR NEED FOR
SPACE & SUPPLIES**

THE MARK CONSISTS OF STANDARD CHARACTERS WITHOUT CLAIM TO ANY PARTICULAR FONT, STYLE, SIZE, OR COLOR.
FOR PROVIDING SELF-STORAGE FACILITIES FOR OTHERS (U.S. CLS. 100 AND 105).
FIRST USE 11-0-2007; IN COMMERCE 11-0-2007.
KOURTNEE HODGES, EXAMINING ATTORNEY

CLASS 39—(Continued).

SN 79-067,217. TUI AG, FED REP GERMANY, FILED 11-3-2008.

TUI Cars

THE MARK CONSISTS OF STANDARD CHARACTERS WITHOUT CLAIM TO ANY PARTICULAR FONT, STYLE, SIZE, OR COLOR.

PRIORITY DATE OF 6-18-2008 IS CLAIMED.

OWNER OF INTERNATIONAL REGISTRATION 0998605 DATED 11-3-2008, EXPIRES 11-3-2018.

OWNER OF U.S. REG. NOS. 2,928,468, 3,476,954 AND OTHERS.

NO CLAIM IS MADE TO THE EXCLUSIVE RIGHT TO USE "CARS", APART FROM THE MARK AS SHOWN.

THE WORDING "TUI" HAS NO MEANING IN A FOREIGN LANGUAGE.

FOR WAREHOUSING SERVICES, NAMELY, PACKAGING AND STORAGE OF GOODS; TRANSPORT OF PERSONS AND GOODS, IN PARTICULAR, BY ROAD, RAIL, SEA AND AIR; PORTER SERVICES; TRANSPORT OF MONEY AND VALUABLES; TRAVEL ORGANIZATION; MAKING TRANSPORTATION BOOKINGS FOR TRAVEL, EXCURSION, AND CRUISES; TRAVEL, EXCURSIONS AND CRUISE ARRANGEMENT; ARRANGEMENT OF TRANSPORT SERVICES; RENTAL OF DIVING SUITS; ORGANIZATION, BOOKING AND ARRANGEMENT OF EXCURSIONS, DAY TRIPS AND SIGHTSEEING TOURS; TRAVEL TRANSPORTATION CONSULTANCY; ESCORTING OF TRAVELERS; RENTAL, BOOKING AND PROVIDING OF AIRCRAFT; RENTAL, BOOKING AND PROVIDING OF SHIPS, IN PARTICULAR ROWING AND MOTOR BOATS, SAILING VESSELS AND CANOES, RENTAL, BOOKING AND PROVIDING OF MOTOR VEHICLES, BICYCLES AND HORSES; PARCEL DELIVERY; ORGANIZATION OF TRIPS, HOLIDAYS AND SIGHTSEEING TOURS; TRAVEL AGENCY SERVICES, NAMELY, MAKING RESERVATIONS AND BOOKING FOR TRANSPORTATION, PROVIDING TRAVEL INFORMATION, ARRANGEMENT OF TRANSPORT SERVICES AND TRAVEL, AND CONSULTING RELATING THERETO; RESERVATION AND BOOKING OF SEATS FOR TRAVEL; PROVIDING TRAVEL INFORMATION ON THE INTERNET, NAMELY, INFORMATION ABOUT RESERVATION AND BOOKING IN THE TOURISM AND BUSINESS TRAVEL SECTOR; DELIVERY, DISPATCHING AND DISTRIBUTION OF NEWSPAPERS AND MAGAZINES; PROVIDED TRAVEL CONSULTING THROUGH TELEPHONE CALL CENTERS AND HOTLINES REGARDING TRAVELS, INCLUDING BUSINESS TRAVEL AND IN THE FIELD OF LOGISTICS, TRANSPORT AND STORAGE; LOCATION OF PASSENGER VEHICLES BY COMPUTER OR VIA GLOBAL-POSITIONING SYSTEM (GPS); LOCATION OF FREIGHT VEHICLES BY COMPUTER OR VIA GLOBAL POSITIONING SYSTEM (GPS); TRAFFIC INFORMATION (U.S. CLS. 100 AND 105).

ELI HELLMAN, EXAMINING ATTORNEY

CLASS 40—MATERIAL TREATMENT

SN 77-429,701. VOLVO GROUP CANADA INC., MONTRÉAL, (QUÉBEC), CANADA, FILED 3-24-2008.

LFS ARTIC

OWNER OF CANADA REG. NO. TMA738414, DATED 4-21-2009, EXPIRES 4-21-2014.

OWNER OF U.S. REG. NOS. 2,699,741, 3,507,000 AND OTHERS.

NO CLAIM IS MADE TO THE EXCLUSIVE RIGHT TO USE "ARTIC", APART FROM THE MARK AS SHOWN.

SEC. 2(F) AS TO "LFS".

FOR MANUFACTURE OF GENERAL PRODUCT LINES IN THE FIELD OF AUTOMOBILES, NAMELY, BUSES, TO THE ORDER AND SPECIFICATION OF OTHERS (U.S. CLS. 100, 103 AND 106).

MYRIAH HABEEB, EXAMINING ATTORNEY

SN 77-451,563. CRAFTMASTER RESTORATION, INC., CLEVELAND, OH. FILED 4-18-2008.

MOSES

THE MARK CONSISTS OF STANDARD CHARACTERS WITHOUT CLAIM TO ANY PARTICULAR FONT, STYLE, SIZE, OR COLOR.

FOR PROVIDING MOBILE EMERGENCY OPERATION SERVICES TO DAMAGED HOMES OR BUSINESSES IN THE NATURE OF RENTING HIGH-POWERED GENERATORS TO PROVIDE POWER, MULTIPLE IONIZATION UNITS FOR PURIFYING AIR, SPACE HEATING APPARATUS IN THE NATURE OF FURNACES TO PREVENT FREEZING PIPES, AND MOLD REMEDIATION EQUIPMENT IN THE NATURE OF WATER EXTRACTORS AND AIR MOVERS TO AID IN REDUCING MOLD GROWTH AND MINIMIZING FURTHER STRUCTURAL DAMAGE (U.S. CLS. 100, 103 AND 106).

DAYNA BROWNE, EXAMINING ATTORNEY

SN 77-486,880. DINO GASPARI MANUFACTURER INC., DBA DINO GASPARI, MONTREAL, CANADA, FILED 5-30-2008.

Dino Gaspari

THE MARK CONSISTS OF STANDARD CHARACTERS WITHOUT CLAIM TO ANY PARTICULAR FONT, STYLE, SIZE, OR COLOR.

THE NAME "DINO GASPARI" DOES NOT IDENTIFY A LIVING INDIVIDUAL.

FOR CUSTOM MANUFACTURER OF FUR AND CLOTH COATS AND ACCESSORIES FOR OTHERS (U.S. CLS. 100, 103 AND 106).

FIRST USE 4-0-1992; IN COMMERCE 4-0-1992.

SOPHIA S. KIM, EXAMINING ATTORNEY

CLASS 40—(Continued).

SN 77-491,424. GENERATION ENERGY, INC., STERLING, VA. FILED 6-5-2008.

GENERATION ENERGY

THE MARK CONSISTS OF STANDARD CHARACTERS WITHOUT CLAIM TO ANY PARTICULAR FONT, STYLE, SIZE, OR COLOR.

NO CLAIM IS MADE TO THE EXCLUSIVE RIGHT TO USE "ENERGY", APART FROM THE MARK AS SHOWN.

FOR PRODUCTION OF ENERGY, NAMELY, WIND ENERGY, SOLAR THERMAL ENERGY AND GEOTHERMAL ENERGY (U.S. CLS. 100, 103 AND 106).

FIRST USE 3-0-2006; IN COMMERCE 3-0-2006.

CIMMERIAN COLEMAN, EXAMINING ATTORNEY

SN 77-548,265. STAHL'S INC., ST. CLAIR SHORES, MI. FILED 8-15-2008.

CAD-PRINTZ

THE MARK CONSISTS OF STANDARD CHARACTERS WITHOUT CLAIM TO ANY PARTICULAR FONT, STYLE, SIZE, OR COLOR.

OWNER OF U.S. REG. NO. 2,568,647.

SEC. 2(F).

FOR CUSTOM MANUFACTURE OF HEAT APPLIED IMAGE TRANSFERS TO THE ORDER AND SPECIFICATION OF OTHERS (U.S. CLS. 100, 103 AND 106).

FIRST USE 7-0-2008; IN COMMERCE 7-0-2008.

SUNG IN, EXAMINING ATTORNEY

CLASS 40—(Continued).

SN 77-561,487. DAVIS STEEL AND IRON CO., INC., MATTHEWS, NC. FILED 9-3-2008.



OWNER OF U.S. REG. NO. 2,349,725.

NO CLAIM IS MADE TO THE EXCLUSIVE RIGHT TO USE "STEEL & IRON CO-INC", APART FROM THE MARK AS SHOWN.

THE MARK CONSISTS OF A STYLIZED LETTER "D" BORDERED BY A HALF RECTANGLE AT AN UPPER AND RIGHT SIDE OF THE STYLIZED LETTER, WHEREIN THE STYLIZED LETTER "D" APPEARS ABOVE THE TERMS "DAVIS STEEL" WHICH APPEAR ABOVE THE TERMS "& IRON CO-INC".

FOR CUSTOM STEEL ROLLING AND FABRICATION TO THE ORDER AND SPECIFICATION OF OTHERS (U.S. CLS. 100, 103 AND 106).

FIRST USE 6-15-1997; IN COMMERCE 6-15-1997.

KIM SAITO, EXAMINING ATTORNEY

SN 77-576,161. IN-STORE PROMOTIONS, INC., ROSEVILLE, MN. FILED 9-22-2008.

ICDS

THE MARK CONSISTS OF STANDARD CHARACTERS WITHOUT CLAIM TO ANY PARTICULAR FONT, STYLE, SIZE, OR COLOR.

FOR PRINTING OF ADVERTISING MATTER, NAMELY, COUPONS ON DEMAND BY CONSUMERS PROXIMATE TO WHERE THE COUPONS ARE TO BE USED (U.S. CLS. 100, 103 AND 106).

GINA FINK, EXAMINING ATTORNEY

CLASS 40—(Continued).

SN 77-581,449. BYRD, MAC, DBA RAMSEY PRESS, INC., MAHWAH, NJ. FILED 9-29-2008.



NO CLAIM IS MADE TO THE EXCLUSIVE RIGHT TO USE "HI-DEF PRINTING", APART FROM THE MARK AS SHOWN.

THE COLOR(S) BLACK, BLUE, GREEN, PURPLE AND ORANGE IS/ARE CLAIMED AS A FEATURE OF THE MARK.

THE COLOR BLACK APPEARS IN THE WORDING "HI-DEF PRINTING", THE LINE UNDER THIS WORDING AND THE OUTLINE OF THE TARGET WITH CROSSHAIRS DESIGN; THE COLORS BLUE, GREEN, PURPLE AND ORANGE EACH APPEAR IN ONE OF THE FOUR QUADRANTS OF THE TARGET WITH CROSSHAIRS DESIGN.

FOR OFFSET PRINTING (U.S. CLS. 100, 103 AND 106).
BARNEY CHARLON, EXAMINING ATTORNEY

SN 77-581,486. BYRD, MAC, DBA RAMSEY PRESS, INC., MAHWAH, NJ. FILED 9-29-2008.



NO CLAIM IS MADE TO THE EXCLUSIVE RIGHT TO USE "HIGH-DEFINITION PRINTING", APART FROM THE MARK AS SHOWN.

THE COLOR(S) BLACK, BLUE, GREEN, ORANGE AND PURPLE IS/ARE CLAIMED AS A FEATURE OF THE MARK.

THE COLOR BLACK APPEARS IN THE WORDING "HIGH-DEFINITION PRINTING", THE LINE UNDER THIS WORDING AND THE OUTLINE OF THE TARGET WITH CROSSHAIRS DESIGN; THE COLORS BLUE, GREEN, PURPLE AND ORANGE EACH APPEAR IN ONE OF THE FOUR QUADRANTS OF THE TARGET WITH CROSSHAIRS DESIGN.

FOR OFFSET PRINTING (U.S. CLS. 100, 103 AND 106).
BARNEY CHARLON, EXAMINING ATTORNEY

SN 77-593,601. INSTEO, LONG BEACH, CA. FILED 10-15-2008.



THE MARK CONSISTS OF THE WORD "INSTEEO" AND THE DESIGN OF TWO SHEETS OF PAPER.

FOR DIGITAL ON-DEMAND PRINTING SERVICES OF BOOKS AND OTHER DOCUMENTS (U.S. CLS. 100, 103 AND 106).

FIRST USE 7-1-2005; IN COMMERCE 7-1-2005.
ALICE SUE CARRUTHERS, EXAMINING ATTORNEY

CLASS 40—(Continued).

SN 77-617,898. TURF ALLIANCE, LLC, WELLAND, CANADA, FILED 11-19-2008.

TURF NATION

THE MARK CONSISTS OF STANDARD CHARACTERS WITHOUT CLAIM TO ANY PARTICULAR FONT, STYLE, SIZE, OR COLOR.

NO CLAIM IS MADE TO THE EXCLUSIVE RIGHT TO USE "TURF", APART FROM THE MARK AS SHOWN.

FOR MANUFACTURE OF SYNTHETIC TURF TO THE ORDER AND/OR SPECIFICATION OF OTHERS (U.S. CLS. 100, 103 AND 106).

SAIMA MAKHDOOM, EXAMINING ATTORNEY

SN 77-672,226. JARES, ROY, PHOENIX, AZ. FILED 2-17-2009.

R STEEL DEPOT

THE MARK CONSISTS OF STANDARD CHARACTERS WITHOUT CLAIM TO ANY PARTICULAR FONT, STYLE, SIZE, OR COLOR.

NO CLAIM IS MADE TO THE EXCLUSIVE RIGHT TO USE "STEEL DEPOT", APART FROM THE MARK AS SHOWN.

FOR MANUFACTURING SERVICES FOR OTHERS IN THE FIELD OF STEEL PRODUCTS (U.S. CLS. 100, 103 AND 106).

MATTHEW KLINE, EXAMINING ATTORNEY

SN 77-694,368. SOO CHIC BOUTIQUE INC., DBA SOO CHIC BOUTIQUE, BLADENBORO, NC. FILED 3-18-2009.



NO CLAIM IS MADE TO THE EXCLUSIVE RIGHT TO USE "DESIGNS", APART FROM THE MARK AS SHOWN.

THE COLOR(S) LIME GREEN, PINK, AND BLACK IS/ARE CLAIMED AS A FEATURE OF THE MARK.

THE MARK CONSISTS OF A LIME GREEN OVAL WITH PINK DOTS AND BLACK OUTLINE CONTAINING THE WORDS "CHIC DESIGNS" IN BLACK.

FOR VINYL PRINTING AND PLOTTING SERVICES (U.S. CLS. 100, 103 AND 106).

FIRST USE 3-17-2009; IN COMMERCE 3-17-2009.
BARBARA BROWN, EXAMINING ATTORNEY

CLASS 40—(Continued).

SN 77-711,919. GREEN CLEAN WATER & WASTE SERVICES, INC. SAN DIEGO, CA. FILED 4-10-2009.



NO CLAIM IS MADE TO THE EXCLUSIVE RIGHT TO USE "WATER & WASTE SERVICES" AND THE PICTORIAL REPRESENTATION OF THE THREE ARROWS RECYCLING SYMBOL, APART FROM THE MARK AS SHOWN.

THE STIPLING IS FOR SHADING PURPOSES ONLY. THE MARK CONSISTS OF AN OCEAN WAVE FLOWING THROUGH THE LETTERS/LOGO; A WORLD GLOBE WITH CIRCULAR ARROWS AROUND IT.

FOR WASTE WATER TREATMENT SERVICES FEATURING VACUUM MANAGEMENT, REMOVAL AND PROCESSING OF CONTAMINATES FROM WATER; ENVIRONMENTAL REMEDIATION SERVICES, NAMELY, SOIL, WASTE AND/OR WATER TREATMENT FACILITIES (U.S. CLS. 100, 103 AND 106).

FIRST USE 7-14-2008; IN COMMERCE 7-14-2008.
THOMAS MANOR, EXAMINING ATTORNEY

CLASS 40—(Continued).

SN 77-716,371. FUTURE TEK, INC., COLUMBUS, MS. FILED 4-17-2009.

Future Tek, Inc.

THE MARK CONSISTS OF STANDARD CHARACTERS WITHOUT CLAIM TO ANY PARTICULAR FONT, STYLE, SIZE, OR COLOR.

NO CLAIM IS MADE TO THE EXCLUSIVE RIGHT TO USE TECH, INC., APART FROM THE MARK AS SHOWN.

FOR MANUFACTURE OF EDUCATIONAL TRAINERS IN THE NATURE OF MODELS USED TO PRACTICE VOCATIONAL SKILLS TO THE ORDER AND/OR SPECIFICATION OF OTHERS (U.S. CLS. 100, 103 AND 106).

FIRST USE 12-24-1997; IN COMMERCE 12-24-1997.
TARAH HARDY, EXAMINING ATTORNEY

SN 77-716,132. BACK THRU THE FUTURE COMPUTER RECYCLING, INC., OGDENSBURG, NJ. FILED 4-17-2009.



OWNER OF U.S. REG. NO. 3,556,578.

NO CLAIM IS MADE TO THE EXCLUSIVE RIGHT TO USE "EXPRESS", APART FROM THE MARK AS SHOWN.

THE MARK CONSISTS OF THE STYLIZED TEXT "SAFE HARBOR EXPRESS" WITH A COMPUTER HARD DRIVE ON THE LEFT.

FOR ELECTRONIC EQUIPMENT RECYCLING AND DISPOSAL SERVICES, NAMELY, ENVIRONMENTALLY FRIENDLY RECYCLING AND DISPOSAL OF COMPUTER HARDWARE AND COMPUTER PERIPHERAL DEVICES (U.S. CLS. 100, 103 AND 106).

FIRST USE 1-1-2009; IN COMMERCE 1-1-2009.
MICHELE SWAIN, EXAMINING ATTORNEY

SN 77-722,134. LF&P INC., DBA LAMINATED FILMS & PACKAGING, PORTSMOUTH, NH. FILED 4-24-2009.



NO CLAIM IS MADE TO THE EXCLUSIVE RIGHT TO USE "LAMINATED FILMS & PACKAGING", APART FROM THE MARK AS SHOWN.

THE MARK CONSISTS OF THE STYLIZED WORDING "LAMINATEDFILMS & PACKAGING" AND "INFINITE POSSIBILITIES". BELOW THE AMPERSAND IS THE SHADOW OF THE AMPERSAND IN THE SHAPE OF THE INFINITY SYMBOL.

FOR CUSTOM MANUFACTURE OF INDUSTRIAL AND COMMERCIAL FLEXIBLE PACKAGING, NAMELY, FLEXIBLE POUCHES, BAGS, BLANKETS, AND COVERS FOR ELECTRONIC COMPONENTS, INDUSTRIAL COMPONENTS, AND MEDICAL COMPONENTS (U.S. CLS. 100, 103 AND 106).

FIRST USE 4-22-2009; IN COMMERCE 4-22-2009.
BARBARA GAYNOR, EXAMINING ATTORNEY

CLASS 40—(Continued).

SN 77-723,074. SENTAGE CORPORATION, MINNEAPOLIS, MN. FILED 4-27-2009.



THE MARK CONSISTS OF THE WORDS "ONE WITH THE NETWORK" SUPERIMPOSED OVER A STYLIZED GLOBE. FOR DENTAL LAB SERVICES (U.S. CLS. 100, 103 AND 106).

FIRST USE 4-27-2009; IN COMMERCE 4-27-2009.
AMY KERTGATE, EXAMINING ATTORNEY

CLASS 40—(Continued).

SN 77-726,257. GROOVY CHICKS, LLC., TULSA, OK. FILED 4-30-2009.



THE COLOR(S) BLACK, WHITE, PINK IS/ARE CLAIMED AS A FEATURE OF THE MARK.

THE MARK CONSISTS OF THE WORDING "GROOVY CHICKS" IN BLACK WITH DOTS ON THE OUTER CURVE OF THE LETTERS "G" AND "C"; IN BETWEEN THE TERMS "GROOVY" AND "CHICKS" ARE SUNGLASSES IN BLACK AND WHITE, LIPS IN PINK WITH BLACK CONTOUR AND A WHITE LINE ON THE LOWER LIP, CHICKEN LEGS IN BLACK AND WHITE.

FOR CUSTOMIZED IMPRINTING OF COMPANY NAMES AND LOGOS ON THE GOODS OF OTHERS, NAMELY, ON PROMOTIONAL MERCHANDISE, APPAREL AND CORPORATE GIFTS; IMPRINTING MESSAGES ON WEARING APPAREL, ACCESSORIES AND MUGS (U.S. CLS. 100, 103 AND 106).

SALLY SHIH, EXAMINING ATTORNEY

SN 77-724,281. MARK RAY, ALPHARETTA, GA. FILED 4-28-2009.

Shredderman Document Destruction Service

THE MARK CONSISTS OF STANDARD CHARACTERS WITHOUT CLAIM TO ANY PARTICULAR FONT, STYLE, SIZE, OR COLOR.

NO CLAIM IS MADE TO THE EXCLUSIVE RIGHT TO USE "DOCUMENT DESTRUCTION SERVICE", APART FROM THE MARK AS SHOWN.

FOR DOCUMENT SHREDDING SERVICES (U.S. CLS. 100, 103 AND 106).

FIRST USE 5-12-2008; IN COMMERCE 4-14-2009.
ROSELLE HERRERA, EXAMINING ATTORNEY

SN 77-727,271. VOIGT & SCHWEITZER, INC., COLUMBUS, OH. FILED 5-1-2009.

VOIGT & SCHWEITZER

THE MARK CONSISTS OF STANDARD CHARACTERS WITHOUT CLAIM TO ANY PARTICULAR FONT, STYLE, SIZE, OR COLOR.

OWNER OF U.S. REG. NO. 2,343,779.
FOR GALVANIZING SERVICES (U.S. CLS. 100, 103 AND 106).

FIRST USE 0-0-1984; IN COMMERCE 0-0-1984.
EVELYN BRADLEY, EXAMINING ATTORNEY

CLASS 41—EDUCATION AND ENTERTAINMENT

SN 76-679,776. MEDICAL NEWS & ISSUES, INC., SCOTTSDALE, AZ. FILED 7-23-2007.

THE INITIATIVE FOR HOPE

THE MARK CONSISTS OF STANDARD CHARACTERS WITHOUT CLAIM TO ANY PARTICULAR FONT, STYLE, SIZE, OR COLOR.

FOR EDUCATION SERVICES, NAMELY, PROVIDING SEMINARS, WORKSHOPS, CLASSES AND INSTRUCTIONAL MATERIALS TO ASSIST CANCER CENTERS TO IMPLEMENT PATIENT TREATMENT AND BUSINESS STANDARDS OF PRACTICE IN THE FIELD OF HEMATOLOGY AND ONCOLOGY (U.S. CLS. 100, 101 AND 107).

FIRST USE 5-1-2007; IN COMMERCE 5-1-2007.
SHANNON TWOHIG, EXAMINING ATTORNEY

SN 76-685,125. ALBA, VICTOR MANUEL REYES, TEPIC, NAYARIT., MEXICO, FILED 12-20-2007.

VAQUERO'S MUSICAL

THE MARK CONSISTS OF STANDARD CHARACTERS WITHOUT CLAIM TO ANY PARTICULAR FONT, STYLE, SIZE, OR COLOR.

NO CLAIM IS MADE TO THE EXCLUSIVE RIGHT TO USE "MUSICAL", APART FROM THE MARK AS SHOWN.

THE ENGLISH TRANSLATION OF "VAQUERO'S MUSICAL" IS "MUSICAL COWBOYS".

FOR ENTERTAINMENT SERVICES, NAMELY, LIVE PERFORMANCES BY A MUSICAL GROUP (U.S. CLS. 100, 101 AND 107).

FIRST USE 1-1-1990; IN COMMERCE 1-1-1990.
MARY ROSSMAN, EXAMINING ATTORNEY

SN 76-691,603. RIVERA, ANTONIO, APEX, NC. FILED 7-28-2008.

CONJUNTO IRRESISTIBLE

THE MARK CONSISTS OF STANDARD CHARACTERS WITHOUT CLAIM TO ANY PARTICULAR FONT, STYLE, SIZE, OR COLOR.

NO CLAIM IS MADE TO THE EXCLUSIVE RIGHT TO USE "CONJUNTO", APART FROM THE MARK AS SHOWN.

THE ENGLISH TRANSLATION OF "CONJUNTO IRRESISTIBLE" IN THE MARK IS IRRESISTIBLE GROUP.

FOR ENTERTAINMENT SERVICES, NAMELY, LIVE PERFORMANCES BY A MUSICAL BAND (U.S. CLS. 100, 101 AND 107).

HENRY S. ZAK, EXAMINING ATTORNEY

CLASS 41—(Continued).

SN 76-692,562. FESTIVAL OF NORTH AMERICAN ORCHESTRAS INC., NEW YORK, NY. FILED 9-4-2008.



THE MARK CONSISTS OF THE WORDS "SPRING FOR MUSIC" WITH A DESIGN CONSISTING OF HORIZONTAL LINES AND CIRCLES, WITHOUT CLAIM TO ANY PARTICULAR COLOR.

FOR ENTERTAINMENT SERVICES IN THE NATURE OF LIVE MUSICAL PERFORMANCES (U.S. CLS. 100, 101 AND 107).

JORDAN BAKER, EXAMINING ATTORNEY

SN 76-692,827. UNIVERSITY CHEER AIR FORCE, INC., HOUSTON, TX. FILED 9-12-2008.



THE MARK CONSISTS OF GEOMETRIC SHAPES FORMING "WINGS" WITH THE LETTERS "UC" IN THE CENTER OF THE "WINGS" IN A STYLIZED FONT.

FOR COMPETITIVE ALL-STAR CHEERLEADING INSTRUCTION FOR INDIVIDUALS, HIGH SCHOOLS AND MIDDLE SCHOOLS (U.S. CLS. 100, 101 AND 107).

FIRST USE 6-1-2008; IN COMMERCE 6-1-2008.
LANA PHAM, EXAMINING ATTORNEY

CLASS 41—(Continued).

SN 76-695,598. BEXAR COUNTY HOSPITAL DISTRICT, DBA UNIVERSITY HEALTH SYSTEM, SAN ANTONIO, TX. FILED 2-5-2009.



NO CLAIM IS MADE TO THE EXCLUSIVE RIGHT TO USE "CENTER" AND "UNIVERSITY HEALTH SYSTEM", APART FROM THE MARK AS SHOWN.

THE MARK CONSISTS OF "CENTER FOR LEARNING EXCELLENCE UNIVERSITY HEALTH SYSTEM" AND A STYLIZED STAR DESIGN. COLOR IS NOT A FEATURE OF THE MARK.

FOR EDUCATIONAL AND PROFESSIONAL DEVELOPMENT CLASSES OFFERED TO UNIVERSITY HEALTH SYSTEM EMPLOYEES AS WELL AS OTHER PERSONS IN THE HEALTHCARE INDUSTRY (U.S. CLS. 100, 101 AND 107).

FIRST USE 10-23-2008; IN COMMERCE 10-23-2008.
PATRICIA EVANKO, EXAMINING ATTORNEY

SN 76-696,548. STAUFFER, ARLEN R., NEW SMYRNA BEACH, FL. FILED 3-27-2009.

SEASIDE BALLOON FEST

THE MARK CONSISTS OF STANDARD CHARACTERS WITHOUT CLAIM TO ANY PARTICULAR FONT, STYLE, SIZE, OR COLOR.

NO CLAIM IS MADE TO THE EXCLUSIVE RIGHT TO USE "BALLOON FEST", APART FROM THE MARK AS SHOWN.

FOR PROVIDING ENTERTAINMENT IN THE NATURE OF AIR SHOWS AND ORGANIZING AND CONDUCTING ENTERTAINMENT EXHIBITIONS IN THE NATURE OF HOT AIR BALLOON FESTIVALS FEATURING HOT AIR BALLOON SHOWS AND RIDES (U.S. CLS. 100, 101 AND 107).

FIRST USE 1-9-2009; IN COMMERCE 1-9-2009.
AMY ALFIERI, EXAMINING ATTORNEY

CLASS 41—(Continued).

SN 76-697,101. ROLFES, ROBIN, PORTER RANCH, CA. FILED 4-27-2009.



THE MARK CONSISTS OF: A LITTLE BIRD WITH SUNGLASSES SINGING INTO A MICROPHONE ON A STAND. THE MICROPHONE IS SLIGHTLY SMALLER THAN THE BIRD.

FOR PRODUCTION OF SOUND RECORDINGS (U.S. CLS. 100, 101 AND 107).

FIRST USE 4-9-2003; IN COMMERCE 4-9-2003.

GEOFFREY FOSDICK, EXAMINING ATTORNEY

SN 77-120,294. THE INSIDE GAME, LLC, SAN DIEGO, CA. FILED 3-1-2007.

THE INSIDE GAME

THE MARK CONSISTS OF STANDARD CHARACTERS WITHOUT CLAIM TO ANY PARTICULAR FONT, STYLE, SIZE, OR COLOR.

NO CLAIM IS MADE TO THE EXCLUSIVE RIGHT TO USE "GAME", APART FROM THE MARK AS SHOWN.

FOR EDUCATION SERVICES, NAMELY, PROVIDING KEYNOTE LECTURES, TRAINING PROGRAMS, COACHING, CLASSES, TELESEMINARS, ONE-ON-ONE AND GROUP INSTRUCTION, PROGRAMS AND WORKSHOPS IN THE FIELD OF LIFE-ENHANCEMENT, ENHANCEMENT OF PSYCHOLOGICAL WELLBEING AND PERSONAL AND PROFESSIONAL GROWTH AND DEVELOPMENT, THE ATTAINMENT OF PERSONAL GOALS AND ASPIRATIONS, SELF-AWARENESS, PERSONAL GROWTH AND DEVELOPMENT, QUANTUM PHYSICS, BRAIN SCIENCE, AFFIRMATIONS, VISION BOARDING, POSITIVE VISUALIZATION, NEURAL LINGUISTIC PROGRAMMING, AND TIME LINING; DEVELOPMENT AND DISSEMINATION OF EDUCATIONAL AND ENTERTAINMENT MATERIALS FOR OTHERS IN THE FIELDS OF LIFE-ENHANCEMENT, ENHANCEMENT OF PSYCHOLOGICAL WELLBEING AND PERSONAL AND PROFESSIONAL GROWTH AND DEVELOPMENT, THE ATTAINMENT OF PERSONAL GOALS AND ASPIRATIONS, SELF-AWARENESS, PERSONAL GROWTH AND DEVELOPMENT, QUANTUM PHYSICS, BRAIN SCIENCE, AFFIRMATIONS, VISION BOARDING, POSITIVE VISUALIZATION, NEURAL LINGUISTIC PROGRAMMING, AND TIME LINING; EDUCATIONAL AND ENTERTAINMENT SERVICES, NAMELY, PROVIDING MOTIVATIONAL AND EDUCATIONAL SPEAKERS; ON-LINE PUBLICATION OF BOOKS, MAGAZINES, NEWSLETTERS ALL IN THE FIELD OF LIFE-ENHANCEMENT, ENHANCEMENT OF PSYCHOLOGICAL WELLBEING AND PERSONAL AND PROFESSIONAL GROWTH AND DEVELOPMENT, THE ATTAINMENT OF PERSONAL GOALS AND ASPIRATIONS, SELF-AWARENESS, PERSONAL GROWTH AND DEVELOPMENT, QUANTUM PHYSICS, BRAIN SCIENCE, AFFIR-

CLASS 41—(Continued).

MATIONS, VISION BOARDING, POSITIVE VISUALIZATION, NEURAL LINGUISTIC PROGRAMMING, AND TIME LINING; ENTERTAINMENT SERVICES, NAMELY, ARRANGING AND CONDUCTING OF COMPETITIONS FOR CONTESTANTS ON A REALITY TELEVISION SHOW IN THE FIELD OF LIFE-ENHANCEMENT, ENHANCEMENT OF PSYCHOLOGICAL WELLBEING AND PERSONAL AND PROFESSIONAL GROWTH AND DEVELOPMENT, THE ATTAINMENT OF PERSONAL GOALS AND ASPIRATIONS, SELF-AWARENESS, PERSONAL GROWTH AND DEVELOPMENT, QUANTUM PHYSICS, BRAIN SCIENCE, AFFIRMATIONS, VISION BOARDING, POSITIVE VISUALIZATION, NEURAL LINGUISTIC PROGRAMMING, AND TIME LINING; ENTERTAINMENT SERVICES, NAMELY, PERSONAL APPEARANCES BY A MOTIVATIONAL SPEAKERS IN THE FIELD OF LIFE-ENHANCEMENT, ENHANCEMENT OF PSYCHOLOGICAL WELLBEING AND PERSONAL AND PROFESSIONAL GROWTH AND DEVELOPMENT, THE ATTAINMENT OF PERSONAL GOALS AND ASPIRATIONS, SELF-AWARENESS, PERSONAL GROWTH AND DEVELOPMENT, QUANTUM PHYSICS, BRAIN SCIENCE, AFFIRMATIONS, VISION BOARDING, POSITIVE VISUALIZATION, NEURAL LINGUISTIC PROGRAMMING, AND TIME LINING; ENTERTAINMENT SERVICES, NAMELY, PROVIDING A RADIO PROGRAM IN THE FIELD OF LIFE-ENHANCEMENT, ENHANCEMENT OF PSYCHOLOGICAL WELLBEING AND PERSONAL AND PROFESSIONAL GROWTH AND DEVELOPMENT, THE ATTAINMENT OF PERSONAL GOALS AND ASPIRATIONS, SELF-AWARENESS, PERSONAL GROWTH AND DEVELOPMENT, QUANTUM PHYSICS, BRAIN SCIENCE, AFFIRMATIONS, VISION BOARDING, POSITIVE VISUALIZATION, NEURAL LINGUISTIC PROGRAMMING, AND TIME LINING; VIA A GLOBAL COMPUTER NETWORK; ENTERTAINMENT SERVICES, NAMELY, PROVIDING A TELEVISION PROGRAM IN THE FIELD OF LIFE-ENHANCEMENT, ENHANCEMENT OF PSYCHOLOGICAL WELLBEING AND PERSONAL AND PROFESSIONAL GROWTH AND DEVELOPMENT, THE ATTAINMENT OF PERSONAL GOALS AND ASPIRATIONS, SELF-AWARENESS, PERSONAL GROWTH AND DEVELOPMENT, QUANTUM PHYSICS, BRAIN SCIENCE, AFFIRMATIONS, VISION BOARDING, POSITIVE VISUALIZATION, NEURAL LINGUISTIC PROGRAMMING, AND TIME LINING; VIA A GLOBAL COMPUTER NETWORK; ENTERTAINMENT SERVICES, NAMELY, PROVIDING ON-LINE COMPUTER GAMES; ENTERTAINMENT, NAMELY, A CONTINUING REALITY TELEVISION SHOW BROADCAST OVER TELEVISION, SATELLITE, AUDIO, AND VIDEO MEDIA (U.S. CLS. 100, 101 AND 107).

SHAUNIA CARLYLE, EXAMINING ATTORNEY

SN 77-301,029. DAVID ARI LEON, LOS ANGELES, CA.
FILED 10-10-2007.

Sound Mind Music

THE MARK CONSISTS OF STANDARD CHARACTERS WITHOUT CLAIM TO ANY PARTICULAR FONT, STYLE, SIZE, OR COLOR.

NO CLAIM IS MADE TO THE EXCLUSIVE RIGHT TO USE "MUSIC", APART FROM THE MARK AS SHOWN.

FOR MUSIC SELECTION SERVICES, NAMELY, SELECTING AND EDITING MUSIC FOR TV, FILM, VIDEO GAMES, AMUSEMENT PARKS, TOYS AND GREETING CARDS (U.S. CLS. 100, 101 AND 107).

FIRST USE 1-15-2006; IN COMMERCE 1-15-2006.
MICHELE SWAIN, EXAMINING ATTORNEY

CLASS 41—(Continued).

SN 77-326,058. WIMAX FORUM, MOUNTAIN VIEW, CA.
FILED 11-9-2007.

WIMAX FORUM CONGRESS EVENT SERIES

THE MARK CONSISTS OF STANDARD CHARACTERS WITHOUT CLAIM TO ANY PARTICULAR FONT, STYLE, SIZE, OR COLOR.

OWNER OF U.S. REG. NOS. 3,182,504 AND 3,382,736.

NO CLAIM IS MADE TO THE EXCLUSIVE RIGHT TO USE "FORUM CONGRESS EVENT SERIES", APART FROM THE MARK AS SHOWN.

SEC. 2(F) AS TO "WIMAX FORUM".

FOR ARRANGING AND CONDUCTING EDUCATIONAL CONFERENCES; ARRANGING OF SEMINARS AND CONFERENCES; EDUCATIONAL SERVICES, NAMELY, CONDUCTING CONFERENCES, EXPOSITIONS, EXHIBITIONS, SEMINARS, SYMPOSIA AND TRAINING COURSES IN THE FIELD OF WIRELESS TELECOMMUNICATIONS, WIRELESS NETWORKING, WIRELESS NETWORKING PRODUCTS, AND WIRELESS NETWORKING TECHNOLOGY AND DISTRIBUTION OF COURSE MATERIAL IN CONNECTION THEREWITH (U.S. CLS. 100, 101 AND 107).

FIRST USE 6-12-2007; IN COMMERCE 6-12-2007.

ANDREW LEASER, EXAMINING ATTORNEY

SN 77-371,140. CARRIE ARIEMMA, MANAHAWKIN, NJ.
FILED 1-14-2008.



THE NAME APPEARING IN THE MARK IS THE STAGE NAME OF A LIVING INDIVIDUAL, WHOSE CONSENT TO REGISTER IS OF RECORD.

THE COLOR(S) BLACK, PINK AND WHITE IS/ARE CLAIMED AS A FEATURE OF THE MARK.

THE MARK CONSISTS OF THE WORDS "CANDIE LYNN" IN PINK OUTLINING, WITH BOLD BLACK AS FILLER, AND A BLACK OUTLINE SHADOW REFLECTING THE LETTERING, WITH WHITE STREAKS NEAR THE STAR DESIGN, IN THE LETTER "I" AND OTHER PARTS OF THE LETTERING. THE LETTER "I" IN THE WORD "CANDIE" CONSISTS OF A MICROPHONE, WITH A PURPLE STAR, SURROUNDED BY BLACK AND PINK HIGHLIGHTING, AS THE DOT IN THE LETTER "I".

FOR ENTERTAINMENT IN THE NATURE OF LIVE PERFORMANCES BY A SINGER (U.S. CLS. 100, 101 AND 107).

FIRST USE 3-29-2004; IN COMMERCE 3-29-2004.
HENRY S. ZAK, EXAMINING ATTORNEY

CLASS 41—(Continued).

SN 77-377,239. IHHR HOSPITALITY PRIVATE LIMITED, NEW DELHI, INDIA, FILED 1-22-2008.

ananda

THE MARK CONSISTS OF STANDARD CHARACTERS WITHOUT CLAIM TO ANY PARTICULAR FONT, STYLE, SIZE, OR COLOR.

OWNER OF U.S. REG. NO. 3,011,041.

THE FOREIGN WORDING IN THE MARK TRANSLATES INTO ENGLISH AS HAPPINESS OR PLEASURE.

FOR EDUCATIONAL SERVICES, NAMELY, SPA TRAINING EXCLUSIVE OF YOGA FOR EMPLOYEES AND GUESTS AT HEALTH SPA RESORTS (U.S. CLS. 100, 101 AND 107).

WON TEAK OH, EXAMINING ATTORNEY

SN 77-408,343. ECOIST, LLC, MIAMI, FL. FILED 2-28-2008.

ECOIST

THE MARK CONSISTS OF STANDARD CHARACTERS WITHOUT CLAIM TO ANY PARTICULAR FONT, STYLE, SIZE, OR COLOR.

OWNER OF U.S. REG. NOS. 3,070,679 AND 3,223,355.

FOR ENTERTAINMENT SERVICES, NAMELY, PROVIDING INFORMATION RELATED TO A DOCUMENTARY TELEVISION SERIES FEATURING ECOLOGICAL AND CONSERVATION ISSUES VIA A GLOBAL COMPUTER NETWORK; INTERSTITIAL TELEVISION PROGRAMS FEATURING ECOLOGICAL AND CONSERVATION ISSUES (U.S. CLS. 100, 101 AND 107).

FIRST USE 0-0-2007; IN COMMERCE 0-0-2007.

LINDSEY RUBIN, EXAMINING ATTORNEY

CLASS 41—(Continued).

SN 77-423,323. SAVANNAH MOVIE TOURS, INC., SAVANNAH, GA. FILED 3-17-2008.



NO CLAIM IS MADE TO THE EXCLUSIVE RIGHT TO USE "FOODIE TOURS", APART FROM THE MARK AS SHOWN.

THE COLOR(S) GREEN, WHITE, AND PURPLE IS/ARE CLAIMED AS A FEATURE OF THE MARK.

THE MARK CONSISTS OF THE COLOR WHITE APPEARS IN THE WORDING "FOODY" AND AS A CIRCLE WITHIN A LARGER CIRCLE. THE COLOR GREENS APPEARS IN THE WORDING "TOURS" AND IN THE STYLIZED CHEF HAT ABOVE THE SECOND "O" IN THE WORD "FOODY". THE COLOR PURPLE APPEARS IN A STYLIZED IMAGE OF A FORK TO THE LEFT OF THE CIRCLE, IN THE CIRCLE, AND IN A STYLIZED IMAGE OF A KNIFE TO THE RIGHT OF THE CIRCLE.

FOR GUIDED TOURS OF RESTAURANTS WITH REGIONAL, HISTORICAL, AND/OR CULTURAL SIGNIFICANCE (U.S. CLS. 100, 101 AND 107).

FIRST USE 10-3-2007; IN COMMERCE 10-3-2007.

SUSAN RICHARDS, EXAMINING ATTORNEY

SN 77-427,319. MALAYSIAN INSTITUTE OF ACCOUNTANTS, KUALA LUMPUR, MALAYSIA, FILED 3-20-2008.



www.wcoa2010kualalumpur.com

NO CLAIM IS MADE TO THE EXCLUSIVE RIGHT TO USE "WORLD CONGRESS OF ACCOUNTANTS 2010", APART FROM THE MARK AS SHOWN.

THE MARK CONSISTS OF A DESIGN ELEMENT COMPOSED OF A FLOWER AND RECTANGLE, AND THE WORDING "WORLD CONGRESS OF ACCOUNTANTS 2010" LOCATED ABOVE A HORIZONTAL LINE, BENEATH WHICH IS THE WORDING "WWW.WCOA2010KUALALUMPUR.COM." THE COLOR RED APPEARS IN THE

CLASS 41—(Continued).

FLOWER AND THE COLOR YELLOW APPEARS IN THE DOTS AROUND THE FLOWER'S STAMEN. THE COLOR BLUE APPEARS IN THE RECTANGLE. THE COLOR BLACK APPEARS IN THE WORDING "WORLD CONGRESS OF ACCOUNTANTS 2010" AND "WWW.WCOA2010KUALALUMPUR.COM" AND IN THE HORIZONTAL LINE THAT SEPARATES THE WORDING. THE COLOR WHITE THAT APPEARS IN AND AROUND THE DESIGN ELEMENT REPRESENTS TRANSPARENT AREAS AND IS NOT PART OF THE MARK.

FOR ARRANGING AND CONDUCTING EDUCATIONAL CONFERENCES FOR THE INTERNATIONAL ACCOUNTANCY AND BUSINESS COMMUNITIES; ORGANIZING, ARRANGING AND CONDUCTING SEMINARS AND WORKSHOPS AT A GLOBAL CONFERENCE OF ACCOUNTANTS, FEATURING INFORMATION IN THE FIELDS OF ACCOUNTING, AUDITING, TAX, BUSINESS AND FINANCE; ORGANIZING AND PLANNING OF EDUCATIONAL CONFERENCES RELATING TO ACCOUNTING, AUDITING, TAX, BUSINESS AND FINANCE; TRAINING COURSES RELATING TO ACCOUNTANCY, NAMELY, TRAINING COURSES FEATURING AUDITING, TAX, BUSINESS AND FINANCE TOPICS IN THE FIELD OF ACCOUNTANCY; PROVIDING ON-LINE, NON-DOWNLOADABLE ELECTRONIC PUBLICATIONS IN THE NATURE OF NEWSLETTERS, FACT SHEETS, MAGAZINES, HANDOUTS, INFORMATIONAL FLYERS, PAMPHLETS, AND BROCHURES RELATING TO A GLOBAL CONFERENCE OF ACCOUNTANTS AND FEATURING INFORMATION IN THE FIELDS OF ACCOUNTING, AUDITING, TAX, BUSINESS AND FINANCE; CONDUCTING MULTIMEDIA AND ELECTRONIC EDUCATIONAL PRESENTATIONS IN THE FIELDS OF ACCOUNTING, AUDITING, TAX, BUSINESS AND FINANCE (U.S. CLS. 100, 101 AND 107).
MEGHAN REINHART, EXAMINING ATTORNEY

CLASS 41—(Continued).

SN 77-431,051. NATIONAL REINING HORSE ASSOCIATION, OKLAHOMA CITY, OK. FILED 3-25-2008.

**NATIONAL REINING HORSE
YOUTH ASSOCIATION**

THE MARK CONSISTS OF STANDARD CHARACTERS WITHOUT CLAIM TO ANY PARTICULAR FONT, STYLE, SIZE, OR COLOR.

OWNER OF U.S. REG. NO. 2,846,964.
NO CLAIM IS MADE TO THE EXCLUSIVE RIGHT TO USE "YOUTH ASSOCIATION", APART FROM THE MARK AS SHOWN.

SEC. 2(F).
FOR PROVIDING A YOUTH PROGRAM FOR YOUTH REINING HORSE RIDERS, NAMELY, ORGANIZING AND CONDUCTING HORSE COMPETITIONS AND SHOWS IN THE FIELD OF REINING HORSES (U.S. CLS. 100, 101 AND 107).

FIRST USE 10-0-2001; IN COMMERCE 10-0-2001.
WANDA KAY PRICE, EXAMINING ATTORNEY

SN 77-432,073. DANNY PURDUE, LLC, NEWBURGH, IN. FILED 3-26-2008.

PROGRAMFEED

THE MARK CONSISTS OF STANDARD CHARACTERS WITHOUT CLAIM TO ANY PARTICULAR FONT, STYLE, SIZE, OR COLOR.

FOR MUSIC VIDEO PRODUCTION AND VIDEO TAPE FILM PRODUCTION (U.S. CLS. 100, 101 AND 107).
BARNEY CHARLON, EXAMINING ATTORNEY

SN 77-440,366. SOULJAH STORY INC., DBA SOULJAH, NEW YORK, NY. FILED 4-4-2008.

SOULJAH

THE MARK CONSISTS OF STANDARD CHARACTERS WITHOUT CLAIM TO ANY PARTICULAR FONT, STYLE, SIZE, OR COLOR.

FOR PRODUCTION AND DISTRIBUTION OF MOTION PICTURES, TELEVISION PROGRAMS AND RADIO PROGRAMS, AUDIO AND VIDEO RECORDING AND PRODUCTION SERVICES (U.S. CLS. 100, 101 AND 107).
STEVEN PEREZ, EXAMINING ATTORNEY

SN 77-429,716. VOLVO GROUP CANADA INC., MONTRÉAL, (QUEBEC), CANADA, FILED 3-24-2008.

LFS ARTIC

PRIORITY CLAIMED UNDER SEC. 44(D) ON CANADA APPLICATION NO. 1377800, FILED 12-7-2007, REG. NO. TMA438414, DATED 4-21-2009, EXPIRES 4-21-2014.

OWNER OF U.S. REG. NOS. 2,699,741, 3,507,000 AND OTHERS.

NO CLAIM IS MADE TO THE EXCLUSIVE RIGHT TO USE "ARTIC", APART FROM THE MARK AS SHOWN.

SEC. 2(F) AS TO "LFS"

FOR TRAINING SERVICES IN THE FIELD OF THE USE AND GENERAL MAINTENANCE OF BUSES (U.S. CLS. 100, 101 AND 107).

TASNEEM HUSSAIN, EXAMINING ATTORNEY

CLASS 41—(Continued).

SN 77-442,993. DIGITAL SPORTS VIDEO, INC., IRVINE, CA.
FILED 4-8-2008.

DSV

THE MARK CONSISTS OF STANDARD CHARACTERS WITHOUT CLAIM TO ANY PARTICULAR FONT, STYLE, SIZE, OR COLOR.

FOR PROVIDING OF TRAINING, ENTERTAINMENT, AND RECRUITING SERVICES, ALL OF THE FOREGOING IN THE FIELD OF ATHLETIC COMPETITIONS; PROVIDING EDUCATIONAL SERVICES, NAMELY, CONDUCTING CLASSES, SEMINARS, CONFERENCES, AND WORKSHOPS IN THE FIELD OF ATHLETIC COMPETITIONS; VIDEO AND FILM DISTRIBUTION, NAMELY, ORGANIZATION OF VIDEO AND FOOTAGE OF SPORTING EVENTS; VIDEOTAPING, NAMELY, PROVIDING AND OBTAINING DIGITAL SPORTS VIDEO; EDUCATIONAL SERVICES, NAMELY, CONDUCTING CLASSES, SEMINARS, CONFERENCES, AND WORKSHOPS FOR PLAYERS IN THE FIELD OF SPORTS; SPORTS TRAINING SERVICE, NAMELY, PRACTICE DESIGN, PRACTICE IMPLEMENTATION, AND GAME STRATEGIES; ORGANIZING COMMUNITY FESTIVALS FEATURING A VARIETY OF ACTIVITIES, NAMELY, SPORTING EVENTS AND CULTURAL ACTIVITIES (U.S. CLS. 100, 101 AND 107).
MAYUR VAGHANI, EXAMINING ATTORNEY

SN 77-450,552. RAINBOW ACADEMY ASSOCIATES, LLC,
WHIPPANY, NJ. FILED 4-17-2008.

Musical Beginnings

THE MARK CONSISTS OF STANDARD CHARACTERS WITHOUT CLAIM TO ANY PARTICULAR FONT, STYLE, SIZE, OR COLOR.

NO CLAIM IS MADE TO THE EXCLUSIVE RIGHT TO USE "MUSICAL", APART FROM THE MARK AS SHOWN.
FOR INSTRUCTION IN THE FIELD OF MUSIC (U.S. CLS. 100, 101 AND 107).
FIRST USE 4-1-2008; IN COMMERCE 4-1-2008.
KIM SAITO, EXAMINING ATTORNEY

CLASS 41—(Continued).

SN 77-452,073. SMALL PAMELA, ORANGEBURG, SC.
FILED 4-18-2008.

Ploverty

THE MARK CONSISTS OF STANDARD CHARACTERS WITHOUT CLAIM TO ANY PARTICULAR FONT, STYLE, SIZE, OR COLOR.

FOR EDUCATIONAL SERVICES, NAMELY, PROVIDING A WEBSITE THAT DISPLAYS VARIOUS REQUESTS, REVIEWS, RECOMMENDATIONS, RANKINGS, AND TRACKINGS ON ISSUES RELATING TO SOCIAL FOUNDATIONS, POVERTY, AND EMOTIONS; EDUCATIONAL SERVICES, NAMELY, CONDUCTING SEMINARS, WORKSHOPS, MENTORING AND TUTORING CLASSES, LECTURES, TELESEMINARS, TELECLASSES, AND PROVIDING COURSES AND WORKSHOPS ON SOCIAL FOUNDATIONS, POVERTY, AND EMOTIONS; EDUCATION IN THE FIELD OF SOCIOLOGY THROUGH CORRESPONDENCE COURSES AND VIDEO CONFERENCES (U.S. CLS. 100, 101 AND 107).

DOMINIC FATHY, EXAMINING ATTORNEY

SN 77-473,366. WORKING IN SUPPORT OF EDUCATION,
INC., NEW YORK, NY. FILED 5-13-2008.

w!se | **Financial Literacy**
CERTIFICATION

NO CLAIM IS MADE TO THE EXCLUSIVE RIGHT TO USE "FINANCIAL LITERACY CERTIFICATION", APART FROM THE MARK AS SHOWN.

THE MARK CONSISTS OF "WISE FINANCIAL LITERACY CERTIFICATION", AND A SOLID LINE BETWEEN "WISE" AND "FINANCIAL LITERACY CERTIFICATION".

FOR CREATING AND PROVIDING EDUCATIONAL MATERIALS AND PROGRAMS, NAMELY, DEVELOPING AND CONDUCTING TRAINING COURSES AND DISTRIBUTION OF TRAINING MATERIALS IN CONNECTION THEREWITH, IN THE FIELD OF FINANCE TO PROMOTE FINANCIAL KNOWLEDGE AND SKILLS AMONG YOUNG PEOPLE OR ADULTS; DEVELOPMENT OF EDUCATIONAL STANDARDIZED ASSESSMENT TESTS TO MEASURE FINANCIAL KNOWLEDGE SKILLS AMONG YOUNG PEOPLE OR ADULTS; PREPARING, ADMINISTERING, AND SCORING STANDARDIZED TESTS; OFFERING PROGRAMS, NAMELY, CLASSES AND WORKSHOPS IN THE FIELD OF FINANCIAL EDUCATION FOR STUDENTS AND TEACHERS IN URBAN AND SUBURBAN ENVIRONMENTS; EDUCATIONAL CONSULTING REGARDING EDUCATIONAL COURSES PERTAINING TO FINANCIAL EDUCATION FOR STUDENTS AND TEACHERS IN URBAN AND SUBURBAN ENVIRONMENTS; CREATING FINANCIAL SEMINARS FOR OTHERS, NAMELY, CAREER OPPORTUNITY SEMINARS FOR YOUNG PEOPLE OR ADULTS (U.S. CLS. 100, 101 AND 107).

INGRID C. EULIN, EXAMINING ATTORNEY

CLASS 41—(Continued).

SN 77-473,438. CHRISTIAN WORKSHOP MINISTRIES, INC., DBA GOD4ME.COM, FARMINGDALE, NY. FILED 5-13-2008.

DISCIPLESHIP BOOT CAMP

THE MARK CONSISTS OF STANDARD CHARACTERS WITHOUT CLAIM TO ANY PARTICULAR FONT, STYLE, SIZE, OR COLOR.

NO CLAIM IS MADE TO THE EXCLUSIVE RIGHT TO USE "DISCIPLESHIP", APART FROM THE MARK AS SHOWN.

FOR PROVIDING ON-LINE RELIGIOUS INSTRUCTION PROMOTING CHRISTIAN AND FAMILY VALUES; RELIGIOUS INSTRUCTION SERVICES (U.S. CLS. 100, 101 AND 107).

FIRST USE 6-1-2005; IN COMMERCE 6-1-2005.
MELVIN AXILBUND, EXAMINING ATTORNEY

SN 77-477,077. HELEN DORON, LONDON, UNITED KINGDOM, FILED 5-16-2008.

READY STEADY MOVE

THE MARK CONSISTS OF STANDARD CHARACTERS WITHOUT CLAIM TO ANY PARTICULAR FONT, STYLE, SIZE, OR COLOR.

PRIORITY CLAIMED UNDER SEC. 44(D) ON ERPN CMNTY TM OFC APPLICATION NO. 6229678, FILED 11-20-2007.

OWNER OF ERPN CMNTY TM OFC REG. NO. 6229678, DATED 8-26-2008, EXPIRES 11-20-2017.

FOR EDUCATION, PROVIDING OF TRAINING, NAMELY, CLASSES TEACHING MOVEMENT THROUGH LANGUAGE TO YOUNG CHILDREN THROUGH SONG, DANCE, PILATES, MARTIAL ARTS AND YOGA (U.S. CLS. 100, 101 AND 107).

RONALD AIKENS, EXAMINING ATTORNEY

CLASS 41—(Continued).

SN 77-487,200. KIDROBOT, INC., NEW YORK, NY. FILED 5-30-2008.

ZOOMIES

THE MARK CONSISTS OF STANDARD CHARACTERS WITHOUT CLAIM TO ANY PARTICULAR FONT, STYLE, SIZE, OR COLOR.

FOR ENTERTAINMENT SERVICES, NAMELY, PRODUCTION AND DISTRIBUTION OF MOTION PICTURES, FILMS, TELEVISION PROGRAMS, AND RADIO PROGRAMS, FEATURING MUSIC, MUSICAL PERFORMANCES, MUSICAL VIDEOS, RELATED FILM CLIPS AND PHOTOGRAPHS AND ANIMATED AND LIVE-ACTION ENTERTAINMENT, ALL IN THE FIELDS OF ANIMATION, SCIENCE FICTION, COMEDY, DRAMA, MYSTERY, AND MUSIC; ENTERTAINMENT SERVICES, NAMELY, PRODUCING AND PROVIDING ONLINE COMPUTER GAMES, ONLINE SOFTWARE-GENERATED VIRTUAL WORLDS, ONLINE INTERACTIVE VIDEO GAME PROGRAMS AND PROVIDING A WEBSITE FEATURING MUSIC, MUSICAL PERFORMANCES, MUSICAL VIDEOS, RELATED FILM CLIPS AND PHOTOGRAPHS AND ANIMATED AND LIVE-ACTION ENTERTAINMENT, ALL IN THE FIELDS OF ANIMATION, SCIENCE FICTION, COMEDY, DRAMA, MYSTERY, AND MUSIC; AUDIO RECORDING AND PRODUCTION OF ANIMATED AND LIVE ACTION ENTERTAINMENT IN THE FIELDS OF ANIMATION, SCIENCE FICTION, COMEDY, DRAMA, MYSTERY, AND MUSIC; ENTERTAINMENT IN THE NATURE OF THEATER PRODUCTIONS FEATURING MUSIC, MUSICAL PERFORMANCES, AND ANIMATED AND LIVE-ACTION ENTERTAINMENT, ALL IN THE FIELDS OF ANIMATION, SCIENCE FICTION, COMEDY, DRAMA, MYSTERY, AND MUSIC; PUBLICATION OF BOOKS, MAGAZINES, CARTOONS, COMIC STRIPS AND COMIC BOOKS; FAN CLUBS; PROVIDING NON-DOWNLOADABLE ONLINE COMPUTER GAMES; PROVIDING ONLINE ELECTRONIC PUBLICATIONS, NAMELY, NEWSLETTERS AND BULLETINS IN THE FIELD OF ENTERTAINMENT; VIDEOTAPE PRODUCTION; AUDIOTAPE PRODUCTION; ENTERTAINMENT SERVICES, NAMELY, PERSONAL APPEARANCES BY ANIMATED CHARACTERS, MUSICAL GROUPS, MUSICAL ARTISTS AND CELEBRITIES; ENTERTAINMENT SERVICES, NAMELY, PROVIDING A WEB SITE FEATURING MUSIC, MUSICAL PERFORMANCES, MUSICAL VIDEOS, RELATED FILM CLIPS AND PHOTOGRAPHS AND ANIMATED AND LIVE-ACTION ENTERTAINMENT IN THE FIELDS OF SCIENCE FICTION, COMEDY, DRAMA, MYSTERY, AND MUSIC; CONDUCTING ENTERTAINMENT EXHIBITIONS IN THE NATURE OF ANIMATION FESTIVALS; ORGANIZING EXHIBITIONS FOR THE PROMOTION OF MUSIC AND THE ARTS (U.S. CLS. 100, 101 AND 107).

LESLEY LAMOTHE, EXAMINING ATTORNEY

CLASS 41—(Continued).

SN 77-494,733. BARRY E. MCGUIRE, DBA BARRY MCGUIRE, CLOVIS, CA. FILED 6-9-2008.

Barry McGuire

THE MARK CONSISTS OF STANDARD CHARACTERS WITHOUT CLAIM TO ANY PARTICULAR FONT, STYLE, SIZE, OR COLOR.

THE NAME "BARRY MCGUIRE" IDENTIFIES A LIVING INDIVIDUAL WHOSE CONSENT IS OF RECORD.

SEC. 2(F).

FOR ARRANGING AND CONDUCTING NIGHT CLUB ENTERTAINMENT EVENTS; ARRANGING FOR TICKET RESERVATIONS FOR SHOWS AND OTHER ENTERTAINMENT EVENTS; BOOKING OF ENTERTAINMENT HALLS; EDUCATIONAL AND ENTERTAINMENT SERVICES, NAMELY, PROVIDING MOTIVATIONAL AND EDUCATIONAL SPEAKERS; ENTERTAINMENT IN THE NATURE OF VISUAL AND AUDIO PERFORMANCES, AND MUSICAL, VARIETY, NEWS AND COMEDY SHOWS; ENTERTAINMENT SERVICES IN THE NATURE OF LIVE MUSICAL PERFORMANCES; ENTERTAINMENT SERVICES, NAMELY, LIVE, TELEVISED AND MOVIE APPEARANCES BY A PROFESSIONAL ENTERTAINER; ENTERTAINMENT SERVICES, NAMELY, PROVIDING A WEB SITE FEATURING PHOTOGRAPHIC, AUDIO, VIDEO AND PROSE PRESENTATIONS FEATURING MUSIC OF THE 1960S; ENTERTAINMENT SERVICES, NAMELY, MULTIMEDIA PRODUCTION SERVICES; ENTERTAINMENT SERVICES, NAMELY, PROVIDING A RADIO PROGRAM IN THE FIELD OF MUSIC OF THE 1960S VIA A GLOBAL COMPUTER NETWORK; ENTERTAINMENT SERVICES, NAMELY, PROVIDING A TELEVISION PROGRAM IN THE FIELD OF MUSIC OF THE 1960S VIA A GLOBAL COMPUTER NETWORK; ENTERTAINMENT SERVICES, NAMELY, PROVIDING PODCASTS IN THE FIELD OF MUSIC OF THE 1960S; ENTERTAINMENT SERVICES, NAMELY, PROVIDING WEBCASTS IN THE FIELD OF MUSIC OF THE 1960S; ENTERTAINMENT, NAMELY, LIVE MUSIC CONCERTS (U.S. CLS. 100, 101 AND 107).

FIRST USE 7-1-1961; IN COMMERCE 7-1-1961.

INGA ERVIN, EXAMINING ATTORNEY

CLASS 41—(Continued).

SN 77-508,071. BIG BUCK PROPERTIES, LLC, MARION, KY. FILED 6-25-2008.



NO CLAIM IS MADE TO THE EXCLUSIVE RIGHT TO USE "BUCK" AND "OUTDOOR GAMES", APART FROM THE MARK AS SHOWN.

THE MARK CONSISTS OF THE STYLIZED WORDING "BIG BUCK" IN LARGE LETTERS OVER THE STYLIZED WORDING "OUTDOOR GAMES" IN SMALLER LETTERS WITH A SILHOUETTE OF THE HEAD AND BACK OF A MALE DEER TO THE RIGHT OF THE WORDS.

FOR ENTERTAINMENT SERVICES, NAMELY, PROMOTING BIG GAME HUNTING, BIRD HUNTING, FISHING, AND TARGET SHOOTING CHARITABLE COMPETITIONS AMONG CELEBRITIES (U.S. CLS. 100, 101 AND 107).

FIRST USE 4-17-2009; IN COMMERCE 4-17-2009.

JULIE GUTTADAURO, EXAMINING ATTORNEY

SN 77-529,017. SANDRA A. SHELTON, FORT WORTH, TX. FILED 7-23-2008.

Communication WorkOuts

THE MARK CONSISTS OF STANDARD CHARACTERS WITHOUT CLAIM TO ANY PARTICULAR FONT, STYLE, SIZE, OR COLOR.

NO CLAIM IS MADE TO THE EXCLUSIVE RIGHT TO USE "COMMUNICATION", APART FROM THE MARK AS SHOWN.

FOR EDUCATION SERVICES, NAMELY, PROVIDING CLASSES, SEMINARS, WORKSHOPS, TUTORING, AND MENTORING IN THE FIELD OF MIDDLE AND HIGH SCHOOL REFORM; EDUCATION SERVICES, NAMELY, PROVIDING LIVE AND ON-LINE CLASSES, SEMINARS, WORKSHOPS, AND TRAINING FOR MENTOR CERTIFICATIONS IN THE FIELD OF PERSONAL/PROFESSIONAL GROWTH, CAREERS, SELF-AWARENESS, HIGH SCHOOL MENTORING, AND DISTRIBUTION OF COURSE MATERIAL IN CONNECTION THEREWITH; EDUCATION SERVICES, NAMELY, PROVIDING CLASSES, SEMINARS, WORKSHOPS, AND TRAINING FOR MENTOR CERTIFICATIONS IN THE FIELD OF PERSONAL/PROFESSIONAL GROWTH, CAREERS, SELF-AWARENESS, HIGH SCHOOL MENTORING, AND DISTRIBUTION OF COURSE MATERIAL IN CONNECTION THEREWITH; AND CONSULTING SERVICES RELATED TO THE AFORESAID SERVICES (U.S. CLS. 100, 101 AND 107).

FIRST USE 7-23-2008; IN COMMERCE 7-23-2008.

DAYNA BROWNE, EXAMINING ATTORNEY

CLASS 41—(Continued).

SN 77-530,413. UNITED CEREBRAL PALSY OF NEW YORK CITY, NEW YORK, NY. FILED 7-24-2008.

SHARE

THE MARK CONSISTS OF STANDARD CHARACTERS WITHOUT CLAIM TO ANY PARTICULAR FONT, STYLE, SIZE, OR COLOR.

FOR ORGANIZING, CONDUCTING AND PROMOTING EXHIBITIONS FOR EDUCATIONAL PURPOSES, NAMELY, THE DEMONSTRATION OF GOODS IN THE FIELD OF TECHNOLOGY-RELATED ASSISTANCE FOR INDIVIDUALS WITH DISABILITIES; LENDING LIBRARY SERVICES FOR PRINTED PUBLICATIONS, AUDIO-VIDEO MEDIA AND ADAPTED TOYS, COMPUTERS AND SPECIALIZED SOFTWARE FOR INDIVIDUALS WITH DISABILITIES (U.S. CLS. 100, 101 AND 107).

FIRST USE 12-0-1992; IN COMMERCE 12-0-1992.
MARLENE BELL, EXAMINING ATTORNEY

SN 77-537,191. TWENTIETH CENTURY FOX FILM CORPORATION, LOS ANGELES, CA. FILED 8-1-2008.

MUNDOFOX

THE MARK CONSISTS OF STANDARD CHARACTERS WITHOUT CLAIM TO ANY PARTICULAR FONT, STYLE, SIZE, OR COLOR.

OWNER OF U.S. REG. NOS. 2,613,398, 2,697,433 AND OTHERS.

FOR PRODUCTION AND DISTRIBUTION OF TELEVISION PROGRAMS AND MOTION PICTURE FILMS; ENTERTAINMENT SERVICES IN THE NATURE OF TELEVISION PROGRAMMING; PROVIDING ON-LINE INFORMATION IN THE FIELD OF TELEVISION, MOTION PICTURE FILM AND VIDEO ENTERTAINMENT, SPORTS, MUSIC, ENTERTAINMENT NEWS, COMPUTER GAMES AND ENTERTAINMENT BLOGS VIA THE INTERNET; ENTERTAINMENT SERVICES IN THE NATURE OF AUDIO VISUAL ENTERTAINMENT, NAMELY, MOTION PICTURE FILMS AND TELEVISION PROGRAMS VIA WIRELESS COMMUNICATION DEVICES; ORGANIZING EXHIBITIONS FOR CULTURAL PURPOSES; ORGANIZING EXHIBITIONS FOR ENTERTAINMENT PURPOSES, NAMELY, FOR FILM FESTIVAL, FILM SHOWING, TELEVISION AWARD SHOW, GAME SHOW, CELEBRITY PERSONAL APPEARANCE AND TALENT SHOW PURPOSES; ENTERTAINMENT IN THE NATURE OF CONDUCTING CONTESTS; ENTERTAINMENT IN THE NATURE OF COMPETITIONS AND GAMES IN THE FIELD OF TELEVISION AND FILM ENTERTAINMENT TRIVIA (U.S. CLS. 100, 101 AND 107).

BARBARA RUTLAND, EXAMINING ATTORNEY

CLASS 41—(Continued).

SN 77-537,465. PETERSON, BRADFORD, LITTLETON, CO. FILED 8-1-2008.

WEDITING

THE MARK CONSISTS OF STANDARD CHARACTERS WITHOUT CLAIM TO ANY PARTICULAR FONT, STYLE, SIZE, OR COLOR.

FOR EDITING DIGITAL IMAGES; POST PRODUCTION SERVICE TO WEDDING AND EVENT PHOTOGRAPHERS (U.S. CLS. 100, 101 AND 107).

JAMES A. RAUEN, EXAMINING ATTORNEY

SN 77-550,919. THE LEARNING ANNEX, L.P., NEW YORK, NY. FILED 8-19-2008.

ONE DAY BUSINESS SCHOOL

THE MARK CONSISTS OF STANDARD CHARACTERS WITHOUT CLAIM TO ANY PARTICULAR FONT, STYLE, SIZE, OR COLOR.

OWNER OF U.S. REG. NO. 3,483,576.

NO CLAIM IS MADE TO THE EXCLUSIVE RIGHT TO USE "ONE DAY", APART FROM THE MARK AS SHOWN.

FOR EDUCATION SERVICES, NAMELY, PROVIDING SEMINARS IN THE FIELD OF BUSINESS EDUCATION AT THE COLLEGE OR GRADUATE SCHOOL LEVEL FOR INDIVIDUALS OF ALL AGES AND EDUCATIONAL BACKGROUNDS (U.S. CLS. 100, 101 AND 107).

JAMES LOVELACE, EXAMINING ATTORNEY

SN 77-550,922. THE LEARNING ANNEX, L.P., NEW YORK, NY. FILED 8-19-2008.

ONE DAY LAW SCHOOL

THE MARK CONSISTS OF STANDARD CHARACTERS WITHOUT CLAIM TO ANY PARTICULAR FONT, STYLE, SIZE, OR COLOR.

OWNER OF U.S. REG. NO. 3,483,576.

NO CLAIM IS MADE TO THE EXCLUSIVE RIGHT TO USE "ONE DAY", APART FROM THE MARK AS SHOWN.

FOR EDUCATION SERVICES, NAMELY, PROVIDING SEMINARS IN THE FIELD OF LEGAL EDUCATION AT THE COLLEGE OR GRADUATE SCHOOL LEVEL FOR INDIVIDUALS OF ALL AGES AND EDUCATIONAL BACKGROUNDS (U.S. CLS. 100, 101 AND 107).

JAMES LOVELACE, EXAMINING ATTORNEY

CLASS 41—(Continued).

SN 77-553,532. HELENA COLLINS, HOPKINTON, MA.
FILED 8-22-2008.

CLASS 41—(Continued).

SN 77-560,104. THE ART OF KICKING, LLC, FOUNTAIN
HILLS, AZ. FILED 9-2-2008.

TASTE BUD ALIGNMENT

THE MARK CONSISTS OF STANDARD CHARACTERS
WITHOUT CLAIM TO ANY PARTICULAR FONT, STYLE,
SIZE, OR COLOR.

FOR EDUCATIONAL SERVICES, NAMELY, CON-
DUCTING, CLASSES AND SEMINARS ON HEALTHY
EATING AND LIFESTYLES; PROVIDING INSTRU-
CTIONAL LECTURES IN THE FIELD OF HEALTH,
WELLNESS AND NUTRITION (U.S. CLS. 100, 101 AND
107).

DAWN FELDMAN, EXAMINING ATTORNEY

SN 77-553,545. EVENT SOURCE NORTHWEST, INC.,
BOTHELL, WA. FILED 8-22-2008.

THE ART OF KICKING

THE MARK CONSISTS OF STANDARD CHARACTERS
WITHOUT CLAIM TO ANY PARTICULAR FONT, STYLE,
SIZE, OR COLOR.

NO CLAIM IS MADE TO THE EXCLUSIVE RIGHT TO
USE "KICKING", APART FROM THE MARK AS SHOWN.

FOR PROVIDING A WEBSITE FEATURING INFOR-
MATION ABOUT HOW TO KICK A BALL (U.S. CLS. 100,
101 AND 107).

KELLEY WELLS, EXAMINING ATTORNEY

TWISTED CASINO

THE MARK CONSISTS OF STANDARD CHARACTERS
WITHOUT CLAIM TO ANY PARTICULAR FONT, STYLE,
SIZE, OR COLOR.

NO CLAIM IS MADE TO THE EXCLUSIVE RIGHT TO
USE "CASINO", APART FROM THE MARK AS SHOWN.

FOR ENTERTAINMENT IN THE NATURE OF PRO-
VIDING MOCK CASINO EVENTS, NAMELY, CASINO-
THEMED PARTIES FEATURING ORIGINAL GAMES OF
CHANCE, CARD GAMES, DICE GAMES, TRIVIA
GAMES, AND ROULETTE GAMES (U.S. CLS. 100, 101
AND 107).

FIRST USE 9-17-2007; IN COMMERCE 9-17-2007.
JULIE VEPPUMTHARA, EXAMINING ATTORNEY

SN 77-554,410. EKLUND, MICHELLE, VICTORVILLE, CA.
FILED 8-24-2008.

Clutter for Causes

THE MARK CONSISTS OF STANDARD CHARACTERS
WITHOUT CLAIM TO ANY PARTICULAR FONT, STYLE,
SIZE, OR COLOR.

FOR EDUCATIONAL SERVICES, NAMELY, CON-
DUCTING PROGRAMS IN THE FIELD OF WORLD
PEACE EDUCATION AND FACILITATION (U.S. CLS.
100, 101 AND 107).

FIRST USE 6-1-2008; IN COMMERCE 6-1-2008.
PAULA MAHONEY, EXAMINING ATTORNEY

SN 77-563,110. SUCCESS ESSENTIALS INC., NEW YORK,
NY. FILED 9-5-2008.

SUCCESS ESSENTIALS INC.

THE MARK CONSISTS OF STANDARD CHARACTERS
WITHOUT CLAIM TO ANY PARTICULAR FONT, STYLE,
SIZE, OR COLOR.

NO CLAIM IS MADE TO THE EXCLUSIVE RIGHT TO
USE "INC.", APART FROM THE MARK AS SHOWN.

FOR EDUCATIONAL SERVICES, NAMELY, TEACH-
ING ENGLISH AS A SECOND LANGUAGE; PROVIDING
INSTRUCTION AND PROGRAMS IN THE FIELDS OF
GOAL ATTAINMENT, CAREER COACHING FOR AD-
VANCEMENT, AND NETWORKING.; EDUCATIONAL
SERVICES, NAMELY, TEACHING ENGLISH TO EN-
GLISH LANGUAGE LEARNERS; PROVIDING SEMI-
NARS, WORKSHOPS, CLASSES, TUTORING AND
MENTORING IN THE FIELDS OF PERSONAL DEVEL-
OPMENT, NETWORKING, SELF IMPROVEMENT,
GOAL ATTAINMENT, CAREER AWARENESS, CAREER
COACHING FOR ADVANCEMENT, AND SELF-MAR-
KETING; PROVIDING TRAINING IN INSTRUCTIONAL
LEADERSHIP SPECIFICALLY GEARED TOWARD EF-
FECTIVE MANAGEMENT TOOLS FOR INCREASING
STUDENT ACHIEVEMENT IN CULTURALLY AND
LINGUISTICALLY DIVERSE POPULATIONS (U.S. CLS.
100, 101 AND 107).

FIRST USE 0-0-1992; IN COMMERCE 0-0-1992.
SUSAN RICHARDS, EXAMINING ATTORNEY

CLASS 41—(Continued).

SN 77-563,577. AZARI, JOHN, MIAMI BEACH, FL. FILED 9-5-2008.

MASTER TRAINER OF LEGENDS
AND WORLD CHAMPIONS

THE MARK CONSISTS OF STANDARD CHARACTERS WITHOUT CLAIM TO ANY PARTICULAR FONT, STYLE, SIZE, OR COLOR.

NO CLAIM IS MADE TO THE EXCLUSIVE RIGHT TO USE "MASTER TRAINER", APART FROM THE MARK AS SHOWN.

FOR PERSONAL TRAINING INSTRUCTION, COACHING AND EDUCATIONAL SERVICES, NAMELY, CONDUCTING EXHIBITIONS, CLASSES, SEMINARS, WORKSHOPS FOR ATHLETIC EVENTS AND PERSONAL FITNESS (U.S. CLS. 100, 101 AND 107).
APRIL HESIK, EXAMINING ATTORNEY

SN 77-563,780. CITYCENTER LAND, LLC, LAS VEGAS, NV. FILED 9-5-2008.

Aria

THE MARK CONSISTS OF THE WORD ARIA IN SCRIPTED LETTERS.

FOR CASINOS; ENTERTAINMENT IN THE NATURE OF LIVE PERFORMANCES BY A MUSIC GROUP; HEALTH CLUB, NAMELY, PROVIDING INSTRUCTION AND EQUIPMENT IN THE FIELD OF PHYSICAL EXERCISE; AMUSEMENT ARCADES; RECREATIONAL SERVICES IN THE NATURE OF POOLS; PROVISION OF SPORTS FACILITIES, SPORTS INSTRUCTION SERVICES IN THE FIELDS OF TENNIS AND GOLF, ARRANGING AND CONDUCTING ATHLETIC EVENTS, ATHLETIC COMPETITIONS AND SPORTS EVENTS, ARRANGING OF SEMINARS, ENTERTAINMENT IN THE NATURE OF DANCE PERFORMANCES; PRESENTATION OF LIVE COMEDY SHOWS AND PLAYS; ART EXHIBITIONS; NIGHT CLUBS; CABARETS; PHOTOGRAPHY SERVICES; PROVIDING FACILITIES FOR RECREATION ACTIVITIES; SPECIAL EVENT PLANNING; BOOKING OF SEATS FOR SHOWS AND BOOKING OF THEATRE TICKETS (U.S. CLS. 100, 101 AND 107).
ROBERT LAVACHE, EXAMINING ATTORNEY

CLASS 41—(Continued).

SN 77-564,836. HEIST MONKEY ENTERTAINMENT, LLC, FOOTHILL RANCH, CA. FILED 9-8-2008.



NO CLAIM IS MADE TO THE EXCLUSIVE RIGHT TO USE "ENTERTAINMENT", APART FROM THE MARK AS SHOWN.

THE COLOR(S) BLACK, BROWN, TAN, YELLOW, AND WHITE IS/ARE CLAIMED AS A FEATURE OF THE MARK.

THE MARK CONSISTS OF A BLACK QUADRILATERAL BACKGROUND OVERLAID WITH A YELLOW QUADRILATERAL, A BROWN AND TAN MONKEY PEERING THROUGH TWO BLACK AND WHITE MOVIE REELS, AND THE WORDING "HEIST MONKEY ENTERTAINMENT" IN WHITE WITH THE "O" IN "MONKEY" IN THE SHAPE OF A MOVIE REEL THAT IS IN BLACK AND WHITE.

FOR ENTERTAINMENT IN THE NATURE OF PROVIDING INFORMATION ABOUT TELEVISION SHOWS VIA A GLOBAL COMPUTER NETWORK; AND TELEVISION SHOW PRODUCTION (U.S. CLS. 100, 101 AND 107).
FIRST USE 7-28-2008; IN COMMERCE 7-28-2008.
DAVID C. REIHNER, EXAMINING ATTORNEY

SN 77-567,619. SQUARE AND LEVEL MEDIA PRODUCTIONS, INC., GLENVIEW, IL. FILED 9-11-2008.

MIGHTY HOUSE

THE MARK CONSISTS OF STANDARD CHARACTERS WITHOUT CLAIM TO ANY PARTICULAR FONT, STYLE, SIZE, OR COLOR.

NO CLAIM IS MADE TO THE EXCLUSIVE RIGHT TO USE "HOUSE", APART FROM THE MARK AS SHOWN.

FOR ENTERTAINMENT SERVICES, NAMELY, PROVIDING AN ON-GOING RADIO PROGRAM IN THE FIELD OF HOME REPAIR AND HOME IMPROVEMENT (U.S. CLS. 100, 101 AND 107).
FIRST USE 1-5-2008; IN COMMERCE 2-17-2008.
NANCY CLARKE, EXAMINING ATTORNEY

CLASS 41—(Continued).

SN 77-569,505. VALERIE GREEN, PORTLAND, ME. FILED 9-14-2008.

Tangowood

THE MARK CONSISTS OF STANDARD CHARACTERS WITHOUT CLAIM TO ANY PARTICULAR FONT, STYLE, SIZE, OR COLOR.

FOR EDUCATION SERVICES, NAMELY, PROVIDING PROGRAMS, WORKSHOPS, PRESENTATIONS, FESTIVALS, RETREATS IN THE FIELDS OF MUSIC AND DANCE; ENTERTAINMENT IN THE NATURE OF LIVE PERFORMANCES BY MUSICIANS AND DANCERS; PROVIDING FACILITIES FOR MOVIES, SHOWS, PLAYS, MUSIC OR EDUCATIONAL TRAINING (U.S. CLS. 100, 101 AND 107).

SOPHIA S. KIM, EXAMINING ATTORNEY

SN 77-572,857. LABORATORY INSTITUTE OF MERCHANDISING, NEW YORK, NY. FILED 9-18-2008.

THE COLLEGE FOR THE BUSINESS OF FASHION

THE MARK CONSISTS OF STANDARD CHARACTERS WITHOUT CLAIM TO ANY PARTICULAR FONT, STYLE, SIZE, OR COLOR.

SEC. 2(F).
FOR EDUCATIONAL SERVICES, NAMELY, CONDUCTING COURSES AT THE UNIVERSITY LEVEL IN THE FIELD OF FASHION (U.S. CLS. 100, 101 AND 107).

FIRST USE 12-31-1989; IN COMMERCE 12-31-1989.
DAVID MURRAY, EXAMINING ATTORNEY

SN 77-574,188. PURE GROUP, DALLAS, TX. FILED 9-19-2008.

Pure Group

THE MARK CONSISTS OF STANDARD CHARACTERS WITHOUT CLAIM TO ANY PARTICULAR FONT, STYLE, SIZE, OR COLOR.

FOR ARRANGING AND CONDUCTING SPECIAL EVENTS; ENTERTAINMENT IN THE NATURE OF RENTAL OF LOW COST INFLATABLE AMUSEMENT JUMPS FOR OUTREACH YOUTH GROUPS AND COMMUNITY EVENTS; LIFE COACHING SERVICES IN THE FIELD OF BUSINESS AND FAMILY RELATIONS (U.S. CLS. 100, 101 AND 107).

FIRST USE 1-1-2002; IN COMMERCE 1-1-2002.
HOWARD B. LEVINE, EXAMINING ATTORNEY

CLASS 41—(Continued).

SN 77-574,709. AVERITT EXPRESS, INC., COOKEVILLE, TN. FILED 9-19-2008.

LANECHANGE

THE MARK CONSISTS OF STANDARD CHARACTERS WITHOUT CLAIM TO ANY PARTICULAR FONT, STYLE, SIZE, OR COLOR.

FOR PROVIDING A PERIODIC E-MAIL NEWSLETTER TO SUBSCRIBERS, NAMELY, MERCHANTS AND EXISTING SHIPPING CUSTOMERS, INFORMING THEM OF SPECIAL DISCOUNTED RATES OFFERED FOR PARTICULAR ROUTES FOR TRANSPORTATION OF GOODS FOR LIMITED TIME PERIODS AND OF OTHER CHANGES IN ROUTE INFORMATION (U.S. CLS. 100, 101 AND 107).

FIRST USE 5-17-2007; IN COMMERCE 5-17-2007.
YAT SYE, LEE, EXAMINING ATTORNEY

SN 77-575,257. CFA INSTITUTE, CHARLOTTESVILLE, VA. FILED 9-22-2008.

GLOBAL INVESTMENT RESEARCH CHALLENGE

THE MARK CONSISTS OF STANDARD CHARACTERS WITHOUT CLAIM TO ANY PARTICULAR FONT, STYLE, SIZE, OR COLOR.

OWNER OF U.S. REG. NO. 3,467,948.
NO CLAIM IS MADE TO THE EXCLUSIVE RIGHT TO USE "GLOBAL INVESTMENT RESEARCH", APART FROM THE MARK AS SHOWN.

FOR ENTERTAINMENT SERVICES, NAMELY, ARRANGING AND CONDUCTING COMPETITIONS IN THE FIELDS OF BUSINESS AND FINANCE; EDUCATIONAL SERVICES, NAMELY, DEVELOPING AND CONDUCTING PROGRAMS IN WHICH INDUSTRY LEADING PROFESSIONALS TEACH BUSINESS AND FINANCE STUDENTS HOW TO RESEARCH AND REPORT ON PUBLICLY TRADED COMPANIES (U.S. CLS. 100, 101 AND 107).

FIRST USE 0-0-2007; IN COMMERCE 0-0-2007.
HENRY S. ZAK, EXAMINING ATTORNEY

CLASS 41—(Continued).

SN 77-577,158. AGASSI, BRYNNER, MODESTO, CA. FILED 9-23-2008.

**THE
SOVERNTY**

THE MARK CONSISTS OF THE TEXT "THE SOVERNTY" WRITTEN IN A STYLIZED FONT.
FOR ENTERTAINMENT IN THE NATURE OF LIVE PERFORMANCES BY A MUSICAL BAND; ENTERTAINMENT SERVICES, NAMELY, PROVIDING A WEB SITE FEATURING MUSICAL PERFORMANCES, MUSICAL VIDEOS, RELATED FILM CLIPS AND PHOTOGRAPHS (U.S. CLS. 100, 101 AND 107).
JERI J. FICKES, EXAMINING ATTORNEY

CLASS 41—(Continued).

SN 77-584,590. PYXIX CORPORATION, WOODLAND HILLS, CA. FILED 10-2-2008.



OWNER OF U.S. REG. NOS. 3,376,543 AND 3,532,555.
NO CLAIM IS MADE TO THE EXCLUSIVE RIGHT TO USE "COMEDY" OR "COMPANY", APART FROM THE MARK AS SHOWN.

THE MARK CONSISTS OF THE DESIGN OF A BOTTLE CAP WITH A HORIZONTAL RECTANGLE LOCATED ACROSS THE MIDDLE OF THE CAP CONTAINING THE WORDS "COMEDY POP" AND THE UNDERLINED WORD "ENJOY" ABOVE THE RECTANGLE, THE PHRASE "LAUGH TILL IT HURTS!" BENEATH THE RECTANGLE, AND THE PHRASE "COMEDYPOP.COM - A PYXIX PRODUCTION" RUNNING ALONG THE BOTTOM EDGE OF THE BOTTLE CAP DESIGN.

FOR ENTERTAINMENT SERVICES, NAMELY, PROVIDING A WEBSITE FEATURING AUDIO CLIPS, VIDEO CLIPS, PERFORMANCES, VIDEOS, FILM CLIPS, PHOTOGRAPHS, OTHER MULTIMEDIA MATERIALS FEATURING COMEDY, CARTOONS, ANIMATION, MUSIC, FILMS, MOVIES, COMEDIES AND CARTOONISTS; ENTERTAINMENT SERVICES, NAMELY, PROVIDING INFORMATION IN THE FIELD OF AUDIO CLIPS, VIDEO CLIPS, PERFORMANCES, VIDEOS, FILM CLIPS, PHOTOGRAPHS, AND OTHER MULTIMEDIA MATERIALS FEATURING COMEDY, CARTOONS, ANIMATION, MUSIC, FILMS, MOVIES, COMEDIES AND CARTOONISTS; ENTERTAINMENT INFORMATION, NAMELY, PROVIDING A WEB SITE FEATURING INFORMATION ABOUT COMEDY, CARTOONS, ANIMATION, MUSIC, FILMS, MOVIES, COMEDIANS AND CARTOONISTS; MOBILE MEDIA AND ENTERTAINMENT SERVICES IN THE NATURE OF CONTENT PREPARATION; MEDIA PRODUCTION SERVICES, NAMELY, VIDEO AND FILM PRODUCTION; ENTERTAINMENT IN THE NATURE OF COMPETITIONS IN THE FIELD OF COMEDY; ON-LINE JOURNALS, NAMELY, BLOGS FEATURING COMEDY AND ENTERTAINMENT (U.S. CLS. 100, 101 AND 107).

FIRST USE 12-18-2006; IN COMMERCE 12-18-2006.
ALLISON SCHRODY, EXAMINING ATTORNEY

SN 77-582,675. JAF INC., NORCROSS, GA. FILED 9-30-2008.

**UNIVERSITY OF TILE AND
STONE**

THE MARK CONSISTS OF STANDARD CHARACTERS WITHOUT CLAIM TO ANY PARTICULAR FONT, STYLE, SIZE, OR COLOR.

NO CLAIM IS MADE TO THE EXCLUSIVE RIGHT TO USE "UNIVERSITY", APART FROM THE MARK AS SHOWN.

SEC. 2(F).
FOR EDUCATIONAL SERVICES, NAMELY, PROVIDING ONLINE AND CLASSROOM TRAINING FOR CERTIFICATION OF PROFESSIONALS IN THE TILE AND STONE INDUSTRY, SPECIFICALLY, IN THE FIELDS OF TILE AND STONE INSTALLATION AND MAINTENANCE (U.S. CLS. 100, 101 AND 107).

FIRST USE 2-15-2003; IN COMMERCE 2-15-2003.
ESTHER BELENKER, EXAMINING ATTORNEY

CLASS 41—(Continued).

SN 77-587,425. ACADEMY OF LASER DENTISTRY, CORAL SPRINGS, FL. FILED 10-7-2008.

E-WAVES

THE MARK CONSISTS OF STANDARD CHARACTERS WITHOUT CLAIM TO ANY PARTICULAR FONT, STYLE, SIZE, OR COLOR.

FOR PROVIDING ON-LINE NEWSLETTERS IN THE FIELD OF LASER DENTISTRY (U.S. CLS. 100, 101 AND 107).

FIRST USE 8-0-2007; IN COMMERCE 8-0-2007.
STEVEN R. FINE, EXAMINING ATTORNEY

SN 77-588,011. MOOG MUSIC, INC., ASHEVILLE, NC. FILED 10-8-2008.

MOOGFEST

THE MARK CONSISTS OF STANDARD CHARACTERS WITHOUT CLAIM TO ANY PARTICULAR FONT, STYLE, SIZE, OR COLOR.

OWNER OF U.S. REG. NOS. 2,473,815, 3,465,771 AND OTHERS.

FOR ENTERTAINMENT, NAMELY, LIVE MUSIC FESTIVALS FEATURING SYNTHESIZER MUSIC AND ELECTRONIC MUSICIANS, AND HONORING MR. ROBERT MOOG; PROVIDING AN ONLINE WEBSITE PORTAL FEATURING INFORMATION ABOUT MUSIC FESTIVALS, MUSICAL ARTISTS AND MUSIC FESTIVAL TICKET INFORMATION (U.S. CLS. 100, 101 AND 107).

FIRST USE 5-31-2004; IN COMMERCE 5-31-2004.
JANICE L. MCMORROW, EXAMINING ATTORNEY

CLASS 41—(Continued).

SN 77-588,180. PICTOGRAM STUDIO, INC., AKA PICTOGRAM, GARRETT PARK, MD. FILED 10-8-2008.

what girls are about

THE MARK CONSISTS OF STANDARD CHARACTERS WITHOUT CLAIM TO ANY PARTICULAR FONT, STYLE, SIZE, OR COLOR.

NO CLAIM IS MADE TO THE EXCLUSIVE RIGHT TO USE "GIRLS", APART FROM THE MARK AS SHOWN.

FOR ARRANGING AND CONDUCTING INCENTIVE AWARD PROGRAMS TO ENCOURAGE THE FREQUENT, CONTINUED AND EFFECTIVE PRACTICE OF PHYSICAL EXERCISE; CONTESTS AND INCENTIVE AWARD PROGRAMS TO ENCOURAGE STUDENTS AND ORGANIZATION MEMBERS TO SET UP AND ACHIEVE GOALS IN ACADEMICS, ATTENDANCE, CITIZENSHIP AND CONDUCT; CONTINUING PUBLIC SERVICE PROGRAMS IN THE FIELDS OF FEMALE-ORIENTED POPULAR CULTURE PRODUCED AND DISTRIBUTED OVER TELEVISION, SATELLITE, FILM, AUDIO, VIDEO, INTERNET, AND 3-D VIRTUAL REALITY MEDIA; EDUCATION INFORMATION; EDUCATIONAL AND ENTERTAINMENT SERVICES, NAMELY, A CONTINUING PROGRAM ABOUT FEMALE-ORIENTED POPULAR CULTURE ACCESSIBLE BY RADIO, TELEVISION, SATELLITE, AUDIO, VIDEO AND COMPUTER NETWORKS; EDUCATIONAL AND ENTERTAINMENT SERVICES, NAMELY, PROVIDING MOTIVATIONAL AND EDUCATIONAL SPEAKERS; EDUCATIONAL RESEARCH; EDUCATIONAL SERVICES, NAMELY, CONDUCTING AND DEVELOPING FORMAL AND INFORMAL TRAINING COURSES, DEMONSTRATIONS, MENTORING, TUTORING, CONFERENCES, CLASSES, PROGRAMS, PRESENTATIONS, RETREATS, ONLINE CLASSES, SEMINARS, CONFERENCES AND WORKSHOPS IN THE FIELDS OF FEMALE-ORIENTED POPULAR CULTURE AND DISTRIBUTION OF TRAINING MATERIAL IN CONNECTION THEREWITH; EDUCATIONAL SERVICES, NAMELY, DEVELOPING AND CONDUCTING TRAINING COURSES AND DISTRIBUTION OF TRAINING MATERIALS IN CONNECTION THEREWITH FOR SUBJECT MATTERS AS REQUESTED BY CUSTOMERS; EDUCATIONAL SERVICES, NAMELY, DEVELOPING ANIMATION BASED INSTRUCTIONS FOR OTHERS IN THE FIELD OF CONSUMER OR MANUFACTURING HOW-TO PROCEDURES; EDUCATIONAL SERVICES, NAMELY, PROVIDING INCENTIVES TO THE GENERAL PUBLIC TO DEMONSTRATE EXCELLENCE IN THE FIELDS OF FEMALE-ORIENTED POPULAR CULTURE; ENTERTAINMENT IN THE NATURE OF VISUAL AND AUDIO PERFORMANCES, AND MUSICAL, VARIETY, NEWS AND COMEDY SHOWS; ENTERTAINMENT INFORMATION; ENTERTAINMENT SERVICES, NAMELY, A MULTIMEDIA PROGRAM SERIES FEATURING COMEDY, ACTION AND ADVENTURE DISTRIBUTED VIA VARIOUS PLATFORMS ACROSS MULTIPLE FORMS OF TRANSMISSION MEDIA; ENTERTAINMENT SERVICES, NAMELY, PLANNING AND CONDUCTING A SERIES OF FILM FESTIVALS; ENTERTAINMENT TICKET AGENCY SERVICES; FAN CLUBS; INFORMATION RELATING TO ENTERTAINMENT AND EDUCATION, PROVIDED ON-LINE FROM A COMPUTER DATABASE OR THE INTERNET; INTERACTIVE EDUCATIONAL AND ENTERTAINMENT SERVICES, NAMELY, PROVIDING A WEB-BASED VIRTUAL EDUCATIONAL THEME-PARK FEATURING ALL FIELDS OF INTEREST TO FEMALES OF ALL AGES, TO AND FOR THE GENERAL PUBLIC, NAMELY, FEATURING CULTURAL INFORMATION ABOUT THE ARTS, FEMALE-ORIENTED POPULAR CULTURE, ACTIVITIES IN THE NATURE OF GAMES, ART, LITERATURE, RECREATION IN THE MATTER OF FEMALE-ORIENTED POPULAR CULTURE GAMES, NON-DOWNLOADABLE MUSICAL PERFORMANCES, NON-DOWNLOADABLE MUSICAL VIDEOS, RELATED NON-DOWNLOADABLE FILM CLIPS, PHOTOGRAPHS, AND OTHER MULTIMEDIA MATERIALS IN THE NATURE OF FEMALE-

CLASS 41—(Continued).

ORIENTED POPULAR CULTURE; PROVIDING WEBSITES FEATURING PHOTOGRAPHIC, AUDIO, VIDEO AND PROSE PRESENTATIONS; PROVIDING WEBSITES WHERE USERS CAN POST RATINGS, REVIEWS AND RECOMMENDATIONS; PROVIDING WEBSITES AT WHICH THE GENERAL PUBLIC CAN RECEIVE ADVICE FROM AN INDIVIDUAL CONCERNING RELATIONSHIPS, SUCH ADVICE BEING FOR ENTERTAINMENT PURPOSES ONLY; PROVIDING ON-LINE E-ZINES, RESOURCE GUIDES, REVIEWS, COMPUTER GAMES, INTERACTIVE GAMES, EXHIBITS, PODCASTS, WEBCASTS, BLOGS, BOOKS, MAGAZINES, JOURNALS, PAMPHLETS, CATALOGS, BROCHURES, AND NEWSLETTERS FEATURING FEMALE-ORIENTED POPULAR CULTURE; PROVIDING ANIMATION PRODUCTION SERVICES RENDERED BY MEANS OF A GLOBAL COMPUTER NETWORK; PROVIDING ON-LINE COMPUTER DATABASES VIA AN ELECTRONIC GLOBAL COMPUTER NETWORK FEATURING FEMALE-ORIENTED POPULAR CULTURE; ON-LINE LIBRARY SERVICES FEATURING FEMALE-ORIENTED POPULAR CULTURE, INDEXES, DATABASES, LITERATURE, FEMALE-ORIENTED POPULAR CULTURE PUBLICATIONS FEATURING ARTICLES, PERIODICALS, MAGAZINES, PUBLICATIONS, BOOKS, DOCUMENTS, ELECTRONIC DOCUMENTS, GRAPHICS, AUDIO-VISUAL INFORMATION AND CONTENT FEATURING FEMALE-ORIENTED POPULAR CULTURE, AND REFERENCE MATERIALS, ALL PROVIDED VIA COMPUTER AND COMMUNICATION NETWORKS; MOBILE MEDIA AND ENTERTAINMENT SERVICES IN THE NATURE OF CONTENT PREPARATION, POST-PRODUCTION; MULTIMEDIA ENTERTAINMENT SERVICES IN THE NATURE OF RECORDING, PRODUCTION AND POST-PRODUCTION SERVICES IN THE FIELDS OF MUSIC, VIDEO, AND FILMS; ON-LINE LIBRARY SERVICES, NAMELY, PROVIDING ELECTRONIC LIBRARY SERVICES WHICH FEATURE NEWSPAPERS, MAGAZINES, PHOTOGRAPHS AND PICTURES VIA AN ON-LINE COMPUTER NETWORK; ORGANIZING EXHIBITIONS FOR EDUCATIONAL, CULTURAL, SPORTING, OR ENTERTAINMENT PURPOSES; ORGANIZING COMMUNITY FESTIVALS AND EVENTS FEATURING A VARIETY OF ACTIVITIES, NAMELY, SPORTING EVENTS, CULTURAL EVENTS, ART EXHIBITIONS, FLEA MARKETS, ETHNIC DANCES AND THE LIKE; ORGANIZING DANCING EVENTS; ORGANIZING FASHION SHOWS; PROVIDING ADVICE AND INFORMATION IN THE FIELD OF EDUCATIONAL AND ENTERTAINMENT ACTIVITIES AND EVENTS FOR CHILDREN; PROVIDING INFORMATION, NEWS AND COMMENTARY IN THE FIELD OF ENTERTAINMENT; PROVIDING INFORMATION, NEWS AND COMMENTARY IN THE FIELD OF RECREATION AND LEISURE ACTIVITIES; PUBLICATION OF THE EDITORIAL CONTENT OF SITES ACCESSIBLE VIA A GLOBAL COMPUTER NETWORK; PUBLICATION OF LEAFLETS, MANUALS, MUSICAL TEXTS, ALMANACS, E-ZINES, MAGAZINES, BOOKS, REVIEWS, PERIODICALS, HANDBOOKS, BROCHURES, PAMPHLETS, JOURNALS, HAND-OUTS, NEWSPAPERS, REVIEWS, CATALOGS, TEXTS, TEXT BOOKS AND OTHER PRINTED MATTER; PUBLICATION AND EDITING OF PRINTED MATTER; ELECTRONIC PUBLISHING SERVICES, NAMELY, PUBLICATION OF TEXT AND GRAPHIC WORKS OF OTHERS ON CD, DVD, OR ON-LINE FEATURING FEMALE-ORIENTED POPULAR CULTURE TO AND FOR THE GENERAL PUBLIC; PUBLISHING OF ELECTRONIC PUBLICATIONS; ONLINE PUBLICATION OF LEAFLETS, MANUALS, MUSICAL TEXTS, ALMANACS, E-ZINES, MAGAZINES, BOOKS, REVIEWS, PERIODICALS, HANDBOOKS, BROCHURES, PAMPHLETS, JOURNALS, HAND-OUTS, NEWSPAPERS, CATALOGS, TEXTS, TEXT BOOKS AND OTHER MATTER; MULTIMEDIA PUBLISHING OF BOOKS, MAGAZINES, JOURNALS, SOFTWARE, GAMES, MUSIC, AND ELECTRONIC PUBLICATIONS; RECREATIONAL SERVICES IN THE NATURE OF CHILDREN'S PLAY AREAS, DAY CAMPS, OVER-NIGHT CAMPS, SWIMMING

CLASS 41—(Continued).

POOLS, AND FACILITIES FOR RECREATION ACTIVITIES; SOCIAL CLUB SERVICES, NAMELY, ARRANGING, ORGANIZING, AND HOSTING SOCIAL EVENTS, GET-TOGETHERS, AND PARTIES FOR CLUB MEMBERS; SWEEPSTAKE SERVICES PROVIDED OVER A GLOBAL COMPUTER NETWORK; WRITING OF TEXTS OTHER THAN PUBLICITY TEXTS; TRAINING IN THE FIELD(S) OF FEMALE-ORIENTED POPULAR CULTURE; EDUCATION SERVICES, NAMELY, CLASSES, COURSES, WORKSHOPS, AND SEMINARS IN THE FIELD OF FEMALE-ORIENTED POPULAR CULTURE (U.S. CLS. 100, 101 AND 107).
FIRST USE 9-16-2008; IN COMMERCE 9-17-2008.
DEBRA LEE, EXAMINING ATTORNEY

SN 77-590,543. ECLICK INTERACTIVE INC., PORT HOPE, ONTARIO, FILED 10-10-2008.

HILARY MAGAZINE

THE MARK CONSISTS OF STANDARD CHARACTERS WITHOUT CLAIM TO ANY PARTICULAR FONT, STYLE, SIZE, OR COLOR.

NO CLAIM IS MADE TO THE EXCLUSIVE RIGHT TO USE "MAGAZINE", APART FROM THE MARK AS SHOWN. THE NAME "HILARY" IDENTIFIES A LIVING INDIVIDUAL WHOSE CONSENT IS OF RECORD.

FOR PROVIDING ONLINE PUBLICATIONS IN THE NATURE OF A MAGAZINE IN THE FIELD OF WOMEN'S ISSUES, INCLUDING FASHION, BEAUTY, TRAVEL AND CAREER ADVICE (U.S. CLS. 100, 101 AND 107).

FIRST USE 4-4-1994; IN COMMERCE 5-10-1995.
KAREN K. BUSH, EXAMINING ATTORNEY

SN 77-592,565. QUIKSILVER, INC., HUNTINGTON BEACH, CA. FILED 10-14-2008.

THE CROSSING

THE MARK CONSISTS OF STANDARD CHARACTERS WITHOUT CLAIM TO ANY PARTICULAR FONT, STYLE, SIZE, OR COLOR.

FOR EDUCATIONAL SERVICES IN THE NATURE OF CLASSES VIA THE INTERNET IN THE FIELD OF OCEAN RESEARCH AND ENVIRONMENTAL CONSERVATION; ENTERTAINMENT SERVICES, NAMELY, A CONTINUING TELEVISION PROGRAM AND LECTURE SERIES PROGRAM VIA THE INTERNET IN THE FIELD OF OCEAN RESEARCH AND ENVIRONMENTAL CONSERVATION (U.S. CLS. 100, 101 AND 107).

GINA FINK, EXAMINING ATTORNEY

CLASS 41—(Continued).

SN 77-593,253. BOISE STATE UNIVERSITY, BOISE, ID.
FILED 10-15-2008.



NO CLAIM IS MADE TO THE EXCLUSIVE RIGHT TO USE "STATE UNIVERSITY", APART FROM THE MARK AS SHOWN.

THE COLOR(S) BLUE, LIGHT BLUE AND WHITE IS/ARE CLAIMED AS A FEATURE OF THE MARK.

THE MARK CONSISTS OF A STYLIZED DESIGN DEPICTING THE WORDS "BOISE STATE" IN LARGE BOLD BLUE LETTERING WITH A DIAMOND SHAPE BETWEEN THE TWO WORDS. THE RIGHT AND LEFT SIDES OF THE TOP ONE-QUARTER OF THE DIAMOND ARE LIGHT BLUE; THE REMAINDER OF THE DIAMOND IS BLUE WITH THREE (3) VERTICAL LINES IN THE CENTER. THE MIDDLE VERTICAL LINE IS SLIGHTLY SMALLER IN WIDTH THAN THE OTHER TWO (2). THE WORD "UNIVERSITY" IS BELOW THE DESIGN IN ALL CAPITAL LETTERING, SPREAD OUT TO REACH ACROSS THE ENTIRE WIDTH OF THE OVERALL DESIGN.

SEC. 2(F) 2(F) IN PART AS TO THE TERM "BOISE."

FOR EDUCATIONAL SERVICES, NAMELY, PROVIDING COURSES OF INSTRUCTION THROUGH CLASSES, SEMINARS AND WORKSHOPS AT THE UNIVERSITY LEVEL (U.S. CLS. 100, 101 AND 107).

FIRST USE 1-1-2002; IN COMMERCE 1-1-2002.

GEOFFREY FOSDICK, EXAMINING ATTORNEY

SN 77-594,539. PIRANA BROTHERS, LLC, OKLAHOMA CITY, OK. FILED 10-16-2008.



THE MARK CONSISTS OF TWO PIRANHA SKELETONS POSITIONED HEAD TO TAIL IN A FREESTYLE YIN YANG DESIGN.

FOR ARRANGING AND CONDUCTING ATHLETIC COMPETITIONS (U.S. CLS. 100, 101 AND 107).

FIRST USE 6-19-2007; IN COMMERCE 6-19-2007.

SANJEEV VOHRA, EXAMINING ATTORNEY

CLASS 41—(Continued).

SN 77-594,801. HOME BOX OFFICE, INC., NEW YORK, NY.
FILED 10-17-2008.

HUNG

THE MARK CONSISTS OF STANDARD CHARACTERS WITHOUT CLAIM TO ANY PARTICULAR FONT, STYLE, SIZE, OR COLOR.

FOR ENTERTAINMENT SERVICES IN THE NATURE OF AN ONGOING TELEVISION PROGRAM IN THE FIELD OF COMEDY (U.S. CLS. 100, 101 AND 107).

MICHELE SWAIN, EXAMINING ATTORNEY

SN 77-594,840. KLK PHOTOGRAPHY, NEWPORT BEACH, CA. FILED 10-17-2008.

KLK Photography

THE MARK CONSISTS OF STANDARD CHARACTERS WITHOUT CLAIM TO ANY PARTICULAR FONT, STYLE, SIZE, OR COLOR.

NO CLAIM IS MADE TO THE EXCLUSIVE RIGHT TO USE "PHOTOGRAPHY", APART FROM THE MARK AS SHOWN.

FOR PHOTOGRAPHY; PHOTOGRAPHY SERVICES; PORTRAIT PHOTOGRAPHY (U.S. CLS. 100, 101 AND 107).

FIRST USE 1-4-2007; IN COMMERCE 1-4-2007.

ZACHARY BELLO, EXAMINING ATTORNEY

SN 77-595,457. SAMURAI COOKING, INC., SAN FRANCISCO, CA. FILED 10-17-2008.

SAMURAI COOKING

THE MARK CONSISTS OF STANDARD CHARACTERS WITHOUT CLAIM TO ANY PARTICULAR FONT, STYLE, SIZE, OR COLOR.

NO CLAIM IS MADE TO THE EXCLUSIVE RIGHT TO USE "COOKING", APART FROM THE MARK AS SHOWN.

FOR ENTERTAINMENT SERVICES, NAMELY, AN ONGOING TELEVISION PROGRAM IN THE NATURE OF A COOKING SHOW (U.S. CLS. 100, 101 AND 107).

RENEE MCCRAY, EXAMINING ATTORNEY

CLASS 41—(Continued).

SN 77-596,525. ARIZONA COMBAT SPORTS, TEMPE, AZ. FILED 10-20-2008.

Arizona combat sports

THE MARK CONSISTS OF STANDARD CHARACTERS WITHOUT CLAIM TO ANY PARTICULAR FONT, STYLE, SIZE, OR COLOR.

NO CLAIM IS MADE TO THE EXCLUSIVE RIGHT TO USE "COMBAT SPORTS", APART FROM THE MARK AS SHOWN.

SEC. 2(F).

FOR MIXED MARTIAL ARTS GYM TEACHING KICKBOXING, MUAY THAI, JIU JITSU (U.S. CLS. 100, 101 AND 107).

FIRST USE 9-1-2000; IN COMMERCE 9-1-2000.
JAMES GRIFFIN, EXAMINING ATTORNEY

CLASS 41—(Continued).

SN 77-601,629. WOW INTERACTIONS, INC, HIGHLANDS RANCH, CO. FILED 10-27-2008.

LEARNING INTERACTIONS

THE MARK CONSISTS OF STANDARD CHARACTERS WITHOUT CLAIM TO ANY PARTICULAR FONT, STYLE, SIZE, OR COLOR.

NO CLAIM IS MADE TO THE EXCLUSIVE RIGHT TO USE "LEARNING", APART FROM THE MARK AS SHOWN.

FOR EDUCATIONAL SERVICES, NAMELY, DEVELOPING CURRICULUM FOR EDUCATORS; EDUCATIONAL SERVICES, NAMELY, DEVELOPING CURRICULUM FOR OTHERS IN THE FIELD OF COMPUTER SKILLS, TECHNICAL SKILLS, CUSTOMER SERVICE SKILLS, SALES TRAINING SKILLS (U.S. CLS. 100, 101 AND 107).

FIRST USE 6-6-2008; IN COMMERCE 6-6-2008.
LIEF MARTIN, EXAMINING ATTORNEY

SN 77-600,943. GREENPAGES, INC., KITTERY, ME. FILED 10-27-2008.

GP VIRTUAL WORLD

THE MARK CONSISTS OF STANDARD CHARACTERS WITHOUT CLAIM TO ANY PARTICULAR FONT, STYLE, SIZE, OR COLOR.

NO CLAIM IS MADE TO THE EXCLUSIVE RIGHT TO USE "VIRTUAL", APART FROM THE MARK AS SHOWN.

FOR EDUCATION, NAMELY, SEMINARS AND WORKSHOPS IN THE FIELD OF INFORMATION TECHNOLOGY (U.S. CLS. 100, 101 AND 107).

FIRST USE 5-31-2008; IN COMMERCE 5-31-2008.
CHARLOTTE CORWIN, EXAMINING ATTORNEY

SN 77-602,715. LYCOS, INC., WALTHAM, MA. FILED 10-29-2008.

YUKON JACKPOT

THE MARK CONSISTS OF STANDARD CHARACTERS WITHOUT CLAIM TO ANY PARTICULAR FONT, STYLE, SIZE, OR COLOR.

NO CLAIM IS MADE TO THE EXCLUSIVE RIGHT TO USE "JACKPOT", APART FROM THE MARK AS SHOWN.

FOR PROVIDING COMPUTER GAMES THAT MAY BE ACCESSED BY USERS ON A GLOBAL COMPUTER NETWORK (U.S. CLS. 100, 101 AND 107).

CHARLES L. JENKINS, EXAMINING ATTORNEY

SN 77-600,945. GREENPAGES, INC., KITTERY, ME. FILED 10-27-2008.

GREENPAGES VIRTUAL WORLD

THE MARK CONSISTS OF STANDARD CHARACTERS WITHOUT CLAIM TO ANY PARTICULAR FONT, STYLE, SIZE, OR COLOR.

OWNER OF U.S. REG. NO. 2,551,550.

NO CLAIM IS MADE TO THE EXCLUSIVE RIGHT TO USE "VIRTUAL", APART FROM THE MARK AS SHOWN.

FOR EDUCATION, NAMELY, SEMINARS AND WORKSHOPS IN THE FIELD OF INFORMATION TECHNOLOGY (U.S. CLS. 100, 101 AND 107).

FIRST USE 5-31-2008; IN COMMERCE 5-31-2008.
CHARLOTTE CORWIN, EXAMINING ATTORNEY

SN 77-606,596. STATE POLICY NETWORK, ARLINGTON, VA. FILED 11-4-2008.

SPN LEADERSHIP TRAINING SERIES

THE MARK CONSISTS OF STANDARD CHARACTERS WITHOUT CLAIM TO ANY PARTICULAR FONT, STYLE, SIZE, OR COLOR.

NO CLAIM IS MADE TO THE EXCLUSIVE RIGHT TO USE "LEADERSHIP TRAINING SERIES", APART FROM THE MARK AS SHOWN.

FOR ONLINE GUIDES AND MANUALS IN THE FIELDS OF THINK TANKS, GRASSROOTS LEADERSHIP AND FUNDRAISING FOR NON-PROFIT ORGANIZATIONS (U.S. CLS. 100, 101 AND 107).

FIRST USE 7-1-2006; IN COMMERCE 7-1-2006.
LAURA KOVALSKY, EXAMINING ATTORNEY

CLASS 41—(Continued).

SN 77-606,783. CEO CHALLENGE LLC, BOULDER, CO. FILED 11-4-2008.



OWNER OF U.S. REG. NOS. 3,161,199, 3,507,339 AND OTHERS.

NO CLAIM IS MADE TO THE EXCLUSIVE RIGHT TO USE "CEO CHALLENGES", APART FROM THE MARK AS SHOWN.

THE COLOR(S) RED AND BLACK IS/ARE CLAIMED AS A FEATURE OF THE MARK.

THE MARK CONSISTS OF THE WORDING "CEO CHALLENGES" IN RED, WITH STYLIZED PARENTHESES BEING IN BLACK.

FOR ARRANGING AND CONDUCTING ATHLETIC COMPETITIONS (U.S. CLS. 100, 101 AND 107).

FIRST USE 5-0-2005; IN COMMERCE 5-0-2005.

STEVEN R. FOSTER, EXAMINING ATTORNEY

SN 77-608,454. INDEPENDENT DIGITAL LABEL, LLC, DBA IDL, URBANA, IL. FILED 11-5-2008.



NO CLAIM IS MADE TO THE EXCLUSIVE RIGHT TO USE "INDEPENDENT DIGITAL LABEL", APART FROM THE MARK AS SHOWN.

THE COLOR(S) GRAY, MAROON/RED, BLACK IS/ARE CLAIMED AS A FEATURE OF THE MARK.

THE MARK CONSISTS OF THE WORDS "INDEPENDENT DIGITAL LABEL" IN THE COLOR BLACK; ABOVE THE WORDS ARE THE LETTERS "IDL"; THE LETTER "I" IS IN BLACK, WITH A RED/MAROON MUSICAL CLEF IN THE LETTER, THE LETTER "D" IS IN RED/MAROON AND THE LETTER "L" IS IN GREY; A GREY BACKGROUND OR SHADOW SURROUNDS THE LETTERS.

FOR MUSIC COMPOSITION AND TRANSCRIPTION FOR OTHERS; MUSIC COMPOSITION FOR OTHERS; MUSIC PRODUCTION SERVICES; MUSIC PUBLISHING SERVICES; PRODUCTION OF SOUND AND MUSIC VIDEO RECORDINGS; PROVIDING AN INTERNET WEBSITE PORTAL IN THE FIELD OF MUSIC (U.S. CLS. 100, 101 AND 107).

HENRY S. ZAK, EXAMINING ATTORNEY

CLASS 41—(Continued).

SN 77-608,808. DISNEY ENTERPRISES, INC., BURBANK, CA. FILED 11-6-2008.



THE NAME(S), PORTRAIT(S), AND/OR SIGNATURE(S) SHOWN IN THE MARK DOES NOT IDENTIFY A PARTICULAR LIVING INDIVIDUAL.

THE MARK CONSISTS OF A MALE FACIAL IMAGE. FOR ENTERTAINMENT SERVICES, NAMELY, PROVIDING EXHIBITIONS AND FESTIVALS FEATURING ART OR MEMORABILIA, AND PROVIDING ENTERTAINMENT IN THE NATURE OF FILM PRESENTATIONS; PRODUCTION OF MOTION PICTURE FILMS; PRODUCTION OF TELEVISION AND RADIO PROGRAMS; PRODUCTION OF SOUND AND VIDEO RECORDINGS; PRODUCTION OF ENTERTAINMENT SHOWS AND INTERACTIVE PROGRAMS FOR DISTRIBUTION VIA TELEVISION, CABLE, SATELLITE, AUDIO AND VIDEO MEDIA, CARTRIDGES, LASER DISCS, COMPUTER DISCS AND ELECTRONIC MEANS; PRODUCTION OF ENTERTAINMENT, NEWS, AND INFORMATION VIA COMMUNICATION AND COMPUTER NETWORKS; THEATER PRODUCTIONS; EDUCATIONAL SERVICES, NAMELY, PROVIDING CLASSES, CONFERENCES, PROGRAMS, SEMINARS, WORKSHOPS, AND LECTURES IN THE FIELDS OF ART, CULTURE OR MEMORABILIA; ONLINE SERVICES, NAMELY, ONLINE ELECTRONIC PUBLISHING OF BOOKS, MAGAZINES, BOOKLETS, AND CATALOGS, AND ONLINE INFORMATION SERVICES IN THE FIELDS OF MOTION PICTURE FILMS, TELEVISION SHOW PROGRAMS, MUSICAL VIDEOS, RELATED FILM CLIPS, PHOTOGRAPHS, AND OTHER MULTIMEDIA MATERIALS, MUSEUMS, ART, CULTURE, MEMORABILIA (U.S. CLS. 100, 101 AND 107).

RON FAIRBANKS, EXAMINING ATTORNEY

SN 77-611,165. OLYMPIC SOCCER ACADEMY, LLC, SEATTLE, WA. FILED 11-10-2008.

OSA SOCCER ACADEMY

THE MARK CONSISTS OF STANDARD CHARACTERS WITHOUT CLAIM TO ANY PARTICULAR FONT, STYLE, SIZE, OR COLOR.

NO CLAIM IS MADE TO THE EXCLUSIVE RIGHT TO USE "SOCCER ACADEMY", APART FROM THE MARK AS SHOWN.

FOR SOCCER INSTRUCTION; ORGANIZING SPORTING EVENTS, NAMELY, SOCCER MATCHES; ENTERTAINMENT IN THE NATURE OF SOCCER GAMES (U.S. CLS. 100, 101 AND 107).

TINA BROWN, EXAMINING ATTORNEY

CLASS 41—(Continued).

SN 77-612,200. KAREN PULVER, CHICAGO, IL. FILED 11-11-2008.

GRATEFUL GODDESSES

THE MARK CONSISTS OF STANDARD CHARACTERS WITHOUT CLAIM TO ANY PARTICULAR FONT, STYLE, SIZE, OR COLOR.

FOR SOCIAL CLUB SERVICES, NAMELY, ARRANGING, ORGANIZING, AND HOSTING SOCIAL EVENTS, GET-TOGETHERS, AND PARTIES FOR CLUB MEMBERS (U.S. CLS. 100, 101 AND 107).

KAREN BRACEY, EXAMINING ATTORNEY

CLASS 41—(Continued).

SN 77-618,139. THE TOILET PAPER LLC, CHICAGO, IL. FILED 11-19-2008.

The Toilet Paper

THE MARK CONSISTS OF STANDARD CHARACTERS WITHOUT CLAIM TO ANY PARTICULAR FONT, STYLE, SIZE, OR COLOR.

FOR PROVIDING ONLINE, NON-DOWNLOADABLE PUBLICATIONS IN THE NATURE OF NEWSLETTERS IN THE FIELD OF ENTERTAINMENT, NAMELY, CURRENT EVENTS, NEWS AND HUMOR (U.S. CLS. 100, 101 AND 107).

FIRST USE 11-17-2008; IN COMMERCE 11-17-2008.
ROBERT LAVACHE, EXAMINING ATTORNEY

SN 77-620,367. WILLIAM JOSEPH GEIS, DBA ROGUES ROAD, APO AE, NY. FILED 11-24-2008.

Rogues Road

SN 77-612,787. OLYMPIC SOCCER ACADEMY, LLC, SEATTLE, WA. FILED 11-12-2008.



NO CLAIM IS MADE TO THE EXCLUSIVE RIGHT TO USE "SOCCER ACADEMY" AND THE DEPICTION OF A SOCCER BALL, APART FROM THE MARK AS SHOWN.

THE MARK CONSISTS OF THE LETTERS "OSA" IN A STYLIZED CURSIVE FONT WITH THE LETTER "S" AROUND A SOCCER BALL, AND THE WORDS "SOCCER", WITH A BLACK BOX AROUND IT, AND "ACADEMY" STACKED BELOW "OSA" AND THE SOCCER BALL.

FOR SOCCER INSTRUCTION; ORGANIZING SPORTING EVENTS, NAMELY, SOCCER MATCHES; ENTERTAINMENT IN THE NATURE OF SOCCER GAMES (U.S. CLS. 100, 101 AND 107).

TINA BROWN, EXAMINING ATTORNEY

THE MARK CONSISTS OF STANDARD CHARACTERS WITHOUT CLAIM TO ANY PARTICULAR FONT, STYLE, SIZE, OR COLOR.

FOR ENTERTAINMENT IN THE NATURE OF VISUAL AND AUDIO PERFORMANCES, NAMELY, MUSICAL BAND, ROCK GROUP, GYMNASTIC, DANCE, AND BALLET PERFORMANCES (U.S. CLS. 100, 101 AND 107).

STEPHEN AQUILA, EXAMINING ATTORNEY

SN 77-620,798. CANCER SIMPLIFIED, INC., SAG HARBOR, NY. FILED 11-24-2008.



NO CLAIM IS MADE TO THE EXCLUSIVE RIGHT TO USE "CANCER", APART FROM THE MARK AS SHOWN.

THE COLOR(S) GREEN, LAVENDER, ORANGE, RED, YELLOW AND DARK GREEN IS/ARE CLAIMED AS A FEATURE OF THE MARK.

THE MARK CONSISTS OF THE WORDS "CANCER SIMPLIFIED" IN INITIAL CAPITAL LETTERS OF VARIOUS COLORS CONSISTING OF RED, ORANGE, LAVENDER, GREEN AND YELLOW ALL UNDERLINED IN LAVENDER IN A BACKGROUND OF DARK GREEN.

FOR DEVELOPMENT AND DISSEMINATION OF EDUCATIONAL MATERIALS OF OTHERS IN THE FIELD OF CANCER (U.S. CLS. 100, 101 AND 107).

KEVIN CORWIN, EXAMINING ATTORNEY

CLASS 41—(Continued).

SN 77-627,764. HERBST GAMING, INC., LAS VEGAS, NV. FILED 12-5-2008.



NO CLAIM IS MADE TO THE EXCLUSIVE RIGHT TO USE "CASINO", APART FROM THE MARK AS SHOWN.

THE LIKENESS (OR, "PORTRAIT") IN THE MARK DOES NOT IDENTIFY A LIVING INDIVIDUAL.

THE COLOR(S) RED, WHITE, BLACK, BEIGE AND YELLOW IS/ARE CLAIMED AS A FEATURE OF THE MARK.

THE MARK CONSISTS OF THE DEPICTION OF A SHERIFF, WEARING A WHITE SHIRT, A RED TIE, A RED AND BLACK VEST WITH A YELLOW BADGE, A BLACK HAT, A BLACK MUSTACHE AND A BEIGE FACE AND HANDS, NEXT TO THE RED WORDS "TERRIBLE'S", OVER THE WORD "RAIL". THE WORDS "RAIL CITY" ARE RED WITH A WHITE BORDER AND A BLACK OUTLINE, OVER THE WORD "CASINO" IN WHITE AGAINST A BLACK OVAL BACKGROUND.

FOR CASINOS (U.S. CLS. 100, 101 AND 107).

FIRST USE 1-1-2007; IN COMMERCE 1-1-2007.

TIMOTHY FINNEGAN, EXAMINING ATTORNEY

CLASS 41—(Continued).

SN 77-632,044. WIRED MINDS TUTORING, LLC, GREER, SC. FILED 12-12-2008.

Wired Minds Tutoring

THE MARK CONSISTS OF STANDARD CHARACTERS WITHOUT CLAIM TO ANY PARTICULAR FONT, STYLE, SIZE, OR COLOR.

NO CLAIM IS MADE TO THE EXCLUSIVE RIGHT TO USE "TUTORING", APART FROM THE MARK AS SHOWN.

FOR ACADEMIC ENRICHMENT PROGRAMS IN THE FIELD(S) OF MATHEMATICS, SCIENCES, READING, WRITING, HISTORY, FOREIGN LANGUAGES, COMPUTER SKILLS, SAT PREPARATION, AND ACT PREPARATION; CHILDREN'S EDUCATIONAL SERVICES, NAMELY, PROVIDING ACADEMIC PERFORMANCE EVALUATION, GUIDANCE AND MONITORING FOR CHILDREN PRE-KINDERGARTEN THROUGH GRADE 12 VIA THE INTERNET; CONDUCTING AFTER-SCHOOL TUTORING PROGRAMS; EDUCATION SERVICES, NAMELY, PROVIDING TUTORING IN THE FIELDS OF MATHEMATICS, SCIENCES, READING, WRITING, HISTORY, FOREIGN LANGUAGES, COMPUTER SKILLS, SAT PREPARATION, AND ACT PREPARATION (U.S. CLS. 100, 101 AND 107).

FIRST USE 2-19-2008; IN COMMERCE 3-8-2008.

SHANNON TWOHIG, EXAMINING ATTORNEY

SN 77-631,256. PASCUA YAQUI TRIBE, TUCSON, AZ. FILED 12-11-2008.

WWW.AVACONCERTS.COM

THE MARK CONSISTS OF STANDARD CHARACTERS WITHOUT CLAIM TO ANY PARTICULAR FONT, STYLE, SIZE, OR COLOR.

OWNER OF U.S. REG. NOS. 2,948,044 AND 3,020,976.

FOR ENTERTAINMENT SERVICES, NAMELY, LIVE PERFORMANCES BY MUSICAL BANDS, LIVE MUSIC CONCERTS, LIVE APPEARANCES BY PROFESSIONAL ENTERTAINERS, AND LIVE SPORTING EVENTS (U.S. CLS. 100, 101 AND 107).

FIRST USE 10-1-2001; IN COMMERCE 10-1-2001.

KATHLEEN M. VANSTON, EXAMINING ATTORNEY

SN 77-632,591. ELIZABETH D. LIEU, LAS VEGAS, NV. FILED 12-13-2008.

The Poker Diva

NO CLAIM IS MADE TO THE EXCLUSIVE RIGHT TO USE "POKER", APART FROM THE MARK AS SHOWN.

THE NAME "THE POKER DIVA" IS A PSEUDONYM OF A LIVING INDIVIDUAL NAMED ELIZABETH D. LIEU, WHOSE CONSENT IS OF RECORD.

THE MARK CONSISTS OF THE STYLIZED WORDS "THE POKER DIVA".

FOR PROVIDING LINKS TO WEB SITES OF OTHERS FEATURING POKER INFORMATION AND SERVICES (U.S. CLS. 100, 101 AND 107).

FIRST USE 12-13-2007; IN COMMERCE 12-13-2007.

JENNIFER HETU, EXAMINING ATTORNEY

CLASS 41—(Continued).

SN 77-633,490. DR. JOHN F. DEMARTINI, HOUSTON, TX.
FILED 12-15-2008.

DR. JOHN DEMARTINI

THE MARK CONSISTS OF STANDARD CHARACTERS WITHOUT CLAIM TO ANY PARTICULAR FONT, STYLE, SIZE, OR COLOR.

SEC. 2(F).

FOR EDUCATIONAL SERVICES, NAMELY, CONDUCTING CLASSES AND SEMINARS IN THE FIELD OF PERSONAL IMPROVEMENT (U.S. CLS. 100, 101 AND 107).

FIRST USE 1-1-1988; IN COMMERCE 1-1-1988.
MICHAEL WEBSTER, EXAMINING ATTORNEY

SN 77-635,651. INSTITUTE OF AUDIO RESEARCH, LLC,
NEW YORK, NY. FILED 12-18-2008.

INSTITUTE OF AUDIO RESEARCH

THE MARK CONSISTS OF STANDARD CHARACTERS WITHOUT CLAIM TO ANY PARTICULAR FONT, STYLE, SIZE, OR COLOR.

NO CLAIM IS MADE TO THE EXCLUSIVE RIGHT TO USE "INSTITUTE", APART FROM THE MARK AS SHOWN.

SEC. 2(F).

FOR ONLINE EDUCATION SERVICES, NAMELY, PROVIDING INSTRUCTION, CLASSES, AND COURSES IN THE FIELDS OF MUSIC PRODUCTION AND AUDIO ENGINEERING OFFERED VIA A GLOBAL COMPUTER NETWORK (U.S. CLS. 100, 101 AND 107).

MARIAM MAHMOUDI, EXAMINING ATTORNEY

SN 77-637,207. CHICAGO ENDURANCE SPORTS, LLC,
EVANSTON, IL. FILED 12-19-2008.

CHICAGO ENDURANCE SPORTS

THE MARK CONSISTS OF STANDARD CHARACTERS WITHOUT CLAIM TO ANY PARTICULAR FONT, STYLE, SIZE, OR COLOR.

NO CLAIM IS MADE TO THE EXCLUSIVE RIGHT TO USE "ENDURANCE SPORTS", APART FROM THE MARK AS SHOWN.

SEC. 2(F).

FOR COACHING AND INSTRUCTIONAL SERVICES RELATED TO MARATHON, TRIATHLON, AND OTHER PERSONAL FITNESS TRAINING AND DISTRIBUTION OF TRAINING MATERIAL IN CONNECTION THEREWITH (U.S. CLS. 100, 101 AND 107).

FIRST USE 7-31-2000; IN COMMERCE 7-31-2000.
ZHALEH DELANEY, EXAMINING ATTORNEY

CLASS 41—(Continued).

SN 77-637,284. CHICAGO ENDURANCE SPORTS, LLC,
EVANSTON, IL. FILED 12-19-2008.



NO CLAIM IS MADE TO THE EXCLUSIVE RIGHT TO USE "ENDURANCE SPORTS", APART FROM THE MARK AS SHOWN.

THE MARK CONSISTS OF A STYLIZED HUMAN FIGURE ENCASED WITHIN A SHADED OVAL. THE TERM "CHICAGO" APPEARS ARCHED ABOVE THE OVAL, AND THE WORDING "ENDURANCE SPORTS" APPEARS HORIZONTALLY BELOW THE OVAL.

SEC. 2(F) AS TO "CHICAGO".

FOR COACHING AND INSTRUCTIONAL SERVICES RELATED TO MARATHON, TRIATHLON, AND OTHER PERSONAL FITNESS TRAINING AND DISTRIBUTION OF TRAINING MATERIAL IN CONNECTION THEREWITH (U.S. CLS. 100, 101 AND 107).

FIRST USE 12-31-2000; IN COMMERCE 12-31-2000.
ZHALEH DELANEY, EXAMINING ATTORNEY

SN 77-640,865. MASTERS, MARCHITA, DEL MAR, CA.
FILED 12-29-2008.

DADS STEP UP

THE MARK CONSISTS OF STANDARD CHARACTERS WITHOUT CLAIM TO ANY PARTICULAR FONT, STYLE, SIZE, OR COLOR.

FOR PROVIDING INFORMATION ON THE SUBJECT OF PARENTING, CHILD RAISING AND RELATED ISSUES CONCERNING EDUCATION AND ENTERTAINMENT OF BABIES, CHILDREN AND TEENAGERS; PROVIDING A WEBSITE THAT FEATURES INFORMAL INSTRUCTION ON THE SUBJECT OF PARENTING, CHILD RAISING AND RELATED ISSUES, NAMELY, BABIES, EARLY CHILDHOOD, SCHOOLING AND TEENAGERS, AND THE EDUCATION AND ENTERTAINMENT OF CHILDREN; ONLINE ENTERTAINMENT SERVICES, NAMELY, PROVIDING A WEB SITE FEATURING FILM CLIPS, PHOTOGRAPHS, STORIES, HUMOR, ONLINE COMPUTER GAMES AND ACTIVITIES, ALL IN THE FIELD OF PARENTING, CHILD RAISING AND RELATED ISSUES, NAMELY, BABIES, EARLY CHILDHOOD, SCHOOLING AND TEENAGERS, AND THE EDUCATION AND ENTERTAINMENT OF CHILDREN; PROVIDING AN ONLINE DIRECTORY OF INFORMATION IN THE NATURE OF AN ONLINE DATABASE FEATURING INFORMATION CONCERNING EDUCATION AND ENTERTAINMENT IN THE FIELDS OF PARENTING, CHILD RAISING AND RELATED ISSUES, NAMELY, BABIES, EARLY CHILDHOOD, SCHOOLING AND TEENAGERS, AND THE EDUCATION AND ENTERTAINMENT OF CHILDREN (U.S. CLS. 100, 101 AND 107).

CHARLES L. JENKINS, EXAMINING ATTORNEY

CLASS 41—(Continued).

SN 77-642,268. MASTERS, MARCHITA PSY.D., DEL MAR, CA. FILED 12-31-2008.

HELPING DADS DO WHAT WE DO

THE MARK CONSISTS OF STANDARD CHARACTERS WITHOUT CLAIM TO ANY PARTICULAR FONT, STYLE, SIZE, OR COLOR.

FOR PROVIDING INFORMATION ON THE SUBJECT OF PARENTING, CHILD RAISING AND RELATED ISSUES CONCERNING EDUCATION AND ENTERTAINMENT OF BABIES, CHILDREN AND TEENAGERS; PROVIDING A WEBSITE THAT FEATURES INFORMAL INSTRUCTION ON THE SUBJECT OF PARENTING, CHILD RAISING AND RELATED ISSUED, NAMELY, BABIES, EARLY CHILDHOOD, SCHOOLING AND TEENAGERS, AND THE EDUCATION AND ENTERTAINMENT OF CHILDREN; ONLINE ENTERTAINMENT SERVICES, NAMELY, PROVIDING A WEB SITE FEATURING FILM CLIPS, PHOTOGRAPHS, STORIES, HUMOR, ONLINE COMPUTER GAMES AND ACTIVITIES, ALL IN THE FIELD OF PARENTING, CHILD RAISING AND RELATED ISSUED, NAMELY, BABIES, EARLY CHILDHOOD, SCHOOLING AND TEENAGERS, AND THE EDUCATION AND ENTERTAINMENT OF CHILDREN; PROVIDING AN ONLINE DIRECTORY OF INFORMATION IN THE NATURE OF AN ONLINE DATABASE FEATURING INFORMATION CONCERNING EDUCATION AND ENTERTAINMENT IN THE FIELDS OF PARENTING, CHILD RAISING AND RELATED ISSUES, NAMELY, BABIES, EARLY CHILDHOOD, SCHOOLING AND TEENAGERS, AND THE EDUCATION AND ENTERTAINMENT OF CHILDREN (U.S. CLS. 100, 101 AND 107).

NICHOLAS COLEMAN, EXAMINING ATTORNEY

SN 77-645,796. FOSTER, BEN, LOS ANGELES, CA. FILED 1-8-2009.

FOSTER FILMS

THE MARK CONSISTS OF STANDARD CHARACTERS WITHOUT CLAIM TO ANY PARTICULAR FONT, STYLE, SIZE, OR COLOR.

NO CLAIM IS MADE TO THE EXCLUSIVE RIGHT TO USE "FILMS", APART FROM THE MARK AS SHOWN.

FOR ENTERTAINMENT SERVICES, NAMELY, TELEVISION PRODUCTION SERVICES, FEATURE FILM PRODUCTION SERVICES, SCREENWRITING, FILM AND TELEVISION SCORE COMPOSITION SERVICES FOR OTHERS, PROVIDING AN INTERNET WEB SITE ACCESSIBLE VIA A GLOBAL COMPUTER NETWORK AND WIRELESS DEVICES FEATURING ENTERTAINMENT INFORMATION RELATING TO MOTION PICTURES, TELEVISION SHOWS, MUSIC AND MEDIA, PRODUCTION AND DISTRIBUTION OF LIVE ACTION AND ANIMATED MOTION PICTURES AND TELEVISION SHOWS, PRESENTATION OF ENTERTAINMENT EXHIBITIONS, NAMELY, EXHIBITIONS FEATURING LIVE DRAMAS ACCOMPANIED BY PRERECORDED MUSIC, ANIMATED MOVIES, AND MULTIMEDIA SHOWS AND PERFORMANCES BY MUSICAL GROUPS, ORGANIZING ENTERTAINMENT COMPETITIONS IN THE FIELD OF MOTION PICTURES AND ANIMATED MOVIES (U.S. CLS. 100, 101 AND 107).

NANCY CLARKE, EXAMINING ATTORNEY

CLASS 41—(Continued).

SN 77-645,804. NATIONAL OCEANIC AND ATMOSPHERIC ADMINISTRATION, WASHINGTON, DC. FILED 1-8-2009.



OWNER OF U.S. REG. NOS. 3,236,080, 3,605,624 AND OTHERS.

THE COLOR(S) BLUE, BLACK, GRAY IS/ARE CLAIMED AS A FEATURE OF THE MARK.

THE MARK CONSISTS OF THE ACRONYM "IOOS". EACH LETTER OF THE ACRONYM IS DIVIDED IN HALF. FOR THE LETTERS "I" AND "S", THE LEFT-SIDE IS IN BLACK WHILE THE RIGHT SIDE IS IN BLUE, GRAY, AND BLACK. FOR THE LETTERS "O", BOTH SIDES CONSIST OF SHADES OF BLUE, GRAY, AND BLACK. THE TWO "O" LETTERS IN THE ACRONYM CONSIST OF GLOBE IMAGES WITH THE CONTINENTS BEING IN BLACK AND THE OCEAN BEING IN BLUE.

FOR EDUCATIONAL SERVICES, NAMELY, CONDUCTING CLASSES, SEMINARS, CONFERENCES, AND WORKSHOPS IN THE FIELD OF OCEANS, COASTAL WATERS, AND GREAT LAKES AND DISTRIBUTION OF COURSE MATERIAL IN CONNECTION THEREWITH (U.S. CLS. 100, 101 AND 107).

FIRST USE 12-2-2008; IN COMMERCE 12-2-2008.

DAVID ELTON, EXAMINING ATTORNEY

SN 77-649,618. SOUTHERN LIVING, INC., BIRMINGHAM, AL. FILED 1-14-2009.

COOKING LIGHT

THE MARK CONSISTS OF STANDARD CHARACTERS WITHOUT CLAIM TO ANY PARTICULAR FONT, STYLE, SIZE, OR COLOR.

OWNER OF U.S. REG. NOS. 1,586,703, 3,317,659 AND OTHERS.

SEC. 2(F).

FOR ENTERTAINMENT IN THE NATURE OF ONGOING TELEVISION PROGRAMS IN THE FIELD OF FOOD, RECIPES, DINING, ENTERTAINING AND LIFESTYLES; ENTERTAINMENT SERVICES, NAMELY, PROVIDING A TELEVISION PROGRAM IN THE FIELD OF FOOD, RECIPES, DINING, ENTERTAINING AND LIFESTYLES VIA A GLOBAL COMPUTER NETWORK; ENTERTAINMENT, NAMELY, PRODUCTION OF TELEVISION SHOWS IN THE FIELD OF FOOD, RECIPES, DINING, ENTERTAINING AND LIFESTYLES (U.S. CLS. 100, 101 AND 107).

ROBERT STRUCK, EXAMINING ATTORNEY

CLASS 41—(Continued).

SN 77-652,055. SCHILIZZI, THERESA, BROOKLYN, NY. FILED 1-19-2009.

Empowering Transitions

THE MARK CONSISTS OF STANDARD CHARACTERS WITHOUT CLAIM TO ANY PARTICULAR FONT, STYLE, SIZE, OR COLOR.

FOR EDUCATIONAL SERVICES, NAMELY, PROVIDING CLASSES, SEMINARS, WORKSHOPS, AND TUTORING IN THE FIELDS OF SELF IMPROVEMENT (U.S. CLS. 100, 101 AND 107).

FIRST USE 9-2-2005; IN COMMERCE 9-2-2005.
TRACY CROSS, EXAMINING ATTORNEY

SN 77-653,662. LOREN ELKINS, LOS ANGELES, CA. FILED 1-21-2009.



NO CLAIM IS MADE TO THE EXCLUSIVE RIGHT TO USE "REPORT", APART FROM THE MARK AS SHOWN.

THE COLOR(S) BLUE, LIGHT BLUE, PURPLE AND PINK IS/ARE CLAIMED AS A FEATURE OF THE MARK.

THE MARK CONSISTS OF THE COLORS BLUE, LIGHT BLUE, PURPLE, WHITE AND PINK WITH THE COLORS BLUE AND LIGHT BLUE APPEARING IN ALTERNATING STRIPES WITHIN THE WORLD BUBBLE, THE TERM "YENTA" APPEARING IN PINK, OUTLINED IN WHITE WITH A PURPLE SHADOW, THE TERM "THE" APPEARING IN WHITE ON PURPLE PARALLELOGRAMS, AND THE TERM "REPORT" APPEARING IN PURPLE WITH WHITE SHADOWS.

FOR ENTERTAINMENT SERVICES, NAMELY, PROVIDING ON-LINE REVIEWS OF VENDORS PERFORMING A VARIOUS SERVICES SPECIFIC TO LOS ANGELES AND OTHER GEOGRAPHIC REGIONS; ON-LINE JOURNALS, NAMELY, BLOGS FEATURING COMMENTARY ON RESOURCE LISTS SPECIFIC TO LOS ANGELES AND OTHER GEOGRAPHIC REGIONS; PROVIDING A WEB SITE THAT FEATURES INFORMAL INSTRUCTION ON ACTIVITIES SPECIFIC TO LOS ANGELES AND OTHER CITY SPECIFIC REGIONS (U.S. CLS. 100, 101 AND 107).

JILL PRATER, EXAMINING ATTORNEY

CLASS 41—(Continued).

SN 77-654,421. CHILDREN'S LEARNING ADVENTURE LICENSING, LLC, PHOENIX, AZ. FILED 1-22-2009.



NO CLAIM IS MADE TO THE EXCLUSIVE RIGHT TO USE "LEARNING", APART FROM THE MARK AS SHOWN.

THE MARK CONSISTS OF THE WORDS "LEARNING ADVENTURE PASSPORT" POSITIONED BENEATH AN IMAGE OF A TRAVEL BAG WITH TWO STRAPS, A TAG, TRAVEL STICKERS, AND CORNER REINFORCEMENTS, WITH THE BAG SUPERIMPOSED ON A BORDERED RECTANGLE.

FOR EDUCATION AND ENTERTAINMENT SERVICES, NAMELY, SUMMER CAMP SERVICES PROVIDED TO CHILDREN IN CHILDCARE CENTERS (U.S. CLS. 100, 101 AND 107).

BRIDGETT SMITH, EXAMINING ATTORNEY

SN 77-656,705. Z-BOX ARTIST GROUP, LLC, NASHVILLE, TN. FILED 1-26-2009.

Z-BOX ARTIST GROUP

THE MARK CONSISTS OF STANDARD CHARACTERS WITHOUT CLAIM TO ANY PARTICULAR FONT, STYLE, SIZE, OR COLOR.

NO CLAIM IS MADE TO THE EXCLUSIVE RIGHT TO USE "ARTIST GROUP", APART FROM THE MARK AS SHOWN.

FOR ENTERTAINMENT SERVICES, NAMELY, MUSICAL SOUND RECORDING PRODUCTION AND PRODUCTION OF AUDIOVISUAL RECORDINGS FEATURING MUSICAL ENTERTAINMENT; ENTERTAINMENT SERVICES, NAMELY, PROVIDING A WEBSITE FEATURING NON-DOWNLOADABLE PRE-RECORDED MUSIC, MUSICAL PERFORMANCES, MUSICAL VIDEOS, RELATED FILM CLIPS, PHOTOGRAPHS, MUSIC NEWS, REVIEWS OF MUSICAL ARTISTS, AND OTHER MULTIMEDIA MATERIALS FEATURING RECORD LABELS AND MUSICAL ARTISTS (U.S. CLS. 100, 101 AND 107).

MEGHAN REINHART, EXAMINING ATTORNEY

CLASS 41—(Continued).

SN 77-660,635. 45TH PARALLEL LLC, RICHLAND, WA. FILED 1-30-2009.

45th Parallel

THE MARK CONSISTS OF STANDARD CHARACTERS WITHOUT CLAIM TO ANY PARTICULAR FONT, STYLE, SIZE, OR COLOR.

FOR ENTERTAINMENT, NAMELY, LIVE PERFORMANCES BY A MUSICAL BAND (U.S. CLS. 100, 101 AND 107).

FIRST USE 1-15-2003; IN COMMERCE 1-15-2003.
MICHAEL KEATING, EXAMINING ATTORNEY

SN 77-671,327. UNIVERSITY OF KANSAS, LAWRENCE, KS. FILED 2-16-2009.



THE MARK CONSISTS OF THE LETTERS "P", "A", "A", "C" UNDER A STYLIZED FIGURE WITH LEGS FORMED BY A SEMI-CIRCLE AND ARMS EXTENDED ABOVE THE HEAD HOLDING ALOFT AN OVERSIZED PENCIL IN A HORIZONTAL POSITION.

FOR EDUCATIONAL RESEARCH, NAMELY, DEVELOPMENT, IMPLEMENTATION AND REVIEW OF CLINICAL TRIALS AND INTERVENTION STUDIES INCORPORATING PHYSICAL ACTIVITY IN ELEMENTARY SCHOOLS; AND PROVIDING ACADEMIC PROGRAMS TO FURTHER THE STUDIES IN THE FIELD OF PHYSICAL ACTIVITY IN CHILDREN (U.S. CLS. 100, 101 AND 107).

FIRST USE 9-1-2003; IN COMMERCE 12-2-2003.
JANET LEE, EXAMINING ATTORNEY

CLASS 41—(Continued).

SN 77-673,929. GREEN, BRANDAHN, DBA FAIROW CLASH, LOS ANGELES, CA. FILED 2-19-2009.

Iconoclashtic Records

THE MARK CONSISTS OF STANDARD CHARACTERS WITHOUT CLAIM TO ANY PARTICULAR FONT, STYLE, SIZE, OR COLOR.

NO CLAIM IS MADE TO THE EXCLUSIVE RIGHT TO USE "RECORDS", APART FROM THE MARK AS SHOWN.

FOR MUSIC PRODUCTION SERVICES; ENTERTAINMENT SERVICES, NAMELY, PROVIDING NON-DOWNLOADABLE PRERECORDED MUSIC, INFORMATION IN THE FIELD OF MUSIC, AND COMMENTARY AND ARTICLES ABOUT MUSIC, ALL ON-LINE VIA A GLOBAL COMPUTER NETWORK (U.S. CLS. 100, 101 AND 107).

FIRST USE 2-18-2009; IN COMMERCE 2-18-2009.
ANDREA K. NADELMAN, EXAMINING ATTORNEY

SN 77-674,332. PATINO JR, REYNALDO H, SAN ANTONIO, TX. AND RIVAS, PEDRO, SAN ANTONIO, TX. FILED 2-20-2009.

SoundBridge

THE MARK CONSISTS OF STANDARD CHARACTERS WITHOUT CLAIM TO ANY PARTICULAR FONT, STYLE, SIZE, OR COLOR.

FOR ENTERTAINMENT, NAMELY, LIVE PERFORMANCES BY A MUSICAL BAND (U.S. CLS. 100, 101 AND 107).

DAVID I, EXAMINING ATTORNEY

SN 77-674,388. WITMER ASSOCIATES, INC., COATESVILLE, PA. FILED 2-20-2009.

THE FIRE BEACON

THE MARK CONSISTS OF STANDARD CHARACTERS WITHOUT CLAIM TO ANY PARTICULAR FONT, STYLE, SIZE, OR COLOR.

NO CLAIM IS MADE TO THE EXCLUSIVE RIGHT TO USE "FIRE", APART FROM THE MARK AS SHOWN.

FOR PROVIDING ON-LINE NEWSLETTERS IN THE FIELD OF PRODUCTS AND PROMOTIONS IN THE FIELDS OF LAW ENFORCEMENT, FIRE FIGHTING, FIRE PREVENTION, AND EMERGENCY RESCUE SERVICES (U.S. CLS. 100, 101 AND 107).

FIRST USE 0-0-2004; IN COMMERCE 0-0-2004.
CIMMERIAN COLEMAN, EXAMINING ATTORNEY

CLASS 41—(Continued).

SN 77-677,380. SCRIPPS NETWORKS, LLC, KNOXVILLE, TN. FILED 2-24-2009.

MAN CAVES

THE MARK CONSISTS OF STANDARD CHARACTERS WITHOUT CLAIM TO ANY PARTICULAR FONT, STYLE, SIZE, OR COLOR.

FOR EDUCATIONAL AND ENTERTAINMENT SERVICES, NAMELY, A CONTINUING PROGRAM ABOUT INTERIOR DESIGN AND DECORATING, ARCHITECTURE AND HOME DESIGN, BUILDING, HOME IMPROVEMENT, HOME REPAIR, AND HOME RENOVATION, ACCESSIBLE BY RADIO, TELEVISION, CABLE, FIBER OPTIC NETWORKS, WIRELESS NETWORKS, SATELLITE, AUDIO VIDEO, AND COMPUTER NETWORKS (U.S. CLS. 100, 101 AND 107).

FIRST USE 6-16-2007; IN COMMERCE 6-16-2007.
TEJBIR SINGH, EXAMINING ATTORNEY

CLASS 41—(Continued).

SN 77-678,599. CREATIVE GOLF, LLC, DBA THINKWORK-PLAY, RALEIGH, NC. FILED 2-25-2009.



think.work.play.

OWNER OF U.S. REG. NOS. 3,258,630 AND 3,381,577.

THE COLOR(S) YELLOW, ORANGE, GREEN, WHITE AND BLACK IS/ARE CLAIMED AS A FEATURE OF THE MARK.

THE MARK CONSISTS OF THE WORDING "THINK-WORK.PLAY." IN BLACK BELOW A GRAPHIC OF A SPHERE THAT IS DIVIDED INTO THREE PARTS, NAMELY, A CRESCENT MOON SHAPE, A REVERSE APOSTROPHE SHAPE, AND A PROLATE SPHEROID SHAPE, WHICH APPEAR LEFT TO RIGHT IN THE COLORS YELLOW, ORANGE AND GREEN, RESPECTIVELY; SEPARATING EACH COLOR SECTION IS A WHITE CURVED LINE.

FOR PERSONAL COACHING SERVICES IN THE FIELD OF CAREER MANAGEMENT, PERSONAL FULFILLMENT, LIFE MANAGEMENT, TIME MANAGEMENT, INTERPERSONAL SKILLS, PERSONAL DEVELOPMENT, COMMUNICATION SKILLS, POSITIVITY, THE MENTAL SIDE OF THE GAME OF GOLF, LEADERSHIP, TEAMBUILDING, AND THE NON-MECHANICAL ASPECTS OF THE SPORT OF GOLF; AND WORKSHOPS AND SEMINARS IN THE FIELD OF CAREER MANAGEMENT, PERSONAL FULFILLMENT, LIFE MANAGEMENT, TIME MANAGEMENT, INTERPERSONAL SKILLS, PERSONAL DEVELOPMENT, COMMUNICATION SKILLS, POSITIVITY, THE MENTAL SIDE OF THE GAME OF GOLF, LEADERSHIP, TEAMBUILDING, AND THE NON-MECHANICAL ASPECTS OF THE SPORT OF GOLF; AND EDUCATIONAL SERVICES, NAMELY, DEVELOPING AND CONDUCTING WORKOUTS, WORKSHOPS, PRESENTATIONS, RETREATS, AND PERSONAL TRAINING IN CAREER MANAGEMENT, PERSONAL FULFILLMENT, LIFE MANAGEMENT, TIME MANAGEMENT, INTERPERSONAL SKILLS, PERSONAL DEVELOPMENT, COMMUNICATION SKILLS, POSITIVITY, THE MENTAL SIDE OF THE GAME OF GOLF, LEADERSHIP, TEAMBUILDING, AND THE NON-MECHANICAL ASPECTS OF THE SPORT OF GOLF (U.S. CLS. 100, 101 AND 107).

FIRST USE 3-1-2008; IN COMMERCE 8-1-2008.

MEGHAN REINHART, EXAMINING ATTORNEY

SN 77-679,523. VALFITNESS, LLC, ALBUQUERQUE, NM. FILED 2-26-2009.

BODYLANGUAGE

THE MARK CONSISTS OF STANDARD CHARACTERS WITHOUT CLAIM TO ANY PARTICULAR FONT, STYLE, SIZE, OR COLOR.

FOR SPECIALIZED BOUTIQUE FITNESS STUDIO SERVICES, NAMELY, PROVIDING FITNESS FACILITIES FEATURING SPECIALIZED FITNESS INSTRUCTION (U.S. CLS. 100, 101 AND 107).

FIRST USE 12-1-2006; IN COMMERCE 2-1-2007.

ANDREA K. NADELMAN, EXAMINING ATTORNEY

CLASS 41—(Continued).

SN 77-679,526. OYSTER 9 LLC, BELLMORE, NY. FILED 2-26-2009.

THE MARRIAGE REFS

THE MARK CONSISTS OF STANDARD CHARACTERS WITHOUT CLAIM TO ANY PARTICULAR FONT, STYLE, SIZE, OR COLOR.

NO CLAIM IS MADE TO THE EXCLUSIVE RIGHT TO USE "MARRIAGE", APART FROM THE MARK AS SHOWN.

FOR ENTERTAINMENT SERVICES, NAMELY, AN ON-GOING TELEVISION PROGRAM IN THE FIELD OF COMEDY AND RELATIONSHIPS; ENTERTAINMENT SERVICES IN THE NATURE OF AN ON-GOING REALITY BASED TELEVISION PROGRAM; ENTERTAINMENT SERVICES, NAMELY, PROVIDING A WEB SITE FEATURING ON-GOING TELEVISION PROGRAM AND VIDEO CLIPS IN THE FIELD OF COMEDY AND RELATIONSHIPS, ENTERTAINMENT RELATED NEWS AND INFORMATION AND COMEDIC COMMENTARY RELATING TO RELATIONSHIPS (U.S. CLS. 100, 101 AND 107).

TAMARA FRAZIER, EXAMINING ATTORNEY

SN 77-679,541. VALFITNESS, LLC, ALBUQUERQUE, NM. FILED 2-26-2009.

BARREFUSION

THE MARK CONSISTS OF STANDARD CHARACTERS WITHOUT CLAIM TO ANY PARTICULAR FONT, STYLE, SIZE, OR COLOR.

FOR EXERCISE INSTRUCTION; PHYSICAL FITNESS INSTRUCTION FEATURING A FITNESS METHOD TO TONE THE UPPER BODY, TONE AND SHAPE THE LEGS AND SEAT, FOCUS ON THE CORE, AND STRETCH ALL MAJOR MUSCLE GROUPS (U.S. CLS. 100, 101 AND 107).

FIRST USE 1-1-2009; IN COMMERCE 1-1-2009.

ANDREA K. NADELMAN, EXAMINING ATTORNEY

SN 77-682,316. MCGEE, STACEY ALLEN, DBA APPALACHIAN GHOSTWALKS, UNICOI, TN. FILED 3-3-2009.



NO CLAIM IS MADE TO THE EXCLUSIVE RIGHT TO USE "PARANORMAL MYSTERIES MUSEUM", APART FROM THE MARK AS SHOWN.

THE COLOR(S) DARK BLUE, LIGHT BLUE, BLACK, GRAY AND WHITE IS/ARE CLAIMED AS A FEATURE OF THE MARK.

THE MARK CONSISTS OF A RECTANGLE OUTLINED IN BLACK. WITHIN THE RECTANGLE IS A DESIGN OF THE ALL SEEING EYE ENCLOSED IN A PYRAMID WITH

CLASS 41—(Continued).

RAYS OF LIGHT EMANATING FROM THE PYRAMID. BENEATH THE ALL SEEING EYE IS THE TOP HALF OR HEAD OF THE SPHINX WITH THE BOTTOM HALF FADING INTO THE MIST BELOW. TO THE LEFT OF THE PYRAMID IS THE DESIGN OF AN UNIDENTIFIED FLYING OBJECT IN THE SHAPE OF A FLYING SAUCER, AND TO THE LOWER LEFT OF THAT, AN IMAGE OF BIGFOOT. TO THE RIGHT OF THE PYRAMID DESIGN IS AN IMAGE OF A UNION CIVIL WAR SOLDIER ON A HORSE. THE FOREGOING DESIGNS ARE DEPICTED IN VARYING SHADES OF DARK BLUE, LIGHT BLUE AND WHITE. BENEATH THE DESIGNS IS THE WORDING "PARANORMAL MYSTERIES MUSEUM" IN STYLIZED FONT. THE LETTERS ARE IN WHITE AND THERE ARE GRAY SHADOWS AROUND THE LETTERS.

FOR MUSEUMS INCLUDING EXHIBITS ABOUT UNIDENTIFIED FLYING OBJECTS, ALIENS, EXTRATERRESTRIAL BIOLOGICAL ENTITIES, BIGFOOT, CRYPTOZOOLOGY AND GHOSTS, GUIDED TOURS OF SAID MUSEUMS (U.S. CLS. 100, 101 AND 107).

NANCY CLARKE, EXAMINING ATTORNEY

SN 77-683,291. KAT VIDEO PRODUCTIONS, INC., DBA KAT COMMUNICATIONS, BISMARCK, ND. FILED 3-4-2009.

GoodHealthTV

THE MARK CONSISTS OF STANDARD CHARACTERS WITHOUT CLAIM TO ANY PARTICULAR FONT, STYLE, SIZE, OR COLOR.

FOR EDUCATION AND ENTERTAINMENT SERVICES, NAMELY, PRODUCTION AND DISTRIBUTION OF ONGOING TELEVISION PROGRAMS IN THE FIELD OF HEALTH AND WELLNESS VIA A GLOBAL COMPUTER NETWORK (U.S. CLS. 100, 101 AND 107).

FIRST USE 7-1-2006; IN COMMERCE 7-24-2006.

TEJBIR SINGH, EXAMINING ATTORNEY

SN 77-683,419. COOKING WITH CAITLIN, LLC, CINCINNATI, OH. FILED 3-4-2009.

COOKING WITH CAITLIN

THE MARK CONSISTS OF STANDARD CHARACTERS WITHOUT CLAIM TO ANY PARTICULAR FONT, STYLE, SIZE, OR COLOR.

NO CLAIM IS MADE TO THE EXCLUSIVE RIGHT TO USE "COOKING", APART FROM THE MARK AS SHOWN.

THE NAME(S), PORTRAIT(S), AND/OR SIGNATURE(S) SHOWN IN THE MARK IDENTIFIES "CAITLIN" MACEACHEN STEININGER, WHOSE CONSENT(S) TO REGISTER IS MADE OF RECORD.

FOR EDUCATIONAL SERVICES, NAMELY, PROVIDING CLASSES IN THE FIELDS OF COOKING AND FOOD; ENTERTAINMENT IN THE NATURE OF ON-GOING TELEVISION PROGRAMS IN THE FIELD OF COOKING; ENTERTAINMENT SERVICES, NAMELY, PROVIDING AN ON-GOING RADIO PROGRAM IN THE FIELD OF FOOD (U.S. CLS. 100, 101 AND 107).

ROBIN CHOSID, EXAMINING ATTORNEY

CLASS 41—(Continued).

SN 77-684,808. BUTEN, DAVID R, DBA PROPERLIVING, LLC, CINCINNATI, OH. FILED S.R. 3-5-2009; AM. P.R. 7-23-2009.

Budget Challenge

THE MARK CONSISTS OF STANDARD CHARACTERS WITHOUT CLAIM TO ANY PARTICULAR FONT, STYLE, SIZE, OR COLOR.

NO CLAIM IS MADE TO THE EXCLUSIVE RIGHT TO USE BUDGET, APART FROM THE MARK AS SHOWN.

FOR EDUCATIONAL SERVICES, NAMELY, CONDUCTING CLASSROOM AND ONLINE COURSEWORK AND FINANCIAL TRANSACTION SIMULATION-BASED TRAINING IN THE FIELD OF PERSONAL FINANCE AND DISTRIBUTION OF COURSE MATERIAL IN CONNECTION THEREWITH (U.S. CLS. 100, 101 AND 107).

FIRST USE 2-13-2009; IN COMMERCE 2-25-2009.
HEATHER SAPP, EXAMINING ATTORNEY

CLASS 41—(Continued).

SN 77-686,734. MAKINGOF, INC., SAN FRANCISCO, CA. FILED 3-9-2009.



THE MARK CONSISTS OF THE WORDING "MAKING OF" IN A BOX, WITH THE LETTER "I" DEPICTED AS A PARTIALLY OPENED DOOR WITH A STAR ON IT AND LIGHT SHINING THROUGH IT.

FOR PROVIDING WEB SITES FEATURING INFORMATION AND NON-DOWNLOADABLE VIDEOS IN THE FIELDS OF ENTERTAINMENT, VIDEO GAMES AND SPORTS; PROVIDING AN INTERACTIVE WEB SITE FEATURING INFORMATION AND OPPORTUNITIES TO PARTICIPATE IN ONLINE COMPETITIONS IN THE FIELDS OF ENTERTAINMENT, VIDEO GAMES AND SPORTS; ENTERTAINMENT IN THE NATURE OF ONLINE COMPETITION IN THE FIELD OF FASHION (U.S. CLS. 100, 101 AND 107).

SALLY SHIH, EXAMINING ATTORNEY

SN 77-687,874. VERMILION DOLLAR LIPS, TAMPA, FL. FILED 3-10-2009.

Vermilion Dollar Lips

THE MARK CONSISTS OF STANDARD CHARACTERS WITHOUT CLAIM TO ANY PARTICULAR FONT, STYLE, SIZE, OR COLOR.

NO CLAIM IS MADE TO THE EXCLUSIVE RIGHT TO USE "LIPS", APART FROM THE MARK AS SHOWN.

FOR EDUCATION SERVICES, NAMELY, PROVIDING CLASSES, SEMINARS, WORKSHOPS, LECTURES IN THE FIELD OF LIP AUGMENTATION (U.S. CLS. 100, 101 AND 107).

FIRST USE 1-1-2006; IN COMMERCE 1-1-2007.
GINA HAYES, EXAMINING ATTORNEY

SN 77-686,507. BURRELL, THOMAS, CHICAGO, IL. FILED 3-9-2009.

YIP HOP

THE MARK CONSISTS OF STANDARD CHARACTERS WITHOUT CLAIM TO ANY PARTICULAR FONT, STYLE, SIZE, OR COLOR.

FOR ENTERTAINMENT AND EDUCATIONAL SERVICES WHOSE PURPOSE IS TO PULL TOGETHER VARIOUS FORMS OF CULTURE THROUGH MUSIC, NAMELY, THROUGH LIVE MUSICAL PERFORMANCES, CLASSES, SEMINARS, WORKSHOPS AND PRINTED COURSE MATERIALS DISTRIBUTED IN CONJUNCTION THEREWITH (U.S. CLS. 100, 101 AND 107).

JANICE L. MCMORROW, EXAMINING ATTORNEY

SN 77-689,495. NATIONAL MUSEUM OF WILDLIFE ART OF THE UNITED STATES, JACKSON, WY. FILED 3-12-2009.

WESTERN VISIONS

THE MARK CONSISTS OF STANDARD CHARACTERS WITHOUT CLAIM TO ANY PARTICULAR FONT, STYLE, SIZE, OR COLOR.

FOR MUSEUM SERVICES; ART EXHIBITIONS (U.S. CLS. 100, 101 AND 107).

FIRST USE 12-31-1988; IN COMMERCE 12-31-1988.
KRISTIN DAHLING, EXAMINING ATTORNEY

CLASS 41—(Continued).

SN 77-691,200. JIMMY COBB ENTERPRISES, INC., TROY, NY. FILED 3-14-2009.

Jimmy Cobb

THE MARK CONSISTS OF STANDARD CHARACTERS WITHOUT CLAIM TO ANY PARTICULAR FONT, STYLE, SIZE, OR COLOR.

THE NAME "JIMMY COBB" IDENTIFIES A LIVING INDIVIDUAL WHOSE CONSENT IS OF RECORD. SEC. 2(F).

FOR ENTERTAINMENT SERVICES IN THE NATURE OF LIVE MUSICAL PERFORMANCES (U.S. CLS. 100, 101 AND 107).

FIRST USE 0-0-1944; IN COMMERCE 0-0-1944.

KRISTIN DAHLING, EXAMINING ATTORNEY

SN 77-694,323. SARNAT, MARJORIE S., GRANADA HILLS, CA. FILED 3-18-2009.



THE MARK CONSISTS OF THE STYLIZED LETTERING "JRIMAGINATION". AN EIGHT-POINTED STAR IS TO THE LEFT OF THE WORDING.

FOR EDUCATION SERVICES, NAMELY, PROVIDING CLASSES, WORKSHOPS IN THE FIELD OF CREATIVITY; MULTIMEDIA PUBLISHING OF BOOKS, MAGAZINES, JOURNALS, SOFTWARE, GAMES, MUSIC, AND ELECTRONIC PUBLICATIONS (U.S. CLS. 100, 101 AND 107).

KIM SAITO, EXAMINING ATTORNEY

SN 77-699,146. SAM SCHWARTZ ENGINEERING, NEW YORK, NY. FILED 3-25-2009.

WALKSHOP

THE MARK CONSISTS OF STANDARD CHARACTERS WITHOUT CLAIM TO ANY PARTICULAR FONT, STYLE, SIZE, OR COLOR.

FOR GUIDED TOURS OF CONSTRUCTION SITES AND URBAN AND CITY DEVELOPMENTS; EDUCATIONAL SERVICES, NAMELY, PROVIDING WALKING WORKSHOPS RELATING TO CONSTRUCTION SITES, COMMUNITY AND URBAN DEVELOPMENT AND CITY PLANNING (U.S. CLS. 100, 101 AND 107).

G. MAYERSCHOFF, EXAMINING ATTORNEY

CLASS 41—(Continued).

SN 77-699,452. THORNBURGH, KRISTI K, DBA AKK HORSE RANCH, OZARK, AL. FILED 3-25-2009.

AKK

THE MARK CONSISTS OF STANDARD CHARACTERS WITHOUT CLAIM TO ANY PARTICULAR FONT, STYLE, SIZE, OR COLOR.

FOR ENTERTAINMENT SERVICES, NAMELY, PRODUCTION OF SPECIAL EFFECTS INCLUDING MODEL-MAKING SERVICES, COMPUTER-GENERATED IMAGERY AND COMPUTER-GENERATED GRAPHICS FOR THE PRODUCTION OF MOTION PICTURES, VIDEOS, AND MOVIE TRAILERS (U.S. CLS. 100, 101 AND 107).

FIRST USE 11-15-2005; IN COMMERCE 11-15-2005.

ELLEN B. AWRICH, EXAMINING ATTORNEY

SN 77-700,667. CORPORATE LEADERSHIP CENTER, BURR RIDGE, IL. FILED 3-27-2009.

CORPORATE LEADERSHIP CENTER

THE MARK CONSISTS OF STANDARD CHARACTERS WITHOUT CLAIM TO ANY PARTICULAR FONT, STYLE, SIZE, OR COLOR.

NO CLAIM IS MADE TO THE EXCLUSIVE RIGHT TO USE "CENTER", APART FROM THE MARK AS SHOWN. SEC. 2(F).

FOR EDUCATIONAL SERVICES, NAMELY, PROVIDING CLASSES, SEMINARS, WORKSHOPS, AND PROFESSIONAL FORUM DISCUSSION FOR BUSINESS AND ACADEMIC LEADERS IN THE FIELD OF DEVELOPING PROFESSIONAL LEADERSHIP SKILLS, DEVELOPING WORKING PARTNERSHIPS BETWEEN EDUCATORS AND BUSINESS LEADERS, AND FOR FACILITATING THE COOPERATION OF LEADERS FOR PRESENTATIONS, EXCHANGES, PARTICIPATION AND ACTIVITIES PERTAINING TO BUSINESS (U.S. CLS. 100, 101 AND 107).

FIRST USE 2-10-2004; IN COMMERCE 2-10-2004.

BRENDAN MCCAULEY, EXAMINING ATTORNEY

SN 77-701,082. NTVB MEDIA, TROY, MI. FILED 3-27-2009.



THE MARK CONSISTS OF THE WORDS "ON ALERT" WITH A VERTICAL LINE INSERTED IN THE TOP OF THE "O".

FOR PROVIDING TELEVISION, CABLE AND SATELLITE TELEVISION PROGRAMMING AND SCHEDULING INFORMATION TO INTERESTED SUBSCRIBERS (U.S. CLS. 100, 101 AND 107).

MICHELE SWAIN, EXAMINING ATTORNEY

CLASS 41—(Continued).

SN 77-702,583. THE OBSERVANT PRESS, LLC, DENVER, CO.
FILED 3-30-2009.

The Observant Press

THE MARK CONSISTS OF STANDARD CHARACTERS WITHOUT CLAIM TO ANY PARTICULAR FONT, STYLE, SIZE, OR COLOR.

NO CLAIM IS MADE TO THE EXCLUSIVE RIGHT TO USE "PRESS", APART FROM THE MARK AS SHOWN.

FOR BOOK PUBLISHING (U.S. CLS. 100, 101 AND 107).
FIRST USE 3-2-2009; IN COMMERCE 3-2-2009.

C. DIONNE CLYBURN, EXAMINING ATTORNEY

CLASS 41—(Continued).

VICES, NAMELY, PROVIDING PRERECORDED MUSIC, INFORMATION IN THE FIELD OF MUSIC, AND COMMENTARY AND ARTICLES ABOUT MUSIC, ALL ON-LINE VIA A GLOBAL COMPUTER NETWORK; ENTERTAINMENT, NAMELY, LIVE MUSIC CONCERTS; ENTERTAINMENT, NAMELY, LIVE PERFORMANCES BY A MUSICAL BAND; ENTERTAINMENT, NAMELY, LIVE PERFORMANCES BY MUSICAL BANDS; MULTIMEDIA ENTERTAINMENT SERVICES IN THE NATURE OF RECORDING, PRODUCTION AND POST-PRODUCTION SERVICES IN THE FIELDS OF MUSIC, VIDEO, AND FILMS; MUSIC COMPOSITION AND TRANSCRIPTION FOR OTHERS; MUSIC COMPOSITION FOR OTHERS; MUSIC PRODUCTION SERVICES; MUSIC SELECTION SERVICES FOR USE IN TELEVISION, FILM, RADIO AND VIDEO GAMES; MUSIC VIDEO PRODUCTION; PLANNING ARRANGEMENT OF SHOWING MOVIES, SHOWS, PLAYS OR MUSICAL PERFORMANCES; POST-PRODUCTION EDITING SERVICES IN THE FIELD OF MUSIC, VIDEOS AND FILMS (U.S. CLS. 100, 101 AND 107).

H. M. FISHER, EXAMINING ATTORNEY

SN 77-702,630. CITYZEN, LOS ANGELES, CA. FILED 3-30-2009.

CITYZEN

THE MARK CONSISTS OF STANDARD CHARACTERS WITHOUT CLAIM TO ANY PARTICULAR FONT, STYLE, SIZE, OR COLOR.

FOR COMPOSITION OF MUSIC FOR OTHERS; CONSULTATION AND ADVICE REGARDING MUSICAL SELECTIONS AND ARRANGEMENTS FOR SOUND RECORDINGS AND LIVE PERFORMANCES; ENTERTAINMENT AND EDUCATION SERVICES IN THE NATURE OF LIVE DANCE AND MUSICAL PERFORMANCES; ENTERTAINMENT AND EDUCATIONAL SERVICES, NAMELY, PROVIDING ADVICE AND INFORMATION FOR MUSIC, VIDEO AND FILM CONCEPT AND SCRIPT DEVELOPMENT; ENTERTAINMENT IN THE NATURE OF AN ONGOING SPECIAL VARIETY, NEWS, MUSIC OR COMEDY SHOW BROADCAST OVER TELEVISION, SATELLITE, AUDIO, AND VIDEO MEDIA; ENTERTAINMENT IN THE NATURE OF VISUAL AND AUDIO PERFORMANCES, AND MUSICAL, VARIETY, NEWS AND COMEDY SHOWS; ENTERTAINMENT IN THE NATURE OF VISUAL AND AUDIO PERFORMANCES, NAMELY, MUSICAL BAND, ROCK GROUP, GYMNASTIC, DANCE, AND BALLET PERFORMANCES; ENTERTAINMENT SERVICES IN THE NATURE OF LIVE MUSICAL PERFORMANCES; ENTERTAINMENT SERVICES, NAMELY, AN ON-LINE ACTIVITY WHERE YOU CREATE YOUR OWN MUSIC VIDEOS; ENTERTAINMENT SERVICES, NAMELY, NON-DOWNLOADABLE RING TONES, PRE-RECORDED MUSIC, VIDEO AND GRAPHICS PRESENTED TO MOBILE COMMUNICATIONS DEVICES VIA A GLOBAL COMPUTER NETWORK AND WIRELESS NETWORKS; ENTERTAINMENT SERVICES, NAMELY, PROVIDING A WEB SITE FEATURING MUSICAL PERFORMANCES, MUSICAL VIDEOS, RELATED FILM CLIPS, PHOTOGRAPHS; ENTERTAINMENT SER-

SN 77-702,648. HOME CARE PULSE, LLC, REXBURG, ID.
FILED 3-30-2009.

BEST of HOME CARE

NO CLAIM IS MADE TO THE EXCLUSIVE RIGHT TO USE "BEST OF HOME CARE", APART FROM THE MARK AS SHOWN.

THE MARK CONSISTS OF THE STYLIZED WORDING "BEST OF HOME CARE" WITH A ZIG ZAG LINE SUGGESTIVE OF HEART MONITOR LINE FORMING THE LETTER A IN THE WORD "CARE" AND UNDERLINING THE WORD "HOME CARE".

FOR PROVIDING RECOGNITION AND INCENTIVES BY THE WAY OF AWARDS TO DEMONSTRATE EXCELLENCE IN THE FIELD OF ELDERLY AND DISABLED HOME CARE SERVICES (U.S. CLS. 100, 101 AND 107).

FIRST USE 1-29-2009; IN COMMERCE 1-29-2009.
JOHN SCHUYLER YARD, EXAMINING ATTORNEY

CLASS 41—(Continued).

SN 77-705,030. TECHNODYNE, LLC, WAYNE, NJ. FILED 4-2-2009.

TECHNODYNE UNIVERSITY

THE MARK CONSISTS OF STANDARD CHARACTERS WITHOUT CLAIM TO ANY PARTICULAR FONT, STYLE, SIZE, OR COLOR.

OWNER OF U.S. REG. NOS. 3,456,927 AND 3,456,928.

NO CLAIM IS MADE TO THE EXCLUSIVE RIGHT TO USE "UNIVERSITY", APART FROM THE MARK AS SHOWN.

FOR EDUCATIONAL SERVICES, NAMELY, PROVIDING CLASSES, CERTIFICATION COURSES, WEB-BASED TRAINING, CONFERENCES, WORKSHOPS, SEMINARS AND LECTURES IN THE FIELDS OF INFORMATION TECHNOLOGY, RISK ADVISORY, DATA SECURITY, DISASTER RECOVERY, BUSINESS CONTINUITY AND RISK MANAGEMENT, AND DISTRIBUTION OF COURSE MATERIALS IN CONNECTION THEREWITH (U.S. CLS. 100, 101 AND 107).

CIMMERIAN COLEMAN, EXAMINING ATTORNEY

SN 77-707,325. TENNECO AUTOMOTIVE OPERATING COMPANY INC., LAKE FOREST, IL. FILED 4-6-2009.

TENNECO TECHNOLOGY TOUR

THE MARK CONSISTS OF STANDARD CHARACTERS WITHOUT CLAIM TO ANY PARTICULAR FONT, STYLE, SIZE, OR COLOR.

OWNER OF U.S. REG. NOS. 1,251,601, 2,192,498 AND OTHERS.

NO CLAIM IS MADE TO THE EXCLUSIVE RIGHT TO USE "TECHNOLOGY TOUR", APART FROM THE MARK AS SHOWN.

FOR EDUCATIONAL SEMINARS AND DRIVER SAFETY TRAINING CONCERNING PROPER USE AND INSTALLATION OF LAND VEHICLE PARTS, NAMELY, EXHAUSTS, BRAKES, STRUTS AND SHOCK ABSORBERS (U.S. CLS. 100, 101 AND 107).

FIRST USE 4-0-2006; IN COMMERCE 4-0-2006.

GEORGE LORENZO, EXAMINING ATTORNEY

CLASS 41—(Continued).

SN 77-707,441. GAILING, STEPHANIE G, SEATTLE, WA. FILED 4-6-2009.

Planetary Apothecary

THE MARK CONSISTS OF STANDARD CHARACTERS WITHOUT CLAIM TO ANY PARTICULAR FONT, STYLE, SIZE, OR COLOR.

FOR ONLINE EDUCATIONAL PUBLICATIONS, NAMELY, CALENDARS AND NEWSLETTERS, IN THE FIELDS OF ASTROLOGY AND WELLNESS; CONDUCTING SEMINARS AND WORKSHOPS IN THE FIELDS OF ASTROLOGY AND WELLNESS (U.S. CLS. 100, 101 AND 107).

FIRST USE 3-10-2009; IN COMMERCE 3-17-2009.

KHANH LE, EXAMINING ATTORNEY

SN 77-707,951. EDELSTON, JENNIFER, NEW YORK, NY. FILED 4-6-2009.

KIDSTORY OF ROCK

THE MARK CONSISTS OF STANDARD CHARACTERS WITHOUT CLAIM TO ANY PARTICULAR FONT, STYLE, SIZE, OR COLOR.

NO CLAIM IS MADE TO THE EXCLUSIVE RIGHT TO USE "ROCK", APART FROM THE MARK AS SHOWN.

FOR DIGITAL VIDEO, AUDIO, AND MULTIMEDIA PUBLISHING SERVICES; EDUCATION SERVICES, NAMELY, PROVIDING CLASSES, SEMINARS, WORKSHOPS IN THE FIELDS OF MUSIC AND READING; MULTIMEDIA PUBLISHING OF BOOKS, MAGAZINES, JOURNALS, SOFTWARE, GAMES, MUSIC, AND ELECTRONIC PUBLICATIONS; TRAINING SERVICES IN THE FIELD OF MUSIC AND READING (U.S. CLS. 100, 101 AND 107).

GINA FINK, EXAMINING ATTORNEY

CLASS 41—(Continued).

SN 77-708,226. CREATIVE CIRCUS, INC., VIRGINIA BEACH, VA. FILED 4-7-2009.

THE CREATIVE CIRCUS

THE MARK CONSISTS OF STANDARD CHARACTERS WITHOUT CLAIM TO ANY PARTICULAR FONT, STYLE, SIZE, OR COLOR.

NO CLAIM IS MADE TO THE EXCLUSIVE RIGHT TO USE "CREATIVE", APART FROM THE MARK AS SHOWN.

FOR EDUCATIONAL SERVICES, NAMELY, PROVIDING COURSES OF INSTRUCTION AT THE VOCATIONAL AND COLLEGE LEVELS, AND CONDUCTING CLASSES, SEMINARS, WORKSHOPS AND INTERNSHIPS, IN THE FIELDS OF ADVERTISING, ART DIRECTION, COPYWRITING, COMMERCIAL PHOTOGRAPHY, AND GRAPHIC DESIGN (U.S. CLS. 100, 101 AND 107).

FIRST USE 1-1-1999; IN COMMERCE 1-1-1999.
AMY KERTGATE, EXAMINING ATTORNEY

SN 77-709,252. SALLY A KING, SARATOGA SPRINGS, NY. FILED 4-8-2009.

BAR GOLF

THE MARK CONSISTS OF STANDARD CHARACTERS WITHOUT CLAIM TO ANY PARTICULAR FONT, STYLE, SIZE, OR COLOR.

NO CLAIM IS MADE TO THE EXCLUSIVE RIGHT TO USE "BAR", APART FROM THE MARK AS SHOWN.

FOR ORGANIZING GOLF THEMED PUB CRAWLS FOR CHARITABLE FUND RAISING PURPOSES AND FOR PROFIT (U.S. CLS. 100, 101 AND 107).

FIRST USE 4-15-2002; IN COMMERCE 4-15-2003.
ANDREA SAUNDERS, EXAMINING ATTORNEY

SN 77-710,697. OTTER ROCK FILMS, INC., CARLSBAD, CA. FILED 4-9-2009.

PICTURE PARK PRODUCTIONS

THE MARK CONSISTS OF STANDARD CHARACTERS WITHOUT CLAIM TO ANY PARTICULAR FONT, STYLE, SIZE, OR COLOR.

NO CLAIM IS MADE TO THE EXCLUSIVE RIGHT TO USE "PICTURE" AND "PRODUCTIONS", APART FROM THE MARK AS SHOWN.

FOR FILM AND VIDEO PRODUCTION (U.S. CLS. 100, 101 AND 107).

HAI-LY LAM, EXAMINING ATTORNEY

CLASS 41—(Continued).

SN 77-711,545. THE WRITE TOOLS, CENTENNIAL, CO. FILED 4-10-2009.

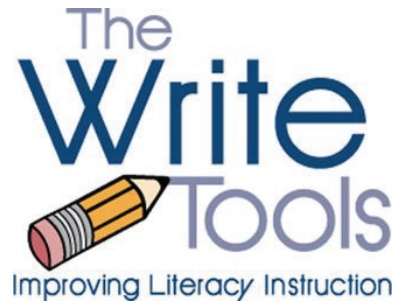

OWNER OF U.S. REG. NO. 3,206,985.

NO CLAIM IS MADE TO THE EXCLUSIVE RIGHT TO USE "LITERACY INSTRUCTION", APART FROM THE MARK AS SHOWN.

THE COLOR(S) DARK BLUE, GREY, WHITE, BLACK, YELLOW-ORANGE AND PINK IS/ARE CLAIMED AS A FEATURE OF THE MARK.

THE MARK CONSISTS OF THE COLOR DARK BLUE APPEARING IN THE WORDING "WRITE" AND "IMPROVING LITERACY INSTRUCTION"; THE COLOR GREY APPEARING IN THE WORDING "THE" AND "TOOLS"; THE COLORS WHITE, BLACK AND YELLOW-ORANGE APPEARING IN THE DESIGN OF A PENCIL; THE COLOR PINK APPEARING IN THE DESIGN OF A PENCIL ERASER.

FOR EDUCATIONAL SERVICES, NAMELY, CONDUCTING WORKSHOPS IN THE FIELD OF WRITING INSTRUCTION AND DISTRIBUTION OF TRAINING MATERIAL IN CONNECTION THEREWITH (U.S. CLS. 100, 101 AND 107).

FIRST USE 6-0-2006; IN COMMERCE 6-0-2006.
AISHA SALEM, EXAMINING ATTORNEY

SN 77-711,778. MATTHEWS & STROTHER, LLC, CHICAGO, IL. FILED 4-10-2009.

Poggled

THE MARK CONSISTS OF STANDARD CHARACTERS WITHOUT CLAIM TO ANY PARTICULAR FONT, STYLE, SIZE, OR COLOR.

FOR PROVIDING ENTERTAINMENT INFORMATION, NAMELY, INFORMATION ABOUT NIGHTLIFE EVENTS AND ACTIVITIES, ARTS EVENTS AND ACTIVITIES, AND LEISURE EVENTS AND ACTIVITIES, VIA THE INTERNET THROUGH AN ONLINE SOCIAL NETWORK; PROVIDING ONLINE COMPUTER DATABASES AND ONLINE SEARCHABLE DATABASES FEATURING ENTERTAINMENT INFORMATION, NAMELY, INFORMATION ABOUT NIGHTLIFE EVENTS AND ACTIVITIES, ARTS EVENTS AND ACTIVITIES, AND LEISURE EVENTS AND ACTIVITIES (U.S. CLS. 100, 101 AND 107).

JOHN KELLY, EXAMINING ATTORNEY

CLASS 41—(Continued).

SN 77-712,028. BEAST STEW, VENICE, CA. FILED 4-11-2009.

Beast Stew

THE MARK CONSISTS OF STANDARD CHARACTERS WITHOUT CLAIM TO ANY PARTICULAR FONT, STYLE, SIZE, OR COLOR.

FOR BOOK PUBLISHING (U.S. CLS. 100, 101 AND 107).
FIRST USE 3-23-2008; IN COMMERCE 3-23-2009.
NANCY CLARKE, EXAMINING ATTORNEY

SN 77-712,040. CHRIS HANSEN, CHATSWORTH, CA. FILED 4-11-2009.

TrapFight

THE MARK CONSISTS OF STANDARD CHARACTERS WITHOUT CLAIM TO ANY PARTICULAR FONT, STYLE, SIZE, OR COLOR.

FOR ENTERTAINMENT SERVICES IN THE NATURE OF LIVE MIXED MARTIAL ARTS (MMA) EVENTS (U.S. CLS. 100, 101 AND 107).
NANCY CLARKE, EXAMINING ATTORNEY

SN 77-712,489. SMITH, MICHAEL E., DBA RED NECK ACTIVIST, PASKENTA, CA. FILED 4-13-2009.



THE MARK CONSISTS OF THE WORDING "RED NECK ACTIVIST" AND A GUITAR DESIGN. THE WORDING IS IN STYLIZED LETTERING, WITH THE WORD "ACTIVIST" CENTERED BELOW THE WORDS "RED NECK". THE GUITAR IS LOCATED ON THE RIGHT SIDE OF THE WORDS AND SLIGHTLY TILTED TO THE RIGHT. THE BODY OF THE GUITAR IS NEXT TO THE WORD "ACTIVIST" AND THE NECK OF THE GUITAR IS NEXT TO THE WORD "NECK".

FOR EDUCATIONAL AND ENTERTAINMENT SERVICES, NAMELY, A CONTINUING PROGRAM ABOUT PATRIOTISM ACCESSIBLE BY RADIO, TELEVISION, SATELLITE, AUDIO, VIDEO AND COMPUTER NETWORKS (U.S. CLS. 100, 101 AND 107).

FIRST USE 4-4-2009; IN COMMERCE 4-8-2009.
KATHY DE JONGE, EXAMINING ATTORNEY

CLASS 41—(Continued).

SN 77-715,499. UCB PHARMA, S.A., B-1070 BRUSSELS, BELGIUM, FILED 4-16-2009.

UCB FAMILY EPILEPSY SCHOLARSHIP PROGRAM

THE MARK CONSISTS OF STANDARD CHARACTERS WITHOUT CLAIM TO ANY PARTICULAR FONT, STYLE, SIZE, OR COLOR.

NO CLAIM IS MADE TO THE EXCLUSIVE RIGHT TO USE "FAMILY EPILEPSY SCHOLARSHIP PROGRAM", APART FROM THE MARK AS SHOWN.

FOR EDUCATION SERVICES, NAMELY, CONDUCTING SEMINARS, WORKSHOPS, INDIVIDUAL OR COLLECTIVE TRAINING, ON THE SUBJECT OF THE PREVENTION AND TREATMENT OF EPILEPSY (U.S. CLS. 100, 101 AND 107).

CAROL SPILS, EXAMINING ATTORNEY

SN 77-716,199. DIANE DEALEY NEILL, SHINGLE SPRINGS, CA. FILED 4-17-2009.



NO CLAIM IS MADE TO THE EXCLUSIVE RIGHT TO USE "CALIFORNIA" AND "FORESTRY", APART FROM THE MARK AS SHOWN.

THE MARK CONSISTS OF THE STYLIZED WORDING "CALIFORNIA" AND "FORESTRY CHALLENGE" DISPLAYED ON A DESIGN OF A STYLIZED FOREST SCENE.

FOR EDUCATIONAL SERVICES, NAMELY, CONDUCTING INSTRUCTION, WORKSHOPS AND COMPETITION EVENTS FOR HIGH SCHOOL STUDENTS IN THE FIELD OF FORESTRY AND DISTRIBUTION OF TRAINING MATERIAL IN CONNECTION THEREWITH (U.S. CLS. 100, 101 AND 107).

FIRST USE 2-1-2003; IN COMMERCE 9-1-2003.
BONNIE LUKEN, EXAMINING ATTORNEY

CLASS 41—(Continued).

SN 77-717,953. THE SEVENTH QUEST, LLC, ASHLAND, OR. FILED 4-20-2009.

SACRED DESIRE

THE MARK CONSISTS OF STANDARD CHARACTERS WITHOUT CLAIM TO ANY PARTICULAR FONT, STYLE, SIZE, OR COLOR.

NO CLAIM IS MADE TO THE EXCLUSIVE RIGHT TO USE "SACRED", APART FROM THE MARK AS SHOWN.

FOR EDUCATION SERVICES, NAMELY, PROVIDING CLASSES, EDUCATIONAL SEMINARS, EXPERIENTIAL WORKSHOPS, AND PRIVATE SESSIONS CONDUCTED BY EXPERIENCED INSTRUCTORS IN THE FIELD OF INTIMACY COACHING, THE ART OF TANTRA, AND SACRED TANTRIC HEALINGS (U.S. CLS. 100, 101 AND 107).

FIRST USE 4-17-2009; IN COMMERCE 4-17-2009.
WON TEAK OH, EXAMINING ATTORNEY

SN 77-718,791. ENVISION COMMUNICATIONS,LLC, ELLICOTT CITY, MD. FILED 4-21-2009.

WaterStone Productions

THE MARK CONSISTS OF STANDARD CHARACTERS WITHOUT CLAIM TO ANY PARTICULAR FONT, STYLE, SIZE, OR COLOR.

NO CLAIM IS MADE TO THE EXCLUSIVE RIGHT TO USE "PRODUCTIONS", APART FROM THE MARK AS SHOWN.

FOR VIDEO PRODUCTION; SCRIPT WRITING (U.S. CLS. 100, 101 AND 107).
EVELYN BRADLEY, EXAMINING ATTORNEY

SN 77-719,182. STUBBS, MICHAEL R., LOS ANGELES, CA. FILED 4-21-2009.



NO CLAIM IS MADE TO THE EXCLUSIVE RIGHT TO USE "HUG", APART FROM THE MARK AS SHOWN.

THE COLOR(S) RED, YELLOW AND WHITE IS/ARE CLAIMED AS A FEATURE OF THE MARK.

THE MARK CONSISTS OF RED LETTERS WITH WHITE HIGHLIGHTS THAT SPELL "HUG DELI" ON YELLOW RECTANGLE SHAPED BACKGROUND.

FOR CONDUCTING ENTERTAINMENT EXHIBITIONS IN THE NATURE OF PUBLIC INTERACTIVE ART PROJECT EVENT (U.S. CLS. 100, 101 AND 107).

FIRST USE 8-30-2005; IN COMMERCE 8-30-2005.
SUSAN LESLIE DUBOIS, EXAMINING ATTORNEY

CLASS 41—(Continued).

SN 77-719,287. PREVENT CANCER FOUNDATION, ALEXANDRIA, VA. FILED 4-22-2009.



OWNER OF U.S. REG. NOS. 2,842,494, 3,304,920 AND 3,498,518.

NO CLAIM IS MADE TO THE EXCLUSIVE RIGHT TO USE "5K RUN/WALK" AND "PREVENT CANCER FOUNDATION", APART FROM THE MARK AS SHOWN.

THE MARK CONSISTS OF THE LITERAL ELEMENTS "STEP AWAY FROM CANCER" AND "5K RUN/WALK" STACKED ABOVE A REPRESENTATION OF A PAIR OF TENNIS SHOES ALL LOCATED ABOVE THE LITERAL ELEMENT "PREVENT CANCER FOUNDATION" IN WHICH THE WORDS "PREVENT" AND "CANCER" ARE SEPARATED BY CROSSING WAVE SHAPES.

FOR ORGANIZING AND CONDUCTING A 5K RUN AND WALK COMPETITION (U.S. CLS. 100, 101 AND 107).

MARIAM MAHMOUDI, EXAMINING ATTORNEY

SN 77-719,308. PREVENT CANCER FOUNDATION, ALEXANDRIA, VA. FILED 4-22-2009.

STEP AWAY FROM CANCER

THE MARK CONSISTS OF STANDARD CHARACTERS WITHOUT CLAIM TO ANY PARTICULAR FONT, STYLE, SIZE, OR COLOR.

FOR ORGANIZING AND CONDUCTING A 5K RUN AND WALK COMPETITION (U.S. CLS. 100, 101 AND 107).

MARIAM MAHMOUDI, EXAMINING ATTORNEY

CLASS 41—(Continued).

SN 77-719,651. PISANI, FRANK, LARCHMONT, NY. AND MURPHY, SHARON, RHINEBACK, NY. FILED 4-22-2009.

ZEPHYR'S POND

THE MARK CONSISTS OF STANDARD CHARACTERS WITHOUT CLAIM TO ANY PARTICULAR FONT, STYLE, SIZE, OR COLOR.

OWNER OF U.S. REG. NO. 2,669,504.

FOR ENTERTAINMENT SERVICES, NAMELY, PRODUCTION OF DVDS, VIDEO TAPES, TELEVISION PROGRAMS, AUDIO PROGRAMS, CDS AND CD-ROMS, INTERNET PROGRAMS, MOTION PICTURE FILMS, ALL FOR OTHERS IN THE FIELD OF MUSIC; ENTERTAINMENT SERVICES IN THE NATURE OF ON-GOING TELEVISION PROGRAMS, INTERNET PROGRAMS, DVD PROGRAMS, AUDIO PROGRAMS, IN THE FIELD OF MUSIC; PROVIDING TELEVISION PROGRAMS AND AUDIO PROGRAMS IN THE FIELD OF MUSIC VIA A GLOBAL COMPUTER NETWORK; PRODUCTION OF PRERECORDED AUDIO TAPES, AUDIO CASSETTES, AUDIO DISCS, COMPACT AUDIO DISCS, DIGITAL AUDIO DISCS AND AUDIO CD-ROMS FEATURING MUSIC; MUSIC PRODUCTION; PRODUCTION OF VIDEO GAME CARTRIDGES, VIDEO AND COMPUTER GAME PROGRAMS; PROVIDING A WEBSITE FEATURING MUSICAL PERFORMANCES, MUSICAL VIDEOS, PHOTOGRAPHS AND OTHER MULTIMEDIA MATERIALS, AND INFORMATION REGARDING THE SERIES OF PROGRAMS ON THE SUBJECT OF MUSIC; PROVIDING AUDIO PODCASTS IN THE FIELD OF MUSICAL PERFORMANCES; AND PROVIDING VIDEO PODCASTS IN THE FIELD OF MUSICAL PERFORMANCES. EDUCATIONAL SERVICES IN THE NATURE OF ON-GOING TELEVISION PROGRAMS, INTERNET PROGRAMS, DVD PROGRAMS, AUDIO PROGRAMS, IN THE FIELD OF MUSIC, PROVIDING TELEVISION PROGRAMS AND AUDIO PROGRAMS IN THE FIELD OF MUSIC VIA A GLOBAL COMPUTER NETWORK (U.S. CLS. 100, 101 AND 107).

AMOS T. MATTHEWS, JR., EXAMINING ATTORNEY

CLASS 41—(Continued).

SN 77-720,299. SCIENCE ROCKS LTD, MULGRAVE VIC 3170, AUSTRALIA, FILED 4-23-2009.

ROCK CHICK & SCIENCE GEEK

THE MARK CONSISTS OF STANDARD CHARACTERS WITHOUT CLAIM TO ANY PARTICULAR FONT, STYLE, SIZE, OR COLOR.

OWNER OF AUSTRALIA REG. NO. 1242698, DATED 5-25-2008, EXPIRES 5-25-2018.

OWNER OF AUSTRALIA REG. NO. 1242698, DATED 5-25-2008, EXPIRES 5-25-2018.

FOR (BASED ON USE IN COMMERCE) EDUCATIONAL AND ENTERTAINMENT SERVICES, NAMELY, A CONTINUING PROGRAM ABOUT SCIENCE ACCESSIBLE BY RADIO, TELEVISION, SATELLITE, AUDIO, VIDEO AND COMPUTER NETWORKS; ENTERTAINMENT AND EDUCATION SERVICES IN THE NATURE OF A SERIES OF SHORT SHOWS FEATURING SCIENCE AND MUSIC DISTRIBUTED TO MOBILE HANDSETS, WHICH MAY INCLUDE VIDEO, TEXT, PHOTOS, ILLUSTRATIONS OR HYPERTEXT; ENTERTAINMENT AND EDUCATIONAL SERVICES IN THE NATURE OF ON-LINE COMPETITIONS IN THE FIELD OF ENTERTAINMENT, EDUCATION, CULTURE, SPORTS, AND OTHER NON-BUSINESS AND NON-COMMERCIAL FIELDS; ENTERTAINMENT AND EDUCATIONAL SERVICES, NAMELY, PROVIDING A WEBSITE THAT DISPLAYS VARIOUS REQUESTS, REVIEWS, RECOMMENDATIONS, RANKINGS, TRACKINGS, VOTES, AND INFORMATION RELATING TO UNCREATED, UNRELEASED, NEW, SPECIAL, POPULAR, AND RARE PRODUCTS, SERVICES, AND EVENTS IN THE FIELDS OF POP CULTURE, ENTERTAINMENT, EDUCATION, LIFESTYLE, AND SPORTS, ALL EXCLUSIVELY FOR NON-BUSINESS AND NON-COMMERCIAL TRANSACTIONS AND PURPOSES; ENTERTAINMENT AND EDUCATIONAL SERVICES, NAMELY, PROVIDING ADVICE AND INFORMATION FOR MUSIC, VIDEO AND FILM CONCEPT AND SCRIPT DEVELOPMENT; ENTERTAINMENT SERVICES IN THE NATURE OF ON-GOING TELEVISION PROGRAMS IN THE FIELD OF CHILDREN'S ENTERTAINMENT; PROVIDING A WEBSITE FEATURING EDUCATION AND ENTERTAINMENT FOR CHILDREN (BASED ON 44(E)) EDUCATIONAL AND ENTERTAINMENT SERVICES, NAMELY, A CONTINUING PROGRAM ABOUT SCIENCE ACCESSIBLE BY RADIO, TELEVISION, SATELLITE, AUDIO, VIDEO AND COMPUTER NETWORKS; ENTERTAINMENT AND EDUCATION SERVICES IN THE NATURE OF A SERIES OF SHORT SHOWS FEATURING SCIENCE AND MUSIC DISTRIBUTED TO MOBILE HANDSETS, WHICH MAY INCLUDE VIDEO, TEXT, PHOTOS, ILLUSTRATIONS OR HYPERTEXT; ENTERTAINMENT AND EDUCATIONAL SERVICES IN THE NATURE OF ON-LINE COMPETITIONS IN THE FIELD OF ENTERTAINMENT, EDUCATION, CULTURE, SPORTS, AND OTHER NON-BUSINESS AND NON-COMMERCIAL FIELDS; ENTERTAINMENT AND EDUCATIONAL SERVICES, NAMELY, PROVIDING A WEBSITE THAT DISPLAYS VARIOUS REQUESTS, REVIEWS, RECOMMENDATIONS, RANKINGS, TRACKINGS, VOTES, AND INFORMATION RELATING TO UNCREATED, UNRELEASED, NEW, SPECIAL, POPULAR, AND RARE PRODUCTS, SERVICES, AND EVENTS IN THE FIELDS OF POP CULTURE, ENTERTAINMENT, EDUCATION, LIFESTYLE, AND SPORTS, ALL EXCLUSIVELY FOR NON-BUSINESS AND NON-COMMERCIAL TRANSACTIONS AND PURPOSES; ENTERTAINMENT AND EDUCATIONAL SERVICES, NAMELY, PROVIDING ADVICE AND INFORMATION FOR MUSIC, VIDEO AND FILM CONCEPT AND SCRIPT DEVELOPMENT; ENTERTAINMENT SERVICES IN THE NATURE OF ON-GOING TELEVISION PROGRAMS IN THE FIELD OF CHILDREN'S ENTERTAINMENT; PROVIDING A WEBSITE FEATURING EDUCATION AND ENTERTAINMENT FOR CHILDREN (U.S. CLS. 100, 101 AND 107).

FIRST USE 7-1-2007; IN COMMERCE 7-1-2007.

SAIMA MAKHDOOM, EXAMINING ATTORNEY

CLASS 41—(Continued).

SN 77-720,794. PASTORE, NANCY, GREENWICH, CT. AND BAUER, PATRICIA, GREENWICH, CT. FILED 4-23-2009.

THE HEALTH SECRET SHOW

THE MARK CONSISTS OF STANDARD CHARACTERS WITHOUT CLAIM TO ANY PARTICULAR FONT, STYLE, SIZE, OR COLOR.

NO CLAIM IS MADE TO THE EXCLUSIVE RIGHT TO USE "HEALTH" OR "SHOW", APART FROM THE MARK AS SHOWN.

FOR ENTERTAINMENT SERVICES, NAMELY, PROVIDING AN ON-GOING RADIO PROGRAM IN THE FIELD OF HEALTH AND WELLNESS (U.S. CLS. 100, 101 AND 107).

FIRST USE 9-30-2008; IN COMMERCE 9-30-2008.
ELIZABETH HUGHITT, EXAMINING ATTORNEY

SN 77-720,959. BESHENICH MUIR & ASSOCIATES, LLC, LEAVENWORTH, KS. FILED 4-23-2009.

DESIGNED BY OPERATIONAL PROFESSIONALS FOR OPERATIONAL PROFESSIONALS

THE MARK CONSISTS OF STANDARD CHARACTERS WITHOUT CLAIM TO ANY PARTICULAR FONT, STYLE, SIZE, OR COLOR.

FOR DEVELOPING TRAINING SYSTEMS AND LEARNING METHODOLOGIES FOR OTHERS; PHYSICAL FITNESS TRAINING SERVICES; TRAINING IN THE USE OF FIREARMS, EXPLOSIVES, VEHICLES USED IN HIGH-SPEED ON AND OFF-ROAD DRIVING, PARACHUTES, HELICOPTERS, AIRCRAFTS; TRAINING SERVICES IN THE FIELD OF FIREARMS, EXPLOSIVES, HIGH-SPEED ON AND OFF ROAD DRIVING, SHOOT HOUSE OPERATIONS, PARACHUTE OPERATIONS, URBAN AND RURAL HELICOPTER OPERATIONS, AIRCRAFT AND AIRCRAFT ASSAULTS, ARMORED TRAINING, LEADERSHIP AND TEAM-BUILDING, AND DEDICATED PRE-DEPLOYMENT TRAINING; PROVIDING FACILITIES FOR TRAINING IN THE FIELDS OF URBAN AND RURAL COMBAT, HELICOPTER OPERATIONS, COMBAT CONVOY, TACTICAL DRIVING, EXPLOSIVES AND FIREARMS TRAINING, PARACHUTE OPERATIONS, PHYSICAL FITNESS (U.S. CLS. 100, 101 AND 107).

FIRST USE 11-0-2008; IN COMMERCE 11-0-2008.
MIDGE BUTLER, EXAMINING ATTORNEY

CLASS 41—(Continued).

SN 77-721,255. TWENTIETH CENTURY FOX FILM CORPORATION, LOS ANGELES, CA. FILED 4-23-2009.



OWNER OF U.S. REG. NOS. 2,033,557, 2,903,242 AND 3,001,994.

NO CLAIM IS MADE TO THE EXCLUSIVE RIGHT TO USE "SPORTS", APART FROM THE MARK AS SHOWN.

THE MARK CONSISTS OF THE STYLIZED WORDS "THE ADVENTURES OF DIGGER AND FRIENDS" WHICH APPEAR INSIDE OF TWO OVAL CONCENTRIC LINES, THE WORDS "FOX SPORTS" WHICH APPEAR UNDER THE WORD "FRIENDS" AND INSIDE OF THE OVAL SHAPE OVERLAPPING ON THE BOTTOM OF THE INNER OVAL LINE AND FIVE COSTUMED GOPHER CHARACTERS WHICH APPEAR ABOVE THE OUTER OVAL LINE.

FOR ENTERTAINMENT SERVICES IN THE NATURE OF A TELEVISION SERIES IN THE FIELDS OF SPORTS AND COMEDY; PROVIDING ON-LINE INFORMATION IN THE FIELD OF TELEVISION AND VIDEO ENTERTAINMENT VIA A GLOBAL COMMUNICATIONS NETWORK; ON-LINE JOURNALS, NAMELY, BLOGS FEATURING PERSONAL OPINIONS IN THE FIELDS OF GENERAL INTEREST, SPORTS AND COMEDY (U.S. CLS. 100, 101 AND 107).

LINDA LAVACHE, EXAMINING ATTORNEY

SN 77-721,753. MARC DEVINCENT, POWELL, OH. FILED 4-24-2009.

The Life Writer

THE MARK CONSISTS OF STANDARD CHARACTERS WITHOUT CLAIM TO ANY PARTICULAR FONT, STYLE, SIZE, OR COLOR.

NO CLAIM IS MADE TO THE EXCLUSIVE RIGHT TO USE "WRITER", APART FROM THE MARK AS SHOWN.

FOR CUSTOM WRITING SERVICES (U.S. CLS. 100, 101 AND 107).

PATRICIA EVANKO, EXAMINING ATTORNEY

CLASS 41—(Continued).

SN 77-721,767. WATSON, ANNA BAIRD, NEW YORK, NY.
FILED 4-24-2009.

The Recession Cookbook

THE MARK CONSISTS OF STANDARD CHARACTERS WITHOUT CLAIM TO ANY PARTICULAR FONT, STYLE, SIZE, OR COLOR.

NO CLAIM IS MADE TO THE EXCLUSIVE RIGHT TO USE "COOKBOOK", APART FROM THE MARK AS SHOWN.

FOR ON-LINE JOURNALS, NAMELY, BLOGS FEATURING RECIPES AND COOKING TIPS (U.S. CLS. 100, 101 AND 107).

FIRST USE 3-2-2009; IN COMMERCE 4-24-2009.
JESSICA FATHY, EXAMINING ATTORNEY

SN 77-721,785. EB VENTURES, INC., DBA FIFTH AVENUE DIGITAL, NEW YORK, NY. FILED 4-24-2009.

FIFTH AVENUE DIGITAL

THE MARK CONSISTS OF STANDARD CHARACTERS WITHOUT CLAIM TO ANY PARTICULAR FONT, STYLE, SIZE, OR COLOR.

NO CLAIM IS MADE TO THE EXCLUSIVE RIGHT TO USE "DIGITAL", APART FROM THE MARK AS SHOWN.

FOR PHOTOGRAPHY (U.S. CLS. 100, 101 AND 107).

FIRST USE 6-1-2004; IN COMMERCE 6-1-2004.
LEIGH CAROLINE CASE, EXAMINING ATTORNEY

SN 77-722,013. NEW ENGLAND PATRIOTS, L.P., FOXBOROUGH, MA. FILED 4-24-2009.

THE BELESTRATOR

THE MARK CONSISTS OF STANDARD CHARACTERS WITHOUT CLAIM TO ANY PARTICULAR FONT, STYLE, SIZE, OR COLOR.

FOR ENTERTAINMENT SERVICES, NAMELY, PROVIDING EXPERT COMMENTARY ON SPORTS EVENTS VIA TELEVISION OR THE INTERNET (U.S. CLS. 100, 101 AND 107).

CHRIS WELLS, EXAMINING ATTORNEY

CLASS 41—(Continued).

SN 77-722,048. EXECUTIVE COMMAND, INC., TEMPE, AZ.
FILED 4-24-2009.

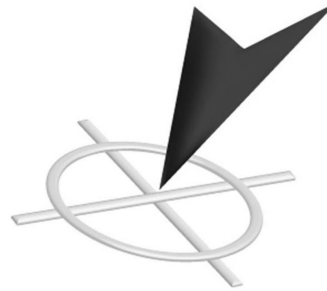

THE MARK CONSISTS OF A WEDGE SHAPED ARROW POINTING AT THE CENTER OF A TARGET.

FOR EDUCATION SERVICES, NAMELY, PROVIDING TRAINING, WORKSHOPS, SEMINARS AND KEYNOTES IN THE FIELDS OF DECISION MAKING, LEADERSHIP, MANAGEMENT, SUPERVISION, TEAMWORK, ETHICS, COMMUNICATION, DECISIVE POINT, DIVERSITY, ADVERSITY, CHANGE STRUCTURE, STRATEGY, COURSE OF ACTION DEVELOPMENT, AUTHORITY AND MISSION ANALYSIS BY UTILIZING LIVE TRAINING SIMULATIONS, REAL-TIME STRATEGY GAMING, AND BEHAVIORAL SCIENCE (U.S. CLS. 100, 101 AND 107).

FIRST USE 1-1-2007; IN COMMERCE 1-1-2007.
NICHOLAS COLEMAN, EXAMINING ATTORNEY

SN 77-722,067. JOHNSON, LOUIS, WELLINGTON, FL. AND MEREDITH, JORDAN, WELLINGTON, UNITED STATES, FILED 4-24-2009.

Augustine

THE MARK CONSISTS OF STANDARD CHARACTERS WITHOUT CLAIM TO ANY PARTICULAR FONT, STYLE, SIZE, OR COLOR.

FOR ENTERTAINMENT IN THE NATURE OF VISUAL AND AUDIO PERFORMANCES, NAMELY, MUSICAL BAND, ROCK GROUP, GYMNASTIC, DANCE, AND BALLET PERFORMANCES; ENTERTAINMENT SERVICES IN THE NATURE OF LIVE MUSICAL PERFORMANCES; ENTERTAINMENT SERVICES, NAMELY, PROVIDING A WEB SITE FEATURING MUSICAL PERFORMANCES, MUSICAL VIDEOS, RELATED FILM CLIPS, PHOTOGRAPHS, AND OTHER MULTIMEDIA MATERIALS FEATURING ORIGINAL SONGS AND MUSIC AND PICTURES; ENTERTAINMENT SERVICES, NAMELY, THE PRESENTATION OF LIVE CHRISTMAS MUSICAL PRODUCTIONS; ENTERTAINMENT, NAMELY, LIVE MUSIC CONCERTS; ENTERTAINMENT, NAMELY, LIVE PERFORMANCES BY A MUSICAL BAND; ENTERTAINMENT, NAMELY, LIVE PERFORMANCES BY MUSICAL BANDS; ENTERTAINMENT, NAMELY, LIVE PERFORMANCES BY ROCK GROUPS (U.S. CLS. 100, 101 AND 107).

FIRST USE 9-1-2008; IN COMMERCE 9-1-2008.
BRENDAN REGAN, EXAMINING ATTORNEY

CLASS 41—(Continued).

SN 77-722,109. GREATER DELAWARE VALLEY SOCIETY OF TRANSPLANT SURGEONS, PHILADELPHIA, PA. FILED 4-24-2009.

CLASS 41—(Continued).

SN 77-722,320. WOODWARD, JENNY, NEW YORK, NY. AND SANTOPIETRO, JILL, NEW YORK, NY. FILED 4-24-2009.

DUAL ADVOCACY

KITCHEN 4B

THE MARK CONSISTS OF STANDARD CHARACTERS WITHOUT CLAIM TO ANY PARTICULAR FONT, STYLE, SIZE, OR COLOR.

FOR EDUCATIONAL SERVICES, NAMELY, CONDUCTING WORKSHOPS, SEMINARS AND TRAINING IN THE FIELD OF TISSUE AND ORGAN DONATION FOR PROFESSIONALS AND COURSE MATERIALS DISTRIBUTED THEREWITH (U.S. CLS. 100, 101 AND 107).

FIRST USE 1-1-2005; IN COMMERCE 1-1-2005.
AMEEN IMAM, EXAMINING ATTORNEY

THE MARK CONSISTS OF STANDARD CHARACTERS WITHOUT CLAIM TO ANY PARTICULAR FONT, STYLE, SIZE, OR COLOR.

NO CLAIM IS MADE TO THE EXCLUSIVE RIGHT TO USE "KITCHEN", APART FROM THE MARK AS SHOWN.

FOR ENTERTAINMENT IN THE NATURE OF ONGOING TELEVISION PROGRAMS AND VIDEO SERIES IN THE FIELD OF AND ADVICE FOR COOKING AND STOCKING A KITCHEN; ON-LINE JOURNALS, NAMELY, BLOGS FEATURING TIPS AND ADVICE FOR COOKING AND STOCKING A KITCHEN; WRITING OF ARTICLES FOR ON-LINE JOURNALS ABOUT FOOD OTHER THAN FOR ADVERTISING OR PUBLICITY (U.S. CLS. 100, 101 AND 107).

FIRST USE 3-16-2009; IN COMMERCE 3-16-2009.
JANET LEE, EXAMINING ATTORNEY

SN 77-722,270. VEGAS.COM, LLC, HENDERSON, NV. FILED 4-24-2009.

SN 77-722,343. BRUNO, PAUL R, HENDERSON, NV. FILED 4-24-2009.

OFFICIAL VEGAS BOX OFFICE

History Czar

THE MARK CONSISTS OF STANDARD CHARACTERS WITHOUT CLAIM TO ANY PARTICULAR FONT, STYLE, SIZE, OR COLOR.

OWNER OF U.S. REG. NOS. 2,921,834, 3,563,363 AND OTHERS.

NO CLAIM IS MADE TO THE EXCLUSIVE RIGHT TO USE "BOX OFFICE", APART FROM THE MARK AS SHOWN.

FOR TRAVEL AGENCY SERVICES, NAMELY, MAKING RESERVATIONS AND BOOKINGS FOR ENTERTAINMENT (U.S. CLS. 100, 101 AND 107).

FIRST USE 3-5-2004; IN COMMERCE 3-5-2004.
KATHERINE CONNOLLY, EXAMINING ATTORNEY

THE MARK CONSISTS OF STANDARD CHARACTERS WITHOUT CLAIM TO ANY PARTICULAR FONT, STYLE, SIZE, OR COLOR.

NO CLAIM IS MADE TO THE EXCLUSIVE RIGHT TO USE "HISTORY", APART FROM THE MARK AS SHOWN.

FOR ENTERTAINMENT SERVICES, NAMELY, PROVIDING AN EDUCATIONAL RADIO PROGRAM IN THE FIELD OF HISTORY VIA A GLOBAL COMPUTER NETWORK (U.S. CLS. 100, 101 AND 107).

FIRST USE 3-4-2009; IN COMMERCE 3-4-2009.
JENNIFER HETU, EXAMINING ATTORNEY

CLASS 41—(Continued).

SN 77-722,358. ECKHARDT, MARK HAMILTON, DBA LYFE SYSTEMS, LOS ANGELES, CA. FILED 4-24-2009.

LYFE Systems

THE MARK CONSISTS OF STANDARD CHARACTERS WITHOUT CLAIM TO ANY PARTICULAR FONT, STYLE, SIZE, OR COLOR.

NO CLAIM IS MADE TO THE EXCLUSIVE RIGHT TO USE "SYSTEMS", APART FROM THE MARK AS SHOWN.

FOR EDUCATIONAL SERVICES, NAMELY, CONDUCTING CONDUCTING WORKSHOPS AND SEMINARS IN THE FIELD OF EFFECTIVENESS, PRODUCTIVITY, COMMUNICATION, LEADERSHIP, MANAGEMENT, AND PERSONAL AND ORGANIZATIONAL DEVELOPMENT AND DISTRIBUTION OF COURSE MATERIAL IN CONNECTION THEREWITH (U.S. CLS. 100, 101 AND 107).

FIRST USE 4-1-2008; IN COMMERCE 4-1-2008.
LAKEISHA LEWIS, EXAMINING ATTORNEY

SN 77-722,447. MOTOR, LLC, TROY, MI. FILED 4-25-2009.

MOTOR

THE MARK CONSISTS OF STANDARD CHARACTERS WITHOUT CLAIM TO ANY PARTICULAR FONT, STYLE, SIZE, OR COLOR.

FOR (BASED ON USE IN COMMERCE) ARRANGING AND CONDUCTING NIGHTCLUB ENTERTAINMENT EVENTS; ARRANGING AND CONDUCTING SPECIAL EVENTS; ENTERTAINMENT SERVICES IN THE NATURE OF LIVE MUSICAL PERFORMANCES; ENTERTAINMENT, NAMELY, LIVE MUSIC CONCERTS; NIGHT CLUBS; PRESENTATION OF MUSICAL PERFORMANCE; THEATRICAL AND MUSICAL FLOOR SHOWS PROVIDED AT DISCOTHEQUES AND NIGHTCLUBS; THEATRICAL AND MUSICAL FLOOR SHOWS PROVIDED AT PERFORMANCE VENUES; (BASED ON INTENT TO USE) MAGAZINE PUBLISHING; PUBLICATION OF MAGAZINES; PUBLISHING OF WEB MAGAZINES; SPECIAL EVENT PLANNING; SPECIAL EVENT PLANNING CONSULTATION (U.S. CLS. 100, 101 AND 107).

FIRST USE 9-16-1996; IN COMMERCE 9-16-1996.
ESTHER BELENKER, EXAMINING ATTORNEY

CLASS 41—(Continued).

SN 77-722,502. AFTER COOL FITNESS, LLC, PHOENIX, AZ. FILED 4-26-2009.

After COOL Fitness

NO CLAIM IS MADE TO THE EXCLUSIVE RIGHT TO USE "FITNESS", APART FROM THE MARK AS SHOWN.

THE COLOR(S) BLUE, ORANGE IS/ARE CLAIMED AS A FEATURE OF THE MARK.

THE MARK CONSISTS OF "AFTER" IS BLUE "COOL" MUST BE CAPITALIZED AND IN ORANGE AND "FITNESS" IS BLUE.

FOR EDUCATIONAL SERVICES, NAMELY, PROVIDING CLASSES IN THE FIELDS OF EXERCISE AND NUTRITION; ENTERTAINMENT SERVICES, NAMELY, CONTEST AND INCENTIVE AWARD PROGRAMS DESIGNED TO REWARD PROGRAM PARTICIPANTS WHO EXERCISE, MAKE HEALTHY EATING CHOICES, AND ENGAGE IN OTHER HEALTH-PROMOTING ACTIVITIES; PHYSICAL FITNESS CONDITIONING CLASSES; PROVIDING A WEB SITE FEATURING INFORMATION ON EXERCISE AND FITNESS; PROVIDING AFTER SCHOOL EDUCATIONAL PROGRAMS FOR CHILDREN IN GRADES 1-8; PROVIDING AN ON-LINE COMPUTER DATABASE FEATURING INFORMATION REGARDING EXERCISE AND FITNESS; PROVIDING FITNESS AND EXERCISE FACILITIES; PROVIDING INFORMATION IN THE FIELD OF EXERCISE TRAINING; PROVIDING INFORMATION ON PHYSICAL EXERCISE (U.S. CLS. 100, 101 AND 107).

PATRICIA EVANKO, EXAMINING ATTORNEY

SN 77-722,516. MIA MATISSE, LAS VEGAS, NV. FILED 4-26-2009.

The Elevate Institute

THE MARK CONSISTS OF STANDARD CHARACTERS WITHOUT CLAIM TO ANY PARTICULAR FONT, STYLE, SIZE, OR COLOR.

NO CLAIM IS MADE TO THE EXCLUSIVE RIGHT TO USE "INSTITUTE", APART FROM THE MARK AS SHOWN.

FOR EDUCATIONAL SERVICES, NAMELY, CONDUCTING DISTANCE LEARNING INSTRUCTION AT THE SECONDARY, COLLEGE AND GRADUATE LEVELS; EDUCATIONAL SERVICES, NAMELY, PROVIDING COURSES OF INSTRUCTION AT THE COLLEGE LEVEL (U.S. CLS. 100, 101 AND 107).

G. MAYERSCHOFF, EXAMINING ATTORNEY

CLASS 41—(Continued).

SN 77-722,548. BARATTA'S ENTERPRISES, LLC, UPPER SADDLE RIVER, NJ. FILED 4-26-2009.



NO CLAIM IS MADE TO THE EXCLUSIVE RIGHT TO USE "SHOW.COM", APART FROM THE MARK AS SHOWN. THE COLOR(S) GREEN AND BLACK IS/ARE CLAIMED AS A FEATURE OF THE MARK.

THE MARK CONSISTS OF THE LETTERS "LBC" ABOVE THE WORDS "SHOW.COM" AND "LB'S CORNER, C IT AND B PART OF IT" ALL SHOWN IN THE COLOR GREEN WITH BLACK OUTLINING.

FOR BOOKING OF ENTERTAINMENT HALLS; CHARITABLE SERVICES, NAMELY, PROVIDING ARTS AND CRAFTS AND EDUCATIONAL MATERIALS IN THE NATURE OF RECYCLED MANUFACTURING BY-PRODUCTS TO NEEDY AND UNDERPRIVILEGED CHILDREN; DIGITAL VIDEO, AUDIO, AND MULTIMEDIA PUBLISHING SERVICES; EDITING OF RADIO AND TELEVISION PROGRAMMES; EDITING OR RECORDING OF SOUNDS AND IMAGES; EDUCATION AND ENTERTAINMENT SERVICES, NAMELY, PRODUCTION AND DISTRIBUTION OF ONGOING TELEVISION PROGRAMS IN THE FIELD OF FAMILY MANAGEMENT AND RELATIONSHIPS; EDUCATIONAL AND ENTERTAINMENT SERVICES, NAMELY, PROVIDING MOTIVATIONAL AND EDUCATIONAL SPEAKERS; EDUCATIONAL AND ENTERTAINMENT SERVICES, NAMELY, PROVIDING MOTIVATIONAL AND EDUCATIONAL SPEAKERS IN THE FIELD OF SELF- AND PERSONAL IMPROVEMENT; EDUCATIONAL AND ENTERTAINMENT SERVICES, NAMELY, PROVIDING ON-LINE INTERACTIVE CHILDREN'S STORIES; EDUCATIONAL SERVICES, NAMELY, CONDUCTING INFORMAL PROGRAMS IN THE FIELDS OF MUSIC AND PRODUCT INVENTIONS USING ON-LINE ACTIVITIES AND INTERACTIVE EXHIBITS, AND PRINTABLE MATERIALS DISTRIBUTED THEREWITH; ENTERTAINMENT AND EDUCATION SERVICES IN THE NATURE OF A SERIES OF SHORT SHOWS FEATURING NEWS IN THE FIELDS OF MUSIC AND PRODUCT INVENTIONS DISTRIBUTED TO MOBILE HANDSETS, WHICH MAY INCLUDE VIDEO, TEXT, PHOTOS, ILLUSTRATIONS OR HYPERTEXT; ENTERTAINMENT AND EDUCATION SERVICES IN THE NATURE OF LIVE DANCE AND MUSICAL PERFORMANCES; ENTERTAINMENT AND EDUCATIONAL SERVICES IN THE NATURE OF ON-LINE COMPETITIONS IN THE FIELD OF ENTERTAINMENT, EDUCATION, CULTURE, SPORTS, AND OTHER NON-BUSINESS AND NON-COMMERCIAL FIELDS; ENTERTAINMENT AND EDUCATIONAL SERVICES, NAMELY, PROVIDING A WEBSITE THAT DISPLAYS VARIOUS REQUESTS, REVIEWS, RECOMMENDATIONS, RANKINGS, TRACKINGS, VOTES, AND INFORMATION RELATING TO UNCREATED, UNRELEASED, NEW, SPECIAL, POPULAR, AND RARE PRODUCTS, SERVICES, AND EVENTS IN THE FIELDS OF POP CULTURE, ENTERTAINMENT, EDUCATION, LIFESTYLE, AND SPORTS, ALL EXCLUSIVELY FOR NON-BUSINESS AND NON-COMMERCIAL TRANSACTIONS AND PURPOSES; ENTERTAINMENT AND EDUCATIONAL SERVICES, NAMELY, PROVIDING ADVICE AND INFORMATION FOR MUSIC, VIDEO AND FILM CONCEPT AND SCRIPT DEVELOPMENT; ENTERTAINMENT AND RECREATIONAL SERVICES, NAMELY, ORGANIZING AND CONDUCTING A KNITTING/CROCHETING EVENT THE PROCEEDS OF WHICH ARE DONATED TO CHARITY; ENTERTAINMENT IN THE NATURE OF AUTOMOBILE RACES; ENTERTAINMENT IN THE NATURE OF BALLET PERFORMANCES; ENTERTAINMENT IN THE NATURE OF

CLASS 41—(Continued).

BASEBALL GAMES; ENTERTAINMENT IN THE NATURE OF BASKETBALL GAMES; ENTERTAINMENT IN THE NATURE OF BEAUTY PAGEANTS; ENTERTAINMENT IN THE NATURE OF BOXING CONTESTS; ENTERTAINMENT IN THE NATURE OF DANCE PERFORMANCES; ENTERTAINMENT IN THE NATURE OF FASHION SHOWS; ENTERTAINMENT IN THE NATURE OF FOOTBALL GAMES; ENTERTAINMENT IN THE NATURE OF LIVE RADIO PERSONALITY PERFORMANCES; ENTERTAINMENT IN THE NATURE OF MAGIC SHOWS; ENTERTAINMENT IN THE NATURE OF ORCHESTRA PERFORMANCES; ENTERTAINMENT IN THE NATURE OF TELEVISION NEWS SHOWS; ENTERTAINMENT IN THE NATURE OF THEATER PRODUCTIONS; ENTERTAINMENT IN THE NATURE OF VISUAL AND AUDIO PERFORMANCES, AND MUSICAL, VARIETY, NEWS AND COMEDY SHOWS; ENTERTAINMENT IN THE NATURE OF VISUAL AND AUDIO PERFORMANCES, NAMELY, MUSICAL BAND, ROCK GROUP, GYMNASIAC, DANCE, AND BALLET PERFORMANCES; ENTERTAINMENT SERVICES IN THE NATURE OF AN ON-GOING REALITY BASED TELEVISION PROGRAM; ENTERTAINMENT SERVICES IN THE NATURE OF AN ONGOING IPTV (INTERNET PROTOCOL TELEVISION), TELEVISION PROGRAMMING SEGMENTS IN THE FIELD OF POSITIVE PSYCHOLOGY, PERSONAL RELATIONSHIPS, THE ART AND SCIENCE OF HAPPINESS; ENTERTAINMENT SERVICES IN THE NATURE OF ON-GOING TELEVISION PROGRAMS IN THE FIELD OF CHILDREN'S ENTERTAINMENT; ENTERTAINMENT SERVICES, NAMELY, A MULTIMEDIA PROGRAM SERIES FEATURING COMEDY, ACTION AND ADVENTURE DISTRIBUTED VIA VARIOUS PLATFORMS ACROSS MULTIPLE FORMS OF TRANSMISSION MEDIA; ENTERTAINMENT SERVICES, NAMELY, AN ON-GOING TELEVISION NEWS SHOW SERIES FEATURING MUSICIANS AND PRODUCT INVENTORS PROVIDED THROUGH WEB SHOW ONLINE; ENTERTAINMENT SERVICES, NAMELY, AN ON-LINE ACTIVITY WHERE YOU CREATE YOUR OWN MUSIC VIDEOS; ENTERTAINMENT SERVICES, NAMELY, CONDUCTING CONTESTS; ENTERTAINMENT SERVICES, NAMELY, DANCE EVENTS BY A RECORDING ARTIST; ENTERTAINMENT SERVICES, NAMELY, LIVE, TELEVISED AND MOVIE APPEARANCES BY A PROFESSIONAL ENTERTAINER; ENTERTAINMENT SERVICES, NAMELY, PROVIDING A WEB SITE FEATURING MUSICAL PERFORMANCES, MUSICAL VIDEOS, RELATED FILM CLIPS, PHOTOGRAPHS, AND OTHER MULTIMEDIA MATERIALS FEATURING NONDOWNLOADABLE PRERECORDED MUSIC; ENTERTAINMENT SERVICES, NAMELY, PROVIDING A WEB SITE FEATURING USER-GENERATED VIDEOS ON A WIDE VARIETY OF TOPICS AND SUBJECTS; ENTERTAINMENT SERVICES, NAMELY, PROVIDING A WEBSITE AT WHICH THE GENERAL PUBLIC CAN RECEIVE ADVICE FROM AN INDIVIDUAL CONCERNING RELATIONSHIPS, SUCH ADVICE BEING FOR ENTERTAINMENT PURPOSES ONLY; ENTERTAINMENT SERVICES, NAMELY, PROVIDING LIVE ENTERTAINMENT BY DANCERS VIA THE INTERNET; ENTERTAINMENT SERVICES, NAMELY, PROVIDING ON-LINE COMPUTER GAMES; ENTERTAINMENT SERVICES, NAMELY, PROVIDING ON-LINE REVIEWS OF RADIO AND TELEVISION SHOWS ABOUT MUSIC AND PRODUCT INVENTIONS; ENTERTAINMENT SERVICES, NAMELY, PROVIDING NONDOWNLOADABLE PRERECORDED MUSIC, INFORMATION IN THE FIELD OF MUSIC, AND COMMENTARY AND ARTICLES ABOUT MUSIC, ALL ON-LINE VIA A GLOBAL COMPUTER NETWORK; ENTERTAINMENT SERVICES, NAMELY, PROVIDING VIDEO PODCASTS IN THE FIELD OF RADIO AND TELEVISION SHOWS ABOUT MUSIC AND PRODUCT INVENTIONS; ENTERTAINMENT SERVICES, NAMELY, PROVIDING VIRTUAL ENVIRONMENTS IN WHICH USERS CAN INTERACT FOR RECREATIONAL, LEISURE OR ENTERTAINMENT PURPOSES; ENTERTAINMENT SERVICES, NAMELY, PROVIDING WEBCASTS IN THE FIELD OF RADIO AND TELEVISION SHOWS ABOUT MUSIC AND PRODUCT INVENTIONS; ORGANIZING ON-LINE EXHIBITIONS AND CONFERENCES IN THE FIELDS OF EDUCATION, CULTURE, SPORTS AND ENTERTAINMENT FOR NON-BUSINESS AND NON-COMMERCIAL PURPOSES; PRODUCTION OF DVDS, VIDEOTAPES AND TELEVISION PROGRAMS FEATURING MUSIC

CLASS 41—(Continued).

AND PRODUCT INVENTIONS; PROVIDING A WEB SITE FEATURING INFORMATION ON EXERCISE AND FITNESS; PROVIDING A WEB SITE FEATURING INFORMATION ON HISTORIC FIGURES; PROVIDING A WEB SITE FEATURING INFORMATION ON YOUTH SPORTS; PROVIDING A WEB SITE FEATURING NON-DOWNLOADABLE INSTRUCTIONAL VIDEOS IN THE FIELD OF FINANCE; PROVIDING A WEB SITE FEATURING ON-LINE PUBLICATIONS IN THE FIELD OF NEWS ARTICLES FOR CHILDREN; PROVIDING A WEB SITE FEATURING SPORTING INFORMATION (U.S. CLS. 100, 101 AND 107).

DAVID YONTEF, EXAMINING ATTORNEY

CLASS 41—(Continued).

SN 77-722,642. SOLAZARRE, LLC, BOONTON, NJ. FILED 4-27-2009.

THE SOL PATH PROGRAM

THE MARK CONSISTS OF STANDARD CHARACTERS WITHOUT CLAIM TO ANY PARTICULAR FONT, STYLE, SIZE, OR COLOR.

NO CLAIM IS MADE TO THE EXCLUSIVE RIGHT TO USE "PROGRAM", APART FROM THE MARK AS SHOWN.

FOR EDUCATIONAL SERVICES, NAMELY, PROVIDING CLASSES, SEMINARS AND WORKSHOPS IN THE AREAS OF YOGA, HEALTH, WELLNESS, MIND MASTERY, LIFE EMPOWERMENT, LIFE DESIGN AND STRESS MANAGEMENT (U.S. CLS. 100, 101 AND 107).

KOURTNEE HODGES, EXAMINING ATTORNEY

SN 77-722,600. ROBERTAS MALECKIS, MORRISVILLE, NC. AND INGA SIRKAITE, MORRISVILLE, NC. FILED 4-26-2009.



THE MARK CONSISTS OF DANCING HUMANS, DANCING COUPLE, DANCING MAN AND WOMAN.

FOR DANCE EVENTS; DANCE INSTRUCTION; DANCE INSTRUCTION FOR CHILDREN; DANCE RESERVATION SERVICES, NAMELY, ARRANGING FOR ADMISSION TO DANCE EVENTS; DANCE SCHOOLS; DANCE STUDIOS; EDUCATION SERVICES, NAMELY, PROVIDING CLASSES AND INSTRUCTION IN THE FIELD OF DANCE; ENTERTAINMENT AND EDUCATION SERVICES IN THE NATURE OF LIVE DANCE AND MUSICAL PERFORMANCES; ENTERTAINMENT IN THE NATURE OF DANCE PERFORMANCES; ENTERTAINMENT IN THE NATURE OF VISUAL AND AUDIO PERFORMANCES, NAMELY, MUSICAL BAND, ROCK GROUP, GYMNASTIC, DANCE, AND BALLET PERFORMANCES; ENTERTAINMENT SERVICES, NAMELY, DANCE EVENTS BY A RECORDING ARTIST; ORGANIZATION OF DANCING EVENTS; ORGANIZING COMMUNITY FESTIVALS FEATURING A VARIETY OF ACTIVITIES, NAMELY, ART EXHIBITIONS, HERITAGE MARKETS, ETHNIC DANCES, AND THE LIKE; ORGANIZING COMMUNITY FESTIVALS FEATURING A VARIETY OF ACTIVITIES, NAMELY, SPORTING EVENTS, ART EXHIBITIONS, FLEA MARKETS, ETHNIC DANCES AND THE LIKE; PROVIDING DANCE HALLS; RENTAL OF DANCE FLOORS; TRAINING OF DANCE INSTRUCTORS (U.S. CLS. 100, 101 AND 107).

FIRST USE 4-1-2009; IN COMMERCE 4-1-2009.
 NAAKWAMA ANKRAH, EXAMINING ATTORNEY

SN 77-722,661. OFFSHORE SAILING SCHOOL LTD., INC., FT. MYERS, FL. FILED 4-27-2009.



OWNER OF U.S. REG. NO. 2,181,602.

NO CLAIM IS MADE TO THE EXCLUSIVE RIGHT TO USE "SAILING CLUB", APART FROM THE MARK AS SHOWN.

THE MARK CONSISTS OF THE WORDS "OFFSHORE SAILING CLUB" AND DESIGN OF SAILS.

SEC. 2(F) "OFFSHORE" HAS BECOME DISTINCTIVE OF THE GOODS/SERVICES THROUGH THE APPLICANT'S SUBSTANTIALLY EXCLUSIVE AND CONTINUOUS USE IN COMMERCE FOR AT LEAST THE FIVE YEARS IMMEDIATELY BEFORE THE DATE OF THIS STATEMENT..

FOR SAILING CLUB SERVICES, NAMELY, ORGANIZING SAILING ACTIVITIES AND MAKING SAILBOATS AVAILABLE TO CLUB MEMBERS AS PART OF THEIR CLUB MEMBERSHIP (U.S. CLS. 100, 101 AND 107).

FIRST USE 4-3-2009; IN COMMERCE 4-3-2009.
 LINDA POWELL, EXAMINING ATTORNEY

CLASS 41—(Continued).

SN 77-722,719. WORLD FOOTBALL INSIDER, INC., ATLANTA, GA. FILED 4-27-2009.

WORLD FOOTBALL INSIDER

THE MARK CONSISTS OF STANDARD CHARACTERS WITHOUT CLAIM TO ANY PARTICULAR FONT, STYLE, SIZE, OR COLOR.

NO CLAIM IS MADE TO THE EXCLUSIVE RIGHT TO USE "WORLD FOOTBALL", APART FROM THE MARK AS SHOWN.

FOR PROVIDING SPORTS INFORMATION AND NEWS RELATING TO SOCCER, KNOWN OUTSIDE THE UNITED STATES AS FOOTBALL, VIA A GLOBAL COMPUTER NETWORK AND WIRELESS NETWORKS (U.S. CLS. 100, 101 AND 107).

MARK SPARACINO, EXAMINING ATTORNEY

CLASS 41—(Continued).

SN 77-722,896. THE PROGRAM, LLC, QUINCY, MA. FILED 4-27-2009.



NO CLAIM IS MADE TO THE EXCLUSIVE RIGHT TO USE "PROGRAM", APART FROM THE MARK AS SHOWN. THE COLOR(S) RED AND BLACK IS/ARE CLAIMED AS A FEATURE OF THE MARK.

THE MARK CONSISTS OF A DOWNWARD FACING SEMI CIRCLE AND AN UPWARD FACING SEMI CIRCLE SURROUNDING AN UPSIDE DOWN LETTER "V" WITH THE WORDS "THE PROGRAM" ACROSS THE MIDDLE PART OF THE CIRCLE. THE COLOR RED APPEARS IN THE UPSIDE DOWN LETTER "V" AND THE COLOR BLACK APPEARS IN THE CIRCLE AND THE WORDS "THE PROGRAM".

FOR ATHLETIC TRAINING SERVICES (U.S. CLS. 100, 101 AND 107).

FIRST USE 8-11-2008; IN COMMERCE 8-11-2008.
ALEX KEAM, EXAMINING ATTORNEY

SN 77-722,753. TAYLOR, COREY, NEW YORK, NY. FILED 4-27-2009.

GYPSY BABIES

THE MARK CONSISTS OF STANDARD CHARACTERS WITHOUT CLAIM TO ANY PARTICULAR FONT, STYLE, SIZE, OR COLOR.

FOR ENTERTAINMENT, NAMELY, LIVE PERFORMANCES BY A MUSICAL GROUP (U.S. CLS. 100, 101 AND 107).

JEFF DEFORD, EXAMINING ATTORNEY

SN 77-722,850. BERKS TECHNICAL INSTITUTE, INC., VIRGINIA BEACH, VA. FILED 4-27-2009.

BTI

THE MARK CONSISTS OF STANDARD CHARACTERS WITHOUT CLAIM TO ANY PARTICULAR FONT, STYLE, SIZE, OR COLOR.

FOR EDUCATIONAL SERVICES, NAMELY, CAREER TRAINING VIA TWO YEAR COLLEGE AND VOCATIONAL LEVEL COURSES IN THE FIELDS OF BUSINESS, LEGAL, MEDICAL AND DENTAL, MESSAGE THERAPY, GRAPHIC AND WEB DESIGN, INTERNET AND NETWORK TECHNOLOGY AND RELATED FIELDS (U.S. CLS. 100, 101 AND 107).

FIRST USE 1-1-1991; IN COMMERCE 1-1-1991.
TIMOTHY FINNEGAN, EXAMINING ATTORNEY

SN 77-722,916. THE PROGRAM, LLC, QUINCY, MA. FILED 4-27-2009.

ONE MORE

THE MARK CONSISTS OF STANDARD CHARACTERS WITHOUT CLAIM TO ANY PARTICULAR FONT, STYLE, SIZE, OR COLOR.

FOR ATHLETIC TRAINING SERVICES (U.S. CLS. 100, 101 AND 107).

ALEX KEAM, EXAMINING ATTORNEY

CLASS 41—(Continued).

SN 77-722,929. JAY STOLLMAN, MILFORD, CT. FILED 4-27-2009.

TOTALLY FUNKED

THE MARK CONSISTS OF STANDARD CHARACTERS WITHOUT CLAIM TO ANY PARTICULAR FONT, STYLE, SIZE, OR COLOR.

FOR ENTERTAINMENT AND EDUCATION SERVICES IN THE NATURE OF LIVE DANCE AND MUSICAL PERFORMANCES; ENTERTAINMENT SERVICES IN THE NATURE OF LIVE MUSICAL PERFORMANCES; ENTERTAINMENT, NAMELY, LIVE MUSIC CONCERTS; ENTERTAINMENT, NAMELY, LIVE PERFORMANCES BY A MUSICAL BAND (U.S. CLS. 100, 101 AND 107).

FIRST USE 3-1-2009; IN COMMERCE 3-1-2009.
LINDA ORNDORFF, EXAMINING ATTORNEY

SN 77-723,011. NIELSEN BUSINESS MEDIA, INC., NEW YORK, NY. FILED 4-27-2009.

SURVEY OF BUYING POWER

THE MARK CONSISTS OF STANDARD CHARACTERS WITHOUT CLAIM TO ANY PARTICULAR FONT, STYLE, SIZE, OR COLOR.

OWNER OF U.S. REG. NO. 1,536,359.

NO CLAIM IS MADE TO THE EXCLUSIVE RIGHT TO USE "SURVEY", APART FROM THE MARK AS SHOWN.

FOR PROVIDING ON-LINE MAGAZINES IN THE FIELD OF DEMOGRAPHIC, ECONOMIC, AND SALES INFORMATION (U.S. CLS. 100, 101 AND 107).

FIRST USE 8-31-2008; IN COMMERCE 8-31-2008.
RICHARD A. STRASER, EXAMINING ATTORNEY

SN 77-723,098. CARLOS ABREU, BEVERLY HILLS, CA. FILED 4-27-2009.

HOLLYWOOD SPOTLIGHT AWARDS

THE MARK CONSISTS OF STANDARD CHARACTERS WITHOUT CLAIM TO ANY PARTICULAR FONT, STYLE, SIZE, OR COLOR.

NO CLAIM IS MADE TO THE EXCLUSIVE RIGHT TO USE "HOLLYWOOD" AND "AWARDS", APART FROM THE MARK AS SHOWN.

FOR PROVIDING RECOGNITION AND INCENTIVES BY THE WAY OF AWARDS TO DEMONSTRATE EXCELLENCE IN THE FIELD OF MOTION PICTURES, TELEVISION, MUSIC, RADIO, AND MULTIMEDIA (U.S. CLS. 100, 101 AND 107).

LINDA LAVACHE, EXAMINING ATTORNEY

CLASS 41—(Continued).

SN 77-723,685. INTERNATIONAL SPECIAL EVENTS SOCIETY, INC., CHICAGO, IL. FILED 4-28-2009.

ISES EVENTWORLD

THE MARK CONSISTS OF STANDARD CHARACTERS WITHOUT CLAIM TO ANY PARTICULAR FONT, STYLE, SIZE, OR COLOR.

OWNER OF U.S. REG. NOS. 2,197,226, 2,301,923 AND OTHERS.

FOR ARRANGING AND CONDUCTING EDUCATION CONFERENCES IN THE FIELD OF SPECIAL EVENTS (U.S. CLS. 100, 101 AND 107).

FIRST USE 4-0-2004; IN COMMERCE 4-0-2004.
AISHA SALEM, EXAMINING ATTORNEY

SN 77-723,744. NAMASTE HOLDINGS, LLC, MANCHESTER, NH. FILED 4-28-2009.

YOGABALANCE

THE MARK CONSISTS OF STANDARD CHARACTERS WITHOUT CLAIM TO ANY PARTICULAR FONT, STYLE, SIZE, OR COLOR.

FOR PHYSICAL FITNESS INSTRUCTION; EDUCATION SERVICES, NAMELY, CLASSES AND TEACHER TRAINING IN THE FIELD OF YOGA, AND DISTRIBUTION OF INSTRUCTIONAL MATERIALS ASSOCIATED THEREWITH (U.S. CLS. 100, 101 AND 107).

FIRST USE 9-1-2004; IN COMMERCE 10-3-2004.
JANICE L. MCMORROW, EXAMINING ATTORNEY

SN 77-723,804. SCHAEFER, ALAN J., DBA SCHAEFER, ALAN J, ATLANTA, GA. FILED 4-28-2009.

**Anatomy Of A Rock Star:
Rock The Inner You**

THE MARK CONSISTS OF STANDARD CHARACTERS WITHOUT CLAIM TO ANY PARTICULAR FONT, STYLE, SIZE, OR COLOR.

FOR EDUCATING AT SENIOR HIGH SCHOOLS; EDUCATING AT UNIVERSITY OR COLLEGES; EDUCATION AND ENTERTAINMENT SERVICES, NAMELY, PRODUCTION AND DISTRIBUTION OF ONGOING TELEVISION PROGRAMS IN THE FIELD OF FAMILY MANAGEMENT AND RELATIONSHIPS; EDUCATION SERVICES, NAMELY, MENTORING IN THE FIELD OF PERSONAL DEVELOPMENT; EDUCATION SERVICES, NAMELY, ONE-ON-ONE MENTORING IN THE FIELD OF PERSONAL DEVELOPMENT; EDUCATION SERVICES, NAMELY, ONE-ON-ONE MENTORING IN THE FIELDS OF PERSONAL DEVELOPMENT; EDUCATION SERVICES, NAMELY, PROVIDING LIVE AND ON-LINE INSTRUCTION IN THE FIELD OF PERSONAL DEVELOPMENT; EDUCATION SERVICES, NAMELY, PROVIDING MENTORING, TUTORING, CLASSES, SEMINARS

CLASS 41—(Continued).

AND WORKSHOPS IN THE FIELD OF PERSONAL DEVELOPMENT; EDUCATION SERVICES, NAMELY, PROVIDING INSTRUCTION IN THE FIELDS OF PERSONAL DEVELOPMENT; EDUCATIONAL AND ENTERTAINMENT SERVICES, NAMELY, A CONTINUING PROGRAM ABOUT PERSONAL DEVELOPMENT ACCESSIBLE BY RADIO, TELEVISION, SATELLITE, AUDIO, VIDEO AND COMPUTER NETWORKS; EDUCATIONAL AND ENTERTAINMENT SERVICES, NAMELY, PROVIDING MOTIVATIONAL AND EDUCATIONAL SPEAKERS IN THE FIELD OF SELF- AND PERSONAL IMPROVEMENT; EDUCATIONAL SERVICES, NAMELY, CONDUCTING SEMINARS, LECTURES, TELESEMINARS, TELECLASSES, AND WORKSHOPS IN PERSONAL AWARENESS; EDUCATIONAL SERVICES, NAMELY, DEVELOPING AND CONDUCTING TRAINING COURSES AND DISTRIBUTION OF TRAINING MATERIALS IN CONNECTION THEREWITH FOR SUBJECT MATTERS AS REQUESTED BY CUSTOMERS; ENTERTAINMENT AND EDUCATION SERVICES IN THE NATURE OF A SERIES OF SHORT SHOWS FEATURING EDUCATION/INSTRUCTION DISTRIBUTED TO MOBILE HANDSETS, WHICH MAY INCLUDE VIDEO, TEXT, PHOTOS, ILLUSTRATIONS OR HYPERTEXT; ENTERTAINMENT AND EDUCATIONAL SERVICES, NAMELY, THE PRESENTATION OF SEMINARS, LECTURES, WORKSHOPS AND PANEL DISCUSSIONS, AND ONGOING TELEVISION AND RADIO TALK SHOWS ALL IN THE FIELD OF PUBLIC INTEREST CONCERNING PERSONAL DEVELOPMENT; ENTERTAINMENT IN THE NATURE OF LIVE STAGE PERFORMANCES IN THE NATURE OF PERSONAL DEVELOPMENT OR LECTURE FOR HIRE IN THE FIELD OF PERSONAL DEVELOPMENT BY AN INDIVIDUAL; ENTERTAINMENT IN THE NATURE OF ONGOING TELEVISION PROGRAMS IN THE FIELD OF PERSONAL DEVELOPMENT (U.S. CLS. 100, 101 AND 107).

FIRST USE 2-1-2009; IN COMMERCE 3-16-2009.
LOURDES AYALA, EXAMINING ATTORNEY

CLASS 41—(Continued).

SN 77-723,851. PRODUCT PARTNERS, LLC, SANTA MONICA, CA. FILED 4-28-2009.

90-DAY HEALTH CHALLENGE

THE MARK CONSISTS OF STANDARD CHARACTERS WITHOUT CLAIM TO ANY PARTICULAR FONT, STYLE, SIZE, OR COLOR.

NO CLAIM IS MADE TO THE EXCLUSIVE RIGHT TO USE "90-DAY HEALTH", APART FROM THE MARK AS SHOWN.

FOR PROVIDING A WEB SITE FEATURING ON-LINE INSTRUCTION IN THE FIELD OF PHYSICAL EXERCISE AND NUTRITION AND TRACKING PROGRESS OF WORKOUTS; EDUCATIONAL SERVICES AND ON-LINE EDUCATIONAL SERVICES, NAMELY, PROVIDING INSTRUCTION IN THE FIELDS OF EXERCISE EQUIPMENT, PHYSICAL EXERCISE AND NUTRITION, AND INSTRUCTIONAL MATERIALS DISTRIBUTED IN CONNECTION THEREWITH; EDUCATIONAL SERVICES, NAMELY, TRACKING PROGRESS OF WORKOUTS FOR OTHERS; PROVIDING INFORMATION IN THE FIELD OF ENTERTAINMENT FEATURING INFORMATION ON REALITY BASED TELEVISION BY MEANS OF A GLOBAL COMPUTER NETWORK; ENTERTAINMENT SERVICES IN THE NATURE OF AN ON-GOING REALITY BASED TELEVISION PROGRAM; ENTERTAINMENT SERVICES, NAMELY, PROVIDING A REALITY BASED TELEVISION PROGRAM VIA A GLOBAL COMPUTER NETWORK; ENTERTAINMENT SERVICES, NAMELY, CONDUCTING CONTESTS; EDUCATION AND ENTERTAINMENT SERVICES, NAMELY, PROVIDING A WEBSITE FEATURING AUDIO CLIPS, VIDEO CLIPS, MUSICAL PERFORMANCES, MUSICAL VIDEOS, FILM CLIPS, PHOTOGRAPHS, AND INFORMATION IN THE FIELD OF AUDIO CLIPS, VIDEO CLIPS, MUSICAL PERFORMANCES, MUSICAL VIDEOS, FILM CLIPS, PHOTOGRAPHS; BLOGS FEATURING INFORMATION IN THE FIELD OF AUDIO CLIPS, VIDEO CLIPS, MUSICAL PERFORMANCES, MUSICAL VIDEOS, FILM CLIPS, PHOTOGRAPHS, AND OTHER MULTIMEDIA MATERIALS (U.S. CLS. 100, 101 AND 107).

TARAH HARDY, EXAMINING ATTORNEY

CLASS 41—(Continued).

SN 77-723,860. PRODUCT PARTNERS, LLC, SANTA MONICA, CA. FILED 4-28-2009.

BEACHBODY'S 90-DAY HEALTH
CHALLENGE

THE MARK CONSISTS OF STANDARD CHARACTERS WITHOUT CLAIM TO ANY PARTICULAR FONT, STYLE, SIZE, OR COLOR.

OWNER OF U.S. REG. NOS. 2,862,904, 3,450,708 AND OTHERS.

NO CLAIM IS MADE TO THE EXCLUSIVE RIGHT TO USE "90-DAY HEALTH", APART FROM THE MARK AS SHOWN.

FOR PROVIDING A WEB SITE FEATURING ON-LINE INSTRUCTION IN THE FIELD OF PHYSICAL EXERCISE AND NUTRITION AND TRACKING PROGRESS OF WORKOUTS; EDUCATIONAL SERVICES AND ON-LINE EDUCATIONAL SERVICES, NAMELY, PROVIDING INSTRUCTION IN THE FIELDS OF EXERCISE EQUIPMENT, PHYSICAL EXERCISE AND NUTRITION, AND INSTRUCTIONAL MATERIALS DISTRIBUTED IN CONNECTION THEREWITH; EDUCATIONAL SERVICES, NAMELY, TRACKING PROGRESS OF WORKOUTS FOR OTHERS; PROVIDING INFORMATION IN THE FIELD OF ENTERTAINMENT FEATURING INFORMATION ON REALITY BASED TELEVISION BY MEANS OF A GLOBAL COMPUTER NETWORK; ENTERTAINMENT SERVICES IN THE NATURE OF AN ON-GOING REALITY BASED TELEVISION PROGRAM; ENTERTAINMENT SERVICES, NAMELY, PROVIDING A REALITY BASED TELEVISION PROGRAM VIA A GLOBAL COMPUTER NETWORK; ENTERTAINMENT SERVICES, NAMELY, CONDUCTING CONTESTS; EDUCATION AND ENTERTAINMENT SERVICES, NAMELY, PROVIDING A WEBSITE FEATURING AUDIO CLIPS, VIDEO CLIPS, MUSICAL PERFORMANCES, MUSICAL VIDEOS, FILM CLIPS, PHOTOGRAPHS, AND INFORMATION IN THE FIELD OF AUDIO CLIPS, VIDEO CLIPS, MUSICAL PERFORMANCES, MUSICAL VIDEOS, FILM CLIPS, PHOTOGRAPHS; BLOGS FEATURING INFORMATION IN THE FIELD OF AUDIO CLIPS, VIDEO CLIPS, MUSICAL PERFORMANCES, MUSICAL VIDEOS, FILM CLIPS, PHOTOGRAPHS, AND OTHER MULTIMEDIA MATERIALS (U.S. CLS. 100, 101 AND 107).

TARAH HARDY, EXAMINING ATTORNEY

SN 77-723,886. MILLER-MOTTE BUSINESS COLLEGE, INC., VIRGINIA BEACH, VA. FILED 4-28-2009.

MILLER-MOTTE

THE MARK CONSISTS OF STANDARD CHARACTERS WITHOUT CLAIM TO ANY PARTICULAR FONT, STYLE, SIZE, OR COLOR.

FOR EDUCATIONAL SERVICES, NAMELY, CAREER TRAINING VIA TWO YEAR COLLEGE AND VOCATIONAL LEVEL COURSES IN THE FIELDS OF BUSINESS, LEGAL, MEDICAL AND DENTAL, TECHNOLOGY, COSMETOLOGY AND MASSAGE THERAPY (U.S. CLS. 100, 101 AND 107).

FIRST USE 3-15-1918; IN COMMERCE 4-1-1988.

BARBARA RUTLAND, EXAMINING ATTORNEY

CLASS 41—(Continued).

SN 77-723,945. MCPHERSON, MATHEW A., NORWALK, WI. FILED 4-28-2009.

LOST ADVENTURES

THE MARK CONSISTS OF STANDARD CHARACTERS WITHOUT CLAIM TO ANY PARTICULAR FONT, STYLE, SIZE, OR COLOR.

FOR ENTERTAINMENT SERVICES, NAMELY, A SEGMENT IN AN ONGOING SERIES FEATURING HUNTING PROVIDED THROUGH TELEVISION, CABLE TELEVISION, SATELLITE TELEVISION, WEBCASTS AND THE INTERNET (U.S. CLS. 100, 101 AND 107).

TOBY BULLOFF, EXAMINING ATTORNEY

SN 77-724,000. UNITED STATES YOUTH VOLLEYBALL LEAGUE, TORRANCE, CA. FILED 4-28-2009.

VOLLEYBALL STARTS HERE

THE MARK CONSISTS OF STANDARD CHARACTERS WITHOUT CLAIM TO ANY PARTICULAR FONT, STYLE, SIZE, OR COLOR.

NO CLAIM IS MADE TO THE EXCLUSIVE RIGHT TO USE "VOLLEYBALL", APART FROM THE MARK AS SHOWN.

FOR COMMUNITY BASED YOUTH VOLLEYBALL PROGRAMS (U.S. CLS. 100, 101 AND 107).

FIRST USE 7-24-2008; IN COMMERCE 7-24-2008.

CORY BOONE, EXAMINING ATTORNEY

SN 77-724,058. MAUI OCEAN CENTER, INC., WAILUKU, MAUI, HI. FILED 4-28-2009.

The Hawaiian Aquarium

THE MARK CONSISTS OF STANDARD CHARACTERS WITHOUT CLAIM TO ANY PARTICULAR FONT, STYLE, SIZE, OR COLOR.

OWNER OF U.S. REG. NO. 2,252,192.

NO CLAIM IS MADE TO THE EXCLUSIVE RIGHT TO USE "AQUARIUM", APART FROM THE MARK AS SHOWN.

SEC. 2(F).

FOR EDUCATIONAL AND ENTERTAINMENT SERVICES IN THE NATURE OF MARINE PARKS AND AQUARIUMS, CULTURAL EXHIBITIONS AND SHOWS IN THE NATURE OF HAWAIIAN FOLK ARTS AND CRAFTS (U.S. CLS. 100, 101 AND 107).

FIRST USE 6-22-1998; IN COMMERCE 6-22-1998.

JENNY PARK, EXAMINING ATTORNEY

CLASS 41—(Continued).

SN 77-724,064. THE COOPER UNION FOR THE ADVANCEMENT OF SCIENCE AND ART, NEW YORK, NY. FILED 4-28-2009.

THE COOPER UNION

THE MARK CONSISTS OF STANDARD CHARACTERS WITHOUT CLAIM TO ANY PARTICULAR FONT, STYLE, SIZE, OR COLOR.
FOR EDUCATIONAL SERVICES, NAMELY, PROVIDING INSTRUCTION AND TRAINING AT THE UNDERGRADUATE, GRADUATE, POST-GRADUATE AND PROFESSIONAL LEVELS (U.S. CLS. 100, 101 AND 107).
FIRST USE 0-0-1859; IN COMMERCE 0-0-1859.
CARYN GLASSER, EXAMINING ATTORNEY

SN 77-724,154. GOPLAY NETWORK, INC., LOS ALTOS, CA. FILED 4-28-2009.

GoPlay

THE MARK CONSISTS OF STANDARD CHARACTERS WITHOUT CLAIM TO ANY PARTICULAR FONT, STYLE, SIZE, OR COLOR.
FOR ENTERTAINMENT SERVICES, NAMELY, PROVIDING AN ON-LINE VIRTUAL ENVIRONMENT FOR TRADING VIRTUAL SPORTS TRADING CARDS AND TOKENS (U.S. CLS. 100, 101 AND 107).
REBECCA SMITH, EXAMINING ATTORNEY

CLASS 41—(Continued).

SN 77-724,209. SCHAEFER, ALAN J., DBA ALAN SCHAEFER, ATLANTA, GA. FILED 4-28-2009.



THE COLOR(S) RED, YELLOW, BLACK AND WHITE IS/ ARE CLAIMED AS A FEATURE OF THE MARK.
THE MARK CONSISTS OF A HEART AND VENTRICLES WHICH ARE IN RED. THE HEART IS OUTLINED IN BLACK AND FEATURES MULTIPLE BLACK DESIGNS AS BACKGROUND. IN THE MIDDLE OF THE HEART IS A BANNER IN YELLOW WITH BLACK OUTLINE FEATURING BLACK LETTERS OF THE WORDING "ANATOMY AND ROCK STAR." THE MIDDLE OF THE HEART FEATURES A BLACK HEART WITH THE WORDING "OF A" IN WHITE. UNDER THE HEART IS THE WORDING "ROCK THE INNER YOU" IN RED.
FOR CONDUCTING WORKSHOPS AND SEMINARS IN PERSONAL AWARENESS; CONDUCTING WORKSHOPS AND SEMINARS IN SELF AWARENESS; CONDUCTING WORKSHOPS AND SEMINARS IN PERSONAL DEVELOPMENT; EDUCATING AT SENIOR HIGH SCHOOLS; EDUCATING AT UNIVERSITY OR COLLEGES; EDUCATION AND ENTERTAINMENT SERVICES, NAMELY, PRODUCTION AND DISTRIBUTION OF ONGOING TELEVISION PROGRAMS IN THE FIELD OF FAMILY MANAGEMENT AND RELATIONSHIPS; EDUCATION SERVICES, NAMELY, PROVIDING LIVE AND ON-LINE SEMINARS IN THE FIELD OF PERSONAL DEVELOPMENT; EDUCATION SERVICES, NAMELY, PROVIDING MENTORING, TUTORING, CLASSES, SEMINARS AND WORKSHOPS IN THE FIELD OF PERSONAL DEVELOPMENT; EDUCATION SERVICES, NAMELY, PROVIDING INSTRUCTION IN THE FIELD OF PERSONAL DEVELOPMENT; EDUCATIONAL AND ENTERTAINMENT SERVICES, NAMELY, A CONTINUING PROGRAM ABOUT PERSONAL DEVELOPMENT ACCESSIBLE BY RADIO, TELEVISION, SATELLITE, AUDIO, VIDEO AND COMPUTER NETWORKS; EDUCATIONAL AND ENTERTAINMENT SERVICES, NAMELY, PROVIDING MOTIVATIONAL AND EDUCATIONAL SPEAKERS; EDUCATIONAL AND ENTERTAINMENT SERVICES, NAMELY, PROVIDING MOTIVATIONAL AND EDUCATIONAL SPEAKERS IN THE FIELD OF SELF- AND PERSONAL IMPROVEMENT; EDUCATIONAL AND ENTERTAINMENT SERVICES, NAMELY, PROVIDING MOTIVATIONAL SPEAKING SERVICES IN THE FIELD OF PERSONAL DEVELOPMENT; ENTERTAINMENT AND EDUCATION SERVICES IN THE NATURE OF A SERIES OF SHORT SHOWS FEATURING INSTRUCTIONAL MATERIALS DISTRIBUTED TO MOBILE HANDSETS, WHICH MAY

CLASS 41—(Continued).

INCLUDE VIDEO, TEXT, PHOTOS, ILLUSTRATIONS OR HYPERTEXT; ENTERTAINMENT AND EDUCATIONAL SERVICES, NAMELY, THE PRESENTATION OF SEMINARS, LECTURES, WORKSHOPS AND PANEL DISCUSSIONS; AND ONGOING TELEVISION AND RADIO TALK SHOWS ALL IN THE FIELD OF PUBLIC INTEREST CONCERNING PERSONAL DEVELOPMENT; ENTERTAINMENT SERVICES IN THE NATURE OF AN ON-GOING REALITY BASED TELEVISION PROGRAM; ENTERTAINMENT SERVICES, NAMELY, AN ON-GOING SERIES FEATURING VIDEOS PROVIDED THROUGH WEBSITES; ENTERTAINMENT SERVICES, NAMELY, PROVIDING A RADIO PROGRAM IN THE FIELD OF PERSONAL DEVELOPMENT VIA A GLOBAL COMPUTER NETWORK; ENTERTAINMENT SERVICES, NAMELY, PROVIDING A TELEVISION PROGRAM IN THE FIELD OF PERSONAL DEVELOPMENT VIA A GLOBAL COMPUTER NETWORK; ENTERTAINMENT SERVICES, NAMELY, PROVIDING AN ON-GOING RADIO PROGRAM IN THE FIELD OF PERSONAL DEVELOPMENT (U.S. CLS. 100, 101 AND 107).

FIRST USE 2-1-2009; IN COMMERCE 3-16-2009.
LOURDES AYALA, EXAMINING ATTORNEY

SN 77-724,217. SCAN HEALTH PLAN, LONG BEACH, CA.
FILED 4-28-2009.

TRADING AGES

THE MARK CONSISTS OF STANDARD CHARACTERS WITHOUT CLAIM TO ANY PARTICULAR FONT, STYLE, SIZE, OR COLOR.

FOR EDUCATIONAL SERVICES, NAMELY, CONDUCTING TRAINING COURSES, SEMINARS AND CONFERENCES IN THE FIELD OF GERIATRIC CARE, SENIOR HEALTH CARE AND SENIOR SENSITIVITY, AND DISTRIBUTION OF MATERIALS IN THE FIELD OF GERIATRIC CARE, SENIOR HEALTH CARE AND SENIOR SENSITIVITY IN CONNECTION THEREWITH (U.S. CLS. 100, 101 AND 107).

FIRST USE 4-24-2009; IN COMMERCE 4-24-2009.
ANDREA BUTLER, EXAMINING ATTORNEY

CLASS 41—(Continued).

SN 77-724,293. THE BOOT CAMP GUY LLC., AKA @ HOME FITNESS LLC., CHICAGO, IL. FILED 4-28-2009.



THE MARK CONSISTS OF HUMAN TORSO AND CHISELING OF ABDOMINAL AREA.

FOR PERSONAL TRAINER SERVICES; PET EXERCISE SERVICES; PROVIDING A WEB SITE FEATURING INFORMATION ON EXERCISE AND FITNESS; PROVIDING A WEBSITE FEATURING ONLINE SPORTS TRAINING AND TRAINING ADVICE AND THE RECORDING OF TRAINING AND WORKOUTS; PROVIDING AN ONLINE COMPUTER DATABASE FEATURING INFORMATION REGARDING EXERCISE AND FITNESS; PROVIDING ANIMAL EXERCISE SERVICES; PROVIDING ASSISTANCE, PERSONAL TRAINING AND PHYSICAL FITNESS CONSULTATION TO CORPORATE CLIENTS TO HELP THEIR EMPLOYEES MAKE PHYSICAL FITNESS, STRENGTH, CONDITIONING, AND EXERCISE ALTERATIONS IN THEIR DAILY LIVING; PROVIDING ASSISTANCE, PERSONAL TRAINING AND PHYSICAL FITNESS CONSULTATION TO INDIVIDUALS TO HELP THEM MAKE PHYSICAL FITNESS, STRENGTH, CONDITIONING, AND EXERCISE IMPROVEMENT IN THEIR DAILY LIVING; PROVIDING FITNESS AND EXERCISE FACILITIES; PROVIDING INFORMATION IN THE FIELD OF EXERCISE TRAINING; PROVIDING INFORMATION ON PHYSICAL EXERCISE (U.S. CLS. 100, 101 AND 107).

ROSELLE HERRERA, EXAMINING ATTORNEY

SN 77-724,320. LUMINAIR HOLDINGS LLC, CHICAGO, IL.
FILED 4-28-2009.

THE COLOR(S) BLACK AND GREEN IS/ARE CLAIMED AS A FEATURE OF THE MARK.

THE MARK CONSISTS OF THE WORD "VIDEYOU" IN BLACK WITH A STYLIZED LETTER "O" THAT IS GREEN WITH A BLACK OUTLINE. A STYLIZED DOT ON THE LETTER "I" THAT IS GREEN WITH A BLACK OUTLINE.

FOR FILM AND VIDEO PRODUCTION; VIDEO PRODUCTION SERVICES (U.S. CLS. 100, 101 AND 107).

KRISTIN CARLSON, EXAMINING ATTORNEY

CLASS 41—(Continued).

SN 77-724,361. MOUFARRIAGE, MARIA TATIANA, LAS VEGAS, NV. FILED 4-28-2009.



THE MARK CONSISTS OF "TAT" IN A STYLIZED FONT. FOR ENTERTAINMENT SERVICES IN THE NATURE OF LIVE MUSICAL PERFORMANCES (U.S. CLS. 100, 101 AND 107).

FIRST USE 6-1-2006; IN COMMERCE 6-1-2006.
JULIE WATSON, EXAMINING ATTORNEY

SN 77-724,373. SANSONE, CYNTHIA, COLUMBUS, OH. FILED 4-28-2009.

Reach. Grow. Thrive.

THE MARK CONSISTS OF STANDARD CHARACTERS WITHOUT CLAIM TO ANY PARTICULAR FONT, STYLE, SIZE, OR COLOR.

FOR LIFE COACHING SERVICES IN THE FIELD OF CHANGE MANAGEMENT, TRANSITION PLANNING, LIFE BALANCE, COMMUNICATION, PERSONAL FULFILLMENT, RELATIONSHIPS, AGING; PROFESSIONAL COACHING SERVICES IN THE FIELD OF CHANGE MANAGEMENT, CHANGE STRATEGY, CHANGE IMPLEMENTATION, LEADERSHIP DEVELOPMENT, BUSINESS DEVELOPMENT, TEAM DEVELOPMENT, INTERPERSONAL COMMUNICATIONS, INTERNAL BUSINESS COMMUNICATIONS, LIFE BALANCE, CAREER PLANNING, RETIREMENT PLANNING, TRANSITION PLANNING; PROVIDING GROUP COACHING AND LEARNING FORUMS IN THE FIELD OF LEADERSHIP DEVELOPMENT (U.S. CLS. 100, 101 AND 107).

ELIZABETH KAJUBI, EXAMINING ATTORNEY

SN 77-724,470. ROBERT CARTAGENA, NEW YORK, NY. FILED 4-28-2009.

SCREWMANEW

THE MARK CONSISTS OF STANDARD CHARACTERS WITHOUT CLAIM TO ANY PARTICULAR FONT, STYLE, SIZE, OR COLOR.

FOR MULTIMEDIA ENTERTAINMENT SERVICES IN THE NATURE OF RECORDING, PRODUCTION AND POST-PRODUCTION SERVICES IN THE FIELDS OF MUSIC, VIDEOS AND FILMS (U.S. CLS. 100, 101 AND 107).

COURTNEY MCCORMICK, EXAMINING ATTORNEY

CLASS 41—(Continued).

SN 77-724,540. PEACEFUL INTEGRATION, PLC, CHANDLER, AZ. FILED 4-28-2009.

EXCUSE POSSE

THE MARK CONSISTS OF STANDARD CHARACTERS WITHOUT CLAIM TO ANY PARTICULAR FONT, STYLE, SIZE, OR COLOR.

FOR ENTERTAINMENT IN THE NATURE OF A RADIO PROGRAM IN THE FIELD OF SELF-AWARENESS AND OVERCOMING PERSONAL BARRIERS; PERSONAL COACHING SERVICES IN THE FIELD OF SELF-AWARENESS AND OVERCOMING PERSONAL BARRIERS (U.S. CLS. 100, 101 AND 107).

GENE MACIOL, EXAMINING ATTORNEY

SN 77-724,607. BIG BULLY MMA PROMOTIONS, LLC, NEW CUMBERLAND, WV. FILED 4-29-2009.

BIG BULLY

THE MARK CONSISTS OF STANDARD CHARACTERS WITHOUT CLAIM TO ANY PARTICULAR FONT, STYLE, SIZE, OR COLOR.

FOR ENTERTAINMENT SERVICES IN THE NATURE OF LIVE MIXED MARTIAL ARTS (MMA) EVENTS; ORGANIZING LIVE MIXED MARTIAL ARTS EVENTS AND COMPETITIONS; PRESENTATION OF MIXED MARTIAL ARTS (MMA) EVENTS (U.S. CLS. 100, 101 AND 107).

LINDA ORNDORFF, EXAMINING ATTORNEY

SN 77-724,663. SAVAGE-ADALMAN, ADAM, DANVERS, MA. FILED 4-29-2009.

Mongrel

THE MARK CONSISTS OF STANDARD CHARACTERS WITHOUT CLAIM TO ANY PARTICULAR FONT, STYLE, SIZE, OR COLOR.

FOR ENTERTAINMENT SERVICES IN THE NATURE OF LIVE MUSICAL PERFORMANCES; PRODUCTION OF SOUND AND MUSIC VIDEO RECORDINGS (U.S. CLS. 100, 101 AND 107).

FIRST USE 9-1-2003; IN COMMERCE 9-1-2003.

JOHN WILKE, EXAMINING ATTORNEY

CLASS 41—(Continued).

SN 77-724,664. AMY ZUCKERMAN, AMHERST, MA. FILED 4-29-2009.

VALLEYWOOD

THE MARK CONSISTS OF STANDARD CHARACTERS WITHOUT CLAIM TO ANY PARTICULAR FONT, STYLE, SIZE, OR COLOR.

FOR ENTERTAINMENT IN THE NATURE OF THEATER PRODUCTIONS (U.S. CLS. 100, 101 AND 107).

YAT SYE, LEE, EXAMINING ATTORNEY

SN 77-724,737. BOSTON GLOBAL BRIDGE INSTITUTE, INC., BOSTON, MA. FILED 4-29-2009.

BOSTON GLOBAL BRIDGE INSTITUTE

THE MARK CONSISTS OF STANDARD CHARACTERS WITHOUT CLAIM TO ANY PARTICULAR FONT, STYLE, SIZE, OR COLOR.

NO CLAIM IS MADE TO THE EXCLUSIVE RIGHT TO USE "BOSTON GLOBAL" AND "INSTITUTE", APART FROM THE MARK AS SHOWN.

FOR EDUCATION SERVICES, NAMELY, PROVIDING CLASSES, SEMINARS, WORKSHOPS, AND PANEL DISCUSSIONS IN THE FIELDS OF SCIENCE, TECHNOLOGY, POLITICS, ECONOMICS, AND GLOBAL AFFAIRS; ORGANIZATION OF CONFERENCES, LEARNING FORUMS, AND SYMPOSIA IN THE FIELDS OF SCIENCE, TECHNOLOGY, POLITICS, ECONOMICS, AND GLOBAL AFFAIRS, ALL FOR EDUCATIONAL PURPOSES (U.S. CLS. 100, 101 AND 107).

B. PARADEWELAI, EXAMINING ATTORNEY

SN 77-724,747. CARNIVAL CORPORATION, MIAMI, FL. FILED 4-29-2009.

FUN PAIRS

THE MARK CONSISTS OF STANDARD CHARACTERS WITHOUT CLAIM TO ANY PARTICULAR FONT, STYLE, SIZE, OR COLOR.

NO CLAIM IS MADE TO THE EXCLUSIVE RIGHT TO USE "PAIRS", APART FROM THE MARK AS SHOWN.

FOR CASINO SERVICES; CASINO SERVICES IN THE NATURE OF A COMPONENT OF A GAMBLING GAME (U.S. CLS. 100, 101 AND 107).

GINA HAYES, EXAMINING ATTORNEY

CLASS 41—(Continued).

SN 77-724,790. LK SPORTS INC., WEST HOLLYWOOD, CA. FILED 4-29-2009.

SwimRIGHT
LEARN-TO-SWIM METHOD

NO CLAIM IS MADE TO THE EXCLUSIVE RIGHT TO USE "LEARN-TO-SWIM METHOD", APART FROM THE MARK AS SHOWN.

THE MARK CONSISTS OF THE STYLIZED TEXT "SWIM-RIGHT LEARN-TO-SWIM METHOD".

FOR SWIMMING INSTRUCTION (U.S. CLS. 100, 101 AND 107).

AMY KERTGATE, EXAMINING ATTORNEY

SN 77-724,797. ABNEY, SONDRRA, AUSTIN, TX. FILED 4-29-2009.



THE STIPPLING IS FOR SHADING PURPOSES ONLY.

THE MARK CONSISTS OF THE STYLIZED TEXT "POWER TO PERFORM" WITH A SWIRL IN THE MIDDLE. FOR PERSONAL TRAINING SERVICES, NAMELY, STRENGTH AND CONDITIONING TRAINING (U.S. CLS. 100, 101 AND 107).

FIRST USE 1-1-2008; IN COMMERCE 3-24-2009.

JULIE WATSON, EXAMINING ATTORNEY

SN 77-724,907. ENGSTROM, MARSHA, WOODLAND, CA. FILED 4-29-2009.

Readers in the Hood

THE MARK CONSISTS OF STANDARD CHARACTERS WITHOUT CLAIM TO ANY PARTICULAR FONT, STYLE, SIZE, OR COLOR.

NO CLAIM IS MADE TO THE EXCLUSIVE RIGHT TO USE "READERS", APART FROM THE MARK AS SHOWN.

FOR SOCIAL CLUB SERVICES, NAMELY, ARRANGING, ORGANIZING, AND HOSTING A BOOK CLUB FOR CLUB MEMBERS (U.S. CLS. 100, 101 AND 107).

FIRST USE 9-1-2003; IN COMMERCE 9-1-2003.

DAVID COLLIER, EXAMINING ATTORNEY

CLASS 41—(Continued).

SN 77-724,908. DEFEND YOURSELF NOW INC., DBA DYN, ARCADIA, CA. FILED 4-29-2009.

DYN

THE MARK CONSISTS OF STANDARD CHARACTERS WITHOUT CLAIM TO ANY PARTICULAR FONT, STYLE, SIZE, OR COLOR.

FOR EDUCATION SERVICES, NAMELY, PROVIDING LECTURES, SEMINARS, WORKSHOPS AND TRAINING IN THE FIELDS OF PERSONAL SAFETY, SELF-DEFENSE AND ASSAULT PREVENTION (U.S. CLS. 100, 101 AND 107).

FIRST USE 2-0-2009; IN COMMERCE 2-0-2009.
MIDGE BUTLER, EXAMINING ATTORNEY

SN 77-725,057. SYNAPTIC SEMINARS LLC, PUYALLUP, WA. FILED 4-29-2009.



The logo for Synaptic Seminars features a stylized swoosh above the word "Synaptic" in a serif font, followed by the word "Seminars" in a bold, sans-serif font.

THE MARK CONSISTS OF A SWOOSH FOLLOWED BY THE WORD "SYNAPTIC" IN ITALICS FOLLOWED BY THE WORD "SEMINARS" IN BOLD PRINT.

FOR EDUCATIONAL SERVICES, NAMELY, CONDUCTING SEMINARS IN THE FIELDS OF PHYSICAL THERAPY AND OCCUPATIONAL THERAPY, AND DISTRIBUTING SEMINAR MATERIALS IN CONNECTION THEREWITH (U.S. CLS. 100, 101 AND 107).

FIRST USE 4-1-2009; IN COMMERCE 4-1-2009.
MATTHEW PAPPAS, EXAMINING ATTORNEY

SN 77-725,075. CASTELLINI, KATRINA J., WOODBURY, NJ. AND FALLON, JR., DR. JOSEPH J., WOODBURY, NJ. FILED 4-29-2009.

No Sugar Added

THE MARK CONSISTS OF STANDARD CHARACTERS WITHOUT CLAIM TO ANY PARTICULAR FONT, STYLE, SIZE, OR COLOR.

FOR RADIO PROGRAM SYNDICATION (U.S. CLS. 100, 101 AND 107).

FIRST USE 10-6-2007; IN COMMERCE 10-6-2007.
MICHAEL ENGEL, EXAMINING ATTORNEY

CLASS 41—(Continued).

SN 77-725,141. FORD MODELS, INC., NEW YORK, NY. FILED 4-29-2009.

FASHION FEAST

THE MARK CONSISTS OF STANDARD CHARACTERS WITHOUT CLAIM TO ANY PARTICULAR FONT, STYLE, SIZE, OR COLOR.

NO CLAIM IS MADE TO THE EXCLUSIVE RIGHT TO USE "FASHION", APART FROM THE MARK AS SHOWN.

FOR ENTERTAINMENT IN THE NATURE OF ONGOING TELEVISION PROGRAMS IN THE FIELD OF FASHION MODELS AND FOOD (U.S. CLS. 100, 101 AND 107).

CAROLINE WOOD, EXAMINING ATTORNEY

SN 77-725,184. TRIANGLE, INC., MALDEN, MA. FILED 4-29-2009.

ABLEVISION

THE MARK CONSISTS OF STANDARD CHARACTERS WITHOUT CLAIM TO ANY PARTICULAR FONT, STYLE, SIZE, OR COLOR.

FOR PRODUCING ON-GOING CABLE TELEVISION PROGRAMS FEATURING AND PRODUCED BY PEOPLE WITH PHYSICAL AND/OR DEVELOPMENTAL DISABILITIES (U.S. CLS. 100, 101 AND 107).

FIRST USE 2-1-2003; IN COMMERCE 2-1-2003.
KATHY DE JONGE, EXAMINING ATTORNEY

SN 77-725,193. SUBSONIK SOUND, LLC, SHAWNEE, OK. FILED 4-29-2009.

SUBSONIK

THE MARK CONSISTS OF STANDARD CHARACTERS WITHOUT CLAIM TO ANY PARTICULAR FONT, STYLE, SIZE, OR COLOR.

FOR AUDIO RECORDING AND PRODUCTION; EDITING OR RECORDING OF SOUNDS AND IMAGES; PRODUCTION OF SOUND AND MUSIC VIDEO RECORDINGS; PROVIDING AUDIO OR VIDEO STUDIOS; PROVIDING VOICE OVERS FOR TAPES, RECORDS AND OTHER RECORDED MEDIA; RECORDING STUDIOS; SOUND RECORDING STUDIOS; VIDEO TAPE RECORDING FOR OTHERS (U.S. CLS. 100, 101 AND 107).

FIRST USE 5-15-2005; IN COMMERCE 5-15-2005.
KAREN BRACEY, EXAMINING ATTORNEY

CLASS 41—(Continued).

SN 77-725,300. BLANCETT, MATTHEW, HARKER HEIGHTS, TX. FILED 4-29-2009.

paradisebro!

THE MARK CONSISTS OF STANDARD CHARACTERS WITHOUT CLAIM TO ANY PARTICULAR FONT, STYLE, SIZE, OR COLOR.

FOR ENTERTAINMENT SERVICES IN THE NATURE OF LIVE MUSICAL PERFORMANCES (U.S. CLS. 100, 101 AND 107).

STEVEN R. FINE, EXAMINING ATTORNEY

CLASS 41—(Continued).

SN 77-725,488. TWENTIETH CENTURY FOX FILM CORPORATION, LOS ANGELES, CA. FILED 4-29-2009.



OWNER OF U.S. REG. NOS. 2,033,557, 2,903,242 AND 3,001,994.

NO CLAIM IS MADE TO THE EXCLUSIVE RIGHT TO USE "SPORTS", APART FROM THE MARK AS SHOWN.

THE MARK CONSISTS OF THE STYLIZED WORDS "THE ADVENTURES OF DIGGER AND FRIENDS" WHICH APPEAR IN THE CENTER, THE WORDS "FOX SPORTS" WHICH APPEAR INSIDE OF THE OVAL SHAPE ON THE TOP CENTER AND FIVE COSTUMED GOPHER CHARACTERS, AND ALL ARE DISPLAYED INSIDE OF THE RECTANGULAR BACKGROUND.

FOR ENTERTAINMENT SERVICES IN THE NATURE OF A TELEVISION SERIES IN THE FIELDS OF SPORTS AND COMEDY; PROVIDING ON-LINE INFORMATION IN THE FIELD OF TELEVISION AND VIDEO ENTERTAINMENT VIA A GLOBAL COMMUNICATIONS NETWORK; ON-LINE JOURNALS, NAMELY, BLOGS FEATURING PERSONAL OPINIONS IN THE FIELDS OF GENERAL INTEREST, SPORTS AND COMEDY (U.S. CLS. 100, 101 AND 107).

LINDA LAVACHE, EXAMINING ATTORNEY

SN 77-725,340. MOOMAH LLC, NEW YORK, NY. FILED 4-29-2009.

Gloga

THE MARK CONSISTS OF STANDARD CHARACTERS WITHOUT CLAIM TO ANY PARTICULAR FONT, STYLE, SIZE, OR COLOR.

FOR PROVIDING EXERCISE INSTRUCTION (U.S. CLS. 100, 101 AND 107).

THEODORE MCBRIDE, EXAMINING ATTORNEY

SN 77-725,493. SECURE DNA CONSULTING, INC., HONOLULU, HI. FILED 4-29-2009.

Shakacon

THE MARK CONSISTS OF STANDARD CHARACTERS WITHOUT CLAIM TO ANY PARTICULAR FONT, STYLE, SIZE, OR COLOR.

FOR COMPUTER EDUCATION TRAINING SERVICES; EDUCATIONAL SERVICES, NAMELY, DEVELOPING, ARRANGING, AND CONDUCTING EDUCATIONAL CONFERENCES AND PROGRAMS AND PROVIDING COURSES OF INSTRUCTION IN THE FIELD OF COMPUTING AND INFORMATION TECHNOLOGY; TEACHING AND TRAINING IN BUSINESS, INDUSTRY AND INFORMATION TECHNOLOGY; TRAINING IN THE USE AND OPERATION OF COMPUTERS (U.S. CLS. 100, 101 AND 107).

FIRST USE 7-0-2007; IN COMMERCE 7-0-2007.
REBECCA GILBERT, EXAMINING ATTORNEY

CLASS 41—(Continued).

SN 77-725,509. SECURE DNA CONSULTING, INC., HONOLULU, HI. FILED 4-29-2009.

Sun. Surf. C Shells.

THE MARK CONSISTS OF STANDARD CHARACTERS WITHOUT CLAIM TO ANY PARTICULAR FONT, STYLE, SIZE, OR COLOR.

FOR COMPUTER EDUCATION TRAINING SERVICES; EDUCATIONAL SERVICES, NAMELY, DEVELOPING, ARRANGING, AND CONDUCTING EDUCATIONAL CONFERENCES AND PROGRAMS AND PROVIDING COURSES OF INSTRUCTION IN THE FIELD OF COMPUTING AND INFORMATION TECHNOLOGY; TEACHING AND TRAINING IN BUSINESS, INDUSTRY AND INFORMATION TECHNOLOGY; TRAINING IN THE USE AND OPERATION OF COMPUTERS (U.S. CLS. 100, 101 AND 107).

FIRST USE 7-0-2008; IN COMMERCE 7-0-2008.
REBECCA GILBERT, EXAMINING ATTORNEY

SN 77-725,523. SUKOTAI CORPORATION, ROSWELL, GA. FILED 4-29-2009.

XFN

THE MARK CONSISTS OF STANDARD CHARACTERS WITHOUT CLAIM TO ANY PARTICULAR FONT, STYLE, SIZE, OR COLOR.

FOR ENTERTAINMENT IN THE NATURE OF COMPETITIONS IN THE FIELD OF SPORTING COMPETITIONS, NAMELY, KICKBOXING, FULL CONTACT KICKBOXING, BOXING, MUAY THAI, THAIBOXING, LOW KICK RULES, MIXED MARTIAL ARTS, MARTIAL ARTS (U.S. CLS. 100, 101 AND 107).

FIRST USE 4-12-2005; IN COMMERCE 4-12-2005.
BRENDAN REGAN, EXAMINING ATTORNEY

SN 77-725,539. HOLLYWOOD ENTERTAINMENT MUSEUM, LOS ANGELES, CA. FILED 4-29-2009.

PLACE

THE MARK CONSISTS OF STANDARD CHARACTERS WITHOUT CLAIM TO ANY PARTICULAR FONT, STYLE, SIZE, OR COLOR.

FOR EDUCATION SERVICES, NAMELY, PROVIDING CLASSES IN THE FIELD OF FILM PRODUCTION FOR AT-RISK YOUTHS; MUSEUMS (U.S. CLS. 100, 101 AND 107).

LINDA E. BLOHM, EXAMINING ATTORNEY

CLASS 41—(Continued).

SN 77-725,545. HOLLYWOOD ENTERTAINMENT MUSEUM, LOS ANGELES, CA. FILED 4-29-2009.

P.L.A.C.E.

THE MARK CONSISTS OF STANDARD CHARACTERS WITHOUT CLAIM TO ANY PARTICULAR FONT, STYLE, SIZE, OR COLOR.

FOR EDUCATION SERVICES, NAMELY, PROVIDING CLASSES IN THE FIELD OF FILM PRODUCTION FOR AT-RISK YOUTHS; MUSEUMS (U.S. CLS. 100, 101 AND 107).

LINDA E. BLOHM, EXAMINING ATTORNEY

SN 77-725,638. HINES, SCOTT M., PALM SPRINGS, CA. FILED 4-30-2009.

MY LIFEUMENTARY

THE MARK CONSISTS OF STANDARD CHARACTERS WITHOUT CLAIM TO ANY PARTICULAR FONT, STYLE, SIZE, OR COLOR.

FOR FILM AND VIDEO PRODUCTION (U.S. CLS. 100, 101 AND 107).

TARAH HARDY, EXAMINING ATTORNEY

SN 77-725,705. MCWILLIAMS, BRUCE, ADDISON, TX. FILED 4-30-2009.

LifeLines

THE MARK CONSISTS OF STANDARD CHARACTERS WITHOUT CLAIM TO ANY PARTICULAR FONT, STYLE, SIZE, OR COLOR.

FOR EDUCATION SERVICES, NAMELY, PROVIDING CLASSES, SEMINARS AND WORKSHOPS IN THE FIELD OF WRITING PERSONAL MEMOIRS (U.S. CLS. 100, 101 AND 107).

NAKWAMA ANKRAH, EXAMINING ATTORNEY

CLASS 41—(Continued).

SN 77-725,758. FRISINA, VINCENT, BROOKLYN, NY.
FILED 4-30-2009.

DJ JOVE

THE MARK CONSISTS OF STANDARD CHARACTERS WITHOUT CLAIM TO ANY PARTICULAR FONT, STYLE, SIZE, OR COLOR.

NO CLAIM IS MADE TO THE EXCLUSIVE RIGHT TO USE "DJ", APART FROM THE MARK AS SHOWN.

THE NAME "DJ DOVE" IDENTIFIES A LIVING INDIVIDUAL WHOSE CONSENT IS OF RECORD.

FOR DISC JOCKEYS FOR PARTIES AND SPECIAL EVENTS; ENTERTAINMENT IN THE NATURE OF LIVE PERFORMANCES BY AN ENTERTAINER, SINGER, ACTOR, MUSICIAN, DANCER, EMCEE; ENTERTAINMENT SERVICES, NAMELY, CONDUCTING PARTIES; MASTER OF CEREMONY SERVICES FOR PARTIES AND SPECIAL EVENTS (U.S. CLS. 100, 101 AND 107).

FRED MANDIR, EXAMINING ATTORNEY

SN 77-725,812. HANNIBAL, CHAUNCEY, A., AKA CHAUNCEY BLACK, LOS ANGELES, CA. FILED 4-30-2009.

BLACKSTREET

THE MARK CONSISTS OF STANDARD CHARACTERS WITHOUT CLAIM TO ANY PARTICULAR FONT, STYLE, SIZE, OR COLOR.

FOR ENTERTAINMENT SERVICES IN THE NATURE OF INSTRUMENTAL AND VOCAL GROUP (U.S. CLS. 100, 101 AND 107).

DOMINICK J. SALEMI, EXAMINING ATTORNEY

SN 77-725,942. RCD MEDIA, INC., MUNDELEIN, IL. FILED 4-30-2009.

Shoot. Edit. Score.

THE MARK CONSISTS OF STANDARD CHARACTERS WITHOUT CLAIM TO ANY PARTICULAR FONT, STYLE, SIZE, OR COLOR.

FOR VIDEO EDITING (U.S. CLS. 100, 101 AND 107).

TOBY BULLOFF, EXAMINING ATTORNEY

CLASS 41—(Continued).

SN 77-725,975. BOB DAVID LIVE, INC., GLEN ALLEN, VA.
FILED 4-30-2009.

YOU'RE ON

THE MARK CONSISTS OF STANDARD CHARACTERS WITHOUT CLAIM TO ANY PARTICULAR FONT, STYLE, SIZE, OR COLOR.

FOR EDUCATION SERVICES, NAMELY, PROVIDING SEMINARS, WORKSHOPS, LECTURES, CLASSES AND MOTIVATIONAL SPEAKING SERVICES IN THE FIELDS OF LEADERSHIP, MANAGEMENT, SALES, COMMUNICATION, CORPORATE AND PERSONAL ASSESSMENT AND MEASUREMENT, AND PROFESSIONAL, PERSONAL AND LEADERSHIP DEVELOPMENT (U.S. CLS. 100, 101 AND 107).

KATHLEEN M. VANSTON, EXAMINING ATTORNEY

SN 77-726,061. CAFIERO, LISA, VIRGINIA BEACH, VA.
FILED 4-30-2009.

Smarcastic

THE MARK CONSISTS OF STANDARD CHARACTERS WITHOUT CLAIM TO ANY PARTICULAR FONT, STYLE, SIZE, OR COLOR.

FOR ENTERTAINMENT AND EDUCATION SERVICES IN THE NATURE OF A SERIES OF SHORT SHOWS FEATURING COMEDY DISTRIBUTED TO MOBILE HANDSETS, WHICH MAY INCLUDE VIDEO, TEXT, PHOTOS, ILLUSTRATIONS OR HYPERTEXT; ENTERTAINMENT IN THE NATURE OF AN ONGOING SPECIAL VARIETY, NEWS, MUSIC OR COMEDY SHOW FEATURING COMEDY BROADCAST OVER TELEVISION, SATELLITE, AUDIO, AND VIDEO MEDIA; ENTERTAINMENT IN THE NATURE OF ONGOING TELEVISION PROGRAMS IN THE FIELD OF COMEDY; ENTERTAINMENT IN THE NATURE OF VISUAL AND AUDIO PERFORMANCES, AND MUSICAL, VARIETY, NEWS AND COMEDY SHOWS; ENTERTAINMENT SERVICES IN THE NATURE OF COMEDY SHOWS; ENTERTAINMENT, NAMELY, A CONTINUING COMEDY SHOW BROADCAST OVER TELEVISION, SATELLITE, AUDIO, AND VIDEO MEDIA; PRESENTATION OF LIVE COMEDY SHOWS (U.S. CLS. 100, 101 AND 107).

JAMES LOVELACE, EXAMINING ATTORNEY

CLASS 41—(Continued).

SN 77-726,225. PROTECTING TIME, LLC, GREENVILLE, SC. FILED 4-30-2009.

PROTECTING TIME

THE MARK CONSISTS OF STANDARD CHARACTERS WITHOUT CLAIM TO ANY PARTICULAR FONT, STYLE, SIZE, OR COLOR.

NO CLAIM IS MADE TO THE EXCLUSIVE RIGHT TO USE "TIME", APART FROM THE MARK AS SHOWN.

FOR EDUCATIONAL SERVICES, NAMELY, CONDUCTING TRAINING COURSES AND DISTRIBUTING TRAINING MATERIALS DESIGNED TO INCREASE PRODUCTIVITY AMONG PROFESSIONAL STAFF MEMBERS (U.S. CLS. 100, 101 AND 107).

FIRST USE 1-12-2009; IN COMMERCE 1-12-2009.
HEATHER SAPP, EXAMINING ATTORNEY

SN 77-726,248. DISCOVER MEDIAWORKS, INC., EAGLE RIVER, WI. FILED 4-30-2009.

TRAIL NATION

THE MARK CONSISTS OF STANDARD CHARACTERS WITHOUT CLAIM TO ANY PARTICULAR FONT, STYLE, SIZE, OR COLOR.

FOR ENTERTAINMENT IN THE NATURE OF ONGOING TELEVISION PROGRAMS IN THE FIELD OF OUTDOOR RECREATION; PROVIDING ON-LINE MAGAZINES IN THE FIELD OF OUTDOOR RECREATION (U.S. CLS. 100, 101 AND 107).

SALLY SHIH, EXAMINING ATTORNEY

SN 77-726,335. THE INCREDIBLE SANDWICH, LLC, ATHENS, GA. FILED 4-30-2009.

THE INCREDIBLE SANDWICH

THE MARK CONSISTS OF STANDARD CHARACTERS WITHOUT CLAIM TO ANY PARTICULAR FONT, STYLE, SIZE, OR COLOR.

FOR ENTERTAINMENT SERVICES IN THE NATURE OF LIVE MUSICAL PERFORMANCES (U.S. CLS. 100, 101 AND 107).

FIRST USE 11-13-2007; IN COMMERCE 11-13-2007.
CYNTHIA TRIPI, EXAMINING ATTORNEY

CLASS 41—(Continued).

SN 77-726,352. CAMP, EDWARD W., EAST ISLIP, NY. FILED 4-30-2009.

RIGHTHANDHUMAN

THE MARK CONSISTS OF STANDARD CHARACTERS WITHOUT CLAIM TO ANY PARTICULAR FONT, STYLE, SIZE, OR COLOR.

FOR PROVIDING ON-LINE PUBLICATIONS IN THE NATURE OF AN E-BOOK IN THE FIELD OF FICTIONAL STORIES (U.S. CLS. 100, 101 AND 107).

FRED MANDIR, EXAMINING ATTORNEY

SN 77-726,354. LEARNING TREE INTERNATIONAL, INC., RESTON, VA. FILED 4-30-2009.

LEARNING TREE ANYWARE

THE MARK CONSISTS OF STANDARD CHARACTERS WITHOUT CLAIM TO ANY PARTICULAR FONT, STYLE, SIZE, OR COLOR.

OWNER OF U.S. REG. NOS. 1,124,714, 2,424,263 AND OTHERS.

NO CLAIM IS MADE TO THE EXCLUSIVE RIGHT TO USE "LEARNING", APART FROM THE MARK AS SHOWN.

FOR EDUCATION AND TRAINING COURSES IN THE FIELDS OF INFORMATION TECHNOLOGY, COMPUTERS, COMPUTER HARDWARE, COMPUTER MAINTENANCE AND REPAIR, COMPUTER SOFTWARE, COMPUTER NETWORKS, COMPUTER SECURITY, TELECOMMUNICATIONS, COMPUTER PROGRAMMING, SOFTWARE ENGINEERING, SOFTWARE DEVELOPMENT, WEBSITE DEVELOPMENT AND WEB SERVICES, AND IN THE FIELDS OF BUSINESS AND MANAGEMENT SKILLS, FINANCE, LEADERSHIP, COMMUNICATION SKILLS, AND PROJECT MANAGEMENT, AND COURSE MATERIALS DISTRIBUTED THEREWITH (U.S. CLS. 100, 101 AND 107).

ALICE SUE CARRUTHERS, EXAMINING ATTORNEY

CLASS 41—(Continued).

SN 77-726,497. BECTON, MARIANNE, WASHINGTON, DC. FILED 4-30-2009.



NO CLAIM IS MADE TO THE EXCLUSIVE RIGHT TO USE "PERSONAL TRAINING", APART FROM THE MARK AS SHOWN.

THE MARK CONSISTS OF THE WORDS "FIT FOR YOU PERSONAL TRAINING LIFETIME FITNESS FOR A FIT LIFE" WITH THE FIGURE OF A WOMAN FORMING THE "Y" AND A CURVED LINE BELOW THE WORDS "FIT FOR" AND ABOVE THE LETTERS "OU".

FOR PERSONAL TRAINING SERVICES, NAMELY, STRENGTH AND CONDITIONING TRAINING; PHYSICAL FITNESS INSTRUCTION (U.S. CLS. 100, 101 AND 107).

FIRST USE 8-1-2006; IN COMMERCE 8-1-2006.
LEIGH CAROLINE CASE, EXAMINING ATTORNEY

SN 77-726,524. PROJECT 1NATION, COLUMBIA, SC. FILED 4-30-2009.

Project 1Nation

THE MARK CONSISTS OF STANDARD CHARACTERS WITHOUT CLAIM TO ANY PARTICULAR FONT, STYLE, SIZE, OR COLOR.

FOR EDUCATION SERVICES, NAMELY, PROVIDING LIVE AND ON-LINE CLASSES, SEMINARS, WORKSHOPS IN THE FIELD OF SOCIAL SERVICES AND COMMUNITY OUTREACH; PROVIDING ON-LINE TRAINING COURSES, SEMINARS, WORKSHOPS IN THE FIELD OF SOCIAL SERVICES AND COMMUNITY OUTREACH (U.S. CLS. 100, 101 AND 107).

FIRST USE 1-12-2009; IN COMMERCE 1-12-2009.
SUSAN STIGLITZ, EXAMINING ATTORNEY

SN 77-726,527. MOM & POP MUSIC CO. LLC, NEW YORK, NY. FILED 4-30-2009.

MOM & POP

THE MARK CONSISTS OF STANDARD CHARACTERS WITHOUT CLAIM TO ANY PARTICULAR FONT, STYLE, SIZE, OR COLOR.

FOR RECORD PRODUCTION SERVICES; PRODUCTION OF LIVE MUSICAL PERFORMANCES; INFORMATION SERVICES RELATING TO THE MUSIC INDUSTRY, MUSICAL SOUND RECORDINGS, MUSIC VIDEOS AND MUSICAL ARTISTS OFFERED OVER THE INTERNET (U.S. CLS. 100, 101 AND 107).

FIRST USE 9-30-2008; IN COMMERCE 9-30-2008.
SANDRA MANIOS, EXAMINING ATTORNEY

CLASS 41—(Continued).

SN 77-726,549. LP & ME, INC., EL DORADO HILLS, CA. FILED 4-30-2009.

Witchapalooza

THE MARK CONSISTS OF STANDARD CHARACTERS WITHOUT CLAIM TO ANY PARTICULAR FONT, STYLE, SIZE, OR COLOR.

FOR ENTERTAINMENT IN THE NATURE OF HALLOWEEN FESTIVAL (U.S. CLS. 100, 101 AND 107).
JOHN KELLY, EXAMINING ATTORNEY

SN 77-726,590. TWENTIETH CENTURY FOX FILM CORPORATION, LOS ANGELES, CA. FILED 4-30-2009.

COPASODES

THE MARK CONSISTS OF STANDARD CHARACTERS WITHOUT CLAIM TO ANY PARTICULAR FONT, STYLE, SIZE, OR COLOR.

FOR ENTERTAINMENT SERVICES IN THE NATURE OF AN ON-GOING TELEVISION SEGMENT FEATURING SPORTS (U.S. CLS. 100, 101 AND 107).

JASON BLAIR, EXAMINING ATTORNEY

SN 77-726,606. KINCAID, ABIGAIL A, SHERMAN OAKS, CA. FILED 4-30-2009.

deflowered

THE MARK CONSISTS OF STANDARD CHARACTERS WITHOUT CLAIM TO ANY PARTICULAR FONT, STYLE, SIZE, OR COLOR.

FOR ENTERTAINMENT IN THE NATURE OF VISUAL AND AUDIO PERFORMANCES, AND MUSICAL, VARIETY, NEWS AND COMEDY SHOWS (U.S. CLS. 100, 101 AND 107).

DEIRDRE ROBERTSON, EXAMINING ATTORNEY

CLASS 41—(Continued).

SN 77-726,655. LAENSALOCIN, LLC, DBA THE ELECTRIC FEELGOOD, SARASOTA, FL. FILED 4-30-2009.

The Electric FeelGood

THE MARK CONSISTS OF STANDARD CHARACTERS WITHOUT CLAIM TO ANY PARTICULAR FONT, STYLE, SIZE, OR COLOR.

FOR PRODUCTION OF MONOSCOPIC AND/OR STEREOSCOPIC VIDEO AND/OR FILM (U.S. CLS. 100, 101 AND 107).

JULIE WATSON, EXAMINING ATTORNEY

SN 77-726,687. DREAM TEAM PRODUCTIONS, TOWSON, MD. FILED 5-1-2009.

GETTIN WEIRD

THE MARK CONSISTS OF STANDARD CHARACTERS WITHOUT CLAIM TO ANY PARTICULAR FONT, STYLE, SIZE, OR COLOR.

FOR ENTERTAINMENT SERVICES, NAMELY, CONDUCTING PARTIES FOR THE PURPOSE OF DATING AND SOCIAL INTRODUCTION FOR ADULTS, PROVIDING A WEB SITE FEATURING ADULT-THEMED PHOTOGRAPHS AND VIDEOS, ENTERTAINMENT SERVICES IN THE NATURE OF ON-GOING TELEVISION, RADIO, FILM, THEATRICAL, VIDEO, AUDIO AND AUDIO-VISUAL PROGRAMS FEATURING ADULT-THEMED PHOTOGRAPHS, VIDEOS AND ADULT THEMED ENTERTAINMENT (U.S. CLS. 100, 101 AND 107).

KATHERINE CONNOLLY, EXAMINING ATTORNEY

SN 77-726,765. HEALD, RIEN, L, NAPERVILLE, IL. FILED 5-1-2009.

muvchat

THE MARK CONSISTS OF STANDARD CHARACTERS WITHOUT CLAIM TO ANY PARTICULAR FONT, STYLE, SIZE, OR COLOR.

FOR (BASED ON USE IN COMMERCE) ARRANGING AND CONDUCTING SPECIAL EVENTS; ENTERTAINMENT SERVICES, NAMELY, MULTIMEDIA PRODUCTION SERVICES(BASED ON INTENT TO USE) PROVIDING A WEB SITE WHERE USERS CAN POST RATINGS, REVIEWS AND RECOMMENDATIONS ON EVENTS AND ACTIVITIES IN THE FIELD OF ENTERTAINMENT AND EDUCATION; PROVIDING AN INTERNET WEBSITE PORTAL IN THE FIELD OF ENTERTAINMENT, CULTURAL AND SPORTING EVENTS (U.S. CLS. 100, 101 AND 107).

FIRST USE 12-16-2008; IN COMMERCE 1-24-2009.

KATHY DE JONGE, EXAMINING ATTORNEY

CLASS 41—(Continued).

SN 77-726,820. SOUAID JANE, DELRAY BEACH, FL. FILED 5-1-2009.

Janie S

THE MARK CONSISTS OF STANDARD CHARACTERS WITHOUT CLAIM TO ANY PARTICULAR FONT, STYLE, SIZE, OR COLOR.

FOR ENTERTAINMENT SERVICES RENDERED THROUGH THE MEDIUM OF TELEVISION IN THE NATURE OF A VARIETY TALK SHOW SERIES (U.S. CLS. 100, 101 AND 107).

MIDGE BUTLER, EXAMINING ATTORNEY

SN 77-726,822. QUAIL HOLLOW COUNTRY CLUB, CHARLOTTE, NC. FILED 5-1-2009.

QUAIL HOLLOW

THE MARK CONSISTS OF STANDARD CHARACTERS WITHOUT CLAIM TO ANY PARTICULAR FONT, STYLE, SIZE, OR COLOR.

FOR COUNTRY CLUB SERVICES (U.S. CLS. 100, 101 AND 107).

FIRST USE 0-0-1961; IN COMMERCE 0-0-1961.

MATTHEW KLINE, EXAMINING ATTORNEY

SN 77-726,880. BELLYROK DANCE AND FITNESS, LLC, HEPHZIBAH, GA. FILED 5-1-2009.

BellyRok

THE MARK CONSISTS OF STANDARD CHARACTERS WITHOUT CLAIM TO ANY PARTICULAR FONT, STYLE, SIZE, OR COLOR.

FOR DANCE INSTRUCTION; EDUCATION SERVICES, NAMELY, PROVIDING CLASSES AND INSTRUCTION IN THE FIELD OF DANCE; PHYSICAL FITNESS CONDITIONING CLASSES; PHYSICAL FITNESS TRAINING SERVICES; TRAINING OF DANCE INSTRUCTORS (U.S. CLS. 100, 101 AND 107).

FIRST USE 5-4-2007; IN COMMERCE 5-4-2007.

KIMBERLY FRYE, EXAMINING ATTORNEY

CLASS 41—(Continued).

SN 77-726,894. BUCK, AMY, SEATTLE, WA. FILED 5-1-2009.

ZUMLATES

THE MARK CONSISTS OF STANDARD CHARACTERS WITHOUT CLAIM TO ANY PARTICULAR FONT, STYLE, SIZE, OR COLOR.

FOR PHYSICAL FITNESS INSTRUCTION SERVICES, NAMELY, PROVIDING CLASSES FEATURING LATIN FUNK FITNESS AND PILATES EXERCISE METHODS (U.S. CLS. 100, 101 AND 107).

FIRST USE 1-7-2009; IN COMMERCE 1-7-2009.
DAVID MILLER, EXAMINING ATTORNEY

SN 77-726,946. ROBERT LABRANCHE SHAW, AVENTURA, FL. FILED 5-1-2009.

BIZZLE AKA CHOWTIME

THE MARK CONSISTS OF STANDARD CHARACTERS WITHOUT CLAIM TO ANY PARTICULAR FONT, STYLE, SIZE, OR COLOR.

FOR ENTERTAINMENT SERVICES IN THE NATURE OF LIVE MUSICAL PERFORMANCES (U.S. CLS. 100, 101 AND 107).

FIRST USE 1-4-2002; IN COMMERCE 1-4-2002.
THOMAS MANOR, EXAMINING ATTORNEY

SN 77-727,101. THE WRITER'S DEN MUSIC GROUP, LLC, FORMERLY MONTAGE MUSIC PUBLISHING, LLC, NASHVILLE, TN. FILED 5-1-2009.

THE WRITER'S DEN MUSIC GROUP

THE MARK CONSISTS OF STANDARD CHARACTERS WITHOUT CLAIM TO ANY PARTICULAR FONT, STYLE, SIZE, OR COLOR.

NO CLAIM IS MADE TO THE EXCLUSIVE RIGHT TO USE "MUSIC GROUP", APART FROM THE MARK AS SHOWN.

FOR MUSIC PUBLISHING SERVICES (U.S. CLS. 100, 101 AND 107).
MICHAEL KEATING, EXAMINING ATTORNEY

CLASS 41—(Continued).

SN 77-727,201. CSJ MANAGEMENT, LTD., FLOWER MOUND, TX. FILED 5-1-2009.



FOR ENTERTAINMENT SERVICES, NAMELY, INDOOR GYMNASIUMS FOR FAMILY AMUSEMENT, PROVIDING PARTY AND PLAY FACILITIES FOR CHILDREN IN THE NATURE OF INTERACTIVE PLAY AREAS, PROVIDING FACILITIES WITH LARGE INFLATABLE PLAY STRUCTURES FOR CHILDREN'S PARTIES, AMUSEMENT ARCADES FEATURING VIDEO AND COIN OPERATED GAMES (U.S. CLS. 100, 101 AND 107).

DANNEAN HETZEL, EXAMINING ATTORNEY

SN 77-727,344. HINTON, ROBERT W., WILLIAMSBURG, PA. FILED 5-1-2009.

THE FEEDMEN

THE MARK CONSISTS OF STANDARD CHARACTERS WITHOUT CLAIM TO ANY PARTICULAR FONT, STYLE, SIZE, OR COLOR.

FOR ENTERTAINMENT IN THE NATURE OF VISUAL AND AUDIO PERFORMANCES, NAMELY, MUSICAL BAND, ROCK GROUP, GYMNASTIC, DANCE, AND BALLET PERFORMANCES (U.S. CLS. 100, 101 AND 107).
JOHN DWYER, EXAMINING ATTORNEY

SN 77-727,346. SHIELD CALIFORNIA HEALTHCARE CENTERS, INC., VALENCIA, CA. FILED 5-1-2009.



THE MARK CONSISTS OF THE WORDS "CARING SOLUTIONS" IN STYLIZED FORMAT, WHERE THE WORD "CARING" IS LOCATED ABOVE THE LETTERS "SOLUT" IN THE WORD "SOLUTIONS", WITH A PARTIAL HEART SHAPE PARTIALLY ENCIRCLING THE WORD "CARING".

FOR PROVIDING RECOGNITION AND INCENTIVES IN THE FORM OF AWARDS AND CONTESTS TO DEMONSTRATE EXCELLENCE IN THE FIELD OF CAREGIVING (U.S. CLS. 100, 101 AND 107).

FIRST USE 9-4-2007; IN COMMERCE 9-4-2007.
JOHN DWYER, EXAMINING ATTORNEY

CLASS 41—(Continued).

SN 77-727,449. ALIGN PILATES, LLC, MINNEAPOLIS, MN. FILED 5-1-2009.



THE MARK CONSISTS OF A STYLIZED LETTER "A". FOR PROVIDING FITNESS AND EXERCISE FACILITIES (U.S. CLS. 100, 101 AND 107). FIRST USE 8-19-2003; IN COMMERCE 8-19-2003. ANGELA DUONG, EXAMINING ATTORNEY

SN 77-727,594. CONTROLLED SUBSTANCE SOUND LABS, SANTA MONICA, CA. FILED 5-1-2009.

CONTROLLED SUBSTANCE SOUND LABS

THE MARK CONSISTS OF STANDARD CHARACTERS WITHOUT CLAIM TO ANY PARTICULAR FONT, STYLE, SIZE, OR COLOR.

FOR ENTERTAINMENT IN THE NATURE OF LIVE PERFORMANCES BY MUSICAL ARTISTS AND GROUPS; ENTERTAINMENT IN THE NATURE OF ONGOING TELEVISION PROGRAMS IN THE FIELD OF MUSIC AND MUSICAL PERFORMANCES; ENTERTAINMENT IN THE NATURE OF VISUAL AND AUDIO PERFORMANCES, AND MUSICAL, VARIETY, NEWS AND COMEDY SHOWS; ENTERTAINMENT IN THE NATURE OF VISUAL AND AUDIO PERFORMANCES, NAMELY, MUSICAL BAND, ROCK GROUP, GYMNAS-TIC, DANCE, AND BALLET PERFORMANCES; ENTERTAINMENT IN THE NATURE OF LIVE CONCERTS AND PERFORMANCES BY MUSICAL ARTISTS AND GROUPS; ENTERTAINMENT SERVICES IN THE NATURE OF LIVE MUSICAL PERFORMANCES; ENTERTAINMENT SERVICES, NAMELY, AN ONGOING SERIES FEATURING MUSICAL ARTISTS AND GROUPS PROVIDED THROUGH CABLE, WEB SITES, TELEVISION, THE INTERNET, AND RADIO; ENTERTAINMENT SERVICES, NAMELY, CONDUCTING PARTIES; ENTERTAINMENT SERVICES, NAMELY, LIVE, TELE-VISED AND MOVIE APPEARANCES BY A PROFESSIONAL ENTERTAINER; ENTERTAINMENT SERVICES, NAMELY, NON-DOWNLOADABLE RINGTONES, PRE-RECORDED MUSIC, VIDEO AND GRAPHICS PRESENTED TO MOBILE COMMUNICATIONS DEVICES VIA A GLOBAL COMPUTER NETWORK AND WIRELESS NETWORKS; ENTERTAINMENT SERVICES, NAMELY, PERSONAL APPEARANCES BY A MUSICAL ARTIST AND GROUP; ENTERTAINMENT SERVICES, NAMELY, PROVIDING A RADIO PROGRAM IN THE

CLASS 41—(Continued).

FIELD OF MUSIC AND MUSICAL PERFORMANCES VIA A GLOBAL COMPUTER NETWORK; ENTERTAINMENT SERVICES, NAMELY, PROVIDING A WEB SITE FEATURING MUSICAL PERFORMANCES, MUSICAL VIDEOS, RELATED FILM CLIPS, PHOTOGRAPHS, AND OTHER MULTIMEDIA MATERIALS FEATURING MUSICAL ARTISTS AND GROUPS; ENTERTAINMENT SERVICES, NAMELY, PROVIDING PODCASTS IN THE FIELD OF MUSIC AND MUSICAL PERFORMANCES; ENTERTAINMENT SERVICES, NAMELY, PROVIDING VIDEO PODCASTS IN THE FIELD OF MUSIC AND MUSICAL PERFORMANCES; ENTERTAINMENT, NAMELY, LIVE MUSIC CONCERTS; ENTERTAINMENT, NAMELY, LIVE PERFORMANCES BY A MUSICAL BAND; ENTERTAINMENT, NAMELY, LIVE PERFORMANCES BY MUSICAL BANDS; ENTERTAINMENT, NAMELY, LIVE PERFORMANCES BY ROCK GROUPS; ENTERTAINMENT, NAMELY, PRODUCTION OF LIVE CONCERTS AND PERFORMANCES BY MUSICAL ARTISTS AND GROUPS AND CONCERTS (U.S. CLS. 100, 101 AND 107).

FIRST USE 8-4-2007; IN COMMERCE 8-4-2007. LINDA E. BLOHM, EXAMINING ATTORNEY

SN 77-727,665. WEBBMEDIA GROUP, LLC, DBA KNOWLEDGEWEBB, BALTIMORE, MD. FILED 5-2-2009.

Don't sweat the tech!

THE MARK CONSISTS OF STANDARD CHARACTERS WITHOUT CLAIM TO ANY PARTICULAR FONT, STYLE, SIZE, OR COLOR.

FOR EDUCATIONAL SERVICES, NAMELY, CONDUCTING MULTIMEDIA AND EMERGING TECHNOLOGY TRAINING IN THE FIELD OF JOURNALISM, WEB PUBLISHING, DIGITAL MEDIA, HIGHER EDUCATION, K-12 EDUCATION AND OTHER LEARNING AND DISTRIBUTION OF TRAINING MATERIAL IN CONNECTION THEREWITH (U.S. CLS. 100, 101 AND 107).

FIRST USE 11-15-2008; IN COMMERCE 11-15-2008. JANET LEE, EXAMINING ATTORNEY

SN 77-727,704. NOCTURNE PRODUCTIONS INC., DEKALB, IL. FILED 5-2-2009.

NOCTURNE

THE MARK CONSISTS OF STANDARD CHARACTERS WITHOUT CLAIM TO ANY PARTICULAR FONT, STYLE, SIZE, OR COLOR.

FOR VIDEO PRODUCTION SERVICES (U.S. CLS. 100, 101 AND 107).

FIRST USE 6-1-1982; IN COMMERCE 6-1-1982. CAROLINE WOOD, EXAMINING ATTORNEY

CLASS 41—(Continued).

SN 77-727,720. YAKOVCHIK, MICHAEL, WEST HOLLYWOOD, CA. FILED 5-2-2009.

GREYTV

THE MARK CONSISTS OF STANDARD CHARACTERS WITHOUT CLAIM TO ANY PARTICULAR FONT, STYLE, SIZE, OR COLOR.

FOR PRODUCTION OF FILMS AND TELEVISION PROGRAMS (U.S. CLS. 100, 101 AND 107).

FIRST USE 6-1-2007; IN COMMERCE 6-1-2007.
CAROLINE WOOD, EXAMINING ATTORNEY

SN 77-727,746. JOHNSON, TERRI R., CHEVERLY, MD. FILED 5-2-2009.



THE COLOR(S) PURPLE, CHARTREUSE, YELLOW, MAGENTA, GREEN, CYAN, RED, ORANGE, BLACK, AND GRAY IS/ARE CLAIMED AS A FEATURE OF THE MARK.

THE MARK CONSISTS OF THE WORDING "FRUITLICIOUS" WITH HAIRLINE BLACK OUTLINING, GRAY SHADOW, AND EIGHT DIFFERENT COLORED LETTERS APPEARING AS FOLLOWS: THE LETTER "F" IS PURPLE, "R" IS CHARTREUSE, "U" IS YELLOW, "I" IS MAGENTA, "T" IS GREEN, "I" IS CYAN, "L" IS RED, "I" IS ORANGE, "C" IS GREEN, "I" IS RED, "U" IS YELLOW, "S" IS MAGENTA. THE WORDING "AND THE" APPEARS IN BLACK WITH BLACK UNDERLINE. THE WORDING "EAT FRESH CREW" APPEARS IN GREEN WITH HAIRLINE BLACK OUTLINING. THE CHERRY IS RED WITH A BLACK STEM AND GRAY SHADOW.

FOR CONSULTATION IN THE FIELD OF K-12 EDUCATIONAL SYSTEMS; DEVELOPING EDUCATIONAL MANUALS FOR OTHERS IN THE FIELD OF NUTRITION EDUCATION; DEVELOPMENT AND DISSEMINATION OF EDUCATIONAL MATERIALS OF OTHERS IN THE FIELD OF NUTRITION EDUCATION; EDUCATING AT SENIOR HIGH SCHOOLS; EDUCATION INFORMATION; EDUCATION SERVICES, NAMELY, PROVIDING HEALTH FAIRS, SEMINARS AND CONFERENCES IN THE FIELD OF NUTRITION EDUCATION; EDUCATIONAL SERVICES, NAMELY, DEVELOPING CURRICULUM FOR EDUCATORS; EDUCATIONAL SERVICES, NAMELY, DEVELOPING CURRICULUM FOR TEACHERS; ENTERTAINMENT AND EDUCATIONAL SERVICES, NAMELY, THE PRESENTATION OF SEMINARS, LECTURES, WORKSHOPS AND PANEL DISCUSSIONS, AND ONGOING TELEVISION AND RADIO TALK SHOWS ALL IN THE FIELD OF PUBLIC INTEREST CONCERNING NUTRITION EDUCATION; INFORMATION ON EDUCATION; ON-LINE EDUCATIONAL PARENTAL TRAINING CLASSES (U.S. CLS. 100, 101 AND 107).

JEAN IM, EXAMINING ATTORNEY

CLASS 41—(Continued).

SN 77-727,792. NOCTURNE PRODUCTIONS INC., DEKALB, IL. FILED 5-3-2009.



THE MARK CONSISTS OF AN IMAGE OF AN OWL WITH SPOTLIGHT EYES SHINING DOWN ON THE WORD "NOCTURNE"; "NOCTURNE" IS WRITTEN IN STYLIZED LETTERS.

FOR VIDEO PRODUCTION SERVICES (U.S. CLS. 100, 101 AND 107).

FIRST USE 6-1-1982; IN COMMERCE 6-1-1982.
CAROLINE WOOD, EXAMINING ATTORNEY

SN 77-727,858. VAILLANT, KEVIN M., ROCKVILLE, MD. FILED 5-3-2009.

Tarkus Sun

THE MARK CONSISTS OF STANDARD CHARACTERS WITHOUT CLAIM TO ANY PARTICULAR FONT, STYLE, SIZE, OR COLOR.

FOR ENTERTAINMENT SERVICES IN THE NATURE OF LIVE MUSICAL PERFORMANCES; ENTERTAINMENT SERVICES, NAMELY, AN ON-LINE ACTIVITY WHERE YOU CREATE YOUR OWN MUSIC VIDEOS; ENTERTAINMENT SERVICES, NAMELY, PROVIDING A WEB SITE FEATURING MUSICAL PERFORMANCES, MUSICAL VIDEOS, RELATED FILM CLIPS, PHOTOGRAPHS, AND OTHER MULTIMEDIA MATERIALS FEATURING TARKUS SUN BAND; ENTERTAINMENT, NAMELY, LIVE MUSIC CONCERTS (U.S. CLS. 100, 101 AND 107).

RENEE SERVANCE, EXAMINING ATTORNEY

SN 77-728,532. CHRISTIANE NORTHRUP, INC., YARMOUTH, ME. FILED 5-4-2009.



THE MARK CONSISTS OF A "C" WITHIN A CIRCLE AND A FANCIFUL "N" TO THE RIGHT OF THE "C".

FOR PROVIDING ON-LINE PUBLICATIONS IN THE NATURE OF AN E-BOOK IN THE FIELD OF WOMEN'S HEALTH ISSUES (U.S. CLS. 100, 101 AND 107).

FIRST USE 4-30-2009; IN COMMERCE 4-30-2009.
VIVIAN MICZNIK FIRST, EXAMINING ATTORNEY

CLASS 41—(Continued).

SN 77-728,806. MCDANIEL, STEPHEN E, SEATTLE, WA.
FILED 5-4-2009.

Freakalytics

THE MARK CONSISTS OF STANDARD CHARACTERS WITHOUT CLAIM TO ANY PARTICULAR FONT, STYLE, SIZE, OR COLOR.

FOR BOOK PUBLISHING; ON-LINE JOURNALS, NAMELY, BLOGS FEATURING ANALYTICS APPLIED TO CURRENT EVENTS (U.S. CLS. 100, 101 AND 107).

FIRST USE 1-27-2009; IN COMMERCE 1-27-2009.
MARIA-VICTORIA SUAREZ, EXAMINING ATTORNEY

SN 77-729,247. TWENTIETH CENTURY FOX FILM CORPORATION, LOS ANGELES, CA. FILED 5-5-2009.

THE CLEVELAND SHOW

THE MARK CONSISTS OF STANDARD CHARACTERS WITHOUT CLAIM TO ANY PARTICULAR FONT, STYLE, SIZE, OR COLOR.

NO CLAIM IS MADE TO THE EXCLUSIVE RIGHT TO USE "SHOW", APART FROM THE MARK AS SHOWN.

FOR ENTERTAINMENT SERVICES IN THE NATURE OF A TELEVISION SERIES FEATURING COMEDY; PROVIDING ON-LINE INFORMATION IN THE FIELD OF TELEVISION AND VIDEO ENTERTAINMENT FEATURING COMEDY VIA A GLOBAL COMMUNICATIONS NETWORK; ON-LINE JOURNALS, NAMELY, BLOGS FEATURING PERSONAL OPINIONS IN THE FIELD OF GENERAL INTEREST AND COMEDY (U.S. CLS. 100, 101 AND 107).

JASON BLAIR, EXAMINING ATTORNEY

SN 77-729,420. THE AMERICAN COLLEGE, BRYN MAWR, PA. FILED 5-5-2009.

HIGHEST STANDARD OF KNOWLEDGE & TRUST

THE MARK CONSISTS OF STANDARD CHARACTERS WITHOUT CLAIM TO ANY PARTICULAR FONT, STYLE, SIZE, OR COLOR.

FOR EDUCATIONAL SERVICES, NAMELY, CONDUCTING COURSES IN THE FIELDS OF INSURANCE AND FINANCIAL PLANNING (U.S. CLS. 100, 101 AND 107).

FIRST USE 1-31-2009; IN COMMERCE 1-31-2009.
DAWN FELDMAN, EXAMINING ATTORNEY

CLASS 41—(Continued).

SN 77-730,045. THE SALVATION ARMY, LONG BEACH, CA.
FILED 5-6-2009.

Young People's Legion

THE MARK CONSISTS OF STANDARD CHARACTERS WITHOUT CLAIM TO ANY PARTICULAR FONT, STYLE, SIZE, OR COLOR.

NO CLAIM IS MADE TO THE EXCLUSIVE RIGHT TO USE "YOUNG PEOPLE'S", APART FROM THE MARK AS SHOWN.

FOR RELIGIOUS AND CHARITABLE EDUCATIONAL SERVICES, NAMELY, CONDUCTING EDUCATIONAL PROGRAMS FOR TEENAGERS AND YOUNG ADULTS, AGES TWELVE TO THIRTY, IN THE FIELDS OF SPIRITUAL, MENTAL, AND SOCIAL GROWTH AND DEVELOPMENT (U.S. CLS. 100, 101 AND 107).

FIRST USE 4-27-1998; IN COMMERCE 4-27-1998.
KATHRYN COWARD, EXAMINING ATTORNEY

SN 77-730,241. BOB DAVID LIVE, INC., GLEN ALLEN, VA.
FILED 5-6-2009.

UNDAUNTED

THE MARK CONSISTS OF STANDARD CHARACTERS WITHOUT CLAIM TO ANY PARTICULAR FONT, STYLE, SIZE, OR COLOR.

FOR EDUCATION SERVICES, NAMELY, PROVIDING SEMINARS, WORKSHOPS, LECTURES, CLASSES AND MOTIVATIONAL SPEAKING SERVICES IN THE FIELDS OF LEADERSHIP, MANAGEMENT, SALES, COMMUNICATION, CORPORATE AND PERSONAL ASSESSMENT AND MEASUREMENT, AND PROFESSIONAL, PERSONAL AND LEADERSHIP DEVELOPMENT (U.S. CLS. 100, 101 AND 107).

KATHLEEN M. VANSTON, EXAMINING ATTORNEY

SN 77-730,926. TWENTIETH CENTURY FOX FILM CORPORATION, LOS ANGELES, CA. FILED 5-6-2009.

NEIGHBORS FROM HELL

THE MARK CONSISTS OF STANDARD CHARACTERS WITHOUT CLAIM TO ANY PARTICULAR FONT, STYLE, SIZE, OR COLOR.

FOR ENTERTAINMENT SERVICES IN THE NATURE OF A TELEVISION SERIES FEATURING COMEDY; PROVIDING ON-LINE INFORMATION IN THE FIELD OF TELEVISION AND VIDEO ENTERTAINMENT FEATURING COMEDY VIA A GLOBAL COMMUNICATIONS NETWORK; ON-LINE JOURNALS, NAMELY, BLOGS FEATURING PERSONAL OPINIONS IN THE FIELD OF GENERAL INTEREST AND COMEDY (U.S. CLS. 100, 101 AND 107).

JASON BLAIR, EXAMINING ATTORNEY

CLASS 41—(Continued).

SN 77-732,629. BOSTON GLOBAL BRIDGE INSTITUTE, INC., BOSTON, MA. FILED 5-8-2009.



NO CLAIM IS MADE TO THE EXCLUSIVE RIGHT TO USE "INSTITUTE", APART FROM THE MARK AS SHOWN.

THE MARK CONSISTS OF THE WORDS "BGB BOSTON GLOBAL BRIDGE INSTITUTE" IN A VARIETY OF FONTS; "BGB" IS DISPLAYED IN A LARGE LOWERCASE FONT, WITH THE INITIAL "B" APPEARING SLIGHTLY ABOVE AND TO THE LEFT OF THE "GB", AND THE LOOP OF THE INITIAL "B" INTERTWINED WITH THE LOOP OF THE "G". UNDER "BGB" IS "BOSTON GLOBAL BRIDGE" IN A SMALLER FONT WITH NO SPACING, APPEARING AS "BOSTONGLOBALBRIDGE", WITH SHADING AND CAPITAL LETTERS TO DISTINGUISH THE WORDS. UNDER "BOSTON GLOBAL BRIDGE", IN A SMALLER UPPERCASE FONT, IS "INSTITUTE".

FOR EDUCATION SERVICES, NAMELY, PROVIDING CLASSES, SEMINARS, WORKSHOPS, AND PANEL DISCUSSIONS IN THE FIELDS OF SCIENCE, TECHNOLOGY, POLITICS, ECONOMICS, AND GLOBAL AFFAIRS; ORGANIZATION OF CONFERENCES, LEARNING FORUMS, AND SYMPOSIA IN THE FIELDS OF SCIENCE, TECHNOLOGY, POLITICS, ECONOMICS, AND GLOBAL AFFAIRS, ALL FOR EDUCATIONAL PURPOSES (U.S. CLS. 100, 101 AND 107).

B. PARADEWELAI, EXAMINING ATTORNEY

SN 77-734,394. TWENTIETH CENTURY FOX FILM CORPORATION, LOS ANGELES, CA. FILED 5-11-2009.

THE ADVENTURES OF DIGGER AND FRIENDS

THE MARK CONSISTS OF STANDARD CHARACTERS WITHOUT CLAIM TO ANY PARTICULAR FONT, STYLE, SIZE, OR COLOR.

FOR ENTERTAINMENT SERVICES IN THE NATURE OF A SERIES OF ONGOING TELEVISION SEGMENTS FEATURING SPORTS AND COMEDY (U.S. CLS. 100, 101 AND 107).

FIRST USE 2-15-2009; IN COMMERCE 2-15-2009.
LINDA LAVACHE, EXAMINING ATTORNEY

CLASS 41—(Continued).

SN 77-735,097. BOB DAVID LIVE, INC., GLEN ALLEN, VA. FILED 5-12-2009.

REFERRAL RICH

THE MARK CONSISTS OF STANDARD CHARACTERS WITHOUT CLAIM TO ANY PARTICULAR FONT, STYLE, SIZE, OR COLOR.

NO CLAIM IS MADE TO THE EXCLUSIVE RIGHT TO USE "REFERRAL", APART FROM THE MARK AS SHOWN.

FOR EDUCATION SERVICES, NAMELY, PROVIDING SEMINARS, WORKSHOPS, LECTURES, CLASSES AND MOTIVATIONAL SPEAKING SERVICES IN THE FIELDS OF LEADERSHIP, MANAGEMENT, SALES, COMMUNICATION, CORPORATE AND PERSONAL ASSESSMENT AND MEASUREMENT, AND PROFESSIONAL, PERSONAL AND LEADERSHIP DEVELOPMENT (U.S. CLS. 100, 101 AND 107).

KATHLEEN M. VANSTON, EXAMINING ATTORNEY

SN 77-735,710. GENERAL MILLS, INC., MINNEAPOLIS, MN. FILED 5-13-2009.

FEEDING DREAMS

THE MARK CONSISTS OF STANDARD CHARACTERS WITHOUT CLAIM TO ANY PARTICULAR FONT, STYLE, SIZE, OR COLOR.

FOR ORGANIZING AND CONDUCTING RECOGNITION PROGRAMS TO RECOGNIZE AND HONOR INDIVIDUALS WHO HAVE MADE OUTSTANDING CONTRIBUTIONS TO THEIR COMMUNITIES (U.S. CLS. 100, 101 AND 107).

CHARLES L. JENKINS, EXAMINING ATTORNEY

SN 77-735,918. ENGSTROM, MARSHA, WOODLAND, CA. FILED 5-13-2009.

Book Club Cheerleader

THE MARK CONSISTS OF STANDARD CHARACTERS WITHOUT CLAIM TO ANY PARTICULAR FONT, STYLE, SIZE, OR COLOR.

NO CLAIM IS MADE TO THE EXCLUSIVE RIGHT TO USE "BOOK CLUB", APART FROM THE MARK AS SHOWN.

FOR PROFESSIONAL COACHING SERVICES, NAMELY, CONSULTING AND CONDUCTING WORKSHOPS IN THE FIELD OF ESTABLISHING AND ENHANCING BOOK CLUBS (U.S. CLS. 100, 101 AND 107).

FIRST USE 3-1-2006; IN COMMERCE 3-1-2006.
DAVID COLLIER, EXAMINING ATTORNEY

CLASS 41—(Continued).

SN 77-736,454. JOHNSON, TERRI R., CHEVERLY, MD. FILED 5-13-2009.



THE COLOR(S) PURPLE, CHARTREUSE, YELLOW, MAGENTA, GREEN, CYAN, RED, ORANGE, BLACK, AND GRAY IS/ARE CLAIMED AS A FEATURE OF THE MARK. THE MARK CONSISTS OF THE WORDING "FRUITLI-CIOUS" WITH HAIRLINE BLACK OUTLINING, GRAY SHADOW, AND EIGHT DIFFERENT COLORED LETTERS APPEARING AS FOLLOWS: THE LETTER F IS PURPLE, R IS CHARTREUSE, U IS YELLOW, I IS MAGENTA, T IS GREEN, I IS CYAN, L IS RED, I IS ORANGE, C IS GREEN, I IS RED, U IS YELLOW, S IS MAGENTA. THE CHERRY IS RED WITH A BLACK STEM AND GRAY SHADOW.

FOR CONSULTATION IN THE FIELD OF K-12 EDUCATIONAL SYSTEMS; DEVELOPING EDUCATIONAL MANUALS FOR OTHERS IN THE FIELD OF NUTRITION EDUCATION.; DEVELOPMENT AND DISSEMINATION OF EDUCATIONAL MATERIALS OF OTHERS IN THE FIELD OF NUTRITION EDUCATION.; EDUCATING AT SENIOR HIGH SCHOOLS; EDUCATION INFORMATION; EDUCATION SERVICES, NAMELY, PROVIDING CLASSES, SEMINARS, WORKSHOPS, TUTORING, AND MENTORING IN THE FIELD OF MIDDLE AND HIGH SCHOOL REFORM; EDUCATION SERVICES, NAMELY, PROVIDING HANDS-ON OPPORTUNITIES FOR CHILDREN IN THE FIELD OF INTUITIVE ENGINEERING THROUGH LIVE, PRINTED, BROADCAST, AND ON-LINE CLASSES, SEMINARS, WORKSHOPS, TRAINING AND CURRICULUM DEVELOPMENT FOR CHILDREN, PARENTS AND EDUCATORS; EDUCATION SERVICES, NAMELY, PROVIDING HEALTH FAIRS, SEMINARS AND CONFERENCES IN THE FIELD OF NUTRITION EDUCATION.; EDUCATIONAL AND ENTERTAINMENT SERVICES, NAMELY, PROVIDING MOTIVATIONAL AND EDUCATIONAL SPEAKERS; EDUCATIONAL AND ENTERTAINMENT SERVICES, NAMELY, PROVIDING ON-LINE INTERACTIVE CHILDREN'S STORIES; EDUCATIONAL PROGRAMS, NAMELY, PRE-SCHOOLS; EDUCATIONAL SERVICES, NAMELY, CONDUCTING INFORMAL PROGRAMS IN THE FIELDS OF NUTRITION EDUCATION, USING ON-LINE ACTIVITIES AND INTERACTIVE EXHIBITS, AND PRINTABLE MATERIALS DISTRIBUTED THEREWITH; EDUCATIONAL SERVICES, NAMELY, CONDUCTING ON-LINE EXHIBITIONS AND DISPLAYS AND INTERACTIVE EXHIBITS IN THE FIELD OF NUTRITION EDUCATION; EDUCATIONAL SERVICES, NAMELY, DEVELOPING CURRICULUM FOR EDUCATORS; EDUCATIONAL SERVICES, NAMELY, PROVIDING DOLLS AND TOYS DESIGNED TO TEACH ABOUT AND PROMOTE DENTAL HEALTH; ENTERTAINMENT AND EDUCATIONAL SERVICES, NAMELY, THE PRESENTATION OF SEMINARS, LECTURES, WORKSHOPS AND PANEL DISCUSSIONS, AND ONGOING TELEVISION AND RADIO TALK SHOWS ALL IN THE FIELD OF PUBLIC INTEREST CONCERNING NUTRITION EDUCATION (U.S. CLS. 100, 101 AND 107).

JEAN IM, EXAMINING ATTORNEY

CLASS 41—(Continued).

SN 77-737,099. HIGHLIGHTS FOR CHILDREN, INC., COLUMBUS, OH. FILED 5-14-2009.

WYATT THE RIOT

THE MARK CONSISTS OF STANDARD CHARACTERS WITHOUT CLAIM TO ANY PARTICULAR FONT, STYLE, SIZE, OR COLOR.

THE NAME "WYATT THE RIOT" DOES NOT IDENTIFY A LIVING INDIVIDUAL.

FOR PROVIDING A WEBSITE FEATURING EDUCATION AND ENTERTAINMENT FOR CHILDREN; ON-LINE PUBLICATIONS, NAMELY, ONLINE PUZZLE BOOKS, ACTIVITY BOOKS AND MAGAZINES FOR CHILDREN; PROVIDING ONLINE PODCASTS IN THE FIELD OF CHILDREN'S EDUCATION AND ENTERTAINMENT, GAMES AND PUZZLES FOR CHILDREN (U.S. CLS. 100, 101 AND 107).

TINA BROWN, EXAMINING ATTORNEY

SN 77-737,166. HIGHLIGHTS FOR CHILDREN, INC., COLUMBUS, OH. FILED 5-14-2009.

WYATT ROGERS

THE MARK CONSISTS OF STANDARD CHARACTERS WITHOUT CLAIM TO ANY PARTICULAR FONT, STYLE, SIZE, OR COLOR.

"WYATT ROGERS" DOES NOT IDENTIFY A LIVING INDIVIDUAL.

FOR PROVIDING A WEBSITE FEATURING EDUCATION AND ENTERTAINMENT FOR CHILDREN; ON-LINE PUBLICATIONS, NAMELY, ONLINE PUZZLE BOOKS, ACTIVITY BOOKS AND MAGAZINES FOR CHILDREN; PROVIDING ONLINE PODCASTS IN THE FIELD OF CHILDREN'S EDUCATION AND ENTERTAINMENT, GAMES AND PUZZLES FOR CHILDREN (U.S. CLS. 100, 101 AND 107).

TINA BROWN, EXAMINING ATTORNEY

SN 77-742,130. BOB DAVID LIVE, INC., GLEN ALLEN, VA. FILED 5-21-2009.



THE COLOR(S) DARK RED, GREY, AND BLACK IS/ARE CLAIMED AS A FEATURE OF THE MARK.

THE MARK CONSISTS OF THE WORD "PULL" FOLLOWED BY THE WORD "NOW" WITH A SINGLE SPACING IN BETWEEN. EACH LETTER IN THE WORD "PULL" IS IN THICK FONT AND IN THE COLOR DARK RED. THE LETTER "U" WITHIN THE WORD "PULL" HAS ITS UPPER FACING TIPS SLIGHTLY BENT INWARD TOWARDS

CLASS 41—(Continued).

EACH OTHER, CREATING THE IMAGE OF A MAGNET, AND ALSO HAS ITS TIPS IN COLOR GREY; ABOVE THE TIPS OF THE LETTER "U" ARE THREE STACKED OVAL WAVES, OF ASCENDING SIZE AND EACH OF GREY COLOR, EMANATING FROM THE LETTER "U" TO CREATE THE IMAGE OF "ELECTROMAGNETIC" ATTRACTIVE ENERGY. UNDERNEATH THE LETTER "U" IS GREY SHADING, THE WORD "NOW" IS IN SMALLER AND SLIGHTLY DIFFERENT FONT, AND IS ENTIRELY BLACK COLOR.

FOR EDUCATION SERVICES, NAMELY, PROVIDING SEMINARS, WORKSHOPS, LECTURES, CLASSES AND MOTIVATIONAL SPEAKING SERVICES IN THE FIELDS OF LEADERSHIP, MANAGEMENT, SALES, COMMUNICATION, CORPORATE AND PERSONAL ASSESSMENT AND MEASUREMENT, AND PROFESSIONAL, PERSONAL AND LEADERSHIP DEVELOPMENT (U.S. CLS. 100, 101 AND 107).

KATHLEEN M. VANSTON, EXAMINING ATTORNEY

SN 77-744,924. CODDINGTON FINANCE CORPORATION PTY LTD, GLADESVILLE NSW, AUSTRALIA, FILED 5-26-2009.

Entrepreneur DNA

THE MARK CONSISTS OF STANDARD CHARACTERS WITHOUT CLAIM TO ANY PARTICULAR FONT, STYLE, SIZE, OR COLOR.

NO CLAIM IS MADE TO THE EXCLUSIVE RIGHT TO USE "ENTREPRENEUR", APART FROM THE MARK AS SHOWN.

FOR EDUCATIONAL SERVICES, NAMELY, DEVELOPING, ARRANGING, AND CONDUCTING EDUCATIONAL CONFERENCES AND PROGRAMS AND PROVIDING COURSES OF INSTRUCTION IN THE FIELD OF BUSINESS AND FINANCIAL CONSULTING (U.S. CLS. 100, 101 AND 107).

FIRST USE 5-27-2007; IN COMMERCE 5-27-2007.

ERNEST SHOSHO, EXAMINING ATTORNEY

CLASS 41—(Continued).

SN 77-746,321. DEEP WELL, INC., MINNEAPOLIS, MN. FILED 5-28-2009.



THE MARK CONSISTS OF A VINTAGE GRAPHICAL DISPLAY OF A CONVERSATION BALLOON WITH THE LETTERS "C" AND "S" IN BLOCK LETTERS IN THE CENTER OF THE BALLOON.

FOR CINEMATOGRAPHIC ADAPTATION AND EDITING; COMPOSITION OF MUSIC FOR OTHERS; DUBBING SERVICES; EDITING OR RECORDING OF SOUNDS AND IMAGES; FILM EDITING; POST-PRODUCTION EDITING SERVICES IN THE FIELD OF MUSIC, VIDEOS AND FILMS; SPECIAL EFFECTS ANIMATION SERVICES FOR FILM AND VIDEO (U.S. CLS. 100, 101 AND 107).

FIRST USE 8-31-2007; IN COMMERCE 8-31-2007.

AARON BRODSKY, EXAMINING ATTORNEY

SN 77-747,575. LEARNING TREE INTERNATIONAL, INC., RESTON, VA. FILED 5-29-2009.



OWNER OF U.S. REG. NOS. 1,124,714, 1,485,608 AND OTHERS.

NO CLAIM IS MADE TO THE EXCLUSIVE RIGHT TO USE "LEARNING", APART FROM THE MARK AS SHOWN.

THE MARK CONSISTS OF A STYLIZED TREE DESIGN AND THE WORDS "LEARNING TREE ANYWARE BE THERE WITH ANYWARE".

FOR PROVIDING EDUCATION AND TRAINING COURSES IN THE FIELDS OF INFORMATION TECHNOLOGY, COMPUTERS, COMPUTER HARDWARE, COMPUTER MAINTENANCE AND REPAIR, COMPUTER SOFTWARE, COMPUTER NETWORKS, COMPUTER SECURITY, TELECOMMUNICATIONS, COMPUTER PROGRAMMING, AND IN THE FIELDS OF BUSINESS AND MANAGEMENT SKILLS, FINANCE, LEADERSHIP, COMMUNICATION SKILLS AND PROJECT MANAGEMENT, AND COURSE MATERIALS PROVIDED IN CONNECTION THEREWITH (U.S. CLS. 100, 101 AND 107).

ALICE SUE CARRUTHERS, EXAMINING ATTORNEY

CLASS 41—(Continued).

SN 77-748,906. JOSE ANTONIO AGUILAR JIMENEZ, AKA PEPE AGUILAR, WOODLAND HILLS, CA. FILED 6-1-2009.

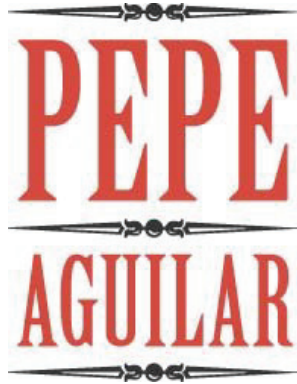

THE COLOR(S) RED AND BLACK IS/ARE CLAIMED AS A FEATURE OF THE MARK.

THE MARK CONSISTS OF THE NAME "PEPE AGUILAR" IN HIGH CASE LETTERS SEPARATED BY BLACK BORDERS.

FOR ENTERTAINMENT SERVICES IN THE NATURE OF LIVE MUSICAL PERFORMANCES (U.S. CLS. 100, 101 AND 107).

FIRST USE 1-1-1981; IN COMMERCE 1-1-1981.
GEOFFREY FOSDICK, EXAMINING ATTORNEY

CLASS 41—(Continued).

SN 77-751,691. GENERAL MILLS, INC., MINNEAPOLIS, MN. FILED 6-4-2009.

GET ON THE BUS

THE MARK CONSISTS OF STANDARD CHARACTERS WITHOUT CLAIM TO ANY PARTICULAR FONT, STYLE, SIZE, OR COLOR.

FOR SWEEPSTAKE SERVICES PROVIDED OVER A GLOBAL COMPUTER NETWORK (U.S. CLS. 100, 101 AND 107).

CHARLES L. JENKINS, EXAMINING ATTORNEY

SN 77-751,509. LEARNING TREE INTERNATIONAL, INC., RESTON, VA. FILED 6-3-2009.



OWNER OF U.S. REG. NOS. 1,124,714, 1,485,608 AND OTHERS.

NO CLAIM IS MADE TO THE EXCLUSIVE RIGHT TO USE "LEARNING", APART FROM THE MARK AS SHOWN.

THE MARK CONSISTS OF A STYLIZED TREE DESIGN AND THE WORDS "LEARNING TREE ANYWARE BE THERE WITH ANYWARE".

FOR EDUCATION AND TRAINING COURSES IN THE FIELDS OF INFORMATION TECHNOLOGY, COMPUTERS, COMPUTER HARDWARE, COMPUTER MAINTENANCE AND REPAIR, COMPUTER SOFTWARE, COMPUTER NETWORKS, COMPUTER SECURITY, TELECOMMUNICATIONS, COMPUTER PROGRAMMING, SOFTWARE ENGINEERING, SOFTWARE DEVELOPMENT, WEBSITE DEVELOPMENT AND WEB SERVICES, AND IN THE FIELDS OF BUSINESS AND MANAGEMENT SKILLS, FINANCE, LEADERSHIP, COMMUNICATION SKILLS AND PROJECT MANAGEMENT, AND COURSE MATERIALS PROVIDED IN CONNECTION THEREWITH (U.S. CLS. 100, 101 AND 107).

ALICE SUE CARRUTHERS, EXAMINING ATTORNEY

SN 77-756,657. DEVINCENT, MARC, POWELL, OH. FILED 6-10-2009.



THE COLOR(S) YELLOW, WHITE, BLACK AND SHADES OF BLUE IS/ARE CLAIMED AS A FEATURE OF THE MARK.

THE MARK CONSISTS OF A STYLIZED BOOK DESIGN IN WHITE, BLUE AND BLACK, OPEN ON A FLAT YELLOW SURFACE, IN A RECTANGULAR SHAPED BACKGROUND CARRIER OUTLINED IN WHITE AND BLUE.

FOR CUSTOM WRITING SERVICES (U.S. CLS. 100, 101 AND 107).

PATRICIA EVANKO, EXAMINING ATTORNEY

CLASS 41—(Continued).

SN 77-762,590. JAKKS PACIFIC, INC., MALIBU, CA. FILED 6-17-2009.

MOBEEZ

THE MARK CONSISTS OF STANDARD CHARACTERS WITHOUT CLAIM TO ANY PARTICULAR FONT, STYLE, SIZE, OR COLOR.

FOR ENTERTAINMENT SERVICES, NAMELY, PROVIDING ENTERTAINMENT IN THE FIELD OF INTERACTIVE GAMES BY MEANS OF A GLOBAL COMPUTER NETWORK; ENTERTAINMENT SERVICES, NAMELY, PROVIDING ON-LINE INTERACTIVE COMPUTER GAMES; PROVIDING A WEBSITE FEATURING EDUCATION AND ENTERTAINMENT FOR CHILDREN; CHILDREN'S ENTERTAINMENT AND AMUSEMENT CENTERS, NAMELY, INTERACTIVE PLAY AREAS; EDUCATIONAL AND ENTERTAINMENT SERVICES, NAMELY, PROVIDING ON-LINE INTERACTIVE CHILDREN'S STORIES; ENTERTAINMENT SERVICES, NAMELY, PROVIDING ONLINE GAMES, ONLINE CONTESTS AND ONLINE PRODUCT TRIVIA ABOUT GAMES AND TOYS, INTENDED FOR CONSUMERS OF ALL AGES; ENTERTAINMENT SERVICES, NAMELY, PROVIDING ONLINE COMPUTER GAMES AND INTERACTIVE MULTIPLAYER ONLINE COMPUTER GAMES VIA A GLOBAL NETWORK; ORGANIZING AND CONDUCTING ONLINE GAME TOURNAMENTS AND EXHIBITIONS; PROVIDING ONLINE COMPUTER GAMES BROADCAST OVER THE INTERNET, SATELLITE, CABLE, AUDIO AND VIDEO MEDIA; ENTERTAINMENT SERVICES, NAMELY, PROVIDING COMPUTER GAMES AND VIDEO GAMES THAT CAN BE ACCESSED AND PLAYED OVER INTERACTIVE TELEVISION, BROADBAND, SATELLITE AND CABLE TELEVISION NETWORKS (U.S. CLS. 100, 101 AND 107).

JORDAN BAKER, EXAMINING ATTORNEY

CLASS 41—(Continued).

SN 77-762,592. JAKKS PACIFIC, INC., MALIBU, CA. FILED 6-17-2009.

MOBEEZ WORLD

THE MARK CONSISTS OF STANDARD CHARACTERS WITHOUT CLAIM TO ANY PARTICULAR FONT, STYLE, SIZE, OR COLOR.

FOR ENTERTAINMENT SERVICES, NAMELY, PROVIDING ENTERTAINMENT IN THE FIELD OF INTERACTIVE GAMES BY MEANS OF A GLOBAL COMPUTER NETWORK; ENTERTAINMENT SERVICES, NAMELY, PROVIDING ON-LINE INTERACTIVE COMPUTER GAMES; PROVIDING A WEBSITE FEATURING EDUCATION AND ENTERTAINMENT FOR CHILDREN; CHILDREN'S ENTERTAINMENT AND AMUSEMENT CENTERS, NAMELY, INTERACTIVE PLAY AREAS; EDUCATIONAL AND ENTERTAINMENT SERVICES, NAMELY, PROVIDING ON-LINE INTERACTIVE CHILDREN'S STORIES; ENTERTAINMENT SERVICES, NAMELY, PROVIDING ONLINE GAMES, ONLINE CONTESTS AND ONLINE PRODUCT TRIVIA ABOUT GAMES AND TOYS, INTENDED FOR CONSUMERS OF ALL AGES; ENTERTAINMENT SERVICES, NAMELY, PROVIDING ONLINE COMPUTER GAMES AND INTERACTIVE MULTIPLAYER ONLINE COMPUTER GAMES VIA A GLOBAL NETWORK; ORGANIZING AND CONDUCTING ONLINE GAME TOURNAMENTS AND EXHIBITIONS; PROVIDING ONLINE COMPUTER GAMES BROADCAST OVER THE INTERNET, SATELLITE, CABLE, AUDIO AND VIDEO MEDIA; ENTERTAINMENT SERVICES, NAMELY, PROVIDING COMPUTER GAMES AND VIDEO GAMES THAT CAN BE ACCESSED AND PLAYED OVER INTERACTIVE TELEVISION, BROADBAND, SATELLITE AND CABLE TELEVISION NETWORKS (U.S. CLS. 100, 101 AND 107).

JORDAN BAKER, EXAMINING ATTORNEY

SN 77-776,854. AFFECTIVA, INC., NEWTONVILLE, MA. FILED 7-8-2009.

AFFECTIVA

THE MARK CONSISTS OF STANDARD CHARACTERS WITHOUT CLAIM TO ANY PARTICULAR FONT, STYLE, SIZE, OR COLOR.

FOR EDUCATION AND TRAINING SERVICES, NAMELY, PROVIDING INSTRUCTIONAL, TUTORIAL AND TRAINING CLASSES AND SEMINARS IN THE FIELD OF MEASURING, MONITORING AND EVALUATING DEMONSTRATIVE DATA DERIVED FROM PHYSIOLOGICAL EXPRESSIONS AND SIGNALS (U.S. CLS. 100, 101 AND 107).

MICHAEL TANNER, EXAMINING ATTORNEY

CLASS 41—(Continued).

SN 77-776,993. SQUARE GROUPER, LLC, MIAMI BEACH, FL. FILED 7-8-2009.

SQUARE GROUPER

THE MARK CONSISTS OF STANDARD CHARACTERS WITHOUT CLAIM TO ANY PARTICULAR FONT, STYLE, SIZE, OR COLOR.

FOR ENTERTAINMENT SERVICES, NAMELY, PRODUCTION OF COMPUTER GAME PROGRAMS AND GAME SOFTWARE FOR ENTERTAINMENT PURPOSES AND PROVIDING INFORMATION IN THE FIELDS OF COMPUTER GAMES, COMPUTER GAME SOFTWARE, MUSIC, MOVIES, FILMS, AND ANIMATION VIA THE INTERNET, HAND HELD COMPUTING DEVICES, MOBILE COMPUTING DEVICES AND PERSONAL COMPUTERS (U.S. CLS. 100, 101 AND 107).

JANICE KIM, EXAMINING ATTORNEY

CLASS 41—(Continued).

SN 77-977,547. RELIANT ENERGY RETAIL HOLDINGS, LLC, HOUSTON, TX. FILED 9-29-2008.

e-Sense

SN 77-781,198. ZUFFA, LLC, LAS VEGAS, NV. FILED 7-14-2009.

UFC UNLEASHED

THE MARK CONSISTS OF STANDARD CHARACTERS WITHOUT CLAIM TO ANY PARTICULAR FONT, STYLE, SIZE, OR COLOR.

OWNER OF U.S. REG. NOS. 2,706,754, 3,650,069 AND 3,650,245.

FOR ENTERTAINMENT IN THE NATURE OF AN ONGOING TELEVISION PROGRAM IN THE FIELD OF SPORTS AND MIXED MARTIAL ARTS; ENTERTAINMENT SERVICES, NAMELY, PRODUCTION OF PROGRAMS FEATURING MIXED MARTIAL ARTS COMPETITIONS AND EVENTS FOR DISTRIBUTION OVER TELEVISION, CABLE, SATELLITE, AUDIO AND GLOBAL COMPUTER NETWORKS (U.S. CLS. 100, 101 AND 107).

FIRST USE 7-25-2005; IN COMMERCE 7-25-2005.
JOHN E. MICHOS, EXAMINING ATTORNEY

SN 77-977,294. DAVITA INC., EL SEGUNDO, CA. FILED 12-10-2008.

EMPOWER

THE MARK CONSISTS OF STANDARD CHARACTERS WITHOUT CLAIM TO ANY PARTICULAR FONT, STYLE, SIZE, OR COLOR.

FOR ONLINE EDUCATIONAL SERVICES, NAMELY, PROVIDING CLASSES, SEMINARS, AND CONFERENCES IN THE FIELD OF CHRONIC KIDNEY DISEASE (U.S. CLS. 100, 101 AND 107).

ROBERT LAVACHE, EXAMINING ATTORNEY

THE MARK CONSISTS OF LOWER CASE "E" FOLLOWED BY A DASH THE CAPITALIZED WORD "SENSE".

FOR CONDUCTING EDUCATIONAL PROGRAMS IN THE FIELD OF POWER CONSUMPTION, ENVIRONMENTAL CONDITIONS AND IMPACT, AND ENERGY UTILIZATION (U.S. CLS. 100, 101 AND 107).

JOHN SCHUYLER YARD, EXAMINING ATTORNEY

CLASS 41—(Continued).

SN 77-977,611. FULL SAIL, INC., WINTER PARK, FL. FILED 12-15-2008.



OWNER OF U.S. REG. NOS. 2,025,339, 3,525,113 AND OTHERS.

NO CLAIM IS MADE TO THE EXCLUSIVE RIGHT TO USE "UNIVERSITY", APART FROM THE MARK AS SHOWN.

THE COLOR(S) ORANGE, WHITE AND SAGE IS/ARE CLAIMED AS A FEATURE OF THE MARK.

THE MARK CONSISTS OF A DESIGN OF AN AIRPLANE WITHIN A CIRCULAR DESIGN AND THE WORDS "FULL SAIL UNIVERSITY" BELOW THE DESIGN. THE AIRPLANE DESIGN IS IN WHITE, THE CIRCULAR DESIGN IS IN ORANGE AND THE WORDS "FULL SAIL UNIVERSITY" ARE IN SAGE.

FOR PROVIDING AN ON-LINE COMPUTER DATABASE FOR STUDENTS IN THE FIELDS OF INSTRUCTION FOR ART, MUSIC PRODUCTION, VIDEO PRODUCTION, AUDIO PRODUCTION, COMPUTER DESIGN, TELEVISION PRODUCTION, FILM COMPUTER ANIMATION, VIDEO AND COMPUTER GAME DESIGN, WEB DESIGN, LIVE EVENT PRODUCTION, ENTERTAINMENT MARKETING, PROMOTION, FUND-RAISING, ACCOUNTING AND ADVERTISING, FOR INDEPENDENT ARTISTS, FILM MAKERS AND RECORDING ARTISTS; EDUCATIONAL SERVICES, NAMELY, PROVIDING LIVE COURSES OF INSTRUCTION, SEMINARS, CONFERENCES AND WORKSHOPS, ON-LINE AND NON-DOWNLOADABLE PRE-RECORDED COURSES OF INSTRUCTION, SEMINARS, CONFERENCES AND WORKSHOPS, ALL IN THE FIELDS OF ART, MUSIC, AUDIO PRODUCTION, FILM PRODUCTION, VIDEO PRODUCTION, TELEVISION PRODUCTION, DIGITAL MEDIA PRODUCTION, WEB DESIGN, COMPUTER ANIMATION, COMPUTER AND VIDEO GAME DESIGN, LIVE EVENT PRODUCTION, AND ENTERTAINMENT MARKETING, NAMELY, MARKETING, PROMOTION, FUND-RAISING, ACCOUNTING AND ADVERTISING FOR INDEPENDENT ARTISTS, FILMMAKERS AND RECORDING ARTISTS; MUSIC PRODUCTION, MOTION PICTURE FILM PRODUCTION, PRODUCTION OF VIDEO DISCS, TELEVISION PRODUCTION, AND COMPUTER ANIMATION PRODUCTION SERVICES; PROVIDING AN ON-LINE PORTAL FOR STUDENTS FOR USE IN CONNECTION WITH COMMUNICATION WITH OTHER STUDENTS AND INSTRUCTORS AND FOR THE SHARING OF INFORMATION, DATA, RESOURCES, PROJECTS AND DIGITAL CONTENT (U.S. CLS. 100, 101 AND 107).

FIRST USE 3-0-2008; IN COMMERCE 4-0-2008.
AMEETA JORDAN, EXAMINING ATTORNEY

CLASS 41—(Continued).

SN 78-562,661. THE CARS UNLIMITED, INC., LINCOLN, MA. FILED 2-8-2005.

THE CARS

THE MARK CONSISTS OF STANDARD CHARACTERS WITHOUT CLAIM TO ANY PARTICULAR FONT, STYLE, SIZE, OR COLOR.

FOR ENTERTAINMENT SERVICES, IN THE NATURE OF A PERFORMING MUSICAL GROUP (U.S. CLS. 100, 101 AND 107).

STEVEN R. FOSTER, EXAMINING ATTORNEY

SN 78-759,971. DAVINCI, DINO, LOS ANGELES, CA. FILED 11-23-2005.

ANIMALNATION ANIMATION

THE MARK CONSISTS OF STANDARD CHARACTERS WITHOUT CLAIM TO ANY PARTICULAR FONT, STYLE, SIZE, OR COLOR.

NO CLAIM IS MADE TO THE EXCLUSIVE RIGHT TO USE "ANIMATION", APART FROM THE MARK AS SHOWN.

FOR ANIMATION PRODUCTION SERVICES (U.S. CLS. 100, 101 AND 107).

AMY ALFIERI, EXAMINING ATTORNEY

SN 78-791,551. HARRAH'S LICENSE COMPANY, LLC, LAS VEGAS, NV. FILED 1-13-2006.



FOR CASINO ENTERTAINMENT SERVICES (U.S. CLS. 100, 101 AND 107).

FIRST USE 8-30-2004; IN COMMERCE 8-30-2004.
JANICE KIM, EXAMINING ATTORNEY

CLASS 41—(Continued).

SN 78-839,192. TRUEBEGINNINGS, LLC, IRVING, TX.
FILED 3-16-2006.



The logo consists of the word "True" in a bold, sans-serif font, followed by a large, bold, black letter "U" that is underlined.

OWNER OF U.S. REG. NOS. 2,975,482 AND 3,043,738.
THE MARK CONSISTS OF THE WORD "TRUE" WITH
THE LETTER "U" UNDERLINED FOLLOWED BY THE
LETTER "U" CONTAINED IN A CIRCLE.

FOR PROVIDING A NON-DOWNLOADABLE ELEC-
TRONIC PUBLICATION VIA A WEBSITE, NAMELY, AN
ONLINE MAGAZINE FEATURING INFORMATION IN
THE FIELDS OF DATING, NETWORKING, INTERPER-
SONAL RELATIONSHIPS AND PSYCHOLOGY (U.S.
CLS. 100, 101 AND 107).

FIRST USE 4-1-2005; IN COMMERCE 4-1-2005.
MYRIAH HABEEB, EXAMINING ATTORNEY

SN 78-864,269. THE TRUSTEE OF THE REUBEN B. KLA-
MER LIVING TRUST, A CALIFORNIA TRUST, THE SOLE
TRUSTEE COMPRISING REUBEN B. KLAMER, A UNI-
TED STATES CITIZEN, SAN DIEGO, CA. FILED 4-18-2006.

SPIN TO WIN

THE MARK CONSISTS OF STANDARD CHARACTERS
WITHOUT CLAIM TO ANY PARTICULAR FONT, STYLE,
SIZE, OR COLOR.

FOR ENTERTAINMENT SERVICES, NAMELY, ON-
GOING TELEVISION PROGRAMS FEATURING GAMES
AND ENTERTAINMENT AND LIVE-ACTION TELEVI-
SION SHOWS; PRODUCTION AND SYNDICATION OF
TELEVISION PROGRAMS, FILMS, ANIMATED FILMS,
AND SOUND AND VIDEO RECORDINGS, RENTAL OF
FILMS AND ANIMATED FILMS; PRODUCTION AND
DISTRIBUTION OF TELEVISION PROGRAMS, FILMS
AND ANIMATED FILMS; RENTAL OF SLOT MA-
CHINES; ORGANIZATION, PRODUCTION AND PRE-
SENTATION OF SPORTING AND GAMING
COMPETITIONS, NAMELY, CONTESTS, EXHIBITIONS,
AND QUIZZES CONCERNING NON-BUSINESS SUB-
JECTS; ORGANIZATION, PRODUCTION AND PRESEN-
TATION OF CONCERTS, LIVE PERFORMANCES,
MUSIC CONCERTS, LIVE MUSIC PERFORMANCES,
PUBLISHING OF MUSICAL REVIEWS; MUSIC PUB-
LISHING; RECORD PRODUCTION; PROVIDING ON-
LINE COMPUTER GAMES; RESERVATION AND
BOOKING SERVICES FOR ENTERTAINMENT, SPORT-
ING, AND CULTURAL EVENTS, NAMELY, CONCERTS,
THEATRE, SHOWS, AND CINEMA TICKETS; TICKET
INFORMATION SERVICES FOR ENTERTAINMENT
EVENTS; INFORMATION AND ADVISORY SERVICES
RELATING TO ALL OF THE AFORESAID SERVICES
(U.S. CLS. 100, 101 AND 107).

TIMOTHY FINNEGAN, EXAMINING ATTORNEY

CLASS 41—(Continued).

SN 78-957,757. KRUGER PRODUCTS LIMITED, MISSISSAU-
GA, ONTARIO, FILED 8-22-2006.



PRIORITY CLAIMED UNDER SEC. 44(D) ON CANADA
APPLICATION NO. 1312533, FILED 8-10-2006, REG. NO.
TMA701062, DATED 11-16-2007, EXPIRES 11-16-2022.

THE COLOR(S) BLUE, WHITE AND RED IS/ARE
CLAIMED AS A FEATURE OF THE MARK.

THE MARK CONSISTS OF FOUR RED HEARTS ON A
WHITE BACKGROUND ENCIRCLED BY A BLUE RING.

FOR ORGANIZATION AND PRESENTATION OF LA-
DIES' CURLING TOURNAMENTS (U.S. CLS. 100, 101
AND 107).

JACLYN KIDWELL, EXAMINING ATTORNEY

SN 79-063,007. SUZAN SABANCI DINCER, TURKEY, FILED
10-15-2008.



The logo consists of the word "Ayışığı" written in a large, bold, black, sans-serif font.

THE MARK CONSISTS OF STANDARD CHARACTERS
WITHOUT CLAIM TO ANY PARTICULAR FONT, STYLE,
SIZE, OR COLOR.

PRIORITY DATE OF 8-4-2008 IS CLAIMED.
OWNER OF INTERNATIONAL REGISTRATION 0987229
DATED 10-15-2008, EXPIRES 10-15-2018.

THE ENGLISH TRANSLATION OF "AYISIGI" IN THE
MARK IS MOONLIGHT.

FOR PROVIDING MUSEUM FACILITIES (U.S. CLS.
100, 101 AND 107).

DAVID MILLER, EXAMINING ATTORNEY

CLASS 41—(Continued).

SN 79-065,388. LAUREUS WORLD SPORTS AWARDS LIMITED, UNITED KINGDOM, FILED 12-19-2008.

LAUREUS PEOPLE'S CHOICE AWARD

THE MARK CONSISTS OF STANDARD CHARACTERS WITHOUT CLAIM TO ANY PARTICULAR FONT, STYLE, SIZE, OR COLOR.

PRIORITY DATE OF 12-4-2008 IS CLAIMED.

OWNER OF INTERNATIONAL REGISTRATION 0993487 DATED 12-19-2008, EXPIRES 12-19-2018.

OWNER OF U.S. REG. NOS. 2,803,900 AND 3,029,239.

NO CLAIM IS MADE TO THE EXCLUSIVE RIGHT TO USE "AWARD", APART FROM THE MARK AS SHOWN.

FOR ENTERTAINMENT AND EDUCATIONAL SERVICES, NAMELY, ARRANGING AND CONDUCTING SPORTING EVENTS AND ATHLETIC COMPETITIONS, ARRANGING AND CONDUCTING AWARDS PROGRAMS IN THE FIELD OF SPORTS; ARRANGING AND CONDUCTING INCENTIVE AWARD PROGRAMS TO ENCOURAGE THE FREQUENT, CONTINUED AND EFFECTIVE PRACTICE OF PHYSICAL EXERCISE; EDUCATION SERVICES, NAMELY, PROVIDING INCENTIVES TO PEOPLE AND ORGANIZATIONS TO DEMONSTRATE EXCELLENCE IN THE FIELD OF SPORTS AND ATHLETICS THROUGH THE ISSUANCE OF AWARDS; PRODUCTION OF TELEVISION AND RADIO PROGRAMS FEATURING SPORTING EVENTS, SPORTS AND ATHLETIC COMPETITIONS, AWARDS SHOWS, THE HISTORY OF SPORTS AND ATHLETICS, HISTORICAL FIGURES AND FAMOUS PERSONS IN THE ATHLETIC AND SPORTING FIELDS; PROVIDING FACILITIES FOR SPORTS AND ATHLETIC COMPETITIONS AND AWARDS PROGRAMS; PROVIDING SPORTS INFORMATION BY MEANS OF TELEPHONE AND A WEBSITE VIA A GLOBAL COMPUTER NETWORK; PROVIDING VARIOUS FACILITIES FOR AN ARRAY OF SPORTING EVENTS, SPORTS AND ATHLETIC COMPETITIONS AND AWARDS PROGRAMS; PROVIDING INFORMATION ON HISTORICAL AND CURRENT SPORTS AND ATHLETIC FIGURES, THE HISTORY OF SPORTS, A SPORTS AWARD PROGRAM, VARIOUS SPORTING AND ATHLETIC EVENTS VIA A WEBSITE BY MEANS OF A GLOBAL COMPUTER NETWORK (U.S. CLS. 100, 101 AND 107).

ROBERT STRUCK, EXAMINING ATTORNEY

CLASS 42—(Continued).

SN 76-978,992. AMINI INNOVATION CORP., PICO RIVERA, CA. FILED 2-14-2005.

MICHAEL AMINI

THE MARK CONSISTS OF STANDARD CHARACTERS WITHOUT CLAIM TO ANY PARTICULAR FONT, STYLE, SIZE, OR COLOR.

THE NAME "MICHAEL AMINI" IDENTIFIES A LIVING INDIVIDUAL WHOSE CONSENT IS OF RECORD.

FOR FURNITURE DESIGN (U.S. CLS. 100 AND 101).

FIRST USE 12-1-1998; IN COMMERCE 12-1-1998.

ELLEN PERKINS, EXAMINING ATTORNEY

SN 77-010,315. AOL LLC, DULLES, VA. FILED 9-29-2006.

CLASS 42—SCIENTIFIC AND COMPUTER SERVICES

SN 76-692,494. SAMBA HOLDINGS, INC., ALBUQUERQUE, NM. FILED 9-2-2008.

FLEETWATCH

THE MARK CONSISTS OF STANDARD CHARACTERS WITHOUT CLAIM TO ANY PARTICULAR FONT, STYLE, SIZE, OR COLOR.

FOR RETRIEVING PUBLIC DOCUMENTS, NAMELY, ELECTRONIC RETRIEVAL OF PUBLIC RECORDS PERTAINING TO MOTOR VEHICLE DRIVERS, MOTOR VEHICLES, MOTOR VEHICLE ACCIDENTS, AND EMPLOYEE BACKGROUNDS (U.S. CLS. 100 AND 101).

FIRST USE 12-2-2002; IN COMMERCE 12-2-2002.

CYNTHIA TRIPI, EXAMINING ATTORNEY

AOL MUSIC NOW

THE MARK CONSISTS OF STANDARD CHARACTERS WITHOUT CLAIM TO ANY PARTICULAR FONT, STYLE, SIZE, OR COLOR.

OWNER OF U.S. REG. NOS. 1,977,731, 1,988,542 AND 2,325,291.

NO CLAIM IS MADE TO THE EXCLUSIVE RIGHT TO USE "MUSIC", APART FROM THE MARK AS SHOWN.

FOR SEARCH ENGINE SERVICES, NAMELY, SEARCHING AND RETRIEVING ENTERTAINMENT INFORMATION FOR OTHERS VIA A GLOBAL COMPUTER NETWORK (U.S. CLS. 100 AND 101).

FIRST USE 11-3-2005; IN COMMERCE 11-3-2005.

KAREN K. BUSH, EXAMINING ATTORNEY

CLASS 42—(Continued).

SN 77-100,854. ECOMMERCE INDUSTRIES, INC., LEESBURG, VA. FILED 2-6-2007.



THE MARK CONSISTS OF THE WORDS "BRITANNIA THE INDEPENDENT'S BEST FRIEND" TOGETHER WITH A RECTANGLE CONTAINING A CONTRASTING OVAL SHAPE, IN THE CENTER OF WHICH ARE SILHOUETTES OF TWO BOOKS LEANING AGAINST A LOWER-CASE LETTER "B".

FOR APPLICATION SERVICE PROVIDER, NAMELY, PROVIDING ONLINE NON-DOWNLOADABLE SOFTWARE FOR USE IN WEBSITE DESIGN AND DEVELOPMENT, DATABASE MANAGEMENT, ORDER PROCESSING AND MANAGEMENT, RECORD KEEPING, BOOK KEEPING, SALES AND PURCHASE ANALYSIS AND REPORT GENERATION, TASK PROCESSING AND MANAGEMENT, ALL IN THE OFFICE PRODUCTS AND COMPUTER CONSUMABLES FIELD; APPLICATION SERVICE PROVIDER, NAMELY, HOSTING COMPUTER SOFTWARE APPLICATIONS FOR OTHERS, IN THE OFFICE PRODUCTS AND COMPUTER CONSUMABLES FIELD; HOSTING AND MAINTAINING AN ONLINE WEBSITE FOR OTHERS TO FACILITATE THE ONLINE SALE OF OFFICE SUPPLIES, OFFICE PRODUCTS, COMPUTERS AND COMPUTER RELATED SUPPLIES AND PRODUCTS, AND FURNITURE VIA THE GLOBAL COMPUTER COMMUNICATIONS NETWORK; HOSTING AND MAINTAINING AN ONLINE WEBSITE FOR OTHERS TO FACILITATE ONLINE ORDERING AND TO MANAGE THE ONLINE RETAIL SERVICES OF OTHERS; PROVIDING CUSTOMIZED ONLINE WEB PAGES FEATURING USER-DEFINED INFORMATION, WHICH INCLUDES SEARCH ENGINES (U.S. CLS. 100 AND 101).

FIRST USE 7-22-2004; IN COMMERCE 7-22-2004.
KIM SAITO, EXAMINING ATTORNEY

SN 77-241,522. BARBER, DIANE E., ROLLING HILLS ESTATES, CA. FILED 7-29-2007.



EQUESTRIAN
designery

NO CLAIM IS MADE TO THE EXCLUSIVE RIGHT TO USE "EQUESTRIAN DESIGNERY", APART FROM THE MARK AS SHOWN.

THE MARK CONSISTS OF A STYLIZED LETTER "D" WITH AN ORIGINAL HORSE DESIGN OF A HORSE STEPPING OVER THE "D" AND THE BUSINESS NAME "EQUESTRIAN DESIGNERY" UNDER THE IMAGE.

FOR INTERIOR DESIGN SERVICES (U.S. CLS. 100 AND 101).

FIRST USE 10-30-2006; IN COMMERCE 10-30-2006.
PAUL MORENO, EXAMINING ATTORNEY

CLASS 42—(Continued).

SN 77-343,152. CASE WESTERN RESERVE UNIVERSITY, CLEVELAND, OH. FILED 12-4-2007.

CLEVELAND FES CENTER

THE MARK CONSISTS OF STANDARD CHARACTERS WITHOUT CLAIM TO ANY PARTICULAR FONT, STYLE, SIZE, OR COLOR.

NO CLAIM IS MADE TO THE EXCLUSIVE RIGHT TO USE "FES CENTER", APART FROM THE MARK AS SHOWN.

SEC. 2(F).

FOR MEDICAL AND SCIENTIFIC RESEARCH IN THE FIELD OF NEUROLOGY; BASIC AND CLINICAL RESEARCH IN THE FIELD OF NEUROLOGICAL SCIENCE AND MEDICINE; ENGINEERING SERVICES, NAMELY, ENGINEERING FOR THE MEDICAL FIELD; AND DEVELOPMENT OF NEW TECHNOLOGY FOR OTHERS IN THE FIELD OF NEUROLOGICAL SCIENCE (U.S. CLS. 100 AND 101).

FIRST USE 0-0-2000; IN COMMERCE 0-0-2000.
HEATHER SAPP, EXAMINING ATTORNEY

SN 77-345,255. ASTROBOTIC TECHNOLOGY, INC., REDMOND, WA. FILED 12-5-2007.

ASTROBOTIC

THE MARK CONSISTS OF STANDARD CHARACTERS WITHOUT CLAIM TO ANY PARTICULAR FONT, STYLE, SIZE, OR COLOR.

FOR TECHNICAL CONSULTATION AND RESEARCH IN THE FIELD OF AEROSPACE ENGINEERING, NAMELY, REGARDING THE ENVIRONMENTS OF EXTRATERRESTRIAL BODIES AND SPACE, AND THE PERFORMANCE AND DEPLOYMENT OF ROBOTS AND INSTRUMENTATION THEREIN; AEROSPACE ENGINEERING, NAMELY, DEVELOPMENT AND DEPLOYMENT OF ROBOTS AND INSTRUMENTATION FOR EXPLORATION, TESTING AND MEASUREMENT OF THE ENVIRONMENTS OF EXTRATERRESTRIAL BODIES AND SPACE, AND OF THEIR OWN TECHNICAL PERFORMANCE IN SUCH ENVIRONMENTS; CONDUCTING SCIENTIFIC RESEARCH AND COMPILING DATA FOR RESEARCH IN THE FIELD OF EXPLORATION, TESTING AND MEASUREMENT OF THE ENVIRONMENTS OF EXTRATERRESTRIAL BODIES AND SPACE, AND OF THE PERFORMANCE OF ROBOTS AND INSTRUMENTATION IN SUCH ENVIRONMENTS (U.S. CLS. 100 AND 101).

SHAUNIA CARLYLE, EXAMINING ATTORNEY

CLASS 42—(Continued).

SN 77-408,289. AUBICE LLC, GREENWOOD VILLAGE, CO.
FILED 2-28-2008.

AUBICE ESD

THE MARK CONSISTS OF STANDARD CHARACTERS WITHOUT CLAIM TO ANY PARTICULAR FONT, STYLE, SIZE, OR COLOR.

NO CLAIM IS MADE TO THE EXCLUSIVE RIGHT TO USE "ESD", APART FROM THE MARK AS SHOWN.

FOR COMPUTER SERVICES, NAMELY, ACTING AS AN APPLICATION SERVICE PROVIDER IN THE FIELD OF INFORMATION SEARCH AND MANAGEMENT TO HOST COMPUTER APPLICATION SOFTWARE FOR SEARCHING, RETRIEVING AND ORGANIZING INFORMATION FROM DATABASES AND COMPUTER NETWORKS (U.S. CLS. 100 AND 101).

FIRST USE 2-1-2008; IN COMMERCE 2-1-2008.
NAKIA HENRY, EXAMINING ATTORNEY

SN 77-429,635. VOLVO GROUP CANADA INC., MONTRÉAL,
(QUÉBEC), CANADA, FILED 3-24-2008.

LFS ARTIC

THE MARK CONSISTS OF STANDARD CHARACTERS WITHOUT CLAIM TO ANY PARTICULAR FONT, STYLE, SIZE, OR COLOR.

OWNER OF CANADA REG. NO. TMA738417, DATED 4-21-2009, EXPIRES 4-21-2014.

OWNER OF U.S. REG. NOS. 2,699,741, 3,507,000 AND OTHERS.

NO CLAIM IS MADE TO THE EXCLUSIVE RIGHT TO USE "ARTIC", APART FROM THE MARK AS SHOWN.

SEC. 2(F) AS TO "LFS".

FOR INSPECTION OF BUSES (U.S. CLS. 100 AND 101).
KAREN K. BUSH, EXAMINING ATTORNEY

CLASS 42—(Continued).

SN 77-483,641. DLF WEBGROUP, INC., EAST SANDWICH,
MA. FILED 5-27-2008.

DLF WEBGROUP WEB STRATEGIES IN PLAIN ENGLISH

THE MARK CONSISTS OF STANDARD CHARACTERS WITHOUT CLAIM TO ANY PARTICULAR FONT, STYLE, SIZE, OR COLOR.

NO CLAIM IS MADE TO THE EXCLUSIVE RIGHT TO USE "WEB STRATEGIES", APART FROM THE MARK AS SHOWN.

SEC. 2(F) AS TO "WEBGROUP WEB STRATEGIES IN PLAIN ENGLISH".

FOR APPLICATION SERVICE PROVIDER, NAMELY, PROVIDING, HOSTING, MANAGING, DEVELOPING, AND MAINTAINING APPLICATIONS, SOFTWARE, WEB SITES, AND DATABASES IN THE FIELDS OF PERSONAL PRODUCTIVITY, WIRELESS COMMUNICATION, MOBILE INFORMATION ACCESS, AND REMOTE DATA MANAGEMENT FOR WIRELESS DELIVERY OF CONTENT TO HANDHELD COMPUTERS, LAPTOPS AND MOBILE ELECTRONIC DEVICES; APPLICATION SERVICE PROVIDER, NAMELY, PROVIDING, HOSTING, MANAGING, DEVELOPING, RESEARCHING, ANALYZING, REPORTING, AND MAINTAINING APPLICATIONS, SOFTWARE, WEB SITES, AND DATABASES OF OTHERS IN THE FIELDS OF HEALTHCARE, BENEFITS PROGRAMS, EMPLOYEE PRODUCTIVITY, RISK MANAGEMENT; CHARITABLE SERVICES, NAMELY, PROVIDING WEB SITE DESIGN FOR OTHERS; DESIGN OF HOME PAGES; DESIGN OF HOME PAGES AND WEB SITES; DESIGN OF HOME PAGES, COMPUTER SOFTWARE AND WEB SITES; DESIGN, CREATION, HOSTING AND MAINTENANCE OF INTERNET SITES FOR THIRD PARTIES; DESIGN, CREATION, HOSTING, MAINTENANCE OF WEB SITES FOR OTHERS; DEVELOPMENT, DESIGN AND UPDATING OF HOME PAGES; HOSTING OF DIGITAL CONTENT ON THE INTERNET; HOSTING OF WEB SITES; HOSTING THE WEB SITES OF OTHERS ON A COMPUTER SERVER FOR A GLOBAL COMPUTER NETWORK; WEB SITE DESIGN; WEB SITE HOSTING SERVICES (U.S. CLS. 100 AND 101).

FIRST USE 1-1-2000; IN COMMERCE 6-21-2000.
H. M. FISHER, EXAMINING ATTORNEY

SN 77-497,112. THEGREENCELL, INC., BETHESDA, MD.
FILED 6-12-2008.

THEGREENCELL

THE MARK CONSISTS OF STANDARD CHARACTERS WITHOUT CLAIM TO ANY PARTICULAR FONT, STYLE, SIZE, OR COLOR.

FOR SCIENTIFIC RESEARCH IN THE FIELD OF THE GENETIC ENGINEERING OF PLANTS (U.S. CLS. 100 AND 101).

MARILYN IZZI, EXAMINING ATTORNEY

CLASS 42—(Continued).

SN 77-497,205. THE AUTOMATION GROUP, INC., HOUSTON, TX. FILED 6-12-2008.



THE MARK CONSISTS OF THE TERM "TAG" WITHIN A CIRCLE THAT IS INSCRIBED IN A SQUARE.
 FOR DESIGN SERVICES FOR INDUSTRIAL PROCESS CONTROL SYSTEMS (U.S. CLS. 100 AND 101).
 FIRST USE 3-1-1996; IN COMMERCE 3-1-1996.
 STEPHEN AQUILA, EXAMINING ATTORNEY

CLASS 42—(Continued).

IN THE FIELD OF DESIGN, SELECTION, IMPLEMENTATION AND USE OF COMPUTER HARDWARE AND SOFTWARE SYSTEMS FOR OTHERS; CREATION AND MAINTENANCE OF WEB SITES FOR OTHERS; CUSTOMIZED SOFTWARE DEVELOPMENT SERVICES; DESIGN AND DEVELOPMENT OF ON-LINE COMPUTER SOFTWARE SYSTEMS; DESIGN, DEVELOPMENT AND IMPLEMENTATION OF SOFTWARE; DESIGNING AND DEVELOPING WEBPAGES ON THE INTERNET; DEVELOPMENT AND CREATION OF COMPUTER PROGRAMMES FOR DATA PROCESSING; DEVELOPMENT, UPDATING AND MAINTENANCE OF SOFTWARE AND DATA BASES; INFORMATION TECHNOLOGY CONSULTATION; MAINTENANCE OF COMPUTER SOFTWARE; SOFTWARE DESIGN AND DEVELOPMENT; UPDATING OF COMPUTER SOFTWARE FOR OTHERS; WEB SITE DEVELOPMENT FOR OTHERS; EXCLUDING ALL OF THE AFORESAID SERVICES IN THE FIELD OF ALARM, LOCKING, AND SURVEILLANCE SYSTEMS FOR BUILDINGS AND VEHICLES (U.S. CLS. 100 AND 101).
 FIRST USE 6-1-1997; IN COMMERCE 6-1-1997.
 SUE LAWRENCE, EXAMINING ATTORNEY

SN 77-526,433. IT WORX, INC., FARMINGTON, CT. FILED 7-18-2008.

ITWORX

THE MARK CONSISTS OF STANDARD CHARACTERS WITHOUT CLAIM TO ANY PARTICULAR FONT, STYLE, SIZE, OR COLOR.
 OWNER OF U.S. REG. NO. 2,671,503.
 FOR ADVISORY SERVICES IN THE FIELD OF PRODUCT DEVELOPMENT AND QUALITY IMPROVEMENT OF SOFTWARE; COMPUTER CODE CONVERSION FOR OTHERS; COMPUTER COMPATIBILITY SERVICES, NAMELY, DATA MAPPING; COMPUTER CONSULTATION; COMPUTER PROGRAMMING AND COMPUTER SYSTEM ANALYSIS; COMPUTER PROGRAMMING AND MAINTENANCE OF COMPUTER PROGRAMS; COMPUTER PROGRAMMING AND SOFTWARE DESIGN; COMPUTER PROGRAMMING FOR OTHERS; COMPUTER SERVICES, NAMELY, CREATING AND MAINTAINING WEB SITES FOR OTHERS; COMPUTER SERVICES, NAMELY, CREATING INDEXES OF INFORMATION, SITES AND OTHER RESOURCES AVAILABLE ON COMPUTER NETWORKS; COMPUTER SERVICES, NAMELY, DESIGNING AND IMPLEMENTING NETWORK WEB PAGES FOR OTHERS; COMPUTER SERVICES, NAMELY, DESIGNING AND IMPLEMENTING WEB SITES FOR OTHERS; COMPUTER SOFTWARE CONSULTANCY; COMPUTER SOFTWARE DESIGN FOR OTHERS; COMPUTER SOFTWARE DESIGN, COMPUTER PROGRAMMING, OR MAINTENANCE OF COMPUTER SOFTWARE; COMPUTER SOFTWARE DEVELOPMENT AND COMPUTER PROGRAMMING DEVELOPMENT FOR OTHERS; COMPUTER SYSTEMS ANALYSIS; CONSULTING IN THE FIELD OF INFORMATION TECHNOLOGY; CONSULTING SERVICES IN THE FIELD OF COMPUTER-BASED INFORMATION SYSTEMS FOR BUSINESSES; CONSULTING SERVICES

SN 77-528,891. SOFTWARE DIMENSIONS CONSULTING AND TRAINING, INC., DBA INTERNATIONAL INSTITUTE FOR SOFTWARE PROCESS, GOLDEN VALLEY, MN. FILED 7-22-2008.

Bug Free Zone

THE MARK CONSISTS OF STANDARD CHARACTERS WITHOUT CLAIM TO ANY PARTICULAR FONT, STYLE, SIZE, OR COLOR.
 SEC. 2(F).
 FOR HOSTING AN ON-LINE COMMUNITY WEB SITE FEATURING INFORMATION ON SOFTWARE ENGINEERING, TESTING, AND MANAGEMENT (U.S. CLS. 100 AND 101).
 FIRST USE 8-15-2001; IN COMMERCE 8-15-2001.
 JENNIFER MARTIN, EXAMINING ATTORNEY

CLASS 42—(Continued).

SN 77-541,613. LULU ENTERPRISES, INC., MORRISVILLE, NC. FILED 8-7-2008.



NO CLAIM IS MADE TO THE EXCLUSIVE RIGHT TO USE "BOOK", APART FROM THE MARK AS SHOWN.

THE MARK CONSISTS OF THE STYLIZED DEPICTION OF THREE BOOKS TO THE LEFT OF THE WORDING "WEREAD THE SOCIAL BOOK DISCOVER REVOLUTION" WHICH APPEARS IN STYLIZED FONT.

FOR COMPUTER SERVICES, NAMELY, CREATING AN ONLINE COMMUNITY FOR USERS TO PARTICIPATE IN DISCUSSIONS, FORM VIRTUAL COMMUNITIES, AND ENGAGE IN SOCIAL NETWORKING REGARDING BOOKS, MUSIC, MOVIES, PERIODICALS AND OTHER MEDIA; HOSTING ON-LINE WEB FACILITIES FOR OTHERS FOR ORGANIZING AND CONDUCTING ONLINE MEETINGS, GATHERINGS, AND INTERACTIVE DISCUSSIONS REGARDING BOOKS, MUSIC, MOVIES, PERIODICALS AND OTHER MEDIA; PROVIDING ONLINE NONDOWNLOADABLE SOFTWARE AND ONLINE TOOLS FOR USE IN ALLOWING USERS TO OBTAIN ACCESS AND TO EMBED ONLINE TOOLS AND INFORMATION RELATING TO BOOKS, MUSIC, MOVIES, PERIODICALS AND OTHER MEDIA INTO THEIR BLOGS, WEBSITES, ONLINE SERVICES, AND OTHER APPLICATIONS AND DEVICES (U.S. CLS. 100 AND 101).

JULIE WATSON, EXAMINING ATTORNEY

SN 77-541,665. LULU ENTERPRISES, INC., MORRISVILLE, NC. FILED 8-7-2008.

weRead

THE MARK CONSISTS OF THE WORDING "WEREAD" WITH ALL BUT THE LETTER "R" APPEARING IN LOWER CASE LETTERS AND THE LETTER "R" APPEARING IN UPPER CASE.

FOR COMPUTER SERVICES, NAMELY, CREATING AN ONLINE COMMUNITY FOR USERS TO PARTICIPATE IN DISCUSSIONS, FORM VIRTUAL COMMUNITIES, AND ENGAGE IN SOCIAL NETWORKING REGARDING BOOKS, MUSIC, MOVIES, PERIODICALS AND OTHER MEDIA; HOSTING ON-LINE WEB FACILITIES FOR OTHERS FOR ORGANIZING AND CONDUCTING ONLINE MEETINGS, GATHERINGS, AND INTERACTIVE DISCUSSIONS REGARDING BOOKS, MUSIC, MOVIES, PERIODICALS AND OTHER MEDIA; PROVIDING ONLINE NONDOWNLOADABLE SOFTWARE AND ONLINE TOOLS FOR USE IN ALLOWING USERS TO OBTAIN ACCESS AND TO EMBED ONLINE TOOLS AND INFORMATION RELATING TO BOOKS, MUSIC, MOVIES, PERIODICALS AND OTHER MEDIA INTO THEIR BLOGS, WEBSITES, ONLINE SERVICES, AND OTHER APPLICATIONS AND DEVICES (U.S. CLS. 100 AND 101).

JULIE WATSON, EXAMINING ATTORNEY

CLASS 42—(Continued).

SN 77-541,715. LULU ENTERPRISES, INC., MORRISVILLE, NC. FILED 8-7-2008.

WEREAD

THE MARK CONSISTS OF STANDARD CHARACTERS WITHOUT CLAIM TO ANY PARTICULAR FONT, STYLE, SIZE, OR COLOR.

FOR COMPUTER SERVICES, NAMELY, CREATING AN ONLINE COMMUNITY FOR USERS TO PARTICIPATE IN DISCUSSIONS, FORM VIRTUAL COMMUNITIES, AND ENGAGE IN SOCIAL NETWORKING REGARDING BOOKS, MUSIC, MOVIES, PERIODICALS AND OTHER MEDIA; HOSTING ON-LINE WEB FACILITIES FOR OTHERS FOR ORGANIZING AND CONDUCTING ONLINE MEETINGS, GATHERINGS, AND INTERACTIVE DISCUSSIONS REGARDING BOOKS, MUSIC, MOVIES, PERIODICALS AND OTHER MEDIA; PROVIDING ONLINE NONDOWNLOADABLE SOFTWARE AND ONLINE TOOLS FOR USE IN ALLOWING USERS TO OBTAIN ACCESS AND TO EMBED ONLINE TOOLS AND INFORMATION RELATING TO BOOKS, MUSIC, MOVIES, PERIODICALS AND OTHER MEDIA INTO THEIR BLOGS, WEBSITES, ONLINE SERVICES, AND OTHER APPLICATIONS AND DEVICES (U.S. CLS. 100 AND 101).

JULIE WATSON, EXAMINING ATTORNEY

SN 77-553,134. DHARMA HOLDING COMPANY, SPRING LAKE, NJ. FILED 8-21-2008.

uFundraiser.com

THE MARK CONSISTS OF STANDARD CHARACTERS WITHOUT CLAIM TO ANY PARTICULAR FONT, STYLE, SIZE, OR COLOR.

FOR PROVIDING TEMPORARY USE OF ONLINE NON-DOWNLOADABLE SOFTWARE TOOLS TO SOLICIT AND COLLECT MONEY FOR ANY PURPOSE (U.S. CLS. 100 AND 101).

WILLIAM P. SHANAHAN, EXAMINING ATTORNEY

CLASS 42—(Continued).

SN 77-568,336. QC INC, LINCOLN, NE. FILED 9-11-2008.



NO CLAIM IS MADE TO THE EXCLUSIVE RIGHT TO USE "COMPUTER SERVICES", APART FROM THE MARK AS SHOWN.

THE MARK CONSISTS OF ARCHED "QUICK CONNECT" WITH "COMPUTER SERVICES WWW.HELPMYPC.COM" CONTAINED IN A BOX.

FOR COMPUTER CONSULTATION; COMPUTER NETWORK DESIGN FOR OTHERS; COMPUTER SERVICES, NAMELY, MONITORING AND REPORTING ON THE PERFORMANCE, AVAILABILITY, AND ERRORS OF WEB SITES OF OTHERS; COMPUTER SERVICES, NAMELY, CREATING AND MAINTAINING WEB SITES FOR OTHERS; COMPUTER SERVICES, NAMELY, DESIGNING AND IMPLEMENTING NETWORK WEB PAGES FOR OTHERS; COMPUTER SERVICES, NAMELY, DESIGNING AND IMPLEMENTING WEB SITES FOR OTHERS; COMPUTER SERVICES, NAMELY, HOSTING OF INSPECTION, TESTING, AND QUALITY CONTROL SERVICES' DIGITAL CONTENT OF OTHERS; COMPUTER SERVICES, NAMELY, MANAGING WEB SITES FOR OTHERS; COMPUTER SERVICES, NAMELY, MONITORING THE WEB SITES OF OTHERS TO IMPROVE SCALABILITY AND PERFORMANCE OF WEB SITES OF OTHERS; COMPUTER SERVICES, NAMELY, MONITORING, TESTING, ANALYZING, AND REPORTING ON THE INTERNET TRAFFIC CONTROL AND CONTENT CONTROL OF THE WEB SITES OF OTHERS; COMPUTER TECHNOLOGY SUPPORT SERVICES, NAMELY, HELP DESK SERVICES; CONSULTATION SERVICES IN THE FIELDS OF SELECTION, IMPLEMENTATION AND USE OF COMPUTER HARDWARE AND SOFTWARE SYSTEMS FOR OTHERS; CONSULTING SERVICES IN THE FIELD OF DESIGN, SELECTION, IMPLEMENTATION AND USE OF COMPUTER HARDWARE AND SOFTWARE SYSTEMS FOR OTHERS; CREATING OR MAINTAINING WEB SITES FOR OTHERS; CREATING, DESIGNING AND MAINTAINING WEB SITES; CREATION AND MAINTENANCE OF WEB SITES FOR OTHERS; DESIGN AND DEVELOPMENT OF NETWORKS; DESIGN AND DEVELOPMENT OF WIRELESS COMPUTER NETWORKS; DESIGN, CREATION, HOSTING, MAINTENANCE OF WEB SITES FOR OTHERS; HOSTING THE WEB SITES OF OTHERS ON A COMPUTER SERVER FOR A GLOBAL COMPUTER NETWORK; INSTALLATION, MAINTENANCE AND REPAIR OF COMPUTER SOFTWARE; INTEGRATION OF COMPUTER SYSTEMS AND NETWORKS; IT CONSULTING SERVICES; IT INTEGRATION SERVICES; MAINTENANCE OF COMPUTER SOFTWARE; PLANNING, DEVELOPMENT AND TECHNICAL SUPPORT OF ELECTRONIC COMMUNICATIONS NETWORKS; PROVIDING PLANNING AND ENGINEERING SERVICES IN THE FIELD OF INFORMATION AND COMMUNICATIONS NETWORKS; REPAIR OF COMPUTER SOFTWARE; REPAIR OF DAMAGED COMPUTER PROGRAMS; TECHNICAL SUPPORT SERVICES, NAMELY, TROUBLESHOOTING OF COMPUTER HARDWARE AND SOFTWARE PROBLEMS; TECHNICAL SUPPORT SERVICES, NAMELY, TROUBLESHOOTING OF COMPUTER SOFTWARE PROBLEMS; TECHNICAL SUPPORT, NAMELY, MONITORING OF NETWORK SYSTEMS; WEB SITE DESIGN; WEB SITE DEVELOPMENT FOR OTHERS; WEB SITE HOSTING SERVICES (U.S. CLS. 100 AND 101).

FIRST USE 8-31-2005; IN COMMERCE 8-31-2005.

GINA FINK, EXAMINING ATTORNEY

CLASS 42—(Continued).

SN 77-577,311. GROOPSY, RIVIERA BEACH, FL. FILED 9-24-2008.

GROOPSY

THE MARK CONSISTS OF STANDARD CHARACTERS WITHOUT CLAIM TO ANY PARTICULAR FONT, STYLE, SIZE, OR COLOR.

FOR COMPUTER SERVICES IN THE NATURE OF CUSTOMIZED WEB PAGES FEATURING USER-DEFINED INFORMATION, PERSONAL PROFILES AND INFORMATION; COMPUTER SERVICES, NAMELY, CREATING AN ON-LINE COMMUNITY FOR REGISTERED USERS TO PARTICIPATE IN DISCUSSIONS, GET FEEDBACK FROM THEIR PEERS, FORM VIRTUAL COMMUNITIES, AND ENGAGE IN SOCIAL NETWORKING; COMPUTER SERVICES, NAMELY, HOSTING AND MAINTAINING AN ON-LINE WEB SITE FOR OTHERS TO CREATE A PERSONAL PROFILE WEB PAGE AND OR GROUP WEB PAGE THAT ENABLES USERS TO JOIN AN ON-LINE INTEREST BASED SOCIAL NETWORK AND ALLOW REGISTERED USERS TO USE CHAT ROOMS AND ELECTRONIC BULLETIN BOARDS FOR TRANSMISSION OF MESSAGES AMONG USERS IN THE FIELD OF GENERAL INTEREST (U.S. CLS. 100 AND 101).

FIRST USE 8-23-2008; IN COMMERCE 9-11-2008.

WILLIAM ROSSMAN, EXAMINING ATTORNEY

SN 77-577,596. TECHPUBS, INC., BOULDER, CO. FILED 9-24-2008.

TECHPUBS

THE MARK CONSISTS OF STANDARD CHARACTERS WITHOUT CLAIM TO ANY PARTICULAR FONT, STYLE, SIZE, OR COLOR.

FOR SERVICES OF A SOFTWARE COMPANY FOR THE AVIATION INDUSTRY, NAMELY, COMPUTER SOFTWARE CONSULTING, DESIGN OF COMPUTER SOFTWARE, COMPUTER SOFTWARE CUSTOMIZATION, CREATION OF WEBSITES FOR OTHERS, COMPUTER PROGRAMMING, UPDATING OF COMPUTER SOFTWARE, CONVERSION OF PRINTED AND ELECTRONIC MATTER FROM PHYSICAL TO DIFFERENT FORMATS OF ELECTRONIC MEDIA, TECHNICAL SUPPORT SERVICES, NAMELY, TROUBLESHOOTING OF COMPUTER SOFTWARE PROBLEMS, INSTALLATION OF COMPUTER SOFTWARE, APPLICATION SERVICE PROVIDER (ASP), NAMELY, HOSTING OF SOFTWARE APPLICATIONS FOR OTHERS IN THE AVIATION INDUSTRY (U.S. CLS. 100 AND 101).

AISHA SALEM, EXAMINING ATTORNEY

CLASS 42—(Continued).

SN 77-577,752. TECHS IN A SEC, NEW YORK, NY. FILED 9-24-2008.

CALL A TECH, NOT A GEEK

THE MARK CONSISTS OF STANDARD CHARACTERS WITHOUT CLAIM TO ANY PARTICULAR FONT, STYLE, SIZE, OR COLOR.

FOR INSTALLATION, MAINTENANCE AND REPAIR OF COMPUTER SOFTWARE (U.S. CLS. 100 AND 101).

FIRST USE 4-1-2005; IN COMMERCE 4-1-2005.
SOPHIA S. KIM, EXAMINING ATTORNEY

SN 77-578,120. TECHPUBS, INC., BOULDER, CO. FILED 9-24-2008.

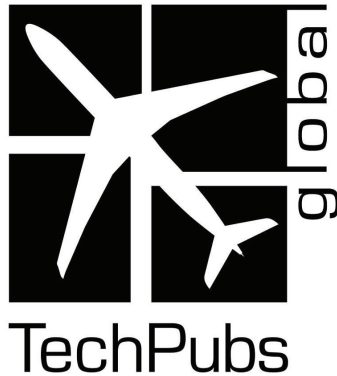

NO CLAIM IS MADE TO THE EXCLUSIVE RIGHT TO USE "GLOBAL", APART FROM THE MARK AS SHOWN.

THE MARK CONSISTS OF FOUR SHADED SQUARES WITH A SILHOUETTE OF AN AIRPLANE IN THE MIDDLE OF THE SQUARES. THE WORD "TECHPUBS" IS UNDERNEATH THE SQUARES AND THE WORD "GLOBAL" IS ON THE RIGHT SIDE OF THE SQUARES.

FOR SERVICES OF A SOFTWARE COMPANY FOR THE AVIATION INDUSTRY, NAMELY, COMPUTER SOFTWARE CONSULTING, DESIGN OF COMPUTER SOFTWARE, COMPUTER SOFTWARE CUSTOMIZATION, CREATION OF WEBSITES FOR OTHERS, COMPUTER PROGRAMMING, UPDATING OF COMPUTER SOFTWARE, CONVERSION OF PRINTED AND ELECTRONIC MATTER FROM PHYSICAL TO DIFFERENT FORMATS OF ELECTRONIC MEDIA, TECHNICAL SUPPORT SERVICES, NAMELY, TROUBLESHOOTING OF COMPUTER SOFTWARE PROBLEMS, INSTALLATION OF COMPUTER SOFTWARE, APPLICATION SERVICE PROVIDER (ASP), NAMELY, HOSTING OF SOFTWARE APPLICATIONS FOR OTHERS IN THE AVIATION INDUSTRY (U.S. CLS. 100 AND 101).

AISHA SALEM, EXAMINING ATTORNEY

CLASS 42—(Continued).

SN 77-588,669. WALKER, DAVID, NEW YORK, NY. AND JOSEPHSEN, LISA, NEW YORK CITY, NY. FILED 10-8-2008.

Ecotone

THE MARK CONSISTS OF STANDARD CHARACTERS WITHOUT CLAIM TO ANY PARTICULAR FONT, STYLE, SIZE, OR COLOR.

FOR GRAPHIC DESIGN AND DEVELOPMENT; WEB DESIGN AND DEVELOPMENT; STATIONERY DESIGN; GRAPHIC ILLUSTRATION SERVICES FOR OTHERS (U.S. CLS. 100 AND 101).

JEFF DEFORD, EXAMINING ATTORNEY

SN 77-589,666. HOTPIER.COM CORPORATION, LA PORTE, IN. FILED 10-9-2008.

hotpier.com

THE MARK CONSISTS OF STANDARD CHARACTERS WITHOUT CLAIM TO ANY PARTICULAR FONT, STYLE, SIZE, OR COLOR.

FOR COMPUTER PROGRAMMING SERVICES (U.S. CLS. 100 AND 101).

RUSS HERMAN, EXAMINING ATTORNEY

SN 77-591,180. PASTERIS ENERGY, INC., YARDLEY, PA. FILED 10-13-2008.



NO CLAIM IS MADE TO THE EXCLUSIVE RIGHT TO USE "ENERGY INC.", APART FROM THE MARK AS SHOWN.

THE MARK CONSISTS OF THREE DIRECTIONAL ARROWS FOLLOWED BY THE WORDS "PASTERIS ENERGY INC.". THE FIRST ARROW IS ON TOP OF THE OTHER TWO ARROWS, AND IS POINTING TO THE RIGHT. THE SECOND ARROW IS BENEATH THE FIRST AND ABOVE THE THIRD, AND POINTS TO THE LEFT. THE THIRD ARROW IS ON THE BOTTOM, AND POINTS TO THE RIGHT.

FOR ENGINEERING AND TECHNICAL CONSULTING IN THE FIELDS OF ENERGY SYSTEM PLANNING, POWER PROJECT DEVELOPMENT, COMBINED HEAT AND POWER PROJECT DEVELOPMENT, DISTRIBUTED GENERATION PROJECT DEVELOPMENT, AND SOLAR AND RENEWABLE ENERGY PROJECT DEVELOPMENT, NAMELY, PROJECT FEASIBILITY ANALYSIS, ANALYSIS OF HEAT AND MATERIAL BALANCES, AND GAS TURBINE INLET AIR COOLING EVALUATIONS (U.S. CLS. 100 AND 101).

FIRST USE 10-1-2006; IN COMMERCE 10-1-2006.

JAMES GRIFFIN, EXAMINING ATTORNEY

CLASS 42—(Continued).

SN 77-594,311. CITYTECH, INC., CHICAGO, IL. FILED 10-16-2008.

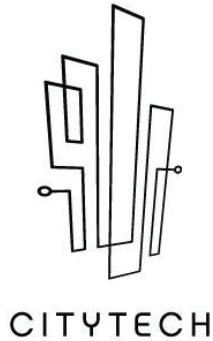

THE MARK CONSISTS OF A SKYLINE IN COMPUTER CIRCUIT FORM ABOVE THE COMPANY SERVICE MARK "CITYTECH".

FOR INFORMATION TECHNOLOGY CONSULTING SERVICES, NAMELY, CONSULTING, DESIGN, AND COMPUTER PROGRAMMING IN THE AREAS OF ENTERPRISE CONTENT MANAGEMENT, ENTERPRISE PORTALS, SERVICES ORIENTED ARCHITECTURE AND MOBILE APPLICATIONS (U.S. CLS. 100 AND 101).

FIRST USE 6-11-2008; IN COMMERCE 6-11-2008.
WILLIAM P. SHANAHAN, EXAMINING ATTORNEY

CLASS 42—(Continued).

SN 77-597,413. OPTIONSXPRESS HOLDINGS, INC., CHICAGO, IL. FILED 10-21-2008.

TQ

THE MARK CONSISTS OF STANDARD CHARACTERS WITHOUT CLAIM TO ANY PARTICULAR FONT, STYLE, SIZE, OR COLOR.

FOR APPLICATION SERVICE PROVIDER (ASP) FEATURING SOFTWARE FOR USE IN TRADING SECURITIES AND COMMODITIES FOR FINANCIAL AND INVESTING SERVICES (U.S. CLS. 100 AND 101).

FIRST USE 10-20-2008; IN COMMERCE 10-20-2008.
SETH A. RAPPAPORT, EXAMINING ATTORNEY

SN 77-598,246. SEVEN WEB HOLDINGS, S.A. DE C.V., MEXICO, MEXICO, FILED 10-22-2008.

SYMPOSIER

THE MARK CONSISTS OF STANDARD CHARACTERS WITHOUT CLAIM TO ANY PARTICULAR FONT, STYLE, SIZE, OR COLOR.

THE ENGLISH TRANSLATION OF "SYMPOSIER" IN THE MARK IS "SYMPOSIA".

FOR TECHNOLOGICAL SERVICES IN THE FIELD OF COMPUTERS CONSISTING OF CONSULTING IN MATTERS REGARDING INFORMATION TECHNOLOGY, DESIGN, IMPLEMENTATION, DEVELOPMENT, MAINTENANCE AND UPDATING OF COMPUTER SYSTEM PROGRAMS; HOSTING AND MAINTENANCE OF INTERNET SITES FOR THIRD PARTIES; PROVIDING A WEBSITE FEATURING TEMPORARY USE OF NON-DOWNLOADABLE SOFTWARE ALLOWING WEB SITE USERS TO UPLOAD, POST AND DISPLAY ONLINE VIDEOS FOR SHARING WITH OTHERS FOR ENTERTAINMENT PURPOSES AND HOSTING AN ONLINE WEBSITE WHICH ALLOWS WEB SITE USERS TO UPLOAD, POST AND DISPLAY ONLINE VIDEOS FOR SHARING WITH OTHERS FOR ENTERTAINMENT PURPOSES; TECHNICAL SUPPORT SERVICES, NAMELY, TROUBLESHOOTING OF COMPUTER HARDWARE AND SOFTWARE PROBLEMS; RENTAL OF COMPUTER SOFTWARE SYSTEMS; HOSTING AN ONLINE WEBSITE FEATURING USE OF NON-DOWNLOADABLE SOFTWARE PROGRAMS FOR ENTERTAINMENT AND EDUCATIONAL PURPOSES; APPLICATION SERVICE PROVIDER (ASP), NAMELY, HOSTING COMPUTER SOFTWARE APPLICATIONS OF OTHERS (U.S. CLS. 100 AND 101).

DOUGLAS LEE, EXAMINING ATTORNEY

SN 77-596,687. PERFORMANCE DYNAMICS, INC., MUNCIE, IN. FILED 10-21-2008.

THERAPYVIEW

THE MARK CONSISTS OF STANDARD CHARACTERS WITHOUT CLAIM TO ANY PARTICULAR FONT, STYLE, SIZE, OR COLOR.

FOR PROVIDING TEMPORARY USE OF NON-DOWNLOADABLE SOFTWARE FOR RECORD KEEPING AND REPORTING REGARDING THERAPY TREATMENT AND HISTORY OF THERAPY (U.S. CLS. 100 AND 101).

MICHELE SWAIN, EXAMINING ATTORNEY

CLASS 42—(Continued).

SN 77-600,071. NAL PHARMA LTD, TORTOLA, BR.VIRGIN ISLANDS, FILED 10-24-2008.



NO CLAIM IS MADE TO THE EXCLUSIVE RIGHT TO USE "PHARMA", APART FROM THE MARK AS SHOWN.

THE MARK CONSISTS OF AN ILLUSTRATION OF AN ATOMIC MODEL ON THE LEFT SEPARATED BY VERTICAL LINE WITH THE WORDS "NAL" OVER THE WORD "PHARMA" TO THE RIGHT OF THE VERTICAL LINE.

FOR RESEARCH AND DEVELOPMENT OF PHARMACEUTICAL PREPARATIONS FOR USE IN PAIN CONTROL, ARTHRITIS, MIGRAINE, ONCOLOGY, UROLOGY, ASTHMA, CHRONIC OBSTRUCTIVE PULMONARY DISEASE (COPD), CARDIOVASCULAR DISEASES, NAUSEA, VOMITING, WOUND HEALING AND PHARMACEUTICAL EYE PRODUCTS FOR THE TREATMENT OF OCULAR IRRITATION, DRY EYE, ALLERGY AND GLAUCOMA (U.S. CLS. 100 AND 101).
FIRST USE 1-7-2008; IN COMMERCE 1-24-2008.

DAVID I, EXAMINING ATTORNEY

CLASS 42—(Continued).

SN 77-600,529. GIGASAVVY, CHINO HILLS, CA. FILED 10-24-2008.



THE MARK CONSISTS OF THE LETTER "G" AT A 45 DEGREE ANGLE WITH TWO DOTS ALONG THE FLAT SIDE OF THE "G" UNDER THE LETTER IS THE WORD "GIGASAVVY".

FOR COMPUTER NETWORK DESIGN FOR OTHERS; CONSULTATION RELATING TO INSTALLATION, MAINTENANCE AND REPAIR OF COMPUTER SOFTWARE (U.S. CLS. 100 AND 101).

CHRISTINA SOBRAL, EXAMINING ATTORNEY

SN 77-600,532. GIGASAVVY, CHINO HILLS, CA. FILED 10-24-2008.



THE MARK CONSISTS OF STANDARD CHARACTERS WITHOUT CLAIM TO ANY PARTICULAR FONT, STYLE, SIZE, OR COLOR.

FOR COMPUTER NETWORK DESIGN FOR OTHERS; CONSULTATION RELATING TO INSTALLATION, MAINTENANCE AND REPAIR OF COMPUTER SOFTWARE (U.S. CLS. 100 AND 101).

CHRISTINA SOBRAL, EXAMINING ATTORNEY

SN 77-600,521. GIGASAVVY, CHINO HILLS, CA. FILED 10-24-2008.



SN 77-607,088. SOFTLAYER TECHNOLOGIES, INC., PLANO, TX. FILED 11-4-2008.



THE MARK CONSISTS OF STANDARD CHARACTERS WITHOUT CLAIM TO ANY PARTICULAR FONT, STYLE, SIZE, OR COLOR.

FOR COMPUTER SERVICES, NAMELY, DATA RECOVERY, DATA RESTORATION, REPAIR OF DAMAGED COMPUTER PROGRAMS AND SOFTWARE, AND CONSULTING SERVICES IN THE FIELD OF DATA LOSS PREVENTION DUE TO SERVER CRASHES, FAILURE OR DAMAGE (U.S. CLS. 100 AND 101).
FIRST USE 9-24-2007; IN COMMERCE 9-24-2007.

JENNIFER HETU, EXAMINING ATTORNEY

THE MARK CONSISTS OF THE LETTER "G" AT A 45 DEGREE ANGLE WITH TWO DOTS ALONG THE FLAT SIDE OF THE "G".

FOR COMPUTER NETWORK DESIGN FOR OTHERS; CONSULTATION RELATING TO INSTALLATION, MAINTENANCE AND REPAIR OF COMPUTER SOFTWARE (U.S. CLS. 100 AND 101).

CHRISTINA SOBRAL, EXAMINING ATTORNEY

CLASS 42—(Continued).

SN 77-609,948. WEALTH GROUP SOFTWARE, L.L.C., NAPERVILLE, IL. FILED 11-7-2008.

Wealth Group Software, LLC

NO CLAIM IS MADE TO THE EXCLUSIVE RIGHT TO USE "WEALTH" AND "SOFTWARE, LLC", APART FROM THE MARK AS SHOWN.

THE MARK CONSISTS OF "WEALTH GROUP SOFTWARE, LLC" IN STYLIZED LETTERS.

FOR PROVIDING ONLINE NON-DOWNLOADABLE COMPUTER SOFTWARE FOR ANALYZING INVESTMENT DATA (U.S. CLS. 100 AND 101).

KAREN K. BUSH, EXAMINING ATTORNEY

CLASS 42—(Continued).

SN 77-613,453. AJINOMOTO CO., INC., CHUO-KU, TOKYO, JAPAN, FILED 11-13-2008.

CORYNEX

THE MARK CONSISTS OF STANDARD CHARACTERS WITHOUT CLAIM TO ANY PARTICULAR FONT, STYLE, SIZE, OR COLOR.

OWNER OF U.S. REG. NO. 3,556,696.

FOR SCIENTIFIC RESEARCH, NAMELY, STRAIN DEVELOPMENT OR CONSTRUCTION OF CELLS WHICH EXPRESSES PEPTIDES AND PROTEINS, FOR THIRD PARTIES; LABORATORY, PILOT PLANT OR COMMERCIAL PRODUCTION SCALE PROCESS DESIGN OF THE FERMENTATION OR MANUFACTURING OF PEPTIDES AND PROTEINS FOR THIRD PARTIES; PROTEIN CHARACTERIZATION FOR THIRD PARTIES; ANALYSIS SERVICES CONCERNING THE EXPRESSION OR FERMENTATION OF PEPTIDE OR PROTEINS FOR THIRD PARTIES; ANALYSIS SERVICE RELATING TO THE PROCESS DESIGN AND MANUFACTURING OF PEPTIDES AND PROTEINS BY MEANS OF FERMENTATION FOR THIRD PARTIES (U.S. CLS. 100 AND 101).

VIVIAN MICZNIK FIRST, EXAMINING ATTORNEY

SN 77-616,082. FREE, VAL, CHICAGO, IL. FILED 11-17-2008.

Gene... Envy

THE MARK CONSISTS OF STANDARD CHARACTERS WITHOUT CLAIM TO ANY PARTICULAR FONT, STYLE, SIZE, OR COLOR.

FOR DESIGN FOR OTHERS IN THE FIELD OF CLOTHING (U.S. CLS. 100 AND 101).

FIRST USE 5-5-2005; IN COMMERCE 5-5-2005.

BARBARA GAYNOR, EXAMINING ATTORNEY

SN 77-610,999. OPTIONSPRESS HOLDINGS, INC., CHICAGO, IL. FILED 11-10-2008.

SYMPHONY ADVISERS

THE MARK CONSISTS OF STANDARD CHARACTERS WITHOUT CLAIM TO ANY PARTICULAR FONT, STYLE, SIZE, OR COLOR.

NO CLAIM IS MADE TO THE EXCLUSIVE RIGHT TO USE "ADVISERS", APART FROM THE MARK AS SHOWN.

FOR APPLICATION SERVICE PROVIDER (ASP) FEATURING SOFTWARE FOR USE IN TRADING SECURITIES AND COMMODITIES FOR FINANCIAL AND INVESTING SERVICES (U.S. CLS. 100 AND 101).

SETH A. RAPPAPORT, EXAMINING ATTORNEY

SN 77-619,585. TERAVIDA SYSTEMS, LLC, KIRKWOOD, MO. FILED 11-21-2008.

climatesuite

THE MARK CONSISTS OF THE WORD "CLIMATE-SUITE" WITH THE "CLIMATE" PORTION IN BOLD TYPEFACE AND THE "SUITE" PORTION IN REGULAR TYPEFACE, ALL LOWER-CASE, FOLLOWED BY A CIRCULAR DESIGN.

FOR PROVIDING ONLINE NON-DOWNLOADABLE COMPUTER SOFTWARE FOR PROJECT PORTFOLIO MANAGEMENT TO CONTROL THE WORK FLOW OF EMERGING CARBON DIOXIDE COMMODITIES (U.S. CLS. 100 AND 101).

FIRST USE 6-1-2008; IN COMMERCE 6-1-2008.

JASON BLAIR, EXAMINING ATTORNEY

CLASS 42—(Continued).

SN 77-624,268. AVINEURO PHARMACEUTICALS, INC., SAN DIEGO, CA. FILED 12-1-2008.

AVINEURO

THE MARK CONSISTS OF STANDARD CHARACTERS WITHOUT CLAIM TO ANY PARTICULAR FONT, STYLE, SIZE, OR COLOR.

THE NAME(S), PORTRAIT(S), AND/OR SIGNATURE(S) SHOWN IN THE MARK DOES NOT IDENTIFY A PARTICULAR LIVING INDIVIDUAL.

THE WORDING "AVINEURO" HAS NO MEANING IN A FOREIGN LANGUAGE.

FOR DEVELOPMENT OF NEW TECHNOLOGY FOR OTHERS IN THE FIELDS OF GENOMICS AND BIOTECHNOLOGY; PHARMACEUTICAL DRUG DEVELOPMENT SERVICES, PHARMACEUTICAL RESEARCH AND DEVELOPMENT, PHARMACEUTICAL RESEARCH SERVICES, COMPILING DATA FOR RESEARCH PURPOSES IN THE FIELD OF MEDICAL SCIENCE AND MEDICAL CONSULTANCY, DEVELOPMENT OF PHARMACEUTICAL PREPARATIONS AND MEDICINES (U.S. CLS. 100 AND 101).

FIRST USE 7-23-2008; IN COMMERCE 11-3-2008.
JERI J. FICKES, EXAMINING ATTORNEY

SN 77-625,941. VEGAS.COM, LLC, HENDERSON, NV. FILED 12-3-2008.



THE MARK CONSISTS OF A FIGURE RESEMBLING A HEXAGON SURROUNDED BY THREE PARTIAL HEXAGONS TO THE LEFT OF THE TEXT "CYLLENIUS".

FOR DESIGN, DEVELOPMENT AND MAINTENANCE OF COMPUTER SOFTWARE; DESIGN, DEVELOPMENT AND MAINTENANCE OF COMPUTER SOFTWARE FOR ONSITE TICKETING, ACCESS CONTROL, ELECTRONIC IDENTIFICATION, CONTROLLED SPENDING, CONTACT MANAGEMENT, ECOMMERCE SHOPPING CARTS, CALL CENTERS, CUSTOMER SERVICE, CONCIERGE SERVICES, CASHLESS PAYMENT PROCESSING, MARKETING AND PROMOTIONS AND SEARCH, PURCHASE AND PROVISION OF INFORMATION REGARDING HOSPITALITY, TRAVEL AND ENTERTAINMENT-RELATED SERVICES AND MERCHANDISE; DESIGN, DEVELOPMENT AND MAINTENANCE OF COMPUTER SOFTWARE FOR USE IN CONNECTION WITH KEYLESS ENTRY, ACCESS CONTROL DEVICES, POINT OF SALE SYSTEMS, VENDING, ARCADES, RADIO-FREQUENCY IDENTIFICATION (RFID) DEVICES, MOBILE ELECTRONIC DEVICES AND COMPUTERS CONNECTED TO THE INTERNET (U.S. CLS. 100 AND 101).

FIRST USE 10-22-2007; IN COMMERCE 10-22-2007.
MATTHEW KLINE, EXAMINING ATTORNEY

CLASS 42—(Continued).

SN 77-630,740. MEDIA MARSHAL NETWORKS, INC., ROANOKE, VA. FILED 12-10-2008.

Media Marshal

THE MARK CONSISTS OF STANDARD CHARACTERS WITHOUT CLAIM TO ANY PARTICULAR FONT, STYLE, SIZE, OR COLOR.

NO CLAIM IS MADE TO THE EXCLUSIVE RIGHT TO USE "MEDIA", APART FROM THE MARK AS SHOWN.

FOR WEB SITE DESIGN SERVICES FEATURING TEMPORARY USE OF NON-DOWNLOADABLE SOFTWARE THAT ENABLES CUSTOMERS TO PROVIDE VIDEO CONTENT ON THEIR WEB SITES (U.S. CLS. 100 AND 101).

FIRST USE 3-31-2007; IN COMMERCE 3-31-2007.

JANICE L. MCMORROW, EXAMINING ATTORNEY

SN 77-647,127. DYAX CORP., CAMBRIDGE, MA. FILED 1-10-2009.

FULLFILLING THE PROMISE OF DISCOVERY

THE MARK CONSISTS OF STANDARD CHARACTERS WITHOUT CLAIM TO ANY PARTICULAR FONT, STYLE, SIZE, OR COLOR.

FOR PROVIDING INFORMATION IN THE FIELD OF MEDICAL AND SCIENTIFIC RESEARCH; PROVIDING MEDICAL AND SCIENTIFIC RESEARCH INFORMATION IN THE FIELD OF PHARMACEUTICALS AND CLINICAL TRIALS; PROVIDING A WEB SITE FEATURING MEDICAL AND SCIENTIFIC RESEARCH INFORMATION ON PHAGES AND PHAGE DISPLAY; PROVIDING A WEB SITE FEATURING INFORMATION ON DRUG DISCOVERY (U.S. CLS. 100 AND 101).

AMY KERTGATE, EXAMINING ATTORNEY

SN 77-658,660. NETWORK VOX SOFTWARE LTDA., JOINVILLE, BRAZIL, FILED 1-28-2009.



THE MARK CONSISTS OF A DESIGN OF A SQUARE, WITH THE TOP RIGHT HAND CORNER OF THE SQUARE SEPARATED FROM THE REST OF THE SQUARE, FOLLOWED BY THE WORD DRIMIO.

FOR RENTAL OF SOFTWARE; INSTALLATION AND MAINTENANCE OF SOFTWARE; SOFTWARE DESIGN AND DEVELOPMENT; DESIGN OF ONLINE COMPUTER SOFTWARE SYSTEMS (U.S. CLS. 100 AND 101).

RONALD MCMORROW, EXAMINING ATTORNEY

CLASS 42—(Continued).

SN 77-659,613. TIGO ENERGY, INC., LOS GATOS, CA. FILED 1-29-2009.

TIGO ENERGY

THE MARK CONSISTS OF STANDARD CHARACTERS WITHOUT CLAIM TO ANY PARTICULAR FONT, STYLE, SIZE, OR COLOR.

NO CLAIM IS MADE TO THE EXCLUSIVE RIGHT TO USE "ENERGY", APART FROM THE MARK AS SHOWN.

THE WORDING "TIGO" HAS NO MEANING IN A FOREIGN LANGUAGE.

FOR TECHNOLOGY PLANNING AND CONSULTING IN THE FIELD OF RENEWABLE ENERGY; COLLECTING TECHNICAL DATA FROM SOLAR ENERGY THERMAL INSTALLATIONS FOR DETERMINING ENERGY USAGE AND EFFICIENCY FOR OTHERS; REMOTE MONITORING SERVICES, NAMELY, SOLAR ENERGY PHOTOVOLTAIC SOLAR MODULES MONITORING SERVICES FOR OTHERS (U.S. CLS. 100 AND 101).
B. PARADEWELAI, EXAMINING ATTORNEY

SN 77-659,647. TIGO ENERGY, INC., LOS GATOS, CA. FILED 1-29-2009.



NO CLAIM IS MADE TO THE EXCLUSIVE RIGHT TO USE "ENERGY", APART FROM THE MARK AS SHOWN.

THE COLOR(S) GREEN AND LIGHT GREEN IS/ARE CLAIMED AS A FEATURE OF THE MARK.

THE MARK CONSISTS OF THE STYLIZED WORD "TIGO" IN GREEN, WITH A LIGHT GREEN LEAF OVER THE I, ON TOP OF THE STYLIZED LIGHT GREEN WORD "ENERGY".

THE WORDING TIGO HAS NO MEANING IN A FOREIGN LANGUAGE.

FOR TECHNOLOGY PLANNING AND CONSULTING IN THE FIELD OF RENEWABLE ENERGY; COLLECTING TECHNICAL DATA FROM SOLAR ENERGY THERMAL INSTALLATIONS FOR DETERMINING ENERGY USAGE AND EFFICIENCY FOR OTHERS; REMOTE MONITORING SERVICES, NAMELY, SOLAR ENERGY PHOTOVOLTAIC SOLAR MODULES MONITORING SERVICES FOR OTHERS (U.S. CLS. 100 AND 101).
B. PARADEWELAI, EXAMINING ATTORNEY

CLASS 42—(Continued).

SN 77-662,972. DARRYL WILLIAM MUNNS, ISELIN, NJ. FILED 2-4-2009.



THE COLOR(S) YELLOW, BLUE AND BLACK IS/ARE CLAIMED AS A FEATURE OF THE MARK.

THE MARK CONSISTS OF A YELLOW STAR ABOVE THE TEXT "INFINITE" ON THE TOP OF A YELLOW TRIANGLE CONTAINING THE BLUE TEXT "WE SEE THE FUTURE NOW" WITH THE TEXT "INNOVATIVE" ON THE LEFT SIDE OF THE TRIANGLE AND THE TEXT "IDEAS" ON THE RIGHT SIDE OF THE TRIANGLE. THE WORDS "INFINITE", "INNOVATIVE" AND "IDEAS" AND THE OUTLINES OF THE STAR AND TRIANGLE APPEAR IN BLACK.

FOR PRODUCT RESEARCH AND DEVELOPMENT (U.S. CLS. 100 AND 101).

ELISSA GARBER KON, EXAMINING ATTORNEY

SN 77-673,732. STRUCTURETEC ENGINEERING CORPORATION, DBA STRUCTURETEC CORPORATION, KALAMAZOO, MI. FILED 2-19-2009.

STRUCTURESCAN

THE MARK CONSISTS OF STANDARD CHARACTERS WITHOUT CLAIM TO ANY PARTICULAR FONT, STYLE, SIZE, OR COLOR.

SEC. 2(F).

FOR NONDESTRUCTIVE INSPECTION AND TESTING SERVICES USING INFRARED, GROUND PENETRATING RADAR, X-RAY AND ULTRASONIC TECHNOLOGIES TO PROVIDE ANALYSIS AND EVALUATION OF BUILDING STRUCTURES, CONSISTING OF THE DETECTION OF WALL AND ROOF LEAKS; CONSULTING SERVICES RELATING TO THE ANALYSIS AND EVALUATION OF BUILDING STRUCTURES, SPECIFICALLY IN THE DETECTION OF WALL AND ROOF LEAKS (U.S. CLS. 100 AND 101).

FIRST USE 12-31-1992; IN COMMERCE 12-31-1992.

RONALD AIKENS, EXAMINING ATTORNEY

CLASS 42—(Continued).

SN 77-678,387. 123PEOPLE INTERNETSERVICES GMBH, VIENNA, AUSTRIA, FILED 2-25-2009.



THE MARK CONSISTS OF THE NUMBER "123" AND THE WORD "PEOPLE" WRITTEN IN A LARGER FONT ON A LOWER PLANE, IN WHICH THE LETTER "O" COMPRISES A DESIGN OF A MAGNIFYING GLASS.

FOR COMPUTER SERVICES, NAMELY, PROVIDING A SEARCH ENGINE FOR OBTAINING DATA ON THE INTERNET CONCERNING INDIVIDUALS (U.S. CLS. 100 AND 101).

JAMES A. RAUEN, EXAMINING ATTORNEY

SN 77-680,161. VIDCLX, L.L.C., SCOTTSDALE, AZ. FILED 2-27-2009.



THE MARK CONSISTS OF TERM "VIDCLX" WRITTEN IN A STYLIZED FONT AND WHERE THE LIGHTER SECTIONS ON THE WORD ARE MEANT TO REPRESENT REFLECTED LIGHT.

FOR PROVIDING TEMPORARY USE OF NON-DOWNLOADABLE SOFTWARE WHICH ENABLES USERS TO PURCHASE PRODUCTS THAT APPEAR ON INTERACTIVE VIDEOS VIEWED VIA TELEVISION OR THE INTERNET (U.S. CLS. 100 AND 101).

RICHARD WHITE, EXAMINING ATTORNEY

CLASS 42—(Continued).

SN 77-689,429. MESSAGE TECHNOLOGIES, INC., ATLANTA, GA. FILED 3-12-2009.

NATURAL CHAT

THE MARK CONSISTS OF STANDARD CHARACTERS WITHOUT CLAIM TO ANY PARTICULAR FONT, STYLE, SIZE, OR COLOR.

NO CLAIM IS MADE TO THE EXCLUSIVE RIGHT TO USE "NATURAL", APART FROM THE MARK AS SHOWN.

FOR APPLICATION SERVICE PROVIDER FEATURING COMPUTER SOFTWARE FOR SPEAKER-INDEPENDENT, NATURAL-LANGUAGE CONVERSATIONAL SPEECH RECOGNITION, IDENTIFICATION, AND PROCESSING, AND FOR LANGUAGE UNDERSTANDING USING ARTIFICIAL INTELLIGENCE; APPLICATION SERVICE PROVIDER FEATURING COMPUTER SOFTWARE APPLICATIONS AND SERVICES USING NATURAL-LANGUAGE UNDERSTANDING IN THE FIELDS OF BANKING AND FINANCIAL SERVICES TRANSACTIONS, TELEPHONE-BASED INFORMATION SERVICES, ELECTRONIC COMMERCE, POINT-OF-SALE AND POINT-OF-SERVICES TRANSACTIONS, TRAVEL SERVICES, TELECOMMUNICATIONS SERVICES, CALLING CARD AND CELLULAR TELEPHONE ACCESS; COMPUTER SERVICES, NAMELY, COMPUTER SOFTWARE DESIGN SERVICES FOR APPLICATION DEVELOPERS AND SOFTWARE INTEGRATORS TO CREATE INTERACTIVE NATURAL-LANGUAGE UNDERSTANDING APPLICATIONS (U.S. CLS. 100 AND 101).

MARGERY A. TIERNEY, EXAMINING ATTORNEY

SN 77-691,741. HEALTH FITNESS DYNAMICS, INC., POMPANO BEACH, FL. FILED 3-16-2009.

HFD Reports

THE MARK CONSISTS OF STANDARD CHARACTERS WITHOUT CLAIM TO ANY PARTICULAR FONT, STYLE, SIZE, OR COLOR.

NO CLAIM IS MADE TO THE EXCLUSIVE RIGHT TO USE "REPORTS", APART FROM THE MARK AS SHOWN.

FOR PROVIDING TEMPORARY USE OF ONLINE NON-DOWNLOADABLE COMPUTER SOFTWARE FOR ONLINE REAL-TIME TRACKING OF THE PROFITABILITY AND PERFORMANCE OF THE KEY FINANCIAL AND OPERATIONAL DATA FOR THE WORLDWIDE SPA INDUSTRY (U.S. CLS. 100 AND 101).

BARBARA BROWN, EXAMINING ATTORNEY

CLASS 42—(Continued).

SN 77-691,765. HEALTH FITNESS DYNAMICS, INC., POM-PANO BEACH, FL. FILED 3-16-2009.



NO CLAIM IS MADE TO THE EXCLUSIVE RIGHT TO USE "REPORTS SPA REPORT PERFORMANCE PROFITABILITY BENCHMARKING", APART FROM THE MARK AS SHOWN.

THE MARK CONSISTS OF ON THE FIRST LINE, THE WORDING: "HFD REPORTS" WHEREIN THE TERM "HFD" IS ENCLOSED IN A BOX AND INSIDE THE BOX AND TO THE LEFT OF THE TERM "HFD" IS A BALL, EXTENDING FROM THE SIDE OF THE BALL JUXTAPOSITION TO THE TERM "HFD" IS A SEMI CIRCULAR FORMATION OF ARROWS, POINTING GENERALLY AT THE TERM "HFD" TWO HORIZONTAL LINES, BELOW THE FIRST LINE OF WORDS, SEPARATE THE FIRST LINE OF WORDS AND A SECOND LINE LOCATED BENEATH THE TWO HORIZONTAL ON THE SECOND LINE, THE WORDING: "HFD SPA REPORT PERFORMANCE PROFITABILITY BENCHMARKING" WHEREIN THERE EXISTS A RIGHTWARD POINTING ARROW BETWEEN "PERFORMANCE" AND "PROFITABILITY" AND A RIGHTWARD POINTING ARROW BETWEEN "PROFITABILITY" AND "BENCHMARKING".

FOR PROVIDING TEMPORARY USE OF ONLINE NON-DOWNLOADABLE COMPUTER SOFTWARE FOR ONLINE REAL-TIME TRACKING OF THE PROFITABILITY AND PERFORMANCE OF THE KEY FINANCIAL AND OPERATIONAL DATA FOR THE WORLDWIDE SPA INDUSTRY (U.S. CLS. 100 AND 101).
BARBARA BROWN, EXAMINING ATTORNEY

SN 77-698,165. TOTAL SYSTEM SERVICES, INC., COLUMBUS, GA. FILED 3-24-2009.

INFONOX

a TSYS company

OWNER OF U.S. REG. NOS. 2,599,320, 3,195,412 AND OTHERS.

NO CLAIM IS MADE TO THE EXCLUSIVE RIGHT TO USE "COMPANY", APART FROM THE MARK AS SHOWN.

THE MARK CONSISTS OF THE WORD "INFONOX" IN BOLD, ALL CAPS FONT WITH A STYLIZED, INCOMPLETE "X" ABOVE THE SMALLER WORDING "A TSYS COMPANY".

FOR PROVIDING A COMPUTERIZED NETWORK OF SELF-SERVICE TRANSACTIONAL SYSTEMS FOR RENDERING AUTOMATED FINANCIAL AND COMMERCIAL SERVICES; APPLICATION SERVICE PROVIDER (ASP) FEATURING SOFTWARE FOR USE IN DATABASE MANAGEMENT IN THE FIELDS OF ELECTRONIC PAYMENT PROCESSING; DATA WAREHOUSING, DATA MINING, DATA ENCRYPTION SERVICE; APPLICATION SERVICE PROVIDER (ASP) FEATURING SOFTWARE FOR USE IN PROVIDING INTERNET-BASED ACCESS TO CREDIT AND DEBIT-CARD TRANSACTION DATA FOR USE IN AUTHORIZING AND CAPTURE (U.S. CLS. 100 AND 101).

FIRST USE 10-31-2008; IN COMMERCE 10-31-2008.
LINDA POWELL, EXAMINING ATTORNEY

CLASS 42—(Continued).

SN 77-699,274. NORRIS, GREGORY, NORTH BERWICK, ME. FILED 3-25-2009.

Sylvatica

THE MARK CONSISTS OF STANDARD CHARACTERS WITHOUT CLAIM TO ANY PARTICULAR FONT, STYLE, SIZE, OR COLOR.

THE WORDING "SYLVATICA" HAS NO MEANING IN A FOREIGN LANGUAGE.

FOR LIFE CYCLE ASSESSMENT OF NEW PRODUCTS, NAMELY, CONSULTING IN THE FIELD OF ENVIRONMENT ASSESSMENT OF NEW PRODUCTS OF OTHERS, AND EVALUATING THE ENVIRONMENTAL IMPACT OF THE PRODUCTS AND SERVICES OF BUSINESSES THROUGH THE APPLICATION OF METHODS, INFORMATION, RESOURCES, AND EXPERIENCES (U.S. CLS. 100 AND 101).

FIRST USE 3-1-1996; IN COMMERCE 3-1-1996.
MICHELLE DUBOIS, EXAMINING ATTORNEY

SN 77-702,498. RME, LLC, TAMPA, FL. FILED 3-30-2009.

SEMINAR RSVP

THE MARK CONSISTS OF STANDARD CHARACTERS WITHOUT CLAIM TO ANY PARTICULAR FONT, STYLE, SIZE, OR COLOR.

NO CLAIM IS MADE TO THE EXCLUSIVE RIGHT TO USE "SEMINAR", APART FROM THE MARK AS SHOWN.

SEC. 2(F).

FOR PROVIDING A WEBSITE FEATURING TEMPORARY USE OF NON-DOWNLOADABLE SOFTWARE ALLOWING WEB SITE USERS TO TRACK RESERVATIONS AND RESPONSES TO THEIR BUSINESS MARKETING SEMINARS (U.S. CLS. 100 AND 101).

FIRST USE 3-1-2003; IN COMMERCE 6-1-2003.
BARBARA GAYNOR, EXAMINING ATTORNEY

SN 77-702,975. E.G.L. GEM LAB LTD., NEW YORK, NY. FILED 3-31-2009.

THE WORLD'S MOST TRUSTED NAME IN GEMOLOGY

THE MARK CONSISTS OF STANDARD CHARACTERS WITHOUT CLAIM TO ANY PARTICULAR FONT, STYLE, SIZE, OR COLOR.

SEC. 2(F).

FOR GEMOLOGICAL SERVICES, NAMELY, IDENTIFICATION AND GRADING OF PRECIOUS GEM STONES AND JEWELRY ITEMS, AND ISSUING CERTIFICATES RELATING TO SUCH IDENTIFICATION AND GRADING (U.S. CLS. 100 AND 101).

FIRST USE 4-0-2001; IN COMMERCE 4-0-2001.
MICHAEL SOUDERS, EXAMINING ATTORNEY

CLASS 42—(Continued).

SN 77-710,352. Q-COMM CORPORATION, OVERLAND PARK, KS. FILED 4-9-2009.

GUARDIAN CLOUD

THE MARK CONSISTS OF STANDARD CHARACTERS WITHOUT CLAIM TO ANY PARTICULAR FONT, STYLE, SIZE, OR COLOR.

NO CLAIM IS MADE TO THE EXCLUSIVE RIGHT TO USE "CLOUD", APART FROM THE MARK AS SHOWN.

FOR APPLICATION SERVICE PROVIDER (ASP), NAMELY, HOSTING COMPUTER SOFTWARE APPLICATIONS OF OTHERS; HOSTING OF DIGITAL CONTENT ON THE INTERNET (U.S. CLS. 100 AND 101).

FIRST USE 1-0-2009; IN COMMERCE 1-0-2009.

MARIA-VICTORIA SUAREZ, EXAMINING ATTORNEY

SN 77-710,399. Q-COMM CORPORATION, OVERLAND PARK, KS. FILED 4-9-2009.

GUARDIAN DATA CENTER

THE MARK CONSISTS OF STANDARD CHARACTERS WITHOUT CLAIM TO ANY PARTICULAR FONT, STYLE, SIZE, OR COLOR.

NO CLAIM IS MADE TO THE EXCLUSIVE RIGHT TO USE "DATA CENTER", APART FROM THE MARK AS SHOWN.

FOR COMPUTER COLOCATION SERVICES, NAMELY, PROVIDING FACILITIES FOR THE LOCATION OF COMPUTER SERVERS WITH THE EQUIPMENT OF OTHERS; HOSTING OF DIGITAL CONTENT ON THE INTERNET; TECHNICAL SUPPORT, NAMELY, MONITORING OF NETWORK SYSTEMS (U.S. CLS. 100 AND 101).

FIRST USE 1-0-2009; IN COMMERCE 1-0-2009.

MARIA-VICTORIA SUAREZ, EXAMINING ATTORNEY

SN 77-710,411. Q-COMM CORPORATION, OVERLAND PARK, KS. FILED 4-9-2009.

GUARDIAN DATASTOR

THE MARK CONSISTS OF STANDARD CHARACTERS WITHOUT CLAIM TO ANY PARTICULAR FONT, STYLE, SIZE, OR COLOR.

NO CLAIM IS MADE TO THE EXCLUSIVE RIGHT TO USE "DATASTOR", APART FROM THE MARK AS SHOWN. FOR HOSTING OF DIGITAL CONTENT ON THE INTERNET (U.S. CLS. 100 AND 101).

FIRST USE 1-0-2009; IN COMMERCE 1-0-2009.

MARIA-VICTORIA SUAREZ, EXAMINING ATTORNEY

CLASS 42—(Continued).

SN 77-711,943. COHEN, STEVEN B., CLEVELAND, OH. FILED 4-10-2009.

firstpixels

THE MARK CONSISTS OF STANDARD CHARACTERS WITHOUT CLAIM TO ANY PARTICULAR FONT, STYLE, SIZE, OR COLOR.

FOR PROVIDING AN INTERACTIVE WEBSITE THAT GIVES COMPUTER USERS THE ABILITY TO EDIT DIGITAL IMAGES (U.S. CLS. 100 AND 101).

SUSAN RICHARDS, EXAMINING ATTORNEY

SN 77-713,274. ADVANTA SOLUTIONS, LLC, PALOS VERDES PENINSULA, CA. FILED 4-14-2009.

ADVANTA SOLUTIONS

THE MARK CONSISTS OF STANDARD CHARACTERS WITHOUT CLAIM TO ANY PARTICULAR FONT, STYLE, SIZE, OR COLOR.

NO CLAIM IS MADE TO THE EXCLUSIVE RIGHT TO USE "SOLUTIONS", APART FROM THE MARK AS SHOWN.

FOR TECHNICAL CONSULTING AND ASSISTANCE WITH THE DEVELOPMENT AND SUPPORT OF COMPUTER SOFTWARE SYSTEMS; AND DESIGN, CREATION, MAINTENANCE AND HOSTING OF WEBSITES AND SOFTWARE APPLICATIONS FOR OTHERS (U.S. CLS. 100 AND 101).

FIRST USE 12-1-1999; IN COMMERCE 12-1-1999.

MARK RADEMACHER, EXAMINING ATTORNEY

SN 77-714,535. DRS. CLACK, SPENCER, WHITE & MCCORMACK, P.A., SARASOTA, FL. FILED 4-15-2009.

SaraPath Diagnostics

THE MARK CONSISTS OF STANDARD CHARACTERS WITHOUT CLAIM TO ANY PARTICULAR FONT, STYLE, SIZE, OR COLOR.

NO CLAIM IS MADE TO THE EXCLUSIVE RIGHT TO USE "DIAGNOSTICS", APART FROM THE MARK AS SHOWN.

FOR MEDICAL LABORATORY SERVICES (U.S. CLS. 100 AND 101).

ELLEN PERKINS, EXAMINING ATTORNEY

CLASS 42—(Continued).

SN 77-717,207. ONLINE LABELS, INC., DBA ONLINELABELS.COM, LONGWOOD, FL. FILED 4-20-2009.

Maestro Label Designer

THE MARK CONSISTS OF STANDARD CHARACTERS WITHOUT CLAIM TO ANY PARTICULAR FONT, STYLE, SIZE, OR COLOR.

NO CLAIM IS MADE TO THE EXCLUSIVE RIGHT TO USE "LABEL DESIGNER", APART FROM THE MARK AS SHOWN.

FOR PROVIDING ONLINE, NON-DOWNLOADABLE COMPUTER SOFTWARE FOR DESIGNING LABELS (U.S. CLS. 100 AND 101).

FIRST USE 10-1-2007; IN COMMERCE 10-1-2007.
DAVID MILLER, EXAMINING ATTORNEY

SN 77-718,646. FUSS & O'NEILL TECHNOLOGIES, LLC, MANCHESTER, CT. FILED 4-21-2009.



NO CLAIM IS MADE TO THE EXCLUSIVE RIGHT TO USE "ONLINE MOORING", APART FROM THE MARK AS SHOWN.

THE MARK CONSISTS OF THE STYLIZED LETTERING "ONLINE", WITH A STYLIZED BOAT TO THE RIGHT. THERE IS AN OVAL SHAPE BELOW THE BOAT, THE STYLIZED LETTERING, "MOORING", IS TO THE RIGHT OF THE BOAT.

FOR APPLICATION SERVICE PROVIDER (ASP) PROVIDING ON-LINE NON-DOWNLOADABLE SOFTWARE FOR USE IN MANAGING BOAT MOORINGS, NAMELY, TRACKING MOORING LOCATIONS AND MOORING PROPERTIES SO THAT WAIT-LIST AND VESSEL INFORMATION CAN BE TRACKED AND MANAGED, SUBMITTING PERMIT APPLICATIONS AND TYING BOAT OWNER REGISTRATION AND VESSEL INFORMATION TO MOORING DATA TO ASSIST HARBORMASTERS AND PERMITTING AGENCIES WITH EMERGENCY ALERTS, DISPUTE RESOLUTION, MOORING LOCATION VERIFICATION, COLLECTION OF FEES AND HARBOR MANAGEMENT (U.S. CLS. 100 AND 101).

FIRST USE 1-1-2009; IN COMMERCE 1-15-2009.
STEVEN JACKSON, EXAMINING ATTORNEY

CLASS 42—(Continued).

SN 77-720,515. ZINGR COMMUNICATIONS, MANCHESTER, NH. FILED 4-23-2009.



THE STIPLING IS FOR SHADING PURPOSES ONLY. THE MARK CONSISTS OF TWO CIRCLES CONNECTED TO EACH OTHER. ONE OF THE CIRCLE HAS THE STYLIZED TEXT "Z" AND THE OTHER HAS THE STYLIZED TEXT "R". AT THE BOTTOM THERE IS THE STYLIZED TEXT "ZINGR".

FOR SOFTWARE AS A SERVICE (SAAS) SERVICES, NAMELY, COMMUNICATIONS SOFTWARE THAT ALLOWS BUSINESSES TO CONNECT TO CONSUMERS VIA MOBILE COMMUNICATIONS DEVICES AND MARKETING SOFTWARE THAT ALLOWS BUSINESS TO SEND ADVERTISEMENTS TO CONSUMERS' MOBILE COMMUNICATIONS DEVICES (U.S. CLS. 100 AND 101).

FIRST USE 1-11-2009; IN COMMERCE 2-21-2009.
MARILYN IZZI, EXAMINING ATTORNEY

SN 77-720,619. IATROS SYNERGY CORP., WEATHERFORD, TX. FILED 4-23-2009.



NO CLAIM IS MADE TO THE EXCLUSIVE RIGHT TO USE "HEART & VASCULAR HEALTH", APART FROM THE MARK AS SHOWN.

THE MARK CONSISTS OF THE STYLIZED WORDS "IATROS SYNERGY HEART & VASCULAR HEALTH" WITH AN IMAGE OF THE GREEK GOD ASCLEPIUS HOLDING HIS STAFF WHICH IS SURROUNDED BY A SERPENT APPEARING BETWEEN THE WORDS "IATROS" AND "SYNERGY".

FOR PREVENTIVE HEART AND VASCULAR RESEARCH (U.S. CLS. 100 AND 101).

RONALD MCMORROW, EXAMINING ATTORNEY

CLASS 42—(Continued).

SN 77-721,343. YOUNG, ROBERT D, BROOKLYN, NY.
FILED 4-23-2009.

URBAN WORKSHOP

THE MARK CONSISTS OF STANDARD CHARACTERS
WITHOUT CLAIM TO ANY PARTICULAR FONT, STYLE,
SIZE, OR COLOR.

SEC. 2(F).
FOR ARCHITECTURAL DESIGN; GRAPHIC DESIGN;
INDUSTRIAL DESIGN; URBAN DESIGN PLANNING
SERVICES (U.S. CLS. 100 AND 101).
FIRST USE 0-0-1997; IN COMMERCE 0-0-1997.
DARRYL SPRUILL, EXAMINING ATTORNEY

SN 77-721,746. CORVENTIS, INC., SAN JOSE, CA. FILED 4-
24-2009.

CARDIOPROTECT

THE MARK CONSISTS OF STANDARD CHARACTERS
WITHOUT CLAIM TO ANY PARTICULAR FONT, STYLE,
SIZE, OR COLOR.

FOR COMPUTER SERVICES, NAMELY, PROVIDING
ONLINE NON-DOWNLOADABLE SOFTWARE FOR RECEIVING,
TRANSMITTING, PROCESSING, STORING
AND DISPLAYING PATIENT MEDICAL DATA (U.S.
CLS. 100 AND 101).
HAI-LY LAM, EXAMINING ATTORNEY

SN 77-722,761. GLOBALFORCE NETWORK, INC., VANCOU-
VER, CANADA, FILED 4-27-2009.

GLOBALFORCE

THE MARK CONSISTS OF STANDARD CHARACTERS
WITHOUT CLAIM TO ANY PARTICULAR FONT, STYLE,
SIZE, OR COLOR.

FOR COMPUTER SERVICES, NAMELY, CREATING
AN ON-LINE COMMUNITY FOR REGISTERED USERS
TO PARTICIPATE IN DISCUSSIONS, GET FEEDBACK
FROM THEIR PEERS, FORM VIRTUAL COMMUNITIES,
AND ENGAGE IN SOCIAL NETWORKING FEATURING
SOCIAL MEDIA AND TOPICS ON SOCIAL CAUSES
AND GLOBAL WARMING (U.S. CLS. 100 AND 101).
FIRST USE 10-16-2008; IN COMMERCE 4-22-2009.
JEFF DEFORD, EXAMINING ATTORNEY

CLASS 42—(Continued).

SN 77-722,816. THE ERP GROUP, INC., TAMPA, FL. FILED
4-27-2009.

**UPGRADE MORE THAN YOUR
SOFTWARE**

THE MARK CONSISTS OF STANDARD CHARACTERS
WITHOUT CLAIM TO ANY PARTICULAR FONT, STYLE,
SIZE, OR COLOR.

FOR CONSULTING IN THE FIELD OF INFORMA-
TION TECHNOLOGY (U.S. CLS. 100 AND 101).
FIRST USE 4-20-2009; IN COMMERCE 4-20-2009.
MARC LEIPZIG, EXAMINING ATTORNEY

SN 77-722,883. TELEMAR SOFTWARE, SAN DIEGO, CA.
FILED 4-27-2009.

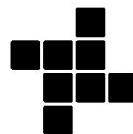

telemark software

NO CLAIM IS MADE TO THE EXCLUSIVE RIGHT TO
USE "SOFTWARE", APART FROM THE MARK AS SHOWN.

THE MARK CONSISTS IN PART OF AN ABSTRACT
DESIGN COMPRISING DARKENED SQUARES.
FOR COMPUTER SOFTWARE CONSULTING SER-
VICES; CONSULTING IN THE FIELD OF INFORMA-
TION TECHNOLOGY (U.S. CLS. 100 AND 101).
FIRST USE 2-1-2000; IN COMMERCE 2-1-2000.
ALEX KEAM, EXAMINING ATTORNEY

SN 77-723,109. U.S.G. ENTERPRISES, INC., MARINA DEL
REY, CA. FILED 4-27-2009.

iSea

THE MARK CONSISTS OF STANDARD CHARACTERS
WITHOUT CLAIM TO ANY PARTICULAR FONT, STYLE,
SIZE, OR COLOR.

FOR COMPUTER SERVICES, NAMELY HOSTING ON-
LINE INTERACTIVE PUBLIC CALENDARS THAT AL-
LOW MULTIPLE PARTICIPANTS TO SHARE CALEN-
DARS AND SCHEDULING INFORMATION (U.S. CLS.
100 AND 101).
SHAUNIA CARLYLE, EXAMINING ATTORNEY

CLASS 42—(Continued).

SN 77-723,130. THE OSTEOPATHIC RESEARCH CENTER, FORT WORTH, TX. FILED 4-27-2009.



NO CLAIM IS MADE TO THE EXCLUSIVE RIGHT TO USE "THE OSTEOPATHIC RESEARCH CENTER", APART FROM THE MARK AS SHOWN.

THE MARK CONSISTS OF THE WORDS "THE OSTEOPATHIC RESEARCH CENTER WHERE SCIENCE MEETS PRACTICE" AND A STYLIZED CIRCLE REPRESENTING STYLIZED HANDS ENCOMPASSING A STYLIZED SPINE. FOR MEDICAL RESEARCH SERVICES (U.S. CLS. 100 AND 101).

FIRST USE 2-9-2009; IN COMMERCE 2-9-2009.
ALICE BENMAMAN, EXAMINING ATTORNEY

CLASS 42—(Continued).

SN 77-723,325. TIMOTHY R. MALOOLY, PLYMOUTH, MN. FILED 4-27-2009.

Water in Motion

THE MARK CONSISTS OF STANDARD CHARACTERS WITHOUT CLAIM TO ANY PARTICULAR FONT, STYLE, SIZE, OR COLOR.

NO CLAIM IS MADE TO THE EXCLUSIVE RIGHT TO USE "WATER", APART FROM THE MARK AS SHOWN.

FOR NETWORKING OF HOME CONTROLS, NAMELY, WIRELESS AND WIRED LIGHTING CONTROLS, THERMOSTAT AND HEATING CONTROLS, ROLLING SHUTTERS AND DOOR CONTROLS, APPLIANCE CONTROLS, NAMELY, OVEN, WASHER, DRYER, REFRIGERATOR, DISHWASHER, LAWN AND GARDEN IRRIGATION CONTROLS, HOME AUDIO AND VIDEO CONTROLS (U.S. CLS. 100 AND 101).

MARILYN IZZI, EXAMINING ATTORNEY

SN 77-723,315. PLANETWIDE GAMES, INC., ALISO VIEJO, CA. FILED 4-27-2009.



OWNER OF U.S. REG. NO. 3,481,929.
THE COLOR(S) RED, BLACK AND WHITE IS/ARE CLAIMED AS A FEATURE OF THE MARK.

THE MARK CONSISTS OF A FIST OUTLINED IN BLACK WITH THE WORD "MASH" APPEARING INSIDE THE FIST IN WHITE LETTERS WITH THE WORD "ON" APPEARING IN BLACK LETTERS INSIDE A WHITE CIRCULAR BUBBLE TO THE RIGHT OF THE FIST.

FOR COMPUTER SERVICES, NAMELY, PROVIDING AN INTERACTIVE WEB SITE THAT ALLOWS USERS TO COLLECT, STORE, MANAGE, DELIVER AND SHOWCASE ELECTRONIC AND PAPER-BASED CONTENT; COMPUTER SERVICES, NAMELY, PROVIDING AN INTERACTIVE WEB SITE THAT ALLOWS USERS TO CREATE THEIR OWN BOOKS; PROVIDING TEMPORARY USE OF ON-LINE NON-DOWNLOADABLE SOFTWARE FOR OBTAIN SOFTWARE AND TO COLLABORATE WITH OTHER USERS FOR THE CREATION OF IMAGES, STORIES AND ARTWORK (U.S. CLS. 100 AND 101).

FIRST USE 9-11-2007; IN COMMERCE 5-17-2008.
C. DIONNE CLYBURN, EXAMINING ATTORNEY

SN 77-723,461. WOODS, ERICK, EAU CLAIRE, WI. FILED 4-27-2009.

MenuSys

THE MARK CONSISTS OF STANDARD CHARACTERS WITHOUT CLAIM TO ANY PARTICULAR FONT, STYLE, SIZE, OR COLOR.

FOR APPLICATION SERVICE PROVIDER (ASP) FEATURING SOFTWARE FOR USE BY MOTOR VEHICLE, MOTORCYCLE, MARINE, RECREATIONAL VEHICLE, ALL-TERRAIN VEHICLE, SNOWMOBILE, PERSONAL WATERCRAFT, TRAILER, AND MANUFACTURED HOUSING DEALERS THAT ENABLES DEALER PERSONNEL TO CREATE, CALCULATE, PRINT, AND STORE CUSTOMIZED SERVICE, INSURANCE, MAINTENANCE, AND AFTERMARKET PRODUCT PRESENTATIONS AND SALES GOALS SETTING, TRACKING, AND COMPREHENSIVE REPORTING (U.S. CLS. 100 AND 101).

FIRST USE 1-1-2008; IN COMMERCE 6-1-2008.
BRIAN NEVILLE, EXAMINING ATTORNEY

CLASS 42—(Continued).

SN 77-723,469. U.S.G. ENTERPRISES, INC., MARINA DEL REY, CA. FILED 4-27-2009.



THE MARK CONSISTS OF TWO OCEAN WAVES AND THE WORD "iSEA".

FOR COMPUTER SERVICES, NAMELY, HOSTING ON-LINE INTERACTIVE PUBLIC CALENDARS THAT ALLOW MULTIPLE PARTICIPANTS TO SHARE CALENDARS AND SCHEDULING INFORMATION (U.S. CLS. 100 AND 101).

SHAUNIA CARLYLE, EXAMINING ATTORNEY

SN 77-723,551. RODRIGUEZ, ELI SAMUEL, WINDSOR, CT. FILED 4-27-2009.



VIGILANT GRAPHICS

NO CLAIM IS MADE TO THE EXCLUSIVE RIGHT TO USE "GRAPHICS", APART FROM THE MARK AS SHOWN.

THE MARK CONSISTS OF A HUMAN EYE IN WHICH THE OUTER SHAPE IS MADE UP OF A CAPITAL LETTER "G" AND THE IRIS IS A CAPITAL LETTER "V". THE PUPIL IS A DARK CIRCLE WITH TWO SMALLER BRIGHT CIRCLES THAT OVERLAP WITHIN THE PUPIL, REPRESENTING A GLARE FROM A LIGHT SOURCE. THE WORDS "VIGILANT GRAPHICS" APPEAR IN CAPITAL LETTERS UNDER THE EYE IN THE TYPE FONT NARKISIM.

FOR GRAPHIC DESIGN (U.S. CLS. 100 AND 101).
FONG HSU, EXAMINING ATTORNEY

SN 77-723,767. SCALABLE SOFTWARE LIMITED, AKA SCALABLE SOFTWARE, INC., RICHMOND, ENGLAND, UNITED KINGDOM, FILED 4-28-2009.

Scalable LIVE!

THE MARK CONSISTS OF STANDARD CHARACTERS WITHOUT CLAIM TO ANY PARTICULAR FONT, STYLE, SIZE, OR COLOR.

NO CLAIM IS MADE TO THE EXCLUSIVE RIGHT TO USE "SCALABLE", APART FROM THE MARK AS SHOWN.

FOR SOFTWARE AS A SERVICE (SAAS) SERVICES FEATURING A WEB-BASED SYSTEM AND ONLINE PORTAL FOR CUSTOMERS TO REMOTELY MANAGE, ADMINISTER, MODIFY AND CONTROL THEIR NETWORKS, END USER COMPUTER DEVICES, DATA AND SOFTWARE APPLICATIONS (U.S. CLS. 100 AND 101).

ANDREA K. NADELMAN, EXAMINING ATTORNEY

CLASS 42—(Continued).

SN 77-723,848. SIRAHU CORPORATION, FREMONT, CA. FILED 4-28-2009.

Apptivo

THE MARK CONSISTS OF STANDARD CHARACTERS WITHOUT CLAIM TO ANY PARTICULAR FONT, STYLE, SIZE, OR COLOR.

FOR APPLICATION SERVICE PROVIDER (ASP), NAMELY, HOSTING COMPUTER SOFTWARE APPLICATIONS OF OTHERS; APPLICATION SERVICE PROVIDER FEATURING SOFTWARE FOR PROVIDING AN ON-LINE DATABASE IN THE FIELD OF TRANSACTION PROCESSING TO UPLOAD TRANSACTIONAL DATA, PROVIDE STATISTICAL ANALYSIS, AND PRODUCE NOTIFICATIONS AND REPORTS; APPLICATION SERVICE PROVIDER, NAMELY, PROVIDING, HOSTING, MANAGING, DEVELOPING, AND MAINTAINING APPLICATIONS, SOFTWARE, WEB SITES, AND DATABASES IN THE FIELDS OF PERSONAL PRODUCTIVITY, WIRELESS COMMUNICATION, MOBILE INFORMATION ACCESS, AND REMOTE DATA MANAGEMENT FOR WIRELESS DELIVERY OF CONTENT TO HANDHELD COMPUTERS, LAPTOPS AND MOBILE ELECTRONIC DEVICES; APPLICATION SERVICE PROVIDER, NAMELY, PROVIDING, HOSTING, MANAGING, DEVELOPING, RESEARCHING, ANALYZING, REPORTING, AND MAINTAINING APPLICATIONS, SOFTWARE, WEB SITES, AND DATABASES OF OTHERS IN THE FIELDS OF HEALTHCARE, BENEFITS PROGRAMS, EMPLOYEE PRODUCTIVITY, RISK MANAGEMENT; COMPUTER SERVICE, ACTING AS AN APPLICATION SERVICE PROVIDER IN THE FIELD OF KNOWLEDGE MANAGEMENT TO HOST COMPUTER APPLICATION SOFTWARE FOR CREATING SEARCHABLE DATABASES OF INFORMATION AND DATA TO ALLOW USERS TO PERFORM, ON-LINE, THE COLLECTING AND ANALYZING OF DIFFERENT TYPES OF OPINION SURVEYS; COMPUTER SERVICE, NAMELY, ACTING AS AN APPLICATION SERVICE PROVIDER IN THE FIELD OF KNOWLEDGE MANAGEMENT TO HOST COMPUTER APPLICATION SOFTWARE FOR CREATING SEARCHABLE DATABASES OF INFORMATION AND DATA; COMPUTER SERVICE, NAMELY, ACTING AS AN APPLICATION SERVICE PROVIDER IN THE FIELD OF KNOWLEDGE MANAGEMENT TO HOST COMPUTER APPLICATION SOFTWARE FOR SEARCHING AND RETRIEVING INFORMATION FROM DATABASES AND COMPUTER NETWORKS; COMPUTER SERVICE, NAMELY, ACTING AS AN APPLICATION SERVICE PROVIDER IN THE FIELD OF KNOWLEDGE MANAGEMENT TO HOST COMPUTER APPLICATION SOFTWARE FOR THE COLLECTION, EDITING, ORGANIZING, MODIFYING, BOOK MARKING, TRANSMISSION, STORAGE AND SHARING OF DATA AND INFORMATION; COMPUTER SERVICES, NAMELY, PROVIDING A WEB-BASED SYSTEM AND ONLINE PORTAL FOR CUSTOMERS TO REMOTELY MANAGE, ADMINISTER, MODIFY AND CONTROL THEIR END USER COMPUTER DEVICES, DATA AND SOFTWARE APPLICATIONS (U.S. CLS. 100 AND 101).

BRIAN PINO, EXAMINING ATTORNEY

CLASS 42—(Continued).

SN 77-724,198. REAL TIME ANALYTICAL LLC, PHOENIX, AZ. FILED 4-28-2009.

AC-PATHWAYS

THE MARK CONSISTS OF STANDARD CHARACTERS WITHOUT CLAIM TO ANY PARTICULAR FONT, STYLE, SIZE, OR COLOR.

FOR COMPUTER PROGRAMMING; COMPUTER PROGRAMMING AND SOFTWARE DESIGN; COMPUTER PROGRAMMING CONSULTANCY; COMPUTER PROGRAMMING SERVICES, NAMELY, CONTENT CREATION FOR VIRTUAL WORLDS AND THREE DIMENSIONAL PLATFORMS; COMPUTER SOFTWARE CONSULTANCY; COMPUTER SOFTWARE DEVELOPMENT; TECHNICAL VERIFICATION AND VALIDATION OF INSTRUMENTATION RADAR SYSTEMS (U.S. CLS. 100 AND 101).

JENNIFER MARTIN, EXAMINING ATTORNEY

CLASS 42—(Continued).

SN 77-724,267. STALBERT, MALIK, COLTON, AR. FILED 4-28-2009.

ZRan Echo

THE MARK CONSISTS OF STANDARD CHARACTERS WITHOUT CLAIM TO ANY PARTICULAR FONT, STYLE, SIZE, OR COLOR.

FOR COMPUTER SOFTWARE DEVELOPMENT; VIDEO GAME DEVELOPMENT SERVICES (U.S. CLS. 100 AND 101).

EMILY CARLSEN, EXAMINING ATTORNEY

SN 77-724,421. VFS-MED, INC., POCATELLO, ID. FILED 4-28-2009.

VFS-MED

THE MARK CONSISTS OF STANDARD CHARACTERS WITHOUT CLAIM TO ANY PARTICULAR FONT, STYLE, SIZE, OR COLOR.

FOR CHEMICAL, BIOCHEMICAL, BIOLOGICAL AND BACTERIOLOGICAL RESEARCH AND ANALYSIS (U.S. CLS. 100 AND 101).

FIRST USE 11-23-2007; IN COMMERCE 11-23-2007.
WILLIAM VERHOSEK, EXAMINING ATTORNEY

SN 77-724,213. PLANETWIDE GAMES, INC., ALISO VIEJO, CA. FILED 4-28-2009.

28/28

THE MARK CONSISTS OF STANDARD CHARACTERS WITHOUT CLAIM TO ANY PARTICULAR FONT, STYLE, SIZE, OR COLOR.

FOR COMPUTER SERVICE, NAMELY, ACTING AS AN APPLICATION SERVICE PROVIDER IN THE FIELD OF KNOWLEDGE MANAGEMENT TO HOST COMPUTER APPLICATION SOFTWARE FOR THE COLLECTION, EDITING, ORGANIZING, MODIFYING, BOOK MARKING, TRANSMISSION, STORAGE AND SHARING OF DATA AND INFORMATION; COMPUTER SOFTWARE DEVELOPMENT AND COMPUTER PROGRAMMING DEVELOPMENT FOR OTHERS; CREATION AND PROVISION OF WEB PAGES TO AND FOR THIRD PARTIES; DESIGN, CREATION, HOSTING AND MAINTENANCE OF INTERNET SITES FOR THIRD PARTIES; PROVIDING A WEB SITE FEATURING TEMPORARY USE OF NON-DOWNLOADABLE SOFTWARE ALLOWING WEB SITE USERS TO UPLOAD, POST AND DISPLAY ONLINE VIDEOS FOR SHARING WITH OTHERS FOR ENTERTAINMENT PURPOSES; PROVIDING A WEBSITE FEATURING ON-LINE NON-DOWNLOADABLE SOFTWARE TOOLS FOR IMAGE EDITING (U.S. CLS. 100 AND 101).

C. DIONNE CLYBURN, EXAMINING ATTORNEY

SN 77-724,440. ZIOSOFT, INC., REDWOOD CITY, CA. FILED 4-28-2009.

VERSAWEB

THE MARK CONSISTS OF STANDARD CHARACTERS WITHOUT CLAIM TO ANY PARTICULAR FONT, STYLE, SIZE, OR COLOR.

FOR COMPUTER SOFTWARE, NAMELY, A BROWSER-BASED SOFTWARE THAT PROVIDES REMOTE ACCESS TO MEDICAL IMAGES AND INFORMATION (U.S. CLS. 100 AND 101).

BARBARA A. GOLD, EXAMINING ATTORNEY

CLASS 42—(Continued).

SN 77-724,731. CONNECTPOINT RESOLUTION SYSTEMS, LLC, DALLAS, TX. FILED 4-29-2009.

CONNECTPOINT

THE MARK CONSISTS OF STANDARD CHARACTERS WITHOUT CLAIM TO ANY PARTICULAR FONT, STYLE, SIZE, OR COLOR.

FOR APPLICATION SERVICE PROVIDER FEATURING SOFTWARE FOR DIAGRAMMING, MEASURING, AND ASSESSING DAMAGE TO ROOFS; APPLICATION SERVICE PROVIDER FEATURING SOFTWARE FOR DIAGRAMMING ROOFS VIA AERIAL IMAGERY (U.S. CLS. 100 AND 101).

FIRST USE 3-23-2009; IN COMMERCE 3-23-2009.
B. PARADEWELAI, EXAMINING ATTORNEY

SN 77-724,739. MORTON, CARI RISA, TALLAHASSEE, FL. FILED 4-29-2009.

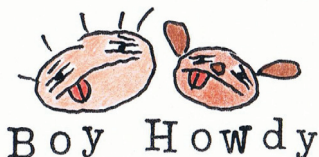

THE COLOR(S) BLACK, RED, TAN, DARK BROWN, BROWN AND WHITE IS/ARE CLAIMED AS A FEATURE OF THE MARK.

THE MARK CONSISTS OF THE TERMS "BOY HOWDY" BELOW THE HEAD OF A BOY AND THE HEAD OF A DOG, BOTH THE DOG AND THE BOY HAVE THEIR TONGUES OUT; THE COLOR BLACK APPEARS IN THE WORDING "BOY HOWDY" AND IN THE BOY AND DOG; THE COLOR RED APPEARS IN THE BOY'S TONGUE AND THE DOG'S TONGUE; THE COLOR TAN APPEARS IN THE BOY'S FACE; THE COLOR DARK BROWN APPEARS IN THE DOG'S EARS AND ON THE DOG'S NOSE; THE COLOR BROWN APPEARS IN THE DOG'S FACE; THE COLOR WHITE APPEARS IN THE FACE OF THE BOY AND DOG.

FOR GRAPHIC ILLUSTRATION SERVICES FOR OTHERS; GRAPHIC ILLUSTRATION SERVICES FOR OTHERS, NAMELY, ILLUSTRATION OF GREETING CARDS, DECALS, BUMPER STICKERS, STATIONERY, MAGAZINES AND NEWSPAPERS FOR OTHERS (U.S. CLS. 100 AND 101).

B. PARADEWELAI, EXAMINING ATTORNEY

CLASS 42—(Continued).

SN 77-724,862. EDL CONSULTING, LTD., WILMETTE, IL. FILED 4-29-2009.

EDLCONSULTING

THE MARK CONSISTS OF STANDARD CHARACTERS WITHOUT CLAIM TO ANY PARTICULAR FONT, STYLE, SIZE, OR COLOR.

FOR INFORMATION TECHNOLOGY CONSULTING SERVICES (U.S. CLS. 100 AND 101).

FIRST USE 7-1-2001; IN COMMERCE 7-1-2001.
MIDGE BUTLER, EXAMINING ATTORNEY

SN 77-725,080. ULTRAMAIN SYSTEMS, INC., ALBUQUERQUE, NM. FILED 4-29-2009.

ULTRAMAIN

THE MARK CONSISTS OF STANDARD CHARACTERS WITHOUT CLAIM TO ANY PARTICULAR FONT, STYLE, SIZE, OR COLOR.

OWNER OF U.S. REG. NOS. 1,624,629 AND 3,250,520.

FOR COMPUTER PROGRAMMING AND SOFTWARE DESIGN; COMPUTER SOFTWARE RENTAL; DESIGN FOR OTHERS IN THE FIELD OF COMPUTER NETWORKS, SOFTWARE, AND ENGINEERING FOR THE MANAGING OF MAINTENANCE AND LOGISTICS OPERATIONS IN THE FIELDS OF AVIATION, TRANSIT, PUBLIC TRANSPORTATION, EDUCATION, CHILD-CARE AND FACILITIES MAINTENANCE; DESIGN OF COMPUTER PROGRAMS AND SOFTWARE RELATING TO AIRCRAFT (U.S. CLS. 100 AND 101).

FIRST USE 10-18-1986; IN COMMERCE 10-18-1986.
DOUGLAS LEE, EXAMINING ATTORNEY

SN 77-725,161. MILENIA AGRO CIÊNCIAS S.A., LONDRI-NA, PR, BRAZIL, FILED 4-29-2009.

MS BIOSOLUTIONS

THE MARK CONSISTS OF STANDARD CHARACTERS WITHOUT CLAIM TO ANY PARTICULAR FONT, STYLE, SIZE, OR COLOR.

FOR RESEARCH AND DEVELOPMENT AND CONSULTATION RELATED THERETO IN THE FIELD OF PRODUCTS FOR INSECT AND DISEASE CONTROL, PRODUCTS FOR AGRICULTURAL USE, SANITARY PRODUCTS INCLUDING DETERGENTS AND SOAPS, PRODUCTS FOR VETERINARY USE, PRODUCTS USED IN GARDENING AND IN THE PROTECTION AND NUTRITION OF PLANTS (U.S. CLS. 100 AND 101).

CAROLINE WOOD, EXAMINING ATTORNEY

CLASS 42—(Continued).

SN 77-725,372. REVELATION GENERATION, INC., FLEMINGTON, NJ. FILED 4-29-2009.

CLASS 42—(Continued).

SN 77-725,458. KIDS THAT SMILE, JACKSON, NJ. FILED 4-29-2009.

BUILD YOUR REVGEN BAND

THE MARK CONSISTS OF STANDARD CHARACTERS WITHOUT CLAIM TO ANY PARTICULAR FONT, STYLE, SIZE, OR COLOR.

FOR DESIGN AND CREATION OF COMPUTER MODELED VERSIONS OF HUMAN BEINGS FOR USE IN INTERNET AND OTHER APPLICATIONS (U.S. CLS. 100 AND 101).

FIRST USE 4-15-2009; IN COMMERCE 4-15-2009.
MELISSA VALLILLO, EXAMINING ATTORNEY



Generating a smile, one personalized gift at a time!

SN 77-725,434. HARDING, DAN, SPRING HILL, TN. FILED 4-29-2009.

Blue Mile Design

THE MARK CONSISTS OF STANDARD CHARACTERS WITHOUT CLAIM TO ANY PARTICULAR FONT, STYLE, SIZE, OR COLOR.

NO CLAIM IS MADE TO THE EXCLUSIVE RIGHT TO USE "DESIGN", APART FROM THE MARK AS SHOWN.

FOR DESIGN AND DEVELOPMENT OF MULTIMEDIA PRODUCTS; GRAPHIC DESIGN SERVICES; PROVIDING GRAPHIC AND MULTIMEDIA DESIGN SERVICES FOR THE PURPOSE OF PROMOTING THE GOODS AND SERVICES OF OTHERS; WEB SITE DESIGN (U.S. CLS. 100 AND 101).

FIRST USE 1-1-2005; IN COMMERCE 1-1-2005.
DAVID C. REIHNER, EXAMINING ATTORNEY

THE STIPPLING IS FOR SHADING PURPOSES ONLY.

THE MARK CONSISTS OF THE WORDING "KIDS THAT SMILE GENERATING A SMILE, ONE PERSONALIZED GIFT AT A TIME" IN A STYLIZED FONT AND A DESIGN OF THREE HUMAN FIGURES TO THE RIGHT OF THE WORDS, A HUMAN MOUTH IN THE SHAPE OF A SMILE BELOW THE WORD "SMILE" AND A HEART OVER THE LETTER "I" IN "KIDS".

FOR CUSTOM DESIGN OF CDS, BOOKS, DVDS, POEM LETTERS, GROWTH CHARTS, ALARM CLOCKS, SINGING STUFFED ANIMALS, STORY BOOK CDS, WALL CLOCKS, WALL ARTS, INVITATIONS, CANDY WRAPPERS, WATER BOTTLE WRAPPERS, MINI WRAPPERS, OVER SIZE WRAPPERS, AND CUSTOM WRAPPERS BASED ON PERSONAL SELECTIONS MADE BY THE CUSTOMER (U.S. CLS. 100 AND 101).

RENEE MCCRAY, EXAMINING ATTORNEY

CLASS 42—(Continued).

SN 77-725,634. LEYVA, ALFONSO SOTO, TLALNEPANTLA, MEXICO, FILED 4-30-2009.



THE COLOR(S) YELLOW, RED, ORANGE, GREEN, TEAL, PURPLE, BLUE, PINK AND BLACK IS/ARE CLAIMED AS A FEATURE OF THE MARK.

THE MARKS CONSISTS OF THE WORDING "GEEHAA" IN THE COLORS YELLOW, RED, ORANGE, GREEN, TEAL, PURPLE, BLUE AND PINK TRANSITIONING IN COLOR FROM LEFT TO RIGHT. THE WORDING IS OUTLINED IN BLACK.

FOR APPLICATION SERVICE PROVIDER (ASP) FEATURING SOFTWARE FOR USE IN UPLOADING, POSTING, SHOWING, DISPLAYING, TAGGING, BLOGGING, SHARING OR OTHERWISE PROVIDING ELECTRONIC MEDIA OR INFORMATION OVER THE INTERNET OR OTHER COMMUNICATIONS NETWORK; COMPUTER SERVICES IN THE NATURE OF CUSTOMIZED WEB PAGES FEATURING USER-DEFINED INFORMATION, PERSONAL PROFILES AND INFORMATION; COMPUTER SERVICES, NAMELY, HOSTING ON-LINE WEB FACILITIES FOR OTHERS FOR ORGANIZING AND CONDUCTING ONLINE MEETINGS, GATHERINGS, AND INTERACTIVE DISCUSSIONS; HOSTING AN ON-LINE WEBSITE FEATURING AN ONLINE SOCIAL COMMUNITY FOR CHILDREN WHERE THEY CAN PRINCIPALLY MEET OTHER KIDS, FOR ENTERTAINMENT AND EDUCATIONAL PURPOSES; PROVIDING A WEBSITE THAT GIVES USERS THE ABILITY TO CREATE CUSTOMIZED WEB PAGES FEATURING USER-DEFINED INFORMATION; PROVIDING A WEBSITE THAT GIVES USERS THE ABILITY TO CREATE CUSTOMIZED WEB PAGES FEATURING USER-DEFINED PROFILES; PROVIDING TEMPORARY USE OF ON-LINE NON-DOWNLOADABLE SOFTWARE FOR POSTING AND READING CLASSIFIEDS, FOR CREATING AND MAINTAINING VIRTUAL COMMUNITIES, FOR SOCIAL NETWORKING, PHOTO SHARING, VIDEO SHARING, TRANSMISSION OF PHOTOGRAPHIC IMAGES, AND TRANSMISSION OF MESSAGES (U.S. CLS. 100 AND 101).

TARAH HARDY, EXAMINING ATTORNEY

SN 77-725,691. TRANSFORMING ARCHITECTURE, LLC, DBA TRANSFORMING ARCHITECTURE, HIGHLAND, MD. FILED 4-30-2009.

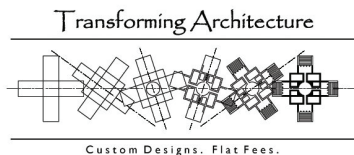

NO CLAIM IS MADE TO THE EXCLUSIVE RIGHT TO USE "ARCHITECTURE" AND "CUSTOM DESIGNS" AND "FLAT FEES", APART FROM THE MARK AS SHOWN.

THE MARK CONSISTS OF THE WORDS "TRANSFORMING ARCHITECTURE" OVER A HORIZONTAL LINE BENEATH WHICH IS A SERIES OF SIX REPRESENTATIONS OF ARCHITECTURAL DRAWINGS OVER ANOTHER HORIZONTAL LINE BENEATH WHICH ARE THE WORDS "CUSTOM DESIGNS." FLAT FEES."

FOR ARCHITECTURAL AND ENGINEERING SERVICES; ARCHITECTURAL CONSULTATION; ARCHITECTURAL DESIGN; CONSULTING SERVICES IN THE FIELD OF ARCHITECTURAL DESIGN (U.S. CLS. 100 AND 101).

JOHN WILKE, EXAMINING ATTORNEY

CLASS 42—(Continued).

SN 77-725,695. YOUNGDAHL CONSULTING GROUP, INC., EL DORADO HILLS, CA. FILED 4-30-2009.

Experience & Integrity You
Can Build On

THE MARK CONSISTS OF STANDARD CHARACTERS WITHOUT CLAIM TO ANY PARTICULAR FONT, STYLE, SIZE, OR COLOR.

FOR ENGINEERING (U.S. CLS. 100 AND 101).

FIRST USE 12-1-2008; IN COMMERCE 12-1-2008.

JIM RINGLE, EXAMINING ATTORNEY

SN 77-725,810. PENGCHENG ZHU, DBA CELLPRO, BRIGHTON, MA. FILED 4-30-2009.

CellPro

THE MARK CONSISTS OF STANDARD CHARACTERS WITHOUT CLAIM TO ANY PARTICULAR FONT, STYLE, SIZE, OR COLOR.

FOR BIOLOGICAL RESEARCH (U.S. CLS. 100 AND 101).

DOMINICK J. SALEMI, EXAMINING ATTORNEY

SN 77-726,186. AMERICAN INTERNATIONAL GROUP, INC., NEW YORK, NY. FILED 4-30-2009.

RETIREMENT ASSET DIRECTOR

THE MARK CONSISTS OF STANDARD CHARACTERS WITHOUT CLAIM TO ANY PARTICULAR FONT, STYLE, SIZE, OR COLOR.

NO CLAIM IS MADE TO THE EXCLUSIVE RIGHT TO USE "RETIREMENT ASSET", APART FROM THE MARK AS SHOWN.

FOR PROVIDING ON-LINE NON-DOWNLOADABLE SOFTWARE IN THE FIELD OF FINANCIAL ADVISORY SERVICES, NAMELY, SOFTWARE FOR ANALYZING INVESTMENT AND RETIREMENT INCOME NEEDS (U.S. CLS. 100 AND 101).

MARGARET POWER, EXAMINING ATTORNEY

CLASS 42—(Continued).

SN 77-726,609. ROSCA, ANDREW, STAMFORD, CT. FILED 4-30-2009.

CLASS 42—(Continued).

SN 77-727,314. TAYLOR JR, BRYAN J, MYRTLE BEACH, SC. FILED 5-1-2009.

PHOTOESCROW

THE MARK CONSISTS OF STANDARD CHARACTERS WITHOUT CLAIM TO ANY PARTICULAR FONT, STYLE, SIZE, OR COLOR.
FOR PROVIDING A WEB SITE THAT GIVES COMPUTER USERS THE ABILITY TO SAFELY AND SECURELY UPLOAD, EXCHANGE AND SHARE PHOTOS (U.S. CLS. 100 AND 101).
FIRST USE 7-30-2007; IN COMMERCE 7-30-2007.
MICHAEL SOUDERS, EXAMINING ATTORNEY

Kiss My Stats

THE MARK CONSISTS OF STANDARD CHARACTERS WITHOUT CLAIM TO ANY PARTICULAR FONT, STYLE, SIZE, OR COLOR.
FOR COMPUTER SERVICES, NAMELY, HOSTING AND MAINTAINING AN ON-LINE WEB SITE FOR OTHERS TO TRACK AND COMPARE PERSONAL HEALTH AND FITNESS STATISTICS (U.S. CLS. 100 AND 101).
FIRST USE 6-3-2006; IN COMMERCE 6-3-2006.
JOHN GARTNER, EXAMINING ATTORNEY

SN 77-727,597. PERFECTION HOME INSPECTION, INC., NAPERVILLE, IL. FILED 5-1-2009.

SN 77-727,252. ERVIN, LOVETT & MILLER, INC., JACKSONVILLE, FL. FILED 5-1-2009.

VideoSpection

THE MARK CONSISTS OF STANDARD CHARACTERS WITHOUT CLAIM TO ANY PARTICULAR FONT, STYLE, SIZE, OR COLOR.
FOR INSPECTIONS OF HOMES (U.S. CLS. 100 AND 101).
FIRST USE 4-25-2009; IN COMMERCE 4-25-2009.
KEVIN CORWIN, EXAMINING ATTORNEY

SN 77-727,634. AARON EDWARD TRAXLER, AKA RAVEN HEART, POLK, OH. FILED 5-2-2009.



Raven Heart Design

THE COLOR(S) RED AND WHITE IS/ARE CLAIMED AS A FEATURE OF THE MARK.
THE MARK CONSISTS OF A RED SQUARE WITHIN A THIN-LINED WHITE SQUARE WITHIN A THICKER-LINED RED SQUARE, WITH THE LETTERING "ELM" APPEARING IN WHITE IN LOWER CASE.
FOR ARCHITECTURAL DESIGN; CONSULTING SERVICES IN THE FIELD OF ARCHITECTURAL DESIGN; LANDSCAPE ARCHITECTURAL DESIGN (U.S. CLS. 100 AND 101).
FIRST USE 3-1-2009; IN COMMERCE 3-1-2009.
MATTHEW EINSTEIN, EXAMINING ATTORNEY

THE MARK CONSISTS OF STANDARD CHARACTERS WITHOUT CLAIM TO ANY PARTICULAR FONT, STYLE, SIZE, OR COLOR.
NO CLAIM IS MADE TO THE EXCLUSIVE RIGHT TO USE "DESIGN", APART FROM THE MARK AS SHOWN.
FOR GRAPHIC DESIGN SERVICES (U.S. CLS. 100 AND 101).
FIRST USE 1-1-2003; IN COMMERCE 6-6-2006.
KATINA MISTER, EXAMINING ATTORNEY

CLASS 42—(Continued).

SN 77-728,542. BUILDER RESOURCES, INC, LAKEWOOD, CO. FILED 5-4-2009.

BRI

THE MARK CONSISTS OF STANDARD CHARACTERS WITHOUT CLAIM TO ANY PARTICULAR FONT, STYLE, SIZE, OR COLOR.

FOR PROVIDING ONLINE NON-DOWNLOADABLE COMPUTER SOFTWARE FOR USE BY CONSTRUCTION COMPANIES TO ORGANIZE AND TRACK INFORMATION IN THE FIELD OF REBATE MANAGEMENT AND ADMINISTRATION (U.S. CLS. 100 AND 101).

FIRST USE 3-5-1991; IN COMMERCE 3-5-1991.

MICHAEL SOUDERS, EXAMINING ATTORNEY

SN 77-728,571. FORTIUSONE, INC., ARLINGTON, VA. FILED 5-4-2009.



OWNER OF U.S. REG. NO. 3,619,841.

THE MARK CONSISTS OF STYLIZED LETTERS "GC" IN WHITE INSIDE A BLACK CIRCLE FOLLOWED BY "GEOCOMMONS" IN STYLIZED LETTERS IN BLACK.

FOR COMPUTER SERVICE, NAMELY, ACTING AS AN APPLICATION SERVICE PROVIDER IN THE FIELD OF KNOWLEDGE MANAGEMENT TO HOST COMPUTER APPLICATION SOFTWARE FOR GEOSPATIAL DATA SHARING, DATA MANAGEMENT AND DATA STORAGE; PROVIDING TEMPORARY ON-LINE, NON-DOWNLOADABLE COMMUNITY INTERACTIVE SOFTWARE TOOLS FOR USERS OF GEOSPATIAL DATA; ON-LINE WEB APPLICATION SOFTWARE AND SERVICE PLATFORMS FOR INTERACTIVE OR PROGRAMMATIC ORGANIZATION AND ANALYSIS OF GEOSPATIAL DATA; PROVIDING ON-LINE, NON-DOWNLOADABLE SOFTWARE FOR USE IN ANALYZING, MANIPULATING AND MANAGING GEOGRAPHIC DATA; PROVIDING ON-LINE COMMUNITY PORTAL HOSTING (U.S. CLS. 100 AND 101).

FIRST USE 5-31-2007; IN COMMERCE 5-31-2007.

BILL DAWE, EXAMINING ATTORNEY

CLASS 42—(Continued).

SN 77-729,603. BUCK CONSULTANTS, LLC, NEW YORK, NY. FILED 5-5-2009.

MY MEDICARE ADVOCATE

THE MARK CONSISTS OF STANDARD CHARACTERS WITHOUT CLAIM TO ANY PARTICULAR FONT, STYLE, SIZE, OR COLOR.

NO CLAIM IS MADE TO THE EXCLUSIVE RIGHT TO USE "MEDICARE", APART FROM THE MARK AS SHOWN. FOR PROVIDING A WEBSITE FEATURING ON-LINE NON-DOWNLOADABLE SOFTWARE FOR COMPARING COMPANY AND GOVERNMENTAL HEALTH BENEFITS FOR EMPLOYEES AND RETIREES (U.S. CLS. 100 AND 101).

ZHALEH DELANEY, EXAMINING ATTORNEY

SN 77-729,627. BUCK CONSULTANTS, LLC, NEW YORK, NY. FILED 5-5-2009.

HELPING YOU MAKE THE RIGHT DECISIONS

THE MARK CONSISTS OF STANDARD CHARACTERS WITHOUT CLAIM TO ANY PARTICULAR FONT, STYLE, SIZE, OR COLOR.

FOR PROVIDING A WEBSITE FEATURING ON-LINE NON-DOWNLOADABLE SOFTWARE FOR COMPARING COMPANY AND GOVERNMENTAL HEALTH BENEFITS FOR EMPLOYEES AND RETIREES (U.S. CLS. 100 AND 101).

ZHALEH DELANEY, EXAMINING ATTORNEY

SN 77-730,811. SJ SEGUNDO HOLDING COMPANY, LLC, EL SEGUNDO, CA. FILED 5-6-2009.

COLOTIVITY

THE MARK CONSISTS OF STANDARD CHARACTERS WITHOUT CLAIM TO ANY PARTICULAR FONT, STYLE, SIZE, OR COLOR.

FOR BACK-UP SERVICES FOR COMPUTER HARD DRIVE DATA; COMPUTER COLOCATION SERVICES, NAMELY, PROVIDING FACILITIES FOR THE LOCATION OF COMPUTER SERVERS WITH THE EQUIPMENT OF OTHERS (U.S. CLS. 100 AND 101).

MICHELE SWAIN, EXAMINING ATTORNEY

CLASS 42—(Continued).

SN 77-732,571. CORVENTIS, INC., SAN JOSE, CA. FILED 5-8-2009.

PIIX POD

THE MARK CONSISTS OF STANDARD CHARACTERS WITHOUT CLAIM TO ANY PARTICULAR FONT, STYLE, SIZE, OR COLOR.

FOR COMPUTER SERVICES, NAMELY, PROVIDING ONLINE NON-DOWNLOADABLE SOFTWARE FOR RECEIVING, TRANSMITTING, PROCESSING, STORING AND DISPLAYING PATIENT MEDICAL DATA (U.S. CLS. 100 AND 101).

HAI-LY LAM, EXAMINING ATTORNEY

SN 77-735,864. E. I. DU PONT DE NEMOURS AND COMPANY, WILMINGTON, DE. FILED 5-13-2009.

TECHNOLOGY THAT FUELS

THE MARK CONSISTS OF STANDARD CHARACTERS WITHOUT CLAIM TO ANY PARTICULAR FONT, STYLE, SIZE, OR COLOR.

FOR SCIENTIFIC AND RESEARCH CONSULTATION IN THE FIELD OF FUELS, DIESEL FUEL, BIOFUEL AND BIODIESEL FUEL (U.S. CLS. 100 AND 101).

MARTHA FROMM, EXAMINING ATTORNEY

SN 77-737,161. NEWBURY CORPORATION, DEDHAM, MA. FILED 5-14-2009.

ND ACCESS

THE MARK CONSISTS OF STANDARD CHARACTERS WITHOUT CLAIM TO ANY PARTICULAR FONT, STYLE, SIZE, OR COLOR.

OWNER OF U.S. REG. NO. 2,688,324.

NO CLAIM IS MADE TO THE EXCLUSIVE RIGHT TO USE "ACCESS", APART FROM THE MARK AS SHOWN.

FOR PROVIDING ON-LINE NON-DOWNLOADABLE SOFTWARE FOR USE BY POLICY HOLDERS TO CREATE PERSONAL ACCOUNTS ON A WEB SITE FOR PURPOSES OF PROCESSING PERSONAL TRANSACTIONS IN THE FIELD OF PROPERTY AND CASUALTY INSURANCE (U.S. CLS. 100 AND 101).

CHARLES L. JENKINS, EXAMINING ATTORNEY

CLASS 42—(Continued).

SN 77-737,274. NEWBURY CORPORATION, DEDHAM, MA. FILED 5-14-2009.

MY INSURANCE

THE MARK CONSISTS OF STANDARD CHARACTERS WITHOUT CLAIM TO ANY PARTICULAR FONT, STYLE, SIZE, OR COLOR.

NO CLAIM IS MADE TO THE EXCLUSIVE RIGHT TO USE "INSURANCE", APART FROM THE MARK AS SHOWN.

FOR PROVIDING ON-LINE NON-DOWNLOADABLE SOFTWARE FOR USE BY POLICY HOLDERS TO CREATE PERSONAL ACCOUNTS ON A WEB SITE FOR PURPOSES OF PROCESSING PERSONAL TRANSACTIONS IN THE FIELD OF PROPERTY AND CASUALTY INSURANCE (U.S. CLS. 100 AND 101).

CHARLES L. JENKINS, EXAMINING ATTORNEY

SN 77-739,057. APPRISS INC., LOUISVILLE, KY. FILED 5-18-2009.

CHOICE

THE MARK CONSISTS OF STANDARD CHARACTERS WITHOUT CLAIM TO ANY PARTICULAR FONT, STYLE, SIZE, OR COLOR.

FOR COMPUTER SERVICES, NAMELY, ACTING AS AN APPLICATION SERVICE PROVIDER IN THE FIELD OF CRIMINAL OFFENDER AND VICTIM INFORMATION MANAGEMENT TO HOST COMPUTER APPLICATION SOFTWARE FOR SEARCHING AND RETRIEVING BY OTHERS OF INFORMATION AGGREGATED FROM OTHER DATABASES AND COMPUTER NETWORKS USED IN CRIMINAL JUSTICE AND LAW ENFORCEMENT (U.S. CLS. 100 AND 101).

HANNO RITTNER, EXAMINING ATTORNEY

SN 77-739,161. REAL TIME ANALYTICAL LLC, PHOENIX, AZ. FILED 5-18-2009.

HUDSPHERE

THE MARK CONSISTS OF STANDARD CHARACTERS WITHOUT CLAIM TO ANY PARTICULAR FONT, STYLE, SIZE, OR COLOR.

FOR COMPUTER PROGRAMMING; COMPUTER PROGRAMMING AND SOFTWARE DESIGN; COMPUTER PROGRAMMING CONSULTANCY; COMPUTER PROGRAMMING SERVICES, NAMELY, CONTENT CREATION FOR VIRTUAL WORLDS AND THREE DIMENSIONAL PLATFORMS; COMPUTER SOFTWARE CONSULTANCY; COMPUTER SOFTWARE DEVELOPMENT (U.S. CLS. 100 AND 101).

JENNIFER MARTIN, EXAMINING ATTORNEY

CLASS 42—(Continued).

SN 77-746,516. BUCK CONSULTANTS, LLC, NEW YORK, NY. FILED 5-28-2009.

3B

THE MARK CONSISTS OF STANDARD CHARACTERS WITHOUT CLAIM TO ANY PARTICULAR FONT, STYLE, SIZE, OR COLOR.

FOR PROVIDING ON-LINE NON-DOWNLOADABLE SOFTWARE FOR SELECTION AND COORDINATION OF INSURANCE VENDORS AND PLANNING, MANAGEMENT, ADMINISTRATION, AND IMPLEMENTATION OF EMPLOYEE BENEFIT PLANS (U.S. CLS. 100 AND 101).

FIRST USE 3-23-2009; IN COMMERCE 3-23-2009.
ZHALEH DELANEY, EXAMINING ATTORNEY

SN 77-760,445. CELL THERAPEUTICS, INC., SEATTLE, WA. FILED 6-16-2009.

CTI

THE MARK CONSISTS OF STANDARD CHARACTERS WITHOUT CLAIM TO ANY PARTICULAR FONT, STYLE, SIZE, OR COLOR.

OWNER OF U.S. REG. NOS. 1,919,206, 2,257,358 AND 2,674,894.

FOR RESEARCH AND DEVELOPMENT OF PHARMACEUTICAL PREPARATIONS; PRODUCT RESEARCH AND DEVELOPMENT FOR OTHERS IN THE FIELD OF PHARMACEUTICAL PREPARATIONS; PRODUCT RESEARCH AND DEVELOPMENT SERVICES, NAMELY, ASSESSING INTENDED TARGET RECIPIENTS OF PHARMACEUTICAL PREPARATIONS AND POSITIONING PHARMACEUTICAL PREPARATIONS FOR SUCCESS IN CLINICAL DEVELOPMENT AND COMMERCIAL USE; AND PROVIDING TECHNICAL CONSULTATION IN THE FIELD OF PHARMACEUTICAL PRODUCT RESEARCH AND DEVELOPMENT (U.S. CLS. 100 AND 101).

FIRST USE 0-0-1998; IN COMMERCE 0-0-1998.
TARAH HARDY, EXAMINING ATTORNEY

CLASS 42—(Continued).

SN 77-776,880. AFFECTIVA, INC., NEWTONVILLE, MA. FILED 7-8-2009.

AFFECTIVA

THE MARK CONSISTS OF STANDARD CHARACTERS WITHOUT CLAIM TO ANY PARTICULAR FONT, STYLE, SIZE, OR COLOR.

FOR SCIENTIFIC RESEARCH FOR OTHERS IN THE FIELD OF PHYSIOLOGICAL EXPRESSIONS AND SIGNALS; INDUSTRIAL RESEARCH FOR OTHERS IN THE FIELD OF PHYSIOLOGICAL EXPRESSIONS AND SIGNALS; PRODUCT RESEARCH AND DEVELOPMENT FOR OTHERS FEATURING SENSOR APPARATUS FOR MEASURING DEMONSTRATIVE PHYSIOLOGICAL EXPRESSIONS AND SIGNALS; DEVELOPMENT OF COMPUTER SOFTWARE FOR OTHERS FOR USE IN MEASURING, MONITORING, AND EVALUATING DEMONSTRATIVE DATA OF PHYSIOLOGICAL EXPRESSIONS AND SIGNALS (U.S. CLS. 100 AND 101).

MICHAEL TANNER, EXAMINING ATTORNEY

SN 77-977,548. RELIANT ENERGY RETAIL HOLDINGS, LLC, HOUSTON, TX. FILED 9-29-2008.

e-Sense

THE MARK CONSISTS OF LOWER CASE "E" FOLLOWED BY A DASH THE CAPITALIZED WORD "SENSE".

FOR UTILITY METER DATA MANAGEMENT AND ANALYSIS, NAMELY, PROVIDING IN-HOME POWER CONSUMPTION, ENVIRONMENTAL IMPACT ANALYSIS AND INSIGHT PROGRAMS TO CONSUMERS, INCLUDING DATA COMMUNICATIONS THROUGH ONLINE EMBEDDED DEVICE AND MOBILE APPLICATIONS; METERING AND MONITORING ELECTRIC POWER CONSUMPTION BY AND FOR RETAIL CUSTOMERS; NETWORKING OF HOME CONTROLS, NAMELY, WIRELESS AND WIRED LIGHTING CONTROLS, THERMOSTAT AND HEATING CONTROLS, ROLLING SHUTTERS AND DOOR CONTROLS, APPLIANCE CONTROLS, NAMELY, OVEN, WASHER, DRYER, REFRIGERATOR, DISHWASHER, LAWN AND GARDEN IRRIGATION CONTROLS, HOME AUDIO AND VIDEO CONTROLS; METERING AND MONITORING ENERGY COST AND USAGE; PROVIDING TEMPORARY USE OF NON-DOWNLOADABLE SOFTWARE FOR ASSESSING AND MONITORING HOUSEHOLD POWER CONSUMPTION, AND ENVIRONMENTAL IMPACT OF POWER CONSUMPTION AND GENERATION (U.S. CLS. 100 AND 101).

JOHN SCHUYLER YARD, EXAMINING ATTORNEY

CLASS 42—(Continued).

SN 78-962,143. RFIdea WORKS CORP., HAYMARKET, VA.
FILED 8-28-2006.

RFIdeaWorks

THE MARK CONSISTS OF STANDARD CHARACTERS WITHOUT CLAIM TO ANY PARTICULAR FONT, STYLE, SIZE, OR COLOR.

FOR DESIGN OF COMPUTER NETWORKS AND SOFTWARE FOR OTHERS FOR THE RADIO FREQUENCY IDENTIFICATION INDUSTRY (U.S. CLS. 100 AND 101).

FIRST USE 12-31-2003; IN COMMERCE 12-31-2003.
EDWARD NELSON, EXAMINING ATTORNEY

CLASS 42—(Continued).

POUNDS, MOLECULES, ANTIBODIES, EPITOPES, ANTIGENS, ENZYMES AND PROTEINS FOR USE IN INDUSTRY, PHARMACEUTICS, BIOTECHNOLOGY, DIAGNOSTICS, CHEMISTRY, COSMETICS, AGRICULTURE, AGROPROCESSING OR HUMAN OR VETERINARY DIAGNOSTICS; RESEARCH AND QUALITY CONTROL FOR DEVELOPING AND OPTIMIZING PROTEINS, ANTIBODIES, EPITOPES, ANTIGENS IN SCIENCE, INDUSTRY, PHARMACEUTICS, CHEMISTRY, COSMETICS, BIOTECHNOLOGY, DIAGNOSTICS, THE VETERINARY SECTOR AND AGRICULTURE; THE DEVELOPMENT AND OPTIMIZATION OF PRODUCTION PROCEDURES AND INDUSTRIAL EXPRESSION OF ENZYMES, AND PROTEINS; RESEARCH SERVICES, DEVELOPMENT SERVICES, PRODUCTION SERVICES, QUALITY CONTROL SERVICES AND CONSULTING FOR GENETIC AND MOLECULAR ENGINEERING IN SCIENCE, INDUSTRY, PHARMACEUTICS, CHEMISTRY, COSMETICS, BIOTECHNOLOGY, DIAGNOSTICS, THE VETERINARY SECTOR AND AGRICULTURE (U.S. CLS. 100 AND 101).

DEBRA LEE, EXAMINING ATTORNEY

SN 79-056,466. PROTEUS, FRANCE, FILED 12-12-2007.

IMMUNO'LINE

PRIORITY DATE OF 6-12-2007 IS CLAIMED.
OWNER OF INTERNATIONAL REGISTRATION 0971243
DATED 12-12-2007, EXPIRES 12-12-2017.

FOR RESEARCH SERVICES AND DEVELOPMENT FOR SCIENCE, PHARMACEUTICS, CHEMICALS, COSMETICS, BIOTECHNOLOGY, DIAGNOSTICS, IMMUNOLOGY, BIOCATALYSIS, BIO-PROCEDURES, THE VETERINARY SECTOR AND AGRICULTURE, NAMELY, DEVELOPMENT OF ASSAY FOR THE EVALUATION OF THE IMMUNOGENICITY OF BIOLOGICS FOR ANIMAL AND HUMAN BEINGS, AND TO EVALUATE THE SPECIFIC IMMUNE RESPONSE OF HUMAN T-CELLS; RESEARCH SERVICES AND DEVELOPMENT FOR INDUSTRY IN THE FIELDS OF HOME HEALTH CARE PRODUCTS, PHARMACEUTICALS, MEDICAL CLINICAL PRODUCTS, AND BIOLOGICAL PRODUCTS PERTAINING TO THE FIELD OF HEALTH CARE, SCIENCE, PHARMACEUTICS, CHEMICALS, COSMETICS, BIOTECHNOLOGY, DIAGNOSTICS, IMMUNOLOGY, BIOCATALYSIS, BIOPROCEDURES, VETERINARY SECTOR, ENVIRONMENTAL REMEDIATION, AGRICULTURE; PHARMACOLOGY RESEARCH; RESEARCH AND DEVELOPMENT OF CHEMICAL, BIOLOGICAL, BIOCHEMICAL, IMMUNOLOGICAL, ANALYSIS TECHNIQUES; RESEARCH AND DEVELOPMENT OF COMBINATORIAL CHEMISTRY TECHNIQUES, MOLECULAR BIOLOGY FOR USE IN INDUSTRY PHARMACEUTICS, BIOTECHNOLOGY, DIAGNOSTICS, CHEMISTRY, COSMETICS, AGRICULTURE, AGROPROCESSING OR VETERINARY DIAGNOSTICS OR DIAGNOSTICS FOR HUMANS; RESEARCH AND DEVELOPMENT OF CHEMICAL OR BIOLOGICAL COM-

SN 79-065,198. WEB ANNOUNCEMENTS LTD., UNITED KINGDOM, FILED 12-23-2008.

iannounce

OWNER OF INTERNATIONAL REGISTRATION 0993006
DATED 12-23-2008, EXPIRES 12-23-2018.

THE COLOR(S) BLUE AND DARK BLUE IS/ARE CLAIMED AS A FEATURE OF THE MARK.

THE LETTER "I" IS SHOWN IN DARK BLUE AND THE REMAINING LETTERS ARE SHOWN IN BLUE.

FOR DESIGN AND DEVELOPMENT OF COMPUTER SOFTWARE; CREATING, MAINTAINING AND HOSTING THE WEBSITES OF OTHERS; TECHNICAL WRITING FOR OTHERS, NAMELY, DESIGNING COMPUTER SOFTWARE FOR BUILDING WEBSITES; DESIGN OF COMPUTER WEBSITES FOR OTHERS; GRAPHIC DESIGN OF COMPUTER WEBSITE PAGES FOR OTHERS (U.S. CLS. 100 AND 101).

REBECCA SMITH, EXAMINING ATTORNEY

CLASS 43—HOTEL AND RESTAURANT SERVICES

SN 76-514,282. ACOSTA, EDWARD R., SAN ANTONIO, TX. FILED 5-15-2003.



L A S P A L A P A S

THE ENGLISH TRANSLATION OF "LAS PALAPAS" IS THE THATCH HUTS.
 FOR RESTAURANT, CATERING, AND PREPARED TAKE-OUT FOOD SERVICES (U.S. CLS. 100 AND 101).
 FIRST USE 12-0-1980; IN COMMERCE 12-0-1980.
 MARY ROSSMAN, EXAMINING ATTORNEY

SN 77-088,074. CLYDE BERNARD AND ASSOCIATES, INC., DELRAN, NJ. FILED 1-22-2007.



SEC. 2(F).
 FOR RESTAURANT AND PUB SERVICES (U.S. CLS. 100 AND 101).
 FIRST USE 1-1-1950; IN COMMERCE 1-1-1950.
 TRACY WHITTAKER-BROWN, EXAMINING ATTORNEY

CLASS 43—(Continued).

SN 77-088,084. CLYDE BERNARD ASSOCIATES, INC., DELRAN, NJ. FILED 1-22-2007.



THE COLOR(S) RED, WHITE, BLACK IS/ARE CLAIMED AS A FEATURE OF THE MARK.
 THE MARK CONSISTS OF THE WORD "OTT'S" IN A STYLIZED FORMAT, WITH RED LETTERING OUTLINED BY WHITE AND BLACK.
 SEC. 2(F).
 FOR RESTAURANT AND PUB SERVICES (U.S. CLS. 100 AND 101).
 FIRST USE 1-1-1950; IN COMMERCE 1-1-1950.
 TRACY WHITTAKER-BROWN, EXAMINING ATTORNEY

SN 77-132,170. PIZZERIA UNO CORPORATION, WILMINGTON, DE. FILED 3-15-2007.



OWNER OF U.S. REG. NOS. 1,329,014, 2,179,797 AND OTHERS.
 NO CLAIM IS MADE TO THE EXCLUSIVE RIGHT TO USE "CHICAGO GRILL EST. 1943", APART FROM THE MARK AS SHOWN.
 THE COLOR(S) RED, YELLOW, BLACK, GRAY, AND WHITE IS/ARE CLAIMED AS A FEATURE OF THE MARK.
 THE MARK CONSISTS OF THE WORD "UNO" IN RED, OUTLINED IN YELLOW, THEN WHITE, BLACK AND GRAY, AND IS LOCATED ABOVE THE WORDS "CHICAGO GRILL", WHICH ARE IN WHITE ON A BLACK BACKGROUND. THERE IS A HORIZONTAL WHITE LINE ABOVE AND BELOW THE WORDS "CHICAGO GRILL" AND A SERIES OF SHORT HORIZONTAL BARS ON EACH SIDE OF THE WORDS. PORTIONS OF THE WORDS "CHICAGO GRILL" AND OF THE HORIZONTAL LINES AND BARS HAVE GRAY SHADING. THE WORDS "EST. 1943" ARE IN BLACK.
 FOR CARRY-OUT RESTAURANTS; FAST-FOOD RESTAURANTS; RESTAURANT AND BAR SERVICES; TAKE-OUT RESTAURANT SERVICES (U.S. CLS. 100 AND 101).
 STEVEN PEREZ, EXAMINING ATTORNEY

CLASS 43—(Continued).

SN 77-245,311. B & C YOON INC., DBA HODORI RESTAURANT, LOS ANGELES, CA. FILED 8-2-2007.

CLASS 43—(Continued).

SN 77-340,726. GS ENTERPRISES LLC, SAN ANTONIO, TX. FILED 11-30-2007.



PEACE & LOVE

NO CLAIM IS MADE TO THE EXCLUSIVE RIGHT TO USE THE NON-LATIN CHARACTERS THAT MEAN "KOREAN RESTAURANT" AND "KOREAN RESTAURANT" IN ENGLISH, APART FROM THE MARK AS SHOWN.

THE COLOR(S) RED, YELLOW, BLUE, BLACK, WHITE, AND ORANGE IS/ARE CLAIMED AS A FEATURE OF THE MARK.

THE MARK CONSISTS OF A STYLIZED BABY TIGER IN A CIRCLE IN ORANGE, THE TWO WHITE KOREAN CHARACTERS IN RED OVAL, THE THREE RED KOREAN CHARACTERS NEXT TO THE THREE WHITE KOREAN CHARACTERS IN A RED SQUARE, WITH ENGLISH WORDING "HODORI" IN YELLOW, THE ENGLISH WORDING "KOREAN RESTAURANT" IN WHITE IN A BLACK RECTANGLE WITH A PAIR OF BANNERS IN RED, YELLOW AND BLUE AS THE BORDER ON TOP AND BOTTOM OF THE WORDING AND DESIGN WITH THE COLOR WHITE AS THE BACKGROUND.

THE ENGLISH TRANSLATION OF "HODORI" IN THE MARK IS BABY TIGER IN ENGLISH.

THE NON-LATIN CHARACTERS IN THE MARK TRANSLITERATE TO "HODORI" AND THIS MEANS BABY TIGER KOREAN RESTAURANT IN ENGLISH.

FOR RESTAURANT SERVICES (U.S. CLS. 100 AND 101).

FIRST USE 1-1-1997; IN COMMERCE 1-1-1997.
SALLY SHIH, EXAMINING ATTORNEY

THE MARK CONSISTS OF STANDARD CHARACTERS WITHOUT CLAIM TO ANY PARTICULAR FONT, STYLE, SIZE, OR COLOR.

OWNER OF U.S. REG. NOS. 3,291,917 AND 3,291,918. FOR RESTAURANT SERVICES (U.S. CLS. 100 AND 101).

FIRST USE 12-19-2006; IN COMMERCE 12-19-2006.
SUSAN RICHARDS, EXAMINING ATTORNEY

SN 77-386,060. CLOUDNINE RESORTS, LLC, PARK CITY, UT. FILED 1-31-2008.

SN 77-291,230. THE WORLD ON YOUR PALATE, PHOENIX, AZ. FILED 9-28-2007.



THE COLOR(S) BLACK, GREY, BLUE AND WHITE IS/ARE CLAIMED AS A FEATURE OF THE MARK.

THE MARK CONSISTS OF A BLACK AND GREY PLATE, WITH A BLUE AND WHITE EARTH SITTING ON THE PLATE AND BESIDE IT THE WORDS IN BLUE, BLACK AND GREY, THE WORLD ON YOUR PALATE.

FOR RESTAURANT AND BAR SERVICES (U.S. CLS. 100 AND 101).

AMOS T. MATTHEWS, JR., EXAMINING ATTORNEY



NO CLAIM IS MADE TO THE EXCLUSIVE RIGHT TO USE "LODGE", APART FROM THE MARK AS SHOWN.

THE COLOR(S) BLACK, WHITE AND BLUE IS/ARE CLAIMED AS A FEATURE OF THE MARK.

THE MARK CONSISTS OF A BLACK RECTANGLE WITH THE WORDS "THE SKY LODGE". THE WORDS "THE" AND "LODGE" ARE WHITE AND THE WORD "SKY" IS BLUE.

FOR HOTEL AND RESORT HOTEL SERVICES; SPA SERVICES, NAMELY, PROVIDING TEMPORARY ACCOMMODATIONS AND MEALS TO CLIENTS OF A HEALTH AND BEAUTY SPA; RESTAURANT, BAR AND CATERING SERVICES (U.S. CLS. 100 AND 101).

FIRST USE 12-26-2007; IN COMMERCE 12-26-2007.
JACLYN KIDWELL, EXAMINING ATTORNEY

CLASS 43—(Continued).

SN 77-404,270. ACHIM'S FRANCHISING, LLC, ATHENS, GA. FILED 2-22-2008.

KEBA SPITFIRE GRILL

THE MARK CONSISTS OF STANDARD CHARACTERS WITHOUT CLAIM TO ANY PARTICULAR FONT, STYLE, SIZE, OR COLOR.

NO CLAIM IS MADE TO THE EXCLUSIVE RIGHT TO USE "GRILL", APART FROM THE MARK AS SHOWN. FOR RESTAURANT SERVICES (U.S. CLS. 100 AND 101).

SANI KHOURI, EXAMINING ATTORNEY

SN 77-412,626. ACHIM'S FRANCHISING, LLC, ATHENS, GA. FILED 3-4-2008.

KEBA
SPITFIRE GRILL

NO CLAIM IS MADE TO THE EXCLUSIVE RIGHT TO USE "GRILL", APART FROM THE MARK AS SHOWN. FOR RESTAURANT SERVICES (U.S. CLS. 100 AND 101).

SANI KHOURI, EXAMINING ATTORNEY

SN 77-432,204. LEITE, MARCELO S., MEXICO, D.F. 05109, MEXICO, FILED 3-26-2008.

Le Bras fogo

PRIORITY CLAIMED UNDER SEC. 44(D) ON MEXICO APPLICATION NO. 1017950, FILED 10-2-2007, REG. NO. 1017950, DATED 12-13-2007, EXPIRES 10-2-2017.

THE COLOR(S) GREEN, BLACK AND BROWN IS/ARE CLAIMED AS A FEATURE OF THE MARK.

THE MARK CONSISTS OF "LE BRAS" IN GREEN SCRIPT WITH A BROWN DIAGONAL LINE THROUGH THE "S" AND THE WORD "FOGO" ABOVE IT IN BLACK.

THE ENGLISH TRANSLATION OF "FOGO LE BRAS" IS "THE ARM FIRE."

FOR PROVIDING OF FOOD AND DRINK (U.S. CLS. 100 AND 101).

TINA BROWN, EXAMINING ATTORNEY

CLASS 43—(Continued).

SN 77-435,858. BLUM ENTERPRISES, LLC, WINTER PARK, FL. FILED 3-31-2008.

EAT WELL. FEEL WELL

THE MARK CONSISTS OF STANDARD CHARACTERS WITHOUT CLAIM TO ANY PARTICULAR FONT, STYLE, SIZE, OR COLOR.

FOR RESTAURANT SERVICES (U.S. CLS. 100 AND 101).

STEVEN PEREZ, EXAMINING ATTORNEY

SN 77-444,621. MILENKO PELES, DYER, IN. FILED 4-10-2008.

CHI-TOWN PIZZA

THE MARK CONSISTS OF STANDARD CHARACTERS WITHOUT CLAIM TO ANY PARTICULAR FONT, STYLE, SIZE, OR COLOR.

NO CLAIM IS MADE TO THE EXCLUSIVE RIGHT TO USE "PIZZA", APART FROM THE MARK AS SHOWN.

SEC. 2(F).

FOR FAST-FOOD RESTAURANTS AND SNACKBARS (U.S. CLS. 100 AND 101).

FIRST USE 4-3-2000; IN COMMERCE 4-3-2000.

SHANNON TWOHIG, EXAMINING ATTORNEY

SN 77-494,617. AMANRESORTS LIMITED, CENTRAL, HONG KONG, FILED 6-9-2008.

AMANGIRI

THE MARK CONSISTS OF STANDARD CHARACTERS WITHOUT CLAIM TO ANY PARTICULAR FONT, STYLE, SIZE, OR COLOR.

OWNER OF SINGAPORE REG. NO. T0815659D, DATED 12-11-2008, EXPIRES 12-11-2018.

THE ENGLISH TRANSLATION OF "AMAN" AND "GIRI" IN THE MARK IS PEACEFUL AND ROCK FORMATION RESPECTIVELY. THE WORDING "AMANGIRI" HAS NO MEANING IN A FOREIGN LANGUAGE.

FOR HOTELS; HOTEL SERVICES; HOTEL CATERING SERVICES; HOTEL ACCOMMODATION SERVICES; HOTEL RESTAURANT SERVICES; RESTAURANTS; RESTAURANT SERVICES; CAFES; CAFETERIA; SNACK BAR SERVICES; BAR SERVICES; FOOD AND DRINK CATERING; TEMPORARY ACCOMMODATION RESERVATIONS; RENTAL OF MEETING ROOMS; RESERVATION OF HOTEL ACCOMMODATION AND RESTAURANT SERVICES; INFORMATION, ADVISORY AND CONSULTANCY SERVICES RELATING TO ALL THE AFORESAID SERVICES (U.S. CLS. 100 AND 101).

JUSTINE D. PARKER, EXAMINING ATTORNEY

CLASS 43—(Continued).

SN 77-520,899. MOLNAR, JAYNE E., DBA ONE LUCKY PUP, INC., CHARLOTTE, NC. FILED 7-13-2008.



NO CLAIM IS MADE TO THE EXCLUSIVE RIGHT TO USE "PUP INC." AND "DOG DAYCARE & BOARDING", APART FROM THE MARK AS SHOWN.

THE STIPPLING IS A FEATURE OF THE MARK; THE STIPPLING IS FOR SHADING PURPOSES ONLY.

THE COLOR(S) RED, BLACK AND WHITE IS/ARE CLAIMED AS A FEATURE OF THE MARK.

THE MARK CONSISTS OF A DESIGN OF A DOG WEARING A COLLAR. THE WORDING "ONE LUCKY PUP INC. DOG DAYCARE & BOARDING" APPEARS IN STYLIZED FONT TO THE RIGHT OF THE DOG DESIGN. THE WORDING "ONE LUCKY PUP INC." IS UNDERLINED. THE COLOR BLACK APPEARS IN THE OUTLINE OF THE DOG, IN THE DOG'S NOSE, EYES, MOUTH, AND OUTLINE OF ITS TONGUE, AND IN THE WORDING "ONE LUCKY PUP INC. DOG DAYCARE & BOARDING". THE COLOR RED APPEARS IN THE DOG'S COLLAR AND IN THE UNDERLINED DESIGN. THE COLOR WHITE APPEARS WITHIN THE DESIGN OF THE DOG.

FOR DAY CARE CENTERS (U.S. CLS. 100 AND 101).
CIMMERIAN COLEMAN, EXAMINING ATTORNEY

SN 77-550,301. B.A.R.M. INTERNATIONAL LIMITED, THE ARCADE, SINGAPORE, FILED 8-19-2008.

DIZZY GOAT

THE MARK CONSISTS OF STANDARD CHARACTERS WITHOUT CLAIM TO ANY PARTICULAR FONT, STYLE, SIZE, OR COLOR.

FOR PROVIDING TRAVEL LODGING INFORMATION SERVICES AND TRAVEL LODGING BOOKING AGENCY SERVICES FOR TRAVELERS AND TOURISTS; TRAVEL AGENCY SERVICES, NAMELY, MAKING RESERVATIONS AND BOOKINGS FOR TEMPORARY LODGING FOR TRAVELERS AND TOURISTS (U.S. CLS. 100 AND 101).

STEVEN R. FINE, EXAMINING ATTORNEY

CLASS 43—(Continued).

SN 77-587,196. SBE ENTERTAINMENT GROUP, LLC, LOS ANGELES, CA. FILED 10-7-2008.

SHARE LOVING SENTIMENT

THE MARK CONSISTS OF STANDARD CHARACTERS WITHOUT CLAIM TO ANY PARTICULAR FONT, STYLE, SIZE, OR COLOR.

FOR PROVIDING HOTEL SERVICES FOR PREFERRED CUSTOMERS; PROVIDING LUXURY HOTEL SERVICES FOR GUESTS; HOTEL, RESTAURANT AND BAR SERVICES; CATERING SERVICES; HOTEL SERVICES, NAMELY, PROVIDING IN-ROOM FOOD (U.S. CLS. 100 AND 101).

KIMBERLY PERRY, EXAMINING ATTORNEY

SN 77-587,218. SBE ENTERTAINMENT GROUP, LLC, LOS ANGELES, CA. FILED 10-7-2008.

STARE LONGINGLY SOUTHWARD

THE MARK CONSISTS OF STANDARD CHARACTERS WITHOUT CLAIM TO ANY PARTICULAR FONT, STYLE, SIZE, OR COLOR.

FOR PROVIDING HOTEL SERVICES FOR PREFERRED CUSTOMERS; PROVIDING LUXURY HOTEL SERVICES FOR GUESTS; HOTEL, RESTAURANT AND BAR SERVICES; CATERING SERVICES; HOTEL SERVICES, NAMELY, PROVIDING IN-ROOM FOOD (U.S. CLS. 100 AND 101).

KIMBERLY PERRY, EXAMINING ATTORNEY

SN 77-587,678. SBE ENTERTAINMENT GROUP, LLC, LOS ANGELES, CA. FILED 10-7-2008.

SHE LOOKS STUNNED

THE MARK CONSISTS OF STANDARD CHARACTERS WITHOUT CLAIM TO ANY PARTICULAR FONT, STYLE, SIZE, OR COLOR.

FOR PROVIDING HOTEL SERVICES FOR PREFERRED CUSTOMERS; PROVIDING LUXURY HOTEL SERVICES FOR GUESTS; HOTEL, RESTAURANT AND BAR SERVICES; CATERING SERVICES; HOTEL SERVICES, NAMELY, IN-ROOM FOOD SERVICES (U.S. CLS. 100 AND 101).

KIM MONINGHOFF, EXAMINING ATTORNEY

CLASS 43—(Continued).

SN 77-590,719. DEVON ENERGY CORPORATION, OKLAHOMA CITY, OK. FILED 10-10-2008.

COLCORD

THE MARK CONSISTS OF STANDARD CHARACTERS WITHOUT CLAIM TO ANY PARTICULAR FONT, STYLE, SIZE, OR COLOR.

SEC. 2(F).
FOR HOTEL, RESTAURANT AND BAR SERVICES (U.S. CLS. 100 AND 101).

FIRST USE 0-0-1910; IN COMMERCE 0-0-1910.
RUSS HERMAN, EXAMINING ATTORNEY

SN 77-591,695. SBE ENTERTAINMENT GROUP, LLC, LOS ANGELES, CA. FILED 10-13-2008.

SMOOCH LARGE SAILORS

THE MARK CONSISTS OF STANDARD CHARACTERS WITHOUT CLAIM TO ANY PARTICULAR FONT, STYLE, SIZE, OR COLOR.

FOR PROVIDING HOTEL SERVICES FOR PREFERRED CUSTOMERS; PROVIDING LUXURY HOTEL SERVICES FOR GUESTS; HOTEL, RESTAURANT AND BAR SERVICES; CATERING SERVICES; HOTEL SERVICES, NAMELY, IN-ROOM FOOD SERVICES (U.S. CLS. 100 AND 101).

KIM MONINGHOFF, EXAMINING ATTORNEY

SN 77-597,611. DISCO SUSHI, INC., NEW YORK, NY. FILED 10-22-2008.



THE MARK CONSISTS OF THE WORD "VINTAGE" ENCLOSED IN A RECTANGLE WITH A DESIGN OF A TREE ABOVE THE RECTANGLE. BELOW THE RECTANGLE IS THE WORDING "IRVING."

FOR RESTAURANT, BAR AND CATERING SERVICES (U.S. CLS. 100 AND 101).

FIRST USE 5-1-2008; IN COMMERCE 5-1-2008.
COURTNEY MCCORMICK, EXAMINING ATTORNEY

CLASS 43—(Continued).

SN 77-602,803. INFUSION INTERNATIONAL GENERAL TRADING CO. W.L.L., SAFAT, 13131, KUWAIT, FILED 10-29-2008.



NO CLAIM IS MADE TO THE EXCLUSIVE RIGHT TO USE "BURGER BOUTIQUE" AND THE ARABIC CHARACTERS IN THE MARK THAT TRANSLITERATE TO "BURGER BOUTIQUE" WHEN READ OR SPOKEN, APART FROM THE MARK AS SHOWN.

THE COLOR(S) RED IS/ARE CLAIMED AS A FEATURE OF THE MARK.

THE MARK CONSISTS OF THE LETTERS "B + F" IN DARK RED AND THE WORDS "BURGER BOUTIQUE" IN LIGHT RED BELOW THE LETTERS, AND BELOW THAT, ARABIC CHARACTERS IN LIGHT RED, CHOSEN FOR SOUNDING PHONETICALLY AS IF ENGLISH WHEN SPOKEN OR READ, NAMELY, SOUNDING LIKE "BURGER BOUTIQUE"

THE ARABIC CHARACTERS IN THE MARK TRANSLITERATE TO "BURGER BOUTIQUE," AND WERE CHOSEN TO SOUND PHONETICALLY THE SAME AS "BURGER BOUTIQUE." THE ARABIC CHARACTERS HAVE NO MEANING IN ARABIC THAT MIGHT BE TRANSLATED INTO ENGLISH.

FOR PROVIDING OF FOOD AND DRINK; RESTAURANT SERVICES; PROVIDING TEMPORARY ACCOMMODATION (U.S. CLS. 100 AND 101).

JILL C. ALT, EXAMINING ATTORNEY

SN 77-607,378. JENKO ENTERTAINMENT CORPORATION, STERLING, VA. FILED 11-4-2008.

MAHALO COVE

THE MARK CONSISTS OF STANDARD CHARACTERS WITHOUT CLAIM TO ANY PARTICULAR FONT, STYLE, SIZE, OR COLOR.

FOR RESTAURANT AND BAR SERVICES, AND A RELATED WEB SITE FEATURING INFORMATION ON FOOD, DRINKS AND ENTERTAINMENT PROVIDED AT A RESTAURANT AND BAR (U.S. CLS. 100 AND 101).

FIRST USE 11-3-2008; IN COMMERCE 11-3-2008.
MATTHEW KLINE, EXAMINING ATTORNEY

CLASS 43—(Continued).

SN 77-607,382. JENKO ENTERTAINMENT CORPORATION, STERLING, VA. FILED 11-4-2008.



THE COLOR(S) ORANGE, BLUE, BROWN, BLUE, GREEN, BEIGE, BLACK, WHITE AND PINK IS/ARE CLAIMED AS A FEATURE OF THE MARK.

THE MARK CONSISTS OF THE WORDING "MAHALO COVE" IN COMBINATION WITH A DESIGN COMPRISING A TROPICAL BEACH SCENE WITH A SETTING SUN. THE COLORS ORANGE AND PINK APPEAR IN THE SKY AND SUN ELEMENTS OF THE DESIGN AND IN REFLECTIONS ON THE WATER. THE WATER ELEMENT OF THE DESIGN IS PRIMARILY BLUE, WITH SOME WHITE, PINK AND ORANGE FOR REFLECTIVE EFFECT. THE COLOR GREEN APPEARS IN THE DISTANT LAND MASS, THE BIRDS HOVERING ABOVE THE BEACH, AND IN LEAVES AND BRUSH AROUND THE PERIMETER OF THE MARK. THE WORDING AND PART OF THE PERIMETER OF THE LOGO ARE PRIMARILY IN THE COLOR BROWN, WITH SOME BLACK. THE BEACH SAND IS IN BEIGE.

FOR RESTAURANT AND BAR SERVICES, AND A RELATED WEB SITE FEATURING INFORMATION ON FOOD, DRINKS AND ENTERTAINMENT PROVIDED AT A RESTAURANT AND BAR (U.S. CLS. 100 AND 101).
FIRST USE 11-3-2008; IN COMMERCE 11-3-2008.
MATTHEW KLINE, EXAMINING ATTORNEY

SN 77-607,398. JENKO ENTERTAINMENT CORPORATION, STERLING, VA. FILED 11-4-2008.



THE COLOR(S) BROWN, GRAY, GREEN AND YELLOW IS/ARE CLAIMED AS A FEATURE OF THE MARK.

THE MARK CONSISTS OF A TORTOISE DESIGN. THE BODY OF THE TORTOISE IS IN GREEN AND GRAY, AND THE SHELL IS BROWN WITH YELLOW FLECKS.

FOR RESTAURANT AND BAR SERVICES (U.S. CLS. 100 AND 101).
FIRST USE 11-3-2008; IN COMMERCE 11-3-2008.
MATTHEW KLINE, EXAMINING ATTORNEY

CLASS 43—(Continued).

SN 77-611,166. OLYMPIC SOCCER ACADEMY, LLC, SEATTLE, WA. FILED 11-10-2008.

OSA SOCCER ACADEMY

THE MARK CONSISTS OF STANDARD CHARACTERS WITHOUT CLAIM TO ANY PARTICULAR FONT, STYLE, SIZE, OR COLOR.

NO CLAIM IS MADE TO THE EXCLUSIVE RIGHT TO USE "SOCCER ACADEMY", APART FROM THE MARK AS SHOWN.

FOR PROVIDING TEMPORARY ACCOMMODATIONS; CAFETERIAS (U.S. CLS. 100 AND 101).
TINA BROWN, EXAMINING ATTORNEY

SN 77-612,785. OLYMPIC SOCCER ACADEMY, LLC, SEATTLE, WA. FILED 11-12-2008.



NO CLAIM IS MADE TO THE EXCLUSIVE RIGHT TO USE "SOCCER ACADEMY", APART FROM THE MARK AS SHOWN.

THE MARK CONSISTS OF THE LETTERS "OSA" IN A STYLIZED CURSIVE FONT WITH THE LETTER "S" AROUND A SOCCER BALL, AND THE WORDS "SOCCER", WITH A BLACK BOX AROUND IT, AND "ACADEMY" STACKED BELOW "OSA" AND THE SOCCER BALL.

FOR PROVIDING TEMPORARY ACCOMMODATIONS; CAFETERIAS (U.S. CLS. 100 AND 101).
TINA BROWN, EXAMINING ATTORNEY

SN 77-620,749. SARAYA CO., LTD., OSAKA, JAPAN, FILED 11-24-2008.

SEJUICED

THE MARK CONSISTS OF STANDARD CHARACTERS WITHOUT CLAIM TO ANY PARTICULAR FONT, STYLE, SIZE, OR COLOR.

FOR PROVIDING NON-ALCOHOLIC FOODS AND BEVERAGES (U.S. CLS. 100 AND 101).
BRIAN NEVILLE, EXAMINING ATTORNEY

CLASS 43—(Continued).

SN 77-621,350. SARAYA CO., LTD., OSAKA, JAPAN, FILED 11-25-2008.



THE COLOR(S) ORANGE, WHITE AND BLACK IS/ARE CLAIMED AS A FEATURE OF THE MARK.

THE MARK CONSISTS OF THE WORD "SEJUICED" IN A BLACK FONT WITH A HALF SLICE OF AN ORANGE THEREABOVE. TWO DROPS ARE SHOWN TO THE RIGHT OF THE ORANGE SLICE. THE OUTER RIND, TRIANGULAR SECTIONS OF THE SLICE AND THE TWO DROPS ARE ORANGE. THE TRIANGULAR SECTIONS ARE EACH BORDERED IN WHITE.

FOR PROVIDING NON-ALCOHOLIC FOODS AND BEVERAGES (U.S. CLS. 100 AND 101).

BRIAN NEVILLE, EXAMINING ATTORNEY

SN 77-627,774. HERBST GAMING, INC., LAS VEGAS, NV. FILED 12-5-2008.



NO CLAIM IS MADE TO THE EXCLUSIVE RIGHT TO USE "CASINO", APART FROM THE MARK AS SHOWN.

THE LIKENESS (OR, "PORTRAIT") IN THE MARK DOES NOT IDENTIFY A LIVING INDIVIDUAL.

THE COLOR(S) RED, WHITE, BLACK, BEIGE AND YELLOW IS/ARE CLAIMED AS A FEATURE OF THE MARK.

THE MARK CONSISTS OF THE DEPICTION OF A SHERIFF, WEARING A WHITE SHIRT, A RED TIE, A RED AND BLACK VEST WITH A YELLOW BADGE, A BLACK HAT, A BLACK MUSTACHE AND A BEIGE FACE AND HANDS, NEXT TO THE RED WORDS "TERRIBLE'S", OVER THE WORD "RAIL". THE WORDS "RAIL CITY" ARE RED WITH A WHITE BORDER AND A BLACK OUTLINE, OVER THE WORD "CASINO" IN WHITE AGAINST A BLACK OVAL BACKGROUND.

FOR COCKTAIL LOUNGES; RESORT HOTELS; RESTAURANT AND BAR SERVICES (U.S. CLS. 100 AND 101).

FIRST USE 1-1-2007; IN COMMERCE 1-1-2007.

TIMOTHY FINNEGAN, EXAMINING ATTORNEY

CLASS 43—(Continued).

SN 77-633,428. BUCA, INC., MINNEAPOLIS, MN. FILED 12-15-2008.



OWNER OF U.S. REG. NOS. 2,058,534, 3,155,109 AND OTHERS.

NO CLAIM IS MADE TO THE EXCLUSIVE RIGHT TO USE "TO GO", APART FROM THE MARK AS SHOWN.

THE COLOR(S) RED, YELLOW, GREEN, WHITE AND PINK IS/ARE CLAIMED AS A FEATURE OF THE MARK.

THE MARK CONSISTS OF THE WORD "BUCA" IN RED WITH A YELLOW INNER OUTLINE AND PINK LIGHT BULBS, THE WORDS "TO GO" IN WHITE LETTERING WITH A RED OUTLINE OVER A GREEN ARROW WITH A YELLOW OUTLINE AND PINK LIGHT BULBS, AND YELLOW LINES INDICATING MOTION.

THE ENGLISH TRANSLATION OF "BUCA" IN THE MARK IS CAVE OR CAVERN.

FOR RESTAURANT SERVICES (U.S. CLS. 100 AND 101).

FIRST USE 1-1-2004; IN COMMERCE 1-1-2004.

DAVID C. REIHNER, EXAMINING ATTORNEY

SN 77-646,429. MAX'S WORLD, INC., SAN FRANCISCO, CA. FILED 1-9-2009.



THE NAME "BILLY BERK" IDENTIFIES A LIVING INDIVIDUAL WHOSE CONSENT IS OF RECORD.

THE MARK CONSISTS OF STYLIZED WORDS "BILLY BERK'S".

FOR RESTAURANT AND BAR SERVICES (U.S. CLS. 100 AND 101).

FIRST USE 9-23-2008; IN COMMERCE 9-23-2008.

DOUGLAS LEE, EXAMINING ATTORNEY

CLASS 43—(Continued).

SN 77-647,468. MAX'S WORLD, INC., SAN FRANCISCO, CA.
FILED 1-12-2009.

BILLY BERK'S

THE MARK CONSISTS OF STANDARD CHARACTERS WITHOUT CLAIM TO ANY PARTICULAR FONT, STYLE, SIZE, OR COLOR.

THE NAME "BILLY BERK" IDENTIFIES A LIVING INDIVIDUAL WHOSE CONSENT IS OF RECORD.

FOR RESTAURANT AND BAR SERVICES (U.S. CLS. 100 AND 101).

FIRST USE 9-23-2008; IN COMMERCE 9-23-2008.
DOUGLAS LEE, EXAMINING ATTORNEY

SN 77-670,448. EMM GROUP HOLDINGS LLC, NEW YORK, NY. FILED 2-13-2009.

ABE & ARTHUR'S

THE MARK CONSISTS OF STANDARD CHARACTERS WITHOUT CLAIM TO ANY PARTICULAR FONT, STYLE, SIZE, OR COLOR.

THE NAME(S), PORTRAIT(S), AND/OR SIGNATURE(S) SHOWN IN THE MARK DOES NOT IDENTIFY A PARTICULAR LIVING INDIVIDUAL.

FOR RESTAURANT SERVICES (U.S. CLS. 100 AND 101).

BARNEY CHARLON, EXAMINING ATTORNEY

SN 77-676,684. SCHEELS ALL SPORTS, INC., FARGO, ND.
FILED 2-24-2009.



THE MARK CONSISTS OF THE WORD "GRAMMA" WITH THE WORD "GINNA'S" DIRECTLY BENEATH, WITH A SINGLE HEART-SHAPE IN FRONT OF THE TWO WORDS. THE HEART HAS A WAVY LINE OUT OF THE TOP, UNDERLINING THE WHOLE MARK.

FOR CAFE AND RESTAURANT SERVICES (U.S. CLS. 100 AND 101).

FIRST USE 8-1-2006; IN COMMERCE 8-1-2006.
GINA FINK, EXAMINING ATTORNEY

CLASS 43—(Continued).

SN 77-678,922. COLD STONE CREAMERY, INC., SCOTTSDALE, AZ. FILED 2-26-2009.



OWNER OF U.S. REG. NOS. 1,968,506, 2,779,570 AND OTHERS.

NO CLAIM IS MADE TO THE EXCLUSIVE RIGHT TO USE "CREAMERY", APART FROM THE MARK AS SHOWN.

THE COLOR(S) RED, YELLOW AND WHITE IS/ARE CLAIMED AS A FEATURE OF THE MARK.

THE MARK CONSISTS OF THE WORDS "COLD STONE CREAMERY" WITH AN ICE CREAM CONE DESIGN SUPERIMPOSED ON A ROUND MEDALLION DESIGN POSITIONED TO THE RIGHT OF THE WORDS. THE COLOR RED APPEARS IN THE WORDS AND IN THE SWIRLED BACKGROUND MEDALLION AND THE TOPPING PORTION OF THE ICE CREAM CONE; THE COLOR YELLOW APPEARS IN AN OVAL SURROUNDING THE WORD "CREAMERY", IN THE CONE, IN THE DROPLETS ABOVE THE ICE CREAM, IN A BORDER AROUND THE ROUND MEDALLION AND IN SHADOWING OF THE WORDS "COLD STONE"; THE COLOR WHITE APPEARS IN THE TOPPING PORTION OF THE ICE CREAM CONE.

FOR RESTAURANT SERVICES; RESTAURANT SERVICES FEATURING ICE CREAM, FROZEN YOGURT, SORBETS AND OTHER FROZEN CONFECTIONS, NAMELY, ICE CREAM, FROZEN YOGURT, AND SORBETS CUSTOM-BLENDED WITH MIX-INS SUCH AS CANDY, FRUITS, AND NUTS, ICE-CREAM PIES, ICE-CREAM CAKES, WAFFLE CONES, WAFFLE BOWLS, SUNDAES, SHAKES, MALTS, SMOOTHIES, AND FROZEN DRINKS (U.S. CLS. 100 AND 101).

FIRST USE 7-1-2002; IN COMMERCE 7-1-2002.
MEGHAN REINHART, EXAMINING ATTORNEY

SN 77-683,509. COOKING WITH CAITLIN, LLC, CINCINNATI, OH. FILED 3-4-2009.

COOKING WITH CAITLIN

THE MARK CONSISTS OF STANDARD CHARACTERS WITHOUT CLAIM TO ANY PARTICULAR FONT, STYLE, SIZE, OR COLOR.

NO CLAIM IS MADE TO THE EXCLUSIVE RIGHT TO USE "COOKING", APART FROM THE MARK AS SHOWN.

THE NAME(S), PORTRAIT(S), AND/OR SIGNATURE(S) SHOWN IN THE MARK IDENTIFIES "CAITLIN" MACEACHEN STEININGER, WHOSE CONSENT(S) TO REGISTER IS MADE OF RECORD.

FOR CATERING; PROVIDING A DATABASE IN THE FIELD OF RECIPES AND COOKING INFORMATION (U.S. CLS. 100 AND 101).

FIRST USE 7-14-2008; IN COMMERCE 7-14-2008.
ROBIN CHOSID, EXAMINING ATTORNEY

CLASS 43—(Continued).

SN 77-697,051. FALBO BROS PIZZERIA, INC., MADISON, WI. FILED 3-23-2009.

FALBO BROS. PIZZERIA

THE MARK CONSISTS OF STANDARD CHARACTERS WITHOUT CLAIM TO ANY PARTICULAR FONT, STYLE, SIZE, OR COLOR.

NO CLAIM IS MADE TO THE EXCLUSIVE RIGHT TO USE "BROS. PIZZERIA", APART FROM THE MARK AS SHOWN.

SEC. 2(F).

FOR RESTAURANT SERVICES; RESTAURANTS FEATURING HOME DELIVERY; TAKE-OUT RESTAURANT SERVICES; RESTAURANTS FEATURING PIZZA, SANDWICHES, AND SALADS (U.S. CLS. 100 AND 101).

FIRST USE 0-0-1992; IN COMMERCE 0-0-1992.

ELLEN BURNS, EXAMINING ATTORNEY

CLASS 43—(Continued).

SN 77-697,711. JONATHAN P FRITZ, SALIDA, CO. FILED 3-24-2009.



THE MARK CONSISTS OF THE STYLIZED WORD "SIMPLE" AGAINST A MOUNTAIN PEAK BACKGROUND. THE LETTER "I" IN THE WORD "SIMPLE" IS SHAPED LIKE A BUILDING.

FOR TOURIST HOSTELS (U.S. CLS. 100 AND 101).

FIRST USE 1-1-2007; IN COMMERCE 2-1-2007.

KIM SAITO, EXAMINING ATTORNEY

SN 77-700,906. TEAM KID CARE NFP, INC., OAK PARK, IL. FILED 3-27-2009.

TEAM KID CARE

THE MARK CONSISTS OF STANDARD CHARACTERS WITHOUT CLAIM TO ANY PARTICULAR FONT, STYLE, SIZE, OR COLOR.

NO CLAIM IS MADE TO THE EXCLUSIVE RIGHT TO USE "KID CARE", APART FROM THE MARK AS SHOWN.

FOR CHARITABLE SERVICES, NAMELY, PROVIDING RESPITE DAY CARE TO CHILDREN WITH SERIOUS MEDICAL CONDITIONS AND THEIR FAMILIES (U.S. CLS. 100 AND 101).

FIRST USE 1-1-2009; IN COMMERCE 1-1-2009.

AMOS T. MATTHEWS, JR., EXAMINING ATTORNEY

SN 77-697,352. IMPERIAL PALACE OF MISSISSIPPI, LLC, AKA IP CASINO RESORT SPA, BILOXI, MS. FILED 3-23-2009.

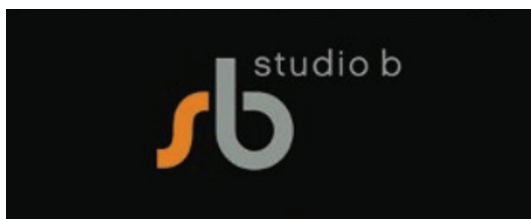

THE COLOR(S) ORANGE AND GRAY IS/ARE CLAIMED AS A FEATURE OF THE MARK.

THE MARK CONSISTS OF LOWER CASE LETTERS "SB" WITH THE "S" BEING ORANGE IN COLOR AND THE "B" GRAY IN COLOR; UP AND TO THE RIGHT OF THE LETTERS "SB" ARE THE WORDS "STUDIO B", ALL IN LOWER CASE AND GRAY IN COLOR. THE COLOR BLACK REPRESENTS BACKGROUND AND IS NOT PART OF THE MARK.

FOR ARENA SERVICES, NAMELY, PROVIDING FACILITIES FOR SPORTS, CONCERTS, CONVENTIONS AND EXHIBITIONS (U.S. CLS. 100 AND 101).

FIRST USE 1-26-2009; IN COMMERCE 1-26-2009.

MICHAEL LITZAU, EXAMINING ATTORNEY

SN 77-704,987. PATRICK S. MOLAK, CORP, NEW BRAUNFELS, TX. FILED 4-2-2009.

JOSEPHINE ST.

THE MARK CONSISTS OF STANDARD CHARACTERS WITHOUT CLAIM TO ANY PARTICULAR FONT, STYLE, SIZE, OR COLOR.

SEC. 2(F).

FOR BAR AND RESTAURANT SERVICES (U.S. CLS. 100 AND 101).

FIRST USE 12-1-1979; IN COMMERCE 12-1-1979.

ELIZABETH KAJUBI, EXAMINING ATTORNEY

CLASS 43—(Continued).

SN 77-708,552. 2 GUYS AND PIE LLC, BONAIRE, GA. FILED 4-7-2009.

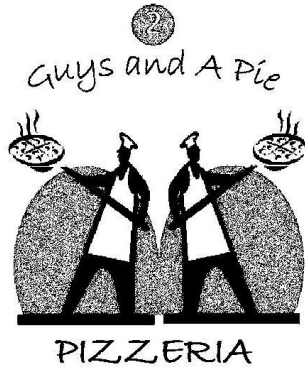

NO CLAIM IS MADE TO THE EXCLUSIVE RIGHT TO USE "PIZZERIA", APART FROM THE MARK AS SHOWN. THE MARK CONSISTS OF AN IMAGE OF TWO PIZZA MAKERS STANDING BACK TO BACK HOLDING UP A PIZZA. BELOW THE IMAGE IS THE STYLIZED WORD "PIZZERIA". ABOVE THE IMAGE IS THE STYLIZED WORDS "GUYS AND A PIE". ABOVE THE WORDS "GUYS AND A PIE" IS AN IMAGE OF A CIRCLE WITH THE STYLIZED NUMBER "2" INSIDE.

FOR RESTAURANT SERVICES (U.S. CLS. 100 AND 101).

FIRST USE 5-1-2008; IN COMMERCE 6-23-2008.
ANGELA M. MICHELI, EXAMINING ATTORNEY

SN 77-711,040. Z GOLF FOOD & BEVERAGE SERVICES, LLC, CAMARILLO, CA. FILED 4-9-2009.

Z GOLF FOOD & BEVERAGE SERVICES

THE MARK CONSISTS OF STANDARD CHARACTERS WITHOUT CLAIM TO ANY PARTICULAR FONT, STYLE, SIZE, OR COLOR.

NO CLAIM IS MADE TO THE EXCLUSIVE RIGHT TO USE "GOLF FOOD & BEVERAGE SERVICES", APART FROM THE MARK AS SHOWN.

FOR CONTRACT FOOD SERVICES FOR GOLF VENUES (U.S. CLS. 100 AND 101).

FIRST USE 1-1-1999; IN COMMERCE 1-1-1999.
MICHAEL WEBSTER, EXAMINING ATTORNEY

CLASS 43—(Continued).

SN 77-712,309. CLOTHESPIN ENTERPRISES, LLC, PHILADELPHIA, PA. FILED 4-13-2009.

THE AMERICAN PUB

THE MARK CONSISTS OF STANDARD CHARACTERS WITHOUT CLAIM TO ANY PARTICULAR FONT, STYLE, SIZE, OR COLOR.

NO CLAIM IS MADE TO THE EXCLUSIVE RIGHT TO USE "PUB", APART FROM THE MARK AS SHOWN.

FOR BAR AND RESTAURANT SERVICES (U.S. CLS. 100 AND 101).

CYNTHIA TRIPI, EXAMINING ATTORNEY

SN 77-717,614. FIAMMAROSSA LLC, NEW YORK, NY. FILED 4-20-2009.

Fiammarossa
Ristorante

NO CLAIM IS MADE TO THE EXCLUSIVE RIGHT TO USE "RISTORANTE", APART FROM THE MARK AS SHOWN.

THE MARK CONSISTS OF THE WORDS "FIAMMAROSSA RISTORANTE" IN THE DEPICTED FONT OR LOGO-TYPE.

THE ENGLISH TRANSLATION OF 'FIAMMAROSSA' IN THE MARK IS 'FLAMING ROSE' OR 'RED FLAME'. THE ENGLISH TRANSLATION OF RISTORANTE IN THE MARK IS RESTAURANT.

FOR RESTAURANT SERVICES (U.S. CLS. 100 AND 101).

MICHAEL WEBSTER, EXAMINING ATTORNEY

CLASS 43—(Continued).

SN 77-720,979. VITO, LAWRENCE S., SANTA ROSA, CA.
FILED 4-23-2009.



NO CLAIM IS MADE TO THE EXCLUSIVE RIGHT TO USE "THE DEPICTION OF THE UNIVERSAL PROHIBITION SYMBOL", APART FROM THE MARK AS SHOWN.

THE MARK CONSISTS OF THE TERM "FAUX QUE" IN STYLIZED LETTERING INSIDE THE UNIVERSAL PROHIBITION SYMBOL.

FOR RESTAURANT AND CATERING SERVICES (U.S. CLS. 100 AND 101).

FIRST USE 3-24-2008; IN COMMERCE 3-24-2008.
JIM RINGLE, EXAMINING ATTORNEY

SN 77-721,667. PACIFICA SENIOR LIVING LLC, SAN DIEGO, CA. FILED 4-24-2009.



NO CLAIM IS MADE TO THE EXCLUSIVE RIGHT TO USE "SENIOR LIVING", APART FROM THE MARK AS SHOWN.

THE MARK CONSISTS OF THE STYLIZED WORDS "PACIFICA SENIOR LIVING". AN IMAGE OF A STYLIZED LEAF ABOVE THE STYLIZED WORDS.

FOR PROVIDING ASSISTANCE, NAMELY, PROVIDING INFORMATION ABOUT ASSISTED LIVING FACILITIES TO SENIOR CITIZENS SEEKING TO DETERMINE ASSISTED LIVING FACILITIES APPROPRIATE FOR THEIR NEEDS; RETIREMENT HOMES (U.S. CLS. 100 AND 101).

FIRST USE 9-1-2008; IN COMMERCE 9-1-2008.
LEIGH CAROLINE CASE, EXAMINING ATTORNEY

CLASS 43—(Continued).

SN 77-721,700. OPP RESTAURANT, LLC, ATLANTA, GA.
FILED 4-24-2009.

LA PIETRA CUCINA

THE MARK CONSISTS OF STANDARD CHARACTERS WITHOUT CLAIM TO ANY PARTICULAR FONT, STYLE, SIZE, OR COLOR.

NO CLAIM IS MADE TO THE EXCLUSIVE RIGHT TO USE "CUCINA", APART FROM THE MARK AS SHOWN.

THE ENGLISH TRANSLATION OF "LA PIETRA CUCINA" IN THE MARK IS THE STONE KITCHEN.

FOR RESTAURANT (U.S. CLS. 100 AND 101).

FIRST USE 8-1-2008; IN COMMERCE 8-1-2008.
KRISTINA MORRIS, EXAMINING ATTORNEY

SN 77-721,886. DO NOT DISTURB D ASSOCIATES LLC, NEW YORK, NY. FILED 4-24-2009.

ZENTAN - DC

THE MARK CONSISTS OF STANDARD CHARACTERS WITHOUT CLAIM TO ANY PARTICULAR FONT, STYLE, SIZE, OR COLOR.

NO CLAIM IS MADE TO THE EXCLUSIVE RIGHT TO USE "DC", APART FROM THE MARK AS SHOWN.

THE ENGLISH TRANSLATION OF ZENTAN IN THE MARK IS SPY.

FOR RESTAURANT, BAR, AND COCKTAIL LOUNGE SERVICES (U.S. CLS. 100 AND 101).

ERNEST SHOSHO, EXAMINING ATTORNEY

SN 77-723,382. PIATTI RESTAURANT COMPANY, L.P., MILL VALLEY, CA. FILED 4-27-2009.

PIATTI

THE MARK CONSISTS OF STANDARD CHARACTERS WITHOUT CLAIM TO ANY PARTICULAR FONT, STYLE, SIZE, OR COLOR.

OWNER OF U.S. REG. NO. 1,965,343.

THE ENGLISH TRANSLATION OF "PIATTI" IN THE MARK IS PLATE OR DISH.

FOR RESTAURANT AND BAR SERVICES (U.S. CLS. 100 AND 101).

FIRST USE 10-30-1987; IN COMMERCE 10-30-1987.
CHRISTINE COOPER, EXAMINING ATTORNEY

CLASS 43—(Continued).

SN 77-723,627. ARK RESTAURANTS CORP., NEW YORK, NY. FILED 4-28-2009.

TAR BEACH

THE MARK CONSISTS OF STANDARD CHARACTERS WITHOUT CLAIM TO ANY PARTICULAR FONT, STYLE, SIZE, OR COLOR.

FOR RESTAURANT, BAR, COCKTAIL LOUNGE AND CATERING SERVICES, PROVIDING BANQUET AND SOCIAL FUNCTION FACILITIES FOR SPECIAL OCCASIONS, TAKE-OUT RESTAURANT SERVICES AND RESTAURANTS FEATURING HOME AND HOTEL ROOM DELIVERY (U.S. CLS. 100 AND 101).
KEVIN DINALLO, EXAMINING ATTORNEY

SN 77-723,653. SUPERTEL HOSPITALITY, INC., NORFOLK, NE. FILED 4-28-2009.

MASTERS INN

THE MARK CONSISTS OF STANDARD CHARACTERS WITHOUT CLAIM TO ANY PARTICULAR FONT, STYLE, SIZE, OR COLOR.

OWNER OF U.S. REG. NOS. 1,539,713, 2,152,378 AND 2,161,930.
NO CLAIM IS MADE TO THE EXCLUSIVE RIGHT TO USE "INN", APART FROM THE MARK AS SHOWN.
FOR HOTEL SERVICES (U.S. CLS. 100 AND 101).
FIRST USE 7-0-1987; IN COMMERCE 7-0-1987.
ROBIN MITTLER, EXAMINING ATTORNEY

SN 77-723,907. BANEY CORPORATION, DBA OXFORD HOTEL, BEND, OR. FILED 4-28-2009.

10 Below

THE MARK CONSISTS OF STANDARD CHARACTERS WITHOUT CLAIM TO ANY PARTICULAR FONT, STYLE, SIZE, OR COLOR.

FOR RESTAURANT AND BAR SERVICES (U.S. CLS. 100 AND 101).
LOURDES AYALA, EXAMINING ATTORNEY

CLASS 43—(Continued).

SN 77-723,960. AGGARWAL, SURINDER, MISSISSAUGA, CANADA, FILED 4-28-2009.

SWEET INDIA

THE MARK CONSISTS OF STANDARD CHARACTERS WITHOUT CLAIM TO ANY PARTICULAR FONT, STYLE, SIZE, OR COLOR.

NO CLAIM IS MADE TO THE EXCLUSIVE RIGHT TO USE "INDIA", APART FROM THE MARK AS SHOWN.
FOR RESTAURANT SERVICES, NAMELY, PROVIDING OF FOOD AND BEVERAGES FOR CONSUMPTION ON AND OFF THE PREMISES (U.S. CLS. 100 AND 101).
AMEEN IMAM, EXAMINING ATTORNEY

SN 77-724,175. MYSILVERSANDS LIMITED, BRISTOL BS48 2LN, UNITED KINGDOM, FILED 4-28-2009.

mysilversands.com

THE MARK CONSISTS OF STANDARD CHARACTERS WITHOUT CLAIM TO ANY PARTICULAR FONT, STYLE, SIZE, OR COLOR.

FOR TRAVEL AGENCY SERVICES, NAMELY, MAKING RESERVATIONS AND BOOKINGS FOR TEMPORARY ACCOMMODATIONS; HOTEL AND LODGING SERVICES, NAMELY, PROVIDING AND RELAYING INFORMATION AND SECURING PAYMENT IN CONNECTION WITH RESERVATIONS AND BOOKINGS FOR TEMPORARY ACCOMMODATIONS, VIA THE INTERNET (U.S. CLS. 100 AND 101).
FIRST USE 10-1-2006; IN COMMERCE 5-4-2007.
JOHN E. MICHOS, EXAMINING ATTORNEY

SN 77-724,657. WHG TM CORP., LAS VEGAS, NV. FILED 4-29-2009.

LOVE YOUR WEEKEND

THE MARK CONSISTS OF STANDARD CHARACTERS WITHOUT CLAIM TO ANY PARTICULAR FONT, STYLE, SIZE, OR COLOR.

FOR HOTEL MOTEL SERVICES MAKING LODGING RESERVATIONS FOR OTHERS (U.S. CLS. 100 AND 101).
FIRST USE 3-15-2009; IN COMMERCE 3-15-2009.
JANICE KIM, EXAMINING ATTORNEY

CLASS 43—(Continued).

SN 77-724,843. ALASKA WAFFLE HOUSE LLC, DBA DRINKER'S TAVERN, PHILADELPHIA, PA. FILED 4-29-2009.

Drinker's Tavern

THE MARK CONSISTS OF STANDARD CHARACTERS WITHOUT CLAIM TO ANY PARTICULAR FONT, STYLE, SIZE, OR COLOR.

NO CLAIM IS MADE TO THE EXCLUSIVE RIGHT TO USE "TAVERN", APART FROM THE MARK AS SHOWN.

FOR BAR AND RESTAURANT SERVICES (U.S. CLS. 100 AND 101).

FIRST USE 6-22-2002; IN COMMERCE 7-1-2002.

WANDA KAY PRICE, EXAMINING ATTORNEY

CLASS 43—(Continued).

SN 77-726,063. DALMAR CORPORATION, HAM LAKE, MN. FILED 4-30-2009.

CHANTICLEAR PIZZA

THE MARK CONSISTS OF STANDARD CHARACTERS WITHOUT CLAIM TO ANY PARTICULAR FONT, STYLE, SIZE, OR COLOR.

OWNER OF U.S. REG. NO. 2,706,728.

NO CLAIM IS MADE TO THE EXCLUSIVE RIGHT TO USE "PIZZA", APART FROM THE MARK AS SHOWN.

FOR RESTAURANT SERVICES (U.S. CLS. 100 AND 101).

FIRST USE 6-8-1995; IN COMMERCE 9-0-2001.

JAMES LOVELACE, EXAMINING ATTORNEY

SN 77-725,094. PIATTI RESTAURANT COMPANY, L.P., MILL VALLEY, CA. FILED 4-29-2009.



OWNER OF U.S. REG. NO. 1,965,343.
THE COLOR(S) RED AND WHITE IS/ARE CLAIMED AS A FEATURE OF THE MARK.

THE MARK CONSISTS OF THE WORDING "PIATTI" IN WHITE INSIDE A RECTANGLE IN RED.

THE ENGLISH TRANSLATION OF "PIATTI" IN THE MARK IS PLATE OR DISH.

FOR RESTAURANT AND BAR SERVICES (U.S. CLS. 100 AND 101).

FIRST USE 10-30-2006; IN COMMERCE 10-30-2006.

CHRISTINE COOPER, EXAMINING ATTORNEY

SN 77-726,095. DARDEN CONCEPTS, INC., ORLANDO, FL. FILED 4-30-2009.

THE BEST THINGS IN LIFE ARE FRESH

SN 77-725,425. FUZION FOOD GROUP USA, INC., SIOUX FALLS, SD. FILED 4-29-2009.

OOMPH!

THE MARK CONSISTS OF STANDARD CHARACTERS WITHOUT CLAIM TO ANY PARTICULAR FONT, STYLE, SIZE, OR COLOR.

FOR RESTAURANT AND BAR SERVICES (U.S. CLS. 100 AND 101).

ROBERT C. CLARK JR., EXAMINING ATTORNEY

THE MARK CONSISTS OF STANDARD CHARACTERS WITHOUT CLAIM TO ANY PARTICULAR FONT, STYLE, SIZE, OR COLOR.

NO CLAIM IS MADE TO THE EXCLUSIVE RIGHT TO USE "FRESH", APART FROM THE MARK AS SHOWN.

FOR RESTAURANT SERVICES (U.S. CLS. 100 AND 101).

LINDA E. BLOHM, EXAMINING ATTORNEY

CLASS 43—(Continued).

SN 77-726,132. HALL, WILLIAM R., DBA MELT SANDWICH SHOP, WHITE PLAINS, NY. FILED 4-30-2009.



NO CLAIM IS MADE TO THE EXCLUSIVE RIGHT TO USE "MELT SANDWICH SHOP", APART FROM THE MARK AS SHOWN.

THE COLOR(S) ORANGE, YELLOW, AND WHITE IS/ARE CLAIMED AS A FEATURE OF THE MARK.

THE MARK CONSISTS OF AN ORANGE BACKGROUND WITH THE LETTERS "M", "E", AND "T" IN UPPERCASE WHITE LETTERS, WITH THE LETTER "L" AND WORDS "SANDWICH" AND "SHOP" IN UPPERCASE YELLOW LETTERS. THE WHOLE IMAGE IS ON A DIAGONAL SLANTING UPWARDS FROM LEFT TO RIGHT. THE "L" HAS A GRAPHICAL ELEMENT OF A DRIP COMING DOWN FROM THE LOWER RIGHT CORNER OF THE LETTER.

FOR CAFE AND RESTAURANT SERVICES; CAFE-RESTAURANTS; CARRY-OUT RESTAURANTS; DELICATESSENS; PROVISION OF FOOD AND DRINK IN RESTAURANTS; RESTAURANT; RESTAURANT SERVICES; RESTAURANT SERVICES FEATURING SANDWICHES; RESTAURANT SERVICES, INCLUDING SIT-DOWN SERVICE OF FOOD AND TAKE-OUT RESTAURANT SERVICES; SERVING OF FOOD AND DRINK/BEVERAGES (U.S. CLS. 100 AND 101).

SAMUEL E. SHARPER JR., EXAMINING ATTORNEY

CLASS 43—(Continued).

SN 77-726,624. PIZZABOGO INTERNATIONAL, INC., AKRON, OH. FILED 4-30-2009.



OWNER OF U.S. REG. NO. 3,212,879.

NO CLAIM IS MADE TO THE EXCLUSIVE RIGHT TO USE "PIZZA", APART FROM THE MARK AS SHOWN.

THE MARK CONSISTS OF THE STYLIZED WORDS "PIZZA BOGO" ENCLOSED WITHIN A CONTRASTING RECTANGLE.

SEC. 2(F).

FOR CARRY-OUT RESTAURANTS; RESTAURANT; RESTAURANT SERVICES; RESTAURANT SERVICES FEATURING PIZZA; RESTAURANT SERVICES, NAMELY, PROVIDING OF FOOD AND BEVERAGES FOR CONSUMPTION ON AND OFF THE PREMISES; RESTAURANTS FEATURING HOME DELIVERY; TAKE-OUT RESTAURANT SERVICES (U.S. CLS. 100 AND 101).

FIRST USE 11-27-2007, THE MARK WAS FIRST USED ANYWHERE IN A DIFFERENT FORM OTHER THAN THAT SOUGHT TO BE REGISTERED AT LEAST AS EARLY AS 06/01/2005; IN COMMERCE 11-27-2007, THE MARK WAS FIRST USED IN COMMERCE IN A DIFFERENT FORM OTHER THAN THAT SOUGHT TO BE REGISTERED AT LEAST AS EARLY AS 06/01/2005.

INGRID C. EULIN, EXAMINING ATTORNEY

SN 77-726,740. EARLY ADVANTAGE ACADEMY, LLC, GRAND RAPIDS, MI. FILED 5-1-2009.

EARLY ADVANTAGE ACADEMY

THE MARK CONSISTS OF STANDARD CHARACTERS WITHOUT CLAIM TO ANY PARTICULAR FONT, STYLE, SIZE, OR COLOR.

NO CLAIM IS MADE TO THE EXCLUSIVE RIGHT TO USE "ACADEMY", APART FROM THE MARK AS SHOWN. FOR DAY AND AFTER SCHOOL CHILD CARE (U.S. CLS. 100 AND 101).

CHRISTOPHER BUONGIORNO, EXAMINING ATTORNEY

CLASS 43—(Continued).

SN 77-727,001. KORILLA BBQ, BAYSIDE, NY. FILED 5-1-2009.

BUN APPÉTIT

THE MARK CONSISTS OF STANDARD CHARACTERS WITHOUT CLAIM TO ANY PARTICULAR FONT, STYLE, SIZE, OR COLOR.

FOR RESTAURANT SERVICES; TAKE-OUT RESTAURANT SERVICES (U.S. CLS. 100 AND 101).
SUSAN LESLIE DUBOIS, EXAMINING ATTORNEY

SN 77-727,092. TURNING POINT MINISTRIES INTERNATIONAL, HOUSTON, TX. FILED 5-1-2009.

Somebody Cares

THE MARK CONSISTS OF STANDARD CHARACTERS WITHOUT CLAIM TO ANY PARTICULAR FONT, STYLE, SIZE, OR COLOR.

OWNER OF U.S. REG. NO. 2,083,594.
FOR EMERGENCY SHELTER SERVICES; SUPPLYING MEALS TO THE HOMELESS OR UNDERPRIVILEGED (U.S. CLS. 100 AND 101).
FIRST USE 6-10-1983; IN COMMERCE 6-10-1983.
SALLY SHIH, EXAMINING ATTORNEY

SN 77-727,810. PALM PAVILION, INC., CLEARWATER BEACH, FL. FILED 5-3-2009.

PALM PAVILION

THE MARK CONSISTS OF STANDARD CHARACTERS WITHOUT CLAIM TO ANY PARTICULAR FONT, STYLE, SIZE, OR COLOR.

FOR RESTAURANT AND BAR SERVICES (U.S. CLS. 100 AND 101).
FIRST USE 5-31-1926; IN COMMERCE 5-31-1926.
VIVIAN MICZNIK FIRST, EXAMINING ATTORNEY

CLASS 43—(Continued).

SN 77-727,879. KANA GIRL'S KATERING, BOISE, ID. FILED 5-3-2009.

Kana GIRL'S

FOR PREPARATION OF FOOD AND BEVERAGES (U.S. CLS. 100 AND 101).

DANNEAN HETZEL, EXAMINING ATTORNEY

SN 77-728,626. ROCKFISH SEAFOOD GRILL, INC., RICHARDSON, TX. FILED 5-4-2009.

ROCK YOUR ROUTINE!

THE MARK CONSISTS OF STANDARD CHARACTERS WITHOUT CLAIM TO ANY PARTICULAR FONT, STYLE, SIZE, OR COLOR.

FOR CATERING (U.S. CLS. 100 AND 101).
FIRST USE 3-26-2009; IN COMMERCE 3-26-2009.
JIM RINGLE, EXAMINING ATTORNEY

SN 77-741,835. MYSILVERSANDS LIMITED, BRISTOL, UNITED KINGDOM, FILED 5-21-2009.



THE MARK CONSISTS OF A SUN, WAVES AND TWO PALM TREES APPEARING ABOVE THE WORDS "MYSILVERSANDS.COM" AND A BEACH APPEARING BELOW THE WORDS.

FOR TRAVEL AGENCY SERVICES, NAMELY, MAKING RESERVATIONS AND BOOKINGS FOR TEMPORARY ACCOMMODATIONS; HOTEL AND LODGING SERVICES, NAMELY, PROVIDING AND RELAYING INFORMATION AND SECURING PAYMENT IN CONNECTION WITH RESERVATIONS AND BOOKINGS FOR TEMPORARY ACCOMMODATIONS, VIA THE INTERNET (U.S. CLS. 100 AND 101).

FIRST USE 10-1-2006; IN COMMERCE 5-4-2007.
JOHN E. MICHOS, EXAMINING ATTORNEY

CLASS 43—(Continued).

SN 77-757,510. DARDEN CONCEPTS, INC., ORLANDO, FL. FILED 6-11-2009.

KEEP LIFE FRESH

THE MARK CONSISTS OF STANDARD CHARACTERS WITHOUT CLAIM TO ANY PARTICULAR FONT, STYLE, SIZE, OR COLOR.

NO CLAIM IS MADE TO THE EXCLUSIVE RIGHT TO USE "FRESH", APART FROM THE MARK AS SHOWN.

FOR RESTAURANT SERVICES (U.S. CLS. 100 AND 101).

LINDA E. BLOHM, EXAMINING ATTORNEY

SN 78-328,821. MARRIOTT INTERNATIONAL, INC., BETHESDA, MD. FILED 11-17-2003.



OWNER OF U.S. REG. NOS. 742,101, 2,209,396 AND OTHERS.

NO CLAIM IS MADE TO THE EXCLUSIVE RIGHT TO USE "INN", APART FROM THE MARK AS SHOWN.

THE COLOR(S) RED, WHITE AND BLUE IS/ARE CLAIMED AS A FEATURE OF THE MARK.

THE MARK CONSISTS OF THE COLORS RED, WHITE, AND BLUE, WITH THE COLOR RED APPEARING IN THE BACKGROUND QUADRILATERAL DESIGN, THE COLOR BLUE APPEARING ON THE OVERLAYING QUADRILATERAL DESIGN, THE WORDING "FAIRFIELD INN MARRIOTT" AND THE CHEVRON DESIGN APPEARING IN WHITE.

FOR HOTEL SERVICES; RESTAURANT SERVICES PROVIDED IN HOTELS; PROVISION OF GENERAL PURPOSE FACILITIES IN HOTELS FOR MEETINGS, CONFERENCES AND EXHIBITIONS; PROVISION OF BANQUET AND SOCIAL FUNCTION FACILITIES IN HOTELS FOR SPECIAL OCCASIONS; AND RESERVATION SERVICES FOR HOTEL ACCOMMODATIONS FOR OTHERS (U.S. CLS. 100 AND 101).

FIRST USE 6-1-2003, THE MARK WAS FIRST USED ANYWHERE IN A DIFFERENT FORM OTHER THAN THAT SOUGHT TO BE REGISTERED AT LEAST AS EARLY AS 05/27/1959.; IN COMMERCE 6-1-2003, THE MARK WAS FIRST USED IN COMMERCE IN A DIFFERENT FORM OTHER THAN THAT SOUGHT TO BE REGISTERED AT LEAST AS EARLY AS 09/14/1960..

ANN E. SAPPENFIELD, EXAMINING ATTORNEY

CLASS 43—(Continued).

SN 79-061,526. UNILEVER N.V., NETHERLANDS, FILED 9-16-2008.

CHEFMANSHIP

THE MARK CONSISTS OF STANDARD CHARACTERS WITHOUT CLAIM TO ANY PARTICULAR FONT, STYLE, SIZE, OR COLOR.

PRIORITY DATE OF 5-13-2008 IS CLAIMED.

OWNER OF INTERNATIONAL REGISTRATION 0983578 DATED 9-16-2008, EXPIRES 9-16-2018.

FOR PROVIDING OF FOOD AND DRINK (U.S. CLS. 100 AND 101).

BONNIE LUKEN, EXAMINING ATTORNEY

SN 79-064,758. LA PIZZA LEGGERA S.R.L., ITALY, FILED 10-28-2008.



OWNER OF INTERNATIONAL REGISTRATION 0957649 DATED 12-21-2007, EXPIRES 12-21-2017.

NO CLAIM IS MADE TO THE EXCLUSIVE RIGHT TO USE "PIZZA LEGGERA", APART FROM THE MARK AS SHOWN.

THE COLOR(S) BLACK, RED AND WHITE IS/ARE CLAIMED AS A FEATURE OF THE MARK.

THE MARK CONSISTS OF A SIGN COMPOSED OF TWO QUADRILATERAL FIGURES OF IDENTICAL SIZE PLACED ONE BESIDE THE OTHER AND SLIGHTLY APART; THE RIGHT-HAND FIGURE IS BLACK WITH THE WORDING "PIZZA LEGGERA" IN WHITE FANCY CHARACTERS INSERTED INSIDE, PLACED ON TWO LINES AND WITH THE WORD "LEGGERA" OF A LARGER SIZE; THE FIGURE ON THE LEFT IS RED AND WITH A WHITE CIRCULAR RING INSERTED INSIDE.

THE ENGLISH TRANSLATION OF "LEGGERA" IN THE MARK IS LIGHT.

FOR RESTAURANTS; PIZZERIAS; TAKE-AWAY PIZZERIAS; SNACK-BARS; SELF-SERVICE RESTAURANTS; CATERING (U.S. CLS. 100 AND 101).

AISHA SALEM, EXAMINING ATTORNEY

SN 79-070,308. GRASSLAND PASTORAL; MEAL DEVELOPMENT; IN INNER MONGOLIA CO., LTD., CHINA, FILED 4-29-2009.

GRASSLAND PASTORAL

OWNER OF INTERNATIONAL REGISTRATION 0929140 DATED 5-21-2007, EXPIRES 5-21-2017.

FOR ACCOMMODATION BUREAU, NAMELY, MAKING RESERVATIONS FOR OTHERS FOR TEMPORARY HOUSING ACCOMMODATIONS; HOTELS; BOARDING HOUSES; CAFES, CANTEENS SERVICES, RESTAURANTS; PROVIDING HOLIDAY CAMPGROUND FACILITIES; BARS AND PUBS; RETIREMENT HOMES; TEA HOUSES; RESTAURANTS; RENTAL OF FOOD SERVICES ITEMS IN THE NATURE OF CHAIRS, TABLES, TABLE LINEN AND GLASSWARE; DAY CARE NURSERIES (U.S. CLS. 100 AND 101).

MIDGE BUTLER, EXAMINING ATTORNEY

CLASS 44—MEDICAL, BEAUTY AND AGRICULTURAL SERVICES

SN 76-689,285. TAPESTRY MEDICAL, INC., LIVERMORE, CA. FILED 5-5-2008.

TRIPLECHEK

THE MARK CONSISTS OF STANDARD CHARACTERS WITHOUT CLAIM TO ANY PARTICULAR FONT, STYLE, SIZE, OR COLOR.

FOR SERVICE PROVIDED TO A PHYSICIAN'S PATIENT ONLY AFTER PATIENT SATISFACTION, ADHERENCE TO THERAPY AND THE QUALITY OF THE SERVICE HAVE BEEN EVALUATED FOR ADHERENCE TO CLINICAL PROTOCOLS, NAMELY, COAGULATION MONITORING SERVICES (U.S. CLS. 100 AND 101).

KATHERINE CHANG, EXAMINING ATTORNEY

CLASS 44—(Continued).

SN 76-696,151. MCCORMACK, ED, BOCA RATON, FL. FILED 3-6-2009.



**Strength Balance
FOR SENIORS**

NO CLAIM IS MADE TO THE EXCLUSIVE RIGHT TO USE "FOR SENIORS", APART FROM THE MARK AS SHOWN.

THE MARK CONSISTS OF THE WORDING "STRENGTH BALANCE FOR SENIORS" AND A DESIGN OF A WINGED PERSON WITH A HALO OVER ITS HEAD AND CURVED RIBBON-LIKE BAR WRAPPED AROUND THE BODY.

FOR PHYSICAL THERAPY SERVICES (U.S. CLS. 100 AND 101).

FIRST USE 12-2-2008; IN COMMERCE 12-2-2008.

SKYE YOUNG, EXAMINING ATTORNEY

SN 76-689,286. TAPESTRY MEDICAL, INC., LIVERMORE, CA. FILED 5-5-2008.

SAFE-T-ZONE

THE MARK CONSISTS OF STANDARD CHARACTERS WITHOUT CLAIM TO ANY PARTICULAR FONT, STYLE, SIZE, OR COLOR.

FOR MEDICAL SERVICES, NAMELY, STABILIZING A PATIENT'S DRUG LEVEL USING THE RESULTS OBTAINED FROM ACTIVELY MONITORING THE PATIENT (U.S. CLS. 100 AND 101).

KATHERINE CHANG, EXAMINING ATTORNEY

SN 76-696,589. JOHNSTON HOLDINGS, INC., DRIFTWOOD, TX. FILED 3-31-2009.



**OAK WILT SPECIALISTS
of Texas**

NO CLAIM IS MADE TO THE EXCLUSIVE RIGHT TO USE "TEXAS", APART FROM THE MARK AS SHOWN.

SEC. 2(F) AS TO "OAK WILT SPECIALISTS" FOR TREE DISEASE TREATMENT AND PREVENTION (U.S. CLS. 100 AND 101).

FIRST USE 11-0-1999; IN COMMERCE 11-0-1999.

THOMAS MANOR, EXAMINING ATTORNEY

SN 76-694,205. REVIVE STUDIO, LLC, PORT JEFFERSON STATION, NY. FILED 11-13-2008.



Revive

Love Your Body NOW

THE MARK CONSISTS OF WORDING "REVIVE STUDIO LOVE YOUR BODY NOW" WITH A SILHOUETTE OF A PERSON FORMING THE "V".

FOR NUTRITIONAL COUNSELING SERVICES (U.S. CLS. 100 AND 101).

ROBERT STRUCK, EXAMINING ATTORNEY

SN 77-080,941. SWIERZEWSKI III, STANLEY J., HOLYOKE, MA. FILED 1-11-2007.

DERMIQUE

THE MARK CONSISTS OF STANDARD CHARACTERS WITHOUT CLAIM TO ANY PARTICULAR FONT, STYLE, SIZE, OR COLOR.

FOR SKIN CARE SALON SERVICES; HEALTH SPA SERVICES, NAMELY, COSMETIC BODY CARE SERVICES; HAIR SALON SERVICES, NAMELY, HAIRDRESSING SALON; COSMETIC ELECTROLYSIS SERVICES (U.S. CLS. 100 AND 101).

FIRST USE 1-5-2007; IN COMMERCE 1-5-2007.

DAVID MILLER, EXAMINING ATTORNEY

CLASS 44—(Continued).

SN 77-408,911. RICHARD VINCENT, RAVENNA, OH. FILED 2-28-2008.

GREAT HEALTH SOURCES

THE MARK CONSISTS OF STANDARD CHARACTERS WITHOUT CLAIM TO ANY PARTICULAR FONT, STYLE, SIZE, OR COLOR.

NO CLAIM IS MADE TO THE EXCLUSIVE RIGHT TO USE "HEALTH SOURCES", APART FROM THE MARK AS SHOWN.

FOR PROVIDING A WEBPAGE WITH LINK AND SOURCES FOR HEALTH IMPROVEMENT INFORMATION TARGETING INDIVIDUALS WHO ARE FORCED TO BE SEATED AND CONFINED TO THE SAME ROUTINE, NAMELY, TRUCK DRIVERS, PILOTS, AND OFFICE WORKERS (U.S. CLS. 100 AND 101).

LINDA MICKLEBURGH, EXAMINING ATTORNEY

SN 77-469,745. FACIAL ENHANCEMENTS, LLC, ATLANTA, GA. FILED 5-8-2008.

**Facial Enhancements, LLC
Where Medicine Meets Art**

THE MARK CONSISTS OF STANDARD CHARACTERS WITHOUT CLAIM TO ANY PARTICULAR FONT, STYLE, SIZE, OR COLOR.

NO CLAIM IS MADE TO THE EXCLUSIVE RIGHT TO USE "FACIAL ENHANCEMENTS, LLC", APART FROM THE MARK AS SHOWN.

FOR SKIN TREATMENT MAINLY INJECTIONS OF DERMAL FILLERS, DERMAL FILLER AGENTS AND NEUROMUSCULAR BLOCKING AGENTS TO REDUCE THE APPEARANCE OF FACIAL FINE LINES AND WRINKLES (U.S. CLS. 100 AND 101).

H. M. FISHER, EXAMINING ATTORNEY

SN 77-503,065. TRENT, INC., AURORA, CO. FILED 6-19-2008.

CASENET MANAGED CARE

THE MARK CONSISTS OF STANDARD CHARACTERS WITHOUT CLAIM TO ANY PARTICULAR FONT, STYLE, SIZE, OR COLOR.

NO CLAIM IS MADE TO THE EXCLUSIVE RIGHT TO USE "MANAGED CARE", APART FROM THE MARK AS SHOWN.

FOR MEDICAL ASSISTANCE SERVICES; MEDICAL COUNSELING; PROVIDING HEALTH INFORMATION; PROVIDING MEDICAL INFORMATION, CONSULTANCY AND ADVISORY SERVICES (U.S. CLS. 100 AND 101).

FIRST USE 1-1-1994; IN COMMERCE 1-1-1994.
ELIZABETH KAJUBI, EXAMINING ATTORNEY

CLASS 44—(Continued).

SN 77-541,160. NURSEFINDERS, INC., ARLINGTON, TX. FILED 8-7-2008.

SINGLE-SOURCE

THE MARK CONSISTS OF STANDARD CHARACTERS WITHOUT CLAIM TO ANY PARTICULAR FONT, STYLE, SIZE, OR COLOR.

OWNER OF U.S. REG. NO. 2,120,812.

SEC. 2(F).

FOR PROVIDING CLINICAL AND PATIENT CARE SERVICES (U.S. CLS. 100 AND 101).

PAUL E. FAHRENKOPF, EXAMINING ATTORNEY

SN 77-550,524. PRECISION RADIO THERAPY, LLC, WEST CHESTER, OH. FILED 8-19-2008.

PRECISION RADIO THERAPY

THE MARK CONSISTS OF STANDARD CHARACTERS WITHOUT CLAIM TO ANY PARTICULAR FONT, STYLE, SIZE, OR COLOR.

NO CLAIM IS MADE TO THE EXCLUSIVE RIGHT TO USE "RADIO THERAPY", APART FROM THE MARK AS SHOWN.

FOR MEDICAL SERVICES IN THE AREA OF RADIO THERAPY AND RADIOSURGERY FOR TUMORS AND OTHER ABNORMALITIES; MEDICAL SERVICES IN THE AREA OF TREATMENT OF VASCULAR MALFORMATIONS, TRIGEMINAL NEURALGIA, ACOUSTIC NEUROMAS AND PITUITARY ADENOMAS (U.S. CLS. 100 AND 101).

FIRST USE 9-1-2003; IN COMMERCE 9-1-2003.

KYLE PEETE, EXAMINING ATTORNEY

SN 77-558,141. KAO KABUSHIKI KAISHA, TA KAO CORPORATION, CHUO-KU, TOKYO, JAPAN, FILED 8-28-2008.

心 肌 体

SHIN-KI-TAI

PRIORITY CLAIMED UNDER SEC. 44(D) ON JAPAN APPLICATION NO. 2008-61599, FILED 7-28-2008, REG. NO. 5229801, DATED 5-15-2009, EXPIRES 5-15-2019.

THE MARK CONSISTS OF THE WORDING "SHIN-KI-TAI" BELOW JAPANESE CHARACTERS.

THE NON-LATIN CHARACTERS IN THE MARK TRANSLITERATE TO "SHIN KI TAI", WHICH HAS NO MEANING IN JAPANESE.

FOR BEAUTY SALONS; HAIRDRESSING SALONS (U.S. CLS. 100 AND 101).

CHARLOTTE CORWIN, EXAMINING ATTORNEY

CLASS 44—(Continued).

SN 77-560,249. ALLEGIANCE GROUP INCORPORATED, SANTA BARBARA, CA. FILED 9-2-2008.

Stag Canyon Vineyards

THE MARK CONSISTS OF STANDARD CHARACTERS WITHOUT CLAIM TO ANY PARTICULAR FONT, STYLE, SIZE, OR COLOR.

NO CLAIM IS MADE TO THE EXCLUSIVE RIGHT TO USE "VINEYARDS", APART FROM THE MARK AS SHOWN.

FOR VINEYARD AND WINERY SERVICES, NAMELY, THE CULTIVATION OF GRAPES FOR OTHERS (U.S. CLS. 100 AND 101).

KAREN K. BUSH, EXAMINING ATTORNEY

SN 77-576,387. YAMADA, JASON, TORRANCE, CA. FILED 9-23-2008.



THE MARK CONSISTS OF THE STYLIZED LETTERS "ISM". AN IMAGE OF A ARC OF THE STYLIZED LETTERS. FOR DENTIST SERVICES (U.S. CLS. 100 AND 101). FIRST USE 8-1-2006; IN COMMERCE 8-1-2007. ANN E. SAPPENFIELD, EXAMINING ATTORNEY

SN 77-583,248. CODAPEDIA, LLC., PHOENIX, MD. FILED 10-1-2008.

CODAPEDIA

THE MARK CONSISTS OF STANDARD CHARACTERS WITHOUT CLAIM TO ANY PARTICULAR FONT, STYLE, SIZE, OR COLOR.

FOR PROVIDING HEALTH CARE INFORMATION VIA THE INTERNET (U.S. CLS. 100 AND 101).

DAVID ELTON, EXAMINING ATTORNEY

CLASS 44—(Continued).

SN 77-589,677. ANDROJEK, INC., KANSAS CITY, MO. FILED 10-9-2008.

SDD

THE MARK CONSISTS OF STANDARD CHARACTERS WITHOUT CLAIM TO ANY PARTICULAR FONT, STYLE, SIZE, OR COLOR.

FOR MEDICAL SERVICES, NAMELY, CLINICAL DIAGNOSTIC SERVICES IN THE NATURE OF MONITORING DECONDENSATION OF HUMAN SPERM DNA AFTER A DEFINED INCUBATION PERIOD; MEDICAL SERVICES, NAMELY, CLINICAL DIAGNOSTIC TESTING SERVICES; MEDICAL DIAGNOSTIC TESTING, MONITORING AND REPORTING SERVICES (U.S. CLS. 100 AND 101).

B. PARADEWELAI, EXAMINING ATTORNEY

SN 77-592,619. ORALECT LICENSING, LTD., PLANO, TX. FILED 10-14-2008.



OWNER OF U.S. REG. NOS. 2,130,607, 3,044,111 AND OTHERS.

NO CLAIM IS MADE TO THE EXCLUSIVE RIGHT TO USE "STRAIGHT TEETH", APART FROM THE MARK AS SHOWN.

THE MARK CONSISTS OF THE WORDING "FASTBRACES" AND "STRAIGHT TEETH" IN A CIRCULAR SEAL WITH THE DESIGN OF A SMILING TRIANGLE THEREIN.

FOR DENTIST SERVICES; ORTHODONTIC SERVICES (U.S. CLS. 100 AND 101).

FIRST USE 10-10-2008; IN COMMERCE 10-10-2008.

RONALD MCMORROW, EXAMINING ATTORNEY

CLASS 44—(Continued).

SN 77-599,065. DR. PHILLIP B. BANDEL, PARIS, TX. FILED 10-23-2008.

NuLook Dermatology

THE MARK CONSISTS OF STANDARD CHARACTERS WITHOUT CLAIM TO ANY PARTICULAR FONT, STYLE, SIZE, OR COLOR.

NO CLAIM IS MADE TO THE EXCLUSIVE RIGHT TO USE "DERMATOLOGY", APART FROM THE MARK AS SHOWN.

FOR MEDICAL SERVICES, NAMELY, DERMATOLOGICAL CONSULTATION (U.S. CLS. 100 AND 101).

FIRST USE 2-1-2008; IN COMMERCE 2-1-2008.
CAROLINE WOOD, EXAMINING ATTORNEY

SN 77-599,073. DR. PHILLIP B. BANDEL, PARIS, TX. FILED 10-23-2008.



NO CLAIM IS MADE TO THE EXCLUSIVE RIGHT TO USE "DERMATOLOGY OF PARIS", APART FROM THE MARK AS SHOWN.

THE MARK CONSISTS OF THE STYLIZED WORD "NULOOK" IN WHICH THE FIRST "O" IS THE COMMONLY ACCEPTED SYMBOLIC REPRESENTATION OF THE MALE SEX AND THE SECOND "O" IS THE COMMONLY ACCEPTED SYMBOLIC REPRESENTATION OF THE FEMALE SEX FOLLOWED BY THE STYLIZED WORDS "DERMATOLOGY OF PARIS." A CURVED LINE APPEARS ABOVE THE STYLIZED WORDS WHICH STARTS AT THE "N" OF NULOOK AND ENDS ON THE "D" OF DERMATOLOGY. THE LINE IS BROKEN IN THE MIDDLE WITH A GRAPHICAL DEPICTION OF A HUMAN EYE.

FOR MEDICAL SERVICES, NAMELY, DERMATOLOGICAL CONSULTATION (U.S. CLS. 100 AND 101).

FIRST USE 2-1-2008; IN COMMERCE 2-1-2008.
CAROLINE WOOD, EXAMINING ATTORNEY

SN 77-601,495. FRALEIGH NURSERY, LLC, MADISON, FL. FILED 10-27-2008.

FRALEIGH NURSERY

THE MARK CONSISTS OF STANDARD CHARACTERS WITHOUT CLAIM TO ANY PARTICULAR FONT, STYLE, SIZE, OR COLOR.

NO CLAIM IS MADE TO THE EXCLUSIVE RIGHT TO USE "NURSERY", APART FROM THE MARK AS SHOWN. SEC. 2(F).

FOR PLANT NURSERIES (U.S. CLS. 100 AND 101).
FIRST USE 8-31-1999; IN COMMERCE 10-19-1999.
KAREN K. BUSH, EXAMINING ATTORNEY

CLASS 44—(Continued).

SN 77-603,092. CHILDREN'S MEDICAL GROUP OF SAGINAW BAY, P.L.L.C., BAY CITY, MI. FILED 10-29-2008.



NO CLAIM IS MADE TO THE EXCLUSIVE RIGHT TO USE "CHILDREN'S MEDICAL GROUP OF SAGINAW BAY", APART FROM THE MARK AS SHOWN.

THE MARK CONSISTS OF THE WORDING "CHILDREN'S MEDICAL GROUP OF SAGINAW BAY" WITH A DESIGN ELEMENT TO THE RIGHT OF THE WORDING "CHILDREN'S MEDICAL GROUP" AND ABOVE THE WORDING "OF SAGINAW BAY" CONSISTING OF FOUR OF STYLIZED CHILDREN AND FOUR FLOWERS ON A GRASS STRIP.

FOR PEDIATRIC MEDICAL SERVICES, PRINCIPALLY THE CARE OF NEWBORNS, INFANTS, CHILDREN AND ADOLESCENTS (U.S. CLS. 100 AND 101).

FIRST USE 5-19-1998; IN COMMERCE 5-19-1998.
BILL DAWE, EXAMINING ATTORNEY

SN 77-607,603. ANDROJEK, INC., KANSAS CITY, MO. FILED 11-5-2008.



THE MARK CONSISTS OF STANDARD CHARACTERS WITHOUT CLAIM TO ANY PARTICULAR FONT, STYLE, SIZE, OR COLOR.

FOR MEDICAL SERVICES, NAMELY, CLINICAL DIAGNOSTIC SERVICES IN THE NATURE OF MONITORING MALE REPRODUCTIVE FUNCTION; MEDICAL SERVICES, NAMELY, CLINICAL DIAGNOSTIC TESTING SERVICES; MEDICAL DIAGNOSTIC TESTING, MONITORING AND REPORTING SERVICES; MEDICAL DIAGNOSTIC TESTING SERVICES FOR OTHERS IN THE FIELD OF MALE REPRODUCTIVE FUNCTION (U.S. CLS. 100 AND 101).

B. PARADEWELAI, EXAMINING ATTORNEY

CLASS 44—(Continued).

SN 77-611,952. GUDRUN SWENSSON, PALMA DE MAL-LORCA, SPAIN, FILED 11-11-2008.



THE EGG

THE COLOR(S) VIOLET, BLUE, PINK AND GREEN IS/ARE CLAIMED AS A FEATURE OF THE MARK.

THE MARK CONSISTS OF THE PHRASE "THE EGG" IN GREEN UNDER A RECTANGLE WITH A VIOLET BACKGROUND, WITHIN WHICH IS DISPLAYED THE FIGURE OF AN EGG SHADED WITH THE ALTERNATING COLORS PINK, GREEN, AND BLUE.

FOR MEDICAL SERVICES, NAMELY, MIDWIFE SERVICES AND MEDICAL CLINICS; HEALTH SPA SERVICES; CONVALESCENT HOMES AND REST HOMES; HEALTH CARE SERVICES; AND HYGIENIC AND BEAUTY CARE SERVICES (U.S. CLS. 100 AND 101).

JOHN DALIER, EXAMINING ATTORNEY

CLASS 44—(Continued).

SN 77-626,306. RESOURCE ADVISORS CORPORATION, HENDERSON, NV, FILED 12-4-2008.

JSA Medical Group

THE MARK CONSISTS OF STANDARD CHARACTERS WITHOUT CLAIM TO ANY PARTICULAR FONT, STYLE, SIZE, OR COLOR.

NO CLAIM IS MADE TO THE EXCLUSIVE RIGHT TO USE "MEDICAL GROUP", APART FROM THE MARK AS SHOWN.

FOR HEALTHCARE SERVICES (U.S. CLS. 100 AND 101).

FIRST USE 5-1-1999; IN COMMERCE 5-1-1999.

SAMUEL E. SHARPER JR., EXAMINING ATTORNEY

SN 77-636,904. CENTENE CORPORATION, ST. LOUIS, MO, FILED 12-19-2008.

SN 77-621,957. THE MINIMALLY INVASIVE SPINE INSTITUTE, P.A., DALLAS, TX, FILED 11-25-2008.



NO CLAIM IS MADE TO THE EXCLUSIVE RIGHT TO USE "MINIMALLY INVASIVE SPINE INSTITUTE", APART FROM THE MARK AS SHOWN.

THE COLOR(S) DARK BLUE, LIGHT BLUE AND WHITE IS/ARE CLAIMED AS A FEATURE OF THE MARK.

THE MARK CONSISTS OF A DARK BLUE VERTICALLY ORIENTED OVAL WITH A LIGHT BLUE BORDER ON ITS RIGHT SIDE, INSIDE OF THE OVAL ARE FIVE HORIZONTALLY ORIENTED OVALS, THE TOP TWO AND BOTTOM TWO OVALS ARE WHITE, THE MIDDLE OVAL IS LIGHT BLUE WITH A WHITE CENTER, A THIN WHITE LINE EXTENDS FROM THE CENTER OF THE MIDDLE OVAL THROUGH THE RIGHT BORDER OF THE DARK BLUE OVAL, TO THE RIGHT OF THE DARK BLUE OVAL, THE WORDS "THE MINIMALLY INVASIVE" ARE INSCRIBED IN DARK BLUE IN INITIALLY CAPITALIZED, LOWER CASE LETTERING, THE WORDS "SPINE INSTITUTE" ARE INSCRIBED BENEATH THE WORDS "THE MINIMALLY INVASIVE" IN LIGHT BLUE UPPER CASE LETTERING.

FOR SURGERY FOR BACK AND NECK CONDITIONS (U.S. CLS. 100 AND 101).

ALICIA COLLINS, EXAMINING ATTORNEY



OWNER OF U.S. REG. NO. 3,497,002.
NO CLAIM IS MADE TO THE EXCLUSIVE RIGHT TO USE "INTEGRATED HEALTHCARE FOR PEOPLE WHO ARE AGED, BLIND OR DISABLED", APART FROM THE MARK AS SHOWN.

THE MARK CONSISTS OF THE WORDS "INTEGRATED HEALTHCARE FOR PEOPLE WHO ARE AGED, BLIND OR DISABLED" AND THE DESIGN OF THREE HANDS.

FOR MANAGED HEALTH CARE SERVICES (U.S. CLS. 100 AND 101).

FIRST USE 12-1-2006; IN COMMERCE 12-1-2006.

WILLIAM BRECKENFELD, EXAMINING ATTORNEY

CLASS 44—(Continued).

SN 77-666,409. TOP TM, LLC, BOCA RATON, FL. FILED 2-9-2009.

THIN ADVENTURE

THE MARK CONSISTS OF STANDARD CHARACTERS WITHOUT CLAIM TO ANY PARTICULAR FONT, STYLE, SIZE, OR COLOR.

FOR PROVIDING WEIGHT REDUCTION DIET PLANNING AND SUPERVISION AND WEIGHT LOSS PROGRAM SERVICES; PROVIDING ADVICE, DIET PLANNING, CONSULTATION AND INFORMATION IN THE FIELD OF WEIGHT LOSS, WEIGHT CONTROL AND NUTRITION (U.S. CLS. 100 AND 101).

AMY ALFIERI, EXAMINING ATTORNEY

CLASS 44—(Continued).

SN 77-688,887. NORTHERN NEW JERSEY CANCER ASSOCIATES, HACKENSACK, NJ. AND HACKENSACK UNIVERSITY MEDICAL CENTER, HACKENSACK, NJ. FILED 3-11-2009.



THE COLOR(S) GREEN, BLUE, AND COMBINATIONS THEREOF IS/ARE CLAIMED AS A FEATURE OF THE MARK.

THE MARK CONSISTS OF A SEMI-CIRCULAR FIVE-LEAF DESIGN WITH THE TOP LEAF BEING GREEN, THE BOTTOM LEAF BEING BLUE AND THE THREE LEAVES PROTRUDING TO THE RIGHT PROGRESSING FROM GREEN TO BLUE.

FOR MEDICAL SERVICES, NAMELY, RADIATION, ONCOLOGY, AND CANCER TREATMENT SERVICES AND PROVIDING INFORMATION ABOUT CANCER AND HEALTH CARE (U.S. CLS. 100 AND 101).

ROBIN CHOSID, EXAMINING ATTORNEY

SN 77-684,338. COMMON GROUND COMMUNITY H.D.F.C., INC., NEW YORK, NY. FILED 3-5-2009.

Vulnerability Index

THE MARK CONSISTS OF STANDARD CHARACTERS WITHOUT CLAIM TO ANY PARTICULAR FONT, STYLE, SIZE, OR COLOR.

NO CLAIM IS MADE TO THE EXCLUSIVE RIGHT TO USE "INDEX", APART FROM THE MARK AS SHOWN.

FOR PROVIDING HEALTH CARE INFORMATION, NAMELY, IDENTIFYING AND PRIORITIZING HOMELESS POPULATIONS ACCORDING TO THE FRAGILITY OF THEIR HEALTH BY MEANS OF SURVEYS AND DATA ANALYSIS, FOR PRIORITIZATION OF PROVIDING HOUSING (U.S. CLS. 100 AND 101).

FIRST USE 1-0-2007; IN COMMERCE 10-0-2007.

CAROLINE WOOD, EXAMINING ATTORNEY

SN 77-697,558. DRS. MELLION, INC., AKRON, OH. FILED 3-24-2009.



NO CLAIM IS MADE TO THE EXCLUSIVE RIGHT TO USE "ORTHODONTICS", APART FROM THE MARK AS SHOWN.

THE MARK CONSISTS OF A TRIANGLE ON TOP OF TWO COLUMNS WITH THE WORDS "GENERATIONS OF SMILES" SPANNING BETWEEN THE COLUMNS JUST BENEATH THE TRIANGLE. AN ARCH WITH THE LETTER "M" IS ALSO BETWEEN THE TWO COLUMNS WITH THE LETTER "M" BEING POSITIONED BENEATH THE ARCH. THE WORDING "MELLION ORTHODONTICS" IS BENEATH THE DESCRIBED LOGO.

FOR ORTHODONTIC SERVICES (U.S. CLS. 100 AND 101).

FIRST USE 2-1-2008; IN COMMERCE 4-1-2008.

ASMAT KHAN, EXAMINING ATTORNEY

CLASS 44—(Continued).

SN 77-699,973. CGK ENTERPRISES, LLC, OXNARD, CA. FILED 3-26-2009.

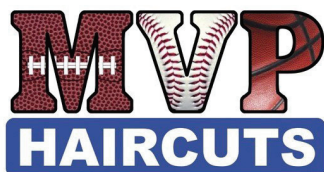

A Guaranteed Victory

OWNER OF U.S. REG. NO. 3,415,394.
NO CLAIM IS MADE TO THE EXCLUSIVE RIGHT TO USE "HAIRCUTS", APART FROM THE MARK AS SHOWN. THE COLOR(S) BROWN, WHITE, RED, ORANGE, BLUE AND BLACK IS/ARE CLAIMED AS A FEATURE OF THE MARK.

THE MARK CONSISTS OF WHITE STITCHING APPEARING HORIZONTALLY THROUGH THE BROWN LETTER "M"; RED STITCHING APPEARING ELIPTICALLY THROUGH THE WHITE LETTER "V"; SMOOTH BLACK LINEAR LINES APPEARING HORIZONTALLY AND VERTICALLY WITHIN THE ORANGE LETTER "P"; ALL APPEARING ABOVE A BLUE HORIZONTAL RECTANGLE ENCLOSING THE WHITE WORD, "HAIRCUT", APPEARING ABOVE THE BLACK WORDS, "A GUARANTEED VICTORY". THE LETTERS "MVP" ARE OUTLINED IN BLACK.

FOR HAIRDRESSING SALONS (U.S. CLS. 100 AND 101).

FIRST USE 8-16-2007; IN COMMERCE 8-16-2007.
STEVEN JACKSON, EXAMINING ATTORNEY

SN 77-701,856. MARSHALL LANDSCAPE, INC., WARREN, MI. FILED 3-30-2009.



NO CLAIM IS MADE TO THE EXCLUSIVE RIGHT TO USE "LANDSCAPE INC.", APART FROM THE MARK AS SHOWN.

THE COLOR(S) YELLOW AND BLACK IS/ARE CLAIMED AS A FEATURE OF THE MARK.

THE MARK CONSISTS OF A SIX POINTED STAR WITH BALLS AT THE END OF EACH POINT APPEARING IN THE COLOR YELLOW. THE WORDING "MARSHALL LANDSCAPE INC." APPEARS IN THE COLOR BLACK ON TOP OF THE STAR DESIGN CENTERED VERTICALLY WITH ONE WORD ON EACH LINE.

FOR HORTICULTURAL SERVICES (U.S. CLS. 100 AND 101).

FIRST USE 0-0-1983; IN COMMERCE 0-0-1983.
COURTNEY MCCORMICK, EXAMINING ATTORNEY

CLASS 44—(Continued).

SN 77-703,641. FLETCHER, C. LESLIE, DBA EDEN ESTHETIC NURSING, TORRANCE, CA. FILED 3-31-2009.

EVOLELIFT

THE MARK CONSISTS OF STANDARD CHARACTERS WITHOUT CLAIM TO ANY PARTICULAR FONT, STYLE, SIZE, OR COLOR.

FOR SKIN TREATMENT SERVICES, NAMELY, THE INJECTION OF DERMAL FILLERS TO REDUCE THE APPEARANCE OF FINE LINES (U.S. CLS. 100 AND 101).

FIRST USE 3-28-2009; IN COMMERCE 3-28-2009.

GISELLE AGOSTO, EXAMINING ATTORNEY

SN 77-704,025. LEWIS, ROBERT, BETTENDORF, IA. FILED 4-1-2009.

The Happy Diabetic

THE MARK CONSISTS OF STANDARD CHARACTERS WITHOUT CLAIM TO ANY PARTICULAR FONT, STYLE, SIZE, OR COLOR.

OWNER OF U.S. REG. NO. 3,614,880.
NO CLAIM IS MADE TO THE EXCLUSIVE RIGHT TO USE "DIABETIC", APART FROM THE MARK AS SHOWN.

FOR COUNSELING SERVICES IN THE FIELDS OF HEALTH, NUTRITION AND LIFESTYLE WELLNESS; DIETARY AND NUTRITIONAL GUIDANCE; FOOD NUTRITION CONSULTATION; NUTRITION COUNSELING; PROVIDING A WEB SITE FEATURING INFORMATION ON HEALTH AND NUTRITION; PROVIDING INFORMATION ABOUT DIETARY SUPPLEMENTS AND NUTRITION (U.S. CLS. 100 AND 101).

FIRST USE 3-1-2003; IN COMMERCE 3-1-2003.

HEATHER THOMPSON, EXAMINING ATTORNEY

SN 77-707,330. NATUREMED, LLC, BOULDER, CO. FILED 4-6-2009.

NatureMed

THE MARK CONSISTS OF STANDARD CHARACTERS WITHOUT CLAIM TO ANY PARTICULAR FONT, STYLE, SIZE, OR COLOR.

FOR MEDICAL CLINICS; MEDICAL SERVICES; INTEGRATIVE MEDICAL SERVICES; NATUROPATHIC MEDICAL CLINIC SERVICES (U.S. CLS. 100 AND 101).

FIRST USE 2-0-2004; IN COMMERCE 2-0-2004.

BRENDAN MCCAULEY, EXAMINING ATTORNEY

CLASS 44—(Continued).

SN 77-708,461. MOBIN, SHEILA N., LOS ANGELES, CA. FILED 4-7-2009.

SPA MOMMA

THE MARK CONSISTS OF STANDARD CHARACTERS WITHOUT CLAIM TO ANY PARTICULAR FONT, STYLE, SIZE, OR COLOR.

NO CLAIM IS MADE TO THE EXCLUSIVE RIGHT TO USE "SPA", APART FROM THE MARK AS SHOWN.

FOR MEDICAL AND DAY SPA SERVICES TARGETED FOR CURRENT AND SOON-TO-BE MOTHERS, NAMELY, MEDICAL CONSULTATIONS, COSMETIC AND PLASTIC SURGERY SERVICES, NONINVASIVE AND MINIMALLY INVASIVE COSMETIC AND AESTHETIC SURGERY SERVICES, WEIGHT REDUCTION DIET PLANNING AND SUPERVISION, HEALTH SPA AND AESTHETIC SALON SERVICES, NAMELY, FACIALS, MASSAGES, CHEMICAL PEELS, MICRODERMABRASION, HAIR REMOVAL, HAIR TRANSPLANTATION, LIPOSUCTION, AND COSMETIC LASER TREATMENTS; HEALTH SPA SERVICES, NAMELY, COSMETIC BODY CARE SERVICES (U.S. CLS. 100 AND 101).

LEIGH CAROLINE CASE, EXAMINING ATTORNEY

CLASS 44—(Continued).

SN 77-714,824. NORTHSTARVETS, CLARKSBURG, NJ. FILED 4-15-2009.



NO CLAIM IS MADE TO THE EXCLUSIVE RIGHT TO USE "VETS" AND "VETERINARY EMERGENCY TRAUMA & SPECIALTY CENTER", APART FROM THE MARK AS SHOWN.

THE COLOR(S) BLUE AND YELLOW IS/ARE CLAIMED AS A FEATURE OF THE MARK.

THE MARK CONSISTS OF A YELLOW STYLIZED EIGHT POINT STAR THAT IS CENTERED ABOVE THE BLUE WORDS "NORTHSTAR VETS" AND UNDERLINED IN YELLOW, UNDER THE YELLOW UNDERLINE ARE THE WORDS IN BLUE COLOR, "VETERINARY EMERGENCY TRAUMA & SPECIALTY CENTER" UNDER "SPECIALTY CENTER" THE WORDS "LEADING THE WAY." ARE IN YELLOW.

FOR VETERINARY EMERGENCY AND TRAUMA SERVICES; VETERINARY SPECIALTY SERVICES PROVIDING ADVANCED MEDICAL, DIAGNOSTIC OR SURGICAL SERVICES FOR ANIMALS (U.S. CLS. 100 AND 101).

FIRST USE 3-28-2009; IN COMMERCE 4-6-2009. ANTHONY RINKER, EXAMINING ATTORNEY

SN 77-710,328. PAUL MARTINEZ, GREENACRES, FL. FILED 4-9-2009.



NO CLAIM IS MADE TO THE EXCLUSIVE RIGHT TO USE "1 FEE MD", APART FROM THE MARK AS SHOWN.

THE COLOR(S) ORANGE, DARK BLUE, AND WHITE IS/ARE CLAIMED AS A FEATURE OF THE MARK.

THE MARK CONSISTS OF THE NUMBER "1", SURROUNDED BY AN OVAL WHICH IS COLORED ORANGE, THE ACTUAL NUMBER "1" IS WHITE, FOLLOWED BY THE WORD FEE WHICH IS IN DARK BLUE, FOLLOWED BY THE LETTERS "MD" WHICH ARE IN ORANGE.

FOR MEDICAL CLINICS (U.S. CLS. 100 AND 101). GINA FINK, EXAMINING ATTORNEY

SN 77-718,447. ACADIA DENTAL MANAGEMENT, LLC, DBA ACADIA DENTAL & DENTURES, HAGERSTOWN, MD. FILED 4-21-2009.



NO CLAIM IS MADE TO THE EXCLUSIVE RIGHT TO USE "DENTAL & DENTURES", APART FROM THE MARK AS SHOWN.

THE COLOR(S) BLUE AND GREEN IS/ARE CLAIMED AS A FEATURE OF THE MARK.

THE MARK CONSISTS OF A STYLIZED "A" MADE UP OF BLUE AND GREEN LINES TO THE LEFT OF THE WORDS "ACADIA AND DENTAL & DENTURES" IN A BLUE STYLIZED FONT. BETWEEN THE TERMS "ACADIA AND DENTAL & DENTURES" IS A GREEN HORIZONTAL LINE.

FOR DENTISTRY (U.S. CLS. 100 AND 101). FIRST USE 3-1-2009; IN COMMERCE 4-1-2009. ERNEST SHOSHO, EXAMINING ATTORNEY

CLASS 44—(Continued).

SN 77-721,764. CORVENTIS, INC., SAN JOSE, CA. FILED 4-24-2009.

CARDIOPROTECT

THE MARK CONSISTS OF STANDARD CHARACTERS WITHOUT CLAIM TO ANY PARTICULAR FONT, STYLE, SIZE, OR COLOR.

FOR COMPUTER SERVICES, NAMELY, PROVIDING AN ONLINE COMPUTER DATABASE FEATURING PATIENT MEDICAL INFORMATION (U.S. CLS. 100 AND 101).

HAI-LY LAM, EXAMINING ATTORNEY

SN 77-723,068. MOW SMART, INC., CENTENNIAL, CO. FILED 4-27-2009.



NO CLAIM IS MADE TO THE EXCLUSIVE RIGHT TO USE "MOW", APART FROM THE MARK AS SHOWN.

THE COLOR(S) GREEN, PURPLE, WHITE AND BLACK IS/ARE CLAIMED AS A FEATURE OF THE MARK.

THE MARK CONSISTS OF THE WORDING "MOW SMART" WITH THE WORD "MOW" APPEARING IN PURPLE VARIEGATED LETTERING, OUTLINED IN WHITE WITH A BLACK BORDER, ABOVE THE WORD "SMART", WHICH APPEARS IN GREEN VARIEGATED LETTERING, OUTLINED IN WHITE WITH A BLACK BORDER. TO THE LEFT OF THE WORD "MOW" IS A DESIGN, WHICH CONSISTS OF EXAGGERATED GRASS SHOOTS APPEARING IN SHADES OF GREEN AND WHITE SPROUTING FROM THE BOTTOM AND TOP OF A PURPLE SEMI-CIRCLE OUTLINED IN WHITE WITH A BLACK BORDER. THE MARK APPEARS ON A TRANSPARENT BACKGROUND, AND NO OTHER COLOR IS CLAIMED AS A FEATURE OF THE MARK.

FOR LAWN MOWING SERVICES (U.S. CLS. 100 AND 101).

FIRST USE 3-20-2009; IN COMMERCE 3-20-2009.
AMY KERTGATE, EXAMINING ATTORNEY

SN 77-723,274. VASTTECH LLC, CONWAY, AR. FILED 4-27-2009.



THE MARK CONSISTS OF TWO THUMB PRINTS IN THE SHAPE OF A HEART WITH THE WORDS "CARDIO ID" TO THE RIGHT OF THE THUMB PRINTS.

FOR HEALTH CARE SERVICES, NAMELY, WELLNESS PROGRAMS (U.S. CLS. 100 AND 101).

JORDAN BAKER, EXAMINING ATTORNEY

CLASS 44—(Continued).

SN 77-723,788. BECKER NEUROLOGICAL INSTITUTE, PLLC, CRESTVIEW HILLS, KY. FILED 4-28-2009.



NO CLAIM IS MADE TO THE EXCLUSIVE RIGHT TO USE "NEUROLOGICAL INSTITUTE, PLLC", APART FROM THE MARK AS SHOWN.

THE MARK CONSISTS OF THE STYLIZED TEXT "BECKER NEUROLOGICAL INSTITUTE, PLLC" WITH A BRAIN DIAGRAM WITH A SPINAL CORD TO LOOK LIKE A LIGHTNING BOLT.

FOR MEDICAL SERVICES, NAMELY, NEUROLOGY (U.S. CLS. 100 AND 101).

FIRST USE 9-1-2007; IN COMMERCE 9-1-2007.
DAVID MURRAY, EXAMINING ATTORNEY

SN 77-723,816. PHARMACY HEALTH SERVICES, INC., MIDDLEBURY, VT. FILED 4-28-2009.

Split Incentive

THE MARK CONSISTS OF STANDARD CHARACTERS WITHOUT CLAIM TO ANY PARTICULAR FONT, STYLE, SIZE, OR COLOR.

FOR DISPENSING MEDICATIONS AT DOSAGE TO ALLOW FOR PILL OR TABLET SPLITTING (U.S. CLS. 100 AND 101).

FIRST USE 6-1-1995; IN COMMERCE 6-1-1995.
DANNEAN HETZEL, EXAMINING ATTORNEY

SN 77-723,827. HERNANDEZ DENTAL, INDIO, CA. FILED 4-28-2009.



THE STIPPLING IS FOR SHADING PURPOSES ONLY. THE MARK CONSISTS OF THE STYLIZED LETTER AND WORDS "HERNANDEZDENTAL INTELLIDONTIX.COM H". THE LETTER "H" IS ENCIRCLED AN ABSTRACT DESIGN.

FOR DENTISTRY; ORTHODONTIC SERVICES (U.S. CLS. 100 AND 101).

BRIAN PINO, EXAMINING ATTORNEY

CLASS 44—(Continued).

SN 77-724,151. ADVENTIST HEALTH SYSTEM SUNBELT HEALTHCARE CORPORATION, DBA ADVENTIST MIDWEST HEALTH, NFP, WINTER PARK, FL. FILED 4-28-2009.

KEEPING YOU WELL

THE MARK CONSISTS OF STANDARD CHARACTERS WITHOUT CLAIM TO ANY PARTICULAR FONT, STYLE, SIZE, OR COLOR.

FOR HOSPITAL AND HEALTH CARE SERVICES (U.S. CLS. 100 AND 101).

FIRST USE 12-31-1999; IN COMMERCE 12-31-1999.
IRA J. GOODSaid, EXAMINING ATTORNEY

CLASS 44—(Continued).

SN 77-724,324. BETTNER VISION, INC., COLORADO SPRINGS, CO. FILED 4-28-2009.



BETTNERVISION

THE STIPPLING IS FOR SHADING PURPOSES ONLY. THE MARK CONSISTS OF THE STYLIZED TEXT "BETTNERVISION" WITH A SQUARE AND AN ABSTRACT DESIGN IN THE MIDDLE.

FOR OPTOMETRY SERVICES (U.S. CLS. 100 AND 101). FIRST USE 1-15-2008; IN COMMERCE 1-15-2008.
NAAKWAMA ANKRAH, EXAMINING ATTORNEY

SN 77-724,168. BENTLEY, CHRISTIAN DEREK, DBA MPOWR ORTHOPAEDICS GROUP, ENCINITAS, CA. FILED 4-28-2009.

MPOWR: Musculoskeletal
Performance, Orthopaedic
Wellness & Rehabilitation

THE MARK CONSISTS OF STANDARD CHARACTERS WITHOUT CLAIM TO ANY PARTICULAR FONT, STYLE, SIZE, OR COLOR.

NO CLAIM IS MADE TO THE EXCLUSIVE RIGHT TO USE "MUSCULOSKELETAL PERFORMANCE, ORTHOPAEDIC WELLNESS AND REHABILITATION", APART FROM THE MARK AS SHOWN.

FOR ORTHOPAEDIC MEDICAL CARE (U.S. CLS. 100 AND 101).
JOHN E. MICHOS, EXAMINING ATTORNEY

SN 77-724,445. RADOVIC DPM, PHILIP, SAN CLEMENTE, CA. FILED 4-28-2009.

NaiLase

THE MARK CONSISTS OF THE STYLIZED TEXT "NAI-LASE" WITH A LINE AND A HALF STAR BURST AT THE END OF THE LINE.

FOR PROVIDING A LASER REMOVAL PROCEDURE FOR NAIL FUNGUS (U.S. CLS. 100 AND 101). FIRST USE 2-0-2009; IN COMMERCE 2-0-2009.
KATHERINE CHANG, EXAMINING ATTORNEY

SN 77-724,196. ROBERT S. ALMEIDA DC, INC., ATTLEBORO, MA. FILED 4-28-2009.

ICAN

THE MARK CONSISTS OF STANDARD CHARACTERS WITHOUT CLAIM TO ANY PARTICULAR FONT, STYLE, SIZE, OR COLOR.

FOR CHIROPRACTIC SERVICES; HEALTH CARE SERVICES, NAMELY, WELLNESS PROGRAMS; MASSAGE; PHYSICAL THERAPY (U.S. CLS. 100 AND 101). FIRST USE 4-28-2009; IN COMMERCE 4-28-2009.
SUSAN LESLIE DUBOIS, EXAMINING ATTORNEY

SN 77-724,990. DONALD SEITZ, NASHVILLE, TN. FILED 4-29-2009.

DOCS AROUND THE CLOCK

THE MARK CONSISTS OF STANDARD CHARACTERS WITHOUT CLAIM TO ANY PARTICULAR FONT, STYLE, SIZE, OR COLOR.

FOR DROP-IN MEDICAL CLINICS FEATURING ROUND-THE-CLOCK NON-EMERGENCY MEDICAL SERVICES; NETWORK OF PHYSICIANS OFFERING ROUND-THE-CLOCK NON-EMERGENCY MEDICAL SERVICES (U.S. CLS. 100 AND 101).
JAMES A. RAUEN, EXAMINING ATTORNEY

CLASS 44—(Continued).

SN 77-725,201. DAPPER GROOMING LOUNGE, LLC, AKA DAPPER, TUCSON, AZ. FILED 4-29-2009.

DAPPER GROOMING LOUNGE

THE MARK CONSISTS OF STANDARD CHARACTERS WITHOUT CLAIM TO ANY PARTICULAR FONT, STYLE, SIZE, OR COLOR.

NO CLAIM IS MADE TO THE EXCLUSIVE RIGHT TO USE "GROOMING LOUNGE", APART FROM THE MARK AS SHOWN.

FOR BARBERING AND COSMETOLOGY SERVICES (U.S. CLS. 100 AND 101).

FIRST USE 4-26-2007; IN COMMERCE 4-26-2007.
MICHAEL LITZAU, EXAMINING ATTORNEY

SN 77-725,453. BESERANY, CHRISTINE, BROADWAY, NC. FILED 4-29-2009.

ORIGO WELLNESS

THE MARK CONSISTS OF STANDARD CHARACTERS WITHOUT CLAIM TO ANY PARTICULAR FONT, STYLE, SIZE, OR COLOR.

NO CLAIM IS MADE TO THE EXCLUSIVE RIGHT TO USE "WELLNESS", APART FROM THE MARK AS SHOWN. THE WORDING "ORIGO" HAS NO MEANING IN A FOREIGN LANGUAGE.

FOR HEALTH CARE SERVICES, NAMELY, WELLNESS PROGRAMS (U.S. CLS. 100 AND 101).

FIRST USE 12-8-2008; IN COMMERCE 12-8-2008.
HANNO RITTNER, EXAMINING ATTORNEY

SN 77-726,109. REGAL NAILS, SALON & SPA, LLC, BATON ROUGE, LA. FILED 4-30-2009.

REGAL

THE MARK CONSISTS OF STANDARD CHARACTERS WITHOUT CLAIM TO ANY PARTICULAR FONT, STYLE, SIZE, OR COLOR.

OWNER OF U.S. REG. NOS. 2,443,591, 3,329,407 AND OTHERS.

FOR HAIR SALON, NAIL SALON, HEALTH DAY SPA SERVICES, NAMELY, COSMETIC BODY CARE SERVICES, BARBER SERVICES, FACIALS, MASSAGES, MANICURES AND PEDICURES (U.S. CLS. 100 AND 101).

FIRST USE 10-29-1996; IN COMMERCE 10-29-1996.
ERIN FALK, EXAMINING ATTORNEY

CLASS 44—(Continued).

SN 77-726,979. DEANNA BRAMBLE, SAN DIEGO, CA. FILED 5-1-2009.

HEALTHATARIAN

THE MARK CONSISTS OF STANDARD CHARACTERS WITHOUT CLAIM TO ANY PARTICULAR FONT, STYLE, SIZE, OR COLOR.

FOR PROVIDING A WEB SITE FEATURING INFORMATION ON HEALTH AND NUTRITION (U.S. CLS. 100 AND 101).

GEORGE LORENZO, EXAMINING ATTORNEY

SN 77-727,299. ROCKINGHAM MEMORIAL HOSPITAL, HARRISONBURG, VA. FILED 5-1-2009.



THE COLOR(S) BLUE, GREEN, AND WHITE IS/ARE CLAIMED AS A FEATURE OF THE MARK.

THE MARK CONSISTS OF A SQUARE OUTLINED IN BLUE WITH A BLUE CURVED LINE THROUGH THE CENTER WITH THE LETTERS "RMH" UNDERNEATH IT AND THE PHRASE "GET WELL, LIVE WELL." UNDERNEATH THE LETTERS "RHM". ALL OF THE TEXT IS IN BLUE. INSIDE THE SQUARE IS ANOTHER SQUARE THAT FROM TOP TO BOTTOM CHANGES FROM BLUE TO WHITE TO GREEN, AND THERE IS A WHITE BORDER AROUND THE INNER SQUARE INSIDE THE BLUE OUTLINE.

FOR HOSPITALS (U.S. CLS. 100 AND 101).
ALYSSA STEEL, EXAMINING ATTORNEY

CLASS 44—(Continued).

SN 77-728,478. HOWARD, CHARLES W., BROAD CHANNEL, NY. FILED 5-4-2009.

TOILETREE

THE MARK CONSISTS OF STANDARD CHARACTERS WITHOUT CLAIM TO ANY PARTICULAR FONT, STYLE, SIZE, OR COLOR.

FOR PROVIDING TOILET SERVICES FOR INDIVIDUALS THROUGH THE USE OF PORTABLE TOILETS; PROVIDING TOILET SERVICES TO INDIVIDUALS THROUGH THE USE OF PORTABLE TOILETS ON A TRUCK; AND RENTAL OF PORTABLE TOILETS (U.S. CLS. 100 AND 101).

FIRST USE 10-31-2008; IN COMMERCE 10-31-2008.
MICHAEL WIENER, EXAMINING ATTORNEY

CLASS 44—(Continued).

SN 77-732,585. CORVENTIS, INC., SAN JOSE, CA. FILED 5-8-2009.

PIIX POD

THE MARK CONSISTS OF STANDARD CHARACTERS WITHOUT CLAIM TO ANY PARTICULAR FONT, STYLE, SIZE, OR COLOR.

FOR COMPUTER SERVICES, NAMELY, PROVIDING AN ONLINE COMPUTER DATABASE FEATURING PATIENT MEDICAL INFORMATION (U.S. CLS. 100 AND 101).

HAI-LY LAM, EXAMINING ATTORNEY

SN 77-728,543. HOWARD, CHARLES W., BROAD CHANNEL, NY. FILED 5-4-2009.

PORTAHEAD

THE MARK CONSISTS OF STANDARD CHARACTERS WITHOUT CLAIM TO ANY PARTICULAR FONT, STYLE, SIZE, OR COLOR.

FOR PROVIDING TOILET SERVICES FOR INDIVIDUALS THROUGH THE USE OF PORTABLE TOILETS; PROVIDING TOILET SERVICES TO INDIVIDUALS THROUGH THE USE OF PORTABLE TOILETS ON A TRUCK; AND RENTAL OF PORTABLE TOILETS (U.S. CLS. 100 AND 101).

FIRST USE 12-31-2005; IN COMMERCE 12-31-2005.
MICHAEL WIENER, EXAMINING ATTORNEY

SN 77-743,066. SHEPHERD CENTER, INC., ATLANTA, GA. FILED 5-22-2009.

YOUR COMEBACK BEGINS HERE

THE MARK CONSISTS OF STANDARD CHARACTERS WITHOUT CLAIM TO ANY PARTICULAR FONT, STYLE, SIZE, OR COLOR.

FOR PRIVATE, NOT-FOR-PROFIT SPECIALTY HOSPITAL SERVICES FOR CARE OF PEOPLE WITH SPINAL CORD INJURIES, ACQUIRED BRAIN INJURIES, MULTIPLE SCLEROSIS, OTHER NEUROLOGICAL DISORDERS, AND UROLOGICAL PROBLEMS (U.S. CLS. 100 AND 101).

ROBIN MITTLER, EXAMINING ATTORNEY

SN 77-728,570. HOWARD, CHARLES W., BROAD CHANNEL, NY. FILED 5-4-2009.

TO DEVELOP & EVOLVE A HUMAN NECESSITY

THE MARK CONSISTS OF STANDARD CHARACTERS WITHOUT CLAIM TO ANY PARTICULAR FONT, STYLE, SIZE, OR COLOR.

FOR PROVIDING TOILET SERVICES FOR INDIVIDUALS THROUGH THE USE OF PORTABLE TOILETS; PROVIDING TOILET SERVICES TO INDIVIDUALS THROUGH THE USE OF PORTABLE TOILETS ON A TRUCK; AND RENTAL OF PORTABLE TOILETS (U.S. CLS. 100 AND 101).

FIRST USE 12-31-2006; IN COMMERCE 12-31-2006.
MICHAEL WIENER, EXAMINING ATTORNEY

SN 77-745,329. ADVENTIST HEALTH SYSTEM SUNBELT HEALTHCARE CORPORATION, DBA ADVENTIST MIDWEST HEALTH, NFP, WINTER PARK, FL. FILED 5-27-2009.

RIGHT IN YOUR OWN BACKYARD

THE MARK CONSISTS OF STANDARD CHARACTERS WITHOUT CLAIM TO ANY PARTICULAR FONT, STYLE, SIZE, OR COLOR.

FOR HOSPITAL AND HEALTH CARE SERVICES (U.S. CLS. 100 AND 101).

FIRST USE 1-31-2008; IN COMMERCE 1-31-2008.
IRA J. GOODSaid, EXAMINING ATTORNEY

CLASS 44—(Continued).

SN 77-745,341. ADVENTIST HEALTH SYSTEM SUNBELT HEALTHCARE CORPORATION, DBA ADVENTIST MIDWEST HEALTH, NFP, WINTER PARK, FL. FILED 5-27-2009.

WORLD-CLASS HEALTH CARE
RIGHT IN YOUR OWN BACKYARD

THE MARK CONSISTS OF STANDARD CHARACTERS WITHOUT CLAIM TO ANY PARTICULAR FONT, STYLE, SIZE, OR COLOR.

NO CLAIM IS MADE TO THE EXCLUSIVE RIGHT TO USE "WORLD-CLASS HEALTH CARE", APART FROM THE MARK AS SHOWN.

FOR HOSPITAL AND HEALTH CARE SERVICES (U.S. CLS. 100 AND 101).

FIRST USE 10-31-2008; IN COMMERCE 10-31-2008.
IRA J. GOODSAD, EXAMINING ATTORNEY

SN 77-745,362. ADVENTIST HEALTH SYSTEM SUNBELT HEALTHCARE CORPORATION, DBA ADVENTIST MIDWEST HEALTH, NFP, WINTER PARK, FL. FILED 5-27-2009.

KEEPING CHICAGO WELL

THE MARK CONSISTS OF STANDARD CHARACTERS WITHOUT CLAIM TO ANY PARTICULAR FONT, STYLE, SIZE, OR COLOR.

NO CLAIM IS MADE TO THE EXCLUSIVE RIGHT TO USE "CHICAGO", APART FROM THE MARK AS SHOWN.

FOR PROVIDING INFORMATION IN THE FIELDS OF HEALTH, HEALTH CARE, MEDICINE AND WELLNESS (U.S. CLS. 100 AND 101).

FIRST USE 6-1-2009; IN COMMERCE 6-1-2009.
IRA J. GOODSAD, EXAMINING ATTORNEY

CLASS 45—PERSONAL AND LEGAL SERVICES

SN 76-692,625. NEW ENGLAND DIVORCE SOLUTIONS, LLC, BOSTON, MA. FILED 9-4-2008.

IS YOUR ATTORNEY A
FINANCIAL EXPERT?
WE ARE.

THE MARK CONSISTS OF STANDARD CHARACTERS WITHOUT CLAIM TO ANY PARTICULAR FONT, STYLE, SIZE, OR COLOR.

FOR CONSULTATION SERVICES FOR FAMILY LAW MATTERS, NAMELY, AIDING LAWYERS AND THEIR CLIENTS IN THE PREPARATION OF MARITAL ASSET DOCUMENTATION FOR USE IN DETERMINING DIVORCE SETTLEMENTS (U.S. CLS. 100 AND 101).

RUDY R. SINGLETON, EXAMINING ATTORNEY

SN 77-420,718. LABTEST INTERNATIONAL, INC., NEW YORK, NY. AND RAGHU, ANDRE, SPRINGFIELD, NJ. FILED 3-13-2008.



NO CLAIM IS MADE TO THE EXCLUSIVE RIGHT TO USE "GLOBAL SECURITY VERIFICATION", APART FROM THE MARK AS SHOWN.

THE COLOR(S) RED, WHITE, BLACK, BLUE, AND LIGHT BLUE IS/ARE CLAIMED AS A FEATURE OF THE MARK.

THE MARK CONSISTS OF A RED CIRCLE SURROUNDING A LIGHT BLUE GLOBE HAVING WHITE LATITUDINAL AND LONGITUDINAL LINES. THE BLUE LETTERS "GSV" OVERLIE THE GLOBE, AND THE BLACK TEXT "GLOBAL SECURITY VERIFICATION" OVERLIES THE WHITE AREA BETWEEN THE GLOBE AND THE RED CIRCLE.

FOR SECURITY INSPECTION SERVICES FOR OTHERS, NAMELY, INSPECTIONS OF WAREHOUSES AND MANUFACTURING FACILITIES FOR COMPLIANCE WITH A COMPREHENSIVE SUPPLY CHAIN SECURITY VERIFICATION PROCEDURE, TO DETERMINE WHETHER APPROPRIATE MINIMUM SECURITY MEASURES, AS PUBLISHED BY THE U.S. BUREAU OF CUSTOMS AND BORDER PROTECTION, ARE IMPLEMENTED AND MAINTAINED (U.S. CLS. 100 AND 101).

FIRST USE 2-0-2004; IN COMMERCE 2-0-2004.
KATHERINE E. HALMEN, EXAMINING ATTORNEY

CLASS 45—(Continued).

SN 77-525,847. CENTRAL JERSEY LEGAL SERVICES, INC., NEW BRUNSWICK, NJ. FILED 7-18-2008.

Central Jersey Legal Services

THE MARK CONSISTS OF STANDARD CHARACTERS WITHOUT CLAIM TO ANY PARTICULAR FONT, STYLE, SIZE, OR COLOR.
NO CLAIM IS MADE TO THE EXCLUSIVE RIGHT TO USE "LEGAL SERVICES", APART FROM THE MARK AS SHOWN.
SEC. 2(F).
FOR LEGAL SERVICES (U.S. CLS. 100 AND 101).
FIRST USE 1-1-2003; IN COMMERCE 1-1-2003.
LAURA KOVALSKY, EXAMINING ATTORNEY

SN 77-580,868. BABY TRAVEL RENTALS, INC., RICHMOND, VA. FILED 9-29-2008.



Baby Travel Rentals

NO CLAIM IS MADE TO THE EXCLUSIVE RIGHT TO USE "BABY TRAVEL RENTALS", APART FROM THE MARK AS SHOWN.
THE MARK CONSISTS OF THE STYLIZED WORDS "BABY TRAVEL RENTALS". ABOVE THE STYLIZED WORDS IS AN IMAGE OF A BABY RUNNING AND HOLDING A SUITCASE IN AN OUTSTRETCHED HAND. THE BABY IS WEARING A DIAPER.
FOR RENTAL OF JUVENILE EQUIPMENT, NAMELY, CRIBS, BASSINETS, HIGH CHAIRS, BOOSTER SEATS, AND BABY CARRIERS, PRIMARILY TO TRAVELERS (U.S. CLS. 100 AND 101).
FIRST USE 4-1-2008; IN COMMERCE 5-1-2008.
GRETTA YAO, EXAMINING ATTORNEY

CLASS 45—(Continued).

SN 77-584,352. HUFF, ESTEE, DANA POINT, CA. FILED 10-2-2008.

THE STILL TECHNIQUE

THE MARK CONSISTS OF STANDARD CHARACTERS WITHOUT CLAIM TO ANY PARTICULAR FONT, STYLE, SIZE, OR COLOR.
NO CLAIM IS MADE TO THE EXCLUSIVE RIGHT TO USE "TECHNIQUE", APART FROM THE MARK AS SHOWN.
FOR COUNSELING IN THE FIELD OF PERSONAL DEVELOPMENT, NAMELY, SELF-IMPROVEMENT, SELF-FULFILLMENT, AND INTERPERSONAL COMMUNICATION (U.S. CLS. 100 AND 101).
ELIZABETH KAJUBI, EXAMINING ATTORNEY

SN 77-595,345. ALICE YOO, MURIETTA, CA. FILED 10-17-2008.

MY MODERN METROPOLIS

THE MARK CONSISTS OF STANDARD CHARACTERS WITHOUT CLAIM TO ANY PARTICULAR FONT, STYLE, SIZE, OR COLOR.
FOR INTERNET BASED SOCIAL NETWORKING SERVICES (U.S. CLS. 100 AND 101).
AMY C. KEAN, EXAMINING ATTORNEY

SN 77-596,850. ROUNDERS NETWORK LLC, SAN RAMON, CA. FILED 10-21-2008.

WHAT'S YOUR TABLE IMAGE?

THE MARK CONSISTS OF STANDARD CHARACTERS WITHOUT CLAIM TO ANY PARTICULAR FONT, STYLE, SIZE, OR COLOR.
FOR INTERNET BASED SOCIAL NETWORKING SERVICES (U.S. CLS. 100 AND 101).
JEFFREY LOOK, EXAMINING ATTORNEY

CLASS 45—(Continued).

SN 77-600,183. AMICUS COURT REPORTERS, INC., CHICAGO, IL. FILED 10-24-2008.

**Amicus Court Reporters,
Inc.**

THE MARK CONSISTS OF STANDARD CHARACTERS WITHOUT CLAIM TO ANY PARTICULAR FONT, STYLE, SIZE, OR COLOR.

NO CLAIM IS MADE TO THE EXCLUSIVE RIGHT TO USE "COURT REPORTERS, INC.", APART FROM THE MARK AS SHOWN.

FOR COURT REPORTING (U.S. CLS. 100 AND 101).
FIRST USE 1-1-2007; IN COMMERCE 1-1-2007.
COURTNEY MCCORMICK, EXAMINING ATTORNEY

SN 77-606,031. THE HUMANE SOCIETY OF CANADA, CHICAGO, IL. FILED 11-3-2008.

HUMANE SOCIETY OF CANADA

THE MARK CONSISTS OF STANDARD CHARACTERS WITHOUT CLAIM TO ANY PARTICULAR FONT, STYLE, SIZE, OR COLOR.

NO CLAIM IS MADE TO THE EXCLUSIVE RIGHT TO USE "HUMANE SOCIETY", APART FROM THE MARK AS SHOWN.

SEC. 2(F).
FOR HUMANE SOCIETY SERVICES, NAMELY, THE CARE AND PROTECTION OF ANIMALS (U.S. CLS. 100 AND 101).
FIRST USE 6-25-1993; IN COMMERCE 6-25-1993.
SHARON MEIER, EXAMINING ATTORNEY

SN 77-631,307. NBA PROPERTIES, INC., NEW YORK, NY. FILED 12-11-2008.

NBA SAFENET

THE MARK CONSISTS OF STANDARD CHARACTERS WITHOUT CLAIM TO ANY PARTICULAR FONT, STYLE, SIZE, OR COLOR.

OWNER OF U.S. REG. NOS. 864,034, 2,239,294 AND 3,529,126.

FOR PROVIDING INFORMATION, CONSULTATION SERVICES, TRACKING AND MONITORING RECORDS, AND A WEB SITE ALL IN THE FIELD OF SAFETY, PROTECTION, WELL-BEING, AND SECURITY OF ATHLETES, SPORTS TEAMS, SPORTS LEAGUES, AND FANS (U.S. CLS. 100 AND 101).
DOMINICK J. SALEMI, EXAMINING ATTORNEY

CLASS 45—(Continued).

SN 77-634,910. ELEPHANT PARENTS, LLC, SEATTLE, WA. FILED 12-17-2008.

ELEPHANT PARENTS

THE MARK CONSISTS OF STANDARD CHARACTERS WITHOUT CLAIM TO ANY PARTICULAR FONT, STYLE, SIZE, OR COLOR.

FOR ON-LINE SOCIAL NETWORKING SERVICES (U.S. CLS. 100 AND 101).
ANDREW RHIM, EXAMINING ATTORNEY

SN 77-634,956. ELEPHANT PARENTS, LLC, SEATTLE, WA. FILED 12-17-2008.



NO CLAIM IS MADE TO THE EXCLUSIVE RIGHT TO USE ".COM", APART FROM THE MARK AS SHOWN.

THE MARK CONSISTS OF THE OUTLINE OF TWO ELEPHANTS, STANDING SIDE BY SIDE, THAT CONTAINS THE WORD "ELEPHANTPARENTS.COM".

FOR ON-LINE SOCIAL NETWORKING SERVICES (U.S. CLS. 100 AND 101).
ANDREW RHIM, EXAMINING ATTORNEY

SN 77-663,763. MPEG LA, LLC, GREENWOOD VILLAGE, CO. FILED 2-5-2009.

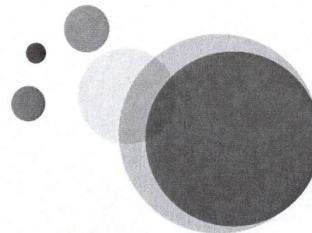

THE MARK CONSISTS OF THREE OVERLAPPING CIRCLES OF DIFFERENT SIZES TO THE RIGHT OF 3 SMALLER CIRCLES.

FOR OFFERING INTELLECTUAL PROPERTY LICENSES (U.S. CLS. 100 AND 101).
RAUL CORDOVA, EXAMINING ATTORNEY

CLASS 45—(Continued).

SN 77-663,979. MPEG LA, LLC, GREENWOOD VILLAGE, CO. FILED 2-5-2009.



OWNER OF U.S. REG. NOS. 2,361,164, 2,361,165 AND 2,394,576.

THE MARK CONSISTS OF THREE INTERSECTING CIRCLES WITH THE UPPER-CASE LETTER "M" INSIDE THE LARGEST CIRCLE. THERE ARE THREE SMALLER CIRCLES TO THE LEFT OF THE INTERSECTING CIRCLES AND THE UPPER-CASE LETTERS ARE TO THE RIGHT OF THE LETTER "M" TO FORM THE MARK "MPEGLA" IN UPPER-CASE LETTERS.

FOR OFFERING INTELLECTUAL PROPERTY LICENSES (U.S. CLS. 100 AND 101).

RAUL CORDOVA, EXAMINING ATTORNEY

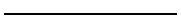

SN 77-664,025. MPEG LA, LLC, GREENWOOD VILLAGE, CO. FILED 2-5-2009.

THE STANDARD FOR STANDARDS

THE MARK CONSISTS OF STANDARD CHARACTERS WITHOUT CLAIM TO ANY PARTICULAR FONT, STYLE, SIZE, OR COLOR.

FOR OFFERING INTELLECTUAL PROPERTY LICENSES (U.S. CLS. 100 AND 101).

RAUL CORDOVA, EXAMINING ATTORNEY

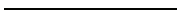

SN 77-664,126. MPEG LA, LLC, GREENWOOD VILLAGE, CO. FILED 2-5-2009.

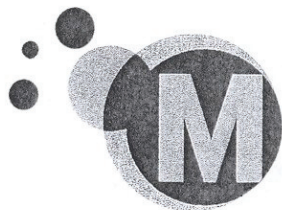

THE MARK CONSISTS OF THREE OVERLAPPING CIRCLES OF DIFFERENT SIZES WITH AN UPPER-CASE LETTER "M" IN THE LARGEST CIRCLE AND 3 SMALLER CIRCLES TO THE LEFT OF THE OVERLAPPING CIRCLES.

FOR OFFERING INTELLECTUAL PROPERTY LICENSES (U.S. CLS. 100 AND 101).

RAUL CORDOVA, EXAMINING ATTORNEY

CLASS 45—(Continued).

SN 77-673,098. SIMPLICITY CONSULTING, LLC, CHARLOTTE, NC. FILED 2-18-2009.



THE COLOR(S) WHITE, GREEN AND GRAY IS/ARE CLAIMED AS A FEATURE OF THE MARK.

THE MARK CONSISTS OF A GREEN CIRCLE WITH A WHITE HOUSE INSIDE; NEXT TO THE WORDS "SIMPLICITY CHANGING HOMES, CHANGING LIVES" IN GRAY STYLIZED LETTERING WITH GREEN DOTS DOTTING THE LETTER "I" IN THE WORD "SIMPLICITY".

FOR ORGANIZATIONAL SERVICES FOR HOME OR PERSONAL PURPOSES, NAMELY, ORGANIZING CHILDREN'S ROOMS, CLOSETS, SCHEDULES, DESKS AND BOOK BAGS (U.S. CLS. 100 AND 101).

ANDREA SAUNDERS, EXAMINING ATTORNEY

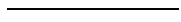

SN 77-683,794. UNITED STATES DEPARTMENT OF HOMELAND SECURITY, WASHINGTON, DC. FILED 3-4-2009.



THE COLOR(S) BLUE, WHITE, GOLD, AND GREY IS/ARE CLAIMED AS A FEATURE OF THE MARK.

THE MARK CONSISTS OF THE DARK BLUE LETTERS "FLUX" TO THE LEFT OF A THREE-DIMENSIONAL CIRCLE DESIGN WITH A HOLE IN THE MIDDLE, TILTED ON ITS EDGE WITH ITS SHADOW REFLECTED AT THE BASE. THE TILTED THREE-DIMENSIONAL CIRCLE DESIGN IS WHITE IN COLOR ON THE TOP EDGE, GOLDEN IN COLOR IN THE CENTER HOLE VISIBLE FROM THE TOP, AND BLUE IN COLOR ON THE OUTER EDGE OF THE CIRCLE THAT FACES THE VIEWER. THE BLUE COLOR INCREASES IN SATURATION TO THE RIGHT EDGE OF THE TILED CIRCLE, AND THE CIRCLE'S SHADOW IS GRAY.

FOR SECURITY SERVICES FOR THE PROTECTION OF PROPERTY AND INDIVIDUALS, NAMELY, PRE-SCREENING AND EXPEDITED SECURITY CLEARANCE SERVICES FOR PREPARATION OF IDENTIFICATION CARDS FOR PARTICIPATING INTERNATIONAL TRAVELERS (U.S. CLS. 100 AND 101).

LAURA KOVALSKY, EXAMINING ATTORNEY

CLASS 45—(Continued).

SN 77-693,507. DAVIS, FRANK E., MAINVILLE, JACKIE L., HARRIS, MARK S., BRIDGE, PETER G., DBA AMERICANOWNED.US, SARATOGA SPRINGS, NY. FILED 3-18-2009.

AO

THE MARK CONSISTS OF STANDARD CHARACTERS WITHOUT CLAIM TO ANY PARTICULAR FONT, STYLE, SIZE, OR COLOR.

FOR INVESTIGATION OR SURVEILLANCE ON BACKGROUND PROFILES (U.S. CLS. 100 AND 101). JOHN DALIER, EXAMINING ATTORNEY

SN 77-703,731. UNITED STATES DEPARTMENT OF HOMELAND SECURITY, WASHINGTON, DC. FILED 3-31-2009.



THE COLOR(S) BLUE, WHITE, GOLD, AND GREY IS/ARE CLAIMED AS A FEATURE OF THE MARK.

THE MARK CONSISTS OF A TILTED THREE-DIMENSIONAL CIRCLE DESIGN THAT IS WHITE IN COLOR ON THE TOP EDGE, GOLDEN IN COLOR IN THE CENTER HOLE VISIBLE FROM THE TOP, AND BLUE ON THE OUTER EDGE OF THE CIRCLE THAT FACES THE VIEWER. THE BLUE COLOR INCREASES IN SATURATION TO THE RIGHT EDGE OF THE TILTED CIRCLE, AND THE CIRCLE'S SHADOW IS GRAY.

FOR SECURITY SERVICES FOR THE PROTECTION OF PROPERTY AND INDIVIDUALS, NAMELY, PRE-SCREENING AND EXPEDITED SECURITY CLEARANCE SERVICES FOR PREPARATION OF IDENTIFICATION CARDS FOR PARTICIPATING INTERNATIONAL TRAVELERS (U.S. CLS. 100 AND 101). LAURA KOVALSKY, EXAMINING ATTORNEY

CLASS 45—(Continued).

SN 77-711,345. HOWE & HUTTON, LTD., CHICAGO, IL. FILED 4-10-2009.

THE LAW FIRM FOR MEETING
PROFESSIONALS

THE MARK CONSISTS OF STANDARD CHARACTERS WITHOUT CLAIM TO ANY PARTICULAR FONT, STYLE, SIZE, OR COLOR.

OWNER OF U.S. REG. NO. 2,824,169.

SEC. 2(F).

FOR PROVIDING LEGAL SERVICES TO PROVIDERS OF TRADE SHOW, CONVENTION, MEETING PLANNING, AND HOSPITALITY SERVICES (U.S. CLS. 100 AND 101).

FIRST USE 3-19-2003; IN COMMERCE 3-19-2003.

KARANENDRA S. CHHINA, EXAMINING ATTORNEY

SN 77-711,838. STEPHENSON, JOY YOUNG, DBA LAW OFFICES OF STEPHENSON, ACQUISTO & COLMAN, BURBANK, CA. FILED 4-10-2009.



LAW OFFICES OF
STEPHENSON
ACQUISTO
& COLMAN

NO CLAIM IS MADE TO THE EXCLUSIVE RIGHT TO USE "LAW OFFICES", APART FROM THE MARK AS SHOWN.

THE NAME(S), PORTRAIT(S), AND/OR SIGNATURE(S) SHOWN IN THE MARK IDENTIFIES JOY YOUNG STEPHENSON, VINCENT ACQUISTO, AND GEORGE COLMAN, WHOSE CONSENT(S) TO REGISTER IS MADE OF RECORD.

THE COLOR(S) BLUE IS/ARE CLAIMED AS A FEATURE OF THE MARK.

THE MARK CONSISTS OF THE WORDING "LAW OFFICES OF STEPHENSON, ACQUISTO & COLMAN" IN DARK BLUE BELOW THE DESIGN OF FOUR SQUARES THAT ARE DEFINED BY DARK BLUE VERTICAL AND HORIZONTAL LINES SEPARATING THE FOUR SQUARES; THE UPPER LEFT SQUARE IS LIGHT BLUE WITH A LETTER "S" IN DARK BLUE, THE UPPER RIGHT SQUARE IS A DARKER SHADE OF BLUE WITH A STYLIZED BLUE CADUCEUS AND GAVEL, THE LOWER RIGHT SQUARE IS LIGHT BLUE WITH THE LETTER "C" IN DARK BLUE; THE LEFT LOWER SQUARE IS A DARKER SHADE OF BLUE WITH THE LETTER "A" IN DARK BLUE.

FOR LEGAL SERVICES (U.S. CLS. 100 AND 101).

FIRST USE 3-28-2009; IN COMMERCE 4-8-2009.

CHRISTOPHER BUONGIORNO, EXAMINING ATTORNEY

CLASS 45—(Continued).

SN 77-718,652. IMAGELIFT CONSULTING, FRISCO, TX. FILED 4-21-2009.

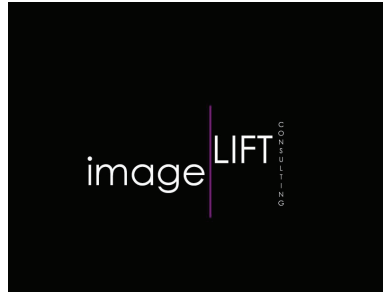

NO CLAIM IS MADE TO THE EXCLUSIVE RIGHT TO USE "CONSULTING", APART FROM THE MARK AS SHOWN.

THE COLOR(S) BLACK, WHITE, AND PURPLE IS/ARE CLAIMED AS A FEATURE OF THE MARK.

THE MARK CONSISTS OF BLACK BACKGROUND, WHITE LETTERING, VERTICAL PURPLE LINE BETWEEN THE WORDS "IMAGE" AND "LIFT". THE WORDS "IMAGE" AND "LIFT" ARE WRITTEN HORIZONTALLY AND THE WORD "CONSULTING" IS WRITTEN VERTICALLY. THE WORD "IMAGE" IS IN ALL LOWER-CASE LETTERS AND THE WORD "LIFT" IS IN ALL UPPER CASE LETTERS. THE WORD "CONSULTING" IS IN LOWER-CASE LETTERS. THERE IS NOT A SPACE BETWEEN THE WORD "IMAGE" AND THE WORD "LIFT". THE WORD "LIFT" IS ALSO SPACIALLY-ORIENTED HIGHER THAN THE WORD "IMAGE".

FOR COLOR ANALYSIS FOR WARDROBE AND FASHION SELECTION; FASHION CONSULTING SERVICES; FASHION INFORMATION; FASHION TREND CONSULTING FOR THE FASHION INDUSTRY; FASHION TREND CONSULTING SERVICES; PERSONAL FASHION CONSULTING SERVICES; PERSONAL IMAGE CONSULTING SERVICES; PERSONAL IMAGE DEVELOPMENT CONSULTATION; PROVIDING FASHION INFORMATION; PROVIDING INFORMATION ABOUT FASHION; PROVIDING INFORMATION IN THE FIELD OF FASHION TRENDS; PROVIDING INFORMATION IN THE FIELD OF PERSONAL DEVELOPMENT, NAMELY, SELF-IMPROVEMENT, SELF-FULFILLMENT, AND INTERPERSONAL COMMUNICATION; PROVIDING INFORMATION IN THE FIELD OF PERSONAL IMAGE DEVELOPMENT; PROVIDING NEWS AND INFORMATION IN THE FIELD OF FASHION (U.S. CLS. 100 AND 101).

JASON BLAIR, EXAMINING ATTORNEY

SN 77-720,577. SWENSEN PERER & KONTOS, AKA SPK, PITTSBURGH, PA. FILED 4-23-2009.

Wrongs righted.

THE MARK CONSISTS OF STANDARD CHARACTERS WITHOUT CLAIM TO ANY PARTICULAR FONT, STYLE, SIZE, OR COLOR.

FOR LEGAL SERVICES, NAMELY, PROVIDING LEGAL CONSULTATION IN THE AREAS OF MEDICAL MALPRACTICE AND PERSONAL INJURY (U.S. CLS. 100 AND 101).

FIRST USE 8-23-2003; IN COMMERCE 8-23-2003.
BRENDAN REGAN, EXAMINING ATTORNEY

CLASS 45—(Continued).

SN 77-721,468. ADDISON M. FISCHER, NAPLES, FL. FILED 4-24-2009.

The power of purr

THE MARK CONSISTS OF STANDARD CHARACTERS WITHOUT CLAIM TO ANY PARTICULAR FONT, STYLE, SIZE, OR COLOR.

FOR TRACKING, LOCATING AND MONITORING SERVICES FOR RECOVERING LOST ANIMALS (U.S. CLS. 100 AND 101).

BRIAN PINO, EXAMINING ATTORNEY

SN 77-722,191. HOMES TO HEARTS, LLC, GLENDALE, WI. FILED 4-24-2009.



NO CLAIM IS MADE TO THE EXCLUSIVE RIGHT TO USE "SENIOR HOME CARE", APART FROM THE MARK AS SHOWN.

THE COLOR(S) RED AND BLACK IS/ARE CLAIMED AS A FEATURE OF THE MARK.

THE MARK CONSISTS OF AN EMBOSSED SHAPE OF A RED HOUSE WITH A HOLE IN THE MIDDLE SHAPED LIKE A HEART BESIDE. TO THE RIGHT SIDE OF THE HOUSE ARE THE WORDS "HEARTS TO HOME" IN THE COLOR RED ALL UNDERLINED IN BLACK. BELOW THE BLACK LINE ARE THE WORDS "SENIOR HOME CARE" IN THE COLOR BLACK."

FOR IN-HOME SUPPORT SERVICES TO SENIOR PERSONS, NAMELY, GERIATRIC CARE MANAGEMENT SERVICES AND PERSONAL AFFAIRS MANAGEMENT SERVICES IN THE NATURE OF THE COORDINATION OF NECESSARY SERVICES AND CARE FOR OLDER INDIVIDUALS (U.S. CLS. 100 AND 101).

FIRST USE 5-22-2008; IN COMMERCE 5-22-2008.
BERYL GARDNER, EXAMINING ATTORNEY

SN 77-723,927. ARCHER MCWHORTER III, DBA WHITE-HANKIE.COM, AUSTIN, TX. FILED 4-28-2009.

WhiteHankie

THE MARK CONSISTS OF STANDARD CHARACTERS WITHOUT CLAIM TO ANY PARTICULAR FONT, STYLE, SIZE, OR COLOR.

FOR ON-LINE SOCIAL NETWORKING SERVICES (U.S. CLS. 100 AND 101).

SALLY SHIH, EXAMINING ATTORNEY

CLASS 45—(Continued).

SN 77-724,258. GARDNER, PETER J., HANOVER, NH. FILED 4-28-2009.

fairlegalfees.com

THE MARK CONSISTS OF STANDARD CHARACTERS WITHOUT CLAIM TO ANY PARTICULAR FONT, STYLE, SIZE, OR COLOR.
FOR LEGAL SERVICES (U.S. CLS. 100 AND 101).
SOPHIA S. KIM, EXAMINING ATTORNEY

CLASS 45—(Continued).

SN 77-726,608. FANS FOREVER, LLC, SAINT LOUIS, MO. FILED 4-30-2009.

Fans Forever

THE MARK CONSISTS OF STANDARD CHARACTERS WITHOUT CLAIM TO ANY PARTICULAR FONT, STYLE, SIZE, OR COLOR.
FOR FUNERAL SERVICES ACCOMPANYING CREMATION (U.S. CLS. 100 AND 101).
DAVID MILLER, EXAMINING ATTORNEY

SN 77-724,423. ARENAS CLAIMS CONSULTING, INC., MURRIETA, CA. FILED 4-28-2009.

NIGHTSHIFT.NET

THE MARK CONSISTS OF STANDARD CHARACTERS WITHOUT CLAIM TO ANY PARTICULAR FONT, STYLE, SIZE, OR COLOR.
FOR ACCIDENT INVESTIGATION SERVICES; INVESTIGATION SERVICES RELATED TO INSURANCE CLAIMS (U.S. CLS. 100 AND 101).
WILLIAM VERHOSEK, EXAMINING ATTORNEY

SN 77-727,011. JOBSON MEDICAL INFORMATION LLC, NEW YORK, NY. FILED 5-1-2009.

PHARMQD

THE MARK CONSISTS OF STANDARD CHARACTERS WITHOUT CLAIM TO ANY PARTICULAR FONT, STYLE, SIZE, OR COLOR.
FOR ON-LINE SOCIAL NETWORKING SERVICES (U.S. CLS. 100 AND 101).
PAM WILLIS, EXAMINING ATTORNEY

SN 77-726,533. BURNS, ERIC, ROHNERT PARK, CA. FILED 4-30-2009.



THE STIPPLING IS FOR SHADING PURPOSES ONLY.
THE MARK CONSISTS OF THE STYLIZED WORDS "WELCOME TO GARAGE CITY POPULATION: ELEVATION": INSIDE A RECTANGULAR SHAPED BOX WITH ROUNDED CORNERS. THERE IS A BAND AROUND THE PERIMETER OF THE SIGN. AN IMAGE OF A CITYSCAPE INSIDE THE BOX.
FOR ON-LINE SOCIAL NETWORKING SERVICES (U.S. CLS. 100 AND 101).
JULIE WATSON, EXAMINING ATTORNEY

SN 77-727,481. MERCEDES FLORES, DALLAS, TX. FILED 5-1-2009.

Benefitness

THE MARK CONSISTS OF STANDARD CHARACTERS WITHOUT CLAIM TO ANY PARTICULAR FONT, STYLE, SIZE, OR COLOR.
FOR IN-HOME SUPPORT SERVICES TO SENIOR PERSONS, NAMELY, GERIATRIC CARE MANAGEMENT SERVICES AND PERSONAL AFFAIRS MANAGEMENT SERVICES IN THE NATURE OF THE COORDINATION OF NECESSARY SERVICES AND CARE FOR OLDER INDIVIDUALS (U.S. CLS. 100 AND 101).
RICHARD A. STRASER, EXAMINING ATTORNEY

SEPT. 8, 2009

U.S. PATENT AND TRADEMARK OFFICE

TM 1097

CLASS 45—(Continued).

SN 77-727,681. GERBEN LAW FIRM, PLLC, WASHINGTON,
DC. FILED 5-2-2009.

CLASS 45—(Continued).

SN 77-727,756. MICHAEL CATANIA, CARLSBAD, CA.
FILED 5-2-2009.

TRADEMARKARMOR.COM

CLAUSE EIGHT

THE MARK CONSISTS OF STANDARD CHARACTERS
WITHOUT CLAIM TO ANY PARTICULAR FONT, STYLE,
SIZE, OR COLOR.
FOR LEGAL SERVICES (U.S. CLS. 100 AND 101).
FIRST USE 8-0-2008; IN COMMERCE 8-0-2008.
JANET LEE, EXAMINING ATTORNEY

THE MARK CONSISTS OF STANDARD CHARACTERS
WITHOUT CLAIM TO ANY PARTICULAR FONT, STYLE,
SIZE, OR COLOR.

OWNER OF U.S. REG. NO. 3,024,514.
NO CLAIM IS MADE TO THE EXCLUSIVE RIGHT TO
USE "EIGHT", APART FROM THE MARK AS SHOWN.
FOR LEGAL SERVICES (U.S. CLS. 100 AND 101).
FIRST USE 2-17-2005; IN COMMERCE 2-17-2005.
DAVID H. STINE, EXAMINING ATTORNEY

* * * * *

SECTION 4.—PRIOR UNITED STATES CLASSIFICATION

APPLICATION IN ONE CLASS

COLLECTIVE MEMBERSHIP MARKS

CLASS 200—COLLECTIVE MEMBERSHIP
SN 77-583,221. CHURCH COMMUNITIES NY INC., RIF-
TON, NY. FILED 10-1-2008.

BRUDERHOF

THE MARK CONSISTS OF STANDARD CHARACTERS
WITHOUT CLAIM TO ANY PARTICULAR FONT, STYLE,
SIZE, OR COLOR.

THE ENGLISH TRANSLATION OF "BRUDERHOF" IN
THE MARK IS PLACE OF THE BROTHERS.
FOR INDICATING MEMBERSHIP IN A RELIGIOUS
ORDER.

TRACY CROSS, EXAMINING ATTORNEY

CERTIFICATION MARKS

CLASS A—GOODS

SN 77-554,623. ANALYCORP, INC., PALO ALTO, CA. FILED
8-25-2008.

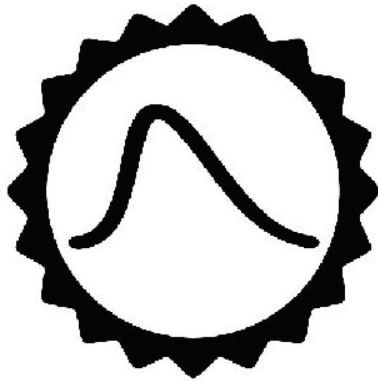

THE MARK CONSISTS OF A SUN WITH A WAVY LINE
IN THE CENTER.

THE CERTIFICATION MARK, AS INTENDED TO BE
USED BY AUTHORIZED PERSONS, IS INTENDED TO
CERTIFY THE CONFORMANCE AND INTEROPERABIL-
ITY OF THE GOODS BASED ON CERTIFIER-SPECIFIED
IMPLEMENTATIONS OF COLLECTIONS OF PROBABIL-
ITY DISTRIBUTIONS.

FOR COMPUTER SOFTWARE FOR MANAGING COL-
LECTIONS OF PROBABILITY DISTRIBUTIONS IN THE
FIELD OF STATISTICAL RISK AND UNCERTAINTY
MODELING.

BENJAMIN OKEKE, EXAMINING ATTORNEY

SN 77-592,152. WISCONSIN MILK MARKETING BOARD,
INC., MADISON, WI. FILED 10-14-2008.



THE MARK CONSISTS OF A MAN, I.E., A CHEESE-
MAKER, HOLDING BLOCKS OF CHEESE.

THE CERTIFICATION MARK, AS USED BY PERSONS
AUTHORIZED BY THE CERTIFIER, CERTIFIES THAT THE
GOODS PROVIDED HAVE ORIGINATED IN THE STATE
OF WISCONSIN AND HAVE MET THE QUALITY AND
INGREDIENT STANDARDS OF MASTER CHEESEMAKER
AS ESTABLISHED BY THE CERTIFIER.

FOR DAIRY PRODUCTS, NAMELY, CHEESE.

FIRST USE 6-1-1998; IN COMMERCE 6-1-1998.

SUSAN HAYASH, EXAMINING ATTORNEY

SN 77-720,454. AUTOMATION TECHNOLOGIES COUNCIL
D/B/A AUTOMATED IMAGING ASSOCIATION, ANN
ARBOR, MI. FILED 4-23-2009.

POCL

THE MARK CONSISTS OF STANDARD CHARACTERS
WITHOUT CLAIM TO ANY PARTICULAR FONT, STYLE,
SIZE, OR COLOR.

OWNER OF U.S. REG. NO. 3,351,298.

THE CERTIFICATION MARK, AS USED BY AUTHO-
RIZED PERSONS, CERTIFIES THAT DATA TRANSMISSION
AND DATA RECEIVER EQUIPMENT AND CABLES MEET
CERTAIN COMMUNICATIONS CONNECTIVITY INTER-
FACE STANDARDS.

FOR DATA TRANSMISSION AND DATA RECEIVER
EQUIPMENT AND CABLES FOR USE IN PHOTO-
GRAPHIC IMAGING.

FIRST USE 1-10-2007; IN COMMERCE 1-10-2007.

AMEEN IMAM, EXAMINING ATTORNEY

SN 77-724,140. METAL CONSTRUCTION ASSOCIATION, GLENVIEW, IL. FILED 4-28-2009.



NO CLAIM IS MADE TO THE EXCLUSIVE RIGHT TO USE "PREMIUM MCM FABRICATOR METAL CONSTRUCTION ASSOCIATION", APART FROM THE MARK AS SHOWN.

THE MARK CONSISTS OF THE WORDING "PREMIUM MCM FABRICATOR METAL CONSTRUCTION ASSOCIATION" IN A STYLIZED FONT AND THE DESIGN OF THREE BLOCK-LIKE SHINGLES TO THE LEFT OF "MCM". THE CERTIFICATION MARK, AS USED BY PERSONS AUTHORIZED BY THE CERTIFIER, CERTIFIES THAT METAL COMPOSITE MATERIAL BEARING THE MARK HAS MET SPECIFIC MCA DEVELOPED STANDARDS OF COMPETENCE IN THE FIELD OF PREMIUM METAL COMPOSITE MATERIAL MANUFACTURE.

FOR METAL COMPOSITE MATERIAL.
FIRST USE 6-1-2007; IN COMMERCE 6-1-2007.
RENEE MCCRAY, EXAMINING ATTORNEY

CLASS B—SERVICES

SN 77-192,987. COMMUNITY RECYCLING & RESOURCE RECOVERY, INC., SUN VALLEY, CA. FILED 5-30-2007.



This business has committed to the reduction of greenhouse gases by composting its food waste.

NO CLAIM IS MADE TO THE EXCLUSIVE RIGHT TO USE "THIS BUSINESS HAS COMMITTED TO THE REDUCTION OF GREENHOUSE GASES BY COMPOSTING ITS FOOD WASTE." AND "DISPOSAL CO., INC." AND "RESOURCE RECOVERY INC.", APART FROM THE MARK AS SHOWN.

THE COLOR(S) BLUE, BEIGE, WHITE, GREEN, RED AND BLACK IS/ARE CLAIMED AS A FEATURE OF THE MARK.

THE MARK CONSISTS OF A DEPICTION OF THE EARTH WHICH IS DEPICTED IN BLUE, WHITE, GREEN AND BEIGE; THE LETTER "A" WHICH IS SUPERIMPOSED ON TOP OF THE EARTH IS IN GREEN; THE ARROWS SUPERIMPOSED ON TOP OF THE EARTH ARE WHITE; THE WORDS "CROWN DISPOSAL CO., INC." AND THE "CROWN" IS RED; THE WORDS "COMMUNITY RECYCLING" AND THE "RECYCLING" SYMBOL IS IN GREEN; THE WORDS "THIS BUSINESS HAS COMMITTED TO THE REDUCTION OF GREENHOUSE GASES BY COMPOSTING ITS FOOD WASTE." IS IN BLACK TYPE FACE.

THE CERTIFICATION MARK, AS INTENDED TO BE USED BY AUTHORIZED PERSONS, IS INTENDED TO CERTIFY THAT THE BUSINESSES DISPLAYING THE MARK HAVE AGREED TO UNDERTAKE AND MEET CERTAIN STANDARDS OF POLLUTION PREVENTION AND WASTE REDUCTION, REUSE AND COMPOSTING, WHICH ARE HIGHER THAN REQUIRED BY STATE OR FEDERAL LAW.

FOR ENVIRONMENTAL REMEDIATION, NAMELY, WASTE DISPOSAL, INCLUDING THE REDUCTION, REUSING AND COMPOSTING OF WASTES.
ALLISON HOLTZ, EXAMINING ATTORNEY

SN 77-192,997. COMMUNITY RECYCLING & RESOURCE RECOVERY, INC., SUN VALLEY, CA. FILED 5-30-2007.



This business has committed to the reduction of greenhouse gases by recycling its waste.

NO CLAIM IS MADE TO THE EXCLUSIVE RIGHT TO USE "THIS BUSINESS HAS COMMITTED TO THE REDUCTION OF GREENHOUSE GASES BY RECYCLING ITS WASTE", "DISPOSAL CO., INC." AND "RECYCLING & RESOURCE RECOVERY, INC.", APART FROM THE MARK AS SHOWN.

THE COLOR(S) BLUE, BEIGE, WHITE, GREEN, RED AND BLACK IS/ARE CLAIMED AS A FEATURE OF THE MARK.

THE MARK CONSISTS OF A DEPICTION OF THE EARTH WHICH IS DEPICTED IN BLUE, WHITE, GREEN AND BEIGE; THE LETTER "A" WHICH IS SUPERIMPOSED ON TOP OF THE EARTH IS IN GREEN AND OUTLINED IN BLACK; THE ARROWS SUPERIMPOSED ON TOP OF THE EARTH ARE WHITE; THE WORDS "CROWN DISPOSAL CO., INC." AND THE "CROWN" IS RED WITH A WHITE HORIZONTAL STRIP AND OUTLINED IN BLACK; THE WORDS "COMMUNITY RECYCLING" AND THE RECYCLING SYMBOL IS IN GREEN; THE WORDING "& RESOURCE RECOVERY, INC." IS IN WHITE ON A BLACK RECTANGULAR BACKGROUND, ALL SURROUNDED BY A WHITE OVAL OUTLINED IN BLACK; THE WORDS "THIS BUSINESS HAS COMMITTED TO THE REDUCTION OF GREENHOUSE GASES BY RECYCLING ITS WASTE" IS IN BLACK TYPE FACE.

THE CERTIFICATION MARK, AS INTENDED TO BE USED BY AUTHORIZED PERSONS, IS INTENDED TO CERTIFY THAT THE BUSINESSES DISPLAYING THE MARK HAVE AGREED TO UNDERTAKE AND MEET CERTAIN STANDARDS OF POLLUTION PREVENTION AND WASTE REDUCTION, REUSE AND RECYCLING, WHICH ARE HIGHER THAN REQUIRED BY STATE OR FEDERAL LAW.

SEC. 2(F) AS TO "COMMUNITY RECYCLING & RESOURCE RECOVERY".

FOR ENVIRONMENTAL REMEDIATION, NAMELY, WASTE DISPOSAL, INCLUDING THE REDUCTION, REUSING AND RECYCLING OF WASTES.

DEIRDRE ROBERTSON, EXAMINING ATTORNEY

SN 77-559,569. REFRIGERATING ENGINEERS & TECHNICIANS ASSOCIATION, SALINAS, CA. FILED 8-30-2008.



NO CLAIM IS MADE TO THE EXCLUSIVE RIGHT TO USE "AUTHORIZED INSTRUCTOR", APART FROM THE MARK AS SHOWN.

THE COLOR(S) BLUE, GOLD, RED, BLACK, AND WHITE IS/ARE CLAIMED AS A FEATURE OF THE MARK.

THE MARK CONSISTS OF THE WORDING "RETA" IN WHITE ABOVE THE WORDING "RAI" IN GOLD WITH RED DOTS IN BETWEEN EACH LETTER AND THE WORDING "AUTHORIZED INSTRUCTOR" IN WHITE, ALL WITHIN A BLUE CIRCLE WITH A GOLD SCALLOPED BORDER WITH A BLACK OUTLINE.

THE CERTIFICATION MARK, AS USED OR INTENDED TO BE USED BY PERSONS AUTHORIZED BY THE CERTIFIER, CERTIFIES THAT THE SERVICES PROVIDED MEETS THE STANDARDS OF KNOWLEDGE, SKILL AND/OR TRAINING ESTABLISHED AND/OR ADOPTED BY CERTIFIER IN THE ART AND SCIENCE OF GIVING INSTRUCTION AND TRAINING IN THE FIELD OF INDUSTRIAL REFRIGERATION INDUSTRY.

FOR EDUCATIONAL SERVICES, NAMELY, INSTRUCTION AND TRAINING IN THE FIELD OF INDUSTRIAL REFRIGERATION.

ANGELA DUONG, EXAMINING ATTORNEY

THE CERTIFICATION MARK, AS USED BY PERSONS AUTHORIZED BY THE CERTIFIER, CERTIFIES THAT THE SERVICES ARE PROVIDED BY PERSONS WHO HAVE DEMONSTRATED A PARTICULAR LEVEL OF COMPETENCY IN THE FIELD OF ORGANIZATION AND PRODUCTIVITY CONSULTING BY HAVING MET CERTAIN EDUCATIONAL AND EXPERIENTIAL STANDARDS FOR ORGANIZATION AND PRODUCTIVITY CONSULTING SET BY THE CERTIFIER.

SEC. 2(F).

FOR ORGANIZATION AND PRODUCTIVITY CONSULTING SERVICES.

FIRST USE 5-0-2002; IN COMMERCE 5-0-2002.

HOWARD SMIGA, EXAMINING ATTORNEY

SN 77-641,220. NATIONAL STUDY GROUP ON CHRONIC DISORGANIZATION, ST. LOUIS, MO. FILED 12-30-2008.

CHRONIC DISORGANIZATION SPECIALIST

THE MARK CONSISTS OF STANDARD CHARACTERS WITHOUT CLAIM TO ANY PARTICULAR FONT, STYLE, SIZE, OR COLOR.

THE CERTIFICATION MARK, AS USED BY PERSONS AUTHORIZED BY THE CERTIFIER, CERTIFIES THAT THE SERVICES ARE PROVIDED BY PERSONS WHO HAVE DEMONSTRATED A PARTICULAR LEVEL OF COMPETENCY IN THE FIELD OF ORGANIZATION AND PRODUCTIVITY CONSULTING BY HAVING MET CERTAIN EDUCATIONAL AND EXPERIENTIAL STANDARDS FOR ORGANIZATION AND PRODUCTIVITY CONSULTING SET BY THE CERTIFIER.

SEC. 2(F).

FOR ORGANIZATION AND PRODUCTIVITY CONSULTING SERVICES.

FIRST USE 5-0-2002; IN COMMERCE 5-0-2002.

HOWARD SMIGA, EXAMINING ATTORNEY

SN 77-723,706. NATIONAL BOARD OF SURGICAL TECHNOLOGY AND SURGICAL ASSISTING, LITTLETON, CO. FILED 4-28-2009.

CSFA

CD SPECIALIST

THE MARK CONSISTS OF STANDARD CHARACTERS WITHOUT CLAIM TO ANY PARTICULAR FONT, STYLE, SIZE, OR COLOR.

THE CERTIFICATION MARK, AS INTENDED TO BE USED BY AUTHORIZED PERSONS, IS INTENDED TO CERTIFY PROFICIENCY IN SELECTED SURGICAL TECHNIQUES AND SKILLS.

FOR SURGICAL ASSISTANT SERVICES.

BRIAN PINO, EXAMINING ATTORNEY

THE MARK CONSISTS OF STANDARD CHARACTERS WITHOUT CLAIM TO ANY PARTICULAR FONT, STYLE, SIZE, OR COLOR.

TRADEMARK REGISTRATIONS ISSUED

PRINCIPAL REGISTER

SECTION 1.— INTERNATIONAL CLASSIFICATION

The short titles associated below with the international class numbers are terms designed merely for quick identification and are not an official part of the international classification. The full names of international classes are given in section 6.1 of the trademark rules of practice.

The designation "U.S. Cl." appearing in this section refers to the U.S. class in effect prior to Sep. 1, 1973 rather than the international class which applies to applications filed on or after that date. For adoption of international classification see notice in the OFFICIAL GAZETTE of Jun. 26, 1973 (911 O.G. TM 210).

CLASS 1—CHEMICALS

- 3,678,141. **MISCELLANEOUS DESIGN**. PENNZOIL-QUAKER STATE COMPANY, (U.S. CLS. 1, 5, 6, 10, 26 AND 46). SN 76-418,018. PUB. 8-30-2005. FILED 6-7-2002.
- 3,678,147. **CHONDROGENE (BLOCK FORM)**. GENENEWS LIMITED, MULTIPLE CLASS, (INT. CLS. 1, 5, 42 AND 44), (U.S. CLS. 1, 5, 6, 10, 18, 26, 44, 46, 51, 52, 100 AND 101). SN 76-568,020. PUB. 9-30-2008. FILED 12-31-2003.
- 3,678,204. **IFORENSIC AND DESIGN**. FORENSIC SCIENCE SERVICE LTD., MULTIPLE CLASS, (INT. CLS. 1, 9, 37, 41 AND 42), (U.S. CLS. 1, 5, 6, 10, 21, 23, 26, 36, 38, 46, 100, 101, 103, 106 AND 107). SN 77-015,611. PUB. 6-23-2009. FILED 10-6-2006.
- 3,678,207. **STEAPLUS (BLOCK FORM)**. LUZENAC EUROPE SAS, MULTIPLE CLASS, (INT. CLS. 1, 16 AND 20), (U.S. CLS. 1, 2, 5, 6, 10, 13, 22, 23, 25, 26, 29, 32, 37, 38, 46 AND 50). SN 77-047,263. PUB. 7-15-2008. FILED 11-18-2006.
- 3,678,218. **TILE GUARD (BLOCK FORM)**. HOMAX PRODUCTS, INC., MULTIPLE CLASS, (INT. CLS. 1, 2, 3, 8 AND 17), (U.S. CLS. 1, 4, 5, 6, 10, 11, 12, 13, 16, 23, 26, 28, 35, 44, 46, 50, 51 AND 52). SN 77-089,409. PUB. 6-23-2009. FILED 1-23-2007.
- 3,678,295. **MISCELLANEOUS DESIGN**. SCHLUTER-SYSTEMS KG, MULTIPLE CLASS, (INT. CLS. 1, 6, 11, 17 AND 19), (U.S. CLS. 1, 2, 5, 6, 10, 12, 13, 14, 21, 23, 25, 26, 31, 33, 34, 35, 46 AND 50). SN 77-312,096. PUB. 4-21-2009. FILED 10-24-2007.
- 3,678,421. **NANOFINISH (BLOCK FORM)**. ORMECON GMBH, MULTIPLE CLASS, (INT. CLS. 1, 2 AND 17), (U.S. CLS. 1, 5, 6, 10, 11, 12, 13, 16, 26, 35, 46 AND 50). SN 77-454,255. PUB. 3-17-2009. FILED 4-22-2008.
- 3,678,458. **FELINE TRIPLE (BLOCK FORM)**. IDEXX LABORATORIES, INC., MULTIPLE CLASS, (INT. CLS. 1 AND 10), (U.S. CLS. 1, 5, 6, 10, 26, 39, 44 AND 46). SN 77-492,618. PUB. 6-23-2009. FILED 6-6-2008.
- 3,678,464. **NOAX (BLOCK FORM)**. COI CERAMICS, INC., (U.S. CLS. 1, 5, 6, 10, 26 AND 46). SN 77-497,244. PUB. 6-23-2009. FILED 6-12-2008.
- 3,678,481. **PAVEWAY (STYLIZED)**. AVECIA BIOLOGICS LIMITED, MULTIPLE CLASS, (INT. CLS. 1, 40 AND 42), (U.S. CLS. 1, 5, 6, 10, 26, 46, 100, 101, 103 AND 106). SN 77-504,361. PUB. 6-23-2009. FILED 6-20-2008.
- 3,678,512. **HEXASOL (BLOCK FORM)**. ARKEMA FRANCE, (U.S. CLS. 1, 5, 6, 10, 26 AND 46). SN 77-519,131. PUB. 11-25-2008. FILED 7-10-2008.
- 3,678,520. **LUNA-COOLANT (BLOCK FORM)**. OHTOMO CHEMICAL INS., CORP., MULTIPLE CLASS, (INT. CLS. 1 AND 4), (U.S. CLS. 1, 5, 6, 10, 15, 26 AND 46). SN 77-522,289. PUB. 6-23-2009. FILED 7-15-2008.
- 3,678,675. **NOMAR (BLOCK FORM)**. MICHELMAN, INC., (U.S. CLS. 1, 5, 6, 10, 26 AND 46). SN 77-542,582. PUB. 6-23-2009. FILED 8-8-2008.
- 3,678,750. **ZIC (BLOCK FORM)**. MERCK KGAA, MULTIPLE CLASS, (INT. CLS. 1 AND 9), (U.S. CLS. 1, 5, 6, 10, 21, 23, 26, 36, 38 AND 46). SN 77-561,569. PUB. 6-23-2009. FILED 9-3-2008.
- 3,678,997. **ORGANICARE AND DESIGN**. AMERICAN AGRI-TECH, LLC, (U.S. CLS. 1, 5, 6, 10, 26 AND 46). SN 77-632,330. PUB. 6-23-2009. FILED 12-12-2008.
- 3,679,014. **DECONGEL AND DESIGN**. CELLULAR BIOENGINEERING, INC., MULTIPLE CLASS, (INT. CLS. 1 AND 3), (U.S. CLS. 1, 4, 5, 6, 10, 26, 46, 50, 51 AND 52). SN 77-637,084. PUB. 6-23-2009. FILED 12-19-2008.
- 3,679,030. **CORROSTALL (BLOCK FORM)**. THOMAS & BETTS INTERNATIONAL, INC., (U.S. CLS. 1, 5, 6, 10, 26 AND 46). SN 77-642,017. PUB. 6-23-2009. FILED 12-31-2008.
- 3,679,081. **A ADVANCED BIOTECHNOLOGIES INC AND DESIGN**. ADVANCED BIOTECHNOLOGIES, INC., (U.S. CLS. 1, 5, 6, 10, 26 AND 46). SN 77-653,708. PUB. 6-23-2009. FILED 1-21-2009.
- 3,679,145. **NAVITAS (BLOCK FORM)**. CONSTRUCTION RESEARCH & TECHNOLOGY, GMBH, (U.S. CLS. 1, 5, 6, 10, 26 AND 46). SN 77-664,197. PUB. 6-23-2009. FILED 2-5-2009.
- 3,679,146. **FULVIC BUFFET (BLOCK FORM)**. BLACK DIRT ORGANICS, LLC, (U.S. CLS. 1, 5, 6, 10, 26 AND 46). SN 77-664,384. PUB. 6-23-2009. FILED 2-5-2009.
- 3,679,151. **FLUPRO (BLOCK FORM)**. SRM CHEMICAL, LTD. CO., (U.S. CLS. 1, 5, 6, 10, 26 AND 46). SN 77-665,136. PUB. 6-23-2009. FILED 2-6-2009.
- 3,679,152. **SHIPLEY BPR (BLOCK FORM)**. ROHM AND HAAS ELECTRONIC MATERIALS LLC, (U.S. CLS. 1, 5, 6, 10, 26 AND 46). SN 77-665,162. PUB. 6-23-2009. FILED 2-6-2009.
- 3,679,305. **ELSOL (BLOCK FORM)**. VERTEC BIOSOLVENTS, INC., (U.S. CLS. 1, 5, 6, 10, 26 AND 46). SN 77-674,039. PUB. 6-23-2009. FILED 2-19-2009.
- 3,679,331. **BAKE-MOR (BLOCK FORM)**. ALLIED BLENDING & INGREDIENTS, INC., (U.S. CLS. 1, 5, 6, 10, 26 AND 46). SN 77-674,861. PUB. 6-23-2009. FILED 2-20-2009.
- 3,679,362. **SILTECH-GUM (BLOCK FORM)**. SILTECH LLC, (U.S. CLS. 1, 5, 6, 10, 26 AND 46). SN 77-675,549. PUB. 6-23-2009. FILED 2-22-2009.
- 3,679,388. **DULANY (BLOCK FORM)**. DULANY INDUSTRIES, INC., MULTIPLE CLASS, (INT. CLS. 1 AND 39), (U.S. CLS. 1, 5, 6, 10, 26, 46, 100 AND 105). SN 77-676,036. PUB. 6-23-2009. FILED 2-23-2009.
- 3,679,415. **MISCELLANEOUS DESIGN**. DULANY INDUSTRIES, INC., MULTIPLE CLASS, (INT. CLS. 1 AND 39), (U.S. CLS. 1, 5, 6, 10, 26, 46, 100 AND 105). SN 77-676,586. PUB. 6-23-2009. FILED 2-23-2009.
- 3,679,416. **BUILDING A UNIFIED CORPORATION THAT THRIVES ON DIVERSITY. (BLOCK FORM)**. DULANY INDUSTRIES, INC., MULTIPLE CLASS, (INT. CLS. 1 AND 39), (U.S. CLS. 1, 5, 6, 10, 26, 46, 100 AND 105). SN 77-676,590. PUB. 6-23-2009. FILED 2-23-2009.
- 3,679,474. **SOY-MATE (BLOCK FORM)**. ADVANCED TECHNOLOGY LLC, (U.S. CLS. 1, 5, 6, 10, 26 AND 46). SN 77-677,167. PUB. 6-23-2009. FILED 2-24-2009.
- 3,679,531. **STAMINA (BLOCK FORM)**. BASF SE, (U.S. CLS. 1, 5, 6, 10, 26 AND 46). SN 77-677,795. PUB. 6-23-2009. FILED 2-25-2009.
- 3,679,557. **BEVERAGE CARBONATION MADE EASY (BLOCK FORM)**. NUCO2 IP LLC, MULTIPLE CLASS, (INT. CLS. 1, 37 AND 39), (U.S. CLS. 1, 5, 6, 10, 26, 46, 100, 103, 105 AND 106). SN 77-678,162. PUB. 6-23-2009. FILED 2-25-2009.
- 3,679,584. **HEATSAVR, THE ORIGINAL LIQUID SOLAR POOL COVER (BLOCK FORM)**. FLEXIBLE SOLUTIONS INTERNATIONAL INC., (U.S. CLS. 1, 5, 6, 10, 26 AND 46).

- SN 77-678,473. PUB. 6-23-2009. FILED 2-25-2009.
- 3,679,756. **DEEQUEST (BLOCK FORM)**. HALLIBURTON ENERGY SERVICES, INC., (U.S. CLS. 1, 5, 6, 10, 26 AND 46). SN 77-696,595. PUB. 6-23-2009. FILED 3-23-2009.
- 3,679,762. **NATURAL-PLEX (BLOCK FORM)**. SILTECH LLC, (U.S. CLS. 1, 5, 6, 10, 26 AND 46). SN 77-698,354. PUB. 6-23-2009. FILED 3-24-2009.
- 3,679,838. **THE NAME THE WORLD BUILDS ON (BLOCK FORM)**. WOLSELEY PLC, MULTIPLE CLASS, (INT. CLS. 1, 2, 3, 6, 7, 8, 9, 11, 12, 16, 17, 19, 20, 21, 22, 24, 25, 27, 35, 36, 37, 38, 39, 40 AND 41), (U.S. CLS. 1, 2, 4, 5, 6, 7, 10, 11, 12, 13, 14, 16, 19, 20, 21, 22, 23, 25, 26, 28, 29, 30, 31, 32, 33, 34, 35, 36, 37, 38, 39, 40, 42, 44, 46, 50, 51, 52, 100, 101, 102, 103, 104, 105, 106 AND 107). SN 78-870,034. PUB. 6-23-2009. FILED 4-26-2006.
- 3,679,855. **MICROBOND AND DESIGN**. UMICORE AG & CO. KG, MULTIPLE CLASS, (INT. CLS. 1, 6, 9 AND 14), (U.S. CLS. 1, 2, 5, 6, 10, 12, 13, 14, 21, 23, 25, 26, 27, 28, 36, 38, 46 AND 50). SN 79-030,648. PUB. 6-23-2009. FILED 8-8-2006.
- 3,679,859. **CRYTUR AND DESIGN**. CRYTUR, SPOLS R.O., MULTIPLE CLASS, (INT. CLS. 1 AND 9), (U.S. CLS. 1, 5, 6, 10, 21, 23, 26, 36, 38 AND 46). SN 79-036,224. PUB. 6-23-2009. FILED 6-1-2006.
- 3,679,873. **MISCELLANEOUS DESIGN**. SIKA AG, MULTIPLE CLASS, (INT. CLS. 1, 2, 17 AND 19), (U.S. CLS. 1, 5, 6, 10, 11, 12, 13, 16, 26, 33, 35, 46 AND 50). SN 79-049,183. PUB. 6-23-2009. FILED 11-6-2007.
- 3,679,907. **BASECLICK (BLOCK FORM)**. BASF VENTURE CAPITAL GMBH, MULTIPLE CLASS, (INT. CLS. 1, 42, 44 AND 45), (U.S. CLS. 1, 5, 6, 10, 26, 46, 100 AND 101). SN 79-056,877. PUB. 6-23-2009. FILED 6-20-2008.
- 3,679,932. **CALYPSONE (BLOCK FORM)**. GIVAUDAN S.A., (U.S. CLS. 1, 5, 6, 10, 26 AND 46). SN 79-058,643. PUB. 6-23-2009. FILED 8-25-2008.
- 3,679,945. **POWERPAGE (BLOCK FORM)**. SILVERBROOK RESEARCH PTY LTD, MULTIPLE CLASS, (INT. CLS. 1, 2, 7, 9 AND 16), (U.S. CLS. 1, 2, 5, 6, 10, 11, 13, 16, 19, 21, 22, 23, 26, 29, 31, 34, 35, 36, 37, 38, 46 AND 50). SN 79-059,266. PUB. 6-23-2009. FILED 7-25-2007.
- 3,679,946. **SINOPEC (STYLIZED)**. CHINA PETROCHEMICAL CORPORATION, MULTIPLE CLASS, (INT. CLS. 1, 4, 17, 19, 37 AND 42), (U.S. CLS. 1, 5, 6, 10, 12, 13, 15, 26, 33, 35, 46, 50, 100, 101, 103 AND 106). SN 79-059,270. PUB. 6-23-2009. FILED 3-17-2008.
- 3,679,956. **TIB (BLOCK FORM)**. TIB CHEMICALS AG, MULTIPLE CLASS, (INT. CLS. 1, 2, 6 AND 14), (U.S. CLS. 1, 2, 5, 6, 10, 11, 12, 13, 14, 16, 23, 25, 26, 27, 28, 46 AND 50). SN 79-059,728. PUB. 6-23-2009. FILED 3-10-2008.
- 3,679,972. **PERESTANE (BLOCK FORM)**. SOLVAY (SOCIÉTÉ ANONYME), MULTIPLE CLASS, (INT. CLS. 1 AND 5), (U.S. CLS. 1, 5, 6, 10, 18, 26, 44, 46, 51 AND 52). SN 79-060,228. PUB. 6-23-2009. FILED 9-8-2008.
- 3,680,007. **THOUGHT LEADERSHIP@FIRMENICH (BLOCK FORM)**. FIRMENICH SA, MULTIPLE CLASS, (INT. CLS. 1, 3, 16, 30 AND 35), (U.S. CLS. 1, 2, 4, 5, 6, 10, 22, 23, 26, 29, 37, 38, 46, 50, 51, 52, 100, 101 AND 102). SN 79-062,421. PUB. 6-23-2009. FILED 8-26-2008.
- 3,680,009. **IERBA (BLOCK FORM)**. PRP HOLDING, MULTIPLE CLASS, (INT. CLS. 1, 5 AND 31), (U.S. CLS. 1, 5, 6, 10, 18, 26, 44, 46, 51 AND 52). SN 79-062,509. PUB. 6-23-2009. FILED 9-9-2008.
- 3,680,041. **WEI HUA AND DESIGN**. ZHEJIANG WEIHUA CHEMICAL CO., LTD., (U.S. CLS. 1, 5, 6, 10, 26 AND 46). SN 79-065,753. PUB. 6-23-2009. FILED 1-14-2009.

CLASS 2—PAINTS

- 3,678,198. **BEE GONE (BLOCK FORM)**. ISK AMERICAS INCORPORATED, (U.S. CLS. 6, 11 AND 16). SN 76-695,914. PUB. 6-23-2009. FILED 2-23-2009.
- 3,678,218 (*See Class 1 for this trademark*).
- 3,678,421 (*See Class 1 for this trademark*).
- 3,678,647. **HADDAR AND DESIGN**. SMR DISTRIBUTING CORP, DBA HADDAR FOODS, MULTIPLE CLASS, (INT. CLS. 2, 3, 29, 30 AND 32), (U.S. CLS. 1, 4, 6, 11, 16, 45, 46, 48, 50, 51 AND 52). SN 77-540,110. PUB. 6-23-2009. FILED 8-6-

- 2008.
- 3,678,831. **PRECISION (BLOCK FORM)**. VISION OPTICS TECHNOLOGIES LTD., (U.S. CLS. 6, 11 AND 16). SN 77-584,329. PUB. 3-17-2009. FILED 10-2-2008.
- 3,678,916. **BRITE-N-EZ ROOF COATING WATER TIGHT TECHNOLOGIES AND DESIGN**. WATER TIGHT TECHNOLOGIES, LLC, (U.S. CLS. 6, 11 AND 16). SN 77-609,390. PUB. 6-23-2009. FILED 11-6-2008.
- 3,679,172. **WE'VE BEEN GREEN SINCE GOD MADE GRASS... (BLOCK FORM)**. ANCHOR COATINGS OF LEESBURG, INC., MULTIPLE CLASS, (INT. CLS. 2, 17 AND 35), (U.S. CLS. 1, 5, 6, 11, 12, 13, 16, 35, 50, 100, 101 AND 102). SN 77-666,410. PUB. 6-23-2009. FILED 2-9-2009.
- 3,679,369. **ESNALUBE (BLOCK FORM)**. METAL IMPROVEMENT COMPANY, LLC, MULTIPLE CLASS, (INT. CLS. 2 AND 4), (U.S. CLS. 1, 6, 11, 15 AND 16). SN 77-675,658. PUB. 6-23-2009. FILED 2-23-2009.
- 3,679,760. **LUBE-LOK (BLOCK FORM)**. METAL IMPROVEMENT COMPANY, LLC, MULTIPLE CLASS, (INT. CLS. 2 AND 4), (U.S. CLS. 1, 6, 11, 15 AND 16). SN 77-697,812. PUB. 6-23-2009. FILED 3-24-2009.
- 3,679,788. **EURO-NOVOC (BLOCK FORM)**. WILLIAMS-HAYWARD PROTECTIVE COATINGS, INC., AKA WILLIAMS-HAYWARD INTERNATIONAL COATINGS, INC., (U.S. CLS. 6, 11 AND 16). SN 77-723,920. PUB. 6-23-2009. FILED 4-28-2009.
- 3,679,838 (*See Class 1 for this trademark*).
- 3,679,873 (*See Class 1 for this trademark*).
- 3,679,891. **OVERLAST (BLOCK FORM)**. SMAGARD LTD., (U.S. CLS. 6, 11 AND 16). SN 79-053,829. PUB. 6-23-2009. FILED 5-7-2008.
- 3,679,945 (*See Class 1 for this trademark*).
- 3,679,956 (*See Class 1 for this trademark*).
- 3,680,021. **PLATIN STAR AND DESIGN**. ECKART GMBH, (U.S. CLS. 6, 11 AND 16). SN 79-063,419. PUB. 6-23-2009. FILED 10-30-2008.
- 3,680,044. **MOLOTOW (BLOCK FORM)**. JUERGEN FEUERSTEIN, MULTIPLE CLASS, (INT. CLS. 2, 16 AND 25), (U.S. CLS. 2, 5, 6, 11, 16, 22, 23, 29, 37, 38, 39 AND 50). SN 79-066,111. PUB. 6-23-2009. FILED 11-20-2008.

CLASS 3—COSMETICS AND CLEANING PREPARATIONS

- 3,678,144. **OCEANIC**. OCEANIC PRZEDSIĘBIORSTWO FARMACEUTYCZNO KOSMETYCZNE SOSZYŃSKI WOJCIECH, MULTIPLE CLASS, (INT. CLS. 3 AND 5), (U.S. CLS. 1, 4, 6, 18, 44, 46, 50, 51 AND 52). SN 76-501,781. PUB. 11-29-2005. FILED 3-18-2003.
- 3,678,150. **TERRA-KLEEN (STYLIZED)**. ENVIRO-SAFE PRODUCTS, INC., (U.S. CLS. 1, 4, 6, 50, 51 AND 52). SN 76-640,302. PUB. 6-23-2009. FILED 6-7-2005.
- 3,678,218 (*See Class 1 for this trademark*).
- 3,678,232. **VONIN (BLOCK FORM)**. LG HOUSEHOLD & HEALTH CARE LTD., (U.S. CLS. 1, 4, 6, 50, 51 AND 52). SN 77-168,166. PUB. 4-28-2009. FILED 4-27-2007.
- 3,678,260. **MISCELLANEOUS DESIGN**. LIZ EARLE BEAUTY CO., LIMITED, MULTIPLE CLASS, (INT. CLS. 3, 35 AND 44), (U.S. CLS. 1, 4, 6, 50, 51, 52, 100, 101 AND 102). SN 77-244,596. PUB. 6-23-2009. FILED 8-1-2007.
- 3,678,269. **ORALCLENS NATURAL AND DESIGN**. ORALDENT LIMITED, (U.S. CLS. 1, 4, 6, 50, 51 AND 52). SN 77-262,150. PUB. 1-13-2009. FILED 8-22-2007.
- 3,678,276. **MATTHEW WILLIAMSON (BLOCK FORM)**. MATTHEW WILLIAMSON, MULTIPLE CLASS, (INT. CLS. 3, 18 AND 25), (U.S. CLS. 1, 2, 3, 4, 6, 22, 39, 41, 50, 51 AND 52). SN 77-289,547. PUB. 3-17-2009. FILED 9-26-2007.
- 3,678,307. **SILHOUETTE (BLOCK FORM)**. MOSHE INC, DBA SCENT-SATIONS, (U.S. CLS. 1, 4, 6, 50, 51 AND 52). SN 77-328,539. PUB. 3-17-2009. FILED 11-13-2007.
- 3,678,308. **SURREAL (BLOCK FORM)**. MOSHE INC, DBA SCENT-SATION, (U.S. CLS. 1, 4, 6, 50, 51 AND 52). SN 77-328,746. PUB. 3-17-2009. FILED 11-13-2007.
- 3,678,347. **SOFTSOAP AND DESIGN**. IES ENTERPRISES, INC., (U.S. CLS. 1, 4, 6, 50, 51 AND 52). SN 77-378,926. PUB. 6-23-2009. FILED 1-23-2008.

- 3,678,355. **MISCELLANEOUS DESIGN**. AMOREPACIFIC CORPORATION, (U.S. CLS. 1, 4, 6, 50, 51 AND 52). SN 77-391,499. PUB. 6-23-2009. FILED 2-7-2008.
- 3,678,361. **SOFTSOAP AND DESIGN**. IES ENTERPRISES, INC., (U.S. CLS. 1, 4, 6, 50, 51 AND 52). SN 77-398,726. PUB. 6-23-2009. FILED 2-15-2008.
- 3,678,365. **CLEANSE & POLISH (STYLIZED)**. LIZ EARLE BEAUTY CO., LIMITED, (U.S. CLS. 1, 4, 6, 50, 51 AND 52). SN 77-403,134. PUB. 6-23-2009. FILED 2-21-2008.
- 3,678,389. **TECNO ORGANIC MAKEUP AND DESIGN**. TECNOCOSMESI S.P.A., (U.S. CLS. 1, 4, 6, 50, 51 AND 52). SN 77-427,108. PUB. 6-23-2009. FILED 3-20-2008.
- 3,678,397. **BURST! (BLOCK FORM)**. THEOCHEM LABORATORIES, INC., (U.S. CLS. 1, 4, 6, 50, 51 AND 52). SN 77-434,338. PUB. 3-17-2009. FILED 3-28-2008.
- 3,678,430. **C43 (BLOCK FORM)**. STROM, ROBERT, AND WHITTEMORE, JERRY, (U.S. CLS. 1, 4, 6, 50, 51 AND 52). SN 77-462,392. PUB. 6-23-2009. FILED 4-30-2008.
- 3,678,442. **HERBALSOURCE AND DESIGN**. HERBAL SOURCE LLC, (U.S. CLS. 1, 4, 6, 50, 51 AND 52). SN 77-477,550. PUB. 6-23-2009. FILED 5-19-2008.
- 3,678,457. **HOLECO (BLOCK FORM)**. DERMA HAIR CARE, LLC, (U.S. CLS. 1, 4, 6, 50, 51 AND 52). SN 77-490,926. PUB. 6-23-2009. FILED 6-4-2008.
- 3,678,471. **LASHSTILETTO (BLOCK FORM)**. L'OREAL USA CREATIVE, INC., (U.S. CLS. 1, 4, 6, 50, 51 AND 52). SN 77-500,072. PUB. 6-23-2009. FILED 6-16-2008.
- 3,678,472. **NATUDERM (BLOCK FORM)**. MANN & SCHRÖDER GMBH, (U.S. CLS. 1, 4, 6, 50, 51 AND 52). SN 77-500,101. PUB. 4-7-2009. FILED 6-16-2008.
- 3,678,510. **ADAIR (BLOCK FORM)**. SIMPLE PRODUCTS CORP, DBA ADAIR PRODUCTS CORP, (U.S. CLS. 1, 4, 6, 50, 51 AND 52). SN 77-518,874. PUB. 6-23-2009. FILED 7-10-2008.
- 3,678,543. **DAWN SARAH JESSICA PARKER (BLOCK FORM)**. VERY FETCHING COMPANY, INC., (U.S. CLS. 1, 4, 6, 50, 51 AND 52). SN 77-527,998. PUB. 6-23-2009. FILED 7-22-2008.
- 3,678,578. **ELEVEN SKIN (BLOCK FORM)**. MEME DELRAY BEACH, LLC, (U.S. CLS. 1, 4, 6, 50, 51 AND 52). SN 77-532,434. PUB. 6-23-2009. FILED 7-28-2008.
- 3,678,599. **STAR POWER (BLOCK FORM)**. MOLDAVON, ILONA, (U.S. CLS. 1, 4, 6, 50, 51 AND 52). SN 77-535,754. PUB. 6-23-2009. FILED 7-31-2008.
- 3,678,600. **MISS OOPS (BLOCK FORM)**. EASY INDUSTRIES, LLC, MULTIPLE CLASS, (INT. CLS. 3 AND 25), (U.S. CLS. 1, 4, 6, 22, 39, 50, 51 AND 52). SN 77-536,121. PUB. 6-23-2009. FILED 7-31-2008.
- 3,678,632. **FORCE VECTOR (BLOCK FORM)**. L'OREAL, (U.S. CLS. 1, 4, 6, 50, 51 AND 52). SN 77-538,954. PUB. 6-23-2009. FILED 8-5-2008.
- 3,678,647 (*See Class 2 for this trademark*).
- 3,678,656. **SENSATIONAL SMILE (BLOCK FORM)**. WHITE SMILE TECHNOLOGIES, LLC, (U.S. CLS. 1, 4, 6, 50, 51 AND 52). SN 77-541,549. PUB. 6-23-2009. FILED 8-7-2008.
- 3,678,730. **MAKUNSI AND DESIGN**. MAKUNSI AROMA (HONG KONG) COMPANY LIMITED, MULTIPLE CLASS, (INT. CLS. 3 AND 21), (U.S. CLS. 1, 2, 4, 6, 13, 23, 29, 30, 33, 40, 50, 51 AND 52). SN 77-555,675. PUB. 6-23-2009. FILED 8-26-2008.
- 3,678,739. **LANCOME LES ORIGINELS (BLOCK FORM)**. LANCOME PARFUMS ET BEAUTE & CIE, (U.S. CLS. 1, 4, 6, 50, 51 AND 52). SN 77-557,048. PUB. 6-23-2009. FILED 8-27-2008.
- 3,678,751. **HYDROLYZE (BLOCK FORM)**. BELLEZZA PRODUCTS, LLC, (U.S. CLS. 1, 4, 6, 50, 51 AND 52). SN 77-561,590. PUB. 1-20-2009. FILED 9-3-2008.
- 3,678,758. **CLIMATE SHIELD (BLOCK FORM)**. ZOTOS INTERNATIONAL, INC., (U.S. CLS. 1, 4, 6, 50, 51 AND 52). SN 77-563,148. PUB. 6-23-2009. FILED 9-5-2008.
- 3,678,763. **GREEN ASSURANCE PROGRAM (BLOCK FORM)**. PURE & NATURAL COMPANY, (U.S. CLS. 1, 4, 6, 50, 51 AND 52). SN 77-566,869. PUB. 6-23-2009. FILED 9-10-2008.
- 3,678,765. **ONDE VERTIGE (BLOCK FORM)**. GA MODEFINE S.A., (U.S. CLS. 1, 4, 6, 50, 51 AND 52). SN 77-568,163. PUB. 6-23-2009. FILED 9-11-2008.
- 3,678,783. **LAN LAY (STYLIZED)**. GREAT-5 INTERNATIONAL INC., (U.S. CLS. 1, 4, 6, 50, 51 AND 52). SN 77-572,817. PUB. 6-23-2009. FILED 9-18-2008.
- 3,678,817. **NATURADERM (BLOCK FORM)**. RHYTHM & BLUE INC. LIMITED, (U.S. CLS. 1, 4, 6, 50, 51 AND 52). SN 77-582,094. PUB. 6-23-2009. FILED 9-30-2008.
- 3,678,929. **BE GOOD TO YOUR BODY (BLOCK FORM)**. BARTLETT, CHRISTY D., DBA SAN DIEGO BATH AND BODY COMPANY, (U.S. CLS. 1, 4, 6, 50, 51 AND 52). SN 77-614,295. PUB. 6-23-2009. FILED 11-14-2008.
- 3,678,938. **EZHAND HYGIENE (BLOCK FORM)**. ALUTA, INC., (U.S. CLS. 1, 4, 6, 50, 51 AND 52). SN 77-618,470. PUB. 6-23-2009. FILED 11-20-2008.
- 3,678,944. **MINERIAL (BLOCK FORM)**. L'OREAL, (U.S. CLS. 1, 4, 6, 50, 51 AND 52). SN 77-619,424. PUB. 6-23-2009. FILED 11-21-2008.
- 3,679,013. **KUSTOM KARE (BLOCK FORM)**. AFFLINK, LLC, (U.S. CLS. 1, 4, 6, 50, 51 AND 52). SN 77-636,735. PUB. 6-23-2009. FILED 12-19-2008.
- 3,679,014 (*See Class 1 for this trademark*).
- 3,679,074. **REAL EARTH (BLOCK FORM)**. REAL EARTH PRODUCTS, LLC, (U.S. CLS. 1, 4, 6, 50, 51 AND 52). SN 77-652,772. PUB. 6-23-2009. FILED 1-20-2009.
- 3,679,076. **BODYWEALTH AND DESIGN**. RAPOZA, DARYL LYN, DBA BODYWEALTH, (U.S. CLS. 1, 4, 6, 50, 51 AND 52). SN 77-652,793. PUB. 6-23-2009. FILED 1-20-2009.
- 3,679,160. **CEXPRESS (BLOCK FORM)**. CAROLS EXPRESS, LLC, (U.S. CLS. 1, 4, 6, 50, 51 AND 52). SN 77-665,841. PUB. 6-23-2009. FILED 2-8-2009.
- 3,679,254. **MOISTURE BLOCK (BLOCK FORM)**. VICTOR SABINO, DBA SABINO INTERNATIONAL, LLC, (U.S. CLS. 1, 4, 6, 50, 51 AND 52). SN 77-672,151. PUB. 6-23-2009. FILED 2-17-2009.
- 3,679,327. **MYJANMARINI (BLOCK FORM)**. JAN MARINI SKIN RESEARCH, MULTIPLE CLASS, (INT. CLS. 3 AND 35), (U.S. CLS. 1, 4, 6, 50, 51, 52, 100, 101 AND 102). SN 77-674,716. PUB. 6-23-2009. FILED 2-20-2009.
- 3,679,354. **EYEDEWS (BLOCK FORM)**. MOOD MENDERS, LLC, AKA MOOD MENDERS, TO GO SPA, (U.S. CLS. 1, 4, 6, 50, 51 AND 52). SN 77-675,394. PUB. 6-23-2009. FILED 2-21-2009.
- 3,679,372. **EFFULGERE (BLOCK FORM)**. AD LUNAM LABS, INC., (U.S. CLS. 1, 4, 6, 50, 51 AND 52). SN 77-675,687. PUB. 6-23-2009. FILED 2-23-2009.
- 3,679,417. **THE GODDESS NEXT DOOR (BLOCK FORM)**. THE GODDESS NEXT DOOR, (U.S. CLS. 1, 4, 6, 50, 51 AND 52). SN 77-676,600. PUB. 6-23-2009. FILED 2-23-2009.
- 3,679,488. **PLAY (BLOCK FORM)**. LRC PRODUCTS LIMITED, MULTIPLE CLASS, (INT. CLS. 3 AND 10), (U.S. CLS. 1, 4, 6, 26, 39, 44, 50, 51 AND 52). SN 77-677,296. PUB. 6-23-2009. FILED 2-24-2009.
- 3,679,497. **AHNU NURTURE BEAUTY AND DESIGN**. AHNU-TRA, INC., (U.S. CLS. 1, 4, 6, 50, 51 AND 52). SN 77-677,402. PUB. 6-23-2009. FILED 2-24-2009.
- 3,679,514. **ANASTASIA BEVERLY HILLS (BLOCK FORM)**. ANASTASIA BEVERLY HILLS, INC., MULTIPLE CLASS, (INT. CLS. 3 AND 21), (U.S. CLS. 1, 2, 4, 6, 13, 23, 29, 30, 33, 40, 50, 51 AND 52). SN 77-677,638. PUB. 6-23-2009. FILED 2-24-2009.
- 3,679,559. **CASSIE GIRL (BLOCK FORM)**. JOSEPH C. PETERS, (U.S. CLS. 1, 4, 6, 50, 51 AND 52). SN 77-678,171. PUB. 6-23-2009. FILED 2-25-2009.
- 3,679,563. **ADDA BROW (BLOCK FORM)**. THE CHRISTI HARRIS COMPANIES, INC., (U.S. CLS. 1, 4, 6, 50, 51 AND 52). SN 77-678,195. PUB. 6-23-2009. FILED 2-25-2009.
- 3,679,613. **AQUA-BUFF GLOSSMASTER (BLOCK FORM)**. HAWKEYE INDUSTRIES, INC., (U.S. CLS. 1, 4, 6, 50, 51 AND 52). SN 77-679,023. PUB. 6-23-2009. FILED 2-26-2009.
- 3,679,734. **POLYGLYCOAT (BLOCK FORM)**. SIMONIZ USA, INC., (U.S. CLS. 1, 4, 6, 50, 51 AND 52). SN 77-686,371. PUB. 6-23-2009. FILED 3-9-2009.
- 3,679,750. **MY SECRET TREASURES (BLOCK FORM)**. MY SECRET TREASURES, LLC, (U.S. CLS. 1, 4, 6, 50, 51 AND 52). SN 77-694,132. PUB. 6-23-2009. FILED 3-18-2009.
- 3,679,754. **RE9 (BLOCK FORM)**. ARBONNE INTERNATIONAL, LLC, (U.S. CLS. 1, 4, 6, 50, 51 AND 52). SN 77-696,147. PUB. 6-23-2009. FILED 3-20-2009.
- 3,679,792. **SAVE YOUR WORLD (BLOCK FORM)**. SAVE YOUR WORLD, L.L.C., MULTIPLE CLASS, (INT. CLS. 3 AND 25), (U.S. CLS. 1, 4, 6, 22, 39, 50, 51 AND 52). SN 77-977,513. PUB. 2-24-2009. FILED 10-2-2008.

- 3,679,800. **SKINNY DIP (BLOCK FORM)**. NEWAYS, INC., (U.S. CLS. 1, 4, 6, 50, 51 AND 52). SN 78-355,299. PUB. 6-23-2009. FILED 1-21-2004.
- 3,679,811. **NANO WHYTE (BLOCK FORM)**, M.D. INTENSIVE, (U.S. CLS. 1, 4, 6, 50, 51 AND 52). SN 78-647,717. PUB. 6-23-2009. FILED 6-9-2005.
- 3,679,823. **BOUNCE (BLOCK FORM)**, RWACHSBERG HOLDINGS INC., MULTIPLE CLASS, (INT. CLS. 3 AND 5), (U.S. CLS. 1, 4, 6, 18, 44, 46, 50, 51 AND 52). SN 78-763,255. PUB. 6-23-2009. FILED 11-30-2005.
- 3,679,826. **RAYITO DE SOL AND DESIGN**. RIGALT S.A., (U.S. CLS. 1, 4, 6, 50, 51 AND 52). SN 78-778,422. PUB. 5-19-2009. FILED 12-21-2005.
- 3,679,838 (*See Class 1 for this trademark*).
- 3,679,861. **CURLFORMERS AND DESIGN**. HAIR FLAIR LIMITED, MULTIPLE CLASS, (INT. CLS. 3, 8 AND 26), (U.S. CLS. 1, 4, 6, 23, 28, 37, 39, 40, 42, 44, 50, 51 AND 52). SN 79-039,514. PUB. 6-23-2009. FILED 6-12-2007.
- 3,679,864. **BEAUTY MATE (BLOCK FORM)**. PETER MALONEY, (U.S. CLS. 1, 4, 6, 50, 51 AND 52). SN 79-044,615. PUB. 6-23-2009. FILED 8-29-2007.
- 3,679,895. **NEW <ID COSMETICS LONDON (STYLIZED)**. CLIVE COLMAN, AND KELLY COLMAN, (U.S. CLS. 1, 4, 6, 50, 51 AND 52). SN 79-055,171. PUB. 3-17-2009. FILED 3-31-2008.
- 3,679,927. **MERCURIT (BLOCK FORM)**. HERMES SCHLEIFMITTEL GMBH & CO. KG, MULTIPLE CLASS, (INT. CLS. 3, 7 AND 8), (U.S. CLS. 1, 4, 6, 13, 19, 21, 23, 28, 31, 34, 35, 44, 50, 51 AND 52). SN 79-058,502. PUB. 6-23-2009. FILED 7-29-2008.
- 3,679,929. **SPEYWOOD UNITS (BLOCK FORM)**. IPSEN BIOPHARM LIMITED, MULTIPLE CLASS, (INT. CLS. 3, 5, 10, 42 AND 44), (U.S. CLS. 1, 4, 6, 18, 26, 39, 44, 46, 50, 51, 52, 100 AND 101). SN 79-058,525. PUB. 6-23-2009. FILED 5-23-2008.
- 3,679,942. **ELONIA (BLOCK FORM)**, PNG GEROLYMATOS; HEALTH AND BEAUTY SA; TRADING AS; PNG GEROLYMATOS SA, MULTIPLE CLASS, (INT. CLS. 3 AND 5), (U.S. CLS. 1, 4, 6, 18, 44, 46, 50, 51 AND 52). SN 79-059,171. PUB. 6-23-2009. FILED 3-7-2008.
- 3,679,955. **11 LA FORCE AND DESIGN**. GADO S.R.L., (U.S. CLS. 1, 4, 6, 50, 51 AND 52). SN 79-059,656. PUB. 6-23-2009. FILED 7-28-2008.
- 3,679,957. **TATTINI AND DESIGN**, TATTINI S.P.A., MULTIPLE CLASS, (INT. CLS. 3, 18 AND 25), (U.S. CLS. 1, 2, 3, 4, 6, 22, 39, 41, 50, 51 AND 52). SN 79-059,792. PUB. 6-23-2009. FILED 12-31-2007.
- 3,679,979. **CANTURI (BLOCK FORM)**. CANTURI CORPORATION PTY LTD, MULTIPLE CLASS, (INT. CLS. 3, 4, 35 AND 42), (U.S. CLS. 1, 4, 6, 15, 50, 51, 52, 100, 101 AND 102). SN 79-060,497. PUB. 6-23-2009. FILED 4-15-2008.
- 3,679,992. **MAX THIERRY MUGLER (BLOCK FORM)**. THIERRY MUGLER S.A.S., (U.S. CLS. 1, 4, 6, 50, 51 AND 52). SN 79-061,275. PUB. 6-23-2009. FILED 10-8-2008.
- 3,680,002. **SOAP'NROLL (BLOCK FORM)**, PARALUX, MULTIPLE CLASS, (INT. CLS. 3, 5 AND 21), (U.S. CLS. 1, 2, 4, 6, 13, 18, 23, 29, 30, 33, 40, 44, 46, 50, 51 AND 52). SN 79-061,881. PUB. 6-23-2009. FILED 10-14-2008.
- 3,680,005. **ECONET (BLOCK FORM)**. KWH MIRKA LTD, (U.S. CLS. 1, 4, 6, 50, 51 AND 52). SN 79-062,287. PUB. 6-23-2009. FILED 11-11-2008.
- 3,680,007 (*See Class 1 for this trademark*).
- 3,680,043. **SEJAWA (BLOCK FORM)**. CHANNOINE COSMETICS AG, (U.S. CLS. 1, 4, 6, 50, 51 AND 52). SN 79-066,044. PUB. 6-23-2009. FILED 2-23-2009.

CLASS 4—LUBRICANTS AND FUELS

- 3,678,520 (*See Class 1 for this trademark*).
- 3,678,664. **FIRESIDE SUPREME (BLOCK FORM)**, THE KROGER CO. OF MICHIGAN, (U.S. CLS. 1, 6 AND 15). SN 77-542,294. PUB. 6-23-2009. FILED 8-8-2008.
- 3,678,903. **FIRESIDE SUPREME (BLOCK FORM)**, THE KROGER CO. OF MICHIGAN, (U.S. CLS. 1, 6 AND 15). SN 77-603,295. PUB. 6-23-2009. FILED 10-29-2008.
- 3,679,349. **AERODYNAMIC (BLOCK FORM)**, PODOLSKI,

- ZDRAVKO, MULTIPLE CLASS, (INT. CLS. 4, 37, 39 AND 41), (U.S. CLS. 1, 6, 15, 100, 101, 103, 105, 106 AND 107). SN 77-675,349. PUB. 6-23-2009. FILED 2-21-2009.
- 3,679,369 (*See Class 2 for this trademark*).
- 3,679,610. **AQUA-BUFF TUFF-STUFF (BLOCK FORM)**. HAWKEYE INDUSTRIES, INC., (U.S. CLS. 1, 6 AND 15). SN 77-678,990. PUB. 6-23-2009. FILED 2-26-2009.
- 3,679,760 (*See Class 2 for this trademark*).
- 3,679,797. **HOMENATURE (BLOCK FORM)**. HOMENATURE INC., MULTIPLE CLASS, (INT. CLS. 4, 8, 11 AND 21), (U.S. CLS. 1, 2, 6, 13, 15, 21, 23, 28, 29, 30, 31, 33, 34, 40, 44 AND 50). SN 77-977,673. PUB. 10-21-2008. FILED 7-28-2008.
- 3,679,806. **HOUSE & HOME STYLE FOR LIVING (BLOCK FORM)**. CANADIAN HOME PUBLISHERS, MULTIPLE CLASS, (INT. CLS. 4, 6, 8, 9, 11, 16, 18, 20, 22, 24 AND 27), (U.S. CLS. 1, 2, 3, 5, 6, 7, 12, 13, 14, 15, 19, 20, 21, 22, 23, 25, 26, 28, 29, 31, 32, 34, 36, 37, 38, 41, 42, 44 AND 50). SN 78-505,896. PUB. 11-6-2007. FILED 10-26-2004.
- 3,679,824. **CONFIDENCE IN EVERY DIRECTION (BLOCK FORM)**. ANADARKO PETROLEUM CORPORATION, MULTIPLE CLASS, (INT. CLS. 4, 25, 36, 37 AND 42), (U.S. CLS. 1, 6, 15, 22, 39, 100, 101, 102, 103 AND 106). SN 78-763,532. PUB. 2-10-2009. FILED 11-30-2005.
- 3,679,825. **BRINGING EXCELLENCE TO THE SURFACE (BLOCK FORM)**. ANADARKO PETROLEUM CORPORATION, MULTIPLE CLASS, (INT. CLS. 4, 25, 36, 37 AND 42), (U.S. CLS. 1, 6, 15, 22, 39, 100, 101, 102, 103 AND 106). SN 78-765,561. PUB. 2-10-2009. FILED 12-2-2005.
- 3,679,946 (*See Class 1 for this trademark*).
- 3,679,979 (*See Class 3 for this trademark*).

CLASS 5—PHARMACEUTICALS

- 3,678,144 (*See Class 3 for this trademark*).
- 3,678,147 (*See Class 1 for this trademark*).
- 3,678,186. **RAPID CHECK (BLOCK FORM)**. AMERICAN BIO MEDICA, (U.S. CLS. 6, 18, 44, 46, 51 AND 52). SN 76-693,799. PUB. 3-17-2009. FILED 10-24-2008.
- 3,678,191. **META-FEM (BLOCK FORM)**. THORNE RESEARCH, INC., (U.S. CLS. 6, 18, 44, 46, 51 AND 52). SN 76-694,799. PUB. 4-21-2009. FILED 12-15-2008.
- 3,678,334. **BRAIN LONGEVITY (BLOCK FORM)**. DHARMA SINGH KHALSA, M.D., MULTIPLE CLASS, (INT. CLS. 5, 16, 41 AND 44), (U.S. CLS. 2, 5, 6, 18, 22, 23, 29, 37, 38, 44, 46, 50, 51, 52, 100, 101 AND 107). SN 77-366,021. PUB. 6-23-2009. FILED 1-7-2008.
- 3,678,348. **KABOOM ACTION STRIPS AND DESIGN**. NUTROLOGY, LLC, (U.S. CLS. 6, 18, 44, 46, 51 AND 52). SN 77-380,155. PUB. 6-23-2009. FILED 1-24-2008.
- 3,678,367. **ICEBERG (BLOCK FORM)**. ESTHETIC FORMULA, (U.S. CLS. 6, 18, 44, 46, 51 AND 52). SN 77-405,512. PUB. 9-2-2008. FILED 2-25-2008.
- 3,678,445. **POO-POURRI HEAVENSCENT SPRITZ THE BOWL BEFORE YOU GO AND NO ONE ELSE WILL EVER KNOW AND DESIGN**. S2 SYNERGY LLC, (U.S. CLS. 6, 18, 44, 46, 51 AND 52). SN 77-479,435. PUB. 6-23-2009. FILED 5-20-2008.
- 3,678,468. **OSTEOALLOGRAFT (BLOCK FORM)**. HELEN ELAINE NEWMAN, (U.S. CLS. 6, 18, 44, 46, 51 AND 52). SN 77-497,897. PUB. 6-23-2009. FILED 6-12-2008.
- 3,678,596. **I BLEED (BLOCK FORM)**. KALCORP ENTERPRISES, INC., (U.S. CLS. 6, 18, 44, 46, 51 AND 52). SN 77-535,453. PUB. 6-23-2009. FILED 7-30-2008.
- 3,678,613. **CARDIOCEA (BLOCK FORM)**. MCPEAK, NANA PATRICIA, (U.S. CLS. 6, 18, 44, 46, 51 AND 52). SN 77-537,508. PUB. 6-23-2009. FILED 8-1-2008.
- 3,678,679. **KEENMIND (BLOCK FORM)**. FLORDIS PTY LIMITED, (U.S. CLS. 6, 18, 44, 46, 51 AND 52). SN 77-543,348. PUB. 6-23-2009. FILED 8-11-2008.
- 3,678,712. **GET THE POWER OF A PILL IN A PATCH. (BLOCK FORM)**. HISAMITSU PHARMACEUTICAL CO., INC., (U.S. CLS. 6, 18, 44, 46, 51 AND 52). SN 77-550,901. PUB. 6-23-2009. FILED 8-19-2008.
- 3,678,771. **MOSKIRIX (BLOCK FORM)**. GLAXOSMITHKLINE BIOLOGICALS, S.A., (U.S. CLS. 6, 18, 44, 46, 51 AND 52). SN 77-569,442. PUB. 6-23-2009. FILED 9-14-2008.

- 3,678,870. **SWEETEN 69 AND DESIGN**. BEAMONSTAR PRODUCTS, (U.S. CLS. 6, 18, 44, 46, 51 AND 52). SN 77-595,486. PUB. 3-10-2009. FILED 10-17-2008.
- 3,678,891. **BIOFLAMMACIDE (BLOCK FORM)**. WIDGEROW, ALAN D. AND DEVILLIERS, MALAN, (U.S. CLS. 6, 18, 44, 46, 51 AND 52). SN 77-600,570. PUB. 6-23-2009. FILED 10-25-2008.
- 3,678,939. **EZHAND HYGIENE (BLOCK FORM)**. ALUTA, INC., (U.S. CLS. 6, 18, 44, 46, 51 AND 52). SN 77-618,473. PUB. 6-23-2009. FILED 11-20-2008.
- 3,679,049. **THE MCCOMBS PLAN FOR HEALTH, VITALITY & TRANSFORMATION DR. JEFF MCCOMBS, DC CANDIDA FORCE DIETARY SUPPLEMENT 250 GELCAPS/HYPOALLERGENIC AND DESIGN**. MCCOMBS, JEFFREY S., DBA MCCOMBS CENTER FOR HEALTH, (U.S. CLS. 6, 18, 44, 46, 51 AND 52). SN 77-647,519. PUB. 6-23-2009. FILED 1-12-2009.
- 3,679,079. **RHEUMATON (BLOCK FORM)**. WAMPOLE LABORATORIES, LLC, (U.S. CLS. 6, 18, 44, 46, 51 AND 52). SN 77-653,345. PUB. 6-23-2009. FILED 1-21-2009.
- 3,679,111. **KYANI (BLOCK FORM)**. KY-ANI SUN, INC., MULTIPLE CLASS, (INT. CLS. 5, 32 AND 35), (U.S. CLS. 6, 18, 44, 45, 46, 48, 51, 52, 100, 101 AND 102). SN 77-657,776. PUB. 6-23-2009. FILED 1-27-2009.
- 3,679,149. **ENRICHING LIFE NATURALLY (BLOCK FORM)**. IGENE BIOTECHNOLOGY, INC., (U.S. CLS. 6, 18, 44, 46, 51 AND 52). SN 77-664,805. PUB. 6-23-2009. FILED 2-6-2009.
- 3,679,201. **WOMEN-EASY (BLOCK FORM)**. TRINH TRAN PHARMACEUTICAL COMPANY LIMITED, (U.S. CLS. 6, 18, 44, 46, 51 AND 52). SN 77-669,317. PUB. 6-23-2009. FILED 2-12-2009.
- 3,679,202. **CQ STEP 1 CQ STEP 2 CQ STEP 3 AND DESIGN**. SMITHKLINE BEECHAM CORPORATION, (U.S. CLS. 6, 18, 44, 46, 51 AND 52). SN 77-669,373. PUB. 6-23-2009. FILED 2-12-2009.
- 3,679,308. **M-80 (BLOCK FORM)**. HANSEN BEVERAGE COMPANY, MULTIPLE CLASS, (INT. CLS. 5 AND 32), (U.S. CLS. 6, 18, 44, 45, 46, 48, 51 AND 52). SN 77-674,165. PUB. 6-23-2009. FILED 2-19-2009.
- 3,679,442. **NAVIGATING THE CLINICAL MAZE OF GI DISORDERS (BLOCK FORM)**. P-VALUE COMMUNICATIONS, (U.S. CLS. 6, 18, 44, 46, 51 AND 52). SN 77-676,894. PUB. 6-23-2009. FILED 2-24-2009.
- 3,679,458. **ASC-J9 (BLOCK FORM)**. ANDROSCIENCE CORPORATION, (U.S. CLS. 6, 18, 44, 46, 51 AND 52). SN 77-677,058. PUB. 6-23-2009. FILED 2-24-2009.
- 3,679,494. **PLAY (BLOCK FORM)**. LRC PRODUCTS LIMITED, (U.S. CLS. 6, 18, 44, 46, 51 AND 52). SN 77-677,366. PUB. 6-23-2009. FILED 2-24-2009.
- 3,679,500. **SCIFEEED (BLOCK FORM)**. CENZONE TECH, INC., MULTIPLE CLASS, (INT. CLS. 5 AND 31), (U.S. CLS. 1, 6, 18, 44, 46, 51 AND 52). SN 77-677,450. PUB. 6-23-2009. FILED 2-24-2009.
- 3,679,538. **FAITH FRESHENERS (BLOCK FORM)**. HEART-FELT, INC., (U.S. CLS. 6, 18, 44, 46, 51 AND 52). SN 77-677,891. PUB. 6-23-2009. FILED 2-25-2009.
- 3,679,553. **NOCTURNAL CALM (BLOCK FORM)**. SULLIVAN, MICHELLE, (U.S. CLS. 6, 18, 44, 46, 51 AND 52). SN 77-678,135. PUB. 6-23-2009. FILED 2-25-2009.
- 3,679,554. **ONDROX (BLOCK FORM)**. LIFESCIENCE SETTLEMENT TRUST, (U.S. CLS. 6, 18, 44, 46, 51 AND 52). SN 77-678,141. PUB. 6-23-2009. FILED 2-25-2009.
- 3,679,656. **INTEGRICIDE (BLOCK FORM)**. NUTRIENT CONTROL SYSTEMS, INC., DBA INTEGRITY AG SYSTEMS, (U.S. CLS. 6, 18, 44, 46, 51 AND 52). SN 77-679,646. PUB. 6-23-2009. FILED 2-27-2009.
- 3,679,657. **INTEGRISTAT (BLOCK FORM)**. NUTRIENT CONTROL SYSTEMS, INC., DBA INTEGRITY AG SYSTEMS, (U.S. CLS. 6, 18, 44, 46, 51 AND 52). SN 77-679,649. PUB. 6-23-2009. FILED 2-27-2009.
- 3,679,658. **INTEGRITY EQ (BLOCK FORM)**. NUTRIENT CONTROL SYSTEMS, INC., DBA INTEGRITY AG SYSTEMS, (U.S. CLS. 6, 18, 44, 46, 51 AND 52). SN 77-679,652. PUB. 6-23-2009. FILED 2-27-2009.
- 3,679,666. **AMEDICHECK (BLOCK FORM)**. AMEDICA BIOTECH, INC., (U.S. CLS. 6, 18, 44, 46, 51 AND 52). SN 77-679,972. PUB. 6-23-2009. FILED 2-27-2009.
- 3,679,723. **EARLYBIRD (BLOCK FORM)**. PACIFIC VET GROUP - USA, INC., (U.S. CLS. 6, 18, 44, 46, 51 AND 52). SN 77-683,048. PUB. 6-23-2009. FILED 3-4-2009.
- 3,679,742. **LAKESHORERESTORE (BLOCK FORM)**. LAKE RESTORATION INC., (U.S. CLS. 6, 18, 44, 46, 51 AND 52). SN 77-689,595. PUB. 6-23-2009. FILED 3-12-2009.
- 3,679,751. **WAL-ACT (BLOCK FORM)**. WALGREEN CO., (U.S. CLS. 6, 18, 44, 46, 51 AND 52). SN 77-695,040. PUB. 6-23-2009. FILED 3-19-2009.
- 3,679,777. **ARTH 2000+ (BLOCK FORM)**. HAPPYWELL, (U.S. CLS. 6, 18, 44, 46, 51 AND 52). SN 77-706,626. PUB. 6-23-2009. FILED 4-3-2009.
- 3,679,778. **BETA RIGHT (BLOCK FORM)**. BIOPOLYMER ENGINEERING, INC., DBA BIOTHERA, (U.S. CLS. 6, 18, 44, 46, 51 AND 52). SN 77-707,532. PUB. 6-23-2009. FILED 4-6-2009.
- 3,679,823 (See Class 3 for this trademark).
- 3,679,827. **"WEIGH TO GO" WEIGHT LOSS CENTERS (STYLIZED)**. "WEIGH TO GO", MULTIPLE CLASS, (INT. CLS. 5 AND 44), (U.S. CLS. 6, 18, 44, 46, 51, 52, 100 AND 101). SN 78-789,009. PUB. 5-19-2009. FILED S.R. 1-11-2006; AM. P.R. 1-11-2006.
- 3,679,872. **WISTA (STYLIZED)**. WISTA LABORATORIES LTD. MULTIPLE CLASS, (INT. CLS. 5, 9, 10, 16, 35, 42 AND 44), (U.S. CLS. 2, 5, 6, 18, 21, 22, 23, 26, 29, 36, 37, 38, 39, 44, 46, 50, 51, 52, 100, 101 AND 102). SN 79-048,971. PUB. 6-23-2009. FILED 12-10-2007.
- 3,679,876. **CHLAMATIS (BLOCK FORM)**. CAMBRIDGE THERANOSTICS LIMITED, (U.S. CLS. 6, 18, 44, 46, 51 AND 52). SN 79-049,470. PUB. 6-23-2009. FILED 12-21-2007.
- 3,679,878. **ATERONON (BLOCK FORM)**. CAMBRIDGE THERANOSTICS LIMITED, (U.S. CLS. 6, 18, 44, 46, 51 AND 52). SN 79-049,889. PUB. 6-23-2009. FILED 1-22-2008.
- 3,679,892. **SPONDYCOAT (BLOCK FORM)**. EUROCOATING S.P.A., MULTIPLE CLASS, (INT. CLS. 5 AND 40), (U.S. CLS. 6, 18, 44, 46, 51, 52, 100, 103 AND 106). SN 79-053,898. PUB. 6-23-2009. FILED 2-27-2008.
- 3,679,893. **SONGHA (STYLIZED)**. GINSANA SA, (U.S. CLS. 6, 18, 44, 46, 51 AND 52). SN 79-054,963. PUB. 6-23-2009. FILED 5-7-2008.
- 3,679,906. **TRIPLINOR (BLOCK FORM)**. BIOFARMA, (U.S. CLS. 6, 18, 44, 46, 51 AND 52). SN 79-056,873. PUB. 6-23-2009. FILED 7-3-2008.
- 3,679,922. **WISECON (BLOCK FORM)**. PAF HOLDING APS, MULTIPLE CLASS, (INT. CLS. 5, 9, 21 AND 37), (U.S. CLS. 2, 6, 13, 18, 21, 23, 26, 29, 30, 33, 36, 38, 40, 44, 46, 50, 51, 52, 100, 103 AND 106). SN 79-058,078. PUB. 6-23-2009. FILED 8-7-2008.
- 3,679,929 (See Class 3 for this trademark).
- 3,679,935. **IN:SHADE (BLOCK FORM)**. DEGUDENT GMBH, MULTIPLE CLASS, (INT. CLS. 5, 9 AND 10), (U.S. CLS. 6, 18, 21, 23, 26, 36, 38, 39, 44, 46, 51 AND 52). SN 79-058,896. PUB. 6-23-2009. FILED 4-18-2008.
- 3,679,940. **LIFEOX (STYLIZED)**. LIFETECH S.R.O., MULTIPLE CLASS, (INT. CLS. 5, 10 AND 11), (U.S. CLS. 6, 13, 18, 21, 23, 26, 31, 34, 39, 44, 46, 51 AND 52). SN 79-059,148. PUB. 6-23-2009. FILED 7-11-2008.
- 3,679,942 (See Class 3 for this trademark).
- 3,679,971. **MISCELLANEOUS DESIGN**. BARRY CALLEBAUT AG, MULTIPLE CLASS, (INT. CLS. 5, 29, 30, 40, 41 AND 42), (U.S. CLS. 6, 18, 44, 46, 51, 52, 100, 101, 103, 106 AND 107). SN 79-060,171. PUB. 6-23-2009. FILED 8-15-2008.
- 3,679,972 (See Class 1 for this trademark).
- 3,679,975. **SÖDERGARDEN (BLOCK FORM)**. LIDL STIFTUNG & CO. KG, MULTIPLE CLASS, (INT. CLS. 5, 29, 30, 31 AND 32), (U.S. CLS. 1, 6, 18, 44, 45, 46, 48, 51 AND 52). SN 79-060,303. PUB. 6-23-2009. FILED 8-28-2008.
- 3,680,002 (See Class 3 for this trademark).
- 3,680,009 (See Class 1 for this trademark).
- 3,680,047. **SITAVIR (BLOCK FORM)**. BIOALLIANCE PHARMA, (U.S. CLS. 6, 18, 44, 46, 51 AND 52). SN 79-066,767. PUB. 6-23-2009. FILED 2-16-2009.

CLASS 6—METAL GOODS

- 3,678,153. **MISCELLANEOUS DESIGN**. SOUTHCO, INC., MULTIPLE CLASS, (INT. CLS. 6 AND 20), (U.S. CLS. 2,

- 12, 13, 14, 22, 23, 25, 32 AND 50). SN 76-671,020. PUB. 6-23-2009. FILED 1-4-2007.
- 3,678,196. **PROSPECT FASTENER AND DESIGN**. PROSPECT FASTENER CORPORATION, (U.S. CLS. 2, 12, 13, 14, 23, 25 AND 50). SN 76-695,772. PUB. 6-23-2009. FILED 2-12-2009.
- 3,678,212. **WE MAKE PROCESSES WORK AND DESIGN**. CARL SCHENCK AG, MULTIPLE CLASS, (INT. CLS. 6, 7, 9, 20 AND 35), (U.S. CLS. 2, 12, 13, 14, 19, 21, 22, 23, 25, 26, 31, 32, 34, 35, 36, 38, 50, 100, 101 AND 102). SN 77-062,116. PUB. 6-23-2009. FILED 12-12-2006.
- 3,678,215. **SPEEDLINER (BLOCK FORM)**. FRANKEN-INDUSTRIE GMBH & CO. KG, MULTIPLE CLASS, (INT. CLS. 6, 12 AND 17), (U.S. CLS. 1, 2, 5, 12, 13, 14, 19, 21, 23, 25, 31, 35, 44 AND 50). SN 77-075,853. PUB. 5-13-2008. FILED 1-4-2007.
- 3,678,256. **LOUVRETEC (BLOCK FORM)**. LOUVRETEC INTERNATIONAL PTY LTD, (U.S. CLS. 2, 12, 13, 14, 23, 25 AND 50). SN 77-234,515. PUB. 6-23-2009. FILED 7-20-2007.
- 3,678,280. **THERMASKIRT (BLOCK FORM)**. THE DISCRETEHEAT COMPANY LIMITED, MULTIPLE CLASS, (INT. CLS. 6 AND 11), (U.S. CLS. 2, 12, 13, 14, 21, 23, 25, 31, 34 AND 50). SN 77-299,568. PUB. 6-23-2009. FILED 10-9-2007.
- 3,678,282. **WE ENABLE MACHINES THAT MAKE LIFE BETTER (BLOCK FORM)**. WALBRO ENGINE MANAGEMENT, L.L.C., MULTIPLE CLASS, (INT. CLS. 6, 7, 9, 12 AND 17), (U.S. CLS. 1, 2, 5, 12, 13, 14, 19, 21, 23, 25, 26, 31, 34, 35, 36, 38, 44 AND 50). SN 77-300,758. PUB. 6-23-2009. FILED 10-10-2007.
- 3,678,295 (*See Class 1 for this trademark*).
- 3,678,343. **TOLEDO FINE LOCKS KEYED ENTRANCE HANDLE AND DEADBOLT SET JUEGO DE CERRADURA DE ENTRADA Y SEGURO TOTAL WARRANTY LIFETIME GARANTIA TOTAL AND DESIGN**. TOLEDO & CO., INC., (U.S. CLS. 2, 12, 13, 14, 23, 25 AND 50). SN 77-375,587. PUB. 6-23-2009. FILED 1-18-2008.
- 3,678,401. **MAGNIQ (BLOCK FORM)**. RAREBASIC (COMBINATIONS) LIMITED, MULTIPLE CLASS, (INT. CLS. 6, 20 AND 37), (U.S. CLS. 2, 12, 13, 14, 22, 23, 25, 32, 50, 100, 103 AND 106). SN 77-435,483. PUB. 6-23-2009. FILED 3-31-2008.
- 3,678,497. **MAX-METAL (BLOCK FORM)**. GRIMCO, INC., (U.S. CLS. 2, 12, 13, 14, 23, 25 AND 50). SN 77-512,264. PUB. 6-23-2009. FILED 7-1-2008.
- 3,678,498. **MAX-METAL (STYLIZED)**. GRIMCO, INC., (U.S. CLS. 2, 12, 13, 14, 23, 25 AND 50). SN 77-512,268. PUB. 6-23-2009. FILED 7-1-2008.
- 3,678,572. **LKM AND DESIGN**. SUPER VISIONS INTERNATIONAL LIMITED, (U.S. CLS. 2, 12, 13, 14, 23, 25 AND 50). SN 77-530,772. PUB. 6-23-2009. FILED 7-24-2008.
- 3,678,631. **ICEWHEELER (BLOCK FORM)**. VIESSMANN KÄLTETECHNIK AG, MULTIPLE CLASS, (INT. CLS. 6, 11, 12, 20, 35, 37 AND 39), (U.S. CLS. 2, 12, 13, 14, 19, 21, 22, 23, 25, 31, 32, 34, 35, 44, 50, 100, 101, 102, 103, 105 AND 106). SN 77-538,945. PUB. 6-23-2009. FILED 8-5-2008.
- 3,678,634. **RAMPARTS (BLOCK FORM)**. CEQUENT CONSUMER PRODUCTS, INC., (U.S. CLS. 2, 12, 13, 14, 23, 25 AND 50). SN 77-539,051. PUB. 6-23-2009. FILED 8-5-2008.
- 3,678,640. **LEGACY (BLOCK FORM)**. GILPIN, INC., (U.S. CLS. 2, 12, 13, 14, 23, 25 AND 50). SN 77-539,468. PUB. 6-23-2009. FILED 8-5-2008.
- 3,678,738. **SEPLA (BLOCK FORM)**. INTERMOOR, INC., (U.S. CLS. 2, 12, 13, 14, 23, 25 AND 50). SN 77-556,936. PUB. 6-23-2009. FILED S.R. 8-27-2008; AM. P.R. 5-5-2009.
- 3,678,746. **COLD STEEL (BLOCK FORM)**. SILVER MOON CREATIONS, INC., MULTIPLE CLASS, (INT. CLS. 6, 14 AND 16), (U.S. CLS. 2, 5, 12, 13, 14, 22, 23, 25, 27, 28, 29, 37, 38 AND 50). SN 77-560,487. PUB. 6-23-2009. FILED 9-2-2008.
- 3,678,782. **THE ROD DOCK (BLOCK FORM)**. ED SORENSEN, (U.S. CLS. 2, 12, 13, 14, 23, 25 AND 50). SN 77-572,325. PUB. 6-23-2009. FILED 9-17-2008.
- 3,678,840. **PARTS MASTER (BLOCK FORM)**. AFTERMARKET AUTO PARTS ALLIANCE, INC., MULTIPLE CLASS, (INT. CLS. 6, 7, 9, 11, 12 AND 17), (U.S. CLS. 1, 2, 5, 12, 13, 14, 19, 21, 23, 25, 26, 31, 34, 35, 36, 38, 44 AND 50). SN 77-586,938. PUB. 6-23-2009. FILED 10-7-2008.
- 3,678,927. **ZIPRIV (BLOCK FORM)**. INDUSTRIAL RIVET & FASTENER CO., (U.S. CLS. 2, 12, 13, 14, 23, 25 AND 50). SN 77-613,036. PUB. 6-23-2009. FILED 11-12-2008.
- 3,678,928. **ZIPSHO (BLOCK FORM)**. INDUSTRIAL RIVET & FASTENER CO., (U.S. CLS. 2, 12, 13, 14, 23, 25 AND 50). SN 77-613,075. PUB. 6-23-2009. FILED 11-12-2008.
- 3,678,941. **QUICKRIVETING SYSTEM (BLOCK FORM)**. INDUSTRIAL RIVET & FASTENER CO., MULTIPLE CLASS, (INT. CLS. 6 AND 7), (U.S. CLS. 2, 12, 13, 14, 19, 21, 23, 25, 31, 34, 35 AND 50). SN 77-618,588. PUB. 6-23-2009. FILED 11-20-2008.
- 3,678,995. **DRYJOIST (BLOCK FORM)**. GDC ENTERPRISES, INC., (U.S. CLS. 2, 12, 13, 14, 23, 25 AND 50). SN 77-631,866. PUB. 6-23-2009. FILED 12-12-2008.
- 3,679,298. **THE HOOKETTE (BLOCK FORM)**. THE PURSE HOOK, INC., (U.S. CLS. 2, 12, 13, 14, 23, 25 AND 50). SN 77-673,891. PUB. 6-23-2009. FILED 2-19-2009.
- 3,679,459. **ONETEX (BLOCK FORM)**. RIMEX METALS (UK) LTD, (U.S. CLS. 2, 12, 13, 14, 23, 25 AND 50). SN 77-677,072. PUB. 6-23-2009. FILED 2-24-2009.
- 3,679,558. **ASC2250 (BLOCK FORM)**. ASSOCIATED STEEL COMPANY, INC., (U.S. CLS. 2, 12, 13, 14, 23, 25 AND 50). SN 77-678,168. PUB. 6-23-2009. FILED 2-25-2009.
- 3,679,602. **SMARTFRAME AND DESIGN**. CRACO MANUFACTURING INC., (U.S. CLS. 2, 12, 13, 14, 23, 25 AND 50). SN 77-678,902. PUB. 6-23-2009. FILED 2-26-2009.
- 3,679,637. **DY TSA (BLOCK FORM)**. DECOLETAJE Y TOR-NILLERIA, S.A., (U.S. CLS. 2, 12, 13, 14, 23, 25 AND 50). SN 77-679,359. PUB. 6-23-2009. FILED 2-26-2009.
- 3,679,752. **MONKEY HOOK (BLOCK FORM)**. THE MONKEY HOOK, LLC, (U.S. CLS. 2, 12, 13, 14, 23, 25 AND 50). SN 77-695,172. PUB. 6-23-2009. FILED 3-19-2009.
- 3,679,780. **MOVING MAX (BLOCK FORM)**. MERCHANT MEDIA, LLC, (U.S. CLS. 2, 12, 13, 14, 23, 25 AND 50). SN 77-708,979. PUB. 6-23-2009. FILED 4-7-2009.
- 3,679,806 (*See Class 4 for this trademark*).
- 3,679,838 (*See Class 1 for this trademark*).
- 3,679,855 (*See Class 1 for this trademark*).
- 3,679,868. **MISCELLANEOUS DESIGN**. ARCELORMITTAL (SOCIÉTÉ ANONYME), MULTIPLE CLASS, (INT. CLS. 6, 7, 9, 12, 19, 21, 39, 40, 41 AND 42), (U.S. CLS. 1, 2, 12, 13, 14, 19, 21, 23, 25, 26, 29, 30, 31, 33, 34, 35, 36, 38, 40, 44, 50, 100, 101, 103, 105, 106 AND 107). SN 79-047,806. PUB. 6-23-2009. FILED 8-3-2007.
- 3,679,875. **AERO - SYS AND DESIGN**. S.C. AEROSTAR S.A., MULTIPLE CLASS, (INT. CLS. 6, 7 AND 12), (U.S. CLS. 2, 12, 13, 14, 19, 21, 23, 25, 31, 34, 35, 44 AND 50). SN 79-049,438. PUB. 6-23-2009. FILED 5-10-2007.
- 3,679,877. **INDUSTRIAL STAR AND DESIGN**. S.C. AEROSTAR S.A., MULTIPLE CLASS, (INT. CLS. 6, 7, 9, 12, 37 AND 42), (U.S. CLS. 2, 12, 13, 14, 19, 21, 23, 25, 26, 31, 34, 35, 36, 38, 44, 50, 100, 101, 103 AND 106). SN 79-049,495. PUB. 6-23-2009. FILED 5-10-2007.
- 3,679,889. **CELL IMPACT (STYLIZED)**. MORPHIC TECHNOLOGIES AKTIEBOLAG; (PUBL.), MULTIPLE CLASS, (INT. CLS. 6, 7, 9, 37, 40 AND 42), (U.S. CLS. 2, 12, 13, 14, 19, 21, 23, 25, 26, 31, 34, 35, 36, 38, 50, 100, 101, 103 AND 106). SN 79-053,665. PUB. 6-23-2009. FILED 2-21-2008.
- 3,679,900. **MORPHIC (STYLIZED)**. MORPHIC TECHNOLOGIES AKTIEBOLAG; (PUBL.), MULTIPLE CLASS, (INT. CLS. 6, 7, 9, 11, 12, 19, 37, 40 AND 42), (U.S. CLS. 1, 2, 12, 13, 14, 19, 21, 23, 25, 26, 31, 33, 34, 35, 36, 38, 44, 50, 100, 101, 103 AND 106). SN 79-056,184. PUB. 6-23-2009. FILED 10-25-2007.
- 3,679,905. **UGIVIS AND DESIGN**. UGIVIS, (U.S. CLS. 2, 12, 13, 14, 23, 25 AND 50). SN 79-056,869. PUB. 6-23-2009. FILED 7-8-2008.
- 3,679,956 (*See Class 1 for this trademark*).
- 3,679,970. **KFV AND DESIGN**. KFV KARL FLIETHER GMBH & CO. KG, MULTIPLE CLASS, (INT. CLS. 6, 9 AND 20), (U.S. CLS. 2, 12, 13, 14, 21, 22, 23, 25, 26, 32, 36, 38 AND 50). SN 79-060,003. PUB. 6-23-2009. FILED 8-18-2008.
- 3,679,988. **ADVAL TECH (BLOCK FORM)**. ADVAL TECH HOLDING AG, MULTIPLE CLASS, (INT. CLS. 6, 7, 17 AND 20), (U.S. CLS. 1, 2, 5, 12, 13, 14, 19, 21, 22, 23, 25, 31, 32, 34, 35 AND 50). SN 79-060,979. PUB. 6-23-2009. FILED 10-1-2008.
- 3,679,997. **T G AND DESIGN**. TONGLING NONFERROUS METALS; GROUP HOLDINGS LTD., (U.S. CLS. 2, 12, 13, 14, 23, 25 AND 50). SN 79-061,514. PUB. 6-23-2009. FILED 8-29-2008.
- 3,680,015. **TST (STYLIZED)**. TAMSAN BAGLANTI ELEMANTLARI; YEDEK PARÇA VE MAKINA; EKIPMANLARI

- TURIZM INSAAT; SANAYI VE TICARET ANONIM SIRKETI, (U.S. CLS. 2, 12, 13, 14, 23, 25 AND 50). SN 79-063,206. PUB. 6-23-2009. FILED 10-20-2008.
- 3,680,016. **ROOFCARRIER (BLOCK FORM)**. A + F GMBH, MULTIPLE CLASS, (INT. CLS. 6, 9 AND 19), (U.S. CLS. 1, 2, 12, 13, 14, 21, 23, 25, 26, 33, 36, 38 AND 50). SN 79-063,217. PUB. 6-23-2009. FILED 11-17-2008.
-
- CLASS 7—MACHINERY**
- 3,678,212 (*See Class 6 for this trademark*).
- 3,678,214. **AFI (BLOCK FORM)**. S.A.E. AFIKIM SPECIAL AGRICULTURAL EQUIPMENT, MULTIPLE CLASS, (INT. CLS. 7 AND 9), (U.S. CLS. 13, 19, 21, 23, 26, 31, 34, 35, 36 AND 38). SN 77-072,399. PUB. 6-23-2009. FILED 12-28-2006.
- 3,678,281. **ZEUS (BLOCK FORM)**. PGI INTERNATIONAL, LTD., (U.S. CLS. 13, 19, 21, 23, 31, 34 AND 35). SN 77-300,732. PUB. 6-23-2009. FILED 10-10-2007.
- 3,678,282 (*See Class 6 for this trademark*).
- 3,678,325. **MIXRITE (BLOCK FORM)**. TEFEN MANUFACTURE & MARKETING PLASTIC PRODUCTS 1990 LTD., (U.S. CLS. 13, 19, 21, 23, 31, 34 AND 35). SN 77-355,115. PUB. 6-23-2009. FILED 12-18-2007.
- 3,678,353. **HT (STYLIZED)**. INFORS AG, MULTIPLE CLASS, (INT. CLS. 7 AND 9), (U.S. CLS. 13, 19, 21, 23, 26, 31, 34, 35, 36 AND 38). SN 77-385,123. PUB. 3-17-2009. FILED 1-31-2008.
- 3,678,379. **RV EXPRESS (BLOCK FORM)**. MAGIC WAND LLC, (U.S. CLS. 13, 19, 21, 23, 31, 34 AND 35). SN 77-417,263. PUB. 6-23-2009. FILED 3-10-2008.
- 3,678,434. **RETHPACK (BLOCK FORM)**. RETHCEIF ENTERPRISES, LLC, DBA RETHCEIF PACKAGING, (U.S. CLS. 13, 19, 21, 23, 31, 34 AND 35). SN 77-468,864. PUB. 6-23-2009. FILED 5-8-2008.
- 3,678,484. **HPFI (BLOCK FORM)**. DRESSER RAND COMPANY, A GENERAL PARTNERSHIP OF NEW YORK, COMPOSED OF DRESSER-RAND GROUP, INC., A CORPORATION OF DELAWARE, AND DRESSER-RAND L.L.C., A LIMITED LIABILITY COMPANY OF DELAWARE., (U.S. CLS. 13, 19, 21, 23, 31, 34 AND 35). SN 77-506,560. PUB. 6-23-2009. FILED 6-24-2008.
- 3,678,546. **FASTHAM (BLOCK FORM)**. COZZINI, INC., (U.S. CLS. 13, 19, 21, 23, 31, 34 AND 35). SN 77-528,223. PUB. 6-23-2009. FILED 7-22-2008.
- 3,678,579. **AQUANOZ (BLOCK FORM)**. LSQ MANUFACTURING, INC., DBA ARTHUR PRODUCTS CO., (U.S. CLS. 13, 19, 21, 23, 31, 34 AND 35). SN 77-532,603. PUB. 6-23-2009. FILED 7-28-2008.
- 3,678,583. **FLOWMASTER INC. (STYLIZED)**. FLOWMASTER, INC., MULTIPLE CLASS, (INT. CLS. 7, 16 AND 25), (U.S. CLS. 2, 5, 13, 19, 21, 22, 23, 29, 31, 34, 35, 37, 38, 39 AND 50). SN 77-534,204. PUB. 6-23-2009. FILED 7-29-2008.
- 3,678,630. **MINIVEYOR AND DESIGN**. RAKO PRODUCTS LIMITED, (U.S. CLS. 13, 19, 21, 23, 31, 34 AND 35). SN 77-538,939. PUB. 6-23-2009. FILED 8-5-2008.
- 3,678,676. **CYCLONE (BLOCK FORM)**. DIAMAX INDUSTRIES, INC., DBA DIAMAX, MULTIPLE CLASS, (INT. CLS. 7 AND 8), (U.S. CLS. 13, 19, 21, 23, 28, 31, 34, 35 AND 44). SN 77-542,675. PUB. 6-23-2009. FILED 8-8-2008.
- 3,678,691. **VECTOR (BLOCK FORM)**. VECTOR CORPORATION, MULTIPLE CLASS, (INT. CLS. 7 AND 9), (U.S. CLS. 13, 19, 21, 23, 26, 31, 34, 35, 36 AND 38). SN 77-546,510. PUB. 6-23-2009. FILED 8-13-2008.
- 3,678,710. **SHINGLE HOG (BLOCK FORM)**. TBD2, INC., (U.S. CLS. 13, 19, 21, 23, 31, 34 AND 35). SN 77-550,231. PUB. 6-23-2009. FILED 8-19-2008.
- 3,678,715. **BIOMAX (BLOCK FORM)**. COMMUNITY POWER CORPORATION, (U.S. CLS. 13, 19, 21, 23, 31, 34 AND 35). SN 77-552,026. PUB. 6-23-2009. FILED 8-20-2008.
- 3,678,720. **P&PE PUMPS & PROCESS EQUIPMENT INC. AND DESIGN**. PUMPS & PROCESS EQUIPMENT, INC., DBA PUMPS & PROCESS EQUIPMENT, MULTIPLE CLASS, (INT. CLS. 7, 11 AND 37), (U.S. CLS. 13, 19, 21, 23, 31, 34, 35, 100, 103 AND 106). SN 77-553,765. PUB. 6-23-2009. FILED 8-22-2008.
- 3,678,824. **WASH JET AND DESIGN**. BSH BOSCH UND SIEMENS HAUSGERAETE GMBH, (U.S. CLS. 13, 19, 21, 23, 31, 34 AND 35). SN 77-583,121. PUB. 6-23-2009. FILED 10-1-2008.
- 3,678,825. **BITNER TOOLING TECHNOLOGIES AND DESIGN**. GAYLEE/BITNER TOOLING TECHNOLOGIES, INC., (U.S. CLS. 13, 19, 21, 23, 31, 34 AND 35). SN 77-583,344. PUB. 6-23-2009. FILED 10-1-2008.
- 3,678,840 (*See Class 6 for this trademark*).
- 3,678,876. **SUPER TUF U.S.A. AND DESIGN**. BEALL MANUFACTURING, INC., (U.S. CLS. 13, 19, 21, 23, 31, 34 AND 35). SN 77-598,324. PUB. 6-23-2009. FILED 10-22-2008.
- 3,678,936. **COSEN (BLOCK FORM)**. COSEN MACHINERY INDUSTRIAL CO., LTD., (U.S. CLS. 13, 19, 21, 23, 31, 34 AND 35). SN 77-618,244. PUB. 6-23-2009. FILED 11-20-2008.
- 3,678,941 (*See Class 6 for this trademark*).
- 3,678,986. **ORSCO (BLOCK FORM)**. LINCOLN INDUSTRIAL CORPORATION, (U.S. CLS. 13, 19, 21, 23, 31, 34 AND 35). SN 77-629,673. PUB. 6-23-2009. FILED 12-9-2008.
- 3,679,008. **SMARTGPS (BLOCK FORM)**. FISCHER & KRECKE GMBH, MULTIPLE CLASS, (INT. CLS. 7 AND 9), (U.S. CLS. 13, 19, 21, 23, 26, 31, 34, 35, 36 AND 38). SN 77-634,913. PUB. 6-23-2009. FILED 12-17-2008.
- 3,679,139. **CORSA (BLOCK FORM)**. TMG PERFORMANCE PRODUCTS, LLC, (U.S. CLS. 13, 19, 21, 23, 31, 34 AND 35). SN 77-663,803. PUB. 6-23-2009. FILED 2-5-2009.
- 3,679,169. **BIOBALER (BLOCK FORM)**. FLD BIOMASS TECHNOLOGY, DBA FLD BIOMASS TECHNOLOGY, (U.S. CLS. 13, 19, 21, 23, 31, 34 AND 35). SN 77-666,262. PUB. 6-23-2009. FILED 2-9-2009.
- 3,679,271. **THE INTERNATIONAL (BLOCK FORM)**. WERNER WATTINGER, (U.S. CLS. 13, 19, 21, 23, 31, 34 AND 35). SN 77-672,959. PUB. 6-23-2009. FILED 2-18-2009.
- 3,679,303. **HSC AND DESIGN**. SILVERLINE AMERICA, S.A. DE C.V., (U.S. CLS. 13, 19, 21, 23, 31, 34 AND 35). SN 77-674,003. PUB. 6-23-2009. FILED 2-19-2009.
- 3,679,396. **CALLISTO (BLOCK FORM)**. MIELE, INC., (U.S. CLS. 13, 19, 21, 23, 31, 34 AND 35). SN 77-676,244. PUB. 6-23-2009. FILED 2-23-2009.
- 3,679,398. **CAPRICORN (BLOCK FORM)**. MIELE, INC., (U.S. CLS. 13, 19, 21, 23, 31, 34 AND 35). SN 77-676,255. PUB. 6-23-2009. FILED 2-23-2009.
- 3,679,399. **EUROPA (BLOCK FORM)**. MIELE, INC., (U.S. CLS. 13, 19, 21, 23, 31, 34 AND 35). SN 77-676,258. PUB. 6-23-2009. FILED 2-23-2009.
- 3,679,402. **SALSA (BLOCK FORM)**. MIELE, INC., (U.S. CLS. 13, 19, 21, 23, 31, 34 AND 35). SN 77-676,272. PUB. 6-23-2009. FILED 2-23-2009.
- 3,679,403. **BOLERO (BLOCK FORM)**. MIELE, INC., (U.S. CLS. 13, 19, 21, 23, 31, 34 AND 35). SN 77-676,276. PUB. 6-23-2009. FILED 2-23-2009.
- 3,679,477. **DIMPLE (BLOCK FORM)**. RICHARD H. JODOIN, (U.S. CLS. 13, 19, 21, 23, 31, 34 AND 35). SN 77-677,181. PUB. 6-23-2009. FILED 2-24-2009.
- 3,679,496. **LITTLINE (BLOCK FORM)**. LITTLINE ENVIRONMENTAL TECHNOLOGIES LLC, (U.S. CLS. 13, 19, 21, 23, 31, 34 AND 35). SN 77-677,401. PUB. 6-23-2009. FILED 2-24-2009.
- 3,679,499. **SUBDUER (BLOCK FORM)**. SPOC AUTOMATION, INC., (U.S. CLS. 13, 19, 21, 23, 31, 34 AND 35). SN 77-677,433. PUB. 6-23-2009. FILED 2-24-2009.
- 3,679,838 (*See Class 1 for this trademark*).
- 3,679,839. **PATRIOT (BLOCK FORM)**. CNH AMERICA LLC, (U.S. CLS. 13, 19, 21, 23, 31, 34 AND 35). SN 78-871,727. PUB. 6-23-2009. FILED 4-27-2006.
- 3,679,866. **RF-LOOPTAG (BLOCK FORM)**. BIELOMATIK LEUZE GMBH + CO KG, MULTIPLE CLASS, (INT. CLS. 7, 9 AND 16), (U.S. CLS. 2, 5, 13, 19, 21, 22, 23, 26, 29, 31, 34, 35, 36, 37, 38 AND 50). SN 79-047,612. PUB. 6-23-2009. FILED 11-14-2007.
- 3,679,868 (*See Class 6 for this trademark*).
- 3,679,875 (*See Class 6 for this trademark*).
- 3,679,877 (*See Class 6 for this trademark*).
- 3,679,889 (*See Class 6 for this trademark*).
- 3,679,899. **DRAIS (BLOCK FORM)**. GEBRÜDER LÖDIGE; MASCHINENBAU-GESELLSCHAFT; MIT BESCHRÄNKTER HAFT, MULTIPLE CLASS, (INT. CLS. 7 AND 11), (U.S. CLS. 13, 19, 21, 23, 31, 34 AND 35). SN 79-056,106. PUB. 6-23-2009. FILED 2-12-2008.

- 3,679,900 (*See Class 6 for this trademark.*)
 3,679,913. **MISCELLANEOUS DESIGN.** LEMKEN GMBH & CO. KG, (U.S. CLS. 13, 19, 21, 23, 31, 34 AND 35). SN 79-057,114. PUB. 6-23-2009. FILED 2-20-2008.
 3,679,921. **KING COBRA (BLOCK FORM).** UZIN UTZ AKTIENGESELLSCHAFT, MULTIPLE CLASS, (INT. CLS. 7 AND 8), (U.S. CLS. 13, 19, 21, 23, 28, 31, 34, 35 AND 44). SN 79-057,892. PUB. 6-23-2009. FILED 7-10-2008.
 3,679,927 (*See Class 3 for this trademark.*)
 3,679,930. **GYGER AND DESIGN.** FRITZ GYGER AG, MULTIPLE CLASS, (INT. CLS. 7, 9, 40 AND 42), (U.S. CLS. 13, 19, 21, 23, 26, 31, 34, 35, 36, 38, 100, 101, 103 AND 106). SN 79-058,608. PUB. 6-23-2009. FILED 6-6-2008.
 3,679,939. **UDOR AND DESIGN.** UDOR - S.R.L., (U.S. CLS. 13, 19, 21, 23, 31, 34 AND 35). SN 79-059,049. PUB. 6-23-2009. FILED 6-11-2008.
 3,679,945 (*See Class 1 for this trademark.*)
 3,679,950. **XBT (BLOCK FORM).** OSG CORPORATION, (U.S. CLS. 13, 19, 21, 23, 31, 34 AND 35). SN 79-059,459. PUB. 6-23-2009. FILED 8-1-2008.
 3,679,951. **EWM ... MIT SYSTEM IN BEWEGUNG. (STYLIZED).** EWM EICHELHARDTER WERKZEUG-; UND MASCHINENBAU GMBH, MULTIPLE CLASS, (INT. CLS. 7 AND 12), (U.S. CLS. 13, 19, 21, 23, 31, 34, 35 AND 44). SN 79-059,482. PUB. 6-23-2009. FILED 7-8-2008.
 3,679,961. **REALM AND DESIGN.** ZHEJIANG XINCHANG REALM ELECTRIC; APPLIANCE CO., LTD, (U.S. CLS. 13, 19, 21, 23, 31, 34 AND 35). SN 79-059,835. PUB. 6-23-2009. FILED 7-25-2008.
 3,679,968. **XCC (STYLIZED).** ZHEJIANG CONTINENTS & XINCHUN; GROUP CO., LTD, (U.S. CLS. 13, 19, 21, 23, 31, 34 AND 35). SN 79-059,956. PUB. 6-23-2009. FILED 7-10-2008.
 3,679,988 (*See Class 6 for this trademark.*)
 3,679,989. **ILLY AND DESIGN.** ILLYCAFFÈ S.P.A., MULTIPLE CLASS, (INT. CLS. 7, 9, 11, 16, 21, 24, 25, 30, 32, 33, 35 AND 41), (U.S. CLS. 2, 5, 13, 19, 21, 22, 23, 26, 29, 30, 31, 33, 34, 35, 36, 37, 38, 39, 40, 42, 45, 46, 47, 48, 49, 50, 100, 101, 102 AND 107). SN 79-061,026. PUB. 6-23-2009. FILED 6-30-2008.
 3,679,990. **MNI AND DESIGN.** MNI HOLDING GMBH, (U.S. CLS. 13, 19, 21, 23, 31, 34 AND 35). SN 79-061,050. PUB. 6-23-2009. FILED 8-5-2008.
 3,679,991. **DELTA SOLUTIONS AND DESIGN.** DELTASOLUTIONS S.R.L., (U.S. CLS. 13, 19, 21, 23, 31, 34 AND 35). SN 79-061,087. PUB. 6-23-2009. FILED 7-22-2008.
 3,680,012. **VERSA (BLOCK FORM).** FEHLMANN AG, (U.S. CLS. 13, 19, 21, 23, 31, 34 AND 35). SN 79-063,018. PUB. 6-23-2009. FILED 11-27-2008.
 3,680,029. **SEVENSTAR (STYLIZED).** BEIJING SEVENSTAR; SCIENCE & TECHNOLOGY CO., LTD, MULTIPLE CLASS, (INT. CLS. 7, 9 AND 11), (U.S. CLS. 13, 19, 21, 23, 26, 31, 34, 35, 36 AND 38). SN 79-064,119. PUB. 6-23-2009. FILED 8-5-2008.
 3,680,035. **BW (STYLIZED).** BOMAG GMBH, MULTIPLE CLASS, (INT. CLS. 7, 37 AND 42), (U.S. CLS. 13, 19, 21, 23, 31, 34, 35, 100, 101, 103 AND 106). SN 79-064,486. PUB. 6-23-2009. FILED 10-14-2008.

CLASS 8—HAND TOOLS

- 3,678,218 (*See Class 1 for this trademark.*)
 3,678,257. **RIVESTO (BLOCK FORM).** KHM MANAGEMENT AG, MULTIPLE CLASS, (INT. CLS. 8 AND 19), (U.S. CLS. 1, 12, 23, 28, 33, 44 AND 50). SN 77-234,843. PUB. 6-23-2009. FILED 7-20-2007.
 3,678,299. **LIGHTFOOT AND DESIGN.** LIGHTFOOT, GREG, (U.S. CLS. 23, 28 AND 44). SN 77-319,057. PUB. 6-23-2009. FILED 11-1-2007.
 3,678,533. **BLIZZARD BUSTER (BLOCK FORM).** SEYMOUR MANUFACTURING CO., INC., (U.S. CLS. 23, 28 AND 44). SN 77-525,669. PUB. 6-23-2009. FILED 7-18-2008.
 3,678,622. **VERMONT FISH & WILDLIFE AND DESIGN.** VERMONT FISH & WILDLIFE DEPARTMENT, MULTIPLE CLASS, (INT. CLS. 8, 16, 20 AND 21), (U.S. CLS. 2, 5, 13, 22, 23, 25, 28, 29, 30, 32, 33, 37, 38, 40, 44 AND 50). SN 77-538,257. PUB. 6-23-2009. FILED 8-4-2008.
 3,678,676 (*See Class 7 for this trademark.*)

- 3,678,759. **JINDELI (BLOCK FORM).** ZHEJIANG JINDELI BEAUTY AND HAIRDRESSING HOUSEHOLD APPLIANCES CO., LTD., MULTIPLE CLASS, (INT. CLS. 8, 9 AND 11), (U.S. CLS. 13, 21, 23, 26, 28, 31, 34, 36, 38 AND 44). SN 77-563,760. PUB. 6-23-2009. FILED 9-5-2008.
 3,678,812. **MARXBURR (BLOCK FORM).** PTS SALES COMPANY, (U.S. CLS. 23, 28 AND 44). SN 77-580,721. PUB. 6-23-2009. FILED 9-28-2008.
 3,678,974. **EXPRESSION (BLOCK FORM).** GREAT AMERICAN MARKETING, INC., MULTIPLE CLASS, (INT. CLS. 8, 9, 16, 17 AND 21), (U.S. CLS. 1, 2, 5, 12, 13, 21, 22, 23, 26, 28, 29, 30, 33, 35, 36, 37, 38, 40, 44 AND 50). SN 77-626,838. PUB. 6-23-2009. FILED 12-4-2008.
 3,679,218. **CHI (BLOCK FORM).** FAROUK SYSTEMS, INC., (U.S. CLS. 23, 28 AND 44). SN 77-670,704. PUB. 5-19-2009. FILED 2-13-2009.
 3,679,456. **TRAC (STYLIZED).** TRAC OUTDOOR PRODUCTS COMPANY, MULTIPLE CLASS, (INT. CLS. 8 AND 12), (U.S. CLS. 19, 21, 23, 28, 31, 35 AND 44). SN 77-677,043. PUB. 6-23-2009. FILED 2-24-2009.
 3,679,586. **MONSTER POINT (BLOCK FORM).** FUNKY-TOWNMALL.COM, INC., (U.S. CLS. 23, 28 AND 44). SN 77-678,532. PUB. 6-23-2009. FILED 2-25-2009.
 3,679,797 (*See Class 4 for this trademark.*)
 3,679,806 (*See Class 4 for this trademark.*)
 3,679,810. **THE POTTERY DISTRICT (BLOCK FORM).** STOKES CANADA INC., MULTIPLE CLASS, (INT. CLS. 8 AND 21), (U.S. CLS. 2, 13, 23, 28, 29, 30, 33, 40, 44 AND 50). SN 78-603,919. PUB. 6-23-2009. FILED 4-7-2005.
 3,679,838 (*See Class 1 for this trademark.*)
 3,679,861 (*See Class 3 for this trademark.*)
 3,679,921 (*See Class 7 for this trademark.*)
 3,679,927 (*See Class 3 for this trademark.*)
 3,679,938. **ZEAL (BLOCK FORM).** COUNTRY KITCHENWARE SUPPLIES LIMITED, MULTIPLE CLASS, (INT. CLS. 8, 9, 21 AND 35), (U.S. CLS. 2, 13, 21, 23, 26, 28, 29, 30, 33, 36, 38, 40, 44, 50, 100, 101 AND 102). SN 79-059,034. PUB. 6-23-2009. FILED 2-29-2008.

CLASS 9—ELECTRICAL AND SCIENTIFIC APPARATUS

- 3,678,140. **IPMOBILENET.** IP MOBILENET, INC., (U.S. CLS. 21, 23, 26, 36 AND 38). SN 76-347,993. PUB. 6-23-2009. FILED 12-3-2001.
 3,678,142. **XSTREAM ACCESS AND DESIGN.** XSTREAM ACCESS LLC, (U.S. CLS. 21, 23, 26, 36 AND 38). SN 76-434,590. PUB. 6-23-2009. FILED 7-26-2002.
 3,678,157. **BOUNCE (BLOCK FORM).** ZBD DISPLAYS LIMITED, MULTIPLE CLASS, (INT. CLS. 9 AND 35), (U.S. CLS. 21, 23, 26, 36, 38, 100, 101 AND 102). SN 76-674,334. PUB. 12-30-2008. FILED 3-20-2007.
 3,678,178. **CHALINO SANCHEZ (BLOCK FORM).** VALLEJO, MARICELA, (U.S. CLS. 21, 23, 26, 36 AND 38). SN 76-692,435. PUB. 6-23-2009. FILED 8-28-2008.
 3,678,181. **DVIGEAR AND DESIGN.** DVIGEAR, INC., (U.S. CLS. 21, 23, 26, 36 AND 38). SN 76-693,171. PUB. 6-23-2009. FILED 9-26-2008.
 3,678,183. **ERGOVATION (BLOCK FORM).** BUCKINGHAM MANUFACTURING COMPANY, INC., (U.S. CLS. 21, 23, 26, 36 AND 38). SN 76-693,405. PUB. 6-23-2009. FILED 10-7-2008.
 3,678,184. **NWIN NORTHWEST INDIAN NEWS AND DESIGN.** TULALIP TRIBE, (U.S. CLS. 21, 23, 26, 36 AND 38). SN 76-693,567. PUB. 6-23-2009. FILED 10-14-2008.
 3,678,185. **LAUS DEO PRODUCTIONS (BLOCK FORM).** MILLARD, CATHERINE, (U.S. CLS. 21, 23, 26, 36 AND 38). SN 76-693,600. PUB. 6-23-2009. FILED 10-16-2008.
 3,678,187. **UNIVERSAL (BLOCK FORM).** GENX INTERNATIONAL, INC., (U.S. CLS. 21, 23, 26, 36 AND 38). SN 76-694,125. PUB. 6-23-2009. FILED 11-7-2008.
 3,678,189. **AVIELO AND DESIGN.** PROJECTIONDESIGN AS, (U.S. CLS. 21, 23, 26, 36 AND 38). SN 76-694,644. PUB. 6-23-2009. FILED 12-4-2008.
 3,678,193. **RECES (STYLIZED).** SIMBIOTE DEVELOPMENT, LLC, (U.S. CLS. 21, 23, 26, 36 AND 38). SN 76-695,678. PUB.

- 6-23-2009. FILED 2-9-2009.
- 3,678,194. **CARESENTRY (STYLIZED)**. SIMBIOTE DEVELOPMENT, LLC, (U.S. CLS. 21, 23, 26, 36 AND 38). SN 77-695,679. PUB. 6-23-2009. FILED 2-9-2009.
- 3,678,195. **ORDERSENTRY (STYLIZED)**. SIMBIOTE DEVELOPMENT, LLC, (U.S. CLS. 21, 23, 26, 36 AND 38). SN 77-695,680. PUB. 6-23-2009. FILED 2-9-2009.
- 3,678,204 (*See Class 1 for this trademark*).
- 3,678,211. **POWERMATE (BLOCK FORM)**. TECHNOLOGY FOR ENERGY CORPORATION, (U.S. CLS. 21, 23, 26, 36 AND 38). SN 77-059,142. PUB. 6-23-2009. FILED 12-7-2006.
- 3,678,212 (*See Class 6 for this trademark*).
- 3,678,214 (*See Class 7 for this trademark*).
- 3,678,219. **MX-DAY/NIGHT SPOTTER (BLOCK FORM)**. WES-CAM INC., (U.S. CLS. 21, 23, 26, 36 AND 38). SN 77-092,342. PUB. 6-23-2009. FILED 1-26-2007.
- 3,678,222. **THE ROUGH GUIDE (BLOCK FORM)**. THE ROUGH GUIDES LIMITED, MULTIPLE CLASS, (INT. CLS. 9 AND 41), (U.S. CLS. 21, 23, 26, 36, 38, 100, 101 AND 107). SN 77-126,703. PUB. 6-23-2009. FILED 3-9-2007.
- 3,678,224. **Q (STYLIZED)**. Q-BAM, INC., MULTIPLE CLASS, (INT. CLS. 9, 35 AND 42), (U.S. CLS. 21, 23, 26, 36, 38, 100, 101 AND 102). SN 77-135,629. PUB. 6-23-2009. FILED 3-20-2007.
- 3,678,227. **BINDI (BLOCK FORM)**. AUSTRALIA ZOO PTY LTD, MULTIPLE CLASS, (INT. CLS. 9, 16, 18, 21, 24, 25, 28, 35, 41, 42, 43 AND 44), (U.S. CLS. 1, 2, 3, 5, 13, 21, 22, 23, 26, 29, 30, 33, 36, 37, 38, 39, 40, 41, 42, 50, 100, 101, 102 AND 107). SN 77-142,956. PUB. 6-23-2009. FILED 3-28-2007.
- 3,678,236. **VIDEO-MILES (BLOCK FORM)**. MILLER, CALUM T. AND HODGSON, PATRICK, MULTIPLE CLASS, (INT. CLS. 9 AND 42), (U.S. CLS. 21, 23, 26, 36, 38, 100 AND 101). SN 77-187,866. PUB. 1-20-2009. FILED 5-23-2007.
- 3,678,241. **L-DEX (BLOCK FORM)**. IMPEDIMED LIMITED, MULTIPLE CLASS, (INT. CLS. 9, 10 AND 44), (U.S. CLS. 21, 23, 26, 36, 38, 39, 44, 100 AND 101). SN 77-208,617. PUB. 6-23-2009. FILED 6-18-2007.
- 3,678,242. **AKKA (BLOCK FORM)**. LA GANTERIE B.C.L. LTÉE, (U.S. CLS. 21, 23, 26, 36 AND 38). SN 77-211,005. PUB. 6-23-2009. FILED 6-20-2007.
- 3,678,247. **SQIDWORKS (BLOCK FORM)**. SQI DIAGNOSTICS SYSTEMS INC., (U.S. CLS. 21, 23, 26, 36 AND 38). SN 77-224,748. PUB. 6-23-2009. FILED 7-9-2007.
- 3,678,278. **SOLERS (BLOCK FORM)**. SOLERS, LTD., (U.S. CLS. 21, 23, 26, 36 AND 38). SN 77-295,749. PUB. 6-23-2009. FILED 10-4-2007.
- 3,678,282 (*See Class 6 for this trademark*).
- 3,678,285. **NATURASIGN (BLOCK FORM)**. STEPOVER GMBH, (U.S. CLS. 21, 23, 26, 36 AND 38). SN 77-305,858. PUB. 6-16-2009. FILED 10-17-2007.
- 3,678,291. **STUDIOPOTTERY.CO.UK AND DESIGN**. STUDIO-POTTERY.CO.UK LTD., MULTIPLE CLASS, (INT. CLS. 9, 35 AND 41), (U.S. CLS. 21, 23, 26, 36, 38, 100, 101, 102 AND 107). SN 77-310,148. PUB. 3-24-2009. FILED 10-22-2007.
- 3,678,294. **THRIVE AND DESIGN**. VINAS, RICARDO, (U.S. CLS. 21, 23, 26, 36 AND 38). SN 77-311,455. PUB. 6-23-2009. FILED 10-23-2007.
- 3,678,296. **ZIEMER S (STYLIZED)**. ZIEMER HOLDING AG, MULTIPLE CLASS, (INT. CLS. 9, 10 AND 44), (U.S. CLS. 21, 23, 26, 36, 38, 39, 44, 100 AND 101). SN 77-312,906. PUB. 10-14-2008. FILED 10-25-2007.
- 3,678,298. **RAM (BLOCK FORM)**. BENTLEY SYSTEMS, INCORPORATED, (U.S. CLS. 21, 23, 26, 36 AND 38). SN 77-318,059. PUB. 6-23-2009. FILED 10-31-2007.
- 3,678,300. **HUSTLAZ ENTERPRIZE (BLOCK FORM)**. HUSTLAZ ENTERPRIZE, LLC, MULTIPLE CLASS, (INT. CLS. 9 AND 41), (U.S. CLS. 21, 23, 26, 36, 38, 100, 101 AND 107). SN 77-324,045. PUB. 6-23-2009. FILED 11-7-2007.
- 3,678,302. **AKKA AND DESIGN**. LA GANTERIE B.C.L. LTÉE, (U.S. CLS. 21, 23, 26, 36 AND 38). SN 77-324,343. PUB. 6-23-2009. FILED 11-8-2007.
- 3,678,310. **MOTODUDS (BLOCK FORM)**. ASHLEA SCHAUMBURG, DBA MOTODUDS, (U.S. CLS. 21, 23, 26, 36 AND 38). SN 77-332,621. PUB. 6-23-2009. FILED 11-19-2007.
- 3,678,320. **GOODGLASSES (BLOCK FORM)**. TESTHEALTH.COM LLC, DBA GOODGLASSES.COM, (U.S. CLS. 21, 23, 26, 36 AND 38). SN 77-348,812. PUB. 6-23-2009. FILED 12-11-2007.
- 3,678,326. **FAIRE FOLK AND DESIGN**. BAIRD, MEGHAN ELIZABETH BRUNNER, AKA MEGHAN BRUNNER, MULTIPLE CLASS, (INT. CLS. 9, 14, 16, 21, 25, 26, 35 AND 38), (U.S. CLS. 2, 5, 13, 21, 22, 23, 26, 27, 28, 29, 30, 33, 36, 37, 38, 39, 40, 42, 50, 100, 101, 102 AND 104). SN 77-355,204. PUB. 6-23-2009. FILED 12-18-2007.
- 3,678,333. **CERTIFIED SCRIPTS FOR SUCCESS (BLOCK FORM)**. MORTGAGE MARKET GUIDE, LLC, MULTIPLE CLASS, (INT. CLS. 9 AND 41), (U.S. CLS. 21, 23, 26, 36, 38, 100, 101 AND 107). SN 77-365,586. PUB. 6-23-2009. FILED 1-7-2008.
- 3,678,336. **SPRUCE (BLOCK FORM)**. OCTOPUS PUBLISHING GROUP LIMITED, MULTIPLE CLASS, (INT. CLS. 9 AND 16), (U.S. CLS. 2, 5, 21, 22, 23, 26, 29, 36, 37, 38 AND 50). SN 77-366,639. PUB. 6-23-2009. FILED 1-8-2008.
- 3,678,337. **EASY SEAL (BLOCK FORM)**. STANFIELD'S LIMITED, (U.S. CLS. 21, 23, 26, 36 AND 38). SN 77-368,208. PUB. 6-23-2009. FILED 1-10-2008.
- 3,678,338. **CELLEBRITE (BLOCK FORM)**. CELLEBRITE USA, CORP., (U.S. CLS. 21, 23, 26, 36 AND 38). SN 77-370,827. PUB. 6-23-2009. FILED 1-14-2008.
- 3,678,342. **CLEARACCESS (BLOCK FORM)**. CLEARACCESS, INC., MULTIPLE CLASS, (INT. CLS. 9 AND 38), (U.S. CLS. 21, 23, 26, 36, 38, 100, 101 AND 104). SN 77-373,683. PUB. 6-23-2009. FILED 1-16-2008.
- 3,678,344. **PROSTREAM (BLOCK FORM)**. HARMONIC INC., (U.S. CLS. 21, 23, 26, 36 AND 38). SN 77-377,744. PUB. 6-23-2009. FILED 1-22-2008.
- 3,678,346. **CONCENTRI (BLOCK FORM)**. KNOTICE, LTD, (U.S. CLS. 21, 23, 26, 36 AND 38). SN 77-378,458. PUB. 6-23-2009. FILED 1-23-2008.
- 3,678,351. **SMART I.D. AND DESIGN**. GUARD-A-KID FRANCHISING CORP., DBA GUARD-A-KID, (U.S. CLS. 21, 23, 26, 36 AND 38). SN 77-383,044. PUB. 6-23-2009. FILED 1-29-2008.
- 3,678,353 (*See Class 7 for this trademark*).
- 3,678,356. **T MOBILE PARTNER AND DESIGN**. DEUTSCHE TELEKOM AG, (U.S. CLS. 21, 23, 26, 36 AND 38). SN 77-392,203. PUB. 3-17-2009. FILED 2-8-2008.
- 3,678,362. **S AND DESIGN**. MCPOLLO (USA) CORP., MULTIPLE CLASS, (INT. CLS. 9 AND 18), (U.S. CLS. 1, 2, 3, 21, 22, 23, 26, 36, 38 AND 41). SN 77-399,659. PUB. 3-17-2009. FILED 2-18-2008.
- 3,678,383. **MGUARD (BLOCK FORM)**. INNOMINATE SECURITY TECHNOLOGIES AG, (U.S. CLS. 21, 23, 26, 36 AND 38). SN 77-419,889. PUB. 6-23-2009. FILED 3-12-2008.
- 3,678,404. **MAGICINFO (BLOCK FORM)**. SAMSUNG ELECTRONICS CO., LTD., (U.S. CLS. 21, 23, 26, 36 AND 38). SN 77-438,961. PUB. 6-23-2009. FILED 4-3-2008.
- 3,678,408. **ELECTRONIC STYLE (BLOCK FORM)**. JACOBS, JOHN, (U.S. CLS. 21, 23, 26, 36 AND 38). SN 77-443,364. PUB. 6-23-2009. FILED 4-8-2008.
- 3,678,420. **VISUAL LEARNING SERVED ON DEMAND (BLOCK FORM)**. LIBRARY VIDEO COMPANY, (U.S. CLS. 21, 23, 26, 36 AND 38). SN 77-453,795. PUB. 6-23-2009. FILED 4-21-2008.
- 3,678,424. **VOLT DEPOT (BLOCK FORM)**. AT BATTERY CO., (U.S. CLS. 21, 23, 26, 36 AND 38). SN 77-455,883. PUB. 6-23-2009. FILED 4-23-2008.
- 3,678,436. **ENERBUS (BLOCK FORM)**. ALSTOM POWER CENTRALES, (U.S. CLS. 21, 23, 26, 36 AND 38). SN 77-470,650. PUB. 3-3-2009. FILED 5-9-2008.
- 3,678,453. **AURORA NETWORKS AND DESIGN**. AURORA NETWORKS, INC., (U.S. CLS. 21, 23, 26, 36 AND 38). SN 77-488,942. PUB. 6-23-2009. FILED 6-2-2008.
- 3,678,454. **BEST BEHAVIOR SIMULATION TRAINING AND DESIGN**. THE HARRINGTON GROUP, INC., DBA HARRINGTON GROUP, AND H3, INC, (U.S. CLS. 21, 23, 26, 36 AND 38). SN 77-489,204. PUB. 6-23-2009. FILED 6-2-2008.
- 3,678,477. **HIT DOUBLE (BLOCK FORM)**. SANYO ELECTRIC CO., LTD., (U.S. CLS. 21, 23, 26, 36 AND 38). SN 77-502,883. PUB. 6-23-2009. FILED 6-19-2008.
- 3,678,479. **MOBILE PLATE HUNTER (BLOCK FORM)**. EL-SAG NORTH AMERICA, LLC, (U.S. CLS. 21, 23, 26, 36 AND 38). SN 77-503,777. PUB. 6-23-2009. FILED 6-20-2008.
- 3,678,492. **T-MOBILE INSTANT MESSAGING (BLOCK FORM)**. DEUTSCHE TELEKOM, (U.S. CLS. 21, 23, 26, 36 AND 38). SN 77-509,227. PUB. 4-7-2009. FILED 6-26-2008.

- 3,678,518. **MODE GREEN (BLOCK FORM)**. WILLIAM J. LALLY, MULTIPLE CLASS, (INT. CLS. 9, 35 AND 42), (U.S. CLS. 21, 23, 26, 36, 38, 100, 101 AND 102). SN 77-522,062. PUB. 6-23-2009. FILED 7-14-2008.
- 3,678,519. **OFFSHORE ADVENTURES (BLOCK FORM)**. FISCHER PRODUCTIONS, LLC, MULTIPLE CLASS, (INT. CLS. 9 AND 41), (U.S. CLS. 21, 23, 26, 36, 38, 100, 101 AND 107). SN 77-522,179. PUB. 6-23-2009. FILED 7-15-2008.
- 3,678,551. **NANOUPDATE (BLOCK FORM)**. MOCANA CORPORATION, (U.S. CLS. 21, 23, 26, 36 AND 38). SN 77-529,146. PUB. 6-23-2009. FILED 7-23-2008.
- 3,678,553. **NANOEAP (BLOCK FORM)**. MOCANA CORPORATION, (U.S. CLS. 21, 23, 26, 36 AND 38). SN 77-529,166. PUB. 6-23-2009. FILED 7-23-2008.
- 3,678,554. **NANORADIUS (BLOCK FORM)**. MOCANA CORPORATION, (U.S. CLS. 21, 23, 26, 36 AND 38). SN 77-529,213. PUB. 6-23-2009. FILED 7-23-2008.
- 3,678,555. **NANOBOOT (BLOCK FORM)**. MOCANA CORPORATION, (U.S. CLS. 21, 23, 26, 36 AND 38). SN 77-529,386. PUB. 6-23-2009. FILED 7-23-2008.
- 3,678,557. **NANOSEC (BLOCK FORM)**. MOCANA CORPORATION, (U.S. CLS. 21, 23, 26, 36 AND 38). SN 77-529,415. PUB. 6-23-2009. FILED 7-23-2008.
- 3,678,558. **NANODTLS (BLOCK FORM)**. MOCANA CORPORATION, (U.S. CLS. 21, 23, 26, 36 AND 38). SN 77-529,449. PUB. 6-23-2009. FILED 7-23-2008.
- 3,678,559. **NANOSSL (BLOCK FORM)**. MOCANA CORPORATION, (U.S. CLS. 21, 23, 26, 36 AND 38). SN 77-529,493. PUB. 6-23-2009. FILED 7-23-2008.
- 3,678,561. **NANOSSH (BLOCK FORM)**. MOCANA CORPORATION, (U.S. CLS. 21, 23, 26, 36 AND 38). SN 77-529,530. PUB. 6-23-2009. FILED 7-23-2008.
- 3,678,562. **TYZUNG C. (BLOCK FORM)**. GEAN, KASANDRA T., MULTIPLE CLASS, (INT. CLS. 9 AND 41), (U.S. CLS. 21, 23, 26, 36, 38, 100, 101 AND 107). SN 77-529,558. PUB. 6-23-2009. FILED 7-23-2008.
- 3,678,586. **IG INDUCED GRATING METHOD (STYLIZED)**. SHIMADZU CORPORATION, (U.S. CLS. 21, 23, 26, 36 AND 38). SN 77-534,412. PUB. 6-23-2009. FILED 7-30-2008.
- 3,678,603. **NOIZE (BLOCK FORM)**. NOIZE MAGAZINE, LLC, DBA CIRCUIT NOIZE MAGAZINE, LLC, MULTIPLE CLASS, (INT. CLS. 9 AND 16), (U.S. CLS. 2, 5, 21, 22, 23, 26, 29, 36, 37, 38 AND 50). SN 77-536,430. PUB. 6-23-2009. FILED 7-31-2008.
- 3,678,616. **THE RANHHANDS (BLOCK FORM)**. FARMERS MARKET MUSIC, LLC, MULTIPLE CLASS, (INT. CLS. 9 AND 41), (U.S. CLS. 21, 23, 26, 36, 38, 100, 101 AND 107). SN 77-537,701. PUB. 6-23-2009. FILED 8-2-2008.
- 3,678,638. **G GREATLAND FIDELITY OF CONNECTION AND DESIGN**. GREATLAND ELECTRONICS TAIWAN LTD., (U.S. CLS. 21, 23, 26, 36 AND 38). SN 77-539,416. PUB. 6-23-2009. FILED 8-5-2008.
- 3,678,672. **SAMBODHA AND DESIGN**. SAMBODHA INC., MULTIPLE CLASS, (INT. CLS. 9, 16 AND 41), (U.S. CLS. 2, 5, 21, 22, 23, 26, 29, 36, 37, 38, 50, 100, 101 AND 107). SN 77-542,450. PUB. 6-23-2009. FILED 8-8-2008.
- 3,678,682. **PSLM (BLOCK FORM)**. HAMAMATSU PHOTONICS K.K., (U.S. CLS. 21, 23, 26, 36 AND 38). SN 77-544,531. PUB. 6-23-2009. FILED 8-12-2008.
- 3,678,685. **POGOMD AND DESIGN**. EXCITEWERKS, INC., (U.S. CLS. 21, 23, 26, 36 AND 38). SN 77-544,902. PUB. 6-23-2009. FILED 8-12-2008.
- 3,678,688. **EPG (BLOCK FORM)**. ESSEX PRODUCTS GROUP, (U.S. CLS. 21, 23, 26, 36 AND 38). SN 77-545,639. PUB. 6-23-2009. FILED 8-13-2008.
- 3,678,690. **MASTRIA (BLOCK FORM)**. ALSTOM, (U.S. CLS. 21, 23, 26, 36 AND 38). SN 77-546,344. PUB. 6-23-2009. FILED 8-13-2008.
- 3,678,691 (*See Class 7 for this trademark*).
- 3,678,692. **A AND DESIGN**. BOSCO DEVELOPMENT LTD., DBA AVANT BROWSER, (U.S. CLS. 21, 23, 26, 36 AND 38). SN 77-546,574. PUB. 6-23-2009. FILED 8-13-2008.
- 3,678,698. **ACCESSORY POWER USA GEAR PRO SERIES AND DESIGN**. BRIGHT IDEAS, INC., (U.S. CLS. 21, 23, 26, 36 AND 38). SN 77-547,546. PUB. 5-19-2009. FILED 8-14-2008.
- 3,678,703. **IMAGEIN AND DESIGN**. HERFF JONES, INC., (U.S. CLS. 21, 23, 26, 36 AND 38). SN 77-548,438. PUB. 6-23-2009. FILED 8-15-2008.
- 3,678,704. **COMFORT KNEES (BLOCK FORM)**. HOLLIDAY, STEWART, (U.S. CLS. 21, 23, 26, 36 AND 38). SN 77-548,604. PUB. 6-23-2009. FILED 8-15-2008.
- 3,678,741. **AMPLIFIRE (BLOCK FORM)**. TORRENT, INC., (U.S. CLS. 21, 23, 26, 36 AND 38). SN 77-559,013. PUB. 1-20-2009. FILED 8-29-2008.
- 3,678,750 (*See Class 1 for this trademark*).
- 3,678,759 (*See Class 8 for this trademark*).
- 3,678,767. **PEACEFUL PEOPLE (BLOCK FORM)**. PEACEFUL RESOLUTIONS FOR LIVING, INC., MULTIPLE CLASS, (INT. CLS. 9, 16 AND 41), (U.S. CLS. 2, 5, 21, 22, 23, 26, 29, 36, 37, 38, 50, 100, 101 AND 107). SN 77-568,862. PUB. 6-23-2009. FILED 9-12-2008.
- 3,678,769. **A AND DESIGN**. NETWORK AUTOMATION, INC., (U.S. CLS. 21, 23, 26, 36 AND 38). SN 77-569,238. PUB. 6-23-2009. FILED 9-12-2008.
- 3,678,770. **NO CODE, NO LIMITS (BLOCK FORM)**. NETWORK AUTOMATION, INC., (U.S. CLS. 21, 23, 26, 36 AND 38). SN 77-569,243. PUB. 6-23-2009. FILED 9-12-2008.
- 3,678,772. **IHARMONIX (BLOCK FORM)**. PARAMOUNT WIRELESS, INC., (U.S. CLS. 21, 23, 26, 36 AND 38). SN 77-569,519. PUB. 6-23-2009. FILED 9-14-2008.
- 3,678,777. **SONIC LIGHTER (BLOCK FORM)**. SONICMULE, INC., (U.S. CLS. 21, 23, 26, 36 AND 38). SN 77-571,122. PUB. 6-23-2009. FILED 9-16-2008.
- 3,678,784. **SPORTS LEGEND (BLOCK FORM)**. BIG ANT STUDIOS PTY LTD, (U.S. CLS. 21, 23, 26, 36 AND 38). SN 77-572,823. PUB. 6-23-2009. FILED 9-18-2008.
- 3,678,785. **SOCCER LEGEND (BLOCK FORM)**. BIG ANT STUDIOS PTY LTD, (U.S. CLS. 21, 23, 26, 36 AND 38). SN 77-572,824. PUB. 6-23-2009. FILED 9-18-2008.
- 3,678,786. **BASKETBALL LEGEND (BLOCK FORM)**. BIG ANT STUDIOS PTY LTD, (U.S. CLS. 21, 23, 26, 36 AND 38). SN 77-572,827. PUB. 6-23-2009. FILED 9-18-2008.
- 3,678,787. **BASEBALL LEGEND (BLOCK FORM)**. BIG ANT STUDIOS PTY LTD, (U.S. CLS. 21, 23, 26, 36 AND 38). SN 77-572,828. PUB. 6-23-2009. FILED 9-18-2008.
- 3,678,803. **MISCELLANEOUS DESIGN**. MEXDER, MERCADO MEXICANO DE DERIVADOS, S.A. DE C.V., AKA MEXDER, MULTIPLE CLASS, (INT. CLS. 9, 16 AND 36), (U.S. CLS. 2, 5, 21, 22, 23, 26, 29, 36, 37, 38, 50, 100, 101 AND 102). SN 77-577,594. PUB. 6-23-2009. FILED 9-24-2008.
- 3,678,804. **MEXDER AND DESIGN**. MEXDER, MERCADO MEXICANO DE DERIVADOS, S.A. DE C.V., AKA MEXDER, MULTIPLE CLASS, (INT. CLS. 9, 16 AND 36), (U.S. CLS. 2, 5, 21, 22, 23, 26, 29, 36, 37, 38, 50, 100, 101 AND 102). SN 77-577,635. PUB. 6-23-2009. FILED 9-24-2008.
- 3,678,808. **MISCELLANEOUS DESIGN**. THE COLEMAN COMPANY, INC., (U.S. CLS. 21, 23, 26, 36 AND 38). SN 77-579,118. PUB. 6-23-2009. FILED 9-25-2008.
- 3,678,840 (*See Class 6 for this trademark*).
- 3,678,864. **MARQUIS (BLOCK FORM)**. GREENSTONE VENTURES, INC., MULTIPLE CLASS, (INT. CLS. 9, 16 AND 41), (U.S. CLS. 2, 5, 21, 22, 23, 26, 29, 36, 37, 38, 50, 100, 101 AND 107). SN 77-594,557. PUB. 3-17-2009. FILED 10-16-2008.
- 3,678,878. **SLIDEBANK (BLOCK FORM)**. DIGITAL IMAGE LTD, FORMERLY DIGITAL IMAGE LLP, (U.S. CLS. 21, 23, 26, 36 AND 38). SN 77-598,634. PUB. 6-23-2009. FILED 10-23-2008.
- 3,678,885. **IG-XL (BLOCK FORM)**. TERADYNE, INC., (U.S. CLS. 21, 23, 26, 36 AND 38). SN 77-599,971. PUB. 6-23-2009. FILED 10-24-2008.
- 3,678,899. **LOOT WARS (BLOCK FORM)**. GOLGI LLC, (U.S. CLS. 21, 23, 26, 36 AND 38). SN 77-602,641. PUB. 6-23-2009. FILED 10-28-2008.
- 3,678,904. **FUTRIX AND DESIGN**. FUTRIX IP LIMITED, (U.S. CLS. 21, 23, 26, 36 AND 38). SN 77-603,666. PUB. 6-23-2009. FILED 10-30-2008.
- 3,678,905. **FREEDOM TO EXPLORE (STYLIZED)**. FUTRIX IP LIMITED, (U.S. CLS. 21, 23, 26, 36 AND 38). SN 77-603,672. PUB. 6-23-2009. FILED 10-30-2008.
- 3,678,915. **THESOURCE (BLOCK FORM)**. PERRY PROPERTIES, LLC, (U.S. CLS. 21, 23, 26, 36 AND 38). SN 77-609,142. PUB. 6-23-2009. FILED 11-6-2008.
- 3,678,974 (*See Class 8 for this trademark*).
- 3,678,984. **THE "RETIREMENT" TRICK (BLOCK FORM)**. THE STRATEGIC COACH INC., MULTIPLE CLASS, (INT. CLS. 9 AND 16), (U.S. CLS. 2, 5, 21, 22, 23, 26, 29, 36,

- 37, 38 AND 50). SN 77-628,870. PUB. 6-23-2009. FILED 12-8-2008.
- 3,678,987. **B AND DESIGN**. E. ARTHUR BROWN COMPANY, INC., MULTIPLE CLASS, (INT. CLS. 9 AND 13), (U.S. CLS. 2, 9, 21, 23, 26, 36 AND 38). SN 77-630,098. PUB. 6-23-2009. FILED 12-10-2008.
- 3,678,992. **RADIANTGRID (BLOCK FORM)**. RADIANTGRID TECHNOLOGIES, LLC, MULTIPLE CLASS, (INT. CLS. 9 AND 42), (U.S. CLS. 21, 23, 26, 36, 38, 100 AND 101). SN 77-631,595. PUB. 6-23-2009. FILED 12-11-2008.
- 3,678,994. **FAST MEASURE AND DESIGN**. WILMAR CORPORATION, (U.S. CLS. 21, 23, 26, 36 AND 38). SN 77-631,854. PUB. 6-23-2009. FILED 12-12-2008.
- 3,678,996. **MISCELLANEOUS DESIGN**. ASPEN PUBLISHERS, INC., (U.S. CLS. 21, 23, 26, 36 AND 38). SN 77-632,192. PUB. 6-23-2009. FILED 12-12-2008.
- 3,678,998. **PSYKE AND DESIGN**. TRAPANE, KEVIN E, (U.S. CLS. 21, 23, 26, 36 AND 38). SN 77-632,716. PUB. 6-23-2009. FILED 12-14-2008.
- 3,679,002. **MOTORMONKEY (BLOCK FORM)**. POWERTRAVELLER LIMITED, (U.S. CLS. 21, 23, 26, 36 AND 38). SN 77-634,185. PUB. 6-23-2009. FILED 12-16-2008.
- 3,679,008 (*See Class 7 for this trademark*).
- 3,679,023. **STREAM BURNER STREAMBURNER.COM AND DESIGN**. EZTAKES, INC., (U.S. CLS. 21, 23, 26, 36 AND 38). SN 77-639,851. PUB. 6-23-2009. FILED 12-24-2008.
- 3,679,044. **ENTREPRENEUR (BLOCK FORM)**. DUNSTER, JEFFREY, MULTIPLE CLASS, (INT. CLS. 9 AND 44), (U.S. CLS. 21, 23, 26, 36, 38, 100 AND 101). SN 77-646,046. PUB. 6-23-2009. FILED 1-8-2009.
- 3,679,048. **PATIENT EDU AND DESIGN**. PATIENT EDU, LLC, (U.S. CLS. 21, 23, 26, 36 AND 38). SN 77-647,188. PUB. 6-23-2009. FILED 1-11-2009.
- 3,679,056. **MISCELLANEOUS DESIGN**. APPLE INC., (U.S. CLS. 21, 23, 26, 36 AND 38). SN 77-648,705. PUB. 6-23-2009. FILED 1-13-2009.
- 3,679,065. **KALEXO TEAMWORK (BLOCK FORM)**. KALEXO, INC., MULTIPLE CLASS, (INT. CLS. 9 AND 42), (U.S. CLS. 21, 23, 26, 36, 38, 100 AND 101). SN 77-650,671. PUB. 6-23-2009. FILED 1-15-2009.
- 3,679,069. **RSA NETWORK INC. (STYLIZED)**. STARFISH NETWORK, INC., DBA RSA NETWORK, INC., MULTIPLE CLASS, (INT. CLS. 9 AND 41), (U.S. CLS. 21, 23, 26, 36, 38, 100, 101 AND 107). SN 77-652,119. PUB. 6-23-2009. FILED 1-19-2009.
- 3,679,097. **TOUCHCOPY (BLOCK FORM)**. NEIL BENSON, (U.S. CLS. 21, 23, 26, 36 AND 38). SN 77-656,497. PUB. 6-23-2009. FILED 1-26-2009.
- 3,679,102. **TOUCHCOPY AND DESIGN**. NEIL BENSON, (U.S. CLS. 21, 23, 26, 36 AND 38). SN 77-656,626. PUB. 6-23-2009. FILED 1-26-2009.
- 3,679,110. **SUNIVA (BLOCK FORM)**. SUNIVA, INC., (U.S. CLS. 21, 23, 26, 36 AND 38). SN 77-657,649. PUB. 6-23-2009. FILED 1-27-2009.
- 3,679,112. **NOVIOUS (BLOCK FORM)**. LONG, WEIHAO ALEXANDER, (U.S. CLS. 21, 23, 26, 36 AND 38). SN 77-657,793. PUB. 6-23-2009. FILED 1-27-2009.
- 3,679,124. **THE REAL COUGAR WOMAN (BLOCK FORM)**. HIGH-YIELD LIVING LLP, MULTIPLE CLASS, (INT. CLS. 9 AND 41), (U.S. CLS. 21, 23, 26, 36, 38, 100, 101 AND 107). SN 77-660,044. PUB. 6-23-2009. FILED 1-30-2009.
- 3,679,128. **KAON INTERACTIVE (BLOCK FORM)**. KAON INTERACTIVE, INCORPORATED, (U.S. CLS. 21, 23, 26, 36 AND 38). SN 77-661,448. PUB. 6-23-2009. FILED 2-2-2009.
- 3,679,141. **WATER GREMLIN (BLOCK FORM)**. WATER GREMLIN CO., MULTIPLE CLASS, (INT. CLS. 9 AND 28), (U.S. CLS. 21, 22, 23, 26, 36, 38 AND 50). SN 77-663,951. PUB. 6-23-2009. FILED 2-5-2009.
- 3,679,147. **INKHORN MUSIC PRODUCTIONS AND DESIGN**. POWELL, ROSEPHANYE DUNN, (U.S. CLS. 21, 23, 26, 36 AND 38). SN 77-664,426. PUB. 6-23-2009. FILED 2-5-2009.
- 3,679,182. **ONE BUTTON RESTORE (BLOCK FORM)**. XPOINT TECHNOLOGIES, INC., (U.S. CLS. 21, 23, 26, 36 AND 38). SN 77-667,412. PUB. 6-23-2009. FILED 2-10-2009.
- 3,679,192. **READMASTER PLUS (BLOCK FORM)**. ACCELERATED CHRISTIAN EDUCATION, INC., (U.S. CLS. 21, 23, 26, 36 AND 38). SN 77-668,504. PUB. 6-23-2009. FILED 2-11-2009.
- 3,679,203. **G-COP (BLOCK FORM)**. JIVOIN, CORNELL P., (U.S. CLS. 21, 23, 26, 36 AND 38). SN 77-669,481. PUB. 6-23-2009. FILED S.R. 2-12-2009; AM. P.R. 5-7-2009.
- 3,679,239. **MYSPEED (BLOCK FORM)**. YOO, DANIEL JHIN, (U.S. CLS. 21, 23, 26, 36 AND 38). SN 77-671,596. PUB. 6-23-2009. FILED 2-17-2009.
- 3,679,248. **WIN-GIB 8-TRACK REVITALIZERS (BLOCK FORM)**. GIBSON, KATHERINE D., DBA KATE'S TRACK SHACK, (U.S. CLS. 21, 23, 26, 36 AND 38). SN 77-672,054. PUB. 6-23-2009. FILED 2-17-2009.
- 3,679,257. **N-XENDIO (BLOCK FORM)**. NOVA, MIGUEL ANGEL, (U.S. CLS. 21, 23, 26, 36 AND 38). SN 77-672,302. PUB. 6-23-2009. FILED 2-17-2009.
- 3,679,261. **THUNDERCAST (BLOCK FORM)**. MITEK CORPORATION, (U.S. CLS. 21, 23, 26, 36 AND 38). SN 77-672,634. PUB. 6-23-2009. FILED 2-18-2009.
- 3,679,282. **DYMOND D47 (BLOCK FORM)**. DYMOND MODELSPORT USA, LTD, (U.S. CLS. 21, 23, 26, 36 AND 38). SN 77-673,355. PUB. 6-23-2009. FILED 2-18-2009.
- 3,679,292. **AZOD & BLUE PRESENTS (BLOCK FORM)**. KURTZ, NICOLE, AND LUNNINGHAM, ALEXIA, (U.S. CLS. 21, 23, 26, 36 AND 38). SN 77-673,665. PUB. 6-23-2009. FILED 2-19-2009.
- 3,679,345. **GET AWARE (BLOCK FORM)**. ALLIANCE ENTERPRISES, INC., MULTIPLE CLASS, (INT. CLS. 9 AND 42), (U.S. CLS. 21, 23, 26, 36, 38, 100 AND 101). SN 77-675,226. PUB. 6-23-2009. FILED 2-20-2009.
- 3,679,350. **THE THINKET (BLOCK FORM)**. WEINSTOCK, DAVID M., (U.S. CLS. 21, 23, 26, 36 AND 38). SN 77-675,352. PUB. 6-23-2009. FILED 2-21-2009.
- 3,679,380. **QP AND DESIGN**. POOL, MARK D., (U.S. CLS. 21, 23, 26, 36 AND 38). SN 77-675,888. PUB. 6-23-2009. FILED 2-23-2009.
- 3,679,389. **BLUEMAGNET (BLOCK FORM)**. JARAD, BASSAM ALI MOHAMMAD, (U.S. CLS. 21, 23, 26, 36 AND 38). SN 77-676,089. PUB. 6-23-2009. FILED 2-23-2009.
- 3,679,393. **PHOENIXR/C (BLOCK FORM)**. RUNTIME GAMES LIMITED, MULTIPLE CLASS, (INT. CLS. 9 AND 28), (U.S. CLS. 21, 22, 23, 26, 36, 38 AND 50). SN 77-676,175. PUB. 6-23-2009. FILED 2-23-2009.
- 3,679,419. **2 AM CLUB (BLOCK FORM)**. 2 AM CLUB RECORDING, LLC, MULTIPLE CLASS, (INT. CLS. 9 AND 41), (U.S. CLS. 21, 23, 26, 36, 38, 100, 101 AND 107). SN 77-676,647. PUB. 6-23-2009. FILED 2-24-2009.
- 3,679,421. **1ST AND 10 (BLOCK FORM)**. LUMA ARCADE, (U.S. CLS. 21, 23, 26, 36 AND 38). SN 77-676,664. PUB. 6-23-2009. FILED 2-24-2009.
- 3,679,422. **REV (BLOCK FORM)**. LUMA ARCADE, (U.S. CLS. 21, 23, 26, 36 AND 38). SN 77-676,667. PUB. 6-23-2009. FILED 2-24-2009.
- 3,679,423. **ISLAND HOP (BLOCK FORM)**. LUMA ARCADE, (U.S. CLS. 21, 23, 26, 36 AND 38). SN 77-676,668. PUB. 6-23-2009. FILED 2-24-2009.
- 3,679,455. **OUNCE LABS (BLOCK FORM)**. OUNCE LABS, INC., (U.S. CLS. 21, 23, 26, 36 AND 38). SN 77-677,017. PUB. 6-23-2009. FILED 2-24-2009.
- 3,679,479. **WEALTHTEC (BLOCK FORM)**. WEALTHTEC, LLC, (U.S. CLS. 21, 23, 26, 36 AND 38). SN 77-677,189. PUB. 6-23-2009. FILED 2-24-2009.
- 3,679,526. **EQUINOX (BLOCK FORM)**. CENTRAL LAKE ARMOR EXPRESS, INC., (U.S. CLS. 21, 23, 26, 36 AND 38). SN 77-677,704. PUB. 6-23-2009. FILED 2-25-2009.
- 3,679,529. **T AND DESIGN**. TIFOSI OPTICS, INC., (U.S. CLS. 21, 23, 26, 36 AND 38). SN 77-677,755. PUB. 6-23-2009. FILED 2-25-2009.
- 3,679,551. **IBONE (BLOCK FORM)**. SPOONJACK LLC, DBA SPOONJACK, (U.S. CLS. 21, 23, 26, 36 AND 38). SN 77-678,073. PUB. 6-23-2009. FILED 2-25-2009.
- 3,679,556. **THE SWITCH IS ON! (BLOCK FORM)**. ATI PROPERTIES, INC., MULTIPLE CLASS, (INT. CLS. 9 AND 16), (U.S. CLS. 2, 5, 21, 22, 23, 26, 29, 36, 37, 38 AND 50). SN 77-678,147. PUB. 6-23-2009. FILED 2-25-2009.
- 3,679,572. **CONTROLPOINT (BLOCK FORM)**. AUTONOMY CORPORATION PLC, MULTIPLE CLASS, (INT. CLS. 9 AND 45), (U.S. CLS. 21, 23, 26, 36, 38, 100 AND 101). SN 77-678,360. PUB. 6-23-2009. FILED 2-25-2009.
- 3,679,575. **COMPUSTAT POINT-IN-TIME (BLOCK FORM)**. STANDARD & POOR'S FINANCIAL SERVICES LLC,

- MULTIPLE CLASS, (INT. CLS. 9 AND 36), (U.S. CLS. 21, 23, 26, 36, 38, 100, 101 AND 102). SN 77-678,391. PUB. 6-23-2009. FILED 2-25-2009.
- 3,679,594. **MADINA LAKE (BLOCK FORM)**. LEONE, MATTHEW, (U.S. CLS. 21, 23, 26, 36 AND 38). SN 77-678,641. PUB. 6-23-2009. FILED 2-26-2009.
- 3,679,598. **GLOBAL POINT-IN-TIME (BLOCK FORM)**. STANDARD & POOR'S FINANCIAL SERVICES LLC, MULTIPLE CLASS, (INT. CLS. 9 AND 36), (U.S. CLS. 21, 23, 26, 36, 38, 100, 101 AND 102). SN 77-678,798. PUB. 6-23-2009. FILED 2-26-2009.
- 3,679,621. **FLAT FIELD (BLOCK FORM)**. RGB SYSTEMS, INCORPORATED, (U.S. CLS. 21, 23, 26, 36 AND 38). SN 77-679,163. PUB. 6-23-2009. FILED 2-26-2009.
- 3,679,647. **RUNEZE (BLOCK FORM)**. RUNEZE, (U.S. CLS. 21, 23, 26, 36 AND 38). SN 77-679,465. PUB. 6-23-2009. FILED 2-26-2009.
- 3,679,653. **OMNICOGNIC (BLOCK FORM)**. OMNICOGNIC, (U.S. CLS. 21, 23, 26, 36 AND 38). SN 77-679,590. PUB. 6-23-2009. FILED 2-27-2009.
- 3,679,655. **FUSEAL (BLOCK FORM)**. GEORGE FISCHER SLOANE, INC., (U.S. CLS. 21, 23, 26, 36 AND 38). SN 77-679,607. PUB. 6-23-2009. FILED 2-27-2009.
- 3,679,671. **MICHAEL RYEN (BLOCK FORM)**. EUROPA EYE WEAR CORP., DBA EUROPA INTERNATIONAL, (U.S. CLS. 21, 23, 26, 36 AND 38). SN 77-680,020. PUB. 6-23-2009. FILED 2-27-2009.
- 3,679,690. **SIMPLIFY STABILITY (BLOCK FORM)**. TRICERAT, INC., (U.S. CLS. 21, 23, 26, 36 AND 38). SN 77-680,356. PUB. 6-23-2009. FILED 2-27-2009.
- 3,679,705. **AUTONOMY CONTROLPOINT (BLOCK FORM)**. AUTONOMY CORPORATION PLC, MULTIPLE CLASS, (INT. CLS. 9 AND 45), (U.S. CLS. 21, 23, 26, 36, 38, 100 AND 101). SN 77-680,620. PUB. 6-23-2009. FILED 2-27-2009.
- 3,679,712. **SLIMTRAK (BLOCK FORM)**. VENTURE RESEARCH INC., (U.S. CLS. 21, 23, 26, 36 AND 38). SN 77-680,718. PUB. 6-23-2009. FILED 2-28-2009.
- 3,679,717. **REDEUX (BLOCK FORM)**. EUROPA EYE WEAR CORP., DBA EUROPA INTERNATIONAL, (U.S. CLS. 21, 23, 26, 36 AND 38). SN 77-680,991. PUB. 6-23-2009. FILED 3-1-2009.
- 3,679,728. **GUNSMOKE (BLOCK FORM)**. CBS BROADCASTING INC., (U.S. CLS. 21, 23, 26, 36 AND 38). SN 77-683,993. PUB. 6-23-2009. FILED 3-5-2009.
- 3,679,730. **CHUCK NORRIS (BLOCK FORM)**. NORRIS, CARLOS RAY, AKA CHUCK NORRIS, (U.S. CLS. 21, 23, 26, 36 AND 38). SN 77-685,121. PUB. 6-23-2009. FILED 3-6-2009.
- 3,679,761. **SAFLOK AND DESIGN**. COMPUTERIZED SECURITY SYSTEMS, INC., (U.S. CLS. 21, 23, 26, 36 AND 38). SN 77-697,840. PUB. 6-23-2009. FILED 3-24-2009.
- 3,679,767. **SECRET AGENT CLANK (BLOCK FORM)**. SONY COMPUTER ENTERTAINMENT AMERICA INC., (U.S. CLS. 21, 23, 26, 36 AND 38). SN 77-701,471. PUB. 6-23-2009. FILED 3-27-2009.
- 3,679,784. **MOXIE (BLOCK FORM)**. CORNUCOPIA BEVERAGES, INC., (U.S. CLS. 21, 23, 26, 36 AND 38). SN 77-713,246. PUB. 6-23-2009. FILED 4-14-2009.
- 3,679,793. **FIXEDGE AND DESIGN**. EPAM SYSTEMS, INC., (U.S. CLS. 21, 23, 26, 36 AND 38). SN 77-977,561. PUB. 7-22-2008. FILED 1-28-2008.
- 3,679,794. **FIX ANTENNA AND DESIGN**. EPAM SYSTEMS, INC., (U.S. CLS. 21, 23, 26, 36 AND 38). SN 77-977,562. PUB. 7-29-2008. FILED 1-28-2008.
- 3,679,795. **FIXEDGE (BLOCK FORM)**. EPAM SYSTEMS, INC., (U.S. CLS. 21, 23, 26, 36 AND 38). SN 77-977,585. PUB. 7-22-2008. FILED 1-23-2008.
- 3,679,804. **FILM FABRIC (BLOCK FORM)**. JAZZ INFORMATION TECHNOLOGY LIMITED T/A FILMIT, MULTIPLE CLASS, (INT. CLS. 9, 16, 35 AND 42), (U.S. CLS. 2, 5, 21, 22, 23, 26, 29, 36, 37, 38, 50, 100, 101 AND 102). SN 78-467,144. PUB. 3-31-2009. FILED 8-13-2004.
- 3,679,806 (*See Class 4 for this trademark*).
- 3,679,828. **MISCELLANEOUS DESIGN**. VOX R&D LIMITED, (U.S. CLS. 21, 23, 26, 36 AND 38). SN 78-807,649. PUB. 9-25-2007. FILED 2-6-2006.
- 3,679,838 (*See Class 1 for this trademark*).
- 3,679,843. **THE WORLD JUST CHANGED (BLOCK FORM)**. SIMON R. DANIEL, MULTIPLE CLASS, (INT. CLS. 9 AND 42), (U.S. CLS. 21, 23, 26, 36, 38, 100 AND 101). SN 78-883,744. PUB. 6-23-2009. FILED 5-15-2006.
- 3,679,844. **MOBYKO (BLOCK FORM)**. MOBYKO LIMITED, MULTIPLE CLASS, (INT. CLS. 9, 35, 38 AND 42), (U.S. CLS. 21, 23, 26, 36, 38, 100, 101, 102 AND 104). SN 78-894,558. PUB. 4-21-2009. FILED 5-26-2006.
- 3,679,845. **HEELYS (BLOCK FORM)**. HEELING SPORTS LIMITED, MULTIPLE CLASS, (INT. CLS. 9, 25 AND 28), (U.S. CLS. 21, 22, 23, 26, 36, 38, 39 AND 50). SN 78-901,166. PUB. 3-17-2009. FILED 6-5-2006.
- 3,679,846. **JERICHO (BLOCK FORM)**. THE CODEMASTERS SOFTWARE COMPANY LIMITED, MULTIPLE CLASS, (INT. CLS. 9, 28 AND 41), (U.S. CLS. 21, 22, 23, 26, 36, 38, 50, 100, 101 AND 107). SN 78-915,515. PUB. 6-23-2009. FILED 6-23-2006.
- 3,679,850. **GOIN' COASTAL (BLOCK FORM)**. ILLUSTRATED ESCAPES, INC., MULTIPLE CLASS, (INT. CLS. 9, 20 AND 25), (U.S. CLS. 2, 13, 21, 22, 23, 25, 26, 32, 36, 38, 39 AND 50). SN 78-969,197. PUB. 6-23-2009. FILED 9-7-2006.
- 3,679,851. **EPAGE (STYLIZED)**. PICSEL (RESEARCH) LIMITED, MULTIPLE CLASS, (INT. CLS. 9 AND 42), (U.S. CLS. 21, 23, 26, 36, 38, 100 AND 101). SN 79-006,826. PUB. 7-4-2006. FILED 8-12-2004.
- 3,679,854. **TOURING SUPERLEGGERA (STYLIZED)**. MÜLLER, WOLF-RÜDLGER, AND KUTSCHER, AXEL, MULTIPLE CLASS, (INT. CLS. 9, 12, 28 AND 42), (U.S. CLS. 19, 21, 22, 23, 26, 31, 35, 36, 38, 44, 50, 100 AND 101). SN 79-017,592. PUB. 6-23-2009. FILED 1-26-2005.
- 3,679,855 (*See Class 1 for this trademark*).
- 3,679,858. **TRIBALFOOTBALL.COM AND DESIGN**. TRIBALFOOTBALL.COM PTY LTD, MULTIPLE CLASS, (INT. CLS. 9, 16, 25, 28, 35, 38 AND 41), (U.S. CLS. 2, 5, 21, 22, 23, 26, 29, 36, 37, 38, 39, 50, 100, 101, 102, 104 AND 107). SN 79-035,375. PUB. 9-9-2008. FILED 7-24-2006.
- 3,679,859 (*See Class 1 for this trademark*).
- 3,679,863. **AGORALIVE (BLOCK FORM)**. WORLD EVENT MANAGEMENT LIMITED, MULTIPLE CLASS, (INT. CLS. 9 AND 41), (U.S. CLS. 21, 23, 26, 36, 38, 100, 101 AND 107). SN 79-044,222. PUB. 6-23-2009. FILED 1-25-2007.
- 3,679,866 (*See Class 7 for this trademark*).
- 3,679,868 (*See Class 6 for this trademark*).
- 3,679,872 (*See Class 5 for this trademark*).
- 3,679,874. **TRACFEED (BLOCK FORM)**. BALFOUR BEATTY PLC, (U.S. CLS. 21, 23, 26, 36 AND 38). SN 79-049,228. PUB. 6-23-2009. FILED 12-13-2007.
- 3,679,877 (*See Class 6 for this trademark*).
- 3,679,882. **AUDINATE (BLOCK FORM)**. AUDINATE PTY LTD, MULTIPLE CLASS, (INT. CLS. 9, 38 AND 42), (U.S. CLS. 21, 23, 26, 36, 38, 100, 101 AND 104). SN 79-051,303. PUB. 6-23-2009. FILED 1-18-2008.
- 3,679,883. **EFS (BLOCK FORM)**. GLOBALPARK AG, MULTIPLE CLASS, (INT. CLS. 9, 35 AND 42), (U.S. CLS. 21, 23, 26, 36, 38, 100, 101 AND 102). SN 79-051,469. PUB. 6-23-2009. FILED 1-23-2008.
- 3,679,884. **MISCELLANEOUS DESIGN**. NAVIGON AG, MULTIPLE CLASS, (INT. CLS. 9, 12, 35, 38, 39 AND 42), (U.S. CLS. 19, 21, 23, 26, 31, 35, 36, 38, 44, 100, 101, 102, 104 AND 105). SN 79-051,602. PUB. 3-17-2009. FILED 9-19-2007.
- 3,679,886. **EMAIL ATTITUDE (BLOCK FORM)**. 1000MERCIS, MULTIPLE CLASS, (INT. CLS. 9, 35, 38, 41 AND 42), (U.S. CLS. 21, 23, 26, 36, 38, 100, 101, 102, 104 AND 107). SN 79-052,803. PUB. 6-23-2009. FILED 4-10-2008.
- 3,679,889 (*See Class 6 for this trademark*).
- 3,679,894. **ZERO OHM LINK AND DESIGN**. INTERNATIONAL AUDIO HOLDING B.V., (U.S. CLS. 21, 23, 26, 36 AND 38). SN 79-055,037. PUB. 6-23-2009. FILED 4-11-2008.
- 3,679,900 (*See Class 6 for this trademark*).
- 3,679,908. **SECUSHOW (BLOCK FORM)**. SECUSTREAM TECHNOLOGIES AS, MULTIPLE CLASS, (INT. CLS. 9, 38 AND 42), (U.S. CLS. 21, 23, 26, 36, 38, 100, 101 AND 104). SN 79-056,894. PUB. 6-23-2009. FILED 3-26-2008.
- 3,679,911. **LIVING UP TO LIFE (BLOCK FORM)**. LEICA MICROSYSTEMS HOLDINGS GMBH, (U.S. CLS. 21, 23, 26, 36 AND 38). SN 79-057,030. PUB. 6-23-2009. FILED 12-20-2007.
- 3,679,915. **SCREENLIGHT (BLOCK FORM)**. RAPHAEL H.J. SEILER, MULTIPLE CLASS, (INT. CLS. 9, 35, 38 AND 42), (U.S. CLS. 21, 23, 26, 36, 38, 100, 101, 102 AND 104). SN 79-

- 057,487. PUB. 6-23-2009. FILED 7-1-2008.
 3,679,919. **MACNAUGHT (BLOCK FORM)**. MACNAUGHT PTY LIMITED, (U.S. CLS. 21, 23, 26, 36 AND 38). SN 79-057,701. PUB. 6-23-2009. FILED 6-27-2008.
 3,679,922 (*See Class 5 for this trademark*).
 3,679,930 (*See Class 7 for this trademark*).
 3,679,934. **NETVU OBSERVER (BLOCK FORM)**. ANGLO DESIGN HOLDINGS PLC, (U.S. CLS. 21, 23, 26, 36 AND 38). SN 79-058,881. PUB. 6-23-2009. FILED 9-5-2008.
 3,679,935 (*See Class 5 for this trademark*).
 3,679,937. **EVS (BLOCK FORM)**. WERMA HOLDING GMBH + CO. KG, (U.S. CLS. 21, 23, 26, 36 AND 38). SN 79-058,947. PUB. 6-23-2009. FILED 8-11-2008.
 3,679,938 (*See Class 8 for this trademark*).
 3,679,945 (*See Class 1 for this trademark*).
 3,679,947. **EUROTECH (BLOCK FORM)**. EUROTECH S.P.A., MULTIPLE CLASS, (INT. CLS. 9, 14 AND 25), (U.S. CLS. 2, 21, 22, 23, 26, 27, 28, 36, 38, 39 AND 50). SN 79-059,327. PUB. 6-23-2009. FILED 1-31-2008.
 3,679,962. **MR BINGO (BLOCK FORM)**. GREENLIGHT LIMITED, MULTIPLE CLASS, (INT. CLS. 9, 38 AND 41), (U.S. CLS. 21, 23, 26, 36, 38, 100, 101, 104 AND 107). SN 79-059,837. PUB. 6-23-2009. FILED 8-22-2008.
 3,679,965. **ADVITO (STYLIZED)**. BCD TRAVEL GERMANY HOLDING GMBH, MULTIPLE CLASS, (INT. CLS. 9, 16, 35, 36, 38, 39, 41, 42 AND 43), (U.S. CLS. 2, 5, 21, 22, 23, 26, 29, 36, 37, 38, 50, 100, 101, 102, 104, 105 AND 107). SN 79-059,935. PUB. 6-23-2009. FILED 10-22-2007.
 3,679,970 (*See Class 6 for this trademark*).
 3,679,980. **HIPPO (BLOCK FORM)**. HIPPO B.V., MULTIPLE CLASS, (INT. CLS. 9 AND 42), (U.S. CLS. 21, 23, 26, 36, 38, 100 AND 101). SN 79-060,536. PUB. 6-23-2009. FILED 9-10-2008.
 3,679,983. **HIPPO AND DESIGN**. HIPPO B.V., MULTIPLE CLASS, (INT. CLS. 9 AND 42), (U.S. CLS. 21, 23, 26, 36, 38, 100 AND 101). SN 79-060,764. PUB. 6-23-2009. FILED 9-10-2008.
 3,679,984. **METREC (BLOCK FORM)**. TECSIS GMBH, (U.S. CLS. 21, 23, 26, 36 AND 38). SN 79-060,813. PUB. 6-23-2009. FILED 8-22-2008.
 3,679,989 (*See Class 7 for this trademark*).
 3,679,993. **SEATALK NG (STYLIZED)**. RAYMARINE UK LIMITED, (U.S. CLS. 21, 23, 26, 36 AND 38). SN 79-061,324. PUB. 6-23-2009. FILED 7-18-2008.
 3,679,994. **ATLASSIAN CLOVER (STYLIZED)**. ATLASSIAN PTY LTD, MULTIPLE CLASS, (INT. CLS. 9, 38 AND 42), (U.S. CLS. 21, 23, 26, 36, 38, 100, 101 AND 104). SN 79-061,338. PUB. 6-23-2009. FILED 8-12-2008.
 3,679,995. **ATLASSIAN CROWD (STYLIZED)**. ATLASSIAN PTY LTD, MULTIPLE CLASS, (INT. CLS. 9, 38 AND 42), (U.S. CLS. 21, 23, 26, 36, 38, 100, 101 AND 104). SN 79-061,339. PUB. 6-23-2009. FILED 8-12-2008.
 3,680,011. **TRIWATCHER (BLOCK FORM)**. ATSUMI ELECTRIC CO., LTD., (U.S. CLS. 21, 23, 26, 36 AND 38). SN 79-063,005. PUB. 6-23-2009. FILED 11-13-2008.
 3,680,016 (*See Class 6 for this trademark*).
 3,680,023. **STEINBERG (BLOCK FORM)**. STEINBERG MEDIA TECHNOLOGIES GMBH, MULTIPLE CLASS, (INT. CLS. 9 AND 42), (U.S. CLS. 21, 23, 26, 36, 38, 100 AND 101). SN 79-063,575. PUB. 6-23-2009. FILED 9-6-2008.
 3,680,027. **NAIM POWERLINE (BLOCK FORM)**. NAIM AUDIO LIMITED, (U.S. CLS. 21, 23, 26, 36 AND 38). SN 79-063,851. PUB. 6-23-2009. FILED 8-6-2008.
 3,680,029 (*See Class 7 for this trademark*).
 3,680,033. **MD MOMARK AND DESIGN**. PARSEK S.R.L., (U.S. CLS. 21, 23, 26, 36 AND 38). SN 79-064,403. PUB. 6-23-2009. FILED 9-23-2008.
 3,680,039. **MOBILE AND DESIGN**. OMRON CORPORATION, (U.S. CLS. 21, 23, 26, 36 AND 38). SN 79-065,416. PUB. 6-23-2009. FILED 12-15-2008.
 3,680,049. **PENETRATOR (BLOCK FORM)**. STEINER-OPTIK GMBH, (U.S. CLS. 21, 23, 26, 36 AND 38). SN 79-066,985. PUB. 6-23-2009. FILED 2-17-2009.
 3,680,051. **RED POINT (BLOCK FORM)**. LUXOTTICA GROUP S.P.A., (U.S. CLS. 21, 23, 26, 36 AND 38). SN 79-067,675. PUB. 6-23-2009. FILED 2-13-2009.
 3,680,052. **BELAY (BLOCK FORM)**. LUXOTTICA GROUP S.P.A., (U.S. CLS. 21, 23, 26, 36 AND 38). SN 79-067,676. PUB. 6-23-2009. FILED 2-13-2009.
 3,680,053. **HIGHSIDE (BLOCK FORM)**. LUXOTTICA GROUP S.P.A., (U.S. CLS. 21, 23, 26, 36 AND 38). SN 79-067,692. PUB. 6-23-2009. FILED 2-13-2009.
 3,680,055. **PLOT (BLOCK FORM)**. LUXOTTICA GROUP S.P.A., (U.S. CLS. 21, 23, 26, 36 AND 38). SN 79-067,716. PUB. 6-23-2009. FILED 2-13-2009.
 3,680,056. **POLARIZE YOUR LIFE (BLOCK FORM)**. LUXOTTICA GROUP S.P.A., (U.S. CLS. 21, 23, 26, 36 AND 38). SN 79-067,717. PUB. 6-23-2009. FILED 2-13-2009.
 3,680,057. **HEADWALL (BLOCK FORM)**. LUXOTTICA GROUP S.P.A., (U.S. CLS. 21, 23, 26, 36 AND 38). SN 79-067,718. PUB. 6-23-2009. FILED 2-13-2009.
 3,680,058. **LOOK DEEPER (BLOCK FORM)**. LUXOTTICA GROUP S.P.A., (U.S. CLS. 21, 23, 26, 36 AND 38). SN 79-067,720. PUB. 6-23-2009. FILED 2-13-2009.
 3,680,059. **THRIVE (BLOCK FORM)**. LUXOTTICA GROUP S.P.A., (U.S. CLS. 21, 23, 26, 36 AND 38). SN 79-067,723. PUB. 6-23-2009. FILED 2-13-2009.
 3,680,060. **EFFLUX (BLOCK FORM)**. LUXOTTICA GROUP S.P.A., (U.S. CLS. 21, 23, 26, 36 AND 38). SN 79-067,726. PUB. 6-23-2009. FILED 2-13-2009.
 3,680,061. **THE BIG ROLL IN PARADISE (STYLIZED)**. NOKIA CORPORATION, MULTIPLE CLASS, (INT. CLS. 9, 38 AND 41), (U.S. CLS. 21, 23, 26, 36, 38, 100, 101, 104 AND 107). SN 79-067,737. PUB. 6-23-2009. FILED 2-27-2009.
-
- CLASS 10—MEDICAL APPARATUS**
- 3,678,177. **ACUSTIMULATOR DR. RICHARD S. BIEN AND DESIGN**. BIEN, RICHARD S., (U.S. CLS. 26, 39 AND 44). SN 76-692,279. PUB. 6-23-2009. FILED 8-21-2008.
 3,678,241 (*See Class 9 for this trademark*).
 3,678,262. **ZEPHYR (BLOCK FORM)**. ZEPHYR TECHNOLOGY LIMITED, (U.S. CLS. 26, 39 AND 44). SN 77-245,439. PUB. 4-7-2009. FILED 8-2-2007.
 3,678,263. **BIOHARNESS (BLOCK FORM)**. ZEPHYR TECHNOLOGY LIMITED, (U.S. CLS. 26, 39 AND 44). SN 77-245,540. PUB. 4-7-2009. FILED 8-2-2007.
 3,678,273. **PENUMBRA P AND DESIGN**. PENUMBRA, INC., (U.S. CLS. 26, 39 AND 44). SN 77-284,023. PUB. 6-23-2009. FILED 9-19-2007.
 3,678,296 (*See Class 9 for this trademark*).
 3,678,447. **D.U.I. ALERT (BLOCK FORM)**. DAVID PUTTERMAN, (U.S. CLS. 26, 39 AND 44). SN 77-484,079. PUB. 6-23-2009. FILED 5-27-2008.
 3,678,458 (*See Class 1 for this trademark*).
 3,678,459. **ZOLL (BLOCK FORM)**. ZOLL MEDICAL CORPORATION, (U.S. CLS. 26, 39 AND 44). SN 77-493,905. PUB. 6-23-2009. FILED 6-9-2008.
 3,678,530. **REBIDOSE (BLOCK FORM)**. ARES TRADING S.A., (U.S. CLS. 26, 39 AND 44). SN 77-524,755. PUB. 6-23-2009. FILED 7-17-2008.
 3,678,538. **K KANEKA MEDICAL PRODUCTS AND DESIGN**. KANEKA CORPORATION, (U.S. CLS. 26, 39 AND 44). SN 77-527,048. PUB. 6-23-2009. FILED 7-21-2008.
 3,678,773. **VMS (BLOCK FORM)**. MIDMARK CORPORATION, (U.S. CLS. 26, 39 AND 44). SN 77-569,861. PUB. 6-23-2009. FILED 9-15-2008.
 3,678,828. **FLEXI-T (BLOCK FORM)**. PROSAN INTERNATIONAL B.V., (U.S. CLS. 26, 39 AND 44). SN 77-584,000. PUB. 6-23-2009. FILED 10-2-2008.
 3,678,842. **THF (BLOCK FORM)**. FISHER AND PAYKEL HEALTHCARE LIMITED, (U.S. CLS. 26, 39 AND 44). SN 77-588,034. PUB. 6-23-2009. FILED 10-8-2008.
 3,678,863. **CHILLY-BILLY (BLOCK FORM)**. RIGHT DOWN BROADWAY, LLC, (U.S. CLS. 26, 39 AND 44). SN 77-594,403. PUB. 6-23-2009. FILED 10-16-2008.
 3,678,931. **BABY-RX AND DESIGN**. TERUMO KABUSHIKI KAISHA, AKA TERUMO CORPORATION, (U.S. CLS. 26, 39 AND 44). SN 77-615,992. PUB. 6-23-2009. FILED 11-17-2008.
 3,678,945. **VRIVX (BLOCK FORM)**. DEEPBREEZE LTD., (U.S. CLS. 26, 39 AND 44). SN 77-619,464. PUB. 6-23-2009. FILED 11-21-2008.
 3,678,946. **VRIVX (STYLIZED)**. DEEPBREEZE LTD., (U.S.

- CLS. 26, 39 AND 44). SN 77-619,468. PUB. 6-23-2009. FILED 11-21-2008.
- 3,678,988. **MR4 (BLOCK FORM)**. MEDICAL QUANT USA, INC., DBA MULTI RADIANCE MEDICAL, (U.S. CLS. 26, 39 AND 44). SN 77-630,406. PUB. 6-23-2009. FILED 12-10-2008.
- 3,678,999. **HOYA CONBIO (BLOCK FORM)**. HOYA PHOTO-NICS, INC., (U.S. CLS. 26, 39 AND 44). SN 77-633,027. PUB. 6-23-2009. FILED 12-15-2008.
- 3,679,063. **MISCELLANEOUS DESIGN**. FRESENIUS MEDICAL CARE DEUTSCHLAND GMBH, MULTIPLE CLASS, (INT. CLS. 10 AND 44), (U.S. CLS. 26, 39, 44, 100 AND 101). SN 77-650,020. PUB. 6-23-2009. FILED 1-15-2009.
- 3,679,158. **ACTIVEO REVOLUTIONIZING BACK CARE (BLOCK FORM)**. ACTIVEO, LLC, (U.S. CLS. 26, 39 AND 44). SN 77-665,566. PUB. 6-23-2009. FILED 2-6-2009.
- 3,679,188. **SNAP! DENTURE (BLOCK FORM)**. LYONS, JOHN, (U.S. CLS. 26, 39 AND 44). SN 77-668,088. PUB. 6-23-2009. FILED 2-11-2009.
- 3,679,318. **VERSASCOOP (BLOCK FORM)**. BIONIX DEVELOPMENT CORPORATION, (U.S. CLS. 26, 39 AND 44). SN 77-674,443. PUB. 6-23-2009. FILED 2-20-2009.
- 3,679,488 (*See Class 3 for this trademark*).
- 3,679,539. **ATTUNE (BLOCK FORM)**. ST. JUDE MEDICAL, CARDIOLOGY DIVISION, INC., DBA ST. JUDE MEDICAL, CARDIOVASCULAR DIVISION, (U.S. CLS. 26, 39 AND 44). SN 77-677,906. PUB. 6-23-2009. FILED 2-25-2009.
- 3,679,698. **SEALGUARD (BLOCK FORM)**. NELLCOR PURITAN BENNETT LLC, (U.S. CLS. 26, 39 AND 44). SN 77-680,508. PUB. 6-23-2009. FILED 2-27-2009.
- 3,679,699. **SEALGUARD EVAC (BLOCK FORM)**. NELLCOR PURITAN BENNETT LLC, (U.S. CLS. 26, 39 AND 44). SN 77-680,510. PUB. 6-23-2009. FILED 2-27-2009.
- 3,679,738. **FREEZE THE DISEASE. FREE THE PATIENT. HOW COOL IS THAT? (BLOCK FORM)**. RESET MEDICAL, INC., (U.S. CLS. 26, 39 AND 44). SN 77-688,380. PUB. 6-23-2009. FILED 3-11-2009.
- 3,679,769. **VETX (BLOCK FORM)**. MARK L. ANDERSON, (U.S. CLS. 26, 39 AND 44). SN 77-702,187. PUB. 6-23-2009. FILED 3-30-2009.
- 3,679,809. **ACCU-READ (BLOCK FORM)**. REPROCESSING PRODUCTS CORPORATION (RPC), (U.S. CLS. 26, 39 AND 44). SN 78-564,329. PUB. 6-23-2009. FILED 2-10-2005.
- 3,679,831. **VULCAN METALS & PRODUCTS AND DESIGN**. PROTEK-INTL LTD, (U.S. CLS. 26, 39 AND 44). SN 78-816,944. PUB. 12-18-2007. FILED 2-16-2006.
- 3,679,872 (*See Class 5 for this trademark*).
- 3,679,924. **BARRIER (BLOCK FORM)**. MÖLNLYCKE HEALTH CARE AB, (U.S. CLS. 26, 39 AND 44). SN 79-058,488. PUB. 6-23-2009. FILED 8-13-2008.
- 3,679,929 (*See Class 3 for this trademark*).
- 3,679,933. **DOT BY RESOUND (BLOCK FORM)**. GN RESOUND A/S, (U.S. CLS. 26, 39 AND 44). SN 79-058,680. PUB. 6-23-2009. FILED 7-12-2008.
- 3,679,935 (*See Class 5 for this trademark*).
- 3,679,940 (*See Class 5 for this trademark*).
- 3,679,987. **IMPIX-MANTA (BLOCK FORM)**. MEDICREA INTERNATIONAL, (U.S. CLS. 26, 39 AND 44). SN 79-060,938. PUB. 6-23-2009. FILED 10-10-2008.
- 3,680,022. **ARTHMED (BLOCK FORM)**. VOMED VOLZER MEDIZINTECHNIK; GMBH & CO. KG, (U.S. CLS. 26, 39 AND 44). SN 79-063,443. PUB. 6-23-2009. FILED 11-19-2008.
- 3,678,295 (*See Class 1 for this trademark*).
- 3,678,301. **SOLZAM (BLOCK FORM)**. CERAGEM CO, LTD., MULTIPLE CLASS, (INT. CLS. 11 AND 27), (U.S. CLS. 13, 19, 20, 21, 23, 31, 34, 37, 42 AND 50). SN 77-324,195. PUB. 6-23-2009. FILED 11-7-2007.
- 3,678,371. **UNIDRAIN (BLOCK FORM)**. UNIDRAIN A/S, MULTIPLE CLASS, (INT. CLS. 11 AND 37), (U.S. CLS. 13, 21, 23, 31, 34, 100, 103 AND 106). SN 77-407,452. PUB. 10-14-2008. FILED 2-27-2008.
- 3,678,385. **SASAKURA (BLOCK FORM)**. SASAKURA ENGINEERING CO., LTD., (U.S. CLS. 13, 21, 23, 31 AND 34). SN 77-420,898. PUB. 6-23-2009. FILED 3-13-2008.
- 3,678,405. **PEEK & VIEW AND DESIGN**. KENWOOD APPLIANCES LUXEMBOURG SA, (U.S. CLS. 13, 21, 23, 31 AND 34). SN 77-440,284. PUB. 6-23-2009. FILED 4-4-2008.
- 3,678,409. **CLUB TOASTER (BLOCK FORM)**. TINBONE LTD, (U.S. CLS. 13, 21, 23, 31 AND 34). SN 77-443,594. PUB. 6-23-2009. FILED 4-9-2008.
- 3,678,411. **TINBONE (BLOCK FORM)**. TINBONE LTD, (U.S. CLS. 13, 21, 23, 31 AND 34). SN 77-444,014. PUB. 6-23-2009. FILED 4-9-2008.
- 3,678,524. **INFINITI HAIR DESIGNER PRO BY CONAIR (BLOCK FORM)**. CONAIR CORPORATION, (U.S. CLS. 13, 21, 23, 31 AND 34). SN 77-523,664. PUB. 11-25-2008. FILED 7-16-2008.
- 3,678,574. **TUCSON GRILL (BLOCK FORM)**. VICTORY INTERNATIONAL GROUP, INC., (U.S. CLS. 13, 21, 23, 31 AND 34). SN 77-531,272. PUB. 6-23-2009. FILED 7-25-2008.
- 3,678,584. **SOLARKING AND DESIGN**. SOLARKING, INC., (U.S. CLS. 13, 21, 23, 31 AND 34). SN 77-534,216. PUB. 6-23-2009. FILED 7-29-2008.
- 3,678,606. **MISCELLANEOUS DESIGN**. TROY FILTERS, LTD., (U.S. CLS. 13, 21, 23, 31 AND 34). SN 77-536,739. PUB. 6-23-2009. FILED 8-1-2008.
- 3,678,631 (*See Class 6 for this trademark*).
- 3,678,652. **CIRCADIAN (BLOCK FORM)**. COOPER TECHNOLOGIES COMPANY, (U.S. CLS. 13, 21, 23, 31 AND 34). SN 77-540,676. PUB. 6-23-2009. FILED 8-6-2008.
- 3,678,655. **LED RETRO 8 (BLOCK FORM)**. GLOBAL MARKETING LIGHTING, LLC, (U.S. CLS. 13, 21, 23, 31 AND 34). SN 77-541,041. PUB. 6-23-2009. FILED 8-6-2008.
- 3,678,720 (*See Class 7 for this trademark*).
- 3,678,745. **GRAFF (BLOCK FORM)**. GRAFF FAUCETS, (U.S. CLS. 13, 21, 23, 31 AND 34). SN 77-560,365. PUB. 6-23-2009. FILED 9-2-2008.
- 3,678,759 (*See Class 8 for this trademark*).
- 3,678,821. **ANRS (BLOCK FORM)**. BSH BOSCH UND SIEMENS HAUSGERAETE GMBH, (U.S. CLS. 13, 21, 23, 31 AND 34). SN 77-583,033. PUB. 6-23-2009. FILED 10-1-2008.
- 3,678,822. **NRS (BLOCK FORM)**. BSH BOSCH UND SIEMENS HAUSGERAETE GMBH, (U.S. CLS. 13, 21, 23, 31 AND 34). SN 77-583,072. PUB. 6-23-2009. FILED 10-1-2008.
- 3,678,823. **CLASSPRESSO (BLOCK FORM)**. BSH BOSCH UND SIEMENS HAUSGERAETE GMBH, (U.S. CLS. 13, 21, 23, 31 AND 34). SN 77-583,091. PUB. 6-23-2009. FILED 10-1-2008.
- 3,678,834. **AERIX (BLOCK FORM)**. BRADLEY FIXTURES CORPORATION, (U.S. CLS. 13, 21, 23, 31 AND 34). SN 77-585,137. PUB. 6-23-2009. FILED 10-3-2008.
- 3,678,837. **AROMA PRESSURE SYSTEM AND DESIGN**. BSH BOSCH UND SIEMENS HAUSGERAETE GMBH, (U.S. CLS. 13, 21, 23, 31 AND 34). SN 77-585,974. PUB. 6-23-2009. FILED 10-6-2008.
- 3,678,840 (*See Class 6 for this trademark*).
- 3,678,893. **PETROTRACE (BLOCK FORM)**. TYCO THERMAL CONTROLS LLC, (U.S. CLS. 13, 21, 23, 31 AND 34). SN 77-601,768. PUB. 6-23-2009. FILED 10-28-2008.
- 3,678,910. **MODERN VESSEL AND DESIGN**. DUNNELL, JEFF, (U.S. CLS. 13, 21, 23, 31 AND 34). SN 77-607,846. PUB. 6-23-2009. FILED 11-5-2008.
- 3,678,933. **GOURMETIER KINGSTON CREATION AND DESIGN**. KINGSTON BRASS INC., (U.S. CLS. 13, 21, 23, 31 AND 34). SN 77-616,160. PUB. 6-23-2009. FILED 11-17-2008.
- 3,678,934. **TAPGUARD (BLOCK FORM)**. GUYOT DESIGNS, LLC, (U.S. CLS. 13, 21, 23, 31 AND 34). SN 77-616,738. PUB. 6-23-2009. FILED 11-18-2008.
- 3,678,947. **BATH SCAPE BT AND DESIGN**. KINGSTON BRASS INC., (U.S. CLS. 13, 21, 23, 31 AND 34). SN 77-

CLASS 11—ENVIRONMENTAL CONTROL APPARATUS

- 3,678,169. **SPARKLE (BLOCK FORM)**. SPINTEK FILTRATION, INC., (U.S. CLS. 13, 21, 23, 31 AND 34). SN 76-691,469. PUB. 6-23-2009. FILED 7-22-2008.
- 3,678,179. **SIRS-E (BLOCK FORM)**. SIRS ELECTRONICS INC, (U.S. CLS. 13, 21, 23, 31 AND 34). SN 76-692,569. PUB. 6-23-2009. FILED 9-4-2008.
- 3,678,228. **ISHOWER (BLOCK FORM)**. CHRISTO LEFROY BROOKS, (U.S. CLS. 13, 21, 23, 31 AND 34). SN 77-150,830. PUB. 3-10-2009. FILED 4-6-2007.
- 3,678,280 (*See Class 6 for this trademark*).

- 619,823. PUB. 6-23-2009. FILED 11-21-2008.
- 3,678,948. **SHOWER SCAPE ST AND DESIGN**. KINGSTON BRASS INC., (U.S. CLS. 13, 21, 23, 31 AND 34). SN 77-619,829. PUB. 6-23-2009. FILED 11-21-2008.
- 3,678,968. **GOURMET SCAPE GT AND DESIGN**. KINGSTON BRASS INC., (U.S. CLS. 13, 21, 23, 31 AND 34). SN 77-625,083. PUB. 6-23-2009. FILED 12-2-2008.
- 3,679,123. **HYGREX (BLOCK FORM)**. HYGREX TECHNOLOGIES, INC., (U.S. CLS. 13, 21, 23, 31 AND 34). SN 77-659,857. PUB. 6-23-2009. FILED 1-30-2009.
- 3,679,157. **ARTECNICA (BLOCK FORM)**. ARTECNICA, INC., MULTIPLE CLASS, (INT. CLS. 11, 14, 20, 21 AND 42), (U.S. CLS. 2, 13, 21, 22, 23, 25, 27, 28, 29, 30, 31, 32, 33, 34, 40, 50, 100 AND 101). SN 77-665,419. PUB. 6-23-2009. FILED 2-6-2009.
- 3,679,237. **UZLOW (BLOCK FORM)**. JB MATSOL, LLC, (U.S. CLS. 13, 21, 23, 31 AND 34). SN 77-671,477. PUB. 6-23-2009. FILED 2-16-2009.
- 3,679,338. **MIGI (BLOCK FORM)**. MIGI LLC, MULTIPLE CLASS, (INT. CLS. 11, 21 AND 24), (U.S. CLS. 2, 13, 21, 23, 29, 30, 31, 33, 34, 40, 42 AND 50). SN 77-675,073. PUB. 6-23-2009. FILED 2-20-2009.
- 3,679,595. **EGGGENIE (STYLIZED)**. E. MISHAN & SONS, INC., MULTIPLE CLASS, (INT. CLS. 11 AND 21), (U.S. CLS. 2, 13, 21, 23, 29, 30, 31, 33, 34, 40 AND 50). SN 77-678,719. PUB. 6-23-2009. FILED 2-26-2009.
- 3,679,608. **VIGILANT (BLOCK FORM)**. MONESSEN HEARTH SYSTEMS COMPANY, (U.S. CLS. 13, 21, 23, 31 AND 34). SN 77-678,982. PUB. 6-23-2009. FILED 2-26-2009.
- 3,679,609. **BAD BOY (BLOCK FORM)**. PRODUCTION RESOURCE GROUP, L.L.C., (U.S. CLS. 13, 21, 23, 31 AND 34). SN 77-678,986. PUB. 6-23-2009. FILED 2-26-2009.
- 3,679,641. **EZGRILL AND DESIGN**. P & M PRODUCTS, LLC, (U.S. CLS. 13, 21, 23, 31 AND 34). SN 77-679,388. PUB. 6-23-2009. FILED 2-26-2009.
- 3,679,663. **STAGE LOGIC (BLOCK FORM)**. STAGE LOGIC PRODUCT GROUP, INC, (U.S. CLS. 13, 21, 23, 31 AND 34). SN 77-679,925. PUB. 6-23-2009. FILED 2-27-2009.
- 3,679,664. **AQUAPEUTICS (BLOCK FORM)**. AQUAPEUTICS LLC, (U.S. CLS. 13, 21, 23, 31 AND 34). SN 77-679,954. PUB. 6-23-2009. FILED 2-27-2009.
- 3,679,670. **SMOK'N-ROB'N (BLOCK FORM)**. LEASON, JEL-LESTER, DBA SMOK'N ROB'N, (U.S. CLS. 13, 21, 23, 31 AND 34). SN 77-680,002. PUB. 6-23-2009. FILED 2-27-2009.
- 3,679,797 (*See Class 4 for this trademark*).
- 3,679,806 (*See Class 4 for this trademark*).
- 3,679,837. **OLD WORLD BILLIARDS (BLOCK FORM)**. ZHONGSHAN RISING DRAGON FOREIGN TECHNOLOGY COMPANY LTD., MULTIPLE CLASS, (INT. CLS. 11, 20, 35, 39 AND 40), (U.S. CLS. 2, 13, 21, 22, 23, 25, 31, 32, 34, 50, 100, 101, 102, 103, 105 AND 106). SN 78-855,259. PUB. 4-21-2009. FILED 4-6-2006.
- 3,679,838 (*See Class 1 for this trademark*).
- 3,679,899 (*See Class 7 for this trademark*).
- 3,679,900 (*See Class 6 for this trademark*).
- 3,679,920. **FABER (BLOCK FORM)**. FABER S.P.A., (U.S. CLS. 13, 21, 23, 31 AND 34). SN 79-057,784. PUB. 6-23-2009. FILED 7-21-2008.
- 3,679,925. **GEA WTT (BLOCK FORM)**. GEA GROUP AKTIENGESELLSCHAFT, MULTIPLE CLASS, (INT. CLS. 11 AND 37), (U.S. CLS. 13, 21, 23, 31, 34, 100, 103 AND 106). SN 79-058,491. PUB. 6-23-2009. FILED 8-8-2008.
- 3,679,926. **WTT (BLOCK FORM)**. GEA GROUP AKTIENGESELLSCHAFT, MULTIPLE CLASS, (INT. CLS. 11 AND 37), (U.S. CLS. 13, 21, 23, 31, 34, 100, 103 AND 106). SN 79-058,492. PUB. 6-23-2009. FILED 8-8-2008.
- 3,679,940 (*See Class 5 for this trademark*).
- 3,679,989 (*See Class 7 for this trademark*).
- 3,680,025. **BARCO (BLOCK FORM)**. BARCO NV, (U.S. CLS. 13, 21, 23, 31 AND 34). SN 79-063,656. PUB. 6-23-2009. FILED 10-23-2008.
- 3,680,029 (*See Class 7 for this trademark*).
- CLS. 19, 21, 23, 31, 35 AND 44). SN 76-529,826. PUB. 5-19-2009. FILED 7-16-2003.
- 3,678,197. **SLIDESTOP TRUNK ORGANIZER AND DESIGN**. MCGRATH, PHILIP M., AND MCGRATH, CYNTHIA A., (U.S. CLS. 19, 21, 23, 31, 35 AND 44). SN 76-695,882. PUB. 6-23-2009. FILED 2-20-2009.
- 3,678,201. **GEN2PLUS (BLOCK FORM)**. AMSTED RAIL COMPANY, INC., (U.S. CLS. 19, 21, 23, 31, 35 AND 44). SN 76-696,716. PUB. 6-23-2009. FILED 4-6-2009.
- 3,678,215 (*See Class 6 for this trademark*).
- 3,678,282 (*See Class 6 for this trademark*).
- 3,678,311. **TRUCK ARMOR (STYLIZED)**. TRUCK ARMOR, LLC, (U.S. CLS. 19, 21, 23, 31, 35 AND 44). SN 77-332,821. PUB. 6-23-2009. FILED 11-19-2007.
- 3,678,312. **MISCELLANEOUS DESIGN**. TRUCK ARMOR, LLC, (U.S. CLS. 19, 21, 23, 31, 35 AND 44). SN 77-333,021. PUB. 6-23-2009. FILED 11-19-2007.
- 3,678,324. **ACE CAFE ACE RACER AND DESIGN**. ACE CAFE LONDON LIMITED, (U.S. CLS. 19, 21, 23, 31, 35 AND 44). SN 77-354,215. PUB. 6-23-2009. FILED 12-17-2007.
- 3,678,441. **ROVER AND DESIGN**. CALEDONIA AMERICAN CAPITAL, LLC, (U.S. CLS. 19, 21, 23, 31, 35 AND 44). SN 77-475,918. PUB. 1-20-2009. FILED 5-15-2008.
- 3,678,448. **ROLL-X-CAGE (BLOCK FORM)**. HAYWOOD MATERIALS HANDLING LIMITED, (U.S. CLS. 19, 21, 23, 31, 35 AND 44). SN 77-484,370. PUB. 4-21-2009. FILED 5-27-2008.
- 3,678,631 (*See Class 6 for this trademark*).
- 3,678,641. **YARD ROVER (BLOCK FORM)**. MARATHON INDUSTRIES, INC., (U.S. CLS. 19, 21, 23, 31, 35 AND 44). SN 77-539,587. PUB. 5-19-2009. FILED 8-5-2008.
- 3,678,658. **EXCELLENCE IN MOTION (BLOCK FORM)**. TEXTRON INC., (U.S. CLS. 19, 21, 23, 31, 35 AND 44). SN 77-541,658. PUB. 6-23-2009. FILED 8-7-2008.
- 3,678,699. **AIXAM ÉCOLOGIC AND DESIGN**. AIXAM MEGA, (U.S. CLS. 19, 21, 23, 31, 35 AND 44). SN 77-547,929. PUB. 6-23-2009. FILED 8-15-2008.
- 3,678,722. **BEDRYDER BUCKLE UP & RIDE AND DESIGN**. BEDRYDER, INC., (U.S. CLS. 19, 21, 23, 31, 35 AND 44). SN 77-554,250. PUB. 3-17-2009. FILED 8-23-2008.
- 3,678,840 (*See Class 6 for this trademark*).
- 3,678,849. **C 250 (BLOCK FORM)**. DAIMLER AG, (U.S. CLS. 19, 21, 23, 31, 35 AND 44). SN 77-589,561. PUB. 6-23-2009. FILED 10-9-2008.
- 3,678,871. **S 600 (BLOCK FORM)**. DAIMLER AG, (U.S. CLS. 19, 21, 23, 31, 35 AND 44). SN 77-597,048. PUB. 6-23-2009. FILED 10-21-2008.
- 3,678,879. **CL 600 (BLOCK FORM)**. DAIMLER AG, (U.S. CLS. 19, 21, 23, 31, 35 AND 44). SN 77-598,855. PUB. 6-23-2009. FILED 10-23-2008.
- 3,678,883. **BIKEBUG (BLOCK FORM)**. MICHAEL SCHNEIDER, (U.S. CLS. 19, 21, 23, 31, 35 AND 44). SN 77-599,951. PUB. 6-23-2009. FILED 10-24-2008.
- 3,678,884. **MISCELLANEOUS DESIGN**. MICHAEL SCHNEIDER, (U.S. CLS. 19, 21, 23, 31, 35 AND 44). SN 77-599,957. PUB. 6-23-2009. FILED 10-24-2008.
- 3,679,015. **LUIMOTO (BLOCK FORM)**. 8 ONE STUDIO, INC., (U.S. CLS. 19, 21, 23, 31, 35 AND 44). SN 77-637,231. PUB. 6-23-2009. FILED 12-19-2008.
- 3,679,016. **T "T" DEVELOPMENT & SALES AND DESIGN**. THE TRUSTEES OF THE TRAPANI FAMILY TRUST DATED OCTOBER 23, 2008, DBA "T" DEVELOPMENT & SALES, (U.S. CLS. 19, 21, 23, 31, 35 AND 44). SN 77-637,509. PUB. 6-23-2009. FILED 12-21-2008.
- 3,679,034. **CLASSIC MOTORCYCLE COMPANY AND DESIGN**. KIERNAN, MICHAEL T, AND KATON, DEBORAH N, (U.S. CLS. 19, 21, 23, 31, 35 AND 44). SN 77-643,834. PUB. 6-23-2009. FILED 1-6-2009.
- 3,679,101. **AC AND DESIGN**. AMERICAN CHROME CHICAGO CO., (U.S. CLS. 19, 21, 23, 31, 35 AND 44). SN 77-656,593. PUB. 6-23-2009. FILED 1-26-2009.
- 3,679,209. **SHIFTERSIN (BLOCK FORM)**. PETCHEL, JOSEPH JOHN, DBA PC RACING, (U.S. CLS. 19, 21, 23, 31, 35 AND 44). SN 77-669,763. PUB. 6-23-2009. FILED 2-12-2009.
- 3,679,223. **WINDSOR AND DESIGN**. SPRATT CYCLE SUPPORT, INC, (U.S. CLS. 19, 21, 23, 31, 35 AND 44). SN 77-670,942. PUB. 6-23-2009. FILED 2-15-2009.
- 3,679,310. **DURAPRO (BLOCK FORM)**. TILLICUM INTERNATIONAL, INC., DBA VENTURE OUTDOORS, (U.S.

CLASS 12—VEHICLES

- 3,678,146. **GRANSFORT**. SATISFIED BRAKE PRODUCTS INC./LES PRODUITS DE FREINS SATISFAIT INC., (U.S.

- CLS. 19, 21, 23, 31, 35 AND 44). SN 77-674,256. PUB. 6-23-2009. FILED 2-19-2009.
- 3,679,409. **NANCY (BLOCK FORM)**. DYNACRAFT BSC, INC., (U.S. CLS. 19, 21, 23, 31, 35 AND 44). SN 77-676,474. PUB. 6-23-2009. FILED 2-23-2009.
- 3,679,456 (*See Class 8 for this trademark*).
- 3,679,838 (*See Class 1 for this trademark*).
- 3,679,854 (*See Class 9 for this trademark*).
- 3,679,867. **LEHEL (STYLIZED)**. LEHEL INTERNATIONAL LIMITED, MULTIPLE CLASS, (INT. CLS. 12 AND 16), (U.S. CLS. 2, 5, 19, 21, 22, 23, 29, 31, 35, 37, 38, 44 AND 50). SN 79-047,638. PUB. 6-23-2009. FILED 8-6-2007.
- 3,679,868 (*See Class 6 for this trademark*).
- 3,679,870. **VOLGA-DNEPRGROUP AIRBRIDGECARGO AIRLINES AND DESIGN**. OBSHCHESTVO S OGRANICHENNOY OTVETCTVENNOSTYU; "VOLGA-DNEPR-MOSKVA", MULTIPLE CLASS, (INT. CLS. 12 AND 37), (U.S. CLS. 19, 21, 23, 31, 35, 44, 100, 103 AND 106). SN 79-048,357. PUB. 6-23-2009. FILED 11-20-2007.
- 3,679,875 (*See Class 6 for this trademark*).
- 3,679,877 (*See Class 6 for this trademark*).
- 3,679,884 (*See Class 9 for this trademark*).
- 3,679,887. **NIBK AND DESIGN**. LEONID KOVALKOV, (U.S. CLS. 19, 21, 23, 31, 35 AND 44). SN 79-052,918. PUB. 6-23-2009. FILED 4-15-2008.
- 3,679,900 (*See Class 6 for this trademark*).
- 3,679,901. **MISCELLANEOUS DESIGN**. GEELY HOLDING GROUP CO., LTD., (U.S. CLS. 19, 21, 23, 31, 35 AND 44). SN 79-056,455. PUB. 6-23-2009. FILED 7-15-2008.
- 3,679,923. **TJM XGS 4WD SUSPENSION AND DESIGN**. TJM PRODUCTS PTY LTD, (U.S. CLS. 19, 21, 23, 31, 35 AND 44). SN 79-058,365. PUB. 6-23-2009. FILED 8-21-2008.
- 3,679,951 (*See Class 7 for this trademark*).
- 3,680,017. **MINI CENTER RAIL (BLOCK FORM)**. BAYERISCHE MOTOREN WERKE; AKTIENGESELLSCHAFT, (U.S. CLS. 19, 21, 23, 31, 35 AND 44). SN 79-063,299. PUB. 6-23-2009. FILED 11-17-2008.
- 3,680,046. **FUBI (BLOCK FORM)**. FUBICOM AB OY, (U.S. CLS. 19, 21, 23, 31, 35 AND 44). SN 79-066,500. PUB. 6-23-2009. FILED 2-17-2009.

CLASS 13—FIREARMS

- 3,678,206. **GALIL (BLOCK FORM)**. ISRAEL WEAPON INDUSTRIES (I.W.I.) LTD., (U.S. CLS. 2 AND 9). SN 77-033,858. PUB. 6-23-2009. FILED 11-1-2006.
- 3,678,867. **MAXUS (BLOCK FORM)**. BROWNING, (U.S. CLS. 2 AND 9). SN 77-594,783. PUB. 3-31-2009. FILED 10-17-2008.
- 3,678,882. **PALM PYRO PAGEANTRY (BLOCK FORM)**. B.J. ALAN COMPANY, (U.S. CLS. 2 AND 9). SN 77-599,647. PUB. 6-23-2009. FILED 10-24-2008.
- 3,678,983. **P380 (BLOCK FORM)**. SAEILO ENTERPRISES, INC., (U.S. CLS. 2 AND 9). SN 77-628,752. PUB. 6-23-2009. FILED 12-8-2008.
- 3,678,987 (*See Class 9 for this trademark*).
- 3,679,736. **AMERICAN SELECT (BLOCK FORM)**. ALLIANT TECHSYSTEMS INC., (U.S. CLS. 2 AND 9). SN 77-688,273. PUB. 6-23-2009. FILED 3-11-2009.

CLASS 14—JEWELRY

- 3,678,209. **MISCELLANEOUS DESIGN**. SILVER STAR DISTRIBUTION COMPANY, INC., MULTIPLE CLASS, (INT. CLS. 14, 25 AND 26), (U.S. CLS. 2, 22, 27, 28, 37, 39, 40, 42 AND 50). SN 77-052,513. PUB. 4-1-2008. FILED 11-28-2006.
- 3,678,323. **WHITEFLASH A CUT ABOVE (BLOCK FORM)**. WHITEFLASH.COM, INC., (U.S. CLS. 2, 27, 28 AND 50). SN 77-353,500. PUB. 6-23-2009. FILED 12-17-2007.
- 3,678,326 (*See Class 9 for this trademark*).
- 3,678,381. **CUFFIES (BLOCK FORM)**. SIMPLYSHE, INC., MULTIPLE CLASS, (INT. CLS. 14 AND 18), (U.S. CLS. 1, 2, 3, 22, 27, 28, 41 AND 50). SN 77-418,122. PUB. 6-23-2009. FILED 3-10-2008.
- 3,678,429. **OPEN HEARTS BY JANE SEYMOUR (BLOCK FORM)**. STERLING JEWELERS INC., (U.S. CLS. 2, 27, 28 AND 50). SN 77-461,631. PUB. 6-23-2009. FILED 4-30-2008.
- 3,678,446. **DECADENT MOMENTS (BLOCK FORM)**. MARIA DAVIS, (U.S. CLS. 2, 27, 28 AND 50). SN 77-482,552. PUB. 6-23-2009. FILED 5-23-2008.
- 3,678,522. **SUPPORT MUSIC.COM (BLOCK FORM)**. NATIONAL ASSOCIATION OF MUSIC MERCHANTS, INC., MULTIPLE CLASS, (INT. CLS. 14, 16 AND 25), (U.S. CLS. 2, 5, 22, 23, 27, 28, 29, 37, 38, 39 AND 50). SN 77-523,006. PUB. 6-23-2009. FILED 7-15-2008.
- 3,678,560. **JESSICA MCCORMACK (BLOCK FORM)**. JESSICA MCCORMACK LIMITED, (U.S. CLS. 2, 27, 28 AND 50). SN 77-529,509. PUB. 6-23-2009. FILED 7-23-2008.
- 3,678,566. **HIGH FIVES & LITTLE KICKERS (BLOCK FORM)**. SMALLPRINT (FRANCHISING) LIMITED, (U.S. CLS. 2, 27, 28 AND 50). SN 77-530,496. PUB. 6-23-2009. FILED 7-24-2008.
- 3,678,567. **MINI MASTERS (BLOCK FORM)**. SMALLPRINT (FRANCHISING) LIMITED, (U.S. CLS. 2, 27, 28 AND 50). SN 77-530,549. PUB. 6-23-2009. FILED 7-24-2008.
- 3,678,746 (*See Class 6 for this trademark*).
- 3,678,889. **MISCELLANEOUS DESIGN**. OFFICIAL BUGLE BOY, LLC, MULTIPLE CLASS, (INT. CLS. 14 AND 24), (U.S. CLS. 2, 27, 28, 42 AND 50). SN 77-600,303. PUB. 6-23-2009. FILED 10-24-2008.
- 3,678,900. **LILLIAN'S GIRL (BLOCK FORM)**. KHACHIAN, ANI, DBA LILLIAN'S GIRL, (U.S. CLS. 2, 27, 28 AND 50). SN 77-602,651. PUB. 6-23-2009. FILED 10-28-2008.
- 3,678,907. **81 (BLOCK FORM)**. HELLS ANGELS MOTORCYCLE CORPORATION, (U.S. CLS. 2, 27, 28 AND 50). SN 77-605,755. PUB. 3-17-2009. FILED 11-2-2008.
- 3,678,914. **GESTUZ (BLOCK FORM)**. B-YOUNG A/S, MULTIPLE CLASS, (INT. CLS. 14, 18 AND 25), (U.S. CLS. 1, 2, 3, 22, 27, 28, 39, 41 AND 50). SN 77-609,076. PUB. 6-23-2009. FILED 11-6-2008.
- 3,678,979. **GOLDEN AGE SERIES (BLOCK FORM)**. WINIFRED ADAMS, (U.S. CLS. 2, 27, 28 AND 50). SN 77-627,400. PUB. 6-23-2009. FILED 12-5-2008.
- 3,679,091. **K (STYLIZED)**. KEN CRAFT INC, (U.S. CLS. 2, 27, 28 AND 50). SN 77-655,384. PUB. 6-23-2009. FILED 1-23-2009.
- 3,679,157 (*See Class 11 for this trademark*).
- 3,679,198. **SORBET (STYLIZED)**. THE BAZAR GROUP, (U.S. CLS. 2, 27, 28 AND 50). SN 77-668,977. PUB. 6-23-2009. FILED 2-12-2009.
- 3,679,364. **BUY IT TODAY, WEAR IT TOMORROW (BLOCK FORM)**. KUO, ROGER J., DBA THEFINESTJEWELRY, (U.S. CLS. 2, 27, 28 AND 50). SN 77-675,597. PUB. 6-23-2009. FILED 2-23-2009.
- 3,679,618. **S AND DESIGN**. SKILLUS CORPORATION, MULTIPLE CLASS, (INT. CLS. 14 AND 35), (U.S. CLS. 2, 27, 28, 50, 100, 101 AND 102). SN 77-679,134. PUB. 6-23-2009. FILED 2-26-2009.
- 3,679,619. **SKILLUS (BLOCK FORM)**. SKILLUS CORPORATION, MULTIPLE CLASS, (INT. CLS. 14 AND 35), (U.S. CLS. 2, 27, 28, 50, 100, 101 AND 102). SN 77-679,141. PUB. 6-23-2009. FILED 2-26-2009.
- 3,679,855 (*See Class 1 for this trademark*).
- 3,679,898. **KISS YOUR ENEMY (BLOCK FORM)**. LISELOTTE ZEH, MULTIPLE CLASS, (INT. CLS. 14, 20 AND 25), (U.S. CLS. 2, 13, 22, 25, 27, 28, 32, 39 AND 50). SN 79-055,986. PUB. 6-23-2009. FILED 4-23-2008.
- 3,679,917. **D'AGUET (BLOCK FORM)**. ALPHONSE DI-TSIMBA MBAMBI-NGOMA, MULTIPLE CLASS, (INT. CLS. 14 AND 25), (U.S. CLS. 2, 22, 27, 28, 39 AND 50). SN 79-057,548. PUB. 6-23-2009. FILED 7-9-2008.
- 3,679,947 (*See Class 9 for this trademark*).
- 3,679,956 (*See Class 1 for this trademark*).
- 3,679,967. **SYLVIA TOLEDANO (BLOCK FORM)**. TOLEDANO SYLVIA, MULTIPLE CLASS, (INT. CLS. 14 AND 18), (U.S. CLS. 1, 2, 3, 22, 27, 28, 41 AND 50). SN 79-059,950. PUB. 6-23-2009. FILED 8-1-2008.
- 3,679,998. **J JUVENIA 1860 AND DESIGN**. JUVENIA MONTRES SA, (U.S. CLS. 2, 27, 28 AND 50). SN 79-061,607. PUB. 6-23-2009. FILED 10-22-2008.
- 3,680,040. **HALDA (BLOCK FORM)**. EPOCH STOCKHOLM AB, (U.S. CLS. 2, 27, 28 AND 50). SN 79-065,474. PUB. 6-23-2009. FILED 1-21-2009.

3,680,045. **SNYPER (STYLIZED)**. SNYPER SA, (U.S. CLS. 2, 27, 28 AND 50). SN 79-066,312. PUB. 6-23-2009. FILED 2-20-2009.

CLASS 15—MUSICAL INSTRUMENTS

3,678,173. **MISCELLANEOUS DESIGN**. REMO, INC., (U.S. CLS. 2, 21 AND 36). SN 76-691,831. PUB. 6-23-2009. FILED 8-4-2008.

3,679,461. **HAPI (BLOCK FORM)**. RHYTHM EARTH, (U.S. CLS. 2, 21 AND 36). SN 77-677,078. PUB. 6-23-2009. FILED 2-24-2009.

3,679,832. **ARC (BLOCK FORM)**. CANNONBALL MUSICAL INSTRUMENTS, L.L.C., (U.S. CLS. 2, 21 AND 36). SN 78-820,961. PUB. 6-23-2009. FILED 2-22-2006.

3,680,001. **HERMANN HAUSER GITARREN REISBACH FRÜHER MÜNCHEN AND DESIGN**. HAUSER, HERMANN, (U.S. CLS. 2, 21 AND 36). SN 79-061,779. PUB. 6-23-2009. FILED 10-6-2008.

CLASS 16—PAPER GOODS AND PRINTED MATTER

3,678,156. **COMPREHENSIVE THERAPY (BLOCK FORM)**. AMERICAN SOCIETY OF CONTEMPORARY MEDICINE, SURGERY & OPHTHALMOLOGY, (U.S. CLS. 2, 5, 22, 23, 29, 37, 38 AND 50). SN 76-673,801. PUB. 6-23-2009. FILED 3-8-2007.

3,678,180. **WALDEN PRODUCTIONS (BLOCK FORM)**. KAPLAN, ABRAM W., (U.S. CLS. 2, 5, 22, 23, 29, 37, 38 AND 50). SN 76-693,074. PUB. 6-23-2009. FILED 9-22-2008.

3,678,207 (*See Class 1 for this trademark*).

3,678,227 (*See Class 9 for this trademark*).

3,678,234. **RELISH (BLOCK FORM)**. PUBLISHING GROUP OF AMERICA, INC., (U.S. CLS. 2, 5, 22, 23, 29, 37, 38 AND 50). SN 77-184,558. PUB. 6-23-2009. FILED 5-18-2007.

3,678,237. **UHLIG (BLOCK FORM)**. UHLIG, LLC, MULTIPLE CLASS, (INT. CLS. 16, 35, 41 AND 42), (U.S. CLS. 2, 5, 22, 23, 29, 37, 38, 50, 100, 101, 102 AND 107). SN 77-190,806. PUB. 5-13-2008. FILED 5-25-2007.

3,678,238. **U UHLIG AND DESIGN**. UHLIG, LLC, MULTIPLE CLASS, (INT. CLS. 16, 35, 41 AND 42), (U.S. CLS. 2, 5, 22, 23, 29, 37, 38, 50, 100, 101, 102 AND 107). SN 77-190,891. PUB. 1-27-2009. FILED 5-25-2007.

3,678,261. **THINK BRINK (BLOCK FORM)**. JOHNSON, LAURA LEAH, (U.S. CLS. 2, 5, 22, 23, 29, 37, 38 AND 50). SN 77-245,243. PUB. 6-23-2009. FILED 8-2-2007.

3,678,275. **SHIMMYZ (STYLIZED)**. YOUNG-ESPEUT, JUDITH, DBA YOUNG, JUDITH, MULTIPLE CLASS, (INT. CLS. 16 AND 41), (U.S. CLS. 2, 5, 22, 23, 29, 37, 38, 50, 100, 101 AND 107). SN 77-288,106. PUB. 6-23-2009. FILED 9-25-2007.

3,678,321. **MISCELLANEOUS DESIGN**. STATE BAR OF GEORGIA, MULTIPLE CLASS, (INT. CLS. 16, 35, 41, 44 AND 45), (U.S. CLS. 2, 5, 22, 23, 29, 37, 38, 50, 100, 101, 102 AND 107). SN 77-349,721. PUB. 6-23-2009. FILED 12-12-2007.

3,678,326 (*See Class 9 for this trademark*).

3,678,328. **INCITE (BLOCK FORM)**. GRQ (CORPORATE) LIMITED, MULTIPLE CLASS, (INT. CLS. 16, 35 AND 41), (U.S. CLS. 2, 5, 22, 23, 29, 37, 38, 50, 100, 101, 102 AND 107). SN 77-361,235. PUB. 3-31-2009. FILED 12-28-2007.

3,678,334 (*See Class 5 for this trademark*).

3,678,336 (*See Class 9 for this trademark*).

3,678,363. **HASSLER LIFE (STYLIZED)**. HASSLER ROMA S.P.A., MULTIPLE CLASS, (INT. CLS. 16 AND 35), (U.S. CLS. 2, 5, 22, 23, 29, 37, 38, 50, 100, 101 AND 102). SN 77-401,520. PUB. 6-23-2009. FILED 2-20-2008.

3,678,377. **AVIATE GLOBAL (BLOCK FORM)**. I2G GLOBAL (JERSEY) LTD, MULTIPLE CLASS, (INT. CLS. 16, 35 AND 36), (U.S. CLS. 2, 5, 22, 23, 29, 37, 38, 50, 100, 101 AND 102). SN 77-415,248. PUB. 4-7-2009. FILED 3-6-2008.

3,678,406. **A-LIST AND DESIGN**. A-LIST SERVICES LLC, DBA A-LIST, MULTIPLE CLASS, (INT. CLS. 16 AND 41), (U.S. CLS. 2, 5, 22, 23, 29, 37, 38, 50, 100, 101 AND 107). SN 77-

441,150. PUB. 3-24-2009. FILED 4-6-2008.

3,678,482. **A SCENTSATIONAL JOURNEY (BLOCK FORM)**. MO'S NOSE, LLC, MULTIPLE CLASS, (INT. CLS. 16, 25, 35 AND 41), (U.S. CLS. 2, 5, 22, 23, 29, 37, 38, 39, 50, 100, 101, 102 AND 107). SN 77-504,404. PUB. 6-23-2009. FILED 6-20-2008.

3,678,485. **I AND DESIGN**. AMERICAN BOOKSELLERS ASSOCIATION, INC., (U.S. CLS. 2, 5, 22, 23, 29, 37, 38 AND 50). SN 77-506,884. PUB. 11-18-2008. FILED 6-24-2008.

3,678,522 (*See Class 14 for this trademark*).

3,678,523. **SUPPORTMUSIC COALITION (BLOCK FORM)**. NATIONAL ASSOCIATION OF MUSIC MERCHANTS, INC., (U.S. CLS. 2, 5, 22, 23, 29, 37, 38 AND 50). SN 77-523,012. PUB. 6-23-2009. FILED 7-15-2008.

3,678,525. **HAMBONE (BLOCK FORM)**. HATCHOOTUCK-NEE, KOI, DBA/ HAMBONE ART, MULTIPLE CLASS, (INT. CLS. 16 AND 35), (U.S. CLS. 2, 5, 22, 23, 29, 37, 38, 50, 100, 101 AND 102). SN 77-523,837. PUB. 6-23-2009. FILED 7-16-2008.

3,678,526. **MISCELLANEOUS DESIGN**. HATCHOOTUCK-NEE, KOI, DBA/ HAMBONE ART, MULTIPLE CLASS, (INT. CLS. 16 AND 35), (U.S. CLS. 2, 5, 22, 23, 29, 37, 38, 50, 100, 101 AND 102). SN 77-523,860. PUB. 6-23-2009. FILED 7-16-2008.

3,678,528. **ZERO GAUGE (BLOCK FORM)**. HAMPDEN PAPERS, INC., (U.S. CLS. 2, 5, 22, 23, 29, 37, 38 AND 50). SN 77-524,606. PUB. 6-23-2009. FILED 7-17-2008.

3,678,541. **WEDDING ESSENTIALS (BLOCK FORM)**. TRIB TOTAL MEDIA, INC., (U.S. CLS. 2, 5, 22, 23, 29, 37, 38 AND 50). SN 77-527,348. PUB. 6-23-2009. FILED 7-21-2008.

3,678,583 (*See Class 7 for this trademark*).

3,678,594. **LIFESTYLE CONSULTING AND DESIGN**. LIFESTYLES CONSULTING, LLC, (U.S. CLS. 2, 5, 22, 23, 29, 37, 38 AND 50). SN 77-535,213. PUB. 6-23-2009. FILED 7-30-2008.

3,678,603 (*See Class 9 for this trademark*).

3,678,604. **THE PETTIBON SYSTEM (BLOCK FORM)**. PETTIBON SYSTEM, INC., (U.S. CLS. 2, 5, 22, 23, 29, 37, 38 AND 50). SN 77-536,486. PUB. 6-23-2009. FILED 7-31-2008.

3,678,611. **FINE ARTS MUSEUMS OF SAN FRANCISCO DE YOUNG LEGION OF HONOR AND DESIGN**. CITY AND COUNTY OF SAN FRANCISCO - FINE ARTS MUSEUMS OF SAN FRANCISCO, MULTIPLE CLASS, (INT. CLS. 16 AND 41), (U.S. CLS. 2, 5, 22, 23, 29, 37, 38, 50, 100, 101 AND 107). SN 77-537,466. PUB. 6-23-2009. FILED 8-1-2008.

3,678,622 (*See Class 8 for this trademark*).

3,678,646. **ABOUNDING RIVER (BLOCK FORM)**. ENGELHART, MATTHEW, (U.S. CLS. 2, 5, 22, 23, 29, 37, 38 AND 50). SN 77-539,981. PUB. 6-23-2009. FILED 8-6-2008.

3,678,653. **MODAPTS (BLOCK FORM)**. INTERNATIONAL MODAPTS ASSOCIATION, INC., (U.S. CLS. 2, 5, 22, 23, 29, 37, 38 AND 50). SN 77-540,693. PUB. 6-23-2009. FILED 8-6-2008.

3,678,654. **ORDERUP! (BLOCK FORM)**. DYNASTUDY, INC., (U.S. CLS. 2, 5, 22, 23, 29, 37, 38 AND 50). SN 77-540,758. PUB. 6-23-2009. FILED 8-6-2008.

3,678,672 (*See Class 9 for this trademark*).

3,678,694. **JA EXPLORING ECONOMICS (BLOCK FORM)**. JA WORLDWIDE, MULTIPLE CLASS, (INT. CLS. 16 AND 41), (U.S. CLS. 2, 5, 22, 23, 29, 37, 38, 50, 100, 101 AND 107). SN 77-546,803. PUB. 6-23-2009. FILED 8-14-2008.

3,678,716. **AFTER MIDNIGHT SOUL (BLOCK FORM)**. LOPEZ, STEVEN M, (U.S. CLS. 2, 5, 22, 23, 29, 37, 38 AND 50). SN 77-552,114. PUB. 6-23-2009. FILED 8-21-2008.

3,678,732. **HIM (BLOCK FORM)**. DIXON, DUANE A., (U.S. CLS. 2, 5, 22, 23, 29, 37, 38 AND 50). SN 77-555,851. PUB. 6-23-2009. FILED 8-26-2008.

3,678,746 (*See Class 6 for this trademark*).

3,678,747. **TICKETMASTER (BLOCK FORM)**. TICKETMASTER ENTERTAINMENT, INC., MULTIPLE CLASS, (INT. CLS. 16, 35 AND 41), (U.S. CLS. 2, 5, 22, 23, 29, 37, 38, 50, 100, 101, 102 AND 107). SN 77-561,038. PUB. 6-23-2009. FILED 9-3-2008.

3,678,753. **STEELBOARD (BLOCK FORM)**. ERNEST PACKAGING, FORMERLY ERNEST PAPER PRODUCTS, INC., (U.S. CLS. 2, 5, 22, 23, 29, 37, 38 AND 50). SN 77-561,834. PUB. 6-23-2009. FILED 9-3-2008.

3,678,761. **ARTILHEIRO (BLOCK FORM)**. IBASIS, INC., (U.S. CLS. 2, 5, 22, 23, 29, 37, 38 AND 50). SN 77-565,084. PUB. 6-23-2009. FILED 9-8-2008.

- 3,678,767 (See Class 9 for this trademark).
- 3,678,801. **MEXDER (BLOCK FORM)**. MEXDER, MERCADO MEXICANO DE DERIVADOS, S.A. DE C.V., AKA MEXDER, (U.S. CLS. 2, 5, 22, 23, 29, 37, 38 AND 50). SN 77-577,442. PUB. 6-23-2009. FILED 9-24-2008.
- 3,678,803 (See Class 9 for this trademark).
- 3,678,804 (See Class 9 for this trademark).
- 3,678,805. **BERNHEIM SELECT (BLOCK FORM)**. ISAAC W. BERNHEIM FOUNDATION, MULTIPLE CLASS, (INT. CLS. 16 AND 44), (U.S. CLS. 2, 5, 22, 23, 29, 37, 38, 50, 100 AND 101). SN 77-577,903. PUB. 6-23-2009. FILED 9-24-2008.
- 3,678,848. **JA FINANCE PARK (BLOCK FORM)**. JA WORLDWIDE, MULTIPLE CLASS, (INT. CLS. 16 AND 41), (U.S. CLS. 2, 5, 22, 23, 29, 37, 38, 50, 100, 101 AND 107). SN 77-589,445. PUB. 6-23-2009. FILED 10-9-2008.
- 3,678,857. **CURLYCUE DESIGNS (BLOCK FORM)**. CURLYCUE DESIGNS, MULTIPLE CLASS, (INT. CLS. 16 AND 42), (U.S. CLS. 2, 5, 22, 23, 29, 37, 38, 50, 100 AND 101). SN 77-591,486. PUB. 6-23-2009. FILED 10-13-2008.
- 3,678,864 (See Class 9 for this trademark).
- 3,678,865. **LSAT (BLOCK FORM)**. LAW SCHOOL ADMISSION COUNCIL, INC., (U.S. CLS. 2, 5, 22, 23, 29, 37, 38 AND 50). SN 77-594,744. PUB. 6-23-2009. FILED 10-17-2008.
- 3,678,943. **AHVRP ASSOCIATION FOR HEALTHCARE VOLUNTEER RESOURCE PROFESSIONALS (BLOCK FORM)**. AMERICAN HOSPITAL ASSOCIATION, MULTIPLE CLASS, (INT. CLS. 16 AND 41), (U.S. CLS. 2, 5, 22, 23, 29, 37, 38, 50, 100, 101 AND 107). SN 77-619,385. PUB. 6-23-2009. FILED 11-21-2008.
- 3,678,952. **UL AND DESIGN**. UPPERCASE LIVING, LLC, (U.S. CLS. 2, 5, 22, 23, 29, 37, 38 AND 50). SN 77-620,707. PUB. 6-23-2009. FILED 11-24-2008.
- 3,678,974 (See Class 8 for this trademark).
- 3,678,984 (See Class 9 for this trademark).
- 3,679,024. **SIGNA CUTS (BLOCK FORM)**. TRISTAR PRODUCTIONS, INC., (U.S. CLS. 2, 5, 22, 23, 29, 37, 38 AND 50). SN 77-639,890. PUB. 6-23-2009. FILED 12-24-2008.
- 3,679,027. **ARTWORK AND DESIGN**. SUZANO PAPEL E CELULOSE S.A., (U.S. CLS. 2, 5, 22, 23, 29, 37, 38 AND 50). SN 77-640,489. PUB. 6-23-2009. FILED 12-29-2008.
- 3,679,037. **CALIFORNIA KEEP RIGHT CALIFORNIAKEE-PRIGHT.COM AND DESIGN**. BREEDLOVE, JESSE RAY, DBA CALIFORNIA KEEP RIGHT, (U.S. CLS. 2, 5, 22, 23, 29, 37, 38 AND 50). SN 77-644,480. PUB. 6-23-2009. FILED 1-6-2009.
- 3,679,055. **PRESENCE (BLOCK FORM)**. MITEL NETWORKS CORPORATION, (U.S. CLS. 2, 5, 22, 23, 29, 37, 38 AND 50). SN 77-648,575. PUB. 6-23-2009. FILED 1-13-2009.
- 3,679,084. **DORIS DANGER (BLOCK FORM)**. WISNIA, CHRISTOPHER TODD, (U.S. CLS. 2, 5, 22, 23, 29, 37, 38 AND 50). SN 77-654,687. PUB. 6-23-2009. FILED 1-22-2009.
- 3,679,092. **ISLAMIC HORIZONS (BLOCK FORM)**. THE ISLAMIC SOCIETY OF NORTH AMERICA, (U.S. CLS. 2, 5, 22, 23, 29, 37, 38 AND 50). SN 77-655,463. PUB. 6-23-2009. FILED 1-23-2009.
- 3,679,104. **STRYBUC INDUSTRIES (BLOCK FORM)**. PIER-ANGELI GROUP, INC., MULTIPLE CLASS, (INT. CLS. 16 AND 35), (U.S. CLS. 2, 5, 22, 23, 29, 37, 38, 50, 100, 101 AND 102). SN 77-656,771. PUB. 6-23-2009. FILED 1-26-2009.
- 3,679,135. **COMMITTED TO ZERO AND DESIGN**. MDU RESOURCES GROUP, INC., MULTIPLE CLASS, (INT. CLS. 16 AND 45), (U.S. CLS. 2, 5, 22, 23, 29, 37, 38, 50, 100 AND 101). SN 77-662,627. PUB. 6-23-2009. FILED 2-3-2009.
- 3,679,156. **1 BAG AT A TIME (BLOCK FORM)**. 1 BAG AT A TIME, (U.S. CLS. 2, 5, 22, 23, 29, 37, 38 AND 50). SN 77-665,401. PUB. 6-23-2009. FILED 2-6-2009.
- 3,679,189. **BEE3 (BLOCK FORM)**. K-SUN CORPORATION, (U.S. CLS. 2, 5, 22, 23, 29, 37, 38 AND 50). SN 77-668,218. PUB. 6-23-2009. FILED 2-11-2009.
- 3,679,229. **BODY, BEAUTY, AND BRAVERY (BLOCK FORM)**. THE BODY, BEAUTY AND BRAVERY PROJECT, LLC, MULTIPLE CLASS, (INT. CLS. 16 AND 41), (U.S. CLS. 2, 5, 22, 23, 29, 37, 38, 50, 100, 101 AND 107). SN 77-671,277. PUB. 6-23-2009. FILED 2-16-2009.
- 3,679,256. **BEAUTY ALERT! (BLOCK FORM)**. BEAUTY ALERT, LLC, (U.S. CLS. 2, 5, 22, 23, 29, 37, 38 AND 50). SN 77-672,276. PUB. 6-23-2009. FILED 2-17-2009.
- 3,679,275. **MISTER BASS CLEF (BLOCK FORM)**. LUNDEEN, JOYCE E., (U.S. CLS. 2, 5, 22, 23, 29, 37, 38 AND 50). SN 77-673,238. PUB. 6-23-2009. FILED 2-18-2009.
- 3,679,276. **MISCELLANEOUS DESIGN**. LUNDEEN, JOYCE E., (U.S. CLS. 2, 5, 22, 23, 29, 37, 38 AND 50). SN 77-673,240. PUB. 6-23-2009. FILED 2-18-2009.
- 3,679,332. **WE HAVEN'T GONE GREEN. WE WERE BORN GREEN. (BLOCK FORM)**. ATLAS PAPER MILLS, LLC, (U.S. CLS. 2, 5, 22, 23, 29, 37, 38 AND 50). SN 77-674,863. PUB. 6-23-2009. FILED 2-20-2009.
- 3,679,334. **REG-ROOM AND DESIGN**. REG-ROOM LLC, MULTIPLE CLASS, (INT. CLS. 16 AND 36), (U.S. CLS. 2, 5, 22, 23, 29, 37, 38, 50, 100, 101 AND 102). SN 77-674,927. PUB. 6-23-2009. FILED 2-20-2009.
- 3,679,347. **JACK SQUAT (BLOCK FORM)**. BILLY J ATTINGER, MULTIPLE CLASS, (INT. CLS. 16 AND 25), (U.S. CLS. 2, 5, 22, 23, 29, 37, 38, 39 AND 50). SN 77-675,302. PUB. 6-23-2009. FILED 2-21-2009.
- 3,679,472. **EYESMART (BLOCK FORM)**. AMERICAN ACADEMY OF OPHTHALMOLOGY, INC., (U.S. CLS. 2, 5, 22, 23, 29, 37, 38 AND 50). SN 77-677,153. PUB. 6-23-2009. FILED 2-24-2009.
- 3,679,490. **THE CHOICE IS YOURS (STYLIZED)**. FRANKLIN COVEY, CO., MULTIPLE CLASS, (INT. CLS. 16 AND 41), (U.S. CLS. 2, 5, 22, 23, 29, 37, 38, 50, 100, 101 AND 107). SN 77-677,303. PUB. 6-23-2009. FILED 2-24-2009.
- 3,679,513. **SUR LA TABLE (STYLIZED)**. SUR LA TABLE, INC., MULTIPLE CLASS, (INT. CLS. 16, 35 AND 41), (U.S. CLS. 2, 5, 22, 23, 29, 37, 38, 50, 100, 101, 102 AND 107). SN 77-677,603. PUB. 6-23-2009. FILED 2-24-2009.
- 3,679,537. **DESERT COMPANION (BLOCK FORM)**. NEVADA PUBLIC RADIO, (U.S. CLS. 2, 5, 22, 23, 29, 37, 38 AND 50). SN 77-677,889. PUB. 6-23-2009. FILED 2-25-2009.
- 3,679,556 (See Class 9 for this trademark).
- 3,679,605. **PROVE IT AND WIN! (BLOCK FORM)**. CAREER PORTFOLIO SYSTEMS, INC., MULTIPLE CLASS, (INT. CLS. 16 AND 35), (U.S. CLS. 2, 5, 22, 23, 29, 37, 38, 50, 100, 101 AND 102). SN 77-678,906. PUB. 6-23-2009. FILED 2-26-2009.
- 3,679,636. **MADINA LAKE (BLOCK FORM)**. LEONE, MATTHEW, (U.S. CLS. 2, 5, 22, 23, 29, 37, 38 AND 50). SN 77-679,331. PUB. 6-23-2009. FILED 2-26-2009.
- 3,679,719. **HEMONC TODAY (BLOCK FORM)**. PNS & WSS INCORPORATED, DBA SLACK INCORPORATED, (U.S. CLS. 2, 5, 22, 23, 29, 37, 38 AND 50). SN 77-681,146. PUB. 6-23-2009. FILED 3-2-2009.
- 3,679,729. **IEEE TRANSACTIONS ON AUDIO, SPEECH, AND LANGUAGE PROCESSING (BLOCK FORM)**. THE INSTITUTE OF ELECTRICAL AND ELECTRONICS ENGINEERS, INC., AKA IEEE, (U.S. CLS. 2, 5, 22, 23, 29, 37, 38 AND 50). SN 77-684,734. PUB. 6-23-2009. FILED 3-5-2009.
- 3,679,747. **THE WOMAN'S WORD (STYLIZED)**. PREFERRED NUTRITION INC., (U.S. CLS. 2, 5, 22, 23, 29, 37, 38 AND 50). SN 77-692,742. PUB. 6-23-2009. FILED 3-17-2009.
- 3,679,749. **PEDIATRIC ANNALS (BLOCK FORM)**. PNS & WSS INCORPORATED, DBA SLACK INCORPORATED, (U.S. CLS. 2, 5, 22, 23, 29, 37, 38 AND 50). SN 77-693,339. PUB. 6-23-2009. FILED 3-17-2009.
- 3,679,753. **ORTHOPAEDICS TODAY EUROPE (BLOCK FORM)**. PNS & WSS INCORPORATED, DBA SLACK INCORPORATED, (U.S. CLS. 2, 5, 22, 23, 29, 37, 38 AND 50). SN 77-696,030. PUB. 6-23-2009. FILED 3-20-2009.
- 3,679,755. **READYFILL (BLOCK FORM)**. INTERNATIONAL PAPER COMPANY, (U.S. CLS. 2, 5, 22, 23, 29, 37, 38 AND 50). SN 77-696,581. PUB. 6-23-2009. FILED 3-23-2009.
- 3,679,773. **BEYOND SEED (BLOCK FORM)**. RESULTS UNLIMITED, (U.S. CLS. 2, 5, 22, 23, 29, 37, 38 AND 50). SN 77-704,965. PUB. 6-23-2009. FILED 4-2-2009.
- 3,679,783. **WHAT THIS COUNTRY NEEDS IS PLENTY OF MOXIE (BLOCK FORM)**. CORNUCOPIA BEVERAGES, INC., (U.S. CLS. 2, 5, 22, 23, 29, 37, 38 AND 50). SN 77-713,237. PUB. 6-23-2009. FILED 4-14-2009.
- 3,679,803. **A-LIST (BLOCK FORM)**. ALLOY MEDIA, DBA ALLOY ENTERTAINMENT, (U.S. CLS. 2, 5, 22, 23, 29, 37, 38 AND 50). SN 78-439,521. PUB. 11-18-2008. FILED 6-22-2004.
- 3,679,804 (See Class 9 for this trademark).
- 3,679,806 (See Class 4 for this trademark).
- 3,679,807. **SPIRIT OF MATH AND DESIGN**. SPIRIT OF MATH SCHOOLS INC., MULTIPLE CLASS, (INT. CLS. 16

- AND 41), (U.S. CLS. 2, 5, 22, 23, 29, 37, 38, 50, 100, 101 AND 107). SN 78-530,055. PUB. 10-17-2006. FILED 12-9-2004.
- 3,679,808. **MISCELLANEOUS DESIGN**. SPIRIT OF MATH SCHOOLS INC., MULTIPLE CLASS, (INT. CLS. 16 AND 41), (U.S. CLS. 2, 5, 22, 23, 29, 37, 38, 50, 100, 101 AND 107). SN 78-530,058. PUB. 10-17-2006. FILED 12-9-2004.
- 3,679,813. **VISION MAGAZINE (BLOCK FORM)**. VISION GLOBAL, (U.S. CLS. 2, 5, 22, 23, 29, 37, 38 AND 50). SN 78-653,671. PUB. 6-23-2009. FILED 6-18-2005.
- 3,679,830. **MISCELLANEOUS DESIGN**. INTERNATIONAL LONGSHORE & WAREHOUSE UNION, LOCAL 13, MULTIPLE CLASS, (INT. CLS. 16, 25 AND 45), (U.S. CLS. 2, 5, 22, 23, 29, 37, 38, 39, 50, 100 AND 101). SN 78-816,195. PUB. 6-23-2009. FILED 2-16-2006.
- 3,679,838 (*See Class 1 for this trademark*).
- 3,679,858 (*See Class 9 for this trademark*).
- 3,679,862. **BRANSCH (STYLIZED)**. BRANSCH GMBH, MULTIPLE CLASS, (INT. CLS. 16, 35 AND 41), (U.S. CLS. 2, 5, 22, 23, 29, 37, 38, 50, 100, 101, 102 AND 107). SN 79-041,721. PUB. 6-23-2009. FILED 6-29-2007.
- 3,679,866 (*See Class 7 for this trademark*).
- 3,679,867 (*See Class 12 for this trademark*).
- 3,679,872 (*See Class 5 for this trademark*).
- 3,679,910. **ATOMICO (BLOCK FORM)**. ATOMICO INVESTMENT HOLDINGS LIMITED, MULTIPLE CLASS, (INT. CLS. 16, 35 AND 36), (U.S. CLS. 2, 5, 22, 23, 29, 37, 38, 50, 100, 101 AND 102). SN 79-057,024. PUB. 6-23-2009. FILED 2-20-2008.
- 3,679,928. **ARCTICPLUS (BLOCK FORM)**. FISHER CLINICAL SERVICES UK LIMITED, MULTIPLE CLASS, (INT. CLS. 16 AND 39), (U.S. CLS. 2, 5, 22, 23, 29, 37, 38, 50, 100 AND 105). SN 79-058,520. PUB. 6-23-2009. FILED 4-3-2008.
- 3,679,931. **ROUGHCARD (BLOCK FORM)**. HENRICUS ANTONIUS KEMPS, (U.S. CLS. 2, 5, 22, 23, 29, 37, 38 AND 50). SN 79-058,631. PUB. 6-23-2009. FILED 8-1-2008.
- 3,679,945 (*See Class 1 for this trademark*).
- 3,679,948. **NUCLEAR POWER? NO THANKS AND DESIGN**. OOA-FONDEN, MULTIPLE CLASS, (INT. CLS. 16 AND 25), (U.S. CLS. 2, 5, 22, 23, 29, 37, 38, 39 AND 50). SN 79-059,398. PUB. 6-23-2009. FILED 9-8-2008.
- 3,679,954. **SELECTIVE/LINE AND DESIGN**. SAINT-GOBAIN EMBALLAGE, MULTIPLE CLASS, (INT. CLS. 16, 21 AND 40), (U.S. CLS. 2, 5, 13, 22, 23, 29, 30, 33, 37, 38, 40, 50, 100, 103 AND 106). SN 79-059,607. PUB. 6-23-2009. FILED 8-14-2008.
- 3,679,965 (*See Class 9 for this trademark*).
- 3,679,989 (*See Class 7 for this trademark*).
- 3,680,007 (*See Class 1 for this trademark*).
- 3,680,010. **GELPOLY (BLOCK FORM)**. PANAC CO., LTD, MULTIPLE CLASS, (INT. CLS. 16 AND 17), (U.S. CLS. 1, 2, 5, 12, 13, 22, 23, 29, 35, 37, 38 AND 50). SN 79-062,943. PUB. 6-23-2009. FILED 11-21-2008.
- 3,680,020. **DAIRY GOOD FOR LIFE! AND DESIGN**. DAIRY AUSTRALIA LIMITED, MULTIPLE CLASS, (INT. CLS. 16, 25, 29, 30, 35 AND 41), (U.S. CLS. 2, 5, 22, 23, 29, 37, 38, 39, 46, 50, 100, 101, 102 AND 107). SN 79-063,418. PUB. 6-23-2009. FILED 10-30-2008.
- 3,680,044 (*See Class 2 for this trademark*).
- 3,680,050. **WOPEX (BLOCK FORM)**. J.S. STAEDTLER GMBH & CO. KG, (U.S. CLS. 2, 5, 22, 23, 29, 37, 38 AND 50). SN 79-067,221. PUB. 6-23-2009. FILED 2-18-2009.

CLASS 17—RUBBER GOODS

- 3,678,215 (*See Class 6 for this trademark*).
- 3,678,218 (*See Class 1 for this trademark*).
- 3,678,277. **ASATEC (BLOCK FORM)**. ASAMER BASALTIC FIBERS GMBH, MULTIPLE CLASS, (INT. CLS. 17, 19, 21, 22 AND 24), (U.S. CLS. 1, 2, 5, 7, 12, 13, 19, 22, 23, 29, 30, 33, 35, 40, 42 AND 50). SN 77-290,081. PUB. 5-5-2009. FILED 9-27-2007.
- 3,678,282 (*See Class 6 for this trademark*).
- 3,678,295 (*See Class 1 for this trademark*).
- 3,678,421 (*See Class 1 for this trademark*).
- 3,678,474. **SOYTHANE (BLOCK FORM)**. SPRAYMAX INDUSTRIAL COATINGS, INC., (U.S. CLS. 1, 5, 12, 13, 35 AND 50). SN 77-500,366. PUB. 6-23-2009. FILED 6-16-2008.

- 3,678,499. **QUICKSKIN (BLOCK FORM)**. ZYVAX, INC., (U.S. CLS. 1, 5, 12, 13, 35 AND 50). SN 77-513,206. PUB. 6-23-2009. FILED 7-2-2008.
- 3,678,794. **POLYPRO FR (BLOCK FORM)**. THE GUND COMPANY, INC., (U.S. CLS. 1, 5, 12, 13, 35 AND 50). SN 77-575,433. PUB. 6-23-2009. FILED 9-22-2008.
- 3,678,840 (*See Class 6 for this trademark*).
- 3,678,974 (*See Class 8 for this trademark*).
- 3,679,172 (*See Class 2 for this trademark*).
- 3,679,565. **ACRILMAX (BLOCK FORM)**. MAXITECH, (U.S. CLS. 1, 5, 12, 13, 35 AND 50). SN 77-678,260. PUB. 6-23-2009. FILED 2-25-2009.
- 3,679,838 (*See Class 1 for this trademark*).
- 3,679,873 (*See Class 1 for this trademark*).
- 3,679,946 (*See Class 1 for this trademark*).
- 3,679,973. **LUCOBIT (BLOCK FORM)**. LUCOBIT AG, MULTIPLE CLASS, (INT. CLS. 17, 19 AND 35), (U.S. CLS. 1, 5, 12, 13, 33, 35, 50, 100, 101 AND 102). SN 79-060,264. PUB. 6-23-2009. FILED 2-11-2008.
- 3,679,986. **ECORASTER (BLOCK FORM)**. PURUS ARZBERG GMBH, MULTIPLE CLASS, (INT. CLS. 17 AND 19), (U.S. CLS. 1, 5, 12, 13, 33, 35 AND 50). SN 79-060,918. PUB. 6-23-2009. FILED 7-1-2008.
- 3,679,988 (*See Class 6 for this trademark*).
- 3,680,010 (*See Class 16 for this trademark*).

CLASS 18—LEATHER GOODS

- 3,678,225. **BELGRAVIA (BLOCK FORM)**. CLIFFORD CO., LTD., MULTIPLE CLASS, (INT. CLS. 18 AND 25), (U.S. CLS. 1, 2, 3, 22, 39 AND 41). SN 77-136,520. PUB. 11-11-2008. FILED 3-21-2007.
- 3,678,227 (*See Class 9 for this trademark*).
- 3,678,276 (*See Class 3 for this trademark*).
- 3,678,362 (*See Class 9 for this trademark*).
- 3,678,381 (*See Class 14 for this trademark*).
- 3,678,433. **JUSTINE CASE (BLOCK FORM)**. JUST IN CASE, INC., (U.S. CLS. 1, 2, 3, 22 AND 41). SN 77-464,773. PUB. 6-23-2009. FILED 5-2-2008.
- 3,678,680. **BOTTLEWISE (BLOCK FORM)**. BOTTLEWISE, LLC, DBA BOTTLEWISE, (U.S. CLS. 1, 2, 3, 22 AND 41). SN 77-544,236. PUB. 4-7-2009. FILED 8-11-2008.
- 3,678,789. **TEMPEST (BLOCK FORM)**. M. J. AINGE & CO. LIMITED, (U.S. CLS. 1, 2, 3, 22 AND 41). SN 77-573,173. PUB. 4-21-2009. FILED 9-18-2008.
- 3,678,914 (*See Class 14 for this trademark*).
- 3,679,381. **MISCELLANEOUS DESIGN**. FILLMORE DESIGN INC., (U.S. CLS. 1, 2, 3, 22 AND 41). SN 77-675,898. PUB. 6-23-2009. FILED 2-23-2009.
- 3,679,600. **FAIRFAX (BLOCK FORM)**. THOROWGOOD LIMITED, (U.S. CLS. 1, 2, 3, 22 AND 41). SN 77-678,844. PUB. 6-23-2009. FILED 2-26-2009.
- 3,679,700. **SUMMER WHINNYS (BLOCK FORM)**. EV'S SOX FOR HORSES, INC., (U.S. CLS. 1, 2, 3, 22 AND 41). SN 77-680,525. PUB. 6-23-2009. FILED 2-27-2009.
- 3,679,711. **MAYA WRAP (BLOCK FORM)**. MAYA WRAP, INC., (U.S. CLS. 1, 2, 3, 22 AND 41). SN 77-680,711. PUB. 6-23-2009. FILED 2-28-2009.
- 3,679,806 (*See Class 4 for this trademark*).
- 3,679,888. **MINIBUS AND DESIGN**. DE LA SIMONE SANDRINE, (U.S. CLS. 1, 2, 3, 22 AND 41). SN 79-053,408. PUB. 6-23-2009. FILED 4-15-2008.
- 3,679,904. **BLACK LILY ACCESSORIES AND DESIGN**. BLACK LILY ACCESSORIES A/S, MULTIPLE CLASS, (INT. CLS. 18 AND 24), (U.S. CLS. 1, 2, 3, 22, 41, 42 AND 50). SN 79-056,856. PUB. 6-23-2009. FILED 7-7-2008.
- 3,679,912. **MISCELLANEOUS DESIGN**. CELINE, MULTIPLE CLASS, (INT. CLS. 18, 24 AND 25), (U.S. CLS. 1, 2, 3, 22, 39, 41, 42 AND 50). SN 79-057,048. PUB. 6-23-2009. FILED 6-19-2008.
- 3,679,957 (*See Class 3 for this trademark*).
- 3,679,967 (*See Class 14 for this trademark*).
- 3,680,004. **MISCELLANEOUS DESIGN**. MARC JACOBS TRADEMARKS L.L.C., MULTIPLE CLASS, (INT. CLS. 18 AND 25), (U.S. CLS. 1, 2, 3, 22, 39 AND 41). SN 79-062,072. PUB. 6-23-2009. FILED 9-5-2008.

3,680,026. **CRISPI AND DESIGN**. MARCOLIN ALESSANDRO, MULTIPLE CLASS, (INT. CLS. 18 AND 25), (U.S. CLS. 1, 2, 3, 22, 39 AND 41). SN 79-063,799. PUB. 6-23-2009. FILED 4-10-2008.

CLASS 19—NON-METALLIC BUILDING MATERIALS

3,678,257 (*See Class 8 for this trademark*).
 3,678,277 (*See Class 17 for this trademark*).
 3,678,295 (*See Class 1 for this trademark*).
 3,678,335. **KETER AND DESIGN**. KETER PLASTIC LTD., MULTIPLE CLASS, (INT. CLS. 19, 20 AND 21), (U.S. CLS. 1, 2, 12, 13, 22, 23, 25, 29, 30, 32, 33, 40 AND 50). SN 77-366,113. PUB. 3-17-2009. FILED 1-8-2008.
 3,678,387. **MONSTER BLOCK AND DESIGN**. HERTZ, DAVID R., (U.S. CLS. 1, 12, 33 AND 50). SN 77-424,214. PUB. 6-23-2009. FILED 3-17-2008.
 3,678,390. **SECURBASE (BLOCK FORM)**. MATÉRIAUX SPÉCIALISÉS LOUISEVILLE INC., (U.S. CLS. 1, 12, 33 AND 50). SN 77-427,158. PUB. 6-23-2009. FILED 3-20-2008.
 3,678,577. **DEK RMAN AND DESIGN**. SHANGHAI DEKORMAN FLOORING CO., LTD., (U.S. CLS. 1, 12, 33 AND 50). SN 77-532,203. PUB. 6-23-2009. FILED 7-27-2008.
 3,678,727. **LIFETIME OUTDOOR STORAGE (BLOCK FORM)**. LIFETIME PRODUCTS, INC., (U.S. CLS. 1, 12, 33 AND 50). SN 77-555,018. PUB. 6-23-2009. FILED 8-25-2008.
 3,678,832. **PLICAST (BLOCK FORM)**. PLIBRICO COMPANY, LLC, (U.S. CLS. 1, 12, 33 AND 50). SN 77-584,528. PUB. 6-23-2009. FILED 10-2-2008.
 3,678,990. **MOUNTAIN KING (BLOCK FORM)**. PEAK VENTURES, INC., DBA CONESTOGA LOG CABINS AND HOMES AND CONESTOGA LOG CABINS, (U.S. CLS. 1, 12, 33 AND 50). SN 77-630,854. PUB. 6-23-2009. FILED 12-11-2008.
 3,679,114. **FLORES (BLOCK FORM)**. ANCHOR WALL SYSTEMS, INC., (U.S. CLS. 1, 12, 33 AND 50). SN 77-658,347. PUB. 6-23-2009. FILED 1-28-2009.
 3,679,125. **KELLY-FRADET (BLOCK FORM)**. ENFIELD LUMBER COMPANY, INC., DBA KELLY-FRADET, (U.S. CLS. 1, 12, 33 AND 50). SN 77-660,989. PUB. 6-23-2009. FILED 2-2-2009.
 3,679,126. **MISCELLANEOUS DESIGN**. ENFIELD LUMBER COMPANY, INC., DBA KELLY-FRADET, (U.S. CLS. 1, 12, 33 AND 50). SN 77-660,991. PUB. 6-23-2009. FILED 2-2-2009.
 3,679,285. **ERO-GUARD AND DESIGN**. ERO-GUARD, INC, (U.S. CLS. 1, 12, 33 AND 50). SN 77-673,507. PUB. 6-23-2009. FILED 2-19-2009.
 3,679,838 (*See Class 1 for this trademark*).
 3,679,868 (*See Class 6 for this trademark*).
 3,679,873 (*See Class 1 for this trademark*).
 3,679,900 (*See Class 6 for this trademark*).
 3,679,946 (*See Class 1 for this trademark*).
 3,679,960. **CEMBRIT (BLOCK FORM)**. DANSK ETERNIT HOLDING A/S, MULTIPLE CLASS, (INT. CLS. 19 AND 37), (U.S. CLS. 1, 12, 33, 50, 100, 103 AND 106). SN 79-059,827. PUB. 6-23-2009. FILED 8-25-2008.
 3,679,973 (*See Class 17 for this trademark*).
 3,679,986 (*See Class 17 for this trademark*).
 3,680,016 (*See Class 6 for this trademark*).

CLASS 20—FURNITURE AND ARTICLES NOT OTHERWISE CLASSIFIED

3,678,153 (*See Class 6 for this trademark*).
 3,678,207 (*See Class 1 for this trademark*).
 3,678,210. **EXPRESSIONS ARTISTICALLY INSPIRED AND DESIGN**. DECORE-ATIVE SPECIALTIES, INC., (U.S. CLS. 2, 13, 22, 25, 32 AND 50). SN 77-053,879. PUB. 6-23-2009. FILED 11-30-2006.
 3,678,212 (*See Class 6 for this trademark*).
 3,678,304. **MISCELLANEOUS DESIGN**. CYNTHIA ALEXANDER, LLC, (U.S. CLS. 2, 13, 22, 25, 32 AND 50). SN 77-

325,165. PUB. 6-23-2009. FILED 11-8-2007.
 3,678,335 (*See Class 19 for this trademark*).
 3,678,401 (*See Class 6 for this trademark*).
 3,678,622 (*See Class 8 for this trademark*).
 3,678,631 (*See Class 6 for this trademark*).
 3,678,766. **NATURE'S WAY (BLOCK FORM)**. VANDOR CORPORATION, (U.S. CLS. 2, 13, 22, 25, 32 AND 50). SN 77-568,323. PUB. 6-23-2009. FILED 9-11-2008.
 3,678,795. **PARROT BAY AND DESIGN**. THE KELLY SUPPLY COMPANY, (U.S. CLS. 2, 13, 22, 25, 32 AND 50). SN 77-575,782. PUB. 3-17-2009. FILED 9-22-2008.
 3,678,847. **ARTISTIC WINE CELLARS (BLOCK FORM)**. WALLEN, PATRICK HAROLD, DBA ARTISTIC WINE CELLARS, AND WALLEN, MADELINE F, DBA ARTISTIC WINE CELLARS, (U.S. CLS. 2, 13, 22, 25, 32 AND 50). SN 77-588,813. PUB. 3-17-2009. FILED 10-8-2008.
 3,678,922. **LEVEL-IT (BLOCK FORM)**. ASHER, SAM M, (U.S. CLS. 2, 13, 22, 25, 32 AND 50). SN 77-610,536. PUB. 6-23-2009. FILED 11-9-2008.
 3,679,019. **AZUDA (STYLIZED)**. AZUDA INTERNATIONAL LTD., MULTIPLE CLASS, (INT. CLS. 20 AND 21), (U.S. CLS. 2, 13, 22, 23, 25, 29, 30, 32, 33, 40 AND 50). SN 77-639,544. PUB. 6-23-2009. FILED 12-24-2008.
 3,679,057. **WORKING FOR PEANUTS PRODUCTIONS (BLOCK FORM)**. TREMEL, JEANNE M, (U.S. CLS. 2, 13, 22, 25, 32 AND 50). SN 77-649,113. PUB. 6-23-2009. FILED 1-14-2009.
 3,679,157 (*See Class 11 for this trademark*).
 3,679,288. **SYMBOL PEDIC (BLOCK FORM)**. EASTERN SLEEP PRODUCTS CO., INC., DBA SYMBOL MATTRESS COMPANY, (U.S. CLS. 2, 13, 22, 25, 32 AND 50). SN 77-673,587. PUB. 6-23-2009. FILED 2-19-2009.
 3,679,414. **FOREMOST AND DESIGN**. FOREMOST GROUPS, INC., (U.S. CLS. 2, 13, 22, 25, 32 AND 50). SN 77-676,573. PUB. 6-23-2009. FILED 2-23-2009.
 3,679,432. **COEXCELL (BLOCK FORM)**. U. S. COEXCELL, INC., (U.S. CLS. 2, 13, 22, 25, 32 AND 50). SN 77-676,768. PUB. 6-23-2009. FILED 2-24-2009.
 3,679,703. **MONKEY MATES BY MONKEY HOOK AND DESIGN**. THE MONKEY HOOK, LLC, (U.S. CLS. 2, 13, 22, 25, 32 AND 50). SN 77-680,553. PUB. 6-23-2009. FILED 2-27-2009.
 3,679,779. **KEEP SMALL THINGS HANDY! (BLOCK FORM)**. THE MONKEY HOOK, LLC, (U.S. CLS. 2, 13, 22, 25, 32 AND 50). SN 77-707,921. PUB. 6-23-2009. FILED 4-6-2009.
 3,679,806 (*See Class 4 for this trademark*).
 3,679,837 (*See Class 11 for this trademark*).
 3,679,838 (*See Class 1 for this trademark*).
 3,679,850 (*See Class 9 for this trademark*).
 3,679,898 (*See Class 14 for this trademark*).
 3,679,902. **WIBI (STYLIZED)**. MAXIAM, MULTIPLE CLASS, (INT. CLS. 20, 24 AND 35), (U.S. CLS. 2, 13, 22, 25, 32, 42, 50, 100, 101 AND 102). SN 79-056,648. PUB. 6-23-2009. FILED 6-16-2008.
 3,679,970 (*See Class 6 for this trademark*).
 3,679,985. **MINUI (BLOCK FORM)**. HANDYSITT A/S, (U.S. CLS. 2, 13, 22, 25, 32 AND 50). SN 79-060,894. PUB. 6-23-2009. FILED 8-22-2008.
 3,679,988 (*See Class 6 for this trademark*).

CLASS 21—HOUSEWARES AND GLASS

3,678,227 (*See Class 9 for this trademark*).
 3,678,277 (*See Class 17 for this trademark*).
 3,678,326 (*See Class 9 for this trademark*).
 3,678,335 (*See Class 19 for this trademark*).
 3,678,373. **IRAGZ AND DESIGN**. IRAGZ, (U.S. CLS. 2, 13, 23, 29, 30, 33, 40 AND 50). SN 77-413,181. PUB. 6-23-2009. FILED 3-5-2008.
 3,678,514. **B.ORGANIZED (BLOCK FORM)**. DYNOLLC, (U.S. CLS. 2, 13, 23, 29, 30, 33, 40 AND 50). SN 77-519,399. PUB. 6-23-2009. FILED 7-10-2008.
 3,678,515. **B.ORGANIZED AND DESIGN**. DYNOLLC, (U.S. CLS. 2, 13, 23, 29, 30, 33, 40 AND 50). SN 77-519,401. PUB. 6-23-2009. FILED 7-10-2008.
 3,678,622 (*See Class 8 for this trademark*).

3,678,730 (*See Class 3 for this trademark*).
 3,678,935. **WATERFARM (BLOCK FORM)**. GENERAL HYDRO-
 PONICS, INC., (U.S. CLS. 2, 13, 23, 29, 30, 33, 40 AND
 50). SN 77-618,022. PUB. 6-23-2009. FILED 11-19-2008.
 3,678,940. **EZHAND HYGIENE (BLOCK FORM)**. ALUTA,
 INC., (U.S. CLS. 2, 13, 23, 29, 30, 33, 40 AND 50). SN 77-
 618,478. PUB. 6-23-2009. FILED 11-20-2008.
 3,678,974 (*See Class 8 for this trademark*).
 3,679,019 (*See Class 20 for this trademark*).
 3,679,157 (*See Class 11 for this trademark*).
 3,679,210. **GET TO THE BOTTOM OF IT (BLOCK FORM)**.
 PHILLIPS, MICHELLE C., (U.S. CLS. 2, 13, 23, 29, 30, 33, 40
 AND 50). SN 77-669,871. PUB. 6-23-2009. FILED 2-13-2009.
 3,679,338 (*See Class 11 for this trademark*).
 3,679,514 (*See Class 3 for this trademark*).
 3,679,582. **PACKET PAL (BLOCK FORM)**. JOHNSON,
 LUANN D., (U.S. CLS. 2, 13, 23, 29, 30, 33, 40 AND 50). SN
 77-678,450. PUB. 6-23-2009. FILED 2-25-2009.
 3,679,595 (*See Class 11 for this trademark*).
 3,679,620. **FIT & FRESH (BLOCK FORM)**. MEDPORT LLC,
 (U.S. CLS. 2, 13, 23, 29, 30, 33, 40 AND 50). SN 77-679,151.
 PUB. 6-23-2009. FILED 2-26-2009.
 3,679,650. **THIS IS MY BEER! (BLOCK FORM)**. ANDERSON,
 RICHARD, (U.S. CLS. 2, 13, 23, 29, 30, 33, 40 AND 50). SN 77-
 679,503. PUB. 6-23-2009. FILED 2-26-2009.
 3,679,726. **BRUSH & FLOSS AT ONCE! (BLOCK FORM)**.
 ORAMEDIX, INC., (U.S. CLS. 2, 13, 23, 29, 30, 33, 40 AND
 50). SN 77-683,624. PUB. 6-23-2009. FILED 3-4-2009.
 3,679,797 (*See Class 4 for this trademark*).
 3,679,810 (*See Class 8 for this trademark*).
 3,679,838 (*See Class 1 for this trademark*).
 3,679,868 (*See Class 6 for this trademark*).
 3,679,922 (*See Class 5 for this trademark*).
 3,679,938 (*See Class 8 for this trademark*).
 3,679,954 (*See Class 16 for this trademark*).
 3,679,959. **COSTA NOVA AND DESIGN**. GRESTEL-PRODUC-
 TOS CERAMICOS, S.A., (U.S. CLS. 2, 13, 23, 29, 30, 33, 40
 AND 50). SN 79-059,816. PUB. 6-23-2009. FILED 9-2-2008.
 3,679,976. **CLICK & COOK (STYLIZED)**. BALLARINI PAOLO
 & FIGLI S.P.A., (U.S. CLS. 2, 13, 23, 29, 30, 33, 40 AND 50).
 SN 79-060,311. PUB. 6-23-2009. FILED 8-8-2008.
 3,679,989 (*See Class 7 for this trademark*).
 3,680,002 (*See Class 3 for this trademark*).
 3,680,019. **MUMMYMUG (BLOCK FORM)**. LINE 12 BUSI-
 NESS DEVELOPMENT BV, (U.S. CLS. 2, 13, 23, 29, 30, 33, 40
 AND 50). SN 79-063,389. PUB. 6-23-2009. FILED 10-9-2008.

CLASS 22—CORDAGE AND FIBERS

3,678,277 (*See Class 17 for this trademark*).
 3,679,187. **MISCELLANEOUS DESIGN**. SANRIO COMPANY,
 LTD., (U.S. CLS. 1, 2, 7, 19, 22, 42 AND 50). SN 77-667,978.
 PUB. 6-23-2009. FILED 2-11-2009.
 3,679,732. **EARTHSPUN (BLOCK FORM)**. PATRICK YARN
 MILL, INC., (U.S. CLS. 1, 2, 7, 19, 22, 42 AND 50). SN 77-
 685,435. PUB. 6-23-2009. FILED 3-6-2009.
 3,679,806 (*See Class 4 for this trademark*).
 3,679,838 (*See Class 1 for this trademark*).
 3,679,977. **ALTO CHROMA AQUAFIL AND DESIGN**. AQUA-
 FIL S.P.A., MULTIPLE CLASS, (INT. CLS. 22 AND 23),
 (U.S. CLS. 1, 2, 7, 19, 22, 42, 43 AND 50). SN 79-060,329. PUB.
 6-23-2009. FILED 4-23-2008.
 3,679,978. **ALTO AQUAFIL AND DESIGN**. AQUAFIL S.P.A.,
 MULTIPLE CLASS, (INT. CLS. 22 AND 23), (U.S. CLS. 1, 2,
 7, 19, 22, 42, 43 AND 50). SN 79-060,330. PUB. 6-23-2009.
 FILED 4-23-2008.

CLASS 23—YARNS AND THREADS

3,679,977 (*See Class 22 for this trademark*).
 3,679,978 (*See Class 22 for this trademark*).

CLASS 24—FABRICS

3,678,227 (*See Class 9 for this trademark*).
 3,678,277 (*See Class 17 for this trademark*).
 3,678,573. **PRESTIGE COLLECTION (STYLIZED)**. SAFDIE &
 CO. INC., (U.S. CLS. 42 AND 50). SN 77-530,808. PUB. 6-23-
 2009. FILED 7-24-2008.
 3,678,660. **NECK ESSENTIALS (BLOCK FORM)**. LITTLE
 RAPIDS CORPORATION, (U.S. CLS. 42 AND 50). SN 77-
 541,802. PUB. 6-23-2009. FILED 8-7-2008.
 3,678,790. **PROACTIVE COMFORT (BLOCK FORM)**. ROTH-
 BARD, MICHAEL, (U.S. CLS. 42 AND 50). SN 77-573,564.
 PUB. 6-23-2009. FILED 9-18-2008.
 3,678,791. **PROACTIVE FOAM (BLOCK FORM)**. ROTHBARD,
 MICHAEL, (U.S. CLS. 42 AND 50). SN 77-573,583. PUB. 6-23-
 2009. FILED 9-18-2008.
 3,678,888. **BUGLE BOY (BLOCK FORM)**. OFFICIAL BUGLE
 BOY, LLC, (U.S. CLS. 42 AND 50). SN 77-600,295. PUB. 6-23-
 2009. FILED 10-24-2008.
 3,678,889 (*See Class 14 for this trademark*).
 3,678,897. **VELATEX (BLOCK FORM)**. ROTHBARD, MI-
 CHAEL, (U.S. CLS. 42 AND 50). SN 77-602,507. PUB. 6-23-
 2009. FILED 10-28-2008.
 3,679,042. **GREEN SPROUTS (BLOCK FORM)**. I PLAY, INC.,
 (U.S. CLS. 42 AND 50). SN 77-645,819. PUB. 6-23-2009.
 FILED 1-8-2009.
 3,679,338 (*See Class 11 for this trademark*).
 3,679,383. **CAPTURE TOP (BLOCK FORM)**. PACIFIC COAST
 FEATHER COMPANY, (U.S. CLS. 42 AND 50). SN 77-
 675,946. PUB. 6-23-2009. FILED 2-23-2009.
 3,679,770. **COTTON BAY AND DESIGN**. HDS IP HOLDING,
 LLC, (U.S. CLS. 42 AND 50). SN 77-703,469. PUB. 6-23-2009.
 FILED 3-31-2009.
 3,679,799. **SOFTWAY AND DESIGN**. DÖHLER S/A, MULTI-
 PLE CLASS, (INT. CLS. 24 AND 25), (U.S. CLS. 22, 39, 42
 AND 50). SN 78-312,842. PUB. 3-17-2009. FILED 10-13-2003.
 3,679,806 (*See Class 4 for this trademark*).
 3,679,822. **ICEARMOR (BLOCK FORM)**. CLAM CORPORA-
 TION, MULTIPLE CLASS, (INT. CLS. 24 AND 25), (U.S.
 CLS. 22, 39, 42 AND 50). SN 78-761,579. PUB. 7-18-2006.
 FILED 11-28-2005.
 3,679,838 (*See Class 1 for this trademark*).
 3,679,856. **NOIR (STYLIZED)**. NOIR. ILLUMINATI II HOLD-
 ING APS, MULTIPLE CLASS, (INT. CLS. 24 AND 25), (U.S.
 CLS. 22, 39, 42 AND 50). SN 79-032,545. PUB. 6-23-2009.
 FILED 10-25-2006.
 3,679,885. **CELIA BIRTWELL (BLOCK FORM)**. BELLA
 CLARK, AND GEORGE CLARK, MULTIPLE CLASS,
 (INT. CLS. 24 AND 25), (U.S. CLS. 22, 39, 42 AND 50). SN
 79-052,426. PUB. 6-23-2009. FILED 2-27-2008.
 3,679,902 (*See Class 20 for this trademark*).
 3,679,904 (*See Class 18 for this trademark*).
 3,679,912 (*See Class 18 for this trademark*).
 3,679,989 (*See Class 7 for this trademark*).

CLASS 25—CLOTHING

3,678,148. **T.REX (BLOCK FORM)**. SVENGIRLY MUSIC,
 INC., (U.S. CLS. 22 AND 39). SN 76-628,627. PUB. 8-5-2008.
 FILED 1-20-2005.
 3,678,151. **RETRO REVOLVER (BLOCK FORM)**. OWUSU,
 HENRY KWAME, (U.S. CLS. 22 AND 39). SN 76-643,108.
 PUB. 6-23-2009. FILED 7-19-2005.
 3,678,209 (*See Class 14 for this trademark*).
 3,678,225 (*See Class 18 for this trademark*).
 3,678,227 (*See Class 9 for this trademark*).
 3,678,254. **ZOOLA (STYLIZED)**. ZOOLA, LLC, (U.S. CLS. 22
 AND 39). SN 77-232,572. PUB. 6-23-2009. FILED 7-18-2007.
 3,678,270. **96 LBS. NET CLASSIC OATS TRADEMARK**
SPECIAL QUALITY FOR THOROUGHBREDS AND DE-
SIGN. SKIRTS DE SOLEIL, (U.S. CLS. 22 AND 39). SN 77-
 274,482. PUB. 5-6-2008. FILED 9-7-2007.
 3,678,276 (*See Class 3 for this trademark*).
 3,678,279. **ARTFORCE AND DESIGN**. SHUO WANG, (U.S.
 CLS. 22 AND 39). SN 77-297,888. PUB. 5-20-2008. FILED 10-
 5-2007.

- 3,678,314. **THE CRAZY ROBERTSON (BLOCK FORM)**. ACKERMAN, VICTOR, (U.S. CLS. 22 AND 39). SN 77-336,196. PUB. 6-23-2009. FILED 11-25-2007.
- 3,678,317. **VETPREP (BLOCK FORM)**. VETPREP CORP., MULTIPLE CLASS, (INT. CLS. 25 AND 41), (U.S. CLS. 22, 39, 100, 101 AND 107). SN 77-345,141. PUB. 6-23-2009. FILED 12-5-2007.
- 3,678,326 (*See Class 9 for this trademark*).
- 3,678,384. **SAW'U SOMEONE ALWAYS WATCHING YOU AND DESIGN**. THOMPSON, VERONICA LEE, (U.S. CLS. 22 AND 39). SN 77-420,435. PUB. 6-23-2009. FILED S.R. 3-12-2008; AM. P.R. 11-20-2008.
- 3,678,395. **JAY GODFREY (BLOCK FORM)**. YUD YUD, LLC, (U.S. CLS. 22 AND 39). SN 77-431,927. PUB. 6-23-2009. FILED 3-26-2008.
- 3,678,407. **CAP STAR (BLOCK FORM)**. MCCALLUM, TIM, (U.S. CLS. 22 AND 39). SN 77-442,881. PUB. 6-23-2009. FILED 4-8-2008.
- 3,678,412. **ALPINE COWBOY (BLOCK FORM)**. ALPINE COWBOY, LLC, (U.S. CLS. 22 AND 39). SN 77-444,394. PUB. 3-17-2009. FILED 4-9-2008.
- 3,678,413. **SHIRLEY PEAR (BLOCK FORM)**. SHIRLEYPEAR LINGERIE LLC, (U.S. CLS. 22 AND 39). SN 77-447,399. PUB. 6-23-2009. FILED 4-14-2008.
- 3,678,435. **ICGARA (BLOCK FORM)**. RICHIE, KARLA, (U.S. CLS. 22 AND 39). SN 77-470,017. PUB. 6-23-2009. FILED 5-9-2008.
- 3,678,438. **ZOE D. (BLOCK FORM)**. MALCOLM & CO. LLC, (U.S. CLS. 22 AND 39). SN 77-475,314. PUB. 6-23-2009. FILED 5-15-2008.
- 3,678,443. **"IT'S THE ONLY GAME." PRIDE OF THE DIAMOND (BLOCK FORM)**. THE NEIMAN SPORTS GROUP, INC., DBA PRIDE OF THE DIAMOND AND IT'S THE ONLY GAME, (U.S. CLS. 22 AND 39). SN 77-477,787. PUB. 6-23-2009. FILED 5-19-2008.
- 3,678,456. **FAKEWORK (STYLIZED)**. FAKE WORK, INC., (U.S. CLS. 22 AND 39). SN 77-490,387. PUB. 10-28-2008. FILED 6-4-2008.
- 3,678,461. **MINISH (BLOCK FORM)**. BATISTA, WILLIAM, (U.S. CLS. 22 AND 39). SN 77-495,413. PUB. 6-23-2009. FILED 6-10-2008.
- 3,678,465. **MUCH THE BEST AND DESIGN**. THAT'S RACING, LLC, (U.S. CLS. 22 AND 39). SN 77-497,662. PUB. 6-23-2009. FILED 6-12-2008.
- 3,678,482 (*See Class 16 for this trademark*).
- 3,678,501. **SHU RYU (BLOCK FORM)**. SHUHSIENLIN, INC, (U.S. CLS. 22 AND 39). SN 77-514,143. PUB. 3-10-2009. FILED 7-2-2008.
- 3,678,503. **BARRA BRAVA (BLOCK FORM)**. ZAMBRANA, OSCAR, (U.S. CLS. 22 AND 39). SN 77-516,004. PUB. 6-23-2009. FILED 7-7-2008.
- 3,678,511. **A (STYLIZED)**. PERFORM GROUP, LLC, (U.S. CLS. 22 AND 39). SN 77-519,024. PUB. 6-23-2009. FILED 7-10-2008.
- 3,678,522 (*See Class 14 for this trademark*).
- 3,678,565. **ROT RALLY (BLOCK FORM)**. REPUBLIC OF TEXAS BIKER RALLY, INC., MULTIPLE CLASS, (INT. CLS. 25, 35 AND 41), (U.S. CLS. 22, 39, 100, 101, 102 AND 107). SN 77-530,017. PUB. 6-23-2009. FILED 7-23-2008.
- 3,678,583 (*See Class 7 for this trademark*).
- 3,678,600 (*See Class 3 for this trademark*).
- 3,678,617. **BS BOOTSCOOTS AND DESIGN**. BOOT SCOOT'S LLC, (U.S. CLS. 22 AND 39). SN 77-537,785. PUB. 6-23-2009. FILED 8-3-2008.
- 3,678,628. **THE ISUCO FAIRIES (BLOCK FORM)**. COOPER, EBONI S., DBA SUMMER COOPER COMPANY, (U.S. CLS. 22 AND 39). SN 77-538,678. PUB. 6-23-2009. FILED 8-4-2008.
- 3,678,649. **SWEET POCKETS (BLOCK FORM)**. SWEET POCKETS, LLC, (U.S. CLS. 22 AND 39). SN 77-540,355. PUB. 6-23-2009. FILED 8-6-2008.
- 3,678,662. **MISCELLANEOUS DESIGN**. JONAH CORP, (U.S. CLS. 22 AND 39). SN 77-542,062. PUB. 6-23-2009. FILED 8-7-2008.
- 3,678,663. **GALOOP (BLOCK FORM)**. JONAH CORP, (U.S. CLS. 22 AND 39). SN 77-542,068. PUB. 6-23-2009. FILED 8-7-2008.
- 3,678,665. **MOE & MADI (BLOCK FORM)**. DMG DESIGN LOUNGE, LLC, (U.S. CLS. 22 AND 39). SN 77-542,307. PUB. 6-23-2009. FILED 8-8-2008.
- 3,678,673. **GET GOOD. OR DIE TRYING. AND DESIGN**. GET GOOD, LLC, (U.S. CLS. 22 AND 39). SN 77-542,463. PUB. 6-23-2009. FILED 8-8-2008.
- 3,678,678. **PRIDE INSIDE (BLOCK FORM)**. ASHER A KALEM, (U.S. CLS. 22 AND 39). SN 77-543,061. PUB. 2-17-2009. FILED 8-8-2008.
- 3,678,689. **EDEN BRIDALS (BLOCK FORM)**. EDEN BRIDALS, INC., (U.S. CLS. 22 AND 39). SN 77-546,311. PUB. 6-23-2009. FILED 8-13-2008.
- 3,678,697. **W AND DESIGN**. PREMIER LEGENDS, INC., (U.S. CLS. 22 AND 39). SN 77-547,392. PUB. 6-23-2009. FILED 8-14-2008.
- 3,678,707. **RUFF & TUFF (BLOCK FORM)**. RELIABLE KNITTING WORKS, INC., DBA RELIABLE OF MILWAUKEE, (U.S. CLS. 22 AND 39). SN 77-549,156. PUB. 6-23-2009. FILED 8-18-2008.
- 3,678,734. **OC OCTOBER (STYLIZED)**. ROS FERNANDEZ, MANUEL, MULTIPLE CLASS, (INT. CLS. 25 AND 35), (U.S. CLS. 22, 39, 100, 101 AND 102). SN 77-556,103. PUB. 3-3-2009. FILED 8-26-2008.
- 3,678,760. **STREETSHIRTS (BLOCK FORM)**. E CONSULTING UK LTD, MULTIPLE CLASS, (INT. CLS. 25 AND 40), (U.S. CLS. 22, 39, 100, 103 AND 106). SN 77-564,406. PUB. 6-23-2009. FILED 9-8-2008.
- 3,678,774. **STIMULATE THE LITTLE GENIUS IN YOUR ARMS (BLOCK FORM)**. YES! SUPERBABY LIMITED, MULTIPLE CLASS, (INT. CLS. 25, 28 AND 35), (U.S. CLS. 22, 23, 38, 39, 50, 100, 101 AND 102). SN 77-570,416. PUB. 6-23-2009. FILED 9-15-2008.
- 3,678,858. **NO OFFENSE (BLOCK FORM)**. LAUREN P. JONES, MULTIPLE CLASS, (INT. CLS. 25, 26 AND 41), (U.S. CLS. 22, 37, 39, 40, 42, 50, 100, 101 AND 107). SN 77-592,469. PUB. 6-23-2009. FILED 10-14-2008.
- 3,678,894. **SPIRIT MARK (BLOCK FORM)**. MAKE YOUR MARK, INC., DBA SPIRIT MARK, (U.S. CLS. 22 AND 39). SN 77-601,799. PUB. 6-23-2009. FILED 10-28-2008.
- 3,678,898. **BIG WORM MOTORSPORTS (BLOCK FORM)**. MODEROW, DAVID, (U.S. CLS. 22 AND 39). SN 77-602,606. PUB. 6-23-2009. FILED 10-28-2008.
- 3,678,914 (*See Class 14 for this trademark*).
- 3,678,963. **MARYLAND HALF MARATHON AND DESIGN**. UNIVERSITY OF MARYLAND MEDICAL SYSTEM FOUNDATION, INC., MULTIPLE CLASS, (INT. CLS. 25 AND 41), (U.S. CLS. 22, 39, 100, 101 AND 107). SN 77-624,463. PUB. 6-23-2009. FILED 12-2-2008.
- 3,678,973. **LEVRIGE (BLOCK FORM)**. BAKOGEORGE, DEMITRIOS S., (U.S. CLS. 22 AND 39). SN 77-625,993. PUB. 6-23-2009. FILED 12-3-2008.
- 3,679,025. **EXTREME BY EDDIE MARC (STYLIZED)**. EDDIE MARC & CO INC, (U.S. CLS. 22 AND 39). SN 77-640,038. PUB. 6-23-2009. FILED 12-25-2008.
- 3,679,040. **LOGO22 (BLOCK FORM)**. JOHNSON, DARRELL, AND WILLIAMS, HARVEY, (U.S. CLS. 22 AND 39). SN 77-645,162. PUB. 6-23-2009. FILED 1-7-2009.
- 3,679,054. **C GARMENT CHUNG TAI GARMENT FACTORY LTD AND DESIGN**. CHUNG TAI GARMENT FACTORY LIMITED, MULTIPLE CLASS, (INT. CLS. 25, 35 AND 40), (U.S. CLS. 22, 39, 100, 101, 102, 103 AND 106). SN 77-647,919. PUB. 6-23-2009. FILED 1-12-2009.
- 3,679,148. **WAYNA (STYLIZED)**. LERNER, ERIK, DBA WAYNA, LLC, AND LERNER, TRACI W., DBA WAYNA, LLC, (U.S. CLS. 22 AND 39). SN 77-664,685. PUB. 6-23-2009. FILED 2-5-2009.
- 3,679,185. **FUNKY DIVAS & DUDES (BLOCK FORM)**. FUNKY DIVAS, MULTIPLE CLASS, (INT. CLS. 25 AND 41), (U.S. CLS. 22, 39, 100, 101 AND 107). SN 77-667,617. PUB. 6-23-2009. FILED 2-10-2009.
- 3,679,191. **GREENWOODY SKATEBOARDS (BLOCK FORM)**. GREENWOODY, LTD., MULTIPLE CLASS, (INT. CLS. 25 AND 28), (U.S. CLS. 22, 23, 38, 39 AND 50). SN 77-668,372. PUB. 6-23-2009. FILED 2-11-2009.
- 3,679,219. **LIVE TO KITEBOARD KITEBOARD TO LIVE (BLOCK FORM)**. /PHIL MUSUMECI/, AND /BARNEY LANGNER JR./, (U.S. CLS. 22 AND 39). SN 77-670,789. PUB. 6-23-2009. FILED 2-14-2009.
- 3,679,220. **LIVE TO SAIL SAIL TO LIVE (BLOCK FORM)**. PHIL MUSUMECI, AND BARNEY LANGNER JR, (U.S.

- CLS. 22 AND 39). SN 77-670,791. PUB. 6-23-2009. FILED 2-14-2009.
- 3,679,222. **LIVE TO GAMBLE GAMBLE TO LIVE (BLOCK FORM)**. /PHIL MUSUMECI/, AND /BARNEY LANGNER JR./, (U.S. CLS. 22 AND 39). SN 77-670,938. PUB. 6-23-2009. FILED 2-15-2009.
- 3,679,283. **FULL-GORILLA APPAREL WWW.FULLGORILLAAPPAREL.COM AND DESIGN**. PETREYKO, JOHN R., DBA FULL-GORILLA APPAREL, AND ULLRICH, BRIAN, DBA FULL-GORILLA APPAREL, (U.S. CLS. 22 AND 39). SN 77-673,388. PUB. 6-23-2009. FILED 2-19-2009.
- 3,679,321. **LIVING DAY BY DAY (BLOCK FORM)**. IDEA FACTORY ASSOCIATES, LLC, (U.S. CLS. 22 AND 39). SN 77-674,532. PUB. 6-23-2009. FILED 2-20-2009.
- 3,679,328. **LIFE ROLLS ON (BLOCK FORM)**. LIFE ROLLS ON FOUNDATION, MULTIPLE CLASS, (INT. CLS. 25, 36 AND 44), (U.S. CLS. 22, 39, 100, 101 AND 102). SN 77-674,775. PUB. 6-23-2009. FILED 2-20-2009.
- 3,679,347 (*See Class 16 for this trademark*).
- 3,679,355. **REVOLVE JEANS (BLOCK FORM)**. PARK, GEORGE, (U.S. CLS. 22 AND 39). SN 77-675,413. PUB. 6-23-2009. FILED 2-22-2009.
- 3,679,373. **UALBANY ALUMNI ASSOCIATION A AND DESIGN**. UNIVERSITY AT ALBANY, STATE UNIVERSITY OF NEW YORK, (U.S. CLS. 22 AND 39). SN 77-675,721. PUB. 6-23-2009. FILED 2-23-2009.
- 3,679,408. **QVO AND DESIGN**. CORTEZ, ROBERT M., (U.S. CLS. 22 AND 39). SN 77-676,420. PUB. 6-23-2009. FILED 2-23-2009.
- 3,679,449. **DOUBLE TAKE (BLOCK FORM)**. DOUBLE TAKE FASHIONS, INC., (U.S. CLS. 22 AND 39). SN 77-676,962. PUB. 6-23-2009. FILED 2-24-2009.
- 3,679,486. **M AND DESIGN**. LONG BAY PARTNERS, L.L.C., MULTIPLE CLASS, (INT. CLS. 25, 36 AND 37), (U.S. CLS. 22, 39, 100, 101, 102, 103 AND 106). SN 77-677,291. PUB. 6-23-2009. FILED 2-24-2009.
- 3,679,521. **NEVER QUIT (BLOCK FORM)**. KARINA CORP INC, (U.S. CLS. 22 AND 39). SN 77-677,677. PUB. 6-23-2009. FILED 2-25-2009.
- 3,679,546. **POLATIKS (BLOCK FORM)**. ASSERTIVE CREATIVITY LLC, (U.S. CLS. 22 AND 39). SN 77-677,971. PUB. 6-23-2009. FILED 2-25-2009.
- 3,679,588. **INTERNATIONAL STUSSY TRIBE (BLOCK FORM)**. STUSSY, INC., (U.S. CLS. 22 AND 39). SN 77-678,621. PUB. 6-23-2009. FILED 2-26-2009.
- 3,679,589. **INCREASE THE PEACE (BLOCK FORM)**. STUSSY, INC., (U.S. CLS. 22 AND 39). SN 77-678,628. PUB. 6-23-2009. FILED 2-26-2009.
- 3,679,591. **TEESTALK (BLOCK FORM)**. KUO JOANN S, DBA TEESTALK AND FRIENDS, (U.S. CLS. 22 AND 39). SN 77-678,634. PUB. 6-23-2009. FILED 2-26-2009.
- 3,679,592. **MADINA LAKE (BLOCK FORM)**. LEONE, MATTHEW, (U.S. CLS. 22 AND 39). SN 77-678,637. PUB. 6-23-2009. FILED 2-26-2009.
- 3,679,593. **TRUE SHAPES (BLOCK FORM)**. PAREDES, CENIA, (U.S. CLS. 22 AND 39). SN 77-678,639. PUB. 6-23-2009. FILED 2-26-2009.
- 3,679,596. **CAMIFIT (BLOCK FORM)**. THE REAL CO., INC, (U.S. CLS. 22 AND 39). SN 77-678,770. PUB. 6-23-2009. FILED 2-26-2009.
- 3,679,642. **HOBABI (BLOCK FORM)**. ZAFARALLA, JEREMY F, AKA JEREMY, (U.S. CLS. 22 AND 39). SN 77-679,401. PUB. 6-23-2009. FILED 2-26-2009.
- 3,679,648. **DESIGNBYNUI.COM (BLOCK FORM)**. DESIGN BY NUI, (U.S. CLS. 22 AND 39). SN 77-679,497. PUB. 6-23-2009. FILED 2-26-2009.
- 3,679,665. **CASHMERA-TEK (BLOCK FORM)**. FLEET STREET, LTD., (U.S. CLS. 22 AND 39). SN 77-679,959. PUB. 6-23-2009. FILED 2-27-2009.
- 3,679,669. **MODASTEN (BLOCK FORM)**. DROR, GIL, (U.S. CLS. 22 AND 39). SN 77-680,000. PUB. 6-23-2009. FILED 2-27-2009.
- 3,679,686. **GAMEGLOVE (BLOCK FORM)**. SHOPKO STORES OPERATING CO., LLC, (U.S. CLS. 22 AND 39). SN 77-680,294. PUB. 6-23-2009. FILED 2-27-2009.
- 3,679,706. **ALIX & KELLY (BLOCK FORM)**. AK DESIGNS, LLC, (U.S. CLS. 22 AND 39). SN 77-680,647. PUB. 6-23-2009. FILED 2-27-2009.
- 3,679,740. **NEW POLATIKS (BLOCK FORM)**. ASSERTIVE CREATIVITY LLC, (U.S. CLS. 22 AND 39). SN 77-688,466. PUB. 6-23-2009. FILED 3-11-2009.
- 3,679,774. **PPD (STYLIZED)**. PREMIUM DENIM, LLC, (U.S. CLS. 22 AND 39). SN 77-705,367. PUB. 6-23-2009. FILED 4-2-2009.
- 3,679,792 (*See Class 3 for this trademark*).
- 3,679,798. **HALO AND DESIGN**. SWITCHBACK, LLC, (U.S. CLS. 22 AND 39). SN 78-274,452. PUB. 9-2-2008. FILED 7-15-2003.
- 3,679,799 (*See Class 24 for this trademark*).
- 3,679,801. **JOE COLLEGE AUTHENTIC SPORTS AND DESIGN**. LAWSON'S SALES COMPANY, INC., (U.S. CLS. 22 AND 39). SN 78-399,436. PUB. 1-20-2009. FILED 4-9-2004.
- 3,679,822 (*See Class 24 for this trademark*).
- 3,679,824 (*See Class 4 for this trademark*).
- 3,679,825 (*See Class 4 for this trademark*).
- 3,679,830 (*See Class 16 for this trademark*).
- 3,679,838 (*See Class 1 for this trademark*).
- 3,679,845 (*See Class 9 for this trademark*).
- 3,679,848. **ARDISTIA NEW YORK AND DESIGN**. ARDISTIA DESIGN WORKS INC., (U.S. CLS. 22 AND 39). SN 78-930,448. PUB. 2-27-2007. FILED 7-16-2006.
- 3,679,850 (*See Class 9 for this trademark*).
- 3,679,852. **TONI (BLOCK FORM)**. WEBER & OTT AG, (U.S. CLS. 22 AND 39). SN 79-008,931. PUB. 5-16-2006. FILED 12-22-2004.
- 3,679,853. **TONI DRESS AND DESIGN**. WEBER & OTT AG, (U.S. CLS. 22 AND 39). SN 79-009,099. PUB. 5-16-2006. FILED 2-7-2005.
- 3,679,856 (*See Class 24 for this trademark*).
- 3,679,858 (*See Class 9 for this trademark*).
- 3,679,885 (*See Class 24 for this trademark*).
- 3,679,898 (*See Class 14 for this trademark*).
- 3,679,912 (*See Class 18 for this trademark*).
- 3,679,917 (*See Class 14 for this trademark*).
- 3,679,944. **PLA SOLE AND DESIGN**. PRESS CONTROL CO., LTD., (U.S. CLS. 22 AND 39). SN 79-059,244. PUB. 6-23-2009. FILED 9-4-2008.
- 3,679,947 (*See Class 9 for this trademark*).
- 3,679,948 (*See Class 16 for this trademark*).
- 3,679,952. **YESMEEN K (BLOCK FORM)**. YASMINE KHALI, (U.S. CLS. 22 AND 39). SN 79-059,492. PUB. 6-23-2009. FILED 4-21-2008.
- 3,679,957 (*See Class 3 for this trademark*).
- 3,679,981. **XTG EXTREME GAME SWIMWEAR UNDERWEAR AND DESIGN**. MENTADO MEDINA, ANTONIO LUIS, (U.S. CLS. 22 AND 39). SN 79-060,687. PUB. 6-23-2009. FILED 5-19-2008.
- 3,679,989 (*See Class 7 for this trademark*).
- 3,679,999. **LOLATORRES (STYLIZED)**. TOWERS CAPITAL S.L., (U.S. CLS. 22 AND 39). SN 79-061,618. PUB. 6-23-2009. FILED 8-5-2008.
- 3,680,000. **J.C. RAGS AND DESIGN**. J.C. RAGS B.V., (U.S. CLS. 22 AND 39). SN 79-061,772. PUB. 6-23-2009. FILED 10-7-2008.
- 3,680,004 (*See Class 18 for this trademark*).
- 3,680,006. **GATTINA AND DESIGN**. BAD HERSFELDER DESSOUS; BÜTEFÜR & HENSEL GMBH, (U.S. CLS. 22 AND 39). SN 79-062,367. PUB. 6-23-2009. FILED 10-24-2008.
- 3,680,020 (*See Class 16 for this trademark*).
- 3,680,026 (*See Class 18 for this trademark*).
- 3,680,044 (*See Class 2 for this trademark*).

CLASS 26—FANCY GOODS

- 3,678,209 (*See Class 14 for this trademark*).
- 3,678,326 (*See Class 9 for this trademark*).
- 3,678,496. **GABRIELLA (BLOCK FORM)**. BYUNG JOO CHOI, DBA KONEX, (U.S. CLS. 37, 39, 40, 42 AND 50). SN 77-512,219. PUB. 6-23-2009. FILED 7-1-2008.
- 3,678,858 (*See Class 25 for this trademark*).
- 3,678,951. **81 (BLOCK FORM)**. HELLS ANGELS MOTORCYCLE CORPORATION, (U.S. CLS. 37, 39, 40, 42 AND 50). SN 77-620,273. PUB. 3-17-2009. FILED 11-23-2008.
- 3,679,085. **MIRAGE SAGO PALM (BLOCK FORM)**. MIRAGE

PLANTS INC. (U.S. CLS. 37, 39, 40, 42 AND 50). SN 77-654,731. PUB. 6-23-2009. FILED 1-22-2009.
 3,679,313. **POWERBOWS (BLOCK FORM)**. POWERBOWS, LLC. (U.S. CLS. 37, 39, 40, 42 AND 50). SN 77-674,367. PUB. 6-23-2009. FILED 2-20-2009.
 3,679,861 (*See Class 3 for this trademark*).

CLASS 27—FLOOR COVERINGS

3,678,200. **R (STYLIZED)**. WILLIAM MARSH RICE UNIVERSITY. (U.S. CLS. 19, 20, 37, 42 AND 50). SN 76-696,290. PUB. 6-23-2009. FILED 3-13-2009.
 3,678,301 (*See Class 11 for this trademark*).
 3,678,598. **L7 (BLOCK FORM)**. COLUMBIA INSURANCE COMPANY. (U.S. CLS. 19, 20, 37, 42 AND 50). SN 77-535,630. PUB. 6-23-2009. FILED 7-31-2008.
 3,678,962. **RAMTURF (BLOCK FORM)**. ATG SPORTS INDUSTRIES, INC., (U.S. CLS. 19, 20, 37, 42 AND 50). SN 77-624,390. PUB. 6-23-2009. FILED 12-2-2008.
 3,679,208. **MDC WALLCOVERINGS (BLOCK FORM)**. EPKO INDUSTRIES, INC., MULTIPLE CLASS, (INT. CLS. 27 AND 35), (U.S. CLS. 19, 20, 37, 42, 50, 100, 101 AND 102). SN 77-669,743. PUB. 6-23-2009. FILED 2-12-2009.
 3,679,806 (*See Class 4 for this trademark*).
 3,679,838 (*See Class 1 for this trademark*).

CLASS 28—TOYS AND SPORTING GOODS

3,678,166. **SPORT CORD (BLOCK FORM)**. SEA TIES, INC., (U.S. CLS. 22, 23, 38 AND 50). SN 76-689,859. PUB. 6-23-2009. FILED 5-21-2008.
 3,678,199. **REINS (BLOCK FORM)**. REIN & CO., LTD., (U.S. CLS. 22, 23, 38 AND 50). SN 76-695,917. PUB. 6-23-2009. FILED 2-23-2009.
 3,678,203. **THE BALANCED GOLFER (BLOCK FORM)**. ROSA, JIM, (U.S. CLS. 22, 23, 38 AND 50). SN 77-008,979. PUB. 6-23-2009. FILED 9-27-2006.
 3,678,227 (*See Class 9 for this trademark*).
 3,678,615. **BP BASEBALL-PERFORMANCE.COM CAN YOU HEAR THE BALL SCREAM? AND DESIGN**. BASEBALL PERFORMANCE LLC, AKA BASEBALL-PERFORMANCE, (U.S. CLS. 22, 23, 38 AND 50). SN 77-537,692. PUB. 6-23-2009. FILED 8-2-2008.
 3,678,657. **WILIS (BLOCK FORM)**. ROW BALANCE, INC., (U.S. CLS. 22, 23, 38 AND 50). SN 77-541,638. PUB. 6-23-2009. FILED 8-7-2008.
 3,678,728. **RAJ (BLOCK FORM)**. MATTEL, INC., (U.S. CLS. 22, 23, 38 AND 50). SN 77-555,245. PUB. 6-23-2009. FILED 8-25-2008.
 3,678,762. **AIRSHOT SUPER DROP (BLOCK FORM)**. MATTEL, INC., (U.S. CLS. 22, 23, 38 AND 50). SN 77-565,111. PUB. 6-23-2009. FILED 9-8-2008.
 3,678,774 (*See Class 25 for this trademark*).
 3,678,799. **DROP FORCE (BLOCK FORM)**. MATTEL, INC., (U.S. CLS. 22, 23, 38 AND 50). SN 77-576,463. PUB. 6-23-2009. FILED 9-23-2008.
 3,678,826. **FLY WHEELS (BLOCK FORM)**. JAKKS PACIFIC, INC., (U.S. CLS. 22, 23, 38 AND 50). SN 77-583,626. PUB. 6-23-2009. FILED 10-1-2008.
 3,678,836. **NEWAGE-RC (STYLIZED)**. NOVATECH ENTERPRISE CO., LTD., (U.S. CLS. 22, 23, 38 AND 50). SN 77-585,708. PUB. 6-23-2009. FILED 10-4-2008.
 3,678,890. **JUST PLANE FUN (BLOCK FORM)**. DOUG WATSON, DBA JUST PLANE FUN, (U.S. CLS. 22, 23, 38 AND 50). SN 77-600,537. PUB. 6-23-2009. FILED 10-25-2008.
 3,678,923. **BATTLE OF THE SEXES (BLOCK FORM)**. IMAGINATION HOLDINGS PTY LTD, (U.S. CLS. 22, 23, 38 AND 50). SN 77-610,566. PUB. 6-23-2009. FILED 11-9-2008.
 3,679,043. **DAZZLE (BLOCK FORM)**. MOTT, JAMES H., (U.S. CLS. 22, 23, 38 AND 50). SN 77-645,888. PUB. 6-23-2009. FILED 1-8-2009.
 3,679,141 (*See Class 9 for this trademark*).
 3,679,191 (*See Class 25 for this trademark*).

3,679,297. **HALT HALT AND DESIGN**. SANTA'S TOY CORPORATION. (U.S. CLS. 22, 23, 38 AND 50). SN 77-673,883. PUB. 6-23-2009. FILED 2-19-2009.
 3,679,342. **SIMPLEXITY (BLOCK FORM)**. MOREFUNNER, LLC, DBA BRAIN BENDER GAMES, (U.S. CLS. 22, 23, 38 AND 50). SN 77-675,136. PUB. 6-23-2009. FILED 2-20-2009.
 3,679,343. **RAVE AND DESIGN**. CJ YOUNGBLOOD ENTERPRISES, INC., (U.S. CLS. 22, 23, 38 AND 50). SN 77-675,155. PUB. 6-23-2009. FILED 2-20-2009.
 3,679,356. **CYPHERCUBE (BLOCK FORM)**. CSK HOLDINGS LLC, (U.S. CLS. 22, 23, 38 AND 50). SN 77-675,457. PUB. 6-23-2009. FILED 2-22-2009.
 3,679,368. **JINGLENOG AND DESIGN**. JINGLEBELL INC., DBA JINGLENOG, (U.S. CLS. 22, 23, 38 AND 50). SN 77-675,639. PUB. 6-23-2009. FILED 2-23-2009.
 3,679,393 (*See Class 9 for this trademark*).
 3,679,404. **SUNTAN TARGET (BLOCK FORM)**. PRETTY UGLY LLC, AND HORVATH, DAVID, AND KIM, SUNMIN, (U.S. CLS. 22, 23, 38 AND 50). SN 77-676,347. PUB. 6-23-2009. FILED 2-23-2009.
 3,679,434. **ACCU-CULL (BLOCK FORM)**. LUCKY2CREATIONS, LLC, (U.S. CLS. 22, 23, 38 AND 50). SN 77-676,803. PUB. 6-23-2009. FILED 2-24-2009.
 3,679,478. **STORY ORNAMENTS (BLOCK FORM)**. STORY ORNAMENTS, LLC, (U.S. CLS. 22, 23, 38 AND 50). SN 77-677,188. PUB. 6-23-2009. FILED 2-24-2009.
 3,679,505. **BRAIN BENDER GAMES (BLOCK FORM)**. MOREFUNNER, LLC, DBA BRAIN BENDER GAMES, (U.S. CLS. 22, 23, 38 AND 50). SN 77-677,491. PUB. 6-23-2009. FILED 2-24-2009.
 3,679,506. **SIMPLEXITY SIMPLE TO LEARN / COMPLEX TO MASTER AND DESIGN**. MOREFUNNER, LLC, DBA BRAIN BENDER GAMES, (U.S. CLS. 22, 23, 38 AND 50). SN 77-677,517. PUB. 6-23-2009. FILED 2-24-2009.
 3,679,509. **BRAIN BENDER GAMES "NO STRAIN NO GAIN" AND DESIGN**. MOREFUNNER, LLC, DBA BRAIN BENDER GAMES, (U.S. CLS. 22, 23, 38 AND 50). SN 77-677,546. PUB. 6-23-2009. FILED 2-24-2009.
 3,679,528. **CHARTER OAK (BLOCK FORM)**. OUTRAGEOUS VENTURES, INC., DBA BIG MOUTH TOYS, (U.S. CLS. 22, 23, 38 AND 50). SN 77-677,748. PUB. 6-23-2009. FILED 2-25-2009.
 3,679,673. **ARIES (BLOCK FORM)**. SEA STRIKER INTERNATIONAL LLC, (U.S. CLS. 22, 23, 38 AND 50). SN 77-680,050. PUB. 6-23-2009. FILED 2-27-2009.
 3,679,679. **CORVUS (BLOCK FORM)**. SEA STRIKER INTERNATIONAL LLC, (U.S. CLS. 22, 23, 38 AND 50). SN 77-680,167. PUB. 6-23-2009. FILED 2-27-2009.
 3,679,684. **PLAY A BETTER BALL (BLOCK FORM)**. ROGER CLEVELAND GOLF COMPANY, INC., (U.S. CLS. 22, 23, 38 AND 50). SN 77-680,256. PUB. 6-23-2009. FILED 2-27-2009.
 3,679,696. **BIO-OSCILLATION (BLOCK FORM)**. PINEAPPLE PLANET, INC., (U.S. CLS. 22, 23, 38 AND 50). SN 77-680,468. PUB. 6-23-2009. FILED 2-27-2009.
 3,679,829. **BRISTLE BLOCKS (BLOCK FORM)**. BATTAT INCORPORATED, (U.S. CLS. 22, 23, 38 AND 50). SN 78-812,307. PUB. 7-10-2007. FILED 2-10-2006.
 3,679,836. **XCALIBUR (BLOCK FORM)**. INTERSPORT NORH AMERICA LTD., (U.S. CLS. 22, 23, 38 AND 50). SN 78-843,032. PUB. 6-23-2009. FILED 3-22-2006.
 3,679,845 (*See Class 9 for this trademark*).
 3,679,846 (*See Class 9 for this trademark*).
 3,679,854 (*See Class 9 for this trademark*).
 3,679,858 (*See Class 9 for this trademark*).
 3,679,880. **S1 (STYLIZED)**. TASK FORCE PROPERTIES; & INVESTMENTS LTD, (U.S. CLS. 22, 23, 38 AND 50). SN 79-051,177. PUB. 6-23-2009. FILED 10-4-2007.
 3,679,881. **S1 SPORT (STYLIZED)**. TASK FORCE PROPERTIES; & INVESTMENTS LTD, (U.S. CLS. 22, 23, 38 AND 50). SN 79-051,179. PUB. 6-23-2009. FILED 10-4-2007.
 3,680,024. **HYPOXI (BLOCK FORM)**. HYPOXI PRODUKTIONS- UND VERTRIEBS GMBH, MULTIPLE CLASS, (INT. CLS. 28, 41 AND 44), (U.S. CLS. 22, 23, 38, 50, 100, 101 AND 107). SN 79-063,595. PUB. 6-23-2009. FILED 10-23-2008.
 3,680,037. **ZOOEVOLUTION (BLOCK FORM)**. WEB&CIRCUS AS, MULTIPLE CLASS, (INT. CLS. 28, 35, 41 AND 42), (U.S. CLS. 22, 23, 38, 50, 100, 101, 102 AND 107). SN 79-065,113. PUB. 6-23-2009. FILED 3-26-2008.

CLASS 29—MEATS AND PROCESSED FOODS

- 3,678,165. **SUPREME MACKEREL BRAND IN TOMATO SAUCE IN TOMATO SAUCE AND DESIGN.** KONUWA, DENNIS KINI, (U.S. CL. 46). SN 76-688,752. PUB. 6-23-2009. FILED 4-18-2008.
- 3,678,226. **INDIA BRAND (STYLIZED).** INDIA TEA & SPICES, INC., MULTIPLE CLASS, (INT. CLS. 29, 30 AND 35), (U.S. CLS. 46, 100, 101 AND 102). SN 77-142,946. PUB. 6-23-2009. FILED 3-28-2007.
- 3,678,376. **MISCELLANEOUS DESIGN.** RICHIN TRADING INC., (U.S. CL. 46). SN 77-414,791. PUB. 3-31-2009. FILED 3-6-2008.
- 3,678,391. **PRO FUSION AND DESIGN.** KHONG GUAN CORPORATION, DBA KGC, AND TO WEI INC., DBA KING WAI TRADING CO., (U.S. CL. 46). SN 77-427,775. PUB. 6-23-2009. FILED 3-20-2008.
- 3,678,398. **TRUE WORLD FOODS TSUKIJI EXPRESS AND DESIGN.** TRUE WORLD HOLDINGS LLC, (U.S. CL. 46). SN 77-434,679. PUB. 6-23-2009. FILED 3-28-2008.
- 3,678,431. **SALSA KING (BLOCK FORM).** PRINCE OF SALSA, LLC, DBA THE SALSA KING, MULTIPLE CLASS, (INT. CLS. 29 AND 30), (U.S. CL. 46). SN 77-463,015. PUB. 6-23-2009. FILED 5-1-2008.
- 3,678,647 (*See Class 2 for this trademark*).
- 3,678,701. **NUTTY OCCASIONS AND DESIGN.** NUTTY OCCASIONS, LLC, (U.S. CL. 46). SN 77-547,962. PUB. 6-23-2009. FILED 8-15-2008.
- 3,678,718. **DAYCATCH (BLOCK FORM).** DAYCATCH A/S, (U.S. CL. 46). SN 77-552,633. PUB. 6-23-2009. FILED 8-21-2008.
- 3,678,737. **LA CHÂTELAINES CHOCOLAT CO. (BLOCK FORM).** LA CHÂTELAINES CHOCOLAT CO., DBA LA CHÂTELAINES CHOCOLAT CO., MULTIPLE CLASS, (INT. CLS. 29 AND 30), (U.S. CL. 46). SN 77-556,751. PUB. 6-23-2009. FILED 8-27-2008.
- 3,678,778. **CACHE VALLEY (BLOCK FORM).** DAIRY FARMERS OF AMERICA, INC., (U.S. CL. 46). SN 77-571,221. PUB. 2-3-2009. FILED 9-16-2008.
- 3,678,796. **FOOD CLUB SINCE 1945 AND DESIGN.** TOPCO HOLDINGS, INC., MULTIPLE CLASS, (INT. CLS. 29 AND 30), (U.S. CL. 46). SN 77-575,849. PUB. 6-23-2009. FILED 9-22-2008.
- 3,678,797. **FULL CIRCLE (BLOCK FORM).** TOPCO HOLDINGS, INC., (U.S. CL. 46). SN 77-575,864. PUB. 6-23-2009. FILED 9-22-2008.
- 3,678,845. **CHICKLESS (BLOCK FORM).** THE WEDGE, DBA EATINGTOLIVE, (U.S. CL. 46). SN 77-588,782. PUB. 3-17-2009. FILED 10-8-2008.
- 3,678,896. **FISH 4 FUTURE SUSTAINABLE FISHERIES & AQUACULTURE. AND FISH4FUTURE.ORG AND DESIGN.** BAYSHORE AG, MULTIPLE CLASS, (INT. CLS. 29 AND 31), (U.S. CLS. 1 AND 46). SN 77-602,473. PUB. 6-23-2009. FILED 10-28-2008.
- 3,678,906. **EST. 1853 THOMAS E. WILSON FINE QUALITY MEATS GUARANTEED AND DESIGN.** TYSON FOODS, INC., (U.S. CL. 46). SN 77-605,214. PUB. 6-23-2009. FILED 10-31-2008.
- 3,679,142. **CAL-ORGANIC FARMS HEALTHY BY CHOICE SINCE 1984 AND DESIGN.** GRIMMWAY ENTERPRISES, INC., MULTIPLE CLASS, (INT. CLS. 29 AND 31), (U.S. CLS. 1 AND 46). SN 77-664,005. PUB. 6-23-2009. FILED 2-5-2009.
- 3,679,153. **TATER Q (BLOCK FORM).** SCHWARTZ, MAX A., (U.S. CL. 46). SN 77-665,332. PUB. 6-23-2009. FILED 2-6-2009.
- 3,679,425. **MISCELLANEOUS DESIGN.** GLOBAL FOODS INTERNATIONAL, INC., (U.S. CL. 46). SN 77-676,685. PUB. 6-23-2009. FILED 2-24-2009.
- 3,679,721. **THEY'RE HAPPY, YOU'RE HAPPY (BLOCK FORM).** FRITO-LAY NORTH AMERICA, INC., MULTIPLE CLASS, (INT. CLS. 29 AND 30), (U.S. CL. 46). SN 77-682,101. PUB. 6-23-2009. FILED 3-3-2009.
- 3,679,789. **SEAL OF ARIZONA UDA AND DESIGN.** UNITED DAIRYMEN OF ARIZONA, (U.S. CL. 46). SN 77-975,560. PUB. 6-23-2009. FILED 9-26-2006.
- 3,679,812. **ADAMS RESERVE (BLOCK FORM).** GREAT LAKES CHEESE COMPANY, INC., (U.S. CL. 46). SN 78-649,462. PUB. 6-23-2009. FILED 6-13-2005.
- 3,679,849. **TROPICAL (BLOCK FORM).** TORN & GLASSER,

- INC., (U.S. CL. 46). SN 78-967,204. PUB. 5-6-2008. FILED 9-5-2006.
- 3,679,865. **OLIO & ITALIA AND DESIGN.** COLLEGIO TOSCANO DEGLI OLIVICOLTORI OL.MA.SAC. MULTIPLE CLASS, (INT. CLS. 29 AND 30), (U.S. CL. 46). SN 79-047,136. PUB. 6-23-2009. FILED 10-30-2007.
- 3,679,879. **ACTOBIOTICS (BLOCK FORM).** ACTOGENIX,; NAAMLOZE VENNOOTSCHAP, MULTIPLE CLASS, (INT. CLS. 29 AND 42), (U.S. CLS. 46, 100 AND 101). SN 79-051,120. PUB. 6-23-2009. FILED 12-10-2007.
- 3,679,936. **FRICO AND DESIGN.** FRIESLAND BRANDS BV, (U.S. CL. 46). SN 79-058,915. PUB. 6-23-2009. FILED 7-9-2008.
- 3,679,971 (*See Class 5 for this trademark*).
- 3,679,975 (*See Class 5 for this trademark*).
- 3,679,982. **GRANCINO (BLOCK FORM).** HOFMEISTER VERMÖGENSVERWALTUNGS; GMBH & CO. KG, (U.S. CL. 46). SN 79-060,753. PUB. 6-23-2009. FILED 8-27-2008.
- 3,680,020 (*See Class 16 for this trademark*).

CLASS 30—STAPLE FOODS

- 3,678,158. **DELFINI D SINCE 1964 QUALITA INFINITA AND DESIGN.** LISA DELFINI, (U.S. CL. 46). SN 76-676,765. PUB. 11-27-2007. FILED 5-14-2007.
- 3,678,167. **CAFES PONT DECAF SABORINALTERABLE PROTECTORA. ENVAS PRESSURITZAT. AND DESIGN.** CAFES PONT, S.L., (U.S. CL. 46). SN 76-690,512. PUB. 6-23-2009. FILED 6-12-2008.
- 3,678,190. **EXTRA!EXTRA! (BLOCK FORM).** LC TRADEMARKS, INC., MULTIPLE CLASS, (INT. CLS. 30 AND 43), (U.S. CLS. 46, 100 AND 101). SN 76-694,751. PUB. 6-23-2009. FILED 12-5-2008.
- 3,678,226 (*See Class 29 for this trademark*).
- 3,678,431 (*See Class 29 for this trademark*).
- 3,678,455. **EARL OF SANDWICH (BLOCK FORM).** EARL OF SANDWICH (FAMILYCO) AG, (U.S. CL. 46). SN 77-489,733. PUB. 6-23-2009. FILED 6-3-2008.
- 3,678,475. **CHIT'S (STYLIZED).** WARD, STANTON, MULTIPLE CLASS, (INT. CLS. 30 AND 43), (U.S. CLS. 46, 100 AND 101). SN 77-500,441. PUB. 6-23-2009. FILED 6-17-2008.
- 3,678,483. **MAURIPAN (BLOCK FORM).** AB MAURI TECHNOLOGY PTY LIMITED, (U.S. CL. 46). SN 77-505,345. PUB. 6-23-2009. FILED 6-23-2008.
- 3,678,588. **THE DEBRA (BLOCK FORM).** NEWCO DINING, LLC, (U.S. CL. 46). SN 77-534,842. PUB. 6-23-2009. FILED 7-30-2008.
- 3,678,647 (*See Class 2 for this trademark*).
- 3,678,735. **KINGBOR AND DESIGN.** BORRAS, S.L. DE PRODUCTOS ALIMENTICIOS, (U.S. CL. 46). SN 77-556,147. PUB. 2-3-2009. FILED 8-26-2008.
- 3,678,737 (*See Class 29 for this trademark*).
- 3,678,796 (*See Class 29 for this trademark*).
- 3,678,815. **REVIVE (BLOCK FORM).** RYLO PRODUCTS LLC, (U.S. CL. 46). SN 77-581,603. PUB. 6-23-2009. FILED 9-29-2008.
- 3,678,877. **TORNADOS AND DESIGN.** RUIZ FOOD PRODUCTS, INC., (U.S. CL. 46). SN 77-598,480. PUB. 6-23-2009. FILED 10-22-2008.
- 3,678,920. **A TASTE OF LIFE PRAEVENTIA AND DESIGN.** BISCUITS LECLERC LTEE, AKA BISCUITS LECLERC LTD., (U.S. CL. 46). SN 77-610,455. PUB. 6-23-2009. FILED 11-8-2008.
- 3,678,958. **NEVE ICE (BLOCK FORM).** DOZOIS, MICHEL, DBA NEVE LUXURY ICE COMPANY, (U.S. CL. 46). SN 77-623,262. PUB. 6-23-2009. FILED 11-29-2008.
- 3,678,959. **NÈVE ICE AND DESIGN.** DOZOIS, MICHEL, DBA NEVE LUXURY ICE COMPANY, (U.S. CL. 46). SN 77-623,279. PUB. 6-23-2009. FILED 11-29-2008.
- 3,678,972. **WHIMSICAL WHOOPIES (BLOCK FORM).** THE KROGER CO. OF MICHIGAN, (U.S. CL. 46). SN 77-625,935. PUB. 3-17-2009. FILED 12-3-2008.
- 3,679,009. **ORGANIC & PURE (BLOCK FORM).** KEHE FOOD DISTRIBUTORS, INC., (U.S. CL. 46). SN 77-634,978. PUB. 6-23-2009. FILED 12-17-2008.
- 3,679,031. **P.O.P. CANDY BUTTER CRUNCH TREATS FRESHLY MADE IN SANTA MONICA, CA GOPOPCAN-**

- DY.COM AND DESIGN.** RAQUEL FLORES, DBA P.O.P CANDY CO., AND WILLIAM WAISTE, DBA P.O.P CANDY CO., (U.S. CL. 46). SN 77-642,084. PUB. 6-23-2009. FILED 12-31-2008.
- 3,679,067. **MISCELLANEOUS DESIGN.** JUST KOSHER CAFE & BAKERY, LLC, (U.S. CL. 46). SN 77-650,995. PUB. 6-23-2009. FILED 1-16-2009.
- 3,679,075. **CHIMES GOOD FOOD CH ES AND DESIGN.** PRINCE DONUTS, INC., (U.S. CL. 46). SN 77-652,791. PUB. 6-23-2009. FILED 1-20-2009.
- 3,679,088. **THE SUGAR MONKEY (BLOCK FORM).** JENNIFER BELL, AKA JENNIFER REED, MULTIPLE CLASS, (INT. CLS. 30 AND 40), (U.S. CLS. 46, 100, 103 AND 106). SN 77-655,275. PUB. 6-23-2009. FILED 1-23-2009.
- 3,679,089. **WWW.THESUGARMONKEY.COM PALM BEACH, FL AND DESIGN.** BELL, JENNIFER, AKA JENNIFER REED, MULTIPLE CLASS, (INT. CLS. 30 AND 40), (U.S. CLS. 46, 100, 103 AND 106). SN 77-655,291. PUB. 6-23-2009. FILED 1-23-2009.
- 3,679,170. **CAPPACHILLO COFFEE ON THE COOL SIDE AND DESIGN.** D.C. ENTERPRIZES, INC., (U.S. CL. 46). SN 77-666,274. PUB. 6-23-2009. FILED 2-9-2009.
- 3,679,326. **FLAN-ES-CEDO (BLOCK FORM).** CEDO-GAUDIER, ROBERTO, (U.S. CL. 46). SN 77-674,703. PUB. 6-23-2009. FILED 2-20-2009.
- 3,679,329. **BARISTADORS COFFEE AND DESIGN.** VANPORT COFFEE COMPANY, LLC, MULTIPLE CLASS, (INT. CLS. 30 AND 43), (U.S. CLS. 46, 100 AND 101). SN 77-674,788. PUB. 6-23-2009. FILED 2-20-2009.
- 3,679,333. **MISCELLANEOUS DESIGN.** AGRO WORLD, INC., (U.S. CL. 46). SN 77-674,882. PUB. 6-23-2009. FILED 2-20-2009.
- 3,679,418. **MISCELLANEOUS DESIGN.** JIFF AND JEFF FOODS CORP., (U.S. CL. 46). SN 77-676,619. PUB. 6-23-2009. FILED 2-23-2009.
- 3,679,437. **TERRY'S PIZZA (BLOCK FORM).** STAR MARKET, INC., (U.S. CL. 46). SN 77-676,840. PUB. 6-23-2009. FILED 2-24-2009.
- 3,679,440. **TERRY'S PIZZA...SINCE 1959 AND DESIGN.** STAR MARKET, INC., (U.S. CL. 46). SN 77-676,868. PUB. 6-23-2009. FILED 2-24-2009.
- 3,679,457. **ENJOY LEO'S BRAND BAGELS HOT AND DESIGN.** LEO'S BAGELS HANOVER SQUARE LLC, MULTIPLE CLASS, (INT. CLS. 30, 35 AND 43), (U.S. CLS. 46, 100, 101 AND 102). SN 77-677,053. PUB. 6-23-2009. FILED 2-24-2009.
- 3,679,483. **MOUNTAIN FOREST (BLOCK FORM).** MOUNTAIN FOREST, LLC, (U.S. CL. 46). SN 77-677,243. PUB. 6-23-2009. FILED 2-24-2009.
- 3,679,489. **DELICIOUSLY TART (BLOCK FORM).** CF PREMIUM PRODUCTS, LLC, AND FIORETTO FRANCHISING CORP., (U.S. CL. 46). SN 77-677,299. PUB. 6-23-2009. FILED 2-24-2009.
- 3,679,560. **FOREVER IN A MOMENT (BLOCK FORM).** TEA FORTÉ, INC., (U.S. CL. 46). SN 77-678,178. PUB. 6-23-2009. FILED 2-25-2009.
- 3,679,639. **SWERVE (BLOCK FORM).** WILBERT, CATHERINE, (U.S. CL. 46). SN 77-679,374. PUB. 6-23-2009. FILED 2-26-2009.
- 3,679,661. **PINAKURAT (BLOCK FORM).** FBC WORLDWIDE, LLC, (U.S. CL. 46). SN 77-679,893. PUB. 6-23-2009. FILED 2-27-2009.
- 3,679,674. **SUN CHIPS (STYLIZED).** FRITO-LAY NORTH AMERICA, INC., (U.S. CL. 46). SN 77-680,098. PUB. 6-23-2009. FILED 2-27-2009.
- 3,679,721 (*See Class 29 for this trademark*).
- 3,679,745. **SAY HAPPY EASTER WITH A KISS! (BLOCK FORM).** HERSHEY CHOCOLATE & CONFECTIONERY CORPORATION, (U.S. CL. 46). SN 77-691,408. PUB. 6-23-2009. FILED 3-16-2009.
- 3,679,821. **MAMITA'S (HOME MADE STYLE) AND DESIGN.** MAMITA'S ICES LTD., (U.S. CL. 46). SN 78-743,919. PUB. 6-23-2009. FILED 10-31-2005.
- 3,679,841. **JAVA JOE'S CAFE (BLOCK FORM).** WM. H. LEAHEY ASSOCIATES, INC., (U.S. CL. 46). SN 78-874,573. PUB. 6-23-2009. FILED 5-2-2006.
- 3,679,857. **MAMMA ITALIA BY INDIAN AND DESIGN.** INDIAN S.R.L., (U.S. CL. 46). SN 79-033,193. PUB. 6-23-2009. FILED 7-27-2006.
- 3,679,865 (*See Class 29 for this trademark*).
- 3,679,963. **NOT GUILTY (BLOCK FORM).** NOT GUILTY GASTRONOMIE AG, MULTIPLE CLASS, (INT. CLS. 30, 32 AND 43), (U.S. CLS. 45, 46, 48, 100 AND 101). SN 79-059,845. PUB. 6-23-2009. FILED 8-7-2008.
- 3,679,971 (*See Class 5 for this trademark*).
- 3,679,975 (*See Class 5 for this trademark*).
- 3,679,989 (*See Class 7 for this trademark*).
- 3,680,007 (*See Class 1 for this trademark*).
- 3,680,013. **MISCELLANEOUS DESIGN.** TERRAMARK MARKENCREATION GMBH, (U.S. CL. 46). SN 79-063,068. PUB. 6-23-2009. FILED 11-3-2008.
- 3,680,020 (*See Class 16 for this trademark*).
- 3,680,036. **CONDORELLI AND DESIGN.** I.D.B. INDUSTRIA DOLCIARIA; Belpasso S.P.A., (U.S. CL. 46). SN 79-064,605. PUB. 6-23-2009. FILED 11-25-2008.
- 3,680,038. **CROCANTERIE (BLOCK FORM).** HORST SCHLUCKWERDER OHG, (U.S. CL. 46). SN 79-065,231. PUB. 6-23-2009. FILED 2-4-2009.

CLASS 31—NATURAL AGRICULTURAL PRODUCTS

- 3,678,205. **JIN WOO VET. PHARM. CO., LTD. (BLOCK FORM).** JIN WOO VET. PHARM. CO., LTD., (U.S. CLS. 1 AND 46). SN 77-033,557. PUB. 6-23-2009. FILED 10-31-2006.
- 3,678,396. **JUNG SEED GENETICS AND DESIGN.** TRELAY SEED COMPANY, (U.S. CLS. 1 AND 46). SN 77-433,482. PUB. 6-23-2009. FILED 3-27-2008.
- 3,678,896 (*See Class 29 for this trademark*).
- 3,678,949. **FORZA (BLOCK FORM).** FORZAFRUT USA, (U.S. CLS. 1 AND 46). SN 77-620,157. PUB. 6-23-2009. FILED 11-22-2008.
- 3,679,090. **WILD PLANET AND DESIGN.** WILD PLANET FOODS, INC., (U.S. CLS. 1 AND 46). SN 77-655,301. PUB. 6-23-2009. FILED 1-23-2009.
- 3,679,142 (*See Class 29 for this trademark*).
- 3,679,319. **HOW'S MY PICKING? (BLOCK FORM).** WISNATZKI, INC., (U.S. CLS. 1 AND 46). SN 77-674,480. PUB. 6-23-2009. FILED 2-20-2009.
- 3,679,500 (*See Class 5 for this trademark*).
- 3,679,567. **STONE CREEK FARMS (BLOCK FORM).** PLANTPEDDLER, INC., (U.S. CLS. 1 AND 46). SN 77-678,287. PUB. 6-23-2009. FILED 2-25-2009.
- 3,679,677. **DEBENEDETTO FARMS (BLOCK FORM).** DEBENEDETTO FRUIT CO., LLC, (U.S. CLS. 1 AND 46). SN 77-680,113. PUB. 6-23-2009. FILED 2-27-2009.
- 3,679,683. **THE DIFFERENCE IS NUTRITION (BLOCK FORM).** NUTRO PRODUCTS, INC., (U.S. CLS. 1 AND 46). SN 77-680,202. PUB. 6-23-2009. FILED 2-27-2009.
- 3,679,758. **GREENIES SENIOR (BLOCK FORM).** NUTRO PRODUCTS, INC., (U.S. CLS. 1 AND 46). SN 77-697,543. PUB. 6-23-2009. FILED 3-24-2009.
- 3,679,759. **GREENIES LITE (BLOCK FORM).** NUTRO PRODUCTS, INC., (U.S. CLS. 1 AND 46). SN 77-697,555. PUB. 6-23-2009. FILED 3-24-2009.
- 3,679,781. **NUTRO AND DESIGN.** NUTRO PRODUCTS, INC., (U.S. CLS. 1 AND 46). SN 77-710,098. PUB. 6-23-2009. FILED 4-8-2009.
- 3,679,847. **ENZA AND DESIGN.** ENZA LIMITED, (U.S. CLS. 1 AND 46). SN 78-926,904. PUB. 1-20-2009. FILED 7-11-2006.
- 3,679,896. **MISCELLANEOUS DESIGN.** PINGYI SEED CO.LTD, (U.S. CLS. 1 AND 46). SN 79-055,771. PUB. 6-23-2009. FILED 6-24-2008.
- 3,679,975 (*See Class 5 for this trademark*).
- 3,680,009 (*See Class 1 for this trademark*).
- 3,680,034. **KIEROYAL (BLOCK FORM).** ANTON PLATTNER, (U.S. CLS. 1 AND 46). SN 79-064,451. PUB. 6-23-2009. FILED 11-5-2008.

CLASS 32—LIGHT BEVERAGES

- 3,678,139. **METAL GURU**. STICHTING LODESTAR, (U.S. CLS. 45, 46 AND 48). SN 76-074,248. PUB. 6-23-2009. FILED 6-20-2000.
- 3,678,293. **SECURITY FEEL BETTER (BLOCK FORM)**. PPN SA, MULTIPLE CLASS. (INT. CLS. 32 AND 33), (U.S. CLS. 45, 46, 47, 48 AND 49). SN 77-311,262. PUB. 6-23-2009. FILED 10-23-2007.
- 3,678,382. **BIOAQA AND DESIGN**. HUSUMER MINERALBRUNNEN HMB GMBH & CO. KG, (U.S. CLS. 45, 46 AND 48). SN 77-419,073. PUB. 11-11-2008. FILED 3-11-2008.
- 3,678,647 (*See Class 2 for this trademark*).
- 3,678,733. **SU FRESH (BLOCK FORM)**. EXPRESS FOODS, INC., (U.S. CLS. 45, 46 AND 48). SN 77-556,056. PUB. 2-24-2009. FILED 8-26-2008.
- 3,678,829. **BUD ICE (BLOCK FORM)**. ANHEUSER-BUSCH, INCORPORATED, (U.S. CLS. 45, 46 AND 48). SN 77-584,300. PUB. 6-23-2009. FILED 10-2-2008.
- 3,678,830. **BUD ICE LIGHT (BLOCK FORM)**. ANHEUSER-BUSCH, INCORPORATED, (U.S. CLS. 45, 46 AND 48). SN 77-584,303. PUB. 6-23-2009. FILED 10-2-2008.
- 3,678,964. **PROMETHEUS SPRINGS (BLOCK FORM)**. PROMETHEUS SPRINGS LLC, (U.S. CLS. 45, 46 AND 48). SN 77-624,768. PUB. 6-23-2009. FILED 12-2-2008.
- 3,678,965. **MISCELLANEOUS DESIGN**. PROMETHEUS SPRINGS LLC, (U.S. CLS. 45, 46 AND 48). SN 77-624,786. PUB. 6-23-2009. FILED 12-2-2008.
- 3,679,005. **DRANK AND DESIGN**. INNOVATIVE BEVERAGE GROUP, INC., (U.S. CLS. 45, 46 AND 48). SN 77-634,686. PUB. 6-23-2009. FILED 12-17-2008.
- 3,679,006. **RELAXED ENERGY DRANK AND DESIGN**. INNOVATIVE BEVERAGE GROUP, INC., (U.S. CLS. 45, 46 AND 48). SN 77-634,687. PUB. 6-23-2009. FILED 12-17-2008.
- 3,679,052. **HOLD MY BEER AND WATCH THIS (BLOCK FORM)**. BIG SKY BREWING COMPANY, (U.S. CLS. 45, 46 AND 48). SN 77-647,740. PUB. 6-23-2009. FILED 1-12-2009.
- 3,679,053. **WE MAKE WATER FUN (BLOCK FORM)**. BIG SKY BREWING COMPANY, (U.S. CLS. 45, 46 AND 48). SN 77-647,745. PUB. 6-23-2009. FILED 1-12-2009.
- 3,679,111 (*See Class 5 for this trademark*).
- 3,679,213. **JUICE SLAM (BLOCK FORM)**. HANSEN BEVERAGE COMPANY, (U.S. CLS. 45, 46 AND 48). SN 77-669,954. PUB. 6-23-2009. FILED 2-13-2009.
- 3,679,264. **ZOË AND DESIGN**. ZOOM WORLDWIDE LLC, (U.S. CLS. 45, 46 AND 48). SN 77-672,691. PUB. 6-23-2009. FILED 2-18-2009.
- 3,679,308 (*See Class 5 for this trademark*).
- 3,679,397. **BIG DADDY (BLOCK FORM)**. SPEAKEASY ALES & LAGERS, INC., (U.S. CLS. 45, 46 AND 48). SN 77-676,246. PUB. 6-23-2009. FILED 2-23-2009.
- 3,679,400. **UNTOUCHABLE (BLOCK FORM)**. SPEAKEASY ALES & LAGERS, INC., (U.S. CLS. 45, 46 AND 48). SN 77-676,269. PUB. 6-23-2009. FILED 2-23-2009.
- 3,679,443. **OE OPTA ENERGY AND DESIGN**. SUNOPTA, INC., (U.S. CLS. 45, 46 AND 48). SN 77-676,895. PUB. 6-23-2009. FILED 2-24-2009.
- 3,679,470. **STONE'S BEER (STYLIZED)**. JONES BREWING COMPANY, AKA JBC BEVERAGE GROUP, INC., (U.S. CLS. 45, 46 AND 48). SN 77-677,139. PUB. 6-23-2009. FILED 2-24-2009.
- 3,679,564. **COASTAL GROVES (BLOCK FORM)**. TROPICANA PRODUCTS, INC., (U.S. CLS. 45, 46 AND 48). SN 77-678,223. PUB. 6-23-2009. FILED 2-25-2009.
- 3,679,682. **PYRAMIST (BLOCK FORM)**. GOVEL, GRANT, (U.S. CLS. 45, 46 AND 48). SN 77-680,185. PUB. 6-23-2009. FILED 2-27-2009.
- 3,679,903. **BRAVA ITALIA AND DESIGN**. AMA S.N.C. DI MASSIMO E; CARLO ALBERTO ROVERE, (U.S. CLS. 45, 46 AND 48). SN 79-056,725. PUB. 6-23-2009. FILED 6-18-2008.
- 3,679,958. **HENRI EHRHART (BLOCK FORM)**. EHRHART AMMERSCHWIHR SA; (SOCIÉTÉ ANONYME), MULTIPLE CLASS, (INT. CLS. 32, 33 AND 42), (U.S. CLS. 45, 46, 47, 48, 49, 100 AND 101). SN 79-059,800. PUB. 6-23-2009. FILED 8-11-2008.
- 3,679,963 (*See Class 30 for this trademark*).
- 3,679,964. **SEE THE USA THE 66 WAY (STYLIZED)**. LODESTAR ANSTALT, (U.S. CLS. 45, 46 AND 48). SN 79-059,904. PUB. 6-23-2009. FILED 8-6-2008.

- 3,679,974. **HAZARDOUS TO ROUTINE LIFE (STYLIZED)**. LODESTAR ANSTALT, (U.S. CLS. 45, 46 AND 48). SN 79-060,285. PUB. 6-23-2009. FILED 8-12-2008.
- 3,679,975 (*See Class 5 for this trademark*).
- 3,679,989 (*See Class 7 for this trademark*).
- 3,680,008. **APOSTEL BRÄU AND DESIGN**. EICHBAUM-BRAUEREIEN AG, (U.S. CLS. 45, 46 AND 48). SN 79-062,508. PUB. 6-23-2009. FILED 8-29-2008.
- 3,680,028. **KILLER BG . MAKES YOU FEEL BETTER . THE ORIGINAL AND DESIGN**. ING. IVAN DUCKO, (U.S. CLS. 45, 46 AND 48). SN 79-064,088. PUB. 6-23-2009. FILED 9-9-2008.
- 3,680,030. **DUCHESS DE BOURGOGNE (BLOCK FORM)**. BROUWERIJ VERHAEGHE VICHTE N.V., (U.S. CLS. 45, 46 AND 48). SN 79-064,182. PUB. 6-23-2009. FILED 10-27-2008.

CLASS 33—WINES AND SPIRITS

- 3,678,213. **FROZEN ROSE (BLOCK FORM)**. PECAN RIDGE VINEYARDS, L.L.C., (U.S. CLS. 47 AND 49). SN 77-071,957. PUB. 6-23-2009. FILED 12-27-2006.
- 3,678,293 (*See Class 32 for this trademark*).
- 3,678,318. **PANACEA WINES (BLOCK FORM)**. TOMAS E. ROMERO, DBA PANACEA WINES, (U.S. CLS. 47 AND 49). SN 77-346,747. PUB. 6-23-2009. FILED 12-7-2007.
- 3,678,780. **PELTIER STATION AND DESIGN**. R&G SCHATZ FARM INC, DBA PELTIER STATION, (U.S. CLS. 47 AND 49). SN 77-571,954. PUB. 6-23-2009. FILED 9-17-2008.
- 3,678,844. **OR (STYLIZED)**. CONSORCIO COMERCIAL ZEPPELIN, S.A. DE C.V., (U.S. CLS. 47 AND 49). SN 77-588,430. PUB. 3-17-2009. FILED 10-8-2008.
- 3,678,855. **LUXURY REBORN (BLOCK FORM)**. POLMOSZYRARDOW SPOLKA OGRANICZONA ODPOWIEDZIALNOSCIA, (U.S. CLS. 47 AND 49). SN 77-590,727. PUB. 4-14-2009. FILED 10-10-2008.
- 3,678,954. **BODEGA DEL DESIERTO (BLOCK FORM)**. BODEGA DEL DESIERTO S.A., (U.S. CLS. 47 AND 49). SN 77-621,802. PUB. 6-23-2009. FILED 11-25-2008.
- 3,679,010. **GRANDPA CHACHA'S HOME STYLE WINE (BLOCK FORM)**. LA VENDEMMIA, INC., (U.S. CLS. 47 AND 49). SN 77-635,996. PUB. 6-23-2009. FILED 12-18-2008.
- 3,679,029. **ROSA MYSTICA (BLOCK FORM)**. STELLA MARIS, INC., (U.S. CLS. 47 AND 49). SN 77-640,946. PUB. 6-23-2009. FILED 12-29-2008.
- 3,679,109. **MOUNT GAY RUM BARBADOS SINCE 1703 EXTRA OLD PERFECTED BY TRADITION SINCE 1703 AND DESIGN**. MOUNT GAY DISTILLERIES LIMITED, (U.S. CLS. 47 AND 49). SN 77-657,485. PUB. 6-23-2009. FILED 1-27-2009.
- 3,679,176. **FU JIN (BLOCK FORM)**. EMPIRE GRAPE COMPANY, LLC, (U.S. CLS. 47 AND 49). SN 77-666,862. PUB. 6-23-2009. FILED 2-10-2009.
- 3,679,301. **MISCELLANEOUS DESIGN**. HAVANA CLUB HOLDING, S.A., (U.S. CLS. 47 AND 49). SN 77-673,973. PUB. 6-23-2009. FILED 2-19-2009.
- 3,679,302. **MISCELLANEOUS DESIGN**. HAVANA CLUB HOLDING, S.A., (U.S. CLS. 47 AND 49). SN 77-673,984. PUB. 6-23-2009. FILED 2-19-2009.
- 3,679,439. **PASSAGES (BLOCK FORM)**. RTG TRADING, (U.S. CLS. 47 AND 49). SN 77-676,859. PUB. 6-23-2009. FILED 2-24-2009.
- 3,679,487. **GEORGE T. STAGG AND DESIGN**. SAZERAC COMPANY, INC., (U.S. CLS. 47 AND 49). SN 77-677,295. PUB. 6-23-2009. FILED 2-24-2009.
- 3,679,515. **MISCELLANEOUS DESIGN**. 12 ZODIACS, INC., (U.S. CLS. 47 AND 49). SN 77-677,656. PUB. 6-23-2009. FILED 2-24-2009.
- 3,679,516. **MISCELLANEOUS DESIGN**. 12 ZODIACS, INC., (U.S. CLS. 47 AND 49). SN 77-677,658. PUB. 6-23-2009. FILED 2-24-2009.
- 3,679,517. **MISCELLANEOUS DESIGN**. 12 ZODIACS, INC., (U.S. CLS. 47 AND 49). SN 77-677,665. PUB. 6-23-2009. FILED 2-25-2009.
- 3,679,518. **MISCELLANEOUS DESIGN**. 12 ZODIACS, INC., (U.S. CLS. 47 AND 49). SN 77-677,668. PUB. 6-23-2009.

FILED 2-25-2009.
 3,679,519. **MISCELLANEOUS DESIGN**. 12 ZODIACS, INC., (U.S. CLS. 47 AND 49). SN 77-677,674. PUB. 6-23-2009. FILED 2-25-2009.
 3,679,520. **MISCELLANEOUS DESIGN**. 12 ZODIACS, INC., (U.S. CLS. 47 AND 49). SN 77-677,676. PUB. 6-23-2009. FILED 2-25-2009.
 3,679,522. **MISCELLANEOUS DESIGN**. 12 ZODIACS, INC., (U.S. CLS. 47 AND 49). SN 77-677,679. PUB. 6-23-2009. FILED 2-25-2009.
 3,679,523. **MISCELLANEOUS DESIGN**. 12 ZODIACS, INC., (U.S. CLS. 47 AND 49). SN 77-677,684. PUB. 6-23-2009. FILED 2-25-2009.
 3,679,524. **MISCELLANEOUS DESIGN**. 12 ZODIACS, INC., (U.S. CLS. 47 AND 49). SN 77-677,687. PUB. 6-23-2009. FILED 2-25-2009.
 3,679,525. **MISCELLANEOUS DESIGN**. 12 ZODIACS, INC., (U.S. CLS. 47 AND 49). SN 77-677,689. PUB. 6-23-2009. FILED 2-25-2009.
 3,679,634. **SIP. SAVE. (BLOCK FORM)**. WILLAMETTE VALLEY VINEYARDS, INC., (U.S. CLS. 47 AND 49). SN 77-679,315. PUB. 6-23-2009. FILED 2-26-2009.
 3,679,688. **MAKOA (BLOCK FORM)**. KOLOA RUM CO., (U.S. CLS. 47 AND 49). SN 77-680,344. PUB. 6-23-2009. FILED 2-27-2009.
 3,679,716. **CITRY (BLOCK FORM)**. MODERN SPIRITS LLC, (U.S. CLS. 47 AND 49). SN 77-680,896. PUB. 6-23-2009. FILED 3-1-2009.
 3,679,748. **MISCELLANEOUS DESIGN**. HAVANA CLUB HOLDING, S.A., (U.S. CLS. 47 AND 49). SN 77-692,912. PUB. 6-23-2009. FILED 3-17-2009.
 3,679,763. **NEWMAN'S OWN (BLOCK FORM)**. NO LIMIT, LLC, (U.S. CLS. 47 AND 49). SN 77-698,455. PUB. 6-23-2009. FILED 3-25-2009.
 3,679,786. **MISCELLANEOUS DESIGN**. HAVANA CLUB HOLDING, S.A., (U.S. CLS. 47 AND 49). SN 77-713,515. PUB. 6-23-2009. FILED 4-14-2009.
 3,679,805. **SLAVIANSKAYA SPIRIT OF RUSSIA (BLOCK FORM)**. VODKA SLAVIANSKAYA LIMITED, (U.S. CLS. 47 AND 49). SN 78-479,590. PUB. 9-20-2005. FILED 9-7-2004.
 3,679,897. **SVETLAYA GOLOVA (BLOCK FORM)**. OB-SHCHESTVO S OGRANITCHENNOI; OTVETSTVENNOSTYOU; "ALEXANDROVY POGREBA", (U.S. CLS. 47 AND 49). SN 79-055,982. PUB. 6-23-2009. FILED 3-6-2008.
 3,679,916. **ALMOST THE SECOND BEST (BLOCK FORM)**. ALTHA PLC, (U.S. CLS. 47 AND 49). SN 79-057,492. PUB. 6-23-2009. FILED 7-2-2008.
 3,679,918. **LASANTA (BLOCK FORM)**. MACDONALD & MUIR LIMITED, (U.S. CLS. 47 AND 49). SN 79-057,609. PUB. 6-23-2009. FILED 7-17-2008.
 3,679,958 (*See Class 32 for this trademark*).
 3,679,989 (*See Class 7 for this trademark*).
 3,679,996. **C CIÙ CIÙ AND DESIGN**. SOCIETÀ AGRICOLA CIÙ CIÙ; DI BARTOLOMEI MASSIMILIANO E; BARTOLOMEI WALTER S.S., (U.S. CLS. 47 AND 49). SN 79-061,388. PUB. 6-23-2009. FILED 9-17-2008.
 3,680,032. **CAYAS (BLOCK FORM)**. JEAN-RENÉ GERMANIER SA, (U.S. CLS. 47 AND 49). SN 79-064,371. PUB. 6-23-2009. FILED 12-29-2008.
 3,680,048. **CENOSCILICAPHOBIC (BLOCK FORM)**. D'ARENBERG PTY LTD, (U.S. CLS. 47 AND 49). SN 79-066,984. PUB. 6-23-2009. FILED 2-20-2009.

CLASS 34—SMOKERS' ARTICLES

3,678,253. **XIRIX (BLOCK FORM)**. BRITISH AMERICAN TOBACCO (BRANDS) LIMITED, (U.S. CLS. 2, 8, 9 AND 17). SN 77-230,231. PUB. 6-23-2009. FILED 7-16-2007.
 3,678,886. **B H PREMIUM QUALITY BENSON & HEDGES MENTHOL B H 100S 25 CLASS A CIGARETTES CANADIAN STYLE AND DESIGN**. PHILIP MORRIS USA INC., (U.S. CLS. 2, 8, 9 AND 17). SN 77-599,997. PUB. 6-23-2009. FILED 10-24-2008.
 3,678,887. **BENSON & HEDGES MENTHOL 100S PREMIUM QUALITY BH PREMIUM BH 25 CLASS A CIGARETTES CANADIAN STYLE AND DESIGN**. PHILIP MORRIS USA

INC., (U.S. CLS. 2, 8, 9 AND 17). SN 77-600,007. PUB. 6-23-2009. FILED 10-24-2008.
 3,679,429. **ORTSAC (BLOCK FORM)**. THE CIGAR AGENCY, L.L.C., (U.S. CLS. 2, 8, 9 AND 17). SN 77-676,724. PUB. 6-23-2009. FILED 2-24-2009.
 3,679,724. **MONTECRISTO CUP (BLOCK FORM)**. CUBAN CIGAR BRANDS, N.V., MULTIPLE CLASS, (INT. CLS. 34 AND 41), (U.S. CLS. 2, 8, 9, 17, 100, 101 AND 107). SN 77-683,405. PUB. 6-23-2009. FILED 3-4-2009.
 3,679,790. **MISCELLANEOUS DESIGN**. OLIVA CIGAR CO., (U.S. CLS. 2, 8, 9 AND 17). SN 77-977,031. PUB. 6-23-2009. FILED 9-30-2008.

SERVICE MARKS

CLASS 35—ADVERTISING AND BUSINESS

3,678,138. **DUNHAM' S. DUNHAM' S ATHLEISURE CORPORATION**, (U.S. CLS. 100, 101 AND 102). SN 75-828,267. PUB. 6-23-2009. FILED 10-22-1999.
 3,678,143. **A AND DESIGN**. AMERICAN WHOLESALE INSURANCE GROUP, INC., MULTIPLE CLASS, (INT. CLS. 35 AND 36), (U.S. CLS. 100, 101 AND 102). SN 76-476,296. PUB. 3-16-2004. FILED 12-16-2002.
 3,678,152. **DSI (BLOCK FORM)**. DATA SYSTEMS INTERNATIONAL, INC., MULTIPLE CLASS, (INT. CLS. 35 AND 42), (U.S. CLS. 100, 101 AND 102). SN 76-651,468. PUB. 6-23-2009. FILED 12-6-2005.
 3,678,155. **THE EXCHANGE BUY , SELL , TRADE AND DESIGN**. J.S. MUSIC CORPORATION, (U.S. CLS. 100, 101 AND 102). SN 76-673,755. PUB. 6-23-2009. FILED 3-8-2007.
 3,678,157 (*See Class 9 for this trademark*).
 3,678,161. **DOCUDATA AND DESIGN**. DOCUDATA SOLUTIONS, L.L.C., MULTIPLE CLASS, (INT. CLS. 35, 40 AND 42), (U.S. CLS. 100, 101, 102, 103 AND 106). SN 76-685,169. PUB. 6-23-2009. FILED 12-21-2007.
 3,678,162. **DOCUDATA (BLOCK FORM)**. DOCUDATA SOLUTIONS, L.L.C., MULTIPLE CLASS, (INT. CLS. 35, 40 AND 42), (U.S. CLS. 100, 101, 102, 103 AND 106). SN 76-685,170. PUB. 6-23-2009. FILED 12-21-2007.
 3,678,163. **ANDIAMO SYSTEMS, INC (BLOCK FORM)**. ANDIAMO SYSTEMS, INC, (U.S. CLS. 100, 101 AND 102). SN 76-687,489. PUB. 6-23-2009. FILED 3-7-2008.
 3,678,170. **GESCORE CONNECT (BLOCK FORM)**. GES EXPOSITION SERVICES, INC., (U.S. CLS. 100, 101 AND 102). SN 76-691,475. PUB. 6-23-2009. FILED 7-22-2008.
 3,678,171. **MOM'S BEST FRIEND (BLOCK FORM)**. MBF AGENCY, LLC, (U.S. CLS. 100, 101 AND 102). SN 76-691,481. PUB. 6-23-2009. FILED 7-22-2008.
 3,678,176. **VIDAVICI (BLOCK FORM)**. LOUISVILLE WINNELSON COMPANY, (U.S. CLS. 100, 101 AND 102). SN 76-692,083. PUB. 6-23-2009. FILED 8-14-2008.
 3,678,188. **PLANT BROTHERS FLOWERING & LANDSCAPING ORNAMENTALS AND DESIGN**. PLANT BROTHERS INC., (U.S. CLS. 100, 101 AND 102). SN 76-694,453. PUB. 6-23-2009. FILED 11-24-2008.
 3,678,212 (*See Class 6 for this trademark*).
 3,678,217. **HRVALUE GROUP (BLOCK FORM)**. HRVALUE GROUP, LLC, MULTIPLE CLASS, (INT. CLS. 35, 36 AND 41), (U.S. CLS. 100, 101, 102 AND 107). SN 77-084,722. PUB. 6-23-2009. FILED 1-17-2007.
 3,678,223. **EXPLORE YOUR HEALTH (BLOCK FORM)**. ALL I AM, INC., (U.S. CLS. 100, 101 AND 102). SN 77-131,404. PUB. 6-23-2009. FILED 3-14-2007.
 3,678,224 (*See Class 9 for this trademark*).
 3,678,226 (*See Class 29 for this trademark*).
 3,678,227 (*See Class 9 for this trademark*).
 3,678,230. **AMERICANA MANHASSET (BLOCK FORM)**. FIFTH AVENUE OF LONG ISLAND REALTY ASSOCIATES, MULTIPLE CLASS, (INT. CLS. 35, 36, 37, 41 AND 45), (U.S. CLS. 100, 101, 102, 103, 106 AND 107). SN 77-163,947. PUB. 6-23-2009. FILED 4-24-2007.
 3,678,233. **TABLEWARE AND DESIGN**. TABLEWARE SOLUTIONS, LTD., MULTIPLE CLASS, (INT. CLS. 35 AND 39),

- (U.S. CLS. 100, 101, 102 AND 105). SN 77-175,848. PUB. 6-23-2009. FILED 5-8-2007.
- 3,678,237 (*See Class 16 for this trademark*).
- 3,678,238 (*See Class 16 for this trademark*).
- 3,678,239. **MATCHMAKING INSTITUTE THE SCHOOL OF MATCHMAKING & RELATIONSHIP SCIENCES AND DESIGN**. MATCHMAKING INSTITUTE INC., MULTIPLE CLASS, (INT. CLS. 35, 41 AND 45), (U.S. CLS. 100, 101, 102 AND 107). SN 77-191,693. PUB. 12-23-2008. FILED 5-29-2007.
- 3,678,246. **TOYOTA MOBILITY AND DESIGN**. TOYOTA JIDOSHA KABUSHIKI KAISHA, T/A TOYOTA MOTOR CORPORATION, MULTIPLE CLASS, (INT. CLS. 35, 36, 37, 39 AND 44), (U.S. CLS. 100, 101, 102, 103, 105 AND 106). SN 77-223,397. PUB. 6-23-2009. FILED 7-6-2007.
- 3,678,259. **A LITTLE SUSSY (BLOCK FORM)**. HILL, NICOLE C., (U.S. CLS. 100, 101 AND 102). SN 77-240,010. PUB. 6-23-2009. FILED 7-26-2007.
- 3,678,260 (*See Class 3 for this trademark*).
- 3,678,272. **MATCHMAKING INSTITUTE THE SCHOOL OF MATCHMAKING AND RELATIONSHIP SCIENCES CERTIFIED MATCHMAKER AND DESIGN**. MATCHMAKING INSTITUTE INC., MULTIPLE CLASS, (INT. CLS. 35, 41 AND 45), (U.S. CLS. 100, 101, 102 AND 107). SN 77-279,810. PUB. 9-16-2008. FILED 9-14-2007.
- 3,678,283. **BRAND IMAGE MERCHANDISING (BLOCK FORM)**. SILKS INTERNATIONAL, INC., (U.S. CLS. 100, 101 AND 102). SN 77-301,490. PUB. 6-23-2009. FILED 10-11-2007.
- 3,678,284. **STAY!NGCONNECTED.COM AND DESIGN**. MASS CONNECTIONS, INC., (U.S. CLS. 100, 101 AND 102). SN 77-302,202. PUB. 6-23-2009. FILED 10-11-2007.
- 3,678,286. **QUICK CLICK (BLOCK FORM)**. NET-A-PORTER LIMITED, MULTIPLE CLASS, (INT. CLS. 35 AND 36), (U.S. CLS. 100, 101 AND 102). SN 77-306,620. PUB. 6-23-2009. FILED 10-17-2007.
- 3,678,287. **CYMETRIX (BLOCK FORM)**. CYMETRIX CORPORATION, MULTIPLE CLASS, (INT. CLS. 35, 36 AND 42), (U.S. CLS. 100, 101 AND 102). SN 77-309,007. PUB. 6-23-2009. FILED 10-19-2007.
- 3,678,288. **MAINE EVERGREEN (BLOCK FORM)**. RUSSELL P. TROCANO, (U.S. CLS. 100, 101 AND 102). SN 77-309,025. PUB. 6-23-2009. FILED 10-19-2007.
- 3,678,291 (*See Class 9 for this trademark*).
- 3,678,292. **SKYHAWKS (BLOCK FORM)**. SKYHAWKS SPORTS ACADEMY, INC., (U.S. CLS. 100, 101 AND 102). SN 77-310,326. PUB. 6-23-2009. FILED 10-22-2007.
- 3,678,297. **WHAT A LOVELY HOME (BLOCK FORM)**. WHATALOVELYHOME, LLC, (U.S. CLS. 100, 101 AND 102). SN 77-314,449. PUB. 6-23-2009. FILED 10-26-2007.
- 3,678,306. **GOT STUFF?! AND DESIGN**. SMITH, GAIL E., (U.S. CLS. 100, 101 AND 102). SN 77-326,669. PUB. 6-23-2009. FILED 11-11-2007.
- 3,678,316. **BETTY CUPCAKE (BLOCK FORM)**. BETTY CUPCAKE, INC. AND SILVERMAN, EVELYN H., (U.S. CLS. 100, 101 AND 102). SN 77-343,501. PUB. 6-23-2009. FILED S.R. 12-4-2007; AM. P.R. 9-3-2008.
- 3,678,319. **PANACEA WINES (BLOCK FORM)**. TOMAS E. ROMERO, DBA PANACEA WINES, (U.S. CLS. 100, 101 AND 102). SN 77-346,784. PUB. 6-23-2009. FILED 12-7-2007.
- 3,678,321 (*See Class 16 for this trademark*).
- 3,678,326 (*See Class 9 for this trademark*).
- 3,678,328 (*See Class 16 for this trademark*).
- 3,678,332. **TONY (BLOCK FORM)**. TONY TIENDAS S.A. DE C.V., (U.S. CLS. 100, 101 AND 102). SN 77-365,164. PUB. 6-23-2009. FILED 1-7-2008.
- 3,678,349. **M2 LIFE CYCLE MANAGEMENT AND DESIGN**. ALMACO GROUP OY, MULTIPLE CLASS, (INT. CLS. 35, 37 AND 42), (U.S. CLS. 100, 101, 102, 103 AND 106). SN 77-380,379. PUB. 6-23-2009. FILED 1-25-2008.
- 3,678,350. **ALAMO REFRIGERATION AND DESIGN**. ALAMO REFRIGERATION, L.P., (U.S. CLS. 100, 101 AND 102). SN 77-380,491. PUB. 6-23-2009. FILED 1-25-2008.
- 3,678,354. **CRESTWOOD TECHNOLOGY GROUP (BLOCK FORM)**. CRESTWOOD TECHNOLOGY GROUP, MULTIPLE CLASS, (INT. CLS. 35 AND 39), (U.S. CLS. 100, 101, 102 AND 105). SN 77-385,501. PUB. 6-23-2009. FILED 1-31-2008.
- 3,678,358. **CERTIFIED PAYCHECK SYSTEMS AND DESIGN**. KARAN IT, LLC, MULTIPLE CLASS, (INT. CLS. 35 AND 42), (U.S. CLS. 100, 101 AND 102). SN 77-394,264. PUB. 6-23-2009. FILED 2-11-2008.
- 3,678,359. **M MANDRIEN (STYLIZED)**. MANDRIEN CORPORATION, MULTIPLE CLASS, (INT. CLS. 35 AND 36), (U.S. CLS. 100, 101 AND 102). SN 77-395,202. PUB. 6-23-2009. FILED 2-12-2008.
- 3,678,363 (*See Class 16 for this trademark*).
- 3,678,369. **TAZ SOLUTIONS (BLOCK FORM)**. TASNER JR., MICHAEL, DBA TAZ SOLUTIONS, (U.S. CLS. 100, 101 AND 102). SN 77-406,876. PUB. 3-17-2009. FILED 2-26-2008.
- 3,678,370. **SHAININ (BLOCK FORM)**. RED X HOLDINGS, LLC, MULTIPLE CLASS, (INT. CLS. 35 AND 41), (U.S. CLS. 100, 101, 102 AND 107). SN 77-407,192. PUB. 6-23-2009. FILED 2-27-2008.
- 3,678,377 (*See Class 16 for this trademark*).
- 3,678,378. **ECREAMERY (BLOCK FORM)**. ECREAMERY, LLC, (U.S. CLS. 100, 101 AND 102). SN 77-415,831. PUB. 6-23-2009. FILED 3-7-2008.
- 3,678,380. **KARMA LIVING (BLOCK FORM)**. KARMA NOW PTY LTD, MULTIPLE CLASS, (INT. CLS. 35 AND 41), (U.S. CLS. 100, 101, 102 AND 107). SN 77-417,870. PUB. 6-23-2009. FILED 3-10-2008.
- 3,678,394. **NEVADA CORPORATE HEADQUARTERS (BLOCK FORM)**. NEVADA CORPORATE HEADQUARTERS, INC., MULTIPLE CLASS, (INT. CLS. 35, 36, 41 AND 45), (U.S. CLS. 100, 101, 102 AND 107). SN 77-431,422. PUB. 6-23-2009. FILED 3-25-2008.
- 3,678,416. **WIGIX KEEPING FEES AT BAY AND DESIGN**. WIGIX, INC., DBA WWW.WIGIX.COM, (U.S. CLS. 100, 101 AND 102). SN 77-451,336. PUB. 6-23-2009. FILED 4-17-2008.
- 3,678,417. **TAKE PRIDE STATEWIDE (BLOCK FORM)**. AUNTIE LITTER, INC., (U.S. CLS. 100, 101 AND 102). SN 77-452,298. PUB. 3-17-2009. FILED 4-18-2008.
- 3,678,428. **WESTCHESTER (BLOCK FORM)**. ARCHSTONE COMMUNITIES LLC, MULTIPLE CLASS, (INT. CLS. 35, 36 AND 37), (U.S. CLS. 100, 101, 102, 103 AND 106). SN 77-459,583. PUB. 6-23-2009. FILED 4-28-2008.
- 3,678,444. **PATTI-KAKE'S (BLOCK FORM)**. KIRKEY, PATTI SUE, DBA PATTI-KAKE'S, (U.S. CLS. 100, 101 AND 102). SN 77-478,704. PUB. 6-23-2009. FILED 5-20-2008.
- 3,678,450. **APOLLO AVIATION LIMITED AND DESIGN**. APOLLO AVIATION HOLDINGS LIMITED, (U.S. CLS. 100, 101 AND 102). SN 77-486,345. PUB. 6-23-2009. FILED 5-29-2008.
- 3,678,460. **MAKING A DIFFERENCE EVERY DAY (BLOCK FORM)**. KISCO SENIOR LIVING, LLC, MULTIPLE CLASS, (INT. CLS. 35, 43 AND 44), (U.S. CLS. 100, 101 AND 102). SN 77-494,687. PUB. 6-23-2009. FILED 6-9-2008.
- 3,678,467. **ACCUVAL (BLOCK FORM)**. ACCUVAL ASSOCIATES, INC., MULTIPLE CLASS, (INT. CLS. 35 AND 36), (U.S. CLS. 100, 101 AND 102). SN 77-497,745. PUB. 6-23-2009. FILED 6-12-2008.
- 3,678,478. **THE BLUE PAGES AND DESIGN**. MYERS, THOMAS, (U.S. CLS. 100, 101 AND 102). SN 77-503,496. PUB. 6-23-2009. FILED 6-19-2008.
- 3,678,482 (*See Class 16 for this trademark*).
- 3,678,488. **TECHLINKS (BLOCK FORM)**. TECHLINKS MEDIA HOLDINGS, INC., MULTIPLE CLASS, (INT. CLS. 35, 41 AND 42), (U.S. CLS. 100, 101, 102 AND 107). SN 77-508,521. PUB. 6-23-2009. FILED 6-26-2008.
- 3,678,500. **S SOVEREIGN HOSPITALITY INTERNATIONAL, LLC AND DESIGN**. SOVEREIGN HOSPITALITY INTERNATIONAL, LLC, MULTIPLE CLASS, (INT. CLS. 35 AND 43), (U.S. CLS. 100, 101 AND 102). SN 77-514,049. PUB. 6-23-2009. FILED 7-2-2008.
- 3,678,507. **DIVINE MOVING (BLOCK FORM)**. DIVINE MOVING & STORAGE LTD, MULTIPLE CLASS, (INT. CLS. 35 AND 39), (U.S. CLS. 100, 101, 102 AND 105). SN 77-517,619. PUB. 6-23-2009. FILED 7-9-2008.
- 3,678,513. **COSTUME UNIVERSE (BLOCK FORM)**. PRAD UNLIMITED, LLC, DBA COSTUME UNIVERSE, (U.S. CLS. 100, 101 AND 102). SN 77-519,295. PUB. 6-23-2009. FILED 7-10-2008.
- 3,678,516. **S SELLSTATE AND DESIGN**. SELLSTATE REALTY SYSTEMS NETWORK, INC., (U.S. CLS. 100, 101 AND 102). SN 77-520,202. PUB. 6-23-2009. FILED 7-11-2008.
- 3,678,518 (*See Class 9 for this trademark*).
- 3,678,525 (*See Class 16 for this trademark*).

- 3,678,526 (*See Class 16 for this trademark*).
- 3,678,532. **AN EDUCATIONAL FORUM TO ADDRESS ISSUES, EXCHANGE IDEAS AND EXPLORE SOLUTIONS. (BLOCK FORM)**. WINDSTORM INSURANCE NETWORK, INC., MULTIPLE CLASS, (INT. CLS. 35 AND 41), (U.S. CLS. 100, 101, 102 AND 107). SN 77-525,575. PUB. 6-23-2009. FILED 7-18-2008.
- 3,678,534. **BETTER LIVING FROM THE INSIDE OUT (BLOCK FORM)**. JOHNS MANVILLE, (U.S. CLS. 100, 101 AND 102). SN 77-525,720. PUB. 6-23-2009. FILED 7-18-2008.
- 3,678,535. **BIDO.COM (STYLIZED)**. RECALL MEDIA GROUP HOLDINGS LLC, MULTIPLE CLASS, (INT. CLS. 35 AND 38), (U.S. CLS. 100, 101, 102 AND 104). SN 77-526,228. PUB. 5-19-2009. FILED 7-18-2008.
- 3,678,536. **MOUNTAIN STATES ENERGY ALLIANCE MSEA AND DESIGN**. THOMAS J. SISK AND COMPANY, MULTIPLE CLASS, (INT. CLS. 35 AND 41), (U.S. CLS. 100, 101, 102 AND 107). SN 77-526,328. PUB. 6-23-2009. FILED 7-18-2008.
- 3,678,542. **FRONT OFFICE STAFF AND DESIGN**. FRONT OFFICE STAFF, (U.S. CLS. 100, 101 AND 102). SN 77-527,840. PUB. 6-23-2009. FILED 7-22-2008.
- 3,678,545. **IDJ AND DESIGN**. JUDGE, JR., ALEXANDER LEE, DBA DJ JUDGE MENTAL, (U.S. CLS. 100, 101 AND 102). SN 77-528,171. PUB. 3-17-2009. FILED 7-22-2008.
- 3,678,556. **SHOPWATCH (BLOCK FORM)**. SHOPPERS' CRITIQUE INTERNATIONAL, L.L.C., (U.S. CLS. 100, 101 AND 102). SN 77-529,410. PUB. 6-23-2009. FILED 7-23-2008.
- 3,678,563. **WIND CONFERENCE (BLOCK FORM)**. WINDSTORM INSURANCE NETWORK, INC., MULTIPLE CLASS, (INT. CLS. 35 AND 41), (U.S. CLS. 100, 101, 102 AND 107). SN 77-529,613. PUB. 6-23-2009. FILED 7-23-2008.
- 3,678,565 (*See Class 25 for this trademark*).
- 3,678,570. **COSMOPROF AND DESIGN**. INNOVATIONS – SUCCESSFUL SALON SERVICES, INC., (U.S. CLS. 100, 101 AND 102). SN 77-530,674. PUB. 6-23-2009. FILED 7-24-2008.
- 3,678,571. **COSMOPROF AND DESIGN**. INNOVATIONS – SUCCESSFUL SALON SERVICES, INC., (U.S. CLS. 100, 101 AND 102). SN 77-530,695. PUB. 6-23-2009. FILED 7-24-2008.
- 3,678,580. **IGNITINGLEADERSHIP AND DESIGN**. EXECUTIVE DEVELOPMENT ARCHITECTS LLC, (U.S. CLS. 100, 101 AND 102). SN 77-532,790. PUB. 6-23-2009. FILED 7-28-2008.
- 3,678,582. **MISCELLANEOUS DESIGN**. ILLINOIS TECHNOLOGY DEVELOPMENT ALLIANCE, (U.S. CLS. 100, 101 AND 102). SN 77-533,700. PUB. 6-23-2009. FILED 7-29-2008.
- 3,678,585. **EZ CONNECT (BLOCK FORM)**. EZ CONNECT, (U.S. CLS. 100, 101 AND 102). SN 77-534,280. PUB. 6-23-2009. FILED 7-29-2008.
- 3,678,601. **W WINSTON FLOWERS SINCE 1944 AND DESIGN**. WINSTON BROTHERS, INC., MULTIPLE CLASS, (INT. CLS. 35 AND 44), (U.S. CLS. 100, 101 AND 102). SN 77-536,195. PUB. 6-23-2009. FILED 7-31-2008.
- 3,678,602. **W AND DESIGN**. WINSTON BROTHERS, INC., MULTIPLE CLASS, (INT. CLS. 35 AND 44), (U.S. CLS. 100, 101 AND 102). SN 77-536,254. PUB. 6-23-2009. FILED 7-31-2008.
- 3,678,608. **SITTERS STUDIO (BLOCK FORM)**. SITTERS IN THE CITY INC., MULTIPLE CLASS, (INT. CLS. 35 AND 43), (U.S. CLS. 100, 101 AND 102). SN 77-537,185. PUB. 6-23-2009. FILED 8-1-2008.
- 3,678,631 (*See Class 6 for this trademark*).
- 3,678,639. **CLOUDED LEOPARD PROJECT (BLOCK FORM)**. CLOUDED LEOPARD PROJECT, (U.S. CLS. 100, 101 AND 102). SN 77-539,419. PUB. 6-23-2009. FILED 8-5-2008.
- 3,678,644. **THE PREFERENCE GROUP (BLOCK FORM)**. BROADLANE, INC., MULTIPLE CLASS, (INT. CLS. 35, 39 AND 42), (U.S. CLS. 100, 101, 102 AND 105). SN 77-539,863. PUB. 6-23-2009. FILED 8-5-2008.
- 3,678,650. **OMNI OMNI SOLUTIONS AND DESIGN**. THARPEROBINS COMPANY, INC., (U.S. CLS. 100, 101 AND 102). SN 77-540,365. PUB. 6-23-2009. FILED 8-6-2008.
- 3,678,668. **ERM AND DESIGN**. ERM-DELAWARE, INC., MULTIPLE CLASS, (INT. CLS. 35, 37, 40, 42 AND 45), (U.S. CLS. 100, 101, 102, 103 AND 106). SN 77-542,362. PUB. 6-23-2009. FILED 8-8-2008.
- 3,678,669. **ERM (BLOCK FORM)**. ERM-DELAWARE, INC., MULTIPLE CLASS, (INT. CLS. 35, 37, 40, 42 AND 45), (U.S. CLS. 100, 101, 102, 103 AND 106). SN 77-542,370. PUB. 6-23-2009. FILED 8-8-2008.
- 3,678,674. **OUTER BANKS TRAVEL GUIDE (BLOCK FORM)**. DARE COUNTY TOURISM BOARD, DBA OUTER BANKS TRAVEL BUREAU, (U.S. CLS. 100, 101 AND 102). SN 77-542,545. PUB. 6-23-2009. FILED 8-8-2008.
- 3,678,681. **METROMARK (BLOCK FORM)**. METROMARK MARKET RESEARCH, INC., MULTIPLE CLASS, (INT. CLS. 35 AND 45), (U.S. CLS. 100, 101 AND 102). SN 77-544,490. PUB. 6-23-2009. FILED 8-12-2008.
- 3,678,684. **HEALTHY MARGINS (BLOCK FORM)**. CURB YOUR CRAVINGS, LLC, (U.S. CLS. 100, 101 AND 102). SN 77-544,687. PUB. 6-23-2009. FILED 8-12-2008.
- 3,678,693. **THE ICE CREAM LOVER'S YOGURT (BLOCK FORM)**. JEFFREY R. BARNES, (U.S. CLS. 100, 101 AND 102). SN 77-546,630. PUB. 6-23-2009. FILED 8-13-2008.
- 3,678,695. **UNCHAIN YOUR BRAIN (BLOCK FORM)**. MED-IACROSS, INC., (U.S. CLS. 100, 101 AND 102). SN 77-547,305. PUB. 6-23-2009. FILED 8-14-2008.
- 3,678,696. **HOTWIRE.COM TRAVEL-TICKER AND DESIGN**. HOTWIRE, INC., MULTIPLE CLASS, (INT. CLS. 35, 39 AND 43), (U.S. CLS. 100, 101, 102 AND 105). SN 77-547,315. PUB. 6-23-2009. FILED 8-14-2008.
- 3,678,702. **ORGANIC TRAVEL (BLOCK FORM)**. DOGFRIENDLY.COM, INC., (U.S. CLS. 100, 101 AND 102). SN 77-548,254. PUB. 6-23-2009. FILED 8-15-2008.
- 3,678,713. **CALIFORNIA CERTIFIED FARMERS MARKET AND DESIGN**. CALIFORNIA CERTIFIED FARMERS MARKET, (U.S. CLS. 100, 101 AND 102). SN 77-550,973. PUB. 6-23-2009. FILED 8-19-2008.
- 3,678,714. **COMFORTSAVE (BLOCK FORM)**. SINGER BROTHERS ACQUISITION LLC, MULTIPLE CLASS, (INT. CLS. 35, 37, 39 AND 42), (U.S. CLS. 100, 101, 102, 103, 105 AND 106). SN 77-551,533. PUB. 6-23-2009. FILED 8-20-2008.
- 3,678,723. **THE OUTER BANKS OF NORTH CAROLINA (BLOCK FORM)**. DARE COUNTY TOURISM BOARD, DBA OUTER BANKS TRAVEL BUREAU, (U.S. CLS. 100, 101 AND 102). SN 77-554,581. PUB. 6-23-2009. FILED 8-25-2008.
- 3,678,726. **PRESTIGE TIME (BLOCK FORM)**. PRESTIGE TIME, LLC., (U.S. CLS. 100, 101 AND 102). SN 77-555,006. PUB. 6-23-2009. FILED 8-25-2008.
- 3,678,734 (*See Class 25 for this trademark*).
- 3,678,736. **FLAMETREE GLASS (BLOCK FORM)**. FLAMETREE GLASS, INC., (U.S. CLS. 100, 101 AND 102). SN 77-556,628. PUB. 6-23-2009. FILED 8-27-2008.
- 3,678,747 (*See Class 16 for this trademark*).
- 3,678,756. **PRESTIGE TIME AND DESIGN**. PRESTIGE TIME, LLC, (U.S. CLS. 100, 101 AND 102). SN 77-563,050. PUB. 6-23-2009. FILED 9-5-2008.
- 3,678,757. **PRESTIGE TIME AND DESIGN**. PRESTIGE TIME, LLC, (U.S. CLS. 100, 101 AND 102). SN 77-563,079. PUB. 6-23-2009. FILED 9-5-2008.
- 3,678,764. **IN YOUR FACE BIG MOUTH ADVERTISING AND DESIGN**. BIG MOUTH MARKETING, LLC, (U.S. CLS. 100, 101 AND 102). SN 77-567,530. PUB. 6-23-2009. FILED 9-11-2008.
- 3,678,768. **KNOWLEDGE . INNOVATION . PERFORMANCE . VALUE (STYLIZED)**. INDEPENDENCE BLUE CROSS, MULTIPLE CLASS, (INT. CLS. 35 AND 36), (U.S. CLS. 100, 101 AND 102). SN 77-569,007. PUB. 6-23-2009. FILED 9-12-2008.
- 3,678,774 (*See Class 25 for this trademark*).
- 3,678,776. **UNITED ROAD (BLOCK FORM)**. UNITED ROAD SERVICES, INC., MULTIPLE CLASS, (INT. CLS. 35 AND 39), (U.S. CLS. 100, 101, 102 AND 105). SN 77-571,033. PUB. 6-23-2009. FILED 9-16-2008.
- 3,678,779. **AMERICAN CAR CARE CENTERS AND DESIGN**. AMERICAN CAR CARE CENTERS, INC., (U.S. CLS. 100, 101 AND 102). SN 77-571,277. PUB. 6-23-2009. FILED 9-16-2008.
- 3,678,781. **TATTOO BRAND CONSULTING (BLOCK FORM)**. TATTOO, MULTIPLE CLASS, (INT. CLS. 35 AND 42), (U.S. CLS. 100, 101 AND 102). SN 77-572,269. PUB. 6-23-2009. FILED 9-17-2008.
- 3,678,792. **CHARITY MIX AND DESIGN**. PREGAME MIX, LLC, MULTIPLE CLASS, (INT. CLS. 35 AND 41), (U.S. CLS.

- 100, 101, 102 AND 107). SN 77-574,444. PUB. 6-23-2009. FILED 9-19-2008.
- 3,678,793. **CHARITYMIX (BLOCK FORM)**. PREGAME MIX, LLC, MULTIPLE CLASS, (INT. CLS. 35 AND 41), (U.S. CLS. 100, 101, 102 AND 107). SN 77-574,447. PUB. 6-23-2009. FILED 9-19-2008.
- 3,678,809. **APEX INVESTIGATION (BLOCK FORM)**. APEX INVESTIGATIVE SERVICES, INC., MULTIPLE CLASS, (INT. CLS. 35 AND 45), (U.S. CLS. 100, 101 AND 102). SN 77-579,128. PUB. 3-17-2009. FILED 9-25-2008.
- 3,678,813. **REX SUPPLY (BLOCK FORM)**. PTS SALES COMPANY, (U.S. CLS. 100, 101 AND 102). SN 77-581,099. PUB. 6-23-2009. FILED 9-29-2008.
- 3,678,814. **REX AND DESIGN**. PTS SALES COMPANY, (U.S. CLS. 100, 101 AND 102). SN 77-581,144. PUB. 6-23-2009. FILED 9-29-2008.
- 3,678,818. **MSC CARE MANAGEMENT AND DESIGN**. MSC GROUP, INC., (U.S. CLS. 100, 101 AND 102). SN 77-582,570. PUB. 6-23-2009. FILED 9-30-2008.
- 3,678,820. **SAVEOLOGY.COM (BLOCK FORM)**. ELEPHANT GROUP, INC., (U.S. CLS. 100, 101 AND 102). SN 77-582,961. PUB. 6-23-2009. FILED 10-1-2008.
- 3,678,841. **DELIVERING THE POST-ACUTE CONTINUUM (BLOCK FORM)**. REHABCARE GROUP, INC., (U.S. CLS. 100, 101 AND 102). SN 77-587,463. PUB. 6-23-2009. FILED 10-7-2008.
- 3,678,854. **PRIDE. OUR SECRET INGREDIENT (BLOCK FORM)**. WISCONSIN MILK MARKETING BOARD, INC., (U.S. CLS. 100, 101 AND 102). SN 77-590,392. PUB. 6-23-2009. FILED 10-10-2008.
- 3,678,859. **ENHANCED SEGMENT PROFILING (BLOCK FORM)**. TRAFFICMARKETPLACE, INC., (U.S. CLS. 100, 101 AND 102). SN 77-592,502. PUB. 6-23-2009. FILED 10-14-2008.
- 3,678,868. **THE GOOD COMPANY (BLOCK FORM)**. TGC HOLDINGS LLC, (U.S. CLS. 100, 101 AND 102). SN 77-594,955. PUB. 6-23-2009. FILED 10-17-2008.
- 3,678,869. **THE GOOD COMPANY GOOD PEOPLE. GREAT DEALS. (BLOCK FORM)**. TGC HOLDINGS LLC, (U.S. CLS. 100, 101 AND 102). SN 77-594,975. PUB. 6-23-2009. FILED 10-17-2008.
- 3,678,880. **PRINTWEAR XPRESS (STYLIZED)**. PRINTWEAR XPRESS FRANCHISING, LLC, (U.S. CLS. 100, 101 AND 102). SN 77-599,172. PUB. 6-23-2009. FILED 10-23-2008.
- 3,678,901. **HROUNDTABLES (BLOCK FORM)**. AMERITAS HOLDING COMPANY, (U.S. CLS. 100, 101 AND 102). SN 77-603,093. PUB. 6-23-2009. FILED 10-29-2008.
- 3,678,918. **IDEACOM (BLOCK FORM)**. INDEPENDENT DISTRIBUTORS ASSOCIATION, LLC, (U.S. CLS. 100, 101 AND 102). SN 77-609,576. PUB. 6-23-2009. FILED 11-7-2008.
- 3,678,932. **THECITYOF BELLAVISTA AND DESIGN**. CITY OF BELLA VISTA, ARKANSAS, (U.S. CLS. 100, 101 AND 102). SN 77-616,013. PUB. 6-23-2009. FILED 11-17-2008.
- 3,678,953. **UL AND DESIGN**. UPPERCASE LIVING, LLC, (U.S. CLS. 100, 101 AND 102). SN 77-621,487. PUB. 6-23-2009. FILED 11-25-2008.
- 3,678,955. **PANT PLANET AND DESIGN**. BROWN, STEPHEN M., DBA PANT PLANET, (U.S. CLS. 100, 101 AND 102). SN 77-621,859. PUB. 6-23-2009. FILED 11-25-2008.
- 3,678,956. **AIM ACADEMICS INTEGRITY MARKSMANSHIP (BLOCK FORM)**. AMATEUR TRAPSHOOTING ASSOCIATION, MULTIPLE CLASS, (INT. CLS. 35 AND 41), (U.S. CLS. 100, 101, 102 AND 107). SN 77-622,218. PUB. 6-23-2009. FILED 11-26-2008.
- 3,678,960. **JOEL COMM (BLOCK FORM)**. COMM, JOEL, (U.S. CLS. 100, 101 AND 102). SN 77-623,341. PUB. 6-23-2009. FILED 11-30-2008.
- 3,678,967. **BADGE BOMB AND DESIGN**. BADGE BOMB LLC, (U.S. CLS. 100, 101 AND 102). SN 77-625,078. PUB. 6-23-2009. FILED 12-2-2008.
- 3,678,975. **GLAMWIRE (BLOCK FORM)**. LEVINE, MILON HENRY, (U.S. CLS. 100, 101 AND 102). SN 77-627,209. PUB. 6-23-2009. FILED 12-5-2008.
- 3,678,978. **WOMEN'S BUSINESS MASTERMIND GROUP WOMEN HELPING WOMEN AND DESIGN**. WOMEN'S BUSINESS MASTERMIND GROUP, INC., (U.S. CLS. 100, 101 AND 102). SN 77-627,255. PUB. 6-23-2009. FILED 12-5-2008.
- 3,679,000. **SKETCHWORKS (BLOCK FORM)**. SKETCHWORKS, INC., DBA SKETCHWORKS, MULTIPLE CLASS, (INT. CLS. 35 AND 42), (U.S. CLS. 100, 101 AND 102). SN 77-633,669. PUB. 6-23-2009. FILED 12-16-2008.
- 3,679,001. **MY DOLL'S LIFE (BLOCK FORM)**. SOPHIA'S HERITAGE COLLECTION, INC., (U.S. CLS. 100, 101 AND 102). SN 77-634,170. PUB. 6-23-2009. FILED 12-16-2008.
- 3,679,003. **GROPPETTI (BLOCK FORM)**. GROPPETTI LTD., INC., MULTIPLE CLASS, (INT. CLS. 35, 37 AND 39), (U.S. CLS. 100, 101, 102, 103, 105 AND 106). SN 77-634,539. PUB. 6-23-2009. FILED 12-16-2008.
- 3,679,004. **RETIRED OFFICERS UNIFORMS LLC AND DESIGN**. RETIRED OFFICERS UNIFORMS, LLC, (U.S. CLS. 100, 101 AND 102). SN 77-634,600. PUB. 6-23-2009. FILED 12-16-2008.
- 3,679,045. ***FARMLAND* ...GLOBAL ENTERPRISES... AND DESIGN**. FARMER, JEFFREY BERNARD, (U.S. CLS. 100, 101 AND 102). SN 77-646,109. PUB. 6-23-2009. FILED 1-8-2009.
- 3,679,051. **ATTITUDE: RADIATING POSSIBILITY (BLOCK FORM)**. GROH PRODUCTIONS, INC., MULTIPLE CLASS, (INT. CLS. 35 AND 41), (U.S. CLS. 100, 101, 102 AND 107). SN 77-647,708. PUB. 6-23-2009. FILED 1-12-2009.
- 3,679,054 (See Class 25 for this trademark).
- 3,679,059. **H MARK HOLDER JEWELLER LOVE HER HOLD HER KEEP HER AND DESIGN**. MARK HOLDER JEWELLER, (U.S. CLS. 100, 101 AND 102). SN 77-649,309. PUB. 6-23-2009. FILED 1-14-2009.
- 3,679,062. **ACRC AND DESIGN**. AG CONTAINER RECYCLING COUNCIL, (U.S. CLS. 100, 101 AND 102). SN 77-650,003. PUB. 6-23-2009. FILED 1-15-2009.
- 3,679,068. **DOC INTERNATIONAL AND DESIGN**. DOC INTERNATIONAL, INC., MULTIPLE CLASS, (INT. CLS. 35, 39, 41 AND 43), (U.S. CLS. 100, 101, 102, 105 AND 107). SN 77-651,016. PUB. 6-23-2009. FILED 1-16-2009.
- 3,679,070. **IDEA GATEWAY (BLOCK FORM)**. IDEA GATEWAY LLC, (U.S. CLS. 100, 101 AND 102). SN 77-652,197. PUB. 6-23-2009. FILED 1-19-2009.
- 3,679,071. **YES AND DESIGN**. PREVO'S FAMILY MARKETS, INC., (U.S. CLS. 100, 101 AND 102). SN 77-652,361. PUB. 6-23-2009. FILED 1-20-2009.
- 3,679,095. **BGT (BLOCK FORM)**. BURN WORLD-WIDE LTD., DBA BGT PARTNERS, MULTIPLE CLASS, (INT. CLS. 35 AND 42), (U.S. CLS. 100, 101 AND 102). SN 77-656,263. PUB. 6-23-2009. FILED 1-26-2009.
- 3,679,098. **ALPACA ACADEMY (BLOCK FORM)**. ALPACA REGISTRY, INC., MULTIPLE CLASS, (INT. CLS. 35 AND 44), (U.S. CLS. 100, 101 AND 102). SN 77-656,508. PUB. 6-23-2009. FILED 1-26-2009.
- 3,679,103. **BLOBLIVE (BLOCK FORM)**. IDEABLOB CORP., (U.S. CLS. 100, 101 AND 102). SN 77-656,686. PUB. 6-23-2009. FILED 1-26-2009.
- 3,679,104 (See Class 16 for this trademark).
- 3,679,105. **BLOBLIVE AND DESIGN**. IDEABLOB CORP., (U.S. CLS. 100, 101 AND 102). SN 77-656,772. PUB. 6-23-2009. FILED 1-26-2009.
- 3,679,108. **EVANGELIZE.COM AND DESIGN**. EIGHT20-EIGHT, LLC, DBA EVANGELIZE.COM, (U.S. CLS. 100, 101 AND 102). SN 77-657,119. PUB. 6-23-2009. FILED 1-27-2009.
- 3,679,111 (See Class 5 for this trademark).
- 3,679,113. **ISOLA (BLOCK FORM)**. ISOLA IMPORTS, INC., (U.S. CLS. 100, 101 AND 102). SN 77-658,322. PUB. 6-23-2009. FILED 1-28-2009.
- 3,679,132. **INMAR (BLOCK FORM)**. INMAR, INC., (U.S. CLS. 100, 101 AND 102). SN 77-662,291. PUB. 6-23-2009. FILED 2-3-2009.
- 3,679,133. **INMAR AND DESIGN**. INMAR, INC., (U.S. CLS. 100, 101 AND 102). SN 77-662,309. PUB. 6-23-2009. FILED 2-3-2009.
- 3,679,134. **SIGNATURE ECOSMART (BLOCK FORM)**. PROLIANCE ENERGY LLC, MULTIPLE CLASS, (INT. CLS. 35, 36 AND 42), (U.S. CLS. 100, 101 AND 102). SN 77-662,515. PUB. 6-23-2009. FILED 2-3-2009.
- 3,679,136. **PETROTECHNICS (BLOCK FORM)**. PETROTECHNICS USA, INC., MULTIPLE CLASS, (INT. CLS. 35 AND 42), (U.S. CLS. 100, 101 AND 102). SN 77-662,991. PUB. 6-23-2009. FILED 2-4-2009.

- 3,679,137. **SIMPLE. STYLE. SMART. (BLOCK FORM)**. SWEDA COMPANY, LLC, (U.S. CLS. 100, 101 AND 102). SN 77-663,190. PUB. 6-23-2009. FILED 2-4-2009.
- 3,679,138. **ALPHA PANEL (BLOCK FORM)**. GINGER CONSULTING, LLC, (U.S. CLS. 100, 101 AND 102). SN 77-663,567. PUB. 6-23-2009. FILED 2-4-2009.
- 3,679,140. **FORTUNATO PARTNERS INC. AND DESIGN**. FEDERICO, NOELLE K., (U.S. CLS. 100, 101 AND 102). SN 77-663,887. PUB. 6-23-2009. FILED 2-5-2009.
- 3,679,159. **1,001FRANCHISES.COM AND DESIGN**. UNIFIED INTELLIGENCE INC., (U.S. CLS. 100, 101 AND 102). SN 77-665,739. PUB. 6-23-2009. FILED 2-7-2009.
- 3,679,161. **SHEEA-B (BLOCK FORM)**. GABRIELLE A. FRIEDLAND, (U.S. CLS. 100, 101 AND 102). SN 77-665,913. PUB. 6-23-2009. FILED 2-9-2009.
- 3,679,162. **SMARTSERVICE TIMELY . PREVENTIVE . MAINTENANCE AND DESIGN**. MORGAN TIRE & AUTO, INC., (U.S. CLS. 100, 101 AND 102). SN 77-665,963. PUB. 6-23-2009. FILED 2-9-2009.
- 3,679,172 (*See Class 2 for this trademark*).
- 3,679,177. **ADBRITE (STYLIZED)**. ADBRITE, INC., (U.S. CLS. 100, 101 AND 102). SN 77-667,143. PUB. 6-23-2009. FILED 2-10-2009.
- 3,679,179. **BLACK LABEL ADS (BLOCK FORM)**. ADBRITE, INC., (U.S. CLS. 100, 101 AND 102). SN 77-667,153. PUB. 6-23-2009. FILED 2-10-2009.
- 3,679,180. **SW2 (BLOCK FORM)**. STARWORKS LLC, MULTIPLE CLASS, (INT. CLS. 35 AND 41), (U.S. CLS. 100, 101, 102 AND 107). SN 77-667,326. PUB. 6-23-2009. FILED 2-10-2009.
- 3,679,195. **ZIMPLEMONEY AND DESIGN**. ZIMPLE, INC., TA ZIMPLEMONEY, (U.S. CLS. 100, 101 AND 102). SN 77-668,640. PUB. 6-23-2009. FILED 2-11-2009.
- 3,679,196. **ECOAST (BLOCK FORM)**. ECOAST SALES SOLUTIONS, INC., (U.S. CLS. 100, 101 AND 102). SN 77-668,887. PUB. 6-23-2009. FILED 2-12-2009.
- 3,679,199. **THE INVISIBLE CLOSE (BLOCK FORM)**. EXTIMATA INC, MULTIPLE CLASS, (INT. CLS. 35 AND 41), (U.S. CLS. 100, 101, 102 AND 107). SN 77-668,998. PUB. 6-23-2009. FILED 2-12-2009.
- 3,679,204. **FIP CREATIVE AND DESIGN**. FOXCHASE IMAGE PRODUCTS, INC., MULTIPLE CLASS, (INT. CLS. 35 AND 42), (U.S. CLS. 100, 101 AND 102). SN 77-669,558. PUB. 6-23-2009. FILED 2-12-2009.
- 3,679,207. **TIP CAPITAL (BLOCK FORM)**. TECHNOLOGY INVESTMENT PARTNERS, LLC, MULTIPLE CLASS, (INT. CLS. 35 AND 36), (U.S. CLS. 100, 101 AND 102). SN 77-669,733. PUB. 6-23-2009. FILED 2-12-2009.
- 3,679,208 (*See Class 27 for this trademark*).
- 3,679,214. **GEC SUMMERWORKUSA.COM WINTERWORKUSA.COM GLOBAL EDUCATIONAL CONCEPTS A DIVISION OF THE SOUTHWESTERN COMPANY. AND DESIGN**. GLOBAL EDUCATIONAL CONCEPTS, INC., MULTIPLE CLASS, (INT. CLS. 35 AND 39), (U.S. CLS. 100, 101, 102 AND 105). SN 77-670,437. PUB. 6-23-2009. FILED 2-13-2009.
- 3,679,221. **SPROUT STRATEGY AND DESIGN**. SPROUT, CORP., DBA SPROUT STRATEGY, (U.S. CLS. 100, 101 AND 102). SN 77-670,820. PUB. 6-23-2009. FILED 2-14-2009.
- 3,679,227. **WINTER CREEK STORE (BLOCK FORM)**. WINTER CREEK STORE, INC., (U.S. CLS. 100, 101 AND 102). SN 77-671,224. PUB. 6-23-2009. FILED 2-16-2009.
- 3,679,228. **SIMM (BLOCK FORM)**. PROSPER BUSINESS DEVELOPMENT CORPORATION, (U.S. CLS. 100, 101 AND 102). SN 77-671,245. PUB. 6-23-2009. FILED 2-16-2009.
- 3,679,234. **INVITATIONS BY YOU (BLOCK FORM)**. VIRTUAL INVENTORIES, INC., (U.S. CLS. 100, 101 AND 102). SN 77-671,392. PUB. 6-23-2009. FILED 2-16-2009.
- 3,679,238. **PROM DOLLARS (BLOCK FORM)**. PROMGIRL LLC, (U.S. CLS. 100, 101 AND 102). SN 77-671,482. PUB. 6-23-2009. FILED 2-16-2009.
- 3,679,241. **MEDAC (BLOCK FORM)**. MEDAC, INC., (U.S. CLS. 100, 101 AND 102). SN 77-671,697. PUB. 6-23-2009. FILED 2-17-2009.
- 3,679,243. **LENS RENTALS.COM AND DESIGN**. LENSRENTALS, INC., MULTIPLE CLASS, (INT. CLS. 35 AND 41), (U.S. CLS. 100, 101, 102 AND 107). SN 77-671,954. PUB. 6-23-2009. FILED 2-17-2009.
- 3,679,245. **S SABIN VACCINE INSTITUTE AND DESIGN**. ALBERT B. SABIN VACCINE INSTITUTE, INC., DBA SABIN VACCINE INSTITUTE, MULTIPLE CLASS, (INT. CLS. 35 AND 42), (U.S. CLS. 100, 101 AND 102). SN 77-671,966. PUB. 6-23-2009. FILED 2-17-2009.
- 3,679,250. **GOLF LIQUIDATION U.S.A. AND DESIGN**. GOLF LIQUIDATION USA, LLC, (U.S. CLS. 100, 101 AND 102). SN 77-672,105. PUB. 6-23-2009. FILED 2-17-2009.
- 3,679,252. **A AND DESIGN**. ASHBA MEDIA, INC., (U.S. CLS. 100, 101 AND 102). SN 77-672,131. PUB. 6-23-2009. FILED 2-17-2009.
- 3,679,253. **MEDICAP (BLOCK FORM)**. MEDICAP PHARMACIES INCORPORATED, (U.S. CLS. 100, 101 AND 102). SN 77-672,145. PUB. 6-23-2009. FILED 2-17-2009.
- 3,679,262. **MY MARTIN'S ONLINE AND DESIGN**. AHOLD LICENSING SA, MULTIPLE CLASS, (INT. CLS. 35 AND 43), (U.S. CLS. 100, 101 AND 102). SN 77-672,635. PUB. 6-23-2009. FILED 2-18-2009.
- 3,679,268. **MISCELLANEOUS DESIGN**. RAINEY, MONTIE, (U.S. CLS. 100, 101 AND 102). SN 77-672,741. PUB. 6-23-2009. FILED 2-18-2009.
- 3,679,272. **GOLFBALL NUT (BLOCK FORM)**. LINKS CHOICE LLC, (U.S. CLS. 100, 101 AND 102). SN 77-673,011. PUB. 6-23-2009. FILED 2-18-2009.
- 3,679,274. **MISCELLANEOUS DESIGN**. MATE, HAYLEY, (U.S. CLS. 100, 101 AND 102). SN 77-673,212. PUB. 6-23-2009. FILED 2-18-2009.
- 3,679,277. **FIND YOUR FETISH (BLOCK FORM)**. TRANSCENDIGITAL, INC., (U.S. CLS. 100, 101 AND 102). SN 77-673,253. PUB. 6-23-2009. FILED 2-18-2009.
- 3,679,280. **CHALET MARKET (BLOCK FORM)**. CROMWELL CORPORATION, MULTIPLE CLASS, (INT. CLS. 35 AND 43), (U.S. CLS. 100, 101 AND 102). SN 77-673,309. PUB. 6-23-2009. FILED 2-18-2009.
- 3,679,289. **ECOPIGGY (BLOCK FORM)**. MATE, HAYLEY, (U.S. CLS. 100, 101 AND 102). SN 77-673,606. PUB. 6-23-2009. FILED 2-19-2009.
- 3,679,293. **TASTEFULLY SIMPLE GIVING WITH GRATITUDE AND DESIGN**. TASTEFULLY SIMPLE, INC., MULTIPLE CLASS, (INT. CLS. 35 AND 36), (U.S. CLS. 100, 101 AND 102). SN 77-673,813. PUB. 6-23-2009. FILED 2-19-2009.
- 3,679,300. **FOUNDATION FOR INTERNATIONAL MEDICAL RELIEF OF CHILDREN (BLOCK FORM)**. FOUNDATION FOR INTERNATIONAL MEDICAL RELIEF OF CHILDREN, (U.S. CLS. 100, 101 AND 102). SN 77-673,927. PUB. 6-23-2009. FILED 2-19-2009.
- 3,679,304. **INSTITUTE FOR HEALTH CARE GOVERNANCE AND DESIGN**. THE CENTER FOR RURAL HEALTH DEVELOPMENT, INC., MULTIPLE CLASS, (INT. CLS. 35 AND 41), (U.S. CLS. 100, 101, 102 AND 107). SN 77-674,034. PUB. 6-23-2009. FILED 2-19-2009.
- 3,679,315. **GOSPELVILLE.COM (BLOCK FORM)**. ADVICE INTERACTIVE GROUP LLC, DBA GOSPELVILLE.COM, (U.S. CLS. 100, 101 AND 102). SN 77-674,414. PUB. 6-23-2009. FILED 2-20-2009.
- 3,679,323. **THE SILVER IGUANA AND DESIGN**. LONESOME PINE, (U.S. CLS. 100, 101 AND 102). SN 77-674,579. PUB. 6-23-2009. FILED 2-20-2009.
- 3,679,325. **EK ASSOCIATES (BLOCK FORM)**. EK ASSOCIATES, INC., (U.S. CLS. 100, 101 AND 102). SN 77-674,697. PUB. 6-23-2009. FILED 2-20-2009.
- 3,679,327 (*See Class 3 for this trademark*).
- 3,679,330. **ADVISOR CONNECT AND DESIGN**. ORION ADVISOR SERVICES, LLC, (U.S. CLS. 100, 101 AND 102). SN 77-674,821. PUB. 6-23-2009. FILED 2-20-2009.
- 3,679,335. **VOUPON (BLOCK FORM)**. DRM LABS, INC., (U.S. CLS. 100, 101 AND 102). SN 77-674,936. PUB. 6-23-2009. FILED 2-20-2009.
- 3,679,336. **VPUNCH (BLOCK FORM)**. DRM LABS, INC., (U.S. CLS. 100, 101 AND 102). SN 77-674,949. PUB. 6-23-2009. FILED 2-20-2009.
- 3,679,337. **7-ELEVEN AND DESIGN**. 7-ELEVEN, INC., (U.S. CLS. 100, 101 AND 102). SN 77-675,061. PUB. 6-23-2009. FILED 2-20-2009.
- 3,679,339. **SPNET (BLOCK FORM)**. SELECTMARK, INC., (U.S. CLS. 100, 101 AND 102). SN 77-675,080. PUB. 6-23-2009. FILED 2-20-2009.
- 3,679,340. **ICE CREAM CAPITAL OF THE WORLD AND DESIGN**. LE MARS AREA CHAMBER OF COMMERCE,

- INC., (U.S. CLS. 100, 101 AND 102). SN 77-675,083. PUB. 6-23-2009. FILED 2-20-2009.
- 3,679,341. **7 ELEVEN AND DESIGN**. 7-ELEVEN, INC., (U.S. CLS. 100, 101 AND 102). SN 77-675,105. PUB. 6-23-2009. FILED 2-20-2009.
- 3,679,346. **AVANI MEDIA (BLOCK FORM)**. AVANI MEDIA INC., (U.S. CLS. 100, 101 AND 102). SN 77-675,233. PUB. 6-23-2009. FILED 2-20-2009.
- 3,679,351. **TAKE BACK THE NIGHT (BLOCK FORM)**. TAKE BACK THE NIGHT, AKA TBTN, (U.S. CLS. 100, 101 AND 102). SN 77-675,353. PUB. 6-23-2009. FILED 2-21-2009.
- 3,679,352. **MARRIAGE COUNSELOR FOR MANUFACTURERS (BLOCK FORM)**. JD TECHNOLOGIES, LLC, (U.S. CLS. 100, 101 AND 102). SN 77-675,372. PUB. 6-23-2009. FILED 2-21-2009.
- 3,679,353. **GOODGIRLS PR (BLOCK FORM)**. GOODGIRLS PR, (U.S. CLS. 100, 101 AND 102). SN 77-675,392. PUB. 6-23-2009. FILED 2-21-2009.
- 3,679,359. **VISIBLE MEN (BLOCK FORM)**. NEIL PHILLIPS, DBA VISIBLE MEN, MULTIPLE CLASS, (INT. CLS. 35 AND 41), (U.S. CLS. 100, 101, 102 AND 107). SN 77-675,502. PUB. 6-23-2009. FILED 2-22-2009.
- 3,679,360. **CRIS CONSIGNMENT (BLOCK FORM)**. ZANDER, CRIS, (U.S. CLS. 100, 101 AND 102). SN 77-675,529. PUB. 6-23-2009. FILED 2-22-2009.
- 3,679,361. **THE WHEEL OF GOLDEN SPOKES AND DESIGN**. GODINET, WAYNE P., (U.S. CLS. 100, 101 AND 102). SN 77-675,530. PUB. 6-23-2009. FILED 2-22-2009.
- 3,679,367. **JRPG (BLOCK FORM)**. DUSCH, DANIEL R. (U.S. CLS. 100, 101 AND 102). SN 77-675,624. PUB. 6-23-2009. FILED 2-23-2009.
- 3,679,375. **CINZIA THE SPA AND DESIGN**. THE SPA AT NORTH BEACH LLC, MULTIPLE CLASS, (INT. CLS. 35 AND 44), (U.S. CLS. 100, 101 AND 102). SN 77-675,850. PUB. 6-23-2009. FILED 2-23-2009.
- 3,679,382. **PUREINTEGRATION AND DESIGN**. PURE INTEGRATION, LLC, MULTIPLE CLASS, (INT. CLS. 35 AND 42), (U.S. CLS. 100, 101 AND 102). SN 77-675,933. PUB. 6-23-2009. FILED 2-23-2009.
- 3,679,384. **PUREINTEGRATION (BLOCK FORM)**. PURE INTEGRATION, LLC, MULTIPLE CLASS, (INT. CLS. 35 AND 42), (U.S. CLS. 100, 101 AND 102). SN 77-675,978. PUB. 6-23-2009. FILED 2-23-2009.
- 3,679,385. **BIZDEX (BLOCK FORM)**. BIZEQUITY CORP., (U.S. CLS. 100, 101 AND 102). SN 77-675,992. PUB. 6-23-2009. FILED 2-23-2009.
- 3,679,386. **KEEPING YOUR CUSTOMERS LOYAL (BLOCK FORM)**. KOBIE MARKETING, INC., (U.S. CLS. 100, 101 AND 102). SN 77-676,005. PUB. 6-23-2009. FILED 2-23-2009.
- 3,679,395. **CHARACTER (BLOCK FORM)**. CHARACTER LLC, (U.S. CLS. 100, 101 AND 102). SN 77-676,223. PUB. 6-23-2009. FILED 2-23-2009.
- 3,679,401. **YOUR SOURCE FOR LABORATORY NOTEBOOKS (BLOCK FORM)**. HAYDEN-MCNEIL, LLC, (U.S. CLS. 100, 101 AND 102). SN 77-676,271. PUB. 6-23-2009. FILED 2-23-2009.
- 3,679,406. **PINK SLIP PARTY LA (BLOCK FORM)**. BCS STAFFING, INC., (U.S. CLS. 100, 101 AND 102). SN 77-676,396. PUB. 6-23-2009. FILED 2-23-2009.
- 3,679,424. **SAVING ENERGY IS SMART BUSINESS (BLOCK FORM)**. MINNESOTA WASTE WISE FOUNDATION, (U.S. CLS. 100, 101 AND 102). SN 77-676,682. PUB. 6-23-2009. FILED 2-24-2009.
- 3,679,431. **SECO INTERNATIONAL (BLOCK FORM)**. SECO INTERNATIONAL, LLC, MULTIPLE CLASS, (INT. CLS. 35 AND 41), (U.S. CLS. 100, 101, 102 AND 107). SN 77-676,758. PUB. 6-23-2009. FILED 2-24-2009.
- 3,679,438. **I AND DESIGN**. HDS IP HOLDING, LLC, (U.S. CLS. 100, 101 AND 102). SN 77-676,841. PUB. 6-23-2009. FILED 2-24-2009.
- 3,679,446. **GOODPOINTS (BLOCK FORM)**. GOODLIFE.COM, INC., (U.S. CLS. 100, 101 AND 102). SN 77-676,927. PUB. 6-23-2009. FILED 2-24-2009.
- 3,679,451. **LOVE-TO-HELP ACCOUNTING, FINANCIAL MANAGEMENT AND CONSULTING (BLOCK FORM)**. LOVE, MARNELL, W., (U.S. CLS. 100, 101 AND 102). SN 77-676,967. PUB. 6-23-2009. FILED 2-24-2009.
- 3,679,453. **COURAGE CARRIES ON (BLOCK FORM)**. RE-SULTS UNLIMITED, (U.S. CLS. 100, 101 AND 102). SN 77-676,987. PUB. 6-23-2009. FILED 2-24-2009.
- 3,679,457 (*See Class 30 for this trademark*).
- 3,679,462. **BAGELS WITH CHUTZPAH (BLOCK FORM)**. LEO'S BAGELS HANOVER SQUARE LLC, MULTIPLE CLASS, (INT. CLS. 35 AND 43), (U.S. CLS. 100, 101 AND 102). SN 77-677,081. PUB. 6-23-2009. FILED 2-24-2009.
- 3,679,463. **SUPER MERCADO JALISCO (BLOCK FORM)**. SUPER MERCADO JALISCO, INC., AND SUPER MERCADO JALISCO II, INC., AND SUPER MERCADO JALISCO #3, INC., AND SUPER MERCADO JALISCO #4, INC., AND CARNICERIA JALISCO INC., DBA SUPER MERCADO JALISCO #5, AND SUPER MERCADO JALISCO #6, INC., (U.S. CLS. 100, 101 AND 102). SN 77-677,085. PUB. 6-23-2009. FILED 2-24-2009.
- 3,679,464. **SMJ AND DESIGN**. SUPER MERCADO JALISCO, INC., AND SUPER MERCADO JALISCO II, INC., AND SUPER MERCADO JALISCO #3, INC., AND SUPER MERCADO JALISCO #4, INC., AND CARNICERIA JALISCO INC., DBA SUPER MERCADO JALISCO #5, AND SUPER MERCADO JALISCO #6, INC., (U.S. CLS. 100, 101 AND 102). SN 77-677,090. PUB. 6-23-2009. FILED 2-24-2009.
- 3,679,465. **STAR AND DESIGN**. STAR MARKET, INC., (U.S. CLS. 100, 101 AND 102). SN 77-677,105. PUB. 6-23-2009. FILED 2-24-2009.
- 3,679,467. **S FACTOR (BLOCK FORM)**. SIMPLY MAC, INC., (U.S. CLS. 100, 101 AND 102). SN 77-677,122. PUB. 6-23-2009. FILED 2-24-2009.
- 3,679,480. **BATTERY GIANT AND DESIGN**. BATTERY GIANT, INC., (U.S. CLS. 100, 101 AND 102). SN 77-677,204. PUB. 6-23-2009. FILED 2-24-2009.
- 3,679,485. **ZENITH (BLOCK FORM)**. ZENITH GLOBAL LOGISTICS, LLC, MULTIPLE CLASS, (INT. CLS. 35 AND 39), (U.S. CLS. 100, 101, 102 AND 105). SN 77-677,281. PUB. 6-23-2009. FILED 2-24-2009.
- 3,679,491. **ZENITH AND DESIGN**. ZENITH GLOBAL LOGISTICS, LLC, MULTIPLE CLASS, (INT. CLS. 35 AND 39), (U.S. CLS. 100, 101, 102 AND 105). SN 77-677,333. PUB. 6-23-2009. FILED 2-24-2009.
- 3,679,498. **MEDIAMAN (BLOCK FORM)**. MEDIAMAN, LLC, (U.S. CLS. 100, 101 AND 102). SN 77-677,416. PUB. 6-23-2009. FILED 2-24-2009.
- 3,679,513 (*See Class 16 for this trademark*).
- 3,679,548. **GETSALES (BLOCK FORM)**. COUPONS, LLC, (U.S. CLS. 100, 101 AND 102). SN 77-677,998. PUB. 6-23-2009. FILED 2-25-2009.
- 3,679,550. **DISCOUNT HITCHES AND DESIGN**. OWEN RENTAL AND SERVICE CENTER, INC., (U.S. CLS. 100, 101 AND 102). SN 77-678,068. PUB. 6-23-2009. FILED 2-25-2009.
- 3,679,561. **WEFEDPAC AND DESIGN**. OHIO FARMERS INSURANCE COMPANY, (U.S. CLS. 100, 101 AND 102). SN 77-678,182. PUB. 6-23-2009. FILED 2-25-2009.
- 3,679,580. **STATEMENTS GO GREEN (BLOCK FORM)**. STROUD TECHNOLOGY GROUP, INC., (U.S. CLS. 100, 101 AND 102). SN 77-678,438. PUB. 6-23-2009. FILED 2-25-2009.
- 3,679,605 (*See Class 16 for this trademark*).
- 3,679,607. **DON'T DO ORDINARY. NO ORDINARY LIFE. (BLOCK FORM)**. THE VMI ALUMNI ASSOCIATION, INC., (U.S. CLS. 100, 101 AND 102). SN 77-678,980. PUB. 6-23-2009. FILED 2-26-2009.
- 3,679,612. **SHATTERING THE SILENCE (BLOCK FORM)**. THE DISPATCH PRINTING COMPANY, (U.S. CLS. 100, 101 AND 102). SN 77-679,014. PUB. 6-23-2009. FILED 2-26-2009.
- 3,679,618 (*See Class 14 for this trademark*).
- 3,679,619 (*See Class 14 for this trademark*).
- 3,679,624. **SOLUTIONS WITHOUT WALLS (BLOCK FORM)**. SMARTREVENUE.COM, (U.S. CLS. 100, 101 AND 102). SN 77-679,169. PUB. 6-23-2009. FILED 2-26-2009.
- 3,679,628. **GET A REAL PET SITTER (BLOCK FORM)**. PET SITTERS INTERNATIONAL, INC., (U.S. CLS. 100, 101 AND 102). SN 77-679,211. PUB. 6-23-2009. FILED 2-26-2009.
- 3,679,635. **CIRRUS MEDICAL STAFFING (BLOCK FORM)**. CIRRUS MEDICAL STAFFING, INC., (U.S. CLS. 100, 101 AND 102). SN 77-679,325. PUB. 6-23-2009. FILED 2-26-2009.
- 3,679,644. **FROM CREATION TO NATURAL DEATH ALL**

- AMERICAN LIFE LEAGUE AND DESIGN. AMERICAN LIFE LEAGUE, INC., (U.S. CLS. 100, 101 AND 102). SN 77-679,419. PUB. 6-23-2009. FILED 2-26-2009.
- 3,679,675. **HOSPITALITYDELIVERED (BLOCK FORM)**. HOSPITALITY DELIVERED, LLC, (U.S. CLS. 100, 101 AND 102). SN 77-680,099. PUB. 6-23-2009. FILED 2-27-2009.
- 3,679,678. **HOSPITALITYDELIVERED AND DESIGN**. HOSPITALITY DELIVERED, LLC, (U.S. CLS. 100, 101 AND 102). SN 77-680,138. PUB. 6-23-2009. FILED 2-27-2009.
- 3,679,681. **WE LISTEN TO YOUR GUESTS (BLOCK FORM)**. WELCHER, ROBERT B., DBA RESTAURANT CONSULTANTS, INC., (U.S. CLS. 100, 101 AND 102). SN 77-680,175. PUB. 6-23-2009. FILED 2-27-2009.
- 3,679,694. **WHAT DO YOU WANT TO BE? (BLOCK FORM)**. B2B VENTURES, LLC, (U.S. CLS. 100, 101 AND 102). SN 77-680,422. PUB. 6-23-2009. FILED 2-27-2009.
- 3,679,713. **NEXCHANGE (BLOCK FORM)**. WHITE, CHRISTOPHER B, DBA NEXCHANGE, (U.S. CLS. 100, 101 AND 102). SN 77-680,759. PUB. 6-23-2009. FILED 2-28-2009.
- 3,679,718. **PAL (BLOCK FORM)**. PACIFIC ATLANTIC LINES, INC., MULTIPLE CLASS, (INT. CLS. 35 AND 39), (U.S. CLS. 100, 101, 102 AND 105). SN 77-681,040. PUB. 6-23-2009. FILED 3-2-2009.
- 3,679,733. **FOOD & WINE 2 GO AND DESIGN**. AMERICAN EXPRESS MARKETING & DEVELOPMENT CORP., (U.S. CLS. 100, 101 AND 102). SN 77-685,582. PUB. 6-23-2009. FILED 3-6-2009.
- 3,679,744. **BATTERY GIANT (BLOCK FORM)**. BATTERY GIANT, INC., (U.S. CLS. 100, 101 AND 102). SN 77-690,593. PUB. 6-23-2009. FILED 3-13-2009.
- 3,679,766. **MISCELLANEOUS DESIGN**. EVRICHART, INC., (U.S. CLS. 100, 101 AND 102). SN 77-699,976. PUB. 6-23-2009. FILED 3-26-2009.
- 3,679,771. **A SEASON TO BE NAUGHTY (BLOCK FORM)**. LOVER'S LANE I.P., LTD., DBA LOVER'S LANE, (U.S. CLS. 100, 101 AND 102). SN 77-703,985. PUB. 6-23-2009. FILED 4-1-2009.
- 3,679,772. **DWOM (BLOCK FORM)**. 3601 LLC, (U.S. CLS. 100, 101 AND 102). SN 77-704,428. PUB. 6-23-2009. FILED 4-1-2009.
- 3,679,776. **ATTENTIONRANK (BLOCK FORM)**. VIDEOEGG, INC., (U.S. CLS. 100, 101 AND 102). SN 77-706,285. PUB. 6-23-2009. FILED 4-3-2009.
- 3,679,787. **THE WISDOM TO LEAD. THE COURAGE TO ACT. THE COMPASSION TO INSPIRE. (BLOCK FORM)**. CENTER FOR CITIZEN LEADERSHIP, AKA THE MISSION CONTINUES, (U.S. CLS. 100, 101 AND 102). SN 77-714,528. PUB. 6-23-2009. FILED 4-15-2009.
- 3,679,791. **THINK INDIE AND DESIGN**. COALITION OF INDEPENDENT MUSIC STORES, LLC, (U.S. CLS. 100, 101 AND 102). SN 77-977,129. PUB. 6-23-2009. FILED 8-8-2008.
- 3,679,804 (*See Class 9 for this trademark*).
- 3,679,815. **FLAGSHIP GAMES INTERNATIONAL AND DESIGN**. FLAGSHIP GAMES INTERNATIONAL, LLC, (U.S. CLS. 100, 101 AND 102). SN 78-672,283. PUB. 6-23-2009. FILED 7-18-2005.
- 3,679,818. **SIMPLY WHOLESOME AND DESIGN**. P. M. KEELING CORPORATION, (U.S. CLS. 100, 101 AND 102). SN 78-708,107. PUB. 6-23-2009. FILED 9-7-2005.
- 3,679,834. **HIP DIGITAL (BLOCK FORM)**. HIP DIGITAL MEDIA INC., MULTIPLE CLASS, (INT. CLS. 35, 38 AND 42), (U.S. CLS. 100, 101, 102 AND 104). SN 78-841,649. PUB. 12-9-2008. FILED 3-20-2006.
- 3,679,835. **H I P AND DESIGN**. HIP DIGITAL MEDIA INC., MULTIPLE CLASS, (INT. CLS. 35, 38 AND 42), (U.S. CLS. 100, 101, 102 AND 104). SN 78-841,667. PUB. 12-16-2008. FILED 3-20-2006.
- 3,679,837 (*See Class 11 for this trademark*).
- 3,679,838 (*See Class 1 for this trademark*).
- 3,679,844 (*See Class 9 for this trademark*).
- 3,679,858 (*See Class 9 for this trademark*).
- 3,679,860. **LARRY ADLER (BLOCK FORM)**. ADLER NOMINEES PTY. LIMITED, MULTIPLE CLASS, (INT. CLS. 35 AND 41), (U.S. CLS. 100, 101, 102 AND 107). SN 79-038,727. PUB. 6-23-2009. FILED 2-23-2007.
- 3,679,862 (*See Class 16 for this trademark*).
- 3,679,869. **NATURMAMA (BLOCK FORM)**, NATURMAMA HOLDINGS PTY LTD, (U.S. CLS. 100, 101 AND 102). SN 79-048,101. PUB. 6-23-2009. FILED 8-6-2007.
- 3,679,871. **P3 (STYLIZED)**, P3 INGENIEURGESELLSCHAFT FÜR; MANAGEMENT & ORGANISATION MBH, MULTIPLE CLASS, (INT. CLS. 35 AND 42), (U.S. CLS. 100, 101 AND 102). SN 79-048,719. PUB. 6-23-2009. FILED 10-22-2007.
- 3,679,872 (*See Class 5 for this trademark*).
- 3,679,883 (*See Class 9 for this trademark*).
- 3,679,884 (*See Class 9 for this trademark*).
- 3,679,886 (*See Class 9 for this trademark*).
- 3,679,890. **COREALCREDIT BANK (BLOCK FORM)**. COREALCREDIT BANK AG, MULTIPLE CLASS, (INT. CLS. 35, 36 AND 38), (U.S. CLS. 100, 101, 102 AND 104). SN 79-053,706. PUB. 6-23-2009. FILED 8-30-2007.
- 3,679,902 (*See Class 20 for this trademark*).
- 3,679,909. **MISCELLANEOUS DESIGN**. CAPGEMINI DEUTSCHLAND GMBH, MULTIPLE CLASS, (INT. CLS. 35, 41 AND 42), (U.S. CLS. 100, 101, 102 AND 107). SN 79-056,897. PUB. 6-23-2009. FILED 5-19-2008.
- 3,679,910 (*See Class 16 for this trademark*).
- 3,679,915 (*See Class 9 for this trademark*).
- 3,679,938 (*See Class 8 for this trademark*).
- 3,679,949. **CGI YACHT FINANCE AND DESIGN**. COMPAGNIE GÉNÉRALE DE LOCATION D'EQUIPEMENTS, MULTIPLE CLASS, (INT. CLS. 35 AND 36), (U.S. CLS. 100, 101 AND 102). SN 79-059,418. PUB. 6-23-2009. FILED 7-10-2008.
- 3,679,953. **ROOTS & RITUALS (BLOCK FORM)**. CHOCO, COÖPERATIEVE; VENNOOTSCHAP MET BEPERKTE; AANSPRAKELIJKHEID, MULTIPLE CLASS, (INT. CLS. 35 AND 41), (U.S. CLS. 100, 101, 102 AND 107). SN 79-059,497. PUB. 6-23-2009. FILED 2-19-2008.
- 3,679,965 (*See Class 9 for this trademark*).
- 3,679,969. **NEWSMILL (BLOCK FORM)**. NEWS AND CROWD CASTING AB, MULTIPLE CLASS, (INT. CLS. 35, 41 AND 42), (U.S. CLS. 100, 101, 102 AND 107). SN 79-059,961. PUB. 6-23-2009. FILED 8-27-2008.
- 3,679,973 (*See Class 17 for this trademark*).
- 3,679,979 (*See Class 3 for this trademark*).
- 3,679,989 (*See Class 7 for this trademark*).
- 3,680,007 (*See Class 1 for this trademark*).
- 3,680,018. **CENIZARO (BLOCK FORM)**. THE RESIDENCE HOTELS & RESORTS; PTE. LTD., MULTIPLE CLASS, (INT. CLS. 35, 36, 43 AND 44), (U.S. CLS. 100, 101 AND 102). SN 79-063,358. PUB. 6-23-2009. FILED 10-16-2008.
- 3,680,020 (*See Class 16 for this trademark*).
- 3,680,031. **MARCCUS (BLOCK FORM)**. STICHTING ARC-CUS, MULTIPLE CLASS, (INT. CLS. 35, 41 AND 45), (U.S. CLS. 100, 101, 102 AND 107). SN 79-064,353. PUB. 6-23-2009. FILED 9-30-2008.
- 3,680,037 (*See Class 28 for this trademark*).
- 3,680,042. **CRYO-BREHM (BLOCK FORM)**. FRAUNHOFER-GESELLSCHAFT ZUR; FÖRDERUNG DER ANGEWANDTEN FORSCHUNG E.V., MULTIPLE CLASS, (INT. CLS. 35 AND 40), (U.S. CLS. 100, 101, 102, 103 AND 106). SN 79-065,931. PUB. 6-23-2009. FILED 11-7-2008.

CLASS 36—INSURANCE AND FINANCIAL

- 3,678,143 (*See Class 35 for this trademark*).
- 3,678,182. **AV AND DESIGN**. AVOCA INSURANCE HOLDINGS, LTD., (U.S. CLS. 100, 101 AND 102). SN 76-693,395. PUB. 2-24-2009. FILED 10-7-2008.
- 3,678,202. **WEALTHSECURE (STYLIZED)**. CORPORATE COMPENSATION PLANS, INC., (U.S. CLS. 100, 101 AND 102). SN 76-696,772. PUB. 6-23-2009. FILED 4-8-2009.
- 3,678,217 (*See Class 35 for this trademark*).
- 3,678,230 (*See Class 35 for this trademark*).
- 3,678,231. **RA THE REALTY ASSOCIATES AND DESIGN**. THE REALTY ASSOCIATES, (U.S. CLS. 100, 101 AND 102). SN 77-164,942. PUB. 6-23-2009. FILED 4-25-2007.
- 3,678,235. **YOUR MONEY. YOUR CHOICE. YOUR BANK. (BLOCK FORM)**. MCNB BANKS, (U.S. CLS. 100, 101 AND 102). SN 77-186,997. PUB. 11-6-2007. FILED 5-22-2007.
- 3,678,246 (*See Class 35 for this trademark*).
- 3,678,255. **PACHIRA (BLOCK FORM)**. PACHIRA IP INC.,

- MULTIPLE CLASS, (INT. CLS. 36 AND 45), (U.S. CLS. 100, 101 AND 102). SN 77-233,339. PUB. 6-23-2009. FILED 7-19-2007.
- 3,678,267. **ALTITUDE CAPITAL PARTNERS (BLOCK FORM)**. ALTITUDE CAPITAL PARTNERS, LLC, (U.S. CLS. 100, 101 AND 102). SN 77-246,978. PUB. 6-23-2009. FILED 8-3-2007.
- 3,678,268. **A ALTITUDE CAPITAL PARTNERS AND DESIGN**. ALTITUDE CAPITAL PARTNERS, LLC, (U.S. CLS. 100, 101 AND 102). SN 77-246,984. PUB. 6-23-2009. FILED 8-3-2007.
- 3,678,274. **PREFERRED PROPERTY PROGRAM (BLOCK FORM)**. JACOBSON, GOLDFARB & SCOTT, INC., (U.S. CLS. 100, 101 AND 102). SN 77-285,982. PUB. 6-23-2009. FILED 9-21-2007.
- 3,678,286 (*See Class 35 for this trademark*).
- 3,678,287 (*See Class 35 for this trademark*).
- 3,678,345. **THE FIRST AND ONLY VEHICLE RETURN PROGRAM (BLOCK FORM)**. WALKAWAY CANADA INCORPORATED, (U.S. CLS. 100, 101 AND 102). SN 77-378,253. PUB. 6-23-2009. FILED 1-23-2008.
- 3,678,359 (*See Class 35 for this trademark*).
- 3,678,377 (*See Class 16 for this trademark*).
- 3,678,386. **SUMMERQUEST (BLOCK FORM)**. VAIL MOUNTAIN SCHOOL, (U.S. CLS. 100, 101 AND 102). SN 77-422,712. PUB. 6-23-2009. FILED 3-14-2008.
- 3,678,388. **MISCELLANEOUS DESIGN**. TREESWING, MULTIPLE CLASS, (INT. CLS. 36 AND 44), (U.S. CLS. 100, 101 AND 102). SN 77-425,350. PUB. 6-23-2009. FILED 3-18-2008.
- 3,678,394 (*See Class 35 for this trademark*).
- 3,678,400. **THE REEF CLUB AND DESIGN**. ARACAZINHO, S.L., MULTIPLE CLASS, (INT. CLS. 36 AND 37), (U.S. CLS. 100, 101, 102, 103 AND 106). SN 77-435,480. PUB. 6-23-2009. FILED 3-31-2008.
- 3,678,403. **FIRSTCOMP (BLOCK FORM)**. ASPEN HOLDINGS, INC., (U.S. CLS. 100, 101 AND 102). SN 77-438,634. PUB. 6-23-2009. FILED 4-3-2008.
- 3,678,410. **JCAM (BLOCK FORM)**. JAMES CAIRD ASSET MANAGEMENT LLP, (U.S. CLS. 100, 101 AND 102). SN 77-443,678. PUB. 3-17-2009. FILED 4-9-2008.
- 3,678,418. **FAMILY FINANCIAL PARTNERS GROWING WEALTH, FOR GENERATIONS AND DESIGN**. FAMILY FINANCIAL PARTNERS, INC., (U.S. CLS. 100, 101 AND 102). SN 77-452,504. PUB. 6-23-2009. FILED 4-18-2008.
- 3,678,427. **MISCELLANEOUS DESIGN**. AMERICAN FAMILY LIFE ASSURANCE COMPANY OF COLUMBUS, (U.S. CLS. 100, 101 AND 102). SN 77-457,779. PUB. 6-23-2009. FILED 4-25-2008.
- 3,678,428 (*See Class 35 for this trademark*).
- 3,678,449. **GLOBALCREDIT ADVISERS AND DESIGN**. GLOBAL CREDIT ADVISERS LLC, (U.S. CLS. 100, 101 AND 102). SN 77-485,594. PUB. 6-23-2009. FILED 5-28-2008.
- 3,678,467 (*See Class 35 for this trademark*).
- 3,678,473. **THE PLANNING CENTER (BLOCK FORM)**. THE PLANNING CENTER, INC., (U.S. CLS. 100, 101 AND 102). SN 77-500,329. PUB. 6-23-2009. FILED 6-16-2008.
- 3,678,486. **THE SHOPS AT RIVERSIDE (BLOCK FORM)**. THE MILLS LIMITED PARTNERSHIP, (U.S. CLS. 100, 101 AND 102). SN 77-507,776. PUB. 6-23-2009. FILED 6-25-2008.
- 3,678,489. **TREEHOUSE GROUP (BLOCK FORM)**. TREEHOUSE GROUP, LLC, (U.S. CLS. 100, 101 AND 102). SN 77-508,651. PUB. 6-23-2009. FILED 6-26-2008.
- 3,678,495. **RETIREMENTREVISED (BLOCK FORM)**. 50+ DIGITAL LLC, (U.S. CLS. 100, 101 AND 102). SN 77-512,165. PUB. 6-23-2009. FILED 7-1-2008.
- 3,678,517. **INDEXIQ (BLOCK FORM)**. FINANCIAL DEVELOPMENT HOLDCO LLC, (U.S. CLS. 100, 101 AND 102). SN 77-521,276. PUB. 6-23-2009. FILED 7-14-2008.
- 3,678,521. **DISCOUNT PROPERTY WHOLESALERS.COM YOUR DISCOUNT REAL ESTATE PROVIDER AND DESIGN**. FAST CASH HOUSE BUYERS, LLC, (U.S. CLS. 100, 101 AND 102). SN 77-522,795. PUB. 6-23-2009. FILED 7-15-2008.
- 3,678,537. **BIOTECH YIELD ENDORSEMENT (BLOCK FORM)**. MONSANTO TECHNOLOGY LLC, (U.S. CLS. 100, 101 AND 102). SN 77-526,985. PUB. 6-23-2009. FILED 7-21-2008.
- 3,678,547. **VOSS FOUNDATION (BLOCK FORM)**. VOSS OF NORWAY ASA, (U.S. CLS. 100, 101 AND 102). SN 77-528,337. PUB. 6-23-2009. FILED 7-22-2008.
- 3,678,548. **VOSS FOUNDATION (STYLIZED)**. VOSS OF NORWAY ASA, (U.S. CLS. 100, 101 AND 102). SN 77-528,488. PUB. 6-23-2009. FILED 7-22-2008.
- 3,678,589. **DIYMORTGAGE.COM (BLOCK FORM)**. UNION NATIONAL MORTGAGE CO., (U.S. CLS. 100, 101 AND 102). SN 77-534,900. PUB. 6-23-2009. FILED 7-30-2008.
- 3,678,609. **COMPASS ON BUSINESS (BLOCK FORM)**. COMPASS BANCSHARES, INC., (U.S. CLS. 100, 101 AND 102). SN 77-537,222. PUB. 6-23-2009. FILED 8-1-2008.
- 3,678,645. **MISCELLANEOUS DESIGN**. LINCOLN INVESTMENT PLANNING, INC., (U.S. CLS. 100, 101 AND 102). SN 77-539,885. PUB. 6-23-2009. FILED 8-5-2008.
- 3,678,711. **ACE THERMO-SCAN (BLOCK FORM)**. ACE LIMITED, (U.S. CLS. 100, 101 AND 102). SN 77-550,399. PUB. 6-23-2009. FILED 8-19-2008.
- 3,678,721. **TAKE A BREAK IN THE POOL AND ON YOUR WALLET. (BLOCK FORM)**. HYDE, AARON JUNIOR, AKA HYDEAWAY OF LUTZ, FLORIDA, (U.S. CLS. 100, 101 AND 102). SN 77-554,033. PUB. 6-23-2009. FILED 8-22-2008.
- 3,678,725. **FULLERTON UNIVERSITY VILLAGE (BLOCK FORM)**. FULLERTON-UNIVERSITY VILLAGE, LLC, MULTIPLE CLASS, (INT. CLS. 36 AND 43), (U.S. CLS. 100, 101 AND 102). SN 77-554,750. PUB. 6-23-2009. FILED 8-25-2008.
- 3,678,729. **FINDATA (BLOCK FORM)**. FINDATA LIMITED, (U.S. CLS. 100, 101 AND 102). SN 77-555,543. PUB. 6-23-2009. FILED 8-26-2008.
- 3,678,743. **SECLUDED SANCTUARY (BLOCK FORM)**. KRAUCUNAS, ROBERT W., (U.S. CLS. 100, 101 AND 102). SN 77-559,624. PUB. 6-23-2009. FILED 8-31-2008.
- 3,678,749. **MISCELLANEOUS DESIGN**. SINGLE PARENT SCHOLARSHIP FUND OF BENTON COUNTY, INC., (U.S. CLS. 100, 101 AND 102). SN 77-561,537. PUB. 6-23-2009. FILED 9-3-2008.
- 3,678,752. **KIDSSTRONG (BLOCK FORM)**. FALSETTI, CHRISTINE MARIE, (U.S. CLS. 100, 101 AND 102). SN 77-561,721. PUB. 1-20-2009. FILED 9-3-2008.
- 3,678,768 (*See Class 35 for this trademark*).
- 3,678,802. **MEXDER (BLOCK FORM)**. MEXDER, MERCADO MEXICANO DE DERIVADOS, S.A. DE C.V., AKA MEXDER, (U.S. CLS. 100, 101 AND 102). SN 77-577,550. PUB. 6-23-2009. FILED 9-24-2008.
- 3,678,803 (*See Class 9 for this trademark*).
- 3,678,804 (*See Class 9 for this trademark*).
- 3,678,806. **IACP INTERNATIONAL ACADEMY OF COMPOUNDING PHARMACISTS FOUNDATION AND DESIGN**. INTERNATIONAL ACADEMY OF COMPOUNDING PHARMACISTS FOUNDATION, (U.S. CLS. 100, 101 AND 102). SN 77-578,398. PUB. 6-23-2009. FILED 9-25-2008.
- 3,678,811. **MERCHANTGUY.COM (BLOCK FORM)**. MERCHANT GUY LLC, (U.S. CLS. 100, 101 AND 102). SN 77-580,671. PUB. 6-23-2009. FILED 9-28-2008.
- 3,678,862. **GRAND RAPIDS STATE AGENCY AND DESIGN**. WILCOX BANCSHARES, INC., (U.S. CLS. 100, 101 AND 102). SN 77-592,904. PUB. 6-23-2009. FILED 10-15-2008.
- 3,678,917. **NEW ORLEANS REALTY (BLOCK FORM)**. NEW ORLEANS REALTY, INCORPORATED, (U.S. CLS. 100, 101 AND 102). SN 77-609,460. PUB. 6-23-2009. FILED 11-6-2008.
- 3,678,970. **RE THE REAL ESTATE GROUP (STYLIZED)**. TREG, INC., DBA THE REAL ESTATE GROUP, (U.S. CLS. 100, 101 AND 102). SN 77-625,858. PUB. 6-23-2009. FILED 12-3-2008.
- 3,679,028. **I. RELI (STYLIZED)**. ASSURANT, INC., (U.S. CLS. 100, 101 AND 102). SN 77-640,755. PUB. 6-23-2009. FILED 12-29-2008.
- 3,679,033. **CREDIT FORGET IT AND DESIGN**. CREDIT FORGET IT, INC., (U.S. CLS. 100, 101 AND 102). SN 77-643,456. PUB. 6-23-2009. FILED 1-5-2009.
- 3,679,058. **BRIDGEFIELD EMPLOYERS INSURANCE COMPANY (BLOCK FORM)**. LIBERTY MUTUAL INSURANCE COMPANY, (U.S. CLS. 100, 101 AND 102). SN 77-649,136. PUB. 6-23-2009. FILED 1-14-2009.
- 3,679,066. **OUR DISTINCTIVE HOME SHOP (BLOCK FORM)**. EWING AND CLARK, INCORPORATED, (U.S. CLS. 100, 101 AND 102). SN 77-650,765. PUB. 6-23-2009. FILED 1-15-2009.
- 3,679,078. **COVIDIEN (BLOCK FORM)**. COVIDIEN AG, (U.S.

- CLS. 100, 101 AND 102). SN 77-653,157. PUB. 6-23-2009. FILED 1-21-2009.
- 3,679,086. **CC COVIDIEN (STYLIZED)**, COVIDIEN AG, (U.S. CLS. 100, 101 AND 102). SN 77-654,939. PUB. 6-23-2009. FILED 1-23-2009.
- 3,679,093. **THE RESERVE AT PARADISUS RESORTS AND DESIGN**, DORPAN, S.L., MULTIPLE CLASS, (INT. CLS. 36 AND 43), (U.S. CLS. 100, 101 AND 102). SN 77-655,587. PUB. 6-23-2009. FILED 1-23-2009.
- 3,679,116. **MISCELLANEOUS DESIGN**, BUYERS BROKERS ONLY, LLC, (U.S. CLS. 100, 101 AND 102). SN 77-658,794. PUB. 6-23-2009. FILED 1-28-2009.
- 3,679,118. **INTRASWEEP AND DESIGN**, INTRASWEEP LLC, (U.S. CLS. 100, 101 AND 102). SN 77-659,105. PUB. 6-23-2009. FILED 1-29-2009.
- 3,679,120. **INTRASWEEP ON-BALANCE-SHEET SWEEP (BLOCK FORM)**, INTRASWEEP LLC, (U.S. CLS. 100, 101 AND 102). SN 77-659,209. PUB. 6-23-2009. FILED 1-29-2009.
- 3,679,127. **THE BENEFITS PROFESSOR (BLOCK FORM)**, DAVINCI INSURANCE SERVICES, INC., (U.S. CLS. 100, 101 AND 102). SN 77-661,136. PUB. 6-23-2009. FILED 2-2-2009.
- 3,679,129. **TULIPS FOR TREMOR AND DESIGN**, INTERNATIONAL ESSENTIAL TREMOR FOUNDATION, AKA IETF, (U.S. CLS. 100, 101 AND 102). SN 77-662,134. PUB. 6-23-2009. FILED 2-3-2009.
- 3,679,130. **TRANSQUOTE (BLOCK FORM)**, TRANSAMERICA CORPORATION, (U.S. CLS. 100, 101 AND 102). SN 77-662,223. PUB. 6-23-2009. FILED 2-3-2009.
- 3,679,134 (*See Class 35 for this trademark*).
- 3,679,190. **WEFIXMONEY.COM (BLOCK FORM)**, REDNESS FINANCIAL LLC, DBA WE FIX MONEY, (U.S. CLS. 100, 101 AND 102). SN 77-668,342. PUB. 6-23-2009. FILED 2-11-2009.
- 3,679,193. **MISCELLANEOUS DESIGN**, FULTON FINANCIAL CORPORATION, (U.S. CLS. 100, 101 AND 102). SN 77-668,530. PUB. 6-23-2009. FILED 2-11-2009.
- 3,679,194. **MISCELLANEOUS DESIGN**, FULTON FINANCIAL CORPORATION, (U.S. CLS. 100, 101 AND 102). SN 77-668,548. PUB. 6-23-2009. FILED 2-11-2009.
- 3,679,207 (*See Class 35 for this trademark*).
- 3,679,215. **WHATEVER YOUR ENDEAVOR (BLOCK FORM)**, ADVANCE PAYROLL FUNDING LTD., (U.S. CLS. 100, 101 AND 102). SN 77-670,495. PUB. 6-23-2009. FILED 2-13-2009.
- 3,679,235. **SCHOLARBUILDER (BLOCK FORM)**, SCHOLARGROUP EQUITY PARTNERS, LLC, (U.S. CLS. 100, 101 AND 102). SN 77-671,412. PUB. 6-23-2009. FILED 2-16-2009.
- 3,679,240. **TRANSCREDIT MOBILE (BLOCK FORM)**, TRANSCREDIT, INC., (U.S. CLS. 100, 101 AND 102). SN 77-671,671. PUB. 6-23-2009. FILED 2-17-2009.
- 3,679,263. **HARBINGER AND DESIGN**, HARBERT MANAGEMENT CORPORATION, (U.S. CLS. 100, 101 AND 102). SN 77-672,672. PUB. 6-23-2009. FILED 2-18-2009.
- 3,679,293 (*See Class 35 for this trademark*).
- 3,679,295. **VIDA SÓLIDA. BANCO SÓLIDO. (BLOCK FORM)**, SUNTRUST BANKS, INC, (U.S. CLS. 100, 101 AND 102). SN 77-673,870. PUB. 6-23-2009. FILED 2-19-2009.
- 3,679,296. **XTRACT RESEARCH (BLOCK FORM)**, XTRACT RESEARCH LLC, MULTIPLE CLASS, (INT. CLS. 36, 38 AND 42), (U.S. CLS. 100, 101, 102 AND 104). SN 77-673,872. PUB. 6-23-2009. FILED 2-19-2009.
- 3,679,320. **STRATEGIC BENEFIT COACH (BLOCK FORM)**, G NELSON INSURANCE AGENCY INC., (U.S. CLS. 100, 101 AND 102). SN 77-674,520. PUB. 6-23-2009. FILED 2-20-2009.
- 3,679,328 (*See Class 25 for this trademark*).
- 3,679,334 (*See Class 16 for this trademark*).
- 3,679,430. **PROVISION (STYLIZED)**, AFFILIATED FM INSURANCE COMPANY, (U.S. CLS. 100, 101 AND 102). SN 77-676,730. PUB. 6-23-2009. FILED 2-24-2009.
- 3,679,475. **SALLIE MAE SMART OPTION STUDENT LOAN (BLOCK FORM)**, SALLIE MAE, INC., (U.S. CLS. 100, 101 AND 102). SN 77-677,169. PUB. 6-23-2009. FILED 2-24-2009.
- 3,679,476. **POWERING YOUR MORTGAGE BUSINESS (BLOCK FORM)**, TAYLOR, BEAN & WHITAKER MORTGAGE CORP., (U.S. CLS. 100, 101 AND 102). SN 77-677,172. PUB. 6-23-2009. FILED 2-24-2009.
- 3,679,481. **SMART OPTION (BLOCK FORM)**, SALLIE MAE, INC., (U.S. CLS. 100, 101 AND 102). SN 77-677,209. PUB. 6-23-2009. FILED 2-24-2009.
- 3,679,484. **FLEXPERTISE (BLOCK FORM)**, EXEMPLAR COMPANIES INC., MULTIPLE CLASS, (INT. CLS. 36 AND 45), (U.S. CLS. 100, 101 AND 102). SN 77-677,268. PUB. 6-23-2009. FILED 2-24-2009.
- 3,679,486 (*See Class 25 for this trademark*).
- 3,679,492. **YOU CONTROL THE JOURNEY (BLOCK FORM)**, CAMBRIDGE INVESTMENT RESEARCH, INC., (U.S. CLS. 100, 101 AND 102). SN 77-677,344. PUB. 6-23-2009. FILED 2-24-2009.
- 3,679,495. **MISCELLANEOUS DESIGN**, CAMBRIDGE INVESTMENT RESEARCH, INC., (U.S. CLS. 100, 101 AND 102). SN 77-677,379. PUB. 6-23-2009. FILED 2-24-2009.
- 3,679,540. **A WORTHY DESTINATION (BLOCK FORM)**, FURLONG, MARK, (U.S. CLS. 100, 101 AND 102). SN 77-677,908. PUB. 6-23-2009. FILED 2-25-2009.
- 3,679,543. **TLP (STYLIZED)**, AMERICAN AUTO GUARDIAN, INC., (U.S. CLS. 100, 101 AND 102). SN 77-677,945. PUB. 6-23-2009. FILED 2-25-2009.
- 3,679,549. **CHEKTODAY (BLOCK FORM)**, FSV PAYMENT SYSTEMS, INC., (U.S. CLS. 100, 101 AND 102). SN 77-678,050. PUB. 6-23-2009. FILED 2-25-2009.
- 3,679,552. **SMART OPTION STUDENT LOAN (BLOCK FORM)**, SALLIE MAE, INC., (U.S. CLS. 100, 101 AND 102). SN 77-678,133. PUB. 6-23-2009. FILED 2-25-2009.
- 3,679,568. **DISCOVERING NEW PATHS (BLOCK FORM)**, PRIMESOLUTIONS SECURITIES, INC., (U.S. CLS. 100, 101 AND 102). SN 77-678,298. PUB. 6-23-2009. FILED 2-25-2009.
- 3,679,570. **WE FOCUS ON YOUR REAL ESTATE - SO YOU CAN FOCUS ON YOUR PRACTICE (BLOCK FORM)**, COLLIER'S BENNETT & KAHNWEILER, INC., (U.S. CLS. 100, 101 AND 102). SN 77-678,337. PUB. 6-23-2009. FILED 2-25-2009.
- 3,679,575 (*See Class 9 for this trademark*).
- 3,679,585. **SETTING THE HIGHEST STANDARDS IN REAL ESTATE (BLOCK FORM)**, MINKEL ENTERPRISES, INC., (U.S. CLS. 100, 101 AND 102). SN 77-678,502. PUB. 6-23-2009. FILED 2-25-2009.
- 3,679,598 (*See Class 9 for this trademark*).
- 3,679,601. **UONLINE (BLOCK FORM)**, UNITUS COMMUNITY CREDIT UNION, (U.S. CLS. 100, 101 AND 102). SN 77-678,853. PUB. 6-23-2009. FILED 2-26-2009.
- 3,679,603. **THE TRUTH IS IN THE PROOF (BLOCK FORM)**, IFS DEVELOPMENT GROUP, LLC, (U.S. CLS. 100, 101 AND 102). SN 77-678,903. PUB. 6-23-2009. FILED 2-26-2009.
- 3,679,606. **PRESCRIPTION WITHOUT ANALYSIS IS MALPRACTICE (BLOCK FORM)**, IFS DEVELOPMENT GROUP, LLC, (U.S. CLS. 100, 101 AND 102). SN 77-678,937. PUB. 6-23-2009. FILED 2-26-2009.
- 3,679,617. **THE GREENVILLE PROJECT C.C.C.I DEF. HIP SUSTAINABLE DEVELOPMENT ARCHAEFRACTUS SINESIS HORTUS IN URBE AND DESIGN**, THE GREENVILLE PROJECT, (U.S. CLS. 100, 101 AND 102). SN 77-679,125. PUB. 6-23-2009. FILED 2-26-2009.
- 3,679,623. **THE GREENVILLE PROJECT (STYLIZED)**, THE GREENVILLE PROJECT, (U.S. CLS. 100, 101 AND 102). SN 77-679,167. PUB. 6-23-2009. FILED 2-26-2009.
- 3,679,627. **INDXIS INDEX ENGINEERING AND DESIGN**, MERGENT, INC., MULTIPLE CLASS, (INT. CLS. 36 AND 42), (U.S. CLS. 100, 101 AND 102). SN 77-679,208. PUB. 6-23-2009. FILED 2-26-2009.
- 3,679,643. **MISCELLANEOUS DESIGN**, ZIONS BANCORPORATION, (U.S. CLS. 100, 101 AND 102). SN 77-679,418. PUB. 6-23-2009. FILED 2-26-2009.
- 3,679,689. **IMPOSSIBLE (BLOCK FORM)**, PALLOTTA, DANIEL, (U.S. CLS. 100, 101 AND 102). SN 77-680,345. PUB. 6-23-2009. FILED 2-27-2009.
- 3,679,693. **MEGAPAY (BLOCK FORM)**, MEGAMEDIA LTD., (U.S. CLS. 100, 101 AND 102). SN 77-680,381. PUB. 6-23-2009. FILED 2-27-2009.
- 3,679,707. **BIKE RIDE FOR PRIDE (BLOCK FORM)**, EMPOWERMENT SOLUTIONS, LLC, DBA EMPOWERMENT SOLUTIONS, (U.S. CLS. 100, 101 AND 102). SN 77-680,657. PUB. 6-23-2009. FILED 2-27-2009.
- 3,679,708. **FUN RUN FOR PRIDE (BLOCK FORM)**, EMPOWERMENT SOLUTIONS, LLC, DBA EMPOWERMENT

- SOLUTIONS, (U.S. CLS. 100, 101 AND 102). SN 77-680,667. PUB. 6-23-2009. FILED 2-27-2009.
- 3,679,709. **WALK FOR PRIDE (BLOCK FORM)**, EMPOWERMENT SOLUTIONS, LLC, DBA EMPOWERMENT SOLUTIONS, (U.S. CLS. 100, 101 AND 102). SN 77-680,668. PUB. 6-23-2009. FILED 2-27-2009.
- 3,679,710. **FOX BUSINESS AND DESIGN**, TWENTIETH CENTURY FOX FILM CORPORATION, (U.S. CLS. 100, 101 AND 102). SN 77-680,670. PUB. 6-23-2009. FILED 2-27-2009.
- 3,679,802. **HOLA AMERICA (BLOCK FORM)**, CIMA TELECOM, INC., (U.S. CLS. 100, 101 AND 102). SN 78-420,667. PUB. 4-10-2007. FILED 5-18-2004.
- 3,679,816. **WILLIAM & EVA FOX FOUNDATION (BLOCK FORM)**, THE WILLIAM AND EVA FOX FOUNDATION, (U.S. CLS. 100, 101 AND 102). SN 78-694,213. PUB. 5-9-2006. FILED 8-17-2005.
- 3,679,817. **WILLIAM & EVA FOX FOUNDATION AND DESIGN**, THE WILLIAM AND EVA FOX FOUNDATION, (U.S. CLS. 100, 101 AND 102). SN 78-694,221. PUB. 5-9-2006. FILED 8-17-2005.
- 3,679,824 (*See Class 4 for this trademark*).
- 3,679,825 (*See Class 4 for this trademark*).
- 3,679,833. **ELITE DESTINATION HOMES (BLOCK FORM)**, REAL ESTATE EQUITIES VACATION INVESTMENTS, LLC, (U.S. CLS. 100, 101 AND 102). SN 78-832,548. PUB. 6-23-2009. FILED 3-8-2006.
- 3,679,838 (*See Class 1 for this trademark*).
- 3,679,842. **TFLOW (BLOCK FORM)**, COG, INC., (U.S. CLS. 100, 101 AND 102). SN 78-876,756. PUB. 12-26-2006. FILED 5-3-2006.
- 3,679,890 (*See Class 35 for this trademark*).
- 3,679,910 (*See Class 16 for this trademark*).
- 3,679,949 (*See Class 35 for this trademark*).
- 3,679,965 (*See Class 9 for this trademark*).
- 3,680,003. **CARBON PLANET AND DESIGN**, CARBON PLANET LIMITED, MULTIPLE CLASS, (INT. CLS. 36 AND 42), (U.S. CLS. 100, 101 AND 102). SN 79-062,021. PUB. 6-23-2009. FILED 8-28-2008.
- 3,680,018 (*See Class 35 for this trademark*).
- 3,680,054. **MISCELLANEOUS DESIGN**, SUMITOMO MITSUBISHI CARD COMPANY, LIMITED, (U.S. CLS. 100, 101 AND 102). SN 79-067,695. PUB. 6-23-2009. FILED 2-10-2009.
-
- CLASS 37—CONSTRUCTION AND REPAIR**
- 3,678,204 (*See Class 1 for this trademark*).
- 3,678,230 (*See Class 35 for this trademark*).
- 3,678,240. **NETBOOTH/NETROOM (BLOCK FORM)**, PRIORITY NETWORKS, INC., (U.S. CLS. 100, 103 AND 106). SN 77-199,408. PUB. 6-23-2009. FILED 6-6-2007.
- 3,678,246 (*See Class 35 for this trademark*).
- 3,678,265. **ENCLAVE RISING (BLOCK FORM)**, SLICKLEIN, KIM, (U.S. CLS. 100, 103 AND 106). SN 77-246,139. PUB. 6-23-2009. FILED 8-3-2007.
- 3,678,330. **MISCELLANEOUS DESIGN**, SNO-ENGINEERING, INC., DBA SE GROUP, (U.S. CLS. 100, 103 AND 106). SN 77-361,915. PUB. 6-23-2009. FILED 12-31-2007.
- 3,678,349 (*See Class 35 for this trademark*).
- 3,678,368. **GERDING EDLEN DEVELOPMENT AND DESIGN**, GERDING/EDLEN DEVELOPMENT COMPANY, LLC, MULTIPLE CLASS, (INT. CLS. 37 AND 42), (U.S. CLS. 100, 101, 103 AND 106). SN 77-405,634. PUB. 6-23-2009. FILED 2-25-2008.
- 3,678,371 (*See Class 11 for this trademark*).
- 3,678,400 (*See Class 36 for this trademark*).
- 3,678,401 (*See Class 6 for this trademark*).
- 3,678,428 (*See Class 35 for this trademark*).
- 3,678,432. **A-1 EXTERMINATORS (BLOCK FORM)**, A-1 EXTERMINATORS, INC., (U.S. CLS. 100, 103 AND 106). SN 77-464,496. PUB. 1-20-2009. FILED 5-2-2008.
- 3,678,470. **CB AND DESIGN**, CB RESOURCES CORPORATION, (U.S. CLS. 100, 103 AND 106). SN 77-499,716. PUB. 11-11-2008. FILED 6-16-2008.
- 3,678,480. **AFFINITY MECHANICAL, INC. AND DESIGN**, AFFINITY MECHANICAL, INC., (U.S. CLS. 100, 103 AND 106). SN 77-503,815. PUB. 6-23-2009. FILED 6-20-2008.
- 3,678,508. **BARNES (BLOCK FORM)**, BARNES, INC., MULTIPLE CLASS, (INT. CLS. 37 AND 44), (U.S. CLS. 100, 101, 103 AND 106). SN 77-517,721. PUB. 6-23-2009. FILED 7-9-2008.
- 3,678,575. **IRON MAVERICK INC. (BLOCK FORM)**, IRON MAVERICK, INC., MULTIPLE CLASS, (INT. CLS. 37 AND 40), (U.S. CLS. 100, 103 AND 106). SN 77-531,952. PUB. 6-23-2009. FILED 7-25-2008.
- 3,678,591. **BALESTRIERI AND DESIGN**, BALESTRIERI ENVIRONMENTAL & DEVELOPMENT, INC., MULTIPLE CLASS, (INT. CLS. 37 AND 42), (U.S. CLS. 100, 101, 103 AND 106). SN 77-534,980. PUB. 6-23-2009. FILED 7-30-2008.
- 3,678,612. **MCPHEARSONS AND DESIGN**, MCPHEARSONS HEATING AND COOLING LLC, (U.S. CLS. 100, 103 AND 106). SN 77-537,497. PUB. 6-23-2009. FILED 8-1-2008.
- 3,678,619. **EXTENDED DEMARC EXTENDING NEWORK RELIABILITY AND DESIGN**, EXTENDED DEMARC, (U.S. CLS. 100, 103 AND 106). SN 77-538,058. PUB. 6-23-2009. FILED 8-4-2008.
- 3,678,631 (*See Class 6 for this trademark*).
- 3,678,637. **BROOKS (BLOCK FORM)**, BROOKS DESIGN/BUILD INC., (U.S. CLS. 100, 103 AND 106). SN 77-539,297. PUB. 6-23-2009. FILED 8-5-2008.
- 3,678,642. **SOLAR DESIGN ASSOCIATES (BLOCK FORM)**, STRONG, STEVEN J., MULTIPLE CLASS, (INT. CLS. 37 AND 42), (U.S. CLS. 100, 101, 103 AND 106). SN 77-539,695. PUB. 6-23-2009. FILED 8-5-2008.
- 3,678,668 (*See Class 35 for this trademark*).
- 3,678,669 (*See Class 35 for this trademark*).
- 3,678,706. **ECOVALUE (BLOCK FORM)**, GAS TURBINE EFFICIENCY PLC, (U.S. CLS. 100, 103 AND 106). SN 77-548,909. PUB. 3-24-2009. FILED 8-17-2008.
- 3,678,714 (*See Class 35 for this trademark*).
- 3,678,720 (*See Class 7 for this trademark*).
- 3,678,798. **JUST BRAKES STOP AND DESIGN**, JUST BRAKES OF NEVADA, INC., (U.S. CLS. 100, 103 AND 106). SN 77-575,894. PUB. 6-23-2009. FILED 9-22-2008.
- 3,678,835. **MULTI-PEST SERVICES (BLOCK FORM)**, BEE-LINE ENTERPRISES, INC., DBA MULTI-PEST SERVICES, INC., (U.S. CLS. 100, 103 AND 106). SN 77-585,395. PUB. 6-23-2009. FILED 10-3-2008.
- 3,678,856. **LEFFLER ENERGY (BLOCK FORM)**, RICHLAND PARTNERS, LLC, (U.S. CLS. 100, 103 AND 106). SN 77-591,319. PUB. 6-23-2009. FILED 10-13-2008.
- 3,678,881. **THE RIGHT PARTNER (BLOCK FORM)**, VALENTI BUILDERS, INC., (U.S. CLS. 100, 103 AND 106). SN 77-599,185. PUB. 6-23-2009. FILED 10-23-2008.
- 3,678,926. **MYP2REPAIR.COM (STYLIZED)**, HOMENET PCS, INC., (U.S. CLS. 100, 103 AND 106). SN 77-612,932. PUB. 6-23-2009. FILED 11-12-2008.
- 3,679,003 (*See Class 35 for this trademark*).
- 3,679,007. **VT HALTER MARINE (BLOCK FORM)**, VT HALTER MARINE, INC., MULTIPLE CLASS, (INT. CLS. 37 AND 42), (U.S. CLS. 100, 101, 103 AND 106). SN 77-634,811. PUB. 5-19-2009. FILED 12-17-2008.
- 3,679,060. **ALL DOGS POOP (BLOCK FORM)**, FROST, LE ANN, DBA ALL DOGS POOP, (U.S. CLS. 100, 103 AND 106). SN 77-649,554. PUB. 6-23-2009. FILED 1-14-2009.
- 3,679,072. **HYDRA FORCE POWERWASHING AND DESIGN**, HYDRA FORCE POWERWASHING, (U.S. CLS. 100, 103 AND 106). SN 77-652,623. PUB. 6-23-2009. FILED 1-20-2009.
- 3,679,163. **SMARTSERVICE TIMELY . PREVENTIVE . MAINTENANCE AND DESIGN**, MORGAN TIRE & AUTO, INC., (U.S. CLS. 100, 103 AND 106). SN 77-665,966. PUB. 6-23-2009. FILED 2-9-2009.
- 3,679,164. **THE URETEK METHOD (BLOCK FORM)**, URETEK USA, INC., (U.S. CLS. 100, 103 AND 106). SN 77-666,056. PUB. 6-23-2009. FILED 2-9-2009.
- 3,679,165. **URETEK USA (BLOCK FORM)**, URETEK USA, INC., (U.S. CLS. 100, 103 AND 106). SN 77-666,070. PUB. 6-23-2009. FILED 2-9-2009.
- 3,679,167. **URETEK (BLOCK FORM)**, URETEK USA, INC., (U.S. CLS. 100, 103 AND 106). SN 77-666,227. PUB. 6-23-2009. FILED 2-9-2009.
- 3,679,168. **URETEK AND DESIGN**, URETEK USA, INC., (U.S. CLS. 100, 103 AND 106). SN 77-666,254. PUB. 6-23-2009. FILED 2-9-2009.
- 3,679,183. **NEW CUSTOM COATINGS AND DESIGN**, NEW

- CUSTOM COATINGS, LLC, (U.S. CLS. 100, 103 AND 106). SN 77-667,604. PUB. 6-23-2009. FILED 2-10-2009.
- 3,679,260. **STORMWATER MAINTENANCE INSPECTION MAINTENANCE REPAIR AND DESIGN**. STORMWATER MAINTENANCE, LLC, (U.S. CLS. 100, 103 AND 106). SN 77-672,416. PUB. 6-23-2009. FILED 2-17-2009.
- 3,679,299. **ROSAPENNY PENINSULA (BLOCK FORM)**. LKW PROPERTIES, LLC, (U.S. CLS. 100, 103 AND 106). SN 77-673,920. PUB. 6-23-2009. FILED 2-19-2009.
- 3,679,348. **LONE OAK (BLOCK FORM)**. CUSTOM VALUE SERVICES, LLC, DBA LONE OAK IRRIGATION, (U.S. CLS. 100, 103 AND 106). SN 77-675,340. PUB. 6-23-2009. FILED 2-21-2009.
- 3,679,349 (*See Class 4 for this trademark*).
- 3,679,365. **GEOESTIMATOR (BLOCK FORM)**. THORNBERY CONSULTING, LLC, (U.S. CLS. 100, 103 AND 106). SN 77-675,612. PUB. 6-23-2009. FILED 2-23-2009.
- 3,679,426. **DRY CLOTHES - SAFE HOMES (BLOCK FORM)**. AMERICAN FRANCHISE SYSTEMS, LLC, (U.S. CLS. 100, 103 AND 106). SN 77-676,687. PUB. 6-23-2009. FILED 2-24-2009.
- 3,679,486 (*See Class 25 for this trademark*).
- 3,679,530. **VALENTINE PLUMBING & HEATING (BLOCK FORM)**. DIVERSITY INVESTMENTS, INC., DBA VALENTINE PLUMBING & HEATING, INC., (U.S. CLS. 100, 103 AND 106). SN 77-677,768. PUB. 6-23-2009. FILED 2-25-2009.
- 3,679,557 (*See Class 1 for this trademark*).
- 3,679,824 (*See Class 4 for this trademark*).
- 3,679,825 (*See Class 4 for this trademark*).
- 3,679,838 (*See Class 1 for this trademark*).
- 3,679,870 (*See Class 12 for this trademark*).
- 3,679,877 (*See Class 6 for this trademark*).
- 3,679,889 (*See Class 6 for this trademark*).
- 3,679,900 (*See Class 6 for this trademark*).
- 3,679,922 (*See Class 5 for this trademark*).
- 3,679,925 (*See Class 11 for this trademark*).
- 3,679,926 (*See Class 11 for this trademark*).
- 3,679,946 (*See Class 1 for this trademark*).
- 3,679,960 (*See Class 19 for this trademark*).
- 3,680,035 (*See Class 7 for this trademark*).
- CLS. 100, 101, 104 AND 107). SN 77-534,715. PUB. 12-30-2008. FILED 7-30-2008.
- 3,678,635. **TW TELECOM AND DESIGN**. TIME WARNER INC., (U.S. CLS. 100, 101 AND 104). SN 77-539,150. PUB. 6-23-2009. FILED 8-5-2008.
- 3,678,740. **GLOBALCOM AND DESIGN**. GLOBALCOM INC., (U.S. CLS. 100, 101 AND 104). SN 77-557,106. PUB. 6-23-2009. FILED 8-27-2008.
- 3,678,788. **DIRT ROAD HIGH SPEED (BLOCK FORM)**. SKY CATCHER COMMUNICATIONS, INC., (U.S. CLS. 100, 101 AND 104). SN 77-572,961. PUB. 6-23-2009. FILED 9-18-2008.
- 3,678,839. **LONG BEACH VIDEO CONFERENCING CENTER (BLOCK FORM)**. KUSAR-ESTORGA, JERI LU, DBA KUSAR COURT REPORTERS AND LEGAL TECHNOLOGIES, MULTIPLE CLASS, (INT. CLS. 38 AND 43), (U.S. CLS. 100, 101 AND 104). SN 77-586,802. PUB. 6-23-2009. FILED 10-6-2008.
- 3,678,919. **UNIFIED DISPATCH (BLOCK FORM)**. UNIFIED DISPATCH, LLC, (U.S. CLS. 100, 101 AND 104). SN 77-610,357. PUB. 6-23-2009. FILED 11-7-2008.
- 3,679,050. **FNT AND DESIGN**. THE BIG TEN CONFERENCE, INC., MULTIPLE CLASS, (INT. CLS. 38 AND 41), (U.S. CLS. 100, 101, 104 AND 107). SN 77-647,520. PUB. 6-23-2009. FILED 1-12-2009.
- 3,679,131. **RAINIER CONNECT AND DESIGN**. MASHELL TELECOM, INC., DBA RAINIER CONNECT, (U.S. CLS. 100, 101 AND 104). SN 77-662,239. PUB. 6-23-2009. FILED 2-3-2009.
- 3,679,143. **PROVE WORLD (BLOCK FORM)**. PROVE WORLD, LLC, (U.S. CLS. 100, 101 AND 104). SN 77-664,099. PUB. 6-23-2009. FILED 2-5-2009.
- 3,679,246. **WEBCAST CITY (BLOCK FORM)**. REALNET PROPERTIES, LTD., MULTIPLE CLASS, (INT. CLS. 38 AND 42), (U.S. CLS. 100, 101 AND 104). SN 77-671,967. PUB. 6-23-2009. FILED 2-17-2009.
- 3,679,296 (*See Class 36 for this trademark*).
- 3,679,448. **GOODLIFE (BLOCK FORM)**. GOODLIFE.COM, INC., (U.S. CLS. 100, 101 AND 104). SN 77-676,953. PUB. 6-23-2009. FILED 2-24-2009.
- 3,679,501. **PAPPAS TELECASTING (BLOCK FORM)**. PAPPAS TELECASTING COMPANIES, (U.S. CLS. 100, 101 AND 104). SN 77-677,456. PUB. 6-23-2009. FILED 2-24-2009.
- 3,679,503. **PAPPAS TELECASTING COMPANIES AND DESIGN**. PAPPAS TELECASTING COMPANIES, (U.S. CLS. 100, 101 AND 104). SN 77-677,470. PUB. 6-23-2009. FILED 2-24-2009.
- 3,679,649. **DITCHMAIL (BLOCK FORM)**. YOUMAIL, INC., (U.S. CLS. 100, 101 AND 104). SN 77-679,498. PUB. 6-23-2009. FILED 2-26-2009.
- 3,679,680. **ADTUBE (BLOCK FORM)**. ALEXIOUS FIERO, (U.S. CLS. 100, 101 AND 104). SN 77-680,169. PUB. 6-23-2009. FILED 2-27-2009.
- 3,679,725. **KPIX (BLOCK FORM)**. CBS BROADCASTING INC., (U.S. CLS. 100, 101 AND 104). SN 77-683,545. PUB. 6-23-2009. FILED 3-4-2009.
- 3,679,739. **FOX BUSINESS AND DESIGN**. TWENTIETH CENTURY FOX FILM CORPORATION, (U.S. CLS. 100, 101 AND 104). SN 77-688,452. PUB. 6-23-2009. FILED 3-11-2009.
- 3,679,834 (*See Class 35 for this trademark*).
- 3,679,835 (*See Class 35 for this trademark*).
- 3,679,838 (*See Class 1 for this trademark*).
- 3,679,840. **PODANGO (BLOCK FORM)**. PODANGO, LLC, MULTIPLE CLASS, (INT. CLS. 38 AND 42), (U.S. CLS. 100, 101 AND 104). SN 78-873,796. PUB. 6-12-2007. FILED 5-1-2006.
- 3,679,844 (*See Class 9 for this trademark*).
- 3,679,858 (*See Class 9 for this trademark*).
- 3,679,882 (*See Class 9 for this trademark*).
- 3,679,884 (*See Class 9 for this trademark*).
- 3,679,886 (*See Class 9 for this trademark*).
- 3,679,890 (*See Class 35 for this trademark*).
- 3,679,908 (*See Class 9 for this trademark*).
- 3,679,915 (*See Class 9 for this trademark*).
- 3,679,943. **ABETTERDAY .TV AND DESIGN**. SODEXO, MULTIPLE CLASS, (INT. CLS. 38 AND 41), (U.S. CLS. 100, 101, 104 AND 107). SN 79-059,235. PUB. 6-23-2009. FILED 8-21-2008.

CLASS 38—COMMUNICATION

- 3,678,149. **CURRENT— (STYLIZED)**. CURRENT MEDIA, LLC, (U.S. CLS. 100, 101 AND 104). SN 76-635,129. PUB. 3-17-2009. FILED 4-4-2005.
- 3,678,216. **NO REPEAT WORK WEEK (BLOCK FORM)**. PRESS COMMUNICATIONS, LLC, (U.S. CLS. 100, 101 AND 104). SN 77-083,224. PUB. 6-23-2009. FILED 1-15-2007.
- 3,678,243. **IQ (STYLIZED)**. FREEIQ, LLC, (U.S. CLS. 100, 101 AND 104). SN 77-211,521. PUB. 6-23-2009. FILED 6-21-2007.
- 3,678,305. **C4 IP (BLOCK FORM)**. CYPRESS COMMUNICATIONS, INC., (U.S. CLS. 100, 101 AND 104). SN 77-326,668. PUB. 6-23-2009. FILED 11-11-2007.
- 3,678,326 (*See Class 9 for this trademark*).
- 3,678,342 (*See Class 9 for this trademark*).
- 3,678,392. **3CINTERACTIVE (STYLIZED)**. 3CINTERACTIVE, LLC, (U.S. CLS. 100, 101 AND 104). SN 77-428,260. PUB. 6-23-2009. FILED 3-21-2008.
- 3,678,425. **T-MOBILE MESSENGER (BLOCK FORM)**. DEUTSCHE TELEKOM, (U.S. CLS. 100, 101 AND 104). SN 77-456,282. PUB. 4-14-2009. FILED 4-23-2008.
- 3,678,487. **DYNTLD (BLOCK FORM)**. DYNAMIC NETWORK SERVICES, INC., MULTIPLE CLASS, (INT. CLS. 38, 42 AND 45), (U.S. CLS. 100, 101 AND 104). SN 77-507,803. PUB. 6-23-2009. FILED 6-25-2008.
- 3,678,493. **T-MOBILE INSTANT MESSAGING (BLOCK FORM)**. DEUTSCHE TELEKOM, (U.S. CLS. 100, 101 AND 104). SN 77-509,935. PUB. 4-14-2009. FILED 6-27-2008.
- 3,678,535 (*See Class 35 for this trademark*).
- 3,678,569. **CONFESSIONAL (BLOCK FORM)**. HEEBNER, TONI, MULTIPLE CLASS, (INT. CLS. 38 AND 45), (U.S. CLS. 100, 101 AND 104). SN 77-530,649. PUB. 6-23-2009. FILED 7-24-2008.
- 3,678,587. **SB NATION (BLOCK FORM)**. SPORTSBLOGS, INC., MULTIPLE CLASS, (INT. CLS. 38 AND 41), (U.S.

3,679,962 (*See Class 9 for this trademark.*)
 3,679,965 (*See Class 9 for this trademark.*)
 3,679,994 (*See Class 9 for this trademark.*)
 3,679,995 (*See Class 9 for this trademark.*)
 3,680,061 (*See Class 9 for this trademark.*)

CLASS 39—TRANSPORTATION AND STORAGE

- 3,678,172. **WINE CELLAR CLUB (BLOCK FORM)**. WINE CELLAR CLUB, INC., (U.S. CLS. 100 AND 105). SN 76-691,738. PUB. 6-23-2009. FILED 8-1-2008.
- 3,678,233 (*See Class 35 for this trademark.*)
 3,678,246 (*See Class 35 for this trademark.*)
- 3,678,250. **DELUXE (BLOCK FORM)**. DELUXE LABORATORIES, INC., (U.S. CLS. 100 AND 105). SN 77-227,100. PUB. 6-23-2009. FILED 7-11-2007.
- 3,678,251. **DELUXE AND DESIGN**. DELUXE LABORATORIES, INC., (U.S. CLS. 100 AND 105). SN 77-227,390. PUB. 6-23-2009. FILED 7-11-2007.
- 3,678,264. **JAL SKYHELL (BLOCK FORM)**. JAPAN AIRLINES INTERNATIONAL CO., LTD., (U.S. CLS. 100 AND 105). SN 77-245,568. PUB. 6-23-2009. FILED 8-2-2007.
- 3,678,329. **ENVIRO WASH A WASTE CRETE SYSTEMS, LLC PRODUCT AND DESIGN**. WASTE CRETE SYSTEMS, LLC., MULTIPLE CLASS, (INT. CLS. 39 AND 40), (U.S. CLS. 100, 103, 105 AND 106). SN 77-361,811. PUB. 6-23-2009. FILED 12-31-2007.
- 3,678,354 (*See Class 35 for this trademark.*)
 3,678,375. **MISCELLANEOUS DESIGN**. SEA TOW SERVICES INTERNATIONAL, INC., (U.S. CLS. 100 AND 105). SN 77-414,342. PUB. 6-23-2009. FILED 3-5-2008.
- 3,678,399. **BLUE DASHER TECHNOLOGIES (BLOCK FORM)**. 360 IN ACTION CORP., DBA BLUE DASHER TECHNOLOGIES, MULTIPLE CLASS, (INT. CLS. 39 AND 41), (U.S. CLS. 100, 101, 105 AND 107). SN 77-435,391. PUB. 6-23-2009. FILED 3-31-2008.
- 3,678,414. **THE GOLDEN CHARIOT (BLOCK FORM)**. THE LUXURY HOLIDAYS, INC., (U.S. CLS. 100 AND 105). SN 77-448,792. PUB. 9-9-2008. FILED 4-15-2008.
- 3,678,507 (*See Class 35 for this trademark.*)
 3,678,590. **T AND DESIGN**. DENVER HOTEL TEATRO, LLC, (U.S. CLS. 100 AND 105). SN 77-534,948. PUB. 6-23-2009. FILED 7-30-2008.
- 3,678,631 (*See Class 6 for this trademark.*)
 3,678,644 (*See Class 35 for this trademark.*)
- 3,678,651. **GOURMET INCLUSIVE BY KARISMA GI VACATION CONSULTANT AND DESIGN**. UNIQUE BRANDS ENTERPRISES, LLC, MULTIPLE CLASS, (INT. CLS. 39 AND 43), (U.S. CLS. 100, 101 AND 105). SN 77-540,395. PUB. 6-23-2009. FILED 8-6-2008.
- 3,678,659. **SATORI (BLOCK FORM)**. SATORI WORLD MEDICAL, INC., MULTIPLE CLASS, (INT. CLS. 39 AND 44), (U.S. CLS. 100, 101 AND 105). SN 77-541,773. PUB. 6-23-2009. FILED 8-7-2008.
- 3,678,661. **MISCELLANEOUS DESIGN**. SATORI WORLD MEDICAL, INC., MULTIPLE CLASS, (INT. CLS. 39 AND 44), (U.S. CLS. 100, 101 AND 105). SN 77-541,819. PUB. 6-23-2009. FILED 8-7-2008.
- 3,678,696 (*See Class 35 for this trademark.*)
 3,678,714 (*See Class 35 for this trademark.*)
- 3,678,717. **SPORTSCARS.COM AND DESIGN**. VERANDA-GLOBAL.COM, INC., DBA FIRST PLACE INTERNET, INC., (U.S. CLS. 100 AND 105). SN 77-552,584. PUB. 6-23-2009. FILED 8-21-2008.
- 3,678,754. **REMOTE DATA BACKUPS (BLOCK FORM)**. REMOTE DATA BACKUPS INC., (U.S. CLS. 100 AND 105). SN 77-562,763. PUB. 6-23-2009. FILED 9-4-2008.
- 3,678,776 (*See Class 35 for this trademark.*)
 3,678,843. **DISNEY'S JUNIOR ADVENTURERS (BLOCK FORM)**. DISNEY ENTERPRISES, INC., (U.S. CLS. 100 AND 105). SN 77-588,291. PUB. 6-23-2009. FILED 10-8-2008.
- 3,678,950. **FORZAFRUT USA (BLOCK FORM)**. FORZAFRUT USA, (U.S. CLS. 100 AND 105). SN 77-620,158. PUB. 6-23-2009. FILED 11-22-2008.
- 3,678,980. **CAPTAIN ZIPLINE.COM AND DESIGN**. A BRITE-WAY CORPORATION, DBA CAPTAIN ZIPLINE, L.L.C., (U.S. CLS. 100 AND 105). SN 77-627,607. PUB. 6-23-2009. FILED 12-5-2008.
- 3,679,003 (*See Class 35 for this trademark.*)
 3,679,068 (*See Class 35 for this trademark.*)
- 3,679,106. **AMERICAN AVIATION ACADEMY AND DESIGN**. AMERICAN AVIATION ACADEMY, INC., MULTIPLE CLASS, (INT. CLS. 39 AND 41), (U.S. CLS. 100, 101, 105 AND 107). SN 77-656,938. PUB. 6-23-2009. FILED 1-26-2009.
- 3,679,214 (*See Class 35 for this trademark.*)
 3,679,244. **COCONUT COASTERS (BLOCK FORM)**. COCONUT COASTERS LLC, (U.S. CLS. 100 AND 105). SN 77-671,959. PUB. 6-23-2009. FILED 2-17-2009.
- 3,679,314. **URIDE (BLOCK FORM)**. TRANSPORTATION GENERAL, INC., (U.S. CLS. 100 AND 105). SN 77-674,400. PUB. 6-23-2009. FILED 2-20-2009.
- 3,679,349 (*See Class 4 for this trademark.*)
 3,679,377. **ALOHA AIR CARGO (BLOCK FORM)**. AEKO KULA, INC., (U.S. CLS. 100 AND 105). SN 77-675,877. PUB. 6-23-2009. FILED 2-23-2009.
- 3,679,378. **ALOHA AIR CARGO AND DESIGN**. AEKO KULA, INC., (U.S. CLS. 100 AND 105). SN 77-675,882. PUB. 6-23-2009. FILED 2-23-2009.
- 3,679,379. **ALOHA AIR CARGO AND DESIGN**. AEKO KULA, INC., (U.S. CLS. 100 AND 105). SN 77-675,884. PUB. 6-23-2009. FILED 2-23-2009.
- 3,679,388 (*See Class 1 for this trademark.*)
 3,679,390. **CARING CARS AND DESIGN**. FAMILY SERVICES CENTER, INC., (U.S. CLS. 100 AND 105). SN 77-676,098. PUB. 6-23-2009. FILED 2-23-2009.
- 3,679,394. **LUXURY IN MOTION (BLOCK FORM)**. DB AVIATION, INC., MULTIPLE CLASS, (INT. CLS. 39 AND 45), (U.S. CLS. 100, 101 AND 105). SN 77-676,215. PUB. 6-23-2009. FILED 2-23-2009.
- 3,679,415 (*See Class 1 for this trademark.*)
 3,679,416 (*See Class 1 for this trademark.*)
- 3,679,466. **ENTERPRISE AND DESIGN**. ENTERPRISE RENT-A-CAR COMPANY, (U.S. CLS. 100 AND 105). SN 77-677,111. PUB. 6-23-2009. FILED 2-24-2009.
- 3,679,485 (*See Class 35 for this trademark.*)
 3,679,491 (*See Class 35 for this trademark.*)
 3,679,557 (*See Class 1 for this trademark.*)
- 3,679,578. **THE LUNCH LADY (BLOCK FORM)**. BEHR, VALERY PINE, (U.S. CLS. 100 AND 105). SN 77-678,412. PUB. 6-23-2009. FILED 2-25-2009.
- 3,679,622. **SUPERCAR SENSATION (BLOCK FORM)**. SUPERCAR SENSATION, LLC, (U.S. CLS. 100 AND 105). SN 77-679,166. PUB. 6-23-2009. FILED 2-26-2009.
- 3,679,625. **SUPERCAR SENSATION S AND DESIGN**. SUPERCAR SENSATION, LLC, (U.S. CLS. 100 AND 105). SN 77-679,181. PUB. 6-23-2009. FILED 2-26-2009.
- 3,679,632. **ACCURROUTE (BLOCK FORM)**. NUCO2 IP LLC, (U.S. CLS. 100 AND 105). SN 77-679,309. PUB. 6-23-2009. FILED 2-26-2009.
- 3,679,718 (*See Class 35 for this trademark.*)
 3,679,720. **E AND DESIGN**. ENTERPRISE RENT-A-CAR COMPANY, (U.S. CLS. 100 AND 105). SN 77-681,395. PUB. 6-23-2009. FILED 3-2-2009.
- 3,679,731. **RESCUE INK (STYLIZED)**. RESCUE INK PRODUCTIONS LLC, (U.S. CLS. 100 AND 105). SN 77-685,185. PUB. 6-23-2009. FILED 3-6-2009.
- 3,679,820. **MYTRAVELGUIDE (BLOCK FORM)**. MTG.COM, MULTIPLE CLASS, (INT. CLS. 39 AND 43), (U.S. CLS. 100, 101 AND 105). SN 78-739,200. PUB. 6-23-2009. FILED 10-24-2005.
- 3,679,837 (*See Class 11 for this trademark.*)
 3,679,838 (*See Class 1 for this trademark.*)
 3,679,868 (*See Class 6 for this trademark.*)
 3,679,884 (*See Class 9 for this trademark.*)
- 3,679,914. **TICMATE (BLOCK FORM)**. TICMATE AB, MULTIPLE CLASS, (INT. CLS. 39, 41 AND 43), (U.S. CLS. 100, 101, 105 AND 107). SN 79-057,218. PUB. 6-23-2009. FILED 3-14-2008.
- 3,679,928 (*See Class 16 for this trademark.*)
 3,679,965 (*See Class 9 for this trademark.*)

CLASS 40—MATERIAL TREATMENT

- 3,678,161 (*See Class 35 for this trademark.*)
 3,678,162 (*See Class 35 for this trademark.*)
 3,678,329 (*See Class 39 for this trademark.*)
 3,678,357. **AROW AND DESIGN.** AROW GLOBAL, INC., MULTIPLE CLASS, (INT. CLS. 40 AND 42), (U.S. CLS. 100, 101, 103 AND 106). SN 77-392,507. PUB. 6-23-2009. FILED 2-8-2008.
 3,678,437. **A ALBACROME AND DESIGN.** ALBACROME, SOCIEDAD ANONIMA DE CAPITAL VARIABLE, (U.S. CLS. 100, 103 AND 106). SN 77-472,357. PUB. 6-23-2009. FILED 5-12-2008.
 3,678,439. **H2O 911 (BLOCK FORM).** H2O 911, INC., (U.S. CLS. 100, 103 AND 106). SN 77-475,352. PUB. 6-23-2009. FILED 5-15-2008.
 3,678,481 (*See Class 1 for this trademark.*)
 3,678,531. **WASTE AS A RESOURCE (BLOCK FORM).** WASTE MANAGEMENT, INC., (U.S. CLS. 100, 103 AND 106). SN 77-525,376. PUB. 6-23-2009. FILED 7-17-2008.
 3,678,575 (*See Class 37 for this trademark.*)
 3,678,607. **LINAMAR (BLOCK FORM).** LINAMAR CORPORATION, MULTIPLE CLASS, (INT. CLS. 40 AND 42), (U.S. CLS. 100, 101, 103 AND 106). SN 77-536,994. PUB. 6-23-2009. FILED 8-1-2008.
 3,678,643. **SEARCHERS (BLOCK FORM).** SEARCHERS 4WD SUPPLY & OUTFITTERS, LLC, (U.S. CLS. 100, 103 AND 106). SN 77-539,852. PUB. 6-23-2009. FILED 8-5-2008.
 3,678,668 (*See Class 35 for this trademark.*)
 3,678,669 (*See Class 35 for this trademark.*)
 3,678,719. **WHEAT FIELD WIND FARM AND DESIGN.** WHEAT FIELD WIND POWER PROJECT LLC, (U.S. CLS. 100, 103 AND 106). SN 77-552,779. PUB. 6-23-2009. FILED 8-21-2008.
 3,678,724. **V AND DESIGN.** VALERO MARKETING AND SUPPLY COMPANY, DBA TA, (U.S. CLS. 100, 103 AND 106). SN 77-554,679. PUB. 6-23-2009. FILED 8-25-2008.
 3,678,760 (*See Class 25 for this trademark.*)
 3,678,850. **MYSTIC SCENIC STUDIOS, INC. AND DESIGN.** MYSTIC SCENIC STUDIOS, INC., (U.S. CLS. 100, 103 AND 106). SN 77-590,104. PUB. 6-23-2009. FILED 10-10-2008.
 3,678,851. **MYSTIC SCENIC STUDIOS, INC. (BLOCK FORM).** MYSTIC SCENIC STUDIOS, INC., (U.S. CLS. 100, 103 AND 106). SN 77-590,169. PUB. 6-23-2009. FILED 10-10-2008.
 3,678,852. **MYSTIC MILLWORK (BLOCK FORM).** MYSTIC SCENIC STUDIOS, INC., (U.S. CLS. 100, 103 AND 106). SN 77-590,292. PUB. 6-23-2009. FILED 10-10-2008.
 3,678,853. **MYSTIC MILLWORK AND DESIGN.** MYSTIC SCENIC STUDIOS, INC., (U.S. CLS. 100, 103 AND 106). SN 77-590,315. PUB. 6-23-2009. FILED 10-10-2008.
 3,679,012. **THE EVENT RETREAT (BLOCK FORM).** ULTIMATE EVENT SERVICES, LLC, MULTIPLE CLASS, (INT. CLS. 40 AND 44), (U.S. CLS. 100, 101, 103 AND 106). SN 77-636,256. PUB. 6-23-2009. FILED 12-18-2008.
 3,679,054 (*See Class 25 for this trademark.*)
 3,679,088 (*See Class 30 for this trademark.*)
 3,679,089 (*See Class 30 for this trademark.*)
 3,679,122. **MICOR (BLOCK FORM).** MICOR INDUSTRIES, INC, (U.S. CLS. 100, 103 AND 106). SN 77-659,523. PUB. 5-19-2009. FILED 1-29-2009.
 3,679,231. **. ADVANTAGE METALS . RECYCLING AND DESIGN.** ADVANTAGE METALS RECYCLING, (U.S. CLS. 100, 103 AND 106). SN 77-671,330. PUB. 6-23-2009. FILED 2-16-2009.
 3,679,242. **ANTICRATE (BLOCK FORM).** BITTLE, JAMES J, (U.S. CLS. 100, 103 AND 106). SN 77-671,852. PUB. 6-23-2009. FILED 2-17-2009.
 3,679,363. **CLIENT MONITOR (BLOCK FORM).** CLIENT MONITOR, (U.S. CLS. 100, 103 AND 106). SN 77-675,593. PUB. 6-23-2009. FILED 2-23-2009.
 3,679,630. **EPIR TECHNOLOGIES AND DESIGN.** EPIR TECHNOLOGIES, INC., MULTIPLE CLASS, (INT. CLS. 40 AND 42), (U.S. CLS. 100, 101, 103 AND 106). SN 77-679,251. PUB. 6-23-2009. FILED 2-26-2009.
 3,679,631. **EPIR TECHNOLOGIES (BLOCK FORM).** EPIR TECHNOLOGIES, INC., MULTIPLE CLASS, (INT. CLS. 40 AND 42), (U.S. CLS. 100, 101, 103 AND 106). SN 77-679,270. PUB. 6-23-2009. FILED 2-26-2009.
 3,679,659. **PRINTFORLESS (BLOCK FORM).** PRINTINGFOR-

- LESS.COM, INC., (U.S. CLS. 100, 103 AND 106). SN 77-679,730. PUB. 6-23-2009. FILED 2-27-2009.
 3,679,672. **SHREDBOX AND DESIGN.** ISECURE INC., (U.S. CLS. 100, 103 AND 106). SN 77-680,026. PUB. 6-23-2009. FILED 2-27-2009.
 3,679,837 (*See Class 11 for this trademark.*)
 3,679,838 (*See Class 1 for this trademark.*)
 3,679,868 (*See Class 6 for this trademark.*)
 3,679,889 (*See Class 6 for this trademark.*)
 3,679,892 (*See Class 5 for this trademark.*)
 3,679,900 (*See Class 6 for this trademark.*)
 3,679,930 (*See Class 7 for this trademark.*)
 3,679,954 (*See Class 16 for this trademark.*)
 3,679,971 (*See Class 5 for this trademark.*)
 3,680,042 (*See Class 35 for this trademark.*)

CLASS 41—EDUCATION AND ENTERTAINMENT

- 3,678,137. **RKO CENTURY.** AMERICAN MULTI-CINEMA, INC., (U.S. CLS. 100, 101 AND 107). SN 75-782,714. PUB. 6-23-2009. FILED 8-24-1999.
 3,678,168. **NILD LEARNING CENTER (BLOCK FORM).** NATIONAL INSTITUTE FOR LEARNING DEVELOPMENT, INC., (U.S. CLS. 100, 101 AND 107). SN 76-691,397. PUB. 6-23-2009. FILED 7-18-2008.
 3,678,175. **E2E ELEVATED TO EXCELLENCE (STYLIZED).** WILLIAMS, CHRISTINA, (U.S. CLS. 100, 101 AND 107). SN 76-691,993. PUB. 6-23-2009. FILED 8-12-2008.
 3,678,192. **HANDS & WORDS ARE NOT FOR HURTING PROJECT (BLOCK FORM).** HANDS ARE NOT FOR HURTING PROJECT, (U.S. CLS. 100, 101 AND 107). SN 76-695,344. PUB. 6-23-2009. FILED 1-16-2009.
 3,678,204 (*See Class 1 for this trademark.*)
 3,678,217 (*See Class 35 for this trademark.*)
 3,678,222 (*See Class 9 for this trademark.*)
 3,678,227 (*See Class 9 for this trademark.*)
 3,678,229. **NYC (STYLIZED).** NYC & COMPANY, INC., (U.S. CLS. 100, 101 AND 107). SN 77-155,139. PUB. 6-23-2009. FILED 4-12-2007.
 3,678,230 (*See Class 35 for this trademark.*)
 3,678,237 (*See Class 16 for this trademark.*)
 3,678,238 (*See Class 16 for this trademark.*)
 3,678,239 (*See Class 35 for this trademark.*)
 3,678,266. **BAISDEN AFTER DARK (BLOCK FORM).** BAISDEN FILMWORKS LLC, (U.S. CLS. 100, 101 AND 107). SN 77-246,468. PUB. 6-23-2009. FILED 8-3-2007.
 3,678,271. **SOLUTION: UNITECH COMMITTED TO YOUR SUCCESS (STYLIZED).** UNITECH, MULTIPLE CLASS, (INT. CLS. 41 AND 42), (U.S. CLS. 100, 101 AND 107). SN 77-277,935. PUB. 6-23-2009. FILED 9-12-2007.
 3,678,272 (*See Class 35 for this trademark.*)
 3,678,275 (*See Class 16 for this trademark.*)
 3,678,289. **J. BULLY (BLOCK FORM).** ROBERTS, JR., FRANCIS L., (U.S. CLS. 100, 101 AND 107). SN 77-309,575. PUB. 12-9-2008. FILED 10-22-2007.
 3,678,290. **BULLY (BLOCK FORM).** ROBERTS, FRANCIS L., JR., (U.S. CLS. 100, 101 AND 107). SN 77-309,580. PUB. 9-23-2008. FILED 10-22-2007.
 3,678,291 (*See Class 9 for this trademark.*)
 3,678,300 (*See Class 9 for this trademark.*)
 3,678,303. **STAR SHOOTER (BLOCK FORM).** STAR SHOOTER COMPANY LLC, (U.S. CLS. 100, 101 AND 107). SN 77-324,906. PUB. 6-23-2009. FILED 11-8-2007.
 3,678,309. **EGM ETHNOGRAPHIC MEDIA (BLOCK FORM).** BEARING FRUIT COMMUNICATIONS, INC., (U.S. CLS. 100, 101 AND 107). SN 77-329,661. PUB. 6-23-2009. FILED 11-14-2007.
 3,678,313. **AFROKIDS (BLOCK FORM).** SULLIVAN, LEO D., DBA LEO SULLIVAN MULTIMEDIA, INC., (U.S. CLS. 100, 101 AND 107). SN 77-336,159. PUB. 6-23-2009. FILED 11-24-2007.
 3,678,317 (*See Class 25 for this trademark.*)
 3,678,321 (*See Class 16 for this trademark.*)
 3,678,327. **BENEFICIAL (STYLIZED).** ASAF DAVID FULKS, DBA THE OC RECORDING COMPANY, (U.S. CLS. 100,

- 101 AND 107). SN 77-358,994. PUB. 6-23-2009. FILED 12-24-2007.
- 3,678,328 (*See Class 16 for this trademark*).
- 3,678,331. **ROTORNEWS (BLOCK FORM)**. HELICOPTER ASSOCIATION INTERNATIONAL, INC., (U.S. CLS. 100, 101 AND 107). SN 77-364,004. PUB. 6-23-2009. FILED 1-4-2008.
- 3,678,333 (*See Class 9 for this trademark*).
- 3,678,334 (*See Class 5 for this trademark*).
- 3,678,339. **AND BABY MAKES TWO AN ADOPTION TALE (BLOCK FORM)**. CHRISTOPHER, NANCI NEIDORF, DBA SKATERQUEEN/SUPERBOY PRODUCTIONS, (U.S. CLS. 100, 101 AND 107). SN 77-370,939. PUB. 6-23-2009. FILED 1-14-2008.
- 3,678,340. **METROLACROSSE (BLOCK FORM)**. METROLACROSSE, INC., (U.S. CLS. 100, 101 AND 107). SN 77-371,944. PUB. 6-23-2009. FILED 1-15-2008.
- 3,678,341. **TEACHING KIDS TO STICK TO THEIR GOALS (BLOCK FORM)**. METROLACROSSE, INC., (U.S. CLS. 100, 101 AND 107). SN 77-371,953. PUB. 6-23-2009. FILED 1-15-2008.
- 3,678,352. **DAMON THE GYPSY (BLOCK FORM)**. DEL CONTE, DAVID C., (U.S. CLS. 100, 101 AND 107). SN 77-383,456. PUB. 6-23-2009. FILED 1-29-2008.
- 3,678,370 (*See Class 35 for this trademark*).
- 3,678,372. **OPEN SKY THEATER (BLOCK FORM)**. HARRAH'S LICENSE COMPANY, LLC, (U.S. CLS. 100, 101 AND 107). SN 77-409,851. PUB. 6-23-2009. FILED 2-29-2008.
- 3,678,380 (*See Class 35 for this trademark*).
- 3,678,394 (*See Class 35 for this trademark*).
- 3,678,399 (*See Class 39 for this trademark*).
- 3,678,406 (*See Class 16 for this trademark*).
- 3,678,415. **BEAT THE HEALTH OUT OF YOU (BLOCK FORM)**. ANANI, SUMYA S., (U.S. CLS. 100, 101 AND 107). SN 77-449,862. PUB. 6-23-2009. FILED 4-16-2008.
- 3,678,440. **CAMP ESCAPADES (BLOCK FORM)**. PEDIATRIC THERAPY NETWORK, (U.S. CLS. 100, 101 AND 107). SN 77-475,500. PUB. 6-23-2009. FILED 5-15-2008.
- 3,678,462. **COMICS KINGDOM (BLOCK FORM)**. HEARST HOLDINGS, INC., (U.S. CLS. 100, 101 AND 107). SN 77-495,961. PUB. 6-23-2009. FILED 6-11-2008.
- 3,678,469. **TWO ONE TWO MUSIC (BLOCK FORM)**. FALLOON, JOHN KEVIN, (U.S. CLS. 100, 101 AND 107). SN 77-499,386. PUB. 6-23-2009. FILED 6-15-2008.
- 3,678,482 (*See Class 16 for this trademark*).
- 3,678,488 (*See Class 35 for this trademark*).
- 3,678,504. **EAT WELL, BE WELL (BLOCK FORM)**. BLYTHEDALE CHILDREN'S HOSPITAL, (U.S. CLS. 100, 101 AND 107). SN 77-516,843. PUB. 6-23-2009. FILED 7-8-2008.
- 3,678,509. **CARLSBAD 5000 (BLOCK FORM)**. COMPETITOR GROUP, INC., (U.S. CLS. 100, 101 AND 107). SN 77-517,842. PUB. 6-23-2009. FILED 7-9-2008.
- 3,678,519 (*See Class 9 for this trademark*).
- 3,678,527. **PEOPLE TALK (BLOCK FORM)**. LEBHAR-FRIEDMAN, INC., (U.S. CLS. 100, 101 AND 107). SN 77-524,499. PUB. 6-23-2009. FILED 7-17-2008.
- 3,678,529. **SITE TALK (BLOCK FORM)**. LEBHAR-FRIEDMAN, INC., (U.S. CLS. 100, 101 AND 107). SN 77-524,718. PUB. 6-23-2009. FILED 7-17-2008.
- 3,678,532 (*See Class 35 for this trademark*).
- 3,678,536 (*See Class 35 for this trademark*).
- 3,678,549. **RED LION (BLOCK FORM)**. RED LION HOTELS HOLDING, INC., (U.S. CLS. 100, 101 AND 107). SN 77-528,682. PUB. 6-23-2009. FILED 7-22-2008.
- 3,678,552. **MISCELLANEOUS DESIGN**. HARRAH'S LICENSE COMPANY, LLC, MULTIPLE CLASS, (INT. CLS. 41 AND 43), (U.S. CLS. 100, 101 AND 107). SN 77-529,148. PUB. 6-23-2009. FILED S.R. 7-23-2008; AM. P.R. 5-12-2009.
- 3,678,562 (*See Class 9 for this trademark*).
- 3,678,563 (*See Class 35 for this trademark*).
- 3,678,564. **WHITE LABEL (BLOCK FORM)**. PERRY, ROBB, AND WOODS, SADIE, (U.S. CLS. 100, 101 AND 107). SN 77-529,897. PUB. 6-23-2009. FILED 7-23-2008.
- 3,678,565 (*See Class 25 for this trademark*).
- 3,678,581. **SJP AND SYMPHONIC JOINTZ PRODUCTIONS AND DESIGN**. GRIFFIN, GERALD, (U.S. CLS. 100, 101 AND 107). SN 77-532,824. PUB. 6-23-2009. FILED 7-28-2008.
- 3,678,587 (*See Class 38 for this trademark*).
- 3,678,592. **PREPARED RESPONSE (BLOCK FORM)**. PREPARED RESPONSE, INC., MULTIPLE CLASS, (INT. CLS. 41 AND 45), (U.S. CLS. 100, 101 AND 107). SN 77-535,078. PUB. 6-23-2009. FILED 7-30-2008.
- 3,678,593. **HAZARD TACTICS (BLOCK FORM)**. PREPARED RESPONSE, INC., MULTIPLE CLASS, (INT. CLS. 41 AND 45), (U.S. CLS. 100, 101 AND 107). SN 77-535,079. PUB. 6-23-2009. FILED 7-30-2008.
- 3,678,595. **LEBLON PRODUCTIONS (BLOCK FORM)**. LEBLON HOLDINGS LLC, (U.S. CLS. 100, 101 AND 107). SN 77-535,267. PUB. 6-23-2009. FILED 7-30-2008.
- 3,678,605. **WAKE UP COLLECTIVE (BLOCK FORM)**. SENTIES, SEGURA ANGEL, DBA ANGEL SENTIES, (U.S. CLS. 100, 101 AND 107). SN 77-536,633. PUB. 6-23-2009. FILED 7-31-2008.
- 3,678,611 (*See Class 16 for this trademark*).
- 3,678,614. **LAURELINES (BLOCK FORM)**. FRANKSTONE, LAURA M., (U.S. CLS. 100, 101 AND 107). SN 77-537,625. PUB. 6-23-2009. FILED 8-2-2008.
- 3,678,616 (*See Class 9 for this trademark*).
- 3,678,618. **KEISER (BLOCK FORM)**. THE KEISER SCHOOL, INC., (U.S. CLS. 100, 101 AND 107). SN 77-538,031. PUB. 6-23-2009. FILED 8-4-2008.
- 3,678,620. **KEISER UNIVERSITY (BLOCK FORM)**. THE KEISER SCHOOL, INC., (U.S. CLS. 100, 101 AND 107). SN 77-538,147. PUB. 6-23-2009. FILED 8-4-2008.
- 3,678,621. **KEISER UNIVERSITY AND DESIGN**. THE KEISER SCHOOL, INC., (U.S. CLS. 100, 101 AND 107). SN 77-538,161. PUB. 6-23-2009. FILED 8-4-2008.
- 3,678,623. **OVALFILM (BLOCK FORM)**. TISHMAN SPEYER PCVST MANAGEMENT, L.L.C., (U.S. CLS. 100, 101 AND 107). SN 77-538,315. PUB. 6-23-2009. FILED 8-4-2008.
- 3,678,624. **OVALLOUNGE (BLOCK FORM)**. TISHMAN SPEYER PCVST MANAGEMENT, L.L.C., (U.S. CLS. 100, 101 AND 107). SN 77-538,322. PUB. 6-23-2009. FILED 8-4-2008.
- 3,678,625. **OVALKIDS (BLOCK FORM)**. TISHMAN SPEYER PCVST MANAGEMENT, L.L.C., (U.S. CLS. 100, 101 AND 107). SN 77-538,333. PUB. 6-23-2009. FILED 8-4-2008.
- 3,678,626. **OVALEVENTS (BLOCK FORM)**. TISHMAN SPEYER PCVST MANAGEMENT, L.L.C., (U.S. CLS. 100, 101 AND 107). SN 77-538,337. PUB. 6-23-2009. FILED 8-4-2008.
- 3,678,627. **VITAL VOICES (BLOCK FORM)**. VITAL VOICES GLOBAL PARTNERSHIP, (U.S. CLS. 100, 101 AND 107). SN 77-538,416. PUB. 6-23-2009. FILED 8-4-2008.
- 3,678,633. **SUCCESS COMMUNICATONS INC AND DESIGN**. SUCCESS COMMUNICATIONS, INC., (U.S. CLS. 100, 101 AND 107). SN 77-539,040. PUB. 6-23-2009. FILED 8-5-2008.
- 3,678,666. **CELTICS CLUB GREEN (BLOCK FORM)**. BANNER SEVENTEEN LLC, (U.S. CLS. 100, 101 AND 107). SN 77-542,337. PUB. 6-23-2009. FILED 8-8-2008.
- 3,678,667. **CLUB GREEN (BLOCK FORM)**. BANNER SEVENTEEN LLC, (U.S. CLS. 100, 101 AND 107). SN 77-542,346. PUB. 6-23-2009. FILED 8-8-2008.
- 3,678,670. **ZOOMIN (BLOCK FORM)**. ZOOM IN, LLC, (U.S. CLS. 100, 101 AND 107). SN 77-542,373. PUB. 6-23-2009. FILED 8-8-2008.
- 3,678,671. **ZOOMIN PHOTOGRAPHY AND DESIGN**. ZOOM IN, LLC, (U.S. CLS. 100, 101 AND 107). SN 77-542,376. PUB. 6-23-2009. FILED 8-8-2008.
- 3,678,672 (*See Class 9 for this trademark*).
- 3,678,683. **NEW WORLD KIDS (BLOCK FORM)**. FOUNDRY MEDIA, LLC, (U.S. CLS. 100, 101 AND 107). SN 77-544,548. PUB. 6-23-2009. FILED 8-12-2008.
- 3,678,687. **MAKEOVER MANOR (BLOCK FORM)**. TV ONE LLC, (U.S. CLS. 100, 101 AND 107). SN 77-545,343. PUB. 6-23-2009. FILED 8-12-2008.
- 3,678,694 (*See Class 16 for this trademark*).
- 3,678,700. **BENNY'S BACK ROOM (BLOCK FORM)**. HARRAH'S LICENSE COMPANY, LLC, (U.S. CLS. 100, 101 AND 107). SN 77-547,938. PUB. 6-23-2009. FILED 8-15-2008.
- 3,678,705. **CUTTING EDGE FITNESS YOUR HEALTHY ADDICTION AND DESIGN**. CUTTING EDGE FITNESS OF BOCA RATON, LLC, (U.S. CLS. 100, 101 AND 107). SN 77-548,753. PUB. 6-23-2009. FILED 8-16-2008.
- 3,678,731. **SEXOCIDE (BLOCK FORM)**. CZECH, DAVID, AND OLSEN, CHRIS, AND WEATHFORD, LAUREN,

- AND MARSHALL, JORDEN, (U.S. CLS. 100, 101 AND 107). SN 77-555,770. PUB. 6-23-2009. FILED 8-26-2008.
- 3,678,742. **KRIPALU YOGADANCE (BLOCK FORM)**. KRIPALU CENTER FOR YOGA & HEALTH, (U.S. CLS. 100, 101 AND 107). SN 77-559,100. PUB. 6-23-2009. FILED 8-29-2008.
- 3,678,744. **KNOWLEDGE PHARMACY .COM AND DESIGN**. THE KNOWLEDGE PHARMACY, INC., AKA KNOWLEDGE PHARMACY, (U.S. CLS. 100, 101 AND 107). SN 77-559,848. PUB. 6-23-2009. FILED 9-2-2008.
- 3,678,747 (*See Class 16 for this trademark*).
- 3,678,755. **PR VIBES (BLOCK FORM)**. CALYSTO COMMUNICATIONS, INC., (U.S. CLS. 100, 101 AND 107). SN 77-562,989. PUB. 6-23-2009. FILED 9-5-2008.
- 3,678,767 (*See Class 9 for this trademark*).
- 3,678,792 (*See Class 35 for this trademark*).
- 3,678,793 (*See Class 35 for this trademark*).
- 3,678,807. **WHOGA (BLOCK FORM)**. HUMMEL, JEANNETTE B., DBA MY YOGA, (U.S. CLS. 100, 101 AND 107). SN 77-578,673. PUB. 6-23-2009. FILED 9-25-2008.
- 3,678,833. **SOAK RECORDS AND DESIGN**. SOAK RECORDS, (U.S. CLS. 100, 101 AND 107). SN 77-584,888. PUB. 6-23-2009. FILED 10-3-2008.
- 3,678,838. **D I V E 5 DEVELOP IMPLEMENT VERIFY ENHANCE AND DESIGN**. TETRA TECHNOLOGIES, INC., (U.S. CLS. 100, 101 AND 107). SN 77-586,164. PUB. 6-23-2009. FILED 10-6-2008.
- 3,678,846. **EL MERO METAL (BLOCK FORM)**. CHAVEZ, ROBERT, (U.S. CLS. 100, 101 AND 107). SN 77-588,802. PUB. 6-23-2009. FILED 10-8-2008.
- 3,678,848 (*See Class 16 for this trademark*).
- 3,678,858 (*See Class 25 for this trademark*).
- 3,678,860. **T TULSA TECH AND DESIGN**. TULSA TECHNOLOGY CENTER EDUCATION FOUNDATION INC., (U.S. CLS. 100, 101 AND 107). SN 77-592,674. PUB. 6-23-2009. FILED 10-14-2008.
- 3,678,864 (*See Class 9 for this trademark*).
- 3,678,872. **EMPOWERMENT ASSOCIATES, L.L.C. KNOWLEDGE.SKILLS.THE EDGE. AND DESIGN**. EMPOWERMENT ASSOCIATES, LLC, (U.S. CLS. 100, 101 AND 107). SN 77-597,073. PUB. 3-17-2009. FILED 10-21-2008.
- 3,678,873. **DIGITAL BOOTCAMP (BLOCK FORM)**. DOGWHISTLE, INC., (U.S. CLS. 100, 101 AND 107). SN 77-598,002. PUB. 6-23-2009. FILED 10-22-2008.
- 3,678,874. **X MARKS THE SPOT (BLOCK FORM)**. W2005 RSI REALTY LLC, MULTIPLE CLASS, (INT. CLS. 41, 43, 44 AND 45), (U.S. CLS. 100, 101 AND 107). SN 77-598,209. PUB. 6-23-2009. FILED 10-22-2008.
- 3,678,875. **X (STYLIZED)**. W2005 RSI REALTY LLC, MULTIPLE CLASS, (INT. CLS. 41, 43, 44 AND 45), (U.S. CLS. 100, 101 AND 107). SN 77-598,214. PUB. 6-23-2009. FILED 10-22-2008.
- 3,678,892. **MARIONETTE (BLOCK FORM)**. CORNELL, KEVIN R., (U.S. CLS. 100, 101 AND 107). SN 77-600,805. PUB. 6-23-2009. FILED 10-27-2008.
- 3,678,911. **OXYMORON ENTERTAINMENT (BLOCK FORM)**. OXYMORON ENTERTAINMENT, INC., (U.S. CLS. 100, 101 AND 107). SN 77-607,902. PUB. 6-23-2009. FILED 11-5-2008.
- 3,678,937. **YOUR HEART IS IN OUR HANDS (BLOCK FORM)**. CENTER FOR ULTRASOUND RESEARCH & EDUCATION CORP., (U.S. CLS. 100, 101 AND 107). SN 77-618,333. PUB. 6-23-2009. FILED 11-20-2008.
- 3,678,942. **GREEN PSYCHOLOGY (BLOCK FORM)**. EAGLE, JAKE G, AND EAGLE, HANNAH, (U.S. CLS. 100, 101 AND 107). SN 77-618,723. PUB. 6-23-2009. FILED 11-20-2008.
- 3,678,943 (*See Class 16 for this trademark*).
- 3,678,956 (*See Class 35 for this trademark*).
- 3,678,957. **HOPE PARTNERSHIPS INTERNATIONAL (BLOCK FORM)**. HOPE PARTNERSHIPS INTERNATIONAL, INC., (U.S. CLS. 100, 101 AND 107). SN 77-622,749. PUB. 6-23-2009. FILED 11-26-2008.
- 3,678,961. **CONNECT GROWING A HEALTHY RELATIONSHIP COMMUNITY. (STYLIZED)**. CENTRAL MINNESOTA TASK FORCE ON BATTERED WOMEN, (U.S. CLS. 100, 101 AND 107). SN 77-623,727. PUB. 6-23-2009. FILED 12-1-2008.
- 3,678,963 (*See Class 25 for this trademark*).
- 3,678,991. **CREATE THE FUTURE DESIGN CONTEST (BLOCK FORM)**. ABP INTERNATIONAL, INC., (U.S. CLS. 100, 101 AND 107). SN 77-631,408. PUB. 6-23-2009. FILED 12-11-2008.
- 3,678,993. **MONUMENT COACHING BUSINESS . LIFE . WEALTH AND DESIGN**. CUNDIFF, JEREMIAH JAMES, DBA MONUMENT COACHING, AND KRISTI CUNDIFF, DBA MONUMENT COACHING, (U.S. CLS. 100, 101 AND 107). SN 77-631,736. PUB. 6-23-2009. FILED 12-12-2008.
- 3,679,017. **FOR FITNESS SAKE LLC AND DESIGN**. FOR FITNESS SAKE, LLC, (U.S. CLS. 100, 101 AND 107). SN 77-637,827. PUB. 6-23-2009. FILED 12-22-2008.
- 3,679,035. **SPORTS BUFF (BLOCK FORM)**. WORLD SPORTS TECHNOLOGY, INC., (U.S. CLS. 100, 101 AND 107). SN 77-644,026. PUB. 6-23-2009. FILED 1-6-2009.
- 3,679,036. **LEAPING LIZARDS NATURE AWARENESS SCHOOL "NURTURING YOUR CHILD IN NATURE" AND DESIGN**. LEAPING LIZARDS NATURE AWARENESS PRESCHOOL, (U.S. CLS. 100, 101 AND 107). SN 77-644,340. PUB. 6-23-2009. FILED 1-6-2009.
- 3,679,038. **THE CHAINSAW MAFIA (BLOCK FORM)**. LARK, SHANNON, DBA THE CHAINSAW MAFIA, (U.S. CLS. 100, 101 AND 107). SN 77-644,509. PUB. 6-23-2009. FILED 1-7-2009.
- 3,679,050 (*See Class 38 for this trademark*).
- 3,679,051 (*See Class 35 for this trademark*).
- 3,679,061. **WEBSTAR (BLOCK FORM)**. SCRILLA HILL ENTERTAINMENT, INC., (U.S. CLS. 100, 101 AND 107). SN 77-649,635. PUB. 6-23-2009. FILED 1-14-2009.
- 3,679,068 (*See Class 35 for this trademark*).
- 3,679,069 (*See Class 9 for this trademark*).
- 3,679,073. **GAMERZUNLIMITED (BLOCK FORM)**. MOSER, DIRK, (U.S. CLS. 100, 101 AND 107). SN 77-652,653. PUB. 6-23-2009. FILED 1-20-2009.
- 3,679,082. **PERFECT P PERFORMANCE AND DESIGN**. PERFECT PERFORMANCE, LLC, (U.S. CLS. 100, 101 AND 107). SN 77-654,085. PUB. 6-23-2009. FILED 1-22-2009.
- 3,679,106 (*See Class 39 for this trademark*).
- 3,679,115. **UNITED BICYCLE INSTITUTE (BLOCK FORM)**. UNITED BICYCLE INSTITUTE, DBA UNITED BICYCLE INSTITUTE, (U.S. CLS. 100, 101 AND 107). SN 77-658,586. PUB. 6-23-2009. FILED 1-28-2009.
- 3,679,119. **MISCELLANEOUS DESIGN**. ROY DEAN ACADEMY, LLC, (U.S. CLS. 100, 101 AND 107). SN 77-659,166. PUB. 6-23-2009. FILED 1-29-2009.
- 3,679,121. **SOULAVIV AND DESIGN**. RAEDE, ROBERT, (U.S. CLS. 100, 101 AND 107). SN 77-659,405. PUB. 6-23-2009. FILED 1-29-2009.
- 3,679,124 (*See Class 9 for this trademark*).
- 3,679,150. **NMDCO NEW MEDIA DISTRIBUTION COMPANY CO AND DESIGN**. NEW MEDIA DISTRIBUTION COMPANY, L.L.C., (U.S. CLS. 100, 101 AND 107). SN 77-665,019. PUB. 6-23-2009. FILED 2-6-2009.
- 3,679,166. **PHROG (BLOCK FORM)**. YANNITTE, THOMAS, (U.S. CLS. 100, 101 AND 107). SN 77-666,079. PUB. 6-23-2009. FILED 2-9-2009.
- 3,679,175. **BON VIE STUDIOS AND DESIGN**. MARQUES, JACQUELINE, (U.S. CLS. 100, 101 AND 107). SN 77-666,786. PUB. 6-23-2009. FILED 2-9-2009.
- 3,679,178. **MY CHILD'S MIND (BLOCK FORM)**. LEVINE, MEL, (U.S. CLS. 100, 101 AND 107). SN 77-667,149. PUB. 6-23-2009. FILED 2-10-2009.
- 3,679,180 (*See Class 35 for this trademark*).
- 3,679,181. **C CHOICE GROUP AND DESIGN**. CHOICE GROUP INCORPORATED, (U.S. CLS. 100, 101 AND 107). SN 77-667,366. PUB. 6-23-2009. FILED 2-10-2009.
- 3,679,185 (*See Class 25 for this trademark*).
- 3,679,199 (*See Class 35 for this trademark*).
- 3,679,211. **SERVICE EXCELLENCE G PARTNERSHIP AND DESIGN**. WILLIAM A. GRAHAM COMPANY, DBA THE GRAHAM COMPANY, (U.S. CLS. 100, 101 AND 107). SN 77-669,891. PUB. 6-23-2009. FILED 2-13-2009.
- 3,679,229 (*See Class 16 for this trademark*).
- 3,679,230. **MENTORPATH (BLOCK FORM)**. KRUEGER HOLDINGS LLC, (U.S. CLS. 100, 101 AND 107). SN 77-671,314. PUB. 6-23-2009. FILED 2-16-2009.
- 3,679,233. **NEW LIFE STORY (BLOCK FORM)**. KRUEGER HOLDINGS LLC, (U.S. CLS. 100, 101 AND 107). SN 77-671,387. PUB. 6-23-2009. FILED 2-16-2009.

- 3,679,243 (*See Class 35 for this trademark*).
- 3,679,247. **FLIPPERS A PRESCHOOL GYMNASTICS & FITNESS PROGRAM AND DESIGN**. GSF SYSTEMS, LLC, (U.S. CLS. 100, 101 AND 107). SN 77-672,046. PUB. 6-23-2009. FILED 2-17-2009.
- 3,679,249. **KEOLA FIT THE HEALTH, THE LIFE, THE WELL-BEING AND DESIGN**. BECKER, ALLISON L, (U.S. CLS. 100, 101 AND 107). SN 77-672,060. PUB. 6-23-2009. FILED 2-17-2009.
- 3,679,255. **SALES INNOVATION LLC MEASURABLY DIFFERENT. AND DESIGN**. SALES INNOVATION, LLC, (U.S. CLS. 100, 101 AND 107). SN 77-672,238. PUB. 6-23-2009. FILED 2-17-2009.
- 3,679,266. **FURRY FOTOS (BLOCK FORM)**. SHIVELY, PETER, (U.S. CLS. 100, 101 AND 107). SN 77-672,723. PUB. 6-23-2009. FILED 2-18-2009.
- 3,679,267. **TEAMGPS (BLOCK FORM)**. FREELIFE INTERNATIONAL HOLDINGS, LLC, (U.S. CLS. 100, 101 AND 107). SN 77-672,734. PUB. 6-23-2009. FILED 2-18-2009.
- 3,679,269. **PLANT SAVVY (BLOCK FORM)**. MONROVIA NURSERY, (U.S. CLS. 100, 101 AND 107). SN 77-672,764. PUB. 6-23-2009. FILED 2-18-2009.
- 3,679,273. **TSR (BLOCK FORM)**. TEXAS SKI RANCH, L.P., (U.S. CLS. 100, 101 AND 107). SN 77-673,127. PUB. 6-23-2009. FILED 2-18-2009.
- 3,679,278. **BASKETBALL SPOTLIGHT HOME FOR FUTURE PHENOMS WWW.BASKETBALLSPOTLIGHT.COM AND DESIGN**. BASKETBALL SPOTLIGHT, (U.S. CLS. 100, 101 AND 107). SN 77-673,281. PUB. 6-23-2009. FILED 2-18-2009.
- 3,679,281. **MENU PLACE PRODUCT AND MARKET INFORMATION FOR TODAY'S FOODSERVICE OPERATOR AND DESIGN**. SYSCO CORPORATION, (U.S. CLS. 100, 101 AND 107). SN 77-673,326. PUB. 6-23-2009. FILED 2-18-2009.
- 3,679,284. **NAUGHTY BOYS HYPNOSIS SHOW (BLOCK FORM)**. WOLF, RAYMOND T., DBA RAY WOLF PRODUCTIONS, (U.S. CLS. 100, 101 AND 107). SN 77-673,411. PUB. 6-23-2009. FILED 2-19-2009.
- 3,679,304 (*See Class 35 for this trademark*).
- 3,679,309. **THE INSOMNIACS (BLOCK FORM)**. DODSON, VYASA M., (U.S. CLS. 100, 101 AND 107). SN 77-674,169. PUB. 6-23-2009. FILED 2-19-2009.
- 3,679,317. **CONNECT STUDENT CELEBRATIONS (BLOCK FORM)**. PHIL WALDREP EVANGELISTIC ASSOCIATION, (U.S. CLS. 100, 101 AND 107). SN 77-674,429. PUB. 6-23-2009. FILED 2-20-2009.
- 3,679,324. **OPERATIONAL INSIGHTS (BLOCK FORM)**. THE VANGUARD GROUP, INC., (U.S. CLS. 100, 101 AND 107). SN 77-674,632. PUB. 6-23-2009. FILED 2-20-2009.
- 3,679,344. **JUST PLAIN YOGA (BLOCK FORM)**. JUST PLAIN ENTERPRISES, (U.S. CLS. 100, 101 AND 107). SN 77-675,188. PUB. 6-23-2009. FILED 2-20-2009.
- 3,679,349 (*See Class 4 for this trademark*).
- 3,679,358. **STREET RANCS (BLOCK FORM)**. OCHOA, MARCO, (U.S. CLS. 100, 101 AND 107). SN 77-675,498. PUB. 6-23-2009. FILED 2-22-2009.
- 3,679,359 (*See Class 35 for this trademark*).
- 3,679,370. **EXTENDED ASSISTANCE (BLOCK FORM)**. BEHAVIOR MANAGEMENT ASSOCIATES, INC., (U.S. CLS. 100, 101 AND 107). SN 77-675,659. PUB. 6-23-2009. FILED 2-23-2009.
- 3,679,371. **BOBBY'S BOOKS (BLOCK FORM)**. MIDWEST CENTER FOR HOME, HOSPICE & PALLIATIVE CARE EDUCATION, (U.S. CLS. 100, 101 AND 107). SN 77-675,663. PUB. 6-23-2009. FILED 2-23-2009.
- 3,679,387. **WE THE PEOPLE FESTIVAL (BLOCK FORM)**. ORLANDO R. PADILLA & LOBORIO MOLINA, (U.S. CLS. 100, 101 AND 107). SN 77-676,024. PUB. 6-23-2009. FILED 2-23-2009.
- 3,679,407. **PLAY SUSHI (BLOCK FORM)**. FUTURE ADS INC., (U.S. CLS. 100, 101 AND 107). SN 77-676,404. PUB. 6-23-2009. FILED 2-23-2009.
- 3,679,410. **SOKA GAKKAI INTERNATIONAL-USA (BLOCK FORM)**. SOKA GAKKAI INTERNATIONAL-USA, AKA SGI-USA, MULTIPLE CLASS, (INT. CLS. 41 AND 45), (U.S. CLS. 100, 101 AND 107). SN 77-676,499. PUB. 6-23-2009. FILED 2-23-2009.
- 3,679,411. **MISCELLANEOUS DESIGN**. SOKA GAKKAI INTERNATIONAL-USA, AKA SGI-USA, MULTIPLE CLASS, (INT. CLS. 41 AND 45), (U.S. CLS. 100, 101 AND 107). SN 77-676,515. PUB. 6-23-2009. FILED 2-23-2009.
- 3,679,413. **BRAND EXCELERATOR AND DESIGN**. LOCKHART, LISA, (U.S. CLS. 100, 101 AND 107). SN 77-676,548. PUB. 6-23-2009. FILED 2-23-2009.
- 3,679,419 (*See Class 9 for this trademark*).
- 3,679,427. **SAVING ENERGY IS SMART BUSINESS (BLOCK FORM)**. MINNESOTA WASTE WISE FOUNDATION, (U.S. CLS. 100, 101 AND 107). SN 77-676,691. PUB. 6-23-2009. FILED 2-24-2009.
- 3,679,428. **AXXESS (BLOCK FORM)**. OLAJIDE, ADENIYI O., (U.S. CLS. 100, 101 AND 107). SN 77-676,719. PUB. 6-23-2009. FILED 2-24-2009.
- 3,679,431 (*See Class 35 for this trademark*).
- 3,679,433. **STOP YOUR DRAMA (BLOCK FORM)**. MARLENE CHISM, (U.S. CLS. 100, 101 AND 107). SN 77-676,775. PUB. 6-23-2009. FILED 2-24-2009.
- 3,679,435. **JA'VION (BLOCK FORM)**. SUTTON, HARVEY MCVADIAN, (U.S. CLS. 100, 101 AND 107). SN 77-676,814. PUB. 6-23-2009. FILED 2-24-2009.
- 3,679,436. **EMBASSY UNIVERSITY (BLOCK FORM)**. EMBASSY UNIVERSITY, INC., (U.S. CLS. 100, 101 AND 107). SN 77-676,826. PUB. 6-23-2009. FILED 2-24-2009.
- 3,679,447. **SPIRITUALITY BOOTCAMP AND DESIGN**. WHITE, KRISTEN, (U.S. CLS. 100, 101 AND 107). SN 77-676,950. PUB. 6-23-2009. FILED 2-24-2009.
- 3,679,450. **GOODLIFE (BLOCK FORM)**. GOODLIFE.COM, INC., (U.S. CLS. 100, 101 AND 107). SN 77-676,964. PUB. 6-23-2009. FILED 2-24-2009.
- 3,679,452. **ENTREPRENEURIAL ENDURANCE: THE SURVIVAL GAME OF THE 21ST CENTURY (BLOCK FORM)**. LAINCO MANAGEMENT GROUP, LLC, (U.S. CLS. 100, 101 AND 107). SN 77-676,978. PUB. 6-23-2009. FILED 2-24-2009.
- 3,679,471. **LESS NICKEL. MORE IRON. (BLOCK FORM)**. DEFINED FITNESS, INC., (U.S. CLS. 100, 101 AND 107). SN 77-677,143. PUB. 6-23-2009. FILED 2-24-2009.
- 3,679,490 (*See Class 16 for this trademark*).
- 3,679,507. **BONDASSAGE (BLOCK FORM)**. BENNIS, JAELEEN, (U.S. CLS. 100, 101 AND 107). SN 77-677,535. PUB. 6-23-2009. FILED 2-24-2009.
- 3,679,513 (*See Class 16 for this trademark*).
- 3,679,527. **A BEAUTIFUL NIGHTMARE (BLOCK FORM)**. SMITH, MICHAEL, AKA MICHAEL NIGHTMARE, (U.S. CLS. 100, 101 AND 107). SN 77-677,730. PUB. 6-23-2009. FILED S.R. 2-25-2009; AM. P.R. 5-18-2009.
- 3,679,532. **FOR THE HEALTH OF IT (BLOCK FORM)**. COOKING WITH CANCER, INC., (U.S. CLS. 100, 101 AND 107). SN 77-677,807. PUB. 6-23-2009. FILED 2-25-2009.
- 3,679,541. **CLAYMATES (BLOCK FORM)**. AIKEN, CLAY, (U.S. CLS. 100, 101 AND 107). SN 77-677,919. PUB. 6-23-2009. FILED 2-25-2009.
- 3,679,544. **NATURAL HARMONY PHOTOGRAPHY (BLOCK FORM)**. WHITE, KEVIN, (U.S. CLS. 100, 101 AND 107). SN 77-677,962. PUB. 6-23-2009. FILED 2-25-2009.
- 3,679,545. **THE CONSTANT CRAFTER (BLOCK FORM)**. MEVERDEN ENTERPRISES, INC., (U.S. CLS. 100, 101 AND 107). SN 77-677,968. PUB. 6-23-2009. FILED 2-25-2009.
- 3,679,547. **THE EXCHANGE (BLOCK FORM)**. NATIONAL CONFLICT RESOLUTION CENTER, (U.S. CLS. 100, 101 AND 107). SN 77-677,975. PUB. 6-23-2009. FILED 2-25-2009.
- 3,679,555. **STAR12 SEMINAR TRAINING AND REWARDS (BLOCK FORM)**. ROCKHURST UNIVERSITY CONTINUING EDUCATION CENTER, INC., (U.S. CLS. 100, 101 AND 107). SN 77-678,144. PUB. 6-23-2009. FILED 2-25-2009.
- 3,679,562. **THE SITE OPTIMIZER (BLOCK FORM)**. PENTON BUSINESS MEDIA, INC., (U.S. CLS. 100, 101 AND 107). SN 77-678,187. PUB. 6-23-2009. FILED 2-25-2009.
- 3,679,566. **QUALITY ASSURANCE SYSTEM (BLOCK FORM)**. FOUNDATIONS, INC., (U.S. CLS. 100, 101 AND 107). SN 77-678,275. PUB. 6-23-2009. FILED 2-25-2009.
- 3,679,573. **LIFETHATWINS! AND DESIGN**. MOSS, PHILLIP W, DBA LIFETHATWINS, (U.S. CLS. 100, 101 AND 107). SN 77-678,380. PUB. 6-23-2009. FILED 2-25-2009.
- 3,679,574. **ED AND DESIGN**. STEPHENS & ASSOCIATES ADVERTISING, INC, (U.S. CLS. 100, 101 AND 107). SN 77-678,383. PUB. 6-23-2009. FILED 2-25-2009.

- 3,679,577. **PENNSYLVANIA'S NEIGHBORHOOD (BLOCK FORM)**. PENNSYLVANIA EDUCATIONAL COMMUNICATION SYSTEMS, DBA PENNSYLVANIA CABLE NETWORK, (U.S. CLS. 100, 101 AND 107). SN 77-678,400. PUB. 6-23-2009. FILED 2-25-2009.
- 3,679,590. **MADINA LAKE (BLOCK FORM)**. LEONE, MATTHEW, (U.S. CLS. 100, 101 AND 107). SN 77-678,632. PUB. 6-23-2009. FILED 2-26-2009.
- 3,679,599. **1-800 CAN LEARN (BLOCK FORM)**. HUNTINGTON MARK, LLC, (U.S. CLS. 100, 101 AND 107). SN 77-678,825. PUB. 6-23-2009. FILED 2-26-2009.
- 3,679,626. **SLOT SINGLES SOCIETY (BLOCK FORM)**. PATIRE, TOM J., (U.S. CLS. 100, 101 AND 107). SN 77-679,185. PUB. 6-23-2009. FILED 2-26-2009.
- 3,679,638. **GRADLAUNCH (BLOCK FORM)**. GRADLAUNCH, LLC, (U.S. CLS. 100, 101 AND 107). SN 77-679,363. PUB. 6-23-2009. FILED 2-26-2009.
- 3,679,645. **MISCELLANEOUS DESIGN**. CLEAR2CARE, INC., (U.S. CLS. 100, 101 AND 107). SN 77-679,458. PUB. 6-23-2009. FILED 2-26-2009.
- 3,679,651. **IN SYNC AND DESIGN**. IN SYNC INCORPORATED, (U.S. CLS. 100, 101 AND 107). SN 77-679,505. PUB. 6-23-2009. FILED 2-26-2009.
- 3,679,660. **EVERYDAY FENG SHUI (BLOCK FORM)**. RIGO, MARIE ELENA, (U.S. CLS. 100, 101 AND 107). SN 77-679,887. PUB. 6-23-2009. FILED 2-27-2009.
- 3,679,662. **THE ONE WHO KNOWS (BLOCK FORM)**. WALDREP, LISA JANKS, MULTIPLE CLASS, (INT. CLS. 41 AND 45), (U.S. CLS. 100, 101 AND 107). SN 77-679,903. PUB. 6-23-2009. FILED 2-27-2009.
- 3,679,697. **FIXGLOBAL (BLOCK FORM)**. HM PUBLISHING LIMITED, (U.S. CLS. 100, 101 AND 107). SN 77-680,471. PUB. 6-23-2009. FILED 2-27-2009.
- 3,679,701. **THE SHOE GODDESS (BLOCK FORM)**. AZRIA, FLORENCE A., (U.S. CLS. 100, 101 AND 107). SN 77-680,534. PUB. 6-23-2009. FILED 2-27-2009.
- 3,679,714. **PUTT N' CRAWL (BLOCK FORM)**. JAXBARS.-COM, LLC, (U.S. CLS. 100, 101 AND 107). SN 77-680,839. PUB. 6-23-2009. FILED 2-28-2009.
- 3,679,715. **PIP AND DESIGN**. PRUITT, DANIEL GRAVES, (U.S. CLS. 100, 101 AND 107). SN 77-680,850. PUB. 6-23-2009. FILED 2-28-2009.
- 3,679,724 (See Class 34 for this trademark).
- 3,679,727. **GUNSMOKE (BLOCK FORM)**. CBS BROADCASTING INC., (U.S. CLS. 100, 101 AND 107). SN 77-683,987. PUB. 6-23-2009. FILED 3-5-2009.
- 3,679,735. **NISC PATHWAYS AND DESIGN**. NATIONAL INFORMATION SOLUTIONS COOPERATIVE, INC., (U.S. CLS. 100, 101 AND 107). SN 77-687,548. PUB. 6-23-2009. FILED 3-10-2009.
- 3,679,737. **FOX BUSINESS AND DESIGN**. TWENTIETH CENTURY FOX FILM CORPORATION, (U.S. CLS. 100, 101 AND 107). SN 77-688,375. PUB. 6-23-2009. FILED 3-11-2009.
- 3,679,743. **THE CHILD WHO KNOWS (BLOCK FORM)**. WALDREP, LISA JANKS, (U.S. CLS. 100, 101 AND 107). SN 77-689,987. PUB. 6-23-2009. FILED 3-12-2009.
- 3,679,757. **MISCELLANEOUS DESIGN**. COOKING WITH CANCER, INC., MULTIPLE CLASS, (INT. CLS. 41 AND 43), (U.S. CLS. 100, 101 AND 107). SN 77-696,926. PUB. 6-23-2009. FILED 3-23-2009.
- 3,679,775. **FUN FORCE (BLOCK FORM)**. CARNIVAL CORPORATION, (U.S. CLS. 100, 101 AND 107). SN 77-705,710. PUB. 6-23-2009. FILED 4-2-2009.
- 3,679,807 (See Class 16 for this trademark).
- 3,679,808 (See Class 16 for this trademark).
- 3,679,814. **ANIME MASTER (BLOCK FORM)**. YTV CANADA, INC., (U.S. CLS. 100, 101 AND 107). SN 78-656,905. PUB. 6-23-2009. FILED 6-23-2005.
- 3,679,838 (See Class 1 for this trademark).
- 3,679,846 (See Class 9 for this trademark).
- 3,679,858 (See Class 9 for this trademark).
- 3,679,860 (See Class 35 for this trademark).
- 3,679,862 (See Class 16 for this trademark).
- 3,679,863 (See Class 9 for this trademark).
- 3,679,868 (See Class 6 for this trademark).
- 3,679,886 (See Class 9 for this trademark).
- 3,679,909 (See Class 35 for this trademark).
- 3,679,914 (See Class 39 for this trademark).
- 3,679,943 (See Class 38 for this trademark).
- 3,679,953 (See Class 35 for this trademark).
- 3,679,962 (See Class 9 for this trademark).
- 3,679,965 (See Class 9 for this trademark).
- 3,679,966. **VOVINAM VIETVÓDAO AND DESIGN**. FEDERATION VOVINAM; VIET VO DAO FRANCE, (U.S. CLS. 100, 101 AND 107). SN 79-059,949. PUB. 6-23-2009. FILED 7-29-2008.
- 3,679,969 (See Class 35 for this trademark).
- 3,679,971 (See Class 5 for this trademark).
- 3,679,989 (See Class 7 for this trademark).
- 3,680,014. **GALLADANCE (STYLIZED)**. DPG, (U.S. CLS. 100, 101 AND 107). SN 79-063,178. PUB. 6-23-2009. FILED 10-20-2008.
- 3,680,020 (See Class 16 for this trademark).
- 3,680,024 (See Class 28 for this trademark).
- 3,680,031 (See Class 35 for this trademark).
- 3,680,037 (See Class 28 for this trademark).
- 3,680,061 (See Class 9 for this trademark).

CLASS 42—SCIENTIFIC AND COMPUTER SERVICES

- 3,678,147 (See Class 1 for this trademark).
- 3,678,152 (See Class 35 for this trademark).
- 3,678,160. **EGENOMICS (BLOCK FORM)**. EGENOMICS, INC., (U.S. CLS. 100 AND 101). SN 76-683,476. PUB. 6-23-2009. FILED 10-29-2007.
- 3,678,161 (See Class 35 for this trademark).
- 3,678,162 (See Class 35 for this trademark).
- 3,678,204 (See Class 1 for this trademark).
- 3,678,208. **SECURITY 2.0 (BLOCK FORM)**. ART OF DEFENCE GMBH, (U.S. CLS. 100 AND 101). SN 77-052,074. PUB. 1-13-2009. FILED 11-28-2006.
- 3,678,220. **MONKEYSPEEK (BLOCK FORM)**. AARON ACCEPTANCE CORPORATION, (U.S. CLS. 100 AND 101). SN 77-101,833. PUB. 6-23-2009. FILED 2-7-2007.
- 3,678,221. **MY DOSTI.COM AND DESIGN**. CHELLAPPAN, RAGHAVAN V, (U.S. CLS. 100 AND 101). SN 77-104,295. PUB. 6-23-2009. FILED 2-9-2007.
- 3,678,224 (See Class 9 for this trademark).
- 3,678,227 (See Class 9 for this trademark).
- 3,678,236 (See Class 9 for this trademark).
- 3,678,237 (See Class 16 for this trademark).
- 3,678,238 (See Class 16 for this trademark).
- 3,678,248. **RESEARCH=HOPE (BLOCK FORM)**. HUNTSMAN CANCER INSTITUTE AT THE UNIVERSITY OF UTAH (A DEPARTMENT OF THE UNIVERSITY OF UTAH), (U.S. CLS. 100 AND 101). SN 77-225,745. PUB. 6-23-2009. FILED 7-10-2007.
- 3,678,249. **STEMWAY BIO-TECH AND DESIGN**. BIGGER INVESTMENTS S.A., MULTIPLE CLASS, (INT. CLS. 42 AND 44), (U.S. CLS. 100 AND 101). SN 77-225,862. PUB. 6-23-2009. FILED 7-10-2007.
- 3,678,252. **DELUXE AND DESIGN**. DELUXE LABORATORIES, INC., (U.S. CLS. 100 AND 101). SN 77-227,410. PUB. 6-23-2009. FILED 7-11-2007.
- 3,678,271 (See Class 41 for this trademark).
- 3,678,287 (See Class 35 for this trademark).
- 3,678,349 (See Class 35 for this trademark).
- 3,678,357 (See Class 40 for this trademark).
- 3,678,358 (See Class 35 for this trademark).
- 3,678,360. **SITWRITE (BLOCK FORM)**. BONZOLIO, INCORPORATED, (U.S. CLS. 100 AND 101). SN 77-398,223. PUB. 6-23-2009. FILED 2-15-2008.
- 3,678,366. **IN-STORE EXPERIENCE AND DESIGN**. IN-STORE EXPERIENCE, (U.S. CLS. 100 AND 101). SN 77-403,652. PUB. 6-23-2009. FILED 2-22-2008.
- 3,678,368 (See Class 37 for this trademark).
- 3,678,374. **LEHDER (BLOCK FORM)**. LEHDER ENVIRONMENTAL SERVICES LIMITED, (U.S. CLS. 100 AND 101). SN 77-413,688. PUB. 6-23-2009. FILED 3-5-2008.
- 3,678,393. **FKP ARCHITECTS AND DESIGN**. FKP ARCHITECTS, INC., (U.S. CLS. 100 AND 101). SN 77-430,432. PUB. 6-23-2009. FILED 3-25-2008.

- 3,678,422. **TOTAL DESIGN PRESCRIPTION (BLOCK FORM)**. COURTNEY SLOANE DESIGNS, LLC, (U.S. CLS. 100 AND 101). SN 77-454,859. PUB. 6-23-2009. FILED 4-22-2008.
- 3,678,426. **T-MOBILE MESSENGER (BLOCK FORM)**. DEUTSCHE TELEKOM, (U.S. CLS. 100 AND 101). SN 77-456,288. PUB. 4-14-2009. FILED 4-23-2008.
- 3,678,451. **PUBLIC INTERACTIVE COMPOSER (BLOCK FORM)**. NATIONAL PUBLIC RADIO, INC., (U.S. CLS. 100 AND 101). SN 77-486,770. PUB. 6-23-2009. FILED 5-29-2008.
- 3,678,452. **MISCELLANEOUS DESIGN**. CIRLARE LLC, (U.S. CLS. 100 AND 101). SN 77-488,629. PUB. 6-23-2009. FILED 6-2-2008.
- 3,678,481 (*See Class 1 for this trademark*).
- 3,678,487 (*See Class 38 for this trademark*).
- 3,678,488 (*See Class 35 for this trademark*).
- 3,678,494. **TWINSTRATA (BLOCK FORM)**. TWINSTRATA, INC., (U.S. CLS. 100 AND 101). SN 77-510,779. PUB. 6-23-2009. FILED 6-29-2008.
- 3,678,518 (*See Class 9 for this trademark*).
- 3,678,591 (*See Class 37 for this trademark*).
- 3,678,607 (*See Class 40 for this trademark*).
- 3,678,636. **JAMIE DRAKE (BLOCK FORM)**. DRAKE DESIGN ASSOCIATES, INC., (U.S. CLS. 100 AND 101). SN 77-539,233. PUB. 6-23-2009. FILED 8-5-2008.
- 3,678,642 (*See Class 37 for this trademark*).
- 3,678,644 (*See Class 35 for this trademark*).
- 3,678,668 (*See Class 35 for this trademark*).
- 3,678,669 (*See Class 35 for this trademark*).
- 3,678,686. **EXCITWERKS AND DESIGN**. EXCITWERKS, INC., (U.S. CLS. 100 AND 101). SN 77-545,097. PUB. 6-23-2009. FILED 8-12-2008.
- 3,678,714 (*See Class 35 for this trademark*).
- 3,678,748. **PROTEK (STYLIZED)**. PROTEK INTERNATIONAL, INC., MULTIPLE CLASS, (INT. CLS. 42 AND 45), (U.S. CLS. 100 AND 101). SN 77-561,306. PUB. 6-23-2009. FILED 9-3-2008.
- 3,678,781 (*See Class 35 for this trademark*).
- 3,678,810. **UNITED TELECOMP (BLOCK FORM)**. UNITED TELECOMP, LLC., (U.S. CLS. 100 AND 101). SN 77-580,168. PUB. 6-23-2009. FILED 9-26-2008.
- 3,678,816. **TRACEY LYNN GOLF (BLOCK FORM)**. BLAKE, TRACEY LYNN, (U.S. CLS. 100 AND 101). SN 77-581,966. PUB. 6-23-2009. FILED 9-30-2008.
- 3,678,819. **BIOQUEST (BLOCK FORM)**. GENOLOGICS LIFE SCIENCES SOFTWARE, INC., (U.S. CLS. 100 AND 101). SN 77-582,685. PUB. 2-17-2009. FILED 9-30-2008.
- 3,678,827. **A/R CONNECTION AND DESIGN**. CALL MOTIONS, LLC, (U.S. CLS. 100 AND 101). SN 77-583,866. PUB. 6-23-2009. FILED 10-2-2008.
- 3,678,857 (*See Class 16 for this trademark*).
- 3,678,866. **DESIGN NINE BROADBAND ARCHITECTURE + ENGINEERING AND DESIGN**. DESIGN NINE, INC., (U.S. CLS. 100 AND 101). SN 77-594,766. PUB. 6-23-2009. FILED 10-17-2008.
- 3,678,925. **GNS GLOBAL NETWORK SYSTEMS (STYLIZED)**. GLOBAL NETWORK SYSTEMS OF MARYLAND, INC., TA GNS, (U.S. CLS. 100 AND 101). SN 77-611,634. PUB. 6-23-2009. FILED 11-11-2008.
- 3,678,971. **CARTOSOFT (BLOCK FORM)**. CARTOSOFT, LLC, (U.S. CLS. 100 AND 101). SN 77-625,877. PUB. 6-23-2009. FILED 12-3-2008.
- 3,678,976. **PEYAK SOLUTIONS (BLOCK FORM)**. PEYAK SOLUTIONS, INC., (U.S. CLS. 100 AND 101). SN 77-627,233. PUB. 6-23-2009. FILED 12-5-2008.
- 3,678,977. **PEYAK SOLUTIONS, INC. AND DESIGN**. PEYAK SOLUTIONS, INC., (U.S. CLS. 100 AND 101). SN 77-627,247. PUB. 6-23-2009. FILED 12-5-2008.
- 3,678,982. **HSSEGUE (BLOCK FORM)**. HSSEGUE, LLC, DBA HSSEGUE, (U.S. CLS. 100 AND 101). SN 77-627,992. PUB. 6-23-2009. FILED 12-6-2008.
- 3,678,992 (*See Class 9 for this trademark*).
- 3,679,000 (*See Class 35 for this trademark*).
- 3,679,007 (*See Class 37 for this trademark*).
- 3,679,032. **BIG4BOOKS (STYLIZED)**. LEXTEL, INC., DBA BIG4 SYSTEMS, (U.S. CLS. 100 AND 101). SN 77-642,982. PUB. 6-23-2009. FILED 1-4-2009.
- 3,679,065 (*See Class 9 for this trademark*).
- 3,679,077. **AUTO DOCKET (BLOCK FORM)**. AMERICAN LEGALNET, INC., (U.S. CLS. 100 AND 101). SN 77-653,104. PUB. 6-23-2009. FILED 1-21-2009.
- 3,679,080. **COMPASS (BLOCK FORM)**. GREEN BLUE INSTITUTE, AKA GREENBLUE, (U.S. CLS. 100 AND 101). SN 77-653,595. PUB. 6-23-2009. FILED 1-21-2009.
- 3,679,087. **BLUEGOLF (BLOCK FORM)**. BLUEGOLF, LLC, (U.S. CLS. 100 AND 101). SN 77-655,064. PUB. 6-23-2009. FILED 1-23-2009.
- 3,679,095 (*See Class 35 for this trademark*).
- 3,679,107. **THE KUMU KIT (STYLIZED)**. HAWAII ENERGY CONNECTION, (U.S. CLS. 100 AND 101). SN 77-657,013. PUB. 6-23-2009. FILED 1-26-2009.
- 3,679,117. **JOETECHIE (BLOCK FORM)**. APPLE, JOSEPH V., (U.S. CLS. 100 AND 101). SN 77-659,035. PUB. 6-23-2009. FILED 1-29-2009.
- 3,679,134 (*See Class 35 for this trademark*).
- 3,679,136 (*See Class 35 for this trademark*).
- 3,679,144. **LUMIPORTAL (BLOCK FORM)**. LUMINYS, INC., (U.S. CLS. 100 AND 101). SN 77-664,144. PUB. 6-23-2009. FILED 2-5-2009.
- 3,679,157 (*See Class 11 for this trademark*).
- 3,679,171. **SPACESPLAN (STYLIZED)**. ARTISAN'S RESOURCE, INC., DBA SPACES INTERIOR DESIGN, (U.S. CLS. 100 AND 101). SN 77-666,357. PUB. 6-23-2009. FILED 2-9-2009.
- 3,679,197. **OTPX (BLOCK FORM)**. PLESMAN, PAUL, (U.S. CLS. 100 AND 101). SN 77-668,950. PUB. 6-23-2009. FILED 2-12-2009.
- 3,679,204 (*See Class 35 for this trademark*).
- 3,679,205. **CAGE AND DESIGN**. IT FOR PROFESSIONALS, INCORPORATED, DBA ITP, (U.S. CLS. 100 AND 101). SN 77-669,695. PUB. 6-23-2009. FILED 2-12-2009.
- 3,679,206. **TIMEPAY (BLOCK FORM)**. ACCUCHEX CORPORATION, (U.S. CLS. 100 AND 101). SN 77-669,711. PUB. 6-23-2009. FILED 2-12-2009.
- 3,679,216. **MORTGAGE SCIENCE AND DESIGN**. SOMISPO, INCORPORATED, DBA MORTGAGE SCIENCE CORPORATION, (U.S. CLS. 100 AND 101). SN 77-670,613. PUB. 6-23-2009. FILED 2-13-2009.
- 3,679,225. **TECHRX INC. AND DESIGN**. TECHRX, INC., (U.S. CLS. 100 AND 101). SN 77-671,032. PUB. 6-23-2009. FILED 2-15-2009.
- 3,679,226. **ELASTICMEETINGS (BLOCK FORM)**. FRALICK, MARK C, (U.S. CLS. 100 AND 101). SN 77-671,203. PUB. 6-23-2009. FILED 2-16-2009.
- 3,679,232. **EVRIHART (BLOCK FORM)**. EVRIHART, INC., (U.S. CLS. 100 AND 101). SN 77-671,363. PUB. 6-23-2009. FILED 2-16-2009.
- 3,679,245 (*See Class 35 for this trademark*).
- 3,679,246 (*See Class 38 for this trademark*).
- 3,679,265. **CORAL BLUE (BLOCK FORM)**. GLOECKNER, KATHRYN, DBA CORAL BLUE DESIGNS, (U.S. CLS. 100 AND 101). SN 77-672,713. PUB. 6-23-2009. FILED 2-18-2009.
- 3,679,296 (*See Class 36 for this trademark*).
- 3,679,306. **POINT RED (BLOCK FORM)**. IJ AMERICA, INC., (U.S. CLS. 100 AND 101). SN 77-674,084. PUB. 6-23-2009. FILED 2-19-2009.
- 3,679,345 (*See Class 9 for this trademark*).
- 3,679,366. **CLICKM AND DESIGN**. CLICK MANAGEMENT, INC., (U.S. CLS. 100 AND 101). SN 77-675,613. PUB. 6-23-2009. FILED 2-23-2009.
- 3,679,382 (*See Class 35 for this trademark*).
- 3,679,384 (*See Class 35 for this trademark*).
- 3,679,392. **SUPERNAL (BLOCK FORM)**. SUPERNAL SOFTWARE, LLC, (U.S. CLS. 100 AND 101). SN 77-676,157. PUB. 6-23-2009. FILED 2-23-2009.
- 3,679,412. **CAPITA (BLOCK FORM)**. CAPITA TECHNOLOGIES, INC., (U.S. CLS. 100 AND 101). SN 77-676,521. PUB. 6-23-2009. FILED 2-23-2009.
- 3,679,420. **I M S AND DESIGN**. STRATIDIS, IOANNIS M., (U.S. CLS. 100 AND 101). SN 77-676,659. PUB. 6-23-2009. FILED 2-24-2009.
- 3,679,454. **PISSSED CONSUMER (BLOCK FORM)**. CONSUMER OPINION CORP., (U.S. CLS. 100 AND 101). SN 77-677,004. PUB. 6-23-2009. FILED 2-24-2009.
- 3,679,460. **MOBILECAL (BLOCK FORM)**. ALLTITE, INC., (U.S. CLS. 100 AND 101). SN 77-677,077. PUB. 6-23-2009.

- FILED 2-24-2009.
- 3,679,493. **DQA AND DESIGN**. PRINCE AGRI PRODUCTS, INC., (U.S. CLS. 100 AND 101). SN 77-677,347. PUB. 6-23-2009. FILED 2-24-2009.
- 3,679,502. **FASTEK (BLOCK FORM)**. FASTEK INTERNATIONAL, LTD., (U.S. CLS. 100 AND 101). SN 77-677,459. PUB. 6-23-2009. FILED 2-24-2009.
- 3,679,504. **BACKUPMYNET (BLOCK FORM)**. SYNCHRONET INDUSTRIES, INC., (U.S. CLS. 100 AND 101). SN 77-677,487. PUB. 6-23-2009. FILED 2-24-2009.
- 3,679,508. **DISCLOSURESCAN (BLOCK FORM)**. HEALTH CARE CONCEPTS, INC. (U.S. CLS. 100 AND 101). SN 77-677,537. PUB. 6-23-2009. FILED 2-24-2009.
- 3,679,510. **MERCHANT DESIGNER (BLOCK FORM)**. TSIHLAS, GEORGE, (U.S. CLS. 100 AND 101). SN 77-677,563. PUB. 6-23-2009. FILED 2-24-2009.
- 3,679,534. **HANCOCK LAND AND DESIGN**. HANCOCK LUMBER COMPANY, INC., (U.S. CLS. 100 AND 101). SN 77-677,857. PUB. 6-23-2009. FILED 2-25-2009.
- 3,679,569. **AOG (BLOCK FORM)**. FORSYTHE TECHNOLOGY, INC., (U.S. CLS. 100 AND 101). SN 77-678,304. PUB. 6-23-2009. FILED 2-25-2009.
- 3,679,579. **SSURU (BLOCK FORM)**. SHOEHOLE DESIGNS, LLC, (U.S. CLS. 100 AND 101). SN 77-678,432. PUB. 6-23-2009. FILED 2-25-2009.
- 3,679,581. **RDMAX (BLOCK FORM)**. RDMAX INC, DBA RDMAX, (U.S. CLS. 100 AND 101). SN 77-678,449. PUB. 6-23-2009. FILED 2-25-2009.
- 3,679,583. **TWINTEL TECHNOLOGY WITH INNOVATIVE NETWORKS AND DESIGN**. TWINTEL SOLUTIONS, INC., (U.S. CLS. 100 AND 101). SN 77-678,470. PUB. 6-23-2009. FILED 2-25-2009.
- 3,679,587. **SEARCHMERCIALS (BLOCK FORM)**. FIERO, ALEXIOUS, (U.S. CLS. 100 AND 101). SN 77-678,591. PUB. 6-23-2009. FILED 2-25-2009.
- 3,679,597. **WEATHERSPY (BLOCK FORM)**. GB INTERNET SOLUTIONS INC., (U.S. CLS. 100 AND 101). SN 77-678,793. PUB. 6-23-2009. FILED 2-26-2009.
- 3,679,611. **NOT ALL DATA CENTERS ARE CREATED EQUAL (BLOCK FORM)**. IO DATA CENTERS, LLC, (U.S. CLS. 100 AND 101). SN 77-679,000. PUB. 6-23-2009. FILED 2-26-2009.
- 3,679,614. **MDWORKOUT (BLOCK FORM)**. GAYMAN, ROBERT, MULTIPLE CLASS, (INT. CLS. 42 AND 44), (U.S. CLS. 100 AND 101). SN 77-679,045. PUB. 6-23-2009. FILED 2-26-2009.
- 3,679,627 (*See Class 36 for this trademark*).
- 3,679,630 (*See Class 40 for this trademark*).
- 3,679,631 (*See Class 40 for this trademark*).
- 3,679,633. **ENWISEN AND DESIGN**. ENWISEN, INC., (U.S. CLS. 100 AND 101). SN 77-679,314. PUB. 6-23-2009. FILED 2-26-2009.
- 3,679,704. **LIFESCAPES INTERNATIONAL (BLOCK FORM)**. LIFESCAPES INTERNATIONAL, INC., (U.S. CLS. 100 AND 101). SN 77-680,578. PUB. 6-23-2009. FILED 2-27-2009.
- 3,679,765. **MISCELLANEOUS DESIGN**. EVRICHART, INC., (U.S. CLS. 100 AND 101). SN 77-699,951. PUB. 6-23-2009. FILED 3-26-2009.
- 3,679,768. **GOSPELVILLE (BLOCK FORM)**. ADVICE INTERACTIVE GROUP LLC, DBA GOSPELVILLE.COM, (U.S. CLS. 100 AND 101). SN 77-701,966. PUB. 6-23-2009. FILED 3-30-2009.
- 3,679,782. **VISIONSALE (BLOCK FORM)**. FNF INTELLECTUAL PROPERTY HOLDINGS, INC., (U.S. CLS. 100 AND 101). SN 77-711,259. PUB. 6-23-2009. FILED 4-10-2009.
- 3,679,804 (*See Class 9 for this trademark*).
- 3,679,824 (*See Class 4 for this trademark*).
- 3,679,825 (*See Class 4 for this trademark*).
- 3,679,834 (*See Class 35 for this trademark*).
- 3,679,835 (*See Class 35 for this trademark*).
- 3,679,840 (*See Class 38 for this trademark*).
- 3,679,843 (*See Class 9 for this trademark*).
- 3,679,844 (*See Class 9 for this trademark*).
- 3,679,851 (*See Class 9 for this trademark*).
- 3,679,854 (*See Class 9 for this trademark*).
- 3,679,868 (*See Class 6 for this trademark*).
- 3,679,871 (*See Class 35 for this trademark*).
- 3,679,872 (*See Class 5 for this trademark*).
- 3,679,877 (*See Class 6 for this trademark*).
- 3,679,879 (*See Class 29 for this trademark*).
- 3,679,882 (*See Class 9 for this trademark*).
- 3,679,883 (*See Class 9 for this trademark*).
- 3,679,884 (*See Class 9 for this trademark*).
- 3,679,886 (*See Class 9 for this trademark*).
- 3,679,889 (*See Class 6 for this trademark*).
- 3,679,900 (*See Class 6 for this trademark*).
- 3,679,907 (*See Class 1 for this trademark*).
- 3,679,908 (*See Class 9 for this trademark*).
- 3,679,909 (*See Class 35 for this trademark*).
- 3,679,915 (*See Class 9 for this trademark*).
- 3,679,929 (*See Class 3 for this trademark*).
- 3,679,930 (*See Class 7 for this trademark*).
- 3,679,941. **CERBA EUROPEAN LAB (STYLIZED)**. CERBA. MULTIPLE CLASS, (INT. CLS. 42 AND 44), (U.S. CLS. 100 AND 101). SN 79-059,153. PUB. 6-23-2009. FILED 7-22-2008.
- 3,679,946 (*See Class 1 for this trademark*).
- 3,679,958 (*See Class 32 for this trademark*).
- 3,679,965 (*See Class 9 for this trademark*).
- 3,679,969 (*See Class 35 for this trademark*).
- 3,679,971 (*See Class 5 for this trademark*).
- 3,679,979 (*See Class 3 for this trademark*).
- 3,679,980 (*See Class 9 for this trademark*).
- 3,679,983 (*See Class 9 for this trademark*).
- 3,679,994 (*See Class 9 for this trademark*).
- 3,679,995 (*See Class 9 for this trademark*).
- 3,680,003 (*See Class 36 for this trademark*).
- 3,680,023 (*See Class 9 for this trademark*).
- 3,680,035 (*See Class 7 for this trademark*).
- 3,680,037 (*See Class 28 for this trademark*).

CLASS 43—HOTEL AND RESTAURANT SERVICES

- 3,678,154. **GRANDUCA AND DESIGN**. GRANDUCA OPERATING COMPANY, L.P., (U.S. CLS. 100 AND 101). SN 76-671,855. PUB. 6-23-2009. FILED 1-26-2007.
- 3,678,159. **DELFINI D SINCE 1964 QUALITA INFINITA AND DESIGN**. LISA DELFINI, (U.S. CLS. 100 AND 101). SN 76-766,766. PUB. 11-27-2007. FILED 5-14-2007.
- 3,678,164. **BENGAL COAST SPICE TRADERS AND DESIGN**. BENGAL COAST RESTAURANTS, L.P., (U.S. CLS. 100 AND 101). SN 76-688,590. PUB. 6-23-2009. FILED 4-14-2008.
- 3,678,174. **HOPCAT (BLOCK FORM)**. 9 VOLT, LLC, (U.S. CLS. 100 AND 101). SN 76-691,839. PUB. 6-23-2009. FILED 8-4-2008.
- 3,678,190 (*See Class 30 for this trademark*).
- 3,678,227 (*See Class 9 for this trademark*).
- 3,678,258. **LONGHORN STEAKHOUSE (STYLIZED)**. RARE HOSPITALITY MANAGEMENT, INC., (U.S. CLS. 100 AND 101). SN 77-239,051. PUB. 6-23-2009. FILED 7-26-2007.
- 3,678,419. **PARSON JACK'S CAFE (BLOCK FORM)**. PARSON JACK'S CAFE OF GOODS AND EVILS, LLC, (U.S. CLS. 100 AND 101). SN 77-453,145. PUB. 1-20-2009. FILED 4-21-2008.
- 3,678,460 (*See Class 35 for this trademark*).
- 3,678,466. **PHO HUYNH HIEP AND DESIGN**. TRAN, LIEU, (U.S. CLS. 100 AND 101). SN 77-497,705. PUB. 6-23-2009. FILED 6-12-2008.
- 3,678,475 (*See Class 30 for this trademark*).
- 3,678,490. **MISCELLANEOUS DESIGN**. CHIKARANOMOTO COMPANY CO. LTD., (U.S. CLS. 100 AND 101). SN 77-508,722. PUB. 6-23-2009. FILED 6-26-2008.
- 3,678,491. **MISCELLANEOUS DESIGN**. CHIKARANOMOTO COMPANY CO. LTD., (U.S. CLS. 100 AND 101). SN 77-508,774. PUB. 6-23-2009. FILED 6-26-2008.
- 3,678,500 (*See Class 35 for this trademark*).
- 3,678,505. **K KING SIGNATURE GROUP AND DESIGN**. KING'S SEAFOOD CO., LLC, (U.S. CLS. 100 AND 101). SN 77-517,502. PUB. 6-23-2009. FILED 7-8-2008.
- 3,678,506. **KING SIGNATURE GROUP (BLOCK FORM)**. KING'S SEAFOOD CO., LLC, (U.S. CLS. 100 AND 101). SN 77-517,508. PUB. 6-23-2009. FILED 7-8-2008.
- 3,678,552 (*See Class 41 for this trademark*).
- 3,678,608 (*See Class 35 for this trademark*).
- 3,678,610. **FRESH. FAST. TASTY. (BLOCK FORM)**. JIMMY JOHN'S ENTERPRISES, LLC, (U.S. CLS. 100 AND 101). SN

- 77-537,369. PUB. 6-23-2009. FILED 8-1-2008.
- 3,678,648. **MANHATTAN CLUB (BLOCK FORM)**. TREL RESTAURANT INC., (U.S. CLS. 100 AND 101). SN 77-540,221. PUB. 6-23-2009. FILED 8-6-2008.
- 3,678,651 (*See Class 39 for this trademark*).
- 3,678,677. **MISCELLANEOUS DESIGN**. V1 BBQ & CAFE, (U.S. CLS. 100 AND 101). SN 77-542,676. PUB. 6-23-2009. FILED 8-8-2008.
- 3,678,696 (*See Class 35 for this trademark*).
- 3,678,708. **OLD COLLEGE INN (STYLIZED)**. CLARK HOSPITALITY, INC., DBA OLD COLLEGE INN RESTAURANT, (U.S. CLS. 100 AND 101). SN 77-549,642. PUB. 6-23-2009. FILED 8-18-2008.
- 3,678,709. **RIPE KITCHEN & BAR AND DESIGN**. RIPE KITCHEN & BAR, INC, (U.S. CLS. 100 AND 101). SN 77-549,859. PUB. 6-23-2009. FILED 8-18-2008.
- 3,678,725 (*See Class 36 for this trademark*).
- 3,678,775. **BISON B B'S CHUCKWAGON AND DESIGN**. BISON BOB'S CHUCKWAGON LLC, (U.S. CLS. 100 AND 101). SN 77-570,449. PUB. 6-23-2009. FILED 9-15-2008.
- 3,678,839 (*See Class 38 for this trademark*).
- 3,678,874 (*See Class 41 for this trademark*).
- 3,678,875 (*See Class 41 for this trademark*).
- 3,678,912. **LA MAISON DU COUSCOUS (BLOCK FORM)**. TARAFI, RACHID, (U.S. CLS. 100 AND 101). SN 77-608,610. PUB. 6-23-2009. FILED 11-6-2008.
- 3,678,930. **POPOVERS ON THE SQUARE (BLOCK FORM)**. POPOVERS ON THE SQUARE, LLC, (U.S. CLS. 100 AND 101). SN 77-614,678. PUB. 6-23-2009. FILED 11-14-2008.
- 3,678,969. **THE CRAZY LOBSTER POPPY HOME OF THE STEAMED SEAFOOD BUCKET AND DESIGN**. A BAR AND GRILL WITH A BITE, INC., DBA THE CRAZY LOBSTER BAR & GRILL, (U.S. CLS. 100 AND 101). SN 77-625,650. PUB. 6-23-2009. FILED 12-3-2008.
- 3,678,981. **RAIL CITY ALE HOUSE AND DESIGN**. HERBST GAMING, INC., (U.S. CLS. 100 AND 101). SN 77-627,807. PUB. 6-23-2009. FILED 12-5-2008.
- 3,678,989. **SANDWICH ARTIST (BLOCK FORM)**. DOCTOR'S ASSOCIATES INC., (U.S. CLS. 100 AND 101). SN 77-630,411. PUB. 6-23-2009. FILED 12-10-2008.
- 3,679,026. **THE PANCAKE MAN (BLOCK FORM)**. KUPER, JAMES W, (U.S. CLS. 100 AND 101). SN 77-640,111. PUB. 6-23-2009. FILED 12-26-2008.
- 3,679,039. **NEW YORK ROMA PIZZA BROOKLYN STYLE AND DESIGN**. NEW YORK / ROMA PIZZA & PASTA, CORP, (U.S. CLS. 100 AND 101). SN 77-644,974. PUB. 6-23-2009. FILED 1-7-2009.
- 3,679,068 (*See Class 35 for this trademark*).
- 3,679,093 (*See Class 36 for this trademark*).
- 3,679,096. **SUBWAY EVERY DAY VALUE MENU (BLOCK FORM)**. DOCTOR'S ASSOCIATES INC., (U.S. CLS. 100 AND 101). SN 77-656,325. PUB. 6-23-2009. FILED 1-26-2009.
- 3,679,099. **ECLIPSE DI LUNA (BLOCK FORM)**. L. TICK, INC., (U.S. CLS. 100 AND 101). SN 77-656,537. PUB. 6-23-2009. FILED 1-26-2009.
- 3,679,100. **SUBWAY EVERY DAY VALUE MENU AND DESIGN**. DOCTOR'S ASSOCIATES INC., (U.S. CLS. 100 AND 101). SN 77-656,541. PUB. 6-23-2009. FILED 1-26-2009.
- 3,679,155. **OLD KENTUCKY BBQ (BLOCK FORM)**. SCHWARTZ, MAX A., (U.S. CLS. 100 AND 101). SN 77-665,361. PUB. 6-23-2009. FILED 2-6-2009.
- 3,679,174. **PIZZERIA ORTICA (BLOCK FORM)**. B&O FOODART A.G., (U.S. CLS. 100 AND 101). SN 77-666,499. PUB. 6-23-2009. FILED 2-9-2009.
- 3,679,186. **GVR GREEN VALLEY RANCH AND DESIGN**. GREEN VALLEY RANCH GAMING, LLC, (U.S. CLS. 100 AND 101). SN 77-667,801. PUB. 6-23-2009. FILED 2-10-2009.
- 3,679,200. **BURNTTOAST (BLOCK FORM)**. DRIVAS, KONSTANTINOS, (U.S. CLS. 100 AND 101). SN 77-669,182. PUB. 6-23-2009. FILED 2-12-2009.
- 3,679,212. **DOLLY'S PIZZA "OUR SECRET'S IN THE SAUCE!" AND DESIGN**. DOLLY'S PIZZA FRANCHISING, INC., DBA DOLLY'S PIZZA, (U.S. CLS. 100 AND 101). SN 77-669,946. PUB. 6-23-2009. FILED 2-13-2009.
- 3,679,236. **THE INN ON LAKE SUPERIOR AND DESIGN**. ZMC HOTELS, INC., (U.S. CLS. 100 AND 101). SN 77-671,436. PUB. 6-23-2009. FILED 2-16-2009.
- 3,679,251. **PHILLY WAY (BLOCK FORM)**. FUHR, DAVID C., DBA THE PHILLY WAY, (U.S. CLS. 100 AND 101). SN 77-672,113. PUB. 6-23-2009. FILED 2-17-2009.
- 3,679,262 (*See Class 35 for this trademark*).
- 3,679,279. **PIZZA PAI USA PIZZAS DELICIOSAS - HECHAS CON AMOR AND DESIGN**. MGM RETAIL PROPERTIES, INC., DBA PIZZA PAI USA, (U.S. CLS. 100 AND 101). SN 77-673,302. PUB. 6-23-2009. FILED 2-18-2009.
- 3,679,280 (*See Class 35 for this trademark*).
- 3,679,286. **TRIPOINT (BLOCK FORM)**. TRINITY BAPTIST CHURCH OF SAN ANTONIO, INC., (U.S. CLS. 100 AND 101). SN 77-673,516. PUB. 6-23-2009. FILED 2-19-2009.
- 3,679,287. **TRIPOINT AND DESIGN**. TRINITY BAPTIST CHURCH OF SAN ANTONIO, INC., (U.S. CLS. 100 AND 101). SN 77-673,551. PUB. 6-23-2009. FILED 2-19-2009.
- 3,679,290. **YAK-ZIES (BLOCK FORM)**. SPAGNOLI, JOE, (U.S. CLS. 100 AND 101). SN 77-673,626. PUB. 6-23-2009. FILED 2-19-2009.
- 3,679,291. **BLACK EYED PIGS BBQ (BLOCK FORM)**. BLACK EYED PIGS BARBECUE CORPORATION, (U.S. CLS. 100 AND 101). SN 77-673,662. PUB. 6-23-2009. FILED 2-19-2009.
- 3,679,294. **DEAUVILLE BEACH RESORT (BLOCK FORM)**. MERUELO, BELINDA, DBA DEAUVILLE BEACH RESORT, (U.S. CLS. 100 AND 101). SN 77-673,827. PUB. 6-23-2009. FILED 2-19-2009.
- 3,679,307. **BOBBEE O'S BBQ (BLOCK FORM)**. BOBBEE O'S BBQ, INC., (U.S. CLS. 100 AND 101). SN 77-674,093. PUB. 6-23-2009. FILED 2-19-2009.
- 3,679,316. **CAMBRIDGE HOUSE (BLOCK FORM)**. CAMBRIDGE HOUSE OF O'FALLON, INC., (U.S. CLS. 100 AND 101). SN 77-674,418. PUB. 6-23-2009. FILED 2-20-2009.
- 3,679,329 (*See Class 30 for this trademark*).
- 3,679,457 (*See Class 30 for this trademark*).
- 3,679,462 (*See Class 35 for this trademark*).
- 3,679,542. **AUTHENTIC MEXICAN CUISINE SALENAS MEXICAN RESTAURANT AT THE VILLAGE GATE AND DESIGN**. BROWNCROFT ENTERPRISES, INC, (U.S. CLS. 100 AND 101). SN 77-677,941. PUB. 6-23-2009. FILED 2-25-2009.
- 3,679,576. **WEDNESDAY WINGOLUTION AND DESIGN**. FOUR M CAPITAL, LLC, (U.S. CLS. 100 AND 101). SN 77-678,392. PUB. 6-23-2009. FILED 2-25-2009.
- 3,679,604. **HOTELSPY (BLOCK FORM)**. GB INTERNET SOLUTIONS INC., (U.S. CLS. 100 AND 101). SN 77-678,905. PUB. 6-23-2009. FILED 2-26-2009.
- 3,679,629. **THE BZ AND DESIGN**. CLARK, RICK, (U.S. CLS. 100 AND 101). SN 77-679,239. PUB. 6-23-2009. FILED 2-26-2009.
- 3,679,640. **SÈ (BLOCK FORM)**. 5TH AVENUE PARTNERS, LLC, MULTIPLE CLASS, (INT. CLS. 43 AND 44), (U.S. CLS. 100 AND 101). SN 77-679,380. PUB. 6-23-2009. FILED 2-26-2009.
- 3,679,654. **HILLBROOK INN (BLOCK FORM)**. CAZ & ASSOCIATES, INC., (U.S. CLS. 100 AND 101). SN 77-679,602. PUB. 6-23-2009. FILED 2-27-2009.
- 3,679,685. **FIGS & HONEY (BLOCK FORM)**. BALL AND CHAIN, INC., (U.S. CLS. 100 AND 101). SN 77-680,257. PUB. 6-23-2009. FILED 2-27-2009.
- 3,679,757 (*See Class 41 for this trademark*).
- 3,679,764. **THE INN ON LAKE SUPERIOR (BLOCK FORM)**. ZMC HOTELS, INC., (U.S. CLS. 100 AND 101). SN 77-699,602. PUB. 6-23-2009. FILED 3-26-2009.
- 3,679,819. **SIMPLY WHOLESOME AND DESIGN**. P. M. KEELING CORPORATION, (U.S. CLS. 100 AND 101). SN 78-708,131. PUB. 6-23-2009. FILED 9-7-2005.
- 3,679,820 (*See Class 39 for this trademark*).
- 3,679,914 (*See Class 39 for this trademark*).
- 3,679,963 (*See Class 30 for this trademark*).
- 3,679,965 (*See Class 9 for this trademark*).
- 3,680,018 (*See Class 35 for this trademark*).

CLASS 44—MEDICAL, BEAUTY AND AGRICULTURAL SERVICES

- 3,678,147 (*See Class 1 for this trademark*).
- 3,678,227 (*See Class 9 for this trademark*).
- 3,678,241 (*See Class 9 for this trademark*).

- 3,678,244. **ENCOMPASS (BLOCK FORM)**. ADVANCED HOMECARE MANAGEMENT, INC., MULTIPLE CLASS, (INT. CLS. 44 AND 45), (U.S. CLS. 100 AND 101). SN 77-212,158. PUB. 4-22-2008. FILED 6-21-2007.
- 3,678,245. **ENCOMPASS HOME HEALTH AND DESIGN**. ADVANCED HOMECARE MANAGEMENT, INC., MULTIPLE CLASS, (INT. CLS. 44 AND 45), (U.S. CLS. 100 AND 101). SN 77-212,305. PUB. 4-22-2008. FILED 6-21-2007.
- 3,678,246 (*See Class 35 for this trademark*).
- 3,678,249 (*See Class 42 for this trademark*).
- 3,678,260 (*See Class 3 for this trademark*).
- 3,678,296 (*See Class 9 for this trademark*).
- 3,678,315. **PREMIER SALONS (BLOCK FORM)**. PREMIER SALONS, INC., (U.S. CLS. 100 AND 101). SN 77-338,022. PUB. 6-23-2009. FILED 11-27-2007.
- 3,678,321 (*See Class 16 for this trademark*).
- 3,678,322. **CELEBRATE YOU! (BLOCK FORM)**. LINDSEY, TYRHA, (U.S. CLS. 100 AND 101). SN 77-349,836. PUB. 6-23-2009. FILED 12-12-2007.
- 3,678,334 (*See Class 5 for this trademark*).
- 3,678,364. **MISCELLANEOUS DESIGN**. MICHIGAN ORTHOPAEDICS AND SPORTS MEDICINE, PC, (U.S. CLS. 100 AND 101). SN 77-402,633. PUB. 1-27-2009. FILED 2-21-2008.
- 3,678,388 (*See Class 36 for this trademark*).
- 3,678,423. **PROTECT YOUR FAMILY'S FUTURE HEALTH (BLOCK FORM)**. STEMSSAVE, INC., (U.S. CLS. 100 AND 101). SN 77-455,834. PUB. 6-23-2009. FILED 4-24-2008.
- 3,678,460 (*See Class 35 for this trademark*).
- 3,678,476. **COMMUNITY HOSPICE "REACHING OUT TO FAMILIES" AND DESIGN**. SOUTHERN COMMUNITY HOSPICE, INC., (U.S. CLS. 100 AND 101). SN 77-500,502. PUB. 6-23-2009. FILED 6-17-2008.
- 3,678,502. **CMA CENTROS MÉDICOS LAS AMÉRICAS AND DESIGN**. COMPREHENSIVE MEDICAL ACCESS (CMA), INC., DBA CENTROS MEDICOS LAS AMERICAS, (U.S. CLS. 100 AND 101). SN 77-515,409. PUB. 6-23-2009. FILED 7-6-2008.
- 3,678,508 (*See Class 37 for this trademark*).
- 3,678,544. **PREFURRED PET CARE (STYLIZED)**. PREFERRED PET CARE, INC., (U.S. CLS. 100 AND 101). SN 77-528,038. PUB. 6-23-2009. FILED 7-22-2008.
- 3,678,568. **BEHAVIOR 911 (BLOCK FORM)**. MICHAEL, DEBORAH M., DBA NORTH SHORE PEDIATRIC THERAPY, (U.S. CLS. 100 AND 101). SN 77-530,564. PUB. 6-23-2009. FILED 7-24-2008.
- 3,678,576. **RECOVERY ROAD MEDICAL CENTER (BLOCK FORM)**. RECOVERY ROAD MEDICAL CENTER, INC., (U.S. CLS. 100 AND 101). SN 77-531,976. PUB. 6-23-2009. FILED 7-25-2008.
- 3,678,601 (*See Class 35 for this trademark*).
- 3,678,602 (*See Class 35 for this trademark*).
- 3,678,629. **REFRESHLIFT (BLOCK FORM)**. DAHAN, PHILLIP E., M.D., DBA ADVANCED AESTHETIC PLASTIC SURGERY, LTD, (U.S. CLS. 100 AND 101). SN 77-538,885. PUB. 6-23-2009. FILED 8-5-2008.
- 3,678,659 (*See Class 39 for this trademark*).
- 3,678,661 (*See Class 39 for this trademark*).
- 3,678,805 (*See Class 16 for this trademark*).
- 3,678,861. **OPTIMAL SLEEP HEALTH REAWAKEN YOUR LIFE AND DESIGN**. STEVEN SCHEER MD INC., (U.S. CLS. 100 AND 101). SN 77-592,758. PUB. 6-23-2009. FILED 10-14-2008.
- 3,678,874 (*See Class 41 for this trademark*).
- 3,678,875 (*See Class 41 for this trademark*).
- 3,678,895. **IMIS INSTITUTE FOR MINIMALLY INVASIVE SPINE SURGERY AND DESIGN**. IMIS, PLLC, (U.S. CLS. 100 AND 101). SN 77-602,292. PUB. 3-17-2009. FILED 10-28-2008.
- 3,678,908. **UK HEALTHCARE (BLOCK FORM)**. UNIVERSITY OF KENTUCKY, (U.S. CLS. 100 AND 101). SN 77-605,789. PUB. 6-23-2009. FILED 11-3-2008.
- 3,678,924. **ZEL SKIN & LASER SPECIALISTS (BLOCK FORM)**. ZEL SKIN & LASER SPECIALISTS, LLC, (U.S. CLS. 100 AND 101). SN 77-610,857. PUB. 6-23-2009. FILED 11-10-2008.
- 3,678,985. **MAGIC JOHNSON (BLOCK FORM)**. JUNE BUG ENTERPRISES, INC., (U.S. CLS. 100 AND 101). SN 77-629,571. PUB. 6-23-2009. FILED 12-9-2008.
- 3,679,011. **REGIONAL MEDICAL CENTER AND DESIGN**. DELAWARE COUNTY MEMORIAL HOSPITAL, DBA REGIONAL MEDICAL CENTER, (U.S. CLS. 100 AND 101). SN 77-636,158. PUB. 6-23-2009. FILED 12-18-2008.
- 3,679,012 (*See Class 40 for this trademark*).
- 3,679,041. **THE CUTARELLI VISION TRIPLE GUARANTEE (BLOCK FORM)**. PAUL E. CUTARELLI, M.D., PLLC, (U.S. CLS. 100 AND 101). SN 77-645,571. PUB. 6-23-2009. FILED 1-8-2009.
- 3,679,044 (*See Class 9 for this trademark*).
- 3,679,063 (*See Class 10 for this trademark*).
- 3,679,083. **KAUFMAN CHILDREN'S CENTER (BLOCK FORM)**. KAUFMAN, NANCY, (U.S. CLS. 100 AND 101). SN 77-654,182. PUB. 6-23-2009. FILED 1-22-2009.
- 3,679,098 (*See Class 35 for this trademark*).
- 3,679,184. **I BAR (BLOCK FORM)**. PATEL, VIMAA, (U.S. CLS. 100 AND 101). SN 77-667,616. PUB. 6-23-2009. FILED 2-10-2009.
- 3,679,217. **G GREENSCHEMES (STYLIZED)**. STOVER, ELAINE, (U.S. CLS. 100 AND 101). SN 77-670,684. PUB. 6-23-2009. FILED 2-13-2009.
- 3,679,224. **ASTRAMED PHYSICIAN P.C. AND DESIGN**. ASTRAMED PHYSICIAN P.C., (U.S. CLS. 100 AND 101). SN 77-670,979. PUB. 6-23-2009. FILED 2-15-2009.
- 3,679,322. **SEASONS DENTAL CARE A BEAUTIFUL SMILE IS ALWAYS IN SEASON AND DESIGN**. JOHN K. PONTIKES, MDM, LLC, (U.S. CLS. 100 AND 101). SN 77-674,553. PUB. 6-23-2009. FILED 2-20-2009.
- 3,679,328 (*See Class 25 for this trademark*).
- 3,679,375 (*See Class 35 for this trademark*).
- 3,679,376. **SONOPATH.COM ENHANCING DIAGNOSTIC EFFICIENCY (BLOCK FORM)**. SONOPATH, (U.S. CLS. 100 AND 101). SN 77-675,868. PUB. 6-23-2009. FILED 2-23-2009.
- 3,679,391. **RSV INTERACTIVE AND DESIGN**. MEDIMMUNE, LLC, (U.S. CLS. 100 AND 101). SN 77-676,123. PUB. 6-23-2009. FILED 2-23-2009.
- 3,679,441. **DOGUEWOOD (BLOCK FORM)**. NALEPA, SUSAN M, (U.S. CLS. 100 AND 101). SN 77-676,892. PUB. 6-23-2009. FILED 2-24-2009.
- 3,679,444. **MISCELLANEOUS DESIGN**. SIRONAHEALTH, INC., (U.S. CLS. 100 AND 101). SN 77-676,901. PUB. 6-23-2009. FILED 2-24-2009.
- 3,679,445. **SIRONAHEALTH (BLOCK FORM)**. SIRONAHEALTH, INC., (U.S. CLS. 100 AND 101). SN 77-676,904. PUB. 6-23-2009. FILED 2-24-2009.
- 3,679,473. **EYESMART (BLOCK FORM)**. AMERICAN ACADEMY OF OPHTHALMOLOGY, INC., (U.S. CLS. 100 AND 101). SN 77-677,160. PUB. 6-23-2009. FILED 2-24-2009.
- 3,679,482. **MANWORKS (BLOCK FORM)**. EASY RENT SYSTEMS, INC., (U.S. CLS. 100 AND 101). SN 77-677,234. PUB. 6-23-2009. FILED 2-24-2009.
- 3,679,511. **WEST COAST DENTAL (BLOCK FORM)**. WEST COAST DENTAL, (U.S. CLS. 100 AND 101). SN 77-677,581. PUB. 6-23-2009. FILED 2-24-2009.
- 3,679,536. **LAKE RESTORATION INCORPORATED (BLOCK FORM)**. LAKE RESTORATION INC., (U.S. CLS. 100 AND 101). SN 77-677,878. PUB. 6-23-2009. FILED 2-25-2009.
- 3,679,614 (*See Class 42 for this trademark*).
- 3,679,615. **SIMPLY BEAUTIFUL SMILES (BLOCK FORM)**. PA DENTAL MANAGEMENT, (U.S. CLS. 100 AND 101). SN 77-679,052. PUB. 6-23-2009. FILED 2-26-2009.
- 3,679,640 (*See Class 43 for this trademark*).
- 3,679,646. **IT'S IN THE BAG! (STYLIZED)**. RUPP SEEDS, INC., (U.S. CLS. 100 AND 101). SN 77-679,459. PUB. 6-23-2009. FILED 2-26-2009.
- 3,679,667. **FLEET FOR LITTLE FEET (BLOCK FORM)**. IMAGE CLEAR ULTRASOUND, INC., (U.S. CLS. 100 AND 101). SN 77-679,995. PUB. 6-23-2009. FILED 2-27-2009.
- 3,679,668. **MAKING YOUR MINISTRY MOBILE (BLOCK FORM)**. IMAGE CLEAR ULTRASOUND, INC., (U.S. CLS. 100 AND 101). SN 77-679,999. PUB. 6-23-2009. FILED 2-27-2009.
- 3,679,676. **THRIVE AND DESIGN**. MEDIMMUNE, LLC, (U.S. CLS. 100 AND 101). SN 77-680,104. PUB. 6-23-2009. FILED 2-27-2009.
- 3,679,691. **RESURGENIZE! (BLOCK FORM)**. RESURGENS ORTHOPAEDICS, P.C., (U.S. CLS. 100 AND 101). SN 77-

680,361. PUB. 6-23-2009. FILED 2-27-2009.
 3,679,741. **BE HEALTHY. TRY ONE THING. (BLOCK FORM)**. AETNA INC., MULTIPLE CLASS, (INT. CLS. 44 AND 45), (U.S. CLS. 100 AND 101). SN 77-688,536. PUB. 6-23-2009. FILED 3-11-2009.
 3,679,746. **BE HEALTHY TRY ONE THING (STYLIZED)**. AETNA INC., MULTIPLE CLASS, (INT. CLS. 44 AND 45), (U.S. CLS. 100 AND 101). SN 77-692,496. PUB. 6-23-2009. FILED 3-17-2009.
 3,679,827 (*See Class 5 for this trademark*).
 3,679,872 (*See Class 5 for this trademark*).
 3,679,907 (*See Class 1 for this trademark*).
 3,679,929 (*See Class 3 for this trademark*).
 3,679,941 (*See Class 42 for this trademark*).
 3,680,018 (*See Class 35 for this trademark*).
 3,680,024 (*See Class 28 for this trademark*).

CLASS 45—PERSONAL AND LEGAL SERVICES

3,678,230 (*See Class 35 for this trademark*).
 3,678,239 (*See Class 35 for this trademark*).
 3,678,244 (*See Class 44 for this trademark*).
 3,678,245 (*See Class 44 for this trademark*).
 3,678,255 (*See Class 36 for this trademark*).
 3,678,272 (*See Class 35 for this trademark*).
 3,678,321 (*See Class 16 for this trademark*).
 3,678,394 (*See Class 35 for this trademark*).
 3,678,402. **OPERATION CLEAN START (BLOCK FORM)**. POWLOWSKI, WILLIAM, (U.S. CLS. 100 AND 101). SN 77-437,241. PUB. 6-23-2009. FILED 4-1-2008.
 3,678,487 (*See Class 38 for this trademark*).
 3,678,550. **HOWSMYDRIVING.COM (STYLIZED)**. DRIVE4-LIFE, LLC, (U.S. CLS. 100 AND 101). SN 77-528,727. PUB. 6-23-2009. FILED 7-22-2008.
 3,678,569 (*See Class 38 for this trademark*).
 3,678,592 (*See Class 41 for this trademark*).
 3,678,593 (*See Class 41 for this trademark*).
 3,678,597. **MISCELLANEOUS DESIGN**. MONTANO, JAVIER, (U.S. CLS. 100 AND 101). SN 77-535,485. PUB. 6-23-2009. FILED 7-31-2008.
 3,678,668 (*See Class 35 for this trademark*).
 3,678,669 (*See Class 35 for this trademark*).
 3,678,681 (*See Class 35 for this trademark*).
 3,678,748 (*See Class 42 for this trademark*).
 3,678,809 (*See Class 35 for this trademark*).
 3,678,874 (*See Class 41 for this trademark*).
 3,678,875 (*See Class 41 for this trademark*).
 3,678,902. **CHILDREN'S ADVOCACY CENTER AND DESIGN**. JOHNSON COUNTY CHILDREN'S ADVOCACY CENTER, (U.S. CLS. 100 AND 101). SN 77-603,193. PUB. 6-23-2009. FILED 10-29-2008.
 3,678,909. **COWBOYS FOR KIDS AND DESIGN**. JOHNSON COUNTY CHILDREN'S ADVOCACY CENTER, (U.S. CLS. 100 AND 101). SN 77-606,689. PUB. 6-23-2009. FILED 11-4-2008.
 3,678,913. **PETTALEZ AND DESIGN**. PETTALEZ, (U.S. CLS. 100 AND 101). SN 77-608,832. PUB. 6-23-2009. FILED 11-6-2008.
 3,678,921. **ELEVATED LIVING (BLOCK FORM)**. ELEVATED LIVING LTD., (U.S. CLS. 100 AND 101). SN 77-610,528. PUB. 6-23-2009. FILED 11-9-2008.
 3,678,966. **SITTING ON YOUR RECEIVABLES WON'T MAKE THEM HATCH (BLOCK FORM)**. PAOLUCCI, MARYLOU A., AKA MARYLOU A. PILEWSKI, (U.S. CLS. 100 AND 101). SN 77-624,907. PUB. 6-23-2009. FILED 12-2-2008.
 3,679,020. **VERISIGN VERIFIED AND DESIGN**. VERISIGN, INC., (U.S. CLS. 100 AND 101). SN 77-639,702. PUB. 6-23-2009. FILED 12-24-2008.
 3,679,021. **VERISIGN VERIFIED (BLOCK FORM)**. VERISIGN, INC., (U.S. CLS. 100 AND 101). SN 77-639,711. PUB. 6-23-2009. FILED 12-24-2008.
 3,679,022. **VERISIGN VERIFIED AND DESIGN**. VERISIGN, INC., (U.S. CLS. 100 AND 101). SN 77-639,728. PUB. 6-23-2009. FILED 12-24-2008.
 3,679,046. **CORNELLBORATION (BLOCK FORM)**. CORNELL UNIVERSITY, (U.S. CLS. 100 AND 101). SN 77-646,276. PUB. 6-23-2009. FILED 1-9-2009.
 3,679,047. **CORNELL BORATION A SOCIAL NETWORK FOR CORNELLIANS WWW.CORNELLBORATION.COM AND DESIGN**. CORNELL UNIVERSITY, (U.S. CLS. 100 AND 101). SN 77-646,299. PUB. 6-23-2009. FILED 1-9-2009.
 3,679,094. **FAMOZE (BLOCK FORM)**. DOSHI, SATISH, (U.S. CLS. 100 AND 101). SN 77-655,989. PUB. 6-23-2009. FILED S.R. 1-24-2009; AM. P.R. 4-9-2009.
 3,679,135 (*See Class 16 for this trademark*).
 3,679,173. **SECURITY INDUSTRY SPECIALISTS, INC. SIS AND DESIGN**. SECURITY INDUSTRY SPECIALISTS, INC., (U.S. CLS. 100 AND 101). SN 77-666,485. PUB. 6-23-2009. FILED 2-9-2009.
 3,679,258. **SHELTERED (BLOCK FORM)**. LOOK PHOTOGRAPHY, INC., (U.S. CLS. 100 AND 101). SN 77-672,327. PUB. 6-23-2009. FILED 2-17-2009.
 3,679,259. **IMAGES SHELTERED AND DESIGN**. LOOK PHOTOGRAPHY, INC., (U.S. CLS. 100 AND 101). SN 77-672,374. PUB. 6-23-2009. FILED 2-17-2009.
 3,679,270. **THE CAELUM ARCHIVE (BLOCK FORM)**. PATRICIA SILVA, (U.S. CLS. 100 AND 101). SN 77-672,853. PUB. 6-23-2009. FILED 2-18-2009.
 3,679,357. **FRANCHISE BUSTERS (BLOCK FORM)**. FRANCHISE BUSTERS, LLC, (U.S. CLS. 100 AND 101). SN 77-675,475. PUB. 6-23-2009. FILED 2-22-2009.
 3,679,374. **BUNDLESAFE (BLOCK FORM)**. ELECTION CFO, LLC, (U.S. CLS. 100 AND 101). SN 77-675,755. PUB. 6-23-2009. FILED 2-23-2009.
 3,679,394 (*See Class 39 for this trademark*).
 3,679,405. **MY SHOWBIZ WORLD (BLOCK FORM)**. TAL, YARON AND DOAN, SHMUEL, PARTNERS, (U.S. CLS. 100 AND 101). SN 77-676,381. PUB. 6-23-2009. FILED 2-23-2009.
 3,679,410 (*See Class 41 for this trademark*).
 3,679,411 (*See Class 41 for this trademark*).
 3,679,468. **SP AND DESIGN**. THE STOLAR PARTNERSHIP LLP, (U.S. CLS. 100 AND 101). SN 77-677,127. PUB. 6-23-2009. FILED 2-24-2009.
 3,679,469. **THE STOLAR PARTNERSHIP LLP (BLOCK FORM)**. THE STOLAR PARTNERSHIP LLP, (U.S. CLS. 100 AND 101). SN 77-677,136. PUB. 6-23-2009. FILED 2-24-2009.
 3,679,484 (*See Class 36 for this trademark*).
 3,679,512. **GLENN MILLER LAW, INC. (BLOCK FORM)**. GLENN MILLER LAW, INC., (U.S. CLS. 100 AND 101). SN 77-677,595. PUB. 6-23-2009. FILED 2-24-2009.
 3,679,535. **DOMAINGUERILLAS.COM (BLOCK FORM)**. WILLIAMS JR, BARRY, (U.S. CLS. 100 AND 101). SN 77-677,866. PUB. 6-23-2009. FILED 2-25-2009.
 3,679,571. **CARE FUNERAL & CREMATION SERVICE (BLOCK FORM)**. BONAR, BRIAN JAMES, (U.S. CLS. 100 AND 101). SN 77-678,356. PUB. 6-23-2009. FILED 2-25-2009.
 3,679,572 (*See Class 9 for this trademark*).
 3,679,616. **DRRT (BLOCK FORM)**. DRRT LIMITED DUBAI, (U.S. CLS. 100 AND 101). SN 77-679,101. PUB. 6-23-2009. FILED 2-26-2009.
 3,679,652. **REALITY FINDERS PARANORMAL INVESTIGATORS (BLOCK FORM)**. REALITY FINDERS, (U.S. CLS. 100 AND 101). SN 77-679,570. PUB. 6-23-2009. FILED 2-26-2009.
 3,679,662 (*See Class 41 for this trademark*).
 3,679,687. **MISCELLANEOUS DESIGN**. DONESA, MANUEL ALCANTARA, (U.S. CLS. 100 AND 101). SN 77-680,303. PUB. 6-23-2009. FILED 2-27-2009.
 3,679,692. **IPG AND DESIGN**. INTERNATIONAL PROGRAM GROUP, (U.S. CLS. 100 AND 101). SN 77-680,368. PUB. 6-23-2009. FILED 2-27-2009.
 3,679,705 (*See Class 9 for this trademark*).
 3,679,741 (*See Class 44 for this trademark*).
 3,679,746 (*See Class 44 for this trademark*).
 3,679,785. **ANYTIME/ANYWHERE SETTLEMENTS (BLOCK FORM)**. TAYLOR, BEAN & WHITAKER MORTGAGE CORP., (U.S. CLS. 100 AND 101). SN 77-713,488. PUB. 6-23-2009. FILED 4-14-2009.
 3,679,796. **VIALUXE (BLOCK FORM)**. VIALUXE INC., (U.S. CLS. 100 AND 101). SN 77-977,635. PUB. 6-10-2008. FILED 12-17-2007.

TM 1150

OFFICIAL GAZETTE

SEPT. 8, 2009

3,679,830 (*See Class 16 for this trademark.*)
3,679,907 (*See Class 1 for this trademark.*)
3,680,031 (*See Class 35 for this trademark.*)

* * * * *

SECTION 2.—PRIOR UNITED STATES CLASSIFICATION

COLLECTIVE MEMBERSHIP MARKS

CLASS 200—COLLECTIVE MEMBERSHIP

3,679,064. **MISCELLANEOUS DESIGN.** BACNET INTERNATIONAL INC., SN 77-650,075. PUB. 6-23-2009. FILED 1-15-2009.

3,679,154. **DEMONOS (BLOCK FORM).** DEMONOS CAR CLUB, SN 77-665,353. PUB. 6-23-2009. FILED 2-6-2009.

3,679,311. **MISCELLANEOUS DESIGN.** ALPHA EPSILON OMEGA, SN 77-674,337. PUB. 6-23-2009. FILED 2-20-2009.

3,679,312. **MISCELLANEOUS DESIGN.** ALPHA EPSILON OMEGA, SN 77-674,340. PUB. 6-23-2009. FILED 2-20-2009.

3,679,533. **WBS AND DESIGN.** DEBOER, WILLIAM D. DBA LWB ENTERPRISES, SN 77-677,848. PUB. 6-23-2009. FILED 2-25-2009.

3,679,695. **BAD CROWD MOTOR CLUB (BLOCK FORM).** BAD CROWD MOTOR CLUB, LLC, SN 77-680,436. PUB. 6-23-2009. FILED 2-27-2009.

3,679,702. **BAD CROWD MOTOR CLUB AND DESIGN.** BAD CROWD MOTOR CLUB, LLC, SN 77-680,539. PUB. 6-23-2009. FILED 2-27-2009.

CERTIFICATION MARKS

CLASS A—GOODS

3,678,800. **MADE IN ALASKA AND DESIGN.** STATE OF

ALASKA DEPARTMENT OF COMMERCE COMMUNITY & ECONOMIC DEVELOPMENT, SN 77-576,527. PUB. 6-23-2009. FILED 9-23-2008.

3,679,722. **REAL CALIFORNIA . CHEESE . AND DESIGN.** CALIFORNIA MILK PRODUCERS ADVISORY BOARD, SN 77-682,137. PUB. 6-23-2009. FILED 3-3-2009.

CLASS B—SERVICES

3,678,145. **OMRI LISTED ORGANIC MATERIALS REVIEW INSTITUTE AND DESIGN.** ORGANIC MATERIALS REVIEW INSTITUTE, SN 76-525,420. PUB. 6-23-2009. FILED 6-25-2003.

3,678,463. **ANGEL THERAPY PRACTITIONER (BLOCK FORM).** DOREEN VIRTUE, LLC, SN 77-496,896. PUB. 6-23-2009. FILED 6-11-2008.

3,678,539. **THAI SELECT THAI CUISINE (BLOCK FORM).** DEPARTMENT OF EXPORT PROMOTION OF THE MINISTRY OF COMMERCE, ROYAL THAI GOVERNMENT, AN AGENCY OF THE KINGDOM OF THAILAND, SN 77-527,068. PUB. 6-23-2009. FILED 7-21-2008.

3,678,540. **THAI SELECT THAI CUISINE AWARDED BY MINISTRY OF COMMERCE THAILAND AND DESIGN.** DEPARTMENT OF EXPORT PROMOTION OF THE MINISTRY OF COMMERCE, ROYAL THAI GOVERNMENT, AN AGENCY OF THE KINGDOM OF THAILAND, SN 77-527,292. PUB. 6-23-2009. FILED 7-21-2008.

3,679,018. **CBV (BLOCK FORM).** THE CANADIAN INSTITUTE OF CHARTERED BUSINESS VALUATORS, SN 77-639,271. PUB. 6-23-2009. FILED 12-23-2008.

* * * * *

TRADEMARK REGISTRATIONS ISSUED UNDER SECTION 1(d)

The following marks have registered on the Principal Register pursuant to the intent-to-use provisions of Section 1(d) of the Trademark Act of 1946, as amended.

SECTION 1.— INTERNATIONAL CLASSIFICATION

The short titles associated below with the international class numbers are terms designed merely for quick identification and are not an official part of the international classification. The full names of international classes are given in section 6.1 of the trademark rules of practice.

The designation "U.S. Cl." appearing in this section refers to the U.S. class in effect prior to Sep. 1, 1973 rather than the international class which applies to applications filed on or after that date. For adoption of international classification see notice in the OFFICIAL GAZETTE of Jun. 26, 1973 (911 O.G. TM 210).

Application in more than one class

3,680,062. TSG SKI & GOLF, LLC, TELLURIDE, CO. SN 74-611,907. PUB. 10-10-2006, FILED 12-16-1994.

TELLURIDE

OWNER OF U.S. REG. NO. 1,962,793.
SEC. 2(F).

CLASS 16—PAPER GOODS AND PRINTED MATTER

FOR PAPER GOODS AND PRINTED MATTER, NAMELY, ADDRESS BOOKS, PHOTOGRAPH ALBUMS, APPOINTMENT BOOKS, MERCHANDISE BAGS, PAPER BAGS, BOOK MARKS, NOTE BOOKS, TRAVEL BOOKS, BUSINESS CARDS, BUSINESS FORMS, CALENDARS, GIFT CARDS, BLANK CARDS, CHRISTMAS CARDS, GREETING CARDS, ENVELOPES, NEWSLETTERS IN THE FIELD OF SKI RESORT SERVICES AND GOLF RESORT SERVICES, NEWSPAPERS, NOTE PADS, POSTCARDS, AND STATIONERY; COASTERS OF PAPER (U.S. CLS. 2, 5, 22, 23, 29, 37, 38 AND 50).

FIRST USE 5-0-2009; IN COMMERCE 5-0-2009.

CLASS 20—FURNITURE AND ARTICLES NOT OTHERWISE CLASSIFIED

FOR NOVELTY ITEMS, NAMELY, JEWELRY BOXES NOT OF METAL, NON-METAL KEY CHAINS, NON-METAL KEY FOBS, PICTURE FRAMES, PLASTIC NOVELTY LICENSE PLATES, AND PLAQUES (U.S. CLS. 2, 13, 22, 25, 32 AND 50).

FIRST USE 5-0-2009; IN COMMERCE 5-0-2009.

CLASS 21—HOUSEWARES AND GLASS

FOR HOUSEWARES, NAMELY, DISHES, BEVERAGE WARE, BOTTLE OPENERS, BASKETS OF WICKER, STRAW, WOOD OR CLOTH, BAKEWARE, AND COASTERS NOT OF PAPER AND NOT BEING TABLE LINEN (U.S. CLS. 2, 13, 23, 29, 30, 33, 40 AND 50).

FIRST USE 5-0-2009; IN COMMERCE 5-0-2009.

CLASS 28—TOYS AND SPORTING GOODS

FOR TOYS AND SPORTING GOODS, NAMELY, STUFFED TOY ANIMALS, GOLF BAGS, GOLF BALLS, CHRISTMAS TREE DECORATIONS, AND SNOW SLEDS FOR RECREATIONAL USE (U.S. CLS. 22, 23, 38 AND 50).

FIRST USE 5-0-2009; IN COMMERCE 5-0-2009.

CLASS 41—EDUCATION AND ENTERTAINMENT

FOR SKI RESORT SERVICES IN THE NATURE OF DOWNHILL SKIING, CROSS COUNTRY SKIING, SNOWMOBILING, ICE SKATING AND GOLFING (U.S. CLS. 100, 101 AND 107).

FIRST USE 0-0-1972; IN COMMERCE 0-0-1972.

3,680,063. APPLE CORPS LIMITED, LONDON, ENGLAND.
SN 75-399,941. PUB. 10-3-2006, FILED 12-4-1997.

BEATLES

OWNER OF U.S. REG. NOS. 1,752,120 AND 2,066,226.

CLASS 6—METAL GOODS

FOR FIGURINES AND COLLECTORS' MODEL VEHICLES AND FIGURES, ALL OF COMMON METAL; METAL MONEY CLIPS OF NON-PRECIOUS METAL; KEY FOBS, KEY RINGS AND KEY CHAINS, ALL OF COMMON METAL; COMMON METAL KEY CHAIN TAGS; STATUETTES AND FIGURINES OF COMMON METAL; NON-ELECTRIC, NON MECHANICAL, NON-LUMINOUS COMMON METAL SIGNS; METAL BOXES; METAL CONTAINERS FOR THE STORAGE AND TRANSPORTATION OF GOODS (U.S. CLS. 2, 12, 13, 14, 23, 25 AND 50).

FIRST USE 1-31-1997; IN COMMERCE 1-31-1997.

CLASS 26—FANCY GOODS

FOR ORNAMENTAL NOVELTY PINS FOR CLOTHING, ORNAMENTAL BUCKLES FOR CLOTHING, AND ORNAMENTAL NOVELTY BUTTONS, ALL OF COMMON METAL (U.S. CLS. 37, 39, 40, 42 AND 50).

FIRST USE 12-31-1997; IN COMMERCE 12-31-1997.

CLASS 28—TOYS AND SPORTING GOODS

FOR TOY MODEL VEHICLES ALL OF COMMON METAL; TOY MODEL FIGURES ALL OF COMMON METAL (U.S. CLS. 22, 23, 38 AND 50).

FIRST USE 7-31-1997; IN COMMERCE 7-31-1997.

3,680,064. FIRST NIAGARA FINANCIAL GROUP, INC., LOCKPORT, NY. SN 75-890,902. PUB. 10-10-2000, FILED 1-7-2000.

FIRST NIAGARA

NO CLAIM IS MADE TO THE EXCLUSIVE RIGHT TO USE "FIRST", APART FROM THE MARK AS SHOWN.

CLASS 35—ADVERTISING AND BUSINESS

FOR LEASING OF OFFICE EQUIPMENT (U.S. CLS. 100, 101 AND 102).
FIRST USE 11-0-2008; IN COMMERCE 11-0-2008.

CLASS 37—CONSTRUCTION AND REPAIR

FOR LEASING OF CONSTRUCTION EQUIPMENT AND BUILDING MACHINERY (U.S. CLS. 100, 103 AND 106).
FIRST USE 11-0-2008; IN COMMERCE 11-0-2008.

CLASS 39—TRANSPORTATION AND STORAGE

FOR LEASING OF MOTOR VEHICLES (U.S. CLS. 100 AND 105).
FIRST USE 11-0-2008; IN COMMERCE 11-0-2008.

3,680,068. BOYDS COLLECTION, LTD., THE, MCSHERRYSTOWN, PA. SN 76-255,720. PUB. 12-10-2002, FILED 5-11-2001.



OWNER OF U.S. REG. NOS. 2,032,320, 2,100,906, AND OTHERS.

CLASS 16—PAPER GOODS AND PRINTED MATTER

FOR PAPER GOODS AND PRINTED MATTER, NAMELY, WRAPPING PAPER, TISSUE PAPER, GIFT BAGS, GIFT BOXES, CARDS, SPECIFICALLY POST CARDS, PLAYING CARDS, GIFT CARDS, AND GREETING CARDS; CHILDREN'S BOOKS, COLORING BOOKS, STATIONERY, PHOTOGRAPHS, MAGAZINES IN THE FIELD OF COLLECTIBLE FIGURINES, COLLECTIBLE FIGURINE BROCHURES, COLLECTIBLE FIGURINE PRODUCT PRICE GUIDES, AND COLLECTIBLE FIGURINE PRODUCT CATALOGS; MAPS AND CALENDARS (U.S. CLS. 2, 5, 22, 23, 29, 37, 38 AND 50).
FIRST USE 8-0-2002; IN COMMERCE 8-0-2002.

CLASS 24—FABRICS

FOR FABRIC, NAMELY, COTTON FABRIC, WOOL FABRIC, NYLON FABRIC, RAYON FABRIC, AND SILK FABRIC; BLANKETS, NAMELY, BED BLANKETS, BED SPREADS, BLANKET THROWS, AND RECEIVING BLANKETS; BED LINENS, NAMELY, SHEETS, PILLOW CASES, PILLOW SHAMS, PILLOW COVERS, AND DUST RUFFLES; COVERS, NAMELY, FABRIC TABLE COVERS, FABRIC TABLE CLOTHS, FABRIC TABLE RUNNERS, CUSHION COVERS, AND FABRIC APPLIANCE COVERS; PIECE GOODS, NAMELY, FABRIC PLACE MATS, FABRIC NAPKINS, DISH CLOTHS, DISH TOWELS, AND POT HOLDERS, AND WINDOW TREATMENTS, NAMELY, CURTAINS AND SHEERS (U.S. CLS. 42 AND 50).
FIRST USE 8-0-2002; IN COMMERCE 8-0-2002.

3,680,069. DECKER, ROBERT J., CHARLOTTESVILLE, VA. SN 76-312,462. PUB. 9-9-2003, FILED 9-13-2001.

EMPOWER THE TOWERS

CLASS 16—PAPER GOODS AND PRINTED MATTER

FOR STICKERS, POSTERS, PRINTED PAPER SIGNS (U.S. CLS. 2, 5, 22, 23, 29, 37, 38 AND 50).
FIRST USE 4-28-2008; IN COMMERCE 5-7-2008.

CLASS 25—CLOTHING

FOR SHIRTS (U.S. CLS. 22 AND 39).
FIRST USE 5-7-2008; IN COMMERCE 5-7-2008.

3,680,071. XTREME SPORTS IMPORTACAO, EXPORTACAO E COMERCIO LTDA., SAO PAULO, SAO PAULO, BRAZIL. SN 76-416,760. PUB. 7-1-2008, FILED 6-4-2002.



CLASS 9—ELECTRICAL AND SCIENTIFIC APPARATUS

FOR STEREO SPEAKERS, COMPACT DISKS CONTAINING SPORTING FILMS AND SPORTING EVENTS; COMPUTERS; EYEGASSES; SUNGLASSES; DVDS CONTAINING SPORTING FILMS AND SPORTING EVENTS, VIDEOCASSETTES CONTAINING SPORTING FILMS AND SPORTING EVENTS, TELEPHONES (U.S. CLS. 21, 23, 26, 36 AND 38).
FIRST USE 11-19-2001; IN COMMERCE 11-19-2001.

CLASS 12—VEHICLES

FOR BICYCLES, MOTORCYCLES (U.S. CLS. 19, 21, 23, 31, 35 AND 44).
FIRST USE 11-19-2001; IN COMMERCE 11-19-2001.

CLASS 14—JEWELRY

FOR CLOCKS, COSTUME JEWELRY (U.S. CLS. 2, 27, 28 AND 50).
FIRST USE 11-19-2001; IN COMMERCE 11-19-2001.

CLASS 16—PAPER GOODS AND PRINTED MATTER

FOR PENS, PENCILS, NOTEBOOKS, SERIES OF NON-FICTION BOOKS, MAGAZINES, ALL IN THE FIELD OF SPORTS, SPORTING EVENTS AND SPORTING FILMS, GLUE FOR STATIONERY OR HOUSEHOLD USE, PEN AND PENCIL CASES, DRAFTING, DRAWING AND UNGRADUATED RULERS (U.S. CLS. 2, 5, 22, 23, 29, 37, 38 AND 50).

FIRST USE 11-19-2001; IN COMMERCE 11-19-2001.

CLASS 28—TOYS AND SPORTING GOODS

FOR SURFBOARDS, WINDSURF BOARDS, RING BUOYS FOR RECREATIONAL USE; BODY BOARDS AND SKATEBOARDS; PLUSH TOYS, TOYS FOR DOMESTIC ANIMALS (U.S. CLS. 22, 23, 38 AND 50).

FIRST USE 11-19-2001; IN COMMERCE 11-19-2001.

CLASS 35—ADVERTISING AND BUSINESS

FOR RETAIL STORES AND DISTRIBUTORSHIPS FEATURING STEREO EQUIPMENT, SWIMMING GEAR, CALCULATORS, COMPUTERS, AUDIO AND VIDEO EQUIPMENT AND ACCESSORIES, CASSETTES, TAPES, TELEPHONE AND COMMUNICATIONS EQUIPMENT, CLOCKS, COSTUME JEWELRY, PENS, PENCILS, NOTEBOOKS, BOOKS, MAGAZINES, NEWSPAPERS, GLUES, PEN AND PENCIL CASES, RULERS, BICYCLES, MOTORCYCLES, TRICYCLES, RECREATIONAL JET BOATS, MOTORBOATS, SAILBOATS, SHIPS, ATHLETIC AND EXERCISE EQUIPMENT AND TOYS, CLOTHING, FOOTWEAR AND HEADGEAR; FRANCHISING SERVICES, NAMELY, OFFERING TECHNICAL ASSISTANCE IN THE ESTABLISHMENT AND/OR OPERATION OF CLOTHING STORES, FOOTWEAR STORES AND RESTAURANTS (U.S. CLS. 100, 101 AND 102).

FIRST USE 11-19-2001; IN COMMERCE 11-19-2001.

CLASS 42—SCIENTIFIC AND COMPUTER SERVICES

FOR LICENSING OF INTELLECTUAL PROPERTY, NAMELY, TRADEMARKS AND COPYRIGHTS (U.S. CLS. 100 AND 101).

FIRST USE 11-19-2001; IN COMMERCE 11-19-2001.

3,680,074. HOSOKAWA, HISASHI, AOBA-KU, YOKOHAMA-SHI, KANAGAWA, JAPAN. SN 76-496,834. PUB. 2-20-2007, FILED 3-13-2003.

ECOFACTURING TECHNOLOGY

NO CLAIM IS MADE TO THE EXCLUSIVE RIGHT TO USE TECHNOLOGY, APART FROM THE MARK AS SHOWN.

CLASS 7—MACHINERY

FOR CONSTRUCTION MACHINE, NAMELY, MACHINE FOR REPAVING (U.S. CLS. 13, 19, 21, 23, 31, 34 AND 35).

FIRST USE 7-4-2008; IN COMMERCE 7-4-2008.

CLASS 37—CONSTRUCTION AND REPAIR

FOR PAVING CONTRACTOR SERVICES, NAMELY, REPAVING (U.S. CLS. 100, 103 AND 106).

FIRST USE 2-14-2004; IN COMMERCE 8-26-2008.

3,680,086. SCHLEIFRING UND APPARATEBAU GMBH, D-82256 FÜRSTENFELDBRUCK, FED REP GERMANY. SN 76-653,286. PUB. 3-18-2008, FILED 1-12-2006.

GIGACAP

THE MARK CONSISTS OF STANDARD CHARACTERS WITHOUT CLAIM TO ANY PARTICULAR FONT, STYLE, SIZE, OR COLOR.

CLASS 9—ELECTRICAL AND SCIENTIFIC APPARATUS

FOR APPARATUS AND INSTRUMENTS FOR CONDUCTING, SWITCHING, TRANSFORMING, ACCUMULATING, REGULATING OR CONTROLLING ELECTRICITY, NAMELY, ROTARY JOINTS, SLIP RINGS AND ELECTRICAL CURRENT COLLECTORS AND PARTS THEREOF; DATA PROCESSING EQUIPMENT, NAMELY, ROTARY JOINTS, SLIP RINGS, ELECTRICAL CURRENT COLLECTORS AND PARTS THEREOF AND COMPUTERS; ELECTRONIC, OPTICAL AND ELECTRO OPTICAL APPARATUS, DEVICES AND COMPONENTS FOR PROCESSING AND TRANSFER OF DATA BETWEEN DEVICES MOVABLE AND PIVOTED AGAINST EACH OTHER, NAMELY, ROTARY JOINTS, SLIP RINGS AND ELECTRICAL CURRENT COLLECTORS AND PARTS THEREOF (U.S. CLS. 21, 23, 26, 36 AND 38).

FIRST USE 1-0-2007; IN COMMERCE 11-0-2007.

CLASS 42—SCIENTIFIC AND COMPUTER SERVICES

FOR SCIENTIFIC AND TECHNOLOGICAL SERVICES, NAMELY, PRODUCT RESEARCH AND DEVELOPMENT OF ROTARY JOINTS, SLIP RINGS AND COLLECTORS AND THEIR PARTS; SCIENTIFIC RESEARCH AND DESIGN IN THE FIELD OF ROTARY JOINTS, SLIP RINGS AND ELECTRICAL CURRENT COLLECTORS AND PARTS THEREOF; INDUSTRIAL RESEARCH IN THE FIELD OF ROTARY JOINTS, SLIP RINGS AND COLLECTORS AND PARTS THEREOF; DESIGN AND DEVELOPMENT OF COMPUTER HARDWARE AND SOFTWARE, NAMELY, ELECTRONIC, OPTICAL AND ELECTRO OPTICAL APPARATUS, DEVICES AND COMPONENTS FOR PROCESSING AND TRANSFER OF DATA BETWEEN DEVICES MOVABLE AND PIVOTED AGAINST EACH OTHER, NAMELY, ROTARY JOINTS, SLIP RINGS, ELECTRICAL CURRENT COLLECTORS AND PARTS THEREOF (U.S. CLS. 100 AND 101).

FIRST USE 1-0-2007; IN COMMERCE 11-0-2007.

3,680,088. HUNTERS ADVANTAGE, LLC, ATLANTA, GA. SN 76-657,147. PUB. 4-15-2008, FILED 3-23-2006.

The Hunt Doctors

THE MARK CONSISTS OF STANDARD CHARACTERS WITHOUT CLAIM TO ANY PARTICULAR FONT, STYLE, SIZE, OR COLOR.

CLASS 16—PAPER GOODS AND PRINTED MATTER

FOR SYNDICATED COLUMNS RELATING TO HEALTH AND SAFETY ISSUES IN THE FIELDS OF HUNTING, FIREARMS AND ARCHERY (U.S. CLS. 2, 5, 22, 23, 29, 37, 38 AND 50).
FIRST USE 12-1-2004; IN COMMERCE 11-1-2006.

CLASS 41—EDUCATION AND ENTERTAINMENT

FOR EDUCATIONAL SERVICES, NAMELY, EDUCATIONAL PROGRAMS, SEMINARS, WORKSHOPS AND CLASSES IN THE FIELD OF HEALTH AND SAFETY ISSUES RELATING TO HUNTING, FIREARMS AND ARCHERY, PUBLIC SERVICE ANNOUNCEMENTS AND PUBLIC SERVICE PROGRAMS IN THE FIELD OF AND SAFETY ISSUES RELATING TO HUNTING, FIREARMS AND ARCHERY PRODUCED AND DISTRIBUTED OVER TELEVISION, SATELLITE, FILM, AUDIO, VIDEO, INTERNET, AND 3-D VIRTUAL REALITY MEDIA (U.S. CLS. 100, 101 AND 107).
FIRST USE 12-1-2004; IN COMMERCE 11-1-2006.

WITHOUT CLAIM TO ANY PARTICULAR FONT, STYLE, SIZE, OR COLOR.

CLASS 36—INSURANCE AND FINANCIAL

FOR PROVIDING INFORMATION IN THE FIELD OF FINANCE VIA A GLOBAL COMPUTER NETWORK (U.S. CLS. 100, 101 AND 102).
FIRST USE 7-24-2008; IN COMMERCE 7-24-2008.

CLASS 41—EDUCATION AND ENTERTAINMENT

FOR EDUCATIONAL SERVICES, NAMELY, CONDUCTING CLASSES, SEMINARS, CONFERENCES AND WORKSHOPS IN THE FIELD OF FINANCE (U.S. CLS. 100, 101 AND 107).
FIRST USE 7-24-2008; IN COMMERCE 7-24-2008.

3,680,092. MCSPORT GROUP LIMITED, CHESTER CH1 2AU, ENGLAND, UNITED KINGDOM. SN 76-661,962. PUB. 2-26-2008, FILED 6-21-2006.



CLASS 25—CLOTHING

FOR GLOVES, NAMELY, CARRIAGE DRIVING GLOVES, CYCLING GLOVES, DRESSAGE GLOVES, EVENTING GLOVES IN THE NATURE OF RIDING GLOVES, MOTORCYCLING GLOVES, RACING GLOVES, RALLY DRIVING GLOVES (U.S. CLS. 22 AND 39).
FIRST USE 12-0-2007; IN COMMERCE 12-0-2007.

CLASS 28—TOYS AND SPORTING GOODS

FOR GLOVES, NAMELY, SHOOTING GLOVES, SQUASH GLOVES, EQUESTRIAN GLOVES, ARCHERY GLOVES, CANOEING GLOVES, CLIMBING GLOVES, FISHING GLOVES, PARAGLIDING GLOVES, POLO GLOVES, RUGBY GLOVES, SHOW JUMPING GLOVES, SURFING GLOVES, TENNIS GLOVES, WAKE BOARDING GLOVES, AND WATER SKIING GLOVES (U.S. CLS. 22, 23, 38 AND 50).
FIRST USE 12-0-2007; IN COMMERCE 12-0-2007.

3,680,106. MIKASA CORPORATION, HIROSHIMA NISHIKU, JAPAN. SN 76-679,436. PUB. 5-20-2008, FILED 7-12-2007.



CLASS 9—ELECTRICAL AND SCIENTIFIC APPARATUS

FOR PRESSURE GAUGES; SIGNAL WHISTLES (U.S. CLS. 21, 23, 26, 36 AND 38).
FIRST USE 10-0-2007; IN COMMERCE 10-0-2007.

CLASS 12—VEHICLES

FOR NON-MOTORIZED BALL CARTS USED TO TRANSPORT VOLLEYBALLS AND BASKETBALLS (U.S. CLS. 19, 21, 23, 31, 35 AND 44).
FIRST USE 10-0-2007; IN COMMERCE 10-0-2007.

CLASS 14—JEWELRY

FOR COMMEMORATIVE, REDUCED IN SIZE BASKETBALLS, VOLLEYBALLS, FOOTBALLS, SOCCER BALLS AND WATER POLO BALLS FEATURING GOLD COVER OF PRECIOUS METAL FOR AUTOGRAPH AND TROPHY USE (U.S. CLS. 2, 27, 28 AND 50).
FIRST USE 10-0-2003; IN COMMERCE 10-0-2003.

3,680,096. JULIE STAV, INC., BEVERLY HILLS, CA. SN 76-670,685. PUB. 7-3-2007, FILED 12-22-2006.

SHOWING MAIN STREET THE DOOR TO WALL STREET
THE MARK CONSISTS OF STANDARD CHARACTERS

CLASS 28—TOYS AND SPORTING GOODS

FOR SPORTS BALLS, NAMELY, VOLLEYBALLS BOTH INDOOR AND OUTDOOR BALLS, FOOTBALLS, BASKETBALLS, SOCCER BALLS, GAME BALLS, PLAYGROUND BALLS, KICKBALL, SOCCER/KICKBALL, RUGBY BALLS, TETHER BALLS; PLAYGROUND / FOUR SQUARE BALLS; SPORTS ACCESSORIES, NAMELY, VOLLEYBALL BAGS, NAMELY, HORIZONTAL BAGS FOR STORAGE OF VOLLEYBALLS, VERTICAL BAGS FOR STORAGE OF VOLLEYBALLS, AND FOOTBALL STORAGE BAGS, BASKETBALL STORAGE BAGS, SOCCER BALL BAGS, HORIZONTAL BAGS FOR STORAGE OF SOCCER BALLS, VERTICAL BAGS FOR STORAGE OF SOCCER BALLS AND NET BAGS FOR STORAGE OF SPORTS BALLS SUCH AS VOLLEYBALLS, BASKETBALLS, SOCCER BALLS, FOOTBALLS, AND WATER POLO BALLS, WATER POLO BAGS, NAMELY, HORIZONTAL BAGS FOR STORAGE OF WATER POLO BALLS, AND VERTICAL BAGS FOR STORAGE OF WATER POLO BALLS, VOLLEYBALL NETS, MINI BASKETBALLS, MINI VOLLEYBALLS, MINI FOOTBALLS, MINI WATER POLO BALLS, COMMEMORATIVE, REDUCED IN SIZE BASKETBALLS, VOLLEYBALLS, FOOTBALLS, SOCCER BALLS AND WATER POLO BALLS FEATURING GOLD COVERS NOT OF PRECIOUS METAL FOR AUTOGRAPH AND TROPHY USE; VOLLEYBALL LINESMEN'S FLAGS, VOLLEYBALL SETTING TRAINING BALLS; KNEE PADS FOR USE IN PLAYING VOLLEYBALL AND BASKETBALL; SPORTS BALL REPAIR KITS COMPRISED OF SPORTS VALVE TOOLS, SPORTS BALL VALVES OR PUNCTURE SEALANTS AND BALL PATCHES; HAND PUMPS FOR INFLATING SPORTS BALLS, NEEDLES BEING PARTS OF HAND PUMPS FOR INFLATING SPORTS BALLS; SOCCER LINE PERSON'S FLAGS; AND NON-MOTORIZED BALL CARTS USED TO STORE VOLLEYBALLS AND BASKETBALLS (U.S. CLS. 22, 23, 38 AND 50).
FIRST USE 10-0-2001; IN COMMERCE 10-0-2001.

CLASS 41—EDUCATION AND ENTERTAINMENT

FOR ONLINE SPORTS AND ENTERTAINMENT INFORMATION VIA GLOBAL COMPUTER COMMUNICATION NETWORKS, NAMELY, INFORMATION ABOUT VOLLEYBALL, FOOTBALL, BASKETBALL, SOCCER, WATER POLO, PLAYGROUND GAMES, KICKBALL, RUGBY, TETHER BALL AND THE BALLS AND THE EQUIPMENT FOR THESE SPORTS GAMES (U.S. CLS. 100, 101 AND 107).
FIRST USE 4-0-2006; IN COMMERCE 4-0-2006.

3,680,108. UPCOMING TM S.A., LUXEMBOURG, LUXEMBOURG, SN 76-679,627. PUB. 2-5-2008, FILED 7-18-2007.



TRADEMARK CONSISTS OF THE WORD "SIXTY", WHICH IS WRITTEN IN WHITE STYLIZED CAPITAL LETTERS AND ON A RECTANGULAR BLACK BACKGROUND WITH A STYLIZED EAGLE HEAD TO THE LEFT OF THE WORD "SIXTY" AND ALSO ENCLOSED IN THE RECTANGULAR BLACK BACKGROUND.

CLASS 18—LEATHER GOODS

FOR LEATHER AND IMITATION LEATHER SOLD IN BULK; LEATHER AND IMITATION LEATHER HANDBAGS; LEATHER AND IMITATION LEATHER GOODS, NAMELY, BAGS, BACKPACKS, WALLETS, SHOULDER STRAP BAGS, BRIEFCASES AND CASES; ANIMAL SKINS AND HIDES; LUGGAGE TRUNKS; SUITCASES; UMBRELLAS, PARASOLS AND WALKING STICKS; WHIPS AND SADDLERY (U.S. CLS. 1, 2, 3, 22 AND 41).
FIRST USE 9-0-2006; IN COMMERCE 3-12-2008.

CLASS 25—CLOTHING

FOR CLOTHING, NAMELY, BELTS, DRESS COATS, TROUSERS, SHORT TROUSERS, SCARVES, HALF COATS, MANTLES, JEANS, BLOUSES, JUMPERS, CARDIGANS, SHIRTS, SPORT SHIRTS, POLO SHIRTS, SUITS, SKIRTS, OVERCOATS, JACKETS, BLAZERS, SHORTS, SWEATERS, T-SHIRTS; SOCKS; SHOES, BOOTS, LACE BOOTS, HALF-BOOTS, SLIPPERS, AND SANDALS; FOOTWEAR; HEADWEAR, NAMELY, HATS, BASEBALL HATS, BALACLAVAS AND CAPS (U.S. CLS. 22 AND 39).
FIRST USE 9-0-2006; IN COMMERCE 3-12-2008.

3,680,116. DISNEY ENTERPRISES, INC., BURBANK, CA. SN 76-683,851. PUB. 4-29-2008, FILED 11-8-2007.

TAKE 180

THE MARK CONSISTS OF STANDARD CHARACTERS WITHOUT CLAIM TO ANY PARTICULAR FONT, STYLE, SIZE, OR COLOR.

CLASS 38—COMMUNICATION

FOR PROVIDING ON-LINE ELECTRONIC BULLETIN BOARDS, FORUMS AND DISCUSSION GROUPS FOR TRANSMISSION OF MESSAGES AMONG COMPUTER USERS THAT ARE EITHER A PART OF A SOCIAL NETWORK OF FRIENDS OR THE GENERAL PUBLIC, IN THE FIELD OF ENTERTAINMENT; ON-LINE BROADCASTING SERVICES, NAMELY, TRANSMISSION OF SOUND, VIDEO AND INFORMATION OVER THE INTERNET (U.S. CLS. 100, 101 AND 104).
FIRST USE 3-31-2009; IN COMMERCE 3-31-2009.

CLASS 41—EDUCATION AND ENTERTAINMENT

FOR ENTERTAINMENT SERVICES, NAMELY, PRODUCTION AND DISTRIBUTION OF MOTION PICTURE FILMS AND TELEVISION SHOWS, MULTIMEDIA INTERNET-BASED ENTERTAINMENT SERVICES IN THE NATURE OF PRODUCTION AND POST-PRODUCTION SERVICES IN THE FIELDS OF ON-LINE VIDEOS AND MOTION PICTURE FILMS AND TELEVISION SHOWS; ENTERTAINMENT SERVICES, NAMELY, PRODUCTION OF SPOKEN WORD, AND STAND UP COMEDY PERFORMANCES; ON-LINE JOURNALS, NAMELY, BLOGS IN THE FIELD OF ENTERTAINMENT (U.S. CLS. 100, 101 AND 107).
FIRST USE 3-31-2009; IN COMMERCE 3-31-2009.

CLASS 42—SCIENTIFIC AND COMPUTER SERVICES

FOR PROVIDING A WEBSITE FEATURING TEMPORARY USE OF NON-DOWNLOADABLE SOFTWARE ALLOWING WEBSITE USERS TO UPLOAD ONLINE VIDEOS FOR SHARING WITH OTHERS FOR ENTERTAINMENT PURPOSES; DISPLAYING THE WEB SITES AND IMAGES OF OTHERS ON A COMPUTER SERVER (U.S. CLS. 100 AND 101).

FIRST USE 3-31-2009; IN COMMERCE 3-31-2009.



3,680,127. ASC SIGNAL CORPORATION, CLEVELAND, OH. SN 76-688,954. PUB. 10-28-2008, FILED 4-24-2008.



THE MARK CONSISTS OF WAVED GEOMETRIC BAND IN THE NATURE OF A WAVE.

CLASS 9—ELECTRICAL AND SCIENTIFIC APPARATUS

FOR COMMUNICATIONS EQUIPMENT, NAMELY, SATELLITE RECEPTION EQUIPMENT, NAMELY, SATELLITE DISHES, AERIALS, RECEIVERS AND TRANSMITTERS; EARTH STATION ANTENNA EQUIPMENT FOR ONE-WAY AND TWO WAY TRANSMISSION, NAMELY, SATELLITE TRANSMITTERS AND RECEIVERS; RADAR, TACTICAL AND SURVEILLANCE EQUIPMENT FOR ONE-WAY AND TWO WAY TRANSMISSION, NAMELY, RADARS, MONITORS AND CAMERAS (U.S. CLS. 21, 23, 26, 36 AND 38).

FIRST USE 2-1-2008; IN COMMERCE 2-1-2008.

CLASS 37—CONSTRUCTION AND REPAIR

FOR SATELLITE DISH AND COMMUNICATIONS EQUIPMENT INSTALLATION SERVICES (U.S. CLS. 100, 103 AND 106).

FIRST USE 2-1-2008; IN COMMERCE 2-1-2008.

CLASS 38—COMMUNICATION

FOR SATELLITE COMMUNICATION SERVICES (U.S. CLS. 100, 101 AND 104).

FIRST USE 2-1-2008; IN COMMERCE 2-1-2008.

3,680,143. GLAMI CO., LTD., KANGWON-DO, REPUBLIC OF KOREA. SN 77-006,310. PUB. 4-1-2008, FILED 9-25-2006.



THE MARK CONSISTS OF THE SILHOUETTE OF A STYLIZED GRYPHON SURROUNDED BY TWO CONCENTRIC RINGS, THE INNER RING CONTAINING A SERIES OF ROUND DOTS.

CLASS 35—ADVERTISING AND BUSINESS

FOR WHOLESALE DISTRIBUTORSHIP IN THE FIELD OF ALCOHOLIC BEVERAGES, NON-ALCOHOLIC BEVERAGES, PHARMACEUTICALS AND DIETARY SUPPLEMENTS; RETAIL STORE SERVICES IN THE FIELD OF ALCOHOLIC BEVERAGES, NON-ALCOHOLIC BEVERAGES, PHARMACEUTICALS AND DIETARY SUPPLEMENTS; IMPORT AND EXPORT AGENCIES IN THE FIELD OF ALCOHOLIC BEVERAGES AND NON-ALCOHOLIC BEVERAGES; PRODUCING PROMOTIONAL MATERIALS FOR OTHERS IN THE NATURE OF PRINT AND STORE PROMOTIONS IN THE FIELD OF ALCOHOLIC BEVERAGES AND NON-ALCOHOLIC BEVERAGES; PACKAGING AND PRIVATE LABELING OF PRODUCTS FOR OTHERS IN THE ALCOHOLIC AND NON-ALCOHOLIC BEVERAGE INDUSTRY; BUSINESS MARKETING SERVICES FOR THE ALCOHOLIC AND NON-ALCOHOLIC BEVERAGE INDUSTRIES (U.S. CLS. 100, 101 AND 102).

FIRST USE 6-10-2009; IN COMMERCE 6-10-2009.

CLASS 40—MATERIAL TREATMENT

FOR MANUFACTURE OF GENERAL PRODUCT LINES IN THE ALCOHOLIC AND NON-ALCOHOLIC BEVERAGE INDUSTRY FOR PRIVATE LABELING AND MARKETING BY OTHERS (U.S. CLS. 100, 103 AND 106).

FIRST USE 6-10-2009; IN COMMERCE 6-10-2009.



3,680,149. PROMONTORY MARK, LLC, WASHINGTON, DC. SN 77-014,610. PUB. 10-23-2007, FILED 10-5-2006.

COMPLIANCE COMPASS

THE MARK CONSISTS OF STANDARD CHARACTERS WITHOUT CLAIM TO ANY PARTICULAR FONT, STYLE, SIZE, OR COLOR.

NO CLAIM IS MADE TO THE EXCLUSIVE RIGHT TO USE "COMPLIANCE", APART FROM THE MARK AS SHOWN.

CLASS 9—ELECTRICAL AND SCIENTIFIC APPARATUS

FOR COMPUTER DIAGNOSTIC SOFTWARE TOOL FOR USE BY FINANCIAL INSTITUTIONS IN MONITORING AND TRACKING REGULATORY COMPLIANCE AND IN ASSESSING COMPLIANCE-RELATED RISKS AND IN CREATING REPORTS RELATING THERETO (U.S. CLS. 21, 23, 26, 36 AND 38).
FIRST USE 9-20-2006; IN COMMERCE 9-20-2006.

CLASS 35—ADVERTISING AND BUSINESS

FOR BUSINESS CONSULTING SERVICES (U.S. CLS. 100, 101 AND 102).
FIRST USE 2-21-2007; IN COMMERCE 2-21-2007.

CLASS 42—SCIENTIFIC AND COMPUTER SERVICES

FOR PROVIDING ONLINE NON-DOWNLOADABLE SOFTWARE AND REGULATORY COMPLIANCE DIAGNOSTIC SOFTWARE TOOLS FOR USE BY FINANCIAL SERVICES INSTITUTIONS IN MONITORING AND TRACKING REGULATORY COMPLIANCE AND IN IDENTIFYING AND ASSESSING COMPLIANCE-RELATED RISKS AND REPORTS GENERATED THEREBY (U.S. CLS. 100 AND 101).
FIRST USE 8-0-2006; IN COMMERCE 8-0-2006.

CLASS 45—PERSONAL AND LEGAL SERVICES

FOR REGULATORY COMPLIANCE SERVICES, NAMELY, REVIEWING STANDARDS AND PRACTICES TO IDENTIFY AND ASSESS COMPLIANCE-RELATED RISKS WITH RESPECT TO FINANCIAL SERVICES INSTITUTIONS LAWS AND REGULATIONS (U.S. CLS. 100 AND 101).
FIRST USE 2-21-2007; IN COMMERCE 2-21-2007.

CLASS 35—ADVERTISING AND BUSINESS

FOR INFORMATION, ADVISORY AND CONSULTANCY SERVICES RELATING TO PRODUCT INFORMATION REGARDING BUILDING MATERIALS, CONCRETE, CEMENT AND CEMENTING PRODUCTS (U.S. CLS. 100, 101 AND 102).
FIRST USE 1-1-2007; IN COMMERCE 1-1-2007.

CLASS 37—CONSTRUCTION AND REPAIR

FOR INSTALLATION SERVICES, NAMELY, INSTALLATION OF AUTOMATED MONITORING SYSTEMS FOR USE IN MONITORING THE LEVELS OF BUILDING MATERIALS, CONCRETE, CEMENT, ASPHALT, PITCH, BITUMEN, AGGREGATES AND FUELS; INFORMATION, ADVISORY AND CONSULTANCY SERVICES, RELATING TO BUILDING CONSTRUCTION, AND THE USE OF BUILDING MATERIALS, CONCRETE, CEMENT AND CEMENTITIOUS PRODUCTS IN BUILDING CONSTRUCTION (U.S. CLS. 100, 103 AND 106).
FIRST USE 1-1-2007; IN COMMERCE 1-1-2007.

CLASS 39—TRANSPORTATION AND STORAGE

FOR TRANSPORTATION AND DELIVERY OF FINISHED AND UNFINISHED PRODUCTS BY ROAD, RAIL AND SEA; TRANSPORTATION FOR FINISHED AND UNFINISHED PRODUCTS IN AND OUT OF STORAGE VIA TRUCK AND RAIL; WAREHOUSING (U.S. CLS. 100 AND 105).
FIRST USE 1-1-2007; IN COMMERCE 1-1-2007.

CLASS 42—SCIENTIFIC AND COMPUTER SERVICES

FOR INSTALLATION, MAINTENANCE AND REPAIR OF COMPUTER SOFTWARE; TECHNOLOGICAL CONSULTING SERVICES RELATING TO BUILDING MATERIALS, CONCRETE, CEMENT AND CEMENTITIOUS PRODUCTS; ALL OF THE AFORESAID SERVICES BEING FOR USE IN RELATION TO THE MONITORING OF LEVELS OF BUILDING MATERIALS, CEMENT, ASPHALT, PITCH, BITUMEN, AGGREGATES AND FUELS (U.S. CLS. 100 AND 101).
FIRST USE 1-1-2007; IN COMMERCE 1-1-2007.

3,680,153. CEMEX UK OPERATIONS LIMITED, SURREY TW20 8TD, UNITED KINGDOM. SN 77-020,161. PUB. 10-14-2008, FILED 10-12-2006.

3,680,155. FUCHS, SVETLANA, LAS VEGAS, NV. SN 77-026,250. PUB. 6-26-2007, FILED 10-20-2006.



NO CLAIM IS MADE TO THE EXCLUSIVE RIGHT TO USE "SMART SILO", APART FROM THE MARK AS SHOWN.

THE MARK CONSISTS OF IMAGE OF A STORAGE TANK WITH EXCLAMATION MARK, AND WORDS "SMART SILO" BENEATH IMAGE.

THE NAME "LANA FUCHS" IDENTIFIES A LIVING INDIVIDUAL WHOSE CONSENT IS OF RECORD.

THE MARK CONSISTS OF ROYAL CROWN WITH JEWELS AND THE WORDING "LANA FUCHS" .

CLASS 14—JEWELRY

FOR BELT BUCKLES OF PRECIOUS METAL; PURSES AND WALLETS OF PRECIOUS METAL (U.S. CLS. 2, 27, 28 AND 50).

FIRST USE 3-0-2006; IN COMMERCE 3-0-2006.

CLASS 18—LEATHER GOODS

FOR BAGS AND HOLDALLS FOR SPORTS CLOTHING; BAGS FOR CARRYING BABIES' ACCESSORIES; CHANGE PURSES; CLOTHING FOR ANIMALS; CLOTHING FOR DOMESTIC PETS; CLUTCH PURSES; CLUTCHES; COIN PURSES; COIN PURSES NOT MADE OF PRECIOUS METAL; COIN PURSES, NOT OF PRECIOUS METALS; DOG CLOTHING; DOG SHOES; LEATHER FOR SHOES; LEATHER PURSES; MULTI-PURPOSE PURSES; PET CLOTHING; PET COLLAR ACCESSORIES, NAMELY, BOWS AND CHARMS; PURSES; SMALL CLUTCH PURSES; SMALL PURSES; WRIST MOUNTED PURSES (U.S. CLS. 1, 2, 3, 22 AND 41).

FIRST USE 3-0-2006; IN COMMERCE 3-0-2006.

CLASS 25—CLOTHING

FOR ATHLETIC SHOES; BALLET SHOES; BALLOON PANTS; BASEBALL SHOES; BEACH SHOES; BELTS; BERMUDA SHORTS; BOARD SHORTS; BOWLING SHOES; BOXER SHORTS; BOXING SHOES; CANVAS SHOES; CAPRI PANTS; CAPS; CARGO PANTS; CHILDREN'S AND INFANTS' CLOTH BIBS; CHILDREN'S CLOTH EATING BIBS; CLEATS FOR ATTACHMENT TO SPORTS SHOES; CLOTHING FOR WEAR IN JUDO PRACTICES; CLOTHING FOR WEAR IN WRESTLING GAMES; CLOTHING, NAMELY, ARM WARMERS; CLOTHING, NAMELY, FOLK COSTUMES; CLOTHING, NAMELY, KNEE WARMERS; CLOTHING, NAMELY, NECK TUBES; CLOTHING, NAMELY, WRAP-AROUNDS; CORSETS; DENIM JACKETS; DENIMS; DOWN JACKETS; DRESS SHIRTS; DRESS SUITS; DRESSES; DRESSING GOWNS; DUSTERS; EVENING DRESSES; FIGURE SKATING CLOTHING, NAMELY, CLOTHING, SHOES, AND WARDROBE AND HOME FURNISHING ACCESSORIES; FINISHED TEXTILE LININGS FOR GARMENTS; FLEECE SHORTS; FUR COATS AND JACKETS; FUR JACKETS; GIRDLES; GOLF SHIRTS; GYM SHORTS; HALTER TOPS; HEAVY JACKETS; HOODS; INFANT AND TODDLER ONE PIECE CLOTHING; INFANT CLOTH DIAPERS; INFANTS' SHOES AND BOOTS; INSOLES; JACKETS; JERSEYS; JOGGING PANTS; KNIT SHIRTS; LEATHER BELTS; LEATHER JACKETS; LEATHER PANTS; LEATHER SHOES; LIGHT-REFLECTING JACKETS; LONG JACKETS; MEN AND WOMEN JACKETS, COATS, TROUSERS, VESTS; MUSCLE TOPS; NIGHT SHIRTS; NON-DISPOSABLE CLOTH TRAINING PANTS; NURSE PANTS; ONE PIECE GARMENT FOR INFANTS AND TODDLERS; OPEN-NECKED SHIRTS; PANTIES, SHORTS AND BRIEFS; PANTS; PARTS OF CLOTHING, NAMELY, GUSSETS FOR TIGHTS, GUSSETS FOR STOCKINGS, GUSSETS FOR BATHING SUITS, GUSSETS FOR UNDERWEAR, GUSSETS FOR LEOTARDS AND GUSSETS FOR FOOTLETS; PETTI-PANTS; PIQUE SHIRTS; PLEATED SKIRTS FOR FORMAL KIMONOS (HAKAMA); POLO SHIRTS; RAIN JACKETS; RAINPROOF JACKETS; RUBBER SHOES; RUGBY SHOES; RUGBY SHORTS; RUGBY TOPS; RUNNING SHOES; SHIRTS; SHIRT FRONTS; SHIRT YOKES; SHIRTS; SHIRTS FOR SUITS; SHOES; SHORT OVERCOAT FOR KIMONO (HAORI); SHORT PETTICOATS; SHORT SETS; SHORT TROUSERS; SHORT-SLEEVED OR LONG-SLEEVED T-SHIRTS; SHORT-SLEEVED SHIRTS; SHORTS; SHOULDER WRAPS; SKI JACKETS; SKI PANTS; SKIRT SUITS; SKIRTS; SKIRTS AND DRESSES; SLEEP SHIRTS; SLEEPING GARMENTS; SLEEVED OR SLEEVELESS JACKETS; SLIDING SHORTS; SMOKING JACKETS; SNOW PANTS; SNOWBOARD PANTS; SOCCER SHOES; SPORT SHIRTS; SPORTS JACKETS; SPORTS SHIRTS;

SPORTS SHIRTS WITH SHORT SLEEVES; STUFF JACKETS; SUEDE JACKETS; SWADDLING CLOTHES; SWEAT PANTS; SWEAT SHORTS; TANK TOPS; TANK-TOPS; TAP PANTS; TAP SHOES; TENNIS SHOES; TIES; TOBOGGAN HATS, PANTS AND CAPS; TOP COATS; TOPS; TRACK PANTS; TRAINING SHOES; UNDER GARMENTS; UNDERARM CLOTHING SHIELDS; VOLLEYBALL SHOES; WALKING SHORTS; WATERPROOF JACKETS AND PANTS; WEDDING DRESSES; WIND RESISTANT JACKETS; WIND-JACKETS; WOMEN'S CEREMONIAL DRESSES; WOMEN'S SHOES; WORK SHOES AND BOOTS; WRAPS (U.S. CLS. 22 AND 39).

FIRST USE 3-0-2006; IN COMMERCE 3-0-2006.

CLASS 35—ADVERTISING AND BUSINESS

FOR CATALOG ORDERING SERVICE FEATURING CLOTHING, SHOES, AND WARDROBE AND HOME FURNISHING ACCESSORIES; DISCOUNT STORES IN THE FIELD OF CLOTHING, SHOES, AND WARDROBE AND HOME FURNISHING ACCESSORIES; DISTRIBUTORSHIPS IN THE FIELD OF CLOTHING, SHOES, AND WARDROBE AND HOME FURNISHING ACCESSORIES; MAIL ORDER CATALOG SERVICES FEATURING CLOTHING, SHOES, AND WARDROBE AND HOME FURNISHING ACCESSORIES; MAIL ORDER SERVICES FEATURING CLOTHING, SHOES, AND WARDROBE AND HOME FURNISHING ACCESSORIES; RETAIL CLOTHING BOUTIQUES; RETAIL CLOTHING STORES; RETAIL CONSIGNMENT STORES FEATURING CLOTHING, SHOES, AND WARDROBE AND HOME FURNISHING ACCESSORIES; RETAIL CONSIGNMENT STORES IN THE FIELD OF CLOTHING, SHOES, AND WARDROBE AND HOME FURNISHING ACCESSORIES; RETAIL DISCOUNT STORE SERVICES IN THE FIELD OF CLOTHING, SHOES, AND WARDROBE AND HOME FURNISHING ACCESSORIES; RETAIL STORES FEATURING CLOTHING, SHOES, AND WARDROBE AND HOME FURNISHING ACCESSORIES; RETAIL CLOTHING, SHOES, AND WARDROBE AND HOME FURNISHING ACCESSORIES STORES; SECOND HAND DEALERSHIPS FEATURING CLOTHING, SHOES, AND WARDROBE AND HOME FURNISHING ACCESSORIES; WHOLESALE DISTRIBUTORSHIPS FEATURING CLOTHING, SHOES, AND WARDROBE AND HOME FURNISHING ACCESSORIES; WHOLESALE STORES FEATURING CLOTHING, SHOES, AND WARDROBE AND HOME FURNISHING ACCESSORIES (U.S. CLS. 100, 101 AND 102).

FIRST USE 3-0-2006; IN COMMERCE 3-0-2006.

CLASS 42—SCIENTIFIC AND COMPUTER SERVICES

FOR DESIGN FOR OTHERS IN THE FIELD OF CLOTHING, SHOES, AND WARDROBE AND HOME FURNISHING ACCESSORIES; DRESS DESIGN (U.S. CLS. 100 AND 101).

FIRST USE 3-0-2006; IN COMMERCE 3-0-2006.

CLASS 45—PERSONAL AND LEGAL SERVICES

FOR CHARITABLE SERVICES, NAMELY, PROVIDING CLOTHING TO NEEDY PERSONS; INTERNET BASED SOCIAL NETWORKING, INTRODUCTION, AND DATING SERVICES; RENTAL OF CLOTHING; RENTAL OF DRESSES; RENTAL OF EVENING DRESSES; RENTAL OF PROTECTIVE CLOTHING AND EQUIPMENT (U.S. CLS. 100 AND 101).

FIRST USE 3-0-2006; IN COMMERCE 3-0-2006.

3,680,160. CITY OF HOPE, DUARTE, CA. SN 77-039,802. PUB. 5-13-2008, FILED 11-8-2006.



OWNER OF U.S. REG. NOS. 1,307,558, 2,357,568, AND OTHERS.

CLASS 36—INSURANCE AND FINANCIAL

FOR CHARITABLE FUNDRAISING SERVICES (U.S. CLS. 100, 101 AND 102).
FIRST USE 1-22-2007; IN COMMERCE 1-22-2007.

CLASS 42—SCIENTIFIC AND COMPUTER SERVICES

FOR MEDICAL RESEARCH SERVICES (U.S. CLS. 100 AND 101).
FIRST USE 1-22-2007; IN COMMERCE 1-22-2007.

CLASS 44—MEDICAL, BEAUTY AND AGRICULTURAL SERVICES

FOR HOSPITAL SERVICES (U.S. CLS. 100 AND 101).
FIRST USE 1-22-2007; IN COMMERCE 1-22-2007.

3,680,166. CHARLOTTE MOSS LLC, NEW YORK, NY. SN 77-047,513. PUB. 7-8-2008, FILED 11-20-2006.



CLASS 24—FABRICS

FOR LINENS FOR HOUSEHOLD AND COMMERCIAL INTERIORS (U.S. CLS. 42 AND 50).
FIRST USE 2-0-2009; IN COMMERCE 2-0-2009.

CLASS 35—ADVERTISING AND BUSINESS

FOR RETAIL STORES AND ONLINE RETAIL STORE SERVICES FEATURING VARIOUS GOODS FOR THE HOME AND OFFICE IN THE NATURE OF PERFUMES, SCENTED ROOM SPRAYS, CANDLES, FURNITURE, FABRICS, LINENS, WALLPAPER, FLATWARE AND CUTLERY, LAMP BASES AND LAMP SHADES, LAMP ACCESSORIES AND LAMP FITTINGS, PRINTED MATTER, NAMELY, BOOKS, MAGAZINES AND NEWSLETTERS REGARDING LIFESTYLES, HOUSEKEEPING, HOME CARE, HOME MAKING, COOKING, ENTERTAINMENT, CRAFTS, GARDENING, INTERIOR DECORATING, STATIONERY, GIFT-WRAPPING PAPER, GIFT CARDS, BAGS AND ACCESSORIES ALL SOLD EMPTY, NAMELY, DUFFEL BAGS, LUGGAGE, GARMENT BAGS, HANDBAGS, SHOULDER BAGS, TOTE BAGS, COSMETIC BAGS, POCKETBOOKS, TOILETRY CASES (U.S. CLS. 100, 101 AND 102).
FIRST USE 4-15-2007; IN COMMERCE 4-15-2007.

CLASS 42—SCIENTIFIC AND COMPUTER SERVICES

FOR INTERIOR DECORATING SERVICES, NAMELY, PROVIDING A WEBSITE FEATURING INFORMATION ON DESIGN, DECORATING AND FURNITURE DESIGN (U.S. CLS. 100 AND 101).
FIRST USE 4-15-2007; IN COMMERCE 4-15-2007.

CLASS 45—PERSONAL AND LEGAL SERVICES

FOR PROVIDING A WEBSITE FEATURING INFORMATION ON PERSONAL STYLE (U.S. CLS. 100 AND 101).
FIRST USE 4-15-2007; IN COMMERCE 4-15-2007.

3,680,167. ANDREA OBSTON MARKETING COMMUNICATIONS, LLC, BLOOMFIELD, CT. SN 77-047,917. PUB. 1-15-2008, FILED 11-20-2006.

B2E

THE MARK CONSISTS OF STANDARD CHARACTERS WITHOUT CLAIM TO ANY PARTICULAR FONT, STYLE, SIZE, OR COLOR.

CLASS 35—ADVERTISING AND BUSINESS

FOR ADVERTISING, MARKETING AND PUBLICITY SERVICES, NAMELY, STRATEGIC MARKETING AUDITS, BRAND DEVELOPMENT AND MARKETING, PUBLIC AND MEDIA RELATIONS, BUSINESS CONSULTATION RELATING TO CRISIS PLANNING AND MANAGEMENT, WEBSITES AND INTERNET ADVERTISING AND RELATIONS WITH MEDIA OUTLETS (U.S. CLS. 100, 101 AND 102).
FIRST USE 9-20-2006; IN COMMERCE 9-20-2006.

CLASS 41—EDUCATION AND ENTERTAINMENT

FOR EDUCATIONAL AND TRAINING SERVICES, NAMELY, WORKSHOPS AND SEMINARS ON ADVERTISING, MARKETING, PUBLICITY AND PUBLIC MEDIA RELATIONS (U.S. CLS. 100, 101 AND 107).
FIRST USE 9-20-2006; IN COMMERCE 9-20-2006.

3,680,172. WINSLOW, EVANS & CROCKER, INC., BOSTON, MA. SN 77-053,191. PUB. 4-8-2008, FILED 11-29-2006.

3,680,175. IRONKEY, INC., LOS ALTOS, CA. SN 77-057,143. PUB. 6-26-2007, FILED 12-5-2006.



THE MARK CONSISTS OF AN UPWARD TRENDING GRAPH LINE IN A RECTANGULAR BOX.

CLASS 35—ADVERTISING AND BUSINESS

FOR PREPARING PROPRIETARY FINANCIAL REPORTS FOR OTHERS (U.S. CLS. 100, 101 AND 102).
FIRST USE 10-1-2004; IN COMMERCE 12-9-2008.

CLASS 36—INSURANCE AND FINANCIAL

FOR FINANCIAL SERVICES, INVESTMENT SERVICES, NAMELY, ASSET ACQUISITION, CONSULTATION, DEVELOPMENT AND MANAGEMENT SERVICES (U.S. CLS. 100, 101 AND 102).
FIRST USE 10-1-2004; IN COMMERCE 12-9-2008.

3,680,174. FAROUK SYSTEMS, INC., HOUSTON, TX. SN 77-055,297. PUB. 4-3-2007, FILED 12-1-2006.

BIOSILK

THE MARK CONSISTS OF STANDARD CHARACTERS WITHOUT CLAIM TO ANY PARTICULAR FONT, STYLE, SIZE, OR COLOR.

OWNER OF U.S. REG. NOS. 1,835,109 AND 2,957,783.

CLASS 9—ELECTRICAL AND SCIENTIFIC APPARATUS

FOR ELECTRIC HAIR CURLING IRONS, ELECTRIC HAIR STYLING IRONS, ELECTRIC HAIR STRAIGHTENING IRONS, AND ELECTRIC HAIR FLAT IRONS (U.S. CLS. 21, 23, 26, 36 AND 38).
FIRST USE 12-22-2008; IN COMMERCE 12-22-2008.

CLASS 11—ENVIRONMENTAL CONTROL APPARATUS

FOR HAIR DRYERS (U.S. CLS. 13, 21, 23, 31 AND 34).
FIRST USE 12-22-2008; IN COMMERCE 12-22-2008.

CLASS 21—HOUSEWARES AND GLASS

FOR HAIR BRUSHES (U.S. CLS. 2, 13, 23, 29, 30, 33, 40 AND 50).
FIRST USE 12-22-2008; IN COMMERCE 12-22-2008.



CLASS 9—ELECTRICAL AND SCIENTIFIC APPARATUS

FOR COMPUTER HARDWARE; COMPUTER PERIPHERALS; COMPUTER SECURITY DEVICES CONNECTED VIA USB PORTS; USB HARDWARE; USB OPERATING SOFTWARE; COMPUTER SOFTWARE FOR USE IN DATA BACKUP, RECOVERY AND RESTORATION; COMPUTER SECURITY SOFTWARE FOR USE IN SECURING DATA, NETWORKS, COMPUTERS AND ONLINE TRANSACTIONS (U.S. CLS. 21, 23, 26, 36 AND 38).
FIRST USE 5-2-2007; IN COMMERCE 5-2-2007.

CLASS 38—COMMUNICATION

FOR PROVIDING ANONYMOUS TRANSMISSION OF INFORMATION OVER GLOBAL COMPUTER NETWORKS (U.S. CLS. 100, 101 AND 104).
FIRST USE 5-2-2007; IN COMMERCE 5-2-2007.

CLASS 42—SCIENTIFIC AND COMPUTER SERVICES

FOR COMPUTER HARDWARE AND SOFTWARE TECHNICAL SUPPORT SERVICES VIA EMAIL, INSTANT MESSAGING, CHAT, ONLINE COMMUNICATIONS AND TELEPHONE; PROVIDING ANTI-VIRUS, ANTI-SPYWARE, AND ANTI-PHISHING UPDATE SERVICES; COMPUTER DATA ENCRYPTION AND COMPUTER PROXY SERVICES FOR USE IN REMOVING IDENTIFYING INFORMATION FROM GLOBAL COMMUNICATION NETWORK TRANSACTIONS FOR OTHERS TO PROVIDE ANONYMITY AND PRIVACY (U.S. CLS. 100 AND 101).
FIRST USE 5-2-2007; IN COMMERCE 5-2-2007.

CLASS 45—PERSONAL AND LEGAL SERVICES

FOR AUTHENTICATION, ISSUANCE AND VALIDATION OF DIGITAL CERTIFICATES; IDENTIFICATION VERIFICATION SERVICES, NAMELY, PROVIDING AUTHENTICATION OF PERSONAL IDENTIFICATION INFORMATION; PROVIDING USER AUTHENTICATION SERVICES IN E-COMMERCE TRANSACTIONS (U.S. CLS. 100 AND 101).
FIRST USE 5-2-2007; IN COMMERCE 5-2-2007.

3,680,176. IRONKEY, INC., LOS ALTOS, CA. SN 77-057,150.
PUB. 6-26-2007, FILED 12-5-2006.

3,680,177. INTEGRYS ENERGY GROUP, INC., CHICAGO,
IL. SN 77-062,252. PUB. 4-29-2008, FILED 12-12-2006.



CLASS 9—ELECTRICAL AND SCIENTIFIC APPARATUS

FOR COMPUTER HARDWARE; COMPUTER PERIPHERALS; COMPUTER SECURITY DEVICES CONNECTED VIA USB PORTS; USB HARDWARE; USB OPERATING SOFTWARE; COMPUTER SOFTWARE FOR USE IN DATA BACKUP, RECOVERY AND RESTORATION; COMPUTER SECURITY SOFTWARE FOR USE IN SECURING DATA, NETWORKS, COMPUTERS AND ONLINE TRANSACTIONS (U.S. CLS. 21, 23, 26, 36 AND 38).
FIRST USE 5-2-2007; IN COMMERCE 5-2-2007.

CLASS 38—COMMUNICATION

FOR PROVIDING ANONYMOUS TRANSMISSION OF INFORMATION OVER GLOBAL COMPUTER NETWORKS (U.S. CLS. 100, 101 AND 104).
FIRST USE 5-2-2007; IN COMMERCE 5-2-2007.

CLASS 42—SCIENTIFIC AND COMPUTER SERVICES

FOR COMPUTER HARDWARE AND SOFTWARE TECHNICAL SUPPORT SERVICES VIA EMAIL, INSTANT MESSAGING, CHAT, ONLINE COMMUNICATIONS AND TELEPHONE; PROVIDING ANTI-VIRUS, ANTI-SPYWARE, AND ANTI-PHISHING UPDATE SERVICES; COMPUTER DATA ENCRYPTION AND COMPUTER PROXY SERVICES FOR USE IN REMOVING IDENTIFYING INFORMATION FROM GLOBAL COMMUNICATION NETWORK TRANSACTIONS FOR OTHERS TO PROVIDE ANONYMITY AND PRIVACY (U.S. CLS. 100 AND 101).
FIRST USE 5-2-2007; IN COMMERCE 5-2-2007.

CLASS 45—PERSONAL AND LEGAL SERVICES

FOR AUTHENTICATION, ISSUANCE AND VALIDATION OF DIGITAL CERTIFICATES; IDENTIFICATION VERIFICATION SERVICES, NAMELY, PROVIDING AUTHENTICATION OF PERSONAL IDENTIFICATION INFORMATION; PROVIDING USER AUTHENTICATION SERVICES IN E-COMMERCE TRANSACTIONS (U.S. CLS. 100 AND 101).
FIRST USE 5-2-2007; IN COMMERCE 5-2-2007.



THE COLOR(S) GRAY AND ORANGE IS/ARE CLAIMED AS A FEATURE OF THE MARK.

THE MARK CONSISTS OF THE WORD "INTEGRYS" SHOWN IN GRAY LETTERING, WITH THREE ORANGE ARROWS OVER THE LETTER "T" IN THE WORD "INTEGRYS".

CLASS 35—ADVERTISING AND BUSINESS

FOR BUSINESS MANAGEMENT SERVICES FOR OTHERS IN THE ENERGY INDUSTRY, NAMELY, BUSINESS MANAGEMENT AND BUSINESS OPERATION; ARRANGING OF CONTRACTUAL SERVICES WITH THIRD PARTIES AND PROVIDING BUSINESS ACQUISITION CONSULTATION IN THE ENERGY INDUSTRY; PROVIDING BUSINESS MARKETING CONSULTATION SERVICES FOR THE ENERGY AND ENERGY FUEL SUPPLY INDUSTRIES; OPERATION OF A BUSINESS FOR OTHERS, NAMELY, PUBLIC UTILITIES AND NON-UTILITY BUSINESSES WHICH BROKER, MARKET, MANAGE AND MONITOR USE OF POWER; OPERATION OF A BUSINESS FOR OTHERS, NAMELY, PUBLIC UTILITIES AND NON-UTILITY BUSINESSES WHICH BROKER, MARKET AND MONITOR USE OF POWER; NEGOTIATION AND SETTLEMENT OF COMMERCIAL TRANSACTIONS FOR THIRD PARTIES IN THE ENERGY SECTOR (U.S. CLS. 100, 101 AND 102).
FIRST USE 12-31-2007; IN COMMERCE 12-31-2007.

CLASS 36—INSURANCE AND FINANCIAL

FOR FACILITATING AND ARRANGING FINANCING FOR INFRASTRUCTURE IN THE ENERGY INDUSTRY; COMMODITY TRADING FOR OTHERS IN THE FIELD OF ENERGY SUPPLY (U.S. CLS. 100, 101 AND 102).
FIRST USE 3-31-2009; IN COMMERCE 3-31-2009.

CLASS 37—CONSTRUCTION AND REPAIR

FOR DEVELOPMENT, MANAGEMENT AND CONSTRUCTION PLANNING FOR OTHERS IN THE ENERGY INDUSTRY OF THE CONSTRUCTION OF GENERATION, PRODUCTION, DISTRIBUTION, TRANSMISSION AND STORAGE FACILITIES (U.S. CLS. 100, 103 AND 106).
FIRST USE 7-13-2009; IN COMMERCE 7-13-2009.

CLASS 39—TRANSPORTATION AND STORAGE

FOR CONSULTATION SERVICES IN THE FIELD OF DISTRIBUTION, TRANSMISSION AND STORAGE OF ENERGY (U.S. CLS. 100 AND 105).
FIRST USE 7-13-2009; IN COMMERCE 7-13-2009.

CLASS 40—MATERIAL TREATMENT

FOR CONSULTATION SERVICES IN THE FIELD OF GENERATION AND PRODUCTION OF ENERGY (U.S. CLS. 100, 103 AND 106).
FIRST USE 7-13-2009; IN COMMERCE 7-13-2009.

3,680,178. NATURE BABY LIMITED, WEST LYNN, AUCKLAND, NEW ZEALAND. SN 77-062,388. PUB. 9-30-2008, FILED 12-12-2006.

3,680,180. UNIVERSAL SYNDICATIONS, INC., CANTON, OH. SN 77-067,767. PUB. 3-3-2009, FILED 12-19-2006.



NO CLAIM IS MADE TO THE EXCLUSIVE RIGHT TO USE "BABY", APART FROM THE MARK AS SHOWN.

THE MARK CONSISTS OF SIDE VIEW OF A BABY WITH A FLOWER ON ITS HEAD SEATED NEXT TO THE WORDS "NATURE BABY".

CLASS 20—FURNITURE AND ARTICLES NOT OTHERWISE CLASSIFIED

FOR SLEEPING SACKS, NAMELY, SLEEPING BAGS; MATTRESSES; FITTED FABRIC FURNITURE COVERS (U.S. CLS. 2, 13, 22, 25, 32 AND 50).

FIRST USE 11-0-1998; IN COMMERCE 7-0-2002.

CLASS 24—FABRICS

FOR TEXTILES AND TEXTILE GOODS, NAMELY, BED AND TABLE COVERS, NAMELY, BLANKETS, RECEIVING BLANKETS, SWADDLING BLANKETS, COT BLANKETS, DUVETS, DUVET COVERS, SHEETS AND BEDDING FOR USE ON CRADLES, CRIBS, COTS AND BEDS, LINEN, TOWELS, HOODED TOWELS, FACE TOWELS, TEA TOWELS, CLOTH BADGES, TRAVELING RUGS, PILLOW SHAMS AND PILLOW CASES, MATTRESS COVERS, UNFITTED FABRIC FURNITURE COVERINGS, CURTAINS OF TEXTILE OR PLASTIC, CUSHION COVERS, BED LINEN, TABLE LINEN (U.S. CLS. 42 AND 50).

FIRST USE 11-0-1998; IN COMMERCE 7-0-2002.

CLASS 25—CLOTHING

FOR CLOTHING, NAMELY, BODYSUITS, LEGLESS BODYSUITS, ROMPER SUITS, KIMONOS, TOPS, BOTTOMS, JERSEYS, OUTERWEAR, CARDIGANS, PANTS, T-SHIRTS, SLEEPWEAR, UNDERWEAR AND SWIMWEAR, MITTENS AND GLOVES, HEADWEAR, FOOTWEAR; HEADWEAR AND FOOTWEAR TO BE WORN BY YOUNG CHILDREN AND BABIES; LAYETTES; TEXTILE DIAPERS IN THE NATURE OF NAPPIES, AND TEXTILE LINERS AND COVERS THEREFOR; AND BABY BIBS NOT OF PAPER (U.S. CLS. 22 AND 39).

FIRST USE 11-0-1998; IN COMMERCE 7-0-2002.



NO CLAIM IS MADE TO THE EXCLUSIVE RIGHT TO USE "MONETARY EXCHANGE" AND "1776", APART FROM THE MARK AS SHOWN.

THE MARK CONSISTS OF CIRCLE WITH EAGLE ABOVE A SHIELD HAVING STARS AND STRIPES ON THE FRONT OF THE SHIELD IN THE CENTER OF THE CIRCLE WITH BANNER ACROSS THE TOP OF THE CIRCLE MOVING BEHIND THE EAGLE.

THE FOREIGN WORDING IN THE MARK TRANSLATES INTO ENGLISH AS ONE OUT OF MANY.

CLASS 14—JEWELRY

FOR COLLECTIBLE COINS, COMMEMORATIVE COINS, NON-MONETARY COINS, ANTIQUE MONETARY COINS FOR COLLECTING PURPOSES, ANTIQUE NON-MONETARY COINS, AND ANTIQUE COLLECTIBLE COINS, ANTIQUE MONETARY COINS FOR COLLECTING PURPOSES; COLLECTIBLE CURRENCY, NAMELY, NON-MONETARY COINS (U.S. CLS. 2, 27, 28 AND 50).

FIRST USE 12-4-2006; IN COMMERCE 12-4-2006.

CLASS 16—PAPER GOODS AND PRINTED MATTER

FOR COLLECTIBLE PAPER MONEY (U.S. CLS. 2, 5, 22, 23, 29, 37, 38 AND 50).

FIRST USE 12-4-2006; IN COMMERCE 12-4-2006.

CLASS 35—ADVERTISING AND BUSINESS

FOR RETAIL SERVICES, NAMELY, MAIL ORDER SERVICES AND TELEPHONE ORDER SERVICES FEATURING COLLECTIBLE COINS, NUMISMATIC COINS, NON-MONETARY COINS, CURRENCY, PAPER MONEY, COIN SUPPLIES IN THE FORM OF COIN ALBUMS, COIN HOLDERS, COIN MATS, COIN WRAPPERS, AND NUMISMATIC MATERIALS IN THE FORM OF COIN ALBUMS, COIN HOLDERS, COIN MATS, COIN WRAPPERS, COIN PURSES (U.S. CLS. 100, 101 AND 102).

FIRST USE 12-4-2006; IN COMMERCE 12-4-2006.

3,680,190. MCDONOUGH BRAUNGART DESIGN CHEMISTRY, LLC, CHARLOTTESVILLE, VA. SN 77-085,009. PUB. 11-27-2007, FILED 1-17-2007.

CRADLE TO CRADLE

THE MARK CONSISTS OF STANDARD CHARACTERS WITHOUT CLAIM TO ANY PARTICULAR FONT, STYLE, SIZE, OR COLOR.

CLASS 35—ADVERTISING AND BUSINESS

FOR BUSINESS CONSULTING SERVICES IN THE FIELD OF DESIGNING AND MANUFACTURING ENVIRONMENTALLY FRIENDLY AND SUSTAINABLE MATERIALS, PRODUCTS AND BUILDINGS (U.S. CLS. 100, 101 AND 102).
FIRST USE 1-21-2002; IN COMMERCE 1-21-2002.

CLASS 41—EDUCATION AND ENTERTAINMENT

FOR EDUCATIONAL SERVICES, NAMELY, CONDUCTING SPEECHES AND PROGRAMS IN THE FIELD OF DESIGNING AND MANUFACTURING ENVIRONMENTALLY FRIENDLY AND SUSTAINABLE MATERIALS, PRODUCTS AND BUILDINGS (U.S. CLS. 100, 101 AND 107).
FIRST USE 1-21-2002; IN COMMERCE 1-21-2002.

CLASS 42—SCIENTIFIC AND COMPUTER SERVICES

FOR ARCHITECTURAL AND ENGINEERING CONSULTING SERVICES IN THE FIELD OF SUSTAINABLE BUILDING DESIGN (U.S. CLS. 100 AND 101).
FIRST USE 1-21-2002; IN COMMERCE 1-21-2002.

3,680,191. MCDONOUGH BRAUNGART DESIGN CHEMISTRY, LLC, CHARLOTTESVILLE, VA. SN 77-085,030. PUB. 11-27-2007, FILED 1-17-2007.



THE MARK CONSISTS OF AN ARBITRARY DESIGN AND THE WORDS "CRADLE TO CRADLE".

CLASS 35—ADVERTISING AND BUSINESS

FOR BUSINESS CONSULTING SERVICES IN THE FIELD OF DESIGNING AND MANUFACTURING ENVIRONMENTALLY FRIENDLY AND SUSTAINABLE MATERIALS, PRODUCTS AND BUILDINGS (U.S. CLS. 100, 101 AND 102).
FIRST USE 8-10-2007; IN COMMERCE 10-5-2007.

CLASS 41—EDUCATION AND ENTERTAINMENT

FOR EDUCATIONAL SERVICES, NAMELY, CONDUCTING SPEECHES AND PROGRAMS IN THE FIELD OF DESIGNING AND MANUFACTURING ENVIRONMENTALLY FRIENDLY AND SUSTAINABLE MATERIALS, PRODUCTS AND BUILDINGS (U.S. CLS. 100, 101 AND 107).
FIRST USE 8-10-2007; IN COMMERCE 10-5-2007.

CLASS 42—SCIENTIFIC AND COMPUTER SERVICES

FOR ARCHITECTURAL AND ENGINEERING CONSULTING SERVICES IN THE FIELD OF SUSTAINABLE BUILDING DESIGN (U.S. CLS. 100 AND 101).
FIRST USE 8-10-2007; IN COMMERCE 10-5-2007.

3,680,192. GRAND SIERRA OPERATING CORP., RENO, NV. SN 77-090,704. PUB. 12-25-2007, FILED 1-25-2007.

THE SUMMIT AT GRAND SIERRA

THE MARK CONSISTS OF STANDARD CHARACTERS WITHOUT CLAIM TO ANY PARTICULAR FONT, STYLE, SIZE, OR COLOR.

CLASS 36—INSURANCE AND FINANCIAL

FOR REAL ESTATE SERVICES, NAMELY, RENTAL, SALE AND MANAGEMENT OF CONDOMINIUMS (U.S. CLS. 100, 101 AND 102).
FIRST USE 6-23-2006; IN COMMERCE 6-23-2006.

CLASS 43—HOTEL AND RESTAURANT SERVICES

FOR HOTEL, RESORT, BAR AND RESTAURANT SERVICES; PROVIDING CONVENTION FACILITIES; HEALTH SPA SERVICES (U.S. CLS. 100 AND 101).
FIRST USE 6-23-2006; IN COMMERCE 6-23-2006.

3,680,197. AFR APPAREL INTERNATIONAL, INC., NORTH RIDGE, CA. SN 77-095,013. PUB. 8-12-2008, FILED 1-30-2007.

THE NAME(S), PORTRAIT(S), AND/OR SIGNATURE(S) SHOWN IN THE MARK IDENTIFIES A LIVING PERSON, WHOSE CONSENT(S) TO REGISTER IS MADE OF RECORD.

CLASS 18—LEATHER GOODS

FOR HANDBAGS; WALLETS (U.S. CLS. 1, 2, 3, 22 AND 41).
FIRST USE 1-1-2007; IN COMMERCE 1-1-2007.

CLASS 25—CLOTHING

FOR BELTS; BELTS MADE OF LEATHER; BELTS OF TEXTILE (U.S. CLS. 22 AND 39).
FIRST USE 9-4-2007; IN COMMERCE 9-4-2007.

3,680,199. KNAUST, CHRISTIAN, NEW YORK, NY. SN 77-096,763. PUB. 9-23-2008, FILED 2-1-2007.

3,680,198. KAIROS INSTITUTE OF SOUND HEALING, LLC, LLANO DE SAN JUAN, NM. SN 77-096,168. PUB. 9-9-2008, FILED 1-31-2007.



THE MARK CONSISTS OF A CIRCLE WITH A BORDER AND AN IMAGE OF A HALF MAN HALF SCORPION IN THE CENTER. INSIDE THE BORDER IS THE LITERAL ELEMENT "BLACK" ON THE LEFT SIDE OF THE CIRCLE, THE LITERAL ELEMENT "SCORPION" ON THE RIGHT SIDE OF THE CIRCLE, AND A DESIGN ELEMENT CONSISTING OF INTERSECTING LINES AT THE TOP OF THE CIRCLE.

ACUTONICS OHM

THE MARK CONSISTS OF STANDARD CHARACTERS WITHOUT CLAIM TO ANY PARTICULAR FONT, STYLE, SIZE, OR COLOR.

OWNER OF U.S. REG. NOS. 2,473,241 AND 2,550,297.

NO CLAIM IS MADE TO THE EXCLUSIVE RIGHT TO USE "OHM", APART FROM THE MARK AS SHOWN.

CLASS 10—MEDICAL APPARATUS

FOR INSTRUMENTS AND EQUIPMENT FOR USE IN CONNECTION WITH A SOUND HEALING SYSTEM, NAMELY, OHM TUNING FORKS (U.S. CLS. 26, 39 AND 44).

FIRST USE 1-1-2001; IN COMMERCE 1-1-2001.

CLASS 41—EDUCATION AND ENTERTAINMENT

FOR EDUCATIONAL SERVICES, NAMELY, PROVIDING CLASSES, SEMINARS, WORKSHOPS, EDUCATIONAL PROGRAMS, AND CONFERENCES IN THE FIELD OF A SOUND HEALING SYSTEM FEATURING OHM TUNING FORKS (U.S. CLS. 100, 101 AND 107).

FIRST USE 1-1-2008; IN COMMERCE 1-1-2008.

CLASS 44—MEDICAL, BEAUTY AND AGRICULTURAL SERVICES

FOR HEALTH CARE SERVICES, NAMELY, PROVIDING TREATMENT USING A SOUND HEALING SYSTEM FEATURING OHM TUNING FORKS (U.S. CLS. 100 AND 101).

FIRST USE 1-1-2008; IN COMMERCE 1-1-2008.

CLASS 9—ELECTRICAL AND SCIENTIFIC APPARATUS

FOR MOTION PICTURE FILMS IN THE NATURE OF ADULT FILMS; PRERECORDED DIGITAL MATERIALS, NAMELY, DVDS, LASER DISCS AND VIDEO TAPES, FEATURING ADULT FILMS (U.S. CLS. 21, 23, 26, 36 AND 38).

FIRST USE 11-0-2006; IN COMMERCE 11-0-2006.

CLASS 41—EDUCATION AND ENTERTAINMENT

FOR MOTION PICTURE FILM PRODUCTION SERVICES (U.S. CLS. 100, 101 AND 107).

FIRST USE 6-0-2007; IN COMMERCE 6-0-2007.

3,680,202. DEUTZ AKTIENGESELLSCHAFT, KOELN, FED REP GERMANY. SN 77-117,493. PUB. 1-22-2008, FILED 2-27-2007.

DEUTZ FIRE PROTECTION

THE MARK CONSISTS OF STANDARD CHARACTERS WITHOUT CLAIM TO ANY PARTICULAR FONT, STYLE, SIZE, OR COLOR.

OWNER OF U.S. REG. NOS. 1,029,906 AND 3,005,603.

NO CLAIM IS MADE TO THE EXCLUSIVE RIGHT TO USE "FIRE PROTECTION", APART FROM THE MARK AS SHOWN.

CLASS 7—MACHINERY

FOR FIXED INTERNAL COMBUSTION ENGINES FOR POWER GENERATION, MACHINE OPERATION, EXCEPT FOR LAND VEHICLES, NAMELY, DIESEL ENGINES AND REPLACEMENT PARTS THEREFORE; ASSEMBLIES, NAMELY, POWER GENERATION ASSEMBLIES (U.S. CLS. 13, 19, 21, 23, 31, 34 AND 35).

FIRST USE 6-15-2007; IN COMMERCE 6-15-2007.

CLASS 9—ELECTRICAL AND SCIENTIFIC APPARATUS

FOR ELECTRONIC CONTROL PANEL CONTAINING CONTROL SYSTEM FOR STARTING AND STOPPING AN ENGINE (U.S. CLS. 21, 23, 26, 36 AND 38).

FIRST USE 6-15-2007; IN COMMERCE 6-15-2007.

CLASS 12—VEHICLES

FOR PARTS OF LAND VEHICLES, NAMELY, INTERNAL COMBUSTION ENGINES, NAMELY, DIESEL ENGINES AND GAS ENGINES (U.S. CLS. 19, 21, 23, 31, 35 AND 44).

FIRST USE 6-15-2007; IN COMMERCE 6-15-2007.

3,680,203. ON TECHNOLOGIES, INC., ST. GEORGE, UT. SN 77-118,137. PUB. 3-4-2008, FILED 2-28-2007.



The logo for ForteGolf features the word "ForteGolf" in a bold, sans-serif font. The letter "o" in "Forte" is replaced by a stylized golf ball with a tee in the center. The letter "o" in "Golf" is replaced by a stylized golf club head.

THE MARK CONSISTS OF A STYLIZED LETTER "O" WITH A GOLF TEE IN THE CENTER OF THE LETTER. THE MARK IS NOT IN COLOR. GRAY IS NOT CONSIDERED A COLOR OR FEATURE OF THE MARK.

CLASS 41—EDUCATION AND ENTERTAINMENT

FOR PROVIDING A WEBSITE THROUGH WHICH GOLFERS RESERVE TEE TIMES AT GOLF COURSES (U.S. CLS. 100, 101 AND 107).

FIRST USE 1-18-2008; IN COMMERCE 4-3-2008.

CLASS 42—SCIENTIFIC AND COMPUTER SERVICES

FOR PROVIDING TEMPORARY USE OF ON-LINE, NON-DOWNLOADABLE SOFTWARE FOR ON-SITE AND WEB-BASED GOLF RESERVATIONS; PROVIDING TEMPORARY USE OF ON-LINE, NON-DOWNLOADABLE SOFTWARE FOR DATABASE MANAGEMENT SOFTWARE USED TO TARGET POTENTIAL CUSTOMERS, AND NON-DOWNLOADABLE SOFTWARE USED TO GENERATE AND SEND MASS ADVERTISING EMAILS FOR MARKETING AND MANAGEMENT OF TEE SHEET; PROVIDING TEMPORARY USE OF ON-LINE, NON-DOWNLOADABLE DATABASE MANAGEMENT SOFTWARE FOR USE IN MANAGING TEE TIME INVENTORY, DATA ANALYSIS AND REPORTING IN THE GOLF AND HOSPITALITY INDUSTRIES (U.S. CLS. 100 AND 101).

FIRST USE 1-18-2008; IN COMMERCE 4-3-2008.

3,680,210. ANDREW BAGG, LOS ANGELES, CA. SN 77-128,972. PUB. 9-23-2008, FILED 3-12-2007.

DJ COBRA

THE MARK CONSISTS OF STANDARD CHARACTERS WITHOUT CLAIM TO ANY PARTICULAR FONT, STYLE, SIZE, OR COLOR.

NO CLAIM IS MADE TO THE EXCLUSIVE RIGHT TO USE "DJ", APART FROM THE MARK AS SHOWN.

CLASS 9—ELECTRICAL AND SCIENTIFIC APPARATUS

FOR PRE-RECORDED CDS FEATURING MUSIC AND MUSICAL PERFORMANCES; DOWNLOADABLE MUSICAL SOUND RECORDINGS FEATURING MUSIC AND MUSICAL PERFORMANCES AND INFORMATION ABOUT A MUSICAL GROUP (U.S. CLS. 21, 23, 26, 36 AND 38).

FIRST USE 1-1-2005; IN COMMERCE 1-1-2006.

CLASS 41—EDUCATION AND ENTERTAINMENT

FOR ENTERTAINMENT IN THE NATURE OF LIVE PERFORMANCES BY A DISC JOCKEY, MUSICAL BAND, VOCALIST, INDIVIDUAL, OR MUSICAL GROUP; ENTERTAINMENT IN THE NATURE OF ONGOING TELEVISION PROGRAMS IN THE FIELD OF COMEDY, REALITY, MUSIC, LIFESTYLE, FASHION, TECHNOLOGY, OR CULTURE (U.S. CLS. 100, 101 AND 107).

FIRST USE 1-1-1997; IN COMMERCE 1-1-2000.

3,680,213. JIM BEAM BRANDS CO., DEERFIELD, IL. SN 77-132,978. PUB. 1-22-2008, FILED 3-16-2007.

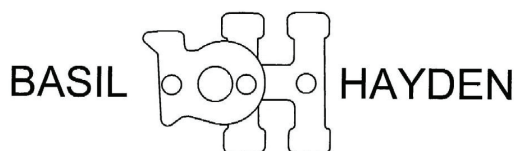

The logo for Basil Hayden features the words "BASIL" and "HAYDEN" in a bold, sans-serif font. Between the two words is a stylized graphic of a bottle cap or a similar shape with three circular elements.

"BASIL HAYDEN" DOES NOT IDENTIFY A LIVING INDIVIDUAL.

THE MARK CONSISTS OF THE LETTERS "BH" OVERLAPPING EACH OTHER. THE FAR RIGHT OF THE B SITS ON TOP OF THE VERTICAL SIDE OF THE LEFT PART OF THE "H"; A CIRCLE SITS IN CENTER ON THE "B" WHERE THE "B" AND "H" OVERLAP; ANOTHER CIRCLE SITS CENTER ON THE RIGHT VERTICAL PART OF THE "H", AND ANOTHER CIRCLE SITS CENTER ON THE LEFT VERTICAL PART OF THE "B". THE WORD "BASIL" IS SITUATED LEFT OF THE "BH", AND THE WORD "HAYDEN" IS SITUATED RIGHT OF THE "BH".

CLASS 6—METAL GOODS

FOR METAL KEY CHAINS; METAL HOOKS THAT REST ON TABLES OR BARS FOR HANGING BAGS AND PURSES (U.S. CLS. 2, 12, 13, 14, 23, 25 AND 50).

FIRST USE 12-0-2007; IN COMMERCE 12-0-2007.

CLASS 16—PAPER GOODS AND PRINTED MATTER

FOR COASTERS MADE OF PAPER; ENVELOPES; PAPER GIFT BAGS; PAPER NAPKINS; PRINTED TICKETS (U.S. CLS. 2, 5, 22, 23, 29, 37, 38 AND 50).
FIRST USE 12-0-2007; IN COMMERCE 12-0-2007.

CLASS 21—HOUSEWARES AND GLASS

FOR BOTTLE OPENERS; COCKTAIL SHAKERS; DRINKING GLASSES; GLASS BEVERAGEWARE; ICE BUCKETS; NAPKIN HOLDERS; NAPKIN RINGS; PLASTIC COASTERS; SALT AND PEPPER SHAKERS; SERVING TRAYS; SHOT GLASSES; SWIZZLE STICKS; WINE BOTTLE CRADLES (U.S. CLS. 2, 13, 23, 29, 30, 33, 40 AND 50).
FIRST USE 12-0-2007; IN COMMERCE 12-0-2007.

3,680,215. STALLEX SKIN CARE, INC., TENAFLY, NJ. SN 77-134,509. PUB. 10-9-2007, FILED 3-19-2007.

DR. NEAL SCHULTZ PARK AVENUE SKIN CARE

THE MARK CONSISTS OF STANDARD CHARACTERS WITHOUT CLAIM TO ANY PARTICULAR FONT, STYLE, SIZE, OR COLOR.

NO CLAIM IS MADE TO THE EXCLUSIVE RIGHT TO USE "SKIN CARE", APART FROM THE MARK AS SHOWN.

THE NAME "DR. NEAL SCHULTZ" IDENTIFIES A LIVING INDIVIDUAL WHOSE CONSENT IS OF RECORD.

CLASS 3—COSMETICS AND CLEANING PREPARATIONS

FOR SKIN CARE PRODUCTS, NAMELY, CLEANSER AND MOISTURIZER; EYE CREAM; AGE SPOT AND PIGMENT SKIN LIGHTENERS; SKIN EXFOLIATING CREAM; SKIN TONERS, TOPICAL SKIN CREAMS CONTAINING ANTIOXIDANTS, ESSENTIAL OILS AND/OR HERBAL EXTRACTS; HAIR CARE PRODUCTS, NAMELY, SHAMPOO (U.S. CLS. 1, 4, 6, 50, 51 AND 52).
FIRST USE 5-4-2007; IN COMMERCE 5-4-2007.

CLASS 5—PHARMACEUTICALS

FOR MEDICINAL CREAMS FOR SKIN CARE, NAMELY, LOTIONS CONTAINING ANTIOXIDANTS, ESSENTIAL OILS, HERBAL EXTRACTS, AND/OR VITAMIN PREPARATIONS (U.S. CLS. 6, 18, 44, 46, 51 AND 52).
FIRST USE 5-4-2007; IN COMMERCE 5-4-2007.

3,680,218. PARACHA, ABDUL WAHEED, STATEN ISLAND, NY. SN 77-137,220. PUB. 9-18-2007, FILED 3-21-2007.

Sundelight

THE MARK CONSISTS OF STANDARD CHARACTERS WITHOUT CLAIM TO ANY PARTICULAR FONT, STYLE, SIZE, OR COLOR.

CLASS 30—STAPLE FOODS

FOR RICE; NOODLES; FLOUR; CHUTNEY; CRACKERS; BISCUITS; HONEY; SPICES; TEA; SAUCES (U.S. CL. 46).
FIRST USE 2-5-2007; IN COMMERCE 8-28-2007.

CLASS 31—NATURAL AGRICULTURAL PRODUCTS

FOR FRESH DATES; UNPROCESSED DATES; UNPROCESSED RICE (U.S. CLS. 1 AND 46).
FIRST USE 2-5-2007; IN COMMERCE 8-28-2007.

3,680,223. AVAIL MEDIA, INC., RESTON, VA. SN 77-141,862. PUB. 4-1-2008, FILED 3-27-2007.

AVAIL MEDIA

THE MARK CONSISTS OF STANDARD CHARACTERS WITHOUT CLAIM TO ANY PARTICULAR FONT, STYLE, SIZE, OR COLOR.

NO CLAIM IS MADE TO THE EXCLUSIVE RIGHT TO USE "MEDIA", APART FROM THE MARK AS SHOWN.

CLASS 9—ELECTRICAL AND SCIENTIFIC APPARATUS

FOR COMPUTER SOFTWARE FOR USE IN THE OPTIMIZATION AND INTEGRATION OF TELEVISION, SATELLITE, BROADBAND AND WIRELESS CONTENT DELIVERY TO NETWORK CARRIERS (U.S. CLS. 21, 23, 26, 36 AND 38).
FIRST USE 5-0-2007; IN COMMERCE 5-0-2007.

CLASS 35—ADVERTISING AND BUSINESS

FOR BUSINESS CONSULTING SERVICES IN THE FIELD OF TELEVISION, SATELLITE, BROADBAND AND WIRELESS CONTENT DELIVERY TO NETWORK CARRIERS (U.S. CLS. 100, 101 AND 102).
FIRST USE 5-0-2007; IN COMMERCE 5-0-2007.

CLASS 38—COMMUNICATION

FOR BROADCASTING SERVICES AND PROVISION OF TELECOMMUNICATION ACCESS TO TELEVISION, BROADBAND, AND SATELLITE (U.S. CLS. 100, 101 AND 104).
FIRST USE 5-0-2007; IN COMMERCE 5-0-2007.

3,680,225. ACTIVE ORGANICS, LP, LEWISVILLE, TX. SN 77-143,026. PUB. 10-9-2007, FILED 3-28-2007.

PHYTORELAXIN

THE MARK CONSISTS OF STANDARD CHARACTERS WITHOUT CLAIM TO ANY PARTICULAR FONT, STYLE, SIZE, OR COLOR.

CLASS 1—CHEMICALS

FOR CHEMICAL COMPOSITIONS CONTAINING BOTANICAL EXTRACTS FOR USE IN THE MANUFACTURE OF COSMETIC, COSMECEUTICAL, DERMATOLOGIC, PHARMACEUTICAL AND NUTRITIONAL PRODUCTS (U.S. CLS. 1, 5, 6, 10, 26 AND 46).
FIRST USE 5-5-2009; IN COMMERCE 5-5-2009.

CLASS 3—COSMETICS AND CLEANING PREPARATIONS

FOR NON-MEDICATED SKINCARE PREPARATIONS CONTAINING BOTANICAL EXTRACTS, NAMELY, LOTIONS, CREAMS, GELS AND SERUMS (U.S. CLS. 1, 4, 6, 50, 51 AND 52).
FIRST USE 5-5-2009; IN COMMERCE 5-5-2009.

CLASS 5—PHARMACEUTICALS

FOR NUTRITIONAL SUPPLEMENTS (U.S. CLS. 6, 18, 44, 46, 51 AND 52).
FIRST USE 5-5-2009; IN COMMERCE 5-5-2009.

CLASS 41—EDUCATION AND ENTERTAINMENT

FOR ENTERTAINMENT SERVICES, NAMELY, PROVIDING AN ON-LINE COMPUTER GAME BY MEANS OF COMMUNICATIONS NETWORKS; ENTERTAINMENT SERVICES IN THE NATURE OF PROVIDING AN ON-LINE MULTI-PLAYER ELECTRONIC COMPUTER GAME; ENTERTAINMENT SERVICES, NAMELY, PROVIDING AN ON-LINE COMPUTER GAME THAT MAY BE ACCESSED BY MEANS OF COMMUNICATIONS NETWORKS (U.S. CLS. 100, 101 AND 107).
FIRST USE 6-15-2009; IN COMMERCE 6-15-2009.

CLASS 45—PERSONAL AND LEGAL SERVICES

FOR ONLINE SOCIAL NETWORKING SERVICES (U.S. CLS. 100 AND 101).
FIRST USE 6-15-2009; IN COMMERCE 6-15-2009.

3,680,229. PIERCE, STEPHEN, TEMPE, AZ. SN 77-146,240. PUB. 10-2-2007, FILED 4-2-2007.

3,680,230. WARNER-ELEKTRA-ATLANTIC CORPORATION, NEW YORK, NY. SN 77-146,407. PUB. 3-18-2008, FILED 4-2-2007.

ONVERSE

music video interactive
MVI

THE MARK CONSISTS OF STANDARD CHARACTERS WITHOUT CLAIM TO ANY PARTICULAR FONT, STYLE, SIZE, OR COLOR.

CLASS 9—ELECTRICAL AND SCIENTIFIC APPARATUS

FOR ENTERTAINMENT SOFTWARE, NAMELY, SOFTWARE THAT IS USED FOR PROVIDING MULTI-PLAYER ACCESS TO AN ON-LINE GAME ENVIRONMENT; COMPUTER GAME SOFTWARE; VIRTUAL REALITY GAME SOFTWARE; COMPUTER GRAPHICS SOFTWARE (U.S. CLS. 21, 23, 26, 36 AND 38).
FIRST USE 6-15-2009; IN COMMERCE 6-15-2009.

CLASS 35—ADVERTISING AND BUSINESS

FOR PROMOTING THE GOODS AND SERVICES OF OTHERS BY MEANS OF OPERATING AN ON-LINE SHOPPING MALL; ISSUING GIFT CERTIFICATES WHICH MAY THEN BE REDEEMED FOR GOODS OR SERVICES (U.S. CLS. 100, 101 AND 102).
FIRST USE 6-15-2009; IN COMMERCE 6-15-2009.

CLASS 38—COMMUNICATION

FOR COMMUNICATION SERVICES IN THE NATURE OF TEXT MESSAGING AND ELECTRONIC MAIL SERVICES USED IN PLAYING ON-LINE COMPUTER GAMES (U.S. CLS. 100, 101 AND 104).
FIRST USE 6-15-2009; IN COMMERCE 6-15-2009.

NO CLAIM IS MADE TO THE EXCLUSIVE RIGHT TO USE "MUSIC VIDEO INTERACTIVE", APART FROM THE MARK AS SHOWN.

THE MARK CONSISTS OF THE WORDS "MUSIC VIDEO INTERACTIVE" OVER THE LETTERS "MVI". COLOR IS NOT CLAIMED AS A FEATURE OF THE MARK.

CLASS 9—ELECTRICAL AND SCIENTIFIC APPARATUS

FOR AUDIO AND AUDIOVISUAL RECORDINGS FEATURING MUSIC AND MUSICAL ENTERTAINMENT; HYBRID, TWO-SIDED OPTICAL DISCS FEATURING COMBINATIONS OF AUDIO AND AUDIOVISUAL RECORDINGS, MULTIMEDIA CONTENT, GRAPHICS, TEXT, VIDEO GAMES, INTERNET WEB LINKS, AND MUSIC AND MUSICAL ENTERTAINMENT-ORIENTED INFORMATION (U.S. CLS. 21, 23, 26, 36 AND 38).
FIRST USE 5-15-2007; IN COMMERCE 5-15-2007.

CLASS 35—ADVERTISING AND BUSINESS

FOR ON-LINE RETAIL STORE SERVICES FEATURING AUDIO AND AUDIOVISUAL RECORDINGS, AND MERCHANDISE (U.S. CLS. 100, 101 AND 102).
FIRST USE 5-15-2007; IN COMMERCE 5-15-2007.

CLASS 41—EDUCATION AND ENTERTAINMENT

FOR ENTERTAINMENT SERVICES, NAMELY, PROVIDING PRERECORDED MUSIC, INFORMATION IN THE FIELD OF MUSIC, AND COMMENTARY AND ARTICLES ABOUT MUSIC, ALL ON-LINE VIA A GLOBAL COMPUTER NETWORK; PROVIDING ENTERTAINMENT INFORMATION, NAMELY, PROVIDING VISUAL, SOUND, AND INTERACTIVE INFORMATION ON RECORDING ARTISTS, RECORDINGS, LYRICS, CONCERT TOURS AND BIOGRAPHICAL INFORMATION ON ARTISTS VIA A GLOBAL COMPUTER NETWORK; PROVIDING MOBILE MEDIA AND ENTERTAINMENT SERVICES IN THE NATURE OF CONTENT PREPARATION; ENTERTAINMENT SERVICES, NAMELY, PROVIDING PRE-RECORDED MUSIC, VIDEO AND GRAPHICS FOR MOBILE COMMUNICATIONS DEVICES VIA A GLOBAL COMPUTER NETWORK AND WIRELESS NETWORKS (U.S. CLS. 100, 101 AND 107).

FIRST USE 5-15-2007; IN COMMERCE 5-15-2007.

3,680,234. NEXTBODY LLC, ORLAND PARK, IL. SN 77-149,027. PUB. 10-9-2007, FILED 4-4-2007.

REDA

THE MARK CONSISTS OF STANDARD CHARACTERS WITHOUT CLAIM TO ANY PARTICULAR FONT, STYLE, SIZE, OR COLOR.

CLASS 5—PHARMACEUTICALS

FOR FOOD SUPPLEMENTS (U.S. CLS. 6, 18, 44, 46, 51 AND 52).

FIRST USE 2-13-2007; IN COMMERCE 8-13-2008.

CLASS 30—STAPLE FOODS

FOR READY TO EAT, CEREAL DERIVED FOOD BARS; GRAIN-BASED FOOD BARS ALSO CONTAINING PROTEIN (U.S. CL. 46).

FIRST USE 2-13-2007; IN COMMERCE 8-13-2008.

3,680,235. GLAZER-KENNEDY INSIDER'S CIRCLE, LLC, TOWSON, MD. SN 77-149,974. PUB. 10-9-2007, FILED 4-5-2007.

INSIDER'S CIRCLE

THE MARK CONSISTS OF STANDARD CHARACTERS WITHOUT CLAIM TO ANY PARTICULAR FONT, STYLE, SIZE, OR COLOR.

CLASS 9—ELECTRICAL AND SCIENTIFIC APPARATUS

FOR AUDIO AND VIDEO RECORDINGS FOCUSING ON MARKETING (U.S. CLS. 21, 23, 26, 36 AND 38).

FIRST USE 12-25-2008; IN COMMERCE 12-25-2008.

CLASS 16—PAPER GOODS AND PRINTED MATTER

FOR PRINTED INSTRUCTIONAL AND EDUCATIONAL MATERIALS IN THE FIELD OF MARKETING AND PERIODICAL NEWSLETTERS FOCUSING ON MARKETING (U.S. CLS. 2, 5, 22, 23, 29, 37, 38 AND 50).

FIRST USE 12-25-2008; IN COMMERCE 12-25-2008.

CLASS 25—CLOTHING

FOR APPAREL, NAMELY, TEE SHIRTS, POLO SHIRTS, HATS AND CAPS (U.S. CLS. 22 AND 39).

FIRST USE 12-25-2008; IN COMMERCE 12-25-2008.

CLASS 41—EDUCATION AND ENTERTAINMENT

FOR EDUCATIONAL SERVICES, NAMELY, CONDUCTING CLASSES AND SEMINARS IN THE FIELD OF MARKETING (U.S. CLS. 100, 101 AND 107).

FIRST USE 12-25-2008; IN COMMERCE 12-25-2008.

3,680,236. HYATT CORPORATION, CHICAGO, IL. SN 77-149,977. PUB. 10-9-2007, FILED 4-5-2007.

ANDAZ

THE MARK CONSISTS OF STANDARD CHARACTERS WITHOUT CLAIM TO ANY PARTICULAR FONT, STYLE, SIZE, OR COLOR.

THE ENGLISH TRANSLATION OF THE WORD "ANDAZ" IN THE MARK IS "STYLE".

CLASS 43—HOTEL AND RESTAURANT SERVICES

FOR HOTELS; RESORT HOTELS; MOTELS; MAKING HOTEL RESERVATIONS FOR OTHERS; RESTAURANT, BAR AND COCKTAIL LOUNGE SERVICES; SPECIALIZED HOTEL SERVICES RENDERED AS PART OF A PROGRAM FOR FREQUENT HOTEL GUESTS; PROVIDING CONFERENCE, EXHIBITION AND MEETING FACILITIES; PROVIDING BANQUET AND SOCIAL FUNCTION FACILITIES FOR SPECIAL OCCASIONS; CATERING FOR THE PROVISION OF FOOD AND BEVERAGES (U.S. CLS. 100 AND 101).

FIRST USE 12-0-2008; IN COMMERCE 12-0-2008.

CLASS 44—MEDICAL, BEAUTY AND AGRICULTURAL SERVICES

FOR HEALTH SPA SERVICES, NAMELY, COSMETIC BODY CARE SERVICES (U.S. CLS. 100 AND 101).

FIRST USE 12-0-2008; IN COMMERCE 12-0-2008.

3,680,239. WESTERN FAMILY FOODS, INC., TIGARD, OR.
SN 77-150,719. PUB. 4-8-2008, FILED 4-6-2007.

NATURAL DIRECTIONS

THE MARK CONSISTS OF STANDARD CHARACTERS WITHOUT CLAIM TO ANY PARTICULAR FONT, STYLE, SIZE, OR COLOR.

OWNER OF U.S. REG. NO. 2,688,110.

NO CLAIM IS MADE TO THE EXCLUSIVE RIGHT TO USE "NATURAL", APART FROM THE MARK AS SHOWN.

CLASS 29—MEATS AND PROCESSED FOODS

FOR ASEPTIC BROTHS, NAMELY, CHICKEN BROTH, ALL NATURAL BEEF BROTH, VEGETABLE BROTH; ASEPTIC SOUPS, NAMELY, CANNED BUTTERNUT SQUASH, CANNED TOMATO BASIL, AND ROASTED PROCESSED RED PEPPER; CANNED SOUPS; OLIVE OIL; SWEETENED APPLESAUCE, UNSWEETENED APPLESAUCE; CINNAMON APPLESAUCE, FRUIT PRESERVES, CANNED BEANS, PEANUT BUTTER, SOY AND FLAX CHIPS; SEA SALT POTATO CHIPS; ROSEMARY POTATO CHIPS, PEPPER POTATO CHIPS; SOY CRISPS, PARMESAN SOY CRISPS, SALT AND VINEGAR SOY CRISPS; FROZEN FOODS, NAMELY, FROZEN FRENCH FIRES, FROZEN VEGETABLES, FROZEN FRUITS, FROZEN VEGGIE BURGER PATTIES; FROZEN PROCESSED EDAMAME; REFRIGERATED FOOD ITEMS, NAMELY, CHEESE, SHREDDED CHEESE, SOUP; YOGURT; BUTTER; AND PROCESSED MASHED POTATOES (U.S. CL. 46).

FIRST USE 4-1-2008; IN COMMERCE 4-1-2008.

CLASS 30—STAPLE FOODS

FOR BALSAMIC VINEGAR, COFFEE; PASTAS, NAMELY, PENNE, RIGATE, SPAGHETTI, FETTUCCINI, FARFALLE, TRI COLORE, WHOLE WHEAT SPAGHETTI; PASTA SAUCES, NAMELY, MARINARA, BOLOGNESE WITH ORGANIC BEEF, PARMAGIANA, AND PUTTANESCA; SALAD DRESSINGS, NAMELY, BALSAMIC, HERBS PROVENCAL, FRENCH, CAESAR, SHIITAKE MUSHROOM; SAUCES, NAMELY, HOT SAUCE, HOISIN SAUCE, TERIYAKI GINGER SAUCE, PEANUT SATAY, WORCESTERSHIRE; DIJON MUSTARD, SPICY MUSTARD, YELLOW MUSTARD; MACARONI AND CHEESE, WHITE CHEDDAR MACARONI AND CHEESE, ALFREDO MACARONI AND CHEESE; MAPLE SYRUP; CRACKERS, NAMELY, STONED WHEAT THIN CRACKERS, STONED WHEAT THIN MINI CRACKERS, PLAIN WATER CRACKERS, PEPPER WATER CRACKERS, CROSTINI CRACKERS, CHEESE CRACKERS, BAKED CRACKERS IN TINY, SMALL, MEDIUM AND LARGE SIZES; WHIT CORN TORTILLA CHIPS, BLUE CORN TORTILLA CHIPS, ULTRA THIN WHITE TORTILLA CHIPS; CHEESE CURLS, CHEESE PUFFS, WHITE CHEDDAR POPCORN, LIGHTLY SALTED POPCORN; KETCHUP, SALSA, GREEN SALSA, COOKIES, CHOCOLATE CHIP COOKIES, SANDWICH COOKIES; BREAKFAST CEREAL; FROZEN CHEESE LASAGNA, FROZEN CHEESE RAVIOLI, FROZEN MUSHROOM RAVIOLI, FROZEN ITALIAN PIZZA; FROZEN ITALIAN THREE-CHEESE PIZZA, FROZEN ITALIAN MUSHROOM PIZZA, FROZEN MEXICAN BLACK-BEAN ENCHILADA, FROZEN MEXICAN CHEESE ENCHILADA, FROZEN MEXICAN BEAN AND CHEESE BURRITO, FROZEN MACARONI AND CHEESE; FROZEN WAFFLES; ICE CREAM, ICE CREAM NOVELTIES, NAMELY, ICE CREAM SANDWICHES AND ICE CREAM DIPPED BARS; POLENTA WITH PESTO, RISOTTO PRIMAVERA; PROCESSED SWEET CORN (U.S. CL. 46).

FIRST USE 12-1-2008; IN COMMERCE 12-1-2008.

CLASS 32—LIGHT BEVERAGES

FOR FRUIT JUICES, APPLE JUICES WITH GRAPEFRUIT AND APPLE JUICE BLEND, SPARKLING WATER; AND GRAPEFRUIT JUICE (U.S. CLS. 45, 46 AND 48).

FIRST USE 5-1-2008; IN COMMERCE 5-1-2008.

3,680,246. CSL BEHRING L.L.C., KING OF PRUSSIA, PA. SN 77-155,193. PUB. 4-22-2008, FILED 4-12-2007.



NO CLAIM IS MADE TO THE EXCLUSIVE RIGHT TO USE "COUNCIL ON PRIMARY IMMUNE DEFICIENCY DISEASE", APART FROM THE MARK AS SHOWN.

THE MARK CONSISTS OF THE WORDS "COUNCIL ON PRIMARY IMMUNE DEFICIENCY DISEASE", AND THE ACRONYM "CPIDD" IN A STYLIZED DESIGN.

CLASS 35—ADVERTISING AND BUSINESS

FOR PROMOTING PUBLIC AWARENESS OF INFORMATION ON CLINICAL NEEDS FOR, AWARENESS, DIAGNOSIS, BENEFITS, CONSEQUENCES, TREATMENT AND MANAGEMENT OF PRIMARY IMMUNE DEFICIENCY DISEASE (U.S. CLS. 100, 101 AND 102).

FIRST USE 3-31-2007; IN COMMERCE 3-31-2007.

CLASS 41—EDUCATION AND ENTERTAINMENT

FOR EDUCATIONAL SERVICES, NAMELY, PROVIDING CLASSES, WORKSHOPS, AND SEMINARS IN THE FIELD OF CLINICAL NEEDS FOR, AWARENESS, DIAGNOSIS, BENEFITS, CONSEQUENCES, TREATMENT AND MANAGEMENT OF PRIMARY IMMUNE DEFICIENCY DISEASE (U.S. CLS. 100, 101 AND 107).

FIRST USE 3-31-2007; IN COMMERCE 3-31-2007.

CLASS 44—MEDICAL, BEAUTY AND AGRICULTURAL SERVICES

FOR CONSULTATION SERVICES RELATING TO THE CLINICAL NEEDS FOR, DIAGNOSIS, BENEFITS, CONSEQUENCES, TREATMENT AND MANAGEMENT OF PRIMARY IMMUNE DEFICIENCY DISEASE (U.S. CLS. 100 AND 101).

FIRST USE 3-31-2007; IN COMMERCE 3-31-2007.

3,680,248. CORVENTIS, INC., MENLO PARK, CA. SN 77-155,390. PUB. 10-14-2008, FILED 4-12-2007.

CORVENTIS

THE MARK CONSISTS OF STANDARD CHARACTERS WITHOUT CLAIM TO ANY PARTICULAR FONT, STYLE, SIZE, OR COLOR.

CLASS 9—ELECTRICAL AND SCIENTIFIC APPARATUS

FOR COMPUTER HARDWARE; COMPUTER SOFTWARE FOR DIAGNOSING, MONITORING, AND TREATING PATIENTS REQUIRING CHRONIC CARE IN THE FIELD OF HEALTHCARE (U.S. CLS. 21, 23, 26, 36 AND 38).

FIRST USE 6-2-2009; IN COMMERCE 6-2-2009.

CLASS 10—MEDICAL APPARATUS

FOR MEDICAL DIAGNOSTIC AND THERAPEUTIC DEVICES, NAMELY, VITAL SIGNS MONITORS AND MEDICAL EVENT DETECTORS (U.S. CLS. 26, 39 AND 44).

FIRST USE 6-2-2009; IN COMMERCE 6-2-2009.

CLASS 42—SCIENTIFIC AND COMPUTER SERVICES

FOR COMPUTER SERVICES, NAMELY, PROVIDING ONLINE NON-DOWNLOADABLE SOFTWARE FOR THE DIAGNOSIS, MONITORING, AND TREATMENT OF PATIENTS REQUIRING CHRONIC CARE IN THE FIELD OF HEALTHCARE (U.S. CLS. 100 AND 101).

FIRST USE 6-2-2009; IN COMMERCE 6-2-2009.

CLASS 44—MEDICAL, BEAUTY AND AGRICULTURAL SERVICES

FOR COMPUTER SERVICES, NAMELY, PROVIDING AN ONLINE COMPUTER DATABASE FEATURING INFORMATION FOR THE DIAGNOSIS, MONITORING AND TREATMENT OF PATIENTS REQUIRING CHRONIC CARE IN THE FIELD OF HEALTHCARE (U.S. CLS. 100 AND 101).

FIRST USE 6-2-2009; IN COMMERCE 6-2-2009.

3,680,254. MISSION PLAYGROUND, LLC, PETALUMA, CA. SN 77-158,011. PUB. 10-9-2007, FILED 4-16-2007.

MISSION PLAYGROUND

THE MARK CONSISTS OF STANDARD CHARACTERS WITHOUT CLAIM TO ANY PARTICULAR FONT, STYLE, SIZE, OR COLOR.

CLASS 16—PAPER GOODS AND PRINTED MATTER

FOR NEWSLETTERS IN THE FIELD OF ENVIRONMENTAL ISSUES; PRINTED INSTRUCTIONAL, EDUCATIONAL, AND TEACHING MATERIALS IN THE FIELD OF ENVIRONMENTAL ISSUES; WIRE-BOUND NOTEBOOKS; BUMPER STICKERS; DECALS; POSTERS; BOOKS IN THE FIELD OF ENVIRONMENTAL ISSUES (U.S. CLS. 2, 5, 22, 23, 29, 37, 38 AND 50).

FIRST USE 7-0-2003; IN COMMERCE 7-0-2003.

CLASS 18—LEATHER GOODS

FOR LUGGAGE; SPORTS BAGS; DUFFEL BAGS; SATCHELS; BOOK BAGS (U.S. CLS. 1, 2, 3, 22 AND 41).

FIRST USE 1-0-2004; IN COMMERCE 1-0-2004.

CLASS 25—CLOTHING

FOR SHIRTS; SHORT-SLEEVED OR LONG-SLEEVED T-SHIRTS; HATS; VESTS; PANTS; JACKETS; BELTS; SHORTS; TANK-TOPS; FOOTWEAR; SWIM WEAR; SKIRTS; COATS; SWEATERS; GLOVES; SCARVES (U.S. CLS. 22 AND 39).

FIRST USE 7-0-2003; IN COMMERCE 7-0-2003.

CLASS 35—ADVERTISING AND BUSINESS

FOR ONLINE RETAIL STORES FEATURING CLOTHING, FOOTWEAR, LUGGAGE AND A WIDE VARIETY OF ENVIRONMENTAL GOODS AND ACCESSORIES; CATALOG ORDERING SERVICE FEATURING CLOTHING AND ACCESSORIES (U.S. CLS. 100, 101 AND 102).

FIRST USE 9-0-2003; IN COMMERCE 9-0-2003.

3,680,256. PAYPAL, INC., SAN JOSE, CA. SN 77-158,744. PUB. 4-15-2008, FILED 4-17-2007.



OWNER OF U.S. REG. NOS. 2,588,408, 2,959,971, AND OTHERS.

CLASS 9—ELECTRICAL AND SCIENTIFIC APPARATUS

FOR COMPUTER SOFTWARE FOR PROCESSING ELECTRONIC PAYMENTS AND TRANSFERRING FUNDS TO AND FROM OTHERS; AUTHENTICATION SOFTWARE FOR CONTROLLING ACCESS TO AND COMMUNICATIONS WITH COMPUTERS THAT MAY BE DOWNLOADED FROM A GLOBAL COMPUTER NETWORK AND/OR RECORDED ON COMPUTER MEDIA; MAGNETICALLY ENCODED CREDIT CARDS AND PAYMENT CARDS; COMPUTER HARDWARE SECURITY DEVICE, NAMELY, A NON-PREDICTABLE CODE CALCULATOR FOR ACCESSING A HOST DATABASE COMPUTER (U.S. CLS. 21, 23, 26, 36 AND 38).

FIRST USE 9-7-2008; IN COMMERCE 9-7-2008.

CLASS 16—PAPER GOODS AND PRINTED MATTER

FOR PAPER AND STATIONERY ITEMS, NAMELY, MEMO PADS AND PENS; PUBLICATIONS AND PRINTED MATERIALS, NAMELY, A SERIES OF INSTRUCTIONAL BOOKS AND TEACHING MATERIALS IN THE FIELD OF CLEARING AND RECONCILING FINANCIAL TRANSACTIONS VIA ELECTRONIC COMMUNICATIONS NETWORKS; CREDIT CARDS WITHOUT MAGNETIC CODING (U.S. CLS. 2, 5, 22, 23, 29, 37, 38 AND 50).

FIRST USE 11-0-2008; IN COMMERCE 11-0-2008.

CLASS 21—HOUSEWARES AND GLASS

FOR CONTAINERS FOR FOOD OR BEVERAGES, NAMELY, TUMBLERS, AND PLASTIC WATER BOTTLES, ALL SOLD EMPTY (U.S. CLS. 2, 13, 23, 29, 30, 33, 40 AND 50).

FIRST USE 11-0-2008; IN COMMERCE 11-0-2008.

CLASS 25—CLOTHING

FOR CLOTHING, NAMELY, SHIRTS, T-SHIRTS, JACKETS AND HEADGEAR (U.S. CLS. 22 AND 39).

FIRST USE 11-0-2008; IN COMMERCE 11-0-2008.

CLASS 36—INSURANCE AND FINANCIAL

FOR FINANCIAL SERVICES, NAMELY, ELECTRONIC FUNDS TRANSFER VIA ELECTRONIC COMMUNICATIONS NETWORKS; CLEARING AND RECONCILING FINANCIAL TRANSACTIONS VIA ELECTRONIC COMMUNICATIONS NETWORKS; PROVIDING A WIDE VARIETY OF PAYMENT AND FINANCIAL SERVICES, NAMELY, CREDIT CARD SERVICES, ISSUING CREDIT CARDS AND LINES OF CREDIT, PROCESSING AND TRANSMISSION OF BILLS AND PAYMENTS THEREOF, BILL PAYMENT SERVICES WITH GUARANTEED PAYMENT DELIVERY, AND BROKERAGE OF MONEY MARKET FUNDS, ALL CONDUCTED VIA A GLOBAL COMMUNICATIONS NETWORK (U.S. CLS. 100, 101 AND 102).

FIRST USE 9-7-2008; IN COMMERCE 9-7-2008.

CLASS 45—PERSONAL AND LEGAL SERVICES

FOR DISPUTE RESOLUTION SERVICES; PROVIDING FINANCIAL FRAUD PROTECTION AND PREVENTION (U.S. CLS. 100 AND 101).

FIRST USE 9-7-2008; IN COMMERCE 9-7-2008.

3,680,259. ALLSTATE INSURANCE COMPANY, NORTH-BROOK, IL. SN 77-158,895. PUB. 7-31-2007, FILED 4-17-2007.

BEYOND FEBRUARY

THE MARK CONSISTS OF STANDARD CHARACTERS WITHOUT CLAIM TO ANY PARTICULAR FONT, STYLE, SIZE, OR COLOR.

CLASS 35—ADVERTISING AND BUSINESS

FOR CHARITABLE SERVICES, NAMELY, ORGANIZING AND CONDUCTING VOLUNTEER PROGRAMS AND COMMUNITY SERVICE PROJECTS (U.S. CLS. 100, 101 AND 102).

FIRST USE 11-1-2008; IN COMMERCE 11-1-2008.

3,680,258. ALLSTATE INSURANCE COMPANY, NORTH-BROOK, IL. SN 77-158,893. PUB. 7-31-2007, FILED 4-17-2007.

CLASS 41—EDUCATION AND ENTERTAINMENT

FOR ORGANIZING, PRESENTING, AND PRODUCING CULTURAL, HERITAGE, AND FAMILY EVENTS ENCOURAGING COMMUNITY INVOLVEMENT (U.S. CLS. 100, 101 AND 107).

FIRST USE 10-25-2007; IN COMMERCE 10-25-2007.

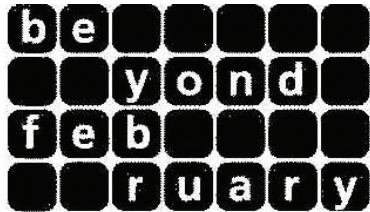

THE MARK CONSISTS OF DESIGN OF "BEYOND FEBRUARY" ON SQUARES LAID OUT IN A SERIES THAT IS SEVEN SQUARES ACROSS AND FOUR SQUARES HIGH.

CLASS 35—ADVERTISING AND BUSINESS

FOR CHARITABLE SERVICES, NAMELY, ORGANIZING AND CONDUCTING VOLUNTEER PROGRAMS AND COMMUNITY SERVICE PROJECTS (U.S. CLS. 100, 101 AND 102).

FIRST USE 11-1-2008; IN COMMERCE 11-1-2008.

3,680,262. GERUS, SHEILA JANE, PENNINGTON, NJ. SN 77-160,390. PUB. 10-16-2007, FILED 4-19-2007.

Renavatio

CLASS 41—EDUCATION AND ENTERTAINMENT

FOR ORGANIZING, PRESENTING, AND PRODUCING CULTURAL, HERITAGE, AND FAMILY EVENTS ENCOURAGING COMMUNITY INVOLVEMENT (U.S. CLS. 100, 101 AND 107).

FIRST USE 10-25-2007; IN COMMERCE 10-25-2007.

THE MARK CONSISTS OF STANDARD CHARACTERS WITHOUT CLAIM TO ANY PARTICULAR FONT, STYLE, SIZE, OR COLOR.

CLASS 35—ADVERTISING AND BUSINESS

FOR ADVERTISING AND MARKETING; ADVERTISING AND PUBLICITY SERVICES, NAMELY, PROMOTING THE GOODS, SERVICES, BRAND IDENTITY AND COMMERCIAL INFORMATION AND NEWS OF THIRD PARTIES THROUGH PRINT, AUDIO, VIDEO, DIGITAL AND ON-LINE MEDIUM; ADVERTISING RELATING TO PHARMACEUTICAL PRODUCTS AND IN-VIVO IMAGING PRODUCTS; ADVERTISING SERVICES, NAMELY, CREATING CORPORATE AND BRAND IDENTITY FOR OTHERS; ADVERTISING SERVICES, NAMELY, PROMOTING AND MARKETING THE GOODS AND SERVICES OF OTHERS THROUGH ALL PUBLIC COMMUNICATION MEANS; CREATING AND UPDATING ADVERTISING MATERIAL; CREATION OF MARKETING TOOLS DESIGNED TO INCREASE A CLIENT COMPANY'S KNOWLEDGE OF CUSTOMER NEEDS, AND ITS COMPETITORS' PRODUCTS AND SERVICES, PRICING, ADVERTISING STRATEGY AND SALES STRATEGY; DESIGN OF ADVERTISING MATERIALS FOR OTHERS; DESIGN OF INTERNET ADVERTISING; DIRECT MAIL ADVERTISING; DISSEMINATION OF ADVERTISING FOR OTHERS VIA AN ON-LINE COMMUNICATIONS NETWORK ON THE INTERNET; ISSUING AND UPDATING OF ADVERTISING TEXTS; LAYOUT SERVICES FOR ADVERTISING PURPOSES; MODELING SERVICES FOR ADVERTISING OR SALES PROMOTION; ON-LINE ADVERTISING AND MARKETING SERVICES; ORGANIZING EXHIBITIONS FOR MEDICAL AND CONSUMER CONVENTIONS; PREPARING AUDIO-VISUAL DISPLAYS IN THE FIELD OF HEALTHCARE; PREPARING AUDIO-VISUAL PRESENTATIONS FOR USE IN ADVERTISING; PROMOTING THE GOODS AND SERVICES OF OTHERS BY DISTRIBUTING ADVERTISING MATERIALS THROUGH A VARIETY OF METHODS; PROMOTION, ADVERTISING AND MARKETING OF ON-LINE WEBSITES; PROVIDING ADVERTISING SERVICES USING 3D AND ANIMATION DESIGNS; MARKET RESEARCH CONSULTATION; MARKET SEGMENTATION CONSULTATION; MARKETING CONSULTING (U.S. CLS. 100, 101 AND 102).

FIRST USE 9-25-2008; IN COMMERCE 9-25-2008.

CLASS 41—EDUCATION AND ENTERTAINMENT

FOR LAYOUT SERVICES OTHER THAN FOR ADVERTISING PURPOSES; WRITING OF ARTICLES FOR JOURNALS OTHER THAN FOR ADVERTISING OR PUBLICITY; WRITING OF ARTICLES FOR PERIODICALS OTHER THAN FOR ADVERTISING OR PUBLICITY; WRITING OF ARTICLES FOR PROFESSIONAL JOURNALS OTHER THAN FOR ADVERTISING OR PUBLICITY; SPECIAL EVENT PLANNING CONSULTATION (U.S. CLS. 100, 101 AND 107).

FIRST USE 8-8-2008; IN COMMERCE 8-8-2008.

CLASS 42—SCIENTIFIC AND COMPUTER SERVICES

FOR DESIGNING WEBSITES FOR ADVERTISING PURPOSES; PRODUCT DEVELOPMENT CONSULTATION; DESIGNING THEME GRAPHICS AND MULTIMEDIA SHOWS FOR CONVENTIONS, PRODUCT LAUNCHES, TRADE SHOWS, KEY NOTE ADDRESSES AND AWARD CEREMONIES FOR OTHERS; GRAPHIC DESIGN SERVICES; DESIGN AND DEVELOPMENT OF MULTIMEDIA PRODUCTS; DESIGN, CREATION, HOSTING, MAINTENANCE OF WEBSITES FOR OTHERS (U.S. CLS. 100 AND 101).

FIRST USE 10-8-2008; IN COMMERCE 10-8-2008.

CLASS 44—MEDICAL, BEAUTY AND AGRICULTURAL SERVICES

FOR MEDICAL AND PHARMACEUTICAL CONSULTATION; PROVIDING MEDICAL INFORMATION, CONSULTANCY AND ADVISORY SERVICES (U.S. CLS. 100 AND 101).

FIRST USE 9-18-2008; IN COMMERCE 9-18-2008.

3,680,266. RELIABILITY BRANDS, LLC, OSWEGO, IL. SN 77-163,479. PUB. 10-14-2008, FILED 4-23-2007.



The logo for ReliabilityBrands features the word "ReliabilityBrands" in a bold, black, sans-serif font. Above the word "Reliability", there are five small circles in a slight arc, colored yellow, orange, red, blue, and green from left to right.

NO CLAIM IS MADE TO THE EXCLUSIVE RIGHT TO USE "BRANDS", APART FROM THE MARK AS SHOWN.

THE COLOR(S) BLACK, YELLOW, ORANGE, RED, BLUE AND GREEN IS/ARE CLAIMED AS A FEATURE OF THE MARK.

THE MARK CONSISTS OF THE WORDING "RELIABILITYBRANDS" IN BLACK, WITH FIVE CIRCLES ARRANGED IN AN ARC ABOVE AND CONNECTING THE FIRST AND SECOND "I'S" IN THE WORDING "RELIABILITY". THE CIRCLES ARE IN THE COLORS YELLOW, ORANGE, RED, BLUE AND GREEN.

CLASS 6—METAL GOODS

FOR BOTTLE CLOSURES OF METAL; CONTAINERS OF METAL FOR TRANSPORT; GENERAL PURPOSE METAL STORAGE CONTAINERS; INDUSTRIAL PACKAGING CONTAINERS OF METAL; INDUSTRIAL PACKAGING CONTAINERS OF METAL; METAL BOTTLE CAPS; METAL CAPS FOR BOTTLES; METAL CLOSURES FOR CONTAINERS; METAL CLOSURES FOR BOTTLES, DRUMS AND CONTAINERS HANDLING LUBRICATING OILS; METAL CONTAINERS FOR THE STORAGE AND TRANSPORTATION OF LUBRICATING OILS; METAL STORAGE DRUMS FOR LUBRICATING OILS (U.S. CLS. 2, 12, 13, 14, 23, 25 AND 50).

FIRST USE 4-1-2007; IN COMMERCE 4-1-2007.

CLASS 20—FURNITURE AND ARTICLES NOT OTHERWISE CLASSIFIED

FOR BOTTLE CLOSURES NOT OF METAL; CONTAINER CLOSURES OF PLASTIC; CONTAINERS FOR INDUSTRIAL AND COMMERCIAL LIQUIDS NOT MADE OF METAL; CONTAINERS, NOT OF METAL FOR COMMERCIAL USE; NON-METAL AND NON-PAPER CLOSURES FOR CONTAINERS; NON-METAL AND NON-PAPER CLOSURES FOR BOTTLES AND CONTAINERS FOR HANDLING LUBRICATING FLUIDS; NON-METAL BOTTLE CAPS; NON-METAL CAPS FOR BOTTLES; NON-METALLIC BOTTLE CAPS; NON-METALLIC CLOSURES FOR CONTAINERS; PLASTIC STORAGE CONTAINERS FOR COMMERCIAL OR INDUSTRIAL USE; PLASTIC STORAGE DRUMS FOR HANDLING LUBRICATING OILS FOR INDUSTRIAL MACHINES AND MILITARY EQUIPMENT (U.S. CLS. 2, 13, 22, 25, 32 AND 50).

FIRST USE 4-1-2007; IN COMMERCE 4-1-2007.

CLASS 21—HOUSEWARES AND GLASS

FOR ALL PURPOSE PORTABLE HOUSEHOLD CONTAINERS FOR SOLVENTS AND LUBRICATING OILS; CONTAINERS FOR HOUSEHOLD OR KITCHEN USE NOT OF PRECIOUS METAL FOR SOLVENTS AND LUBRICATING OILS; CONTAINERS FOR HOUSEHOLD USE TO STORE SOLVENTS AND LUBRICATING OILS; PLASTIC STORAGE CONTAINERS FOR DOMESTIC USE TO STORE SOLVENTS AND LUBRICATING OILS; PORTABLE PLASTIC CONTAINERS FOR STORING HOUSEHOLD AND KITCHEN SOLVENT AND LUBRICATING OIL GOODS (U.S. CLS. 2, 13, 23, 29, 30, 33, 40 AND 50).

FIRST USE 4-1-2007; IN COMMERCE 4-1-2007.

CLASS 40—MATERIAL TREATMENT

FOR BOTTLING; CUSTOM MANUFACTURE OF CONTAINERS, BOTTLES, DRUMS AND RECEPTACLES FOR LUBRICATING OILS AND SYNTHETIC LUBRICATING OILS FOR INDUSTRIAL MACHINES AND MILITARY EQUIPMENT, NAMELY, PLASTIC FUEL OR GAS CONTAINERS FOR HOUSEHOLD AND COMMERCIAL USE (U.S. CLS. 100, 103 AND 106).

FIRST USE 4-1-2007; IN COMMERCE 4-1-2007.

3,680,270. KARAN GLEDDIE, CHERTERMERE, ALBERTA. SN 77-165,924. PUB. 4-8-2008, FILED 4-25-2007.

EVERYONE HAS BLONDE DAYS

THE MARK CONSISTS OF STANDARD CHARACTERS WITHOUT CLAIM TO ANY PARTICULAR FONT, STYLE, SIZE, OR COLOR.

CLASS 16—PAPER GOODS AND PRINTED MATTER

FOR PRINTED MATTER AND PAPER GOODS, NAMELY, INSPIRATIONAL AND/OR DRAMA FEATURES, NAMELY, STATIONERY, WRITING PAPER, ENVELOPES, NOTEBOOKS, DIARIES, NOTE CARDS, GREETING CARDS; PENS, PENCILS, CASES THEREFOR, BOOK MARKS, PRINTED INSTRUCTIONAL, EDUCATIONAL AND TEACHING MATERIALS; ANNOUNCEMENT CARDS; ART PICTURES; ART PRINTS; CARDS BEARING UNIVERSAL GREETINGS; DAILY PLANNERS; DATE BOOKS; FOUNTAIN PENS; MERCHANDISE BAGS; PAPER WEIGHTS; SCRAPBOOKS; STICKERS; AND WALL CALENDARS (U.S. CLS. 2, 5, 22, 23, 29, 37, 38 AND 50).

FIRST USE 11-30-2007; IN COMMERCE 11-30-2007.

CLASS 18—LEATHER GOODS

FOR ALL-PURPOSE CARRY BAGS, BACKPACKS, BOOK BAGS, CARRYING CASES, PURSES NOT OF PRECIOUS METAL AND LEATHER BAGS (U.S. CLS. 1, 2, 3, 22 AND 41).

FIRST USE 5-31-2009; IN COMMERCE 5-31-2009.

CLASS 25—CLOTHING

FOR CLOTHING FOR WOMEN, NAMELY, SHIRTS, T-SHIRTS, SWEATSHIRTS, JOGGING SUITS, TROUSERS, PANTS, SHORTS, TANK TOPS, JACKETS, HATS AND CAPS (U.S. CLS. 22 AND 39).

FIRST USE 5-31-2009; IN COMMERCE 5-31-2009.

CLASS 41—EDUCATION AND ENTERTAINMENT

FOR EDUCATIONAL SERVICES, NAMELY, CONDUCTING CLASSES AND SEMINARS IN THE FIELD OF PERSONAL DEVELOPMENT AND SELF-IMPROVEMENT (U.S. CLS. 100, 101 AND 107).

FIRST USE 6-30-2007; IN COMMERCE 6-30-2007.

3,680,278. PUBLICIS GROUPE S.A., PARIS, FRANCE. SN 77-169,983. PUB. 9-23-2008, FILED 5-1-2007.

PRODIGIOUS WORLDWIDE

THE MARK CONSISTS OF STANDARD CHARACTERS WITHOUT CLAIM TO ANY PARTICULAR FONT, STYLE, SIZE, OR COLOR.

NO CLAIM IS MADE TO THE EXCLUSIVE RIGHT TO USE "WORLDWIDE", APART FROM THE MARK AS SHOWN.

CLASS 35—ADVERTISING AND BUSINESS

FOR BUSINESS CONSULTING SERVICES IN THE FIELD OF ELECTRONIC COMMERCE; ADVERTISING AND MARKETING AGENCY SERVICES, NAMELY, THE CREATION, DEVELOPMENT AND DISSEMINATION OF ADVERTISING AND PROMOTIONAL MATERIALS VIA DIRECT MAIL, NEWSPAPER, RADIO, TELEVISION, A GLOBAL COMPUTER NETWORK AND OTHER INTERACTIVE MEDIA (U.S. CLS. 100, 101 AND 102).

FIRST USE 4-30-2007; IN COMMERCE 4-30-2007.

CLASS 42—SCIENTIFIC AND COMPUTER SERVICES

FOR COMPUTER SERVICES IN THE FIELDS OF ELECTRONIC COMMERCE, ADVERTISING AND MARKETING, NAMELY, DESIGNING AND IMPLEMENTING NETWORK WEB SITES, ELECTRONIC COMMERCE SOFTWARE APPLICATIONS AND INFORMATION TECHNOLOGY COMPUTER NETWORK SYSTEMS FOR OTHERS (U.S. CLS. 100 AND 101).

FIRST USE 4-30-2007; IN COMMERCE 4-30-2007.

3,680,280. KALSEC, INC., KALAMAZOO, MI. SN 77-170,852. PUB. 10-30-2007, FILED 5-2-2007.

**PRODUCTS, SERVICE AND
SCIENCE YOU CAN TRUST . .
. NATURALLY**

THE MARK CONSISTS OF STANDARD CHARACTERS WITHOUT CLAIM TO ANY PARTICULAR FONT, STYLE, SIZE, OR COLOR.

CLASS 2—PAINTS

FOR A HOUSE MARK FOR A FULL LINE OF FOOD COLORS (U.S. CLS. 6, 11 AND 16).

FIRST USE 7-24-2007; IN COMMERCE 7-24-2007.

CLASS 30—STAPLE FOODS

FOR A HOUSE MARK FOR A FULL LINE OF EXTRACTS USED AS FLAVORING (U.S. CL. 46).

FIRST USE 7-24-2007; IN COMMERCE 7-24-2007.

3,680,287. MCDONOUGH BRAUNGART DESIGN CHEMISTRY, LLC, CHARLOTTESVILLE, VA. SN 77-174,604. PUB. 4-22-2008, FILED 5-7-2007.

C2C

THE MARK CONSISTS OF STANDARD CHARACTERS WITHOUT CLAIM TO ANY PARTICULAR FONT, STYLE, SIZE, OR COLOR.

CLASS 35—ADVERTISING AND BUSINESS

FOR BUSINESS CONSULTING SERVICES IN THE FIELD OF DESIGNING AND MANUFACTURING ENVIRONMENTALLY FRIENDLY AND SUSTAINABLE MATERIALS, PRODUCTS AND BUILDINGS (U.S. CLS. 100, 101 AND 102).
FIRST USE 12-2-2001; IN COMMERCE 12-2-2001.

CLASS 41—EDUCATION AND ENTERTAINMENT

FOR EDUCATIONAL SERVICES, NAMELY, CONDUCTING SPEECHES AND PROGRAMS IN THE FIELD OF DESIGNING AND MANUFACTURING ENVIRONMENTALLY FRIENDLY AND SUSTAINABLE MATERIALS, PRODUCTS AND BUILDINGS (U.S. CLS. 100, 101 AND 107).
FIRST USE 10-5-2007; IN COMMERCE 10-5-2007.

CLASS 42—SCIENTIFIC AND COMPUTER SERVICES

FOR ARCHITECTURAL AND ENGINEERING CONSULTING SERVICES IN THE FIELD OF SUSTAINABLE BUILDING DESIGN (U.S. CLS. 100 AND 101).
FIRST USE 12-1-2001; IN COMMERCE 12-2-2001.

3,680,288. RAAB, RACHEL M., SANTA BARBARA, CA. SN 77-175,070. PUB. 4-22-2008, FILED 5-8-2007.

RAABstrat

THE MARK CONSISTS OF STANDARD CHARACTERS WITHOUT CLAIM TO ANY PARTICULAR FONT, STYLE, SIZE, OR COLOR.

CLASS 16—PAPER GOODS AND PRINTED MATTER

FOR STICKERS (U.S. CLS. 2, 5, 22, 23, 29, 37, 38 AND 50).
FIRST USE 8-0-2003; IN COMMERCE 8-0-2003.

CLASS 25—CLOTHING

FOR CLOTHING, NAMELY, SHIRTS, SWEATSHIRTS (U.S. CLS. 22 AND 39).
FIRST USE 8-0-2003; IN COMMERCE 8-0-2003.

CLASS 26—FANCY GOODS

FOR BUTTONS, NAMELY, ORNAMENTAL NOVELTY BUTTONS (U.S. CLS. 37, 39, 40, 42 AND 50).
FIRST USE 8-0-2003; IN COMMERCE 8-0-2003.

CLASS 41—EDUCATION AND ENTERTAINMENT

FOR PHOTOGRAPHY SERVICES; ENTERTAINMENT SERVICES, NAMELY, PROVIDING A WEB SITE FEATURING PHOTOGRAPHS (U.S. CLS. 100, 101 AND 107).
FIRST USE 8-13-2003; IN COMMERCE 8-13-2003.

3,680,290. COUNTRYMARK COOPERATIVE, LLP, DBA COUNTRYMARK COOPERATIVE, INDIANAPOLIS, IN. SN 77-175,807. PUB. 10-14-2008, FILED 5-8-2007.



OWNER OF U.S. REG. NOS. 2,657,529 AND 2,679,308.
THE COLOR(S) RED (PMS 1805), BLACK, AND GRAY (PMS COOL GRAY 8) IS/ARE CLAIMED AS A FEATURE OF THE MARK.

THE MARK CONSISTS OF HALF SHAPED "C" IS RED AND REMAINING HALF SHAPED "C" IS BLACK, ENCASED IN A WAVY CIRCLE DESIGN WITH GRAY AND BLACK COMPONENTS.

CLASS 4—LUBRICANTS AND FUELS

FOR ALL GRADES OF DIESEL FUEL AND GASOLINE; FUEL FROM CRUDE OIL; DIESEL FUEL FOR RESIDENTIAL HEATING; FUELS USED FOR HEATING OIL; KEROSENE; FOSSIL FUEL SUBSTITUTES, NAMELY, BIO-FUELS; RENEWABLE FUELS; AND ETHANOL FUELS; MOTOR OIL; LUBRICATING OIL; FUEL OIL; AND NON-CHEMICAL ADDITIVES FOR OILS AND FUELS (U.S. CLS. 1, 6 AND 15).
FIRST USE 6-13-2007; IN COMMERCE 6-13-2007.

CLASS 25—CLOTHING

FOR PROMOTIONAL ITEMS, NAMELY, SHIRTS FOR MEN, WOMEN AND CHILDREN, HATS, AND GLOVES (U.S. CLS. 22 AND 39).
FIRST USE 6-13-2007; IN COMMERCE 6-13-2007.

CLASS 35—ADVERTISING AND BUSINESS

FOR BUSINESS CONSULTING AND DISTRIBUTORSHIP SERVICES IN THE FIELD OF AGRICULTURE AND COMMODITIES, AND RETAIL STORE SERVICES FEATURING PETROLEUM PRODUCTS, AND RETAIL GASOLINE SUPPLY SERVICES; FORWARD CONTRACTING SERVICES, NAMELY, CONTRACTING TO PROVIDE GOODS OR SERVICES IN THE FUTURE AT A SET PRICE (U.S. CLS. 100, 101 AND 102).
FIRST USE 6-13-2007; IN COMMERCE 6-13-2007.

CLASS 36—INSURANCE AND FINANCIAL

FOR CREDIT CARD SERVICES AND FINANCING SERVICES; FINANCIAL RISK MANAGEMENT CONSULTATION, NAMELY, PRICE RISK MANAGEMENT SERVICES (U.S. CLS. 100, 101 AND 102).

FIRST USE 6-13-2007; IN COMMERCE 6-13-2007.

CLASS 39—TRANSPORTATION AND STORAGE

FOR TRANSPORTATION AND DELIVERY OF FUELS AND OILS (U.S. CLS. 100 AND 105).

FIRST USE 6-13-2007; IN COMMERCE 6-13-2007.

CLASS 40—MATERIAL TREATMENT

FOR FUEL REFINING; AND OIL REFINING; FUEL TREATMENT SERVICES (U.S. CLS. 100, 103 AND 106).

FIRST USE 6-13-2007; IN COMMERCE 6-13-2007.

3,680,291. INFIN8 BODY WORKS, INC., BUFFALO, NY. SN 77-176,093. PUB. 3-4-2008, FILED 5-9-2007.

INFIN8

THE MARK CONSISTS OF STANDARD CHARACTERS WITHOUT CLAIM TO ANY PARTICULAR FONT, STYLE, SIZE, OR COLOR.

CLASS 30—STAPLE FOODS

FOR ORGANIC HEALTH FOODS, NAMELY, PROCESSED WHOLE GRAINS, COFFEE BEANS, ROASTED AND GROUND SESAME SEEDS, TEA, FOOD FLAVORINGS BEING NON-ESSENTIAL OILS, SALTS, FERMENTED PRODUCTS IN THE NATURE OF MISO BEAN PASTE AND SHOYU (SOY SAUCE), SEA SALT, AND NATURAL SWEETENERS (U.S. CL. 46).

FIRST USE 2-9-2008; IN COMMERCE 2-9-2008.

CLASS 41—EDUCATION AND ENTERTAINMENT

FOR EDUCATIONAL AND TRAINING SERVICES, NAMELY, CONDUCTING LIVE WORKSHOPS, SEMINARS, COURSES, AND CLASSES IN YOGA, REIKI, AND MEDITATION (U.S. CLS. 100, 101 AND 107).

FIRST USE 2-9-2008; IN COMMERCE 2-9-2008.

3,680,299. LLOYD IP LIMITED, CUMBRIA, UNITED KINGDOM. SN 77-180,725. PUB. 4-1-2008, FILED 5-14-2007.

AKITO

THE MARK CONSISTS OF STANDARD CHARACTERS WITHOUT CLAIM TO ANY PARTICULAR FONT, STYLE, SIZE, OR COLOR.

CLASS 9—ELECTRICAL AND SCIENTIFIC APPARATUS

FOR PROTECTIVE HELMETS; SPORTS HELMETS; MOTORCYCLE HELMETS; PROTECTIVE WEAR FOR MOTORCYCLISTS, NAMELY, PROTECTIVE SUITS, PROTECTIVE JACKETS, PROTECTIVE TROUSERS AND PANTS, PROTECTIVE BODY ARMOR, NAMELY, HARD PLATE PERSONAL BODY ARMOR, PROTECTIVE BOOTS, PROTECTIVE GLOVES; GOGGLES FOR SPORTS; MOTORCYCLE GOGGLES; SPECTACLES; BATTERIES; REPLACEMENT PARTS AND FITTINGS FOR THE AFOREMENTIONED GOODS (U.S. CLS. 21, 23, 26, 36 AND 38).

FIRST USE 0-0-1985; IN COMMERCE 2-0-2009.

CLASS 25—CLOTHING

FOR MOTORCYCLE CLOTHING, MOTORCYCLE FOOTWEAR, NAMELY, MOTORCYCLE JACKETS, MOTORCYCLE PANTS, MOTORCYCLE BOOTS (U.S. CLS. 22 AND 39).

FIRST USE 0-0-1985; IN COMMERCE 2-0-2009.

3,680,315. ZONK DESIGNS, INC., ATLANTA, GA. SN 77-185,808. PUB. 10-14-2008, FILED 5-21-2007.

SNOOZERPEDIC

THE MARK CONSISTS OF STANDARD CHARACTERS WITHOUT CLAIM TO ANY PARTICULAR FONT, STYLE, SIZE, OR COLOR.

OWNER OF U.S. REG. NOS. 1,961,983 AND 2,961,982.

CLASS 20—FURNITURE AND ARTICLES NOT OTHERWISE CLASSIFIED

FOR PILLOWS, MATTRESSES AND CUSHIONS (U.S. CLS. 2, 13, 22, 25, 32 AND 50).

FIRST USE 1-7-2007; IN COMMERCE 1-7-2007.

CLASS 24—FABRICS

FOR BEDDING, NAMELY, PILLOW CASES AND BED LINEN (U.S. CLS. 42 AND 50).

FIRST USE 1-7-2007; IN COMMERCE 1-7-2007.

3,680,319. THE ORIGINAL CREATORS MÉXICO, S.A DE C.V., COL. LOMAS DE CHAPULTE, MEXICO. SN 77-187,565. PUB. 4-15-2008, FILED 5-22-2007.

WANNADO CITY

THE MARK CONSISTS OF STANDARD CHARACTERS WITHOUT CLAIM TO ANY PARTICULAR FONT, STYLE, SIZE, OR COLOR.

OWNER OF U.S. REG. NOS. 2,940,946, 2,973,086, AND 3,174,726.

CLASS 25—CLOTHING

FOR T-SHIRTS; HATS; POLO SHIRTS; SHIRTS (U.S. CLS. 22 AND 39).
FIRST USE 8-1-2004; IN COMMERCE 8-1-2004.

CLASS 28—TOYS AND SPORTING GOODS

FOR PLUSH TOYS (U.S. CLS. 22, 23, 38 AND 50).
FIRST USE 8-1-2004; IN COMMERCE 8-1-2004.

CLASS 41—EDUCATION AND ENTERTAINMENT

FOR ENTERTAINMENT SERVICES, NAMELY, LIVE PERFORMANCES FEATURING DANCE, COMEDY, MAGIC AND MUSIC; EDUCATIONAL SERVICES, NAMELY, PROVIDING INSTRUCTION ON PERFORMING MAGIC TRICKS; PRODUCTION OF RADIO OR TELEVISION PROGRAMS; MUSIC PRODUCTION (U.S. CLS. 100, 101 AND 107).
FIRST USE 10-0-2007; IN COMMERCE 10-0-2007.

3,680,338. THE MAGIC OF CURTIS ADAMS, INC., LAS VEGAS, NV. SN 77-194,909. PUB. 5-6-2008, FILED 5-31-2007.



CLASS 9—ELECTRICAL AND SCIENTIFIC APPARATUS

FOR PRERECORDED ELECTRONIC MEDIA FEATURING DANCE, COMEDY, MAGIC AND MUSICAL PERFORMANCES; MUSICAL VIDEO RECORDINGS FEATURING LIVE DANCE, COMEDY, MAGIC AND MUSICAL PERFORMANCES (U.S. CLS. 21, 23, 26, 36 AND 38).
FIRST USE 10-0-2007; IN COMMERCE 4-0-2007.

CLASS 14—JEWELRY

FOR JEWELRY (U.S. CLS. 2, 27, 28 AND 50).
FIRST USE 7-29-2009; IN COMMERCE 7-29-2009.

CLASS 16—PAPER GOODS AND PRINTED MATTER

FOR PRINTED MATERIALS, NAMELY, POSTERS (U.S. CLS. 2, 5, 22, 23, 29, 37, 38 AND 50).
FIRST USE 10-0-2007; IN COMMERCE 10-0-2007.

CLASS 25—CLOTHING

FOR CLOTHING, NAMELY, T-SHIRTS, SHIRTS, SWEATSHIRTS, JACKETS, AND HATS (U.S. CLS. 22 AND 39).
FIRST USE 7-29-2009; IN COMMERCE 7-29-2009.

CLASS 28—TOYS AND SPORTING GOODS

FOR PLAYING CARDS (U.S. CLS. 22, 23, 38 AND 50).
FIRST USE 7-29-2009; IN COMMERCE 7-29-2009.

3,680,343. SECOND LICENSE APPLICATION CORPORATION, D/FW AIRPORT, TX. SN 77-197,807. PUB. 11-13-2007, FILED 6-5-2007.



THE COLOR(S) BLUE, GRAY, AND GREEN IS/ARE CLAIMED AS A FEATURE OF THE MARK.

THE MARK CONSISTS OF THE WORD "IDEARC" WHICH APPEARS IN GRAY NEXT TO THREE CONCENTRIC ARCS WHICH APPEAR IN THE COLORS BLUE, GRAY AND GREEN.

CLASS 42—SCIENTIFIC AND COMPUTER SERVICES

FOR DESIGN OF WEBSITES, INCLUDING ON-LINE STORES FOR OTHERS; WEB SITE HOSTING SERVICES; COMPUTER SERVICES, NAMELY, PROVIDING SEARCH ENGINES FOR OBTAINING DATA ON THE INTERNET (U.S. CLS. 100 AND 101).
FIRST USE 11-0-2006; IN COMMERCE 11-0-2006.

CLASS 45—PERSONAL AND LEGAL SERVICES

FOR REGISTRATION OF DOMAIN NAMES FOR IDENTIFICATION OF USERS ON A GLOBAL COMPUTER NETWORK (U.S. CLS. 100 AND 101).
FIRST USE 11-0-2006; IN COMMERCE 11-0-2006.

3,680,358. CUSTOM PRESSED, LLC, LOS FELIX, CA. SN 77-208,770. PUB. 12-4-2007, FILED 6-18-2007.

FRESHPRESSED SCREEN SHOPS

THE MARK CONSISTS OF STANDARD CHARACTERS WITHOUT CLAIM TO ANY PARTICULAR FONT, STYLE, SIZE, OR COLOR.

NO CLAIM IS MADE TO THE EXCLUSIVE RIGHT TO USE "SCREEN SHOPS", APART FROM THE MARK AS SHOWN.

CLASS 16—PAPER GOODS AND PRINTED MATTER

FOR BROCHURES FEATURING INFORMATION ON GIFT-WRAPPING PAPER, DIARIES, ASSIGNMENT BOOKS, AGENDAS, PAPER FOLDERS, CALENDARS, NOTEBOOKS, NOTEPADS, FABRIC COVERED NOTEBOOKS, ADDRESS BOOKS, RING BINDERS, PHOTO ALBUMS, PAPER GIFT BAGS, CARDBOARD STORAGE BOXES, STICKERS, PRINTED PAPER LABELS; PHOTOGRAPHS, BLANK JOURNALS, JOURNAL COVERS, PAPERBACK AND HARDCOVER COMPOSITION BOOKS, AND COLORING BOOKS (U.S. CLS. 2, 5, 22, 23, 29, 37, 38 AND 50).

FIRST USE 10-15-2007; IN COMMERCE 12-3-2007.

CLASS 35—ADVERTISING AND BUSINESS

FOR RETAIL STORE SERVICES FEATURING SHIRTS, SWEATSHIRTS, TOPS, FLEECE PANTS, UNDERWEAR, T-SHIRTS, SLEEPWEAR, PAJAMAS, HEADWEAR, NAMELY, HATS, CAPS, VISORS; SOCKS, SCARVES; BANDANNAS, HEADBANDS; GIFT-WRAPPING PAPER, DIARIES, ASSIGNMENT BOOKS, AGENDAS, PAPER FOLDERS, CALENDARS, NOTEBOOKS, NOTEPADS, FABRIC-COVERED NOTEBOOKS, ADDRESS BOOKS, RING BINDERS, PHOTO ALBUMS, PAPER GIFT BAGS, CARDBOARD STORAGE BOXES, STICKERS, PRINTED PAPER LABELS; PHOTOGRAPHS, JOURNALS, JOURNAL COVERS, PAPERBACK BOOKS, HARDCOVER BOOKS, AND COLORING BOOKS, ALL OF THE ABOVE WITH SCREEN PRINTING (U.S. CLS. 100, 101 AND 102).

FIRST USE 10-15-2007; IN COMMERCE 12-17-2008.

3,680,365. FOUNDATION FOR OSTEOPOROSIS RESEARCH AND EDUCATION, OAKLAND, CA. SN 77-217,303. PUB. 12-11-2007, FILED 6-27-2007.

BONESENSE

THE MARK CONSISTS OF STANDARD CHARACTERS WITHOUT CLAIM TO ANY PARTICULAR FONT, STYLE, SIZE, OR COLOR.

CLASS 16—PAPER GOODS AND PRINTED MATTER

FOR PRINTED MATERIALS, NAMELY, BROCHURES, NEWSLETTERS IN THE FIELD OF WOMEN'S HEALTH (U.S. CLS. 2, 5, 22, 23, 29, 37, 38 AND 50).

FIRST USE 4-0-2008; IN COMMERCE 4-0-2008.

CLASS 44—MEDICAL, BEAUTY AND AGRICULTURAL SERVICES

FOR ONLINE INFORMATION SERVICES IN THE FIELD OF WOMEN'S HEALTH (U.S. CLS. 100 AND 101).

FIRST USE 5-0-2009; IN COMMERCE 5-0-2009.

3,680,373. ROBONICA (PROPRIETARY) LIMITED, ROOI-HUISKRAAL, CENTURION, SOUTH AFRICA. SN 77-225,537. PUB. 3-11-2008, FILED 7-10-2007.

ROBONI-I

THE MARK CONSISTS OF STANDARD CHARACTERS WITHOUT CLAIM TO ANY PARTICULAR FONT, STYLE, SIZE, OR COLOR.

CLASS 9—ELECTRICAL AND SCIENTIFIC APPARATUS

FOR REMOTE CONTROL UNITS, COMPUTER PROGRAMS AND DOWNLOADABLE SOFTWARE, ALL FOR USE IN OPERATING REMOTE AND RADIO CONTROLLABLE ROBOTIC TOYS AND THEIR PARTS (U.S. CLS. 21, 23, 26, 36 AND 38).

FIRST USE 5-27-2009; IN COMMERCE 5-27-2009.

CLASS 28—TOYS AND SPORTING GOODS

FOR ACTION SKILL GAMES; REMOTE CONTROLLABLE ROBOTIC TOYS AND PARTS AND ACCESSORIES THEREFOR; CONSTRUCTION KITS FOR CONSTRUCTING REMOTE CONTROLLABLE ROBOTIC TOYS; PARTS AND ACCESSORIES FOR USE WITH REMOTE CONTROLLABLE ROBOTIC TOYS SOLD AS A UNIT THERETO (U.S. CLS. 22, 23, 38 AND 50).

FIRST USE 5-27-2009; IN COMMERCE 5-27-2009.

3,680,383. THE KROGER CO. OF MICHIGAN, LIVONIA, MI. SN 77-242,346. PUB. 9-30-2008, FILED 7-30-2007.

ACTIVE LIFESTYLE

THE MARK CONSISTS OF STANDARD CHARACTERS WITHOUT CLAIM TO ANY PARTICULAR FONT, STYLE, SIZE, OR COLOR.

CLASS 5—PHARMACEUTICALS

FOR POWDERED NUTRITIONAL SUPPLEMENT DRINK MIX (U.S. CLS. 6, 18, 44, 46, 51 AND 52).

FIRST USE 10-0-2007; IN COMMERCE 10-0-2007.

CLASS 30—STAPLE FOODS

FOR OATMEAL, READY TO EAT, CEREAL DERIVED FOOD BARS AND PASTA (U.S. CL. 46).

FIRST USE 2-0-2008; IN COMMERCE 2-0-2008.

3,680,384. GUST, DAVID, CHICAGO, IL. SN 77-243,294. PUB. 2-5-2008, FILED 7-31-2007.

3,680,391. ITALIAN FOOD DEVELOPMENT CORP., MIAMI, FL. SN 77-252,078. PUB. 3-4-2008, FILED 8-10-2007.

ALOESENSE

THE MARK CONSISTS OF STANDARD CHARACTERS WITHOUT CLAIM TO ANY PARTICULAR FONT, STYLE, SIZE, OR COLOR.

OWNER OF U.S. REG. NOS. 2,667,617 AND 2,936,240.

CLASS 9—ELECTRICAL AND SCIENTIFIC APPARATUS

FOR DISPOSABLE PLASTIC GLOVES FOR LABORATORY USE (U.S. CLS. 21, 23, 26, 36 AND 38). FIRST USE 3-7-2008; IN COMMERCE 3-7-2008.

CLASS 10—MEDICAL APPARATUS

FOR GLOVES FOR MEDICAL USE (U.S. CLS. 26, 39 AND 44). FIRST USE 3-7-2008; IN COMMERCE 3-7-2008.

3,680,390. AMERICAN HOME REALTY NETWORK, INC., SAN FRANCISCO, CA. SN 77-251,566. PUB. 7-22-2008, FILED 8-9-2007.

NEIGHBORCITY

THE MARK CONSISTS OF STANDARD CHARACTERS WITHOUT CLAIM TO ANY PARTICULAR FONT, STYLE, SIZE, OR COLOR.

CLASS 35—ADVERTISING AND BUSINESS

FOR REFERRAL SERVICES IN THE FIELDS OF REAL ESTATE BROKERAGE SERVICES AND MORTGAGE LENDING SERVICES (U.S. CLS. 100, 101 AND 102). FIRST USE 9-10-2007; IN COMMERCE 9-10-2007.

CLASS 36—INSURANCE AND FINANCIAL

FOR PROVIDING INFORMATION IN THE FIELD OF REAL ESTATE, NAMELY, REAL ESTATE LISTINGS AND REAL ESTATE LENDING SERVICES VIA THE INTERNET (U.S. CLS. 100, 101 AND 102). FIRST USE 9-10-2007; IN COMMERCE 9-10-2007.

MAMMA CHE BUONO

THE MARK CONSISTS OF STANDARD CHARACTERS WITHOUT CLAIM TO ANY PARTICULAR FONT, STYLE, SIZE, OR COLOR.

THE FOREIGN WORDING IN THE MARK TRANSLATES INTO ENGLISH AS MAMMA IT IS SO GOOD.

CLASS 30—STAPLE FOODS

FOR FOOD PRODUCTS, NAMELY, GELATO, ICE CREAM, PASTRIES, AND COFFEE (U.S. CL. 46). FIRST USE 7-25-2008; IN COMMERCE 7-25-2008.

CLASS 35—ADVERTISING AND BUSINESS

FOR FOOD KIOSK SERVICES; RETAIL STORE SERVICES FEATURING BOOKS, NEWSPAPERS, AND MAGAZINES (U.S. CLS. 100, 101 AND 102). FIRST USE 7-25-2008; IN COMMERCE 7-25-2008.

CLASS 38—COMMUNICATION

FOR INTERNET CAFE SERVICES, NAMELY, PROVIDING TELECOMMUNICATIONS CONNECTIONS TO THE INTERNET IN CAFE ENVIRONMENT (U.S. CLS. 100, 101 AND 104). FIRST USE 7-25-2008; IN COMMERCE 7-25-2008.

CLASS 41—EDUCATION AND ENTERTAINMENT

FOR ENTERTAINMENT SERVICES, NAMELY, LIVE PERFORMANCES BY CLOWNS, MAGICIANS, PUPPETEERS, STORYTELLERS, MUSICIANS, MIMICS, JUGGLERS, MIMES, COMEDIANS, ARTISTS, AND ENTERTAINERS, FACE PAINTING; CHILDREN'S AMUSEMENT CENTERS, NAMELY, INTERACTIVE PLAY AREAS (U.S. CLS. 100, 101 AND 107). FIRST USE 7-25-2008; IN COMMERCE 7-25-2008.

CLASS 43—HOTEL AND RESTAURANT SERVICES

FOR CAFE, COFFEE SHOP, RESTAURANT SERVICES (U.S. CLS. 100 AND 101). FIRST USE 7-25-2008; IN COMMERCE 7-25-2008.

3,680,392. ITALIAN FOOD DEVELOPMENT CORP., MIAMI, FL. SN 77-252,545. PUB. 3-4-2008, FILED 8-10-2007.



THE MARK CONSISTS OF A SMILEY FACE WITH ITS TONGUE STICKING OUT OF THE CORNER OF ITS MOUTH WITH THE WORDS "MAMMA CHE BUONO!"

ACROSS ITS FACE.

THE FOREIGN WORDING IN THE MARK TRANSLATES INTO ENGLISH AS MAMMA IT IS SO GOOD.

CLASS 30—STAPLE FOODS

FOR FOOD PRODUCTS, NAMELY, GELATO, ICE CREAM, PASTRIES, AND COFFEE (U.S. CL. 46).
FIRST USE 7-25-2008; IN COMMERCE 7-25-2008.

CLASS 35—ADVERTISING AND BUSINESS

FOR FOOD KIOSK SERVICES; RETAIL STORE SERVICES FEATURING BOOKS, NEWSPAPERS, AND MAGAZINES (U.S. CLS. 100, 101 AND 102).
FIRST USE 7-25-2008; IN COMMERCE 7-25-2008.

CLASS 38—COMMUNICATION

FOR INTERNET CAFE SERVICES, NAMELY, PROVIDING TELECOMMUNICATIONS CONNECTIONS TO THE INTERNET IN CAFE ENVIRONMENT (U.S. CLS. 100, 101 AND 104).
FIRST USE 7-25-2008; IN COMMERCE 7-25-2008.

CLASS 41—EDUCATION AND ENTERTAINMENT

FOR ENTERTAINMENT SERVICES, NAMELY, LIVE PERFORMANCES BY CLOWNS, MAGICIANS, PUPPETEERS, STORYTELLERS, MUSICIANS, MIMICS, JUGGLERS, MIMES, COMEDIANS, ARTISTS, AND ENTERTAINERS; FACE PAINTING; CHILDREN'S AMUSEMENT CENTERS, NAMELY, INTERACTIVE PLAY AREAS (U.S. CLS. 100, 101 AND 107).
FIRST USE 7-25-2008; IN COMMERCE 7-25-2008.

CLASS 43—HOTEL AND RESTAURANT SERVICES

FOR CAFE, COFFEE SHOP, RESTAURANT SERVICES (U.S. CLS. 100 AND 101).
FIRST USE 7-25-2008; IN COMMERCE 7-25-2008.

3,680,395. TEXT PILOT LLC, DBA HITUP.COM, SAN FRANCISCO, CA. SN 77-256,468. PUB. 8-19-2008, FILED 8-15-2007.

hit up

THE MARK CONSISTS OF STANDARD CHARACTERS WITHOUT CLAIM TO ANY PARTICULAR FONT, STYLE, SIZE, OR COLOR.

CLASS 38—COMMUNICATION

FOR PROVIDING ONLINE ELECTRONIC BULLETIN BOARDS FOR REAL-TIME INTERACTION AND FUNCTIONALITY AMONG USERS OF COMPUTERS, MOBILE AND HANDHELD COMPUTERS, AND WIRED AND WIRELESS COMMUNICATION DEVICES IN THE FIELD OF GENERAL INTEREST; PROVIDING ON-LINE FORUMS FOR TRANSMISSION OF MESSAGES AMONG USERS IN THE FIELD OF GENERAL INTEREST; PROVIDING E-MAIL AND INSTANT MESSAGING SERVICES (U.S. CLS. 100, 101 AND 104).
FIRST USE 8-15-2007; IN COMMERCE 8-15-2007.

CLASS 45—PERSONAL AND LEGAL SERVICES

FOR INTERNET BASED SOCIAL NETWORKING SERVICES (U.S. CLS. 100 AND 101).
FIRST USE 8-15-2007; IN COMMERCE 8-15-2007.

3,680,405. ORIGINS NATURAL RESOURCES INC., NEW YORK, NY. SN 77-271,851. PUB. 2-19-2008, FILED 9-5-2007.

YOU ARE WHAT YOUR SKIN EATS

THE MARK CONSISTS OF STANDARD CHARACTERS WITHOUT CLAIM TO ANY PARTICULAR FONT, STYLE, SIZE, OR COLOR.

CLASS 35—ADVERTISING AND BUSINESS

FOR ON-LINE RETAIL STORE SERVICES FEATURING PERSONAL CARE PRODUCTS, COSMETICS, COSMECEUTICALS, TOILETRIES, ESSENTIAL OILS, BATH AND BODY PRODUCTS, MEDICATED AND NON-MEDICATED SKIN CARE PREPARATIONS, HAIR CARE PREPARATIONS; RETAIL STORE SERVICES FEATURING PERSONAL CARE PRODUCTS, COSMETICS, COSMECEUTICALS, TOILETRIES, ESSENTIAL OILS, BATH AND BODY PRODUCTS, MEDICATED AND NON-MEDICATED SKIN CARE PREPARATIONS, HAIR CARE PREPARATIONS; PROVIDING CONSUMER INFORMATION IN THE FIELD OF BEAUTY, NAMELY, REGARDING THE USE AND SELECTION OF PERSONAL CARE PRODUCTS, COSMETICS, COSMECEUTICALS, TOILETRIES, ESSENTIAL OILS, BATH AND BODY PRODUCTS, MEDICATED AND NON-MEDICATED SKIN CARE PREPARATIONS, HAIR CARE PREPARATIONS (U.S. CLS. 100, 101 AND 102).
FIRST USE 10-1-2007; IN COMMERCE 10-1-2007.

CLASS 44—MEDICAL, BEAUTY AND AGRICULTURAL SERVICES

FOR CONSULTATION SERVICES IN THE FIELD OF MAKEUP, NAMELY, ON-LINE MAKEUP CONSULTATION SERVICES AND IN-PERSON MAKEUP CONSULTATION AND APPLICATION SERVICES (U.S. CLS. 100 AND 101).
FIRST USE 10-1-2007; IN COMMERCE 10-1-2007.

3,680,406. VEYANCE TECHNOLOGIES, INC., FAIRLAWN, OH. SN 77-272,126. PUB. 9-30-2008, FILED 9-5-2007.

VEYANCE

THE MARK CONSISTS OF STANDARD CHARACTERS WITHOUT CLAIM TO ANY PARTICULAR FONT, STYLE, SIZE, OR COLOR.

CLASS 35—ADVERTISING AND BUSINESS

FOR RETAIL STORE SERVICES AND DISTRIBUTION OF ENGINEERED PRODUCTS MANUFACTURED BY OTHERS, NAMELY, CONVEYOR BELTS, SPlicing MATERIALS FOR CONVEYOR BELTS, POWER TRANSMISSION BELTS, RUBBER, POLY-VINYL CHLORIDE, AND PLASTIC INDUSTRIAL HOSE AND ASSOCIATED FITTINGS, HYDRAULIC HOSE, FITTINGS, CRIMPERS, AUTOMOTIVE BELTS, TENSIONERS, HOSE AND HOSE ACCESSORIES, COMMERCIAL TRUCK BELTS, AND TENSIONERS, GARDEN HOSE, LAWN MOWER BELTS, POWER TRANSMISSION BELTS FOR ALL TERRAIN VEHICLES, POWER TRANSMISSION BELTS FOR SNOWMOBILES (U.S. CLS. 100, 101 AND 102).

FIRST USE 8-1-2007; IN COMMERCE 8-1-2007.

CLASS 40—MATERIAL TREATMENT

FOR MANUFACTURING SERVICES FOR OTHERS IN THE FIELD OF ENGINEERED PRODUCTS, NAMELY, CONVEYOR BELTS, SPlicing MATERIALS FOR CONVEYOR BELTS, POWER TRANSMISSION BELTS, RUBBER, POLY-VINYL CHLORIDE, AND PLASTIC INDUSTRIAL HOSE AND ASSOCIATED FITTINGS, HYDRAULIC HOSE, FITTINGS, CRIMPERS, AUTOMOTIVE BELTS, TENSIONERS, HOSE AND HOSE ACCESSORIES, COMMERCIAL TRUCK BELTS, HOSE AND HOSE ACCESSORIES, AIR SPRINGS, AND TENSIONERS, GARDEN HOSE, LAWN MOWER BELTS, POWER TRANSMISSION BELTS FOR ALL TERRAIN VEHICLES, POWER TRANSMISSION BELTS FOR SNOWMOBILES (U.S. CLS. 100, 103 AND 106).

FIRST USE 8-1-2007; IN COMMERCE 8-1-2007.

3,680,442. HECHO LATINO, INC., DALLAS, TX. SN 77-295,895. PUB. 5-20-2008, FILED 10-4-2007.

D'HECHOS

THE MARK CONSISTS OF STANDARD CHARACTERS WITHOUT CLAIM TO ANY PARTICULAR FONT, STYLE, SIZE, OR COLOR.

THE WORDING "D'HECHOS" HAS NO MEANING IN A FOREIGN LANGUAGE.

CLASS 14—JEWELRY

FOR JEWELRY, NAMELY, BRACELETS AND NECKLACES (U.S. CLS. 2, 27, 28 AND 50).

FIRST USE 8-9-2008; IN COMMERCE 8-9-2008.

CLASS 25—CLOTHING

FOR CLOTHING, NAMELY, HATS, CAPS, VISORS, SHIRTS, T-SHIRTS, TANK-TOPS, KNIT TOPS, WOVEN TOPS, HALTER TOPS, SWIMWEAR, UNDERWEAR, BOXER SHORTS, DRESSES, SKIRTS, BELTS, FOOTWEAR, SWEATERS, VESTS, SCARVES AND TIES (U.S. CLS. 22 AND 39).

FIRST USE 8-9-2008; IN COMMERCE 8-9-2008.

CLASS 35—ADVERTISING AND BUSINESS

FOR RETAIL STORE SERVICES, ON-LINE RETAIL STORE SERVICES AND MAIL ORDER CATALOG SERVICES FEATURING CLOTHING AND JEWELRY (U.S. CLS. 100, 101 AND 102).

FIRST USE 8-9-2008; IN COMMERCE 8-9-2008.

3,680,443. HECHO LATINO, INC., DALLAS, TX. SN 77-297,116. PUB. 3-25-2008, FILED 10-5-2007.

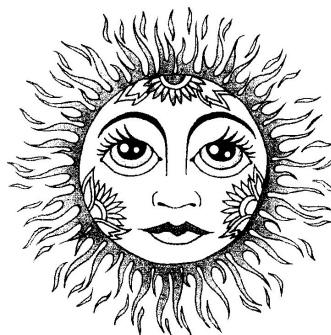

THE MARK CONSISTS OF A SUN WITH A FACE (EYES, MOUTH, EYEBROWS, EYELASHES AND NOSE) AND FLOWERS SURROUNDED BY FLAMES.

CLASS 14—JEWELRY

FOR JEWELRY, NAMELY, BRACELETS AND NECKLACES (U.S. CLS. 2, 27, 28 AND 50).

FIRST USE 8-9-2008; IN COMMERCE 8-9-2008.

CLASS 25—CLOTHING

FOR CLOTHING, NAMELY, HATS, CAPS, VISORS, SHIRTS, T-SHIRTS, TANK-TOPS, KNIT TOPS, WOVEN TOPS, HALTER TOPS, SWIMWEAR, UNDERWEAR, BOXER SHORTS, DRESSES, SKIRTS, BELTS, FOOTWEAR, SWEATERS, VESTS, SCARVES AND TIES (U.S. CLS. 22 AND 39).

FIRST USE 8-9-2008; IN COMMERCE 8-9-2008.

CLASS 35—ADVERTISING AND BUSINESS

FOR RETAIL STORE SERVICES FEATURING CLOTHING AND JEWELRY PROVIDED IN APPLICANT'S STORES, CATALOGS AND ONLINE WEBSITE (U.S. CLS. 100, 101 AND 102).

FIRST USE 8-9-2008; IN COMMERCE 8-9-2008.

3,680,446. C. R. BARD, INC., MURRAY HILL, NJ. SN 77-299,640. PUB. 7-29-2008, FILED 10-9-2007.

SIMETRY

THE MARK CONSISTS OF STANDARD CHARACTERS WITHOUT CLAIM TO ANY PARTICULAR FONT, STYLE, SIZE, OR COLOR.

CLASS 16—PAPER GOODS AND PRINTED MATTER

FOR PRINTED INSTRUCTIONAL, EDUCATIONAL, AND TEACHING MATERIALS, AND PRINTED MAGAZINES, ALL REGARDING BRACHYTHERAPY PRODUCTS, EQUIPMENT AND PROCEDURES AND FEATURING DEMONSTRATIVE INFORMATION RELATING THERETO (U.S. CLS. 2, 5, 22, 23, 29, 37, 38 AND 50).

FIRST USE 12-0-2007; IN COMMERCE 12-0-2007.

CLASS 41—EDUCATION AND ENTERTAINMENT

FOR PROVIDING INFORMATION, CONSULTATION, INSTRUCTION AND EDUCATIONAL SERVICES, ALL IN THE NATURE OF TRAINING AND INSTRUCTION ON HOW TO USE BRACHYTHERAPY PRODUCTS AND EQUIPMENT AND HOW TO PERFORM BRACHYTHERAPY PROCEDURES (U.S. CLS. 100, 101 AND 107).
FIRST USE 12-0-2007; IN COMMERCE 12-0-2007.

3,680,449. FORTE INTERNET SOFTWARE, INC., ESCONDI-
DO, CA. SN 77-299,962. PUB. 7-8-2008, FILED 10-9-2007.

IPANELS

THE MARK CONSISTS OF STANDARD CHARACTERS WITHOUT CLAIM TO ANY PARTICULAR FONT, STYLE, SIZE, OR COLOR.

CLASS 38—COMMUNICATION

FOR PROVIDING AND MANAGING SOCIAL NETWORKS FOR OTHERS, NAMELY, PROVIDING COMMUNICATION BY MOBILE PHONE, VOICEMAIL ON A MULTIMEDIA AND GLOBAL COMPUTER NETWORK (U.S. CLS. 100, 101 AND 104).
FIRST USE 3-24-2007; IN COMMERCE 10-3-2008.

CLASS 41—EDUCATION AND ENTERTAINMENT

FOR BLOGS FEATURING ONLINE FORUMS AND COMMENTARY IN THE FIELDS OF SOCIAL STUDIES AND ENTERTAINMENT (U.S. CLS. 100, 101 AND 107).
FIRST USE 3-24-2007; IN COMMERCE 10-3-2008.

3,680,450. GUARDIAN TELEVISION ENTERPRISES, INC.,
COLUMBUS, OH. SN 77-300,575. PUB. 3-25-2008, FILED
10-10-2007.



NO CLAIM IS MADE TO THE EXCLUSIVE RIGHT TO USE "NETWORK", APART FROM THE MARK AS SHOWN.
THE MARK CONSISTS OF THE CHARACTERS ".2 NETWORK" WITHIN A CIRCLE.

CLASS 38—COMMUNICATION

FOR TELEVISION BROADCASTING (U.S. CLS. 100, 101 AND 104).
FIRST USE 6-8-2009; IN COMMERCE 6-8-2009.

CLASS 41—EDUCATION AND ENTERTAINMENT

FOR PRODUCTION AND DISTRIBUTION OF TELEVISION SHOWS AND MOVIES (U.S. CLS. 100, 101 AND 107).
FIRST USE 6-8-2009; IN COMMERCE 6-8-2009.

3,680,451. GUARDIAN TELEVISION ENTERPRISES, INC.,
COLUMBUS, OH. SN 77-300,592. PUB. 3-25-2008, FILED
10-10-2007.



NO CLAIM IS MADE TO THE EXCLUSIVE RIGHT TO USE "NETWORK", APART FROM THE MARK AS SHOWN.
THE MARK CONSISTS OF THE CHARACTERS ".3 NETWORK" WITHIN A CIRCLE.

CLASS 38—COMMUNICATION

FOR TELEVISION BROADCASTING (U.S. CLS. 100, 101 AND 104).
FIRST USE 6-8-2009; IN COMMERCE 6-8-2009.

CLASS 41—EDUCATION AND ENTERTAINMENT

FOR PRODUCTION AND DISTRIBUTION OF TELEVISION SHOWS AND MOVIES (U.S. CLS. 100, 101 AND 107).
FIRST USE 6-8-2009; IN COMMERCE 6-8-2009.

3,680,452. GUARDIAN TELEVISION ENTERPRISES, INC.,
COLUMBUS, OH. SN 77-300,606. PUB. 3-25-2008, FILED
10-10-2007.

DOT 2 NETWORK

THE MARK CONSISTS OF STANDARD CHARACTERS WITHOUT CLAIM TO ANY PARTICULAR FONT, STYLE, SIZE, OR COLOR.

NO CLAIM IS MADE TO THE EXCLUSIVE RIGHT TO USE "NETWORK", APART FROM THE MARK AS SHOWN.

CLASS 38—COMMUNICATION

FOR TELEVISION BROADCASTING (U.S. CLS. 100, 101 AND 104).
FIRST USE 6-8-2009; IN COMMERCE 6-8-2009.

CLASS 41—EDUCATION AND ENTERTAINMENT

FOR PRODUCTION AND DISTRIBUTION OF TELEVISION SHOWS AND MOVIES (U.S. CLS. 100, 101 AND 107).
FIRST USE 6-8-2009; IN COMMERCE 6-8-2009.

3,680,453. GUARDIAN TELEVISION ENTERPRISES, INC., COLUMBUS, OH. SN 77-300,617. PUB. 3-25-2008, FILED 10-10-2007.

DOT 3 NETWORK

THE MARK CONSISTS OF STANDARD CHARACTERS WITHOUT CLAIM TO ANY PARTICULAR FONT, STYLE, SIZE, OR COLOR.

NO CLAIM IS MADE TO THE EXCLUSIVE RIGHT TO USE "NETWORK", APART FROM THE MARK AS SHOWN.

CLASS 38—COMMUNICATION

FOR TELEVISION BROADCASTING (U.S. CLS. 100, 101 AND 104).
FIRST USE 6-8-2009; IN COMMERCE 6-8-2009.

CLASS 41—EDUCATION AND ENTERTAINMENT

FOR PRODUCTION AND DISTRIBUTION OF TELEVISION SHOWS AND MOVIES (U.S. CLS. 100, 101 AND 107).
FIRST USE 6-8-2009; IN COMMERCE 6-8-2009.

3,680,454. GUARDIAN TELEVISION ENTERPRISES, INC., COLUMBUS, OH. SN 77-300,635. PUB. 3-25-2008, FILED 10-10-2007.

POINT 2 NETWORK

THE MARK CONSISTS OF STANDARD CHARACTERS WITHOUT CLAIM TO ANY PARTICULAR FONT, STYLE, SIZE, OR COLOR.

NO CLAIM IS MADE TO THE EXCLUSIVE RIGHT TO USE "NETWORK", APART FROM THE MARK AS SHOWN.

CLASS 38—COMMUNICATION

FOR TELEVISION BROADCASTING (U.S. CLS. 100, 101 AND 104).
FIRST USE 6-8-2009; IN COMMERCE 6-8-2009.

CLASS 41—EDUCATION AND ENTERTAINMENT

FOR PRODUCTION AND DISTRIBUTION OF TELEVISION SHOWS AND MOVIES (U.S. CLS. 100, 101 AND 107).
FIRST USE 6-8-2009; IN COMMERCE 6-8-2009.

3,680,455. GUARDIAN TELEVISION ENTERPRISES, INC., COLUMBUS, OH. SN 77-300,641. PUB. 3-25-2008, FILED 10-10-2007.

POINT 3 NETWORK

THE MARK CONSISTS OF STANDARD CHARACTERS WITHOUT CLAIM TO ANY PARTICULAR FONT, STYLE, SIZE, OR COLOR.

NO CLAIM IS MADE TO THE EXCLUSIVE RIGHT TO USE "NETWORK", APART FROM THE MARK AS SHOWN.

CLASS 38—COMMUNICATION

FOR TELEVISION BROADCASTING (U.S. CLS. 100, 101 AND 104).
FIRST USE 6-8-2009; IN COMMERCE 6-8-2009.

CLASS 41—EDUCATION AND ENTERTAINMENT

FOR PRODUCTION AND DISTRIBUTION OF TELEVISION SHOWS AND MOVIES (U.S. CLS. 100, 101 AND 107).
FIRST USE 6-8-2009; IN COMMERCE 6-8-2009.

3,680,459. SECURITIES INDUSTRY AND FINANCIAL MARKETS ASSOCIATION, NEW YORK, NY. SN 77-303,329. PUB. 4-1-2008, FILED 10-12-2007.

ASF

THE MARK CONSISTS OF STANDARD CHARACTERS WITHOUT CLAIM TO ANY PARTICULAR FONT, STYLE, SIZE, OR COLOR.

OWNER OF U.S. REG. NOS. 2,789,970 AND 3,358,424.

CLASS 16—PAPER GOODS AND PRINTED MATTER

FOR BOOKS, JOURNALS, PAMPHLETS, NEWSLETTERS, COURSE BOOKS, STUDIES, DATABASE REPORTS AND BROCHURES, ALL PERTAINING TO THE SECURITIZATION INDUSTRY (U.S. CLS. 2, 5, 22, 23, 29, 37, 38 AND 50).
FIRST USE 2-1-2008; IN COMMERCE 9-5-2003.

CLASS 35—ADVERTISING AND BUSINESS

FOR ASSOCIATION SERVICES, NAMELY, REPRESENTING AND PROMOTING THE INTERESTS AND OBJECTIVES OF PARTICIPANTS IN THE SECURITIZATION INDUSTRY ON ISSUES MATERIAL TO THE INDUSTRY (U.S. CLS. 100, 101 AND 102).

FIRST USE 2-1-2002; IN COMMERCE 9-5-2003.

CLASS 41—EDUCATION AND ENTERTAINMENT

FOR EDUCATIONAL SERVICES, NAMELY, CONDUCTING CONFERENCES, PROGRAMS AND SEMINARS IN THE FIELD OF SECURITIZATION, SECURITIES AND FINANCIAL MARKETS (U.S. CLS. 100, 101 AND 107).

FIRST USE 2-1-2002; IN COMMERCE 9-5-2003.

3,680,462. STRANDS, INC., CORVALLIS, OR. SN 77-306,002.
PUB. 11-4-2008, FILED 10-17-2007.

STRANDS

THE MARK CONSISTS OF STANDARD CHARACTERS WITHOUT CLAIM TO ANY PARTICULAR FONT, STYLE, SIZE, OR COLOR.

OWNER OF U.S. REG. NOS. 3,198,805, 3,198,807, AND OTHERS.

CLASS 9—ELECTRICAL AND SCIENTIFIC APPARATUS

FOR COMPUTER SOFTWARE FOR CREATING INDICES OF MEDIA CONTENT AND DATA; DOWNLOADABLE COMPUTER SOFTWARE FOR SEARCHING, RETRIEVING AND ACCESSING MEDIA CONTENT AND DATA VIA A GLOBAL COMPUTER NETWORK; COMPUTER SOFTWARE TO ENABLE PEER-TO-PEER NETWORKING AND DATA SHARING VIA ELECTRONIC COMMUNICATIONS NETWORKS; SEARCH ENGINE SOFTWARE; COMPUTER SOFTWARE FOR CONDUCTING AND COORDINATING REAL-TIME AND ASYNCHRONOUS COMMUNICATIONS AMONG COMPUTER USERS SHARING INFORMATION AND AUDIO DATA VIA ELECTRONIC COMMUNICATIONS NETWORKS (U.S. CLS. 21, 23, 26, 36 AND 38).

FIRST USE 5-28-2008; IN COMMERCE 5-28-2008.

CLASS 35—ADVERTISING AND BUSINESS

FOR ADVERTISING SERVICES, NAMELY, PROMOTING THE GOODS AND SERVICES OF OTHERS BY PROVIDING HYPERTEXT LINKS TO THE WEB SITES OF OTHERS; PROMOTING THE GOODS AND SERVICES OF OTHERS BY PROVIDING A WEB SITE WHICH FEATURES ADVERTISEMENTS FOR THE GOODS AND SERVICES OF OTHERS ON A GLOBAL COMPUTER NETWORK; BUSINESS SERVICES, NAMELY, PROVIDING CONSUMER PRODUCT INFORMATION VIA THE INTERNET AND ELECTRONIC COMMUNICATION NETWORKS (U.S. CLS. 100, 101 AND 102).

FIRST USE 5-28-2008; IN COMMERCE 5-28-2008.

CLASS 38—COMMUNICATION

FOR ELECTRONIC TRANSMISSION AND RECEPTION OF MUSIC AND DATA OVER A GLOBAL COMPUTER NETWORK AND ELECTRONIC COMMUNICATION NETWORKS (U.S. CLS. 100, 101 AND 104).

FIRST USE 5-28-2008; IN COMMERCE 5-28-2008.

CLASS 41—EDUCATION AND ENTERTAINMENT

FOR ELECTRONIC PUBLISHING SERVICES, NAMELY, PUBLICATION OF THE USER-CREATED TEXT, AUDIO, VIDEO, AND GRAPHIC WORKS OF OTHERS ONLINE FEATURING CURRENT EVENTS AND ENTERTAINMENT; ONLINE JOURNALS, NAMELY, BLOGS FEATURING CURRENT EVENTS AND ENTERTAINMENT (U.S. CLS. 100, 101 AND 107).

FIRST USE 5-28-2008; IN COMMERCE 5-28-2008.

CLASS 42—SCIENTIFIC AND COMPUTER SERVICES

FOR APPLICATION SERVICE PROVIDER (ASP) FEATURING SOFTWARE FOR SEARCHING, RETRIEVING AND ACCESSING MEDIA CONTENT AND DATA (U.S. CLS. 100 AND 101).

FIRST USE 5-28-2008; IN COMMERCE 5-28-2008.

3,680,463. IHD PUBLISHING, LLC, EDNA, TX. SN 77-306,191.
PUB. 9-23-2008, FILED 10-17-2007.



THE COLOR(S) BLACK, BLUE, RED, GREEN, YELLOW, BROWN, WHITE, LIGHT BLUE AND GRAY IS/ARE CLAIMED AS A FEATURE OF THE MARK.

THE COLOR BLACK APPEARS IN THE HAT, PUPILS, MOUSTACHE, CAPE, BODY-SPOTS, BOOTS AND OUTLINES OF THE CHARACTER DETAILS IN THE MARK. THE COLOR BLUE APPEARS IN THE HAT BAND. THE COLOR RED APPEARS IN THE CAPE LINING, NOSE, AND TONGUE. THE COLOR GREEN APPEARS IN THE BODY OF THE CHARACTER. THE COLOR YELLOW APPEARS IN THE EYES AND VEST. THE COLOR BROWN APPEARS IN THE VEST AND HANDLES FOR THE PICK AND SHOVELS. THE COLOR GRAY APPEARS IN THE HAT, BOOTS, PICK AND SHOVEL. THE COLOR LIGHT BLUE APPEARS IN THE GLOVES AND BOOTS OF THE CHARACTER. THE COLOR WHITE APPEARS AS SHADING THROUGHOUT THE CHARACTER DESIGN.

CLASS 9—ELECTRICAL AND SCIENTIFIC APPARATUS

FOR DOWNLOADABLE EDUCATIONAL MATERIALS, NAMELY, BOOKS, COLORING BOOKS, LESSON PLANS, POSTERS, AND STICKERS, ALL PROMOTING DENTAL HEALTH FOR CHILDREN (U.S. CLS. 21, 23, 26, 36 AND 38).

FIRST USE 6-16-2009; IN COMMERCE 6-16-2009.

CLASS 16—PAPER GOODS AND PRINTED MATTER

FOR PRINTED EDUCATIONAL MATERIALS, NAMELY, BOOKS, COLORING BOOKS, LESSON PLANS, POSTERS, AND STICKERS, ALL PROMOTING DENTAL HEALTH FOR CHILDREN (U.S. CLS. 2, 5, 22, 23, 29, 37, 38 AND 50).

FIRST USE 6-16-2009; IN COMMERCE 6-16-2009.

CLASS 44—MEDICAL, BEAUTY AND AGRICULTURAL SERVICES

FOR INFORMATIONAL SERVICES, NAMELY, PROVIDING AN INTERACTIVE WEBSITE FEATURING INFORMATION ABOUT DENTAL HEALTH FOR CHILDREN AND PARENTS (U.S. CLS. 100 AND 101).

FIRST USE 6-16-2009; IN COMMERCE 6-16-2009.

CLASS 16—PAPER GOODS AND PRINTED MATTER

FOR PRINTED EDUCATIONAL MATERIALS, NAMELY, BOOKS, COLORING BOOKS, LESSON PLANS, POSTERS, AND STICKERS, ALL PROMOTING DENTAL HEALTH FOR CHILDREN (U.S. CLS. 2, 5, 22, 23, 29, 37, 38 AND 50).

FIRST USE 6-16-2009; IN COMMERCE 6-16-2009.

CLASS 44—MEDICAL, BEAUTY AND AGRICULTURAL SERVICES

FOR INFORMATIONAL SERVICES, NAMELY, PROVIDING AN INTERACTIVE WEBSITE FEATURING INFORMATION ABOUT DENTAL HEALTH FOR CHILDREN AND PARENTS (U.S. CLS. 100 AND 101).

FIRST USE 6-16-2009; IN COMMERCE 6-16-2009.

3,680,464. IHD PUBLISHING, LLC, EDNA, TX. SN 77-306,227. PUB. 9-23-2008, FILED 10-17-2007.



THE COLOR(S) GOLD, BROWN, BLACK, BLUE, RED, WHITE AND TAN IS/ARE CLAIMED AS A FEATURE OF THE MARK.

THE COLOR BLACK APPEARS IN THE PUPILS, HAT AND OUTLINES OF THE FEATURES OF THE CHARACTER DESIGN. THE COLOR BLUE IS IN THE BODY, EYES, GLOVES, TEETH, BOOTS AND ROPE OF THE CHARACTER. THE COLOR RED IS IN THE HAT BAND, NOSE, TONGUE, STAR AND BOOTS OF THE CHARACTER. THE COLOR BROWN IS IN THE HAT. THE COLOR TAN IS IN THE GLOVES OF THE CHARACTER. THE COLOR GOLD IS LOCATED IN THE "R" ON THE CHARACTER'S HAT.

CLASS 9—ELECTRICAL AND SCIENTIFIC APPARATUS

FOR DOWNLOADABLE EDUCATIONAL MATERIALS, NAMELY, BOOKS, COLORING BOOKS, LESSON PLANS, POSTERS, AND STICKERS, ALL PROMOTING DENTAL HEALTH FOR CHILDREN (U.S. CLS. 21, 23, 26, 36 AND 38).

FIRST USE 6-16-2009; IN COMMERCE 6-16-2009.

3,680,465. IHD PUBLISHING, LLC, EDNA, TX. SN 77-306,244. PUB. 9-23-2008, FILED 10-17-2007.



THE COLOR(S) RED, WHITE, BLUE, TAN, BLACK, LIGHT BLUE AND GRAY IS/ARE CLAIMED AS A FEATURE OF THE MARK.

THE COLOR RED APPEARS IN THE CAP, FACE, NOSE, LIPS AND DRESS SASH OF THE CHARACTER. THE COLOR LIGHT BLUE APPEARS IN THE HAIR, EYES, COLOR AND HEMLINE OF THE DRESS ON THE CHARACTER. THE COLOR WHITE APPEARS IN THE CAP, HAIR, EYES, FACE, TEETH, DRESS STRIPES, DRESS HEM AND BOOTS OF THE CHARACTER. THE COLOR BLUE APPEARS IN THE BODY OF THE DRESS. THE COLOR TAN APPEARS IN THE FACE. THE COLOR GRAY APPEARS IN THE BOOTS. THE COLOR BLACK APPEARS IN THE PUPILS, BOOTS AND OUTLINES OF THE CHARACTER DETAILS IN THE MARK.

CLASS 9—ELECTRICAL AND SCIENTIFIC APPARATUS

FOR DOWNLOADABLE EDUCATIONAL MATERIALS, NAMELY, BOOKS, COLORING BOOKS, LESSON PLANS, POSTERS, AND STICKERS, ALL PROMOTING DENTAL HEALTH FOR CHILDREN (U.S. CLS. 21, 23, 26, 36 AND 38).

FIRST USE 6-16-2009; IN COMMERCE 6-16-2009.

CLASS 16—PAPER GOODS AND PRINTED MATTER

FOR PRINTED EDUCATIONAL MATERIALS, NAMELY, BOOKS, COLORING BOOKS, LESSON PLANS, POSTERS, AND STICKERS, ALL PROMOTING DENTAL HEALTH FOR CHILDREN (U.S. CLS. 2, 5, 22, 23, 29, 37, 38 AND 50).

FIRST USE 6-16-2009; IN COMMERCE 6-16-2009.

CLASS 44—MEDICAL, BEAUTY AND AGRICULTURAL SERVICES

FOR INFORMATIONAL SERVICES, NAMELY, PROVIDING AN INTERACTIVE WEBSITE FEATURING INFORMATION ABOUT DENTAL HEALTH FOR CHILDREN AND PARENTS (U.S. CLS. 100 AND 101).
FIRST USE 6-16-2009; IN COMMERCE 6-16-2009.

3,680,468. SHESCONNECTED MULTIMEDIA CORP., FRAMINGHAM, MA. SN 77-307,508. PUB. 5-13-2008, FILED 10-18-2007.

3,680,466. IHD PUBLISHING, LLC, EDNA, TX. SN 77-306,266.
PUB. 9-23-2008, FILED 10-17-2007.



THE COLOR(S) BROWN, BLACK, BLUE, RED, WHITE AND TAN IS/ARE CLAIMED AS A FEATURE OF THE MARK.

THE COLOR BLACK APPEARS IN THE PUPILS AND OUTLINES OF THE FEATURES OF THE CHARACTER DESIGN. THE COLOR BLUE IS IN THE ARMS, BRISTLES, TUBE, GLOVES, AND TEETH. THE COLOR WHITE IS IN THE HAT, EYES, GLOVES, TEETH, ARMS, BODY, AND TUBE. THE COLOR RED IS IN THE HAT BAND, NOSE, SCARF, TUBE CAP AND BODY. THE COLORS BROWN AND TAN ARE IN THE HAT, BOOTS, HOLSTER AND BELT OF THE CHARACTER.

CLASS 9—ELECTRICAL AND SCIENTIFIC APPARATUS

FOR DOWNLOADABLE EDUCATIONAL MATERIALS, NAMELY, BOOKS, COLORING BOOKS, LESSON PLANS, POSTERS, AND STICKERS, ALL PROMOTING DENTAL HEALTH FOR CHILDREN (U.S. CLS. 21, 23, 26, 36 AND 38).

FIRST USE 6-16-2009; IN COMMERCE 6-16-2009.

CLASS 16—PAPER GOODS AND PRINTED MATTER

FOR PRINTED EDUCATIONAL MATERIALS, NAMELY, BOOKS, COLORING BOOKS, LESSON PLANS, POSTERS, AND STICKERS, ALL PROMOTING DENTAL HEALTH FOR CHILDREN (U.S. CLS. 2, 5, 22, 36, 37, 38 AND 50).

FIRST USE 6-16-2009; IN COMMERCE 6-16-2009.

CLASS 44—MEDICAL, BEAUTY AND AGRICULTURAL SERVICES

FOR INFORMATIONAL SERVICES, NAMELY, PROVIDING AN INTERACTIVE WEBSITE FEATURING INFORMATION ABOUT DENTAL HEALTH FOR CHILDREN AND PARENTS (U.S. CLS. 100 AND 101).
FIRST USE 6-16-2009; IN COMMERCE 6-16-2009.

SHESCONNECTED

THE MARK CONSISTS OF STANDARD CHARACTERS WITHOUT CLAIM TO ANY PARTICULAR FONT, STYLE, SIZE, OR COLOR.

CLASS 35—ADVERTISING AND BUSINESS

FOR PROMOTING THE GOODS AND SERVICES OF OTHERS VIA MOBILE PHONES, EMAIL, WIRELESS DEVICES, AND THE INTERNET; PROMOTING THE GOODS AND SERVICES OF OTHERS BY MEANS OF OPERATING AN ON-LINE SHOPPING MALL WITH LINKS TO THE RETAIL WEB SITES OF OTHERS; INTERNET CONSUMER COMPARISON SHOPPING SERVICES; PROVIDING RATINGS AND REVIEWS OF BUSINESSES AND PRODUCTS AND SERVICES FOR USE BY CONSUMERS IN THE FIELDS OF FASHION, BEAUTY, HEALTH, FITNESS, FAMILY, SPIRITUALITY, RELATIONSHIPS, CUISINE, MONEY AND FINANCE, TECHNOLOGY, POLITICS, WORK LIFE, CONSERVATION AND RECYCLING, VOLUNTEERISM AND CHARITY, WOMEN'S ORGANIZATIONS, AUTOMOTIVE, CONSUMER ELECTRONICS, APPLIANCES, PACKAGED GOODS, CONSUMABLE GOODS, FOODS, EDUCATION, ENTERTAINMENT, CONSUMER-ORIENTED SERVICES, NAMELY, CHILD CARE, EDUCATION, CAREER, HOME DECORATING, HOME MAINTENANCE OR REPAIR; PROVIDING DATABASES CONTAINING COMMERCIAL INFORMATION RELATING TO PRODUCTS AND MERCHANTS IN THE FIELDS OF FASHION, BEAUTY, HEALTH, FITNESS, FAMILY, SPIRITUALITY, RELATIONSHIPS, CUISINE, MONEY AND FINANCE, TECHNOLOGY, POLITICS, WORK LIFE, CONSERVATION AND RECYCLING, VOLUNTEERISM AND CHARITY, WOMEN'S ORGANIZATIONS, AUTOMOTIVE, CONSUMER ELECTRONICS, APPLIANCES, PACKAGED GOODS, CONSUMABLE GOODS, FOODS, EDUCATION, ENTERTAINMENT, CONSUMER-ORIENTED SERVICES, NAMELY, CHILD CARE, EDUCATION, CAREER, HOME DECORATING, HOME MAINTENANCE OR REPAIR; PROVIDING DATABASES FEATURING CONSUMER PRODUCT INFORMATION; PROVIDING REWARDS AND INCENTIVES, NAMELY, PROVIDING BONUS INCENTIVES AND REWARD PROGRAMS FOR CONSUMERS TO PROMOTE THE SALE OF THE GOODS AND SERVICES OF OTHERS; BUSINESS CONSULTING SERVICES; PROVIDING ECONOMIC FORECASTING MODELS IN THE FIELD OF MARKET RESEARCH; ADVERTISING AND PROMOTIONAL SERVICES AND RELATED CONSULTATION; ADVERTISING, PROMOTION AND MARKETING SERVICES VIA THE INTERNET AND MOBILE PHONES, PERSONAL DIGITAL ASSISTANTS, HANDHELD DIGITAL ELECTRONIC DEVICES, AND OTHER PERSONAL MEDIA DEVICES; PROMOTING THE SALE OF GOODS AND SERVICES OF OTHERS BY PROVIDING HYPERTEXT LINKS TO THE WEB SITE OF OTHERS; MARKET ANALYSIS AND RESEARCH SERVICES; BUSINESS MARKETING CONSULTING SERVICES; CONSUMER RESEARCH SERVICES, NAMELY, CONSUMER PROFILING AND CONSUMER ANALYSIS AND PROJECTION OF CONSUMER ATTITUDES, MOTIVATIONS, AND BEHAVIOR; CONDUCTING PUBLIC OPINION POLLS FOR COMMERCIAL USE AND FOR THE ASSESSMENT AND EVALUATION OF THE QUALITY OF GOODS AND SERVICES PROVIDED BY OTHERS; PROVIDING INFORMATION OVER MOBILE

PHONES AND THE INTERNET IN THE FIELDS OF POLITICS, WORK LIFE, CAREERS, VOLUNTEERING, CHARITY, WOMEN'S ORGANIZATIONS, AUTOMOBILES, CONSUMER ELECTRONICS, APPLIANCES, PACKAGED AND CONSUMER GOODS; PROVIDING AN INTERNET LINK TO THE WEB SITES AND BLOGS OF OTHERS FEATURING CONTENT, TOOLS AND APPLICATIONS RELATED TO POLITICS, WORK LIFE, CAREERS, VOLUNTEERING, CHARITY, WOMEN'S ORGANIZATIONS, AUTOMOBILES, CONSUMER ELECTRONICS, APPLIANCES, PACKAGED AND CONSUMER GOODS (U.S. CLS. 100, 101 AND 102).

FIRST USE 10-1-2008; IN COMMERCE 10-1-2008.

CLASS 38—COMMUNICATION

FOR PROVIDING EMAIL AND INSTANT MESSAGING SERVICES; STREAMING OF AUDIO AND VIDEO MATERIAL ON THE INTERNET AND ON MOBILE PHONES, PERSONAL DIGITAL ASSISTANTS, HANDHELD DIGITAL ELECTRONIC DEVICES, AND OTHER PERSONAL MEDIA DEVICES (U.S. CLS. 100, 101 AND 104).

FIRST USE 10-1-2008; IN COMMERCE 10-1-2008.

CLASS 39—TRANSPORTATION AND STORAGE

FOR PROVIDING INFORMATION ON THE INTERNET AND ON MOBILE PHONES, PERSONAL DIGITAL ASSISTANTS, HANDHELD DIGITAL ELECTRONIC DEVICES, AND OTHER PERSONAL MEDIA DEVICES IN THE FIELDS OF TRAVEL AND TRAVEL ARRANGEMENTS; PROVIDING AN INTERNET LINK TO THE WEB SITES AND BLOGS OF OTHERS FEATURING CONTENT, TOOLS AND APPLICATIONS RELATED TO TRAVEL AND TRAVEL ARRANGEMENTS (U.S. CLS. 100 AND 105).

FIRST USE 4-1-2009; IN COMMERCE 4-1-2009.

CLASS 42—SCIENTIFIC AND COMPUTER SERVICES

FOR COMPUTER SERVICES, NAMELY, PROVIDING A SEARCH ENGINE ON THE INTERNET AND ON MOBILE PHONES, PERSONAL DIGITAL ASSISTANTS, HANDHELD DIGITAL ELECTRONIC DEVICES, AND OTHER PERSONAL MEDIA DEVICES FOR OBTAINING INFORMATION ON CONSUMER PRODUCTS AND MERCHANTS; AND PROVIDING HOSTING, MANAGING, DEVELOPING, AND MAINTAINING APPLICATIONS, SOFTWARE, WEBSITES, AND DATABASES IN THE FIELDS OF PERSONAL PRODUCTIVITY, WIRELESS COMMUNICATION, MOBILE INFORMATION ACCESS, AND REMOTE DATA MANAGEMENT FOR WIRELESS DELIVERY OF CONTENT TO HANDHELD COMPUTERS, LAPTOPS AND MOBILE ELECTRONIC DEVICES; PROVIDING INFORMATION OVER MOBILE PHONES AND THE INTERNET IN THE FIELD OF TECHNOLOGY; PROVIDING AN INTERNET LINK TO THE WEB SITES AND BLOGS OF OTHERS FEATURING CONTENT, TOOLS AND APPLICATIONS RELATED TO TECHNOLOGY (U.S. CLS. 100 AND 101).

FIRST USE 10-1-2008; IN COMMERCE 10-1-2008.

CLASS 45—PERSONAL AND LEGAL SERVICES

FOR ON-LINE SOCIAL NETWORKING SERVICES; PROVIDING INFORMATION OVER MOBILE PHONES AND THE INTERNET IN THE FIELDS OF FASHION, FAMILY, SPIRITUALITY AND RELATIONSHIPS; PROVIDING AN INTERNET LINK TO THE WEB SITES AND BLOGS OF OTHERS FEATURING CONTENT, TOOLS AND APPLICATIONS RELATED TO FASHION, FAMILY, SPIRITUALITY AND RELATIONSHIPS (U.S. CLS. 100 AND 101).

FIRST USE 10-1-2008; IN COMMERCE 10-1-2008.

3,680,475. JOBSITE123.COM, INC., DAVIE, FL. SN 77-309,610. PUB. 3-10-2009, FILED 10-22-2007.

JOBSITE123

THE MARK CONSISTS OF STANDARD CHARACTERS WITHOUT CLAIM TO ANY PARTICULAR FONT, STYLE, SIZE, OR COLOR.

CLASS 35—ADVERTISING AND BUSINESS

FOR ONLINE BUSINESS DIRECTORIES FEATURING LOCAL CONSTRUCTION SUPPLIERS; PROVIDING AN ONLINE DIRECTORY INFORMATION SERVICE FEATURING INFORMATION REGARDING CONSTRUCTION CONTRACTORS (U.S. CLS. 100, 101 AND 102).

FIRST USE 3-16-2008; IN COMMERCE 3-16-2008.

CLASS 37—CONSTRUCTION AND REPAIR

FOR PROVIDING INFORMATION VIA THE INTERNET IN THE FIELD OF CONSTRUCTION, NAMELY, CONSTRUCTION CHECKLISTS, RESOURCES IN THE NATURE OF CONSTRUCTION MATERIALS AND CONSTRUCTION EQUIPMENT, BUILDING DEPARTMENTS, NAMELY, DEPARTMENTS THAT PROVIDE CONSTRUCTION PLANNING SERVICES AND INSPECTIONS DURING THE COURSE OF BUILDING (U.S. CLS. 100, 103 AND 106).

FIRST USE 3-16-2008; IN COMMERCE 3-16-2008.

CLASS 39—TRANSPORTATION AND STORAGE

FOR PROVIDING INFORMATION VIA THE INTERNET ABOUT PUBLIC UTILITY SERVICES (U.S. CLS. 100 AND 105).

FIRST USE 3-16-2008; IN COMMERCE 3-16-2008.

CLASS 45—PERSONAL AND LEGAL SERVICES

FOR PROVIDING INFORMATION VIA THE INTERNET IN THE FIELD OF OBTAINING ZONING, DESIGN AND CONSTRUCTION PERMITS FOR DEVELOPMENT PROJECTS (U.S. CLS. 100 AND 101).

FIRST USE 3-16-2008; IN COMMERCE 3-16-2008.

3,680,487. GWENDOLYN FREMPONG BOADU, POUND RIDGE, NY. SN 77-313,676. PUB. 10-14-2008, FILED 10-25-2007.



THE MARK CONSISTS OF A HIGH HEELED SHOE WITH WINGS, AND THE WORD "GWYNETH" OVER THE SHOE.

CLASS 25—CLOTHING

FOR SHOES (U.S. CLS. 22 AND 39).

FIRST USE 9-0-2007; IN COMMERCE 9-0-2007.

CLASS 35—ADVERTISING AND BUSINESS

FOR ONLINE RETAIL STORE SERVICES FEATURING SHOES (U.S. CLS. 100, 101 AND 102).
FIRST USE 9-0-2007; IN COMMERCE 9-0-2007.

3,680,500. THE IDENTITY CIRCLE LLC, WESTPORT, CT.
SN 77-318,903. PUB. 4-15-2008, FILED 11-1-2007.

THE IDENTITY CIRCLE

THE MARK CONSISTS OF STANDARD CHARACTERS WITHOUT CLAIM TO ANY PARTICULAR FONT, STYLE, SIZE, OR COLOR.

CLASS 35—ADVERTISING AND BUSINESS

FOR MANAGEMENT AND BUSINESS CONSULTING SERVICES IN THE FIELD OF IDENTITY, LEADERSHIP AND HUMAN RESOURCES DEVELOPMENT FOR COMPANIES AND INDIVIDUALS (U.S. CLS. 100, 101 AND 102).

FIRST USE 3-10-2008; IN COMMERCE 5-1-2008.

CLASS 41—EDUCATION AND ENTERTAINMENT

FOR EDUCATIONAL SERVICES, NAMELY, CONDUCTING TRAINING FOR INDIVIDUALS AND GROUPS IN THE FIELD OF SELF-AWARENESS AND PERSONAL GROWTH AND DEVELOPMENT (U.S. CLS. 100, 101 AND 107).

FIRST USE 3-10-2008; IN COMMERCE 5-1-2008.

3,680,502. I365 INC., EMERYVILLE, CA. SN 77-320,050. PUB. 4-15-2008, FILED 11-2-2007.

i365

THE MARK CONSISTS OF STANDARD CHARACTERS WITHOUT CLAIM TO ANY PARTICULAR FONT, STYLE, SIZE, OR COLOR.

CLASS 9—ELECTRICAL AND SCIENTIFIC APPARATUS

FOR COMPUTER SOFTWARE FOR USE IN BACK-UP OF COMPUTER HARD DRIVE DATA, BACK-UP OF COMPUTER NETWORKS, DATA RECOVERY, CONVERSION OF DATA OR DOCUMENTS FROM PHYSICAL TO ELECTRONIC MEDIA, CONDUCTING ELECTRONIC DISCOVERY, DATA ENCRYPTION, DATA WAREHOUSING, ELECTRONIC STORAGE OF DATA; AND ARCHIVING DATABASES, IMAGES AND OTHER ELECTRONIC DATA; COMPUTER SOFTWARE FOR USE IN BACK-UP OF COMPUTER HARD DRIVE DATA, BACK-UP OF COMPUTER NETWORKS, DATA RECOVERY, CONVERSION OF DATA OR DOCUMENTS FROM PHYSICAL TO ELECTRONIC MEDIA, CONDUCTING ELECTRONIC DISCOVERY, DATA ENCRYPTION, DATA WAREHOUSING, ELECTRONIC STORAGE OF DATA; AND ARCHIVING DATABASES, IMAGES AND OTHER ELECTRONIC DATA, THAT MAY BE DOWNLOADED FROM A GLOBAL COMPUTER NETWORK; COMPUTER SOFTWARE FOR USE IN THE SAFEGUARDING OF DIGITAL FILES, INCLUDING AUDIO, VIDEO, TEXT, BINARY, STILL IMAGES, GRAPHICS AND MULTIMEDIA FILES; COMPUTER SOFTWARE FOR THE CREATION OF FIREWALLS; COMPUTER SOFTWARE TO AUTOMATE DATA WAREHOUSING; COMPUTER SOFTWARE FOR USE IN STORING AND MANAGING THE BLOCK-LEVEL CHANGES WITHIN FILES AND DATABASES OF CLIENTS (U.S. CLS. 21, 23, 26, 36 AND 38).

FIRST USE 9-23-2008; IN COMMERCE 9-23-2008.

CLASS 38—COMMUNICATION

FOR PROVISION OF ACCESS TO DATA OR DOCUMENTS STORED ELECTRONICALLY IN CENTRAL FILES FOR REMOTE CONSULTATION (U.S. CLS. 100, 101 AND 104).

FIRST USE 9-23-2008; IN COMMERCE 9-23-2008.

CLASS 39—TRANSPORTATION AND STORAGE

FOR ELECTRONIC STORAGE OF DATA; STORAGE SERVICES FOR ARCHIVING DATABASES, IMAGES AND OTHER ELECTRONIC DATA; REMOTE COMPUTER DATA BACKUP SERVICES, NAMELY, STORAGE SERVICE FOR ARCHIVING DATABASES, IMAGES, AND OTHER ELECTRONIC DATA (U.S. CLS. 100 AND 105).

FIRST USE 9-23-2008; IN COMMERCE 9-23-2008.

CLASS 42—SCIENTIFIC AND COMPUTER SERVICES

FOR BACK-UP SERVICES FOR COMPUTER HARD DRIVE DATA; BACK-UP SERVICES FOR COMPUTER NETWORKS; REMOTE BACK-UP SERVICES FOR COMPUTER HARD DRIVE DATA; REMOTE BACK-UP SERVICES FOR COMPUTER NETWORKS; COMPUTER SERVICES, NAMELY, DATA RECOVERY SERVICES; COMPUTER DISASTER RECOVERY PLANNING; CONVERSION OF DATA OR DOCUMENTS FROM PHYSICAL TO ELECTRONIC MEDIA; CONDUCTING ELECTRONIC DISCOVERY SERVICES VIA GLOBAL COMPUTER NETWORKS FOR LAWYERS AND CORPORATIONS; DATA ENCRYPTION SERVICES; DATA WAREHOUSING; APPLICATION SERVICE PROVIDER (ASP) FEATURING SOFTWARE FOR USE IN BACK-UP OF COMPUTER HARD DRIVE DATA, BACK-UP OF COMPUTER NETWORKS, DATA RECOVERY, CONVERSION OF DATA OR DOCUMENTS FROM PHYSICAL TO ELECTRONIC MEDIA, CONDUCTING ELECTRONIC DISCOVERY, DATA ENCRYPTION, DATA WAREHOUSING, ELECTRONIC STORAGE OF DATA; AND ARCHIVING DATABASES, IMAGES AND OTHER ELECTRONIC DATA (U.S. CLS. 100 AND 101).

FIRST USE 9-23-2008; IN COMMERCE 9-23-2008.

3,680,507. BASTIANELLI GROUP, INC., WILMINGTON, DE. SN 77-321,520. PUB. 9-30-2008, FILED 11-5-2007.

3,680,518. CLEAR WIND RENEWABLE POWER, INC., MINNEAPOLIS, MN. SN 77-323,893. PUB. 10-7-2008, FILED 11-7-2007.

STRATEGY HOUSE

THE MARK CONSISTS OF STANDARD CHARACTERS WITHOUT CLAIM TO ANY PARTICULAR FONT, STYLE, SIZE, OR COLOR.

NO CLAIM IS MADE TO THE EXCLUSIVE RIGHT TO USE "STRATEGY", APART FROM THE MARK AS SHOWN.

CLASS 35—ADVERTISING AND BUSINESS

FOR BUSINESS CONSULTATION, BUSINESS MANAGEMENT, AND BUSINESS MANAGEMENT CONSULTATION, NAMELY, DEVELOPING, IMPLEMENTING, AND EVALUATING BUSINESS PLANS FOR OTHERS (U.S. CLS. 100, 101 AND 102).

FIRST USE 1-1-2008; IN COMMERCE 1-1-2008.

CLASS 41—EDUCATION AND ENTERTAINMENT

FOR PROFESSIONAL COACHING SERVICES IN THE FIELD OF BUSINESS (U.S. CLS. 100, 101 AND 107).

FIRST USE 1-1-2008; IN COMMERCE 1-1-2008.

3,680,508. ARCADIA GROUP, ATLANTA, GA. SN 77-322,231. PUB. 10-7-2008, FILED 11-6-2007.

INSIGHT

THE MARK CONSISTS OF STANDARD CHARACTERS WITHOUT CLAIM TO ANY PARTICULAR FONT, STYLE, SIZE, OR COLOR.

CLASS 3—COSMETICS AND CLEANING PREPARATIONS

FOR NON-MEDICATED SKIN LOTION FOR USE BY DIABETICS (U.S. CLS. 1, 4, 6, 50, 51 AND 52).

FIRST USE 8-22-2008; IN COMMERCE 8-22-2008.

CLASS 10—MEDICAL APPARATUS

FOR MEDICAL HOSIERY FOR USE BY DIABETICS, NAMELY, SUPPORT SOCKS (U.S. CLS. 26, 39 AND 44).

FIRST USE 11-20-2008; IN COMMERCE 11-20-2008.

CLEAR WIND

THE MARK CONSISTS OF STANDARD CHARACTERS WITHOUT CLAIM TO ANY PARTICULAR FONT, STYLE, SIZE, OR COLOR.

NO CLAIM IS MADE TO THE EXCLUSIVE RIGHT TO USE "WIND", APART FROM THE MARK AS SHOWN.

CLASS 35—ADVERTISING AND BUSINESS

FOR BUSINESS CONSULTING SERVICES IN THE FIELD OF RENEWABLE ENERGY POWER PRODUCTION; BUSINESS MANAGEMENT SERVICES IN THE FIELD OF RENEWABLE ELECTRICAL ENERGY PROJECTS, WIND POWER PROJECTS, AND UTILITY-SCALE WIND FARM PROJECTS; MANAGEMENT AND OPERATION ASSISTANCE SERVICES TO COMMERCIAL BUSINESSES IN THE FIELD OF WIND POWER ENERGY PROJECTS; BUSINESS PLANNING SERVICES, NAMELY, EVALUATION OF LAND FOR WIND ENERGY PROJECTS (U.S. CLS. 100, 101 AND 102).

FIRST USE 3-31-2008; IN COMMERCE 4-15-2009.

CLASS 37—CONSTRUCTION AND REPAIR

FOR PLANNING, LAYING OUT AND CONSTRUCTION OF WIND ENERGY PRODUCTION FACILITIES (U.S. CLS. 100, 103 AND 106).

FIRST USE 3-31-2008; IN COMMERCE 4-15-2009.

3,680,532. CORE INTELLECTUAL PROPERTIES HOLDINGS, LLC, GOODYEAR, AZ. SN 77-328,793. PUB. 4-22-2008, FILED 11-13-2007.



THE COLOR(S) LIGHT GREEN AND GREEN IS/ARE CLAIMED AS A FEATURE OF THE MARK.

THE MARK CONSISTS OF THE WORD "GOGREEN" WITH "GO" IN A LIGHT GREEN AND "GREEN" IN A GREEN COLOR WITH GREEN LEAVES SPLAYED OUT ABOVE.

CLASS 1—CHEMICALS

FOR FERTILIZERS; FERTILIZERS FOR AGRICULTURAL USE; FERTILIZERS FOR DOMESTIC USE; SOIL ADDITIVES; CHEMICAL ADDITIVES FOR USE IN THE MANUFACTURE OF NUTRITIONAL SUPPLEMENTS, FOOD SUPPLEMENTS, COSMETICS; BOTANICAL EXTRACTS FOR USE IN MAKING COSMETICS; SOIL CONDITIONERS FOR AGRICULTURAL, DOMESTIC AND HORTICULTURAL USE (U.S. CLS. 1, 5, 6, 10, 26 AND 46).

FIRST USE 1-15-2009; IN COMMERCE 1-15-2009.

CLASS 3—COSMETICS AND CLEANING PREPARATIONS

FOR COSMETICS (U.S. CLS. 1, 4, 6, 50, 51 AND 52).
FIRST USE 1-15-2009; IN COMMERCE 1-15-2009.

CLASS 5—PHARMACEUTICALS

FOR PESTICIDES FOR INDUSTRIAL, COMMERCIAL, GARDEN, LAWN AND PROFESSIONAL USE; ANIMAL FEED ADDITIVE FOR USE AS A NUTRITIONAL SUPPLEMENT FOR MEDICAL PURPOSES; DIETARY SUPPLEMENTS; DIETARY SUPPLEMENTS FOR ANIMALS; FOOD SUPPLEMENTS; NUTRACEUTICALS FOR USE AS A DIETARY SUPPLEMENT; NUTRITIONAL ADDITIVES FOR MEDICAL PURPOSES FOR USE IN FOODS AND DIETARY SUPPLEMENTS FOR HUMAN CONSUMPTION; NUTRITIONAL SUPPLEMENTS; PLANT EXTRACTS FOR MEDICAL, VETERINARY AND PHARMACEUTICAL PURPOSES (U.S. CLS. 6, 18, 44, 46, 51 AND 52).

FIRST USE 1-15-2009; IN COMMERCE 1-15-2009.

CLASS 31—NATURAL AGRICULTURAL PRODUCTS

FOR ANIMAL FEED ADDITIVES FOR NONNUTRITIONAL PURPOSES FOR USE AS INGREDIENT OR FILLER; NUTRITIONAL ADDITIVES FOR ANIMAL FOODSTUFFS, NOT FOR MEDICAL PURPOSES (U.S. CLS. 1 AND 46).

FIRST USE 2-16-2009; IN COMMERCE 2-16-2009.

CLASS 42—SCIENTIFIC AND COMPUTER SERVICES

FOR DESIGN FOR OTHERS IN THE FIELD OF USE OF FERTILIZERS AND PESTICIDES, LAWN CARE, LANDSCAPE GARDENING, SOIL ADDITIVES (U.S. CLS. 100 AND 101).

FIRST USE 1-8-2009; IN COMMERCE 1-8-2009.

3,680,535. FRITO-LAY NORTH AMERICA, INC., PLANO, TX. SN 77-329,457. PUB. 4-15-2008, FILED 11-14-2007.

PINCH OF SALT

THE MARK CONSISTS OF STANDARD CHARACTERS WITHOUT CLAIM TO ANY PARTICULAR FONT, STYLE, SIZE, OR COLOR.

CLASS 29—MEATS AND PROCESSED FOODS

FOR POTATO CHIPS; POTATO CRISPS; POTATO-BASED SNACK FOODS (U.S. CL. 46).

FIRST USE 2-0-2008; IN COMMERCE 2-0-2008.

CLASS 30—STAPLE FOODS

FOR CORN CHIPS; CORN-BASED SNACK FOODS; TORTILLA CHIPS; GRAIN-BASED CHIPS; FLOUR-BASED CHIPS (U.S. CL. 46).

FIRST USE 2-0-2008; IN COMMERCE 2-0-2008.

3,680,536. JUZA, THOMAS J., ONEIDA, WI. AND JUZA, MICHELLE M., ONEIDA, WI. SN 77-329,464. PUB. 9-16-2008, FILED 11-14-2007.

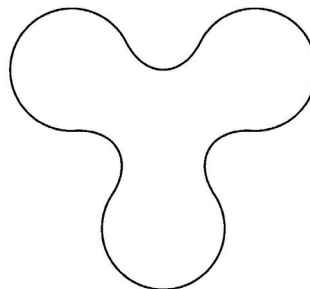

THE MARK CONSISTS OF TRI-LOBE DESIGN.

CLASS 25—CLOTHING

FOR SHOES AND CLOTHING, NAMELY, FLIP FLOPS, SANDALS, T-SHIRTS (U.S. CLS. 22 AND 39).

FIRST USE 11-0-2008; IN COMMERCE 11-0-2008.

CLASS 26—FANCY GOODS

FOR ORNAMENTS, NAMELY, SHOE ORNAMENTS, NOT OF PRECIOUS METAL, NOT INCLUDING ORNAMENTS FOR JAPANESE SANDALS; ORNAMENTAL BUTTONS; ORNAMENTAL DESIGNS AND FASTENERS FOR CLOTHING AND SHOES, NOT INCLUDING, JAPANESE SANDALS, NAMELY, SNAP FASTENERS AND PRESS STUDS (U.S. CLS. 37, 39, 40, 42 AND 50).

FIRST USE 11-0-2008; IN COMMERCE 11-0-2008.

3,680,541. WFAA-TV, INC., DALLAS, TX. SN 77-330,043. PUB. 4-29-2008, FILED 11-15-2007.

BIG D NYE

THE MARK CONSISTS OF STANDARD CHARACTERS WITHOUT CLAIM TO ANY PARTICULAR FONT, STYLE, SIZE, OR COLOR.

NO CLAIM IS MADE TO THE EXCLUSIVE RIGHT TO USE "BIG D", APART FROM THE MARK AS SHOWN.

CLASS 35—ADVERTISING AND BUSINESS

FOR ADVERTISING THE GOODS AND SERVICES OF OTHERS ON TELEVISION, IN PRINT AND ON THE INTERNET (U.S. CLS. 100, 101 AND 102).

FIRST USE 12-31-2007; IN COMMERCE 12-31-2007.

CLASS 41—EDUCATION AND ENTERTAINMENT

FOR ORGANIZING AND CONDUCTING A NEW YEARS EVE EVENT WITH LIVE MUSIC, SPORTING EXHIBITIONS, FIREWORKS, CONTESTS AND GIVEAWAYS; ENTERTAINMENT IN THE NATURE OF ONGOING TELEVISED PROGRAMS IN THE NATURE OF NEW YEARS EVE EVENTS WITH LIVE MUSIC, FOOD, DRINKS, SPORTING EXHIBITIONS, FIREWORKS, CONTESTS AND GIVEAWAYS (U.S. CLS. 100, 101 AND 107).

FIRST USE 12-31-2007; IN COMMERCE 12-31-2007.

3,680,542. ACCESS LIBERTY, LLC, TREMONT, IL. SN 77-330,913. PUB. 4-29-2008, FILED 11-15-2007.

ACCESS LIBERTY

THE MARK CONSISTS OF STANDARD CHARACTERS WITHOUT CLAIM TO ANY PARTICULAR FONT, STYLE, SIZE, OR COLOR.

CLASS 9—ELECTRICAL AND SCIENTIFIC APPARATUS

FOR COMPUTER SOFTWARE PROGRAMS USED FOR PLANNING, MANAGEMENT, AND ADMINISTRATION OF ELECTIONS (U.S. CLS. 21, 23, 26, 36 AND 38).

FIRST USE 11-30-2007; IN COMMERCE 11-30-2007.

CLASS 35—ADVERTISING AND BUSINESS

FOR ADVISORY AND CONSULTANCY SERVICES IN THE FIELD OF ELECTION PLANNING, MANAGEMENT, AND ADMINISTRATION (U.S. CLS. 100, 101 AND 102).

FIRST USE 11-30-2007; IN COMMERCE 11-30-2007.

3,680,543. NEIGHBORHOOD CO. LTD., TOKYO, JAPAN. SN 77-331,133. PUB. 10-14-2008, FILED 11-16-2007.

BULLINK

THE MARK CONSISTS OF STANDARD CHARACTERS WITHOUT CLAIM TO ANY PARTICULAR FONT, STYLE, SIZE, OR COLOR.

THE WORDING "BULLINK" HAS NO MEANING IN A FOREIGN LANGUAGE.

CLASS 16—PAPER GOODS AND PRINTED MATTER

FOR PAPER STATIONERY; NOTEBOOKS; ENVELOPES; PENCILS; BALL-POINT PENS; PAPER TAGS (U.S. CLS. 2, 5, 22, 23, 29, 37, 38 AND 50).

FIRST USE 7-20-2008; IN COMMERCE 7-20-2008.

CLASS 25—CLOTHING

FOR CLOTHING, NAMELY, SHIRTS, PANTS, SHOES, TEE SHIRTS, JACKETS, JEANS; BELTS FOR CLOTHING; FOOTWEAR (U.S. CLS. 22 AND 39).

FIRST USE 7-20-2008; IN COMMERCE 7-20-2008.

3,680,549. C4MEDIA INC., TORONTO, ONTARIO. SN 77-332,098. PUB. 9-30-2008, FILED 11-16-2007.

INFOQ

THE MARK CONSISTS OF STANDARD CHARACTERS WITHOUT CLAIM TO ANY PARTICULAR FONT, STYLE, SIZE, OR COLOR.

PRIORITY CLAIMED UNDER SEC. 44(D) ON ERPNCMNTY TM OFC APPLICATION NO. 6447288, FILED 11-16-2007.

CLASS 9—ELECTRICAL AND SCIENTIFIC APPARATUS

FOR SOUND AND VIDEO RECORDINGS FEATURING INFORMATION ON THE TOPIC OF INFORMATION TECHNOLOGY; PHOTOGRAPHIC SLIDES; DOWNLOADABLE ELECTRONIC PUBLICATIONS, NAMELY, JOURNALS, MAGAZINES, NEWSLETTERS, BOOKS, ARTICLES, PRESENTATIONS AND INTERVIEWS FEATURING INFORMATION ON THE TOPIC OF INFORMATION TECHNOLOGY (U.S. CLS. 21, 23, 26, 36 AND 38).

FIRST USE 5-0-2006; IN COMMERCE 5-0-2006.

CLASS 35—ADVERTISING AND BUSINESS

FOR ADVERTISING, MARKETING AND LEAD GENERATION SERVICES, NAMELY, PROVIDING BUSINESS LEAD GENERATION SERVICES FOR OTHERS; PROMOTING THE GOODS AND SERVICES OF OTHER COMPANIES BY PLACING ADVERTISEMENTS; PUBLICATION OF PUBLICITY TEXTS; CONSULTANCY, ADVISORY AND INFORMATION SERVICES RELATING TO ALL THE AFORESAID SERVICES (U.S. CLS. 100, 101 AND 102).

FIRST USE 5-0-2006; IN COMMERCE 5-0-2006.

CLASS 38—COMMUNICATION

FOR TELECOMMUNICATIONS, NAMELY, PROVISION OF ON-LINE FORUMS IN RELATION TO SOFTWARE DEVELOPMENT; PROVIDING THE TRANSMISSION OF DAILY NEWS, EXPERT INTERVIEWS, VIDEO CONFERENCE PRESENTATIONS, ALL RELATING TO THE FIELD OF SOFTWARE DEVELOPMENT; PROVIDING ON-LINE DISCUSSION FORUMS FOR REGISTERED USERS TO DISCUSS THE FIELD OF SOFTWARE DEVELOPMENT; CONSULTANCY, ADVISORY AND INFORMATION SERVICES RELATING TO ALL THE AFORESAID SERVICES (U.S. CLS. 100, 101 AND 104).

FIRST USE 5-0-2006; IN COMMERCE 5-0-2006.

CLASS 42—SCIENTIFIC AND COMPUTER SERVICES

FOR NEWS REPORTING SERVICES IN THE FIELD OF SOFTWARE DEVELOPMENT NEWS (U.S. CLS. 100 AND 101).

FIRST USE 5-0-2006; IN COMMERCE 5-0-2006.

3,680,554. SWEET REVENGE ENTERPRISES, INC., NEW YORK CITY, NY. SN 77-334,241. PUB. 11-4-2008, FILED 11-20-2007.

3,680,566. THE TRUSTEES OF THE COPPOLA FAMILY TRUST, RUTHERFORD, CA. SN 77-335,477. PUB. 4-15-2008, FILED 11-21-2007.

SWEET REVENGE

THE MARK CONSISTS OF STANDARD CHARACTERS WITHOUT CLAIM TO ANY PARTICULAR FONT, STYLE, SIZE, OR COLOR.

CLASS 30—STAPLE FOODS

FOR BAKERY PRODUCTS; CUPCAKES; CAKES; PARFAITS; ICE CREAM SANDWICHES; COFFEE; HOT CHOCOLATE; TEA; ICED TEA (U.S. CL. 46).
FIRST USE 2-28-2007; IN COMMERCE 2-28-2007.

CLASS 43—HOTEL AND RESTAURANT SERVICES

FOR RESTAURANT AND CAFE SERVICES (U.S. CLS. 100 AND 101).
FIRST USE 2-28-2007; IN COMMERCE 2-28-2007.

3,680,556. SWEET REVENGE ENTERPRISES, INC., NEW YORK CITY, NY. SN 77-334,354. PUB. 11-4-2008, FILED 11-20-2007.



THE MARK CONSISTS OF THE WORD "SWEET" ABOVE THE WORD "REVENGE" WITH A HORIZONTAL SERIES OF DOTS BETWEEN THE WORDS AS SHOWN ON THE DRAWING, WITH THE WORDS BEING IN STYLIZED FONT AS SHOWN IN THE DRAWING, WITH THE LETTERS IN THE WORD "SWEET" HAVING A SPECIAL PATINA AS SHOWN ON THE DRAWING, ALL ON A BACKGROUND HAVING A PATINA AS SHOWN IN THE DRAWING.

CLASS 30—STAPLE FOODS

FOR BAKERY PRODUCTS; CUPCAKES; CAKES; PARFAITS; ICE CREAM SANDWICHES; COFFEE; HOT CHOCOLATE; TEA; ICED TEA (U.S. CL. 46).
FIRST USE 2-28-2007; IN COMMERCE 2-28-2007.

CLASS 43—HOTEL AND RESTAURANT SERVICES

FOR RESTAURANT AND CAFE SERVICES (U.S. CLS. 100 AND 101).
FIRST USE 2-28-2007; IN COMMERCE 2-28-2007.

KNOWINE

THE MARK CONSISTS OF STANDARD CHARACTERS WITHOUT CLAIM TO ANY PARTICULAR FONT, STYLE, SIZE, OR COLOR.

CLASS 33—WINES AND SPIRITS

FOR WINE (U.S. CLS. 47 AND 49).
FIRST USE 6-29-2009; IN COMMERCE 6-29-2009.

CLASS 35—ADVERTISING AND BUSINESS

FOR RETAIL STORE SERVICES AND ONLINE RETAIL STORE SERVICES PROVIDED VIA THE GLOBAL COMPUTER NETWORK IN THE FIELDS OF WINES AND WINE ACCESSORIES, SPECIALTY AND GOURMET FOODS AND BEVERAGES, KITCHENWARE, DISHWARE, BEVERAGeware, HOUSEWARES, LINENS, CLOTHING, FURNITURE, HOME ACCESSORIES, DECORATIVE ACCESSORIES, CAMERAS, FILM AND PHOTOGRAPHIC SUPPLIES, PRE-RECORDED DVDS, TAPES AND CDS FEATURING MOTION PICTURES AND MUSIC, MOTION PICTURE COLLECTIBLES, CIGARS AND SMOKERS' ARTICLES, LEATHER GOODS, JEWELRY, BOOKS, MAGAZINES, STATIONERY ITEMS, POSTERS, COMPUTER ACCESSORIES, WRITING INSTRUMENTS, TOYS, GAMES, AND GIFTWARE; BUYING CLUB SERVICES, NAMELY, PROVIDING TO CLUB MEMBERS REGULAR SHIPMENTS OF WINE, AND DISCOUNTED MAIL-ORDER AND ONLINE ORDERING SERVICES, INFORMATION AND INVITATIONS TO MEMBERS-ONLY EVENTS IN THE FIELDS OF FOOD, WINE, TRAVEL AND BEVERAGES (U.S. CLS. 100, 101 AND 102).
FIRST USE 4-1-2008; IN COMMERCE 4-1-2008.

3,680,573. AHSAY SYSTEMS CORPORATION LIMITED, CAUSEWAY BAY, HONG KONG. SN 77-336,703. PUB. 12-16-2008, FILED 11-26-2007.



PRIORITY CLAIMED UNDER SEC. 44(D) ON HONG KONG APPLICATION NO. 300999000, FILED 11-22-2007, REG. NO. 300999000, DATED 11-22-2007, EXPIRES 11-22-2017.

THE MARK CONSISTS OF THE WORD LETTERS "AH" WITH THE LETTERS "SAY" ENCLOSED WITHIN STYLIZED SQUARE.

THE TERM HAS NO MEANING IN A FOREIGN LANGUAGE.

CLASS 9—ELECTRICAL AND SCIENTIFIC APPARATUS

FOR COMPUTER PROGRAMS AND SOFTWARE FOR ARCHIVING DATABASES, IMAGES, BUSINESS AND TECHNICAL INFORMATION AND OTHER ELECTRONIC DATA; COMPUTER PROGRAMS AND SOFTWARE FOR RECOVERING COMPUTERIZED DATA; COMPUTER PROGRAMS AND SOFTWARE FOR DATA CONVERSION AND DATA PROCESSING (U.S. CLS. 21, 23, 26, 36 AND 38).

FIRST USE 1-0-2009; IN COMMERCE 1-0-2009.

CLASS 39—TRANSPORTATION AND STORAGE

FOR ELECTRONIC STORAGE OF DATA; STORAGE SERVICES FOR ARCHIVING DATABASES, IMAGES, BUSINESS AND TECHNICAL INFORMATION AND OTHER ELECTRONIC DATA (U.S. CLS. 100 AND 105).

FIRST USE 1-0-2009; IN COMMERCE 1-0-2009.

CLASS 42—SCIENTIFIC AND COMPUTER SERVICES

FOR COMPUTERIZED DATA RECOVERY SERVICES; DATA CONVERSION OF COMPUTER PROGRAM DATA OR INFORMATION; DEVELOPMENT AND CREATION OF COMPUTER PROGRAMS FOR DATA PROCESSING; COMPUTER CONSULTANCY SERVICES RELATING TO ALL THE AFORESAID SERVICES (U.S. CLS. 100 AND 101).

FIRST USE 1-0-2009; IN COMMERCE 1-0-2009.

CLASS 41—EDUCATION AND ENTERTAINMENT

FOR RECORD PRODUCTION; MUSIC PRODUCTION; AUDIO RECORDING AND PRODUCTION; MOTION PICTURE SONG PRODUCTION; RECORDING STUDIOS; ENTERTAINMENT SERVICES, NAMELY, PRODUCING MUSICAL AUDIO AND VIDEO PROGRAMS; MUSIC COMPOSITION AND TRANSCRIPTION FOR OTHERS; SONG WRITING SERVICES; ENTERTAINMENT IN THE NATURE OF A LIVE MUSICAL PERFORMER, MUSICAL BAND OR MUSICAL GROUP; ENTERTAINMENT IN THE NATURE OF LIVE PERFORMANCES BY A MUSICAL ARTIST, MUSICAL GROUP OR MUSICAL BAND; ENTERTAINMENT IN THE NATURE OF VISUAL AND AUDIO PERFORMANCES BY A MUSICAL ARTIST, MUSICAL GROUP AND MUSICAL BAND; ENTERTAINMENT, NAMELY, LIVE MUSIC CONCERTS; ENTERTAINMENT, NAMELY, PERSONAL APPEARANCES BY A MUSICIAN, MUSICAL GROUP OR MUSICAL BAND; ENTERTAINMENT SERVICES, NAMELY, PROVIDING A WEB SITE FEATURING MUSICAL PERFORMANCES, MUSICAL VIDEOS, RELATED FILM CLIPS, PHOTOGRAPHS, AND OTHER MULTIMEDIA MATERIALS; ENTERTAINMENT SERVICES, NAMELY, PROVIDING PRERECORDED MUSIC, INFORMATION IN THE FIELD OF MUSIC, COMMENTARY AND ARTICLES ABOUT MUSIC, ALL ONLINE VIA A GLOBAL COMPUTER NETWORK; ENTERTAINMENT IN THE NATURE OF LIVE MUSICAL PERFORMANCES PERFORMED BY ARTISTS ON TOUR (U.S. CLS. 100, 101 AND 107).

FIRST USE 4-0-2002; IN COMMERCE 4-0-2002.

3,680,587. NAKED WINES, LLC, HOOD RIVER, OR. SN 77-339,477. PUB. 1-13-2009, FILED 11-28-2007.

3,680,585. PREMIERE COMMISSION, INC., NEW YORK, NY. SN 77-339,199. PUB. 8-5-2008, FILED 11-28-2007.

PREMIERE COMMISSION

THE MARK CONSISTS OF STANDARD CHARACTERS WITHOUT CLAIM TO ANY PARTICULAR FONT, STYLE, SIZE, OR COLOR.

CLASS 9—ELECTRICAL AND SCIENTIFIC APPARATUS

FOR MUSICAL SOUND RECORDINGS; AUDIO-VISUAL RECORDINGS, NAMELY, PRERECORDED COMPACT DISCS, TAPE CASSETTES, AUDIO CASSETTES, AUDIO TAPES, AUDIO DISCS, RECORDS, CD-ROMS, VIDEO TAPES, VIDEO CASSETTES, VIDEO DISCS, DVDS, DATS, MP3S, AND LASER DISCS, ALL FEATURING MUSIC; DOWNLOADABLE MUSICAL SOUND RECORDINGS; DOWNLOADABLE VIDEO RECORDINGS FEATURING MUSIC (U.S. CLS. 21, 23, 26, 36 AND 38).

FIRST USE 2-0-2007; IN COMMERCE 2-0-2007.

CLUB DIVA

THE MARK CONSISTS OF STANDARD CHARACTERS WITHOUT CLAIM TO ANY PARTICULAR FONT, STYLE, SIZE, OR COLOR.

NO CLAIM IS MADE TO THE EXCLUSIVE RIGHT TO USE "CLUB", APART FROM THE MARK AS SHOWN.

CLASS 35—ADVERTISING AND BUSINESS

FOR MEMBERSHIP SERVICES FOR MEMBERS OF WINE CLUB IN THE NATURE OF MAIL ORDER SERVICES FOR CLUB MEMBERS FEATURING GIFTS IN THE FIELD OF WOMEN'S SENSUALITY, NAMELY, HORMONE CREAMS, VITAMIN SUPPLEMENTS, HEALTH SUPPLEMENTS, VITAMINS AND MINERALS, PERSONAL MOISTURIZERS, FACE CREAM, FACE CREAM WITH SUNBLOCK, PERSONAL LUBRICANTS, BOOKS ABOUT WOMEN'S SENSUALITY, ADULT SEXUAL AIDES, ADULT SEXUALLY-THEMED GAMES, LINGERIE, MASSAGE OILS, AND BATH OILS (U.S. CLS. 100, 101 AND 102).

FIRST USE 11-0-2007; IN COMMERCE 11-0-2007.

CLASS 39—TRANSPORTATION AND STORAGE

FOR WINE CLUB SERVICES FEATURING PERIODIC SHIPMENTS OF WINE TO MEMBERS (U.S. CLS. 100 AND 105).

FIRST USE 11-0-2007; IN COMMERCE 11-0-2007.

3,680,593. YOURSPHERE MEDIA, INC., DAVIS, CA. SN 77-342,210. PUB. 5-6-2008, FILED 12-3-2007.

YOURSPHERE

THE MARK CONSISTS OF STANDARD CHARACTERS WITHOUT CLAIM TO ANY PARTICULAR FONT, STYLE, SIZE, OR COLOR.

CLASS 35—ADVERTISING AND BUSINESS

FOR PROVIDING AN ONLINE DIRECTORY INFORMATION SERVICE FEATURING INFORMATION REGARDING, AND IN THE NATURE OF, GENERAL INTEREST, SOCIAL NETWORKING, AND VIRTUAL COMMUNITY; ADVERTISING, MARKETING AND PROMOTION SERVICES (U.S. CLS. 100, 101 AND 102).
FIRST USE 9-9-2008; IN COMMERCE 9-9-2008.

CLASS 38—COMMUNICATION

FOR AUDIO AND VIDEO BROADCASTING SERVICES OVER THE INTERNET; PROVIDING ON-LINE CHAT ROOMS AND ELECTRONIC BULLETIN BOARDS FOR TRANSMISSION OF MESSAGES AMONG USERS IN THE FIELD OF GENERAL INTEREST (U.S. CLS. 100, 101 AND 104).
FIRST USE 9-9-2008; IN COMMERCE 9-9-2008.

CLASS 42—SCIENTIFIC AND COMPUTER SERVICES

FOR COMPUTER SERVICES, NAMELY, CREATING AN ONLINE COMMUNITY FOR REGISTERED USERS TO PARTICIPATE IN COMPETITIONS, SHOWCASE THEIR SKILLS, GET FEEDBACK FROM THEIR PEERS, FORM VIRTUAL COMMUNITIES, ENGAGE IN SOCIAL NETWORKING AND IMPROVE THEIR TALENT (U.S. CLS. 100 AND 101).
FIRST USE 9-9-2008; IN COMMERCE 9-9-2008.

3,680,595. SPECTRA PRODUCTS INC., ETOBICOKE, CANADA. SN 77-342,747. PUB. 9-30-2008, FILED 12-3-2007.

TERMIN-8R

THE MARK CONSISTS OF STANDARD CHARACTERS WITHOUT CLAIM TO ANY PARTICULAR FONT, STYLE, SIZE, OR COLOR.

CLASS 2—PAINTS

FOR RUST INHIBITORS, NAMELY, ANTI-RUST GREASES, ANTI-RUST OILS, RUST PREVENTATIVES IN THE NATURE OF A COATING (U.S. CLS. 6, 11 AND 16).
FIRST USE 2-18-2000; IN COMMERCE 12-5-2006.

CLASS 4—LUBRICANTS AND FUELS

FOR PENETRATING OILS; LUBRICANTS, NAMELY, INDUSTRIAL LUBRICANTS, ALL PURPOSE LUBRICANTS, AUTOMOTIVE LUBRICANTS (U.S. CLS. 1, 6 AND 15).
FIRST USE 2-18-2000; IN COMMERCE 12-5-2006.

3,680,600. LINDE AKTIENGESELLSCHAFT, 80331 MÜNCHEN/MUNICH, FED REP GERMANY. SN 77-344,377. PUB. 4-1-2008, FILED 12-5-2007.

REMEO

THE MARK CONSISTS OF STANDARD CHARACTERS WITHOUT CLAIM TO ANY PARTICULAR FONT, STYLE, SIZE, OR COLOR.

CLASS 41—EDUCATION AND ENTERTAINMENT

FOR TRAINING IN THE FIELD OF HOME HEALTH CARE (U.S. CLS. 100, 101 AND 107).
FIRST USE 9-26-2008; IN COMMERCE 9-26-2008.

CLASS 44—MEDICAL, BEAUTY AND AGRICULTURAL SERVICES

FOR HEALTH CARE SERVICES; HOME HEALTH CARE SERVICES; PROVIDING HEALTH CARE FACILITIES FOR LONG AND SHORT TERM CARE (U.S. CLS. 100 AND 101).
FIRST USE 9-26-2008; IN COMMERCE 9-26-2008.

3,680,611. PACIFIC COAST BUILDING PRODUCTS, INC., RANCHO CORDOVA, CA. SN 77-347,121. PUB. 4-29-2008, FILED 12-7-2007.

DEFINE YOUR DESIGN

THE MARK CONSISTS OF STANDARD CHARACTERS WITHOUT CLAIM TO ANY PARTICULAR FONT, STYLE, SIZE, OR COLOR.

CLASS 19—NON-METALLIC BUILDING MATERIALS

FOR EXTRUDED COMPOSITE PLASTICS IN THE FORM OF BENDER BOARDS (U.S. CLS. 1, 12, 33 AND 50).
FIRST USE 1-30-2009; IN COMMERCE 2-5-2009.

CLASS 20—FURNITURE AND ARTICLES NOT OTHERWISE CLASSIFIED

FOR PLASTIC GARDEN AND LANDSCAPING STAKES (U.S. CLS. 2, 13, 22, 25, 32 AND 50).
FIRST USE 7-8-2009; IN COMMERCE 7-8-2009.

3,680,616. TWEEN PARENT LLC, NEW YORK, NY. SN 77-347,764. PUB. 10-14-2008, FILED 12-10-2007.



NO CLAIM IS MADE TO THE EXCLUSIVE RIGHT TO USE ".COM", APART FROM THE MARK AS SHOWN.

CLASS 41—EDUCATION AND ENTERTAINMENT

FOR INFORMATION IN THE FIELD OF PARENTING CONCERNING EDUCATION OF CHILDREN; INFORMATION IN THE FIELD OF PARENTING CONCERNING ENTERTAINMENT OF CHILDREN; PROVIDING ADVICE AND INFORMATION IN THE FIELD OF EDUCATIONAL AND ENTERTAINMENT ACTIVITIES AND EVENTS FOR CHILDREN; PROVIDING ON-LINE RESOURCE GUIDES FOR RELATIVES CONCERNING CHILDREN IN THE FIELDS OF EDUCATION, RECREATION, AND ENTERTAINMENT; PROVIDING A WEBSITE FEATURING INFORMATION ON YOUTH SPORTS; PROVIDING A WEBSITE THAT FEATURES INFORMATION IN THE FIELDS OF FITNESS AND EXERCISE TRAINING, PARTY PLANNING AND SPECIAL EVENT PLANNING, ART (U.S. CLS. 100, 101 AND 107).

FIRST USE 12-10-2008; IN COMMERCE 12-10-2008.

CLASS 42—SCIENTIFIC AND COMPUTER SERVICES

FOR PROVIDING A WEBSITE THAT FEATURES INFORMATION ABOUT ECOLOGY AND ENVIRONMENTAL INFORMATION ABOUT CLIMATE CHANGE AND BIODIVERSITY; PROVIDING A WEBSITE THAT FEATURES INFORMATION FOR PARENTS AND CHILDREN ON COMPUTERS, THE INTERNET AND COMMUNICATIONS TECHNOLOGY (U.S. CLS. 100 AND 101).

FIRST USE 11-24-2008; IN COMMERCE 11-24-2008.

CLASS 44—MEDICAL, BEAUTY AND AGRICULTURAL SERVICES

FOR INFORMATION IN THE FIELD OF PARENTING CONCERNING THE HEALTH, MEDICINE, HYGIENE AND EMOTIONAL DEVELOPMENT OF CHILDREN; PROVIDING A WEBSITE THAT FEATURES INFORMATION ON CHILDREN'S NUTRITION; PROVIDING A WEBSITE THAT FEATURES INFORMATION ABOUT BEAUTY; PROVIDING ON-LINE INFORMATION VIA THE INTERNET IN THE FIELDS OF ANIMALS AND PETS, RELATING TO BREEDING, SELECTION OF THE ANIMALS AND PETS, CARE, GROOMING, FEEDING AND NUTRITION; INFORMATION ABOUT PARENTING TOPICS, NAMELY, DRUG AND ALCOHOL AWARENESS (U.S. CLS. 100 AND 101).

FIRST USE 11-18-2008; IN COMMERCE 11-18-2008.

CLASS 45—PERSONAL AND LEGAL SERVICES

FOR INFORMATION IN THE FIELD OF PARENTING CONCERNING INTRAFAMILY RELATIONSHIPS; PROVIDING INFORMATION IN THE FIELD OF CHILD SAFETY; PROVIDING ADVICE AND INFORMATION ON APPROPRIATE GIFTS FOR FRIENDS AND FAMILY MEMBERS; PROVIDING A WEBSITE THAT FEATURES INFORMATION ABOUT FASHION AND CULTURE (U.S. CLS. 100 AND 101).

FIRST USE 12-2-2008; IN COMMERCE 12-2-2008.

3,680,636. CLEAR WIND RENEWABLE POWER, INC., MINNEAPOLIS, MN. SN 77-352,678. PUB. 10-7-2008, FILED 12-14-2007.



NO CLAIM IS MADE TO THE EXCLUSIVE RIGHT TO USE "WIND", APART FROM THE MARK AS SHOWN.

THE MARK CONSISTS OF THE WORDS "CLEAR WIND" AND A CURVED LINE DEPICTING A GUST OF WIND.

CLASS 35—ADVERTISING AND BUSINESS

FOR BUSINESS CONSULTING SERVICES IN THE FIELD OF RENEWABLE ENERGY POWER PRODUCTION; BUSINESS MANAGEMENT SERVICES IN THE FIELD OF RENEWABLE ELECTRICAL ENERGY PROJECTS, WIND POWER PROJECTS, AND UTILITY-SCALE WIND FARM PROJECTS; MANAGEMENT AND OPERATION ASSISTANCE SERVICES TO COMMERCIAL BUSINESSES IN THE FIELD OF WIND POWER ENERGY PROJECTS; BUSINESS PLANNING SERVICES, NAMELY, EVALUATION OF LAND FOR WIND ENERGY PROJECTS (U.S. CLS. 100, 101 AND 102).

FIRST USE 3-31-2008; IN COMMERCE 4-15-2009.

CLASS 37—CONSTRUCTION AND REPAIR

FOR PLANNING, LAYING OUT AND CONSTRUCTION OF WIND ENERGY PRODUCTION FACILITIES (U.S. CLS. 100, 103 AND 106).

FIRST USE 3-31-2008; IN COMMERCE 4-15-2009.

3,680,643. AMERICHEM, INC., CUYAHOGA FALLS, OH. SN 77-355,414. PUB. 9-9-2008, FILED 12-19-2007.

INSPIRED COLOR. DEFINED
PERFORMANCE.

THE MARK CONSISTS OF STANDARD CHARACTERS WITHOUT CLAIM TO ANY PARTICULAR FONT, STYLE, SIZE, OR COLOR.

CLASS 1—CHEMICALS

FOR CHEMICAL ADDITIVES FOR USE IN PLASTIC FORMULATIONS (U.S. CLS. 1, 5, 6, 10, 26 AND 46).

FIRST USE 1-1-2008; IN COMMERCE 1-1-2008.

CLASS 2—PAINTS

FOR COLOR CONCENTRATE COMPOUNDS FOR USE IN COLORING THERMOPLASTICS (U.S. CLS. 6, 11 AND 16).

FIRST USE 1-1-2008; IN COMMERCE 1-1-2008.

CLASS 40—MATERIAL TREATMENT

FOR COLOR MATCHING SERVICES RELATING TO PLASTIC MATERIALS, NAMELY, COLOR MIXING, BLENDING AND COLORIZING SERVICES (U.S. CLS. 100, 103 AND 106).

FIRST USE 1-1-2008; IN COMMERCE 1-1-2008.

3,680,644. AMERICHEM, INC., CUYAHOGA FALLS, OH. SN 77-356,648. PUB. 9-9-2008, FILED 12-20-2007.



OWNER OF U.S. REG. NOS. 909,908 AND 1,555,388.
THE MARK CONSISTS OF A STYLIZED A IN A CIRCLE.

CLASS 1—CHEMICALS

FOR CHEMICAL ADDITIVES FOR USE IN PLASTIC FORMULATIONS (U.S. CLS. 1, 5, 6, 10, 26 AND 46).

FIRST USE 1-1-2008; IN COMMERCE 1-1-2008.

CLASS 2—PAINTS

FOR COLOR CONCENTRATE COMPOUNDS FOR USE IN COLORING THERMOPLASTICS (U.S. CLS. 6, 11 AND 16).

FIRST USE 1-1-2008; IN COMMERCE 1-1-2008.

CLASS 40—MATERIAL TREATMENT

FOR COLOR MATCHING SERVICES RELATING TO PLASTIC MATERIALS, NAMELY, COLOR MIXING, BLENDING AND COLORIZING SERVICES (U.S. CLS. 100, 103 AND 106).

FIRST USE 1-1-2008; IN COMMERCE 1-1-2008.

3,680,645. AMERICHEM, INC., CUYAHOGA FALLS, OH. SN 77-356,868. PUB. 9-9-2008, FILED 12-20-2007.

americhem

OWNER OF U.S. REG. NOS. 909,908 AND 3,092,533.
THE MARK CONSISTS OF THE WORD "AMERICHEM" IN STYLIZED FONT.

CLASS 1—CHEMICALS

FOR CHEMICAL ADDITIVES FOR USE IN PLASTICS FORMULATIONS (U.S. CLS. 1, 5, 6, 10, 26 AND 46).

FIRST USE 1-1-2008; IN COMMERCE 1-1-2008.

CLASS 2—PAINTS

FOR COLOR CONCENTRATE COMPOUNDS FOR USE IN COLORING THERMOPLASTICS (U.S. CLS. 6, 11 AND 16).

FIRST USE 1-1-2008; IN COMMERCE 1-1-2008.

CLASS 40—MATERIAL TREATMENT

FOR COLOR MATCHING SERVICES RELATING TO PLASTIC MATERIALS, NAMELY, COLOR MIXING, BLENDING AND COLORIZING (U.S. CLS. 100, 103 AND 106).

FIRST USE 1-1-2008; IN COMMERCE 1-1-2008.

3,680,647. EMERITUS CORPORATION, SEATTLE, WA. SN 77-358,235. PUB. 11-25-2008, FILED 12-21-2007.

EMERITUS

THE MARK CONSISTS OF STANDARD CHARACTERS WITHOUT CLAIM TO ANY PARTICULAR FONT, STYLE, SIZE, OR COLOR.

OWNER OF U.S. REG. NOS. 2,333,116 AND 2,840,150.

CLASS 41—EDUCATION AND ENTERTAINMENT

FOR EDUCATIONAL SERVICES, NAMELY, PROVIDING COURSES OF INSTRUCTION ABOUT ALZHEIMER'S DISEASE AND CARING FOR PERSONS SUFFERING FROM ALZHEIMER'S DISEASE (U.S. CLS. 100, 101 AND 107).

FIRST USE 8-31-2006; IN COMMERCE 8-31-2006.

CLASS 43—HOTEL AND RESTAURANT SERVICES

FOR PROVIDING ASSISTED LIVING AND RETIREMENT HOUSING; AND PROVIDING ELDER CARE SERVICES (U.S. CLS. 100 AND 101).

FIRST USE 4-3-1998; IN COMMERCE 4-3-1998.

CLASS 44—MEDICAL, BEAUTY AND AGRICULTURAL SERVICES

FOR PROVIDING HEALTH CARE FOR THE ELDERLY, DISABLED AND RETIRED PERSONS; NURSING HOME SERVICES; AND HOME HEALTH CARE SERVICES; PROVIDING INFORMATION IN THE FIELDS OF HEALTH AND MEDICINE; HOSPICE SERVICES; PALLIATIVE CARE SERVICES (U.S. CLS. 100 AND 101).

FIRST USE 4-3-1998; IN COMMERCE 4-3-1998.

3,680,648. SET MAGAZINE, INC., BOCA RATON, FL. SN 77-358,320. PUB. 9-16-2008, FILED 12-21-2007.

I'm SET

THE MARK CONSISTS OF STANDARD CHARACTERS WITHOUT CLAIM TO ANY PARTICULAR FONT, STYLE, SIZE, OR COLOR.

CLASS 16—PAPER GOODS AND PRINTED MATTER

FOR PRINTED PERIODICALS FEATURING CONTENT RELATED TO SPORTS, ATHLETES, OTHER SPORTS FIGURES AND SPORTS CELEBRITIES, SPORTS COMPETITIONS, AND ENTERTAINMENT AND OTHER EVENTS INVOLVING ATHLETES, SPORTS CELEBRITIES AND OTHER SPORTS FIGURES (U.S. CLS. 2, 5, 22, 23, 29, 37, 38 AND 50).

FIRST USE 6-1-2009; IN COMMERCE 6-1-2009.

CLASS 41—EDUCATION AND ENTERTAINMENT

FOR PROVIDING A WEBSITE FEATURING PHOTOGRAPHIC, AUDIO, VIDEO AND PROSE PRESENTATIONS, ALL RELATED TO SPORTS, ATHLETES, OTHER SPORTS FIGURES AND SPORTS CELEBRITIES, SPORTS COMPETITIONS, AND ENTERTAINMENT AND OTHER EVENTS INVOLVING ATHLETES, SPORTS CELEBRITIES AND OTHER SPORTS FIGURES; ENTERTAINMENT, NAMELY, PRODUCTION AND DISTRIBUTION OF TELEVISION PROGRAMS TO BE BROADCAST OVER TELEVISION, RADIO, SATELLITE, INTERNET, AUDIO AND VIDEO MEDIA RELATED TO SPORTS, ATHLETES, OTHER SPORTS FIGURES AND SPORTS CELEBRITIES, SPORTS COMPETITIONS, AND ENTERTAINMENT AND OTHER EVENTS INVOLVING ATHLETES, SPORTS CELEBRITIES AND OTHER SPORTS FIGURES (U.S. CLS. 100, 101 AND 107).

FIRST USE 9-27-2007; IN COMMERCE 9-27-2007.

3,680,649. EMERITUS CORPORATION, SEATTLE, WA. SN 77-358,823. PUB. 11-25-2008, FILED 12-22-2007.

EMERITUS SENIOR LIVING

THE MARK CONSISTS OF STANDARD CHARACTERS WITHOUT CLAIM TO ANY PARTICULAR FONT, STYLE, SIZE, OR COLOR.

OWNER OF U.S. REG. NOS. 2,333,116 AND 2,840,150.

NO CLAIM IS MADE TO THE EXCLUSIVE RIGHT TO USE "SENIOR LIVING", APART FROM THE MARK AS SHOWN.

CLASS 41—EDUCATION AND ENTERTAINMENT

FOR EDUCATIONAL SERVICES, NAMELY, PROVIDING COURSES OF INSTRUCTION ABOUT ALZHEIMER'S DISEASE AND CARING FOR PERSONS SUFFERING FROM ALZHEIMER'S DISEASE (U.S. CLS. 100, 101 AND 107).

FIRST USE 4-16-2008; IN COMMERCE 4-16-2008.

CLASS 43—HOTEL AND RESTAURANT SERVICES

FOR PROVIDING ASSISTED LIVING AND RETIREMENT HOUSING; AND PROVIDING ELDER CARE SERVICES (U.S. CLS. 100 AND 101).

FIRST USE 4-16-2008; IN COMMERCE 4-16-2008.

CLASS 44—MEDICAL, BEAUTY AND AGRICULTURAL SERVICES

FOR PROVIDING HEALTH CARE FOR THE ELDERLY, DISABLED AND RETIRED PERSONS; NURSING HOME SERVICES; AND HOME HEALTH CARE SERVICES; PROVIDING INFORMATION IN THE FIELDS OF HEALTH AND MEDICINE; HOSPICE SERVICES; PALLIATIVE CARE SERVICES (U.S. CLS. 100 AND 101).

FIRST USE 4-16-2008; IN COMMERCE 4-16-2008.

3,680,650. EMERITUS CORPORATION, SEATTLE, WA. SN 77-358,828. PUB. 11-25-2008, FILED 12-22-2007.



OWNER OF U.S. REG. NOS. 2,333,116 AND 2,840,150. NO CLAIM IS MADE TO THE EXCLUSIVE RIGHT TO USE "SENIOR LIVING", APART FROM THE MARK AS SHOWN.

THE MARK CONSISTS OF "EMERITUS SENIOR LIVING" IN STYLIZED FORM ABOVE WHICH APPEARS A LEAF WITHIN A CIRCLE.

CLASS 41—EDUCATION AND ENTERTAINMENT

FOR EDUCATIONAL SERVICES, NAMELY, PROVIDING COURSES OF INSTRUCTION ABOUT ALZHEIMER'S DISEASE AND CARING FOR PERSONS SUFFERING FROM ALZHEIMER'S DISEASE (U.S. CLS. 100, 101 AND 107).

FIRST USE 4-16-2008; IN COMMERCE 4-16-2008.

CLASS 43—HOTEL AND RESTAURANT SERVICES

FOR PROVIDING ASSISTED LIVING AND RETIREMENT HOUSING; AND PROVIDING ELDER CARE SERVICES (U.S. CLS. 100 AND 101).

FIRST USE 4-16-2008; IN COMMERCE 4-16-2008.

CLASS 44—MEDICAL, BEAUTY AND AGRICULTURAL SERVICES

FOR PROVIDING HEALTH CARE FOR THE ELDERLY, DISABLED AND RETIRED PERSONS; NURSING HOME SERVICES; AND HOME HEALTH CARE SERVICES; PROVIDING INFORMATION IN THE FIELDS OF HEALTH AND MEDICINE; HOSPICE SERVICES; PALLIATIVE CARE SERVICES (U.S. CLS. 100 AND 101).

FIRST USE 4-16-2008; IN COMMERCE 4-16-2008.

3,680,655. EPOCORP CORPORATION, MIAMI, FL. SN 77-359,929. PUB. 10-21-2008, FILED 12-27-2007.

EPOCORP

THE MARK CONSISTS OF STANDARD CHARACTERS WITHOUT CLAIM TO ANY PARTICULAR FONT, STYLE, SIZE, OR COLOR.

CLASS 36—INSURANCE AND FINANCIAL

FOR REAL ESTATE MANAGEMENT AND LEASING SERVICES IN THE FIELD OF COMMUNITIES, RETAIL STORES, SHOPPING MALLS, OFFICE BUILDINGS, RESIDENTIAL HOME AND CONDOMINIUM PROJECTS, COUNTRY CLUBS, AND RECREATIONAL FACILITIES (U.S. CLS. 100, 101 AND 102).
FIRST USE 2-0-2008; IN COMMERCE 2-0-2008.

CLASS 37—CONSTRUCTION AND REPAIR

FOR REAL ESTATE DEVELOPMENT AND CONSTRUCTION SERVICES, NAMELY, PLANNING, LAYING OUT, AND CONSTRUCTION OF COMMUNITIES, RETAIL STORES, SHOPPING MALLS, OFFICE BUILDINGS, RESIDENTIAL HOME AND CONDOMINIUM PROJECTS, COUNTRY CLUBS, AND RECREATIONAL FACILITIES (U.S. CLS. 100, 103 AND 106).
FIRST USE 2-0-2008; IN COMMERCE 2-0-2008.

3,680,656. LEHRMITT ASSOCIATES INC., SUNSET VALLEY, TX. SN 77-360,096. PUB. 5-13-2008, FILED 12-27-2007.



THE COLOR(S) BLUE AND GRAY IS/ARE CLAIMED AS A FEATURE OF THE MARK.

THE MARK CONSISTS OF THE WORD "UTZI" IN BLUE WITH A BACKGROUND GRAY ORNAMENTAL FLOURISH.

CLASS 14—JEWELRY

FOR CHARMS; COSTUME JEWELRY; JEWELRY; JEWELRY CASES; JEWELRY CHAINS; JEWELRY WATCHES (U.S. CLS. 2, 27, 28 AND 50).
FIRST USE 11-1-2007; IN COMMERCE 8-5-2008.

CLASS 18—LEATHER GOODS

FOR HANDBAGS, PURSES AND WALLETS; KEY WALLETS; LEATHER BAGS, SUITCASES AND WALLETS; PURSES AND WALLETS OF PRECIOUS METAL; WALLET CHAINS; WALLETS; DRAWSTRING POUCHES; LEATHER POUCHES; POUCHES AND BAGS SOLD EMPTY FOR ATTACHMENT TO BACKPACKS; WEARABLE STRAP-ON POUCH; JEWELRY ORGANIZERS FOR TRAVEL; HANDBAGS FOR MEN; BELT BAGS; FANNY PACKS; WAIST PACKS (U.S. CLS. 1, 2, 3, 22 AND 41).

FIRST USE 11-1-2007; IN COMMERCE 6-5-2008.

3,680,673. BISHOP OF THE NORTH AMERICAN REGION OF SUKYO MAHIKARI, RANCHO SANTA MARGARITA, CA. SN 77-368,971. PUB. 5-27-2008, FILED 1-10-2008.

Improve yourself...improve
the world

THE MARK CONSISTS OF STANDARD CHARACTERS WITHOUT CLAIM TO ANY PARTICULAR FONT, STYLE, SIZE, OR COLOR.

CLASS 16—PAPER GOODS AND PRINTED MATTER

FOR BOOKS, PAMPHLETS, MAGAZINES, POSTERS, PAPER PRINTED SIGNS, LEAFLETS AND INSTRUCTION MANUALS, ALL IN THE FIELD OF RELIGIOUS AND SPIRITUAL SERVICES; STATIONERY; PAINTINGS; DECALS; PENS; PENCILS; NOTE PADS; DESKTOP ORGANIZERS; DESKTOP PLANNERS; DESKTOP BUSINESS CARD HOLDERS; PENCIL HOLDERS; PEN HOLDERS (U.S. CLS. 2, 5, 22, 23, 29, 37, 38 AND 50).
FIRST USE 2-1-2008; IN COMMERCE 2-1-2008.

CLASS 25—CLOTHING

FOR CLOTHING, NAMELY, SHIRTS, SHORTS, SWEAT SHIRTS, RUNNING PANTS, CAPS, SOCKS, JACKETS (U.S. CLS. 22 AND 39).
FIRST USE 2-1-2008; IN COMMERCE 2-1-2008.

CLASS 45—PERSONAL AND LEGAL SERVICES

FOR RELIGIOUS AND SPIRITUAL SERVICES, NAMELY, PROVIDING GATHERINGS TO DEVELOP AND ENHANCE THE SPIRITUAL LIVES OF INDIVIDUALS (U.S. CLS. 100 AND 101).
FIRST USE 2-1-2008; IN COMMERCE 2-1-2008.

3,680,682. TIKI VENTURES LLC, NEW YORK, NY. SN 77-373,775. PUB. 5-27-2008, FILED 1-16-2008.

TIKI VENTURES

THE MARK CONSISTS OF STANDARD CHARACTERS WITHOUT CLAIM TO ANY PARTICULAR FONT, STYLE, SIZE, OR COLOR.

NO CLAIM IS MADE TO THE EXCLUSIVE RIGHT TO

USE "VENTURES", APART FROM THE MARK AS SHOWN. THE NAME ATIIM "TIKI" BARBER IDENTIFIES A LIVING INDIVIDUAL WHOSE CONSENT IS OF RECORD.

3,680,700. NEWTEK BUSINESS SERVICES, INC., NEW YORK, NY. SN 77-389,633. PUB. 10-14-2008, FILED 2-6-2008.

CLASS 35—ADVERTISING AND BUSINESS

FOR ADVERTISING AND MARKETING; ADVERTISING AND PROMOTIONAL SERVICES; ADVERTISING, MARKETING AND PROMOTION SERVICES; BUSINESS ADVICE AND ANALYSIS OF MARKETS; BUSINESS ADVICE AND INFORMATION; BUSINESS MARKETING CONSULTING SERVICES; BUSINESS MARKETING SERVICES; MARKETING CONSULTING; CONSULTING SERVICES RELATED TO THE ADMINISTRATIVE COORDINATION OF ORGANIZATIONS PROVIDING HUMANITARIAN ACTIVITIES (U.S. CLS. 100, 101 AND 102).
FIRST USE 4-1-2008; IN COMMERCE 4-1-2008.

NEWTEK DATA STORAGE

THE MARK CONSISTS OF STANDARD CHARACTERS WITHOUT CLAIM TO ANY PARTICULAR FONT, STYLE, SIZE, OR COLOR.

NO CLAIM IS MADE TO THE EXCLUSIVE RIGHT TO USE "DATA STORAGE", APART FROM THE MARK AS SHOWN.

CLASS 36—INSURANCE AND FINANCIAL

FOR REAL ESTATE INVESTMENT (U.S. CLS. 100, 101 AND 102).
FIRST USE 4-1-2008; IN COMMERCE 4-1-2008.

CLASS 39—TRANSPORTATION AND STORAGE

FOR STORAGE SERVICES FOR ARCHIVING DATABASES, IMAGES, MESSAGES, DOCUMENTS AND OTHER ELECTRONIC DATA (U.S. CLS. 100 AND 105).
FIRST USE 10-0-2006; IN COMMERCE 10-0-2006.

3,680,693. IMAGINOVA CORP., NEW YORK, NY. SN 77-385,833. PUB. 8-19-2008, FILED 1-31-2008.

CLASS 42—SCIENTIFIC AND COMPUTER SERVICES

FOR COMPUTER SERVICE, NAMELY, ACTING AS AN APPLICATION SERVICE PROVIDER (ASP) FEATURING SOFTWARE FOR USE IN THE TRANSMISSION, STORAGE AND SHARING OF DATA AND INFORMATION (U.S. CLS. 100 AND 101).
FIRST USE 10-0-2006; IN COMMERCE 10-0-2006.

NEWSARAMA

3,680,716. RAW THRILLS, INC., SKOKIE, IL. SN 77-395,420. PUB. 6-24-2008, FILED 2-12-2008.

THE MARK CONSISTS OF STANDARD CHARACTERS WITHOUT CLAIM TO ANY PARTICULAR FONT, STYLE, SIZE, OR COLOR.

H2OVERDRIVE

CLASS 38—COMMUNICATION

FOR PROVIDING AN ON-LINE INTERACTIVE BULLETIN BOARD FOR TRANSMISSION OF MESSAGES AMONG COMPUTER USERS CONCERNING COMIC BOOKS, SCIENCE FICTION, TELEVISION, MOVIES, AND VIDEO GAMES (U.S. CLS. 100, 101 AND 104).
FIRST USE 1-1-1999; IN COMMERCE 1-1-1999.

THE MARK CONSISTS OF STANDARD CHARACTERS WITHOUT CLAIM TO ANY PARTICULAR FONT, STYLE, SIZE, OR COLOR.

CLASS 41—EDUCATION AND ENTERTAINMENT

FOR ON-LINE PUBLICATION OF COMIC BOOKS AND REPORTS, ARTICLES, COMMENTARY, AND INFORMATION IN THE FIELDS OF COMIC BOOKS, SCIENCE FICTION, TELEVISION, MOVIES, AND VIDEO GAMES; ENTERTAINMENT SERVICES, NAMELY, PROVIDING INFORMATION BY MEANS OF A GLOBAL COMPUTER NETWORK IN THE FIELDS OF COMIC BOOKS, SCIENCE FICTION, TELEVISION, MOVIES, AND VIDEO GAMES; ON-LINE JOURNALS, NAMELY, INTERACTIVE WEB LOGS FEATURING COMIC BOOKS, SCIENCE FICTION, TELEVISION, MOVIES, AND VIDEO GAMES (U.S. CLS. 100, 101 AND 107).
FIRST USE 1-1-1999; IN COMMERCE 1-1-1999.

CLASS 9—ELECTRICAL AND SCIENTIFIC APPARATUS

FOR VIDEO GAME SOFTWARE (U.S. CLS. 21, 23, 26, 36 AND 38).
FIRST USE 1-27-2009; IN COMMERCE 5-18-2009.

CLASS 28—TOYS AND SPORTING GOODS

FOR ARCADE-TYPE ELECTRONIC VIDEO GAMES (U.S. CLS. 22, 23, 38 AND 50).
FIRST USE 1-27-2009; IN COMMERCE 5-19-2009.

3,680,747. FAT GOOSE, INC., SAN FRANCISCO, CA. SN 77-407,354. PUB. 7-22-2008, FILED 2-27-2008.

3,680,757. RAL VENTURES, COLUMBIA CITY, LA. SN 77-414,274. PUB. 7-22-2008, FILED 3-5-2008.

FAT GOOSE

THE MARK CONSISTS OF STANDARD CHARACTERS WITHOUT CLAIM TO ANY PARTICULAR FONT, STYLE, SIZE, OR COLOR.

CLASS 42—SCIENTIFIC AND COMPUTER SERVICES

FOR COMPUTER SERVICES, NAMELY, HOSTING THE WEBSITES OF OTHERS ON A COMPUTER SERVER FOR A GLOBAL COMPUTER NETWORK; APPLICATION SERVICE PROVIDER (ASP) FEATURING SOFTWARE FOR USE IN DEVELOPING WEBSITES (U.S. CLS. 100 AND 101).

FIRST USE 9-0-2007; IN COMMERCE 9-0-2007.

CLASS 45—PERSONAL AND LEGAL SERVICES

FOR ONLINE SOCIAL NETWORKING SERVICES (U.S. CLS. 100 AND 101).

FIRST USE 9-0-2007; IN COMMERCE 9-0-2007.

3,680,750. NEXTERA ENERGY POWER MARKETING, LLC, JUNO BEACH, FL. SN 77-410,258. PUB. 7-15-2008, FILED 2-29-2008.

EARTHERA

THE MARK CONSISTS OF STANDARD CHARACTERS WITHOUT CLAIM TO ANY PARTICULAR FONT, STYLE, SIZE, OR COLOR.

CLASS 36—INSURANCE AND FINANCIAL

FOR BROKERAGE IN THE FIELD OF ENVIRONMENTAL CREDITS, OFFSETS AND ALLOWANCES OF OTHERS RESULTING FROM THE PURCHASE, GENERATION, OR USE OF ENERGY, OR THE AVOIDANCE OF THE EMISSION OF ANY GAS, CHEMICAL OR OTHER SUBSTANCE TO THE AIR, SOIL OR WATER (U.S. CLS. 100, 101 AND 102).

FIRST USE 4-1-2009; IN COMMERCE 4-1-2009.

CLASS 42—SCIENTIFIC AND COMPUTER SERVICES

FOR ANALYZING AND EVALUATING THE ENVIRONMENTAL CHARACTERISTICS, ATTRIBUTES, CREDITS, BENEFITS, REDUCTIONS, OFFSETS AND ALLOWANCES OF OTHERS RESULTING FROM THE PURCHASE, GENERATION, OR USE OF ENERGY, OR THE AVOIDANCE OF THE EMISSION OF ANY GAS, CHEMICAL OR OTHER SUBSTANCE TO THE AIR, SOIL OR WATER (U.S. CLS. 100 AND 101).

FIRST USE 4-1-2009; IN COMMERCE 4-1-2009.



THE MARK CONSISTS OF A MOSQUITO'S HEAD WITH TWO CROSSED BONES BEHIND THE HEAD. THE MOSQUITO'S PROBOSCIS EXTENDS IN A STRAIGHT LINE BELOW THE HEAD OF THE MOSQUITO. ON EITHER SIDE OF THE PROBOSCIS ARE TWO BARBED STRUCTURES, WHICH ARE THE MOSQUITO'S ANTENNAE. THE DESIGN APPEARS ON A SHADED BACKGROUND.

CLASS 25—CLOTHING

FOR HATS; T-SHIRTS; SWEATERS (U.S. CLS. 22 AND 39).

FIRST USE 4-0-2008; IN COMMERCE 4-0-2008.

CLASS 37—CONSTRUCTION AND REPAIR

FOR PEST CONTROL (U.S. CLS. 100, 103 AND 106).

FIRST USE 4-0-2008; IN COMMERCE 4-0-2008.

3,680,759. U.S. LAND TITLE, LLC, ATLANTA, GA. SN 77-414,413. PUB. 3-10-2009, FILED 3-6-2008.

NATIONS SEARCH

THE MARK CONSISTS OF STANDARD CHARACTERS WITHOUT CLAIM TO ANY PARTICULAR FONT, STYLE, SIZE, OR COLOR.

NO CLAIM IS MADE TO THE EXCLUSIVE RIGHT TO USE "SEARCH", APART FROM THE MARK AS SHOWN.

CLASS 36—INSURANCE AND FINANCIAL

FOR REAL ESTATE ESCROW SERVICES (U.S. CLS. 100, 101 AND 102).

FIRST USE 9-30-2007; IN COMMERCE 9-30-2007.

CLASS 38—COMMUNICATION

FOR ONLINE TITLE DOCUMENT DELIVERY (U.S. CLS. 100, 101 AND 104).

FIRST USE 6-30-2009; IN COMMERCE 6-30-2009.

CLASS 45—PERSONAL AND LEGAL SERVICES

FOR CLOSING SERVICES FOR MORTGAGE LOANS; PREPARING AND ORGANIZING LOAN CLOSING DOCUMENTS; REAL ESTATE CLOSING SERVICES; REAL ESTATE SETTLEMENT SERVICES; TITLE SEARCHING (U.S. CLS. 100 AND 101).

FIRST USE 9-30-2007; IN COMMERCE 9-30-2007.

3,680,776. WILLARD AGRI-SERVICE, INC., WORTON, MD. SN 77-428,336. PUB. 10-21-2008, FILED 3-21-2008.



THE COLOR(S) BLACK AND GREEN IS/ARE CLAIMED AS A FEATURE OF THE MARK.

THE MARK CONSISTS OF THE LETTERS "ECO" AND THE SUPERSCRIPIT "N" IN BLACK. THERE IS A SOLID GREEN CIRCLE IN THE CENTER OF THE LETTER "O".

3,680,760. COLDER PRODUCTS COMPANY, ST. PAUL, MN. SN 77-415,181. PUB. 10-14-2008, FILED 3-6-2008.

BREAKAWAY

THE MARK CONSISTS OF STANDARD CHARACTERS WITHOUT CLAIM TO ANY PARTICULAR FONT, STYLE, SIZE, OR COLOR.

CLASS 6—METAL GOODS

FOR METAL COUPLINGS FOR FLUID HANDLING (U.S. CLS. 2, 12, 13, 14, 23, 25 AND 50).

FIRST USE 6-20-2008; IN COMMERCE 6-20-2008.

CLASS 17—RUBBER GOODS

FOR NON-METAL COUPLINGS MADE OF PLASTIC FOR FLUID HANDLING (U.S. CLS. 1, 5, 12, 13, 35 AND 50).

FIRST USE 6-20-2008; IN COMMERCE 6-20-2008.

CLASS 42—SCIENTIFIC AND COMPUTER SERVICES

FOR CONSULTATION SERVICES IN THE FIELD OF LAND USE EFFICIENCY PLANNING (U.S. CLS. 100 AND 101).

FIRST USE 2-28-2007; IN COMMERCE 2-28-2007.

CLASS 44—MEDICAL, BEAUTY AND AGRICULTURAL SERVICES

FOR AGRICULTURAL CONSULTATION SERVICES, NAMELY, CONSULTING PERTAINING TO USE OF NUTRIENTS (U.S. CLS. 100 AND 101).

FIRST USE 2-28-2007; IN COMMERCE 2-28-2007.

3,680,769. I LOVE REWARDS INC., NEW YORK, NY. SN 77-420,670. PUB. 8-5-2008, FILED 3-13-2008.

RETHINK REWARDS

THE MARK CONSISTS OF STANDARD CHARACTERS WITHOUT CLAIM TO ANY PARTICULAR FONT, STYLE, SIZE, OR COLOR.

NO CLAIM IS MADE TO THE EXCLUSIVE RIGHT TO USE "REWARDS", APART FROM THE MARK AS SHOWN.

CLASS 9—ELECTRICAL AND SCIENTIFIC APPARATUS

FOR SOFTWARE FOR ONLINE POINTS-BASED REWARD PROGRAMS THAT DRIVE THE EMPLOYEE BEHAVIORS AND MOTIVATE EMPLOYEES THROUGH EMPLOYEE RECOGNITION AND SALES INCENTIVES (U.S. CLS. 21, 23, 26, 36 AND 38).

FIRST USE 5-1-2008; IN COMMERCE 5-1-2008.

CLASS 35—ADVERTISING AND BUSINESS

FOR BUSINESS CONSULTING SERVICE FOR MANAGING EMPLOYEE INCENTIVE PROGRAMS, NAMELY, BUILDING ONLINE POINTS-BASED REWARD PROGRAMS FOR OTHERS (U.S. CLS. 100, 101 AND 102).

FIRST USE 5-1-2008; IN COMMERCE 5-1-2008.

3,680,790. ENCORE LEGAL SOLUTIONS, LOS ANGELES, CA. SN 77-435,551. PUB. 2-17-2009, FILED 3-31-2008.



Knowledge. Innovation. Results.

OWNER OF U.S. REG. NOS. 2,955,790 AND 2,955,791.

NO CLAIM IS MADE TO THE EXCLUSIVE RIGHT TO USE "DISCOVERY SOLUTIONS", APART FROM THE MARK AS SHOWN.

THE MARK CONSISTS OF AN IMAGE OF A CD-ROM NEXT TO THE WORDS "ENCORE DISCOVERY SOLUTIONS" AND "KNOWLEDGE. INNOVATION. RESULTS."

CLASS 35—ADVERTISING AND BUSINESS

FOR DOCUMENT REPRODUCTION; DATA PROCESSING IN THE NATURE OF ELECTRONIC CODING AND INDEXING OF LEGAL DOCUMENTS FOR ATTORNEYS; LEGAL DOCUMENT MANAGEMENT SERVICES, NAMELY, DOCUMENT INDEXING, COPYING, DOCUMENT REPRODUCTION, DOCUMENT TRACKING AND MANAGEMENT SERVICES IN THE NATURE OF DOCUMENT PRODUCTION; DEPOSITION DATABASE MANAGEMENT SERVICES; VALUE-ADDED RESELLER SERVICES, NAMELY, DISTRIBUTORSHIP SERVICES IN THE FIELD OF COMPUTER SOFTWARE; DATA PROCESSING SERVICES, NAMELY, FILTERING DOCUMENTS AND REMOVING DUPLICATE DOCUMENTS (U.S. CLS. 100, 101 AND 102).

FIRST USE 6-0-2008; IN COMMERCE 6-0-2008.

CLASS 42—SCIENTIFIC AND COMPUTER SERVICES

FOR COMPUTER CONSULTATION SERVICES, NAMELY, DATA RECOVERY, EXTRACTION AND REPRODUCTION SERVICES; GRAPHIC DESIGN SERVICES FOR LEGAL PROCEEDINGS; CONVERSION OF DATA OR DOCUMENTS FROM PHYSICAL TO ELECTRONIC MEDIA; COMPUTER SERVICES, NAMELY, HOSTING AND MAINTAINING AN ONLINE WEB SITE FOR OTHERS TO ACCESS, SHARE, AND MANAGE INFORMATION DURING LITIGATION; DATA FORENSIC SERVICES, NAMELY, COLLECTING, PRESERVING, AND ANALYZING PAPER DOCUMENTS AND ELECTRONICALLY STORED INFORMATION FOR PRODUCTION OF LEGAL OR OTHER DOCUMENTS; LEGAL DOCUMENT MANAGEMENT SERVICES, NAMELY, PUBLIC DOCUMENT RETRIEVAL (U.S. CLS. 100 AND 101).

FIRST USE 6-0-2008; IN COMMERCE 6-0-2008.

CLASS 45—PERSONAL AND LEGAL SERVICES

FOR LEGAL SUPPORT AND CONSULTING SERVICES, NAMELY, PREPARING AND PRESENTING LEGAL EXHIBITS AND ELECTRONIC PRESENTATION OF EXHIBITS, DEPOSITION TRANSCRIPTS, AND VIDEO DEPOSITIONS IN THE LEGAL FIELD; LEGAL SUPPORT AND CONSULTING SERVICES, NAMELY, PROVIDING DATABASES AND REPORTING SERVICES FOR THE PRODUCTION OF LEGAL DOCUMENTS; TRIAL CONSULTING SERVICES; LITIGATION SUPPORT SERVICES, NAMELY, CD-ROM AND PHOTOGRAPHIC SLIDE PRODUCTION FOR USE AS EXHIBITS IN LEGAL PROCEEDINGS AND CONSULTING SERVICES IN CONNECTION THEREWITH; LITIGATION SUPPORT SERVICES, NAMELY, DEPOSITION DIGESTING SERVICES; LITIGATION SUPPORT SERVICES IN THE NATURE OF PROJECT AND DOCUMENT MANAGEMENT, NAMELY, ASSISTING IN DISCOVERY; LEGAL DOCUMENT PREPARATION FOR ATTORNEYS; LITIGATION SUPPORT SERVICES IN THE NATURE OF CONDUCTING ELECTRONIC ONLINE DATA DISCOVERY SERVICES FOR ATTORNEYS; LICENSING OF COMPUTER SOFTWARE (U.S. CLS. 100 AND 101).

FIRST USE 6-0-2008; IN COMMERCE 6-0-2008.

3,680,791. ENCORE LEGAL SOLUTIONS, LOS ANGELES, CA. SN 77-435,555. PUB. 2-17-2009, FILED 3-31-2008.

Encore Discovery Solutions

THE MARK CONSISTS OF STANDARD CHARACTERS WITHOUT CLAIM TO ANY PARTICULAR FONT, STYLE, SIZE, OR COLOR.

OWNER OF U.S. REG. NOS. 2,955,790 AND 2,955,791.

NO CLAIM IS MADE TO THE EXCLUSIVE RIGHT TO USE "DISCOVERY SOLUTIONS", APART FROM THE MARK AS SHOWN.

CLASS 35—ADVERTISING AND BUSINESS

FOR DOCUMENT REPRODUCTION; DATA PROCESSING IN THE NATURE OF ELECTRONIC CODING AND INDEXING OF LEGAL DOCUMENTS FOR ATTORNEYS; LEGAL DOCUMENT MANAGEMENT SERVICES, NAMELY, DOCUMENT INDEXING, COPYING, DOCUMENT REPRODUCTION, DOCUMENT TRACKING AND MANAGEMENT SERVICES IN THE NATURE OF DOCUMENT PRODUCTION; DEPOSITION DATABASE MANAGEMENT SERVICES; VALUE-ADDED RESELLER SERVICES, NAMELY, DISTRIBUTORSHIP SERVICES IN THE FIELD OF COMPUTER SOFTWARE; DATA PROCESSING SERVICES, NAMELY, FILTERING DOCUMENTS AND REMOVING DUPLICATE DOCUMENTS (U.S. CLS. 100, 101 AND 102).

FIRST USE 6-0-2008; IN COMMERCE 6-0-2008.

CLASS 39—TRANSPORTATION AND STORAGE

FOR ELECTRONIC ONLINE STORAGE FOR LEGAL DOCUMENTS; LEGAL DOCUMENT MANAGEMENT SERVICES, NAMELY, ELECTRONIC DOCUMENT STORAGE (U.S. CLS. 100 AND 105).

FIRST USE 6-0-2008; IN COMMERCE 6-0-2008.

CLASS 41—EDUCATION AND ENTERTAINMENT

FOR LEGAL DOCUMENT MANAGEMENT SERVICES, NAMELY, DIGITAL IMAGING OF DOCUMENTS (U.S. CLS. 100, 101 AND 107).

FIRST USE 6-0-2008; IN COMMERCE 6-0-2008.

CLASS 42—SCIENTIFIC AND COMPUTER SERVICES

FOR COMPUTER CONSULTATION SERVICES, NAMELY, DATA RECOVERY, EXTRACTION AND REPRODUCTION SERVICES; GRAPHIC DESIGN SERVICES FOR LEGAL PROCEEDINGS; CONVERSION OF DATA OR DOCUMENTS FROM PHYSICAL TO ELECTRONIC MEDIA; COMPUTER SERVICES, NAMELY, HOSTING AND MAINTAINING AN ONLINE WEB SITE FOR OTHERS TO ACCESS, SHARE, AND MANAGE INFORMATION DURING LITIGATION; DATA FORENSIC SERVICES, NAMELY, COLLECTING, PRESERVING, AND ANALYZING PAPER DOCUMENTS AND ELECTRONICALLY STORED INFORMATION FOR PRODUCTION OF LEGAL OR OTHER DOCUMENTS; LEGAL DOCUMENT MANAGEMENT SERVICES, NAMELY, PUBLIC DOCUMENT RETRIEVAL (U.S. CLS. 100 AND 101).

FIRST USE 6-0-2008; IN COMMERCE 6-0-2008.

CLASS 45—PERSONAL AND LEGAL SERVICES

FOR LEGAL SUPPORT AND CONSULTING SERVICES, NAMELY, PREPARING AND PRESENTING LEGAL EXHIBITS AND ELECTRONIC PRESENTATION OF EXHIBITS, DEPOSITION TRANSCRIPTS, AND VIDEO DEPOSITIONS IN THE LEGAL FIELD; LEGAL SUPPORT AND CONSULTING SERVICES, NAMELY, PROVIDING DATABASES AND REPORTING SERVICES FOR THE PRODUCTION OF LEGAL DOCUMENTS; TRIAL CONSULTING SERVICES; LITIGATION SUPPORT SERVICES, NAMELY, CD-ROM AND PHOTOGRAPHIC SLIDE PRODUCTION FOR USE AS EXHIBITS IN LEGAL PROCEEDINGS AND CONSULTING SERVICES IN CONNECTION THEREWITH; LITIGATION SUPPORT SERVICES, NAMELY, DEPOSITION DIGESTING SERVICES; LITIGATION SUPPORT SERVICES IN THE NATURE OF PROJECT AND DOCUMENT MANAGEMENT, NAMELY, ASSISTING IN DISCOVERY; LEGAL DOCUMENT PREPARATION FOR ATTORNEYS; LITIGATION SUPPORT SERVICES IN THE NATURE OF CONDUCTING ELECTRONIC ONLINE DATA DISCOVERY SERVICES FOR ATTORNEYS; LICENSING OF COMPUTER SOFTWARE (U.S. CLS. 100 AND 101).

FIRST USE 6-0-2008; IN COMMERCE 6-0-2008.

3,680,792. AMERICAN AUTOMOBILE ASSOCIATION, INC., HEATHROW, FL. SN 77-435,675. PUB. 1-27-2009, FILED 3-31-2008.

AAA AUTOMANAGER

THE MARK CONSISTS OF STANDARD CHARACTERS WITHOUT CLAIM TO ANY PARTICULAR FONT, STYLE, SIZE, OR COLOR.

OWNER OF U.S. REG. NOS. 829,265 AND 2,900,596.

NO CLAIM IS MADE TO THE EXCLUSIVE RIGHT TO USE "AUTO MANAGER", APART FROM THE MARK AS SHOWN.

CLASS 38—COMMUNICATION

FOR PROVIDING E-MAIL NOTIFICATION OF MOTOR VEHICLE SERVICE AND ASSOCIATED SERVICE DEADLINES, AUTOMAKER RECALLS AND SAFETY ALERTS, AND PAYMENT DEADLINES (U.S. CLS. 100, 101 AND 104).

FIRST USE 1-0-2008; IN COMMERCE 1-0-2008.

CLASS 39—TRANSPORTATION AND STORAGE

FOR ELECTRONIC STORAGE OF DOCUMENTS REGARDING MOTOR VEHICLE MAINTENANCE, FINANCING, INSURANCE, AND WARRANTY INFORMATION (U.S. CLS. 100 AND 105).

FIRST USE 1-0-2008; IN COMMERCE 1-0-2008.

3,680,799. STEEL INDUSTRY HERITAGE CORPORATION, HOMESTEAD, PA. SN 77-438,129. PUB. 2-10-2009, FILED 4-2-2008.

Tour Anytime
stop. play. go.

NO CLAIM IS MADE TO THE EXCLUSIVE RIGHT TO USE "TOUR", APART FROM THE MARK AS SHOWN.

THE MARK CONSISTS OF THE WORDS "TOUR ANYTIME STOP. PLAY. GO." WITH VERTICAL LINES OF DIFFERING LENGTHS RAISING UP ABOVE THE LETTERS "IME" IN THE WORD "ANYTIME".

CLASS 9—ELECTRICAL AND SCIENTIFIC APPARATUS

FOR DOWNLOADABLE AUDIO FILES FEATURING LIVE AND RECORDED PROGRAMS ABOUT A REGION'S INDUSTRIAL, HISTORICAL, CULTURAL AND NATURAL FEATURES AND RESOURCES (U.S. CLS. 21, 23, 26, 36 AND 38).

FIRST USE 11-29-2007; IN COMMERCE 11-29-2007.

CLASS 41—EDUCATION AND ENTERTAINMENT

FOR EDUCATIONAL SERVICES, NAMELY, DEVELOPING AND PROVIDING PROGRAMS ABOUT A REGION'S INDUSTRIAL, HISTORICAL, CULTURAL AND NATURAL FEATURES AND RESOURCES; ENTERTAINMENT SERVICES, NAMELY, DEVELOPING LIVE AND RECORDED PROGRAMS ABOUT A REGION'S INDUSTRIAL, HISTORICAL, CULTURAL AND NATURAL FEATURES AND RESOURCES; ENTERTAINMENT SERVICES, NAMELY, PROVIDING NON-DOWNLOADABLE AUDIO FILES PRESENTED TO COMMUNICATIONS DEVICES VIA A GLOBAL COMPUTER NETWORK AND WIRELESS NETWORKS FEATURING LIVE AND RECORDED PROGRAMS ABOUT A REGION'S INDUSTRIAL, HISTORICAL, CULTURAL AND NATURAL FEATURES AND RESOURCES (U.S. CLS. 100, 101 AND 107).

FIRST USE 11-29-2007; IN COMMERCE 11-29-2007.

3,680,812. SUMMITAS LLC, BOSTON, MA. SN 77-441,279. PUB. 11-25-2008, FILED 4-7-2008.

SUMMITAS

THE MARK CONSISTS OF STANDARD CHARACTERS WITHOUT CLAIM TO ANY PARTICULAR FONT, STYLE, SIZE, OR COLOR.

THE WORDING "SUMMITAS" HAS NO MEANING IN A FOREIGN LANGUAGE.

CLASS 36—INSURANCE AND FINANCIAL

FOR PROVIDING AN INTERACTIVE WEB SITE FEATURING FINANCIAL INFORMATION ABOUT WEALTH MANAGEMENT AND PHILANTHROPY SERVICES CONCERNING MONETARY DONATIONS (U.S. CLS. 100, 101 AND 102).

FIRST USE 3-27-2009; IN COMMERCE 3-27-2009.

CLASS 42—SCIENTIFIC AND COMPUTER SERVICES

FOR PROVIDING AN INTERACTIVE WEB SITE FEATURING ONLINE NON-DOWNLOADABLE SOFTWARE WHICH PROVIDES A SECURE COLLABORATIVE WORKSPACE FOR WEALTH MANAGEMENT, SOCIAL NETWORKING FUNCTIONALITY AND DATA STORAGE (U.S. CLS. 100 AND 101).

FIRST USE 3-27-2009; IN COMMERCE 3-27-2009.

CLASS 45—PERSONAL AND LEGAL SERVICES

FOR PROVIDING AN INTERACTIVE WEB SITE FEATURING INFORMATION ABOUT LIFESTYLES (U.S. CLS. 100 AND 101).

FIRST USE 3-27-2009; IN COMMERCE 3-27-2009.

3,680,840. CONSUMER CREDIT COUNSELING SERVICE OF VENTURA COUNTY, CAMARILLO, CA. SN 77-456,069. PUB. 1-13-2009, FILED 4-23-2008.



NO CLAIM IS MADE TO THE EXCLUSIVE RIGHT TO USE "FINANCIAL SOLUTIONS", APART FROM THE MARK AS SHOWN.

THE MARK CONSISTS OF THE WORD "SUREPATH" WITH THE WORDS "FINANCIAL SOLUTIONS" BENEATH IT AND RIGHT-ALIGNED, AND BRACKETED BY SWOOSHES ABOVE THE "SURE" AND BELOW THE "FINANCIAL SOLUTIONS".

CLASS 36—INSURANCE AND FINANCIAL

FOR PROVIDING MONEY MANAGEMENT, CREDIT COUNSELING AND DEBT COUNSELING SERVICES; PROVIDING ON-LINE INFORMATION IN THE FIELD OF MONEY MANAGEMENT, CREDIT COUNSELING AND DEBT COUNSELING; PROVIDING FINANCIAL INFORMATION TO INDIVIDUALS AND BUSINESSES ABOUT THE CREATION AND MANAGEMENT OF BUDGETS FOR HOUSING EXPENSES, LIVING EXPENSES, EDUCATIONAL EXPENSES, HEALTH CARE EXPENSES, TAX EXPENSES, TRANSPORTATION EXPENSES AND RETIREMENT SAVINGS (U.S. CLS. 100, 101 AND 102).

FIRST USE 4-25-2009; IN COMMERCE 4-25-2009.

CLASS 41—EDUCATION AND ENTERTAINMENT

FOR EDUCATIONAL SERVICES, NAMELY, CONDUCTING CLASSES, SEMINARS, CONFERENCES AND WORKSHOPS IN THE FIELDS OF MONEY MANAGEMENT, CREDIT COUNSELING AND DEBT COUNSELING FOR HOUSING EXPENSES, LIVING EXPENSES, EDUCATIONAL EXPENSES, HEALTH CARE EXPENSES, TAX EXPENSES, TRANSPORTATION EXPENSES AND RETIREMENT SAVINGS (U.S. CLS. 100, 101 AND 107).

FIRST USE 4-25-2009; IN COMMERCE 4-25-2009.

3,680,849. GREAT LAKES ORTHODONTICS, LTD., TONAWANDA, NY. SN 77-457,372. PUB. 2-17-2009, FILED 4-24-2008.

DENTASOAK

THE MARK CONSISTS OF STANDARD CHARACTERS WITHOUT CLAIM TO ANY PARTICULAR FONT, STYLE, SIZE, OR COLOR.

CLASS 3—COSMETICS AND CLEANING PREPARATIONS

FOR CLEANER FOR DENTURES AND ORTHODONTIC APPLIANCES (U.S. CLS. 1, 4, 6, 50, 51 AND 52).

FIRST USE 8-26-2008; IN COMMERCE 8-26-2008.

CLASS 5—PHARMACEUTICALS

FOR DISINFECTANT FOR DENTURES AND ORTHODONTIC APPLIANCES (U.S. CLS. 6, 18, 44, 46, 51 AND 52).

FIRST USE 8-26-2008; IN COMMERCE 8-26-2008.

3,680,851. CATHOLIC HEALTHCARE WEST, SAN FRANCISCO, CA. SN 77-457,548. PUB. 9-30-2008, FILED 4-24-2008.

HELMET YOUR HEAD

THE MARK CONSISTS OF STANDARD CHARACTERS WITHOUT CLAIM TO ANY PARTICULAR FONT, STYLE, SIZE, OR COLOR.

CLASS 16—PAPER GOODS AND PRINTED MATTER

FOR ANATOMICAL MODELS OF THE SKULL AND BRAIN FOR INSTRUCTIONAL AND EDUCATIONAL PURPOSES AND PRINTED MATERIALS, NAMELY, STUDY GUIDES AND HANDOUTS RELATING TO THE IMPORTANCE OF WEARING HELMETS WHEN ENGAGING IN SPORTS AND RECREATIONAL ACTIVITIES (U.S. CLS. 2, 5, 22, 23, 29, 37, 38 AND 50).

FIRST USE 6-30-1995; IN COMMERCE 5-30-2008.

CLASS 35—ADVERTISING AND BUSINESS

FOR PROMOTING PUBLIC AWARENESS OF THE IMPORTANCE OF WEARING OF HELMETS WHEN ENGAGING IN SPORTS AND RECREATIONAL ACTIVITIES (U.S. CLS. 100, 101 AND 102).

FIRST USE 6-30-1995; IN COMMERCE 5-30-2008.

3,680,853. ALLIANCE FOR LUPUS RESEARCH, INC., NEW YORK, NY. SN 77-457,817. PUB. 9-16-2008, FILED 4-25-2008.

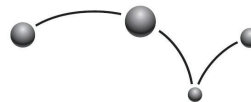

THE MARK CONSISTS OF A TWO DIMENSIONAL DESIGN OF A MOLECULE WITH FOUR ATOMS AND BONDS BETWEEN THE ATOMS.

CLASS 16—PAPER GOODS AND PRINTED MATTER

FOR PUBLICATIONS, NAMELY, NEWSLETTERS, MAGAZINES AND PAMPHLETS ON LUPUS AND ON OTHER AUTO-IMMUNE DISEASES, ON CHARITABLE SERVICES, ON FUNDRAISING AND ON SCIENTIFIC AND MEDICAL RESEARCH (U.S. CLS. 2, 5, 22, 23, 29, 37, 38 AND 50).

FIRST USE 8-30-2002; IN COMMERCE 8-30-2002.

CLASS 36—INSURANCE AND FINANCIAL

FOR CHARITABLE FUND RAISING SERVICES; PROVIDING FUNDING AND GRANTS FOR RESEARCH AND DEVELOPMENT ACTIVITIES IN THE FIELD OF LUPUS RESEARCH; CHARITABLE FUND RAISING SERVICES BY MEANS OF WALKATHONS AND RACES; PROVIDING INFORMATION VIA A WEB SITE, NAMELY, PROVIDING INDIVIDUALS WITH THE INFORMATION AND OPPORTUNITY TO MAKE MONETARY DONATIONS TO THEIR FAVORITE CHARITY, CHARITABLE FUND RAISING AND PROVIDING FUNDING AND GRANTS FOR SCIENTIFIC AND MEDICAL RESEARCH (U.S. CLS. 100, 101 AND 102).
FIRST USE 8-30-2002; IN COMMERCE 8-30-2002.

CLASS 35—ADVERTISING AND BUSINESS

FOR VENDING IN THE FIELD OF JEWELRY DESIGNED OUT OF BEADS GLASS PEARLS TURQUOISE WOOD GEMSTONES CRYSTAL SILVER LEATHER SHELL GOLD (U.S. CLS. 100, 101 AND 102).
FIRST USE 7-6-2009; IN COMMERCE 7-6-2009.

CLASS 40—MATERIAL TREATMENT

FOR IMPRINTING MESSAGES ON WEARING APPAREL, ACCESSORIES AND MUGS (U.S. CLS. 100, 103 AND 106).
FIRST USE 7-6-2009; IN COMMERCE 7-6-2009.

3,680,854. MATTHEWS, VANESSA, WEST HOLLYWOOD, CA. AND MANCINI, NANCY, WEST HOLLYWOOD, CA. SN 77-457,874. PUB. 9-23-2008, FILED 4-25-2008.



THE MARK CONSISTS OF THE STYLIZED WORDS "THE SOREHEADS". ABOVE THE STYLIZED WORDS IS AN ABSTRACT DESIGN.

CLASS 25—CLOTHING

FOR HOODED SWEAT SHIRTS; T-SHIRTS (U.S. CLS. 22 AND 39).
FIRST USE 1-2-2008; IN COMMERCE 3-10-2008.

CLASS 28—TOYS AND SPORTING GOODS

FOR DOLLS (U.S. CLS. 22, 23, 38 AND 50).
FIRST USE 1-1-2008; IN COMMERCE 3-10-2008.

3,680,856. PEYTON, BETTIE SUSAN, DBA BEACHALITY PLAY. UNWIND. SHINE., LEESBURG, FL. SN 77-458,305. PUB. 10-14-2008, FILED 4-25-2008.

BEACHality
Play. Unwind. Shine.

THE COLOR(S) BLUE IS/ARE CLAIMED AS A FEATURE OF THE MARK.

THE COLOR BLUE APPEARS IN THE WORDING "BEACHALITY PLAY. UNWIND. SHINE.".

3,680,860. NOTHING BUT SALT LLC, PIKESVILLE, MD. SN 77-458,504. PUB. 9-30-2008, FILED 4-25-2008.

NOTHING BUT SALT

THE MARK CONSISTS OF STANDARD CHARACTERS WITHOUT CLAIM TO ANY PARTICULAR FONT, STYLE, SIZE, OR COLOR.

NO CLAIM IS MADE TO THE EXCLUSIVE RIGHT TO USE "SALT", APART FROM THE MARK AS SHOWN.

CLASS 3—COSMETICS AND CLEANING PREPARATIONS

FOR NON-MEDICATED BATH SALTS, BATH SALTS WITH FRAGRANCES, MINERAL SALTS IN THE NATURE OF BATH SALTS NOT FOR MEDICAL PURPOSES (U.S. CLS. 1, 4, 6, 50, 51 AND 52).
FIRST USE 5-6-2009; IN COMMERCE 5-6-2009.

CLASS 30—STAPLE FOODS

FOR SALTS FOR CULINARY PURPOSES, NAMELY, TABLE SALTS, SEA SALTS, MINERAL SALT FOR HUMAN CONSUMPTION, COOKING SALT, FLAVORED SALT, TABLE SALT MIXED WITH SPICES, TABLE SALT MIXED WITH FLAVORINGS, DRY SPICE RUBS FOR MEATS AND FISH (U.S. CL. 46).
FIRST USE 2-28-2009; IN COMMERCE 2-28-2009.

3,680,863. OWENS, KEVIN, PERTH, AUSTRALIA. SN 77-459,135. PUB. 3-10-2009, FILED 4-28-2008.

CALiCO

THE MARK CONSISTS OF STANDARD CHARACTERS WITHOUT CLAIM TO ANY PARTICULAR FONT, STYLE, SIZE, OR COLOR.

OWNER OF AUSTRALIA REG. NO. 1005184, DATED 6-7-2004, EXPIRES 6-7-2014.

CLASS 41—EDUCATION AND ENTERTAINMENT

FOR EDUCATION SERVICES, NAMELY, PROVIDING CONDUCTING SEMINARS, CLASSES AND WORKSHOPS IN THE FIELD OF HEALTH AND FITNESS; TRAINING IN THE USE OF COMPUTERS AND HEALTH RELATED EQUIPMENT; PROVIDING ONLINE INFORMATION VIA THE INTERNET IN THE FIELD OF FITNESS; PROVIDING ONLINE PUBLICATIONS, NAMELY, MAGAZINES IN THE FIELD OF HEALTH AND FITNESS; ENTERTAINMENT SERVICES, NAMELY, PROVIDING PRERECORDED, NON-DOWNLOADABLE DIGITAL MUSIC VIA THE INTERNET; HEALTH CLUB SERVICES, NAMELY, PROVIDING INSTRUCTION AND EQUIPMENT IN THE FIELD OF PHYSICAL EXERCISE; PHYSICAL FITNESS CONSULTATION (U.S. CLS. 100, 101 AND 107).

FIRST USE 5-17-2004; IN COMMERCE 5-17-2004.

CLASS 44—MEDICAL, BEAUTY AND AGRICULTURAL SERVICES

FOR MEDICAL SERVICES, NAMELY, BEAUTY SALONS; PERFORMING DIAGNOSIS OF DISEASES, NAMELY, MEDICAL ANALYSIS USING X-RAY EXAMINATIONS AND TAKING BLOOD SAMPLES; PHARMACEUTICAL ADVICE; COUNSELING SERVICES IN THE FIELD OF HEALTH AND NUTRITION; AND, PROVIDING AN ON-LINE COMPUTER DATABASE FEATURING INFORMATION REGARDING HEALTH (U.S. CLS. 100 AND 101).

FIRST USE 5-17-2004; IN COMMERCE 5-17-2004.

3,680,866. DOMINION BEARING COMPANY, PORTLAND, OR. SN 77-459,968. PUB. 9-23-2008, FILED 4-28-2008.

NEW DEPARTURE

THE MARK CONSISTS OF STANDARD CHARACTERS WITHOUT CLAIM TO ANY PARTICULAR FONT, STYLE, SIZE, OR COLOR.

CLASS 6—METAL GOODS

FOR METAL LOCKNUTS; METAL LOCK WASHERS (U.S. CLS. 2, 12, 13, 14, 23, 25 AND 50).

FIRST USE 4-15-2009; IN COMMERCE 4-15-2009.

CLASS 7—MACHINERY

FOR MACHINE PARTS, NAMELY, BALL BEARINGS, DOUBLE ROW BALL BEARINGS, CYLINDRICAL ROLLER BEARINGS, SPHERICAL THRUST BEARINGS, ROLLER BEARINGS, BALL BEARING INSERTS, SPHERICAL BEARINGS, NEEDLE BEARINGS, PLAIN SPHERICAL BEARINGS, BEARING ADAPTERS, SELF ALIGNING BALL BEARINGS, THRUST BALL BEARINGS, ANGULAR CONTACT BALL BEARINGS, NEEDLE BEARINGS, THRUST NEEDLE BEARINGS, THRUST ROLLER BEARINGS, TAPERED ROLLER BEARINGS, JOURNAL BEARINGS, LINEAR BEARINGS, LINEAR SHAFTING, MAGNETO BALL BEARINGS, MOUNTED BALL BEARINGS, MOUNTED ROLLER BEARINGS, BEARING HEATERS, BEARING PULLERS, AND ALL OTHER TYPES OF ANTI-FRICTION BEARINGS; AND ROD ENDS FOR USE IN INDUSTRIAL APPLICATIONS; MAINLY, MINING, SAWMILLS, AND PULP AND PAPER MACHINERY; MACHINE PARTS, NAMELY, PILLOW BLOCKS AND FLANGE BLOCKS (U.S. CLS. 13, 19, 21, 23, 31, 34 AND 35).

FIRST USE 4-15-2009; IN COMMERCE 4-15-2009.

3,680,871. AMERICAN COLLEGE OF SPORTS MEDICINE, INC., INDIANAPOLIS, IN. SN 77-460,984. PUB. 10-21-2008, FILED 4-29-2008.

CEPA

THE MARK CONSISTS OF STANDARD CHARACTERS WITHOUT CLAIM TO ANY PARTICULAR FONT, STYLE, SIZE, OR COLOR.

CLASS 35—ADVERTISING AND BUSINESS

FOR ASSOCIATION SERVICES, NAMELY, PROMOTING THE INTERESTS OF INDIVIDUALS AND ENTITIES IN THE FIELD OF CLINICAL EXERCISE PHYSIOLOGY; AND, PROMOTING THE EXCHANGE OF INFORMATION AND RESOURCES WITHIN THE SCIENTIFIC RESEARCH AND MEDICAL COMMUNITIES TO ACHIEVE ADVANCES IN THE FIELD OF CLINICAL EXERCISE PHYSIOLOGY FOR THE BETTERMENT OF HEALTH, FITNESS AND QUALITY OF LIFE (U.S. CLS. 100, 101 AND 102).

FIRST USE 5-0-2008; IN COMMERCE 5-0-2008.

CLASS 44—MEDICAL, BEAUTY AND AGRICULTURAL SERVICES

FOR PROVIDING INFORMATION REGARDING CLINICAL EXERCISE PHYSIOLOGY FOR THE BETTERMENT OF HEALTH, FITNESS AND QUALITY OF LIFE (U.S. CLS. 100 AND 101).

FIRST USE 5-0-2008; IN COMMERCE 5-0-2008.

3,680,879. SAUL AMARISTA, FOREST KNOLLS, CA. SN 77-464,288. PUB. 11-4-2008, FILED 5-2-2008.



Las Buenas Obras Venezolana

NO CLAIM IS MADE TO THE EXCLUSIVE RIGHT TO USE "LOS CHOCOLATES", APART FROM THE MARK AS SHOWN.

THE COLOR(S) WHITE, BLACK, YELLOW, BLUE, RED, AND BROWN IS/ARE CLAIMED AS A FEATURE OF THE MARK.

THE MARK CONSISTS OF THE WORDING "LOS CHOCOLATES" IN BLACK, WITH "KEREKUPAI-MERU" IN WHITE WITHIN A RED RECTANGLE WITH A BLACK MOUNTAIN, BLACK TREES, AND A BROWN TREE IN THE BACKGROUND. BELOW THE RECTANGLE IS A YELLOW LINE AND A BLUE LINE. BELOW THE LINES IS THE WORDING "LAS BUENAS OBRAS VENEZOLANA" IN BLACK.

THE FOREIGN WORDING IN THE MARK TRANSLATES INTO ENGLISH AS THE CHOCOLATES, AND FALL FROM THE DEEPEST PLACE, AND VENEZUELAN GOOD DEEDS.

CLASS 29—MEATS AND PROCESSED FOODS

FOR COCOA BUTTER FOR FOOD PURPOSES; CHOCOLATE MILK; CHOCOLATE NUT BUTTER; DAIRY-BASED CHOCOLATE FOOD BEVERAGES; FRUIT-BASED ORGANIC FOOD BARS, ALSO CONTAINING CHOCOLATE; SOY-BASED FOOD BARS ALSO CONTAINING CHOCOLATE; VEGETABLE-BASED CHOCOLATE FOOD BEVERAGES (U.S. CL. 46).

FIRST USE 6-11-2009; IN COMMERCE 6-11-2009.

CLASS 30—STAPLE FOODS

FOR CANDY WITH COCOA; COCOA; COCOA; COCOA BEVERAGES WITH MILK; COCOA EXTRACTS FOR HUMAN CONSUMPTION; COCOA MIXES; COCOA POWDER; COCOA SPREADS; COCOA-BASED BEVERAGES; COCOA-BASED INGREDIENT IN CONFECTIONERY PRODUCTS; PREPARED COCOA AND COCOA-BASED BEVERAGES; CHOCOLATE; CHOCOLATE AND CHOCOLATES; CHOCOLATE BARS; CHOCOLATE CANDIES; CHOCOLATE CHIPS; CHOCOLATE COVERED NUTS; CHOCOLATE COVERED RAISINS; CHOCOLATE FONDUE; CHOCOLATE FOOD BEVERAGES NOT BEING DAIRY-BASED OR VEGETABLE BASED; CHOCOLATE MOUSSE (U.S. CL. 46).

FIRST USE 6-1-2009; IN COMMERCE 6-1-2009.

3,680,881. KALMATRON CORPORATION, SAN FRANCISCO, CA. SN 77-464,853. PUB. 9-30-2008, FILED 5-2-2008.

K¹⁰⁰

THE MARK CONSISTS OF THE DESIGNATION "K" TO THE POWER OF "100".

CLASS 1—CHEMICALS

FOR CONCRETE ADMIXTURES (U.S. CLS. 1, 5, 6, 10, 26 AND 46).

FIRST USE 5-10-2008; IN COMMERCE 10-30-2008.

CLASS 2—PAINTS

FOR CONCRETE PROTECTIVE COATINGS, NAMELY, CONCRETE MOISTURE BARRIER COATING, POLYMER COATINGS FOR CONCRETE, PAINT FOR CONCRETE FLOORS, EPOXY COATING FOR USE ON CONCRETE INDUSTRIAL FLOORS (U.S. CLS. 6, 11 AND 16).

FIRST USE 5-10-2008; IN COMMERCE 10-30-2008.

3,680,893. GOLDEN ROAD FOOD SERVICES, LLC, MANHATTAN BEACH, CA. SN 77-466,673. PUB. 2-3-2009, FILED 5-6-2008.

FRESH BROTHERS

THE MARK CONSISTS OF STANDARD CHARACTERS WITHOUT CLAIM TO ANY PARTICULAR FONT, STYLE, SIZE, OR COLOR.

NO CLAIM IS MADE TO THE EXCLUSIVE RIGHT TO USE "FRESH", APART FROM THE MARK AS SHOWN.

CLASS 39—TRANSPORTATION AND STORAGE

FOR DELIVERY OF FOOD BY RESTAURANTS, NAMELY, AMERICAN FOOD, ITALIAN FOOD, AND PIZZA PIES MADE TO ORDER (U.S. CLS. 100 AND 105).

FIRST USE 6-0-2008; IN COMMERCE 6-0-2008.

CLASS 43—HOTEL AND RESTAURANT SERVICES

FOR RESTAURANTS AND CARRY-OUT RESTAURANTS PERTAINING TO AMERICAN FOOD, ITALIAN FOOD AND PIZZA PIES MADE TO ORDER, FOR HOME AND REMOTE LOCATION DELIVERY, FOR CONSUMPTION WITHIN THE RESTAURANT, AND BY CARRY-OUT (U.S. CLS. 100 AND 101).

FIRST USE 6-22-2008; IN COMMERCE 6-22-2008.

3,680,910. INDEPENDENCE VISITOR CENTER CORPORATION, PHILADELPHIA, PA. SN 77-469,221. PUB. 11-4-2008, FILED 5-8-2008.

City Hall
VISITOR CENTER 

NO CLAIM IS MADE TO THE EXCLUSIVE RIGHT TO USE "CITY HALL VISITOR CENTER", APART FROM THE MARK AS SHOWN.

THE MARK CONSISTS OF THE WORDING "CITY HALL VISITOR CENTER" WITH A STAR OVER THE "I" IN "CITY" AND A DESIGN CONSISTING OF A LINE DRAWING OF THE TOP PORTION OF "PHILADELPHIA'S CITY HALL".

CLASS 35—ADVERTISING AND BUSINESS

FOR RETAIL STORE SERVICES FEATURING SOUVENIRS AND GIFTS; CHAMBER OF COMMERCE SERVICES, NAMELY, PROMOTING BUSINESS AND TOURISM FOR PHILADELPHIA CITY HALL AND THE CITY OF PHILADELPHIA (U.S. CLS. 100, 101 AND 102).

FIRST USE 5-0-2007; IN COMMERCE 5-0-2007.

CLASS 39—TRANSPORTATION AND STORAGE

FOR TRAVEL ARRANGEMENT SERVICES, NAMELY, CONDUCTING ONSITE TOURS FOR OTHERS (U.S. CLS. 100 AND 105).

FIRST USE 5-0-2007; IN COMMERCE 5-0-2007.

CLASS 41—EDUCATION AND ENTERTAINMENT

FOR EDUCATIONAL SERVICES, NAMELY, PROVIDING INFORMATION ON THE HISTORY OF PHILADELPHIA CITY HALL (U.S. CLS. 100, 101 AND 107).

FIRST USE 5-0-2007; IN COMMERCE 5-0-2007.

CLASS 43—HOTEL AND RESTAURANT SERVICES

FOR PROVIDING CONVENTION GENERAL PURPOSE FACILITIES; MAKING HOTEL RESERVATIONS FOR OTHERS; RESTAURANT SERVICES (U.S. CLS. 100 AND 101).

FIRST USE 5-0-2007; IN COMMERCE 5-0-2007.

3,680,911. INDEPENDENCE VISITOR CENTER CORPORATION, PHILADELPHIA, PA. SN 77-469,227. PUB. 11-4-2008, FILED 5-8-2008.



NO CLAIM IS MADE TO THE EXCLUSIVE RIGHT TO USE "BALLROOM", APART FROM THE MARK AS SHOWN.

THE COLOR(S) BLACK AND WHITE IS/ARE CLAIMED AS A FEATURE OF THE MARK.

THE MARK CONSISTS OF THE WORDING "INDEPENDENCE BALLROOM" WITH A STAR APPEARING BELOW A QUILL IN THE COLOR BLACK ON A WHITE BACKGROUND.

CLASS 41—EDUCATION AND ENTERTAINMENT

FOR ENTERTAINMENT SERVICES, NAMELY, PROVIDING BALLROOM FACILITIES (U.S. CLS. 100, 101 AND 107).

FIRST USE 1-0-2007; IN COMMERCE 1-0-2007.

CLASS 43—HOTEL AND RESTAURANT SERVICES

FOR PROVIDING OF FOOD AND DRINK SERVICES; PROVIDING FACILITIES FOR EXHIBITIONS AND CONVENTIONS, PROVIDING BANQUET AND SOCIAL FUNCTION FACILITIES FOR SPECIAL OCCASIONS (U.S. CLS. 100 AND 101).

FIRST USE 1-0-2007; IN COMMERCE 1-0-2007.

3,680,912. INDEPENDENCE VISITOR CENTER CORPORATION, PHILADELPHIA, PA. SN 77-469,231. PUB. 11-4-2008, FILED 5-8-2008.



OWNER OF U.S. REG. NO. 2,739,868.

NO CLAIM IS MADE TO THE EXCLUSIVE RIGHT TO

USE "VISITOR CENTER", APART FROM THE MARK AS SHOWN.

THE MARK CONSISTS OF THE WORDING "INDEPENDENCE VISITOR CENTER" WITH A STAR APPEARING BELOW A QUILL.

CLASS 35—ADVERTISING AND BUSINESS

FOR RETAIL STORE SERVICES FEATURING SOUVENIRS AND GIFTS; CHAMBER OF COMMERCE SERVICES, NAMELY, PROMOTING BUSINESS AND TOURISM IN THE PHILADELPHIA AREA (U.S. CLS. 100, 101 AND 102).

FIRST USE 11-0-2006; IN COMMERCE 11-0-2006.

CLASS 39—TRANSPORTATION AND STORAGE

FOR TRAVEL ARRANGEMENT SERVICES, NAMELY, MAKING RESERVATIONS AND BOOKINGS FOR TRANSPORTATION; TRAVEL INFORMATION SERVICES; CONDUCTING SIGHTSEEING TOURS FOR OTHERS (U.S. CLS. 100 AND 105).

FIRST USE 11-0-2006; IN COMMERCE 11-0-2006.

CLASS 41—EDUCATION AND ENTERTAINMENT

FOR EDUCATIONAL SERVICES, NAMELY, CONDUCTING EXHIBITIONS, DISPLAYS AND INTERACTIVE EXHIBITS IN THE FIELDS OF AMERICAN HISTORY, CULTURE AND POLITICS; MUSEUMS; ARRANGING FOR TICKET RESERVATIONS FOR SHOWS AND OTHER ENTERTAINMENT EVENTS (U.S. CLS. 100, 101 AND 107).

FIRST USE 11-0-2006; IN COMMERCE 11-0-2006.

CLASS 43—HOTEL AND RESTAURANT SERVICES

FOR PROVIDING CONVENTION GENERAL PURPOSE FACILITIES; MAKING HOTEL RESERVATIONS FOR OTHERS; RESTAURANT SERVICES (U.S. CLS. 100 AND 101).

FIRST USE 11-0-2006; IN COMMERCE 11-0-2006.

3,680,926. IN TOUCH CONCEPTS, INC., HICKSVILLE, NY. SN 77-471,517. PUB. 10-14-2008, FILED 5-12-2008.

ZCOM

THE MARK CONSISTS OF STANDARD CHARACTERS WITHOUT CLAIM TO ANY PARTICULAR FONT, STYLE, SIZE, OR COLOR.

CLASS 9—ELECTRICAL AND SCIENTIFIC APPARATUS

FOR CELLULAR TELEPHONE PRODUCTS, NAMELY, CELLULAR TELEPHONES AND CELLULAR TELEPHONE ACCESSORIES, NAMELY, CELLULAR TELEPHONE RECHARGERS, CELLULAR PHONE HOLDERS, CELLULAR PHONE CASES AND CELLULAR PHONE HEADSETS (U.S. CLS. 21, 23, 26, 36 AND 38).

FIRST USE 3-1-2009; IN COMMERCE 3-1-2009.

CLASS 35—ADVERTISING AND BUSINESS

FOR RETAIL STORE SERVICES FEATURING CELLULAR TELEPHONES, TELECOMMUNICATION SERVICE PLANS FOR CELLULAR TELEPHONES AND TELECOMMUNICATION SERVICE ACTIVATION FOR CELLULAR TELEPHONES (U.S. CLS. 100, 101 AND 102).
FIRST USE 9-1-2008; IN COMMERCE 9-1-2008.

3,680,966. DIGITAL FAIRWAY CORPORATION, TORONTO, ONTARIO, CANADA. SN 77-476,185. PUB. 10-21-2008, FILED 5-16-2008.



3,680,928. PENDLETON WOOLEN MILLS, INC., PORTLAND, OR. SN 77-471,731. PUB. 10-14-2008, FILED 5-12-2008.

PENDLETON COLORPLAY

THE MARK CONSISTS OF STANDARD CHARACTERS WITHOUT CLAIM TO ANY PARTICULAR FONT, STYLE, SIZE, OR COLOR.

OWNER OF U.S. REG. NOS. 2,296,846, 2,717,244, AND OTHERS.

THE MARK CONSISTS OF "COMMSOLV KNOW YOUR TELECOM NETWORK" AND THE DESIGN OF THREE CURVED LINES.

CLASS 22—CORDAGE AND FIBERS

FOR CARDED WOOL (U.S. CLS. 1, 2, 7, 19, 22, 42 AND 50).
FIRST USE 3-1-2008; IN COMMERCE 3-1-2008.

CLASS 9—ELECTRICAL AND SCIENTIFIC APPARATUS

FOR SOFTWARE FOR USE IN PLANNING, DESIGNING, PROVISIONING, ORDERING, TRACKING, ALLOCATING, SERVICING, AND FOR MANAGING OPERATIONS, INVENTORY, TIME AND COST EFFICIENCY WITH RESPECT TO VOICE AND DATA CIRCUITS, VOICE AND VIDEO SERVICES, WIRELESS AND MOBILE COMMUNICATIONS DEVICES AND SERVICES, AND NETWORK EQUIPMENT MANAGEMENT (U.S. CLS. 21, 23, 26, 36 AND 38).
FIRST USE 10-31-2008; IN COMMERCE 10-31-2008.

CLASS 23—YARNS AND THREADS

FOR YARN; WOOL YARN; YARN AND THREAD FOR TEXTILE PURPOSES (U.S. CL. 43).
FIRST USE 3-1-2008; IN COMMERCE 3-1-2008.

CLASS 42—SCIENTIFIC AND COMPUTER SERVICES

FOR PROVIDING SOFTWARE AS A SERVICE (SAAS) FOR USE IN MANAGING COMMUNICATIONS SERVICES AND ASSETS; APPLICATION SERVICE PROVIDER, NAMELY, PROVIDING, HOSTING, MANAGING, DEVELOPING, AND MAINTAINING APPLICATIONS AND SOFTWARE IN THE FIELD OF COMMUNICATION SERVICES AND COMMUNICATION ASSET MANAGEMENT; COMPUTER SOFTWARE DESIGN, INSTALLATION AND MAINTENANCE (U.S. CLS. 100 AND 101).
FIRST USE 10-31-2008; IN COMMERCE 10-31-2008.

3,680,957. MORE CUPCAKES, LLC, CHICAGO, IL. SN 77-475,514. PUB. 10-14-2008, FILED 5-15-2008.

FOREVER MORE CUPCAKES

THE MARK CONSISTS OF STANDARD CHARACTERS WITHOUT CLAIM TO ANY PARTICULAR FONT, STYLE, SIZE, OR COLOR.

NO CLAIM IS MADE TO THE EXCLUSIVE RIGHT TO USE "CUPCAKES", APART FROM THE MARK AS SHOWN.

3,680,968. TUFFDOCK SYSTEMS, LLC, GERMANTOWN, OH. SN 77-476,560. PUB. 3-3-2009, FILED 5-16-2008.

CLASS 25—CLOTHING

FOR T-SHIRTS (U.S. CLS. 22 AND 39).
FIRST USE 10-1-2008; IN COMMERCE 10-1-2008.

TUFFDOCK

CLASS 30—STAPLE FOODS

FOR CAKE MIXES; CAKES; CUP CAKES (U.S. CL. 46).
FIRST USE 9-12-2008; IN COMMERCE 9-12-2008.

THE MARK CONSISTS OF STANDARD CHARACTERS WITHOUT CLAIM TO ANY PARTICULAR FONT, STYLE, SIZE, OR COLOR.

CLASS 43—HOTEL AND RESTAURANT SERVICES

FOR CATERING (U.S. CLS. 100 AND 101).
FIRST USE 9-27-2008; IN COMMERCE 9-27-2008.

CLASS 9—ELECTRICAL AND SCIENTIFIC APPARATUS

FOR SAFETY ACCESSORIES, NAMELY, MOUNTING UNITS MADE OF PVC FOR ATTACHING FIRE EXTINGUISHERS TO BOAT DOCKS (U.S. CLS. 21, 23, 26, 36 AND 38).

FIRST USE 9-5-2008; IN COMMERCE 9-5-2008.

CLASS 11—ENVIRONMENTAL CONTROL APPARATUS

FOR LIGHTING STATIONS IN THE NATURE OF LIGHTING FIXTURES MADE OF PVC, USED ON BOAT DOCKS; PLUMBING FIXTURES, NAMELY, A PVC BOAT DOCK-MOUNTED WASHING APPARATUS COMPRISING PVC HOUSING, COUPLERS, PIPING, VALVES, WATER HOSE AND HOSE END SPRAYER, SOLD AS A UNIT (U.S. CLS. 13, 21, 23, 31 AND 34).

FIRST USE 9-5-2008; IN COMMERCE 9-5-2008.

CLASS 19—NON-METALLIC BUILDING MATERIALS

FOR BOAT DOCK PILINGS MADE OF PVC (U.S. CLS. 1, 12, 33 AND 50).

FIRST USE 9-5-2008; IN COMMERCE 9-5-2008.

3,680,976. THE LITTLE GIRAFFE, INC., VAN NUYS, CA. SN 77-478,076. PUB. 10-21-2008, FILED 5-19-2008.

GIRAFFE & FRIENDS

THE MARK CONSISTS OF STANDARD CHARACTERS WITHOUT CLAIM TO ANY PARTICULAR FONT, STYLE, SIZE, OR COLOR.

CLASS 18—LEATHER GOODS

FOR PET PRODUCTS, NAMELY, CARRYING BAGS TO CARRY PETS, NAMELY, BAGS, TRAVEL BAGS AND TOTE BAGS TO CARRY DOGS AND CATS (U.S. CLS. 1, 2, 3, 22 AND 41).

FIRST USE 4-13-2009; IN COMMERCE 4-13-2009.

CLASS 20—FURNITURE AND ARTICLES NOT OTHERWISE CLASSIFIED

FOR PET PRODUCTS, NAMELY, PILLOWS, PORTABLE BEDS FOR PETS AND PORTABLE LOUNGES FOR USE BY DOGS AND CATS (U.S. CLS. 2, 13, 22, 25, 32 AND 50).

FIRST USE 4-13-2009; IN COMMERCE 4-13-2009.

CLASS 24—FABRICS

FOR PET PRODUCTS, NAMELY, BLANKETS, TOWELS, THROWS AND SHEETS, FOR USE BY DOGS AND CATS (U.S. CLS. 42 AND 50).

FIRST USE 4-13-2009; IN COMMERCE 4-13-2009.

3,680,978. IT'S WHAT IT IS, LLC, HOUSTON, TX. SN 77-478,507. PUB. 11-4-2008, FILED 5-19-2008.

Thank You U.S.
War Veterans...
"True
Heroes"

THE MARK CONSISTS OF THE WORDING "THANK YOU U.S. WAR VETERANS "TRUE HEROES" ALONG WITH THE LETTERS "RLB" WHICH ARE SITUATED IN A REVERSE ORIENTATION.

CLASS 16—PAPER GOODS AND PRINTED MATTER

FOR BUMPER STICKERS (U.S. CLS. 2, 5, 22, 23, 29, 37, 38 AND 50).

FIRST USE 1-31-2009; IN COMMERCE 3-5-2009.

CLASS 24—FABRICS

FOR CLOTH FLAGS; FABRIC FLAGS; NYLON FLAGS (U.S. CLS. 42 AND 50).

FIRST USE 12-31-2008; IN COMMERCE 3-5-2009.

3,681,011. AMERICAN SPECIALTY HEALTH INCORPORATED, SAN DIEGO, CA. SN 77-484,326. PUB. 10-21-2008, FILED 5-27-2008.

Just a Hop, Skip, and a Click Away

THE MARK CONSISTS OF STANDARD CHARACTERS WITHOUT CLAIM TO ANY PARTICULAR FONT, STYLE, SIZE, OR COLOR.

CLASS 41—EDUCATION AND ENTERTAINMENT

FOR PROVIDING A WEB SITE FEATURING INFORMATION ON EXERCISE AND FITNESS (U.S. CLS. 100, 101 AND 107).

FIRST USE 4-30-2008; IN COMMERCE 6-1-2008.

CLASS 44—MEDICAL, BEAUTY AND AGRICULTURAL SERVICES

FOR PROVIDING A WEB SITE FEATURING INFORMATION ON HEALTH AND NUTRITION (U.S. CLS. 100 AND 101).

FIRST USE 4-30-2008; IN COMMERCE 6-1-2008.

3,681,015. WPPI ENERGY, SUN PRAIRIE, WI. SN 77-485,496.
PUB. 10-21-2008, FILED 5-28-2008.

3,681,042. MXT CARD SERVICES, LLC, NEW CASTLE, DE.
SN 77-492,995. PUB. 12-30-2008, FILED 6-6-2008.

The way energy should be



THE MARK CONSISTS OF STANDARD CHARACTERS WITHOUT CLAIM TO ANY PARTICULAR FONT, STYLE, SIZE, OR COLOR.

CLASS 35—ADVERTISING AND BUSINESS

FOR ENERGY USAGE MANAGEMENT; INFORMATION IN THE FIELD OF ENERGY EFFICIENCY (U.S. CLS. 100, 101 AND 102).
FIRST USE 12-11-2008; IN COMMERCE 12-11-2008.

CLASS 39—TRANSPORTATION AND STORAGE

FOR PUBLIC UTILITY SERVICES IN THE NATURE OF ELECTRICITY DISTRIBUTION (U.S. CLS. 100 AND 105).
FIRST USE 12-11-2008; IN COMMERCE 12-11-2008.

CLASS 40—MATERIAL TREATMENT

FOR PRODUCTION OF ENERGY (U.S. CLS. 100, 103 AND 106).
FIRST USE 12-11-2008; IN COMMERCE 12-11-2008.

NO CLAIM IS MADE TO THE EXCLUSIVE RIGHT TO USE "REWARDS", APART FROM THE MARK AS SHOWN. THE COLOR(S) RED, BLUE, BLACK AND WHITE IS/ARE CLAIMED AS A FEATURE OF THE MARK.

THE MARK CONSISTS OF THE WORDS "VICTORY LANE REWARDS" IN STYLIZED LETTERING IN BLACK AND WHITE AND A STYLIZED BLACK CHECKED FLAG DESIGN, ALL SUPERIMPOSED ON A RED, BLACK AND BLUE OVAL DESIGN.

CLASS 35—ADVERTISING AND BUSINESS

FOR PROMOTING THE SALE OF CREDIT CARD ACCOUNTS THROUGH THE ADMINISTRATION OF INCENTIVE AWARD PROGRAMS (U.S. CLS. 100, 101 AND 102).
FIRST USE 8-0-2008; IN COMMERCE 8-0-2008.

CLASS 36—INSURANCE AND FINANCIAL

FOR CREDIT CARD SERVICES (U.S. CLS. 100, 101 AND 102).
FIRST USE 5-0-2008; IN COMMERCE 5-0-2008.

3,681,020. MERLIN'S MAGIK LLC, CORVALLIS, MT. SN 77-486,622. PUB. 10-28-2008, FILED 5-29-2008.

3,681,051. DEFFENBAUGH INDUSTRIES, INC., KANSAS CITY, KS. SN 77-495,161. PUB. 3-10-2009, FILED 6-10-2008.

Get Slik



THE MARK CONSISTS OF STANDARD CHARACTERS WITHOUT CLAIM TO ANY PARTICULAR FONT, STYLE, SIZE, OR COLOR.

CLASS 3—COSMETICS AND CLEANING PREPARATIONS

FOR COSMETICS; MASSAGE OILS (U.S. CLS. 1, 4, 6, 50, 51 AND 52).
FIRST USE 12-10-2008; IN COMMERCE 12-10-2008.

CLASS 25—CLOTHING

FOR HATS; JEANS; PANTS; SWEAT SHIRTS; TANK TOPS; UNDERGARMENTS; T-SHIRTS (U.S. CLS. 22 AND 39).
FIRST USE 1-21-2009; IN COMMERCE 1-21-2009.

NO CLAIM IS MADE TO THE EXCLUSIVE RIGHT TO USE "WASTE SOLUTIONS AND RECYCLING", APART FROM THE MARK AS SHOWN.

THE MARK CONSISTS OF THE WORD "DEFFENBAUGH" LOCATED ABOVE THE WORDS "WASTE SOLUTIONS AND RECYCLING" WITH THE "D" IN "DEFFENBAUGH" INCORPORATING AN UPWARD POINTING ARROW AS THE STRAIGHT SIDE OF THE LETTER "D".

CLASS 39—TRANSPORTATION AND STORAGE

FOR GARBAGE AND WASTE PICK UP COLLECTION (U.S. CLS. 100 AND 105).
FIRST USE 4-22-2008; IN COMMERCE 4-22-2008.

CLASS 40—MATERIAL TREATMENT

FOR RECYCLING OF WASTE AND TRASH (U.S. CLS. 100, 103 AND 106).
FIRST USE 4-22-2008; IN COMMERCE 4-22-2008.

3,681,064. TUFFDOCK SYSTEMS, LLC, GERMANTOWN, OH. SN 77-497,410. PUB. 3-3-2009, FILED 6-12-2008.

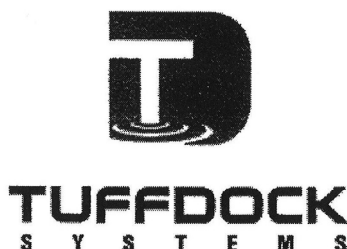

NO CLAIM IS MADE TO THE EXCLUSIVE RIGHT TO USE "SYSTEMS", APART FROM THE MARK AS SHOWN.

THE MARK CONSISTS OF THE LETTER "T" APPEARING AS A DESIGN OF A BOAT DOCK WITH WATER RIPPLES AT THE BOTTOM OF THE "T", APPEARING WITHIN THE LETTER "D", OVER THE WORDING "TUFFDOCK SYSTEMS".

CLASS 9—ELECTRICAL AND SCIENTIFIC APPARATUS

FOR SAFETY ACCESSORIES, NAMELY, MOUNTING UNITS MADE OF PVC FOR ATTACHING FIRE EXTINGUISHERS TO BOAT DOCKS (U.S. CLS. 21, 23, 26, 36 AND 38).

FIRST USE 6-5-2008; IN COMMERCE 9-5-2008.

CLASS 11—ENVIRONMENTAL CONTROL APPARATUS

FOR LIGHTING STATIONS IN THE NATURE OF LIGHTING FIXTURES MADE OF PVC, USED ON BOAT DOCKS; PLUMBING FIXTURES, NAMELY, A PVC BOAT DOCK-MOUNTED WASHING APPARATUS COMPRISING PVC HOUSING, COUPLERS, PIPING, VALVES, WATER HOSE AND HOSE END SPRAYER, SOLD AS A UNIT (U.S. CLS. 13, 21, 23, 31 AND 34).

FIRST USE 9-5-2008; IN COMMERCE 9-5-2008.

CLASS 19—NON-METALLIC BUILDING MATERIALS

FOR BOAT DOCK PILINGS MADE OF PVC (U.S. CLS. 1, 12, 33 AND 50).

FIRST USE 9-5-2008; IN COMMERCE 9-5-2008.

3,681,066. FULL SERVICE DELI DISTRIBUTORS, INC., DANA POINT, CA. SN 77-497,857. PUB. 11-11-2008, FILED 6-12-2008.

SMOKEYS HOUSE OF BARBEQUE

THE MARK CONSISTS OF STANDARD CHARACTERS WITHOUT CLAIM TO ANY PARTICULAR FONT, STYLE,

SIZE, OR COLOR.

NO CLAIM IS MADE TO THE EXCLUSIVE RIGHT TO USE "HOUSE OF BARBEQUE", APART FROM THE MARK AS SHOWN.

CLASS 25—CLOTHING

FOR WEARING APPAREL, NAMELY, SHIRTS, T-SHIRTS, SHORTS, AND APRONS (U.S. CLS. 22 AND 39).
FIRST USE 4-1-2008; IN COMMERCE 4-1-2008.

CLASS 30—STAPLE FOODS

FOR FOOD PREPARATIONS, NAMELY, SALAD DRESSING BARBEQUE SAUCE MARINADE KETCHUP AND HOT SAUCE (U.S. CL. 46).

FIRST USE 4-1-2008; IN COMMERCE 4-1-2008.

CLASS 43—HOTEL AND RESTAURANT SERVICES

FOR RESTAURANT SERVICES (U.S. CLS. 100 AND 101).

FIRST USE 4-1-2008; IN COMMERCE 4-1-2008.

3,681,075. ALDIS, INC., OAK RIDGE, TN. SN 77-499,942. PUB. 2-24-2009, FILED 6-16-2008.

ALDIS

THE MARK CONSISTS OF STANDARD CHARACTERS WITHOUT CLAIM TO ANY PARTICULAR FONT, STYLE, SIZE, OR COLOR.

THE WORDING "ALDIS" HAS NO MEANING IN A FOREIGN LANGUAGE.

CLASS 39—TRANSPORTATION AND STORAGE

FOR ENVIRONMENTALLY CONSCIOUS MANAGEMENT OF VEHICULAR TRAFFIC FLOW THROUGH ADVANCED TRAFFIC LIGHT APPARATUS AND COMPUTERIZED IMAGING TECHNOLOGY; MANAGEMENT OF VEHICULAR AND PEDESTRIAN TRAFFIC FLOW THROUGH ADVANCED COMMUNICATIONS NETWORK AND TECHNOLOGY TO ALLOW RIGHT-OF-WAY TO SAFETY AND EMERGENCY VEHICLES (U.S. CLS. 100 AND 105).

FIRST USE 5-1-2007; IN COMMERCE 7-1-2008.

CLASS 45—PERSONAL AND LEGAL SERVICES

FOR DIGITAL VIDEO MONITORING, NAMELY, MONITORING TRAFFIC VIOLATIONS WITH DIGITAL VIDEO CAMERAS (U.S. CLS. 100 AND 101).

FIRST USE 5-1-2007; IN COMMERCE 7-1-2008.

3,681,086. AFC ENTERPRISES, INC., ATLANTA, GA. SN 77-506,242. PUB. 9-30-2008, FILED 6-24-2008.



OWNER OF U.S. REG. NOS. 1,021,254, 1,030,944, AND 1,121,096.

NO CLAIM IS MADE TO THE EXCLUSIVE RIGHT TO USE "LOUISIANA KITCHEN", APART FROM THE MARK AS SHOWN.

THE MARK CONSISTS OF THE WORD "POPEYES" WRITTEN IN STYLIZED LETTERS ABOVE THE WORDS "LOUISIANA KITCHEN" DISPLAYED WITHIN AN OBLONG CYLINDER SHAPE, WITH A FLEUR DE LIS BEFORE THE WORD "LOUISIANA" AND A FLEUR DE LIS AFTER THE WORD "KITCHEN".

CLASS 29—MEATS AND PROCESSED FOODS

FOR PREPARED CHICKEN AND SEAFOOD FOR CONSUMPTION ON OR OFF THE PREMISES (U.S. CL. 46).

FIRST USE 7-0-2008; IN COMMERCE 7-0-2008.

CLASS 43—HOTEL AND RESTAURANT SERVICES

FOR RESTAURANT SERVICES (U.S. CLS. 100 AND 101).

FIRST USE 7-0-2008; IN COMMERCE 7-0-2008.

CLASS 29—MEATS AND PROCESSED FOODS

FOR PREPARED CHICKEN AND SEAFOOD FOR CONSUMPTION ON OR OFF THE PREMISES (U.S. CL. 46).

FIRST USE 7-0-2008; IN COMMERCE 7-0-2008.

CLASS 43—HOTEL AND RESTAURANT SERVICES

FOR RESTAURANT SERVICES (U.S. CLS. 100 AND 101).

FIRST USE 7-0-2008; IN COMMERCE 7-0-2008.

3,681,088. AFC ENTERPRISES, INC., ATLANTA, GA. SN 77-506,289. PUB. 9-30-2008, FILED 6-24-2008.



3,681,087. AFC ENTERPRISES, INC., ATLANTA, GA. SN 77-506,282. PUB. 9-30-2008, FILED 6-24-2008.



NO CLAIM IS MADE TO THE EXCLUSIVE RIGHT TO USE "LOUISIANA KITCHEN", APART FROM THE MARK AS SHOWN.

THE MARK CONSISTS OF A STYLIZED "P" WITHIN THE CENTER OF A CENTRAL CIRCLE WITH THE WORDS "LOUISIANA KITCHEN" DISPLAYED WITHIN THE BORDERS OF AN OUTER CIRCLE AND THE CENTRAL CIRCLE, THE WORDS BEING SEPARATED BY TWO FLEURS DE LIS.

THE MARK CONSISTS OF A STYLIZED "P".

CLASS 29—MEATS AND PROCESSED FOODS

FOR PREPARED CHICKEN AND SEAFOOD FOR CONSUMPTION ON OR OFF THE PREMISES (U.S. CL. 46).

FIRST USE 7-0-2008; IN COMMERCE 7-0-2008.

CLASS 43—HOTEL AND RESTAURANT SERVICES

FOR RESTAURANT SERVICES (U.S. CLS. 100 AND 101).

FIRST USE 7-0-2008; IN COMMERCE 7-0-2008.

3,681,089. AFC ENTERPRISES, INC., ATLANTA, GA. SN 77-506,307. PUB. 9-30-2008, FILED 6-24-2008.



OWNER OF U.S. REG. NOS. 1,021,254, 1,030,944, AND 1,121,096.

NO CLAIM IS MADE TO THE EXCLUSIVE RIGHT TO USE "LOUISIANA KITCHEN", APART FROM THE MARK AS SHOWN.

THE MARK CONSISTS OF A STYLIZED "P" WITHIN THE CENTER OF A CENTRAL CIRCLE WITH THE WORDS "LOUISIANA KITCHEN" DISPLAYED WITHIN THE BORDERS OF AN OUTER CIRCLE AND THE CENTRAL CIRCLE. THE WORDS BEING SEPARATED BY TWO FLEURS DE LIS, WITH THE WORD "POPEYES" WRITTEN IN STYLIZED LETTERS BELOW THE CIRCLES.

CLASS 29—MEATS AND PROCESSED FOODS

FOR PREPARED CHICKEN AND SEAFOOD FOR CONSUMPTION ON OR OFF THE PREMISES (U.S. CL. 46).

FIRST USE 7-0-2008; IN COMMERCE 7-0-2008.

CLASS 43—HOTEL AND RESTAURANT SERVICES

FOR RESTAURANT SERVICES (U.S. CLS. 100 AND 101).

FIRST USE 7-0-2008; IN COMMERCE 7-0-2008.

3,681,090. ONEWIRE, INC., NEW YORK, NY. SN 77-507,530. PUB. 12-9-2008, FILED 6-25-2008.

ONEWIRE

THE MARK CONSISTS OF STANDARD CHARACTERS WITHOUT CLAIM TO ANY PARTICULAR FONT, STYLE, SIZE, OR COLOR.

CLASS 35—ADVERTISING AND BUSINESS

FOR EMPLOYMENT HIRING, RECRUITING, PLACEMENT, AND STAFFING SERVICES; PROVIDING BUSINESS INFORMATION ON EMPLOYMENT AND CAREERS; ONLINE RECRUITING SERVICES; NAMELY, PROVIDING SEARCHABLE JOB POSTINGS AND RESUME POSTINGS; CAREER MANAGEMENT SERVICES; PROVIDING INFORMATION ON EMPLOYMENT OPPORTUNITIES AND UNEMPLOYMENT RATES; ONLINE INTERACTIVE RESUME PREPARATIONS FOR OTHERS; ONLINE BUSINESS NETWORKING SERVICES (U.S. CLS. 100, 101 AND 102).

FIRST USE 12-23-2008; IN COMMERCE 12-23-2008.

CLASS 41—EDUCATION AND ENTERTAINMENT

FOR ONLINE INTERACTIVE CAREER COUNSELING SERVICES (U.S. CLS. 100, 101 AND 107).

FIRST USE 12-23-2008; IN COMMERCE 12-23-2008.

CLASS 42—SCIENTIFIC AND COMPUTER SERVICES

FOR APPLICATION SERVICE PROVIDER (ASP) FEATURING SOFTWARE IN THE FIELDS OF STAFFING MANAGEMENT, MANAGEMENT, ADMINISTRATION, TRACKING, MONITORING, AUTOMATION, AND ASSESSMENT OF STAFFING, HIRING, RECRUITING, AND EMPLOYEE-RETENTION PROCESSES, WORKFORCE AND LOGISTICS MANAGEMENT AND PLANNING, AND DECISION SUPPORT (U.S. CLS. 100 AND 101).

FIRST USE 12-23-2008; IN COMMERCE 12-23-2008.

3,681,091. OSI INDUSTRIES, LLC, AURORA, IL. SN 77-507,829. PUB. 12-30-2008, FILED 6-25-2008.

OSI ADVANTAGE

THE MARK CONSISTS OF STANDARD CHARACTERS WITHOUT CLAIM TO ANY PARTICULAR FONT, STYLE, SIZE, OR COLOR.

OWNER OF U.S. REG. NOS. 2,229,039, 3,203,541, AND OTHERS.

CLASS 40—MATERIAL TREATMENT

FOR PROVIDING INFORMATION AND ADVISORY AND CONSULTATION SERVICES, ALL RELATING TO FOOD PROCESSING (U.S. CLS. 100, 103 AND 106).

FIRST USE 1-2-2008; IN COMMERCE 1-2-2008.

CLASS 42—SCIENTIFIC AND COMPUTER SERVICES

FOR MEASUREMENT EVALUATIONS IN THE FOOD SERVICE INDUSTRY, NAMELY, MEASURING AND EVALUATING FOOD PROCESSING TECHNOLOGY; BENCHMARKING, STANDARD SETTING AND TESTING, NAMELY, DEVELOPMENT OF VOLUNTARY STANDARDS FOR THE FOOD SERVICES INDUSTRY, AND EVALUATING AND TESTING ORGANIZATIONS TO DETERMINE WHETHER THE ORGANIZATIONS CONFORM TO THE ESTABLISHED STANDARDS; PRODUCT AND EQUIPMENT SAFETY TESTING (U.S. CLS. 100 AND 101).

FIRST USE 1-2-2008; IN COMMERCE 1-2-2008.

3,681,102. COVARRUBIAS, MANUEL CONTRERAS, GUA-DALAJARA, JALISCO, MEXICO. SN 77-512,521. PUB. 11-25-2008, FILED 7-1-2008.

EL VENADO AZUL

THE MARK CONSISTS OF STANDARD CHARACTERS WITHOUT CLAIM TO ANY PARTICULAR FONT, STYLE, SIZE, OR COLOR.

THE FOREIGN WORDING IN THE MARK TRANSLATES INTO ENGLISH AS THE BLUE DEER.

CLASS 9—ELECTRICAL AND SCIENTIFIC APPARATUS

FOR AUDIO AND VIDEO RECORDINGS FEATURING MUSIC AND DRAMATIC THEMES; AUDIO TAPES FEATURING MUSIC; COMPACT DISCS FEATURING MUSIC; DIGITAL MEDIA, NAMELY, PRE-RECORDED VIDEO CASSETTES, DIGITAL VIDEO DISCS, DIGITAL VERSATILE DISCS, DOWNLOADABLE AUDIO AND VIDEO RECORDINGS, DVDS, AND HIGH DEFINITION DIGITAL DISKS FEATURING MUSIC AND DRAMATIC THEMES; DOWNLOADABLE MUSICAL SOUND RECORDINGS; DOWNLOADABLE VIDEO RECORDINGS FEATURING MUSIC; DVDS FEATURING MUSIC AND DRAMATIC THEMES; MUSICAL SOUND RECORDINGS; MUSICAL VIDEO RECORDINGS; PRERECORDED AUDIO CASSETTES FEATURING MUSIC; PRERECORDED AUDIO TAPES FEATURING MUSIC; PRERECORDED VIDEO CASSETTES FEATURING MUSIC AND DRAMATIC THEMES; PRERECORDED VIDEO TAPES FEATURING MUSIC AND DRAMATIC THEMES (U.S. CLS. 21, 23, 26, 36 AND 38).

FIRST USE 8-4-1999; IN COMMERCE 10-21-2003.

CLASS 41—EDUCATION AND ENTERTAINMENT

FOR ENTERTAINMENT SERVICES, NAMELY, NON-DOWNLOADABLE RINGTONES, PRE-RECORDED MUSIC, VIDEO AND GRAPHICS PRESENTED TO MOBILE COMMUNICATIONS DEVICES VIA A GLOBAL COMPUTER NETWORK AND WIRELESS NETWORKS; ENTERTAINMENT SERVICES, NAMELY, PERSONAL APPEARANCES BY A MUSICAL GROUP; ENTERTAINMENT SERVICES, NAMELY, PROVIDING A WEB SITE FEATURING MUSICAL PERFORMANCES, MUSICAL VIDEOS, RELATED FILM CLIPS, PHOTOGRAPHS, AND OTHER MULTIMEDIA MATERIALS; ENTERTAINMENT, NAMELY, LIVE PERFORMANCES BY A MUSICAL BAND; PRODUCTION OF RADIO AND TELEVISION PROGRAMS; PRODUCTION OF SOUND AND MUSIC VIDEO RECORDINGS (U.S. CLS. 100, 101 AND 107).

FIRST USE 8-4-1999; IN COMMERCE 8-9-2008.

3,681,110. HICKORY TECH CORPORATION, MANKATO, MN. SN 77-518,215. PUB. 12-9-2008, FILED 7-9-2008.

SINGLELINK

THE MARK CONSISTS OF STANDARD CHARACTERS WITHOUT CLAIM TO ANY PARTICULAR FONT, STYLE, SIZE, OR COLOR.

CLASS 35—ADVERTISING AND BUSINESS

FOR BUSINESS CONSULTATION IN THE FIELD OF TELECOMMUNICATIONS, INTERNET AND NETWORK COMMUNICATIONS, COMMUNICATION SECURITY; BUSINESS CONSULTATION IN THE FIELD OF PLANNING, DESIGN, IMPLEMENTATION, OPERATIONAL SUPPORT, AND OPTIMIZATION OF INTERNET AND NETWORK COMMUNICATION SYSTEMS; OPERATION AND ADMINISTRATION OF TELECOMMUNICATION SYSTEMS AND NETWORKS FOR OTHERS (U.S. CLS. 100, 101 AND 102).

FIRST USE 10-8-2008; IN COMMERCE 10-8-2008.

CLASS 38—COMMUNICATION

FOR COMMUNICATION SERVICES, NAMELY, TRANSMISSION OF VOICE, AUDIO, VISUAL IMAGES AND DATA BY TELECOMMUNICATIONS NETWORKS, WIRELESS COMMUNICATION NETWORKS, THE INTERNET, INFORMATION SERVICES NETWORKS AND DATA NETWORKS; INTERNET TELEPHONY SERVICES; PROVIDING TELECOMMUNICATION CONNECTIONS TO THE INTERNET OR DATABASES; TELECOMMUNICATION CONSULTATION IN THE NATURE OF TECHNICAL CONSULTING IN THE FIELD OF AUDIO, TEXT AND VISUAL DATA TRANSMISSION AND COMMUNICATION; TELECOMMUNICATION SERVICES, NAMELY, LOCAL AND LONG DISTANCE TRANSMISSION OF VOICE, DATA, GRAPHICS AND VIDEO BY MEANS OF BROADBAND OPTICAL OR WIRELESS NETWORKS; TELECOMMUNICATION ACCESS SERVICES; VOICE OVER INTERNET PROTOCOL (VOIP) SERVICES; VOICE OVER IP SERVICES; VIDEO TELECONFERENCING; VIDEO TELEPHONE SERVICES; WIRELESS PBX SERVICES; RENTAL OF TELECOMMUNICATIONS APPARATUS AND INSTALLATIONS (U.S. CLS. 100, 101 AND 104).

FIRST USE 10-8-2008; IN COMMERCE 10-8-2008.

CLASS 42—SCIENTIFIC AND COMPUTER SERVICES

FOR MONITORING THE COMPUTER SYSTEMS OF OTHERS FOR TECHNICAL PURPOSES AND PROVIDING BACK-UP COMPUTER PROGRAMS AND FACILITIES; TECHNICAL SUPPORT, NAMELY, MONITORING OF NETWORK SYSTEMS (U.S. CLS. 100 AND 101).

FIRST USE 10-8-2008; IN COMMERCE 10-8-2008.

3,681,115. ZALMA, ALYSA, LAKE OSWEGO, OR. SN 77-520,276. PUB. 12-16-2008, FILED 7-11-2008.

BodyImagery

THE MARK CONSISTS OF STANDARD CHARACTERS WITHOUT CLAIM TO ANY PARTICULAR FONT, STYLE, SIZE, OR COLOR.

CLASS 9—ELECTRICAL AND SCIENTIFIC APPARATUS

FOR SOUND RECORDINGS FEATURING MUSIC AND SPOKEN WORDS IN THE FIELDS OF THERAPEUTIC GUIDED IMAGERY, PSYCHOTHERAPY, MEDICINE, COUNSELING, PERSONAL DEVELOPMENT, AND MOTIVATION FOR CONDITIONS, DISORDERS, AND BEHAVIORS, EATING AND EATING WELLNESS, WEIGHT LOSS AND CONTROL, ADDICTIONS, DEPRESSION, ANXIETY, STRESS, AND HEALTH; MUSICAL SOUND RECORDINGS; MUSICAL VIDEO RECORDINGS (U.S. CLS. 21, 23, 26, 36 AND 38).

FIRST USE 10-1-2008; IN COMMERCE 12-15-2008.

CLASS 44—MEDICAL, BEAUTY AND AGRICULTURAL SERVICES

FOR THERAPEUTIC GUIDED IMAGERY SERVICES FOR ADDRESSING CONDITIONS, DISORDERS, AND BEHAVIORS; EATING AND EATING WELLNESS, WEIGHT LOSS AND CONTROL, ADDICTIONS, DEPRESSION, ANXIETY, STRESS, AND HEALTH; PSYCHOTHERAPY, MEDICAL, AND COUNSELING SERVICES FOR ADDRESSING MEDICAL CONDITIONS, DISORDERS, AND BEHAVIORS; COUNSELING SERVICES FOR EATING DISORDERS AND EATING WELLNESS, WEIGHT LOSS AND CONTROL, ADDICTIONS, DEPRESSION, ANXIETY, AND HEALTH (U.S. CLS. 100 AND 101).

FIRST USE 10-1-2008; IN COMMERCE 11-2-2008.

CLASS 41—EDUCATION AND ENTERTAINMENT

FOR ARRANGING AND CONDUCTING INCENTIVE AWARD PROGRAMS TO ENCOURAGE THE FREQUENT, CONTINUED AND EFFECTIVE PRACTICE OF PHYSICAL EXERCISE; PROVIDING A WEB SITE FEATURING INFORMATION ON EXERCISE AND FITNESS; PROVIDING ASSISTANCE, PERSONAL TRAINING AND PHYSICAL FITNESS CONSULTATION TO CORPORATE CLIENTS TO HELP THEIR EMPLOYEES MAKE PHYSICAL FITNESS, STRENGTH, CONDITIONING, AND EXERCISE ALTERATIONS IN THEIR DAILY LIVING; PROVIDING ASSISTANCE, PERSONAL TRAINING AND PHYSICAL FITNESS CONSULTATION TO INDIVIDUALS TO HELP THEM MAKE PHYSICAL FITNESS, STRENGTH, CONDITIONING, AND EXERCISE IMPROVEMENT IN THEIR DAILY LIVING; PROVIDING INFORMATION IN THE FIELD OF EXERCISE TRAINING; PROVIDING INFORMATION ON PHYSICAL EXERCISE (U.S. CLS. 100, 101 AND 107).

FIRST USE 8-1-2008; IN COMMERCE 8-1-2008.

CLASS 44—MEDICAL, BEAUTY AND AGRICULTURAL SERVICES

FOR COUNSELING SERVICES IN THE FIELDS OF HEALTH, NUTRITION AND LIFESTYLE WELLNESS; DIETARY AND NUTRITIONAL GUIDANCE; FOOD NUTRITION CONSULTATION; NUTRITION COUNSELING; PROVIDING A WEB SITE FEATURING INFORMATION ON HEALTH AND NUTRITION; PROVIDING AN ON-LINE COMPUTER DATABASE FEATURING INFORMATION REGARDING HEALTH AND NUTRITION; PROVIDING ASSISTANCE, FITNESS EVALUATION AND CONSULTATION TO CORPORATE CLIENTS TO HELP THEIR EMPLOYEES MAKE HEALTH, WELLNESS AND NUTRITIONAL CHANGES IN THEIR DAILY LIVING TO IMPROVE HEALTH; PROVIDING ASSISTANCE, FITNESS EVALUATION AND CONSULTATION TO INDIVIDUALS TO HELP THEM MAKE HEALTH, WELLNESS AND NUTRITIONAL CHANGES IN THEIR DAILY LIVING TO IMPROVE HEALTH (U.S. CLS. 100 AND 101).

FIRST USE 8-1-2008; IN COMMERCE 8-1-2008.

3,681,128. FRITZ, STACY KAM, DBA FIT2ORDER, LEXINGTON, SC. SN 77-522,344. PUB. 12-9-2008, FILED 7-15-2008.



NO CLAIM IS MADE TO THE EXCLUSIVE RIGHT TO USE "EMPLOYEE WELLNESS", APART FROM THE MARK AS SHOWN.

THE COLOR(S) BLACK, WHITE AND RED IS/ARE CLAIMED AS A FEATURE OF THE MARK.

THE MARK CONSISTS OF A TENNIS SHOE ARCHING ON TOE ON A DINNER PLATE. THE DINNER PLATE AND TENNIS SHOE ARE IN BLACK AND WHITE WITH RED MARKING ON TENNIS SHOE AND THE WORDING "FITNESS TO ORDER" IS SUPERIMPOSED ON THE DESIGN AND APPEARS IN RED WITH BLACK OUTLINING. THE WORDING "EMPLOYEE WELLNESS...STEP BY STEP" APPEARS BELOW IN BLACK.

CLASS 35—ADVERTISING AND BUSINESS

FOR PROVIDING ASSISTANCE, FITNESS EVALUATION AND CONSULTATION TO CORPORATE CLIENTS TO HELP THEIR EMPLOYEES MAKE HEALTH, WELLNESS AND NUTRITIONAL CHANGES IN THEIR DAILY LIVING TO INCREASE PRODUCTIVITY AND LOWER HEALTH CARE COSTS (U.S. CLS. 100, 101 AND 102).

FIRST USE 8-1-2008; IN COMMERCE 8-1-2008.

3,681,137. MISTER PIZZA CO., LTD., SEOUL, REPUBLIC OF KOREA. SN 77-524,809. PUB. 12-2-2008, FILED 7-17-2008.



OWNER OF U.S. REG. NO. 2,922,900.
THE COLOR(S) RED, YELLOW, AND BLACK IS/ARE CLAIMED AS A FEATURE OF THE MARK.

THE MARK CONSISTS OF A BLACK OUTLINED HAND FIGURE TOSSING A YELLOW COLORED PIZZA FIGURE NEXT TO THE RED COLORED WORDS "MR. PIZZA".

CLASS 30—STAPLE FOODS

FOR PIZZAS; SPAGHETTI; PASTA; MACARONI; RAVIOLI; NOODLES (U.S. CL. 46).

FIRST USE 12-1-2005; IN COMMERCE 12-1-2005.

CLASS 43—HOTEL AND RESTAURANT SERVICES

FOR CAFETERIAS; RESTAURANT SERVICES; SELF-SERVICE RESTAURANTS; BUFFET-STYLE RESTAURANTS; CHAIN RESTAURANTS (U.S. CLS. 100 AND 101).

FIRST USE 12-1-2005; IN COMMERCE 12-1-2005.

3,681,140. DEBENEDETTI, STEPHEN, BOISE, ID. SN 77-525,445. PUB. 12-30-2008, FILED 7-17-2008.

THE SCREEN DOOR GUY

THE MARK CONSISTS OF STANDARD CHARACTERS WITHOUT CLAIM TO ANY PARTICULAR FONT, STYLE, SIZE, OR COLOR.

NO CLAIM IS MADE TO THE EXCLUSIVE RIGHT TO USE "SCREEN DOOR", APART FROM THE MARK AS SHOWN.

CLASS 35—ADVERTISING AND BUSINESS

FOR WHOLESALE AND RETAIL STORE SERVICES FEATURING ALL TYPES OF SCREEN DOORS, INCLUDING RETRACTABLE SCREEN DOORS (U.S. CLS. 100, 101 AND 102).

FIRST USE 1-0-2009; IN COMMERCE 1-0-2009.

CLASS 37—CONSTRUCTION AND REPAIR

FOR INSTALLATION OF ALL TYPES OF SCREEN DOORS, INCLUDING RETRACTABLE SCREEN DOORS (U.S. CLS. 100, 103 AND 106).

FIRST USE 1-0-2009; IN COMMERCE 1-0-2009.

3,681,141. ARC ABRASIVES, INC., TROY, OH. SN 77-525,746. PUB. 3-24-2009, FILED 7-18-2008.

PREDATOR NO METAL STANDS A CHANCE

THE MARK CONSISTS OF STANDARD CHARACTERS WITHOUT CLAIM TO ANY PARTICULAR FONT, STYLE, SIZE, OR COLOR.

CLASS 3—COSMETICS AND CLEANING PREPARATIONS

FOR INDUSTRIAL AND COMMERCIAL CLEANING, CONDITIONING AND POLISHING ABRASIVES, NAMELY, SANDPAPER, RESIN AND FIBER DISCS, CLOTH CARTRIDGE ROLLS, BUFFING PADS, ABRASIVE PADS AND BONDED ABRASIVES; COATED ABRASIVES AND SANDPAPER IN THE FORM OF SHEETS, ROLLS AND DISCS (U.S. CLS. 1, 4, 6, 50, 51 AND 52).

FIRST USE 9-15-2008; IN COMMERCE 9-15-2008.

CLASS 7—MACHINERY

FOR SANDING DISCS, GRINDING WHEELS, FLAP-WHEELS AND GRIT BELTS USED AS ATTACHMENTS TO MACHINERY AND TOOLS FOR INDUSTRIAL AND COMMERCIAL CLEANING, CONDITIONING AND POLISHING; ABRASIVE DISCS FOR USE WITH POWER-OPERATED HAND TOOLS AND POWER-OPERATED ABRADING DISCS (U.S. CLS. 13, 19, 21, 23, 31, 34 AND 35).

FIRST USE 9-15-2008; IN COMMERCE 9-15-2008.

3,681,147. COLUMBIA STEEL CASTING CO., INC., PORTLAND, OR. SN 77-528,022. PUB. 3-3-2009, FILED 7-22-2008.

COLUMBIA STEEL

THE MARK CONSISTS OF STANDARD CHARACTERS WITHOUT CLAIM TO ANY PARTICULAR FONT, STYLE, SIZE, OR COLOR.

OWNER OF U.S. REG. NO. 1,003,192.

NO CLAIM IS MADE TO THE EXCLUSIVE RIGHT TO USE "STEEL", APART FROM THE MARK AS SHOWN.

CLASS 6—METAL GOODS

FOR STEEL CASTINGS; METAL CHAINS FOR DRAG LINES AND METAL LINKS FOR SUCH CHAINS; METAL LIFTING CHAINS AND METAL CHAIN LINKS (U.S. CLS. 2, 12, 13, 14, 23, 25 AND 50).

FIRST USE 6-30-2009; IN COMMERCE 6-30-2009.

CLASS 7—MACHINERY

FOR MACHINE PARTS FOR EARTH MOVING EQUIPMENT, NAMELY, REPLACEMENT TEETH AND ADAPTERS; MACHINE PARTS FOR ROCK CRUSHERS, NAMELY, CRUSHING JAWS, CRUSHING PLATES AND OTHER WEAR PIECES; MACHINE PARTS FOR GRINDING MILLS AND ROLLER MILLS, NAMELY, REPLACEMENT WEAR PARTS; MACHINE PARTS FOR GRINDING MACHINES FOR USE IN COAL-FIRED POWER GENERATION; MACHINE PARTS FOR MINING EQUIPMENT, NAMELY, COMPLETE RIGGING ASSEMBLIES AND DRAG LINE PARTS; AND MACHINE PARTS FOR INDUSTRIAL SCRAP SHREDDERS (U.S. CLS. 13, 19, 21, 23, 31, 34 AND 35).

FIRST USE 4-30-2009; IN COMMERCE 4-30-2009.

3,681,174. JEWISH PRO-LIFE FOUNDATION, INC., PITTSBURGH, PA. SN 77-537,559. PUB. 1-20-2009, FILED 8-1-2008.



NO CLAIM IS MADE TO THE EXCLUSIVE RIGHT TO USE "JEWISH PRO-LIFE FOUNDATION", APART FROM THE MARK AS SHOWN.

THE MARK CONSISTS OF THE WORDING "JEWISH PRO-LIFE FOUNDATION" AND THE STAR OF DAVID CONTAINING THE DESIGN OF A MOTHER HOLDING A BABY.

CLASS 16—PAPER GOODS AND PRINTED MATTER

FOR BROCHURES ABOUT FETAL DEVELOPMENT, THE RISKS OF ABORTION, AND ALTERNATIVES TO ABORTION IN THE JEWISH COMMUNITY ; PRINTED GOODS, NAMELY, POSTERS, BUMPER STICKERS, STATIONERY (U.S. CLS. 2, 5, 22, 23, 29, 37, 38 AND 50).
FIRST USE 9-15-2008; IN COMMERCE 9-15-2008.

CLASS 41—EDUCATION AND ENTERTAINMENT

FOR EDUCATIONAL SERVICES, NAMELY, PROVIDING SEMINARS AND WORKSHOPS IN THE FIELD OF EDUCATION IN THE AREA OF FETAL DEVELOPMENT, THE RISKS OF ABORTION, AND ALTERNATIVES TO ABORTION IN THE JEWISH COMMUNITY, AND DISTRIBUTION OF MATERIALS IN CONNECTION THEREWITH (U.S. CLS. 100, 101 AND 107).
FIRST USE 4-28-2009; IN COMMERCE 4-28-2009.

3,681,184. DAWNBREAKER, INC., ROCHESTER, NY. SN 77-544,535. PUB. 12-23-2008, FILED 8-12-2008.



Commercial Potential Assessment

NO CLAIM IS MADE TO THE EXCLUSIVE RIGHT TO USE "CPA COMMERCIAL POTENTIAL ASSESSMENT", APART FROM THE MARK AS SHOWN.

THE MARK CONSISTS OF "CPA COMMERCIAL POTENTIAL ASSESSMENT".

CLASS 35—ADVERTISING AND BUSINESS

FOR BUSINESS RESEARCH RELATED TO COMMERCIALIZATION ASSISTANCE (U.S. CLS. 100, 101 AND 102).
FIRST USE 4-15-2009; IN COMMERCE 4-15-2009.

CLASS 42—SCIENTIFIC AND COMPUTER SERVICES

FOR TECHNOLOGY RESEARCH IN THE FIELD OF COMMERCIALIZATION ASSISTANCE (U.S. CLS. 100 AND 101).
FIRST USE 4-15-2009; IN COMMERCE 4-15-2009.

3,681,187. NELLE'S NIBBLES, LLC, WESTPORT, CT. SN 77-544,892. PUB. 1-20-2009, FILED 8-12-2008.

NELLE'S NIBBLES

THE MARK CONSISTS OF STANDARD CHARACTERS WITHOUT CLAIM TO ANY PARTICULAR FONT, STYLE, SIZE, OR COLOR.

CLASS 30—STAPLE FOODS

FOR BAKERY GOODS (U.S. CL. 46).
FIRST USE 11-0-2008; IN COMMERCE 11-0-2008.

CLASS 35—ADVERTISING AND BUSINESS

FOR WHOLESALE AND RETAIL STORE SERVICES FEATURING BAKERY GOODS (U.S. CLS. 100, 101 AND 102).
FIRST USE 11-0-2008; IN COMMERCE 11-0-2008.

3,681,191. CONCISE CONSULTANTS, LTD., NEW YORK, NY. SN 77-546,389. PUB. 2-24-2009, FILED 8-13-2008.

MarDona

THE MARK CONSISTS OF STANDARD CHARACTERS WITHOUT CLAIM TO ANY PARTICULAR FONT, STYLE, SIZE, OR COLOR.

CLASS 29—MEATS AND PROCESSED FOODS

FOR OLIVE OILS AND EDIBLE OILS FOR HUMAN CONSUMPTION; PROCESSED VEGETABLES (U.S. CL. 46).
FIRST USE 7-26-2008; IN COMMERCE 7-26-2008.

CLASS 30—STAPLE FOODS

FOR VINEGARS; SAUCES; BALSAMIC GLAZES (U.S. CL. 46).
FIRST USE 7-26-2008; IN COMMERCE 7-26-2008.

3,681,192. CONCISE CONSULTANTS, LTD., NEW YORK, NY. SN 77-546,992. PUB. 2-24-2009, FILED 8-14-2008.



THE LIKENESS (OR, "PORTRAIT") IN THE MARK DOES NOT IDENTIFY A LIVING INDIVIDUAL.

THE MARK CONSISTS OF STYLIZED LETTERS OF THE WORD "MARDONA" WITH A BUST OF A MAN IN THE "O".

CLASS 29—MEATS AND PROCESSED FOODS

FOR OLIVE OILS AND EDIBLE OILS FOR HUMAN CONSUMPTION; PROCESSED VEGETABLES (U.S. CL. 46).

FIRST USE 7-26-2008; IN COMMERCE 7-26-2008.

CLASS 30—STAPLE FOODS

FOR VINEGARS; SAUCES; BALSAMIC GLAZES (U.S. CL. 46).

FIRST USE 7-26-2008; IN COMMERCE 7-26-2008.

3,681,206. VELONATION LLC, CHEVY CHASE, MD. SN 77-552,861. PUB. 1-20-2009, FILED 8-21-2008.

VELONATION

THE MARK CONSISTS OF STANDARD CHARACTERS WITHOUT CLAIM TO ANY PARTICULAR FONT, STYLE, SIZE, OR COLOR.

CLASS 41—EDUCATION AND ENTERTAINMENT

FOR PROVIDING A WEBSITE FEATURING INFORMATION ABOUT CYCLING (U.S. CLS. 100, 101 AND 107).

FIRST USE 10-5-2000; IN COMMERCE 6-1-2009.

CLASS 42—SCIENTIFIC AND COMPUTER SERVICES

FOR HOSTING AN ON-LINE COMMUNITY WEB SITE FEATURING SHARED COMMUNICATIONS BETWEEN COMMUNITY MEMBERS INTERESTED IN CYCLING; PROVIDING A WEB SITE THAT GIVES COMPUTER USERS THE ABILITY TO EXCHANGE AND SHARE DIGITAL MEDIA (U.S. CLS. 100 AND 101).

FIRST USE 10-5-2000; IN COMMERCE 6-1-2009.

3,681,209. NOVOLOGIX, INC., EDEN PRAIRIE, MN. SN 77-555,641. PUB. 1-13-2009, FILED 8-26-2008.

THE MARK CONSISTS OF THE TERM "NOVOLOGIX". THE SECOND "O" IN THE WORD IS STYLIZED.

CLASS 35—ADVERTISING AND BUSINESS

FOR MEDICAL REFERRALS; MANAGED CARE SERVICES, NAMELY, ELECTRONIC PROCESSING OF HEALTH CARE AND PHARMACEUTICAL INFORMATION (U.S. CLS. 100, 101 AND 102).

FIRST USE 9-10-2008; IN COMMERCE 9-10-2008.

CLASS 36—INSURANCE AND FINANCIAL

FOR INSURANCE CLAIMS ADMINISTRATION FOR MEDICAL CLAIMS AND PHARMACEUTICALS, PROCESSING OF INSURANCE CLAIMS AND PAYMENT DATA (U.S. CLS. 100, 101 AND 102).

FIRST USE 9-10-2008; IN COMMERCE 9-10-2008.

CLASS 42—SCIENTIFIC AND COMPUTER SERVICES

FOR COMPUTER SERVICES, NAMELY, INTEGRATING COMPUTER DELIVERY NETWORKS TO MANAGE THE AUTHORIZATION OF SERVICES AND RELATED CLAIMS, AND THE ORDERING AND TRACKING OF MEDICAL SUPPLIES; PROVIDING TEMPORARY USE OF ON-LINE NON-DOWNLOADABLE PROPRIETARY SOFTWARE FOR USE BY MANAGED CARE ORGANIZATIONS, HOME HEALTH AGENCIES, CLINICIANS, PHYSICIANS, MANUFACTURERS AND DISTRIBUTORS, AND THIRD PARTY HEALTH CARE CONSULTANTS IN MANAGING WORKFLOW PROCESSES (U.S. CLS. 100 AND 101).

FIRST USE 9-10-2008; IN COMMERCE 9-10-2008.

3,681,210. NOVOLOGIX, INC., EDEN PRAIRIE, MN. SN 77-555,646. PUB. 1-13-2009, FILED 8-26-2008.

NOVOLOGIX

THE MARK CONSISTS OF STANDARD CHARACTERS WITHOUT CLAIM TO ANY PARTICULAR FONT, STYLE, SIZE, OR COLOR.

CLASS 35—ADVERTISING AND BUSINESS

FOR MEDICAL REFERRALS; MANAGED CARE SERVICES, NAMELY, ELECTRONIC PROCESSING OF HEALTH CARE AND PHARMACEUTICAL INFORMATION (U.S. CLS. 100, 101 AND 102).

FIRST USE 9-10-2008; IN COMMERCE 9-10-2008.

CLASS 36—INSURANCE AND FINANCIAL

FOR INSURANCE CLAIMS ADMINISTRATION FOR MEDICAL CLAIMS AND PHARMACEUTICALS, PROCESSING OF INSURANCE CLAIMS AND PAYMENT DATA (U.S. CLS. 100, 101 AND 102).

FIRST USE 9-10-2008; IN COMMERCE 9-10-2008.

CLASS 42—SCIENTIFIC AND COMPUTER SERVICES

FOR COMPUTER SERVICES, NAMELY, INTEGRATING COMPUTER DELIVERY NETWORKS TO MANAGE THE AUTHORIZATION OF SERVICES AND RELATED CLAIMS, AND THE ORDERING AND TRACKING OF MEDICAL SUPPLIES; PROVIDING TEMPORARY USE OF ON-LINE NON-DOWNLOADABLE PROPRIETARY SOFTWARE FOR USE BY MANAGED CARE ORGANIZATIONS, HOME HEALTH AGENCIES, CLINICIANS, PHYSICIANS, MANUFACTURERS AND DISTRIBUTORS, AND THIRD PARTY HEALTH CARE CONSULTANTS IN MANAGING WORKFLOW PROCESSES (U.S. CLS. 100 AND 101).

FIRST USE 9-10-2008; IN COMMERCE 9-10-2008.

3,681,213. PROFESSIONAL BULL RIDERS, INC., PUEBLO, CO. SN 77-556,831. PUB. 12-16-2008, FILED 8-27-2008.

3,681,232. PLAYCORE IP SUB, INC., CHATTANOOGA, TN. SN 77-564,518. PUB. 3-10-2009, FILED 9-8-2008.



OWNER OF U.S. REG. NOS. 3,052,710, 3,249,568, AND OTHERS.

THE MARK CONSISTS OF THE WORDING "TEAM PBR" WITH A BULL AND RIDER DESIGN TO THE RIGHT AND A STAR DESIGN TO THE LOWER LEFT THAT CONTAINS "PBR" IN THE CENTER OF THE STAR.

CLASS 14—JEWELRY

FOR ORNAMENTAL PINS (U.S. CLS. 2, 27, 28 AND 50).
FIRST USE 1-0-2007; IN COMMERCE 1-0-2007.

CLASS 25—CLOTHING

FOR CLOTHING FOR MEN AND WOMEN, NAMELY, SHIRTS (U.S. CLS. 22 AND 39).
FIRST USE 1-0-2007; IN COMMERCE 1-0-2007.

CLASS 41—EDUCATION AND ENTERTAINMENT

FOR FAN CLUBS (U.S. CLS. 100, 101 AND 107).
FIRST USE 1-0-2007; IN COMMERCE 1-0-2007.

NATUREGROUNDS

THE MARK CONSISTS OF STANDARD CHARACTERS WITHOUT CLAIM TO ANY PARTICULAR FONT, STYLE, SIZE, OR COLOR.

CLASS 16—PAPER GOODS AND PRINTED MATTER

FOR BROCHURES AND PAMPHLETS ABOUT THE DESIGN, CONSTRUCTION AND INSTALLATION OF NATURE-INTEGRATED PLAY ENVIRONMENTS (U.S. CLS. 2, 5, 22, 23, 29, 37, 38 AND 50).
FIRST USE 9-0-2008; IN COMMERCE 9-0-2008.

CLASS 35—ADVERTISING AND BUSINESS

FOR PROMOTING PUBLIC AWARENESS OF THE NEED FOR THE INTEGRATION OF NATURE INTO PLAY ENVIRONMENTS (U.S. CLS. 100, 101 AND 102).
FIRST USE 9-0-2008; IN COMMERCE 9-0-2008.

CLASS 41—EDUCATION AND ENTERTAINMENT

FOR EDUCATIONAL SERVICES, NAMELY, CONDUCTING SEMINARS AND LECTURES IN THE FIELD OF THE DESIGN, CONSTRUCTION AND INSTALLATION OF NATURE-INTEGRATED PLAY ENVIRONMENTS (U.S. CLS. 100, 101 AND 107).
FIRST USE 9-0-2008; IN COMMERCE 9-0-2008.

3,681,227. STULL LOGISTICS INC., AUSTIN, TX. SN 77-562,569. PUB. 2-17-2009, FILED 9-4-2008.

3,681,250. SOMANETICS CORPORATION, TROY, MI. SN 77-571,325. PUB. 2-24-2009, FILED 9-16-2008.

PLG

THE MARK CONSISTS OF STANDARD CHARACTERS WITHOUT CLAIM TO ANY PARTICULAR FONT, STYLE, SIZE, OR COLOR.

CLASS 35—ADVERTISING AND BUSINESS

FOR THIRD PARTY FREIGHT LOGISTICS MANAGEMENT (U.S. CLS. 100, 101 AND 102).
FIRST USE 10-0-2008; IN COMMERCE 10-0-2008.

CLASS 39—TRANSPORTATION AND STORAGE

FOR WAREHOUSING SERVICES FOR OTHERS (U.S. CLS. 100 AND 105).
FIRST USE 10-0-2008; IN COMMERCE 10-0-2008.

SCR

THE MARK CONSISTS OF STANDARD CHARACTERS WITHOUT CLAIM TO ANY PARTICULAR FONT, STYLE, SIZE, OR COLOR.

CLASS 9—ELECTRICAL AND SCIENTIFIC APPARATUS

FOR DOWNLOADABLE ELECTRONIC NEWSLETTERS IN THE MEDICAL FIELD (U.S. CLS. 21, 23, 26, 36 AND 38).
FIRST USE 1-19-2009; IN COMMERCE 1-19-2009.

CLASS 16—PAPER GOODS AND PRINTED MATTER

FOR PRINTED NEWSLETTERS IN THE MEDICAL FIELD (U.S. CLS. 2, 5, 22, 23, 29, 37, 38 AND 50).
FIRST USE 9-30-2008; IN COMMERCE 9-30-2008.

CLASS 41—EDUCATION AND ENTERTAINMENT

FOR PROVIDING NEWSLETTERS IN THE MEDICAL FIELD VIA EMAIL (U.S. CLS. 100, 101 AND 107).
FIRST USE 9-30-2008; IN COMMERCE 9-30-2008.

3,681,256. NATIONAL PACKING CORPORATION, BRONX, NY. SN 77-573,110. PUB. 2-24-2009, FILED 9-18-2008.



OWNER OF U.S. REG. NO. 2,731,756.
NO CLAIM IS MADE TO THE EXCLUSIVE RIGHT TO USE "ALIMENTOS", APART FROM THE MARK AS SHOWN.

THE STIPPLING IS FOR SHADING PURPOSES ONLY.
THE MARK CONSISTS OF SILHOUETES OF THREE MOUNTAINS WITH "ALIMENTOS" ON TOP, "DE MI TIERRA" ON THE BOTTOM OF THE MOUNTAINS, AND "DELICIOSAMENTE NUESTROS" BELOW THAT.

THE FOREIGN WORDING IN THE MARK TRANSLATES INTO ENGLISH AS FOOD FROM MY HOMETLAND DELICIOUSLY OURS.

CLASS 29—MEATS AND PROCESSED FOODS

FOR SAUSAGES; SALAMI (U.S. CL. 46).
FIRST USE 12-1-2008; IN COMMERCE 12-1-2008.

CLASS 30—STAPLE FOODS

FOR AREPAS (U.S. CL. 46).
FIRST USE 12-1-2008; IN COMMERCE 12-1-2008.

3,681,261. ITM RESEARCH, EAST HAMPTON, NY. SN 77-573,913. PUB. 3-31-2009, FILED 9-19-2008.



OWNER OF U.S. REG. NOS. 3,409,766, 3,552,070, AND OTHERS.

NO CLAIM IS MADE TO THE EXCLUSIVE RIGHT TO USE "STRATEGY", APART FROM THE MARK AS SHOWN.

THE COLOR(S) BLUE, LIGHT BLUE, AND WHITE IS/ARE CLAIMED AS A FEATURE OF THE MARK.

THE MARK CONSISTS OF A BLUE RECTANGLE THAT IS THICK ON THE BOTTOM, WITH THREE WAVE-LIKE LINES IN THE CENTER OF THE RECTANGLE IN THREE SHADES OF LIGHT BLUE, AND WHITE INSIDE THE RECTANGLE BEHIND THE WAVY LINES. THE STYLIZED WORDING "BLUE OCEAN STRATEGY" IS WRITTEN IN WHITE IN THE LOWER BLUE SECTION OF THE RECTANGLE.

CLASS 35—ADVERTISING AND BUSINESS

FOR BUSINESS MANAGEMENT AND CONSULTATION (U.S. CLS. 100, 101 AND 102).
FIRST USE 3-14-2008; IN COMMERCE 3-14-2008.

CLASS 41—EDUCATION AND ENTERTAINMENT

FOR DEVELOPMENT AND DISSEMINATION OF EDUCATIONAL MATERIALS OF OTHERS IN THE FIELD OF BUSINESS STRATEGY, MANAGEMENT, AND LEADERSHIP; EDUCATIONAL SERVICES, NAMELY, CONDUCTING WORKSHOPS, SEMINARS, CLASSES IN THE FIELD OF BUSINESS STRATEGY, MANAGEMENT, AND LEADERSHIP (U.S. CLS. 100, 101 AND 107).

FIRST USE 3-14-2008; IN COMMERCE 3-14-2008.

3,681,276. TOSHIBA AMERICA BUSINESS SOLUTIONS, IRVINE, CA. SN 77-579,347. PUB. 3-3-2009, FILED 9-26-2008.

DON'T COPY. LEAD.

THE MARK CONSISTS OF STANDARD CHARACTERS WITHOUT CLAIM TO ANY PARTICULAR FONT, STYLE, SIZE, OR COLOR.

CLASS 35—ADVERTISING AND BUSINESS

FOR COMPUTER SERVICES, NAMELY, PROVIDING ON-LINE WEBSITE FEATURING INFORMATION ON BUSINESS AND OFFICE MACHINERY, NAMELY, PROVIDING PRODUCT, MARKETING, SALES AND DISTRIBUTION INFORMATION TO DEALERS OF COPIERS, FAX MACHINES, MULTIFUNCTION COMPUTER PERIPHERALS AND OFFICE EQUIPMENT (U.S. CLS. 100, 101 AND 102).

FIRST USE 11-1-2008; IN COMMERCE 11-1-2008.

CLASS 37—CONSTRUCTION AND REPAIR

FOR COMPUTER SERVICES, NAMELY, PROVIDING ON-LINE WEBSITE FEATURING INFORMATION ON BUSINESS AND OFFICE MACHINERY, NAMELY, PROVIDING REPAIR INFORMATION TO DEALERS OF COPIERS, FAX MACHINES, MULTIFUNCTION PERIPHERALS AND OFFICE EQUIPMENT (U.S. CLS. 100, 103 AND 106).

FIRST USE 11-1-2008; IN COMMERCE 11-1-2008.

3,681,283. CUISINE SOLUTIONS, INC., ALEXANDRIA, VA.
SN 77-580,033. PUB. 3-24-2009, FILED 9-26-2008.

CUISINE DELIGHT

THE MARK CONSISTS OF STANDARD CHARACTERS WITHOUT CLAIM TO ANY PARTICULAR FONT, STYLE, SIZE, OR COLOR.

NO CLAIM IS MADE TO THE EXCLUSIVE RIGHT TO USE "CUISINE", APART FROM THE MARK AS SHOWN.

CLASS 29—MEATS AND PROCESSED FOODS

FOR FROZEN AND REFRIGERATED ENTREES CONSISTING PRIMARILY OF MEAT, FISH, SEAFOOD, POULTRY, OR VEGETABLES, PRINCIPALLY COOKED UNDER VACUUM BY THE SOUS VIDE PROCESS (U.S. CL. 46).

FIRST USE 1-22-2009; IN COMMERCE 1-22-2009.

CLASS 30—STAPLE FOODS

FOR FROZEN AND REFRIGERATED ENTREES CONSISTING PRIMARILY OF PASTA AND RICE, PRINCIPALLY COOKED UNDER VACUUM BY THE SOUS VIDE PROCESS (U.S. CL. 46).

FIRST USE 1-22-2009; IN COMMERCE 1-22-2009.

3,681,292. HEADCASE RECORDS, LLC, AKA HEADCASE PRODUCTIONS, LLC, GREENWOOD VILLAGE, CO.
SN 77-583,423. PUB. 3-10-2009, FILED 10-1-2008.

HeadCase Records

THE MARK CONSISTS OF STANDARD CHARACTERS WITHOUT CLAIM TO ANY PARTICULAR FONT, STYLE, SIZE, OR COLOR.

NO CLAIM IS MADE TO THE EXCLUSIVE RIGHT TO USE "RECORDS", APART FROM THE MARK AS SHOWN.

CLASS 9—ELECTRICAL AND SCIENTIFIC APPARATUS

FOR DOWNLOADABLE MP3 FILES, MP3 RECORDINGS, ON-LINE DISCUSSION BOARDS, WEBCASTS AND PODCASTS FEATURING MUSIC, AUDIO BOOKS AND NEWS BROADCASTS; MUSICAL SOUND RECORDINGS; MUSICAL VIDEO RECORDINGS; VISUAL RECORDINGS AND AUDIOVISUAL RECORDINGS FEATURING MUSIC AND ANIMATION (U.S. CLS. 21, 23, 26, 36 AND 38).

FIRST USE 11-10-2008; IN COMMERCE 2-17-2009.

CLASS 35—ADVERTISING AND BUSINESS

FOR ENTERTAINMENT MARKETING SERVICES, NAMELY, MARKETING, PROMOTION AND ADVERTISING FOR INDEPENDENT RECORDING ARTISTS; PRODUCING PROMOTIONAL VIDEOTAPES, VIDEO DISCS, AND AUDIOVISUAL RECORDINGS; RETAIL MUSIC AND RECORD STORES (U.S. CLS. 100, 101 AND 102).

FIRST USE 11-10-2008; IN COMMERCE 2-17-2009.

CLASS 41—EDUCATION AND ENTERTAINMENT

FOR AUDIO AND VIDEO RECORDING SERVICES; AUDIO RECORDING AND PRODUCTION; CONSULTATION AND ADVICE REGARDING MUSICAL SELECTIONS AND ARRANGEMENTS FOR SOUND RECORDINGS AND LIVE PERFORMANCES; MULTIMEDIA ENTERTAINMENT SERVICES IN THE NATURE OF RECORDING, PRODUCTION AND POST-PRODUCTION SERVICES IN THE FIELDS OF MUSIC, VIDEO, AND FILMS; PRODUCTION OF SOUND AND IMAGE RECORDINGS ON SOUND AND IMAGE CARRIERS; PRODUCTION OF SOUND AND MUSIC VIDEO RECORDINGS; PRODUCTION OF SOUND RECORDINGS; RECORD MASTER PRODUCTION; RECORD PRODUCTION; RECORDING STUDIO SERVICES; RECORDING STUDIOS (U.S. CLS. 100, 101 AND 107).

FIRST USE 11-10-2008; IN COMMERCE 2-17-2009.

3,681,341. STOKELY-VAN CAMP, INC., CHICAGO, IL. SN
77-599,806. PUB. 1-20-2009, FILED 10-24-2008.



OWNER OF U.S. REG. NOS. 1,852,801, 3,356,900, AND OTHERS.

THE MARK CONSISTS OF A STYLIZED LETTER "G" CONTAINING A LIGHTNING BOLT DESIGN WITHIN THE LETTER.

CLASS 18—LEATHER GOODS

FOR TOTE BAGS, DUFFLE BAGS, LUGGAGE AND UMBRELLAS (U.S. CLS. 1, 2, 3, 22 AND 41).

FIRST USE 3-31-2009; IN COMMERCE 3-31-2009.

CLASS 21—HOUSEWARES AND GLASS

FOR PORTABLE BEVERAGE DISPENSERS AND ICE CHESTS FOR FOOD AND BEVERAGES (U.S. CLS. 2, 13, 23, 29, 30, 33, 40 AND 50).

FIRST USE 3-31-2009; IN COMMERCE 3-31-2009.

CLASS 24—FABRICS

FOR TOWELS (U.S. CLS. 42 AND 50).

FIRST USE 3-31-2009; IN COMMERCE 3-31-2009.

CLASS 25—CLOTHING

FOR JACKETS, PULLOVERS, SHORTS, SHIRTS, SWEATERS, VISORS, HATS, SWEAT PANTS, SWEAT SHIRTS, SWEAT SHORTS, SWEAT SUITS, AND T-SHIRTS (U.S. CLS. 22 AND 39).

FIRST USE 3-31-2009; IN COMMERCE 3-31-2009.

CLASS 28—TOYS AND SPORTING GOODS

FOR GOLF BAGS, GOLF BALLS, AND HEAD COVERS FOR GOLF CLUBS (U.S. CLS. 22, 23, 38 AND 50).

FIRST USE 3-31-2009; IN COMMERCE 3-31-2009.

3,681,347. COMPANY, STEVEN LEO, BOYNTON BEACH, FL. SN 77-601,024. PUB. 3-24-2009, FILED 10-27-2008.

CAFFEINE IS THE ENEMY

THE MARK CONSISTS OF STANDARD CHARACTERS WITHOUT CLAIM TO ANY PARTICULAR FONT, STYLE, SIZE, OR COLOR.

CLASS 30—STAPLE FOODS

FOR ARTIFICIAL COFFEE AND TEA; BEVERAGES MADE OF TEA; BLACK TEA; CEREAL BASED ENERGY BARS; COCOA; COCOA-BASED CONDIMENTS AND SEASONINGS FOR FOOD AND DRINK; COFFEE; COFFEE AND TEA; CORN STARCH BASED DRINK, IN THE NATURE OF A FOOD BEVERAGE CONSISTING PRIMARILY OF MAIZE AND PORRIDGE; DISPOSABLE CUPS WITH A TEA-FILLED POUCH ULTRASONICALLY WELDED TO ONE SIDE OF THE BOTTOM OF THE CUP, WHICH ALLOWS THE NATURAL FIBER POUCH TO FLOAT NEAR THE BOTTOM; FLAVOURINGS OF TEA; FRUIT TEAS; GREEN TEA; HERB TEA; HERBAL TEA; ICE CREAM DRINKS; ICED TEA; INSTANT TEA; JAPANESE GREEN TEA; LIME TEA; MIXES IN THE NATURE OF CONCENTRATES, SYRUPS OR POWDERS USED IN THE PREPARATION OF TEA BASED BEVERAGES; OOLONG TEA; SAGE TEA; TEA; TEA BAGS; TEA EXTRACTS; TEA FOR INFUSIONS; TEA OF PARCHED POWDER OF BARLEY WITH HUSK (MUGI-CHA); TEA OF SALTY KELP POWDER (KOMBU-CHA); TEA PODS; TEA SUBSTITUTES; TEA-BASED BEVERAGES WITH FRUIT FLAVORING; THEINE-FREE TEA SWEETENED WITH SWEETENERS (U.S. CL. 46).
FIRST USE 1-1-2007; IN COMMERCE 1-1-2008.

CLASS 32—LIGHT BEVERAGES

FOR ALOE VERA DRINKS; BOTTLED DRINKING WATER; COFFEE-FLAVORED SOFT DRINK; COLAS; CONCENTRATES, SYRUPS OR POWDERS USED IN THE PREPARATION OF SOFT DRINKS; DISTILLED DRINKING WATER; DRINKING WATER; DRINKING WATER WITH VITAMINS; ENERGY DRINKS; ESSENCES FOR USE IN MAKING SOFT DRINKS; FRUIT DRINKS; FRUIT DRINKS AND FRUIT JUICES; FRUIT DRINKS AND JUICES; FRUIT FLAVORED DRINKS; FRUIT FLAVORED SOFT DRINKS; FRUIT FLAVOURED DRINKS; FRUIT JUICES AND FRUIT DRINKS; FRUIT-BASED SOFT DRINKS FLAVORED WITH TEA; GUARANA DRINKS; ISOTONIC DRINKS; POP; POWDERS USED IN THE PREPARATION OF ISOTONIC SPORTS DRINKS AND SPORTS BEVERAGES; PURIFIED BOTTLED DRINKING WATER; SOFT DRINKS; SOFT DRINKS FLAVORED WITH TEA; SPORTS DRINKS; SPORTS DRINKS, NAMELY, ENERGY DRINKS; SYRUPS FOR MAKING SOFT DRINKS (U.S. CLS. 45, 46 AND 48).
FIRST USE 1-1-2007; IN COMMERCE 1-1-2008.

3,681,352. BAKER BAND WEAR, L.L.C., BERNICE, OK. SN 77-603,298. PUB. 3-17-2009, FILED 10-29-2008.

HONK! QUACK! BANG!

THE MARK CONSISTS OF STANDARD CHARACTERS WITHOUT CLAIM TO ANY PARTICULAR FONT, STYLE,

SIZE, OR COLOR.

CLASS 6—METAL GOODS

FOR COMMON METAL BANDS FOR IDENTIFICATION OF BIRDS (U.S. CLS. 2, 12, 13, 14, 23, 25 AND 50).
FIRST USE 2-1-2009; IN COMMERCE 2-1-2009.

CLASS 14—JEWELRY

FOR JEWELRY MADE FROM NON-PRECIOUS METALS, NAMELY, RINGS, BRACELETS AND NECKLACES (U.S. CLS. 2, 27, 28 AND 50).
FIRST USE 2-1-2009; IN COMMERCE 2-1-2009.

CLASS 18—LEATHER GOODS

FOR PET ACCESSORIES, NAMELY, LEATHER AND NYLON DOG COLLARS (U.S. CLS. 1, 2, 3, 22 AND 41).
FIRST USE 2-1-2009; IN COMMERCE 2-1-2009.

CLASS 25—CLOTHING

FOR APPAREL AND HEADWEAR, NAMELY, SHIRTS, HATS AND CAPS (U.S. CLS. 22 AND 39).
FIRST USE 8-22-2008; IN COMMERCE 8-22-2008.

3,681,363. TRILOGI, INC., LAKELAND, FL. SN 77-605,924. PUB. 3-17-2009, FILED 11-3-2008.

TRILOGI

THE MARK CONSISTS OF STANDARD CHARACTERS WITHOUT CLAIM TO ANY PARTICULAR FONT, STYLE, SIZE, OR COLOR.

CLASS 35—ADVERTISING AND BUSINESS

FOR ACCOUNTS RECEIVABLE SERVICES (U.S. CLS. 100, 101 AND 102).
FIRST USE 4-30-2009; IN COMMERCE 4-30-2009.

CLASS 36—INSURANCE AND FINANCIAL

FOR FINANCIAL CONSULTANCY SERVICES IN THE AREA OF HEALTHCARE (U.S. CLS. 100, 101 AND 102).
FIRST USE 4-30-2009; IN COMMERCE 4-30-2009.

3,681,379. MARK D RAINVILLE, DBA MDR HOLDINGS LLC, MALVERN, PA. SN 77-614,366. PUB. 3-31-2009, FILED 11-14-2008.

Moolanomics

THE MARK CONSISTS OF STANDARD CHARACTERS WITHOUT CLAIM TO ANY PARTICULAR FONT, STYLE, SIZE, OR COLOR.

CLASS 16—PAPER GOODS AND PRINTED MATTER

FOR NEWSLETTERS IN THE FIELD OF INVESTING (U.S. CLS. 2, 5, 22, 23, 29, 37, 38 AND 50).
FIRST USE 11-19-2008; IN COMMERCE 11-19-2008.

CLASS 41—EDUCATION AND ENTERTAINMENT

FOR PROVIDING NEWSLETTERS IN THE FIELD OF INVESTING VIA E-MAIL (U.S. CLS. 100, 101 AND 107).
FIRST USE 11-19-2008; IN COMMERCE 11-19-2008.

3,681,399. AUTISM NEW JERSEY, INC., EWING, NJ. SN 77-622,881. PUB. 4-7-2009, FILED 11-26-2008.



NO CLAIM IS MADE TO THE EXCLUSIVE RIGHT TO USE "AUTISM NEW JERSEY", APART FROM THE MARK AS SHOWN.

THE MARK CONSISTS OF STYLIZED BUTTERFLY WINGS POSITIONED TO THE LEFT OF THE LITERAL ELEMENT "AUTISM NEW JERSEY".

3,681,382. CAMP BOW WOW DISTRIBUTION LLC, BOULDER, CO. SN 77-616,831. PUB. 3-31-2009, FILED 11-18-2008.

HOME BUDDIES BY CAMP BOW
WOW

THE MARK CONSISTS OF STANDARD CHARACTERS WITHOUT CLAIM TO ANY PARTICULAR FONT, STYLE, SIZE, OR COLOR.

OWNER OF U.S. REG. NOS. 2,681,167, 3,364,523, AND OTHERS.
SEC. 2(F) "CAMP".

CLASS 37—CONSTRUCTION AND REPAIR

FOR PET WASTE REMOVAL SERVICES (U.S. CLS. 100, 103 AND 106).
FIRST USE 12-10-2008; IN COMMERCE 12-10-2008.

CLASS 41—EDUCATION AND ENTERTAINMENT

FOR PET EXERCISE SERVICES; PET TRAINING SERVICES (U.S. CLS. 100, 101 AND 107).
FIRST USE 12-10-2008; IN COMMERCE 12-10-2008.

CLASS 44—MEDICAL, BEAUTY AND AGRICULTURAL SERVICES

FOR PET CARE SERVICES, NAMELY, DOG WALKING, DOG BATHING, NON-MEDICATED PET GROOMING AND IN-HOME MEDICAL CARE (U.S. CLS. 100 AND 101).
FIRST USE 12-10-2008; IN COMMERCE 12-10-2008.

CLASS 45—PERSONAL AND LEGAL SERVICES

FOR PET SITTING (U.S. CLS. 100 AND 101).
FIRST USE 12-10-2008; IN COMMERCE 12-10-2008.

CLASS 35—ADVERTISING AND BUSINESS

FOR PUBLIC ADVOCACY TO PROMOTE AWARENESS OF AUTISM AND THE INTERESTS OF INDIVIDUALS WITH AUTISM; PROVIDING AN ON-LINE DIRECTORY INFORMATION SERVICE FEATURING INFORMATION REGARDING AUTISM SUPPORT SERVICES (U.S. CLS. 100, 101 AND 102).
FIRST USE 4-7-2009; IN COMMERCE 4-7-2009.

CLASS 36—INSURANCE AND FINANCIAL

FOR CHARITABLE FUND RAISING TO SUPPORT OUTREACH PROGRAMS AND SERVICES TO INDIVIDUALS, FAMILIES AND PROFESSIONALS IN THE FIELD OF AUTISM (U.S. CLS. 100, 101 AND 102).
FIRST USE 4-7-2009; IN COMMERCE 4-7-2009.

CLASS 41—EDUCATION AND ENTERTAINMENT

FOR EDUCATIONAL SERVICES, NAMELY, CONDUCTING CLASSES, MEETINGS, WORKSHOPS AND CONFERENCES IN THE FIELD OF AUTISM AND DISTRIBUTING COURSE MATERIALS IN CONNECTION THEREWITH; PROVIDING A WEBSITE WITH EDUCATIONAL INFORMATION ABOUT AUTISM CLASSES, MEETINGS, WORKSHOPS, CONFERENCES AND ADVOCACY PROGRAMS; PROVIDING INFORMATION ABOUT EDUCATIONAL RESOURCES AVAILABLE FOR INDIVIDUALS WITH AUTISM (U.S. CLS. 100, 101 AND 107).
FIRST USE 4-7-2009; IN COMMERCE 4-7-2009.

3,681,416. LARSON TEXTS, INC., ERIE, PA. SN 77-976,976. PUB. 9-2-2008, FILED 3-28-2008.

Big Ideas Math

THE MARK CONSISTS OF STANDARD CHARACTERS WITHOUT CLAIM TO ANY PARTICULAR FONT, STYLE, SIZE, OR COLOR.

NO CLAIM IS MADE TO THE EXCLUSIVE RIGHT TO USE "MATH", APART FROM THE MARK AS SHOWN.

CLASS 16—PAPER GOODS AND PRINTED MATTER

FOR EDUCATIONAL PUBLICATIONS, NAMELY, EDUCATIONAL LEARNING CARDS, FLASH CARDS, ACTIVITY CARDS, WORKBOOKS, TEXTBOOKS, ACTIVITY BOOKS, STORY BOOKS, PUZZLE BOOKS, PRINTED PUZZLES, TEACHER GUIDES, MANUALS, POSTERS, EDUCATIONAL CARD GAMES AND EDUCATIONAL BOOKLETS IN THE FIELD OF MATHEMATICS; PRINTED INSTRUCTIONAL, EDUCATIONAL, AND TEACHING MATERIALS IN THE FIELD OF MATHEMATICS; TEXTBOOKS IN THE FIELD OF MATHEMATICS (U.S. CLS. 2, 5, 22, 23, 29, 37, 38 AND 50).

FIRST USE 6-17-2008; IN COMMERCE 6-17-2008.

CLASS 41—EDUCATION AND ENTERTAINMENT

FOR EDUCATION SERVICES, NAMELY, PROVIDING TUTORIAL SESSIONS IN THE FIELD(S) OF MATHEMATICS; EDUCATIONAL SERVICES, NAMELY, CONDUCTING ON-LINE EXHIBITIONS AND DISPLAYS AND INTERACTIVE EXHIBITS IN THE FIELD OF MATHEMATICS (U.S. CLS. 100, 101 AND 107).

FIRST USE 6-17-2008; IN COMMERCE 6-17-2008.

3,681,419. BESTLINE INTERNATIONAL RESEARCH INC., BLAINE, WA. SN 77-977,412. PUB. 11-27-2007, FILED 2-15-2007.

XLR-8

THE MARK CONSISTS OF STANDARD CHARACTERS WITHOUT CLAIM TO ANY PARTICULAR FONT, STYLE, SIZE, OR COLOR.

CLASS 1—CHEMICALS

FOR ALPHA-OLEFINS SOLD AS AN INTEGRAL COMPONENT OF CHEMICAL ENGINE TREATMENTS AND ADDITIVES FOR ENGINE OILS, GASOLINE AND DIESEL FUELS, TRANSMISSION FLUIDS AND COOLING SYSTEMS; ALPHA-OLEFINS SOLD AS AN INTEGRAL COMPONENT OF CHEMICAL GASOLINE ADDITIVES (U.S. CLS. 1, 5, 6, 10, 26 AND 46).

FIRST USE 10-9-2008; IN COMMERCE 10-9-2008.

CLASS 4—LUBRICANTS AND FUELS

FOR ALPHA-OLEFINS SOLD AS AN INTEGRAL COMPONENT OF NON-CHEMICAL ENGINE TREATMENTS AND ADDITIVES FOR ENGINE OILS, GASOLINE AND DIESEL FUELS, TRANSMISSION FLUIDS AND COOLING SYSTEMS; ALPHA-OLEFINS SOLD AS AN INTEGRAL COMPONENT OF NON-CHEMICAL GASOLINE ADDITIVES (U.S. CLS. 1, 6 AND 15).

FIRST USE 10-9-2008; IN COMMERCE 10-9-2008.

3,681,422. D.B.R., INC., SUFFERN, NY. SN 77-977,431. PUB. 10-14-2008, FILED 11-20-2007.

YOUR VERY OWN STYLE

THE MARK CONSISTS OF STANDARD CHARACTERS WITHOUT CLAIM TO ANY PARTICULAR FONT, STYLE, SIZE, OR COLOR.

CLASS 25—CLOTHING

FOR ARTICLES OF CLOTHING, NAMELY, JACKETS, SKIRTS, TROUSERS, BLOUSES, SCARVES, SHORTS, SWEATERS, DRESSES, TOPS (U.S. CLS. 22 AND 39).

FIRST USE 3-0-2008; IN COMMERCE 3-0-2008.

CLASS 35—ADVERTISING AND BUSINESS

FOR RETAIL CLOTHING STORE SERVICES (U.S. CLS. 100, 101 AND 102).

FIRST USE 3-0-2008; IN COMMERCE 3-0-2008.

3,681,423. STYLECASTER MEDIA GROUP LLC, NEW YORK, NY. SN 77-977,440. PUB. 11-11-2008, FILED 5-23-2007.

STYLECASTER

THE MARK CONSISTS OF STANDARD CHARACTERS WITHOUT CLAIM TO ANY PARTICULAR FONT, STYLE, SIZE, OR COLOR.

CLASS 35—ADVERTISING AND BUSINESS

FOR DISSEMINATION OF ADVERTISING FOR OTHERS VIA THE INTERNET; PROMOTING THE WEB SITES AND PRODUCTS OF OTHERS, NAMELY, DISTRIBUTING ADVERTISING FOR OTHERS VIA AN ONLINE ELECTRONIC COMMUNICATIONS NETWORK (U.S. CLS. 100, 101 AND 102).

FIRST USE 10-31-2008; IN COMMERCE 10-31-2008.

CLASS 41—EDUCATION AND ENTERTAINMENT

FOR PROVIDING ENTERTAINMENT SERVICES, NAMELY, PROVIDING WEBCASTS IN THE FIELD OF FASHION, CLOTHING AND WEATHER VIA A GLOBAL COMPUTER NETWORK (U.S. CLS. 100, 101 AND 107).

FIRST USE 10-31-2008; IN COMMERCE 10-31-2008.

CLASS 42—SCIENTIFIC AND COMPUTER SERVICES

FOR PROVIDING TEMPORARY USE OF ON-LINE NON-DOWNLOADABLE SOFTWARE TO ENHANCE THE CAPABILITIES OF E-COMMERCE, ADVERTISING AND BROWSING APPLICATIONS BY ENABLING SUCH APPLICATIONS TO PROVIDE USERS WITH RECOMMENDATIONS FOR PRODUCTS, SERVICES AND INFORMATION IN THE FIELDS OF FASHION, CLOTHING AND WEATHER FORECASTS, ALL VIA A GLOBAL COMPUTER NETWORK; PROVIDING A WEBSITE FEATURING INFORMATION IN THE FIELD OF WEATHER FORECASTS; COMPUTER SERVICES, NAMELY, HOSTING ON-LINE WEB FACILITIES FOR OTHERS FOR ORGANIZING AND CONDUCTING INTERACTIVE DISCUSSIONS REGARDING FASHION, CLOTHING AND WEATHER FORECASTS; PROVIDING CUSTOMIZED WEB PAGES FEATURING USER-DEFINED INFORMATION AND PERSONAL PROFILES (U.S. CLS. 100 AND 101).

FIRST USE 10-31-2008; IN COMMERCE 10-31-2008.

CLASS 45—PERSONAL AND LEGAL SERVICES

FOR PROVIDING A WEBSITE FEATURING INFORMATION IN THE FIELDS OF FASHION AND CLOTHING FASHION; PROVIDING ONLINE SOCIAL NETWORKING SERVICES FOR THOSE INTERESTED IN FASHION, FASHION CLOTHING AND WEATHER FORECAST TOPICS (U.S. CLS. 100 AND 101).

FIRST USE 10-31-2008; IN COMMERCE 10-31-2008.

3,681,424. UNLIMITED CAD SERVICES, LLC, PACIFIC PALISADES, CA. SN 77-977,443. PUB. 9-23-2008, FILED 3-9-2007.



CLASS 35—ADVERTISING AND BUSINESS

FOR FINANCIAL RECORDKEEPING FOR MANAGEMENT OF DATA (U.S. CLS. 100, 101 AND 102).

FIRST USE 2-0-2008; IN COMMERCE 2-0-2008.

CLASS 39—TRANSPORTATION AND STORAGE

FOR ELECTRONIC STORAGE OF FILES FOR PURPOSES OF MANAGING DATA (U.S. CLS. 100 AND 105).

FIRST USE 2-0-2008; IN COMMERCE 2-0-2008.

3,681,427. SOLARNET, LLC, MANHATTAN BEACH, CA. SN 77-977,526. PUB. 7-22-2008, FILED 9-26-2007.

SOLARNET

THE MARK CONSISTS OF STANDARD CHARACTERS WITHOUT CLAIM TO ANY PARTICULAR FONT, STYLE, SIZE, OR COLOR.

CLASS 35—ADVERTISING AND BUSINESS

FOR WHOLESALE DISTRIBUTORSHIP OF PHOTOVOLTAIC PANELS AND SOLAR POWER SYSTEMS; BUSINESS CONSULTING SERVICES, NAMELY, ASSISTING WITH THE OPERATION, MANAGEMENT, MARKETING AND BRANDING OF SOLAR POWER SYSTEM DEALERSHIPS; MANAGEMENT OF SOLAR POWER SYSTEMS FOR OTHERS; SOLAR ENERGY BUSINESS REFERRAL SERVICES, NAMELY, PROVIDING INFORMATION TO GROUP MEMBERS ON THE GOODS AND SERVICES OF OTHERS FOR USE IN CONNECTION WITH SOLAR POWER SYSTEMS, SOLAR ARRAYS AND SOLAR ENERGY (U.S. CLS. 100, 101 AND 102).

FIRST USE 0-0-2007; IN COMMERCE 0-0-2007.

CLASS 37—CONSTRUCTION AND REPAIR

FOR INSTALLATION, REPAIR AND MAINTENANCE OF PHOTOVOLTAIC PANELS AND SOLAR POWER SYSTEMS FOR OTHERS (U.S. CLS. 100, 103 AND 106).

FIRST USE 4-0-2009; IN COMMERCE 4-0-2009.

CLASS 40—MATERIAL TREATMENT

FOR SOLAR PARKS AND SOLAR POWER FACILITIES, NAMELY, GENERATION OF ENERGY THROUGH SOLAR POWER SYSTEMS FOR USE BY OTHERS; TECHNICAL CONSULTATION IN THE FIELD OF GENERATION AND PRODUCTION OF SOLAR ENERGY (U.S. CLS. 100, 103 AND 106).

FIRST USE 0-0-2007; IN COMMERCE 0-0-2007.

CLASS 41—EDUCATION AND ENTERTAINMENT

FOR EDUCATION SERVICES, NAMELY, PROVIDING CLASSES, SEMINARS, WORKSHOPS IN THE FIELDS OF OPERATION, MANAGEMENT, MARKETING AND BRANDING OF SOLAR POWER SYSTEM DEALERSHIPS (U.S. CLS. 100, 101 AND 107).

FIRST USE 4-0-2009; IN COMMERCE 4-0-2009.

CLASS 42—SCIENTIFIC AND COMPUTER SERVICES

FOR SOLAR POWER SERVICES, NAMELY, TECHNICAL CONSULTATION IN THE FIELD OF SOLAR ENERGY TECHNOLOGY, ENGINEERING SERVICES, DESIGN FOR OTHERS IN THE FIELD OF SOLAR POWER SYSTEMS (U.S. CLS. 100 AND 101).

FIRST USE 0-0-2007; IN COMMERCE 0-0-2007.

3,681,429. PROGRESSIVE CASUALTY INSURANCE COMPANY, MAYFIELD VILLAGE, OH. SN 77-977,541. PUB. 3-17-2009, FILED 9-7-2007.

MYRATE

THE MARK CONSISTS OF STANDARD CHARACTERS WITHOUT CLAIM TO ANY PARTICULAR FONT, STYLE, SIZE, OR COLOR.

CLASS 9—ELECTRICAL AND SCIENTIFIC APPARATUS

FOR ELECTRONIC DEVICE, NAMELY, AN ELECTRONIC DATA LOGGER FOR MONITORING, RECORDING AND REPORTING DATA PERTAINING TO THE LOCATION AND OPERATION OF MOTOR VEHICLES; PARTS AND ACCESSORIES USED IN SUCH ELECTRONIC DATA LOGGER, NAMELY, COMPUTER FIRMWARE FOR USE IN MONITORING, RECORDING AND REPORTING DATA PERTAINING TO THE LOCATION AND OPERATION OF MOTOR VEHICLES, POWER ADAPTER, FLASH MEMORY CARD AND A TRANSCEIVER (U.S. CLS. 21, 23, 26, 36 AND 38).
FIRST USE 5-0-2008; IN COMMERCE 5-0-2008.

3,681,449. ANGLES BEAUTY-CARE GROUP, INC., SAN DIEGO, CA. SN 78-337,209. PUB. 7-5-2005, FILED 12-5-2003.



THE MARK CONSISTS OF STANDARD CHARACTERS WITHOUT CLAIM TO ANY PARTICULAR FONT, STYLE, SIZE, OR COLOR.
OWNER OF U.S. REG. NO. 2,518,282.

CLASS 36—INSURANCE AND FINANCIAL

FOR MOTOR VEHICLE INSURANCE UNDERWRITING AND ADMINISTRATION, NAMELY, PROVIDING PREMIUM RATE COMPUTING (U.S. CLS. 100, 101 AND 102).
FIRST USE 5-0-2008; IN COMMERCE 5-0-2008.

CLASS 9—ELECTRICAL AND SCIENTIFIC APPARATUS

FOR HAIR STYLING TOOLS, NAMELY, ELECTRIC FLAT IRONS AND ELECTRIC CURLING IRONS (U.S. CLS. 21, 23, 26, 36 AND 38).
FIRST USE 1-0-1999; IN COMMERCE 1-0-1999.

3,681,434. EKLUTNA, INC., EAGLE RIVER, AK. SN 77-977,580. PUB. 9-30-2008, FILED 3-15-2007.



CLASS 11—ENVIRONMENTAL CONTROL APPARATUS

FOR HAND HELD ELECTRIC HAIR DRYERS (U.S. CLS. 13, 21, 23, 31 AND 34).
FIRST USE 3-25-2005; IN COMMERCE 3-25-2005.

NO CLAIM IS MADE TO THE EXCLUSIVE RIGHT TO USE "SERVICES LLC", APART FROM THE MARK AS SHOWN.

3,681,450. ANGLES BEAUTY-CARE GROUP, INC., SAN DIEGO, CA. SN 78-337,353. PUB. 7-5-2005, FILED 12-5-2003.



OWNER OF U.S. REG. NO. 2,518,282.
THE MARK CONSISTS OF THE CAPITAL LETTERS "HAI" IN STYLIZED TYPE WITH TWO CURVED, EXPANDING ARCS, ONE ABOVE AND ONE BELOW.

CLASS 35—ADVERTISING AND BUSINESS

FOR BUSINESS SERVICES, NAMELY, FACILITIES MANAGEMENT OF TECHNICAL OPERATIONS (U.S. CLS. 100, 101 AND 102).
FIRST USE 7-0-2008; IN COMMERCE 7-0-2008.

CLASS 9—ELECTRICAL AND SCIENTIFIC APPARATUS

FOR HAIR STYLING TOOLS, NAMELY, ELECTRIC FLAT IRONS AND ELECTRIC CURLING IRONS (U.S. CLS. 21, 23, 26, 36 AND 38).
FIRST USE 1-0-1999; IN COMMERCE 1-0-1999.

CLASS 36—INSURANCE AND FINANCIAL

FOR LEASING OR RENTING OF BUILDINGS AND LAND (U.S. CLS. 100, 101 AND 102).
FIRST USE 7-0-2008; IN COMMERCE 7-0-2008.

CLASS 11—ENVIRONMENTAL CONTROL APPARATUS

FOR HAND HELD ELECTRIC HAIR DRYERS (U.S. CLS. 13, 21, 23, 31 AND 34).
FIRST USE 3-25-2005; IN COMMERCE 3-25-2005.

CLASS 37—CONSTRUCTION AND REPAIR

FOR CONSTRUCTION, MAINTENANCE, REPAIR AND RENOVATION OF BUILDINGS; CONSTRUCTION CONSULTATION; CONSTRUCTION PLANNING; CONSTRUCTION MANAGEMENT; CONSTRUCTION OF HIGHWAYS, STREETS AND BRIDGES; GENERAL CONSTRUCTION CONTRACTING (U.S. CLS. 100, 103 AND 106).
FIRST USE 7-0-2008; IN COMMERCE 7-0-2008.

CLASS 42—SCIENTIFIC AND COMPUTER SERVICES

FOR ENGINEERING SERVICES FOR BUILDING AND PROPERTY CONDITION ASSESSMENT, FACILITY MANAGEMENT, REPAIR AND RESTORATION (U.S. CLS. 100 AND 101).
FIRST USE 7-0-2008; IN COMMERCE 7-0-2008.

3,681,456. SECOND CITY, INC., CHICAGO, IL. SN 78-391,675.
PUB. 10-21-2008, FILED 3-26-2004.

SECOND CITY TELEVISION NETWORK

THE MARK CONSISTS OF STANDARD CHARACTERS WITHOUT CLAIM TO ANY PARTICULAR FONT, STYLE, SIZE, OR COLOR.

PRIORITY CLAIMED UNDER SEC. 44(D) ON CANADA APPLICATION NO. 1203158, FILED 1-12-2004, REG. NO. TMA712853, DATED 4-25-2008, EXPIRES 4-25-2023.

OWNER OF U.S. REG. NOS. 1,413,702 AND 1,472,660.

NO CLAIM IS MADE TO THE EXCLUSIVE RIGHT TO USE "TELEVISION NETWORK" , APART FROM THE MARK AS SHOWN.

SEC. 2(F) AS TO "SECOND CITY".

CLASS 9—ELECTRICAL AND SCIENTIFIC APPARATUS

FOR PRE-RECORDED DIGITAL VIDEO DISCS (DVD) AND PRE-RECORDED VIDEOTAPES FEATURING ENTERTAINMENT, NAMELY, COMEDY SHOWS (U.S. CLS. 21, 23, 26, 36 AND 38).

FIRST USE 6-8-2004; IN COMMERCE 6-8-2004.

CLASS 41—EDUCATION AND ENTERTAINMENT

FOR ENTERTAINMENT SERVICES, NAMELY, PRODUCTION OF DIGITAL VIDEO DISCS (DVD) AND PRE-RECORDED VIDEOTAPES FEATURING ENTERTAINMENT, NAMELY, COMEDY SHOWS (U.S. CLS. 100, 101 AND 107).

FIRST USE 6-8-2004; IN COMMERCE 6-8-2004.

3,681,461. CITY OF LA QUINTA, LA QUINTA, CA. SN 78-426,623. PUB. 9-27-2005, FILED 5-27-2004.



NO CLAIM IS MADE TO THE EXCLUSIVE RIGHT TO USE "RESORT", APART FROM THE MARK AS SHOWN.

CLASS 39—TRANSPORTATION AND STORAGE

FOR RENTAL OF GOLF CARTS (U.S. CLS. 100 AND 105).

FIRST USE 2-28-2005; IN COMMERCE 2-28-2005.

CLASS 41—EDUCATION AND ENTERTAINMENT

FOR PROVIDING INSTRUCTION IN THE FIELD OF GOLF; GOLF CLUB SERVICES; RENTAL OF GOLF EQUIPMENT; PROVIDING FACILITIES FOR GOLF TOURNAMENTS; ARRANGING AND CONDUCTING ATHLETIC COMPETITIONS IN THE FIELD OF GOLF; GOLF COURSES; ENTERTAINMENT IN THE NATURE OF GOLF TOURNAMENTS (U.S. CLS. 100, 101 AND 107).

FIRST USE 2-28-2005; IN COMMERCE 2-28-2005.

CLASS 43—HOTEL AND RESTAURANT SERVICES

FOR RESTAURANT SERVICES (U.S. CLS. 100 AND 101).

FIRST USE 2-28-2005; IN COMMERCE 2-28-2005.

3,681,462. INTERNATIONAL BUSINESS MACHINES CORPORATION, ARMONK, NY. SN 78-474,405. PUB. 12-6-2005, FILED 8-26-2004.

EXPRESS

THE MARK CONSISTS OF STANDARD CHARACTERS WITHOUT CLAIM TO ANY PARTICULAR FONT, STYLE, SIZE, OR COLOR.

PRIORITY CLAIMED UNDER SEC. 44(D) ON TURKEY APPLICATION NO. 2004/25120, FILED 8-10-2004.

CLASS 9—ELECTRICAL AND SCIENTIFIC APPARATUS

FOR COMPUTER HARDWARE; OPERATING SYSTEM SOFTWARE FOR COMPUTERS AND SERVERS; COMPUTER SOFTWARE FOR USE IN CONNECTING DISPARATE COMPUTER SYSTEMS, SERVERS AND STORAGE DEVICES; COMPUTER SOFTWARE FOR MANAGING HARDWARE, SOFTWARE, AND PROCESSES THAT EXIST WITHIN AN INFORMATION TECHNOLOGY ENVIRONMENT; ALL FOR USE SOLELY IN CONNECTION WITH AN INFORMATION TECHNOLOGY SYSTEM DESIGNED SPECIFICALLY FOR SMALL TO MID-SIZE BUSINESSES NEEDS; AND INSTRUCTION MANUALS SOLD AS A UNIT THEREWITH (U.S. CLS. 21, 23, 26, 36 AND 38).

FIRST USE 11-12-2002; IN COMMERCE 11-12-2002.

CLASS 37—CONSTRUCTION AND REPAIR

FOR TESTING, INSTALLATION, UPDATING, AND MAINTENANCE OF COMPUTER HARDWARE (U.S. CLS. 100, 103 AND 106).

FIRST USE 11-12-2002; IN COMMERCE 11-12-2002.

CLASS 42—SCIENTIFIC AND COMPUTER SERVICES

FOR TECHNICAL SUPPORT SERVICES, NAMELY, TROUBLESHOOTING OF COMPUTER HARDWARE AND COMPUTER SOFTWARE PROBLEMS; INTEGRATION OF COMPUTER SYSTEMS AND NETWORKS; COMPUTER SYSTEMS DESIGN SERVICES FOR OTHERS; COMPUTER SYSTEMS ANALYSIS; TESTING, INSTALLATION, UPDATING AND MAINTENANCE OF COMPUTER SOFTWARE; COMPUTER PROGRAMMING FOR OTHERS; COMPUTER CONSULTATION; ALL FOR USE SOLELY IN CONNECTION WITH AN INFORMATION TECHNOLOGY SYSTEM DESIGNED SPECIFICALLY FOR SMALL TO MID-SIZE BUSINESSES NEEDS (U.S. CLS. 100 AND 101).

FIRST USE 11-12-2002; IN COMMERCE 11-12-2002.

3,681,464. SILVER SLIPPER LICENSING, LLC, PASADENA, CA. SN 78-481,874. PUB. 4-11-2006, FILED 9-10-2004.

SILVER SLIPPER

THE MARK CONSISTS OF STANDARD CHARACTERS WITHOUT CLAIM TO ANY PARTICULAR FONT, STYLE, SIZE, OR COLOR.

CLASS 6—METAL GOODS

FOR GOODS MADE FROM NON-PRECIOUS METAL, NAMELY, KEY CHAINS, BANKS, MONEY CLIPS, KEY RINGS, LICENSE PLATES, NAME BADGES, NAME PLATES, HIGH SECURITY LOCKS AND SHEET METAL PLATES PRIMARILY FOR THE CASINO AND GAMING INDUSTRY, AND TROPHIES (U.S. CLS. 2, 12, 13, 14, 23, 25 AND 50).

FIRST USE 11-9-2006; IN COMMERCE 11-9-2006.

CLASS 14—JEWELRY

FOR SOUVENIR ITEMS, NAMELY, WATCHES, TIE TACKS, AND ORNAMENTAL PINS (U.S. CLS. 2, 27, 28 AND 50).

FIRST USE 11-9-2006; IN COMMERCE 11-9-2006.

CLASS 18—LEATHER GOODS

FOR BAGS, NAMELY, TOTE BAGS, BEACH BAGS, FANNY PACKS, UMBRELLAS, SOUVENIR BAGS AND SPORTS BAGS (U.S. CLS. 1, 2, 3, 22 AND 41).

FIRST USE 11-9-2006; IN COMMERCE 11-9-2006.

CLASS 21—HOUSEWARES AND GLASS

FOR DRINKING GLASSES, MUGS, TANKARDS, TUMBLERS, DECANTERS, BEER JUGS, COFFEE CUPS, DRINKING FLASKS, FLASKS, PLASTIC CUPS, SHOT GLASSES, AND SALT AND PEPPER SHAKERS (U.S. CLS. 2, 13, 23, 29, 30, 33, 40 AND 50).

FIRST USE 11-9-2006; IN COMMERCE 11-9-2006.

CLASS 25—CLOTHING

FOR CLOTHING, NAMELY, HATS, CAPS, BEACHWEAR, VISORS, COATS, COVERUPS, GOLF SHIRTS, GYM SHORTS, JACKETS, JERSEYS, POLO SHIRTS, PULLOVERS, PANTS, TOPS, SHIRTS, SPORT SHIRTS, SWEATERS, SWEATSHIRTS, T-SHIRTS, WIND RESISTANT JACKETS, AND WIND SHIRTS (U.S. CLS. 22 AND 39).

FIRST USE 11-9-2006; IN COMMERCE 11-9-2006.

CLASS 28—TOYS AND SPORTING GOODS

FOR PLAYING CARDS, CASINO CHIPS, POKER CHIPS, AND DICE (U.S. CLS. 22, 23, 38 AND 50).

FIRST USE 11-9-2006; IN COMMERCE 11-9-2006.

CLASS 34—SMOKERS' ARTICLES

FOR CIGARETTE LIGHTERS NOT OF PRECIOUS METAL, AND MATCHES (U.S. CLS. 2, 8, 9 AND 17).

FIRST USE 11-9-2006; IN COMMERCE 11-9-2006.

CLASS 35—ADVERTISING AND BUSINESS

FOR RETAIL STORES FEATURING SOUVENIR AND GIFT ITEMS, CASINO-RELATED ITEMS, CLOTHING, TOILETRIES, JEWELRY, BAGS, TOTE BAGS, DRINKING UTENSILS (U.S. CLS. 100, 101 AND 102).

FIRST USE 11-9-2006; IN COMMERCE 11-9-2006.

CLASS 36—INSURANCE AND FINANCIAL

FOR FINANCIAL SPONSORSHIP OF CASINO AND GAMING CONTESTS AND TOURNAMENTS (U.S. CLS. 100, 101 AND 102).

FIRST USE 11-9-2006; IN COMMERCE 11-9-2006.

CLASS 41—EDUCATION AND ENTERTAINMENT

FOR CONDUCTING AND PROVIDING FACILITIES FOR SPECIAL EVENTS FEATURING CASINO AND GAMING CONTESTS AND TOURNAMENTS (U.S. CLS. 100, 101 AND 107).

FIRST USE 11-9-2006; IN COMMERCE 11-9-2006.

3,681,466. INTERNATIONAL BUSINESS MACHINES CORPORATION, ARMONK, NY. SN 78-491,470. PUB. 12-6-2005, FILED 9-29-2004.

THINK EXPRESS

THE MARK CONSISTS OF STANDARD CHARACTERS WITHOUT CLAIM TO ANY PARTICULAR FONT, STYLE, SIZE, OR COLOR.

CLASS 9—ELECTRICAL AND SCIENTIFIC APPARATUS

FOR COMPUTER HARDWARE; OPERATING SYSTEM SOFTWARE FOR COMPUTERS AND SERVERS; COMPUTER SOFTWARE FOR USE IN CONNECTING DISPARATE COMPUTER SYSTEMS, SERVERS AND STORAGE DEVICES; COMPUTER SOFTWARE FOR MANAGING HARDWARE, SOFTWARE, AND PROCESSES THAT EXIST WITHIN AN INFORMATION TECHNOLOGY ENVIRONMENT; COMPUTERS; COMPUTER PERIPHERALS AND COMPUTER ACCESSORIES; ALL FOR USE SOLELY IN CONNECTION WITH AN INFORMATION TECHNOLOGY SYSTEM DESIGNED SPECIFICALLY FOR SMALL TO MID-SIZE BUSINESSES NEEDS; AND INSTRUCTION MANUALS SOLD AS A UNIT THEREWITH (U.S. CLS. 21, 23, 26, 36 AND 38).

FIRST USE 12-20-2004; IN COMMERCE 12-20-2004.

CLASS 16—PAPER GOODS AND PRINTED MATTER

FOR PRINTED MATTER, NAMELY, MAGAZINES, BOOKS, CATALOGS, BROCHURES, PAMPHLETS, INSTRUCTION MANUALS, ALL IN THE FIELD OF COMPUTERS, COMPUTER HARDWARE, AND COMPUTER SOFTWARE FOR USE SOLELY IN CONNECTION WITH AN INFORMATION TECHNOLOGY SYSTEM DESIGNED SPECIFICALLY FOR SMALL TO MID-SIZE BUSINESSES NEEDS (U.S. CLS. 2, 5, 22, 23, 29, 37, 38 AND 50).

FIRST USE 12-20-2004; IN COMMERCE 12-20-2004.

3,681,479. ACCO BRANDS CORPORATION, LINCOLN-SHIRE, IL. SN 78-551,524. PUB. 3-14-2006, FILED 1-21-2005.



The logo for SmartFit system features a stylized icon of a hand holding a computer mouse, followed by the text "SmartFit" in a large, bold, sans-serif font, and "system" in a smaller, lowercase, sans-serif font below it.

NO CLAIM IS MADE TO THE EXCLUSIVE RIGHT TO USE "SYSTEM", APART FROM THE MARK AS SHOWN.

CLASS 9—ELECTRICAL AND SCIENTIFIC APPARATUS

FOR COMPUTER STANDS SPECIALLY DESIGNED FOR HOLDING A MONITOR; COMPUTER STANDS SPECIALLY DESIGNED FOR HOLDING A LAPTOP; MOUNTING RACKS FOR COMPUTER MONITORS AND LAPTOP COMPUTERS; WRIST RESTS AND SUPPORTS FOR COMPUTER MOUSE USERS; AND COMPUTER SCREENS AND FILTERS (U.S. CLS. 21, 23, 26, 36 AND 38).

FIRST USE 7-31-2005; IN COMMERCE 7-31-2005.

CLASS 16—PAPER GOODS AND PRINTED MATTER

FOR COPYHOLDERS (U.S. CLS. 2, 5, 22, 23, 29, 37, 38 AND 50).

FIRST USE 8-1-2006; IN COMMERCE 8-1-2006.

CLASS 20—FURNITURE AND ARTICLES NOT OTHERWISE CLASSIFIED

FOR FOOT RESTS, PORTABLE BACK SUPPORT FOR USE WITH CHAIRS, AND SEAT CUSHIONS; COMPUTER KEYBOARD TRAYS; COMPUTER FURNITURE (U.S. CLS. 2, 13, 22, 25, 32 AND 50).

FIRST USE 8-1-2006; IN COMMERCE 8-1-2006.

3,681,493. AVUE TECHNOLOGIES CORPORATION, TACOMA, WA. SN 78-611,558. PUB. 9-19-2006, FILED 4-19-2005.

AVUE. ANYTHING ELSE IS
FOR AMATEURS.

THE MARK CONSISTS OF STANDARD CHARACTERS WITHOUT CLAIM TO ANY PARTICULAR FONT, STYLE, SIZE, OR COLOR.

CLASS 35—ADVERTISING AND BUSINESS

FOR BUSINESS CONSULTING SERVICES IN THE FIELD OF WORKFORCE MANAGEMENT AND HUMAN RESOURCES, PROVIDED VIA TELEPHONE, FACSIMILE, AND E-MAIL, INCLUDING TRANSACTION PROCESSING, DECISION SUPPORT, AND WORKFLOW ENABLING, ALL IN THE AREAS OF PERSONNEL FORECASTING, POSITION DESIGN, STAFFING, RECRUITMENT, HIRING, TRAINING, EVALUATION, DEVELOPMENT, COMPENSATION, COMPLIANCE, ANALYSIS, ORGANIZATIONAL ARCHITECTURE ANALYSIS, MANAGEMENT AND SUCCESSION PLANNING (U.S. CLS. 100, 101 AND 102).

FIRST USE 5-0-2009; IN COMMERCE 5-0-2009.

CLASS 42—SCIENTIFIC AND COMPUTER SERVICES

FOR PROVIDING USE OF ON-LINE NON-DOWNLOADABLE SOFTWARE FOR USE IN WORKFORCE MANAGEMENT AND HUMAN RESOURCES, INCLUDING TRANSACTION PROCESSING, DECISION SUPPORT, AND WORKFLOW ENABLING, ALL IN THE AREAS OF PERSONNEL FORECASTING, POSITION DESIGN, STAFFING, RECRUITMENT, HIRING, TRAINING, EVALUATION, DEVELOPMENT, COMPENSATION, COMPLIANCE, ANALYSIS, ORGANIZATIONAL ARCHITECTURE ANALYSIS, MANAGEMENT AND SUCCESSION PLANNING (U.S. CLS. 100 AND 101).

FIRST USE 5-0-2009; IN COMMERCE 5-0-2009.

3,681,501. LINDAMOOD, L. STUART, SNOWMASS VILLAGE, CO. SN 78-650,899. PUB. 5-8-2007, FILED 6-15-2005.

ASPEN COLORS

THE MARK CONSISTS OF STANDARD CHARACTERS WITHOUT CLAIM TO ANY PARTICULAR FONT, STYLE, SIZE, OR COLOR.

NO CLAIM IS MADE TO THE EXCLUSIVE RIGHT TO USE "ASPEN", APART FROM THE MARK AS SHOWN.

CLASS 25—CLOTHING

FOR CLOTHING, NAMELY, SHIRTS (U.S. CLS. 22 AND 39).

FIRST USE 3-0-2005; IN COMMERCE 6-0-2005.

CLASS 35—ADVERTISING AND BUSINESS

FOR ART GALLERY (U.S. CLS. 100, 101 AND 102).

FIRST USE 3-0-2005; IN COMMERCE 3-0-2005.

3,681,507. NUCON STEEL CORPORATION, WILMINGTON, DE. SN 78-659,726. PUB. 3-21-2006, FILED 6-28-2005.

NUTRUS 3.0

THE MARK CONSISTS OF STANDARD CHARACTERS WITHOUT CLAIM TO ANY PARTICULAR FONT, STYLE, SIZE, OR COLOR.

OWNER OF U.S. REG. NO. 2,837,299.

CLASS 6—METAL GOODS

FOR STEEL FRAMING; STEEL JOISTS; STEEL TRUSSES; STEEL FASTENERS; AND PARTS FOR ALL OF THE FOREGOING (U.S. CLS. 2, 12, 13, 14, 23, 25 AND 50).

FIRST USE 6-9-2009; IN COMMERCE 6-9-2009.

CLASS 40—MATERIAL TREATMENT

FOR MANUFACTURE OF STEEL FRAMING; STEEL JOISTS; STEEL TRUSSES; STEEL FASTENERS; AND, PARTS FOR ALL OF THE FOREGOING, TO THE ORDER AND SPECIFICATION OF OTHERS; MANUFACTURE OF GENERAL PRODUCT LINES IN THE FIELD OF STEEL FRAMING SYSTEMS TO THE ORDER AND SPECIFICATION OF OTHERS (U.S. CLS. 100, 103 AND 106).
FIRST USE 6-4-2009; IN COMMERCE 6-4-2009.

CLASS 42—SCIENTIFIC AND COMPUTER SERVICES

FOR ENGINEERING SERVICES (U.S. CLS. 100 AND 101).
FIRST USE 6-4-2009; IN COMMERCE 6-4-2009.

CLASS 42—SCIENTIFIC AND COMPUTER SERVICES

FOR COMPUTER SECURITY SERVICE, NAMELY, RESTRICTING ACCESS TO COMPUTER NETWORKS, MEDIA, INDIVIDUALS; DEVELOPMENT OF SOFTWARE FOR USE BY FACILITIES TO ENSURE THE SECURE OPERATION OF COMPUTER NETWORK; RESEARCH IN THE FIELD OF INTELLIGENCE AND SECURITY TECHNICAL SUPPORT SERVICES, NAMELY, TROUBLESHOOTING OF COMPUTER HARDWARE AND SOFTWARE PROBLEMS; MONITORING OF RESIDENTIAL, COMMERCIAL, MILITARY AND INDUSTRIAL SITES FOR DETECTION OF VOLATILE AND NON-VOLATILE ORGANIC AND INORGANIC COMPOUNDS; RADAR DETECTION SERVICES AND DETECTION CLOSED CIRCUIT TELEVISION (CCTV) SERVICES (U.S. CLS. 100 AND 101).
FIRST USE 9-30-2007; IN COMMERCE 9-30-2007.

CLASS 45—PERSONAL AND LEGAL SERVICES

FOR CONSULTING SERVICES IN THE FIELD OF MAINTAINING THE SECURITY AND INTEGRITY OF COMPUTER NETWORKS AND DATABASES; MONITORING OF COMPUTER AND NETWORK SYSTEMS FOR SECURITY PURPOSES; CONTROL OF BUILDING ACCESS AND SECURITY SYSTEMS; MONITORING BURGLAR AND SECURITY ALARMS; SECURITY INSPECTION SERVICES FOR OTHERS; PROVIDING INFORMATION REGARDING UNDERSTANDING AND PREVENTING TERRORISM; ELECTRONIC MONITORING SERVICES VIA CLOSE CIRCUIT TELEVISION IN THE FIELD OF MONITORING BUILDING AND PERIMETER ACCESS (U.S. CLS. 100 AND 101).
FIRST USE 9-30-2007; IN COMMERCE 9-30-2007.

3,681,508. FIGG ENGINEERING GROUP, TALLAHASSEE, FL. SN 78-662,861. PUB. 10-10-2006, FILED 7-1-2005.

FIGG BRIDGE DESIGN CHARETTE

THE MARK CONSISTS OF STANDARD CHARACTERS WITHOUT CLAIM TO ANY PARTICULAR FONT, STYLE, SIZE, OR COLOR.
NO CLAIM IS MADE TO THE EXCLUSIVE RIGHT TO USE "BRIDGE DESIGN CHARETTE", APART FROM THE MARK AS SHOWN.

CLASS 35—ADVERTISING AND BUSINESS

FOR PUBLIC OPINION POLLING WHICH INVOLVES THE COMMUNITY OR OTHER INTERESTED PARTIES IN THE PROCESS OF CREATING AESTHETICALLY PLEASING BRIDGES BY CAPTURING THE PARTICIPANT'S VISION WITH SELECTIONS OF KEY AESTHETIC FEATURES CHOSEN THROUGH VOTING (U.S. CLS. 100, 101 AND 102).
FIRST USE 7-7-2008; IN COMMERCE 7-7-2008.

3,681,512. LUCASFILM LTD., SAN FRANCISCO, CA. SN 78-665,647. PUB. 4-11-2006, FILED 7-7-2005.

CLASS 42—SCIENTIFIC AND COMPUTER SERVICES

FOR BRIDGE DESIGN AND DEVELOPMENT SERVICES (U.S. CLS. 100 AND 101).
FIRST USE 7-7-2008; IN COMMERCE 7-7-2008.



LUCASARTS

3,681,511. ICX TECHNOLOGIES, INC., ARLINGTON, VA. SN 78-664,502. PUB. 10-10-2006, FILED 7-6-2005.

ICX

THE MARK CONSISTS OF STANDARD CHARACTERS WITHOUT CLAIM TO ANY PARTICULAR FONT, STYLE, SIZE, OR COLOR.

OWNER OF U.S. REG. NOS. 1,745,262, 2,284,759, AND OTHERS.
THE MARK CONSISTS OF THE STANDARD CHARACTERS "LUCASARTS" AND A STYLIZED DESIGN OF THE SUN AND HUMAN FIGURE.

CLASS 9—ELECTRICAL AND SCIENTIFIC APPARATUS

FOR PRE-RECORDED CD-ROMS, DVDS, COMPACT DISCS, AND VIDEO DISCS, FEATURING ENTERTAINMENT RELATED TO FILMS, GAMES AND MUSIC; COMPUTER GAME SOFTWARE; COMPUTER GAME SOFTWARE AND MANUALS SOLD AS A UNIT; COMPUTER VIDEO GAME SOFTWARE; COMPUTER VIDEO GAME SOFTWARE AND MANUALS SOLD AS A UNIT; INTERACTIVE VIDEO GAME PROGRAMS; INTERACTIVE COMPUTER GAME PROGRAMS; DOWNLOADABLE COMPUTER GAME SOFTWARE; DOWNLOADABLE INTERACTIVE ENTERTAINMENT SOFTWARE FOR PLAYING COMPUTER GAMES; DOWNLOADABLE INTERACTIVE ENTERTAINMENT SOFTWARE FOR PLAYING VIDEO GAMES (U.S. CLS. 21, 23, 26, 36 AND 38).

FIRST USE 10-0-2005; IN COMMERCE 10-0-2005.

CLASS 41—EDUCATION AND ENTERTAINMENT

FOR ENTERTAINMENT SERVICES PROVIDED ON-LINE BY MEANS OF GLOBAL AND LOCAL AREA NETWORKS, NAMELY, PROVIDING INFORMATION REGARDING INTERACTIVE COMPUTER GAME SOFTWARE, INTERACTIVE VIDEO GAME SOFTWARE AND INTERACTIVE COMPUTER GAMES AND INTERACTIVE VIDEO GAMES, ALL ON-LINE BY MEANS OF GLOBAL AND LOCAL AREA NETWORKS; PROVIDING NEWS AND INFORMATION PROGRAMMING IN THE FIELD OF ENTERTAINMENT RELATING TO INTERACTIVE COMPUTER GAME SOFTWARE AND INTERACTIVE VIDEO GAME SOFTWARE OVER AN ELECTRONIC NETWORK; PROVIDING NEWS PROGRAMMING IN THE FIELD OF ENTERTAINMENT RELATING TO SCIENCE FICTION OVER AN ELECTRONIC NETWORK; FAN CLUB SERVICES; AND PROVIDING INTERACTIVE COMPUTER GAME SOFTWARE OVER AN ELECTRONIC NETWORK (U.S. CLS. 100, 101 AND 107).

FIRST USE 10-0-2005; IN COMMERCE 10-0-2005.

3,681,516. GENERAL ELECTRIC COMPANY, SCHENECTADY, NY. SN 78-668,114. PUB. 10-10-2006, FILED 7-12-2005.

H SYSTEM

THE MARK CONSISTS OF STANDARD CHARACTERS WITHOUT CLAIM TO ANY PARTICULAR FONT, STYLE, SIZE, OR COLOR.

NO CLAIM IS MADE TO THE EXCLUSIVE RIGHT TO USE "SYSTEM", APART FROM THE MARK AS SHOWN.

CLASS 7—MACHINERY

FOR GAS TURBINES AND STEAM TURBINES (U.S. CLS. 13, 19, 21, 23, 31, 34 AND 35).

FIRST USE 6-0-1998; IN COMMERCE 12-0-2000.

CLASS 11—ENVIRONMENTAL CONTROL APPARATUS

FOR STEAM GENERATORS USED AS A PRIMARY COMPONENT FOR COMBINED CYCLE POWER PLANTS PRIMARILY FOR THE UTILITY INDUSTRY (U.S. CLS. 13, 21, 23, 31 AND 34).

FIRST USE 6-0-1998; IN COMMERCE 12-0-2000.

3,681,540. GOLDART INTERNATIONAL INC., NEW YORK, NY. SN 78-723,473. PUB. 10-2-2007, FILED 9-29-2005.

assorties

THE MARK CONSISTS OF STANDARD CHARACTERS WITHOUT CLAIM TO ANY PARTICULAR FONT, STYLE, SIZE, OR COLOR.

OWNER OF U.S. REG. NO. 3,224,238.

CLASS 14—JEWELRY

FOR JEWELRY COMPRISED IN WHOLE OR PART OF PRECIOUS METALS AND THEIR ALLOYS AND GOODS IN PRECIOUS METALS OR COATED THEREWITH, NAMELY, BADGES, BRACELETS, BROOCHES, BUCKLES, BUTTONS, CHAINS, CHARMS, CRESTS, CROSSES, CRUCIFIXES, CUFFLINKS, EARRINGS, LOCKETS, MONEY CLIPS, NECKLACES, PENDANTS, PINS, RINGS, CHARMS OF SAINT CHRISTOPHER, STAR OF DAVID CHARMS, TIE CLIPS, TIE SLIDERS, TIE PINS; PRECIOUS STONES; HOROLOGICAL AND CHRONOMETRIC INSTRUMENTS; CLOCKS, WATCHES AND WATCHES AND WATCHBANDS; KNICKKNACKS MADE IN WHOLE OR PART OF PRECIOUS METALS, NAMELY, BADGES, BEADS, BRACELETS, BROOCHES, BUCKLES, BUTTONS, CHAINS, CHARMS, EARRINGS, NECKLACES, PENDANTS, AND RINGS (U.S. CLS. 2, 27, 28 AND 50).

FIRST USE 1-3-2008; IN COMMERCE 1-3-2008.

CLASS 19—NON-METALLIC BUILDING MATERIALS

FOR ARTIFICIAL STONES, STONES, ARTIFICIAL MARBLE, MARBLE (U.S. CLS. 1, 12, 33 AND 50).

FIRST USE 1-3-2008; IN COMMERCE 1-3-2008.

3,681,544. VAST RESOURCES, INC., CHATSWORTH, CA. SN 78-730,269. PUB. 6-6-2006, FILED 10-10-2005.

69

THE MARK CONSISTS OF STANDARD CHARACTERS WITHOUT CLAIM TO ANY PARTICULAR FONT, STYLE, SIZE, OR COLOR.

CLASS 3—COSMETICS AND CLEANING PREPARATIONS

FOR SKIN AND FACE MOISTURIZERS, NON-MEDICATED CREAMS, TO MAINTAIN MOISTURE OF VAGINAL TISSUES (U.S. CLS. 1, 4, 6, 50, 51 AND 52).

FIRST USE 1-0-2009; IN COMMERCE 1-0-2009.

CLASS 10—MEDICAL APPARATUS

FOR ADULT SEX AIDS, NAMELY, ELECTRIC AND NON-ELECTRIC MASSAGE DEVICES FOR MASSAGING OR VIBRATING PORTIONS OF THE FACE AND BODY; STIMULATION DEVICES FOR AIDING IN AROUSAL AND SEXUAL PERFORMANCE; AND VIBRATORS (U.S. CLS. 26, 39 AND 44).

FIRST USE 1-0-2009; IN COMMERCE 1-0-2009.

3,681,550. E. I. DU PONT DE NEMOURS AND COMPANY, WILMINGTON, DE. SN 78-748,303. PUB. 10-10-2006, FILED 11-7-2005.

SMOOTHTRADE

THE MARK CONSISTS OF STANDARD CHARACTERS WITHOUT CLAIM TO ANY PARTICULAR FONT, STYLE, SIZE, OR COLOR.

CLASS 35—ADVERTISING AND BUSINESS

FOR BUSINESS CONSULTING IN CONNECTION WITH IMPORT AND EXPORT OF AGRICULTURAL GOODS, NAMELY, FRESH FRUITS AND VEGETABLES (U.S. CLS. 100, 101 AND 102).
FIRST USE 3-9-2006; IN COMMERCE 3-9-2006.

CLASS 41—EDUCATION AND ENTERTAINMENT

FOR DEVELOPMENT AND DISSEMINATION OF EDUCATIONAL MATERIALS FOR OTHERS IN THE FIELD OF AGRICULTURE, NAMELY, APPLICATION OF PESTICIDES AND THEIR RESIDUE ON FOODS (U.S. CLS. 100, 101 AND 107).
FIRST USE 3-9-2006; IN COMMERCE 3-9-2006.

CLASS 42—SCIENTIFIC AND COMPUTER SERVICES

FOR PROFESSIONAL CONSULTING SERVICES AND ADVICE ABOUT AGRICULTURAL CHEMISTRY, NAMELY, APPLICATION OF PESTICIDES AND PESTICIDE RESIDUE ON FOODS (U.S. CLS. 100 AND 101).
FIRST USE 3-9-2006; IN COMMERCE 3-9-2006.

3,681,551. MICRO TARGET MEDIA HOLDINGS INC., TORONTO, CANADA. SN 78-748,739. PUB. 11-6-2007, FILED 11-7-2005.

mtm
MICRO TARGET MEDIA

THE MARK CONSISTS OF STANDARD CHARACTERS WITHOUT CLAIM TO ANY PARTICULAR FONT, STYLE, SIZE, OR COLOR.

PRIORITY CLAIMED UNDER SEC. 44(D) ON CANADA APPLICATION NO. 1278746, FILED 11-7-2005, REG. NO. TMA695020, DATED 8-29-2007, EXPIRES 8-29-2022.

CLASS 6—METAL GOODS

FOR NON-LUMINOUS AND NON MECHANICAL METAL SIGNS; METAL HOLDERS FOR SIGNS (U.S. CLS. 2, 12, 13, 14, 23, 25 AND 50).
FIRST USE 11-1-2005; IN COMMERCE 11-1-2005.

CLASS 35—ADVERTISING AND BUSINESS

FOR ADVERTISING AND ADVERTISEMENT BUSINESS MANAGEMENT SERVICES; RENTAL AND LEASING OF ADVERTISING SIGNS, ADVERTISING MATERIALS AND ADVERTISING SPACE TO DISPLAY ADVERTISEMENTS IN OR ON STRUCTURES; RETAIL AND CATALOGUE ORDERING SERVICES FEATURING ADVERTISING MATERIALS AND SIGNAGE (U.S. CLS. 100, 101 AND 102).
FIRST USE 11-1-2005; IN COMMERCE 11-1-2005.

CLASS 40—MATERIAL TREATMENT

FOR PRINTING SERVICES AND PRINTING OF ADVERTISING MATTER (U.S. CLS. 100, 103 AND 106).
FIRST USE 11-1-2005; IN COMMERCE 11-1-2005.

3,681,553. THE OLIVE ORCHARD, INC., CHAGRIN FALLS, OH. SN 78-766,919. PUB. 1-20-2009, FILED 12-5-2005.



CLASS 29—MEATS AND PROCESSED FOODS

FOR BOTTLED OLIVE OIL, OLIVES, TAPENADES (U.S. CL. 46).
FIRST USE 11-0-2004; IN COMMERCE 11-0-2004.

CLASS 35—ADVERTISING AND BUSINESS

FOR ON-LINE AND RETAIL STORE SERVICES FEATURING OLIVES, BOTTLED OLIVE OIL, TAPENADES, DIPPING SPICES, DIPPING PLATES, HAND CREAM, SOAP, BODY LOTION, BATH AND SHOWER GEL, EXFOLIANTS, JEWELRY, AND GREETING CARDS (U.S. CLS. 100, 101 AND 102).
FIRST USE 11-0-2004; IN COMMERCE 11-0-2004.

3,681,576. BIOVIGILANT SYSTEMS, INC., TUCSON, AZ. SN 78-830,546. PUB. 9-25-2007, FILED 3-6-2006.

BIOVIGILANT

THE MARK CONSISTS OF STANDARD CHARACTERS WITHOUT CLAIM TO ANY PARTICULAR FONT, STYLE, SIZE, OR COLOR.

CLASS 9—ELECTRICAL AND SCIENTIFIC APPARATUS

FOR ELECTRICAL AND OPTICAL INSTRUMENTS FOR MONITORING AND TESTING AIR AND WATER FOR AGRICULTURE, CONSUMER, GOVERNMENTAL, MILITARY, HOMELAND SECURITY, RETAIL, TRANSPORTATION, ENTERTAINMENT, FOOD, LODGING, EDUCATION AND HEALTHCARE INDUSTRIES, FOR LABORATORY APPLICATIONS, AND FOR MANUFACTURING APPLICATIONS, NAMELY, PHARMACEUTICAL AND MEDICAL DEVICE MANUFACTURING, FOOD PROCESSING MANUFACTURING, SEMICONDUCTOR MANUFACTURING AND OPTICAL MANUFACTURING (U.S. CLS. 21, 23, 26, 36 AND 38).
FIRST USE 7-7-2008; IN COMMERCE 7-7-2008.

CLASS 41—EDUCATION AND ENTERTAINMENT

FOR PUBLISHING WHITE PAPERS IN THE FIELD OF AIR AND/OR WATER TESTING, ANALYSIS AND MONITORING SYSTEMS (U.S. CLS. 100, 101 AND 107).
FIRST USE 7-7-2008; IN COMMERCE 7-7-2008.

3,681,580. ASSOCIATION OF NATIONAL ADVERTISERS, INC., NEW YORK, NY. SN 78-833,617. PUB. 9-30-2008, FILED 3-9-2006.

THE ADVERTISER

THE MARK CONSISTS OF STANDARD CHARACTERS WITHOUT CLAIM TO ANY PARTICULAR FONT, STYLE, SIZE, OR COLOR.
SEC. 2(F).

CLASS 9—ELECTRICAL AND SCIENTIFIC APPARATUS

FOR DOWNLOADABLE ELECTRONIC PUBLICATIONS IN THE NATURE OF MAGAZINES, NEWSLETTERS AND PERIODICALS IN THE FIELD OF ADVERTISING AND MARKETING (U.S. CLS. 21, 23, 26, 36 AND 38).
FIRST USE 4-10-2008; IN COMMERCE 4-10-2008.

CLASS 16—PAPER GOODS AND PRINTED MATTER

FOR MAGAZINES, NEWSLETTERS AND PERIODICALS IN THE FIELD OF ADVERTISING AND MARKETING (U.S. CLS. 2, 5, 22, 23, 29, 37, 38 AND 50).
FIRST USE 9-1-1991; IN COMMERCE 9-1-1991.

3,681,585. PORTIONPAC CHEMICAL CORPORATION, CHICAGO, IL. SN 78-847,245. PUB. 10-14-2008, FILED 3-27-2006.

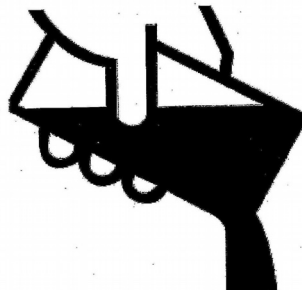

THE MARK CONSISTS OF AN ABSTRACT OF A HAND POURING LIQUID FROM A POUCH.

CLASS 3—COSMETICS AND CLEANING PREPARATIONS

FOR CLEANING PREPARATIONS FOR COMMERCIAL, INSTITUTIONAL AND BUSINESS USE; DEGREASING PREPARATIONS USED IN NON-MANUFACTURING PROCESSES FOR COMMERCIAL, INSTITUTIONAL AND BUSINESS OPERATIONS; LAUNDRY DETERGENTS FOR COMMERCIAL, INSTITUTIONAL AND BUSINESS USE; DISHWASHING DETERGENTS FOR COMMERCIAL, INSTITUTIONAL AND BUSINESS USE (U.S. CLS. 1, 4, 6, 50, 51 AND 52).
FIRST USE 1-1-2006; IN COMMERCE 1-1-2006.

CLASS 5—PHARMACEUTICALS

FOR SANITIZERS AND DEODORIZERS FOR COMMERCIAL, INSTITUTIONAL AND BUSINESS USE; GERMICIDES FOR COMMERCIAL, INSTITUTIONAL AND BUSINESS USE (U.S. CLS. 6, 18, 44, 46, 51 AND 52).
FIRST USE 1-1-2006; IN COMMERCE 1-1-2006.

CLASS 41—EDUCATION AND ENTERTAINMENT

FOR PROVIDING OF TRAINING AND EDUCATION, NAMELY, PROVIDING CLASSES, SEMINARS AND WORKSHOPS IN THE AREA OF DEGREASING, CLEANING AND SANITIZING OF FIXTURES, EQUIPMENT, FACILITIES AND STRUCTURES; AND CONDUCTING EDUCATIONAL CONFERENCES AND PROGRAMS FOR GOVERNMENT ENTITIES IN THE FIELD OF CLEANING AND SANITATION OF FACILITIES (U.S. CLS. 100, 101 AND 107).
FIRST USE 1-1-2006; IN COMMERCE 1-1-2006.

3,681,588. SAN MAR CORPORATION, PRESTON, WA. SN 78-858,252. PUB. 10-24-2006, FILED 4-10-2006.

RED HOUSE

THE MARK CONSISTS OF STANDARD CHARACTERS WITHOUT CLAIM TO ANY PARTICULAR FONT, STYLE, SIZE, OR COLOR.

CLASS 18—LEATHER GOODS

FOR ALL PURPOSE CARRYING BAGS, NAMELY, MESSENGER BAGS, BOOK BAGS, CARRYING CASES, CARRY-ALL BAGS, HANDBAGS, PURSES, SCHOOL BAGS, TOTE-BAGS (U.S. CLS. 1, 2, 3, 22 AND 41).
FIRST USE 1-18-2007; IN COMMERCE 1-18-2007.

3,681,594. VONAGE MARKETING LLC, HOLMDEL, NJ. SN 78-870,810. PUB. 5-15-2007, FILED 4-27-2006.

CLASS 25—CLOTHING

FOR CLOTHING AND ACCESSORIES, NAMELY, BLOUSES, SHIRTS, SPORT SHIRTS, POLO SHIRTS, KNIT SHIRTS, GOLF SHIRTS, WOVEN SHIRTS, WIND SHIRTS, T-SHIRTS, LONG SLEEVE SHIRTS, SWEAT-SHIRTS, SWEATERS, JACKETS, LEATHER JACKETS, PULLOVERS, SPORT COATS, SHAWLS AND STOLEES, SCARVES, UNIFORMS; FLEECE OUTERWEAR, NAMELY, PULLOVERS, SWEAT SHIRTS, LONG SLEEVE SHIRTS, SCARVES (U.S. CLS. 22 AND 39).
FIRST USE 1-4-2007; IN COMMERCE 1-4-2007.



THE MARK CONSISTS OF STYLIZED V WITH DOT.

CLASS 9—ELECTRICAL AND SCIENTIFIC APPARATUS

FOR TELECOMMUNICATIONS AND DATA NETWORKING HARDWARE, NAMELY, DEVICES FOR TRANSPORTING VOICE COMMUNICATIONS VIA A GLOBAL COMMUNICATIONS NETWORK (U.S. CLS. 21, 23, 26, 36 AND 38).
FIRST USE 6-29-2006; IN COMMERCE 6-29-2006.

3,681,590. VISUALIMITS, LLC, HENDERSON, MI. SN 78-861,542. PUB. 5-15-2007, FILED 4-14-2006.

CLASS 38—COMMUNICATION

FOR TELEPHONY COMMUNICATION SERVICES (U.S. CLS. 100, 101 AND 104).
FIRST USE 6-29-2006; IN COMMERCE 6-29-2006.

VISUALIMITS

3,681,604. KNISPO SOLUTIONS, INC., AIRDRIE, CANADA. SN 78-913,209. PUB. 1-20-2009, FILED 6-21-2006.

THE MARK CONSISTS OF STANDARD CHARACTERS WITHOUT CLAIM TO ANY PARTICULAR FONT, STYLE, SIZE, OR COLOR.

KNISPO

CLASS 9—ELECTRICAL AND SCIENTIFIC APPARATUS

FOR ELECTRONIC ADVERTISEMENT AND MESSAGING DISPLAY UNITS (U.S. CLS. 21, 23, 26, 36 AND 38).
FIRST USE 6-15-2006; IN COMMERCE 6-15-2006.

THE MARK CONSISTS OF STANDARD CHARACTERS WITHOUT CLAIM TO ANY PARTICULAR FONT, STYLE, SIZE, OR COLOR.

CLASS 35—ADVERTISING AND BUSINESS

FOR DISSEMINATION OF ADVERTISING FOR OTHERS VIA ELECTRONIC DISPLAYS (U.S. CLS. 100, 101 AND 102).
FIRST USE 6-15-2006; IN COMMERCE 6-15-2006.

PRIORITY CLAIMED UNDER SEC. 44(D) ON CANADA APPLICATION NO. 1284507, FILED 12-23-2005, REG. NO. TMA727683, DATED 11-3-2008, EXPIRES 11-3-2023.

CLASS 41—EDUCATION AND ENTERTAINMENT

FOR PROVIDING INFORMATION IN THE FIELD OF GAMING VIA ELECTRONIC DISPLAYS (U.S. CLS. 100, 101 AND 107).
FIRST USE 6-15-2006; IN COMMERCE 6-15-2006.

CLASS 35—ADVERTISING AND BUSINESS

FOR (BASED ON USE IN COMMERCE) PROVIDING CONSUMER INFORMATION IN THE FIELDS OF HOUSEHOLD PRODUCTS AND HOME CARE VIA COMPUTER NETWORKS AND GLOBAL COMMUNICATION NETWORKS; ADVERTISING AND MARKETING FOR OTHERS; (BASED ON 44(E)) PROVIDING AN ONLINE ELECTRONIC RETAIL BOOKSTORE (U.S. CLS. 100, 101 AND 102).
FIRST USE 7-13-2007; IN COMMERCE 7-13-2007.

CLASS 36—INSURANCE AND FINANCIAL

FOR (BASED ON 44(E)) PROVIDING FINANCE, INVESTMENT, STOCK TRADING, MONEY LENDING AND BANKING RELATED INFORMATION OVER COMPUTER NETWORKS AND GLOBAL COMMUNICATION NETWORKS; PROVIDING FINANCIAL INVESTMENT INFORMATION, AND STOCK AND BOND INFORMATION AND PRICE QUOTATIONS, ALL OVER COMPUTER NETWORKS AND GLOBAL COMMUNICATION NETWORKS; FINANCIAL ANALYSIS OVER COMPUTER NETWORKS AND GLOBAL COMMUNICATION NETWORKS; FINANCIAL NEWS REPORTING SERVICES OVER COMPUTER NETWORKS AND GLOBAL COMMUNICATION NETWORKS (U.S. CLS. 100, 101 AND 102).

CLASS 41—EDUCATION AND ENTERTAINMENT

FOR (BASED ON 44(E)) ENTERTAINMENT SERVICES, NAMELY, PROVIDING ONLINE REVIEWS OF BOOKS PERTAINING TO INVESTING AND SELF IMPROVEMENT (U.S. CLS. 100, 101 AND 107).

3,681,610. ZAYAN FINANCE, LLC., WESTBURY, NY. SN 78-931,722. PUB. 11-13-2007, FILED 7-18-2006.

ZAYAN

THE MARK CONSISTS OF STANDARD CHARACTERS WITHOUT CLAIM TO ANY PARTICULAR FONT, STYLE, SIZE, OR COLOR.

THE FOREIGN WORDING IN THE MARK TRANSLATES INTO ENGLISH AS BEAUTIFUL.

CLASS 35—ADVERTISING AND BUSINESS

FOR PROMOTION OF FINANCIAL AND INSURANCE SERVICES, ON BEHALF OF THIRD PARTIES (U.S. CLS. 100, 101 AND 102).

FIRST USE 10-1-2008; IN COMMERCE 10-1-2008.

CLASS 36—INSURANCE AND FINANCIAL

FOR INSURANCE AGENCY AND BROKERAGE; INSURANCE CONSULTATION; INSURANCE SERVICES, NAMELY, WRITING PROPERTY AND CASUALTY INSURANCE (U.S. CLS. 100, 101 AND 102).

FIRST USE 10-1-2008; IN COMMERCE 10-1-2008.

3,681,612. CHEFWEAR, INC., CHICAGO, IL. SN 78-945,096. PUB. 4-8-2008, FILED 8-4-2006.

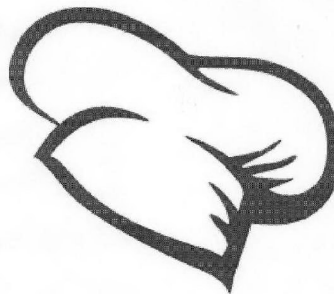

OWNER OF U.S. REG. NO. 2,897,130.

CLASS 25—CLOTHING

FOR CLOTHING FOR RESTAURANT FOOD SERVICE AND FOOD PREPARATION STAFF, NAMELY, T-SHIRTS, SHIRTS, PANTS, TUNICS, APRONS, SHORTS, SHOES, SCARVES (U.S. CLS. 22 AND 39).

FIRST USE 4-0-2006; IN COMMERCE 4-0-2006.

CLASS 35—ADVERTISING AND BUSINESS

FOR MAIL-ORDER CATALOG SERVICES FEATURING CLOTHING FOR FOOD SERVICE AND FOOD PREPARATION STAFF, EXCLUDING HATS (U.S. CLS. 100, 101 AND 102).

FIRST USE 4-0-2006; IN COMMERCE 4-0-2006.

3,681,613. BUCKHORN INVESTORS, LTD., SAN ANTONIO, TX. SN 78-945,218. PUB. 5-6-2008, FILED 8-4-2006.

THE OLDEST SALOON IN TEXAS

THE MARK CONSISTS OF STANDARD CHARACTERS WITHOUT CLAIM TO ANY PARTICULAR FONT, STYLE, SIZE, OR COLOR.

NO CLAIM IS MADE TO THE EXCLUSIVE RIGHT TO USE "TEXAS", APART FROM THE MARK AS SHOWN.

CLASS 21—HOUSEWARES AND GLASS

FOR COASTERS NOT OF PAPER AND NOT BEING TABLE LINEN (U.S. CLS. 2, 13, 23, 29, 30, 33, 40 AND 50).

FIRST USE 3-10-2009; IN COMMERCE 3-10-2009.

CLASS 25—CLOTHING

FOR CLOTHING, NAMELY, SHIRTS (U.S. CLS. 22 AND 39).

FIRST USE 7-23-2009; IN COMMERCE 7-23-2009.

3,681,617. ENTERPRISE ELECTRONICS CORPORATION, ENTERPRISE, AL. SN 78-951,235. PUB. 10-2-2007, FILED 8-14-2006.

SIDPOL

THE MARK CONSISTS OF STANDARD CHARACTERS WITHOUT CLAIM TO ANY PARTICULAR FONT, STYLE, SIZE, OR COLOR.

CLASS 9—ELECTRICAL AND SCIENTIFIC APPARATUS

FOR RADAR SYSTEMS COMPRISED OF A TOWER, RADAR PEDESTAL, RADAR ANTENNA, RADOME, RECEIVER AND TRANSMITTER, FOR THE IDENTIFICATION OF WEATHER TARGETS AND OTHER OBJECTS; COMPUTER HARDWARE AND SOFTWARE FOR THE CONTROL AND OPERATION OF SAID RADAR SYSTEM; SCIENTIFIC AND ELECTRONIC APPARATUSES, NAMELY, RADAR SIGNAL PROCESSORS AND DOPPLER SIGNAL PROCESSORS USED IN A RADAR SYSTEM FOR THE IDENTIFICATION, CLASSIFICATION, AND LOCATION OF WEATHER TARGETS AND OTHER OBJECTS; SCIENTIFIC AND ELECTRONIC APPARATUSES, NAMELY, DIGITAL RECEIVERS AND COMPUTER HARDWARE FOR THE GATHERING AND PROCESSING OF ENVIRONMENTAL WEATHER AND CLIMATOLOGICAL RADAR DATA (U.S. CLS. 21, 23, 26, 36 AND 38).

FIRST USE 8-31-2005; IN COMMERCE 8-31-2005.

CLASS 37—CONSTRUCTION AND REPAIR

FOR INSTALLATION AND REPAIR SERVICES, NAMELY, MAINTENANCE, REPAIR AND INSTALLATION OF CONVENTIONAL AND DOPPLER WEATHER SURVEILLANCE RADAR SYSTEMS (U.S. CLS. 100, 103 AND 106).

FIRST USE 6-22-2009; IN COMMERCE 6-22-2009.

3,681,618. ADVNT BIOTECHNOLOGIES, LLC, PHOENIX, AZ. SN 78-952,160. PUB. 11-4-2008, FILED 8-15-2006.

Pro Strips Rapid Screening System

THE MARK CONSISTS OF STANDARD CHARACTERS WITHOUT CLAIM TO ANY PARTICULAR FONT, STYLE, SIZE, OR COLOR.

NO CLAIM IS MADE TO THE EXCLUSIVE RIGHT TO USE "STRIPS RAPID SCREENING SYSTEM", APART FROM THE MARK AS SHOWN.

CLASS 1—CHEMICALS

FOR ENVIRONMENTAL SAFETY TEST KITS FOR LABORATORY USE COMPRISED OF CHEMICALLY TREATED TEST STRIPS, WHEREIN THE TEST STRIPS ARE TREATED WITH ANOLYTE CATALYSTS AND CATALYTIC AGENTS, AND MULTI-STRIP TEST CARTRIDGES WITH TEST CHANNELS USED FOR THE OF DETECTING AND IDENTIFYING TOXIC, BIOLOGICAL OR ENVIRONMENTAL BIOWARFARE AGENTS; ENVIRONMENTAL SAFETY TESTING DEVICES FOR LABORATORY USE, NAMELY, PORTABLE DETECTION INSTRUMENTS IN THE FORM OF HAND-HELD ASSAYS USING CHEMICALLY TREATED TEST STRIPS, WHEREIN THE TEST STRIPS ARE TREATED WITH ANOLYTE CATALYSTS AND CATALYTIC AGENTS, AND MULTI-TEST STRIP CARTRIDGES WITH TEST CHANNELS USED FOR THE PURPOSE OF DETECTING AND IDENTIFYING TOXIC, BIOLOGICAL AND ENVIRONMENTAL BIOWARFARE AGENTS IN THE FORM OF ANTHRAX, RICIN TOXIN, BOTULINUM TOXIN, Y PESTIS PLAGUE TOXIN, SEB AND OTHER RELATED BIOWARFARE AGENTS (U.S. CLS. 1, 5, 6, 10, 26 AND 46).

FIRST USE 10-1-2006; IN COMMERCE 10-16-2006.

CLASS 9—ELECTRICAL AND SCIENTIFIC APPARATUS

FOR ENVIRONMENTAL SAFETY TEST KITS FOR LABORATORY USE COMPRISED OF NON-CHEMICAL UNTREATED TEST STRIPS, WHEREIN THE STRIPS COMPRISE PAPER OR TEST FABRIC, AND MULTI-STRIP TEST CARTRIDGES WITH TEST CHANNELS USED FOR THE OF DETECTING AND IDENTIFYING TOXIC, BIOLOGICAL OR ENVIRONMENTAL BIOWARFARE AGENTS; ENVIRONMENTAL SAFETY TESTING DEVICES FOR LABORATORY USE, NAMELY, PORTABLE DETECTION INSTRUMENTS IN THE FORM OF HAND-HELD ASSAYS USING NON-CHEMICAL UNTREATED TEST STRIPS, WHEREIN THE STRIPS COMPRISE PAPER OR TEST FABRIC, AND MULTI-TEST STRIP CARTRIDGES WITH TEST CHANNELS USED FOR THE PURPOSE OF DETECTING AND IDENTIFYING TOXIC, BIOLOGICAL AND ENVIRONMENTAL BIOWARFARE AGENTS IN THE FORM OF ANTHRAX, RICIN TOXIN, BOTULINUM TOXIN, Y PESTIS PLAGUE TOXIN, SEB AND OTHER RELATED BIOWARFARE AGENTS (U.S. CLS. 21, 23, 26, 36 AND 38).

FIRST USE 10-1-2006; IN COMMERCE 10-16-2006.

CLASS 10—MEDICAL APPARATUS

FOR MEDICAL DIAGNOSTIC TEST KITS COMPRISED OF NON-CHEMICAL UNTREATED TEST STRIPS, WHEREIN THE STRIPS COMPRISE PAPER OR TEST FABRIC, AND MULTI-STRIP TEST CARTRIDGES WITH TEST CHANNELS FOR DETECTING AND IDENTIFYING THE PRESENCE OF TOXIC OR BIOLOGICAL WARFARE AGENTS WITHIN THE BODY OF A PATIENT; MEDICAL DIAGNOSTIC TESTING DEVICES COMPRISED OF HAND-HELD ASSAYS USING NON-CHEMICAL UNTREATED TEST STRIPS, WHEREIN THE STRIPS COMPRISE PAPER OR TEST FABRIC, AND MULTI-STRIP CARTRIDGES FOR DETECTING AND IDENTIFYING THE PRESENCE OF BIOLOGICAL WARFARE AGENTS WITHIN THE BODY OF A PATIENT, NAMELY, ANTHRAX, RICIN TOXIN, BOTULINUM TOXIN, Y PESTIS PLAGUE TOXIN, SEB AND OTHER RELATED BIOWARFARE AGENTS (U.S. CLS. 26, 39 AND 44).

FIRST USE 10-1-2006; IN COMMERCE 10-16-2006.

3,681,620. ZOOLIFE, INC., ESCONDIDO, CA. SN 78-957,050. PUB. 9-23-2008, FILED 8-21-2006.

PLANKTONIC

THE MARK CONSISTS OF STANDARD CHARACTERS WITHOUT CLAIM TO ANY PARTICULAR FONT, STYLE, SIZE, OR COLOR.

CLASS 5—PHARMACEUTICALS

FOR VETERINARY PREPARATIONS FOR TREATMENT OF SKIN, HAIR, ORAL, GASTROINTESTINAL, SOFT TISSUE, MUCOUS COAT, MUCOUS MEMBRANES, HORN, FEET, BEAK, TEETH, EYES, EARS, NOSE, BONE, ELECTROLYTES, NERVOUS SYSTEM, CARDIOVASCULAR SYSTEM, IMMUNE SYSTEM, UROGENITAL SYSTEM, AND REPRODUCTIVE SYSTEM; PHARMACEUTICAL PREPARATIONS FOR TREATMENT OF SKIN, HAIR, ORAL, GASTROINTESTINAL, SOFT TISSUE, MUCOUS MEMBRANES, TEETH, EYES, EARS, NOSE, BONE, ELECTROLYTES, NERVOUS SYSTEM, CARDIOVASCULAR SYSTEM, IMMUNE SYSTEM, UROGENITAL SYSTEM, AND REPRODUCTIVE SYSTEM; DIETETIC FOODS ADAPTED FOR MEDICAL USE; ANIMAL FEED ADDITIVE FOR USE AS A NUTRITIONAL SUPPLEMENT FOR MEDICAL PURPOSES; FOOD SUPPLEMENTS; DIETARY SUPPLEMENTS; MINERAL SUPPLEMENTS; NUTRITIONAL SUPPLEMENTS; VACCINES; VITAMINS (U.S. CLS. 6, 18, 44, 46, 51 AND 52).

FIRST USE 12-5-2004; IN COMMERCE 12-5-2004.

CLASS 31—NATURAL AGRICULTURAL PRODUCTS

FOR ANIMAL FEED; DRINKS FOR ANIMALS (U.S. CLS. 1 AND 46).

FIRST USE 12-5-2004; IN COMMERCE 12-5-2004.

3,681,628. TECHNOLOGY LIFELINE INC., INDIANAPOLIS, IN. SN 78-972,591. PUB. 5-15-2007, FILED 9-12-2006.

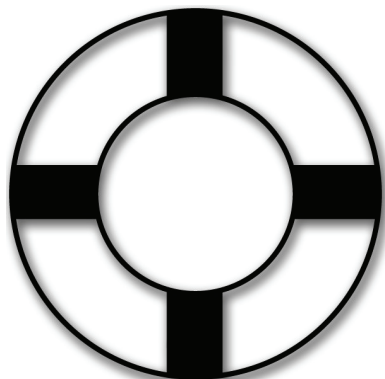

THE MARK CONSISTS OF A CIRCLE OR LIFE PRESERVER.

CLASS 35—ADVERTISING AND BUSINESS

FOR RETAIL SERVICES BY DIRECT SOLICITATION BY SALES AGENTS IN THE FIELD OF COMPUTERS, COMPUTER SOFTWARE AND COMPUTER PARTS (U.S. CLS. 100, 101 AND 102).

FIRST USE 2-6-2008; IN COMMERCE 2-6-2008.

CLASS 37—CONSTRUCTION AND REPAIR

FOR INSTALLATION, MAINTENANCE AND REPAIR OF DATA COMMUNICATIONS SYSTEMS, COMPUTER SYSTEMS AND COMPUTER NETWORKS (U.S. CLS. 100, 103 AND 106).

FIRST USE 2-6-2008; IN COMMERCE 2-6-2008.

CLASS 38—COMMUNICATION

FOR PROVIDING E-MAIL SERVICES (U.S. CLS. 100, 101 AND 104).

FIRST USE 2-6-2008; IN COMMERCE 2-6-2008.

CLASS 42—SCIENTIFIC AND COMPUTER SERVICES

FOR DATA ENCRYPTION SERVICES; MONITORING THE COMPUTER SYSTEMS OF OTHERS FOR TECHNICAL PURPOSES AND PROVIDING BACK-UP COMPUTER PROGRAMS AND FACILITIES; TECHNICAL SUPPORT, NAMELY, PROVIDING BACK-UP COMPUTER PROGRAMS AND FACILITIES; WEB SITE HOSTING SERVICES (U.S. CLS. 100 AND 101).

FIRST USE 2-6-2008; IN COMMERCE 2-6-2008.

3,681,639. UNITED STATES POSTAL SERVICE, WASHINGTON, DC. SN 78-981,178. PUB. 4-17-2007, FILED 7-3-2006.



OWNER OF U.S. REG. NOS. 2,963,878, 3,113,972, AND OTHERS.

NO CLAIM IS MADE TO THE EXCLUSIVE RIGHT TO USE "EST. 1775" AND "OFFICIAL LICENSED PRODUCT", APART FROM THE MARK AS SHOWN.

THE MARK CONSISTS OF WORDING "UNITED STATES POSTAL SERVICE EST. 1775 OFFICIAL LICENSED PRODUCT" AND THE DESIGN OF A STYLIZED STANDING EAGLE WITH OUTSTRETCHED WINGS ON A STAMP-LIKE BACKGROUND.

SEC. 2(F) AS TO THE WORDING "UNITED STATES POSTAL SERVICE" FOR THE GOODS LISTED IN INTERNATIONAL CLASS 16.

CLASS 16—PAPER GOODS AND PRINTED MATTER

FOR STATIONERY, GREETING AND NOTE CARDS, POSTERS, FRAMED PRINTS, UNFRAMED PRINTS, STAMP ART PRINTS (U.S. CLS. 2, 5, 22, 23, 29, 37, 38 AND 50).
FIRST USE 12-0-2007; IN COMMERCE 12-0-2007.

CLASS 25—CLOTHING

FOR SHIRTS, AND T-SHIRTS (U.S. CLS. 22 AND 39).
FIRST USE 3-0-2008; IN COMMERCE 3-0-2008.

CLASS 8—HAND TOOLS

FOR KNIVES (U.S. CLS. 23, 28 AND 44).
FIRST USE 0-0-1995; IN COMMERCE 0-0-1995.

CLASS 16—PAPER GOODS AND PRINTED MATTER

FOR COOKBOOKS (U.S. CLS. 2, 5, 22, 23, 29, 37, 38 AND 50).
FIRST USE 0-0-1988; IN COMMERCE 4-4-2007.

CLASS 21—HOUSEWARES AND GLASS

FOR CAKE TINS; COOKWARE, NAMELY, POTS, PANS, NON-ELECTRIC WOKS, CASSEROLE DISHES, BAKING TRAYS, AU GRATIN DISHES, ROASTING TINS IN THE NATURE OF ROASTING PANS; NON-ELECTRIC KETTLES; TEAPOTS NOT OF PRECIOUS METAL; BAKEWARE; STAINLESS STEEL COOKWARE, NAMELY, CASSEROLE DISHES, STOCK POTS, PANS, SAUCEPANS (U.S. CLS. 2, 13, 23, 29, 30, 33, 40 AND 50).
FIRST USE 0-0-1995; IN COMMERCE 11-18-2005.

CLASS 24—FABRICS

FOR OVEN MITTS, TOWELS (U.S. CLS. 42 AND 50).
FIRST USE 0-0-1993; IN COMMERCE 4-4-2007.

CLASS 25—CLOTHING

FOR APRONS (U.S. CLS. 22 AND 39).
FIRST USE 0-0-1993; IN COMMERCE 2-5-2007.

3,681,640. AGA RANGEMASTER GROUP PLC, WARWICKSHIRE, UNITED KINGDOM. SN 78-981,180. PUB. 12-12-2006, FILED 6-8-2004.



THE MARK CONSISTS OF THE LETTERS "AGA" WITHIN A RECTANGLE WITH FOUR CONCAVE SIDES.

* * * * *

SECTION 2.— INTERNATIONAL CLASSIFICATION

The short titles associated below with the international class numbers are terms designed merely for quick identification and are not an official part of the international classification. The full names of international classes are given in section 6.1 of the trademark rules of practice.

The designation "U.S. Cl." appearing in this section refers to the U.S. class in effect prior to Sep. 1, 1973 rather than the international class which applies to applications filed on or after that date. For adoption of international classification see notice in the OFFICIAL GAZETTE of Jun. 26, 1973 (911 O.G. TM 210).

Application in one class

CLASS 1—CHEMICALS

3,680,216. AGROFRESH INC., PHILADELPHIA, PA. SN 77-135,357. PUB. 9-25-2007, FILED 3-20-2007.

SMARTTAB

THE MARK CONSISTS OF STANDARD CHARACTERS WITHOUT CLAIM TO ANY PARTICULAR FONT, STYLE, SIZE, OR COLOR.

OWNER OF U.S. REG. NO. 2,751,304.

FOR CHEMICALS FOR MAINTAINING THE LIFE, PRESERVING THE FRESHNESS AND REGULATING THE RIPENING PROCESS AND GROWTH OF FRUITS AND VEGETABLES (U.S. CLS. 1, 5, 6, 10, 26 AND 46).

FIRST USE 12-31-2003; IN COMMERCE 7-15-2004.

3,680,257. GENOVIQUE SPECIALTIES HOLDINGS CORPORATION, ROSEMONT, IL. SN 77-158,762. PUB. 4-15-2008, FILED 4-17-2007.

GENOVIQUE SPECIALTIES

THE MARK CONSISTS OF STANDARD CHARACTERS WITHOUT CLAIM TO ANY PARTICULAR FONT, STYLE, SIZE, OR COLOR.

NO CLAIM IS MADE TO THE EXCLUSIVE RIGHT TO USE "SPECIALTIES", APART FROM THE MARK AS SHOWN.

FOR ALDEHYDES AND KETONES; BENZOIC ACID; BENZOPHENONE; BENZYL ALCOHOL; CHEMICALS FOR USE IN INDUSTRY AND SCIENCE; CHEMICAL VEHICLES USED IN THE MANUFACTURE OF PAINTS; PLASTICIZERS; POLYMER COMPOSITIONS USED IN THE MANUFACTURE OF COMMERCIAL AND INDUSTRIAL GOODS; SPECIALTY CHEMICALS, NAMELY, CHEMICAL ADDITIVES FOR GENERAL INDUSTRIAL USE IN THE MANUFACTURE OF A WIDE VARIETY OF GOODS (U.S. CLS. 1, 5, 6, 10, 26 AND 46).

FIRST USE 12-1-2008; IN COMMERCE 12-1-2008.

CLASS 1—(Continued).

3,680,589. ETHOX CHEMICALS, LLC, GREENVILLE, SC. SN 77-339,672. PUB. 9-16-2008, FILED 11-29-2007.

NOXFOAM

THE MARK CONSISTS OF STANDARD CHARACTERS WITHOUT CLAIM TO ANY PARTICULAR FONT, STYLE, SIZE, OR COLOR.

FOR DEFOAMING AGENTS, CHEMICAL ANTI-FOAMING AGENTS FOR USE IN REDUCING AIR OR OTHER GAS ENTRAINMENT IN PAINT, INK, CHEMICAL, AGRICULTURAL AND BIOCHEMICAL FORMULATIONS, AND LOW FOAMING SURFACTANTS FOR USE AS WETTING AGENTS, EMULSIFIERS, OR DISPERSING AGENTS IN PAINT, INK, CHEMICAL, AGRICULTURAL OR BIOCHEMICAL FORMULATIONS (U.S. CLS. 1, 5, 6, 10, 26 AND 46).

FIRST USE 6-0-2008; IN COMMERCE 6-0-2008.

3,680,816. MULTISORB TECHNOLOGIES, INC., BUFFALO, NY. SN 77-442,500. PUB. 10-14-2008, FILED 4-8-2008.

MULTIFORM CSF

THE MARK CONSISTS OF STANDARD CHARACTERS WITHOUT CLAIM TO ANY PARTICULAR FONT, STYLE, SIZE, OR COLOR.

FOR PREFORMED DESICCANTS; CHEMICAL AGENTS FOR SEQUESTRATION OF CARBON DIOXIDE, OXYGEN, WATER VAPOR, AIRBORNE VOLATILE ORGANIC COMPOUNDS, AIRBORNE TOXINS, ODORS, AND OTHER AIR POLLUTANTS, NAMELY, ADSORBENTS, ABSORBENTS, SORBENTS, AND DESORBERS FOR USE IN GENERAL PRODUCT PACKAGING AND SHIPPING, AND IN THE ELECTRONICS AND ELECTRO-OPTICAL, PHARMACEUTICAL, AND NUTRACEUTICAL INDUSTRIES (U.S. CLS. 1, 5, 6, 10, 26 AND 46).

FIRST USE 5-8-2006; IN COMMERCE 5-8-2006.

CLASS 1—(Continued).

3,680,865. CUMMINS INTELLECTUAL PROPERTY, INC., COLUMBUS, IN. SN 77-459,811. PUB. 3-17-2009, FILED 4-28-2008.

ES COMPLEAT

THE MARK CONSISTS OF STANDARD CHARACTERS WITHOUT CLAIM TO ANY PARTICULAR FONT, STYLE, SIZE, OR COLOR.

NO CLAIM IS MADE TO THE EXCLUSIVE RIGHT TO USE "ES", APART FROM THE MARK AS SHOWN.
FOR ANTIFREEZE, COOLANTS, COOLANTS FOR VEHICLE ENGINES (U.S. CLS. 1, 5, 6, 10, 26 AND 46).
FIRST USE 6-16-2009; IN COMMERCE 6-16-2009.

3,680,878. MORTON INTERNATIONAL, INC., CHICAGO, IL. SN 77-464,228. PUB. 9-23-2008, FILED 5-2-2008.

**FOR SOFT WATER NOTHING
WORKS HARDER**

THE MARK CONSISTS OF STANDARD CHARACTERS WITHOUT CLAIM TO ANY PARTICULAR FONT, STYLE, SIZE, OR COLOR.

OWNER OF U.S. REG. NOS. 1,805,673 AND 2,810,805.
SEC. 2(F).
FOR SALT FOR WATER SOFTENING; WATER SOFTENING CHEMICALS; WATER SOFTENING PELLETS; WATER-SOFTENING PREPARATIONS (U.S. CLS. 1, 5, 6, 10, 26 AND 46).
FIRST USE 8-7-1992; IN COMMERCE 8-7-1992.

3,680,987. ANASPEC, INC., SAN JOSE, CA. SN 77-480,713. PUB. 10-21-2008, FILED 5-21-2008.

Z-Fish

THE MARK CONSISTS OF STANDARD CHARACTERS WITHOUT CLAIM TO ANY PARTICULAR FONT, STYLE, SIZE, OR COLOR.

FOR BIOCHEMICALS, NAMELY, MONOCLONAL ANTIBODIES FOR IN VITRO SCIENTIFIC OR RESEARCH USE; DIAGNOSTIC KITS CONSISTING PRIMARILY OF MONOCLONAL ANTIBODIES, BUFFERS, AND REAGENTS TO MONITOR TOXICITY OF DRUGS; LABORATORY CHEMICALS, NAMELY, AN ANTIBODY REAGENT USED FOR THE DETECTION OF ANTIGENS IN CELL AND TISSUE ANALYSIS FOR IN VITRO DIAGNOSTIC USE (U.S. CLS. 1, 5, 6, 10, 26 AND 46).
FIRST USE 5-1-2009; IN COMMERCE 5-1-2009.

CLASS 1—(Continued).

3,681,161. DELTA CARBONA, L.P., FAIRFIELD, NJ. SN 77-533,886. PUB. 3-31-2009, FILED 7-29-2008.

COLOR GRABBER

THE MARK CONSISTS OF STANDARD CHARACTERS WITHOUT CLAIM TO ANY PARTICULAR FONT, STYLE, SIZE, OR COLOR.

OWNER OF U.S. REG. NO. 2,997,580.
NO CLAIM IS MADE TO THE EXCLUSIVE RIGHT TO USE "COLOR", APART FROM THE MARK AS SHOWN.
FOR LAUNDRY PRODUCTS, NAMELY, CHEMICALLY TREATED FABRIC CLOTHS AND DISPOSABLE SHEETS WHICH ABSORB EXCESS DYE, COLOR AND IMPURITIES FROM THE WASH CYCLE (U.S. CLS. 1, 5, 6, 10, 26 AND 46).
FIRST USE 4-1-2009; IN COMMERCE 4-1-2009.

3,681,200. SACHEM, INC., AUSTIN, TX. SN 77-549,375. PUB. 1-13-2009, FILED 8-18-2008.

AVANTA AC

THE MARK CONSISTS OF STANDARD CHARACTERS WITHOUT CLAIM TO ANY PARTICULAR FONT, STYLE, SIZE, OR COLOR.

FOR CHEMICALS FOR USE IN INDUSTRY AND SCIENCE, NAMELY, CHEMICALS FOR USE IN PREPARATION OF ADVANCED CERAMICS MATERIALS (U.S. CLS. 1, 5, 6, 10, 26 AND 46).
FIRST USE 8-15-2008; IN COMMERCE 8-15-2005.

3,681,201. SACHEM, INC., AUSTIN, TX. SN 77-549,391. PUB. 1-13-2009, FILED 8-18-2008.

ENVURE

THE MARK CONSISTS OF STANDARD CHARACTERS WITHOUT CLAIM TO ANY PARTICULAR FONT, STYLE, SIZE, OR COLOR.

FOR CHEMICALS FOR USE IN INDUSTRY AND SCIENCE, NAMELY, HIGH PURITY STRONG ORGANIC BASES (U.S. CLS. 1, 5, 6, 10, 26 AND 46).
FIRST USE 4-17-2006; IN COMMERCE 4-17-2006.

CLASS 1—(Continued).

3,681,203. SACHEM, INC., AUSTIN, TX. SN 77-549,414. PUB. 1-13-2009, FILED 8-18-2008.

EXPELL

THE MARK CONSISTS OF STANDARD CHARACTERS WITHOUT CLAIM TO ANY PARTICULAR FONT, STYLE, SIZE, OR COLOR.

FOR CHEMICALS FOR USE IN INDUSTRY AND SCIENCE, NAMELY, CHEMICALS FOR USE IN DISPLACEMENT CHROMATOGRAPHY, NAMELY, CATION, ANION, HIC AND REVERSE PHASE DISPLACER COMPOUNDS (U.S. CLS. 1, 5, 6, 10, 26 AND 46).

FIRST USE 10-22-2007; IN COMMERCE 10-22-2007.

CLASS 1—(Continued).

3,681,598. NAVINTA LLC, EWING, NJ. SN 78-885,870. PUB. 9-18-2007, FILED 5-17-2006.

NAVINTA

THE MARK CONSISTS OF STANDARD CHARACTERS WITHOUT CLAIM TO ANY PARTICULAR FONT, STYLE, SIZE, OR COLOR.

FOR CHEMICALS, NAMELY, PRECURSORS AND ADDITIVES ALL FOR USE IN THE MANUFACTURE OF PHARMACEUTICALS (U.S. CLS. 1, 5, 6, 10, 26 AND 46).

FIRST USE 6-9-2009; IN COMMERCE 6-9-2009.

3,681,321. SURFATECH CORPORATION, DACULA, GA. SN 77-592,784. PUB. 3-17-2009, FILED 10-14-2008.

HIGH DEFINITION POLYMERS

THE MARK CONSISTS OF STANDARD CHARACTERS WITHOUT CLAIM TO ANY PARTICULAR FONT, STYLE, SIZE, OR COLOR.

NO CLAIM IS MADE TO THE EXCLUSIVE RIGHT TO USE "POLYMERS", APART FROM THE MARK AS SHOWN. FOR CHEMICAL ADDITIVES FOR USE IN THE MANUFACTURE OF PERSONAL CARE PRODUCTS (U.S. CLS. 1, 5, 6, 10, 26 AND 46).

FIRST USE 4-12-2009; IN COMMERCE 4-12-2009.

3,681,637. NANOSTATICS, LLC, CIRCLEVILLE, OH. SN 78-981,157. PUB. 4-3-2007, FILED 2-1-2006.

NANOSTATICS

THE MARK CONSISTS OF STANDARD CHARACTERS WITHOUT CLAIM TO ANY PARTICULAR FONT, STYLE, SIZE, OR COLOR.

FOR POLYMERIC FIBER COMPOSITIONS OF SUB-MICRON SIZE FOR USE IN MODIFYING SURFACE FUNCTIONALITY (U.S. CLS. 1, 5, 6, 10, 26 AND 46).

FIRST USE 7-18-2008; IN COMMERCE 7-18-2008.

3,681,506. ADHESIVE TECHNOLOGIES, INC., HAMPTON, NH. SN 78-657,908. PUB. 10-16-2007, FILED 6-24-2005.

ADHESIVE TECH

THE MARK CONSISTS OF STANDARD CHARACTERS WITHOUT CLAIM TO ANY PARTICULAR FONT, STYLE, SIZE, OR COLOR.

OWNER OF U.S. REG. NO. 2,719,700.

NO CLAIM IS MADE TO THE EXCLUSIVE RIGHT TO USE "ADHESIVE", APART FROM THE MARK AS SHOWN.

FOR GLUE STICKS AND ALL PURPOSE ADHESIVES FOR GENERAL BONDING AND REPAIR PURPOSES (U.S. CLS. 1, 5, 6, 10, 26 AND 46).

FIRST USE 6-0-1999; IN COMMERCE 6-0-1999.

CLASS 2—PAINTS

3,680,283. SUN CHEMICAL CORPORATION, PARSIPPANY, NJ. SN 77-173,082. PUB. 9-18-2007, FILED 5-4-2007.

SUNMETALLICS

THE MARK CONSISTS OF STANDARD CHARACTERS WITHOUT CLAIM TO ANY PARTICULAR FONT, STYLE, SIZE, OR COLOR.

FOR METALLIC PIGMENTS (U.S. CLS. 6, 11 AND 16).

FIRST USE 11-16-2007; IN COMMERCE 6-3-2008.

CLASS 2—(Continued).

3,680,396. KAMCRETE, LLC, MESA, AZ. SN 77-260,509. PUB. 2-26-2008, FILED 8-21-2007.

INSTA DRIVE

THE MARK CONSISTS OF STANDARD CHARACTERS WITHOUT CLAIM TO ANY PARTICULAR FONT, STYLE, SIZE, OR COLOR.

FOR COATINGS IN THE NATURE OF DECORATIVE SPRAY COATING AND DECORATIVE FINISH FOR PATIOS, DRIVEWAYS, GARAGE FLOORS AND OUTDOOR FLOORINGS; CONCRETE MOISTURE BARRIER COATING; PAINT FOR CONCRETE FLOORS (U.S. CLS. 6, 11 AND 16).

FIRST USE 1-4-2008; IN COMMERCE 1-4-2008.

CLASS 2—(Continued).

3,680,596. SAWGRASS TECHNOLOGIES, INC., MOUNT PLEASANT, SC. SN 77-343,265. PUB. 5-6-2008, FILED 12-4-2007.

Ink. Differently.

THE MARK CONSISTS OF STANDARD CHARACTERS WITHOUT CLAIM TO ANY PARTICULAR FONT, STYLE, SIZE, OR COLOR.

NO CLAIM IS MADE TO THE EXCLUSIVE RIGHT TO USE "INK", APART FROM THE MARK AS SHOWN.

FOR INK CARTRIDGES FOR PRINTERS; INK JET CARTRIDGES; INK JET PRINTER INK; PRINTING INK; PRINTING INKS; PRINTING INKS, COATINGS, PIGMENTS AND DISPERSIONS FOR USE IN THE GRAPHIC ARTS INDUSTRY (U.S. CLS. 6, 11 AND 16).

FIRST USE 5-12-2008; IN COMMERCE 5-12-2008.

3,681,122. BECKER-UNDERWOOD, INC., AMES, IA. SN 77-521,705. PUB. 12-23-2008, FILED 7-14-2008.

IMPACT

THE MARK CONSISTS OF STANDARD CHARACTERS WITHOUT CLAIM TO ANY PARTICULAR FONT, STYLE, SIZE, OR COLOR.

FOR COLORANT FOR MULCH (U.S. CLS. 6, 11 AND 16).

FIRST USE 7-28-2008; IN COMMERCE 7-30-2008.

3,680,412. FÁBRICA DE ARTEFATOS DE LÁTEX ESTRELA - EPRISTINTA LTDA., GOIANA, SÃO ROQUE, BRAZIL. SN 77-279,716. PUB. 9-30-2008, FILED 9-14-2007.



THE MARK CONSISTS OF THE WORD "EPRISTINTA" WITH A SEGMENTED SEMI CIRCLE OVER THE WORD. "EPRISTINTA" HAS NO MEANING IN A FOREIGN LANGUAGE. THE PORTUGUESE WORD "TINTA" MEANS "PAINT" IN ENGLISH.

FOR PAINTS, VARNISHES, LACQUERS; RUST PRESERVATIVES IN THE NATURE OF A COATING; WOOD PRESERVATIVES; COLORANTS, PAINTS AND DYES FOR GENERAL INDUSTRIAL USE; RAW NATURAL RESINS FOR USE IN THE MANUFACTURE OF RESINS AND FOR GENERAL INDUSTRIAL USE; METALS IN FOIL AND POWDER FORM FOR PAINTERS, DECORATORS, PRINTERS AND ARTISTS (U.S. CLS. 6, 11 AND 16).

FIRST USE 1-23-2007; IN COMMERCE 1-23-2007.

3,681,373. HOWARD GROTE & SONS, INC., MCFARLAND, WI. SN 77-611,594. PUB. 3-31-2009, FILED 11-11-2008.

BLADESKIN

THE MARK CONSISTS OF STANDARD CHARACTERS WITHOUT CLAIM TO ANY PARTICULAR FONT, STYLE, SIZE, OR COLOR.

FOR COATINGS IN THE NATURE OF STRENGTHENING SPRAY-ON SURFACE FILMS FOR PROTECTING SURFACES FROM WEATHERING, WEAR, AND MOISTURE; PROTECTIVE COATINGS FOR WINDMILL AND WIND TURBINE BLADES (U.S. CLS. 6, 11 AND 16).

FIRST USE 7-1-2009; IN COMMERCE 7-1-2009.

CLASS 3—COSMETICS AND CLEANING PREPARATIONS

3,680,072. PREMIER DENTAL PRODUCTS COMPANY, PLYMOUTH MEETING, PA. SN 76-436,349. PUB. 10-14-2008, FILED 7-31-2002.

Bravo 

FOR KIT CONSISTING OF PRIMARILY OF TOOTH WHITENING GEL BUT ALSO CONTAINING TRAY MATERIALS, TRAY CASES, SYRINGES, AND A COSMETIC BAG, SOLD AS A UNIT (U.S. CLS. 1, 4, 6, 50, 51 AND 52).

FIRST USE 9-0-2002; IN COMMERCE 9-0-2002.

3,680,090. JOHNSON & JOHNSON, NEW BRUNSWICK, NJ. SN 76-658,323. PUB. 5-8-2007, FILED 4-12-2006.

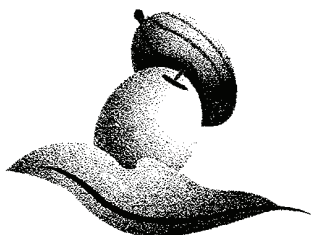

THE MARK CONSISTS OF A SHEA NUT, COCOA BEAN AND A LEAF. THE MARK IS NOT IN COLOR.

FOR SKIN CLEANSERS AND BATH WASH, SKIN MOISTURIZERS, BODY LOTIONS, AND SKIN CREAMS (U.S. CLS. 1, 4, 6, 50, 51 AND 52).

FIRST USE 7-15-2008; IN COMMERCE 7-15-2008.

3,680,123. SHIN'S TRADING CO., INC., LOS ANGELES, CA. SN 76-687,887. PUB. 8-5-2008, FILED 3-19-2008.

LITTLE MISS NAILS

THE MARK CONSISTS OF STANDARD CHARACTERS WITHOUT CLAIM TO ANY PARTICULAR FONT, STYLE, SIZE, OR COLOR.

NO CLAIM IS MADE TO THE EXCLUSIVE RIGHT TO USE "NAILS", APART FROM THE MARK AS SHOWN.

THE NAME "MISS NAILS" DOES NOT IDENTIFY A LIVING INDIVIDUAL.

FOR ARTIFICIAL NAILS (U.S. CLS. 1, 4, 6, 50, 51 AND 52).

FIRST USE 5-1-2009; IN COMMERCE 5-1-2009.

CLASS 3—(Continued).

3,680,129. LIPO CHEMICALS, INC., PATERSON, NJ. SN 76-688,999. PUB. 9-23-2008, FILED 4-25-2008.

LIPOBUTTER

THE MARK CONSISTS OF STANDARD CHARACTERS WITHOUT CLAIM TO ANY PARTICULAR FONT, STYLE, SIZE, OR COLOR.

FOR SKIN CARE PRODUCTS, NAMELY, MOISTURIZING PRODUCTS, SKIN SOFTENING EMOLLIENTS, ANTI-AGING PRODUCTS, SKIN CREAM, HAND CREAM AND FACIAL CREAM; HAIR TREATMENT PRODUCTS, NAMELY, HAIR CONDITIONERS AND CREAMS FOR HAIR (U.S. CLS. 1, 4, 6, 50, 51 AND 52).

FIRST USE 1-0-2009; IN COMMERCE 1-0-2009.

3,680,150. PPG INDUSTRIES OHIO, INC., CLEVELAND, OH. SN 77-014,898. PUB. 5-15-2007, FILED 10-5-2006.

SPECTRACLEAN

THE MARK CONSISTS OF STANDARD CHARACTERS WITHOUT CLAIM TO ANY PARTICULAR FONT, STYLE, SIZE, OR COLOR.

FOR PAINT REMOVING, PAINT PURGING AND PAINT CLEANING PREPARATIONS FOR USE IN INDUSTRIAL PAINTING AND MANUFACTURING FACILITIES (U.S. CLS. 1, 4, 6, 50, 51 AND 52).

FIRST USE 10-4-2006; IN COMMERCE 10-4-2006.

3,680,226. KERDOON, DAVID, LOS ANGELES, CA. SN 77-143,116. PUB. 10-2-2007, FILED 3-28-2007.

ENLIGHTEN YOUR SKIN

THE MARK CONSISTS OF STANDARD CHARACTERS WITHOUT CLAIM TO ANY PARTICULAR FONT, STYLE, SIZE, OR COLOR.

FOR TEA BASED SKIN CLEANSERS; NON-MEDICATED FOAMING BATH PREPARATIONS; FACIAL MASKS; BODY WASH AND BODY SOAP; BODY SCRUBS; SKIN MOISTURIZERS; SKIN CREAMS AND SKIN LOTIONS; ANTI-WRINKLE CREAMS; BODY OIL; NON-MEDICATED SKIN CLEANSING WIPES AND PADS; SKIN TONERS; NON-MEDICATED BATH TREATMENT PREPARATIONS TO SOOTHE AND RELIEVE IRRITATED SKIN; SHAVING GELS; LIP BALMS; AND SUNSCREEN PREPARATIONS; NON-MEDICATED ACNE SOAP (U.S. CLS. 1, 4, 6, 50, 51 AND 52).

FIRST USE 5-30-2009; IN COMMERCE 5-30-2009.

CLASS 3—(Continued).

3,680,247. SEQUENCE, INC., ENGLEWOOD, NJ. SN 77-155,230. PUB. 10-9-2007, FILED 4-12-2007.

CLASS 3—(Continued).

3,680,308. SAKURA PROPERTIES, LLC, SALEM, UT. SN 77-184,584. PUB. 9-16-2008, FILED 5-18-2007.

SISEL SAFE

NATURAL STRENGTH

THE MARK CONSISTS OF STANDARD CHARACTERS WITHOUT CLAIM TO ANY PARTICULAR FONT, STYLE, SIZE, OR COLOR.

FOR HAIR CARE PRODUCTS, NAMELY, NON-MEDICATED SHAMPOO, CONDITIONERS, HAIRSPRAY, VOLUMIZING SPRAY, FINISHING SPRAY, FORMING SPRAY, TEXTURIZERS, HAIR RELAXERS, HAIR STYLING GELS, HAIR THICKENERS AND TEXTURIZERS, MOUSSE, HAIR COLORING PREPARATIONS, HAIR PERMING PREPARATIONS, LEAVE-IN CONDITIONERS AND HAIR BUILD-UP REMOVERS (U.S. CLS. 1, 4, 6, 50, 51 AND 52).
FIRST USE 5-29-2009; IN COMMERCE 5-29-2009.

THE MARK CONSISTS OF STANDARD CHARACTERS WITHOUT CLAIM TO ANY PARTICULAR FONT, STYLE, SIZE, OR COLOR.

FOR BODY CARE, HAIR CARE AND SKIN CARE PREPARATIONS, NAMELY, HAIR AND SKIN LOTIONS, CREAMS, GELS, CLEANSERS, SHAMPOOS, CONDITIONERS, SOAPS, DEODORANTS, BODY OILS; HAIR OILS; SEAWEED-BASED BODY, HAIR AND SKIN CARE PREPARATIONS, NAMELY, BODY, HAIR AND SKIN LOTIONS, CREAMS, GELS, CLEANSERS, SHAMPOOS, CONDITIONERS, SOAPS, DEODORANTS, OILS; PREPARATIONS INTENDED TO PROMOTE HEALING, REGENERATION, ANTI-AGING AND STEM CELL ACTIVATION, AND TO REDUCE DRYNESS AND SLOW DOWN AGING AND DEGENERATIVE CONDITIONS FOR THE SKIN AND HAIR, NAMELY, BODY, HAIR AND SKIN LOTIONS, CREAMS, GELS, CLEANSERS, SHAMPOOS, CONDITIONERS, SOAPS, DEODORANTS AND OILS (U.S. CLS. 1, 4, 6, 50, 51 AND 52).
FIRST USE 6-30-2007; IN COMMERCE 6-30-2007.

3,680,318. TUPPERWARE PRODUCTS S.A., FRIBOURG, SWITZERLAND. SN 77-187,478. PUB. 10-7-2008, FILED 5-22-2007.

DAILY STYLE

3,680,251. FREDERIC MALLE CONSULTANTS, 75001 PARIS, FRANCE. SN 77-156,784. PUB. 4-8-2008, FILED 4-13-2007.

THE MARK CONSISTS OF STANDARD CHARACTERS WITHOUT CLAIM TO ANY PARTICULAR FONT, STYLE, SIZE, OR COLOR.

NO CLAIM IS MADE TO THE EXCLUSIVE RIGHT TO USE "STYLE", APART FROM THE MARK AS SHOWN.
FOR HAIR CARE PRODUCTS, NAMELY, SHAMPOO AND CONDITIONER (U.S. CLS. 1, 4, 6, 50, 51 AND 52).
FIRST USE 5-21-2009; IN COMMERCE 5-21-2009.

OUTRAGEOUS

3,680,321. TUPPERWARE PRODUCTS S.A., FRIBOURG, SWITZERLAND. SN 77-187,902. PUB. 10-14-2008, FILED 5-23-2007.

THE MARK CONSISTS OF STANDARD CHARACTERS WITHOUT CLAIM TO ANY PARTICULAR FONT, STYLE, SIZE, OR COLOR.

FOR PERFUMERY, NAMELY, PERFUMES (U.S. CLS. 1, 4, 6, 50, 51 AND 52).
FIRST USE 9-15-2007; IN COMMERCE 9-15-2007.

GLAMOUR LILAC

THE MARK CONSISTS OF STANDARD CHARACTERS WITHOUT CLAIM TO ANY PARTICULAR FONT, STYLE,

CLASS 3—(Continued).

SIZE, OR COLOR.

NO CLAIM IS MADE TO THE EXCLUSIVE RIGHT TO USE "LILAC", APART FROM THE MARK AS SHOWN.

FOR PERFUMES; EAU DE COLOGNE; FRAGRANCES FOR PERSONAL USE; NON-MEDICATED LOTIONS FOR FACE AND BODY (U.S. CLS. 1, 4, 6, 50, 51 AND 52).

FIRST USE 6-14-2008; IN COMMERCE 6-14-2008.

CLASS 3—(Continued).

3,680,324. TUPPERWARE PRODUCTS S.A., FRIBOURG, SWITZERLAND. SN 77-188,005. PUB. 11-13-2007, FILED 5-23-2007.

WHITE RESULT

THE MARK CONSISTS OF STANDARD CHARACTERS WITHOUT CLAIM TO ANY PARTICULAR FONT, STYLE, SIZE, OR COLOR.

FOR NON-MEDICATED CREAMS FOR THE CARE OF THE SKIN (U.S. CLS. 1, 4, 6, 50, 51 AND 52).

FIRST USE 6-14-2008; IN COMMERCE 6-14-2008.

3,680,322. TUPPERWARE PRODUCTS S.A., FRIBOURG, SWITZERLAND. SN 77-187,908. PUB. 11-13-2007, FILED 5-23-2007.

INSPIRATION ANGEL

THE MARK CONSISTS OF STANDARD CHARACTERS WITHOUT CLAIM TO ANY PARTICULAR FONT, STYLE, SIZE, OR COLOR.

FOR PERFUMES; EAU DE COLOGNE; FRAGRANCES FOR PERSONAL USE; DEODORANTS AND ANTIPERSPIRANTS FOR PERSONAL USE; NON-MEDICATED LOTIONS FOR FACE AND BODY (U.S. CLS. 1, 4, 6, 50, 51 AND 52).

FIRST USE 6-14-2008; IN COMMERCE 6-14-2008.

3,680,375. SUM-BO-SHINE, WOODSTOCK, GA. AND SUM-BO-SHINE, INC., WOODSTOCK, GA. SN 77-231,047. PUB. 7-1-2008, FILED S.R. 7-17-2007; AM. P.R. 3-7-2008.

"I'm HAPPY here!"

THE MARK CONSISTS OF STANDARD CHARACTERS WITHOUT CLAIM TO ANY PARTICULAR FONT, STYLE, SIZE, OR COLOR.

FOR BODY AND BEAUTY CARE COSMETICS; BABY LOTION; BABY OIL; BABY POWDER; BABY SHAMPOO (U.S. CLS. 1, 4, 6, 50, 51 AND 52).

FIRST USE 10-1-2005; IN COMMERCE 10-1-2005.

3,680,323. TUPPERWARE PRODUCTS S.A., FRIBOURG, SWITZERLAND. SN 77-187,921. PUB. 11-13-2007, FILED 5-23-2007.

3,680,394. FORD, THOMAS, C., AUSTIN, TX. SN 77-254,683. PUB. 12-30-2008, FILED 8-14-2007.

LIKE U

THE MARK CONSISTS OF STANDARD CHARACTERS WITHOUT CLAIM TO ANY PARTICULAR FONT, STYLE, SIZE, OR COLOR.

FOR PERFUMES; EAU DE COLOGNE; FRAGRANCES FOR PERSONAL USE; DEODORANTS AND ANTIPERSPIRANTS FOR PERSONAL USE; NON-MEDICATED LOTIONS FOR FACE AND BODY (U.S. CLS. 1, 4, 6, 50, 51 AND 52).

FIRST USE 6-14-2008; IN COMMERCE 6-14-2008.



OWNER OF U.S. REG. NOS. 3,076,975, 3,127,260, AND 3,229,399.

NO CLAIM IS MADE TO THE EXCLUSIVE RIGHT TO USE "WHITE PATCHOULI", APART FROM THE MARK AS SHOWN.

CLASS 3—(Continued).

THE NAME "TOM FORD" IDENTIFIES A PARTICULAR LIVING INDIVIDUAL WHOSE CONSENT IS OF RECORD.

THE COLOR(S) WHITE AND GOLD IS/ARE CLAIMED AS A FEATURE OF THE MARK.

THE MARK CONSISTS OF A CONFIGURATION OF A WHITE BOTTLE WITH AN ELONGATED WHITE CAP, WITH LINES AND RIDGES APPEARING VERTICALLY FROM THE TOP TO THE BOTTOM OF THE CAP AND FROM BELOW THE NECK TO THE BASE OF THE BOTTLE. THE COLOR GOLD APPEARS IN THE THREE CORDS WRAPPED AROUND THE NECK OF THE BOTTLE AND IN THE PLAQUE CONTAINING THE LETTERS "TF", WHICH ALSO APPEAR IN GOLD ENGRAVED LETTERING BUT ARE OUTLINED IN BLACK IN THE DRAWING TO SHOW THEY EXIST, AND IN THE GOLD DRAWSTRING AFFIXED TO THE NECK OF THE BOTTLE. A GOLD RECTANGULAR SHAPED PLAQUE WITH THE WORDS "TOM FORD WHITE PATCHOULI", ALSO IN GOLD ENGRAVED LETTERING BUT ARE OUTLINED IN BLACK IN THE DRAWING TO SHOW THEY EXIST, APPEARS ABOVE THE BASE OF THE BOTTLE. THE BLACK LINES APPEARING IN THE DRAWING ARE THERE ONLY TO GIVE DEPTH TO THE RIDGES OF THE BOTTLE AND BLACK IS NOT CLAIMED AS A COLORED FEATURE OF THE BOTTLE.

FOR FRAGRANCES FOR PERSONAL USE (U.S. CLS. 1, 4, 6, 50, 51 AND 52).

FIRST USE 9-1-2008; IN COMMERCE 9-1-2008.

3,680,426. ATTIQ MARVIN J., SAN DIEGO, CA. SN 77-288,835. PUB. 8-26-2008, FILED 9-25-2007.

BARBER SIDE

THE MARK CONSISTS OF STANDARD CHARACTERS WITHOUT CLAIM TO ANY PARTICULAR FONT, STYLE, SIZE, OR COLOR.

NO CLAIM IS MADE TO THE EXCLUSIVE RIGHT TO USE "BARBER", APART FROM THE MARK AS SHOWN.

FOR HAIR POMADES (U.S. CLS. 1, 4, 6, 50, 51 AND 52).

FIRST USE 12-1-2008; IN COMMERCE 12-1-2008.

3,680,492. PARFUMS DE COEUR, LTD., DARIEN, CT. SN 77-315,682. PUB. 4-8-2008, FILED 10-29-2007.

CELEBRITY IMPOSTERS

THE MARK CONSISTS OF STANDARD CHARACTERS WITHOUT CLAIM TO ANY PARTICULAR FONT, STYLE, SIZE, OR COLOR.

OWNER OF U.S. REG. NO. 1,678,197.

FOR WOMEN'S AND MEN'S FRAGRANCES, NAMELY, PERFUME, COLOGNE, EAU DE TOILETTE, AFTERSHAVE, SCENTED BODY SPRAYS AND PERSONAL DEODORANTS; SHOWER GELS; BODY LOTIONS; BODY POWDERS; SOAPS (U.S. CLS. 1, 4, 6, 50, 51 AND 52).

FIRST USE 8-0-2008; IN COMMERCE 8-0-2008.

CLASS 3—(Continued).

3,680,568. BHALLA, FRANCE J., CAMARILLO, CA. SN 77-335,726. PUB. 4-29-2008, FILED 11-21-2007.

GANIQUE

THE MARK CONSISTS OF STANDARD CHARACTERS WITHOUT CLAIM TO ANY PARTICULAR FONT, STYLE, SIZE, OR COLOR.

FOR SKIN MOISTURIZERS; SKIN LOTION; SKIN CREAMS; SKIN CLEANSERS; SKIN CLEANSING CREAM; SKIN CLEANSING LOTION; COSMETIC CREAMS FOR SKIN CARE; COSMETIC PREPARATIONS FOR SKIN RENEWAL; LOTIONS FOR SKIN; NON-MEDICATED SKIN CREAMS; SKIN CONDITIONERS; SKIN CARE PREPARATIONS; NAMELY, FRUIT ACID PEELS FOR SKIN; SKIN ABRASIVE PREPARATIONS; AND SKIN SCRUBS AND MASKS (U.S. CLS. 1, 4, 6, 50, 51 AND 52).

FIRST USE 3-31-2009; IN COMMERCE 3-31-2009.

3,680,577. MENARD, INC., EAU CLAIRE, WI. SN 77-337,013. PUB. 4-8-2008, FILED 11-26-2007.

RESOLUTION

THE MARK CONSISTS OF STANDARD CHARACTERS WITHOUT CLAIM TO ANY PARTICULAR FONT, STYLE, SIZE, OR COLOR.

FOR ALL-PURPOSE CLEANING PREPARATIONS FOR HOUSEHOLD AND INDUSTRIAL USE, CARPET CLEANING PREPARATIONS, FABRIC SOFTENERS FOR LAUNDRY USE, GLASS CLEANING PREPARATIONS, LAUNDRY DETERGENT, LAUNDRY SOAP, SOAPS FOR HOUSEHOLD USE (U.S. CLS. 1, 4, 6, 50, 51 AND 52).

FIRST USE 4-0-2008; IN COMMERCE 4-0-2008.

3,680,594. UNILEVER SUPPLY CHAIN, INC., CLINTON, CT. SN 77-342,444. PUB. 5-6-2008, FILED 12-3-2007.

EVENLY GORGEOUS

THE MARK CONSISTS OF STANDARD CHARACTERS WITHOUT CLAIM TO ANY PARTICULAR FONT, STYLE, SIZE, OR COLOR.

FOR BODY WASHES; BATH SOAPS (U.S. CLS. 1, 4, 6, 50, 51 AND 52).

FIRST USE 3-0-2009; IN COMMERCE 3-0-2009.

CLASS 3—(Continued).

3,680,598. BABCOCK & WILCOX TECHNICAL SERVICES Y-12, LLC, OAK RIDGE, TN. SN 77-343,681. PUB. 5-6-2008, FILED 12-4-2007.

SIMWYPES

THE MARK CONSISTS OF THE LETTERS "SIMWYPES", WHERE THE LETTER "Y" APPEARS AS A SUBSCRIPT IN RELATION TO THE REST OF THE LETTERS.

FOR CHEMICALLY IMPREGNATED CLOTHS FOR DUSTING AND CLEANING (U.S. CLS. 1, 4, 6, 50, 51 AND 52).

FIRST USE 2-14-2008; IN COMMERCE 10-16-2008.

3,680,624. BUBBLES, INC., VIENNA, VA. SN 77-349,303. PUB. 4-15-2008, FILED 12-11-2007.

SPRING ROLL

THE MARK CONSISTS OF STANDARD CHARACTERS WITHOUT CLAIM TO ANY PARTICULAR FONT, STYLE, SIZE, OR COLOR.

FOR HAIR SALON PRODUCTS, NAMELY, SHAMPOOS, CONDITIONERS, STYLING PREPARATIONS, SOAPS, TOILET WATER, SKIN CREAMS AND BODY LOTIONS (U.S. CLS. 1, 4, 6, 50, 51 AND 52).

FIRST USE 6-9-2009; IN COMMERCE 6-9-2009.

3,680,714. SILVERSUN INDUSTRIES, MOKENA, IL. SN 77-395,316. PUB. 10-21-2008, FILED 2-12-2008.

CreteClean

THE MARK CONSISTS OF STANDARD CHARACTERS WITHOUT CLAIM TO ANY PARTICULAR FONT, STYLE, SIZE, OR COLOR.

FOR CLEANER FOR USE ON CONCRETE (U.S. CLS. 1, 4, 6, 50, 51 AND 52).

FIRST USE 6-0-2006; IN COMMERCE 6-0-2006.

CLASS 3—(Continued).

3,680,730. SHISEIDO COMPANY, LTD., TOKYO, JAPAN. SN 77-402,673. PUB. 7-22-2008, FILED 2-21-2008.



OWNER OF U.S. REG. NOS. 2,402,309 AND 2,648,798. THE ENGLISH TRANSLATION OF "CLÉ DE PEAU BEAUTÉ" IS "KEY TO BEAUTIFUL SKIN".

FOR NON-MEDICATED SKIN CARE PREPARATIONS; BODY CARE PRODUCTS, NAMELY, BODY SOAPS, BODY CREAMS, BODY LOTIONS, BODY POWDERS; NON-MEDICATED SUNCARE PRODUCTS, NAMELY, SUNSCREEN, SUN BLOCK AND SUN TANNING PREPARATIONS; PREPARATIONS TO PROTECT THE SKIN FROM THE SUN, NAMELY, NON-MEDICATED SUN CREAMS AND NON-MEDICATED AFTER-SUN LOTIONS; PERFUME, COLOGNE, COSMETICS AND MAKEUP (U.S. CLS. 1, 4, 6, 50, 51 AND 52).

FIRST USE 9-0-2006; IN COMMERCE 9-0-2006.

3,680,781. THIERRY MUGLER PARFUMS S.A.S., NEUILLY-SUR-SEINE, FRANCE. SN 77-433,043. PUB. 10-7-2008, FILED 3-27-2008.

ANGEL SUNESSENCE

THE MARK CONSISTS OF STANDARD CHARACTERS WITHOUT CLAIM TO ANY PARTICULAR FONT, STYLE, SIZE, OR COLOR.

OWNER OF U.S. REG. NOS. 1,843,424 AND 3,051,023. FOR PERFUMARY AND THERETO RELATED PERFUMED PRODUCTS, NAMELY, EAU DE TOILETTE (U.S. CLS. 1, 4, 6, 50, 51 AND 52).

FIRST USE 3-2-2009; IN COMMERCE 4-0-2009.

3,680,782. THIERRY MUGLER PARFUMS S.A.S., NEUILLY-SUR-SEINE, FRANCE. SN 77-433,069. PUB. 10-7-2008, FILED 3-27-2008.

ALIEN SUNESSENCE

THE MARK CONSISTS OF STANDARD CHARACTERS WITHOUT CLAIM TO ANY PARTICULAR FONT, STYLE, SIZE, OR COLOR.

CLASS 3—(Continued).

OWNER OF U.S. REG. NOS. 2,776,116, 3,021,113, AND 3,124,258.
FOR PERFUMARY AND THERETO RELATED PERFUMED PRODUCTS, NAMELY, EAU DE TOILETTE (U.S. CLS. 1, 4, 6, 50, 51 AND 52).
FIRST USE 3-2-2009; IN COMMERCE 4-0-2009.

CLASS 3—(Continued).

3,680,832. PERFORMANCE BRANDS, INC., SUNRISE, FL. SN 77-453,195. PUB. 9-23-2008, FILED 4-21-2008.

3,680,820. PERFUME SOURCE, INC., LOS ANGELES, CA. SN 77-443,823. PUB. 3-24-2009, FILED 4-9-2008.

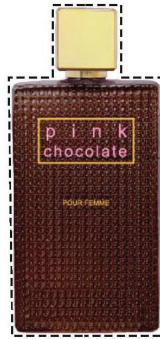

THE COLOR(S) BROWN, GOLD, AND PINK IS/ARE CLAIMED AS A FEATURE OF THE MARK.
THE MARK CONSISTS OF THE DESIGN FOR A GLASS PERFUME BOTTLE. THE BOTTLE IS SHAPED AS A RECTANGULAR CUBE WITH AN EMBOSSED SQUARE PATTERN ON THE REAR SURFACE OF THE BOTTLE. THE GLASS FEATURES A BROWN TINT. THE CAP FOR THE BOTTLE COMPRISES A GOLD CUBE. THE FRONT OF THE BOTTLE FEATURES A GOLD RECTANGLE WITH THE LETTERING "PINK CHOCOLATE" WRITTEN WITHIN THE RECTANGLE IN PINK LETTERS. THE SHAPE OF THE BOTTLE ITSELF IS NOT A PART OF THE MARK.
THE FOREIGN WORDING IN THE MARK TRANSLATES INTO ENGLISH AS FOR HER.
FOR PERFUMES, EAU DE COLOGNES AND AFTER-SHAVES (U.S. CLS. 1, 4, 6, 50, 51 AND 52).
FIRST USE 3-0-2008; IN COMMERCE 3-0-2008.

SERIOUSLY HOT

THE MARK CONSISTS OF STANDARD CHARACTERS WITHOUT CLAIM TO ANY PARTICULAR FONT, STYLE, SIZE, OR COLOR.
FOR SUN-TANNING PREPARATIONS (U.S. CLS. 1, 4, 6, 50, 51 AND 52).
FIRST USE 9-1-2008; IN COMMERCE 9-1-2008.

3,680,833. PERFORMANCE BRANDS, INC., SUNRISE, FL. SN 77-453,206. PUB. 9-23-2008, FILED 4-21-2008.

DARK DEVOTIONS

THE MARK CONSISTS OF STANDARD CHARACTERS WITHOUT CLAIM TO ANY PARTICULAR FONT, STYLE, SIZE, OR COLOR.
FOR SUN-TANNING PREPARATIONS (U.S. CLS. 1, 4, 6, 50, 51 AND 52).
FIRST USE 9-1-2008; IN COMMERCE 9-1-2008.

3,680,876. BEAUTY HOLDING LLC, DBA BEAUTY HOLDING COMPANY, INC., DENTON, TX. SN 77-464,013. PUB. 9-2-2008, FILED 5-2-2008.

TRUE LOVE 4EVER

THE MARK CONSISTS OF STANDARD CHARACTERS WITHOUT CLAIM TO ANY PARTICULAR FONT, STYLE, SIZE, OR COLOR.
FOR SUN-TANNING PREPARATIONS (U.S. CLS. 1, 4, 6, 50, 51 AND 52).
FIRST USE 9-1-2008; IN COMMERCE 9-1-2008.

REDEFINE

THE MARK CONSISTS OF STANDARD CHARACTERS WITHOUT CLAIM TO ANY PARTICULAR FONT, STYLE, SIZE, OR COLOR.
FOR COLOGNE (U.S. CLS. 1, 4, 6, 50, 51 AND 52).
FIRST USE 10-6-2008; IN COMMERCE 10-6-2008.

CLASS 3—(Continued).

3,680,882. SY KESSLER SALES, INC., DALLAS, TX. SN 77-465,658. PUB. 1-27-2009, FILED 5-5-2008.

SPARKLE PAK

THE MARK CONSISTS OF STANDARD CHARACTERS WITHOUT CLAIM TO ANY PARTICULAR FONT, STYLE, SIZE, OR COLOR.

OWNER OF U.S. REG. NO. 3,245,003.

NO CLAIM IS MADE TO THE EXCLUSIVE RIGHT TO USE "PAK", APART FROM THE MARK AS SHOWN.

FOR CLEANING PREPARATIONS FOR MIXING WITH WATER IN PRE-MEASURED AMOUNTS TO PROVIDE AN ULTRASOUND CONDUCTIVE BATH FOR USE IN ULTRASONIC CLEANING MACHINES (U.S. CLS. 1, 4, 6, 50, 51 AND 52).

FIRST USE 12-1-2008; IN COMMERCE 12-1-2008.

3,680,977. THERAMETICS, L.L.C., OKLAHOMA CITY, OK. SN 77-478,270. PUB. 10-21-2008, FILED 5-19-2008.

TheraWhite

THE MARK CONSISTS OF STANDARD CHARACTERS WITHOUT CLAIM TO ANY PARTICULAR FONT, STYLE, SIZE, OR COLOR.

FOR COSMETICS (U.S. CLS. 1, 4, 6, 50, 51 AND 52).

FIRST USE 6-15-2008; IN COMMERCE 6-30-2008.

3,680,980. MANA PRODUCTS, INC., LONG ISLAND CITY, NY. SN 77-478,728. PUB. 10-21-2008, FILED 5-20-2008.

Mineral Photo Touch

THE MARK CONSISTS OF STANDARD CHARACTERS WITHOUT CLAIM TO ANY PARTICULAR FONT, STYLE, SIZE, OR COLOR.

FOR COSMETICS (U.S. CLS. 1, 4, 6, 50, 51 AND 52).

FIRST USE 6-23-2008; IN COMMERCE 6-23-2008.

CLASS 3—(Continued).

3,681,017. TUPPERWARE PRODUCTS S.A., FRIBOURG, SWITZERLAND. SN 77-485,844. PUB. 11-4-2008, FILED 5-29-2008.

STRONG IMPACT

THE MARK CONSISTS OF STANDARD CHARACTERS WITHOUT CLAIM TO ANY PARTICULAR FONT, STYLE, SIZE, OR COLOR.

FOR PERFUMERY; DEODORANTS AND ANTIPERSPIRANTS FOR PERSONAL USE; TALCUM POWDER (U.S. CLS. 1, 4, 6, 50, 51 AND 52).

FIRST USE 6-14-2008; IN COMMERCE 6-14-2008.

3,681,038. KLEIN, LAURA, DBA ORGANIC AUTHORITY, BEVERLY HILLS, CA. SN 77-492,690. PUB. 12-23-2008, FILED 6-6-2008.

Organic Authority

THE MARK CONSISTS OF STANDARD CHARACTERS WITHOUT CLAIM TO ANY PARTICULAR FONT, STYLE, SIZE, OR COLOR.

OWNER OF U.S. REG. NO. 3,306,266.

NO CLAIM IS MADE TO THE EXCLUSIVE RIGHT TO USE "ORGANIC", APART FROM THE MARK AS SHOWN.

FOR CLEANING AGENTS AND PREPARATIONS MADE IN WHOLE OR SIGNIFICANT PART OF ORGANIC MATERIALS (U.S. CLS. 1, 4, 6, 50, 51 AND 52).

FIRST USE 11-25-2008; IN COMMERCE 11-25-2008.

3,681,055. TUPPERWARE PRODUCTS S.A., FRIBOURG, SWITZERLAND. SN 77-496,108. PUB. 11-4-2008, FILED 6-11-2008.

BEAUTY VERT

THE MARK CONSISTS OF STANDARD CHARACTERS WITHOUT CLAIM TO ANY PARTICULAR FONT, STYLE, SIZE, OR COLOR.

NO CLAIM IS MADE TO THE EXCLUSIVE RIGHT TO USE "BEAUTY", APART FROM THE MARK AS SHOWN.

THE FOREIGN WORDING IN THE MARK TRANSLATES INTO ENGLISH AS GREEN.

FOR PERFUMERY, DEODORANTS AND ANTIPERSPIRANTS FOR PERSONAL USE, TALCUM POWDER (U.S. CLS. 1, 4, 6, 50, 51 AND 52).

FIRST USE 6-28-2008; IN COMMERCE 6-28-2008.

CLASS 3—(Continued).

3,681,056. TUPPERWARE PRODUCTS S.A., FRIBOURG, SWITZERLAND. SN 77-496,114. PUB. 10-28-2008, FILED 6-11-2008.

BELLE NOIRE

THE MARK CONSISTS OF STANDARD CHARACTERS WITHOUT CLAIM TO ANY PARTICULAR FONT, STYLE, SIZE, OR COLOR.

THE ENGLISH TRANSLATION OF "BELLE NOIRE" IS BEAUTIFUL BLACK.

FOR PERFUMERY (U.S. CLS. 1, 4, 6, 50, 51 AND 52).
FIRST USE 12-13-2008; IN COMMERCE 12-13-2008.

CLASS 3—(Continued).

3,681,068. TUPPERWARE PRODUCTS S.A., FRIBOURG, SWITZERLAND. SN 77-498,178. PUB. 11-4-2008, FILED 6-13-2008.

OZADO CORPUS

THE MARK CONSISTS OF STANDARD CHARACTERS WITHOUT CLAIM TO ANY PARTICULAR FONT, STYLE, SIZE, OR COLOR.

NO CLAIM IS MADE TO THE EXCLUSIVE RIGHT TO USE "CORPUS", APART FROM THE MARK AS SHOWN.

FOR PERFUMERY, DEODORANTS AND ANTIPERSPIRANTS FOR PERSONAL USE, TALCUM POWDER (U.S. CLS. 1, 4, 6, 50, 51 AND 52).

FIRST USE 7-12-2008; IN COMMERCE 7-12-2008.

3,681,058. COLGATE-PALMOLIVE COMPANY, NEW YORK, NY. SN 77-496,126. PUB. 11-11-2008, FILED 6-11-2008.

**YOUR SMILE IS YOUR
TRADEMARK**

THE MARK CONSISTS OF STANDARD CHARACTERS WITHOUT CLAIM TO ANY PARTICULAR FONT, STYLE, SIZE, OR COLOR.

FOR ORAL CARE PRODUCTS, NAMELY, TOOTH-PASTE, DENTAL BLEACHING GEL, NON-MEDICATED DENTAL RINSE, NON-MEDICATED DENTAL FOAM FOR CLEANING TEETH, TOOTH WHITENING GEL, TOOTH WHITENING PASTE, BREATH FRESHENERS AND MOUTHWASH (U.S. CLS. 1, 4, 6, 50, 51 AND 52).

FIRST USE 2-23-2009; IN COMMERCE 2-23-2009.

3,681,070. TUPPERWARE PRODUCTS S.A., FRIBOURG, SWITZERLAND. SN 77-498,295. PUB. 11-25-2008, FILED 6-13-2008.



THE NAME(S), PORTRAIT(S), AND/OR SIGNATURE(S) SHOWN IN THE MARK DOES NOT IDENTIFY A PARTICULAR LIVING INDIVIDUAL.

THE MARK CONSISTS OF THE PHRASE "ARMAND DUPREE" IN STYLIZED LETTERS WITH THE WORD "ARMAND" ABOVE THE WORD "DUPREE".

FOR PERFUMERY; COSMETICS; DEODORANTS AND ANTIPERSPIRANTS FOR PERSONAL USE; TALCUM POWDER; HAND AND BODY CREAMS; NAIL POLISH AND NAIL CARE PREPARATIONS; PERFUMED SOAPS (U.S. CLS. 1, 4, 6, 50, 51 AND 52).

FIRST USE 6-14-2008; IN COMMERCE 6-14-2008.

3,681,059. TUPPERWARE PRODUCTS S.A., FRIBOURG, SWITZERLAND. SN 77-496,134. PUB. 10-28-2008, FILED 6-11-2008.

SOPHIE ROSE

THE MARK CONSISTS OF STANDARD CHARACTERS WITHOUT CLAIM TO ANY PARTICULAR FONT, STYLE, SIZE, OR COLOR.

THE NAME(S), PORTRAIT(S), AND/OR SIGNATURE(S) SHOWN IN THE MARK DOES NOT IDENTIFY A PARTICULAR LIVING INDIVIDUAL.

FOR PERFUMERY (U.S. CLS. 1, 4, 6, 50, 51 AND 52).
FIRST USE 9-20-2008; IN COMMERCE 9-20-2008.

3,681,136. ATHENA COSMETICS, INC., HENDERSON, NV. SN 77-523,524. PUB. 10-14-2008, FILED 7-16-2008.

HAIR BY REVITALASH

CLASS 3—(Continued).

THE MARK CONSISTS OF STANDARD CHARACTERS WITHOUT CLAIM TO ANY PARTICULAR FONT, STYLE, SIZE, OR COLOR.

OWNER OF U.S. REG. NOS. 3,246,814 AND 3,301,353. NO CLAIM IS MADE TO THE EXCLUSIVE RIGHT TO USE "HAIR", APART FROM THE MARK AS SHOWN.

FOR NON-MEDICATED HAIR AND SCALP CONDITIONERS (U.S. CLS. 1, 4, 6, 50, 51 AND 52).

FIRST USE 1-30-2009; IN COMMERCE 1-30-2009.

3,681,215. BRIANZA BELLA, LLC, CARLINVILLE, IL. SN 77-557,660. PUB. 1-13-2009, FILED 8-28-2008.



THE MARK CONSISTS OF A DARKER COMPLEXION WOMAN WITH A GARDENIA ON HER GOWN AND IN HER HAIR, HOLDING A JAR IN HER LEFT OUTSTRETCHED HAND WITH A HALF CIRCLE BEHIND HER HEAD CREATING A SILHOUETTE.

FOR BODY AND BEAUTY CARE COSMETICS (U.S. CLS. 1, 4, 6, 50, 51 AND 52).

FIRST USE 5-15-2009; IN COMMERCE 5-15-2009.

3,681,226. PROCTER & GAMBLE COMPANY, THE, CINCINNATI, OH. SN 77-562,526. PUB. 1-13-2009, FILED 9-4-2008.



THE MARK CONSISTS OF A VERTICLE COLUMM OF OVERLAPPING CIRCLES WITH A VERTICLE WAVE FORM LINE OVERLAPPING SUCH CIRCLES.

FOR NON-MEDICATED SKIN CARE PREPARATIONS (U.S. CLS. 1, 4, 6, 50, 51 AND 52).

FIRST USE 7-6-2009; IN COMMERCE 7-6-2009.

CLASS 3—(Continued).

3,681,251. SPANKIN' KLEEN, LLC, SANTA ROSA, CA. SN 77-571,689. PUB. 2-10-2009, FILED 9-17-2008.

SKWEET

THE MARK CONSISTS OF STANDARD CHARACTERS WITHOUT CLAIM TO ANY PARTICULAR FONT, STYLE, SIZE, OR COLOR.

FOR CLEANING PREPARATIONS FOR SPORTS BOTTLES AND HYDRATION PACKS (U.S. CLS. 1, 4, 6, 50, 51 AND 52).

FIRST USE 12-0-2008; IN COMMERCE 5-0-2009.

3,681,264. CARDEAUX COSMETICS, NORTH MIAMI BEACH, FL. SN 77-574,386. PUB. 3-3-2009, FILED 9-19-2008.

COUGAR KIT

THE MARK CONSISTS OF STANDARD CHARACTERS WITHOUT CLAIM TO ANY PARTICULAR FONT, STYLE, SIZE, OR COLOR.

NO CLAIM IS MADE TO THE EXCLUSIVE RIGHT TO USE "KIT", APART FROM THE MARK AS SHOWN.

FOR COSMETICS (U.S. CLS. 1, 4, 6, 50, 51 AND 52).

FIRST USE 6-1-2009; IN COMMERCE 6-1-2009.

3,681,288. SUPREME CHEMICALS OF GEORGIA, INC., CUMMING, GA. SN 77-581,779. PUB. 3-3-2009, FILED 9-30-2008.

OIL GRABBER

THE MARK CONSISTS OF STANDARD CHARACTERS WITHOUT CLAIM TO ANY PARTICULAR FONT, STYLE, SIZE, OR COLOR.

NO CLAIM IS MADE TO THE EXCLUSIVE RIGHT TO USE "OIL", APART FROM THE MARK AS SHOWN.

FOR CLEANING PREPARATION FOR THE REMOVAL OF OIL STAINS, GREASE, ANTI-FREEZE, TRANSMISSION FLUID, TAR, WAX, COOKING OILS, FOOD GREASE, HYDRAULIC FLUID, AND OTHER OIL-BASED MATERIALS (U.S. CLS. 1, 4, 6, 50, 51 AND 52).

FIRST USE 3-30-2009; IN COMMERCE 3-30-2009.

CLASS 3—(Continued).

3,681,291. THE PROCTER & GAMBLE COMPANY, CINCINNATI, OH. SN 77-582,282. PUB. 2-10-2009, FILED 9-30-2008.

CLASS 3—(Continued).

3,681,312. EVERYDAY SHORTS INC, CALGARY, ALBERTA, CANADA. SN 77-589,283. PUB. 3-3-2009, FILED 10-9-2008.

LOVE AT FIRST SNIFF

THE MARK CONSISTS OF STANDARD CHARACTERS WITHOUT CLAIM TO ANY PARTICULAR FONT, STYLE, SIZE, OR COLOR.
 FOR FABRIC SOFTENERS; LAUNDRY DETERGENTS (U.S. CLS. 1, 4, 6, 50, 51 AND 52).
 FIRST USE 2-10-2009; IN COMMERCE 2-10-2009.



FOR COSMETIC SUN-TANNING PREPARATIONS; INDOOR SUN TANNING PREPARATIONS; SKIN GELS FOR ACCELERATING, ENHANCING OR EXTENDING TANS; SUN TAN GEL; SUN TAN LOTION; SUN TAN OIL; SUN-TANNING OILS; SUN-TANNING OILS AND LOTIONS; SUN-TANNING PREPARATIONS; SUNTAN CREAMS; TANNING CREAMS; TANNING GELS; TANNING OILS (U.S. CLS. 1, 4, 6, 50, 51 AND 52).
 FIRST USE 1-8-2009; IN COMMERCE 1-8-2009.

3,681,295. CIANELLI, WILLIAM A, ELMSFORD, NY. SN 77-585,362. PUB. 3-24-2009, FILED 10-3-2008.



3,681,349. SEATTLE GOURMET FOODS, INC., KENT, WA. SN 77-601,589. PUB. 3-17-2009, FILED 10-27-2008.

NO CLAIM IS MADE TO THE EXCLUSIVE RIGHT TO USE "100% NATURAL, PREMIUM HAND BALM, BEST BALMS, FOR DRY, CHAPPED AND DAMAGED SKIN", APART FROM THE MARK AS SHOWN.

THE COLOR(S) YELLOW, RED, BLACK AND BROWN IS/ARE CLAIMED AS A FEATURE OF THE MARK.

THE MARK CONSIST OF THE WORDING "100% NATURAL", "PREMIUM HAND BALM, 100% NATURAL" AND "FOR DRY, CHAPPED AND DAMAGED SKIN" IN YELLOW AND OUTLINED IN BROWN. THE MARK ALSO INCLUDES THE WORDING "FEMINI QUE ULTRA BLEND" IN YELLOW AND OUTLINED IN RED. THE APOSTROPHE IN "FEMINI QUE" IS IN THE FORM OF A BLACK TRIANGLE. THE WORDING APPEARS ON A CIRCLE THAT HAS A YELLOW OUTER BAND THAT IS OUTLINED IN BROWN WITH RED AND BROWN SAND. THE MARK ALSO INCLUDES THE YELLOW WORDING "BEST BALMS" WITH THE STYLIZED INITIAL "BB" IN YELLOW AND OUTLINED IN BROWN. A BROWN BEE/INSECT IS SUPERIMPOSED OVER THE STYLIZED "BB" ELEMENT.

FOR SKIN CARE PREPARATIONS, NAMELY, BODY BALM (U.S. CLS. 1, 4, 6, 50, 51 AND 52).
 FIRST USE 2-8-2009; IN COMMERCE 2-8-2009.



OWNER OF U.S. REG. NO. 2,468,250.
 NO CLAIM IS MADE TO THE EXCLUSIVE RIGHT TO USE "MINTS", APART FROM THE MARK AS SHOWN.
 THE MARK CONSISTS OF A STYLIZED "M" INSIDE A SQUARE WITH ROUNDED CORNERS TO THE LEFT OF THE WORD "MYNTZ!".
 FOR BREATH MINTS FOR USE AS A BREATH FRESHENER (U.S. CLS. 1, 4, 6, 50, 51 AND 52).
 FIRST USE 2-23-2009; IN COMMERCE 3-12-2009.

CLASS 3—(Continued).

3,681,390. PARFUMS BY CHRISTOPHER JOSEPH, LLC, IRVINE, CA. SN 77-619,938. PUB. 3-31-2009, FILED 11-21-2008.



THE MARK CONSISTS OF A CROWN SUBSTANTIALLY SURROUNDED BY A GENERALLY CIRCULAR ELEMENT HAVING AN APPEARANCE RESEMBLING A TWO-HEADED SERPENT.

FOR LIQUID PERFUMES; PERFUME; PERFUMES (U.S. CLS. 1, 4, 6, 50, 51 AND 52).
FIRST USE 5-4-2009; IN COMMERCE 5-4-2009.

CLASS 3—(Continued).

3,681,396. SUKI, INC., NORTHAMPTON, MA. SN 77-621,430. PUB. 4-7-2009, FILED 11-25-2008.

sukispa

THE MARK CONSISTS OF STANDARD CHARACTERS WITHOUT CLAIM TO ANY PARTICULAR FONT, STYLE, SIZE, OR COLOR.

OWNER OF U.S. REG. NOS. 2,810,547 AND 3,274,289.
FOR COSMETICS (U.S. CLS. 1, 4, 6, 50, 51 AND 52).
FIRST USE 1-1-2009; IN COMMERCE 1-1-2009.

3,681,397. SUKI, INC., NORTHAMPTON, MA. SN 77-621,431. PUB. 4-7-2009, FILED 11-25-2008.

sukiface

THE MARK CONSISTS OF STANDARD CHARACTERS WITHOUT CLAIM TO ANY PARTICULAR FONT, STYLE, SIZE, OR COLOR.

OWNER OF U.S. REG. NOS. 2,810,547 AND 3,274,289.
FOR COSMETICS (U.S. CLS. 1, 4, 6, 50, 51 AND 52).
FIRST USE 1-1-2009; IN COMMERCE 1-1-2009.

3,681,391. PARFUMS BY CHRISTOPHER JOSEPH, LLC, IRVINE, CA. SN 77-619,958. PUB. 3-31-2009, FILED 11-21-2008.

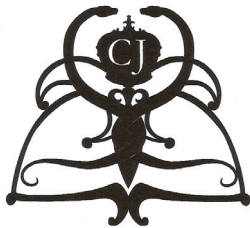

THE MARK CONSISTS OF A CROWN SUBSTANTIALLY SURROUNDED BY A GENERALLY CIRCULAR ELEMENT HAVING AN APPEARANCE RESEMBLING A TWO-HEADED SERPENT, THE CROWN COMPRISING THE HEAD OF AN ELEMENT RESEMBLING THE BODY OF AN INSECT, THE BODY BEING SURROUNDED BY A FRAMEWORK RESEMBLING SPREAD WINGS.

FOR LIQUID PERFUMES; PERFUME; PERFUMES (U.S. CLS. 1, 4, 6, 50, 51 AND 52).
FIRST USE 5-4-2009; IN COMMERCE 5-4-2009.

3,681,436. VICTORIA'S SECRET STORES BRAND MANAGEMENT, INC., REYNOLDSBURG, OH. SN 77-977,586. PUB. 3-24-2009, FILED 1-2-2009.

SECRET CHARM

THE MARK CONSISTS OF STANDARD CHARACTERS WITHOUT CLAIM TO ANY PARTICULAR FONT, STYLE, SIZE, OR COLOR.

FOR BODY BUTTER; BODY CREAMS; BODY LOTIONS; BODY WASHES; HAND CREAMS; NON-MEDICATED SKIN CARE PREPARATION, NAMELY, BODY MIST (U.S. CLS. 1, 4, 6, 50, 51 AND 52).
FIRST USE 6-4-2009; IN COMMERCE 6-4-2009.

CLASS 3—(Continued).

3,681,437. BELLAH BRANDS INCORPORATED, LOS ANGELES, CA. SN 77-977,589. PUB. 2-10-2009, FILED 2-7-2008.

HALLE

THE MARK CONSISTS OF STANDARD CHARACTERS WITHOUT CLAIM TO ANY PARTICULAR FONT, STYLE, SIZE, OR COLOR.

FOR PERFUME, COLOGNE, FRAGRANCES, SKIN CARE PREPARATIONS, AND SOAPS (U.S. CLS. 1, 4, 6, 50, 51 AND 52).

FIRST USE 4-0-2009; IN COMMERCE 4-0-2009.

3,681,438. COSMETIC DERMATOLOGY, INC., MIAMI, FL. SN 77-977,597. PUB. 12-16-2008, FILED 7-28-2008.

TIME ARREST

THE MARK CONSISTS OF STANDARD CHARACTERS WITHOUT CLAIM TO ANY PARTICULAR FONT, STYLE, SIZE, OR COLOR.

FOR SKIN CREAMS, SKIN LOTIONS, SKIN MOISTURIZERS, SKIN EMOLLIENTS, EYE CREAMS AND NON-MEDICATED SKIN SERUMS (U.S. CLS. 1, 4, 6, 50, 51 AND 52).

FIRST USE 5-28-2009; IN COMMERCE 5-28-2009.

3,681,460. NOUVELLE PARFUMERIE GANDOUR, MIAMI, FL. SN 78-421,417. PUB. 9-27-2005, FILED 5-19-2004.

BODY WHITE

THE MARK CONSISTS OF STANDARD CHARACTERS WITHOUT CLAIM TO ANY PARTICULAR FONT, STYLE, SIZE, OR COLOR.

NO CLAIM IS MADE TO THE EXCLUSIVE RIGHT TO USE "BODY", APART FROM THE MARK AS SHOWN.

FOR FRAGRANCES FOR PERSONAL USE, PERFUME, COLOGNE, BODY SPRAY, BODY CREAMS, BODY MOISTURIZERS AND BODY LOTIONS (U.S. CLS. 1, 4, 6, 50, 51 AND 52).

FIRST USE 2-2-2004; IN COMMERCE 1-13-2005.

CLASS 3—(Continued).

3,681,520. OLEVA GROUP ENTERPRISES, INC., RICHMOND, BRITISH COLUMBIA. SN 78-673,943. PUB. 4-4-2006, FILED 7-19-2005.

①éva

FOR PERFUMES, TOILET SOAPS, COSMETICS, NAMELY, DEODORANTS FOR PERSONAL USE; CREAMS, LOTIONS, AND OILS FOR THE FACE AND THE BODY; SKIN CLEANSING MILKS, SKIN CREAMS AND BODY OILS; MAKE-UP CREAMS; BEAUTY MASKS; MAKE-UP REMOVERS; EYE SHADOWS; LIPSTICKS; MASCARA; ROUGE; CRAYONS FOR THE EYES AND THE LIPS; POWDERS, CREAMS, OILS AND LOTIONS FOR SUNTANNING AND AFTER SUN EXPOSURE; PRE- AND AFTER SHAVE LOTIONS; TALCUM POWDERS; BATH SALTS; BATH FOAM; BATH OIL; ESSENTIAL OILS FOR PERSONAL USE; AFTER BATH CREAMS, LOTIONS AND OILS; SHAMPOOS; HAIR CONDITIONERS; DEPILATORY CREAMS; NAIL ENAMELS; NAIL POLISHES; HAIR LOTIONS, HAIR MOUSSE; DENTIFRICES; SOAPS FOR HOUSEHOLD USE; POTPOURRI; ROOM SCENTERS, NAMELY, ROOM FRAGRANCES AND SCENTED ROOM SPRAYS (U.S. CLS. 1, 4, 6, 50, 51 AND 52).

FIRST USE 9-8-2005; IN COMMERCE 6-18-2009.

3,681,524. PHILOSOPHY, INC., PHOENIX, AZ. SN 78-683,533. PUB. 4-25-2006, FILED 8-2-2005.

SPRINKLE, SPRINKLE LITTLE STAR

THE MARK CONSISTS OF STANDARD CHARACTERS WITHOUT CLAIM TO ANY PARTICULAR FONT, STYLE, SIZE, OR COLOR.

FOR SKIN CARE KITS, OR GIFT SETS CONTAINING LIP GLOSS, AND 3-IN-1 SHAMPOO, SHOWER GEL AND BUBBLE BATH (U.S. CLS. 1, 4, 6, 50, 51 AND 52).

FIRST USE 4-28-2009; IN COMMERCE 4-28-2009.

CLASS 3—(Continued).

3,681,556. NATURAL BEAUTY INNOVATIONS, LLC, NEW YORK, NY. SN 78-775,853. PUB. 4-17-2007, FILED 12-19-2005.

TERRALINA

THE MARK CONSISTS OF STANDARD CHARACTERS WITHOUT CLAIM TO ANY PARTICULAR FONT, STYLE, SIZE, OR COLOR.

FOR SKIN CARE PRODUCTS, NAMELY, SKIN LOTIONS, SOAPS, CLEANSERS, GELS, CREAMS, MOISTURIZERS, CLARIFIERS, TONERS, AND NON-MEDICATED SERUMS (U.S. CLS. 1, 4, 6, 50, 51 AND 52).
FIRST USE 3-12-2007; IN COMMERCE 3-12-2007.

3,681,565. PHILOSOPHY, INC., PHOENIX, AZ. SN 78-795,569. PUB. 9-26-2006, FILED 1-20-2006.

TANGERINE MILK

THE MARK CONSISTS OF STANDARD CHARACTERS WITHOUT CLAIM TO ANY PARTICULAR FONT, STYLE, SIZE, OR COLOR.

FOR HAIR CARE PREPARATIONS; NON-MEDICATED BATH PREPARATIONS (U.S. CLS. 1, 4, 6, 50, 51 AND 52).

FIRST USE 6-18-2009; IN COMMERCE 6-18-2009.

CLASS 4—LUBRICANTS AND FUELS

3,680,555. RPM WOOD FINISHES GROUP, INC., HICKORY, NC. SN 77-334,350. PUB. 10-28-2008, FILED 11-20-2007.

QUICK FILL

THE MARK CONSISTS OF STANDARD CHARACTERS WITHOUT CLAIM TO ANY PARTICULAR FONT, STYLE, SIZE, OR COLOR.

NO CLAIM IS MADE TO THE EXCLUSIVE RIGHT TO USE "FILL", APART FROM THE MARK AS SHOWN.

FOR SYNTHETIC WAX USED TO REPAIR AND FILL HOLES AND CRACKS, ADHERE TO SURROUNDING MATERIALS AND SEAL SURFACES FOR USE IN INTERIOR ENVIRONMENTS (U.S. CLS. 1, 6 AND 15).
FIRST USE 9-0-2007; IN COMMERCE 9-0-2007.

CLASS 4—(Continued).

3,681,545. RENEGADE DIVISION, LLC, LEWISBURG, KY. SN 78-734,655. PUB. 12-30-2008, FILED 10-17-2005.

MONSTER

THE MARK CONSISTS OF STANDARD CHARACTERS WITHOUT CLAIM TO ANY PARTICULAR FONT, STYLE, SIZE, OR COLOR.

FOR FUEL FOR MOTOR VEHICLES, NAMELY, HIGH PERFORMANCE GASOLINE RACING FUEL AND HIGH PERFORMANCE DIESEL RACING FUEL; FUEL OIL (U.S. CLS. 1, 6 AND 15).

FIRST USE 1-5-2006; IN COMMERCE 2-6-2006.

CLASS 5—PHARMACEUTICALS

3,680,120. DANIEL BAUM COMPANY, LANCASTER, PA. SN 76-685,806. PUB. 12-23-2008, FILED 1-15-2008.

ENCRYPT

FOR ANIMAL FEED SUPPLEMENTS; ADDITIVES FOR USE IN ANIMAL FOOD, NAMELY, NON-MEDICATED NUTRITIONAL ADDITIVES AND/OR SUPPLEMENTS FOR ANIMALS USED TO ABATE ENTERIC PATHOGENS (U.S. CLS. 6, 18, 44, 46, 51 AND 52).

FIRST USE 9-19-2005; IN COMMERCE 9-19-2005.

3,680,147. JOHNSON & JOHNSON, NEW BRUNSWICK, NJ. SN 77-013,186. PUB. 2-6-2007, FILED 10-4-2006.

LISTERINE SMART RINSE

THE MARK CONSISTS OF STANDARD CHARACTERS WITHOUT CLAIM TO ANY PARTICULAR FONT, STYLE, SIZE, OR COLOR.

OWNER OF U.S. REG. NOS. 41,413, 118,052, AND OTHERS.

NO CLAIM IS MADE TO THE EXCLUSIVE RIGHT TO USE "RINSE", APART FROM THE MARK AS SHOWN.

FOR MEDICATED ANTICAVITY FLUORIDE MOUTHWASH (U.S. CLS. 6, 18, 44, 46, 51 AND 52).
FIRST USE 2-12-2008; IN COMMERCE 2-12-2008.

CLASS 5—(Continued).

3,680,148. JOHNSON & JOHNSON, NEW BRUNSWICK, NJ. SN 77-013,209. PUB. 2-6-2007, FILED 10-4-2006.

SMART RINSE

THE MARK CONSISTS OF STANDARD CHARACTERS WITHOUT CLAIM TO ANY PARTICULAR FONT, STYLE, SIZE, OR COLOR.

NO CLAIM IS MADE TO THE EXCLUSIVE RIGHT TO USE "RINSE", APART FROM THE MARK AS SHOWN.

FOR MEDICATED ANTICAVITY FLUORIDE MOUTHWASH (U.S. CLS. 6, 18, 44, 46, 51 AND 52).
FIRST USE 2-12-2008; IN COMMERCE 2-12-2008.

CLASS 5—(Continued).

3,680,271. NUFARM AMERICAS, BURR RIDGE, IL. SN 77-166,177. PUB. 10-30-2007, FILED 4-26-2007.

CLOAK

THE MARK CONSISTS OF STANDARD CHARACTERS WITHOUT CLAIM TO ANY PARTICULAR FONT, STYLE, SIZE, OR COLOR.

FOR PESTICIDES; HERBICIDES; INSECTICIDES (U.S. CLS. 6, 18, 44, 46, 51 AND 52).
FIRST USE 6-30-2009; IN COMMERCE 6-30-2009.

3,680,158. WHITMIRE MICRO-GEN RESEARCH LABORATORIES, INC., ST. LOUIS, MO. SN 77-037,412. PUB. 4-10-2007, FILED 11-6-2006.

ULTRA-PURE

THE MARK CONSISTS OF STANDARD CHARACTERS WITHOUT CLAIM TO ANY PARTICULAR FONT, STYLE, SIZE, OR COLOR.

FOR INSECTICIDES, MITICIDES FOR DOMESTIC AND AGRICULTURAL USE, AND FUNGICIDES FOR THE TURF AND ORNAMENTALS MARKET (U.S. CLS. 6, 18, 44, 46, 51 AND 52).

FIRST USE 10-0-2007; IN COMMERCE 10-0-2007.

3,680,297. VITACOST.COM INC., BOCA RATON, FL. SN 77-179,931. PUB. 11-6-2007, FILED 5-14-2007.

NLS

THE MARK CONSISTS OF STANDARD CHARACTERS WITHOUT CLAIM TO ANY PARTICULAR FONT, STYLE, SIZE, OR COLOR.

FOR DIETARY AND NUTRITIONAL SUPPLEMENTS (U.S. CLS. 6, 18, 44, 46, 51 AND 52).

FIRST USE 6-25-2009; IN COMMERCE 6-25-2009.

3,680,263. LIMIARTO, DANNY, JAKARTA BARAT, INDONESIA. SN 77-160,739. PUB. 10-14-2008, FILED 4-19-2007.

TREELAINS

THE MARK CONSISTS OF STANDARD CHARACTERS WITHOUT CLAIM TO ANY PARTICULAR FONT, STYLE, SIZE, OR COLOR.

PRIORITY CLAIMED UNDER SEC. 44(D) ON INDONESIA APPLICATION NO. 002007002215, FILED 1-24-2007.

THE WORDING "TREELAINS" HAS NO MEANING IN ENGLISH.

FOR MEDICINES FOR HUMAN PURPOSES, NAMELY, PHARMACEUTICAL PREPARATIONS FOR THE TREATMENT OF DISORDERS OF THE IMMUNE SYSTEM, THE METABOLIC SYSTEM, FOR THE TREATMENT OF INFLAMMATORY DISORDERS, FOR USE IN DERMATOLOGY; VITAMIN AND FOOD SUPPLEMENTS (U.S. CLS. 6, 18, 44, 46, 51 AND 52).

FIRST USE 10-23-2008; IN COMMERCE 10-23-2008.

3,680,332. GNOSIS S.P.A., DESIO (MI), ITALY. SN 77-190,700. PUB. 11-20-2007, FILED 5-25-2007.



THE COLOR(S) RED AND GOLD IS/ARE CLAIMED AS A FEATURE OF THE MARK.

THE MARK CONSISTS OF THE TERM "THQUEEN" IN STYLIZED LETTERING AND A CROWN OVER "QUEEN" PORTION OF THE MARK. THE LETTERS "TH" AND THE JEWELS IN THE CROWN ARE RED AND THE WORD "QUEEN" AND THE CROWN ARE IN GOLD.

FOR DIETETIC SUBSTANCES ADAPTED FOR MEDICAL USE (U.S. CLS. 6, 18, 44, 46, 51 AND 52).

FIRST USE 5-30-2007; IN COMMERCE 5-30-2007.

CLASS 5—(Continued).

3,680,361. NOVARTIS AG, BASEL, SWITZERLAND. SN 77-211,956. PUB. 11-13-2007, FILED 6-21-2007.

MAALOX TOTAL RELIEF

THE MARK CONSISTS OF STANDARD CHARACTERS WITHOUT CLAIM TO ANY PARTICULAR FONT, STYLE, SIZE, OR COLOR.

FOR PHARMACEUTICAL PREPARATIONS FOR RELIEF OF GASTRO-INTESTINAL DISTRESS (U.S. CLS. 6, 18, 44, 46, 51 AND 52).

FIRST USE 2-26-2008; IN COMMERCE 2-26-2008.

3,680,388. STANBIO LABORATORY, INC., BOERNE, TX. SN 77-251,143. PUB. 9-23-2008, FILED 8-9-2007.

RELY

THE MARK CONSISTS OF STANDARD CHARACTERS WITHOUT CLAIM TO ANY PARTICULAR FONT, STYLE, SIZE, OR COLOR.

FOR MEDICAL DIAGNOSTIC TESTING KITS FOR USE IN DETECTING DISEASE AND INFLAMMATORY CONDITIONS COMPRISING CHEMICAL REAGENTS FOR MEDICAL OR VETERINARY PURPOSES (U.S. CLS. 6, 18, 44, 46, 51 AND 52).

FIRST USE 1-1-2009; IN COMMERCE 1-1-2009.

3,680,444. RAINFOREST NUTRITIONALS, INC., RALEIGH, NC. SN 77-298,472. PUB. 8-12-2008, FILED 10-8-2007.

GENONUTRIENT

THE MARK CONSISTS OF STANDARD CHARACTERS WITHOUT CLAIM TO ANY PARTICULAR FONT, STYLE, SIZE, OR COLOR.

FOR NATURAL PRODUCTS, NAMELY, DIETARY SUPPLEMENTS THAT INFLUENCE HUMAN GENE ACTIVITY (U.S. CLS. 6, 18, 44, 46, 51 AND 52).

FIRST USE 6-15-2009; IN COMMERCE 6-15-2009.

CLASS 5—(Continued).

3,680,469. NATUREX, INC., SOUTH HACKENSACK, NJ. SN 77-307,880. PUB. 4-8-2008, FILED 10-18-2007.

HYDROXPURE

THE MARK CONSISTS OF STANDARD CHARACTERS WITHOUT CLAIM TO ANY PARTICULAR FONT, STYLE, SIZE, OR COLOR.

FOR DIETETIC SUBSTANCES ADAPTED FOR MEDICAL USE; FOOD SUPPLEMENTS FOR MEDICAL USE; MINERAL FOOD SUPPLEMENTS (U.S. CLS. 6, 18, 44, 46, 51 AND 52).

FIRST USE 1-0-2009; IN COMMERCE 1-0-2009.

3,680,470. NATUREX, INC., SOUTH HACKENSACK, NJ. SN 77-307,898. PUB. 4-8-2008, FILED 10-18-2007.

YERBAPURE

THE MARK CONSISTS OF STANDARD CHARACTERS WITHOUT CLAIM TO ANY PARTICULAR FONT, STYLE, SIZE, OR COLOR.

FOR DIETETIC SUBSTANCES ADAPTED FOR MEDICAL USE; FOOD SUPPLEMENTS FOR MEDICAL USE; MINERAL FOOD SUPPLEMENTS (U.S. CLS. 6, 18, 44, 46, 51 AND 52).

FIRST USE 1-0-2009; IN COMMERCE 1-0-2009.

3,680,481. GREYSTONE MEDICAL, INC., MEMPHIS, TN. SN 77-312,064. PUB. 9-16-2008, FILED 10-24-2007.

PHI

THE MARK CONSISTS OF STANDARD CHARACTERS WITHOUT CLAIM TO ANY PARTICULAR FONT, STYLE, SIZE, OR COLOR.

FOR WOUND DRESSINGS; MEDICATED WOUND DRESSINGS; WOUND, BURN AND SURGICAL DRESSINGS IMPREGNATED WITH OINTMENT; TOPICAL DRESSINGS FOR USE IN THE TREATMENT OF WOUNDS, BURNS, SKIN ULCERS AND OTHER SKIN CONDITIONS; AND INGREDIENT COMPONENT IN TOPICAL PHARMACEUTICAL PREPARATIONS THAT PROMOTE THE HEALING AND REPARATION OF SKIN (U.S. CLS. 6, 18, 44, 46, 51 AND 52).

FIRST USE 11-30-2008; IN COMMERCE 11-30-2008.

CLASS 5—(Continued).

3,680,483. ZHEJIANG TIANHUANG MEDICINAL PLANT PHARMACEUTICAL CO., LTD, ZHEJIANG PROVINCE, CHINA. SN 77-312,866. PUB. 12-2-2008, FILED 10-25-2007.



THE NON-LATIN CHARACTERS IN THE MARK TRANSLITERATE TO "LI" AND "ZUAN" AND THESE TRANSLATE TO "STAND" AND "DRILL" IN ENGLISH. THE PHRASE "LI ZUAN" HAS NO MEANING IN A FOREIGN LANGUAGE.

FOR MEDICINES FOR HUMAN PURPOSES, NAMELY, ANTIALLERGIC MEDICINES, MEDICINES FOR THE TREATMENT OF GASTROINTESTINAL DISEASES, MEDICINES FOR ENHANCING RESISTANCE AGAINST DISEASES, ANTI-FATIGUE MEDICINES; CHINESE MEDICINE NOSTRUM, NAMELY, DENDROBIUM CANDIDUM IN GRAIN FORM OR PILL FORM FOR THE PREVENTION AND TREATMENT OF DISORDERS OF THE NERVOUS SYSTEM, THE IMMUNE SYSTEM, THE CARDIO-VASCULAR SYSTEM, THE METABOLIC SYSTEM, THE RESPIRATORY SYSTEM, THE MUSCULO-SKELETAL SYSTEM, THE GENITOURINARY SYSTEM; CHINESE MEDICINE NOSTRUM, NAMELY, DENDROBIUM CANDIDUM IN GRAIN FORM OR PILL FORM FOR THE TREATMENT OF INFLAMMATORY DISORDERS, FOR USE IN DERMATOLOGY, ONCOLOGY, HEMATOLOGY AND IN TISSUE AND ORGAN TRANSPLANTATION, IN OPHTHALMOLOGY AND FOR GASTROENTEROLOGICAL DISORDERS; PHARMACEUTICAL PREPARATION FOR THE TREATMENT OF GOUT; PHARMACEUTICAL PREPARATIONS FOR THE TREATMENT OF INFECTIOUS DISEASES; MEDICINAL ALCOHOL; DIETETIC SUBSTANCES ADAPTED FOR MEDICAL USE; CANDY FOR MEDICAL PURPOSES; DIETETIC FOODS ADAPTED FOR MEDICAL PURPOSES; MEDICINAL DRINKS; MEDICINAL DRINKS CONTAINING GINSENG; MEDICINAL PREPARATIONS FOR THE MOUTH TO BE APPLIED IN THE FORM OF CAPSULES; INJECTION, NAMELY, INJECTABLE PHARMACEUTICALS FOR TREATMENT OF ANAPHYLACTIC REACTIONS, INJECTABLE DERMAL FILLER; DIETETIC BEVERAGES ADAPTED FOR MEDICAL PURPOSES, NAMELY, HERBAL TEA MADE FROM DENDROBIUM CANDIDUM FOR THE PREVENTION AND TREATMENT OF DISORDERS OF THE NERVOUS SYSTEM, THE IMMUNE SYSTEM, THE CARDIO-VASCULAR SYSTEM, THE METABOLIC SYSTEM, THE RESPIRATORY SYSTEM, THE MUSCULO-SKELETAL SYSTEM, THE GENITOURINARY SYSTEM; DIETETIC BEVERAGES ADAPTED FOR MEDICAL PURPOSES, NAMELY, HERBAL TEA MADE FROM DENDROBIUM CANDIDUM FOR THE TREATMENT OF INFLAMMATORY DISORDERS, FOR USE IN DERMATOLOGY, ONCOLOGY, HEMATOLOGY AND IN TISSUE AND ORGAN TRANSPLANTATION, IN OPHTHALMOLOGY AND FOR GASTROENTEROLOGICAL DISORDERS; NUTRITIONAL LIQUIDS NOT FOR MEDICAL PURPOSES, NAMELY, DIETARY SUPPLEMENTAL DRINKS; NUTRITIONAL SUPPLEMENTS IN CAPSULE AND PILL FORM, NOT FOR MEDICAL PURPOSES (U.S. CLS. 6, 18, 44, 46, 51 AND 52).

FIRST USE 4-20-1998; IN COMMERCE 5-5-2008.

CLASS 5—(Continued).

3,680,496. CENTRAL GARDEN & PET COMPANY, WALNUT CREEK, CA. SN 77-317,991. PUB. 4-15-2008, FILED 10-31-2007.

GREEN YARD. GREEN PLANET.

THE MARK CONSISTS OF STANDARD CHARACTERS WITHOUT CLAIM TO ANY PARTICULAR FONT, STYLE, SIZE, OR COLOR.

FOR INSECTICIDES; PESTICIDES; HERBICIDES FOR DOMESTIC USE; FUNGICIDES (U.S. CLS. 6, 18, 44, 46, 51 AND 52).

FIRST USE 4-1-2008; IN COMMERCE 4-1-2008.

3,680,519. RICECO LLC, MEMPHIS, TN. SN 77-324,635. PUB. 10-7-2008, FILED 11-8-2007.



OWNER OF U.S. REG. NOS. 1,640,179, 1,883,295, AND 2,461,712.

NO CLAIM IS MADE TO THE EXCLUSIVE RIGHT TO USE "PROPANIL FLOWABLE HERBICIDE", APART FROM THE MARK AS SHOWN.

THE COLOR(S) RED, GREEN AND WHITE IS/ARE CLAIMED AS A FEATURE OF THE MARK.

THE MARK CONSISTS OF THE RED WORDING "SUPER WHAM!" SET AGAINST GREEN PLANTS, ALL WITHIN TWO CONCENTRIC OVALS, THE SMALLER OVAL BEING RED AND THE LARGER ONE BEING WHITE, WITH THE RED WORDS "PROPANIL FLOWABLE HERBICIDE" OUTSIDE THE RED OVAL AND WITHIN THE WHITE ONE. THE OVALS ARE CONTAINED WITHIN A RED RECTANGLE.

FOR HERBICIDES FOR AGRICULTURAL USE (U.S. CLS. 6, 18, 44, 46, 51 AND 52).

FIRST USE 12-0-2007; IN COMMERCE 12-0-2007.

3,680,634. CELAVIE BIOSCIENCES LLC, READING, PA. SN 77-351,183. PUB. 5-6-2008, FILED 12-13-2007.

CELAVET

THE MARK CONSISTS OF STANDARD CHARACTERS WITHOUT CLAIM TO ANY PARTICULAR FONT, STYLE, SIZE, OR COLOR.

FOR STEM CELL TREATMENTS FOR ANIMALS (U.S. CLS. 6, 18, 44, 46, 51 AND 52).

FIRST USE 2-28-2009; IN COMMERCE 2-28-2009.

CLASS 5—(Continued).

3,680,666. WATSON PHARMACEUTICALS, INC., CORONA, CA. SN 77-366,454. PUB. 6-10-2008, FILED 1-8-2008.

CLASS 5—(Continued).

3,680,707. CHRISTUS HEALTH, HOUSTON, TX. SN 77-391,646. PUB. 3-17-2009, FILED 2-7-2008.

NEXT CHOICE

THE MARK CONSISTS OF STANDARD CHARACTERS WITHOUT CLAIM TO ANY PARTICULAR FONT, STYLE, SIZE, OR COLOR.

FOR ORAL CONTRACEPTIVES FOR WOMEN (U.S. CLS. 6, 18, 44, 46, 51 AND 52).

FIRST USE 7-6-2009; IN COMMERCE 7-6-2009.

SCENT FROM HEAVEN

THE MARK CONSISTS OF STANDARD CHARACTERS WITHOUT CLAIM TO ANY PARTICULAR FONT, STYLE, SIZE, OR COLOR.

FOR MEDICATED BABY OILS; MEDICATED BABY POWDERS (U.S. CLS. 6, 18, 44, 46, 51 AND 52).

FIRST USE 2-19-2008; IN COMMERCE 2-19-2008.

3,680,675. E. I. DU PONT DE NEMOURS AND COMPANY, WILMINGTON, DE. SN 77-369,783. PUB. 4-15-2008, FILED 1-11-2008.

3,680,756. BARR LABORATORIES, INC., MONTVALE, NJ. SN 77-413,014. PUB. 11-25-2008, FILED 3-4-2008.

CALTERYX

THE MARK CONSISTS OF STANDARD CHARACTERS WITHOUT CLAIM TO ANY PARTICULAR FONT, STYLE, SIZE, OR COLOR.

FOR INSECTICIDES FOR USE BY PROFESSIONAL PEST MANAGEMENT COMPANIES (U.S. CLS. 6, 18, 44, 46, 51 AND 52).

FIRST USE 5-29-2008; IN COMMERCE 5-29-2008.

TRI-LO-SPRINTEC

THE MARK CONSISTS OF STANDARD CHARACTERS WITHOUT CLAIM TO ANY PARTICULAR FONT, STYLE, SIZE, OR COLOR.

OWNER OF U.S. REG. NOS. 2,733,297 AND 2,856,625. FOR PHARMACEUTICALS, NAMELY, CONTRACEPTIVES (U.S. CLS. 6, 18, 44, 46, 51 AND 52).

FIRST USE 6-30-2009; IN COMMERCE 6-30-2009.

3,680,683. IDEAVILLAGE PRODUCTS CORP., WAYNE, NJ. SN 77-375,017. PUB. 11-4-2008, FILED 1-18-2008.

3,680,801. CHEMINOVA, INC., RESEARCH TRIANGLE PARK, NC. SN 77-438,949. PUB. 12-30-2008, FILED 4-3-2008.

THIS IS YOUR SHOT

THE MARK CONSISTS OF STANDARD CHARACTERS WITHOUT CLAIM TO ANY PARTICULAR FONT, STYLE, SIZE, OR COLOR.

FOR NUTRITIONAL, DIETARY AND FOOD SUPPLEMENTS (U.S. CLS. 6, 18, 44, 46, 51 AND 52).

FIRST USE 1-20-2008; IN COMMERCE 1-20-2008.

RHYTHM

THE MARK CONSISTS OF STANDARD CHARACTERS WITHOUT CLAIM TO ANY PARTICULAR FONT, STYLE, SIZE, OR COLOR.

FOR HERBICIDES FOR AGRICULTURAL USE (U.S. CLS. 6, 18, 44, 46, 51 AND 52).

FIRST USE 6-10-2009; IN COMMERCE 6-10-2009.

CLASS 5—(Continued).

3,680,806. CHEMINOVA, INC., RESEARCH TRIANGLE PARK, NC. SN 77-440,184. PUB. 12-30-2008, FILED 4-4-2008.

CLASS 5—(Continued).

3,680,898. SUN BROTHERS, LLC, OVERTON, NV. SN 77-467,095. PUB. 10-7-2008, FILED 5-6-2008.

DAWN



THE MARK CONSISTS OF STANDARD CHARACTERS WITHOUT CLAIM TO ANY PARTICULAR FONT, STYLE, SIZE, OR COLOR.
FOR HERBICIDES FOR AGRICULTURAL USE (U.S. CLS. 6, 18, 44, 46, 51 AND 52).
FIRST USE 6-9-2009; IN COMMERCE 6-9-2009.

THE COLOR(S) GOLD IS/ARE CLAIMED AS A FEATURE OF THE MARK.
THE MARK CONSISTS OF A THREE DIMENSIONAL COIN WITH THE WORDS "SUN BROTHERS" ON THE OUTER PORTIONS, WITH DOTS IN BETWEEN EACH LETTER. THE INNER PORTION IS THE HEADS OF TWO ROMAN SOLDIERS WITH HELMETS IN A THREE DIMENSIONAL FORMAT. THE ENTIRE LOGO IS IN VARIOUS SHADES OF GOLD.
FOR DIETARY AND NUTRITIONAL SUPPLEMENTS (U.S. CLS. 6, 18, 44, 46, 51 AND 52).
FIRST USE 5-1-2008; IN COMMERCE 5-1-2008.

3,680,838. BSP PHARMA, INC., EGG HARBOR TOWNSHIP, NJ. SN 77-455,492. PUB. 9-16-2008, FILED 4-23-2008.

3,680,900. SUN BROTHERS, LLC, OVERTON, NV. SN 77-467,120. PUB. 10-7-2008, FILED 5-6-2008.

JOYN

SUN WARRIOR

THE MARK CONSISTS OF STANDARD CHARACTERS WITHOUT CLAIM TO ANY PARTICULAR FONT, STYLE, SIZE, OR COLOR.
FOR DIETARY SUPPLEMENTS (U.S. CLS. 6, 18, 44, 46, 51 AND 52).
FIRST USE 8-25-2008; IN COMMERCE 8-25-2008.

THE COLOR(S) GOLD IS/ARE CLAIMED AS A FEATURE OF THE MARK.
THE MARK CONSISTS OF THE WORDS "SUN WARRIOR" IN GOLD WITH LIGHT GOLD ON THE SIDE AND DARK SHADING ON THE OTHER, REPRESENTING A THREE DIMENSIONAL IMAGE.
FOR DIETARY AND NUTRITIONAL SUPPLEMENTS (U.S. CLS. 6, 18, 44, 46, 51 AND 52).
FIRST USE 5-1-2008; IN COMMERCE 5-1-2008.

CLASS 5—(Continued).

3,680,916. KEYSTONE DENTAL, INC., BURLINGTON, MA. SN 77-470,114. PUB. 10-7-2008, FILED 5-9-2008.

DYNAMATRIX

THE MARK CONSISTS OF STANDARD CHARACTERS WITHOUT CLAIM TO ANY PARTICULAR FONT, STYLE, SIZE, OR COLOR.

FOR BIOLOGICAL TISSUE, NAMELY, SMALL INTESTINAL SUBMUCOSA FOR USE IN DENTAL AND ORAL SURGERY (U.S. CLS. 6, 18, 44, 46, 51 AND 52).

FIRST USE 1-1-2009; IN COMMERCE 1-1-2009.

3,680,959. NUTRI-HEALTH SUPPLEMENTS, L.L.C., COTTONWOOD, AZ. SN 77-475,708. PUB. 9-30-2008, FILED 5-15-2008.

SERRA VO-D

THE MARK CONSISTS OF STANDARD CHARACTERS WITHOUT CLAIM TO ANY PARTICULAR FONT, STYLE, SIZE, OR COLOR.

OWNER OF U.S. REG. NOS. 3,264,196 AND 3,264,197. FOR DIETARY AND NUTRITIONAL SUPPLEMENTS (U.S. CLS. 6, 18, 44, 46, 51 AND 52).

FIRST USE 10-1-2008; IN COMMERCE 10-1-2008.

3,680,981. ISI BRANDS INC., GRAND RAPIDS, MI. SN 77-479,037. PUB. 10-21-2008, FILED 5-20-2008.

ELECTROLYTE FUEL

THE MARK CONSISTS OF STANDARD CHARACTERS WITHOUT CLAIM TO ANY PARTICULAR FONT, STYLE, SIZE, OR COLOR.

NO CLAIM IS MADE TO THE EXCLUSIVE RIGHT TO USE "ELECTROLYTE", APART FROM THE MARK AS SHOWN.

FOR DIETARY SUPPLEMENTS (U.S. CLS. 6, 18, 44, 46, 51 AND 52).

FIRST USE 1-0-2008; IN COMMERCE 1-0-2008.

CLASS 5—(Continued).

3,681,021. TERRABOOST MEDIA, LLC, MIAMI, FL. SN 77-487,011. PUB. 10-28-2008, FILED 5-30-2008.



THE MARK CONSISTS OF THE STYLIZED WORDING "TAZZA" BELOW THE DESIGN OF A DROPLET FALLING INTO A SYMMETRICAL DESIGN FORMED BY CURVED LINES WITH COIL SHAPES ON THE BOTTOM, ABSTRACTLY REPRESENTING A PAIR OF HANDS CATCHING THE DROPLET.

FOR MEDICATED SKIN CARE PREPARATIONS, NAMELY, SKIN SANITIZER LOTIONS, FOAMS AND GELS; AND PRE-MOISTENED DISINFECTANT TOWEL-ETTES FOR SANITIZING AND CLEANING THE SKIN (U.S. CLS. 6, 18, 44, 46, 51 AND 52).

FIRST USE 5-16-2009; IN COMMERCE 5-16-2009.

3,681,040. FUNCTIONAL TECHNOLOGIES CORPORATION, VANCOUVER, CANADA. SN 77-492,942. PUB. 12-30-2008, FILED 6-6-2008.

PHYTERRA

THE MARK CONSISTS OF STANDARD CHARACTERS WITHOUT CLAIM TO ANY PARTICULAR FONT, STYLE, SIZE, OR COLOR.

FOR BIOMEDICAL COMPOUNDS, NAMELY, PEPTIDE SUBSTRATES USED IN ANALYZING AND DETECTING CERTAIN TOXINS FOR CLINICAL OR MEDICAL LABORATORY USE; DIETARY AND NUTRITIONAL SUPPLEMENTS; DIETARY SUPPLEMENTS; DIETARY SUPPLEMENTS FOR ANIMALS; DIETARY SUPPLEMENTS FOR HUMAN CONSUMPTION; MICRONUTRIENT ANIMAL FEED; NUTRACEUTICALS FOR THE TREATMENT OF HUMAN AND ANIMAL MEDICAL CONDITIONS, NAMELY, HEAVY METAL DEFICIENCIES, STRESS RELATED CONDITIONS, SKIN DISORDERS AND MYCOSES, DIETARY DISORDER AND MALFUNCTION, BACTERIAL INFECTIONS OF THE BUCCAL CAVITY AND DENTAL PLAQUE; NUTRACEUTICALS FOR USE AS A DIETARY SUPPLEMENT; NUTRITIVE SUBSTANCES FOR MICRO-ORGANISMS FOR MEDICAL USE; SYNTHETIC PEPTIDES FOR PHARMACEUTICAL PURPOSES; TESTING KITS CONTAINING PEPTIDE SUBSTRATES USED IN ANALYZING AND DETECTING CERTAIN TOXINS FOR CLINICAL OR MEDICAL LABORATORY USE; VACCINES; YEAST OR YEAST EXTRACTS FOR MEDICAL, VETERINARY OR PHARMACEUTICAL PURPOSES (U.S. CLS. 6, 18, 44, 46, 51 AND 52).

FIRST USE 6-0-2009; IN COMMERCE 6-0-2009.

CLASS 5—(Continued).

3,681,049. MOMENTUM MANAGEMENT LLC, BEVERLY HILLS, CA. SN 77-495,070. PUB. 11-4-2008, FILED 6-10-2008.



THE MARK CONSISTS OF THE WORD "ROCK" ATOP THE WORD "ON", WITH THE "O" IN "ON" BEING LARGER THAN THE OTHER LETTERS AND HAVING A SQUIGGLE DESIGN AT THE TOP.
 FOR DIETARY AND NUTRITIONAL SUPPLEMENTS; NUTRACEUTICALS FOR USE AS A DIETARY SUPPLEMENT (U.S. CLS. 6, 18, 44, 46, 51 AND 52).
 FIRST USE 6-25-2009; IN COMMERCE 6-25-2009.

3,681,063. A&J INTERNATIONAL TRADE COMPANY, LTD., RANCHO CUCAMONGA, CA. SN 77-497,343. PUB. 11-4-2008, FILED 6-12-2008.



THE MARK CONSISTS OF THE LETTERS "A", CAPITALIZED, "M", AND "Y" IN AN ITALICIZED CURSIVE FONT.
 FOR ADULT DIAPERS; FEMININE HYGIENE PADS; MENSTRUATION TAMPONS; PANTY LINERS; PANTY SHIELDS; SANITARY NAPKINS; SANITARY PADS; TAMPONS (U.S. CLS. 6, 18, 44, 46, 51 AND 52).
 FIRST USE 3-15-2009; IN COMMERCE 3-15-2009.

CLASS 5—(Continued).

3,681,077. FUNCTIONAL TECHNOLOGIES CORPORATION, VANCOUVER, CANADA. SN 77-500,308. PUB. 12-23-2008, FILED 6-16-2008.



THE COLOR(S) GREEN, BLUE, BROWN IS/ARE CLAIMED AS A FEATURE OF THE MARK.
 THE MARK CONSISTS OF A BLUE SPHERE ENCAPSULATED ON THE RIGHT SIDE BY A BROWN CURVE AND ON THE LEFT SIDE BY A GREEN CURVE.
 FOR BIOMEDICAL COMPOUNDS, NAMELY, PEPTIDE SUBSTRATES USED IN ANALYZING AND DETECTING CERTAIN TOXINS FOR CLINICAL OR MEDICAL LABORATORY USE; DIETARY AND NUTRITIONAL SUPPLEMENTS; DIETARY SUPPLEMENTS; DIETARY SUPPLEMENTS FOR ANIMALS; DIETARY SUPPLEMENTS FOR HUMAN CONSUMPTION; MICRONUTRIENT ANIMAL FEED; NUTRACEUTICALS FOR THE TREATMENT OF HUMAN AND ANIMAL MEDICAL CONDITIONS, NAMELY, HEAVY METAL DEFICIENCIES, STRESS RELATED CONDITIONS, SKIN DISORDERS AND MYCOSES, DIETARY DISORDER AND MALFUNCTION, BACTERIAL INFECTIONS OF THE BUCCAL CAVITY AND DENTAL PLAQUE; NUTRACEUTICALS FOR USE AS A DIETARY SUPPLEMENT; NUTRITIVE SUBSTANCES FOR MICROORGANISMS FOR MEDICAL USE; SYNTHETIC PEPTIDES FOR PHARMACEUTICAL PURPOSES; TESTING KITS CONTAINING PEPTIDE SUBSTRATES USED IN ANALYZING AND DETECTING CERTAIN TOXINS FOR CLINICAL OR MEDICAL LABORATORY USE; VACCINES; YEAST OR YEAST EXTRACTS FOR MEDICAL, VETERINARY OR PHARMACEUTICAL PURPOSES (U.S. CLS. 6, 18, 44, 46, 51 AND 52).
 FIRST USE 6-0-2009; IN COMMERCE 6-0-2009.

3,681,121. HEALTHY DIRECTIONS, LLC, POTOMAC, MD. SN 77-521,633. PUB. 3-31-2009, FILED 7-14-2008.



THE MARK CONSISTS OF STANDARD CHARACTERS WITHOUT CLAIM TO ANY PARTICULAR FONT, STYLE, SIZE, OR COLOR.
 FOR NUTRITIONAL SUPPLEMENTS (U.S. CLS. 6, 18, 44, 46, 51 AND 52).
 FIRST USE 9-11-2008; IN COMMERCE 9-11-2008.

CLASS 5—(Continued).

3,681,130. RIDLEY U.S. HOLDINGS INC., MANKATO, MN.
SN 77-522,801. PUB. 12-23-2008, FILED 7-15-2008.

RUNNER'S RHYTHM

THE MARK CONSISTS OF STANDARD CHARACTERS
WITHOUT CLAIM TO ANY PARTICULAR FONT, STYLE,
SIZE, OR COLOR.

FOR ANIMAL FEED SUPPLEMENTS (U.S. CLS. 6, 18,
44, 46, 51 AND 52).

FIRST USE 5-22-2009; IN COMMERCE 5-22-2009.

CLASS 5—(Continued).

3,681,181. CHAMPION PERFORMANCE PRODUCTS, INC.,
SUNRISE, FL. SN 77-544,377. PUB. 12-30-2008, FILED 8-12-
2008.

**ESSENTIAL NUTRITION FOR
THE DEMANDING NEEDS OF
ATHLETES**

THE MARK CONSISTS OF STANDARD CHARACTERS
WITHOUT CLAIM TO ANY PARTICULAR FONT, STYLE,
SIZE, OR COLOR.

FOR DIETARY AND NUTRITIONAL SUPPLEMENTS
(U.S. CLS. 6, 18, 44, 46, 51 AND 52).

FIRST USE 9-30-2008; IN COMMERCE 9-30-2008.

3,681,145. TRUOX, INC., MCCLELLAN, CA. SN 77-527,151.
PUB. 12-9-2008, FILED 7-21-2008.

Cryptolyte

THE MARK CONSISTS OF STANDARD CHARACTERS
WITHOUT CLAIM TO ANY PARTICULAR FONT, STYLE,
SIZE, OR COLOR.

FOR DISINFECTANTS FOR HYGIENE PURPOSES;
DISINFECTANTS FOR SANITARY PURPOSES (U.S.
CLS. 6, 18, 44, 46, 51 AND 52).

FIRST USE 12-2-2008; IN COMMERCE 5-27-2009.

3,681,202. BALCHEM CORPORATION, NEW HAMPTON,
NY. SN 77-549,408. PUB. 11-4-2008, FILED 8-18-2008.

AMINOSHURE

THE MARK CONSISTS OF STANDARD CHARACTERS
WITHOUT CLAIM TO ANY PARTICULAR FONT, STYLE,
SIZE, OR COLOR.

FOR ENCAPSULATED AMINO ACIDS FOR ANIMAL
NUTRITION (U.S. CLS. 6, 18, 44, 46, 51 AND 52).

FIRST USE 10-1-2008; IN COMMERCE 10-1-2008.

3,681,156. LAMETCO INTERNATIONAL LLC, BUCKNER,
KY. AND METALLO, TODD S., LOUISVILLE, KY. SN 77-
531,755. PUB. 12-16-2008, FILED 7-25-2008.

Zip-n-Zap

THE MARK CONSISTS OF STANDARD CHARACTERS
WITHOUT CLAIM TO ANY PARTICULAR FONT, STYLE,
SIZE, OR COLOR.

FOR DIETARY FOOD SUPPLEMENTS (U.S. CLS. 6, 18,
44, 46, 51 AND 52).

FIRST USE 3-1-2009; IN COMMERCE 4-1-2009.

3,681,221. STOKELY-VAN CAMP, INC., CHICAGO, IL. SN 77-
560,576. PUB. 12-23-2008, FILED 9-2-2008.

GATORADE

THE MARK CONSISTS OF STANDARD CHARACTERS
WITHOUT CLAIM TO ANY PARTICULAR FONT, STYLE,
SIZE, OR COLOR.

OWNER OF U.S. REG. NOS. 848,245, 1,605,457, AND
OTHERS.

FOR NON-ALCOHOLIC, VITAMIN AND/OR NUTRI-
TIONALLY FORTIFIED FRUIT-FLAVORED BEV-
ERAGES (U.S. CLS. 6, 18, 44, 46, 51 AND 52).

FIRST USE 1-30-2009; IN COMMERCE 1-30-2009.

CLASS 5—(Continued).

3,681,223. STOKELY-VAN CAMP, INC., CHICAGO, IL. SN 77-561,565. PUB. 12-23-2008, FILED 9-3-2008.

GATORADE A.M.

THE MARK CONSISTS OF STANDARD CHARACTERS WITHOUT CLAIM TO ANY PARTICULAR FONT, STYLE, SIZE, OR COLOR.

OWNER OF U.S. REG. NOS. 848,245, 3,243,095, AND OTHERS.

FOR NON-ALCOHOLIC, VITAMIN AND/OR NUTRITIONALLY FORTIFIED FRUIT-FLAVORED BEVERAGES (U.S. CLS. 6, 18, 44, 46, 51 AND 52).
FIRST USE 1-30-2009; IN COMMERCE 1-30-2009.

3,681,228. BRIAN R STEARNS, BROOMFIELD, CO. SN 77-563,606. PUB. 1-27-2009, FILED 9-5-2008.



THE COLOR(S) RED, WHITE, SILVER, BLACK, ORANGE IS/ARE CLAIMED AS A FEATURE OF THE MARK.

THE MARK CONSISTS OF A STICK FIGURE WITH ROCKET AND STARS. THE ROCKET AND STARS ARE LOCATED IN THE CIRCLE HEAD AREA. THE COLOR RED APPEARS IN THE NOSE CONE AND BOOSTERS OF THE ROCKET. THE COLOR ORANGE APPEARS IN THE FLAMES COMING OUT OF THE ROCKET. THE COLOR SILVER APPEARS IN THE BODY OF THE ROCKET AND IN THE BODY OF THE STICK FIGURE. THE COLOR WHITE APPEARS IN THE STARS. THE COLOR BLACK APPEARS IN THE REFLECTION ON THE BODY OF THE ROCKET AND INSIDE THE STICK FIGURE'S HEAD.

FOR VITAMIN FORTIFIED BEVERAGES (U.S. CLS. 6, 18, 44, 46, 51 AND 52).
FIRST USE 1-22-2009; IN COMMERCE 1-22-2009.

CLASS 5—(Continued).

3,681,259. FULLBAR LLC, GREENWOOD VILLAGE, CO. SN 77-573,384. PUB. 2-10-2009, FILED 9-18-2008.

FULLBITES

THE MARK CONSISTS OF STANDARD CHARACTERS WITHOUT CLAIM TO ANY PARTICULAR FONT, STYLE, SIZE, OR COLOR.

FOR MEAL REPLACEMENT SNACKS (U.S. CLS. 6, 18, 44, 46, 51 AND 52).

FIRST USE 7-1-2009; IN COMMERCE 7-1-2009.

3,681,267. VINTAGE PHARMACEUTICALS, LLC, HUNTSVILLE, AL. SN 77-576,973. PUB. 4-14-2009, FILED 9-23-2008.

GILDESS

THE MARK CONSISTS OF STANDARD CHARACTERS WITHOUT CLAIM TO ANY PARTICULAR FONT, STYLE, SIZE, OR COLOR.

FOR PHARMACEUTICAL ORAL CONTRACEPTIVES FOR PREVENTION OF PREGNANCY IN WOMEN (U.S. CLS. 6, 18, 44, 46, 51 AND 52).

FIRST USE 4-30-2009; IN COMMERCE 4-30-2009.

3,681,269. TCMZONE, LLC, CHANDLER, AZ. SN 77-577,150. PUB. 2-10-2009, FILED 9-23-2008.

TCM ZONE

THE MARK CONSISTS OF STANDARD CHARACTERS WITHOUT CLAIM TO ANY PARTICULAR FONT, STYLE, SIZE, OR COLOR.

FOR HERBAL DIETARY SUPPLEMENTS (U.S. CLS. 6, 18, 44, 46, 51 AND 52).
FIRST USE 1-28-2009; IN COMMERCE 1-28-2009.

CLASS 5—(Continued).

3,681,273. ALKERMES, INC., CAMBRIDGE, MA. SN 77-578,157. PUB. 2-17-2009, FILED 9-24-2008.

Vivitol

OWNER OF U.S. REG. NO. 3,104,288.
THE MARK CONSISTS OF THE TERM "VIVITROL" WITH AN ARCH OVER THE TWO "I"'S.
FOR POLYMER-BASED DRUG DELIVERY FORMULATIONS FOR CLINICAL USE; AND PHARMACEUTICAL PRODUCTS, NAMELY, INJECTABLE DRUG DELIVERY FORMULATIONS USED AS FACILITATING AGENTS FOR OTHER PHARMACEUTICAL PREPARATIONS (U.S. CLS. 6, 18, 44, 46, 51 AND 52).
FIRST USE 5-4-2008; IN COMMERCE 5-4-2009.

CLASS 5—(Continued).

3,681,304. MEDTECH PRODUCTS INC., IRVINGTON, NY. SN 77-588,226. PUB. 2-17-2009, FILED 10-8-2008.

THE CHLORASEPTIC TOUCH

THE MARK CONSISTS OF STANDARD CHARACTERS WITHOUT CLAIM TO ANY PARTICULAR FONT, STYLE, SIZE, OR COLOR.
OWNER OF U.S. REG. NOS. 837,014, 3,513,856, AND OTHERS.
FOR PHARMACEUTICAL PREPARATIONS FOR THE RELIEF OF THROAT AND MOUTH SORENESS (U.S. CLS. 6, 18, 44, 46, 51 AND 52).
FIRST USE 6-15-2009; IN COMMERCE 6-15-2009.

3,681,301. HEALTHY DIRECTIONS, LLC, POTOMAC, MD. SN 77-588,015. PUB. 12-23-2008, FILED 10-8-2008.

IFS DEFENSE

THE MARK CONSISTS OF STANDARD CHARACTERS WITHOUT CLAIM TO ANY PARTICULAR FONT, STYLE, SIZE, OR COLOR.
FOR NUTRITIONAL SUPPLEMENTS (U.S. CLS. 6, 18, 44, 46, 51 AND 52).
FIRST USE 4-0-2009; IN COMMERCE 4-0-2009.

3,681,306. NEW VISION ENTERPRISES INC. EL PASO, TX. SN 77-588,452. PUB. 3-3-2009, FILED 10-8-2008.

FIRE STARTER

THE MARK CONSISTS OF STANDARD CHARACTERS WITHOUT CLAIM TO ANY PARTICULAR FONT, STYLE, SIZE, OR COLOR.
FOR DIETARY SUPPLEMENTS (U.S. CLS. 6, 18, 44, 46, 51 AND 52).
FIRST USE 11-17-2008; IN COMMERCE 11-17-2008.

3,681,303. MEDTECH PRODUCTS INC., IRVINGTON, NY. SN 77-588,211. PUB. 2-17-2009, FILED 10-8-2008.

ONE TOUCH RELIEF. THE CHLORASEPTIC TOUCH.

THE MARK CONSISTS OF STANDARD CHARACTERS WITHOUT CLAIM TO ANY PARTICULAR FONT, STYLE, SIZE, OR COLOR.
OWNER OF U.S. REG. NOS. 837,014, 3,513,856, AND OTHERS.
FOR PHARMACEUTICAL PREPARATIONS FOR THE RELIEF OF THROAT AND MOUTH SORENESS (U.S. CLS. 6, 18, 44, 46, 51 AND 52).
FIRST USE 6-15-2009; IN COMMERCE 6-15-2009.

3,681,316. PROKOZ, INC. ALPHARETTA, GA. SN 77-590,540. PUB. 3-3-2009, FILED 10-10-2008.

GUARDRAIL

THE MARK CONSISTS OF STANDARD CHARACTERS WITHOUT CLAIM TO ANY PARTICULAR FONT, STYLE, SIZE, OR COLOR.
FOR HERBICIDES, INSECTICIDES, PESTICIDES AND FUNGICIDES FOR HOME, GARDEN AND LAWN USE AND FOR PROFESSIONAL USE (U.S. CLS. 6, 18, 44, 46, 51 AND 52).
FIRST USE 4-1-2009; IN COMMERCE 4-1-2009.

CLASS 5—(Continued).

3,681,357. ANIMAL SCIENCE PRODUCTS, INC., NACOGDOCHES, TX. SN 77-604,550. PUB. 3-17-2009, FILED 10-30-2008.

Vac-Pac

THE MARK CONSISTS OF STANDARD CHARACTERS WITHOUT CLAIM TO ANY PARTICULAR FONT, STYLE, SIZE, OR COLOR.

FOR ADJUVANTS FOR USE WITH VACCINES; VACCINE ADJUVANTS; VACCINE STABILIZERS; VACCINES; VETERINARY VACCINES (U.S. CLS. 6, 18, 44, 46, 51 AND 52).

FIRST USE 12-31-1994; IN COMMERCE 12-31-1994.

3,681,358. ANIMAL SCIENCE PRODUCTS, INC., NACOGDOCHES, TX. SN 77-604,786. PUB. 3-17-2009, FILED 10-31-2008.

Vac-Pac Plus

THE MARK CONSISTS OF STANDARD CHARACTERS WITHOUT CLAIM TO ANY PARTICULAR FONT, STYLE, SIZE, OR COLOR.

FOR ADJUVANTS FOR USE WITH VACCINES; VACCINE ADJUVANTS; VACCINE STABILIZERS; VACCINES; VETERINARY VACCINES (U.S. CLS. 6, 18, 44, 46, 51 AND 52).

FIRST USE 12-31-1994; IN COMMERCE 12-31-1994.

3,681,361. WATSON PHARMACEUTICALS, INC., CORONA, CA. SN 77-605,175. PUB. 3-3-2009, FILED 10-31-2008.



THE MARK CONSISTS OF TWO HORIZONTAL BARS, THE RIGHT ENDS OF WHICH ARE FLARED, SITUATED ABOVE THE WORD "RAPAFLO".

FOR PHARMACEUTICAL PREPARATION FOR THE TREATMENT OF PAINFUL OR DIFFICULT URINATION (U.S. CLS. 6, 18, 44, 46, 51 AND 52).

FIRST USE 3-23-2009; IN COMMERCE 3-23-2009.

CLASS 5—(Continued).

3,681,457. RECKITT BENCKISER INC., PARSIPPANY, NJ. SN 78-397,882. PUB. 8-30-2005, FILED 4-7-2004.

LYSOL DISINFECTING SPRAY TO GO

THE MARK CONSISTS OF STANDARD CHARACTERS WITHOUT CLAIM TO ANY PARTICULAR FONT, STYLE, SIZE, OR COLOR.

OWNER OF U.S. REG. NOS. 53,937, 831,212, AND OTHERS.

NO CLAIM IS MADE TO THE EXCLUSIVE RIGHT TO USE "DISINFECTING SPRAY", APART FROM THE MARK AS SHOWN.

FOR ALL PURPOSE DISINFECTING PREPARATIONS; SANITIZING PREPARATIONS FOR HOUSEHOLD, COMMERCIAL, INDUSTRIAL AND INSTITUTIONAL USE; GERMICIDES; DEODORIZERS AND SANITIZERS FOR BATHROOM AND TOILETS (U.S. CLS. 6, 18, 44, 46, 51 AND 52).

FIRST USE 12-20-2006; IN COMMERCE 12-20-2006.

3,681,483. CYMCORP INTERNATIONAL INC., KIRKLAND, CANADA. SN 78-573,450. PUB. 9-30-2008, FILED 2-23-2005.

TRIOZYME

THE MARK CONSISTS OF STANDARD CHARACTERS WITHOUT CLAIM TO ANY PARTICULAR FONT, STYLE, SIZE, OR COLOR.

PRIORITY CLAIMED UNDER SEC. 44(D) ON CANADA APPLICATION NO. 1243129, FILED 1-11-2005, REG. NO. TMA691730, DATED 7-10-2007, EXPIRES 7-10-2022.

FOR ENZYMATIC FOOD SUPPLEMENTS IN CAPSULE, TABLET, PILL AND POWDER FORM CONSISTING OF SPROUTED GRAINS FOR THE TREATMENT OF THE DIGESTIVE SYSTEM FOR THE ASSIMILATION OF NUTRIENTS, VITAMINS, MINERALS, AND TRACE ELEMENTS (U.S. CLS. 6, 18, 44, 46, 51 AND 52).

FIRST USE 10-20-2006; IN COMMERCE 10-20-2006.

3,681,497. RAINFOREST NUTRITIONALS, INC., RALEIGH, NC. SN 78-623,422. PUB. 7-24-2007, FILED 5-5-2005.

WATERWORKS

THE MARK CONSISTS OF STANDARD CHARACTERS WITHOUT CLAIM TO ANY PARTICULAR FONT, STYLE, SIZE, OR COLOR.

FOR DIETARY AND NUTRITIONAL SUPPLEMENTS (U.S. CLS. 6, 18, 44, 46, 51 AND 52).

FIRST USE 6-15-2009; IN COMMERCE 6-15-2009.

CLASS 5—(Continued).

3,681,500. EXPRESS DIAGNOSTICS INT'L, INC., MARION, IA. SN 78-645,766. PUB. 4-11-2006, FILED 6-7-2005.



FOR DRUG TESTING KITS COMPRISED PRIMARILY OF REAGENTS AND CHEMICALS FOR USE IN TESTING FOR THE PRESENCE OR ABSENCE OF CONTROLLED SUBSTANCES IN THE SALIVA AND URINE (U.S. CLS. 6, 18, 44, 46, 51 AND 52).

FIRST USE 6-1-2009; IN COMMERCE 6-1-2009.

CLASS 5—(Continued).

3,681,530. NANOBIO CORPORATION, ANN ARBOR, MI. SN 78-689,475. PUB. 5-9-2006, FILED 8-10-2005.

NANOVAX

THE MARK CONSISTS OF STANDARD CHARACTERS WITHOUT CLAIM TO ANY PARTICULAR FONT, STYLE, SIZE, OR COLOR.

OWNER OF U.S. REG. NOS. 2,737,404, 2,743,857, AND OTHERS.

FOR ANTI-MICROBIAL, ANTI-SPORICIDAL, ANTI-VIRAL, ANTI-FUNGAL, AND ANTI-BACTERIAL PREPARATIONS, SOLUTIONS, AND EMULSIONS FOR USE AS AN INTEGRAL COMPONENT OF VACCINES FOR THE PREVENTION OF MUCOSAL DISEASES AND ILLNESS CAUSED BY AIRBORNE VIRUS AND BACTERIA (U.S. CLS. 6, 18, 44, 46, 51 AND 52).

FIRST USE 8-10-2005; IN COMMERCE 6-15-2009.

3,681,629. VOMRAIS INNOVATIONS, INC., CHANDLER, AZ. SN 78-972,820. PUB. 5-1-2007, FILED 9-12-2006.

PROSIT

THE MARK CONSISTS OF STANDARD CHARACTERS WITHOUT CLAIM TO ANY PARTICULAR FONT, STYLE, SIZE, OR COLOR.

FOR ADHESIVE BANDAGES; ADHESIVE FOR BANDAGES FOR SKIN WOUNDS; ANALGESICS; ANESTHETICS FOR NON-SURGICAL USE; ANESTHETICS FOR SURGICAL AND NON-SURGICAL USE; ANESTHETICS FOR SURGICAL USE; ANTI-DERMOINFECTIVES; ANTI-INFECTIVES; ANTI-INFLAMMATORIES; ANTI-INFLAMMATORY AND ANTIPYRETIC PREPARATIONS; ANTIBACTERIAL SUBSTANCES FOR MEDICAL PURPOSES; ANTIMICROBIAL COATINGS TO PREVENT THE GROWTH OF MOLD, MILDEW, BACTERIA AND FUNGUS ON VARIOUS SURFACES; ANTIMICROBIALS FOR DERMATOLOGIC USE; ANTI-VIRALS; BACTERIOSTATS FOR MEDICINAL, DENTAL AND VETERINARY USE; BANDAGES FOR DRESSINGS; BANDAGES FOR SKIN WOUNDS; BURN DRESSINGS; DERMATOLOGICALS; DRESSINGS FOR WOUNDS, BURNS AND SURGERY; SELF ADHESIVE DRESSINGS; SHOE DEODORIZERS; SURGICAL BANDAGES; SURGICAL DRESSINGS; WOUND DRESSINGS (U.S. CLS. 6, 18, 44, 46, 51 AND 52).

FIRST USE 12-12-2006; IN COMMERCE 12-12-2006.

3,681,522. NERITES CORPORATION, MADISON, WI. SN 78-678,460. PUB. 4-11-2006, FILED 7-26-2005.

Medhesive

THE MARK CONSISTS OF STANDARD CHARACTERS WITHOUT CLAIM TO ANY PARTICULAR FONT, STYLE, SIZE, OR COLOR.

FOR ADHESIVES FOR DENTISTRY AND DENTAL TECHNICAL PURPOSES; DENTURE ADHESIVES; MEDICAL ADHESIVES FOR BINDING WOUNDS (U.S. CLS. 6, 18, 44, 46, 51 AND 52).

FIRST USE 3-17-2008; IN COMMERCE 3-17-2008.

CLASS 5—(Continued).

3,681,633. BAYER SCHERING PHARMA AKTIENGESELLSCHAFT, BERLIN, FED REP GERMANY. SN 78-979,346. PUB. 9-27-2005, FILED 9-8-2004.

INTENDIS

THE MARK CONSISTS OF STANDARD CHARACTERS WITHOUT CLAIM TO ANY PARTICULAR FONT, STYLE, SIZE, OR COLOR.
FOR PHARMACEUTICAL PREPARATIONS FOR USE IN DERMATOLOGY AND SKIN CARE (U.S. CLS. 6, 18, 44, 46, 51 AND 52).
FIRST USE 4-0-2003; IN COMMERCE 4-0-2003.

CLASS 6—METAL GOODS

3,680,114. RIVERWEST ENGINEERING & DESIGN, INC., WEST ALLIS, WI. SN 76-683,030. PUB. 9-23-2008, FILED 10-17-2007.



FOR RECYCLE CENTERS COMPRISED OF METAL BINS (U.S. CLS. 2, 12, 13, 14, 23, 25 AND 50).
FIRST USE 11-30-2007; IN COMMERCE 5-7-2008.

CLASS 6—(Continued).

3,680,316. RYDER CLIPS UNLIMITED, INC., LIGHTHOUSE POINT, FL. SN 77-186,619. PUB. 5-6-2008, FILED 5-21-2007.

DOES YOUR BIKE HAVE BELLS
OR DOES YOUR BIKE HAVE
BALLS?

THE MARK CONSISTS OF STANDARD CHARACTERS WITHOUT CLAIM TO ANY PARTICULAR FONT, STYLE, SIZE, OR COLOR.
FOR NOVELTY ORNAMENTS, BALL-SHAPED ORNAMENTS, AND HANGING SOUND PRODUCING BALL-SHAPED ORNAMENTS MADE OF COMMON METALS USED FOR ATTACHMENT TO VEHICLES (U.S. CLS. 2, 12, 13, 14, 23, 25 AND 50).
FIRST USE 7-13-2009; IN COMMERCE 7-13-2009.

3,680,491. C.E. SHEPHERD COMPANY, L.P., HOUSTON, TX. SN 77-315,607. PUB. 4-15-2008, FILED 10-29-2007.

MaxStop

THE MARK CONSISTS OF STANDARD CHARACTERS WITHOUT CLAIM TO ANY PARTICULAR FONT, STYLE, SIZE, OR COLOR.
FOR WIRE MESH SECURITY FENCE (U.S. CLS. 2, 12, 13, 14, 23, 25 AND 50).
FIRST USE 9-1-2008; IN COMMERCE 9-1-2008.

3,680,993. HIGH TECH GUTTER SUPPLY, CLIFTON, NJ. SN 77-481,409. PUB. 10-14-2008, FILED 5-22-2008.

LEAFTECHUS

THE MARK CONSISTS OF STANDARD CHARACTERS WITHOUT CLAIM TO ANY PARTICULAR FONT, STYLE, SIZE, OR COLOR.
FOR METAL GUTTER PROTECTION PRODUCTS, NAMELY, GUTTER PIPES, METAL GUTTERS AND GUTTER GUARDS (U.S. CLS. 2, 12, 13, 14, 23, 25 AND 50).
FIRST USE 4-1-2008; IN COMMERCE 4-1-2008.

CLASS 6—(Continued).

3,681,163. FIRSTCALL STUDIO EQUIPMENT, SYLMAR, CA. SN 77-534,373. PUB. 12-23-2008, FILED 7-30-2008.

RIGHTIGHT

THE MARK CONSISTS OF STANDARD CHARACTERS WITHOUT CLAIM TO ANY PARTICULAR FONT, STYLE, SIZE, OR COLOR.

FOR METAL TUBING RECEIVER MOUNTS FOR SECURING EQUIPMENT TO AERIAL BOOM BASKETS (U.S. CLS. 2, 12, 13, 14, 23, 25 AND 50).

FIRST USE 9-22-2008; IN COMMERCE 9-22-2008.

3,681,272. PRIMESOURCE BUILDING PRODUCTS, INC., CARROLLTON, TX. SN 77-578,111. PUB. 3-10-2009, FILED 9-24-2008.



PRIMESOURCE
BUILDING PRODUCTS INC.

OWNER OF U.S. REG. NOS. 1,703,953 AND 2,215,518. NO CLAIM IS MADE TO THE EXCLUSIVE RIGHT TO USE "BUILDING PRODUCTS INC.", APART FROM THE MARK AS SHOWN.

FOR METAL BUILDING MATERIALS, NAMELY, HANGER WIRE AND CLIPS AND FASTENING PINS FOR SECURING HANGER WIRE (U.S. CLS. 2, 12, 13, 14, 23, 25 AND 50).

FIRST USE 6-0-2007; IN COMMERCE 6-0-2007.

3,681,364. BRUCE TEMESY, DBA YIKESID, PALOS VERDES ESTATES, CA. SN 77-607,090. PUB. 3-24-2009, FILED 11-4-2008.

yikes ID

THE MARK CONSISTS OF STANDARD CHARACTERS WITHOUT CLAIM TO ANY PARTICULAR FONT, STYLE, SIZE, OR COLOR.

NO CLAIM IS MADE TO THE EXCLUSIVE RIGHT TO USE "ID", APART FROM THE MARK AS SHOWN.

FOR IDENTIFICATION TAGS OF METAL (U.S. CLS. 2, 12, 13, 14, 23, 25 AND 50).

FIRST USE 8-1-2008; IN COMMERCE 6-1-2009.

CLASS 6—(Continued).

3,681,473. NEWELL OPERATING COMPANY, ATLANTA, GA. SN 78-537,017. PUB. 3-21-2006, FILED 12-22-2004.

SMALL CHANGE BIG IMPACT

THE MARK CONSISTS OF STANDARD CHARACTERS WITHOUT CLAIM TO ANY PARTICULAR FONT, STYLE, SIZE, OR COLOR.

FOR METAL CABINET HARDWARE, NAMELY, HINGES, DOOR CATCHES, DRAWER CATCHES, DRAWER PULLS, KNOBS, AND LATCHES; METAL DESK HARDWARE, NAMELY, DRAWER SLIDES, DRAWER PULLS, AND KNOBS; COAT HOOKS; AND HAND RAIL BRACKETS, ALL MADE PRIMARILY OF METAL, METAL GARMENT HOOKS (U.S. CLS. 2, 12, 13, 14, 23, 25 AND 50).

FIRST USE 7-31-2005; IN COMMERCE 7-31-2005.

3,681,485. HAGEMEYER NORTH AMERICA, INC., CHARLESTON, SC. SN 78-582,351. PUB. 4-18-2006, FILED 3-8-2005.

VERSAPRO

THE MARK CONSISTS OF STANDARD CHARACTERS WITHOUT CLAIM TO ANY PARTICULAR FONT, STYLE, SIZE, OR COLOR.

FOR METAL FASTENERS, NAMELY, NUTS, BOLTS, ANCHORS, TOGGLE BOLTS, HEX CAP SCREWS, CONCRETE SCREWS, LAG BOLTS, CHAIN, SHEET METAL SCREWS, DRY WALL SCREWS, EYE BOLTS, FLAT HEAD MACHINE SCREWS, LOCK WASHERS, TAPPING SCREWS, WASHERS, GROUND CLIPS, PLATE SCREWS, TIE WIRE, AND NAIL PLATES; AND METAL CASTERS (U.S. CLS. 2, 12, 13, 14, 23, 25 AND 50).

FIRST USE 9-0-2007; IN COMMERCE 9-0-2007.

CLASS 7—MACHINERY

CLASS 7—(Continued).

3,680,094. CONTOUR HARDENING, INC., INDIANAPOLIS, IN. SN 76-665,449. PUB. 5-1-2007, FILED 9-1-2006.

CLASS 7—(Continued).

3,680,113. CHAIDEMENOS, SPYROS, LONDON, ONTARIO, CANADA. SN 76-682,852. PUB. 9-23-2008, FILED 10-11-2007.

THE POWER TO BE THERE FIRST

THE MARK CONSISTS OF STANDARD CHARACTERS WITHOUT CLAIM TO ANY PARTICULAR FONT, STYLE, SIZE, OR COLOR.

NO CLAIM IS MADE TO THE EXCLUSIVE RIGHT TO USE "POWER", APART FROM THE MARK AS SHOWN.

FOR VEHICLE-MOUNTED AC GENERATORS (U.S. CLS. 13, 19, 21, 23, 31, 34 AND 35).

FIRST USE 11-1-2008; IN COMMERCE 11-1-2008.

WISE MAN

THE MARK CONSISTS OF STANDARD CHARACTERS WITHOUT CLAIM TO ANY PARTICULAR FONT, STYLE, SIZE, OR COLOR.

NO CLAIM IS MADE TO THE EXCLUSIVE RIGHT TO USE "WISE", APART FROM THE MARK AS SHOWN.

FOR MACHINE TOOLS, NAMELY, CLAMPS FOR USE IN THE PRECISION CLAMPING OF WORK PIECES (U.S. CLS. 13, 19, 21, 23, 31, 34 AND 35).

FIRST USE 10-12-2007; IN COMMERCE 10-12-2007.

3,680,099. LEAR BAYLOR, INC., GARDEN GROVE, CA. SN 76-674,746. PUB. 9-25-2007, FILED 3-28-2007.

POWERSURGE

THE MARK CONSISTS OF STANDARD CHARACTERS WITHOUT CLAIM TO ANY PARTICULAR FONT, STYLE, SIZE, OR COLOR.

FOR MARINE ELECTRIC POWER PLANTS, NAMELY, ELECTRIC BOAT MOTORS; GEARS FOR BOATS AND ELECTRICAL CONTROLLERS FOR MOTORS, ALL SOLD AS A COMPONENT PART OF ELECTRIC BOAT MOTORS (U.S. CLS. 13, 19, 21, 23, 31, 34 AND 35).

FIRST USE 5-1-2009; IN COMMERCE 5-1-2009.

3,680,186. SAXON ENERGY SERVICES, INC., CALGARY, CANADA. SN 77-074,544. PUB. 9-23-2008, FILED 1-2-2007.

ATD

3,680,103. HOLLEY PERFORMANCE PRODUCTS, INC., BOWLING GREEN, KY. SN 76-676,998. PUB. 10-23-2007, FILED 5-17-2007.

SPEED WARRIOR

THE MARK CONSISTS OF STANDARD CHARACTERS WITHOUT CLAIM TO ANY PARTICULAR FONT, STYLE, SIZE, OR COLOR.

NO CLAIM IS MADE TO THE EXCLUSIVE RIGHT TO USE "SPEED", APART FROM THE MARK AS SHOWN.

FOR INTAKE MANIFOLDS FOR LAND VEHICLE INTERNAL COMBUSTION ENGINES (U.S. CLS. 13, 19, 21, 23, 31, 34 AND 35).

FIRST USE 4-25-2008; IN COMMERCE 4-25-2008.

THE MARK CONSISTS OF STANDARD CHARACTERS WITHOUT CLAIM TO ANY PARTICULAR FONT, STYLE, SIZE, OR COLOR.

PRIORITY CLAIMED UNDER SEC. 44(D) ON CANADA APPLICATION NO. 1326066, FILED 11-28-2006, REG. NO. TMA708102, DATED 2-22-2008, EXPIRES 2-22-2023.

FOR OIL AND GAS WELL DRILLING RIGS (U.S. CLS. 13, 19, 21, 23, 31, 34 AND 35).

FIRST USE 9-0-2008; IN COMMERCE 9-0-2008.

CLASS 7—(Continued).

3,680,300. CLYDE BERGEMANN, INC., ATLANTA, GA. SN 77-181,443. PUB. 11-6-2007, FILED 5-15-2007.

CLYBER

THE MARK CONSISTS OF STANDARD CHARACTERS WITHOUT CLAIM TO ANY PARTICULAR FONT, STYLE, SIZE, OR COLOR.

FOR APPARATUS, NAMELY, STEAM CLEANERS, VACUUM CLEANERS, HIGH-PRESSURE WASHERS, JET WASHERS, DESLAGGERS, SHOT CLEANERS, SOOTBLOWERS AND WATER CANNONS, FOR CLEANING INDUSTRIAL PLANT AND MACHINERY, POWER GENERATION PLANT, POWER GENERATION EQUIPMENT AND GENERATORS; APPARATUS AND MACHINES, NAMELY, STEAM CLEANERS, VACUUM-CLEANERS, HIGH-PRESSURE WASHERS, JET WASHERS, DESLAGGERS, SHOT CLEANERS, SOOTBLOWERS AND WATER CANNONS FOR CLEANING BOILERS, HEAT EXCHANGERS AND HEATERS; SOOTBLOWERS; MATERIALS HANDLING APPARATUS, NAMELY, DISCHARGING HOPPERS, DRAG CHAINS, DRAG LINES, CONVEYORS AND TRANSPORTERS, APPARATUS FOR HANDLING BULK MATERIALS AND LOOSE MATERIALS, NAMELY, CONVEYORS, TRANSPORTERS AND PNEUMATIC CONVEYORS, ALL FOR USE IN THE POWER GENERATION INDUSTRY; REPLACEMENT PARTS AND FITTINGS FOR ALL THE AFORESAID GOODS (U.S. CLS. 13, 19, 21, 23, 31, 34 AND 35).

FIRST USE 6-1-2008; IN COMMERCE 6-1-2008.

CLASS 7—(Continued).

3,680,427. CLEAN CASH TECHNOLOGIES, INC., CLEARWATER, FL. SN 77-290,202. PUB. 3-25-2008, FILED 9-27-2007.

BETTER BILL

THE MARK CONSISTS OF STANDARD CHARACTERS WITHOUT CLAIM TO ANY PARTICULAR FONT, STYLE, SIZE, OR COLOR.

FOR CLEANING MACHINE, NAMELY, A MACHINE USED FOR THE WASHING OF PAPER CURRENCY (U.S. CLS. 13, 19, 21, 23, 31, 34 AND 35).

FIRST USE 11-1-2008; IN COMMERCE 11-1-2008.

3,680,432. INTERNATIONAL CONSORTIUM, HENDERSONVILLE, TN. SN 77-293,744. PUB. 10-14-2008, FILED 10-2-2007.

TRAILER DRIVE SYSTEMS

THE MARK CONSISTS OF STANDARD CHARACTERS WITHOUT CLAIM TO ANY PARTICULAR FONT, STYLE, SIZE, OR COLOR.

NO CLAIM IS MADE TO THE EXCLUSIVE RIGHT TO USE "TRAILER" AND "SYSTEMS", APART FROM THE MARK AS SHOWN.

FOR ELECTRIC AND HYDRAULIC MECHANISMS TO ASSIST IN MANEUVERING AND HITCHING A TRAILER, CONSISTING OF A HYDRAULIC CYLINDER, AN ELECTRIC MOTOR AND JACKSCREW, OR A LINEAR ACTUATOR FOR RAISING AND LOWERING A TRAILER, HYDRAULIC WHEELS OR TRACK MOTORS OR ELECTRIC WHEEL MOTORS WITH CHAIN REDUCTION FOR MANEUVERING A TRAILER, AND A HANDHELD REMOTE CONTROL OR DETACHABLE HANDHELD CONTROL MODULE FOR OPERATING AND CONTROLLING THE VARIOUS MECHANISMS (U.S. CLS. 13, 19, 21, 23, 31, 34 AND 35).

FIRST USE 9-29-2006; IN COMMERCE 9-29-2006.

3,680,389. A. GOLDBERGER CONTROLS, INC., KUTZTOWN, PA. SN 77-251,526. PUB. 2-12-2008, FILED 8-9-2007.

VACUUMJAK

THE MARK CONSISTS OF STANDARD CHARACTERS WITHOUT CLAIM TO ANY PARTICULAR FONT, STYLE, SIZE, OR COLOR.

FOR VACUUM PUMPS (U.S. CLS. 13, 19, 21, 23, 31, 34 AND 35).

FIRST USE 1-15-2009; IN COMMERCE 1-15-2009.

CLASS 7—(Continued).

3,680,433. INTERNATIONAL CONSORTIUM, HENDERSONVILLE, TN. SN 77-293,748. PUB. 10-14-2008, FILED 10-2-2007.

iDrive

THE MARK CONSISTS OF STANDARD CHARACTERS WITHOUT CLAIM TO ANY PARTICULAR FONT, STYLE, SIZE, OR COLOR.

FOR ELECTRIC AND HYDRAULIC MECHANISMS TO ASSIST IN MANEUVERING AND HITCHING A TRAILER, CONSISTING OF A HYDRAULIC CYLINDER, AN ELECTRIC MOTOR AND JACKSCREW, OR A LINEAR ACTUATOR FOR RAISING AND LOWERING A TRAILER, HYDRAULIC WHEELS OR TRACK MOTORS OR ELECTRIC WHEEL MOTORS WITH CHAIN REDUCTION FOR MANEUVERING A TRAILER, AND A HANDHELD REMOTE CONTROL OR DETACHABLE HANDHELD CONTROL MODULE FOR OPERATING AND CONTROLLING THE VARIOUS MECHANISMS (U.S. CLS. 13, 19, 21, 23, 31, 34 AND 35).

FIRST USE 9-29-2006; IN COMMERCE 9-29-2006.

3,680,436. INTERNATIONAL CONSORTIUM, HENDERSONVILLE, TN. SN 77-294,201. PUB. 10-14-2008, FILED 10-2-2007.

iDrive

Trailer Drive Systems

NO CLAIM IS MADE TO THE EXCLUSIVE RIGHT TO USE "TRAILER" AND "SYSTEMS", APART FROM THE MARK AS SHOWN.

FOR ELECTRIC AND HYDRAULIC MECHANISMS TO ASSIST IN MANEUVERING AND HITCHING A TRAILER, CONSISTING OF A HYDRAULIC CYLINDER, AN ELECTRIC MOTOR AND JACKSCREW, OR A LINEAR ACTUATOR FOR RAISING AND LOWERING A TRAILER, HYDRAULIC WHEELS OR TRACK MOTORS OR ELECTRIC WHEEL MOTORS WITH CHAIN REDUCTION FOR MANEUVERING A TRAILER, AND A HANDHELD REMOTE CONTROL OR DETACHABLE HANDHELD CONTROL MODULE FOR OPERATING AND CONTROLLING THE VARIOUS MECHANISMS E HANDHELD CONTROL MODULE FOR OPERATING AND CONTROLLING THE VARIOUS MECHANISMS (U.S. CLS. 13, 19, 21, 23, 31, 34 AND 35).

FIRST USE 9-29-2006; IN COMMERCE 9-29-2006.

CLASS 7—(Continued).

3,680,471. HARDINGE, INC., ELMIRA, NY. SN 77-308,634. PUB. 4-1-2008, FILED 10-19-2007.

5C² ROTARY INDEXERS

NO CLAIM IS MADE TO THE EXCLUSIVE RIGHT TO USE "ROTARY INDEXERS", APART FROM THE MARK AS SHOWN.

FOR COLLETS (U.S. CLS. 13, 19, 21, 23, 31, 34 AND 35). FIRST USE 2-0-2008; IN COMMERCE 2-0-2008.

3,680,520. REGAL BELOIT ELECTRIC MOTORS, INC., FORT WAYNE, IN. SN 77-324,710. PUB. 10-14-2008, FILED 11-8-2007.

Proline

THE MARK CONSISTS OF STANDARD CHARACTERS WITHOUT CLAIM TO ANY PARTICULAR FONT, STYLE, SIZE, OR COLOR.

FOR ELECTRICAL RESIDENTIAL AND COMMERCIAL HVAC AND REFRIGERATION MOTORS (U.S. CLS. 13, 19, 21, 23, 31, 34 AND 35).

FIRST USE 6-1-2008; IN COMMERCE 6-1-2008.

3,680,658. MORIDGE MANUFACTURING, INC., MOUNDRIDGE, KS. SN 77-360,922. PUB. 4-15-2008, FILED 12-28-2007.

ANTIVIBE POWER PLATFORM

THE MARK CONSISTS OF STANDARD CHARACTERS WITHOUT CLAIM TO ANY PARTICULAR FONT, STYLE, SIZE, OR COLOR.

NO CLAIM IS MADE TO THE EXCLUSIVE RIGHT TO USE "PLATFORM", APART FROM THE MARK AS SHOWN.

FOR RIDING LAWN MOWER PARTS, NAMELY, STRUCTURAL ASSEMBLIES WHICH ISOLATE THE ENGINE AND DRIVE TRAIN FROM THE OPERATOR LOCATION (U.S. CLS. 13, 19, 21, 23, 31, 34 AND 35).

FIRST USE 10-25-2007; IN COMMERCE 6-26-2009.

CLASS 7—(Continued).

3,680,813. SMURFIT-STONE CONTAINER ENTERPRISES, INC., CHICAGO, IL. SN 77-441,706. PUB. 10-14-2008, FILED 4-7-2008.

META WRAP-8

THE MARK CONSISTS OF STANDARD CHARACTERS WITHOUT CLAIM TO ANY PARTICULAR FONT, STYLE, SIZE, OR COLOR.

OWNER OF U.S. REG. NO. 2,173,188.
FOR PACKAGING MACHINERY (U.S. CLS. 13, 19, 21, 23, 31, 34 AND 35).
FIRST USE 11-9-2008; IN COMMERCE 11-9-2008.

3,680,884. VALENITE, LLC, MADISON HEIGHTS, MI. SN 77-465,879. PUB. 9-30-2008, FILED 5-5-2008.

VFORCE

THE MARK CONSISTS OF STANDARD CHARACTERS WITHOUT CLAIM TO ANY PARTICULAR FONT, STYLE, SIZE, OR COLOR.

FOR TOOLS FOR POWER OPERATED METAL CUTTING MACHINES AND TOOLS, NAMELY, MILLING TOOLS (U.S. CLS. 13, 19, 21, 23, 31, 34 AND 35).
FIRST USE 4-0-2008; IN COMMERCE 5-0-2008.

3,680,938. MEYER PRODUCTS, CLEVELAND, OH. SN 77-473,044. PUB. 10-21-2008, FILED 5-13-2008.

DRIVE PRO

THE MARK CONSISTS OF STANDARD CHARACTERS WITHOUT CLAIM TO ANY PARTICULAR FONT, STYLE, SIZE, OR COLOR.

FOR SNOW PLOWS (U.S. CLS. 13, 19, 21, 23, 31, 34 AND 35).
FIRST USE 3-0-2007; IN COMMERCE 3-0-2007.

CLASS 7—(Continued).

3,680,939. MEYER PRODUCTS, CLEVELAND, OH. SN 77-473,107. PUB. 10-21-2008, FILED 5-13-2008.

LOT PRO

THE MARK CONSISTS OF STANDARD CHARACTERS WITHOUT CLAIM TO ANY PARTICULAR FONT, STYLE, SIZE, OR COLOR.

FOR SNOW PLOWS (U.S. CLS. 13, 19, 21, 23, 31, 34 AND 35).
FIRST USE 3-0-2008; IN COMMERCE 3-0-2008.

3,680,941. MEYER PRODUCTS LLC, CLEVELAND, OH. SN 77-473,141. PUB. 10-14-2008, FILED 5-13-2008.

ROAD PRO

THE MARK CONSISTS OF STANDARD CHARACTERS WITHOUT CLAIM TO ANY PARTICULAR FONT, STYLE, SIZE, OR COLOR.

FOR SNOW PLOWS (U.S. CLS. 13, 19, 21, 23, 31, 34 AND 35).
FIRST USE 8-0-2008; IN COMMERCE 8-0-2008.

3,680,956. NISSEI PLASTIC INDUSTRIAL CO., LTD., NAGANO-KEN, JAPAN. SN 77-474,865. PUB. 1-20-2009, FILED 5-15-2008.

X-PUMP

THE MARK CONSISTS OF STANDARD CHARACTERS WITHOUT CLAIM TO ANY PARTICULAR FONT, STYLE, SIZE, OR COLOR.

FOR PLASTIC PROCESSING MACHINES, NAMELY, PLASTIC INJECTION MOLDING MACHINE, PLASTIC BLOW MOLDING MACHINE, PLASTIC STRETCH BLOW MOLDING MACHINE; RUBBER-GOODS MANUFACTURING MACHINES, NAMELY, INJECTION MOLDING MACHINE (U.S. CLS. 13, 19, 21, 23, 31, 34 AND 35).
FIRST USE 2-5-2006; IN COMMERCE 2-5-2006.

CLASS 7—(Continued).

3,681,037. HEALTHY GAIN INVESTMENTS, LIMITED, TORTOLA, BR.VIRGIN ISLANDS. SN 77-491,458. PUB. 11-4-2008, FILED 6-5-2008.

HOOVER PLATINUM COLLECTION

THE MARK CONSISTS OF STANDARD CHARACTERS WITHOUT CLAIM TO ANY PARTICULAR FONT, STYLE, SIZE, OR COLOR.

OWNER OF U.S. REG. NOS. 715,707, 2,896,365, AND OTHERS.

NO CLAIM IS MADE TO THE EXCLUSIVE RIGHT TO USE "COLLECTION", APART FROM THE MARK AS SHOWN.

FOR FLOOR CLEANING MACHINES (U.S. CLS. 13, 19, 21, 23, 31, 34 AND 35).

FIRST USE 7-0-2008; IN COMMERCE 7-0-2008.

3,681,045. Q INDUSTRIES, INC., FT. LAUDERDALE, FL. SN 77-494,187. PUB. 11-4-2008, FILED 6-9-2008.

DIABLOWW

THE MARK CONSISTS OF STANDARD CHARACTERS WITHOUT CLAIM TO ANY PARTICULAR FONT, STYLE, SIZE, OR COLOR.

FOR AIR COMPRESSORS (U.S. CLS. 13, 19, 21, 23, 31, 34 AND 35).

FIRST USE 1-7-2009; IN COMMERCE 1-7-2009.

3,681,120. EMHART GLASS S.A., CHAM, SWITZERLAND. SN 77-521,486. PUB. 12-9-2008, FILED 7-14-2008.

FLEXINSPECT

THE MARK CONSISTS OF STANDARD CHARACTERS WITHOUT CLAIM TO ANY PARTICULAR FONT, STYLE, SIZE, OR COLOR.

OWNER OF U.S. REG. NOS. 2,374,400 AND 2,374,620.

FOR GLASS FORMING EQUIPMENT, NAMELY, GLASS FEEDERS, GLASS FORMING MACHINES, GLASS INSPECTION MACHINES, AND ELECTRICAL CONTROL SYSTEMS SOLD AS A COMPONENT PART OF THE LISTED GLASS FORMING EQUIPMENT (U.S. CLS. 13, 19, 21, 23, 31, 34 AND 35).

FIRST USE 10-29-2008; IN COMMERCE 10-29-2008.

CLASS 7—(Continued).

3,681,129. DELAWARE CAPITAL FORMATION, INC., WILMINGTON, DE. SN 77-522,461. PUB. 12-30-2008, FILED 7-15-2008.



OWNER OF U.S. REG. NOS. 941,402, 1,404,635, AND 1,905,333.

THE MARK CONSISTS OF THE WORDS "WISECO ARMORGLIDE" IN A STYLIZED FORM, TOGETHER WITH A SHIELD DESIGN BEHIND THE WORD "ARMORGLIDE".

FOR COATINGS SOLD AS AN INTEGRAL COMPONENT OF PISTONS FOR ENGINES (U.S. CLS. 13, 19, 21, 23, 31, 34 AND 35).

FIRST USE 1-1-2009; IN COMMERCE 1-1-2009.

3,681,234. MULTQUIP, INC., CARSON, CA. SN 77-565,827. PUB. 1-27-2009, FILED 9-9-2008.

SLH

THE MARK CONSISTS OF STANDARD CHARACTERS WITHOUT CLAIM TO ANY PARTICULAR FONT, STYLE, SIZE, OR COLOR.

FOR CONSTRUCTION EQUIPMENT, NAMELY, SELF-LEVELING HANDLES FOR CONCRETE SAWS OR OTHER EQUIPMENT WITH TILT FUNCTIONS MAINTAINING THE HANDLE AT COMFORTABLE OPERATOR'S HEIGHT (U.S. CLS. 13, 19, 21, 23, 31, 34 AND 35).

FIRST USE 12-13-2005; IN COMMERCE 12-13-2005.

CLASS 7—(Continued).

3,681,268. PRO CONSULTING SPECIALISTS ENGINEERING, DBA PM TECHNOLOGIES, OSSEO, MN. SN 77-577,003. PUB. 2-17-2009, FILED 9-23-2008.

Jet-Direct

THE MARK CONSISTS OF STANDARD CHARACTERS WITHOUT CLAIM TO ANY PARTICULAR FONT, STYLE, SIZE, OR COLOR.

FOR AGITATORS FOR CIRCULATING LIQUID MEDIA; HIGH-PRESSURE PUMPS FOR WASHING APPLIANCES AND INSTALLATIONS; MACHINES FOR CLEANING SURFACES USING HIGH PRESSURE WATER; MULTI-PURPOSE HIGH PRESSURE WASHERS; PRESSURE WASHING MACHINES (U.S. CLS. 13, 19, 21, 23, 31, 34 AND 35).

FIRST USE 12-1-2008; IN COMMERCE 12-1-2008.

3,681,290. FORMAX, INC., MOKENA, IL. SN 77-582,171. PUB. 3-10-2009, FILED 9-30-2008.

CASHINEDGE

THE MARK CONSISTS OF STANDARD CHARACTERS WITHOUT CLAIM TO ANY PARTICULAR FONT, STYLE, SIZE, OR COLOR.

OWNER OF U.S. REG. NOS. 1,205,134 AND 1,684,297. FOR ELECTRIC FOOD PROCESSING MACHINES, NAMELY, MACHINES FOR SLICING FOOD PRODUCTS, AND PARTS THEREFOR (U.S. CLS. 13, 19, 21, 23, 31, 34 AND 35).

FIRST USE 2-6-2009; IN COMMERCE 2-6-2009.

3,681,308. BISON GEAR & ENGINEERING CORP., ST. CHARLES, IL. SN 77-588,683. PUB. 1-20-2009, FILED 10-8-2008.

FLEXTORQ

THE MARK CONSISTS OF STANDARD CHARACTERS WITHOUT CLAIM TO ANY PARTICULAR FONT, STYLE, SIZE, OR COLOR.

FOR ELECTRIC MOTORS FOR MACHINES, NAMELY, GEAR MOTORS, FRACTIONAL HORSE-POWER GEAR MOTORS, ELECTRIC MOTORS FOR MACHINES WITH DIGITAL SERVO DRIVE CONTROLLERS AND REPLACEMENT PARTS AND FITTINGS THEREFOR (U.S. CLS. 13, 19, 21, 23, 31, 34 AND 35).

FIRST USE 3-1-2009; IN COMMERCE 3-1-2009.

CLASS 7—(Continued).

3,681,309. BISON GEAR & ENGINEERING CORP., ST. CHARLES, IL. SN 77-588,781. PUB. 1-20-2009, FILED 10-8-2008.

FlexTorq

THE MARK CONSISTS OF A STYLIZED FORM OF THE MARK.

FOR ELECTRIC MOTORS FOR MACHINES, NAMELY, GEAR MOTORS, FRACTIONAL HORSE-POWER GEAR MOTORS, ELECTRIC MOTORS FOR MACHINES WITH DIGITAL SERVO DRIVE CONTROLLERS AND REPLACEMENT PARTS AND FITTINGS THEREFOR (U.S. CLS. 13, 19, 21, 23, 31, 34 AND 35).

FIRST USE 3-1-2009; IN COMMERCE 3-1-2009.

3,681,455. J E PISTONS, INC., HUNTINGTON BEACH, CA. SN 78-372,682. PUB. 10-4-2005, FILED 2-23-2004.

TUFF SKIRT

THE MARK CONSISTS OF STANDARD CHARACTERS WITHOUT CLAIM TO ANY PARTICULAR FONT, STYLE, SIZE, OR COLOR.

NO CLAIM IS MADE TO THE EXCLUSIVE RIGHT TO USE "SKIRT", APART FROM THE MARK AS SHOWN.

FOR INTERNAL COMBUSTION ENGINE COATINGS SOLD AS AN INTEGRAL COMPONENT OF ENGINE PISTONS (U.S. CLS. 13, 19, 21, 23, 31, 34 AND 35).

FIRST USE 1-1-2007; IN COMMERCE 1-1-2007.

3,681,555. MEIKO MASCHINENBAU GMBH & CO. KG, OFFENBURG, FED REP GERMANY. SN 78-773,987. PUB. 3-25-2008, FILED 12-15-2005.



THE COLOR(S) BLUE, WHITE, BLACK IS/ARE CLAIMED AS A FEATURE OF THE MARK.

CLASS 7—(Continued).

THE COLOR BLUE APPEARS IN THE RECTANGULAR BACKGROUND BEHIND THE WORDING "MIKE CONTROLLED". THE COLOR WHITE APPEARS IN THE WORDING "CONTROLLED". THE COLOR BLACK APPEARS IN THE WORDING "MIKE".

FOR MACHINE AND MACHINE TOOLS, NAMELY, WASHING MACHINES FOR INDUSTRIAL PARTS, TEXTILE WASHING MACHINES FOR INDUSTRIAL PURPOSES; DISHWASHERS FOR INDUSTRIAL USE; AUTOMATIC WASHING MACHINES FOR TROLLEYS, CONTAINERS AND TRANSPORT CARTS; ROLLER CONVEYORS; AUTOMATIC STACKING MACHINES; ELECTRIC MACHINES FOR SORTING, NAMELY, WASTE SORTING MACHINES, SILVERWARE SORTING MACHINES, TRAY SORTING MACHINES, DISH SORTING MACHINES, DRINKING GLASS AND CUP SORTING MACHINES, SORTING MACHINES FOR LEFTOVER FOODS AND SORTING MACHINES FOR COVERS FOR FOOD; SORTING MACHINES AND STACKING MACHINES FOR TABLE WEAR (U.S. CLS. 13, 19, 21, 23, 31, 34 AND 35).

FIRST USE 4-0-2003; IN COMMERCE 4-0-2003.

3,681,578. JMP INDUSTRIES, INC., CLEVELAND, OH. SN 78-833,520. PUB. 10-24-2006, FILED 3-9-2006.

CRM-114

THE MARK CONSISTS OF STANDARD CHARACTERS WITHOUT CLAIM TO ANY PARTICULAR FONT, STYLE, SIZE, OR COLOR.

FOR EXTRUDING MACHINE PARTS, NAMELY, DIE PLATES, DIE PLATE HOLDERS, DIE INSERTS AND DIES (U.S. CLS. 13, 19, 21, 23, 31, 34 AND 35).

FIRST USE 6-1-2009; IN COMMERCE 6-1-2009.

3,681,579. JMP INDUSTRIES, INC., CLEVELAND, OH. SN 78-833,547. PUB. 10-24-2006, FILED 3-9-2006.

FGD-135

THE MARK CONSISTS OF STANDARD CHARACTERS WITHOUT CLAIM TO ANY PARTICULAR FONT, STYLE, SIZE, OR COLOR.

FOR EXTRUDING MACHINE PARTS, NAMELY, DIE PLATES, DIE PLATE HOLDERS, DIE INSERTS AND DIES (U.S. CLS. 13, 19, 21, 23, 31, 34 AND 35).

FIRST USE 6-1-2009; IN COMMERCE 6-1-2009.

CLASS 7—(Continued).

3,681,587. GEMMILL, TERRENCE N., MILL CREEK, WA. SN 78-852,357. PUB. 11-21-2006, FILED 4-3-2006.

STALLGEM

THE MARK CONSISTS OF STANDARD CHARACTERS WITHOUT CLAIM TO ANY PARTICULAR FONT, STYLE, SIZE, OR COLOR.

FOR AGRICULTURAL EQUIPMENT, NAMELY, A MACHINE FOR SEPARATING ANIMAL MANURE FROM BEDDING (U.S. CLS. 13, 19, 21, 23, 31, 34 AND 35).

FIRST USE 4-15-2009; IN COMMERCE 4-15-2009.

3,681,600. JMP INDUSTRIES, INC., CLEVELAND, OH. SN 78-891,271. PUB. 12-12-2006, FILED 5-24-2006.

TRANSPORTER

THE MARK CONSISTS OF STANDARD CHARACTERS WITHOUT CLAIM TO ANY PARTICULAR FONT, STYLE, SIZE, OR COLOR.

FOR EXTRUDER EQUIPMENT (U.S. CLS. 13, 19, 21, 23, 31, 34 AND 35).

FIRST USE 6-1-2009; IN COMMERCE 6-1-2009.

3,681,603. CONSUMER SALES NETWORK, INC., BLOOMINGTON, MN. SN 78-902,603. PUB. 9-2-2008, FILED 6-7-2006.

EZ-GARDEN TOOLS

THE MARK CONSISTS OF STANDARD CHARACTERS WITHOUT CLAIM TO ANY PARTICULAR FONT, STYLE, SIZE, OR COLOR.

NO CLAIM IS MADE TO THE EXCLUSIVE RIGHT TO USE "TOOLS", APART FROM THE MARK AS SHOWN.

FOR POWER LAWN AND GARDEN TOOLS, NAMELY, BATTERY-OPERATED SPRAYERS, RECHARGEABLE HEDGE CUTTERS AND CULTIVATORS (U.S. CLS. 13, 19, 21, 23, 31, 34 AND 35).

FIRST USE 4-1-2009; IN COMMERCE 4-1-2009.

CLASS 8—HAND TOOLS

CLASS 8—(Continued).

3,680,152. THE ONTARIO KNIFE COMPANY, FRANKLINVILLE, NY. SN 77-018,603. PUB. 4-3-2007, FILED 10-11-2006.

STRIKE FIGHTER

THE MARK CONSISTS OF STANDARD CHARACTERS WITHOUT CLAIM TO ANY PARTICULAR FONT, STYLE, SIZE, OR COLOR.

OWNER OF U.S. REG. NOS. 2,826,239, 3,013,538, AND OTHERS.

FOR KNIVES USED FOR HUNTING, SPORT, MILITARY, LAW ENFORCEMENT, FOOD PREPARATION AND HOUSEHOLD USE; HAND TOOLS FOR EMERGENCY SERVICES, NAMELY, KNIVES (U.S. CLS. 23, 28 AND 44).

FIRST USE 5-30-2009; IN COMMERCE 5-30-2009.

CLASS 8—(Continued).

3,680,337. LEATHERMAN TOOL GROUP, INC., PORTLAND, OR. SN 77-194,333. PUB. 11-6-2007, FILED 5-31-2007.

FREESTYLE

THE MARK CONSISTS OF STANDARD CHARACTERS WITHOUT CLAIM TO ANY PARTICULAR FONT, STYLE, SIZE, OR COLOR.

FOR MULTI-FUNCTION HAND TOOL COMPRISED OF TWO OR MORE OF THE FOLLOWING TOOL ELEMENTS – PLIERS, KNIFE, BIT DRIVER WITH BITS, AND CARABINER (U.S. CLS. 23, 28 AND 44).

FIRST USE 5-1-2009; IN COMMERCE 5-1-2009.

3,680,875. GRILLSLINGER INTERNATIONAL LIMITED, WELLINGTON, NEW ZEALAND. SN 77-462,581. PUB. 9-30-2008, FILED 4-30-2008.

GRILLSLINGER

THE MARK CONSISTS OF STANDARD CHARACTERS WITHOUT CLAIM TO ANY PARTICULAR FONT, STYLE, SIZE, OR COLOR.

OWNER OF NEW ZEALAND REG. NO. 737933, DATED 5-11-2006, EXPIRES 10-28-2015.

FOR TOOL BELT WITH BARBEQUE TOOLS, NAMELY, TONGS, SPATULA, KNIFE, SOLD TOGETHER AS A UNIT (U.S. CLS. 23, 28 AND 44).

FIRST USE 3-31-2007; IN COMMERCE 3-31-2007.

3,680,181. CURTIS STONE, LONDON, UNITED KINGDOM. SN 77-067,898. PUB. 11-27-2007, FILED 12-19-2006.

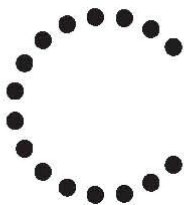

THE MARK CONSISTS OF THE LETTER "C" IN A DOTTED FORMAT.

FOR CUTLERY, KNIVES, FLATWARE, TABLEWARE, COOKING AND FOOD PREPARATION TOOLS, NAMELY, MORTARS AND PESTLES, AND FOOD PRESENTATION RINGS CONSISTING OF STAINLESS STEEL CYLINDERS AND CHROME TAMPERS USED TO PLATE UP MEALS AND SET DESSERTS (U.S. CLS. 23, 28 AND 44).

FIRST USE 11-29-2008; IN COMMERCE 11-29-2008.

3,680,927. KELD NORGAARD, KOLDING, DENMARK. SN 77-471,531. PUB. 10-21-2008, FILED 5-12-2008.

Z-IN

THE MARK CONSISTS OF STANDARD CHARACTERS WITHOUT CLAIM TO ANY PARTICULAR FONT, STYLE, SIZE, OR COLOR.

FOR MANUALLY OPERATED WEDGE-TYPE LIFTING TOOL FOR PLACING AND LIFTING WINDOWS AND DOORS FOR MOUNTING THE SAME IN A WALL OPENING DURING BUILDING CONSTRUCTION (U.S. CLS. 23, 28 AND 44).

FIRST USE 1-6-2009; IN COMMERCE 1-6-2009.

CLASS 8—(Continued).

3,681,033. HEB GROCERY COMPANY LP, SAN ANTONIO, TX. SN 77-490,723. PUB. 10-14-2008, FILED 6-4-2008.

CLASS 8—(Continued).

3,681,616. THE ONTARIO KNIFE COMPANY, FRANKLINVILLE, NY. SN 78-947,545. PUB. 4-3-2007, FILED 8-8-2006.

HILL COUNTRY ESSENTIALS

THE MARK CONSISTS OF STANDARD CHARACTERS WITHOUT CLAIM TO ANY PARTICULAR FONT, STYLE, SIZE, OR COLOR.

FOR DISPOSABLE RAZORS, ELECTRIC RAZORS, NON-ELECTRIC RAZORS, RAZOR BLADES (U.S. CLS. 23, 28 AND 44).

FIRST USE 10-18-2008; IN COMMERCE 10-18-2008.



3,681,248. GB II CORPORATION, DBA COLUMBIA RIVER KNIFE & TOOL COMPANY, TUALATIN, OR. SN 77-571,002. PUB. 2-10-2009, FILED 9-16-2008.

METAL OVER METAL

THE MARK CONSISTS OF STANDARD CHARACTERS WITHOUT CLAIM TO ANY PARTICULAR FONT, STYLE, SIZE, OR COLOR.

NO CLAIM IS MADE TO THE EXCLUSIVE RIGHT TO USE "METAL", APART FROM THE MARK AS SHOWN.

FOR KNIVES, NAMELY, HUNTING KNIVES, FISHING KNIVES AND MILITARY KNIVES, BAYONETS, FOLDING POCKET KNIVES, ALL CONTAINING AN ELECTRIC INSULATION FEATURE (U.S. CLS. 23, 28 AND 44).

FIRST USE 5-30-2009; IN COMMERCE 5-30-2009.

IGNITOR



THE MARK CONSISTS OF STANDARD CHARACTERS WITHOUT CLAIM TO ANY PARTICULAR FONT, STYLE, SIZE, OR COLOR.

FOR FOLDING KNIVES (U.S. CLS. 23, 28 AND 44).

FIRST USE 1-14-2009; IN COMMERCE 1-14-2009.



3,681,615. THE ONTARIO KNIFE COMPANY, FRANKLINVILLE, NY. SN 78-947,528. PUB. 3-27-2007, FILED 8-8-2006.

CLASS 9—ELECTRICAL AND SCIENTIFIC APPARATUS

3,680,080. HAGEMEYER NORTH AMERICA, INC., CHARLESTON, SC. SN 76-628,319. PUB. 4-25-2006, FILED 1-19-2005.

FLEX

VOLTRON

THE MARK CONSISTS OF STANDARD CHARACTERS WITHOUT CLAIM TO ANY PARTICULAR FONT, STYLE, SIZE, OR COLOR.

FOR KNIVES, NAMELY, HUNTING KNIVES, FISHING KNIVES AND MILITARY KNIVES, BAYONETS, FOLDING POCKET KNIVES, ALL CONTAINING AN ELECTRIC INSULATION FEATURE (U.S. CLS. 23, 28 AND 44).

FIRST USE 5-30-2009; IN COMMERCE 5-30-2009.

THE MARK CONSISTS OF STANDARD CHARACTERS WITHOUT CLAIM TO ANY PARTICULAR FONT, STYLE, SIZE, OR COLOR.

FOR CABLE TERMINALS, AND CABLE ASSEMBLIES COMPRISED OF CABLES AND CABLE CONNECTORS RELATED TO APPLIANCE AND BUILDING ELECTRICITY USE (U.S. CLS. 21, 23, 26, 36 AND 38).

FIRST USE 9-0-2007; IN COMMERCE 9-0-2007.

CLASS 9—(Continued).

3,680,093. MOBILEYE TECHNOLOGIES LIMITED, NICOSIA 1034, CYPRUS. SN 76-665,357. PUB. 2-19-2008, FILED 8-29-2006.

MOBILEYE AWS

THE MARK CONSISTS OF STANDARD CHARACTERS WITHOUT CLAIM TO ANY PARTICULAR FONT, STYLE, SIZE, OR COLOR.

OWNER OF U.S. REG. NO. 3,150,324.

NO CLAIM IS MADE TO THE EXCLUSIVE RIGHT TO USE "AWS", APART FROM THE MARK AS SHOWN.

FOR ELECTRONIC SYSTEM IN THE NATURE OF CAMERA AND VISION MODULE FOR PROVIDING ASSISTANCE WHILE DRIVING; COMPUTER HARDWARE AND SOFTWARE FOR MONITORING AND PROVIDING WARNING AND ASSISTANCE WHILE DRIVING AND NAVIGATING MOTOR VEHICLES; INSTRUCTIONAL MANUALS SOLD THEREWITH AS A UNIT (U.S. CLS. 21, 23, 26, 36 AND 38).

FIRST USE 0-0-2002; IN COMMERCE 2-0-2004.

3,680,110. WILBUR CURTIS COMPANY, MONTEBELLO, CA. SN 76-680,198. PUB. 5-13-2008, FILED 8-2-2007.

INTELLISENSE

THE MARK CONSISTS OF STANDARD CHARACTERS WITHOUT CLAIM TO ANY PARTICULAR FONT, STYLE, SIZE, OR COLOR.

FOR ELECTRONIC SENSOR TO SENSE AND DISPLAY THE VOLUME OF PRODUCT IN A BEVERAGE SERVER AND THE LENGTH OF TIME SINCE THE PRODUCT WAS BREWED (U.S. CLS. 21, 23, 26, 36 AND 38).

FIRST USE 4-15-2009; IN COMMERCE 4-15-2009.

3,680,134. WINNEBAGO INDUSTRIES, INC., FOREST CITY, IA. SN 76-690,035. PUB. 11-25-2008, FILED 5-27-2008.

GPgo

THE MARK CONSISTS OF THE WORD "GPgo" IN STYLIZED FONT WITH THE LETTER "GP" IN UPPER CASE AND THE LETTERS "GO" IN LOWER CASE.

FOR GLOBAL POSITIONING SYSTEMS, NAMELY, HANDHELD GLOBAL POSITIONING UNITS, HOLDERS FOR GLOBAL POSITIONING UNITS, CONTROL PADS FOR GLOBAL POSITIONING UNITS MOUNTABLE ON DASH PANELS OF MOTOR HOMES, AND GLOBAL POSITIONING COLOR MONITORS MOUNTABLE ON DASH PANELS OF MOTOR HOMES (U.S. CLS. 21, 23, 26, 36 AND 38).

FIRST USE 8-11-2008; IN COMMERCE 8-11-2008.

CLASS 9—(Continued).

3,680,142. ATLANTIC CITY COIN & SLOT SERVICE COMPANY, INC., PLEASANTVILLE, NJ. SN 77-004,728. PUB. 9-4-2007, FILED 9-21-2006.

ROLLIN' IN THE CASH

THE MARK CONSISTS OF STANDARD CHARACTERS WITHOUT CLAIM TO ANY PARTICULAR FONT, STYLE, SIZE, OR COLOR.

FOR GAMING EQUIPMENT, NAMELY, SLOT MACHINES WITH OR WITHOUT VIDEO OUTPUT AND PARTS THEREFOR (U.S. CLS. 21, 23, 26, 36 AND 38).

FIRST USE 4-21-2009; IN COMMERCE 4-21-2009.

3,680,151. XLLERATE CONSULTING, LLC, GARLAND, TX. SN 77-016,477. PUB. 10-21-2008, FILED 10-8-2006.



THE MARK CONSISTS OF A STYLIZED VERSION OF THE WORD "XLLERATE".

FOR COMPUTER SOFTWARE PROVIDED ON RECORDED MEDIA OR DOWNLOADABLE FROM A GLOBAL COMPUTER NETWORK, FOR AUTOMATING MANUAL BUSINESS PRACTICES, DOCUMENTING BUSINESS PROCESSES, CREATING, MANAGING AND INTEGRATING DATABASES, PROVIDING STATISTICAL ANALYSES, NOTIFICATIONS AND REPORTS, AND PROVIDING REAL-TIME, INTEGRATED BUSINESS MANAGEMENT TOOLS; COMPUTER SOFTWARE PROVIDED ON RECORDED MEDIA OR DOWNLOADABLE FROM A GLOBAL COMPUTER NETWORK, FOR WORD PROCESSING, SPREADSHEET PREPARATION, CHARTING AND GRAPHING; ELECTRONIC PUBLICATIONS, NAMELY, MANUALS FEATURING TRAINING IN SOFTWARE UTILIZATION AND BUSINESS PROCESS IMPROVEMENTS RECORDED ON COMPUTER MEDIA (U.S. CLS. 21, 23, 26, 36 AND 38).

FIRST USE 9-7-2005; IN COMMERCE 9-7-2005.

CLASS 9—(Continued).

3,680,156. RED CHIP COMPANY LTD., ROAD TOWN, TORTOLA, BR. VIRGIN ISLANDS. SN 77-026,749. PUB. 4-29-2008, FILED 10-23-2006.

XENYX

FOR APPARATUS FOR RECORDING, TRANSMISSION OR REPRODUCTION OF SOUND OR IMAGES; SOUND MIXING APPARATUS, NAMELY, ANALOG MIXERS, POWERED MIXERS, AUDIO MIXERS AND AMPLIFIED AUDIO MIXERS; MICROPHONE PREAMPLIFIERS (U.S. CLS. 21, 23, 26, 36 AND 38).

FIRST USE 2-27-2006; IN COMMERCE 2-27-2006.

3,680,162. RCADIA MEDICAL IMAGING LTD., HAIFA, ISRAEL. SN 77-043,751. PUB. 5-13-2008, FILED 11-14-2006.

COR ANALYZER

THE MARK CONSISTS OF STANDARD CHARACTERS WITHOUT CLAIM TO ANY PARTICULAR FONT, STYLE, SIZE, OR COLOR.

NO CLAIM IS MADE TO THE EXCLUSIVE RIGHT TO USE "ANALYZER", APART FROM THE MARK AS SHOWN. FOR COMPUTER SOFTWARE FOR MEDICAL IMAGING (U.S. CLS. 21, 23, 26, 36 AND 38).

FIRST USE 4-29-2009; IN COMMERCE 4-29-2009.

3,680,164. BEST BUY ENTERPRISE SERVICES, INC., RICHFIELD, MN. SN 77-046,555. PUB. 5-1-2007, FILED 11-17-2006.

ROCKETFISH

THE MARK CONSISTS OF STANDARD CHARACTERS WITHOUT CLAIM TO ANY PARTICULAR FONT, STYLE, SIZE, OR COLOR.

FOR AUDIO-VISUAL CABLES; ACCESSORIES FOR CONSUMER VIDEO GAME MACHINES ADAPTED FOR USE WITH TELEVISION, HAND-HELD VIDEO GAME MACHINES AND STAND-ALONE VIDEO GAME MACHINES, NAMELY, AUDIO-VISUAL CABLES, USB CABLES, ELECTRIC CABLES, CABLE CONNECTORS, CAR ADAPTERS, ADAPTER PLUGS AND POWER ADAPTERS (U.S. CLS. 21, 23, 26, 36 AND 38).

FIRST USE 6-23-2006; IN COMMERCE 6-23-2006.

CLASS 9—(Continued).

3,680,171. ENVISTA CORPORATION, BEVERLY, MA. SN 77-053,042. PUB. 1-13-2009, FILED 11-29-2006.

ENVISTA

THE MARK CONSISTS OF STANDARD CHARACTERS WITHOUT CLAIM TO ANY PARTICULAR FONT, STYLE, SIZE, OR COLOR.

FOR COMPUTER SOFTWARE SYSTEMS FOR FINANCIAL MODELING AND SIMULATION OF LARGE-SCALE CIVIL-ENGINEERED INFRASTRUCTURE AND BUILDINGS TO TRANSPORTATION AGENCIES, ELECTRIC, GAS, PETROLEUM AND WATER AND WASTE-WATER PROVIDERS, GOVERNMENT INSTITUTIONS, DEFENSE AGENCIES, AND CORPORATIONS (U.S. CLS. 21, 23, 26, 36 AND 38).

FIRST USE 5-6-2008; IN COMMERCE 5-13-2008.

3,680,182. SPIELO MANUFACTURING ULC, MONCTON, NEW BRUNSWICK, CANADA. SN 77-069,193. PUB. 4-24-2007, FILED 12-21-2006.

MAXIMUS BETUS

THE MARK CONSISTS OF STANDARD CHARACTERS WITHOUT CLAIM TO ANY PARTICULAR FONT, STYLE, SIZE, OR COLOR.

FOR RECONFIGURABLE CASINO AND LOTTERY GAMING EQUIPMENT, NAMELY, SLOT MACHINES AND VIDEO LOTTERY TERMINALS AND OPERATIONAL COMPUTER GAME SOFTWARE THEREFOR (U.S. CLS. 21, 23, 26, 36 AND 38).

FIRST USE 11-30-2007; IN COMMERCE 11-30-2007.

3,680,183. SPIELO MANUFACTURING ULC, MONCTON, NEW BRUNSWICK, CANADA. SN 77-069,258. PUB. 4-24-2007, FILED 12-21-2006.

MAID MARION

THE MARK CONSISTS OF STANDARD CHARACTERS WITHOUT CLAIM TO ANY PARTICULAR FONT, STYLE, SIZE, OR COLOR.

FOR RECONFIGURABLE CASINO AND LOTTERY GAMING EQUIPMENT, NAMELY, SLOT MACHINES AND VIDEO LOTTERY TERMINALS AND OPERATIONAL COMPUTER GAME SOFTWARE THEREFOR (U.S. CLS. 21, 23, 26, 36 AND 38).

FIRST USE 9-30-2007; IN COMMERCE 9-30-2007.

CLASS 9—(Continued).

3,680,185. COLLEXIS B.V., 4191 NW GELDERMALSEN, NETHERLANDS. SN 77-069,954. PUB. 10-2-2007, FILED 12-21-2006.

WHAT DO YOU WANT TO KNOW?

THE MARK CONSISTS OF STANDARD CHARACTERS WITHOUT CLAIM TO ANY PARTICULAR FONT, STYLE, SIZE, OR COLOR.

FOR COMPUTER SOFTWARE FOR USE IN DATABASE MANAGEMENT AND ANALYSIS (U.S. CLS. 21, 23, 26, 36 AND 38).

FIRST USE 1-0-2007; IN COMMERCE 1-0-2007.

3,680,189. SLING MEDIA, INC., FOSTER CITY, CA. SN 77-079,435. PUB. 6-24-2008, FILED 1-9-2007.

SLINGPROJECTOR

THE MARK CONSISTS OF STANDARD CHARACTERS WITHOUT CLAIM TO ANY PARTICULAR FONT, STYLE, SIZE, OR COLOR.

FOR COMPUTER SOFTWARE FOR USE IN TRANSMITTING A COMBINATION OF THE AUDIO, VIDEO AND IMAGE OUTPUT FROM A COMPUTER OVER A NETWORK FOR DISPLAY ON A TELEVISION OR OTHER VIDEO MONITOR (U.S. CLS. 21, 23, 26, 36 AND 38).

FIRST USE 9-30-2008; IN COMMERCE 9-30-2008.

3,680,194. BILL LAWRENCE, CORONA, CA. SN 77-091,608. PUB. 7-10-2007, FILED 1-25-2007.

KEYSTONE

THE MARK CONSISTS OF STANDARD CHARACTERS WITHOUT CLAIM TO ANY PARTICULAR FONT, STYLE, SIZE, OR COLOR.

FOR ELECTRICAL PICKUPS FOR USE WITH MUSICAL INSTRUMENTS; ELECTRONIC SOUND PICKUP FOR GUITARS AND BASSES; GUITAR AMPLIFIERS; GUITAR CABLES (U.S. CLS. 21, 23, 26, 36 AND 38).

FIRST USE 2-25-2007; IN COMMERCE 2-25-2007.

CLASS 9—(Continued).

3,680,200. BELLON ENTERTAINMENT INC., PORT WASHINGTON, NY. SN 77-109,933. PUB. 12-4-2007, FILED 2-16-2007.

NINJA WARRIOR

THE MARK CONSISTS OF STANDARD CHARACTERS WITHOUT CLAIM TO ANY PARTICULAR FONT, STYLE, SIZE, OR COLOR.

THE FOREIGN WORDING IN THE MARK TRANSLATES INTO ENGLISH AS SECRET SOLDIER.

FOR PRE-RECORDED COMPACT DISCS, LASER DISCS, CD-ROMS, DVDS, DVD-ROMS, VIDEOTAPES, VIDEOCASSETTES, AND OTHER PRE-RECORDED OPTICAL, ELECTRONIC, DIGITAL, AND MAGNETIC MEDIA FEATURING COMPETITION-BASED ENTERTAINMENT AND COMPANION PROGRAMMING WITH ACTUAL AND/OR FICTIONAL CHARACTERS INVOLVED IN COMEDIC, DRAMATIC, DOCUMENTAL AND ANIMATED STORIES; COMPUTER GAME SOFTWARE; COMPUTER GAME PROGRAMS AND CARTRIDGES; ELECTRONIC GAME PROGRAMS; VIDEO GAME SOFTWARE; COMPUTER SCREEN SAVER SOFTWARE; DOWNLOADABLE GRAPHICS AND SOUND RECORDINGS VIA A GLOBAL COMPUTER NETWORK AND WIRELESS DEVICES; ANALOG AND DIGITAL MATERIALS, NAMELY, DOWNLOADABLE VIDEO RECORDINGS, AUDIO RECORDINGS, DIGITAL PHOTOGRAPHS, DIGITAL STILL IMAGES, DIGITAL MOVING IMAGES, COMPUTER SOFTWARE SCREEN SAVERS, AND DIGITAL COMPUTER DESKTOP BACKGROUND IMAGES FOR COMPUTERS AND WIRELESS DEVICES; MOTION PICTURE FILMS FEATURING COMPETITION-BASED ENTERTAINMENT AND COMPANION PROGRAMMING WITH ACTUAL AND/OR FICTIONAL CHARACTERS INVOLVED IN COMEDIC, DRAMATIC, DOCUMENTAL AND ANIMATED STORIES (U.S. CLS. 21, 23, 26, 36 AND 38).

FIRST USE 5-2-2007; IN COMMERCE 5-2-2007.

3,680,201. BENTYLER ENTERPRISES, INC., SUNNYVALE, CA. SN 77-111,383. PUB. 8-14-2007, FILED 2-20-2007.

HazPlan

THE MARK CONSISTS OF STANDARD CHARACTERS WITHOUT CLAIM TO ANY PARTICULAR FONT, STYLE, SIZE, OR COLOR.

FOR SOFTWARE FOR THE INVENTORY, TRACKING, MANAGEMENT AND REPORTING OF HAZARDOUS MATERIALS AND HAZARDOUS WASTE (U.S. CLS. 21, 23, 26, 36 AND 38).

FIRST USE 4-24-2006; IN COMMERCE 3-9-2009.

CLASS 9—(Continued).

3,680,209. THE WEST AMERICA CORPORATION, LAYTON, UT. SN 77-128,796. PUB. 9-23-2008, FILED 3-12-2007.

EMP

THE MARK CONSISTS OF STANDARD CHARACTERS WITHOUT CLAIM TO ANY PARTICULAR FONT, STYLE, SIZE, OR COLOR.

FOR A FULL LINE OF HOME AUDIO EQUIPMENT, NAMELY, SPEAKERS, SUBWOOFERS, IN-WALL SPEAKERS, AND OUTDOOR SPEAKERS (U.S. CLS. 21, 23, 26, 36 AND 38).

FIRST USE 12-31-2007; IN COMMERCE 12-31-2007.

3,680,217. FLIR SYSTEMS, INC., WILSONVILLE, OR. SN 77-136,960. PUB. 4-22-2008, FILED 3-21-2007.

RANGER HRC

THE MARK CONSISTS OF STANDARD CHARACTERS WITHOUT CLAIM TO ANY PARTICULAR FONT, STYLE, SIZE, OR COLOR.

NO CLAIM IS MADE TO THE EXCLUSIVE RIGHT TO USE "HRC", APART FROM THE MARK AS SHOWN.

FOR ELECTROMAGNETIC SENSITIVE IMAGING SYSTEMS COMPRISED OF INFRARED CAMERAS, LENSES, CIRCUIT BOARDS, PROGRAMMABLE SEMICONDUCTOR MICROPROCESSORS AND OPERATING SOFTWARE; DIGITAL IMAGE PROCESSING HARDWARE AND SOFTWARE, PROGRAMMABLE SEMICONDUCTOR MICROPROCESSORS AND OPERATING SOFTWARE (U.S. CLS. 21, 23, 26, 36 AND 38).

FIRST USE 3-14-2008; IN COMMERCE 3-14-2008.

3,680,243. ICAD, INC., NASHUA, NH. SN 77-153,241. PUB. 4-1-2008, FILED 4-10-2007.

PRECISIONPOINT

THE MARK CONSISTS OF STANDARD CHARACTERS WITHOUT CLAIM TO ANY PARTICULAR FONT, STYLE, SIZE, OR COLOR.

FOR PRERECORDED COMPUTER PROGRAMS AND SOFTWARE FOR ANALYZING AND PROCESSING MEDICAL IMAGING DATA (U.S. CLS. 21, 23, 26, 36 AND 38).

FIRST USE 6-16-2009; IN COMMERCE 6-16-2009.

CLASS 9—(Continued).

3,680,244. J.H. FENNER & CO. LIMITED, YORKSHIRE, ENGLAND. SN 77-153,796. PUB. 4-15-2008, FILED 4-11-2007.

RESCAN

THE MARK CONSISTS OF STANDARD CHARACTERS WITHOUT CLAIM TO ANY PARTICULAR FONT, STYLE, SIZE, OR COLOR.

FOR ELECTRONIC CONDITION MONITORING SYSTEM AND RIP DETECTION SYSTEM, NAMELY, TRANSDUCERS AND TACHOMETERS FOR CONVEYOR BELTS (U.S. CLS. 21, 23, 26, 36 AND 38).

FIRST USE 1-0-2007; IN COMMERCE 1-0-2007.

3,680,249. CARDINAL HEALTH 303, INC., SAN DIEGO, CA. SN 77-156,515. PUB. 1-15-2008, FILED 4-13-2007.

CAREFUSION

THE MARK CONSISTS OF STANDARD CHARACTERS WITHOUT CLAIM TO ANY PARTICULAR FONT, STYLE, SIZE, OR COLOR.

OWNER OF U.S. REG. NOS. 2,901,516, 2,908,615, AND OTHERS.

FOR COMPUTER SOFTWARE AND COMPUTER HARDWARE THAT ENABLES HEALTH CARE ESTABLISHMENTS TO ENHANCE PATIENT SAFETY BY VERIFYING AND DOCUMENTING MEDICAL ORDERS FOR PATIENT TREATMENT (U.S. CLS. 21, 23, 26, 36 AND 38).

FIRST USE 4-0-2002; IN COMMERCE 4-0-2002.

CLASS 9—(Continued).

3,680,281. GREENLEAF, MICHAEL, SEATTLE, WA. SN 77-170,860. PUB. 10-30-2007, FILED 5-2-2007.

Future Soul Records

THE MARK CONSISTS OF STANDARD CHARACTERS WITHOUT CLAIM TO ANY PARTICULAR FONT, STYLE, SIZE, OR COLOR.

NO CLAIM IS MADE TO THE EXCLUSIVE RIGHT TO USE "RECORDS", APART FROM THE MARK AS SHOWN.

FOR AUDIO RECORDINGS FEATURING MUSIC; DOWNLOADABLE MP3 FILES, MP3 RECORDINGS, ONLINE DISCUSSION BOARDS, WEB CASTS, POD CASTS FEATURING MUSIC, AUDIO BOOKS AND NEWS BROADCASTS; DOWNLOADABLE RING TONES, GRAPHICS AND MUSIC VIA A GLOBAL COMPUTER NETWORK AND WIRELESS DEVICES; DOWNLOADABLE MUSIC VIA THE INTERNET AND WIRELESS DEVICES; MUSICAL SOUND RECORDINGS (U.S. CLS. 21, 23, 26, 36 AND 38).

FIRST USE 5-1-2008; IN COMMERCE 1-1-2009.

3,680,292. HI-TECH TRANSPORT ELECTRONICS, EUGENE, OR. SN 77-176,563. PUB. 10-21-2008, FILED 5-9-2007.

Load Smart

NO CLAIM IS MADE TO THE EXCLUSIVE RIGHT TO USE "LOAD" AND "SMART", APART FROM THE MARK AS SHOWN.

THE MARK CONSISTS IN PART OF A STYLIZED FULCRUM.

FOR ON-BOARD VEHICLE SCALE SYSTEMS, NAMELY, SOFTWARE, HARDWARE, SENSORS AND COMMUNICATION DEVICES FOR COMMUNICATING, CALIBRATING, MONITORING, DISPLAYING AND PROVIDING VEHICLE AND CARGO WEIGHT INFORMATION, AND PARTS THEREFOR (U.S. CLS. 21, 23, 26, 36 AND 38).

FIRST USE 6-19-2009; IN COMMERCE 6-19-2009.

3,680,302. BP MICROSYSTEMS LP, DBA BPM MICROSYSTEMS, HOUSTON, TX. SN 77-181,697. PUB. 10-21-2008, FILED 5-15-2007.

FLASHSTREAM

CLASS 9—(Continued).

THE MARK CONSISTS OF STANDARD CHARACTERS WITHOUT CLAIM TO ANY PARTICULAR FONT, STYLE, SIZE, OR COLOR.

FOR ELECTRONIC EQUIPMENT, NAMELY, TEST INSTRUMENTATION FOR PROGRAMMING NON-VOLATILE COMPUTER MEMORY, AND USER MANUALS SOLD TOGETHER THEREWITH (U.S. CLS. 21, 23, 26, 36 AND 38).

FIRST USE 8-1-2007; IN COMMERCE 8-1-2007.

3,680,303. BP MICROSYSTEMS LP, DBA BPM MICROSYSTEMS, HOUSTON, TX. SN 77-181,706. PUB. 10-21-2008, FILED 5-15-2007.



THE MARK CONSISTS OF A FELINE ANIMAL AGAINST A STRIATED BACKGROUND.

FOR ELECTRONIC EQUIPMENT, NAMELY, TEST INSTRUMENTATION FOR PROGRAMMING NON-VOLATILE COMPUTER MEMORY, AND USER MANUALS SOLD TOGETHER THEREWITH (U.S. CLS. 21, 23, 26, 36 AND 38).

FIRST USE 8-1-2007; IN COMMERCE 8-1-2007.

3,680,304. BP MICROSYSTEMS LP, DBA BPM MICROSYSTEMS, HOUSTON, TX. SN 77-181,716. PUB. 10-21-2008, FILED 5-15-2007.



NO CLAIM IS MADE TO THE EXCLUSIVE RIGHT TO USE "ENGINE CO-PROCESSOR", APART FROM THE MARK AS SHOWN.

THE MARK CONSISTS OF AN ARRANGEMENT OF CIRCLES AND ELONGATED CIRCLES OF VARYING SIZES IN A CURVED, RADIATING PATTERN.

FOR ELECTRONIC EQUIPMENT, NAMELY, TEST INSTRUMENTATION FOR PROGRAMMING NON-VOLATILE COMPUTER MEMORY, AND USER MANUALS SOLD TOGETHER THEREWITH (U.S. CLS. 21, 23, 26, 36 AND 38).

FIRST USE 8-1-2007; IN COMMERCE 8-1-2007.

CLASS 9—(Continued).

3,680,306. CREATIVE MERCHANDISING CONCEPTS, INC., MISSISSAUGA, CANADA. SN 77-182,490. PUB. 5-13-2008, FILED 5-16-2007.

INFO SHOW

THE MARK CONSISTS OF STANDARD CHARACTERS WITHOUT CLAIM TO ANY PARTICULAR FONT, STYLE, SIZE, OR COLOR.

FOR MOTION ACTIVATED ELECTRONIC ADVERTISING AND MESSAGING LCD, PLASMA, AND LED DISPLAY UNITS (U.S. CLS. 21, 23, 26, 36 AND 38).

FIRST USE 11-15-2008; IN COMMERCE 11-15-2008.

3,680,311. COULTER ROBERT W., NEW YORK, NY. SN 77-185,505. PUB. 8-26-2008, FILED 5-20-2007.

CrazyBabe

THE MARK CONSISTS OF STANDARD CHARACTERS WITHOUT CLAIM TO ANY PARTICULAR FONT, STYLE, SIZE, OR COLOR.

FOR MOTION PICTURE FILMS ABOUT NAKED WOMEN (U.S. CLS. 21, 23, 26, 36 AND 38).

FIRST USE 11-0-2006; IN COMMERCE 11-0-2006.

3,680,312. SOLARTRAX LTD., CORONA DEL MAR, CA. SN 77-185,603. PUB. 11-20-2007, FILED 5-21-2007.

SKYTRAX

THE MARK CONSISTS OF STANDARD CHARACTERS WITHOUT CLAIM TO ANY PARTICULAR FONT, STYLE, SIZE, OR COLOR.

FOR ELECTRONIC DEVICE FOR TRACKING INTERNET SATELLITE (U.S. CLS. 21, 23, 26, 36 AND 38).

FIRST USE 0-0-2008; IN COMMERCE 0-0-2008.

CLASS 9—(Continued).

3,680,313. SOLARTRAX LTD., CORONA DEL MAR, CA. SN 77-185,604. PUB. 11-20-2007, FILED 5-21-2007.

SOLARTRAX

THE MARK CONSISTS OF STANDARD CHARACTERS WITHOUT CLAIM TO ANY PARTICULAR FONT, STYLE, SIZE, OR COLOR.

FOR ELECTRONIC DEVICE FOR TRACKING THE SUN (U.S. CLS. 21, 23, 26, 36 AND 38).

FIRST USE 0-0-2008; IN COMMERCE 0-0-2008.

3,680,320. BIG FISH GAMES, INC., SEATTLE, WA. SN 77-187,616. PUB. 11-6-2007, FILED 5-22-2007.

Farm 51

THE MARK CONSISTS OF STANDARD CHARACTERS WITHOUT CLAIM TO ANY PARTICULAR FONT, STYLE, SIZE, OR COLOR.

FOR ELECTRONIC GAME PROGRAMS (U.S. CLS. 21, 23, 26, 36 AND 38).

FIRST USE 9-20-2007; IN COMMERCE 9-20-2007.

3,680,328. PLANTRONICS, INC., SANTA CRUZ, CA. SN 77-188,763. PUB. 4-29-2008, FILED 5-23-2007.

**SOUND AND COMFORT:
TOGETHER AGAIN**

THE MARK CONSISTS OF STANDARD CHARACTERS WITHOUT CLAIM TO ANY PARTICULAR FONT, STYLE, SIZE, OR COLOR.

NO CLAIM IS MADE TO THE EXCLUSIVE RIGHT TO USE "SOUND", APART FROM THE MARK AS SHOWN.

FOR LISTENING AMPLIFICATION DEVICES FOR USE WITH TELEPHONES, TELEVISIONS, PERSONAL LISTENING DEVICES (U.S. CLS. 21, 23, 26, 36 AND 38).

FIRST USE 7-1-2007; IN COMMERCE 7-1-2007.

CLASS 9—(Continued).

3,680,333. KABUSHIKI KAISHA HUDSON, TOKYO, JAPAN. SN 77-191,603. PUB. 4-29-2008, FILED 5-29-2007.

FISHING MASTER

THE MARK CONSISTS OF STANDARD CHARACTERS WITHOUT CLAIM TO ANY PARTICULAR FONT, STYLE, SIZE, OR COLOR.

NO CLAIM IS MADE TO THE EXCLUSIVE RIGHT TO USE "FISHING", APART FROM THE MARK AS SHOWN.

FOR COMPUTER VIDEO GAME PROGRAMS FOR MOBILE PHONES; COMPUTER VIDEO GAME SOFTWARE FOR MOBILE PHONES; COMPUTER VIDEO GAME PROGRAMS DOWNLOADABLE VIA THE INTERNET AND WIRELESS DEVICES (U.S. CLS. 21, 23, 26, 36 AND 38).

FIRST USE 9-18-2007; IN COMMERCE 9-18-2007.

CLASS 9—(Continued).

3,680,352. PALTRONICS, INC, CRYSTAL LAKE, IL. SN 77-200,133. PUB. 4-1-2008, FILED 6-7-2007.

PAL OVERLAY

THE MARK CONSISTS OF STANDARD CHARACTERS WITHOUT CLAIM TO ANY PARTICULAR FONT, STYLE, SIZE, OR COLOR.

NO CLAIM IS MADE TO THE EXCLUSIVE RIGHT TO USE "OVERLAY", APART FROM THE MARK AS SHOWN.

FOR COMPUTER HARDWARE AND SOFTWARE USED TO CONNECT ELECTRONIC GAMING MACHINES AND OTHER CASINO GAMING DEVICES TO DISTRIBUTE GAMING DATA AND MEDIA CONTENT (U.S. CLS. 21, 23, 26, 36 AND 38).

FIRST USE 1-26-2009; IN COMMERCE 1-26-2009.

3,680,341. PLANTRONICS, INC., SANTA CRUZ, CA. SN 77-197,276. PUB. 4-29-2008, FILED 6-4-2007.

VIRTUAL PHONE BOOTH

THE MARK CONSISTS OF STANDARD CHARACTERS WITHOUT CLAIM TO ANY PARTICULAR FONT, STYLE, SIZE, OR COLOR.

NO CLAIM IS MADE TO THE EXCLUSIVE RIGHT TO USE "VIRTUAL", APART FROM THE MARK AS SHOWN.

FOR HEADSETS AND ACCESSORIES, NAMELY, CARRYING CASES AND DIGITAL AUDIO ADAPTERS FOR COMPUTER USE, FOR USE WITH MOBILE PHONES, TELEPHONES, PERSONAL DIGITAL ASSISTANTS, MP3 PLAYERS, COMPUTERS, DVD PLAYERS AND CD PLAYERS (U.S. CLS. 21, 23, 26, 36 AND 38).

FIRST USE 7-8-2007; IN COMMERCE 7-8-2007.

3,680,359. KEANE, INC., BOSTON, MA. SN 77-209,601. PUB. 10-2-2007, FILED 6-19-2007.

Keane
enabling transformation

OWNER OF U.S. REG. NOS. 1,428,164, 1,457,693, AND OTHERS.

FOR COMPUTER PROGRAMS FOR USE IN MANAGING THE ACCOUNTING, BILLING, PATIENT RECORDS, MANAGEMENT AND HUMAN RESOURCES RECORDS AND FUNCTIONS OF BOTH LONG-TERM CARE AND ACUTE CARE FACILITIES (U.S. CLS. 21, 23, 26, 36 AND 38).

FIRST USE 3-15-2009; IN COMMERCE 3-15-2009.

CLASS 9—(Continued).

3,680,364. AIRCELL LLC, ITASCA, IL. SN 77-216,179. PUB. 10-30-2007, FILED 6-26-2007.

CLASS 9—(Continued).

3,680,367. ROSETTA STONE LTD., ARLINGTON, VA. SN 77-218,708. PUB. 10-14-2008, FILED 6-29-2007.

GOGO



Language Learning Success

OWNER OF U.S. REG. NO. 2,781,324.
THE COLOR(S) BLUE, WHITE AND GRAY IS/ARE CLAIMED AS A FEATURE OF THE MARK.

THE MARK CONSISTS OF A BLUE ANGULAR IMAGE IN THE SHAPE OF A ROSETTA STONE WITH TWO HORIZONTAL WHITE LINES EXTENDING FROM THE LEFT AND ACROSS THE CENTER OF THE IMAGE, FOLLOWED BY THE WORDS "LANGUAGE LEARNING SUCCESS". THE COLOR GRAY APPEARS UNDER THE STONE DESIGN.

SEC. 2(F) AS TO "LANGUAGE LEARNING SUCCESS".
FOR COMPUTER SOFTWARE FOR TEACHING FOREIGN LANGUAGES; COMPUTER SOFTWARE FOR LEARNING FOREIGN LANGUAGES (U.S. CLS. 21, 23, 26, 36 AND 38).

FIRST USE 8-28-2007; IN COMMERCE 8-28-2007.

THE MARK CONSISTS OF STANDARD CHARACTERS WITHOUT CLAIM TO ANY PARTICULAR FONT, STYLE, SIZE, OR COLOR.

FOR COMPUTER AND TELECOMMUNICATIONS NETWORK HARDWARE AND SOFTWARE FOR IMPLEMENTING LOCAL AREA NETWORKS ONBOARD AIRCRAFTS TO ENABLE USERS TO TRANSMIT AND RECEIVE VOICE, VIDEO, AND DATA WITHIN THE AIRCRAFTS, BETWEEN THE AIRCRAFTS, BETWEEN THE AIRCRAFTS AND THE GROUND, AND BETWEEN THE GROUND AND THE AIRCRAFTS. LOCAL AREA NETWORK ACCESS POINTS FOR COMMUNICATING WITH COMPUTER AND TELECOMMUNICATIONS USERS LOCATED ONBOARD AIRCRAFTS FOR TRANSMITTING AND RECEIVING VOICE, VIDEO, AND DATA WITHIN THE AIRCRAFTS, BETWEEN THE AIRCRAFTS, BETWEEN THE AIRCRAFTS AND THE GROUND, AND BETWEEN THE GROUND AND THE AIRCRAFTS. COMPUTER AND TELECOMMUNICATIONS NETWORK HARDWARE AND SOFTWARE FOR TRANSMITTING AND RECEIVING VOICE, VIDEO, AND DATA BETWEEN COMPUTER AND TELECOMMUNICATIONS USERS, LOCATED ONBOARD AN AIRCRAFT, AND COMPUTER, AND TELECOMMUNICATIONS SYSTEMS LOCATED ONBOARD THE AIRCRAFT, COMPUTER AND TELECOMMUNICATION SYSTEMS LOCATED ONBOARD ANOTHER AIRCRAFT, AND COMPUTER AND TELECOMMUNICATIONS SYSTEMS LOCATED ON THE GROUND. COMPUTER AND TELECOMMUNICATIONS NETWORK ACCESS SERVER HARDWARE AND SOFTWARE ONBOARD AIRCRAFTS FOR TRANSMITTING AND RECEIVING VOICE, VIDEO, AND DATA FROM THE GROUND TO IDENTIFIED USERS LOCATED ONBOARD THE AIRCRAFTS, FROM IDENTIFIED USERS LOCATED ONBOARD THE AIRCRAFTS TO THE GROUND, AND FROM IDENTIFIED USERS LOCATED ONBOARD ONE AIRCRAFT TO IDENTIFIED USERS ONBOARD ANOTHER AIRCRAFT, AND BETWEEN IDENTIFIED USERS WITHIN AN AIRCRAFT (U.S. CLS. 21, 23, 26, 36 AND 38).

FIRST USE 6-28-2008; IN COMMERCE 6-28-2008.

3,680,408. BOURLAND, KERRI, LITCHFIELD PARK, AZ. SN 77-275,561. PUB. 3-4-2008, FILED 9-10-2007.

TRAINING AT YOUR FINGERTIPS

THE MARK CONSISTS OF STANDARD CHARACTERS WITHOUT CLAIM TO ANY PARTICULAR FONT, STYLE, SIZE, OR COLOR.

NO CLAIM IS MADE TO THE EXCLUSIVE RIGHT TO USE "TRAINING", APART FROM THE MARK AS SHOWN. FOR DOWNLOADABLE VIDEO RECORDINGS FEATURING INSTRUCTIONS ON HOW TO USE SOFTWARE; DOWNLOADABLE WEBCASTS IN THE FIELD OF INSTRUCTIONS ON HOW TO USE SOFTWARE; DOWNLOADABLE ELECTRONIC PUBLICATIONS IN THE NATURE OF INSTRUCTIONAL MATERIALS IN THE FIELD OF SOFTWARE USE; DOWNLOADABLE PODCASTS IN THE FIELD OF INSTRUCTIONS ON HOW TO USE SOFTWARE (U.S. CLS. 21, 23, 26, 36 AND 38).

FIRST USE 11-15-2007; IN COMMERCE 1-4-2008.

CLASS 9—(Continued).

3,680,416. ACTIVIDENTITY (AUSTRALIA) PTY LTD., FREMONT, CA. SN 77-283,814. PUB. 3-11-2008, FILED 9-19-2007.

ActivIdentity SecureLogin

THE MARK CONSISTS OF STANDARD CHARACTERS WITHOUT CLAIM TO ANY PARTICULAR FONT, STYLE, SIZE, OR COLOR.

OWNER OF U.S. REG. NOS. 2,753,867 AND 3,178,485. NO CLAIM IS MADE TO THE EXCLUSIVE RIGHT TO USE "SECURE LOGIN", APART FROM THE MARK AS SHOWN.

FOR COMPUTER SOFTWARE IN THE FIELD OF CONTROLLING NETWORK FUNCTIONS AND ACCESS IN THE FIELD OF NETWORK SECURITY AND SERVER SECURITY (U.S. CLS. 21, 23, 26, 36 AND 38).

FIRST USE 0-0-2005; IN COMMERCE 0-0-2005.

3,680,420. T-MOBILE USA, INC., BELLEVUE, WA. SN 77-286,303. PUB. 3-11-2008, FILED 9-21-2007.

THE OFFICIAL PHONE OF FUN

THE MARK CONSISTS OF STANDARD CHARACTERS WITHOUT CLAIM TO ANY PARTICULAR FONT, STYLE, SIZE, OR COLOR.

FOR WIRELESS HANDHELD TELECOMMUNICATIONS DEVICES, NAMELY, WIRELESS TELECOMMUNICATIONS DEVICES THAT COMBINE WIRELESS VOICE AND DATA TELECOMMUNICATIONS FUNCTIONS, DIGITAL IMAGING FUNCTIONS, COMPUTING FUNCTIONS, PERMIT THE TWO-WAY WIRELESS TRANSMISSION OF E-MAIL AND TEXT, PERMIT WIRELESS ACCESS TO A GLOBAL COMPUTER NETWORK, GAMING AND MULTIMEDIA FUNCTIONALITY (U.S. CLS. 21, 23, 26, 36 AND 38).

FIRST USE 10-31-2007; IN COMMERCE 10-31-2007.

3,680,428. IGT, RENO, NV. SN 77-292,637. PUB. 3-4-2008, FILED 10-1-2007.

DOUBLE SUPER SILVER 7

THE MARK CONSISTS OF STANDARD CHARACTERS WITHOUT CLAIM TO ANY PARTICULAR FONT, STYLE, SIZE, OR COLOR.

NO CLAIM IS MADE TO THE EXCLUSIVE RIGHT TO USE "7", APART FROM THE MARK AS SHOWN.

FOR GAMING MACHINES, NAMELY, DEVICES WHICH ACCEPT A WAGER (U.S. CLS. 21, 23, 26, 36 AND 38).

FIRST USE 6-20-2008; IN COMMERCE 6-20-2008.

CLASS 9—(Continued).

3,680,429. AGILIS INTERNATIONAL, INC., ROCKVILLE, MD. SN 77-292,707. PUB. 3-18-2008, FILED 10-1-2007.

Accelerate Your Gain

THE MARK CONSISTS OF STANDARD CHARACTERS WITHOUT CLAIM TO ANY PARTICULAR FONT, STYLE, SIZE, OR COLOR.

FOR COMPUTER SOFTWARE FOR PROVIDING AN ON-LINE DATABASE IN THE FIELD OF TRANSACTION PROCESSING TO UPLOAD TRANSACTIONAL DATA, PROVIDE STATISTICAL ANALYSIS, AND PRODUCE NOTIFICATIONS AND REPORTS; COMPUTER SOFTWARE FOR THE FIELD OF WAREHOUSING AND DISTRIBUTION, TO MANAGE TRANSACTIONAL DATA, PROVIDE STATISTICAL ANALYSIS, AND PRODUCE NOTIFICATIONS AND REPORTS (U.S. CLS. 21, 23, 26, 36 AND 38).

FIRST USE 6-6-2008; IN COMMERCE 6-6-2008.

3,680,447. PALMER PERFORMANCE ENGINEERING, INC., OREM, UT. SN 77-299,674. PUB. 9-16-2008, FILED 10-9-2007.

DashCommand

THE MARK CONSISTS OF STANDARD CHARACTERS WITHOUT CLAIM TO ANY PARTICULAR FONT, STYLE, SIZE, OR COLOR.

FOR COMPUTER SOFTWARE, NAMELY, MOTOR VEHICLE DIAGNOSTIC MONITORING AND TUNING PROGRAMS FOR DESKTOP AND PORTABLE COMPUTERS (U.S. CLS. 21, 23, 26, 36 AND 38).

FIRST USE 5-17-2007; IN COMMERCE 5-17-2007.

CLASS 9—(Continued).

3,680,461. NEUROMATION STUDIO LLC, MIAMI BEACH, FL. SN 77-305,707. PUB. 4-8-2008, FILED 10-17-2007.

NEUROMATION

THE MARK CONSISTS OF STANDARD CHARACTERS WITHOUT CLAIM TO ANY PARTICULAR FONT, STYLE, SIZE, OR COLOR.

FOR DIGITAL MEDIA, NAMELY, DVDS FEATURING DIGITALLY ANIMATED AUDIO AND VIDEO CONTENT FOR USE WITH BIOFEEDBACK AND NEUROFEEDBACK SYSTEMS; COMPUTER SOFTWARE FOR USE WITH BIOFEEDBACK AND NEUROFEEDBACK SYSTEMS THAT PROVIDES FEEDBACK AND INFORMATION TO PATIENTS REGARDING THE STATUS OF SELECTED PHYSIOLOGICAL FUNCTIONS (U.S. CLS. 21, 23, 26, 36 AND 38).

FIRST USE 6-19-2009; IN COMMERCE 6-19-2009.

CLASS 9—(Continued).

3,680,476. SEBASTIAN (CHARLES) KING, DBA BIG MONEY RECORDS (FORMERLY NU MU RECORDS), LOS ANGELES, CA. SN 77-310,036. PUB. 9-23-2008, FILED 10-22-2007.

BIG MONEY RECORDS

THE MARK CONSISTS OF STANDARD CHARACTERS WITHOUT CLAIM TO ANY PARTICULAR FONT, STYLE, SIZE, OR COLOR.

NO CLAIM IS MADE TO THE EXCLUSIVE RIGHT TO USE "RECORDS", APART FROM THE MARK AS SHOWN.

FOR MUSICAL SOUND RECORDINGS; COMPACT DISCS, AUDIO CASSETTES, AUDIO DIGITAL TAPES, PHONOGRAPH RECORDS, MULTI-MEDIA SOFTWARE RECORDED ON CD-ROM, PRERECORDED VIDEO TAPES, LASER DISKS AND DVDS ALL FEATURING MUSIC (U.S. CLS. 21, 23, 26, 36 AND 38).

FIRST USE 7-7-2007; IN COMMERCE 12-10-2007.

3,680,467. NINTENDO OF AMERICA INC., REDMOND, WA. SN 77-306,758. PUB. 9-30-2008, FILED 10-17-2007.

DK JUNGLE CLIMBER

THE MARK CONSISTS OF STANDARD CHARACTERS WITHOUT CLAIM TO ANY PARTICULAR FONT, STYLE, SIZE, OR COLOR.

PRIORITY CLAIMED UNDER SEC. 44(D) ON JAPAN APPLICATION NO. 2007-077543, FILED 7-10-2007, REG. NO. 5116771, DATED 3-7-2008, EXPIRES 3-7-2018.

FOR VIDEO GAME CARTRIDGES; PROGRAMS FOR VIDEO GAMES; ROM CARTRIDGES STORING PROGRAMS FOR VIDEO GAME MACHINES; MEMORY CARDS FOR VIDEO GAMES; PROGRAMS FOR HAND-HELD GAMES WITH LIQUID CRYSTAL DISPLAYS; ROM CARTRIDGES STORING PROGRAMS FOR HAND-HELD GAMES WITH LIQUID CRYSTAL DISPLAYS; DOWNLOADABLE PROGRAMS FOR COMPUTERS, NAMELY, COMPUTER GAMES; PROGRAMS FOR COMPUTERS, NAMELY, COMPUTER GAMES; ELECTRONIC GAME SOFTWARE (U.S. CLS. 21, 23, 26, 36 AND 38).

FIRST USE 9-10-2007; IN COMMERCE 9-10-2007.

3,680,477. SEBASTIAN (CHARLES) KING, DBA SALVATION RECORDS, LOS ANGELES, CA. SN 77-310,106. PUB. 9-23-2008, FILED 10-22-2007.

SALVATION RECORDS

THE MARK CONSISTS OF STANDARD CHARACTERS WITHOUT CLAIM TO ANY PARTICULAR FONT, STYLE, SIZE, OR COLOR.

NO CLAIM IS MADE TO THE EXCLUSIVE RIGHT TO USE "RECORDS", APART FROM THE MARK AS SHOWN.

FOR MUSICAL SOUND RECORDINGS; COMPACT DISCS, AUDIO CASSETTES, AUDIO DIGITAL TAPES, PHONOGRAPH RECORDS, MULTI-MEDIA SOFTWARE RECORDED ON CD-ROM, PRERECORDED VIDEO TAPES, LASER DISKS AND DVDS ALL FEATURING MUSIC (U.S. CLS. 21, 23, 26, 36 AND 38).

FIRST USE 7-7-2007; IN COMMERCE 11-11-2008.

CLASS 9—(Continued).

3,680,484. NINTENDO OF AMERICA INC., REDMOND, WA.
SN 77-313,051. PUB. 9-30-2008, FILED 10-25-2007.

CLASS 9—(Continued).

3,680,495. SEMTECH CORPORATION, CAMARILLO, CA. SN
77-317,963. PUB. 3-25-2008, FILED 10-31-2007.

ENDLESS OCEAN

THE MARK CONSISTS OF STANDARD CHARACTERS WITHOUT CLAIM TO ANY PARTICULAR FONT, STYLE, SIZE, OR COLOR.

PRIORITY CLAIMED UNDER SEC. 44(D) ON JAPAN APPLICATION NO. 2007-077537, FILED 7-10-2007, REG. NO. 5116766, DATED 3-7-2008, EXPIRES 3-7-2018.

FOR VIDEO GAME DISCS; PROGRAMS FOR VIDEO GAMES; OPTICAL DISCS, CD-ROM, DVD-ROM, ALL STORING PROGRAMS FOR VIDEO GAME MACHINES; PROGRAMS FOR COMPUTERS, NAMELY, COMPUTER GAMES; OTHER ELECTRONIC MACHINES, APPARATUS AND THEIR PARTS, NAMELY, ELECTRONIC GAME SOFTWARE; RECORDED COMPACT DISCS FEATURING ENTERTAINMENT CONTENT, NAMELY, MUSIC, STORIES, GAMES AND GAME HINTS; RECORDED VIDEO DISCS FEATURING CHILDREN'S ENTERTAINMENT CONTENT, NAMELY, MUSIC, GAMES (U.S. CLS. 21, 23, 26, 36 AND 38).

FIRST USE 1-21-2008; IN COMMERCE 1-21-2008.

SemPulse

THE MARK CONSISTS OF STANDARD CHARACTERS WITHOUT CLAIM TO ANY PARTICULAR FONT, STYLE, SIZE, OR COLOR.

FOR INTEGRATED CIRCUITS (ICS), SEMICONDUCTOR DEVICES USED TO CONVERT ONE VOLTAGE TO ANOTHER AND USED TO PROVIDE A FIXED VOLTAGE OUTPUT OVER A WIDE RANGE OF CURRENT, VOLTAGE REGULATORS, VOLTAGE REFERENCES, LIGHT EMITTING DIODE (LED) DRIVERS, DRIVER ICS, AND ELECTRONIC DEVICES, NAMELY, REGULATORS USED TO PROVIDE FAST RESPONSES TO CHANGES IN OUTPUT LOADING (U.S. CLS. 21, 23, 26, 36 AND 38).

FIRST USE 10-2-2008; IN COMMERCE 10-2-2008.

3,680,488. TRISTAR PRODUCTS, INC., FAIRFIELD, NJ. SN
77-314,285. PUB. 10-14-2008, FILED 10-26-2007.

3,680,513. SNACK DADDY, LLC, SEATTLE, WA. SN 77-
322,573. PUB. 4-29-2008, FILED 11-6-2007.

RECHARGED EAR

THE MARK CONSISTS OF STANDARD CHARACTERS WITHOUT CLAIM TO ANY PARTICULAR FONT, STYLE, SIZE, OR COLOR.

NO CLAIM IS MADE TO THE EXCLUSIVE RIGHT TO USE "EAR", APART FROM THE MARK AS SHOWN.

FOR ASSISTIVE LISTENING DEVICE NOT FOR MEDICAL PURPOSES (U.S. CLS. 21, 23, 26, 36 AND 38).

FIRST USE 6-1-2009; IN COMMERCE 6-1-2009.

SNACK DADDY

THE MARK CONSISTS OF STANDARD CHARACTERS WITHOUT CLAIM TO ANY PARTICULAR FONT, STYLE, SIZE, OR COLOR.

NO CLAIM IS MADE TO THE EXCLUSIVE RIGHT TO USE "SNACK", APART FROM THE MARK AS SHOWN.

FOR VENDING MACHINES (U.S. CLS. 21, 23, 26, 36 AND 38).

FIRST USE 10-0-2007; IN COMMERCE 10-0-2007.

CLASS 9—(Continued).

3,680,522. GRIDPOINT, INC., ARLINGTON, VA. SN 77-325,858. PUB. 9-30-2008, FILED 11-9-2007.

GRIDPOINT INTELLIGENCE

THE MARK CONSISTS OF STANDARD CHARACTERS WITHOUT CLAIM TO ANY PARTICULAR FONT, STYLE, SIZE, OR COLOR.

OWNER OF U.S. REG. NOS. 3,320,099, 3,341,158, AND 3,341,169.

FOR COMPUTER HARDWARE; COMPUTER SOFTWARE FOR USE BY PUBLIC UTILITIES IN THE STORAGE, DEPLOYMENT, GENERATION, TRANSMISSION, MEASUREMENT, VERIFICATION AND CONTROL OF ELECTRICAL ENERGY; ELECTRIC CONTROL DEVICES FOR HEATING AND ENERGY MANAGEMENT (U.S. CLS. 21, 23, 26, 36 AND 38).
FIRST USE 11-30-2007; IN COMMERCE 11-30-2007.

3,680,528. AIRCELL LLC, ITASCA, IL. SN 77-327,233. PUB. 4-1-2008, FILED 11-12-2007.

wi-fi with wings

THE MARK CONSISTS OF STANDARD CHARACTERS WITHOUT CLAIM TO ANY PARTICULAR FONT, STYLE, SIZE, OR COLOR.

FOR COMPUTER AND TELECOMMUNICATIONS NETWORK HARDWARE AND SOFTWARE FOR IMPLEMENTING LOCAL AREA NETWORKS ONBOARD AIRCRAFTS TO ENABLE USERS TO TRANSMIT AND RECEIVE VOICE, VIDEO, AND DATA WITHIN THE AIRCRAFTS, BETWEEN THE AIRCRAFTS, BETWEEN THE AIRCRAFTS AND THE GROUND, AND BETWEEN THE GROUND AND THE AIRCRAFTS; LOCAL AREA NETWORK ACCESS POINTS FOR COMMUNICATING WITH COMPUTER AND TELECOMMUNICATIONS USERS LOCATED ONBOARD AIRCRAFTS FOR TRANSMITTING AND RECEIVING VOICE, VIDEO, AND DATA WITHIN THE AIRCRAFTS, BETWEEN THE AIRCRAFTS, BETWEEN THE AIRCRAFTS AND THE GROUND, AND BETWEEN THE GROUND AND THE AIRCRAFTS; COMPUTER AND TELECOMMUNICATIONS NETWORK HARDWARE AND SOFTWARE FOR

CLASS 9—(Continued).

TRANSMITTING AND RECEIVING VOICE, VIDEO, AND DATA BETWEEN COMPUTER AND TELECOMMUNICATIONS USERS, LOCATED ONBOARD AN AIRCRAFT, AND COMPUTER, AND TELECOMMUNICATIONS SYSTEMS LOCATED ONBOARD THE AIRCRAFT, COMPUTER AND TELECOMMUNICATION SYSTEMS LOCATED ONBOARD ANOTHER AIRCRAFT, AND COMPUTER AND TELECOMMUNICATIONS SYSTEMS LOCATED ON THE GROUND; COMPUTER AND TELECOMMUNICATIONS NETWORK ACCESS SERVER HARDWARE AND SOFTWARE ONBOARD AIRCRAFTS FOR TRANSMITTING AND RECEIVING VOICE, VIDEO, AND DATA FROM THE GROUND TO IDENTIFIED USERS LOCATED ONBOARD THE AIRCRAFTS, FROM IDENTIFIED USERS LOCATED ONBOARD THE AIRCRAFTS TO THE GROUND, AND FROM IDENTIFIED USERS LOCATED ONBOARD ONE AIRCRAFT TO IDENTIFIED USERS ONBOARD ANOTHER AIRCRAFT, AND BETWEEN IDENTIFIED USERS WITHIN AN AIRCRAFT (U.S. CLS. 21, 23, 26, 36 AND 38).

FIRST USE 6-28-2008; IN COMMERCE 6-28-2008.

3,680,537. DC COMICS, NEW YORK, NY. SN 77-329,756. PUB. 4-15-2008, FILED 11-14-2007.

THE DARK KNIGHT

THE MARK CONSISTS OF STANDARD CHARACTERS WITHOUT CLAIM TO ANY PARTICULAR FONT, STYLE, SIZE, OR COLOR.

OWNER OF U.S. REG. NO. 1,458,274.

FOR MOTION PICTURE FILMS FEATURING COMEDY, DRAMA, ACTION, ADVENTURE AND/OR ANIMATION, AND MOTION PICTURE FILMS FOR BROADCAST ON TELEVISION FEATURING COMEDY, DRAMA, ACTION, ADVENTURE AND/OR ANIMATION; AUDIO TAPES, AUDIO-VIDEO TAPES, AUDIO VIDEO CASSETTES, AUDIO VIDEO DISCS, AND DIGITAL VERSATILE DISCS FEATURING MUSIC, COMEDY, DRAMA, ACTION, ADVENTURE, AND/OR ANIMATION; SUNGLASSES; AND DECORATIVE MAGNETS (U.S. CLS. 21, 23, 26, 36 AND 38).

FIRST USE 7-18-2008; IN COMMERCE 7-18-2008.

3,680,544. BARRETT PRODUCTIONS, WABAN, MA. SN 77-331,242. PUB. 10-14-2008, FILED 11-16-2007.

PLAYING WITH THE BAND

THE MARK CONSISTS OF STANDARD CHARACTERS WITHOUT CLAIM TO ANY PARTICULAR FONT, STYLE, SIZE, OR COLOR.

FOR AUDIO AND VIDEO RECORDINGS FEATURING INSTRUCTIONAL MUSIC (U.S. CLS. 21, 23, 26, 36 AND 38).

FIRST USE 7-1-2008; IN COMMERCE 7-1-2008.

CLASS 9—(Continued).

3,680,546. INNCOM INTERNATIONAL, INC., NIAN TIC, CT. SN 77-331,658. PUB. 10-28-2008, FILED 11-16-2007.

ENVIRO-MODE

THE MARK CONSISTS OF STANDARD CHARACTERS WITHOUT CLAIM TO ANY PARTICULAR FONT, STYLE, SIZE, OR COLOR.

FOR THERMOSTATS; SMART THERMOSTATS; SMART DIGITAL THERMOSTATS; CLIMATE CONTROL SYSTEMS CONSISTING OF DIGITAL THERMOSTATS, AIR CONDITIONING, HEATING, VENTILATION AND DRYING CONTROL DEVICES; THERMOSTAT COMPONENT DEVICES, NAMELY, TOUCHSCREENS, PROGRAMMABLE SWITCHES, THERMOSTAT DEVICE COMPONENT THAT ALLOWS USERS TO ENABLE A PROPERTY'S ENERGY CONSERVATION AND SAVINGS STRATEGIES, AND NOTIFIES A PROPERTY THAT THE USER IS ELECTING TO PARTICIPATE IN ENVIRONMENTAL SUSTAINABILITY PROGRAMS (U.S. CLS. 21, 23, 26, 36 AND 38).

FIRST USE 1-28-2008; IN COMMERCE 1-28-2008.

3,680,558. GENERITON CO., LTD., HSINCHU CITY, TAIWAN. SN 77-334,847. PUB. 1-27-2009, FILED 11-21-2007.

Generit^{on}

PRIORITY CLAIMED UNDER SEC. 44(D) ON TAIWAN APPLICATION NO. 096037711, FILED 8-7-2007.

THE MARK CONSISTS OF THE WORD "GENERITON" WHEREIN LETTERS OF "IT" ARE IN ITALIC TYPE, WITH A SQUARE SHADING IN THE BACKGROUND.

FOR ACCESS CONTROL AND ALARM MONITORING SYSTEMS; ADAPTER RINGS FOR ATTACHING OBJECTIVES ON CAMERAS; AUDIO CIRCUIT BOARDS; AUTOMATIC CASH REGISTERS; AUTOMATIC COMBUSTION CONTROL MACHINES AND INSTRUMENTS; AUTOMATIC CONTROLLERS FOR REVOLVING DOORS; AUTOMATIC ELECTRICAL DISTRIBUTION APPARATUS; BLANK DISKETTES; CAMERAS SHUTTERS; CARBON DIOXIDE DETECTORS; CELLULAR TELEPHONES; CHROMATOGRAPHY COLUMNS FOR USE IN PURIFICATION IN THE LABORATORY; CHRONOGRAPHS FOR USE AS SPECIALIZED TIME RECORDING APPARATUS; CIGAR LIGHTERS FOR AUTOMOBILES; CINEMATOGRAPHIC CAMERAS; CLINOMETER; CLINOMETERS; COLLAPSIBLE LIGHT DIRECTORS AND DIFFUSERS FOR USE WITH PHOTOGRAPHIC LIGHTING EQUIPMENT FOR PROFESSIONAL AND HIGH-END PHOTOGRAPHY; COLOR FILTERS FOR TELEVISION AND MOTION PICTURE FILM CAMERAS; COMMERCIAL SAFETY NETS; COMMUNICATION HUBS; COMMUNICATIONS SERVERS; COMPACT DISC CASES; COMPACT DISC PLAYERS; COMPACT DISCS; COMPARATORS; COMPONENT FEATURE OF AN OSCILLOSCOPE, NAMELY, AN ELECTRICAL SIGNAL ACQUISITION MODE; COMPUTER CENTRAL PROCESSING UNITS; COMPUTER CHASSIS; COMPUTER CHIPS; COMPUTER CURSOR CONTROL DEVICES, NAMELY, TRACKBALLS; COMPUTER DATABASE MANAGEMENT SOFTWARE FOR USE IN PERSONALIZING THE CONTENT OF EMAIL COMMUNICATIONS; COMPUTER E-COMMERCE SOFTWARE TO ALLOW USERS TO PERFORM ELECTRONIC BUSINESS TRANSACTIONS VIA A GLOBAL COMPUTER NETWORK; COMPUTER FIRMWARE FOR USE IN DATABASE MANAGEMENT; COMPUTER FIRMWARE FOR USE AS A SPREADSHEET, COMPUTER FIRMWARE FOR WORD PROCESSING; COMPUTER HARD DISCS; COMPUTER JOYSTICKS; COMPUTER PERIPH-

CLASS 9—(Continued).

ERAL APPARATUS; COMPUTER PRINTERS; COMPUTER SOFTWARE FOR USE IN RELATION TO DIGITAL ANIMATION AND SPECIAL EFFECTS OF IMAGES; DIGITAL PHONES; EARPHONES; EARPHONES AND HEADPHONES; ELECTRIC WIRES AND CABLES; ELECTRONIC APPARATUS FOR THE REMOTE CONTROL OF INDUSTRIAL OPERATIONS; ELECTRONIC DESK CALCULATORS; ELECTROPLATING MACHINES; ELECTROSTATIC COATING MACHINES; ELECTROSTATIC EMISSION CONTROL DEVICES, NAMELY, ELECTROSTATIC PRECIPITATORS FOR REDUCING PARTICULATE EMISSION IN INDUSTRIAL APPLICATIONS; HANDS FREE KITS FOR PHONES; HAND-HELD DEVICE COMPRISED OF CHEMICAL AND HEAT SENSORS FOR THE DETECTION OF EXPLOSIVES; HARD DRIVES FOR COMPUTERS; HEAT DETECTION SYSTEMS COMPRISED OF FIBER OPTIC LINEAR LOOP CONFIGURATIONS, HEAT DETECTORS, MONITORS; HELMET SAFETY LIGHTS; HIGH FREQUENCY SWITCHES; HIGH PRESSURE MANOMETERS; LABORATORY EQUIPMENT AND SUPPLIES, NAMELY, INCUBATORS; OPACIMETER; OPEN-WIRE TRANSMISSION MACHINES AND APPARATUS; OPTICAL SEMICONDUCTOR AMPLIFIERS; OPTICAL SHUTTERS; PORTABLE ELECTRONIC RECORDER FOR MEASURING AND RECORDING MULTIPLE VOLTAGE, CURRENT AND THERMOCOUPLE READINGS FROM VARIOUS TRANSDUCERS; REMOTE CURSOR CONTROLS FOR COMPUTERS (U.S. CLS. 21, 23, 26, 36 AND 38).

FIRST USE 1-8-2009; IN COMMERCE 1-8-2009.

3,680,565. A123 SYSTEMS, INC., WATERTOWN, MA. SN 77-335,459. PUB. 9-30-2008, FILED 11-21-2007.

ENERLAND

THE MARK CONSISTS OF STANDARD CHARACTERS WITHOUT CLAIM TO ANY PARTICULAR FONT, STYLE, SIZE, OR COLOR.

FOR BATTERIES; ENERGY STORAGE PRODUCTS, NAMELY, ELECTRICAL STORAGE BATTERIES (U.S. CLS. 21, 23, 26, 36 AND 38).

FIRST USE 1-15-2008; IN COMMERCE 1-15-2008.

3,680,574. INTEGRATED SOLUTIONS, INC., HOLMDEL, NJ. SN 77-336,922. PUB. 10-7-2008, FILED 11-26-2007.

DATAREADY

THE MARK CONSISTS OF STANDARD CHARACTERS WITHOUT CLAIM TO ANY PARTICULAR FONT, STYLE, SIZE, OR COLOR.

FOR SOFTWARE, NAMELY, DATA AND INFORMATION MANAGEMENT SOFTWARE FOR INTEGRATING, EXTRACTING, AND CONFIGURING DATA, MAINTAINING DATA INTEGRITY AND MAINTAINING SYSTEM AND DATA SECURITY (U.S. CLS. 21, 23, 26, 36 AND 38).

FIRST USE 1-1-2009; IN COMMERCE 1-1-2009.

CLASS 9—(Continued).

3,680,575. MECHANIX WEAR, INC., VALENCIA, CA. SN 77-336,975. PUB. 9-16-2008, FILED 11-26-2007.



THE MARK CONSISTS OF THE LETTERS "MRT" ALL CONNECTED AT THE TOP, WITH FOUR HORIZONTAL LINES OF VARYING LENGTH STACKED VERTICALLY TO THE RIGHT OF THE "T".

FOR PROTECTIVE GLOVES, NAMELY, DURABLE PROTECTIVE GLOVES PRIMARILY WORN BY MECHANICS TO PROTECT AGAINST BURNS AND ABRASIONS (U.S. CLS. 21, 23, 26, 36 AND 38).

FIRST USE 1-0-2008; IN COMMERCE 1-0-2008.

3,680,576. MECHANIX WEAR, INC., VALENCIA, CA. SN 77-336,981. PUB. 9-16-2008, FILED 11-26-2007.

MRT

THE MARK CONSISTS OF STANDARD CHARACTERS WITHOUT CLAIM TO ANY PARTICULAR FONT, STYLE, SIZE, OR COLOR.

FOR PROTECTIVE GLOVES, NAMELY, DURABLE PROTECTIVE GLOVES PRIMARILY WORN BY MECHANICS TO PROTECT AGAINST BURNS AND ABRASIONS (U.S. CLS. 21, 23, 26, 36 AND 38).

FIRST USE 1-0-2008; IN COMMERCE 1-0-2008.

CLASS 9—(Continued).

3,680,578. KABUSHIKI KAISHA TOSHIBA, DBA TOSHIBA CORPORATION, MINATO-KU, TOKYO, JAPAN. SN 77-337,722. PUB. 12-9-2008, FILED 11-27-2007.



THE MARK CONSISTS OF THE LETTERS "GF" IN STYLIZED FORM.

FOR BROADCASTING HARDWARE AND SOFTWARE PLATFORM BASED ON FLASH MEMORY FOR USE IN VIDEO BROADCASTING, PRODUCTION, AND EDITING; COMPUTER HARDWARE AND SOFTWARE FOR USE IN VIDEO BROADCASTING, PRODUCTION, AND EDITING (U.S. CLS. 21, 23, 26, 36 AND 38).

FIRST USE 12-31-2008; IN COMMERCE 2-28-2009.

3,680,579. KABUSHIKI KAISHA TOSHIBA, DBA TOSHIBA CORPORATION, MINATO-KU, TOKYO, JAPAN. SN 77-337,773. PUB. 12-9-2008, FILED 11-27-2007.



NO CLAIM IS MADE TO THE EXCLUSIVE RIGHT TO USE "CAM", APART FROM THE MARK AS SHOWN.

THE MARK CONSISTS OF THE LETTERS "GFCAM" IN STYLIZED FORM.

FOR BROADCASTING HARDWARE AND SOFTWARE PLATFORM BASED ON FLASH MEMORY FOR USE IN VIDEO BROADCASTING, PRODUCTION, AND EDITING; COMPUTER HARDWARE AND SOFTWARE FOR USE IN VIDEO BROADCASTING, PRODUCTION, AND EDITING (U.S. CLS. 21, 23, 26, 36 AND 38).

FIRST USE 12-31-2008; IN COMMERCE 2-28-2009.

CLASS 9—(Continued).

3,680,580. KABUSHIKI KAISHA TOSHIBA, DBA TOSHIBA CORPORATION, MINATO-KU, TOKYO, JAPAN. SN 77-337,796. PUB. 12-9-2008, FILED 11-27-2007.

GF STATION

NO CLAIM IS MADE TO THE EXCLUSIVE RIGHT TO USE "STATION", APART FROM THE MARK AS SHOWN. THE MARK CONSISTS OF THE LETTERS "GFSTATION" IN STYLIZED FORM.

FOR BROADCASTING HARDWARE AND SOFTWARE PLATFORM BASED ON FLASH MEMORY FOR USE IN VIDEO BROADCASTING, PRODUCTION, AND EDITING; COMPUTER HARDWARE AND SOFTWARE FOR USE IN VIDEO BROADCASTING, PRODUCTION, AND EDITING (U.S. CLS. 21, 23, 26, 36 AND 38).
FIRST USE 12-31-2008; IN COMMERCE 2-28-2009.

CLASS 9—(Continued).

3,680,604. SIEMENS ENERGY & AUTOMATION, INC., ALPHARETTA, GA. SN 77-344,826. PUB. 10-21-2008, FILED 12-5-2007.

ESP200

THE MARK CONSISTS OF STANDARD CHARACTERS WITHOUT CLAIM TO ANY PARTICULAR FONT, STYLE, SIZE, OR COLOR.

OWNER OF U.S. REG. NOS. 1,719,944 AND 1,753,652.
FOR ELECTRONIC OVERLOAD PROTECTORS AND ELECTRICAL CONTACTORS THAT ARE COMPONENT PARTS OF ELECTRICAL MOTOR STARTERS WHICH ARE NOT FOR LAND VEHICLES (U.S. CLS. 21, 23, 26, 36 AND 38).
FIRST USE 9-30-2008; IN COMMERCE 1-31-2009.

3,680,581. KABUSHIKI KAISHA TOSHIBA, DBA TOSHIBA CORPORATION, MINATO-KU, TOKYO, JAPAN. SN 77-337,836. PUB. 12-9-2008, FILED 11-27-2007.

GF PAK

NO CLAIM IS MADE TO THE EXCLUSIVE RIGHT TO USE "PAK", APART FROM THE MARK AS SHOWN. THE MARK CONSISTS OF THE LETTERS "GFPAK" IN STYLIZED FORM.

FOR BROADCASTING HARDWARE AND SOFTWARE PLATFORM BASED ON FLASH MEMORY FOR USE IN VIDEO BROADCASTING, PRODUCTION, AND EDITING; COMPUTER HARDWARE AND SOFTWARE FOR USE IN VIDEO BROADCASTING, PRODUCTION, AND EDITING (U.S. CLS. 21, 23, 26, 36 AND 38).
FIRST USE 12-31-2008; IN COMMERCE 2-28-2009.

3,680,608. ATG CEYLON (PVT) LIMITED, IPZ KATUNAYAKE, SRI LANKA. SN 77-345,809. PUB. 4-8-2008, FILED 12-6-2007.

MAXITHERM

THE MARK CONSISTS OF STANDARD CHARACTERS WITHOUT CLAIM TO ANY PARTICULAR FONT, STYLE, SIZE, OR COLOR.

FOR PROTECTIVE SAFETY WORK GLOVES; PROTECTIVE SAFETY GLOVES FOR INDUSTRIAL USE (U.S. CLS. 21, 23, 26, 36 AND 38).
FIRST USE 1-0-2008; IN COMMERCE 1-0-2009.

CLASS 9—(Continued).

3,680,630. TOPICS ENTERTAINMENT, INC., RENTON, WA. SN 77-350,361. PUB. 5-13-2008, FILED 12-12-2007.

FILM FESTIVAL GEMS

THE MARK CONSISTS OF STANDARD CHARACTERS WITHOUT CLAIM TO ANY PARTICULAR FONT, STYLE, SIZE, OR COLOR.

NO CLAIM IS MADE TO THE EXCLUSIVE RIGHT TO USE "FILM FESTIVAL", APART FROM THE MARK AS SHOWN.

FOR DIGITAL MEDIA, NAMELY, PRE-RECORDED VIDEO CASSETTES, DIGITAL VIDEO DISCS, DIGITAL VERSATILE DISCS, DVDS, AND HIGH DEFINITION DIGITAL DISKS FEATURING ACTION, ADVENTURE, ANIMATION, COMEDY, DOCUMENTARY, DRAMA, FAMILY, HORROR, MUSICALS, MYSTERY, ROMANCE, SCIENCE FICTION AND SUSPENSE MOTION PICTURES (U.S. CLS. 21, 23, 26, 36 AND 38).
FIRST USE 1-11-2008; IN COMMERCE 1-11-2008.

CLASS 9—(Continued).

3,680,646. MATSUSHITA ELECTRIC INDUSTRIAL CO., LTD., OSAKA, JAPAN. SN 77-357,950. PUB. 10-21-2008, FILED 12-21-2007.



NO CLAIM IS MADE TO THE EXCLUSIVE RIGHT TO USE "TECHNOLOGY", APART FROM THE MARK AS SHOWN.

THE MARK CONSISTS OF THE WORDS "MOTION FOCUS TECHNOLOGY" AND A SERIES OF 7 PARALLEL, HORIZONTAL LINES IN A SLANTED STACK SITUATED BELOW THE "N" IN "MOTION" AND TO THE LEFT OF THE WORDS "FOCUS" AND "TECHNOLOGY".

FOR SLIM TELEVISION SETS EQUIPPED WITH A FLAT PLASMA OR FLAT LIQUID CRYSTAL DISPLAY (U.S. CLS. 21, 23, 26, 36 AND 38).

FIRST USE 1-7-2008; IN COMMERCE 1-7-2008.

3,680,631. TOPICS ENTERTAINMENT, INC., RENTON, WA. SN 77-350,424. PUB. 5-13-2008, FILED 12-12-2007.



NO CLAIM IS MADE TO THE EXCLUSIVE RIGHT TO USE "FILM FESTIVAL", APART FROM THE MARK AS SHOWN.

THE MARK CONSISTS OF THE WORDS "FILM FESTIVAL GEMS" WITH BRANCHES OF LEAVES ON EITHER END OF THE PHRASE THAT ARE SHAPED LIKE PARENTHESIS.

FOR DIGITAL MEDIA, NAMELY, PRE-RECORDED VIDEO CASSETTES, DIGITAL VIDEO DISCS, DIGITAL VERSATILE DISCS, DVDS, AND HIGH DEFINITION DIGITAL DISKS FEATURING ACTION, ADVENTURE, ANIMATION, COMEDY, DOCUMENTARY, DRAMA, FAMILY, HORROR, MUSICALS, MYSTERY, ROMANCE, SCIENCE FICTION AND SUSPENSE MOTION PICTURES (U.S. CLS. 21, 23, 26, 36 AND 38).
FIRST USE 1-11-2008; IN COMMERCE 1-11-2008.

3,680,660. ELKINS EARTHWORKS, LLC, MEDINA, OH. SN 77-364,341. PUB. 9-23-2008, FILED 1-4-2008.

ENVISION

THE MARK CONSISTS OF STANDARD CHARACTERS WITHOUT CLAIM TO ANY PARTICULAR FONT, STYLE, SIZE, OR COLOR.

FOR GAS MONITORS, NAMELY, GAS SENSORS FOR IDENTIFYING AND/OR MEASURING GAS CONCENTRATION FOR CERTAIN TYPES OF GASSES; LAND-FILL GAS ANALYZERS; GAS MIGRATION MONITORING PROBES FOR IDENTIFYING, MONITORING AND/OR MEASURING GAS CONCENTRATION FOR VARIOUS TYPES OF GASSES; COMPUTER SOFTWARE FOR COLLECTING, STORING AND ANALYZING DATA FROM GAS ANALYZERS; COMPUTER SOFTWARE FOR GENERATING ENVIRONMENTAL COMPLIANCE REPORTS; CALIBRATION CHECKERS TO MEASURE GAS PROPERTIES; LEACHATE LEVEL MONITORS FOR MEASURING CONCENTRATION OF MATERIALS ESCAPING LANDFILLS; COMPUTER HARDWARE IN THE NATURE OF A FIELD COMPUTER FOR GATHERING GAS DATA; TEMPERATURE PROFILER, NAMELY, TEMPERATURE SENSORS (U.S. CLS. 21, 23, 26, 36 AND 38).

FIRST USE 3-1-2009; IN COMMERCE 3-1-2009.

CLASS 9—(Continued).

3,680,661. ELKINS EARTHWORKS, LLC, MEDINA, OH. SN 77-364,385. PUB. 9-23-2008, FILED 1-4-2008.



THE MARK CONSISTS OF A GLOBE OF THE EARTH WITH A SWISH MADE UP OF 9 CIRCLES WITH THE WORD "ENVISION" IN FRONT OF THE GLOBE.

FOR GAS MONITORS, NAMELY, GAS SENSORS FOR IDENTIFYING AND/OR MEASURING GAS CONCENTRATION FOR CERTAIN TYPES OF GASSES; LAND-FILL GAS ANALYZERS; GAS MIGRATION MONITORING PROBES FOR IDENTIFYING, MONITORING AND/OR MEASURING GAS CONCENTRATION FOR VARIOUS TYPES OF GASSES; COMPUTER SOFTWARE FOR COLLECTING, STORING AND ANALYZING DATA FROM GAS ANALYZERS; COMPUTER SOFTWARE FOR GENERATING ENVIRONMENTAL COMPLIANCE REPORTS; CALIBRATION CHECKERS TO MEASURE GAS PROPERTIES; LEACHATE LEVEL MONITORS FOR MEASURING CONCENTRATION OF MATERIALS ESCAPING LANDFILLS; COMPUTER HARDWARE IN THE NATURE OF A FIELD COMPUTER FOR GATHERING GAS DATA; TEMPERATURE PROFILER, NAMELY, TEMPERATURE SENSORS (U.S. CLS. 21, 23, 26, 36 AND 38).

FIRST USE 3-1-2009; IN COMMERCE 3-1-2009.

CLASS 9—(Continued).

3,680,677. POLK AUDIO, INC., BALTIMORE, MD. SN 77-369,875. PUB. 5-27-2008, FILED 1-11-2008.

POLK DIGITAL LOGIC

THE MARK CONSISTS OF STANDARD CHARACTERS WITHOUT CLAIM TO ANY PARTICULAR FONT, STYLE, SIZE, OR COLOR.

OWNER OF U.S. REG. NOS. 2,190,498, 2,462,291, AND 2,888,137.

NO CLAIM IS MADE TO THE EXCLUSIVE RIGHT TO USE "DIGITAL LOGIC", APART FROM THE MARK AS SHOWN.

FOR DIGITAL SIGNAL PROCESSING SYSTEM COMPRISED OF DIGITAL SIGNAL PROCESSOR, SENSORS AND REMOTE CONTROL FOR USE IN CONNECTION WITH HOME THEATER SYSTEMS TO REMOTELY CONTROL AND MANAGE PERFORMANCE AND OPTIMIZATION THEREOF (U.S. CLS. 21, 23, 26, 36 AND 38).

FIRST USE 6-5-2009; IN COMMERCE 6-5-2009.

3,680,671. CODONICS, INC., MIDDLEBURG HEIGHTS, OH. SN 77-367,494. PUB. 9-30-2008, FILED 1-9-2008.

INTEGRITY

THE MARK CONSISTS OF STANDARD CHARACTERS WITHOUT CLAIM TO ANY PARTICULAR FONT, STYLE, SIZE, OR COLOR.

FOR PORTABLE STORAGE MEDIA DATA IMPORT SYSTEM COMPRISED OF COMPUTER HARDWARE AND SOFTWARE FOR MEDICAL IMAGES/INFORMATION; COMPUTER SOFTWARE FOR USE IN THE MEDICAL FIELD FOR READING PORTABLE STORAGE MEDIA, RECONCILING RECEIVED MEDICAL IMAGES, AND SEARCHING RECEIVED MEDICAL IMAGES; COMPUTER SOFTWARE FOR STORING PATIENT MEDICAL IMAGES/INFORMATION FROM PORTABLE STORAGE MEDIA TO A PACS SYSTEM, A LOCAL OR REMOTE DICOM ARCHIVE, A CD/DVD BURNER, OR ANOTHER PORTABLE STORAGE MEDIA RECORDING SYSTEM (U.S. CLS. 21, 23, 26, 36 AND 38).

FIRST USE 11-26-2007; IN COMMERCE 11-26-2007.

3,680,684. C&S OPERATIONS, INC., SYRACUSE, NY. SN 77-375,764. PUB. 5-13-2008, FILED 1-18-2008.



THE MARK CONSISTS OF THE WORD "FIDDLEHEAD" POSITIONED ASIDE A CIRCULAR LOGO WITH A FANCIFUL LETTER "F" INSIDE THE CIRCLE.

FOR COMPUTER SOFTWARE FOR USE IN SHARING THE VIDEO, AUDIO, APPLICATIONS, AND OTHER DATA PROCESSING CAPABILITY FROM ONE CENTRAL PROCESSOR ACROSS A NETWORK OF PERIPHERAL DEVICES (U.S. CLS. 21, 23, 26, 36 AND 38).

FIRST USE 9-1-2008; IN COMMERCE 9-1-2008.

CLASS 9—(Continued).

3,680,706. ITBRIX LLC, COLORADO SPRINGS, CO. SN 77-391,573. PUB. 7-15-2008, FILED 2-7-2008.

WORDFRAME

THE MARK CONSISTS OF STANDARD CHARACTERS WITHOUT CLAIM TO ANY PARTICULAR FONT, STYLE, SIZE, OR COLOR.

FOR COMPUTER COMMUNICATIONS SOFTWARE FOR CONNECTING MULTIPLE WEB USERS FOR COMMUNITY BASED, COLLABORATIVE WORK AND COMMUNICATION; WEB PUBLISHING AND BLOGGING; COMPUTER COMMUNICATIONS SOFTWARE PLATFORMS FOR CONNECTING MULTIPLE WEB USERS FOR COMMUNITY BASED, COLLABORATIVE WORK AND COMMUNICATION, WEB PUBLISHING AND BLOGGING; DOWNLOADABLE COMPUTER COMMUNICATIONS SOFTWARE FOR CONNECTING MULTIPLE WEB USERS FOR COMMUNITY BASED, COLLABORATIVE WORK AND COMMUNICATION, WEB PUBLISHING AND BLOGGING (U.S. CLS. 21, 23, 26, 36 AND 38).

FIRST USE 2-26-2008; IN COMMERCE 2-26-2008.

3,680,712. THE TJIFFEN COMPANY, LLC, HAUPPAUGE, NY. SN 77-394,384. PUB. 6-17-2008, FILED 2-12-2008.

TRAIL TREKKER

THE MARK CONSISTS OF STANDARD CHARACTERS WITHOUT CLAIM TO ANY PARTICULAR FONT, STYLE, SIZE, OR COLOR.

FOR MONOPODS FOR CAMERAS (U.S. CLS. 21, 23, 26, 36 AND 38).

FIRST USE 5-28-2009; IN COMMERCE 5-28-2009.

CLASS 9—(Continued).

3,680,719. BARGOLD SOFTWARE SOLUTIONS, LLC, LONG ISLAND CITY, NY. SN 77-397,416. PUB. 10-21-2008, FILED 2-14-2008.



NO CLAIM IS MADE TO THE EXCLUSIVE RIGHT TO USE "STORAGE ETRACKER", APART FROM THE MARK AS SHOWN.

THE MARK CONSISTS OF THE WORDS "BARGOLD" IN STYLIZED MIXED CASE LETTERING SET ABOVE THE WORDS "STORAGE ETRACKER" IN BLOCK CAPITAL LETTERS. A GRAPHIC IMAGE COMPRISED OF OPPOSING SMALL AND LARGE CONCENTRIC HALF CIRCLES APPEARS ABOVE THE FOREGOING WORDING.

FOR COMPUTER SOFTWARE USED TO MONITOR THE STATUS OF STORAGE UNITS AND FOR SCHEDULING TASKS FOR WORKERS ALL IN THE FIELD OF SELF-STORAGE (U.S. CLS. 21, 23, 26, 36 AND 38).

FIRST USE 1-21-2009; IN COMMERCE 1-21-2009.

3,680,726. IMC HOLDINGS I, LLC, BLAINE, WA. SN 77-400,941. PUB. 10-14-2008, FILED 2-19-2008.

BEBIZ

THE MARK CONSISTS OF STANDARD CHARACTERS WITHOUT CLAIM TO ANY PARTICULAR FONT, STYLE, SIZE, OR COLOR.

FOR COMPUTER SOFTWARE FOR DEVELOPING WEBPAGES FOR PRODUCTS AND SERVICES, SETTING-UP AND MAINTAINING AN ONLINE PAYMENT SYSTEM FOR PRODUCTS AND SERVICES, GATHERING AND ANALYZING INFORMATION ABOUT CUSTOMERS, COMPETITORS, AND THE MARKET, MARKETING FOR PRODUCTS AND SERVICES USING EMAIL, CREATING ADVERTISEMENTS FOR PRODUCTS AND SERVICES, AND SELECTING PRODUCTS AND SERVICES, ALL FOR USE IN ESTABLISHING AND OPERATING AN ONLINE BUSINESS; COMPUTER SOFTWARE FOR PERFORMING MARKET RESEARCH; COMPUTER SOFTWARE FOR WRITING AND FORMATTING MARKETING, PROMOTIONAL, AND SALES COPY AND FOR CREATING A WEBSITE FOR A BUSINESS; COMPUTER SOFTWARE FOR MANAGING TRAFFIC AND SALES CONVERSIONS; COMPUTER E-COMMERCE SOFTWARE TO ALLOW USERS TO PERFORM ELECTRONIC BUSINESS TRANSACTIONS VIA A GLOBAL COMPUTER NETWORK (U.S. CLS. 21, 23, 26, 36 AND 38).

FIRST USE 5-0-2008; IN COMMERCE 5-0-2008.

CLASS 9—(Continued).

3,680,731. MWH SOFT, INC., BROOMFIELD, CO. SN 77-402,696. PUB. 12-2-2008, FILED 2-21-2008.

CAPPLAN

THE MARK CONSISTS OF STANDARD CHARACTERS WITHOUT CLAIM TO ANY PARTICULAR FONT, STYLE, SIZE, OR COLOR.

FOR SOFTWARE, NAMELY, A COMPREHENSIVE DECISION SUPPORT TOOL THAT CALCULATES PROJECT COSTS, PROJECTS FUTURE COSTS AND ESTIMATES TIMELINE OF PROJECT COMPLETION, DESIGNED TO OPTIMIZE THE OPERATION OF WATER DISTRIBUTION AND SANITARY SYSTEMS AND TO HELP WATER AND WASTEWATER UTILITIES EFFECTIVELY PRIORITIZE SEWER REHABILITATION PROJECTS FOR SHORT AND LONG TERM BENEFITS, NAMELY, THE ABILITY TO DEVELOP A SOUND, COST-EFFECTIVE CAPITAL PROGRAM WITH IMPROVED SYSTEM PERFORMANCE AND THE PROGRAM CONSIDERS BOTH SYSTEM STRUCTURAL CONDITION ASSESSMENT AND RISK ASSESSMENT OF THE PROBABILITY AND CONSEQUENCE OF FAILURE FOR EACH ASSET (U.S. CLS. 21, 23, 26, 36 AND 38).
FIRST USE 3-27-2008; IN COMMERCE 3-27-2008.

3,680,735. TRACFONE WIRELESS, INC., MIAMI, FL. SN 77-402,939. PUB. 8-26-2008, FILED 2-21-2008.

NET¹10
NO BILLS. NO CONTRACTS. NO EVIL.

OWNER OF U.S. REG. NOS. 3,118,250, 3,253,506, AND OTHERS.

THE MARK CONSISTS OF THE WORDS "NET 10 NO BILLS.NO CONTRACTS.NO EVIL," WITH A SMALLER TRIANGLE POINTING TOWARDS THE "1" IN "10" OVER THE LARGER TRIANGLE POINTING TOWARDS THE "1" IN "10".

FOR ELECTRONIC COMMUNICATIONS EQUIPMENT, NAMELY, CELLULAR TELEPHONES; PREPAID AIR TIME CELLULAR TELEPHONES; CELLULAR TELEPHONE ACCESSORIES, NAMELY, BATTERY CHARGERS, STANDS SPECIFICALLY DESIGNED FOR HOLDING CELL PHONES, HEADSET KITS COMPRISED OF HANDS FREE ELECTRONIC EARPIECE WITH MICROPHONE AND HOLSTER SPECIFICALLY DESIGNED FOR CARRYING CELL PHONES, HANDS FREE HEADSETS FOR CELL PHONES, CARRYING CASES WITH FLAPS SPECIFICALLY DESIGNED FOR CARRYING CELL PHONES, POWER ADAPTERS, BATTERIES, CARRY SLEEVES SPECIFICALLY DESIGNED FOR CARRYING CELL PHONES, DECORATIVE CELL PHONE FACE PLATES, BELT CLIPS, HOLSTERS AND MOUNTING ATTACHMENTS ALL SPECIFICALLY DESIGNED FOR CARRYING CELL PHONES (U.S. CLS. 21, 23, 26, 36 AND 38).

FIRST USE 8-31-2007; IN COMMERCE 10-31-2007.

CLASS 9—(Continued).

3,680,745. BIGEYE, INC., CHICAGO, IL. SN 77-406,130. PUB. 12-2-2008, FILED 2-26-2008.

BIG EYE RECORDS

THE MARK CONSISTS OF STANDARD CHARACTERS WITHOUT CLAIM TO ANY PARTICULAR FONT, STYLE, SIZE, OR COLOR.

NO CLAIM IS MADE TO THE EXCLUSIVE RIGHT TO USE "RECORDS", APART FROM THE MARK AS SHOWN. FOR AUDIO RECORDINGS FEATURING MUSIC; PRE-RECORDED CDS FEATURING MUSIC AND MUSIC INSTRUCTION (U.S. CLS. 21, 23, 26, 36 AND 38).
FIRST USE 5-1-2008; IN COMMERCE 5-1-2008.

3,680,752. TERRY, KEITH H., SPEARFISH, SD. SN 77-410,767. PUB. 7-22-2008, FILED 3-2-2008.

Terminal Velocity

THE MARK CONSISTS OF STANDARD CHARACTERS WITHOUT CLAIM TO ANY PARTICULAR FONT, STYLE, SIZE, OR COLOR.

FOR ENGINE PARTS, NAMELY, ELECTRONIC FUEL MANAGEMENT CONTROLLERS FOR AUTOMOBILES, MOTORCYCLES, AND DIESEL TRUCKS (U.S. CLS. 21, 23, 26, 36 AND 38).

FIRST USE 7-22-2008; IN COMMERCE 7-22-2008.

3,680,779. TRUMPF GMBH + CO. KG, DITZINGEN, FED REP GERMANY. SN 77-430,513. PUB. 10-7-2008, FILED 3-25-2008.

TRUHEAT

THE MARK CONSISTS OF STANDARD CHARACTERS WITHOUT CLAIM TO ANY PARTICULAR FONT, STYLE, SIZE, OR COLOR.

PRIORITY CLAIMED UNDER SEC. 44(D) ON FED REP GERMANY APPLICATION NO. 30769169, FILED 10-2-2007, REG. NO. 307639169, DATED 11-14-2007, EXPIRES 10-2-2017.

FOR ELECTRICAL CONVERTERS AND POWER SUPPLIES FOR INDUSTRIAL PURPOSES, NOT FOR USE WITH AIR AND WATER HEATERS (U.S. CLS. 21, 23, 26, 36 AND 38).

FIRST USE 11-1-2008; IN COMMERCE 11-1-2008.

CLASS 9—(Continued).

3,680,804. CISCO TECHNOLOGY, INC., SAN JOSE, CA. SN 77-439,596. PUB. 9-30-2008, FILED 4-3-2008.

CISCO LUMIN

THE MARK CONSISTS OF STANDARD CHARACTERS WITHOUT CLAIM TO ANY PARTICULAR FONT, STYLE, SIZE, OR COLOR.

OWNER OF U.S. REG. NOS. 2,574,340, 2,959,329, AND OTHERS.

FOR OPTICAL TRANSMITTERS AND RECEIVERS FOR USE IN CABLE TELEVISION SYSTEMS AND FOR PROVIDING CABLE TELEVISION SERVICES (U.S. CLS. 21, 23, 26, 36 AND 38).

FIRST USE 12-0-2008; IN COMMERCE 12-0-2008.

3,680,805. DILLON SUNGLASS COMPANY, SCOTTSDALE, AZ. SN 77-440,123. PUB. 3-31-2009, FILED 4-4-2008.

NIR

THE MARK CONSISTS OF STANDARD CHARACTERS WITHOUT CLAIM TO ANY PARTICULAR FONT, STYLE, SIZE, OR COLOR.

FOR SUNGLASSES (U.S. CLS. 21, 23, 26, 36 AND 38).
FIRST USE 5-13-2008; IN COMMERCE 5-13-2008.

3,680,809. IGT CORPORATION, RENO, NV. SN 77-440,633. PUB. 2-24-2009, FILED 4-4-2008.

REEL DEPTH

THE MARK CONSISTS OF STANDARD CHARACTERS WITHOUT CLAIM TO ANY PARTICULAR FONT, STYLE, SIZE, OR COLOR.

FOR GAMING MACHINES, NAMELY, DEVICES WHICH ACCEPT A WAGER (U.S. CLS. 21, 23, 26, 36 AND 38).

FIRST USE 8-25-2008; IN COMMERCE 8-25-2008.

CLASS 9—(Continued).

3,680,810. DENNIS, FELIX, LONDON, UNITED KINGDOM. SN 77-440,748. PUB. 10-7-2008, FILED 4-4-2008.

MONKEY

THE MARK CONSISTS OF STANDARD CHARACTERS WITHOUT CLAIM TO ANY PARTICULAR FONT, STYLE, SIZE, OR COLOR.

FOR ELECTRONIC PUBLICATIONS, NAMELY, MAGAZINES IN THE FIELD OF MEN'S LIFESTYLE, POPULAR CULTURE, CURRENT EVENTS, FILMS AND MUSIC (U.S. CLS. 21, 23, 26, 36 AND 38).

FIRST USE 11-0-2006; IN COMMERCE 11-0-2006.

3,680,823. PUNCH SOFTWARE LLC, KANSAS CITY, MO. SN 77-446,265. PUB. 10-7-2008, FILED 4-11-2008.

NEXGEN

THE MARK CONSISTS OF STANDARD CHARACTERS WITHOUT CLAIM TO ANY PARTICULAR FONT, STYLE, SIZE, OR COLOR.

FOR COMPUTER SOFTWARE FOR HOME DESIGN, ADDITION, IMPROVEMENT, REMODELING AND COMPUTER-ASSISTED DRAFTING, NAMELY, SOFTWARE FOR DEVELOPING DESIGNS AND PLANS FOR HOME DESIGN, HOME ADDITIONS, HOME IMPROVEMENTS, HOME REMODELING AND FOR DRAFTING OF ARCHITECTURAL PLANS FOR RESIDENTIAL HOMES (U.S. CLS. 21, 23, 26, 36 AND 38).

FIRST USE 8-0-2008; IN COMMERCE 8-0-2008.

3,680,828. PHIATON CORPORATION, IRVINE, CA. SN 77-451,082. PUB. 12-2-2008, FILED 4-17-2008.

VHST-VALVES OF HEART SOUND TECHNOLOGY

THE MARK CONSISTS OF STANDARD CHARACTERS WITHOUT CLAIM TO ANY PARTICULAR FONT, STYLE, SIZE, OR COLOR.

NO CLAIM IS MADE TO THE EXCLUSIVE RIGHT TO USE "SOUND TECHNOLOGY", APART FROM THE MARK AS SHOWN.

FOR HEADPHONES (U.S. CLS. 21, 23, 26, 36 AND 38).
FIRST USE 4-30-2009; IN COMMERCE 5-13-2009.

CLASS 9—(Continued).

3,680,855. MOAEC, INC., BILLERICA, MA. SN 77-458,246.
PUB. 10-7-2008, FILED 4-25-2008.

PC MO

THE MARK CONSISTS OF STANDARD CHARACTERS WITHOUT CLAIM TO ANY PARTICULAR FONT, STYLE, SIZE, OR COLOR.

NO CLAIM IS MADE TO THE EXCLUSIVE RIGHT TO USE "PC", APART FROM THE MARK AS SHOWN.

FOR COMPUTER SOFTWARE FOR ORGANIZING, SEARCHING, STORING, STREAMING OR GENERATING MEDIA SELECTIONS, DATA SELECTIONS AND PLAYLISTS (U.S. CLS. 21, 23, 26, 36 AND 38).

FIRST USE 6-15-2009; IN COMMERCE 6-15-2009.

3,680,897. MOAEC, INC., BILLERICA, MA. SN 77-466,971.
PUB. 10-7-2008, FILED 5-6-2008.

EASY, FAST, ALL MEDIA, ALL SCREENS

THE MARK CONSISTS OF STANDARD CHARACTERS WITHOUT CLAIM TO ANY PARTICULAR FONT, STYLE, SIZE, OR COLOR.

FOR COMPUTER SOFTWARE FOR ORGANIZING, SEARCHING, STORING, STREAMING OR GENERATING MEDIA SELECTIONS, DATA SELECTIONS AND PLAYLISTS (U.S. CLS. 21, 23, 26, 36 AND 38).

FIRST USE 6-15-2009; IN COMMERCE 6-15-2009.

3,680,922. SIMDESK TECHNOLOGIES, INC., DBA MEZEO SOFTWARE CORPORATION, HOUSTON, TX. SN 77-470,725. PUB. 10-7-2008, FILED 5-9-2008.

MEZEO

THE MARK CONSISTS OF STANDARD CHARACTERS WITHOUT CLAIM TO ANY PARTICULAR FONT, STYLE, SIZE, OR COLOR.

FOR COMPUTER SOFTWARE PLATFORMS FOR THE REMOTE COLLECTION, EDITING, ORGANIZING, TRANSMISSION, STORAGE AND SHARING OF DATA AND INFORMATION, FOR PROVIDING DESKTOP, MOBILE AND INTERNET BROWSER ACCESS TO THE SERVICES PROVIDED BY THE PLATFORMS, AND FOR PROVIDING APPLICATION PROGRAMING INTERFACES FOR THIRD PARTY DEVELOPMENT OF SOFTWARE APPLICATIONS THAT CAN USE THE SERVICES OF THE PLATFORMS (U.S. CLS. 21, 23, 26, 36 AND 38).

FIRST USE 2-10-2009; IN COMMERCE 2-10-2009.

CLASS 9—(Continued).

3,680,923. SIMDESK TECHNOLOGIES, INC., DBA MEZEO SOFTWARE CORPORATION, HOUSTON, TX. SN 77-470,739. PUB. 10-7-2008, FILED 5-9-2008.

MEZEO SOFTWARE

THE MARK CONSISTS OF STANDARD CHARACTERS WITHOUT CLAIM TO ANY PARTICULAR FONT, STYLE, SIZE, OR COLOR.

NO CLAIM IS MADE TO THE EXCLUSIVE RIGHT TO USE "SOFTWARE", APART FROM THE MARK AS SHOWN.

FOR COMPUTER SOFTWARE PLATFORMS FOR THE REMOTE COLLECTION, EDITING, ORGANIZING, TRANSMISSION, STORAGE AND SHARING OF DATA AND INFORMATION, FOR PROVIDING DESKTOP, MOBILE AND INTERNET BROWSER ACCESS TO THE SERVICES PROVIDED BY THE PLATFORMS, AND FOR PROVIDING APPLICATION PROGRAMING INTERFACES FOR THIRD PARTY DEVELOPMENT OF SOFTWARE APPLICATIONS THAT CAN USE THE SERVICES OF THE PLATFORMS (U.S. CLS. 21, 23, 26, 36 AND 38).

FIRST USE 2-10-2009; IN COMMERCE 2-10-2009.

3,680,949. COBRA SYSTEMS, INC., ANAHEIM, CA. SN 77-473,531. PUB. 10-21-2008, FILED 5-13-2008.

TRAKINETICS

THE MARK CONSISTS OF STANDARD CHARACTERS WITHOUT CLAIM TO ANY PARTICULAR FONT, STYLE, SIZE, OR COLOR.

FOR COMPUTER HARDWARE AND COMPUTER SOFTWARE FOR INVENTORY AND ASSET TRACKING AND MANAGEMENT, PHYSICAL LOCATION ACCESS CONTROL, AND RELATED DATA COLLECTION USING BAR CODES AND RFID, SOLD AS A UNIT (U.S. CLS. 21, 23, 26, 36 AND 38).

FIRST USE 1-1-2009; IN COMMERCE 1-1-2009.

CLASS 9—(Continued).

3,680,972. CARLSON SOFTWARE, INC., MAYSVILLE, KY.
SN 77-477,044. PUB. 10-14-2008, FILED 5-16-2008.

SURVNET

THE MARK CONSISTS OF STANDARD CHARACTERS WITHOUT CLAIM TO ANY PARTICULAR FONT, STYLE, SIZE, OR COLOR.

FOR COMPUTER SOFTWARE FOR CIVIL ENGINEERING, NAMELY, NETWORK LEAST-SQUARES PROCESSING OF SURVEY MEASUREMENTS (U.S. CLS. 21, 23, 26, 36 AND 38).

FIRST USE 12-31-2003; IN COMMERCE 12-31-2003.

3,680,975. OAKLEY, INC., FOOTHILL RANCH, CA. SN 77-478,065. PUB. 10-21-2008, FILED 5-19-2008.

FIVES SQUARED

THE MARK CONSISTS OF STANDARD CHARACTERS WITHOUT CLAIM TO ANY PARTICULAR FONT, STYLE, SIZE, OR COLOR.

OWNER OF U.S. REG. NO. 2,521,451.

FOR PROTECTIVE EYEWEAR, NAMELY, SPECTACLES, PRESCRIPTION EYEWEAR, ANTI GLARE GLASSES AND SUNGLASSES AND THEIR PARTS AND ACCESSORIES, NAMELY, REPLACEMENT LENSES, FRAMES, EARSTEMS, AND NOSE PIECES; CASES SPECIALLY ADAPTED FOR SPECTACLES AND SUNGLASSES AND THEIR PARTS AND ACCESSORIES (U.S. CLS. 21, 23, 26, 36 AND 38).

FIRST USE 11-15-2008; IN COMMERCE 11-15-2008.

3,680,983. MANTECH INTERNATIONAL CORPORATION, FAIRFAX, VA. SN 77-479,321. PUB. 8-5-2008, FILED 5-20-2008.

CROWBAR

THE MARK CONSISTS OF STANDARD CHARACTERS WITHOUT CLAIM TO ANY PARTICULAR FONT, STYLE, SIZE, OR COLOR.

FOR ENCODED INTEGRATED CIRCUIT CARDS CONTAINING PROGRAMMING USED TO GENERATE PASSWORDS FOR THE PURPOSE OF EVALUATING COMPUTER NETWORK SECURITY; SOFTWARE FOR GENERATING PASSWORDS FOR THE PURPOSE OF EVALUATING COMPUTER NETWORK SECURITY (U.S. CLS. 21, 23, 26, 36 AND 38).

FIRST USE 5-14-2009; IN COMMERCE 5-14-2009.

CLASS 9—(Continued).

3,680,988. INVENTEAM, LLC, BEND, OR. SN 77-480,871. PUB. 10-21-2008, FILED 5-22-2008.

FOOTPOWER

THE MARK CONSISTS OF STANDARD CHARACTERS WITHOUT CLAIM TO ANY PARTICULAR FONT, STYLE, SIZE, OR COLOR.

FOR AN ELECTRONIC INTERFACE COMPONENT DESIGNED TO CONNECT A PAD-TYPE ELECTRONIC PERIPHERAL DEVICE TO A COMPUTER TO PERMIT A USER TO CONTROL THE COMPUTER THROUGH INPUTS MADE TO THE PAD-TYPE ELECTRONIC PERIPHERAL DEVICE (U.S. CLS. 21, 23, 26, 36 AND 38).

FIRST USE 6-1-2009; IN COMMERCE 6-1-2009.

3,680,989. NEXSTAR, INC., LITTLE CANADA, MN. SN 77-480,902. PUB. 10-21-2008, FILED 5-22-2008.

HOME CARE WITH A FLAIR

THE MARK CONSISTS OF STANDARD CHARACTERS WITHOUT CLAIM TO ANY PARTICULAR FONT, STYLE, SIZE, OR COLOR.

NO CLAIM IS MADE TO THE EXCLUSIVE RIGHT TO USE "HOME CARE", APART FROM THE MARK AS SHOWN.

FOR DOWNLOADABLE ELECTRONIC NEWSLETTERS IN THE FIELDS OF HOME REPAIR, MAINTENANCE AND IMPROVEMENT (U.S. CLS. 21, 23, 26, 36 AND 38).

FIRST USE 10-26-2007; IN COMMERCE 10-26-2007.

3,681,012. SENSE NETWORKS, INC., NEW YORK, NY. SN 77-484,465. PUB. 10-21-2008, FILED 5-27-2008.

MACROSENSE

THE MARK CONSISTS OF STANDARD CHARACTERS WITHOUT CLAIM TO ANY PARTICULAR FONT, STYLE, SIZE, OR COLOR.

FOR COMPUTER SOFTWARE PLATFORM FOR THE AGGREGATION AND ANALYSIS OF HISTORICAL AND REAL-TIME LOCATION DATA GENERATED BY LOCATION-ENABLED DEVICES (U.S. CLS. 21, 23, 26, 36 AND 38).

FIRST USE 6-9-2008; IN COMMERCE 6-9-2008.

CLASS 9—(Continued).

3,681,013. SENSE NETWORKS, INC., NEW YORK, NY. SN 77-484,468. PUB. 10-21-2008, FILED 5-27-2008.

CITYSENSE

THE MARK CONSISTS OF STANDARD CHARACTERS WITHOUT CLAIM TO ANY PARTICULAR FONT, STYLE, SIZE, OR COLOR.

FOR COMPUTER APPLICATION SOFTWARE FOR MOBILE DEVICES, NAMELY, A NIGHTLIFE AND SOCIAL DISCOVERY MOBILE PHONE APPLICATION BASED ON REAL-TIME ACTIVITY DATA (U.S. CLS. 21, 23, 26, 36 AND 38).

FIRST USE 6-9-2008; IN COMMERCE 6-9-2008.

3,681,030. FUJITSU LIMITED, KANAGAWA, 211-8588, JAPAN. SN 77-490,208. PUB. 9-30-2008, FILED 6-3-2008.

WANDIRECTOR

THE MARK CONSISTS OF STANDARD CHARACTERS WITHOUT CLAIM TO ANY PARTICULAR FONT, STYLE, SIZE, OR COLOR.

FOR COMPUTER HARDWARE USED FOR SECURE AND EFFICIENT ACCESS TO NETWORK STORAGE AND TELECOMMUNICATIONS EQUIPMENT, NAMELY, GATEWAY HARDWARE (U.S. CLS. 21, 23, 26, 36 AND 38).

FIRST USE 2-1-2008; IN COMMERCE 2-1-2008.

3,681,039. IGT, RENO, NV. SN 77-492,799. PUB. 11-4-2008, FILED 6-6-2008.

WOLF RUN PARTY

THE MARK CONSISTS OF STANDARD CHARACTERS WITHOUT CLAIM TO ANY PARTICULAR FONT, STYLE, SIZE, OR COLOR.

OWNER OF U.S. REG. NO. 3,243,056.
FOR GAMING MACHINES, NAMELY, DEVICES WHICH ACCEPT A WAGER (U.S. CLS. 21, 23, 26, 36 AND 38).

FIRST USE 4-17-2009; IN COMMERCE 6-30-2009.

CLASS 9—(Continued).

3,681,041. SARTORIUS STEDIM BIOTECH GMBH, GOETTINGEN, FED REP GERMANY. SN 77-492,945. PUB. 10-28-2008, FILED 6-6-2008.

BACTAIR

THE MARK CONSISTS OF STANDARD CHARACTERS WITHOUT CLAIM TO ANY PARTICULAR FONT, STYLE, SIZE, OR COLOR.

THE WORDING "BACTAIR" HAS NO MEANING IN A FOREIGN LANGUAGE.

FOR SCIENTIFIC APPARATUS FOR THE COLLECTION AND CULTIVATION OF MICROORGANISMS, NAMELY, CULTURE MEDIUM DISHES; AIR GERM COLLECTORS COMPRISING A NATURAL EARTH CONTAINER WITH BASIN OR TUB, AND A LID WITH INTEGRATED AIR SUCTION DEVICES FOR ANALYZING AIR GERMS USING THE IMPACTION METHOD (U.S. CLS. 21, 23, 26, 36 AND 38).

FIRST USE 2-1-2009; IN COMMERCE 2-1-2009.

3,681,048. DIGITAL RAPIDS CORPORATION, MARKHAM, CANADA. SN 77-495,059. PUB. 11-11-2008, FILED 6-10-2008.

TouchStream

THE MARK CONSISTS OF STANDARD CHARACTERS WITHOUT CLAIM TO ANY PARTICULAR FONT, STYLE, SIZE, OR COLOR.

FOR COMPUTER HARDWARE, SOFTWARE, AND COMBINATIONS THEREOF FOR THE RECORDING, ENCODING, PROCESSING, STREAMING AND DISTRIBUTION OF VIDEO, AUDIO, IMAGES AND ASSOCIATED DATA; ELECTRONIC DEVICES, NAMELY, ENCODERS, FOR THE RECORDING, ENCODING, PROCESSING, STREAMING AND DISTRIBUTION OF VIDEO, AUDIO, IMAGES AND ASSOCIATED DATA (U.S. CLS. 21, 23, 26, 36 AND 38).

FIRST USE 9-12-2008; IN COMMERCE 6-19-2009.

CLASS 9—(Continued).

3,681,069. COMPUTIZE! CONSULTING, INC., BROOKLYN, NY. SN 77-498,213. PUB. 11-11-2008, FILED 6-13-2008.

Bringing Technology To Your Door

THE MARK CONSISTS OF THE STYLIZED WORDING "A-LIST" APPEARING ABOVE THE STYLIZED WORDING "BRINGING TECHNOLOGY TO YOUR DOOR".

FOR GUEST ADMINISTRATION SOFTWARE FOR IDENTIFYING, TRACKING AND RECORDING DATA ON ATTENDEES AND/OR INVITEES TO AN EVENT (U.S. CLS. 21, 23, 26, 36 AND 38).

FIRST USE 8-20-2008; IN COMMERCE 8-20-2008.

3,681,094. IMPACT GUIDANCE SYSTEMS, INC., HOUSTON, TX. SN 77-508,912. PUB. 2-17-2009, FILED 6-26-2008.

THE MARK CONSISTS OF STANDARD CHARACTERS WITHOUT CLAIM TO ANY PARTICULAR FONT, STYLE, SIZE, OR COLOR.

OWNER OF U.S. REG. NO. 3,353,945. FOR FORCE MEASUREMENT PRODUCTS, NAMELY, DIGITAL FORCE GAUGES, DIGITAL TORQUE GAUGES AND MANUAL AND MOTORIZED TEST STANDS USED THEREWITH SOLD AS A UNIT WITH THE GAUGES; SENSORS FOR THE DETERMINATION OF TEMPERATURES, POSITIONS AND DISTANCES (U.S. CLS. 21, 23, 26, 36 AND 38).

FIRST USE 2-19-2009; IN COMMERCE 2-19-2009.

CLASS 9—(Continued).

3,681,097. AMPLIFIER RESEARCH CORPORATION, SOUTHERTON, PA. SN 77-509,727. PUB. 11-25-2008, FILED 6-27-2008.



OWNER OF U.S. REG. NOS. 1,788,797, 3,325,182, AND OTHERS.

THE COLOR(S) ORANGE IS/ARE CLAIMED AS A FEATURE OF THE MARK.

THE MARK CONSISTS OF AN ORANGE STRIPE AND THE LETTERS "AR".

FOR RADIO FREQUENCY POWER AMPLIFIERS; MICROWAVE POWER AMPLIFIERS; MICROPROCESSOR-BASED CONTROLLERS FOR COORDINATING AND SUPERVISING INSTRUMENTS USED FOR ELECTROMAGNETIC COMPATIBILITY TESTING; ELECTRONIC NOISE EMITTERS AND LOW NOISE AMPLIFIERS FOR ELECTROMAGNETIC COMPATIBILITY TESTING; ANTENNAS; TEST CELLS, NAMELY, ENCLOSURES FOR USE IN TESTING ELECTRONIC EQUIPMENT AND ELECTRONIC COMPONENTS FOR ELECTROMAGNETIC COMPATIBILITY; ELECTRIC CURRENT CONDUCTING DEVICES, NAMELY, RF CONNECTORS; RF DIRECTIONAL COUPLERS; RF POWER ATTENUATORS; RF IMPEDANCE MATCHING TRANSFORMERS; COAXIAL CABLES; ELECTROMAGNETIC WAVEGUIDES; ADAPTERS FOR CONNECTING COAXIAL CABLES TO WAVEGUIDES; RF POWER METERS; POWER SENSORS FOR USE IN RF POWER MEASUREMENTS; RF ELECTRIC FIELD GENERATORS; COMBINATION ELECTROMAGNETIC COMPATIBILITY TESTING PACKAGES, EACH INCLUDING A TEST CELL AND A RADIO FREQUENCY POWER AMPLIFIER; ELECTROMAGNETIC FIELD IMMUNITY AND EMISSIONS TESTING SOFTWARE; RADIO FREQUENCY FIELD PROBES, AND STANDS, CLAMPS AND FIBEROPTIC CABLES FOR USE WITH FIELD PROBES; ELECTRONIC DEVICES EACH CONSISTING PRINCIPALLY OF A COMBINER AND CONTROLLER THAT ENABLE PLURAL RADIO FREQUENCY OR MICROWAVE POWER AMPLIFIERS TO OPERATE TOGETHER FOR INCREASED POWER OUTPUT; GENERATORS AND TEST INSTRUMENTS FOR RADIO FREQUENCY CONDUCTED IMMUNITY TESTING; AND GENERATORS FOR GENERATING TRANSIENT ELECTRICAL WAVES AND TEST INSTRUMENTS FOR TESTING THE RESPONSES OF AUTOMOTIVE EQUIPMENT FOR CONDUCTION OF SUCH WAVES (U.S. CLS. 21, 23, 26, 36 AND 38).

FIRST USE 2-28-2006; IN COMMERCE 2-28-2006.

3,681,103. ADMMICRO PROPERTIES, L.L.C., ROANOKE, VA. SN 77-513,556. PUB. 10-7-2008, FILED 7-2-2008.



OWNER OF U.S. REG. NO. 3,404,469.

THE MARK CONSISTS OF ENCIRCLED GREEK LETTER "MU" FOLLOWED BY THE WORD "ADMMICRO" WITH "ENERGY SOLUTIONS YOU CAN COUNT ON" STACKED UNDERNEATH.

FOR ELECTRICAL MONITORING AND CONTROL DEVICES FOR HEATING, COOLING, LIGHTING AND ENERGY MANAGEMENT; THERMOSTATS; ELECTRICAL LIGHTING AND LOAD CONTROLLERS (U.S. CLS. 21, 23, 26, 36 AND 38).

FIRST USE 9-0-2008; IN COMMERCE 9-0-2008.

CLASS 9—(Continued).

3,681,105. PERFECT 10 ANTENNA COMPANY INC., NORTH LITTLE ROCK, AR. SN 77-514,610. PUB. 12-2-2008, FILED 7-3-2008.

MAXPIPE

THE MARK CONSISTS OF STANDARD CHARACTERS WITHOUT CLAIM TO ANY PARTICULAR FONT, STYLE, SIZE, OR COLOR.

FOR CABLES FOR ELECTRICAL OR OPTICAL SIGNAL TRANSMISSION; CABLES FOR OPTICAL SIGNAL TRANSMISSION; COAXIAL CABLES (U.S. CLS. 21, 23, 26, 36 AND 38).

FIRST USE 11-11-2008; IN COMMERCE 11-11-2008.

3,681,106. NEC SYSTEM TECHNOLOGIES, LTD., OSAKA-SHI, OSAKA, JAPAN. SN 77-515,474. PUB. 11-25-2008, FILED 7-7-2008.

SITESHELL

THE MARK CONSISTS OF STANDARD CHARACTERS WITHOUT CLAIM TO ANY PARTICULAR FONT, STYLE, SIZE, OR COLOR.

FOR COMPUTER SOFTWARE FOR PROTECTING AND SECURING COMPUTER NETWORKS AND APPLICATIONS; COMPUTER SOFTWARE FOR USE IN SECURITY FOR PROTECTING NETWORKS AND WEB APPLICATIONS FROM UNAUTHORIZED ACCESS; COMPUTER HARDWARE AND COMPUTER SOFTWARE FOR USE IN THE FIELD OF INFORMATION TECHNOLOGY SECURITY, NAMELY, WEB APPLICATION FIREWALLS; COMPUTER SERVERS (U.S. CLS. 21, 23, 26, 36 AND 38).

FIRST USE 4-20-2009; IN COMMERCE 4-20-2009.

3,681,108. DIGI INTERNATIONAL INC., MINNETONKA, MN. SN 77-517,629. PUB. 12-2-2008, FILED 7-9-2008.

DIGI TRANSPORT

THE MARK CONSISTS OF STANDARD CHARACTERS WITHOUT CLAIM TO ANY PARTICULAR FONT, STYLE, SIZE, OR COLOR.

OWNER OF U.S. REG. NOS. 2,317,478, 2,630,891, AND OTHERS.

FOR COMPUTER HARDWARE AND EMBEDDED SOFTWARE, NAMELY, WIRED AND WIRELESS ROUTERS (U.S. CLS. 21, 23, 26, 36 AND 38).

FIRST USE 11-16-2008; IN COMMERCE 11-16-2008.

CLASS 9—(Continued).

3,681,134. POLYMER TECHNOLOGY SYSTEMS, INC., INDIANAPOLIS, IN. SN 77-523,266. PUB. 12-9-2008, FILED 7-16-2008.

CARDIOCHEK LINK

THE MARK CONSISTS OF STANDARD CHARACTERS WITHOUT CLAIM TO ANY PARTICULAR FONT, STYLE, SIZE, OR COLOR.

OWNER OF U.S. REG. NO. 3,085,202.

NO CLAIM IS MADE TO THE EXCLUSIVE RIGHT TO USE "LINK", APART FROM THE MARK AS SHOWN.

FOR SOFTWARE FOR A HAND-HELD ELECTRONIC INSTRUMENT FOR ANALYZING BLOOD DRAWN FROM A LIVING HUMAN BEING (U.S. CLS. 21, 23, 26, 36 AND 38).

FIRST USE 3-31-2009; IN COMMERCE 3-31-2009.

3,681,138. CERTAIN AFFINITY, INC., AUSTIN, TX. SN 77-524,966. PUB. 12-9-2008, FILED 7-17-2008.

AGE OF BOOTY

THE MARK CONSISTS OF STANDARD CHARACTERS WITHOUT CLAIM TO ANY PARTICULAR FONT, STYLE, SIZE, OR COLOR.

FOR COMPUTER GAME SOFTWARE, COMPUTER GAME PROGRAMS, COMPUTER GAME CARTRIDGES, AND CD ROMS CONTAINING VIDEO GAMES FOR ENTERTAINMENT USES, AND INSTRUCTIONAL MANUALS SOLD AS A UNIT THEREWITH (U.S. CLS. 21, 23, 26, 36 AND 38).

FIRST USE 10-15-2008; IN COMMERCE 10-15-2008.

3,681,157. EMX INDUSTRIES, INC., CLEVELAND, OH. SN 77-531,815. PUB. 12-23-2008, FILED 7-25-2008.

BLUEGUARD

THE MARK CONSISTS OF STANDARD CHARACTERS WITHOUT CLAIM TO ANY PARTICULAR FONT, STYLE, SIZE, OR COLOR.

FOR COMPUTER HARDWARE AND SOFTWARE SYSTEM COMPRISED OF WIRELESS ENABLED MICROCONTROLLER FOR USE IN ACCESS CONTROL, IDENTIFICATION, SECURITY AND SAFETY (U.S. CLS. 21, 23, 26, 36 AND 38).

FIRST USE 5-11-2009; IN COMMERCE 5-11-2009.

CLASS 9—(Continued).

3,681,158. VEDENTE CORPORATION, BOULDER, CO. SN 77-532,131. PUB. 12-23-2008, FILED 7-26-2008.

Be Cool, Be Safe, Be Seen

THE MARK CONSISTS OF STANDARD CHARACTERS WITHOUT CLAIM TO ANY PARTICULAR FONT, STYLE, SIZE, OR COLOR.

FOR REFLECTIVE AND ILLUMINATED CLOTHING FOR SAFETY PURPOSES; SAFETY PRODUCTS, NAMELY, REFLECTIVE HELMET SKIRTS; SAFETY PRODUCTS, NAMELY, REFLECTIVE SAFETY BANDS TO BE WORN ON THE BODY (U.S. CLS. 21, 23, 26, 36 AND 38).

FIRST USE 10-1-2007; IN COMMERCE 10-1-2007.

3,681,169. STODDARD, JILL A. SAN DIEGO, CA. SN 77-535,298. PUB. 12-23-2008, FILED 7-30-2008.

IT'S NOT IN THERE.

THE MARK CONSISTS OF STANDARD CHARACTERS WITHOUT CLAIM TO ANY PARTICULAR FONT, STYLE, SIZE, OR COLOR.

FOR DECORATIVE MAGNETS (U.S. CLS. 21, 23, 26, 36 AND 38).

FIRST USE 2-18-2009; IN COMMERCE 2-18-2009.

3,681,178. BTU INTERNATIONAL, INC., NORTH BILLERICA, MA. SN 77-542,354. PUB. 1-27-2009, FILED 8-8-2008.

Meridian

THE MARK CONSISTS OF THE WORD "MERIDIAN" AND THE "A" IS IN THE SHAPE OF A PYRAMID.

FOR THERMAL PROCESSING APPARATUS FOR PROCESSING SOLAR CELLS AND SEMICONDUCTOR WAFERS (U.S. CLS. 21, 23, 26, 36 AND 38).

FIRST USE 3-16-2009; IN COMMERCE 3-16-2009.

CLASS 9—(Continued).

3,681,183. CERNER INNOVATION, INC., OVERLAND PARK, KS. SN 77-544,458. PUB. 11-4-2008, FILED 8-12-2008.

DISCERN NCODE

THE MARK CONSISTS OF STANDARD CHARACTERS WITHOUT CLAIM TO ANY PARTICULAR FONT, STYLE, SIZE, OR COLOR.

OWNER OF U.S. REG. NOS. 1,935,796, 2,064,528, AND OTHERS.

FOR COMPUTER SOFTWARE FOR USE IN THE HEALTHCARE FIELD, NAMELY, SOFTWARE FOR MANAGING, STORING, ANALYZING, MAINTAINING, PROCESSING, STRUCTURING, REVIEWING, BUILDING, EDITING, DISTRIBUTING, COMMUNICATING, ORGANIZING, SHARING, REFERENCING, MONITORING AND INTEGRATING HEALTHCARE INFORMATION; COMPUTER SOFTWARE FOR AUTOMATING CLINICAL AND ADMINISTRATIVE HEALTHCARE PROCESSES (U.S. CLS. 21, 23, 26, 36 AND 38).

FIRST USE 12-1-2008; IN COMMERCE 12-1-2008.

3,681,188. MILLIPORE CORPORATION, BILLERICA, MA. SN 77-544,971. PUB. 11-4-2008, FILED 8-12-2008.

MILLICOAT

THE MARK CONSISTS OF STANDARD CHARACTERS WITHOUT CLAIM TO ANY PARTICULAR FONT, STYLE, SIZE, OR COLOR.

FOR CELL CULTURE PLATES FOR LABORATORY USE (U.S. CLS. 21, 23, 26, 36 AND 38).

FIRST USE 10-8-2008; IN COMMERCE 10-8-2008.

3,681,208. WENGER'S FEED MILL, INC., RHEEMS, PA. SN 77-553,400. PUB. 2-10-2009, FILED 8-22-2008.

FEED OPTIMIZER

THE MARK CONSISTS OF STANDARD CHARACTERS WITHOUT CLAIM TO ANY PARTICULAR FONT, STYLE, SIZE, OR COLOR.

NO CLAIM IS MADE TO THE EXCLUSIVE RIGHT TO USE "FEED", APART FROM THE MARK AS SHOWN.

FOR COMPUTER PROGRAMS AND ONLINE, DOWNLOADABLE SOFTWARE IN THE FIELD OF POULTRY, LIVESTOCK AND ANIMAL FEED, ANIMAL HUSBANDRY AND AGRICULTURE (U.S. CLS. 21, 23, 26, 36 AND 38).

FIRST USE 3-21-2007; IN COMMERCE 3-21-2007.

CLASS 9—(Continued).

3,681,212. GLOBAL GAMING GROUP, INC., LAS VEGAS, NV. SN 77-555,974. PUB. 11-18-2008, FILED 8-26-2008.

Turtle Fortune

THE MARK CONSISTS OF STANDARD CHARACTERS WITHOUT CLAIM TO ANY PARTICULAR FONT, STYLE, SIZE, OR COLOR.

FOR GAMING EQUIPMENT, NAMELY, SLOT MACHINES WITH OR WITHOUT VIDEO OUTPUT (U.S. CLS. 21, 23, 26, 36 AND 38).

FIRST USE 5-14-2008; IN COMMERCE 5-14-2008.

3,681,214. IGT, RENO, NV. SN 77-556,954. PUB. 1-27-2009, FILED 8-27-2008.

GREENBACK ATTACK

THE MARK CONSISTS OF STANDARD CHARACTERS WITHOUT CLAIM TO ANY PARTICULAR FONT, STYLE, SIZE, OR COLOR.

FOR GAMING MACHINES, NAMELY, DEVICES WHICH ACCEPT A WAGER (U.S. CLS. 21, 23, 26, 36 AND 38).

FIRST USE 4-15-2009; IN COMMERCE 4-15-2009.

3,681,230. FRESH, LLC, BRENTWOOD, TN. SN 77-564,404. PUB. 1-27-2009, FILED 9-8-2008.

Digital 45

THE MARK CONSISTS OF STANDARD CHARACTERS WITHOUT CLAIM TO ANY PARTICULAR FONT, STYLE, SIZE, OR COLOR.

NO CLAIM IS MADE TO THE EXCLUSIVE RIGHT TO USE "DIGITAL", APART FROM THE MARK AS SHOWN.

FOR DIGITAL MEDIA, NAMELY, PRE-RECORDED VIDEO CASSETTES, DIGITAL VIDEO DISCS, DIGITAL VERSATILE DISCS, DOWNLOADABLE AUDIO AND VIDEO RECORDINGS, DVDS, AND HIGH DEFINITION DIGITAL DISKS FEATURING SOUND RECORDINGS, A MUSIC VIDEO PLAYABLE ON DVD PLAYERS AND PORTABLE MP3 PLAYERS, ELECTRONIC PRESS KIT AND ARTIST PHOTOGRAPHS AND ALBUM ARTWORK (U.S. CLS. 21, 23, 26, 36 AND 38).

FIRST USE 5-24-2009; IN COMMERCE 6-10-2009.

CLASS 9—(Continued).

3,681,244. AEQUITAS TECHNOLOGIES LLC, HERNDON, VA. SN 77-569,460. PUB. 2-3-2009, FILED 9-14-2008.

iGala

THE MARK CONSISTS OF STANDARD CHARACTERS WITHOUT CLAIM TO ANY PARTICULAR FONT, STYLE, SIZE, OR COLOR.

FOR DIGITAL PHOTO FRAMES FOR DISPLAYING DIGITAL PICTURES, VIDEO CLIPS AND MUSIC (U.S. CLS. 21, 23, 26, 36 AND 38).

FIRST USE 9-1-2008; IN COMMERCE 9-1-2008.

3,681,253. HOME BOX OFFICE, INC., NEW YORK, NY. SN 77-572,496. PUB. 1-20-2009, FILED 9-17-2008.

RESPECT THE BING

THE MARK CONSISTS OF STANDARD CHARACTERS WITHOUT CLAIM TO ANY PARTICULAR FONT, STYLE, SIZE, OR COLOR.

FOR GAMING DEVICES, NAMELY, GAMING MACHINES, SLOT MACHINES, WITH OR WITHOUT VIDEO INPUT; GAMING MACHINES; SLOT MACHINES; MACHINES FOR PLAYING GAME OF CHANCE (U.S. CLS. 21, 23, 26, 36 AND 38).

FIRST USE 3-1-2009; IN COMMERCE 3-1-2009.

3,681,254. DEIDOX, LLC, PASADENA, CA. SN 77-573,019. PUB. 2-10-2009, FILED 9-18-2008.

DEIDOX

THE MARK CONSISTS OF THE STYLIZED WORD "DEIDOX".

THE MARK DOES NOT HAVE ANY TRANSLATION OR MEANING IN ENGLISH.

FOR MOTION PICTURE SHORT DOCUMENTARY FILMS ABOUT RELIGION (U.S. CLS. 21, 23, 26, 36 AND 38).

FIRST USE 1-1-2009; IN COMMERCE 2-15-2009.

CLASS 9—(Continued).

3,681,257. INTEGRATED MORTGAGE ORIGATION SYSTEMS, INC., AUBURN, WA. SN 77-573,115. PUB. 2-10-2009, FILED 9-18-2008.

IMOS

THE MARK CONSISTS OF STANDARD CHARACTERS WITHOUT CLAIM TO ANY PARTICULAR FONT, STYLE, SIZE, OR COLOR.

FOR SOFTWARE FOR LEAD GENERATION AND MATCHING, NAMELY, MATCHING CONSUMER REQUESTS FOR LOANS AND REAL ESTATE COLLECTED OVER THE INTERNET TO LOAN ORIGINATORS, BROKERAGES, BROKERS, AGENTS AND AGENCIES INTERESTED IN THOSE REQUESTS (U.S. CLS. 21, 23, 26, 36 AND 38).

FIRST USE 8-21-2008; IN COMMERCE 8-21-2008.

3,681,260. CZAUS, STEPHEN, SIGNAL HILL, CA. SN 77-573,704. PUB. 2-10-2009, FILED 9-18-2008.

BATSCAN

THE MARK CONSISTS OF STANDARD CHARACTERS WITHOUT CLAIM TO ANY PARTICULAR FONT, STYLE, SIZE, OR COLOR.

FOR COMPUTER PROGRAMS FOR AN INVENTORY TRACKING SYSTEM IN THE NATURE OF A BATCH VALIDATION AND INVENTORY CONTROL SYSTEM USING BARCODE SCANNING TECHNOLOGY (U.S. CLS. 21, 23, 26, 36 AND 38).

FIRST USE 6-1-2006; IN COMMERCE 6-1-2006.

3,681,270. OCEAN OPTICS, INC., DUNEDIN, FL. SN 77-577,238. PUB. 12-30-2008, FILED 9-23-2008.



THE MARK CONSISTS OF THE TERM "NEOFOX" WITH A TAIL DRAWING EXTENDED FROM THE "X".

FOR PHASE MEASUREMENT SYSTEM, NAMELY, AN OPTICAL SENSING DEVICE FOR MEASUREMENT OF LUMINESCENCE LIFETIME, PHASE AND INTENSITY, SOLD AS A COMPONENT DETECTION FEATURE OF FIBER OPTIC CHEMICAL SENSORS (U.S. CLS. 21, 23, 26, 36 AND 38).

FIRST USE 2-16-2009; IN COMMERCE 5-7-2009.

CLASS 9—(Continued).

3,681,282. M&M MERCHANDISERS, INC, FORT WORTH, TX. SN 77-580,024. PUB. 3-3-2009, FILED 9-26-2008.



NO CLAIM IS MADE TO THE EXCLUSIVE RIGHT TO USE "GUITAR CONTROLLER", APART FROM THE MARK AS SHOWN.

THE COLOR(S) BLACK AND GRAY IS/ARE CLAIMED AS A FEATURE OF THE MARK.

THE MARK CONSISTS OF THE COLOR 100% BLACK APPEARING IN THE "GCX" LOGO/TEXT WITH THE COLOR 50% GRAY APPEARING AS THE SHADING OF THE "GCX" TEXT.

FOR GAME CONTROLLERS FOR COMPUTER GAMES (U.S. CLS. 21, 23, 26, 36 AND 38).

FIRST USE 9-1-2008; IN COMMERCE 11-24-2008.

3,681,307. COHERENT, INC., SANTA CLARA, CA. SN 77-588,547. PUB. 3-3-2009, FILED 10-8-2008.

CHAMELEON VISION

THE MARK CONSISTS OF STANDARD CHARACTERS WITHOUT CLAIM TO ANY PARTICULAR FONT, STYLE, SIZE, OR COLOR.

OWNER OF U.S. REG. NO. 3,258,726.

NO CLAIM IS MADE TO THE EXCLUSIVE RIGHT TO USE "VISION", APART FROM THE MARK AS SHOWN.

FOR LASERS NOT FOR MEDICAL USE (U.S. CLS. 21, 23, 26, 36 AND 38).

FIRST USE 12-3-2008; IN COMMERCE 12-3-2008.

CLASS 9—(Continued).

3,681,323. TYCO ELECTRONICS CORPORATION, BERWYN, PA. SN 77-593,586. PUB. 3-3-2009, FILED 10-15-2008.

D2V

THE MARK CONSISTS OF STANDARD CHARACTERS WITHOUT CLAIM TO ANY PARTICULAR FONT, STYLE, SIZE, OR COLOR.

FOR ELECTRICAL CABLE CONNECTOR ADAPTER USED TO CONVERT ONE VIDEO PROTOCOL TO ANOTHER VIDEO PROTOCOL (U.S. CLS. 21, 23, 26, 36 AND 38).

FIRST USE 12-1-2008; IN COMMERCE 12-1-2008.

CLASS 9—(Continued).

3,681,331. DIGITAL CONTROL INCORPORATED, KENT, WA. SN 77-596,092. PUB. 3-31-2009, FILED 10-20-2008.

F2

THE MARK CONSISTS OF STANDARD CHARACTERS WITHOUT CLAIM TO ANY PARTICULAR FONT, STYLE, SIZE, OR COLOR.

FOR ELECTRONIC AND DIGITAL LOCATING DATA RECEIVERS, REMOTE DISPLAYS IN THE NATURE OF FLAT PANEL DISPLAYS, BATTERIES AND BATTERY CHARGERS, AND SOFTWARE, ALL FOR USE IN LOCATING AND MONITORING SUBSURFACE TRANSMITTERS, RECEIVERS, DRILLHEADS, DRILLPIPES, REAMERS, AUGERS, BORING TOOLS, AND BURIED UTILITY LINES, CABLES AND PIPES, AND FOR COLLECTING AND DISPLAYING DATA RELATING TO SAME (U.S. CLS. 21, 23, 26, 36 AND 38).

FIRST USE 3-27-2009; IN COMMERCE 3-27-2009.

3,681,328. PRACTICE PARTNERS, INC., MIRAMAR, FL. SN 77-595,009. PUB. 3-10-2009, FILED 10-17-2008.



NO CLAIM IS MADE TO THE EXCLUSIVE RIGHT TO USE "AUTOMATED HEALTHCARE SOLUTIONS", APART FROM THE MARK AS SHOWN.

THE COLOR(S) BLUE AND GRAY IS/ARE CLAIMED AS A FEATURE OF THE MARK.

THE MARK CONSISTS OF THE LETTERS "AHCS" APPEARING IN GRAY DIRECTLY ABOVE THE WORDS "AUTOMATED HEALTHCARE SOLUTIONS", WHICH ALSO IS IN GRAY. A FANCIFUL VERSION OF A CADUCEUS APPEARS IN TWO SHADES OF BLUE TO THE LEFT OF THE LETTERS AND WORDS.

FOR COMPUTER SOFTWARE FOR USE IN MANAGING THE DISPENSING OF PRESCRIPTION MEDICATION (U.S. CLS. 21, 23, 26, 36 AND 38).

FIRST USE 1-1-2008; IN COMMERCE 1-1-2008.

3,681,334. GIBLIM DESIGN PTY. LIMITED, TELOPEA, AUSTRALIA. SN 77-597,694. PUB. 3-17-2009, FILED 10-22-2008.

DECIMATOR

THE MARK CONSISTS OF STANDARD CHARACTERS WITHOUT CLAIM TO ANY PARTICULAR FONT, STYLE, SIZE, OR COLOR.

FOR COMPUTER PROGRAMS FOR EDITING IMAGES, SOUND AND VIDEO; COMPUTER SOFTWARE FOR USE IN THE ENCRYPTION AND DECRYPTION OF DIGITAL FILES, INCLUDING AUDIO, VIDEO, TEXT, BINARY, STILL IMAGES, GRAPHICS AND MULTIMEDIA FILES; COMPUTER SOFTWARE FOR USE IN THE SAFEGUARDING OF DIGITAL FILES, INCLUDING AUDIO, VIDEO, TEXT, BINARY, STILL IMAGES, GRAPHICS AND MULTIMEDIA FILES; DISTRIBUTION AMPLIFIERS FOR AUDIO AND VIDEO SIGNALS; ELECTRONIC INTERCONNECTERS FOR AUDIO AND VIDEO SIGNALS; ELECTRONIC SCALERS FOR AUDIO AND VIDEO SIGNALS; ELECTRONIC SWITCHERS FOR AUDIO AND VIDEO SIGNALS; MATRIX SWITCHERS FOR AUDIO AND VIDEO SIGNALS; TELECOMMUNICATIONS AND DATA NETWORKING HARDWARE, NAMELY, DEVICES FOR TRANSPORTING AND AGGREGATING VOICE, DATA, AND VIDEO COMMUNICATIONS ACROSS MULTIPLE NETWORK INFRASTRUCTURES AND COMMUNICATIONS PROTOCOLS; TRANSMITTERS AND RECEIVERS FOR AUDIO AND VIDEO SIGNALS FOR TRANSMISSION OVER TWISTED PAIR CABLES; VIDEO PROCESSORS (U.S. CLS. 21, 23, 26, 36 AND 38).

FIRST USE 1-8-2009; IN COMMERCE 1-8-2009.

CLASS 9—(Continued).

3,681,340. SENAPPS LLC, SALT LAKE CITY, UT. SN 77-599,786. PUB. 3-10-2009, FILED 10-24-2008.

SHOWME SOROBAN

THE MARK CONSISTS OF STANDARD CHARACTERS WITHOUT CLAIM TO ANY PARTICULAR FONT, STYLE, SIZE, OR COLOR.

NO CLAIM IS MADE TO THE EXCLUSIVE RIGHT TO USE "SOROBAN", APART FROM THE MARK AS SHOWN.

THE FOREIGN WORDING IN THE MARK TRANSLATES INTO ENGLISH AS "ABACUS".

FOR COMPUTER SOFTWARE FOR TUTORING IN THE USE OF AN ABACUS (U.S. CLS. 21, 23, 26, 36 AND 38).

FIRST USE 5-10-2009; IN COMMERCE 5-10-2009.

CLASS 9—(Continued).

3,681,362. PANASONIC CORPORATION, OSAKA, JAPAN. SN 77-605,445. PUB. 3-17-2009, FILED 10-31-2008.

LVF

THE MARK CONSISTS OF STANDARD CHARACTERS WITHOUT CLAIM TO ANY PARTICULAR FONT, STYLE, SIZE, OR COLOR.

FOR DIGITAL STILL CAMERAS (U.S. CLS. 21, 23, 26, 36 AND 38).

FIRST USE 10-31-2008; IN COMMERCE 10-31-2008.

3,681,344. DIEBOLD, INCORPORATED, NORTH CANTON, OH. SN 77-600,485. PUB. 3-17-2009, FILED 10-24-2008.

DIEBOLD EXCHANGE COMMUNITY

THE MARK CONSISTS OF STANDARD CHARACTERS WITHOUT CLAIM TO ANY PARTICULAR FONT, STYLE, SIZE, OR COLOR.

OWNER OF U.S. REG. NOS. 682,872, 1,701,403, AND OTHERS.

FOR COMPUTER SOFTWARE DEVELOPMENT TOOLS (U.S. CLS. 21, 23, 26, 36 AND 38).

FIRST USE 10-26-2008; IN COMMERCE 10-26-2008.

3,681,372. GBP SOFTWARE, LLC, DBA CLUETRUST, RESTON, VA. SN 77-611,589. PUB. 4-7-2009, FILED 11-11-2008.

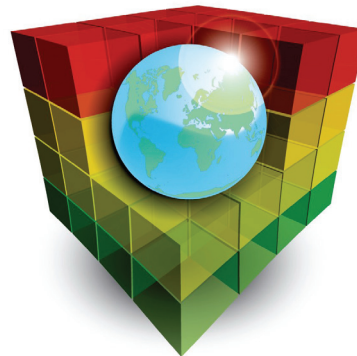

3,681,355. MERITOR WABCO VEHICLE CONTROL SYSTEMS, TROY, MI. SN 77-604,153. PUB. 3-24-2009, FILED 10-30-2008.

SmartTrac

THE MARK CONSISTS OF STANDARD CHARACTERS WITHOUT CLAIM TO ANY PARTICULAR FONT, STYLE, SIZE, OR COLOR.

FOR ELECTRONIC STABILITY CONTROLS FOR LAND VEHICLES (U.S. CLS. 21, 23, 26, 36 AND 38).

FIRST USE 4-1-2009; IN COMMERCE 4-1-2009.

THE COLOR(S) RED, YELLOW, GREEN, LIGHT BLUE, BLUE, GRAY, WHITE AND BLACK IS/ARE CLAIMED AS A FEATURE OF THE MARK.

THE MARK CONSISTS OF THE COLOR RED IN THE UPPER MOST CUBES, THE COLOR YELLOW IN THE MIDDLE CUBES, THE COLOR GREEN IN THE LOWEST CUBES, THE COLORS LIGHT BLUE AND BLUE IN THE OCEANS ON THE GLOBE, THE COLOR GRAY IN THE CONTINENTS, THE COLOR WHITE IN THE REFLECTION AND PENUMBRA OF LIGHT IN THE UPPER RIGHT OF THE GLOBE DESIGN AND THE COLOR BLACK IN THE SHADOWS.

FOR COMPUTER SOFTWARE FOR MAP DESIGN AND GEOGRAPHIC INFORMATION SYSTEMS THAT MAY BE DOWNLOADED FROM A GLOBAL COMPUTER NETWORK (U.S. CLS. 21, 23, 26, 36 AND 38).

FIRST USE 11-18-2008; IN COMMERCE 5-6-2009.

CLASS 9—(Continued).

3,681,377. SEALED AIR CORPORATION (US), ELMWOOD PARK, NJ. SN 77-613,941. PUB. 2-3-2009, FILED 11-13-2008.

TAGMATE

THE MARK CONSISTS OF STANDARD CHARACTERS WITHOUT CLAIM TO ANY PARTICULAR FONT, STYLE, SIZE, OR COLOR.

FOR ELECTRONIC HAND-HELD DEVICES FOR USE IN TRACKING, READING, MONITORING AND PROCESSING OF DATA FROM RADIO FREQUENCY IDENTIFICATION TEMPERATURE SENSING DEVICES (U.S. CLS. 21, 23, 26, 36 AND 38).

FIRST USE 8-13-2008; IN COMMERCE 8-13-2008.

CLASS 9—(Continued).

3,681,414. HEWLETT-PACKARD DEVELOPMENT COMPANY, L.P., HOUSTON, TX. SN 77-976,442. PUB. 8-21-2007, FILED 10-25-2006.

DREAMCOLOR

THE MARK CONSISTS OF STANDARD CHARACTERS WITHOUT CLAIM TO ANY PARTICULAR FONT, STYLE, SIZE, OR COLOR.

FOR COMPUTERS; COMPUTER HARDWARE; NOTE-BOOK COMPUTERS; COMPUTER PERIPHERALS; COMPUTER MONITORS; FLAT PANEL DISPLAY SCREENS; LIQUID CRYSTAL DISPLAY PANELS; VIDEO SCREENS; COMPUTER PRINTERS; INKJET PRINTERS; LASER PRINTERS; DIGITAL PRINTERS (U.S. CLS. 21, 23, 26, 36 AND 38).

FIRST USE 3-0-2007; IN COMMERCE 3-0-2007.

3,681,385. CASTE PUBLISHING LLC, PEPPER PIKE, OH. SN 77-617,288. PUB. 3-31-2009, FILED 11-19-2008.

FBOMB

THE MARK CONSISTS OF STANDARD CHARACTERS WITHOUT CLAIM TO ANY PARTICULAR FONT, STYLE, SIZE, OR COLOR.

FOR ELECTRONIC PUBLICATIONS, NAMELY, MAGAZINES FEATURING ARTICLES, INTERVIEWS AND INFORMATION ON TOPICS OF INTEREST TO YOUNG WOMEN, RECORDED ON COMPUTER MEDIA (U.S. CLS. 21, 23, 26, 36 AND 38).

FIRST USE 3-0-2009; IN COMMERCE 3-0-2009.

3,681,420. HTI IP, LLC, ATLANTA, GA. SN 77-977,422. PUB. 11-25-2008, FILED 10-31-2007.

IN-DRIVE

THE MARK CONSISTS OF STANDARD CHARACTERS WITHOUT CLAIM TO ANY PARTICULAR FONT, STYLE, SIZE, OR COLOR.

FOR NAVIGATIONAL SYSTEM, COMPRISING ELECTRONIC TRANSMITTERS, RECEIVERS, CIRCUITRY, MICROPROCESSORS, CELLULAR TELEPHONE AND COMPUTER SOFTWARE ALL FOR USE IN NAVIGATION AND ALL INCORPORATED INTO A MOTOR VEHICLE (U.S. CLS. 21, 23, 26, 36 AND 38).

FIRST USE 5-27-2009; IN COMMERCE 5-27-2009.

3,681,412. CARGILL, INCORPORATED, WAYZATA, MN. SN 77-643,247. PUB. 3-31-2009, FILED 1-5-2009.

INPERSPECTIVE

THE MARK CONSISTS OF STANDARD CHARACTERS WITHOUT CLAIM TO ANY PARTICULAR FONT, STYLE, SIZE, OR COLOR.

FOR DOWNLOADABLE ELECTRONIC NEWSLETTERS IN THE FIELD OF HEALTH, NUTRITION AND FOOD MANUFACTURING (U.S. CLS. 21, 23, 26, 36 AND 38).

FIRST USE 1-14-2009; IN COMMERCE 1-14-2009.

3,681,430. KABUSHIKI KAISHA MORPHO, AKA MORPHO, INC., TOKYO, JAPAN. SN 77-977,549. PUB. 1-8-2008, FILED 10-26-2006.

MORPHO

THE MARK CONSISTS OF STANDARD CHARACTERS WITHOUT CLAIM TO ANY PARTICULAR FONT, STYLE, SIZE, OR COLOR.

FOR COMPUTER PROGRAMS AND SOFTWARE FOR IMAGE PROCESSING; COMPUTER PROGRAMS AND SOFTWARE FOR IMAGE PROCESSING USED FOR MOBILE PHONES (U.S. CLS. 21, 23, 26, 36 AND 38).

FIRST USE 8-29-2006; IN COMMERCE 4-15-2009.

CLASS 9—(Continued).

3,681,442. THE JOHNSON GROUP, MCLEAN, VA. SN 77-977,634. PUB. 11-4-2008, FILED 6-11-2008.

PAPER CLIPS

THE MARK CONSISTS OF STANDARD CHARACTERS WITHOUT CLAIM TO ANY PARTICULAR FONT, STYLE, SIZE, OR COLOR.

FOR PRE-RECORDED AUDIO AND VIDEO RECORDINGS FEATURING ENTERTAINMENT, DOCUMENTARY AND EDUCATIONAL MOTION PICTURE FILMS ON A WIDE VARIETY OF THEMES; MOTION PICTURE FILMS ABOUT GENERAL RELEASE ENTERTAINMENT, DOCUMENTARY, EDUCATION, DRAMA, ANIMATION, AND LIVE ACTION (U.S. CLS. 21, 23, 26, 36 AND 38).

FIRST USE 8-23-2003; IN COMMERCE 8-23-2003.

3,681,443. MSTATION AUDIO, INC., EL MONTE, CA. SN 77-977,640. PUB. 5-6-2008, FILED 12-10-2007.



THE MARK CONSISTS OF THE LETTER "M" IN A CIRCLE.

FOR AUDIO SPEAKERS; LOUD SPEAKERS; LOUD SPEAKERS AND STEREO SYSTEMS COMPRISED OF SPEAKERS, SPEAKERS USED ON DOCKING STATIONS FOR PORTABLE AUDIO DEVICES, NAMELY, MP3 PLAYERS, AND DOCKING STATIONS FOR USE WITH AUDIO SPEAKERS; ELECTRONIC AND OPTICAL COMMUNICATIONS INSTRUMENTS AND COMPONENTS, NAMELY, AUDIO SPEAKERS, CARRYING AND PROTECTIVE CASES FOR AUDIO DEVICES, BATTERY PACKS, NAMELY, BATTERIES WITH INTEGRATED DOCKING FOR MOBILE ELECTRONIC DEVICES; BATTERIES AND BATTERY CHARGERS FOR USE AS EXTERNAL POWER SOURCES WITH MOBILE CONSUMER ELECTRONIC PRODUCTS; ELECTRICAL CELLS AND BATTERIES, NAMELY, EXTERNAL POWER SOURCES WITH INTEGRATED HOUSING AND ELECTRICAL CONNECTOR; CELL PHONE BATTERY CHARGERS, NAMELY, EXTERNAL POWER SOURCES WITH INTEGRATED HOUSING AND ELECTRICAL CONNECTOR FOR MOBILE PHONES; AND MOBILE TELEPHONE BATTERIES, NAMELY, EXTERNAL BATTERY PACKS WITH INTEGRATED DOCKING FOR MOBILE TELEPHONES (U.S. CLS. 21, 23, 26, 36 AND 38).

FIRST USE 11-30-2007; IN COMMERCE 11-30-2007.

CLASS 9—(Continued).

3,681,444. MSTATION AUDIO, INC., EL MONTE, CA. SN 77-977,641. PUB. 5-6-2008, FILED 12-10-2007.

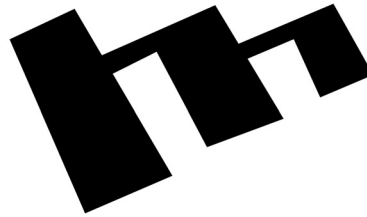

THE MARK CONSISTS OF THE LETTER "M."

FOR AUDIO SPEAKERS; LOUD SPEAKERS; LOUD SPEAKERS AND STEREO SYSTEMS COMPRISED OF SPEAKERS, SPEAKERS USED ON DOCKING STATIONS FOR PORTABLE AUDIO DEVICES, NAMELY, MP3 PLAYERS, AND DOCKING STATIONS FOR USE WITH AUDIO SPEAKERS; ELECTRONIC AND OPTICAL COMMUNICATIONS INSTRUMENTS AND COMPONENTS, NAMELY, AUDIO SPEAKERS, CARRYING AND PROTECTIVE CASES FOR AUDIO DEVICES, BATTERY PACKS, NAMELY, BATTERIES WITH INTEGRATED DOCKING FOR MOBILE ELECTRONIC DEVICES; BATTERIES AND BATTERY CHARGERS FOR USE AS EXTERNAL POWER SOURCES WITH MOBILE CONSUMER ELECTRONIC PRODUCTS; ELECTRICAL CELLS AND BATTERIES, NAMELY, EXTERNAL POWER SOURCES WITH INTEGRATED HOUSING AND ELECTRICAL CONNECTOR; CELL PHONE BATTERY CHARGERS, NAMELY, EXTERNAL POWER SOURCES WITH INTEGRATED HOUSING AND ELECTRICAL CONNECTOR FOR MOBILE PHONES; AND MOBILE TELEPHONE BATTERIES, NAMELY, EXTERNAL BATTERY PACKS WITH INTEGRATED DOCKING FOR MOBILE TELEPHONES (U.S. CLS. 21, 23, 26, 36 AND 38).

FIRST USE 11-30-2007; IN COMMERCE 11-30-2007.

3,681,446. LIFE LEAPS, PORTLAND, OR. SN 78-285,423. PUB. 12-28-2004, FILED 8-10-2003.

COMMUTER COACH

NO CLAIM IS MADE TO THE EXCLUSIVE RIGHT TO USE "COACH", APART FROM THE MARK AS SHOWN.

FOR PRE-RECORDED AUDIO CDS AND DOWNLOADABLE MP3 FILES FEATURING INSTRUCTION ON A VARIETY OF TOPICS, NAMELY, PERSONAL DEVELOPMENT, BUSINESS TOPICS, AND CAREER MANAGEMENT (U.S. CLS. 21, 23, 26, 36 AND 38).

FIRST USE 11-23-2008; IN COMMERCE 12-3-2008.

3,681,447. THULE TOWING SYSTEMS LLC, LODI, CA. SN 78-301,074. PUB. 12-18-2007, FILED 9-16-2003.

JOURNEY

FOR ELECTRONIC BRAKE CONTROLS FOR LAND VEHICLE TRAILERS (U.S. CLS. 21, 23, 26, 36 AND 38).

FIRST USE 11-20-2004; IN COMMERCE 11-20-2004.

CLASS 9—(Continued).

3,681,448. ELEMENT ELECTRONICS, LLC, MINNEAPOLIS, MN. SN 78-319,372. PUB. 8-29-2006, FILED 10-28-2003.

ELEMENT

FOR CAMERAS (U.S. CLS. 21, 23, 26, 36 AND 38).
FIRST USE 11-30-2008; IN COMMERCE 11-30-2008.

CLASS 9—(Continued).

3,681,472. LAW ENFORCEMENT TECHNOLOGIES, INC., MISHAWAKA, IN. SN 78-535,397. PUB. 5-2-2006, FILED 12-20-2004.

FADD

3,681,467. ANDERSON KILL & OLICK, P.C., NEW YORK, NY. SN 78-505,458. PUB. 5-2-2006, FILED 10-25-2004.

AKO RECOVERYMAX

THE MARK CONSISTS OF STANDARD CHARACTERS WITHOUT CLAIM TO ANY PARTICULAR FONT, STYLE, SIZE, OR COLOR.

FOR CUSTOMIZED DATABASE MANAGEMENT SOFTWARE ALLOWING USER TO STORE, ORGANIZE, AND ANALYZE THE CONTENTS OF ALL OF ITS INSURANCE POLICIES (U.S. CLS. 21, 23, 26, 36 AND 38).
FIRST USE 7-23-2009; IN COMMERCE 7-23-2009.

THE MARK CONSISTS OF STANDARD CHARACTERS WITHOUT CLAIM TO ANY PARTICULAR FONT, STYLE, SIZE, OR COLOR.

FOR DIVERSIONARY DEVICE, NAMELY, A HAND EMPLACED OR PROPULSION ASSISTED, NON-EXPLOSIVE, NON-LETHAL DISORIENTING DEVICE WHICH EMITS SOUND, BRIGHT LIGHT, OR OTHER IRRITANTS AFTER ACTIVATION BY THE USER (U.S. CLS. 21, 23, 26, 36 AND 38).
FIRST USE 9-25-2007; IN COMMERCE 9-25-2007.

3,681,477. MIDAS YELLOW LTD., DRY DRAYTON, CAMBRIDGE, UNITED KINGDOM. SN 78-548,939. PUB. 10-21-2008, FILED 1-18-2005.

3,681,468. SUN MICROSYSTEMS, INC., SANTA CLARA, CA. SN 78-509,488. PUB. 3-28-2006, FILED 11-1-2004.

JAVA

THE MARK CONSISTS OF STANDARD CHARACTERS WITHOUT CLAIM TO ANY PARTICULAR FONT, STYLE, SIZE, OR COLOR.

OWNER OF U.S. REG. NOS. 1,516,265, 2,921,013, AND OTHERS.

FOR COMPUTER PERIPHERALS; TELEVISION SET TOP BOXES; COMPACT DISC PLAYERS; INTERNET TELEVISION HARDWARE, NAMELY, DIGITAL TELEVISION RECEIVERS, PROGRAMMABLE DIGITAL TELEVISION RECORDERS, AND TELEVISION DECODERS; TELEVISION SETS (U.S. CLS. 21, 23, 26, 36 AND 38).
FIRST USE 6-8-2009; IN COMMERCE 6-8-2009.

XJTAG

THE MARK CONSISTS OF STANDARD CHARACTERS WITHOUT CLAIM TO ANY PARTICULAR FONT, STYLE, SIZE, OR COLOR.

OWNER OF ERPN CMNTY TM OFC REG. NO. 3294501, DATED 7-31-2003, EXPIRES 7-31-2013.

FOR COMPUTER SOFTWARE, COMPUTER HARDWARE, APPARATUS, AND INSTRUMENTS, ALL FOR TESTING, DIAGNOSIS, AND DESIGN OF ELECTRONIC CIRCUITRY, CIRCUIT BOARDS, CONNECTORS, INTEGRATED CIRCUITS, AND DISPLAYS (U.S. CLS. 21, 23, 26, 36 AND 38).
FIRST USE 9-30-2002; IN COMMERCE 3-24-2005.

CLASS 9—(Continued).

3,681,496. VARIAN MEDICAL SYSTEMS, INC., PALO ALTO, CA. SN 78-618,931. PUB. 8-8-2006, FILED 4-28-2005.

MICROLINAC

THE MARK CONSISTS OF STANDARD CHARACTERS WITHOUT CLAIM TO ANY PARTICULAR FONT, STYLE, SIZE, OR COLOR.
FOR INDUSTRIAL LINEAR PARTICLE ACCELERATOR (U.S. CLS. 21, 23, 26, 36 AND 38).
FIRST USE 5-28-2009; IN COMMERCE 5-28-2009.

3,681,498. TIMEGATE STUDIOS, INC., SUGARLAND, TX. SN 78-628,080. PUB. 1-31-2006, FILED 5-11-2005.

SECTION 8

THE MARK CONSISTS OF STANDARD CHARACTERS WITHOUT CLAIM TO ANY PARTICULAR FONT, STYLE, SIZE, OR COLOR.
FOR COMPUTER GAME SOFTWARE (U.S. CLS. 21, 23, 26, 36 AND 38).
FIRST USE 1-0-2005; IN COMMERCE 1-26-2009.

3,681,502. POWER PRODUCTS, INC., KANSAS CITY, MO. SN 78-653,229. PUB. 3-7-2006, FILED 6-17-2005.

SLEEPRIGHT

THE MARK CONSISTS OF STANDARD CHARACTERS WITHOUT CLAIM TO ANY PARTICULAR FONT, STYLE, SIZE, OR COLOR.
OWNER OF U.S. REG. NO. 2,289,753.
FOR EAR PLUGS NOT FOR MEDICAL PURPOSES (U.S. CLS. 21, 23, 26, 36 AND 38).
FIRST USE 5-28-2009; IN COMMERCE 5-28-2009.

CLASS 9—(Continued).

3,681,529. FORTNA, INC., WEST READING, PA. SN 78-689,382. PUB. 10-24-2006, FILED 8-10-2005.

FORTNADCDESIGNER

THE MARK CONSISTS OF STANDARD CHARACTERS WITHOUT CLAIM TO ANY PARTICULAR FONT, STYLE, SIZE, OR COLOR.
FOR COMPUTER SOFTWARE FOR THE ARCHITECTURAL DESIGN OF DISTRIBUTION CENTERS AND WAREHOUSES (U.S. CLS. 21, 23, 26, 36 AND 38).
FIRST USE 5-22-2009; IN COMMERCE 5-22-2009.

3,681,531. HERE STUDIOS, LLC, DALLAS, TX. SN 78-690,550. PUB. 4-18-2006, FILED 8-11-2005.



NO CLAIM IS MADE TO THE EXCLUSIVE RIGHT TO USE "TUNES", APART FROM THE MARK AS SHOWN.
THE MARK CONSISTS, IN PART, OF A PAIR OF HEADPHONES SUPERIMPOSED OVER THE WORDING, HERE! TUNES, WITH THE EXCLAMATION POINT APPEARING ON THE RIGHT EAR PIECE OF THE HEADPHONES, AND DESIGN.
FOR DOWNLOADABLE RING TONES (U.S. CLS. 21, 23, 26, 36 AND 38).
FIRST USE 1-1-2006; IN COMMERCE 1-1-2006.

3,681,574. TRIDENT MICROSYSTEMS, INC., SUNNYVALE, CA. SN 78-822,028. PUB. 5-29-2007, FILED 2-23-2006.

DCI

THE MARK CONSISTS OF STANDARD CHARACTERS WITHOUT CLAIM TO ANY PARTICULAR FONT, STYLE, SIZE, OR COLOR.
FOR A FEATURE OF AN INTEGRATED CHIP, NAMELY, VIDEO SOFTWARE FOR ENHANCING AND CONTROLLING VISUAL CONTRAST IN TELEVISIONS (U.S. CLS. 21, 23, 26, 36 AND 38).
FIRST USE 1-0-2007; IN COMMERCE 1-0-2007.

CLASS 9—(Continued).

3,681,575. BIOVIGILANT SYSTEMS, INC., TUCSON, AZ. SN 78-827,615. PUB. 10-31-2006, FILED 3-2-2006.

IMD-A

THE MARK CONSISTS OF STANDARD CHARACTERS WITHOUT CLAIM TO ANY PARTICULAR FONT, STYLE, SIZE, OR COLOR.

FOR ELECTRICAL AND OPTICAL INSTRUMENTS FOR MONITORING AND TESTING AIR AND WATER FOR DETECTING MICROBIAL CONTAMINATION, FOR AGRICULTURE, CONSUMER, GOVERNMENTAL, MILITARY, HOMELAND SECURITY, RETAIL, TRANSPORTATION, ENTERTAINMENT, FOOD, LODGING, EDUCATION AND HEALTHCARE INDUSTRIES, FOR LABORATORY APPLICATIONS, FOOD PROCESSING MANUFACTURING AND OPTICAL DEVICE MANUFACTURING, AND FOR PHARMACEUTICAL AND MEDICAL DEVICE MANUFACTURING INDUSTRIES (U.S. CLS. 21, 23, 26, 36 AND 38).

FIRST USE 12-6-2007; IN COMMERCE 12-6-2007.

3,681,577. CENTEX CORPORATION, DALLAS, TX. SN 78-830,985. PUB. 5-22-2007, FILED 3-7-2006.

CTC CONNECT

THE MARK CONSISTS OF STANDARD CHARACTERS WITHOUT CLAIM TO ANY PARTICULAR FONT, STYLE, SIZE, OR COLOR.

NO CLAIM IS MADE TO THE EXCLUSIVE RIGHT TO USE "CONNECT", APART FROM THE MARK AS SHOWN.

FOR COMPUTER PROGRAMS FOR USE IN CONNECTION WITH THE PREPARATION OF TITLE INSURANCE POLICIES AND CLOSING OF REAL ESTATE TRANSACTIONS (U.S. CLS. 21, 23, 26, 36 AND 38).

FIRST USE 8-1-2007; IN COMMERCE 8-1-2007.

CLASS 9—(Continued).

3,681,591. LASTING IMPRESSIONS FOR PAPER, INC., WOODS CROSS, UT. SN 78-862,945. PUB. 10-10-2006, FILED 4-17-2006.

DO YOU MIX?

THE MARK CONSISTS OF STANDARD CHARACTERS WITHOUT CLAIM TO ANY PARTICULAR FONT, STYLE, SIZE, OR COLOR.

FOR COMPUTER SOFTWARE FOR ORGANIZING AND DISPLAYING DESIGN ELEMENTS AND/OR IMAGES (U.S. CLS. 21, 23, 26, 36 AND 38).

FIRST USE 2-18-2009; IN COMMERCE 2-18-2009.

3,681,593. SA INTERNATIONAL INC., SALT LAKE CITY, UT. SN 78-869,473. PUB. 10-17-2006, FILED 4-25-2006.

FLEXI

THE MARK CONSISTS OF STANDARD CHARACTERS WITHOUT CLAIM TO ANY PARTICULAR FONT, STYLE, SIZE, OR COLOR.

FOR COMPUTER SOFTWARE FOR SIGN MAKING AND DIGITAL PRINTING (U.S. CLS. 21, 23, 26, 36 AND 38).

FIRST USE 3-0-1995; IN COMMERCE 2-0-2006.

3,681,599. RED.COM, INC., LAKE FOREST, CA. SN 78-887,684. PUB. 10-23-2007, FILED 5-19-2006.

REDCODE

THE MARK CONSISTS OF STANDARD CHARACTERS WITHOUT CLAIM TO ANY PARTICULAR FONT, STYLE, SIZE, OR COLOR.

FOR COMPUTER SOFTWARE FOR EDITING, FORMATTING, AND MANIPULATION OF HIGH RESOLUTION AUDIO AND VIDEO FILES IN THE FIELD OF CINEMATOGRAPHY (U.S. CLS. 21, 23, 26, 36 AND 38).

FIRST USE 8-31-2007; IN COMMERCE 8-31-2007.

CLASS 9—(Continued).

3,681,607. CLOUD SYSTEMS INC., SAN FRANCISCO, CA. SN 78-927,150. PUB. 7-29-2008, FILED 7-11-2006.

CLASS 9—(Continued).

3,681,623. XLLERATE CONSULTING, LLC, GARLAND, TX. SN 78-966,613. PUB. 10-28-2008, FILED 9-3-2006.

CONTROL|SIMPLIFIED

XLLERATE

THE MARK CONSISTS OF STANDARD CHARACTERS WITHOUT CLAIM TO ANY PARTICULAR FONT, STYLE, SIZE, OR COLOR.

FOR COMPUTER SOFTWARE FOR MANAGING THE COMMUNICATION PATH BETWEEN HARDWARE AND SOFTWARE BASED DEVICES OVER MULTIPLE PROTOCOLS (U.S. CLS. 21, 23, 26, 36 AND 38).

FIRST USE 5-1-2006; IN COMMERCE 6-19-2006.

THE MARK CONSISTS OF STANDARD CHARACTERS WITHOUT CLAIM TO ANY PARTICULAR FONT, STYLE, SIZE, OR COLOR.

FOR COMPUTER SOFTWARE PROVIDED ON RECORDED MEDIA OR DOWNLOADABLE FROM A GLOBAL COMPUTER NETWORK, FOR AUTOMATING MANUAL BUSINESS PRACTICES, DOCUMENTING BUSINESS PROCESSES, CREATING, MANAGING AND INTEGRATING DATABASES, PROVIDING STATISTICAL ANALYSES, NOTIFICATIONS AND REPORTS, AND PROVIDING REAL-TIME, INTEGRATED BUSINESS MANAGEMENT TOOLS; COMPUTER SOFTWARE PROVIDED ON RECORDED MEDIA OR DOWNLOADABLE FROM A GLOBAL COMPUTER NETWORK, FOR WORD PROCESSING, SPREADSHEET PREPARATION, CHARTING AND GRAPHING; ELECTRONIC PUBLICATIONS, NAMELY, MANUALS FEATURING TRAINING IN SOFTWARE UTILIZATION AND BUSINESS PROCESS IMPROVEMENTS RECORDED ON COMPUTER MEDIA (U.S. CLS. 21, 23, 26, 36 AND 38).

FIRST USE 9-7-2005; IN COMMERCE 9-7-2005.

3,681,609. THE FORCE, INC., HUNTSVILLE, AL. SN 78-930,954. PUB. 7-31-2007, FILED 7-17-2006.

RCMD

CLASS 10—MEDICAL APPARATUS

3,680,184. LINVATEC CORPORATION, LARGO, FL. SN 77-069,388. PUB. 5-22-2007, FILED 12-21-2006.

THE MARK CONSISTS OF STANDARD CHARACTERS WITHOUT CLAIM TO ANY PARTICULAR FONT, STYLE, SIZE, OR COLOR.

FOR COMPUTER SOFTWARE, NAMELY, SOFTWARE FOR USE IN IDENTIFYING FAILURE CONCERNS RELATED TO DEFENSE SYSTEMS AND IDENTIFYING CORRESPONDING PROACTIVE MAINTENANCE ACTIONS, ANALYZING RELIABILITY AND MAINTENANCE ISSUES RELATED TO DEFENSE SYSTEMS, AND DEVELOPING MAINTENANCE STRATEGIES RELATED TO DEFENSE SYSTEMS, INCLUDING DEVELOPING PROACTIVE MAINTENANCE PLANS, MAINTENANCE CHECKLISTS, AREA INSPECTIONS, CHANGES AND ADDITIONS TO OPERATING PROCEDURES, CHANGES AND ADDITIONS TO TECHNICAL PUBLICATIONS, CHANGES AND ADDITIONS TO TRAINING PROGRAMS, PHYSICAL REDESIGNS TO EQUIPMENT, AND OTHER CHANGES AND ADDITIONS FOR MANAGING FAILURE CONSEQUENCES IN DEFENSE SYSTEMS (U.S. CLS. 21, 23, 26, 36 AND 38).

FIRST USE 7-31-2004; IN COMMERCE 10-13-2008.

HEX FLEX

THE MARK CONSISTS OF STANDARD CHARACTERS WITHOUT CLAIM TO ANY PARTICULAR FONT, STYLE, SIZE, OR COLOR.

FOR SURGICAL DEVICES, NAMELY, CANNULAS FOR PROVIDING ACCESS DURING ENDOSCOPIC SURGICAL PROCEDURES AND CANNULA DRIVERS FOR ENGAGING THE CANNULAS AND DRIVING THEM INTO A DESIRED POSITION (U.S. CLS. 26, 39 AND 44).

FIRST USE 9-24-2008; IN COMMERCE 9-24-2008.

CLASS 10—(Continued).

3,680,193. TRAIBER, S.L., 43206 REUS (TARRAGONA), SPAIN. SN 77-091,241. PUB. 3-4-2008, FILED 1-25-2007.

VERCOL

THE MARK CONSISTS OF THE WORD "VERCOL" IN A STYLIZED TYPE FACE.

FOR SURGICAL, MEDICAL, DENTAL AND VETERINARY APPARATUS, NAMELY, VERTEBRAL ORTHOPEDIC APPARATUS (U.S. CLS. 26, 39 AND 44).
FIRST USE 0-0-2001; IN COMMERCE 0-0-2006.

3,680,195. LIGHT SCIENCES ONCOLOGY, INC., BELLEVUE, WA. SN 77-092,600. PUB. 3-25-2008, FILED 1-26-2007.

LIGHT INFUSION TECHNOLOGY

THE MARK CONSISTS OF STANDARD CHARACTERS WITHOUT CLAIM TO ANY PARTICULAR FONT, STYLE, SIZE, OR COLOR.

NO CLAIM IS MADE TO THE EXCLUSIVE RIGHT TO USE "TECHNOLOGY", APART FROM THE MARK AS SHOWN.

FOR PHOTOTHERAPEUTIC DEVICES FOR MEDICAL PURPOSES (U.S. CLS. 26, 39 AND 44).
FIRST USE 7-14-2009; IN COMMERCE 7-14-2009.

3,680,277. THOMAS MEDICAL PRODUCTS, INC., MALVERN, PA. SN 77-169,337. PUB. 10-30-2007, FILED 4-30-2007.

HEARTSPAN

THE MARK CONSISTS OF STANDARD CHARACTERS WITHOUT CLAIM TO ANY PARTICULAR FONT, STYLE, SIZE, OR COLOR.

FOR SURGICAL CATHETERS AND NEEDLES (U.S. CLS. 26, 39 AND 44).
FIRST USE 3-0-2007; IN COMMERCE 3-0-2007.

CLASS 10—(Continued).

3,680,374. STEVE, AYANRUOH, YONKERS, NY. SN 77-228,688. PUB. 6-10-2008, FILED 7-12-2007.

SCOMET

THE MARK CONSISTS OF STANDARD CHARACTERS WITHOUT CLAIM TO ANY PARTICULAR FONT, STYLE, SIZE, OR COLOR.

FOR HANDHELD INTEGRATED MEDICAL EXAMINATION DEVICE USED TO EXAMINE ANY PART OF THE BODY, CONSISTING PRIMARILY OF AN EKG MACHINE, SPIROMETER, PULSEOXIMETER, BLOOD PRESSURE MONITOR, WEIGHING SCALE, GLUCOMETER, NEBULIZER AND A THERMOMETER (U.S. CLS. 26, 39 AND 44).
FIRST USE 3-29-2007; IN COMMERCE 3-29-2007.

3,680,402. ALCON, INC., CH-6331 HUNENBERG, SWITZERLAND. SN 77-271,202. PUB. 3-4-2008, FILED 9-4-2007.

FOR RADIO FREQUENCY IDENTIFICATION CHIP SOLD AS AN INTEGRAL COMPONENT OF OPHTHALMIC SURGICAL APPARATUS FOR USE DURING VITREORETINAL SURGERY (U.S. CLS. 26, 39 AND 44).
FIRST USE 7-31-2008; IN COMMERCE 7-31-2008.

3,680,403. ALCON, INC., CH-6331 HUNENBERG, SWITZERLAND. SN 77-271,213. PUB. 2-26-2008, FILED 9-4-2007.

ENGAUGE

THE MARK CONSISTS OF STANDARD CHARACTERS WITHOUT CLAIM TO ANY PARTICULAR FONT, STYLE, SIZE, OR COLOR.

FOR RADIO FREQUENCY IDENTIFICATION CHIP SOLD AS AN INTEGRAL COMPONENT OF OPHTHALMIC SURGICAL APPARATUS FOR USE DURING VITREORETINAL SURGERY (U.S. CLS. 26, 39 AND 44).
FIRST USE 7-31-2008; IN COMMERCE 7-31-2008.

CLASS 10—(Continued).

3,680,435. OSTEOTECH, INC., EATONTOWN, NJ. SN 77-294,132. PUB. 6-10-2008, FILED 10-2-2007.

PLEXUR 

OWNER OF U.S. REG. NO. 3,294,506.
THE MARK CONSISTS OF A STYLIZED LETTER "M" APPEARING IN AN OVAL TO THE RIGHT OF THE WORD "PLEXUR".

FOR SURGICAL IMPLANTS, NAMELY, COMPOSITE MATERIALS COMPRISED PRIMARILY OF SYNTHETIC MATERIAL AND HUMAN BONE FOR SURGICAL PROCEDURES (U.S. CLS. 26, 39 AND 44).

FIRST USE 4-21-2009; IN COMMERCE 4-21-2009.

3,680,474. SMITH & NEPHEW, INC., MEMPHIS, TN. SN 77-309,555. PUB. 9-9-2008, FILED 10-22-2007.

POWERMINI

THE MARK CONSISTS OF STANDARD CHARACTERS WITHOUT CLAIM TO ANY PARTICULAR FONT, STYLE, SIZE, OR COLOR.

FOR MEDICAL DEVICES, NAMELY, ENDOSCOPIC SURGICAL SYSTEM COMPRISING A MOTOR DRIVE UNIT, CONTROL UNIT, BLADES AND INSTRUMENTS FOR ENDOSCOPIC SURGERY (U.S. CLS. 26, 39 AND 44).

FIRST USE 6-3-2009; IN COMMERCE 6-3-2009.

3,680,489. 9082-9912 QUÉBEC INC., BOISBRIAND, CANADA. SN 77-314,754. PUB. 10-14-2008, FILED 10-26-2007.

iComfort

THE MARK CONSISTS OF STANDARD CHARACTERS WITHOUT CLAIM TO ANY PARTICULAR FONT, STYLE, SIZE, OR COLOR.

OWNER OF CANADA REG. NO. TMA718,721, DATED 7-17-2008, EXPIRES 7-17-2023.

FOR ELECTRICAL MASSAGE ARMCHAIRS; ELECTRICAL BASINS FOR FOOT MASSAGE; HANDLE ELECTRICAL MASSAGERS; FEET MASSAGE ELECTRICAL UNITS; FEET, ANKLES AND CALVES MASSAGE ELECTRICAL UNITS; THERAPEUTIC ELECTRICAL IN-FRA-RED HEATING SAUNAS; HOME AND CAR MICROPROCESSOR-CONTROLLED MASSAGE SEAT COVERS (U.S. CLS. 26, 39 AND 44).

FIRST USE 1-1-2009; IN COMMERCE 1-1-2009.

CLASS 10—(Continued).

3,680,509. GLOBUS MEDICAL, INC., AUDUBON, PA. SN 77-322,257. PUB. 5-13-2008, FILED 11-6-2007.

CORRIDOR

THE MARK CONSISTS OF STANDARD CHARACTERS WITHOUT CLAIM TO ANY PARTICULAR FONT, STYLE, SIZE, OR COLOR.

THE WORDING "CORRIDOR" HAS NO MEANING IN A FOREIGN LANGUAGE.

FOR SURGICAL IMPLANTS COMPRISED OF ARTIFICIAL MATERIAL FOR USE IN SPINE SURGERY (U.S. CLS. 26, 39 AND 44).

FIRST USE 10-18-2007; IN COMMERCE 2-24-2009.

3,680,564. SURGICRAFT, LTD., REDDITCH, UNITED KINGDOM. SN 77-335,083. PUB. 2-17-2009, FILED 11-21-2007.

STALIF C

THE MARK CONSISTS OF STANDARD CHARACTERS WITHOUT CLAIM TO ANY PARTICULAR FONT, STYLE, SIZE, OR COLOR.

OWNER OF U.S. REG. NO. 2,859,890.
NO CLAIM IS MADE TO THE EXCLUSIVE RIGHT TO USE "C", APART FROM THE MARK AS SHOWN.

FOR ORTHOPEDIC IMPLANTS, NAMELY, SPINAL IMPLANTS COMPRISING ARTIFICIAL MATERIAL (U.S. CLS. 26, 39 AND 44).

FIRST USE 8-1-2008; IN COMMERCE 10-1-2008.

3,680,602. DEPUY, INC., WARSAW, IN. SN 77-344,762. PUB. 4-22-2008, FILED 12-5-2007.

X-MESH

THE MARK CONSISTS OF STANDARD CHARACTERS WITHOUT CLAIM TO ANY PARTICULAR FONT, STYLE, SIZE, OR COLOR.

FOR ORTHOPAEDIC IMPLANTS COMPOSED OF ARTIFICIAL MATERIAL; SURGICAL INSTRUMENTS FOR USE IN ORTHOPAEDIC SURGERY (U.S. CLS. 26, 39 AND 44).

FIRST USE 0-0-2008; IN COMMERCE 0-0-2008.

CLASS 10—(Continued).

3,680,859. OPTO ELETRÔNICA S/A, SÃO PAULO, BRAZIL.
SN 77-458,482. PUB. 10-7-2008, FILED 4-25-2008.



THE COLOR(S) MAGENTA AND BLACK IS/ARE CLAIMED AS A FEATURE OF THE MARK.

THE MARK CONSISTS OF A STYLIZED "X" WITH THE SECOND UPPER ARM AND LOWER LEG OF THE "X" IN BLACK WITH THE REST BEING IN MAGENTA AND THE WORD "LINK" IN MAGENTA.

FOR SURGICAL AND MEDICAL APPARATUS AND INSTRUMENTS, NAMELY, LASER AND LIGHT EMITTING DIODE (LED) DEVICE FOR USE IN THE OPHTHALMIC FIELD (U.S. CLS. 26, 39 AND 44).
FIRST USE 12-8-2008; IN COMMERCE 12-8-2008.

3,681,073. GROVE MEDICAL LLC, MIAMI, FL. SN 77-499,879.
PUB. 11-18-2008, FILED 6-16-2008.

SENSIS WITH QUIKSTRIPS

THE MARK CONSISTS OF STANDARD CHARACTERS WITHOUT CLAIM TO ANY PARTICULAR FONT, STYLE, SIZE, OR COLOR.

FOR CONDOMS (U.S. CLS. 26, 39 AND 44).
FIRST USE 3-0-2009; IN COMMERCE 3-0-2009.

3,681,074. GROVE MEDICAL LLC, MIAMI, FL. SN 77-499,936.
PUB. 11-18-2008, FILED 6-16-2008.

SENSIS

THE MARK CONSISTS OF STANDARD CHARACTERS WITHOUT CLAIM TO ANY PARTICULAR FONT, STYLE, SIZE, OR COLOR.

FOR CONDOMS (U.S. CLS. 26, 39 AND 44).
FIRST USE 3-0-2009; IN COMMERCE 3-0-2009.

CLASS 10—(Continued).

3,681,080. ENCOMPASS GROUP, LLC, DBA ALBAHEALTH, LLC, MCDONOUGH, GA. SN 77-501,551. PUB. 10-7-2008, FILED 6-18-2008.

ESSENTIALCARE

THE MARK CONSISTS OF STANDARD CHARACTERS WITHOUT CLAIM TO ANY PARTICULAR FONT, STYLE, SIZE, OR COLOR.

OWNER OF U.S. REG. NOS. 3,000,364 AND 3,289,832.
FOR MEDICAL COMPRESSION STOCKINGS AND TIGHTS (U.S. CLS. 26, 39 AND 44).
FIRST USE 4-15-2009; IN COMMERCE 4-15-2009.

3,681,095. WRIGHT MEDICAL TECHNOLOGY, INC., ARLINGTON, TN. SN 77-508,984. PUB. 10-14-2008, FILED 6-26-2008.

G-FORCE

THE MARK CONSISTS OF STANDARD CHARACTERS WITHOUT CLAIM TO ANY PARTICULAR FONT, STYLE, SIZE, OR COLOR.

FOR MEDICAL DEVICES FOR SOFT TISSUE FIXATION, NAMELY, SUTURE ANCHORS AND INTERFERENCE SCREWS (U.S. CLS. 26, 39 AND 44).
FIRST USE 2-27-2009; IN COMMERCE 2-27-2009.

3,681,126. TYCO HEALTHCARE GROUP LP, NORTH HAVEN, CT. SN 77-522,185. PUB. 12-9-2008, FILED 7-15-2008.

V-LOC

THE MARK CONSISTS OF STANDARD CHARACTERS WITHOUT CLAIM TO ANY PARTICULAR FONT, STYLE, SIZE, OR COLOR.

FOR SURGICAL AND MEDICAL INSTRUMENTS, NAMELY, SUTURES, LIGATURES, AND SUTURE KITS COMPRISED OF SUTURES AND NEEDLES (U.S. CLS. 26, 39 AND 44).
FIRST USE 6-19-2009; IN COMMERCE 6-19-2009.

CLASS 10—(Continued).

3,681,135. APPLIED BIOKINETICS LLC, HOUSTON, TX. SN 77-523,317. PUB. 12-9-2008, FILED 7-16-2008.

HEEL-EEZ

THE MARK CONSISTS OF STANDARD CHARACTERS WITHOUT CLAIM TO ANY PARTICULAR FONT, STYLE, SIZE, OR COLOR.

FOR ORTHOTICS FOR THE FEET, ORTHOPEDIC FOOTWEAR, ORTHOPEDIC ARCH SUPPORTS FOR SHOES OR BOOTS, ORTHOPEDIC HEEL PADS, ORTHOPEDIC HEEL AND FOOT SUPPORTS (U.S. CLS. 26, 39 AND 44).

FIRST USE 2-1-2009; IN COMMERCE 6-27-2009.

CLASS 10—(Continued).

3,681,220. ZAGULA, MATTHEW J., DBA COMFORT STEPZ, GEORGETOWN, KY. SN 77-560,216. PUB. 1-27-2009, FILED 9-2-2008.

Comfort Stepz

THE MARK CONSISTS OF STANDARD CHARACTERS WITHOUT CLAIM TO ANY PARTICULAR FONT, STYLE, SIZE, OR COLOR.

NO CLAIM IS MADE TO THE EXCLUSIVE RIGHT TO USE "COMFORT", APART FROM THE MARK AS SHOWN. FOR ORTHOTIC INSERTS FOR FOOTWEAR; ORTHOTICS FOR FEET (U.S. CLS. 26, 39 AND 44).

FIRST USE 1-31-2009; IN COMMERCE 1-31-2009.

3,681,152. WRIGHT MEDICAL TECHNOLOGY, INC., ARLINGTON, TN. SN 77-529,740. PUB. 10-14-2008, FILED 7-23-2008.

CORETRAK

THE MARK CONSISTS OF STANDARD CHARACTERS WITHOUT CLAIM TO ANY PARTICULAR FONT, STYLE, SIZE, OR COLOR.

FOR MEDICAL DEVICES, NAMELY, ORTHOPEDIC EXTERNAL FIXATION DEVICES FOR TREATMENT OF BONE FRACTURES AND DISEASES (U.S. CLS. 26, 39 AND 44).

FIRST USE 3-31-2008; IN COMMERCE 3-31-2008.

3,681,237. OSSUR HF, REYKJAVIK, ICELAND. SN 77-566,667. PUB. 3-17-2009, FILED 9-10-2008.

COLD RUSH

THE MARK CONSISTS OF STANDARD CHARACTERS WITHOUT CLAIM TO ANY PARTICULAR FONT, STYLE, SIZE, OR COLOR.

NO CLAIM IS MADE TO THE EXCLUSIVE RIGHT TO USE "COLD", APART FROM THE MARK AS SHOWN.

FOR TEMPERATURE THERAPY DEVICE FOR TREATMENT OF ANATOMY COMPRISED OF A THERMAL PAD, FLUIDIC PAD, AND HEAT EXCHANGER, NAMELY, ORTHOPEDIC CAST COOLING SYSTEM COMPRISED OF A MEMBRANE WRAPPED AROUND THE CAST, A VACUUM PUMP AND HOSES TO FACILITATE AIR FLOW TO FACILITATE HEALING AND COMFORT (U.S. CLS. 26, 39 AND 44).

FIRST USE 1-21-2009; IN COMMERCE 1-21-2009.

3,681,204. ASCENSION ORTHOPEDICS, INC., AUSTIN, TX. SN 77-549,740. PUB. 12-23-2008, FILED 8-18-2008.

Transforming Extremities

THE MARK CONSISTS OF STANDARD CHARACTERS WITHOUT CLAIM TO ANY PARTICULAR FONT, STYLE, SIZE, OR COLOR.

NO CLAIM IS MADE TO THE EXCLUSIVE RIGHT TO USE "EXTREMITIES", APART FROM THE MARK AS SHOWN.

FOR ORTHOPEDIC IMPLANTS COMPOSED OF ARTIFICIAL MATERIALS FOR USE THROUGHOUT THE HUMAN BODY (U.S. CLS. 26, 39 AND 44).

FIRST USE 1-29-2009; IN COMMERCE 1-29-2009.

3,681,265. SLEEPING WELL, LLC, SHELBURNE, VT. SN 77-575,604. PUB. 2-10-2009, FILED 9-22-2008.

ZQuiet

THE MARK CONSISTS OF STANDARD CHARACTERS WITHOUT CLAIM TO ANY PARTICULAR FONT, STYLE, SIZE, OR COLOR.

FOR DEVICE USED AS A MOUTH GUARD TO PREVENT SNORING (U.S. CLS. 26, 39 AND 44).

FIRST USE 1-0-2009; IN COMMERCE 4-15-2009.

CLASS 10—(Continued).

3,681,284. ULTRADENT PRODUCTS, INC., SOUTH JORDAN, UT. SN 77-580,190. PUB. 3-10-2009, FILED 9-26-2008.

VALO

THE MARK CONSISTS OF STANDARD CHARACTERS WITHOUT CLAIM TO ANY PARTICULAR FONT, STYLE, SIZE, OR COLOR.

FOR DENTAL PRODUCTS, NAMELY, LIGHTS FOR CURING DENTAL COMPOSITES (U.S. CLS. 26, 39 AND 44).

FIRST USE 5-1-2009; IN COMMERCE 5-1-2009.

CLASS 10—(Continued).

3,681,465. STRYKER CORPORATION, KALAMAZOO, MI. SN 78-483,262. PUB. 6-27-2006, FILED 9-14-2004.

BACKSMART

THE MARK CONSISTS OF STANDARD CHARACTERS WITHOUT CLAIM TO ANY PARTICULAR FONT, STYLE, SIZE, OR COLOR.

FOR PATIENT AND/OR INVALID REPOSITIONING AND TRANSFER DEVICES, NAMELY, POWER OPERATED MOBILITY STRETCHERS; AIR INFLATED MATTRESSES FOR USE IN FACILITATING PATIENT TRANSFER FROM ONE PATIENT SUPPORT SURFACE TO ANOTHER ADJACENT ONE; AIR INFLATED MATTRESSES FOR USE IN AN IN-BED ENVIRONMENT FOR ASSISTING IN PATIENT POSITION MANIPULATION (U.S. CLS. 26, 39 AND 44).

FIRST USE 1-7-2009; IN COMMERCE 1-7-2009.

3,681,482. ABBOTT CARDIOVASCULAR SYSTEMS, INC., SANTA CLARA, CA. SN 78-572,429. PUB. 12-20-2005, FILED 2-22-2005.

HERCULINK ELITE

THE MARK CONSISTS OF STANDARD CHARACTERS WITHOUT CLAIM TO ANY PARTICULAR FONT, STYLE, SIZE, OR COLOR.

OWNER OF U.S. REG. NO. 2,559,359.
FOR CATHETERS AND MEDICAL CATHETERS TIPS; STENTS AND DRUG COATED STENTS; COATING COMPONENTS FOR MEDICAL CATHETERS AND GUIDE WIRES; SURGICAL INSTRUMENTS FOR USE IN CARDIAC PROCEDURES EXCLUDING ORTHOPEDIC SURGERY (U.S. CLS. 26, 39 AND 44).

FIRST USE 3-8-2006; IN COMMERCE 3-8-2006.

3,681,317. PAC-DENT INTERNATIONAL, INC., DBA DENTAL APPARATUS, WALNUT, CA. SN 77-590,891. PUB. 3-3-2009, FILED 10-11-2008.

i | Mix

3,681,518. SHALON VENTURES RESEARCH LLC, PALO ALTO, CA. SN 78-670,054. PUB. 4-11-2006, FILED 7-13-2005.

SIENTRA

THE MARK CONSISTS OF ITALIC LOWER-CASE "I" FOLLOWED BY A VERTICAL BAR "|", THEN FOLLOWED BY "MIX" IN SMALL CAP FORMAT.

FOR DENTAL PRODUCTS, NAMELY, PLASTIC MATERIAL FOR FABRICATING COMPLETE AND PARTIAL DENTURE LINERS/RELINES, AND FOR FABRICATING GASKETS FOR OVER DENTURES (U.S. CLS. 26, 39 AND 44).

FIRST USE 7-1-2007; IN COMMERCE 7-1-2007.

THE MARK CONSISTS OF STANDARD CHARACTERS WITHOUT CLAIM TO ANY PARTICULAR FONT, STYLE, SIZE, OR COLOR.

FOR SURGICAL IMPLANTS COMPRISING ARTIFICIAL MATERIALS (U.S. CLS. 26, 39 AND 44).

FIRST USE 5-11-2009; IN COMMERCE 5-11-2009.

CLASS 10—(Continued).

3,681,549. CAPPELLA, INC., AUBURNDALE, MA. SN 78-744,374. PUB. 1-9-2007, FILED 11-1-2005.

SIDEGUARD

THE MARK CONSISTS OF STANDARD CHARACTERS WITHOUT CLAIM TO ANY PARTICULAR FONT, STYLE, SIZE, OR COLOR.

FOR MEDICAL DEVICE, NAMELY, A STENT FOR USE IN A BIFURCATED REGION OF A VESSEL; MEDICAL DEVICE, NAMELY, A STENT FOR USE AT AN OSTIUM; MEDICAL DEVICE, NAMELY, A STENT FOR USE IN A SIDE BRANCH VESSEL; MEDICAL DEVICE DELIVERY CATHETER FOR DELIVERING STENTS FOR USE IN BIFURCATED VESSEL REGIONS, OSTIUM, AND SIDE BRANCH VESSELS; MEDICAL DEVICE, NAMELY, A STENT FOR DELIVERY OF MEDICATION TO A BIFURCATED REGION OF A VESSEL; MEDICAL DEVICE, NAMELY, A STENT FOR DELIVERY OF MEDICATION AT AN OSTIUM; MEDICAL DEVICE, NAMELY, A STENT FOR DELIVERY OF MEDICATION AT A SIDE BRANCH VESSEL (U.S. CLS. 26, 39 AND 44).

FIRST USE 5-12-2009; IN COMMERCE 5-12-2009.

3,681,560. HS TM, LLC, NEWARK, DE. SN 78-787,716. PUB. 10-17-2006, FILED 1-9-2006.

MAXIGRIP

THE MARK CONSISTS OF STANDARD CHARACTERS WITHOUT CLAIM TO ANY PARTICULAR FONT, STYLE, SIZE, OR COLOR.

FOR DENTAL HAND INSTRUMENTS, NAMELY, CURETTES AND SCALERS (U.S. CLS. 26, 39 AND 44).

FIRST USE 4-0-2006; IN COMMERCE 4-0-2006.

CLASS 10—(Continued).

3,681,583. GUIDED DELIVERY SYSTEMS INC., SANTA CLARA, CA. SN 78-845,999. PUB. 5-15-2007, FILED 3-24-2006.

ACCUCINCH

THE MARK CONSISTS OF STANDARD CHARACTERS WITHOUT CLAIM TO ANY PARTICULAR FONT, STYLE, SIZE, OR COLOR.

FOR MEDICAL DEVICES FOR USE BY INTERVENTIONAL CARDIOLOGISTS IN MITRAL VALVE REPAIR, NAMELY, IMPLANTS CONSISTING OF ARTIFICIAL MATTER, ANCHORS, CABLES, CATHETERS, SLEEVES, AND SURGICAL APPARATUSES USED TO DELIVER CARDIAC IMPLANTS DURING SURGERY (U.S. CLS. 26, 39 AND 44).

FIRST USE 3-5-2009; IN COMMERCE 3-5-2009.

3,681,630. VOMRAIS INNOVATIONS, INC., CHANDLER, AZ. SN 78-972,837. PUB. 4-24-2007, FILED 9-12-2006.

PROSIT

THE MARK CONSISTS OF STANDARD CHARACTERS WITHOUT CLAIM TO ANY PARTICULAR FONT, STYLE, SIZE, OR COLOR.

FOR COMPRESSION BANDAGES; CUSHION LINERS FOR PROSTHETIC LIMBS; ELASTIC BANDAGES; PADDING FOR ORTHOPEDIC CASTS (U.S. CLS. 26, 39 AND 44).

FIRST USE 12-12-2006; IN COMMERCE 12-12-2006.

CLASS 11—ENVIRONMENTAL CONTROL APPARATUS

3,680,138. NEWPEX, FREMONT, CA. SN 76-692,693. PUB. 2-10-2009, FILED 9-9-2008.

JENBO

THE MARK CONSISTS OF STANDARD CHARACTERS WITHOUT CLAIM TO ANY PARTICULAR FONT, STYLE, SIZE, OR COLOR.

THE WORDING "JENBO" HAS NO FOREIGN MEANING. FOR LIGHT BULBS (U.S. CLS. 13, 21, 23, 31 AND 34).

FIRST USE 12-16-2008; IN COMMERCE 12-16-2008.

CLASS 11—(Continued).

3,680,267. FLUIDMASTER, INC., SAN JUAN CAPISTRANO, CA. SN 77-164,504. PUB. 10-2-2007, FILED 4-24-2007.



OWNER OF U.S. REG. NOS. 2,631,591, 2,903,475, AND OTHERS.

NO CLAIM IS MADE TO THE EXCLUSIVE RIGHT TO USE "ORIGINAL PARTS", APART FROM THE MARK AS SHOWN.

FOR PLUMBING SUPPLIES, NAMELY, FILL VALVES, FLAPPERS, FLUSH VALVES, GASKETS, BALL COCKS, TANK LEVERS, NON-METAL TOILET FITTINGS, NAMELY, TOILET SEATS, TOILET TANK BALLS AND TOILET TANKS; SPECIALLY ADAPTED NON-METAL TOILET FITTING HARDWARE, NAMELY, WASHERS, LOCKNUTS (U.S. CLS. 13, 21, 23, 31 AND 34).

FIRST USE 10-31-2008; IN COMMERCE 10-31-2008.

3,680,275. MILLIPORE CORPORATION, BILLERICA, MA. SN 77-169,151. PUB. 11-13-2007, FILED 4-30-2007.

VOC-PAK

THE MARK CONSISTS OF STANDARD CHARACTERS WITHOUT CLAIM TO ANY PARTICULAR FONT, STYLE, SIZE, OR COLOR.

FOR WATER PURIFICATION UNITS FOR LABORATORY USE, FOR REMOVING CONTAMINANTS FROM WATER (U.S. CLS. 13, 21, 23, 31 AND 34).

FIRST USE 2-5-2009; IN COMMERCE 2-5-2009.

3,680,284. KOHLER CO., KOHLER, WI. SN 77-173,359. PUB. 10-14-2008, FILED 5-4-2007.

SHOWER LOCKER

THE MARK CONSISTS OF STANDARD CHARACTERS WITHOUT CLAIM TO ANY PARTICULAR FONT, STYLE, SIZE, OR COLOR.

NO CLAIM IS MADE TO THE EXCLUSIVE RIGHT TO USE "SHOWER", APART FROM THE MARK AS SHOWN.

FOR SHOWER PANELS INCORPORATING SHELVING UNITS (U.S. CLS. 13, 21, 23, 31 AND 34).

FIRST USE 8-25-2007; IN COMMERCE 8-25-2007.

CLASS 11—(Continued).

3,680,422. PROCESS FILTRATION LLC, HOUSTON, TX. SN 77-287,932. PUB. 8-26-2008, FILED 9-25-2007.

Performance Separations

THE MARK CONSISTS OF STANDARD CHARACTERS WITHOUT CLAIM TO ANY PARTICULAR FONT, STYLE, SIZE, OR COLOR.

NO CLAIM IS MADE TO THE EXCLUSIVE RIGHT TO USE "SEPARATIONS", APART FROM THE MARK AS SHOWN.

FOR INDUSTRIAL FILTERS FOR FILTERING SOLIDS AND/OR WATER FROM HYDROCARBONS (U.S. CLS. 13, 21, 23, 31 AND 34).

FIRST USE 8-29-2008; IN COMMERCE 8-29-2008.

3,680,456. FPI FIREPLACE PRODUCTS INTERNATIONAL LTD., DELTA BRITISH COLUMBIA, CANADA. SN 77-301,627. PUB. 1-22-2008, FILED 10-11-2007.



OWNER OF U.S. REG. NOS. 2,822,641 AND 2,824,702. THE MARK CONSISTS OF "ONE REGENCY ONE TREE" WITH A TREE BETWEEN THE TWO PHRASES.

FOR FIREPLACES; PARTS, ACCESSORIES AND ATTACHMENTS FOR FIREPLACES, NAMELY, VENTILATING LOUVERS, BURNERS, SOLD AS PARTS OF FIREPLACES; GAS, WOOD BURNING AND SOLID FUEL BURNING STOVES; PARTS, ACCESSORIES AND ATTACHMENTS FOR STOVES, NAMELY, VENTILATING LOUVERS, BURNERS, SOLD AS PARTS OF STOVES (U.S. CLS. 13, 21, 23, 31 AND 34).

FIRST USE 4-30-2009; IN COMMERCE 4-30-2009.

CLASS 11—(Continued).

3,680,685. EUROPEAN TOUCH HOLDINGS, INC., MILWAU-
KEE, WI. SN 77-378,295. PUB. 4-8-2008, FILED 1-23-2008.

RINATO SPA

THE MARK CONSISTS OF STANDARD CHARACTERS WITHOUT CLAIM TO ANY PARTICULAR FONT, STYLE, SIZE, OR COLOR.

NO CLAIM IS MADE TO THE EXCLUSIVE RIGHT TO USE "SPA", APART FROM THE MARK AS SHOWN.

THE WORDING "RINATO" HAS NO MEANING OTHER THAN TRADEMARK SIGNIFICANCE.

FOR PEDICURE SPAS, NAMELY, FOOT BATHS FOR USE IN PEDICURE SALONS AND DAY SPAS (U.S. CLS. 13, 21, 23, 31 AND 34).

FIRST USE 3-31-2008; IN COMMERCE 4-30-2008.

3,680,686. EUROPEAN TOUCH HOLDINGS, INC., MILWAU-
KEE, WI. SN 77-378,302. PUB. 4-8-2008, FILED 1-23-2008.

RINATO XL

THE MARK CONSISTS OF STANDARD CHARACTERS WITHOUT CLAIM TO ANY PARTICULAR FONT, STYLE, SIZE, OR COLOR.

NO CLAIM IS MADE TO THE EXCLUSIVE RIGHT TO USE "XL", APART FROM THE MARK AS SHOWN.

THE WORDING "RINATO" HAS NO MEANING OTHER THAN TRADEMARK SIGNIFICANCE.

FOR PEDICURE SPAS, NAMELY, FOOT BATHS FOR USE IN PEDICURE SALONS AND DAY SPAS (U.S. CLS. 13, 21, 23, 31 AND 34).

FIRST USE 3-31-2008; IN COMMERCE 6-30-2008.

3,680,691. THE BLACK & DECKER CORPORATION, TOW-
SON, MD. SN 77-384,525. PUB. 4-22-2008, FILED 1-30-2008.



OWNER OF U.S. REG. NOS. 649,651, 2,987,002, AND OTHERS.

THE MARK CONSISTS OF "PORTER CABLE" AND STAR DESIGN.

FOR FLASHLIGHTS AND REPLACEMENT LIGHT BULBS (U.S. CLS. 13, 21, 23, 31 AND 34).

FIRST USE 10-31-2008; IN COMMERCE 10-31-2008.

CLASS 11—(Continued).

3,680,701. INTELTECH CORPORATION, FORT LAUDER-
DALE, FL. SN 77-389,635. PUB. 9-23-2008, FILED 2-6-2008.

SILESCENT

THE MARK CONSISTS OF STANDARD CHARACTERS WITHOUT CLAIM TO ANY PARTICULAR FONT, STYLE, SIZE, OR COLOR.

FOR CEILING LIGHTS AND SOLID-STATE LIGHTING SYSTEMS COMPRISED PRIMARILY OF FIXTURES, POWER AND CONTROLS CIRCUITRY, LIGHT EMITTING DIODES OR SOLID-STATE EMITTERS (U.S. CLS. 13, 21, 23, 31 AND 34).

FIRST USE 4-16-2009; IN COMMERCE 5-13-2009.

3,680,723. CYCLONE RANGE HOODS INC., LONG ISLAND
CITY, NY. SN 77-400,116. PUB. 7-22-2008, FILED 2-19-2008.



NO CLAIM IS MADE TO THE EXCLUSIVE RIGHT TO USE "USA", APART FROM THE MARK AS SHOWN.

THE COLOR(S) RED IS/ARE CLAIMED AS A FEATURE OF THE MARK.

THE MARK CONSISTS OF THE WORDING "CYCLONE" ABOVE "USA". THE COLOR RED APPEARS THROUGHOUT THE ENTIRE MARK.

FOR COOKING RANGES; ELECTRIC RANGES; EXHAUST HOODS FOR KITCHENS; HUMIDITY CONTROL DEVICE, NAMELY, A PORTABLE CONTAINER CONTAINING A MOISTURE-SENSITIVE SILICA COPOLYMER THAT ABSORBS OR RELEASES MOISTURE TO MAINTAIN RELATIVE HUMIDITY IN A PARTICULAR RANGE; RANGE HOODS; VENTILATION HOODS (U.S. CLS. 13, 21, 23, 31 AND 34).

FIRST USE 9-1-2008; IN COMMERCE 10-1-2008.

CLASS 11—(Continued).

3,680,724. SELKIRK CANADA CORPORATION, STONEY CREEK, CANADA. SN 77-400,465. PUB. 11-11-2008, FILED 2-19-2008.

VERSA-LINER

THE MARK CONSISTS OF STANDARD CHARACTERS WITHOUT CLAIM TO ANY PARTICULAR FONT, STYLE, SIZE, OR COLOR.

FOR HEATING SUPPLIES AND EQUIPMENT, NAMELY, CHIMNEY FLUES AND PARTS THEREFOR (U.S. CLS. 13, 21, 23, 31 AND 34).

FIRST USE 5-31-2008; IN COMMERCE 5-31-2008.

3,680,729. INTELTECH CORPORATION, FORT LAUDERDALE, FL. SN 77-402,333. PUB. 9-23-2008, FILED 2-21-2008.



FOR CEILING LIGHTS AND SOLID-STATE LIGHTING SYSTEMS COMPRISED PRIMARILY OF FIXTURES, POWER AND CONTROLS CIRCUITRY, LIGHT EMITTING DIODES OR SOLID-STATE EMITTERS (U.S. CLS. 13, 21, 23, 31 AND 34).

FIRST USE 4-16-2009; IN COMMERCE 5-13-2009.

3,680,783. DORAN, PAUL S., COLUMBIA FALLS, MT. SN 77-434,283. PUB. 9-30-2008, FILED 3-28-2008.

Fountain of Life Water Appliance

THE MARK CONSISTS OF STANDARD CHARACTERS WITHOUT CLAIM TO ANY PARTICULAR FONT, STYLE, SIZE, OR COLOR.

OWNER OF U.S. REG. NO. 2,844,676.

NO CLAIM IS MADE TO THE EXCLUSIVE RIGHT TO USE "WATER APPLIANCE", APART FROM THE MARK AS SHOWN.

FOR WATER PURIFICATION AND FILTRATION APPARATUS FOR USE IN PRODUCING POTABLE WATER (U.S. CLS. 13, 21, 23, 31 AND 34).

FIRST USE 6-10-2009; IN COMMERCE 6-10-2009.

CLASS 11—(Continued).

3,680,902. OSRAM SYLVANIA, INC., DANVERS, MA. SN 77-468,187. PUB. 10-14-2008, FILED 5-7-2008.

SYLVANIA

THE MARK CONSISTS OF STANDARD CHARACTERS WITHOUT CLAIM TO ANY PARTICULAR FONT, STYLE, SIZE, OR COLOR.

OWNER OF U.S. REG. NOS. 434,729, 2,875,127, AND OTHERS.

FOR ULTRAVIOLET LIGHT SOURCES FOR WATER PURIFICATION NOT FOR MEDICAL PURPOSES, NAMELY, LAMPS AND LIGHT BULBS (U.S. CLS. 13, 21, 23, 31 AND 34).

FIRST USE 4-0-1969; IN COMMERCE 4-0-1969.

3,680,929. GRAVER TECHNOLOGIES LLC, GLASGOW, DE. SN 77-471,744. PUB. 10-21-2008, FILED 5-12-2008.

E-PAK

THE MARK CONSISTS OF STANDARD CHARACTERS WITHOUT CLAIM TO ANY PARTICULAR FONT, STYLE, SIZE, OR COLOR.

FOR FILTRATION APPARATUS, NAMELY, CARTRIDGES CONTAINING ACTIVATED CARBONS, ION EXCHANGE RESINS, OR INORGANIC ADSORBENTS, FOR USE IN THE PURIFICATION OF ACTIVE PHARMACEUTICAL INGREDIENTS, INTERMEDIATES AND FINE CHEMICALS (U.S. CLS. 13, 21, 23, 31 AND 34).

FIRST USE 6-24-2009; IN COMMERCE 6-24-2009.

3,681,025. SPEAKMAN COMPANY, NEW CASTLE, DE. SN 77-487,501. PUB. 10-28-2008, FILED 5-30-2008.

NATURE'S AIR CONDITIONER

THE MARK CONSISTS OF STANDARD CHARACTERS WITHOUT CLAIM TO ANY PARTICULAR FONT, STYLE, SIZE, OR COLOR.

NO CLAIM IS MADE TO THE EXCLUSIVE RIGHT TO USE "AIR CONDITIONER", APART FROM THE MARK AS SHOWN.

FOR EVAPORATIVE AIR COOLERS (U.S. CLS. 13, 21, 23, 31 AND 34).

FIRST USE 5-13-2009; IN COMMERCE 5-13-2009.

CLASS 11—(Continued).

3,681,322. JAMES K. PAULIN, CLEVELAND, OH. AND JOSEPH SEKERAK, CLEVELAND, OH. SN 77-592,958. PUB. 3-10-2009, FILED 10-15-2008.

THE MARK CONSISTS OF STANDARD CHARACTERS WITHOUT CLAIM TO ANY PARTICULAR FONT, STYLE, SIZE, OR COLOR.

FOR COMMERCIAL COOKING OVENS (U.S. CLS. 13, 21, 23, 31 AND 34).

FIRST USE 10-15-2008; IN COMMERCE 10-15-2008.

Char-Master

CLASS 11—(Continued).

3,681,543. LF, LLC, WILMINGTON, DE. SN 78-725,202. PUB. 6-6-2006, FILED 10-3-2005.

THE MARK CONSISTS OF STANDARD CHARACTERS WITHOUT CLAIM TO ANY PARTICULAR FONT, STYLE, SIZE, OR COLOR.

FOR LAMPS AND LAMP SHADES (U.S. CLS. 13, 21, 23, 31 AND 34).

FIRST USE 12-0-2005; IN COMMERCE 12-0-2005.

DESIGN & COMBINE

3,681,605. BODY BY JAKE GLOBAL, LLC, LOS ANGELES, CA. SN 78-917,170. PUB. 7-24-2007, FILED 6-26-2006.

MICRO GRILL

THE MARK CONSISTS OF STANDARD CHARACTERS WITHOUT CLAIM TO ANY PARTICULAR FONT, STYLE, SIZE, OR COLOR.

NO CLAIM IS MADE TO THE EXCLUSIVE RIGHT TO USE "GRILL", APART FROM THE MARK AS SHOWN.

FOR ELECTRIC GRILLS (U.S. CLS. 13, 21, 23, 31 AND 34).

FIRST USE 11-0-2006; IN COMMERCE 11-0-2006.

THE OUTDOOR COMPANY

3,681,527. THE COLEMAN COMPANY, INC., WICHITA, KS. SN 78-684,484. PUB. 4-18-2006, FILED 8-3-2005.

THE MARK CONSISTS OF STANDARD CHARACTERS WITHOUT CLAIM TO ANY PARTICULAR FONT, STYLE, SIZE, OR COLOR.

NO CLAIM IS MADE TO THE EXCLUSIVE RIGHT TO USE "COMPANY", APART FROM THE MARK AS SHOWN.

FOR LIGHTING, HEATING AND COOKING EQUIPMENT, NAMELY, GASOLINE AND PROPANE FUELED STOVES, LANTERNS AND LAMPS; CANDLE LANTERNS, LANTERN IGNITORS, LANTERN TRIPODS, BUTANE LIGHTERS FOR FIREPLACES; ELECTRIC AND BATTERY OPERATED NIGHTLIGHTS; ELECTRIC AND BATTERY OPERATED SPOT LIGHTS; ELECTRIC AND BATTERY OPERATED LANTERNS, CLIP-ON LIGHTS; FLUORESCENT HANGING LIGHTS; BATTERY OPERATED KEY CHAIN LIGHTS; INCANDESCENT MANTLES; GLASS LANTERN GLOBES; PROPANE FUELED PORTABLE HEATERS; GASOLINE AND PROPANE FUELED GRIDDLES AND GRILLS; GASOLINE, CHARCOAL, AND PROPANE FUELED BARBECUE GRILLS; FLASHLIGHTS; FLASHLIGHTS SOLD TOGETHER WITH FLASHLIGHT BATTERIES; PORTABLE HEATER COOLERS USED FOR FOOD STORAGE AND TRANSPORT; CHEMICALLY ACTIVATED LIGHT STICKS; AND FUEL FILTERS FOR CAMP STOVES (U.S. CLS. 13, 21, 23, 31 AND 34).

FIRST USE 9-29-2008; IN COMMERCE 4-14-2009.

CLASS 12—VEHICLES

3,680,095. LEAR BAYLOR, INC., GARDEN GROVE, CA. SN 76-668,016. PUB. 3-27-2007, FILED 10-25-2006.

DOUBLE-DUCK

THE MARK CONSISTS OF STANDARD CHARACTERS WITHOUT CLAIM TO ANY PARTICULAR FONT, STYLE, SIZE, OR COLOR.

FOR BOATING CLEATS FOR SECURING AN OBJECT TO A BOAT AND SECURING A BOAT TO A DOCKING STRUCTURE (U.S. CLS. 19, 21, 23, 31, 35 AND 44).

FIRST USE 5-1-2009; IN COMMERCE 5-1-2009.

CLASS 12—(Continued).

3,680,117. ACCURIDE CORPORATION, EVANSVILLE, IN.
SN 76-684,270. PUB. 4-29-2008, FILED 11-21-2007.

STATESMAN

THE MARK CONSISTS OF STANDARD CHARACTERS
WITHOUT CLAIM TO ANY PARTICULAR FONT, STYLE,
SIZE, OR COLOR.

FOR WHEELS FOR COMMERCIAL TRUCKS (U.S.
CLS. 19, 21, 23, 31, 35 AND 44).

FIRST USE 11-11-2008; IN COMMERCE 11-11-2008.

3,680,493. SHIMANO INC., SAKAI CITY, OSAKA, JAPAN. SN
77-316,443. PUB. 4-15-2008, FILED 10-29-2007.

E-Thru

THE MARK CONSISTS OF STANDARD CHARACTERS
WITHOUT CLAIM TO ANY PARTICULAR FONT, STYLE,
SIZE, OR COLOR.

FOR BICYCLE PARTS AND FITTINGS, NAMELY,
HUBS, INTERNAL GEAR HUBS, BICYCLE DYNAMO
HUBS, HUB QUICK RELEASE LEVERS, AND HUB
QUICK RELEASE DEVICES (U.S. CLS. 19, 21, 23, 31, 35
AND 44).

FIRST USE 2-0-2008; IN COMMERCE 2-0-2008.

CLASS 12—(Continued).

3,680,504. MELLING SPORTSCARS, INC., BIG LAKE, MN.
SN 77-320,674. PUB. 4-15-2008, FILED 11-2-2007.

GT-1

THE MARK CONSISTS OF STANDARD CHARACTERS
WITHOUT CLAIM TO ANY PARTICULAR FONT, STYLE,
SIZE, OR COLOR.

FOR AUTOMOBILES; LAND VEHICLE PARTS,
NAMELY, AXLES; LAND VEHICLE PARTS, NAMELY,
DIFFERENTIALS; LAND VEHICLE PARTS, NAMELY,
DRIVE GEARS; LAND VEHICLE PARTS, NAMELY,
FENDERS; LAND VEHICLE PARTS, NAMELY, TRANS-
MISSIONS; LAND VEHICLE PARTS, NAMELY,
WHEELS; LAND VEHICLE PARTS, NAMELY, WIND-
SHIELDS; LAND VEHICLE SUSPENSION PARTS,
NAMELY, TORSION/SWAY BARS; LAND VEHICLE
TRANSMISSIONS AND REPLACEMENT PARTS THERE-
OF; LAND VEHICLES AND STRUCTURAL PARTS
THEREFOR; STEERING UNITS FOR LAND VEHICLES
AND PARTS THEREOF; STRUCTURAL PARTS FOR
AUTOMOBILES; VEHICLE PARTS, NAMELY, SHOCK
ABSORBERS; BRAKE BLOCKS FOR LAND VEHICLES;
BRAKE CALIPERS FOR LAND VEHICLES; BRAKE
SYSTEMS FOR VEHICLES; BRAKES FOR LAND VEHI-
CLES; AUTOMOBILE ENGINES; VEHICLE PARTS,
NAMELY, SUSPENSION STRUTS; CLUTCHES FOR
LAND VEHICLES (U.S. CLS. 19, 21, 23, 31, 35 AND 44).
FIRST USE 5-29-2009; IN COMMERCE 5-29-2009.

3,680,533. CARDONE INDUSTRIES, INC., PHILADELPHIA,
PA. SN 77-328,962. PUB. 4-15-2008, FILED 11-14-2007.

TOTAL ECLIPSE

THE MARK CONSISTS OF STANDARD CHARACTERS
WITHOUT CLAIM TO ANY PARTICULAR FONT, STYLE,
SIZE, OR COLOR.

FOR BRAKES, BRAKE CALIPERS AND BRAKE PADS,
ALL FOR MOTOR VEHICLES (U.S. CLS. 19, 21, 23, 31, 35
AND 44).

FIRST USE 6-0-2009; IN COMMERCE 6-0-2009.

3,680,534. CARDONE INDUSTRIES, INC., PHILADELPHIA,
PA. SN 77-328,975. PUB. 4-15-2008, FILED 11-14-2007.

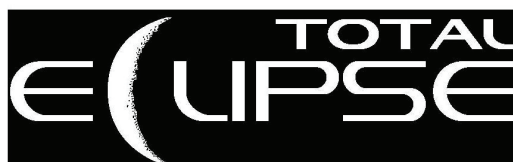

CLASS 12—(Continued).

THE MARK CONSISTS OF A BOX CONTAINING THE WORDS "TOTAL ECLIPSE" WITH A CRESCENT MOON DESIGN FOR THE LETTER "C" IN "ECLIPSE".

FOR BRAKES, BRAKE CALIPERS AND BRAKE PADS, ALL FOR MOTOR VEHICLES (U.S. CLS. 19, 21, 23, 31, 35 AND 44).

FIRST USE 6-0-2009; IN COMMERCE 6-0-2009.

3,680,553. FULL SPEED AHEAD, INC., WOODINVILLE, WA. SN 77-334,161. PUB. 4-29-2008, FILED 11-20-2007.

K-FORCE

THE MARK CONSISTS OF STANDARD CHARACTERS WITHOUT CLAIM TO ANY PARTICULAR FONT, STYLE, SIZE, OR COLOR.

OWNER OF U.S. REG. NO. 3,198,864.

FOR BICYCLE PARTS AND ACCESSORIES, NAMELY, CRANK SETS AND BOTTOM BRACKETS, HANDLEBARS, HANDLEBAR STEMS, SEATPOSTS, BRAKES, WHEELS, HUBS FOR WHEELS, SPOKES FOR WHEELS AND RIMS FOR WHEELS, SADDLES, CHAINRINGS (U.S. CLS. 19, 21, 23, 31, 35 AND 44).

FIRST USE 3-1-2001; IN COMMERCE 3-1-2005.

3,680,962. COUNTRY COACH LLC, JUNCTION CITY, OR. SN 77-476,046. PUB. 10-14-2008, FILED 5-15-2008.

VERANDA

THE MARK CONSISTS OF STANDARD CHARACTERS WITHOUT CLAIM TO ANY PARTICULAR FONT, STYLE, SIZE, OR COLOR.

FOR MOTOR HOMES AND STRUCTURAL VEHICLE PARTS THEREFORE (U.S. CLS. 19, 21, 23, 31, 35 AND 44).

FIRST USE 7-1-2008; IN COMMERCE 7-1-2008.

3,681,060. THE GREEN BEAR COMPANY, LLC, STRATFORD, CT. SN 77-496,185. PUB. 3-31-2009, FILED 6-11-2008.



NO CLAIM IS MADE TO THE EXCLUSIVE RIGHT TO

CLASS 12—(Continued).

USE "INFANT", APART FROM THE MARK AS SHOWN.

THE MARK CONSISTS OF AN OUTLINE OF A BABY, PARTIALLY SWADDLED IN A BLANKET THAT IS BEING HELD BY A BIRD'S BEAK. UNDERNEATH THE BABY, THE WORDS "INFANT ARMOR" APPEAR WITH AN ARC SPANNING FROM THE FIRST LETTER "N" IN THE WORD "INFANT" TO THE SECOND LETTER "R" IN THE WORD "ARMOR". UNDERNEATH THE WORDS "INFANT ARMOR" ARE THE WORDS "HELPING MOMS WIN THE WAR AGAINST GERMS". TWO HORIZONTAL LINES APPEAR ABOVE AND BELOW THE WORDING "HELPING MOMS WIN THE WAR AGAINST GERMS".

FOR INFANT CAR SEAT COVERS (U.S. CLS. 19, 21, 23, 31, 35 AND 44).

FIRST USE 6-1-2008; IN COMMERCE 12-1-2008.

3,681,139. OLD WORLD INDUSTRIES, INC., NORTH-BROOK, IL. SN 77-525,183. PUB. 12-2-2008, FILED 7-17-2008.

OPTIX

THE MARK CONSISTS OF STANDARD CHARACTERS WITHOUT CLAIM TO ANY PARTICULAR FONT, STYLE, SIZE, OR COLOR.

FOR WINDSHIELD WIPERS AND WINDSHIELD WIPER BLADES (U.S. CLS. 19, 21, 23, 31, 35 AND 44).

FIRST USE 9-0-2008; IN COMMERCE 9-0-2008.

3,681,305. SRJ, INC., ADDISON, IL. SN 77-588,246. PUB. 3-3-2009, FILED 10-8-2008.



THE MARK CONSISTS OF "DOGBONE" LETTER INSIDE THE SHAPE OF RUBBER TRACK TREAD PATTERN.

FOR ALL-TERRAIN, SELF-PROPELLED TRACKED CARRIERS (U.S. CLS. 19, 21, 23, 31, 35 AND 44).

FIRST USE 5-1-2009; IN COMMERCE 5-1-2009.

CLASS 12—(Continued).

3,681,324. HENRY, STEVEN, MORENO VALLEY, CA. SN 77-593,648. PUB. 3-10-2009, FILED 10-15-2008.

BOZZ HOGG

THE MARK CONSISTS OF STANDARD CHARACTERS WITHOUT CLAIM TO ANY PARTICULAR FONT, STYLE, SIZE, OR COLOR.

FOR SCOOTERS (U.S. CLS. 19, 21, 23, 31, 35 AND 44).
FIRST USE 1-20-2006; IN COMMERCE 2-25-2007.

3,681,475. AERODYNAMIC TRAILER SYSTEMS, LTD., AUBURN TOWNSHIP, OH. SN 78-544,699. PUB. 4-4-2006, FILED 1-10-2005.

**Fuel Saver by A.T.
S.**

THE MARK CONSISTS OF STANDARD CHARACTERS WITHOUT CLAIM TO ANY PARTICULAR FONT, STYLE, SIZE, OR COLOR.

NO CLAIM IS MADE TO THE EXCLUSIVE RIGHT TO USE "FUEL SAVER", APART FROM THE MARK AS SHOWN.

FOR DRAG REDUCING APPARATUS FOR VEHICLES, NAMELY, INFLATABLE BLADDERS FOR PROVIDING AERODYNAMIC CONTOURS EXTENDING REARWARDLY FROM A BOX-TRAILER (U.S. CLS. 19, 21, 23, 31, 35 AND 44).

FIRST USE 6-21-2009; IN COMMERCE 6-21-2009.

CLASS 13—FIREARMS

3,680,670. ULTIMATE MUZZLELOADING PRODUCTS, LLC, AZTEC, NM. SN 77-367,426. PUB. 5-20-2008, FILED 1-9-2008.

ACCULOAD

THE MARK CONSISTS OF STANDARD CHARACTERS WITHOUT CLAIM TO ANY PARTICULAR FONT, STYLE, SIZE, OR COLOR.

FOR ACCESSORIES FOR MUZZLE LOADING FIREARMS, NAMELY, BULLET STARTERS AND SEATERS (U.S. CLS. 2 AND 9).

FIRST USE 2-28-2008; IN COMMERCE 2-28-2008.

CLASS 13—(Continued).

3,680,954. PINNACLE AMMUNITION COMPANY, ST. LOUIS, MO. SN 77-474,432. PUB. 10-21-2008, FILED 5-14-2008.

BIS-MAXX BRAND BISMUTH

THE MARK CONSISTS OF STANDARD CHARACTERS WITHOUT CLAIM TO ANY PARTICULAR FONT, STYLE, SIZE, OR COLOR.

NO CLAIM IS MADE TO THE EXCLUSIVE RIGHT TO USE "BRAND BISMUTH", APART FROM THE MARK AS SHOWN.

FOR AMMUNITION (U.S. CLS. 2 AND 9).
FIRST USE 8-22-2008; IN COMMERCE 8-22-2008.

3,681,368. LAUGHRIDGE, WILLIAM R., FREMONT, NE. AND GUTEKUNST, RALPH M., NORTH BEND, NE. SN 77-609,628. PUB. 3-31-2009, FILED 11-7-2008.

LUMI SIGHTS

THE MARK CONSISTS OF STANDARD CHARACTERS WITHOUT CLAIM TO ANY PARTICULAR FONT, STYLE, SIZE, OR COLOR.

NO CLAIM IS MADE TO THE EXCLUSIVE RIGHT TO USE "SIGHTS", APART FROM THE MARK AS SHOWN.

FOR GUNSIGHTS FOR FIREARMS (U.S. CLS. 2 AND 9).

FIRST USE 5-29-2007; IN COMMERCE 5-29-2007.

3,681,413. EMISSIVE ENERGY CORPORATION, NORTH KINGSTOWN, RI. SN 77-649,400. PUB. 3-31-2009, FILED 1-14-2009.

INFORCE

THE MARK CONSISTS OF STANDARD CHARACTERS WITHOUT CLAIM TO ANY PARTICULAR FONT, STYLE, SIZE, OR COLOR.

FOR MOUNTING SYSTEMS COMPRISED OF, NAMELY, RINGS, BASES, MOUNTS, BRACKETS AND FASTENERS, FOR USE IN ATTACHING OPTICAL LENS SIGHTS, HOLOGRAPHIC LENS SIGHTS, LASER SIGHTS, NIGHT VISION DEVICES IN THE NATURE OF INFRARED DETECTORS, INVISIBLE LIGHT PROJECTORS, VISIBLE LIGHT PROJECTORS AND SCOPES TO WEAPON PLATFORMS (U.S. CLS. 2 AND 9).

FIRST USE 10-1-2008; IN COMMERCE 10-14-2008.

CLASS 14—JEWELRY

3,680,219. THE TUG MCGRAW FOUNDATION, NAPA, CA. SN 77-138,124. PUB. 11-6-2007, FILED 3-22-2007.

CLASS 14—(Continued).

3,680,380. DIAMOND TWINS CORPORATION, LAWRENCE, NY. SN 77-238,401. PUB. 11-20-2007, FILED 7-25-2007.

45YGB

ManoJewels

THE MARK CONSISTS OF STANDARD CHARACTERS WITHOUT CLAIM TO ANY PARTICULAR FONT, STYLE, SIZE, OR COLOR.
FOR BRACELETS (U.S. CLS. 2, 27, 28 AND 50).
FIRST USE 9-0-2004; IN COMMERCE 9-0-2004.

THE MARK CONSISTS OF STANDARD CHARACTERS WITHOUT CLAIM TO ANY PARTICULAR FONT, STYLE, SIZE, OR COLOR.
FOR JEWELRY (U.S. CLS. 2, 27, 28 AND 50).
FIRST USE 9-25-2007; IN COMMERCE 9-25-2007.

3,680,329. SKERKAVICH, BONNIE L, FOUNTAIN HILLS, AZ. SN 77-188,905. PUB. 4-29-2008, FILED 5-23-2007.

3,680,505. PHYSI-CAL ENTERPRISES INCORPORATED, VANCOUVER, CANADA. SN 77-320,785. PUB. 5-13-2008, FILED 11-3-2007.

MISS TIARA



THE MARK CONSISTS OF STANDARD CHARACTERS WITHOUT CLAIM TO ANY PARTICULAR FONT, STYLE, SIZE, OR COLOR.
NO CLAIM IS MADE TO THE EXCLUSIVE RIGHT TO USE "TIARA", APART FROM THE MARK AS SHOWN.
FOR PET JEWELRY (U.S. CLS. 2, 27, 28 AND 50).
FIRST USE 6-18-2007; IN COMMERCE 6-18-2007.

OWNER OF U.S. REG. NO. 2,970,869.
THE COLOR(S) RED AND WHITE IS/ARE CLAIMED AS A FEATURE OF THE MARK.
THE MARK CONSISTS OF A RED BOX WITH CURVED EDGES AND THE WORD "MIO" WRITTEN IN WHITE LETTERS WITHIN THE RED BOX.
THE FOREIGN WORDING IN THE MARK TRANSLATES INTO ENGLISH AS MINE.
FOR WATCHES FOR USE WHILE SWIMMING; WATCHES CONTAINING A HEART RATE MONITORING FUNCTION; WATCHES CONTAINING A ECG FUNCTION; WATCHES CONTAINING A PEDOMETER FUNCTION (U.S. CLS. 2, 27, 28 AND 50).
FIRST USE 3-31-2001; IN COMMERCE 3-31-2001.

3,680,354. MONTRES TUDOR SA, 1211 GENEVE 26, SWITZERLAND. SN 77-202,743. PUB. 4-29-2008, FILED 6-11-2007.

3,680,732. EK SUCCESS, LTD., CLIFTON, NJ. SN 77-402,750. PUB. 10-14-2008, FILED 2-21-2008.

Be Anything But Obvious

Jolee's

THE MARK CONSISTS OF STANDARD CHARACTERS WITHOUT CLAIM TO ANY PARTICULAR FONT, STYLE, SIZE, OR COLOR.
FOR WATCHES AND PARTS THEREOF (U.S. CLS. 2, 27, 28 AND 50).
FIRST USE 6-30-2009; IN COMMERCE 6-30-2009.

THE MARK CONSISTS OF STANDARD CHARACTERS WITHOUT CLAIM TO ANY PARTICULAR FONT, STYLE, SIZE, OR COLOR.
FOR JEWELRY (U.S. CLS. 2, 27, 28 AND 50).
FIRST USE 6-2-2008; IN COMMERCE 6-2-2008.

CLASS 14—(Continued).

3,680,906. ALEX AND ANI, INC., CRANSTON, RI. SN 77-468,809. PUB. 10-14-2008, FILED 5-8-2008.

TURN PEACE UP

THE MARK CONSISTS OF STANDARD CHARACTERS WITHOUT CLAIM TO ANY PARTICULAR FONT, STYLE, SIZE, OR COLOR.

FOR JEWELRY (U.S. CLS. 2, 27, 28 AND 50).
FIRST USE 1-17-2009; IN COMMERCE 2-17-2009.

3,680,907. ALEX AND ANI, INC., CRANSTON, RI. SN 77-468,819. PUB. 10-14-2008, FILED 5-8-2008.



THE MARK CONSISTS OF INVERTED PEACE SYMBOL CONTAINING THE WORDS "TURN PEACE UP" LOCATED AT THE TOP OF THE EXTERIOR CIRCLE.

FOR JEWELRY (U.S. CLS. 2, 27, 28 AND 50).
FIRST USE 2-17-2009; IN COMMERCE 2-17-2009.

3,681,235. MCR PASSIONS, INC., MIAMI, FL. SN 77-566,062. PUB. 3-17-2009, FILED 9-9-2008.

OSIREC

THE MARK CONSISTS OF STANDARD CHARACTERS WITHOUT CLAIM TO ANY PARTICULAR FONT, STYLE, SIZE, OR COLOR.

THE WORDING "OSIREC" HAS NO MEANING IN A FOREIGN LANGUAGE.

FOR JEWELRY, INCLUDING BRACELETS, BANGLES, RINGS, PENDANTS, AND NECKLACES MADE OF PRECIOUS METALS AND THEIR ALLOYS; WATCHES, WATCH STRAPS, AND CLOCKS (U.S. CLS. 2, 27, 28 AND 50).
FIRST USE 6-5-2009; IN COMMERCE 6-5-2009.

CLASS 14—(Continued).

3,681,402. SPENCER GIFTS LLC, EGG HARBOR TOWNSHIP, NJ. SN 77-623,774. PUB. 4-7-2009, FILED 12-1-2008.

BOOBIES MAKE ME SMILE

THE MARK CONSISTS OF STANDARD CHARACTERS WITHOUT CLAIM TO ANY PARTICULAR FONT, STYLE, SIZE, OR COLOR.

FOR BRACELETS MADE OF SILICONE (U.S. CLS. 2, 27, 28 AND 50).
FIRST USE 3-1-2009; IN COMMERCE 3-1-2009.

3,681,433. LIZ CLAIBORNE, INC., NEW YORK, NY. SN 77-977,579. PUB. 9-23-2008, FILED 6-20-2008.



THE MARK CONSISTS OF A CIRCLE WITH AN INNER CIRCULAR BORDER. WITHIN THE BORDER, THERE IS AN OVAL THAT INTERSECTS TWO UPPERCASE LETTER "BS", WHERE THE CENTER LINE OF EACH LETTER IS CONNECTED.

FOR BRACELETS; EARRINGS; JEWELRY; NECKLACES; PENDANTS; PINS BEING JEWELRY (U.S. CLS. 2, 27, 28 AND 50).
FIRST USE 2-0-2009; IN COMMERCE 2-0-2009.

3,681,513. ATIT DIAMOND CORPORATION, NEW YORK CITY, NY. SN 78-665,839. PUB. 3-28-2006, FILED 7-7-2005.

DIVINE 9

THE MARK CONSISTS OF STANDARD CHARACTERS WITHOUT CLAIM TO ANY PARTICULAR FONT, STYLE, SIZE, OR COLOR.

FOR DIAMONDS; PRECIOUS GEMSTONES (U.S. CLS. 2, 27, 28 AND 50).
FIRST USE 6-15-2009; IN COMMERCE 6-15-2009.

CLASS 14—(Continued).

3,681,542. LIFTED RESEARCH GROUP INC., IRVINE, CA.
SN 78-724,726. PUB. 1-31-2006, FILED 10-1-2005.

LUXIRIE

THE MARK CONSISTS OF STANDARD CHARACTERS
WITHOUT CLAIM TO ANY PARTICULAR FONT, STYLE,
SIZE, OR COLOR.

FOR JEWELRY (U.S. CLS. 2, 27, 28 AND 50).
FIRST USE 4-23-2009; IN COMMERCE 4-23-2009.

3,681,558. MEGUMI CHARM, INC., SANTA MONICA, CA.
SN 78-782,695. PUB. 2-10-2009, FILED 12-29-2005.

MEGUMI

THE MARK CONSISTS OF STANDARD CHARACTERS
WITHOUT CLAIM TO ANY PARTICULAR FONT, STYLE,
SIZE, OR COLOR.

THE FOREIGN WORDING IN THE MARK TRANSLATES
INTO ENGLISH AS GRACE, MERCY, BOUNTY, OR BLES-
SING.

FOR JEWELRY, NAMELY, ANKLE BRACELETS,
BODY-PIERCING RINGS, BODY-PIERCING STUDS,
BRACELETS, CHARMS, CHOKERS, CLIP EARRINGS,
CUFF-LINKS, EAR STUDS, EARRINGS, JEWEL
CHAINS, JEWEL PENDANTS, JEWELRY CHAINS, JEWEL-
RY WATCHES, NECK CHAINS, NECKLACES, PEN-
DANTS AND JEWELRY RING (U.S. CLS. 2, 27, 28 AND
50).

FIRST USE 10-15-2006; IN COMMERCE 10-15-2006.

CLASS 15—MUSICAL INSTRUMENTS

3,680,079. COLORKEYS INCORPORATED, TORONTO, ON-
TARIO, CANADA. SN 76-626,764. PUB. 3-21-2006, FILED 1-
3-2005.

COLORKEYS

FOR KEYBOARD MUSICAL INSTRUMENTS (U.S.
CLS. 2, 21 AND 36).
FIRST USE 9-5-2008; IN COMMERCE 9-5-2008.

CLASS 15—(Continued).

3,680,411. WENGER CORPORATION, OWATONNA, MN. SN
77-278,930. PUB. 3-4-2008, FILED 9-13-2007.

PREFACE

THE MARK CONSISTS OF STANDARD CHARACTERS
WITHOUT CLAIM TO ANY PARTICULAR FONT, STYLE,
SIZE, OR COLOR.

FOR SHEET MUSIC STANDS (U.S. CLS. 2, 21 AND 36).
FIRST USE 10-1-2007; IN COMMERCE 10-1-2007.

3,681,164. WILLIAMS, MICHAEL J., NEWARK, OH. SN 77-
534,520. PUB. 12-23-2008, FILED 7-30-2008.



THE MARK CONSISTS OF THE WORD "HEART-
STRINGS" WRITTEN IN STYLIZED CURSIVE FORMAT
WITH A PORTION OF THE LETTER "H" HAVING A
HEART SHAPE.

FOR ELECTRIC GUITARS (U.S. CLS. 2, 21 AND 36).
FIRST USE 7-30-2008; IN COMMERCE 7-30-2008.

3,681,165. WILLIAMS, MICHAEL J., NEWARK, OH. SN 77-
534,532. PUB. 12-23-2008, FILED 7-30-2008.

Heartstrings

THE MARK CONSISTS OF STANDARD CHARACTERS
WITHOUT CLAIM TO ANY PARTICULAR FONT, STYLE,
SIZE, OR COLOR.

FOR ELECTRIC GUITARS (U.S. CLS. 2, 21 AND 36).
FIRST USE 7-30-2008; IN COMMERCE 7-30-2008.

CLASS 15—(Continued).

3,681,557. STANNARD, JOHN, CLEARWATER, FL. SN 78-776,200. PUB. 5-9-2006, FILED 12-19-2005.

SCREECH

THE MARK CONSISTS OF STANDARD CHARACTERS WITHOUT CLAIM TO ANY PARTICULAR FONT, STYLE, SIZE, OR COLOR.

FOR CYMBALS AND PERCUSSION INSTRUMENTS (U.S. CLS. 2, 21 AND 36).

FIRST USE 7-23-2009; IN COMMERCE 7-23-2009.

CLASS 16—PAPER GOODS AND PRINTED MATTER

3,680,077. CERRUTI 1881, 75008 PARIS, FRANCE. SN 76-583,171. PUB. 9-30-2008, FILED 3-26-2004.

CERRUTI 1881

THE MARK CONSISTS OF STANDARD CHARACTERS WITHOUT CLAIM TO ANY PARTICULAR FONT, STYLE, SIZE, OR COLOR.

OWNER OF U.S. REG. NOS. 1,043,896, 1,411,168, AND OTHERS.

FOR PEN OR PENCIL HOLDERS; PENCIL OR PEN BOXES; DESK PADS; PAPER KNIVES; WRITING INSTRUMENTS; FOUNTAIN PENS, PENCILS, INK PENS (U.S. CLS. 2, 5, 22, 23, 29, 37, 38 AND 50).

FIRST USE 0-0-2002; IN COMMERCE 12-31-2004.

3,680,082. BARKER, JEAN YVONNE, D'IBERVILLE, MS. SN 76-635,679. PUB. 4-11-2006, FILED 4-11-2005.



Notable Legacy
A JOURNEY THRU TIME

FOR CUSTOMIZABLE JOURNAL BOOKS RELATING TO GENEALOGY (U.S. CLS. 2, 5, 22, 23, 29, 37, 38 AND 50).

FIRST USE 9-26-2006; IN COMMERCE 9-26-2006.

CLASS 16—(Continued).

3,680,091. CHAMBERLAIN COLLEGE OF NURSING LLC, OAKBROOK TERRACE, IL. SN 76-658,714. PUB. 5-8-2007, FILED 4-19-2006.

CHAMBERLAIN

THE MARK CONSISTS OF STANDARD CHARACTERS WITHOUT CLAIM TO ANY PARTICULAR FONT, STYLE, SIZE, OR COLOR.

FOR PRINTED INSTRUCTIONAL MATERIALS FOR USE IN THE FIELD OF MEDICINE (U.S. CLS. 2, 5, 22, 23, 29, 37, 38 AND 50).

FIRST USE 12-31-2008; IN COMMERCE 12-31-2008.

3,680,102. WISZNEAUCKAS, NICKI TABOR, DARNES-TOWN, MD. SN 76-676,932. PUB. 11-13-2007, FILED 5-16-2007.

Obars

THE MARK CONSISTS OF STANDARD CHARACTERS WITHOUT CLAIM TO ANY PARTICULAR FONT, STYLE, SIZE, OR COLOR.

FOR STATIONERY; GREETING CARDS (U.S. CLS. 2, 5, 22, 23, 29, 37, 38 AND 50).

FIRST USE 3-7-2009; IN COMMERCE 3-7-2009.

3,680,139. CHAMBERLAIN COLLEGE OF NURSING LLC, OAKBROOK TERRACE, IL. SN 76-979,000. PUB. 5-8-2007, FILED 3-29-2006.

CHAMBERLAIN COLLEGE OF NURSING

THE MARK CONSISTS OF STANDARD CHARACTERS WITHOUT CLAIM TO ANY PARTICULAR FONT, STYLE, SIZE, OR COLOR.

NO CLAIM IS MADE TO THE EXCLUSIVE RIGHT TO USE "COLLEGE OF NURSING", APART FROM THE MARK AS SHOWN.

FOR PRINTED INSTRUCTIONAL MATERIALS FOR USE IN THE FIELD OF MEDICINE (U.S. CLS. 2, 5, 22, 23, 29, 37, 38 AND 50).

FIRST USE 12-31-2008; IN COMMERCE 12-31-2008.

CLASS 16—(Continued).

3,680,154. HOWARD, JEFF, ELGIN, IL. SN 77-025,712. PUB. 12-4-2007, FILED 10-20-2006.



NO CLAIM IS MADE TO THE EXCLUSIVE RIGHT TO USE "SPORTSWEAR GRAPHICS EXPRESS, INC.", APART FROM THE MARK AS SHOWN.

FOR IRON-ON TRANSFERS FOR CLOTHING, BANNERS, FLAGS AND OTHER DISPLAYS ASSOCIATED WITH SHOWING SUPPORT FOR TEAMS OR CAUSES (U.S. CLS. 2, 5, 22, 23, 29, 37, 38 AND 50).

FIRST USE 1-1-2004; IN COMMERCE 1-1-2004.

3,680,204. HARVEY ENTERPRISES, LLC, ST. LOUIS, MO. SN 77-118,611. PUB. 4-15-2008, FILED 2-28-2007.

BRING YOUR BEST

THE MARK CONSISTS OF STANDARD CHARACTERS WITHOUT CLAIM TO ANY PARTICULAR FONT, STYLE, SIZE, OR COLOR.

OWNER OF U.S. REG. NOS. 2,702,226 AND 2,940,621.

FOR EDUCATIONAL AND SCHOOL PRODUCTS, NAMELY, PENS, PENCILS (U.S. CLS. 2, 5, 22, 23, 29, 37, 38 AND 50).

FIRST USE 11-0-2008; IN COMMERCE 11-0-2008.

3,680,237. RUDOLPH GONZALES III, CORPUS CHRISTI, TX. SN 77-150,110. PUB. 8-12-2008, FILED 4-5-2007.

FRIGHT LIGHTS

THE MARK CONSISTS OF STANDARD CHARACTERS WITHOUT CLAIM TO ANY PARTICULAR FONT, STYLE, SIZE, OR COLOR.

FOR HALLOWEEN GOODIE BAGS OF PAPER OR PLASTIC, PLASTIC GIFT BAG, FABRIC GIFT BAG, MERCHANDISE BAGS, PAPER GIFT BAGS, PAPER PARTY BAGS (U.S. CLS. 2, 5, 22, 23, 29, 37, 38 AND 50).

FIRST USE 10-6-2008; IN COMMERCE 10-6-2008.

CLASS 16—(Continued).

3,680,285. CSE ASSOCIATES, WINDSOR, CA. SN 77-173,507. PUB. 10-21-2008, FILED 5-4-2007.

Math on the Level

THE MARK CONSISTS OF STANDARD CHARACTERS WITHOUT CLAIM TO ANY PARTICULAR FONT, STYLE, SIZE, OR COLOR.

NO CLAIM IS MADE TO THE EXCLUSIVE RIGHT TO USE "MATH", APART FROM THE MARK AS SHOWN.

FOR PRINTED INSTRUCTIONAL, EDUCATIONAL, AND TEACHING MATERIALS IN THE FIELD OF MATH EDUCATION (U.S. CLS. 2, 5, 22, 23, 29, 37, 38 AND 50).

FIRST USE 1-1-2007; IN COMMERCE 6-1-2007.

3,680,366. PUBLISHING GROUP OF AMERICA, INC., FRANKLIN, TN. SN 77-217,981. PUB. 11-4-2008, FILED 6-28-2007.

SPRY

THE MARK CONSISTS OF STANDARD CHARACTERS WITHOUT CLAIM TO ANY PARTICULAR FONT, STYLE, SIZE, OR COLOR.

FOR PRINTED MATERIALS, NAMELY, NEWSPAPER SUPPLEMENTS AND MAGAZINES IN THE FIELDS OF HEALTH AND LIFESTYLE (U.S. CLS. 2, 5, 22, 23, 29, 37, 38 AND 50).

FIRST USE 9-1-2007; IN COMMERCE 8-0-2008.

3,680,400. TEXAS RANGERS BASEBALL PARTNERS, ARLINGTON, TX. SN 77-267,813. PUB. 9-16-2008, FILED 8-29-2007.

RANGERS BALLPARK IN ARLINGTON

THE MARK CONSISTS OF STANDARD CHARACTERS WITHOUT CLAIM TO ANY PARTICULAR FONT, STYLE, SIZE, OR COLOR.

OWNER OF U.S. REG. NOS. 1,608,247, 2,630,769, AND OTHERS.

NO CLAIM IS MADE TO THE EXCLUSIVE RIGHT TO USE "BALLPARK", APART FROM THE MARK AS SHOWN. SEC. 2(F) AS TO "ARLINGTON".

FOR PAPER GOODS AND PRINTED MATTER, NAMELY, POSTERS, POSTCARDS, COLLECTIBLE STAMPS, COMMEMORATIVE STAMPS, MOUNTED PHOTOGRAPHS (U.S. CLS. 2, 5, 22, 23, 29, 37, 38 AND 50).

FIRST USE 5-0-2008; IN COMMERCE 5-0-2008.

CLASS 16—(Continued).

3,680,501. SCHWEITZER-MAUDUIT INTERNATIONAL, INC., ALPHARETTA, GA. SN 77-319,261. PUB. 9-30-2008, FILED 11-1-2007.

ALGINEX

THE MARK CONSISTS OF STANDARD CHARACTERS WITHOUT CLAIM TO ANY PARTICULAR FONT, STYLE, SIZE, OR COLOR.

FOR WRAPPING PAPERS FOR CIGARETTES, CIGARILLOS, AND CIGARS (U.S. CLS. 2, 5, 22, 23, 29, 37, 38 AND 50).

FIRST USE 3-0-2008; IN COMMERCE 3-0-2008.

3,680,605. NERDHEALTH LLC, POMPANO BEACH, FL. SN 77-344,920. PUB. 5-6-2008, FILED 12-5-2007.

NERDELMAN

THE MARK CONSISTS OF STANDARD CHARACTERS WITHOUT CLAIM TO ANY PARTICULAR FONT, STYLE, SIZE, OR COLOR.

FOR CARTOON STRIPS; ANIMATION CELS (U.S. CLS. 2, 5, 22, 23, 29, 37, 38 AND 50).

FIRST USE 7-28-2009; IN COMMERCE 7-28-2009.

3,680,676. BISHOP OF THE NORTH AMERICAN REGION OF SUKYO MAHIKARI, RANCHO SANTA MARGARITA, CA. SN 77-369,866. PUB. 5-27-2008, FILED 1-11-2008.

Yoko Civilization Research Institute

THE MARK CONSISTS OF STANDARD CHARACTERS WITHOUT CLAIM TO ANY PARTICULAR FONT, STYLE, SIZE, OR COLOR.

NO CLAIM IS MADE TO THE EXCLUSIVE RIGHT TO USE "RESEARCH INSTITUTE", APART FROM THE MARK AS SHOWN.

FOR BOOKS, PAMPHLETS, MAGAZINES, POSTERS, PAPER PRINTED SIGNS, LEAFLETS AND INSTRUCTION MANUALS, ALL IN THE FIELD OF RELIGIOUS AND SPIRITUAL SERVICES; STATIONERY; PAINTINGS; DECALS; PENS; PENCILS; NOTE PADS; DESKTOP ORGANIZERS; DESKTOP PLANNERS; DESKTOP BUSINESS CARD HOLDERS; PENCIL HOLDERS; PEN HOLDERS (U.S. CLS. 2, 5, 22, 23, 29, 37, 38 AND 50).

FIRST USE 2-1-2008; IN COMMERCE 2-1-2008.

CLASS 16—(Continued).

3,680,767. PAINTMATES, LLC, ATLANTIC HIGHLANDS, NJ. SN 77-419,867. PUB. 7-29-2008, FILED 3-12-2008.

EZ Mural

THE MARK CONSISTS OF STANDARD CHARACTERS WITHOUT CLAIM TO ANY PARTICULAR FONT, STYLE, SIZE, OR COLOR.

NO CLAIM IS MADE TO THE EXCLUSIVE RIGHT TO USE "MURAL", APART FROM THE MARK AS SHOWN.

FOR DRY TRANSFERS; DECORATIVE TRANSFERS FOR WALLS; DRY TRANSFERS FOR MURALS; PAINT TRANSFERS; PAINT TRANSFERS FOR MURALS; PAINT TRANSFER DECALS; DRY TRANSFER DECALS (U.S. CLS. 2, 5, 22, 23, 29, 37, 38 AND 50).

FIRST USE 4-30-2009; IN COMMERCE 4-30-2009.

3,680,788. BROOK-SCHWARTZ, DENISE, SAN DIEGO, CA. SN 77-435,278. PUB. 4-7-2009, FILED 3-30-2008.

Itty Town

THE MARK CONSISTS OF THE WORDS "ITTY TOWN" IN STYLIZED FORM WITH A PAW PRINT BETWEEN THE WORDS AND A DESIGN ON EITHER END OF THE WORDS.

FOR GREETING CARDS, POST CARDS, NOTE CARDS, CALENDARS, CALENDAR REFILLS, GIFT WRAP PAPER, PAPER GIFT BAGS, GIFT BOOKS FEATURING ANIMALS (U.S. CLS. 2, 5, 22, 23, 29, 37, 38 AND 50).

FIRST USE 5-6-2008; IN COMMERCE 5-6-2008.

3,680,814. SMURFIT-STONE CONTAINER ENTERPRISES, INC., CHICAGO, IL. SN 77-441,711. PUB. 10-14-2008, FILED 4-7-2008.

META WRAP-8

THE MARK CONSISTS OF STANDARD CHARACTERS WITHOUT CLAIM TO ANY PARTICULAR FONT, STYLE, SIZE, OR COLOR.

OWNER OF U.S. REG. NO. 2,173,188.

FOR CARTONS MADE OF PAPERBOARD AND BLANKS THEREFOR (U.S. CLS. 2, 5, 22, 23, 29, 37, 38 AND 50).

FIRST USE 11-9-2008; IN COMMERCE 11-9-2008.

CLASS 16—(Continued).

3,680,842. COCOA LILLY CORPORATION, IRVINE, CA. SN 77-456,250. PUB. 9-16-2008, FILED 4-23-2008.

WHY BE PRETTY WHEN YOU CAN
BE GORGEOUS

THE MARK CONSISTS OF STANDARD CHARACTERS WITHOUT CLAIM TO ANY PARTICULAR FONT, STYLE, SIZE, OR COLOR.

FOR COFFEE TABLE BOOKS FEATURING COSMETICS AND BEAUTY RELATED TOPICS; EDUCATIONAL BOOKS FEATURING COSMETICS AND BEAUTY THERAPY ADVICE; NOTE BOOKS; ENVELOPES FOR STATIONERY USE; FILE POCKETS; ORGANIZERS FOR STATIONERY USE; PAPER STATIONERY; STATIONERY WRITING PAPER AND ENVELOPES; STATIONERY-TYPE PORTFOLIOS; STICKERS; CALENDARS; PRINTED CALENDARS; WALL CALENDARS; POSTERS; ANNOUNCEMENT CARDS; BLANK CARDS; BLANK NOTE CARDS; CHRISTMAS CARDS; HOLIDAY CARDS; INVITATION CARDS; POSTCARDS AND GREETING CARDS; PRINTED INVITATIONS (U.S. CLS. 2, 5, 22, 23, 29, 37, 38 AND 50).

FIRST USE 7-0-1999; IN COMMERCE 7-0-1999.

3,680,844. SENARIO LLC, WOODSTOCK, IL. SN 77-456,638. PUB. 9-30-2008, FILED 4-24-2008.

Color Shine

THE MARK CONSISTS OF STANDARD CHARACTERS WITHOUT CLAIM TO ANY PARTICULAR FONT, STYLE, SIZE, OR COLOR.

NO CLAIM IS MADE TO THE EXCLUSIVE RIGHT TO USE "COLOR", APART FROM THE MARK AS SHOWN.

FOR PRINTED MATTER, NAMELY, SHEETS ON WHICH PATTERNS ARE PRINTED FOR COLORING AND AFFIXATION IN WINDOWS OR OTHER PLACES (U.S. CLS. 2, 5, 22, 23, 29, 37, 38 AND 50).

FIRST USE 1-10-2009; IN COMMERCE 1-10-2009.

CLASS 16—(Continued).

3,680,889. ELEVATED EXISTENCE, LLC, ELMWOOD PARK, NJ. SN 77-466,405. PUB. 10-7-2008, FILED 5-6-2008.

ELEVATED EXISTENCE

THE MARK CONSISTS OF STANDARD CHARACTERS WITHOUT CLAIM TO ANY PARTICULAR FONT, STYLE, SIZE, OR COLOR.

FOR GENERAL FEATURE MAGAZINES (U.S. CLS. 2, 5, 22, 23, 29, 37, 38 AND 50).

FIRST USE 6-27-2008; IN COMMERCE 6-27-2008.

3,680,945. LEAGUE DESIGN PARTNERS, LLC, JACKSON, NJ. SN 77-473,246. PUB. 10-14-2008, FILED 5-13-2008.

7TH INNING SCRATCH

THE MARK CONSISTS OF STANDARD CHARACTERS WITHOUT CLAIM TO ANY PARTICULAR FONT, STYLE, SIZE, OR COLOR.

NO CLAIM IS MADE TO THE EXCLUSIVE RIGHT TO USE "SCRATCH", APART FROM THE MARK AS SHOWN.

FOR SCRATCH OFF CARDS FOR USE AT BASEBALL EVENTS (U.S. CLS. 2, 5, 22, 23, 29, 37, 38 AND 50).

FIRST USE 4-9-2009; IN COMMERCE 4-9-2009.

3,680,990. NEXSTAR, INC., LITTLE CANADA, MN. SN 77-480,913. PUB. 10-21-2008, FILED 5-22-2008.

HOME CARE WITH A FLAIR

THE MARK CONSISTS OF STANDARD CHARACTERS WITHOUT CLAIM TO ANY PARTICULAR FONT, STYLE, SIZE, OR COLOR.

NO CLAIM IS MADE TO THE EXCLUSIVE RIGHT TO USE "HOME CARE", APART FROM THE MARK AS SHOWN.

FOR NEWSLETTERS IN THE FIELDS OF HOME REPAIR, MAINTENANCE AND IMPROVEMENT (U.S. CLS. 2, 5, 22, 23, 29, 37, 38 AND 50).

FIRST USE 10-26-2007; IN COMMERCE 10-26-2007.

CLASS 16—(Continued).

3,680,996. INTENTIONALLY URBAN MAGAZINE, LLC, PORTLAND, OR. SN 77-481,610. PUB. 10-28-2008, FILED 5-22-2008.

IN|UR

THE MARK CONSISTS OF THE INITIALS "IN" AND "UR" SEPARATED BY A VERTICAL LINE.

FOR MAGAZINES FEATURING MUSIC, FILM, PARENTING, FASHION, BEAUTY, YOGA, SPORTS, HEALTH, RESEARCH, NUTRITION, RECIPES, LIFESTYLE, COMMUTING AND TRANSPORTATION, BUSINESS, ENVIRONMENTALISM, NON-PROFIT ORGANIZATIONS, SHOPPING, FINANCE AND INVESTMENT, SEX AND RELATIONSHIPS, DATING, ADVICE, HOME AND GARDEN, QUEER-THEMED ISSUES, REAL ESTATE, COMPLEMENTARY AND ALTERNATIVE MEDICINE, AND GREEN, ORGANIC, AND SUSTAINABLE PRODUCTS (U.S. CLS. 2, 5, 22, 23, 29, 37, 38 AND 50).

FIRST USE 1-1-2008; IN COMMERCE 6-1-2008.

3,681,026. DAUBERT CROMWELL, LLC, ALSIP, IL. SN 77-487,570. PUB. 10-28-2008, FILED 5-30-2008.

FERRO-PAK

THE MARK CONSISTS OF STANDARD CHARACTERS WITHOUT CLAIM TO ANY PARTICULAR FONT, STYLE, SIZE, OR COLOR.

FOR CHEMICALLY TREATED PAPERS AND PLASTIC FILMS FOR WRAPPING AND PACKAGING USED IN PREVENTING METALS FROM TARNISHING AND CORRODING (U.S. CLS. 2, 5, 22, 23, 29, 37, 38 AND 50).

FIRST USE 3-0-2004; IN COMMERCE 9-0-2004.

3,681,119. DH2 INTERNATIONAL, INC., ORLANDO, FL. SN 77-521,446. PUB. 12-9-2008, FILED 7-14-2008.

RIP-N-STICK

THE MARK CONSISTS OF STANDARD CHARACTERS WITHOUT CLAIM TO ANY PARTICULAR FONT, STYLE, SIZE, OR COLOR.

FOR WRAPPING PAPER (U.S. CLS. 2, 5, 22, 23, 29, 37, 38 AND 50).

FIRST USE 2-20-2009; IN COMMERCE 2-20-2009.

CLASS 16—(Continued).

3,681,171. LACHRISBREN CORPORATION, PINNACLE, NC. SN 77-536,703. PUB. 2-10-2009, FILED 8-1-2008.



NO CLAIM IS MADE TO THE EXCLUSIVE RIGHT TO USE "CARD", APART FROM THE MARK AS SHOWN.

THE COLOR(S) BLUE, GREEN, RED, YELLOW, GOLD, WHITE, PINK, AND BLACK IS/ARE CLAIMED AS A FEATURE OF THE MARK.

THE MARK CONSISTS OF THE WORDING "WISH CARD" IN CIRCULAR LETTERING AROUND A LILY ON A RECTANGULAR SHAPED BACKGROUND. A CANDLE REPRESENTS THE LETTER "I" IN "WISH". THE COLOR GREEN APPEARS IN THE WORDING "WISH CARD," IN THE LILY'S STIGMA, AND IN THE BACKGROUND. THE COLOR RED APPEARS AS OUTLINING FOR THE WORDING, AS OUTLINING FOR THE CANDLE FLAME, AND AS ACCENTS IN THE FLOWER. THE COLOR YELLOW APPEARS IN THE CANDLE FLAME, IN THE MIDDLE OF THE FLOWER, AND IN THE BACKGROUND DESIGN. THE COLOR GOLD APPEARS IN THE LILY'S STAMEN AND IN THE BORDER. THE COLOR WHITE APPEARS IN THE TOP OF THE CANDLE AND IN THE BACKGROUND DESIGN. THE COLOR PINK APPEARS IN THE FLOWER. THE COLOR BLUE APPEARS IN THE BACKGROUND. THE COLOR BLACK APPEARS IN THE WORDING "WWW.WISHCARD.US."

FOR CARDS BEARING UNIVERSAL GREETINGS; CHRISTMAS CARDS; CORRESPONDENCE CARDS; GIFT CARDS; GREETING CARDS; HOLIDAY CARDS; MOTIVATIONAL CARDS; OCCASION CARDS; TRADING CARDS (U.S. CLS. 2, 5, 22, 23, 29, 37, 38 AND 50).

FIRST USE 10-31-2008; IN COMMERCE 10-31-2008.

3,681,173. ALARIE, KEVIN, CROFTON, MD. SN 77-537,558. PUB. 3-3-2009, FILED 8-1-2008.

Kevin Alarie Photography

THE MARK CONSISTS OF STANDARD CHARACTERS WITHOUT CLAIM TO ANY PARTICULAR FONT, STYLE, SIZE, OR COLOR.

NO CLAIM IS MADE TO THE EXCLUSIVE RIGHT TO USE "PHOTOGRAPHY", APART FROM THE MARK AS SHOWN.

THE NAME "KEVIN ALARIE" IDENTIFIES A LIVING INDIVIDUAL WHOSE CONSENT IS OF RECORD.

FOR PHOTOGRAPHS (U.S. CLS. 2, 5, 22, 23, 29, 37, 38 AND 50).

FIRST USE 9-13-2008; IN COMMERCE 12-5-2008.

CLASS 16—(Continued).

3,681,195. PRAYDIS, ROBERT, HANOVER, PA. SN 77-548,023. PUB. 1-13-2009, FILED 8-15-2008.

LOVER'S ART

THE MARK CONSISTS OF STANDARD CHARACTERS WITHOUT CLAIM TO ANY PARTICULAR FONT, STYLE, SIZE, OR COLOR.

NO CLAIM IS MADE TO THE EXCLUSIVE RIGHT TO USE "ART", APART FROM THE MARK AS SHOWN.

FOR PHOTOGRAPHIC ART, NAMELY, ART PRINTS, PHOTOGRAPHS, PRINTED ART REPRODUCTIONS (U.S. CLS. 2, 5, 22, 23, 29, 37, 38 AND 50).

FIRST USE 6-1-2008; IN COMMERCE 2-1-2009.

3,681,196. BIOMET 3I, LLC, PALM BEACH GARDENS, FL. SN 77-548,075. PUB. 1-6-2009, FILED 8-15-2008.

JIRD

THE MARK CONSISTS OF STANDARD CHARACTERS WITHOUT CLAIM TO ANY PARTICULAR FONT, STYLE, SIZE, OR COLOR.

FOR JOURNAL IN THE FIELD OF DENTISTRY AND ORAL RECONSTRUCTION (U.S. CLS. 2, 5, 22, 23, 29, 37, 38 AND 50).

FIRST USE 6-12-2009; IN COMMERCE 6-12-2009.

3,681,246. UNITED STATES OF AMERICA RUGBY FOOTBALL UNION, INC., DBA USA RUGBY, BOULDER, CO. SN 77-570,080. PUB. 2-3-2009, FILED 9-15-2008.

ROOKIE RUGBY

THE MARK CONSISTS OF STANDARD CHARACTERS WITHOUT CLAIM TO ANY PARTICULAR FONT, STYLE, SIZE, OR COLOR.

OWNER OF U.S. REG. NOS. 1,805,352 AND 2,190,678.

NO CLAIM IS MADE TO THE EXCLUSIVE RIGHT TO USE "RUGBY", APART FROM THE MARK AS SHOWN.

FOR BROCHURES ABOUT RUGBY; MAGAZINES FEATURING RUGBY; NEWSLETTERS IN THE FIELD OF RUGBY; PAMPHLETS IN THE FIELD OF RUGBY (U.S. CLS. 2, 5, 22, 23, 29, 37, 38 AND 50).

FIRST USE 12-31-2008; IN COMMERCE 12-31-2008.

CLASS 16—(Continued).

3,681,247. ARM LIMITED, CAMBRIDGE, UNITED KINGDOM. SN 77-570,259. PUB. 1-6-2009, FILED 9-15-2008.

PRIMECELL

THE MARK CONSISTS OF STANDARD CHARACTERS WITHOUT CLAIM TO ANY PARTICULAR FONT, STYLE, SIZE, OR COLOR.

FOR PRINTED MATERIALS, NAMELY, INSTRUCTIONAL, SPECIFICATION AND DEVELOPMENT MANUALS, DATASHEETS, AND BROCHURES, ALL IN THE AREA OF DESIGN AND DEVELOPMENT OF COMPUTER CHIPS, INTEGRATED CIRCUITS AND COMPUTER SOFTWARE USED TO TEST AND INTEGRATE COMPONENTS OF INTEGRATED CIRCUITS, AND IN THE AREA OF ASSEMBLING SYSTEM-ON-CHIP DESIGNS FROM SOFT IP MACRO CELLS (U.S. CLS. 2, 5, 22, 23, 29, 37, 38 AND 50).

FIRST USE 4-23-1999; IN COMMERCE 4-23-1999.

3,681,293. OGDEN PUBLICATIONS, INC., TOPEKA, KS. SN 77-584,751. PUB. 2-24-2009, FILED 10-3-2008.

LIVING WISELY, LIVING WELL

THE MARK CONSISTS OF STANDARD CHARACTERS WITHOUT CLAIM TO ANY PARTICULAR FONT, STYLE, SIZE, OR COLOR.

FOR PRINTED PUBLICATION, NAMELY, MAGAZINE ABOUT CREATING AND MAINTAINING A HEALTHY HOME (U.S. CLS. 2, 5, 22, 23, 29, 37, 38 AND 50).

FIRST USE 11-1-2005; IN COMMERCE 11-1-2005.

3,681,294. DOUGLASS, LISA LOMAX, UPPER MARLBORO, MD. SN 77-585,336. PUB. 3-10-2009, FILED 10-3-2008.

Baloney Books

THE MARK CONSISTS OF STANDARD CHARACTERS WITHOUT CLAIM TO ANY PARTICULAR FONT, STYLE, SIZE, OR COLOR.

NO CLAIM IS MADE TO THE EXCLUSIVE RIGHT TO USE "BOOKS", APART FROM THE MARK AS SHOWN.

FOR CHILDREN'S BOOKS (U.S. CLS. 2, 5, 22, 23, 29, 37, 38 AND 50).

FIRST USE 3-7-2009; IN COMMERCE 3-7-2009.

CLASS 16—(Continued).

3,681,329. LEANIN' TREE INC., BOULDER, CO. SN 77-595,287. PUB. 3-10-2009, FILED 10-17-2008.

GROWING EXPRESSIONS

THE MARK CONSISTS OF STANDARD CHARACTERS WITHOUT CLAIM TO ANY PARTICULAR FONT, STYLE, SIZE, OR COLOR.

FOR GREETING CARDS (U.S. CLS. 2, 5, 22, 23, 29, 37, 38 AND 50).

FIRST USE 3-2-2009; IN COMMERCE 3-2-2009.

CLASS 16—(Continued).

3,681,371. MORGAN, REBECCA L., DBA DATING GODDESS, SAN JOSE, CA. SN 77-611,569. PUB. 3-31-2009, FILED 11-11-2008.



NO CLAIM IS MADE TO THE EXCLUSIVE RIGHT TO USE "DATING", APART FROM THE MARK AS SHOWN.

THE COLOR(S) BLACK, RED, GRAY, BLUE AND GREEN IS/ARE CLAIMED AS A FEATURE OF THE MARK.

THE MARK CONSISTS OF THE WORDING "DATING GODDESS" IN BLACK. THE LETTER "O" IS IN THE DESIGN OF A GRAY TIARA WITH RED, BLUE, AND GREEN JEWELS. THE CURVE OF THE LETTER "G" ON THE WORD "DATING" CONTAINS A RED HEART.

FOR BOOKS IN THE FIELD OF DATING (U.S. CLS. 2, 5, 22, 23, 29, 37, 38 AND 50).

FIRST USE 5-9-2006; IN COMMERCE 5-9-2006.

3,681,383. QUEENER, JIM, WENTZVILLE, MO. SN 77-616,863. PUB. 3-31-2009, FILED 11-18-2008.

LifeTymz

THE MARK CONSISTS OF STANDARD CHARACTERS WITHOUT CLAIM TO ANY PARTICULAR FONT, STYLE, SIZE, OR COLOR.

FOR GREETING CARDS (U.S. CLS. 2, 5, 22, 23, 29, 37, 38 AND 50).

FIRST USE 6-1-2009; IN COMMERCE 6-1-2009.

3,681,342. SOW FORTH PUBLISHING, LLC, LEWIS CENTER, OH. SN 77-599,919. PUB. 3-17-2009, FILED 10-24-2008.

COOL SCIENCE MATTERS

THE MARK CONSISTS OF STANDARD CHARACTERS WITHOUT CLAIM TO ANY PARTICULAR FONT, STYLE, SIZE, OR COLOR.

NO CLAIM IS MADE TO THE EXCLUSIVE RIGHT TO USE "SCIENCE", APART FROM THE MARK AS SHOWN.

FOR PRINTED INSTRUCTIONAL, EDUCATIONAL, AND TEACHING MATERIALS, NAMELY, BOOKS, STORYBOOKS, WORKBOOKS, ACTIVITY BOOKS, COLORING BOOKS AND POSTERS FEATURING MATERIAL FOR EDUCATING AND ENTERTAINING CHILDREN IN THE FIELD OF SCIENCE (U.S. CLS. 2, 5, 22, 23, 29, 37, 38 AND 50).

FIRST USE 8-6-2008; IN COMMERCE 3-6-2009.

3,681,387. SAFETYTAT, LLC, PHOENIX, MD. SN 77-617,649. PUB. 3-31-2009, FILED 11-19-2008.

Tateck

THE MARK CONSISTS OF STANDARD CHARACTERS WITHOUT CLAIM TO ANY PARTICULAR FONT, STYLE, SIZE, OR COLOR.

FOR TEMPORARY TATTOOS, NAMELY, IDENTIFICATION TATTOOS FOR PEOPLE (U.S. CLS. 2, 5, 22, 23, 29, 37, 38 AND 50).

FIRST USE 10-20-2008; IN COMMERCE 10-20-2008.

CLASS 16—(Continued).

3,681,400. STANFIELD, JAMES W., DBA OTR PUBLICATIONS, HIGH POINT, NC. SN 77-623,296. PUB. 4-7-2009, FILED 11-29-2008.



NO CLAIM IS MADE TO THE EXCLUSIVE RIGHT TO USE "PUBLICATIONS", APART FROM THE MARK AS SHOWN.

FOR BOOKS IN THE FIELD OF TRAVEL PHOTOGRAPHY (U.S. CLS. 2, 5, 22, 23, 29, 37, 38 AND 50).

FIRST USE 1-1-2009; IN COMMERCE 3-1-2009.

CLASS 16—(Continued).

3,681,421. SWANSON TOOL CO., INC., FRANKFORT, IL. SN 77-977,430. PUB. 1-6-2009, FILED 1-31-2008.



THE MARK CONSISTS OF STANDARD CHARACTERS WITHOUT CLAIM TO ANY PARTICULAR FONT, STYLE, SIZE, OR COLOR.

OWNER OF U.S. REG. NOS. 179,499, 2,678,861, AND OTHERS.

SEC. 2(F).
FOR CARPENTER PENCILS (U.S. CLS. 2, 5, 22, 23, 29, 37, 38 AND 50).

FIRST USE 2-0-1998; IN COMMERCE 2-0-1998.

3,681,418. BISHOP OF THE NORTH AMERICAN REGION OF SUKYO MAHIKARI, RANCHO SANTA MARGARITA, CA. SN 77-977,399. PUB. 9-2-2008, FILED 1-28-2008.



THE MARK CONSISTS OF STANDARD CHARACTERS WITHOUT CLAIM TO ANY PARTICULAR FONT, STYLE, SIZE, OR COLOR.

OWNER OF U.S. REG. NO. 2,205,206.

THE FOREIGN WORDING IN THE MARK TRANSLATES INTO ENGLISH AS "SUKYO SALES" AND "PUBLICATIONS".

FOR BOOKS, PAMPHLETS, MAGAZINES, AND LEAFLETS, ALL FEATURING INFORMATION ABOUT RELIGIOUS AND SPIRITUAL SERVICES; POSTERS, PRINTED PAPER SIGNS, STATIONERY, PAINTINGS, DECALS, PENS, PENCILS, NOTE PADS, DESKTOP ORGANIZERS, DESKTOP PLANNERS, DESKTOP BUSINESS CARD HOLDERS, PENCIL HOLDERS, PEN HOLDERS, INSTRUCTION MANUALS FOR HELPING MEMBERS GET ORGANIZED IN WORKING WITH THE ASSOCIATED RELIGIOUS AND SPIRITUAL SERVICES (U.S. CLS. 2, 5, 22, 23, 29, 37, 38 AND 50).

FIRST USE 6-1-2008; IN COMMERCE 6-1-2008.

3,681,426. FRP, INC., NASHVILLE, TN. SN 77-977,523. PUB. 10-14-2008, FILED 4-21-2008.



THE MARK CONSISTS OF STANDARD CHARACTERS WITHOUT CLAIM TO ANY PARTICULAR FONT, STYLE, SIZE, OR COLOR.

NO CLAIM IS MADE TO THE EXCLUSIVE RIGHT TO USE "BOOKS", APART FROM THE MARK AS SHOWN.

FOR NON-FICTION BOOKS ON A VARIETY OF TOPICS (U.S. CLS. 2, 5, 22, 23, 29, 37, 38 AND 50).

FIRST USE 3-0-2009; IN COMMERCE 4-0-2009.

CLASS 16—(Continued).

3,681,439. DISNEY ENTERPRISES, INC., BURBANK, CA. SN 77-977,608. PUB. 9-23-2008, FILED 2-4-2008.



OWNER OF U.S. REG. NOS. 1,536,967, 3,242,910, AND 3,341,092.

NO CLAIM IS MADE TO THE EXCLUSIVE RIGHT TO USE "STORE", APART FROM THE MARK AS SHOWN.

THE MARK CONSISTS OF A WORD AND IMAGE THAT INCLUDES AN OVAL AND STARS.

FOR APPLIQUES IN THE FORM OF DECALS; CHILDREN'S ACTIVITY BOOKS; COLORING BOOKS; DIARIES; ENVELOPES; GREETING CARDS; NOTE PAPER; NOTEBOOKS; PAPER NAPKINS; PHOTOGRAPH ALBUMS; PRINTED INVITATIONS; STATIONERY; STICKERS; OFFICE AND SCHOOL SUPPLIES, NAMELY, BALL POINT PENS, DRAWING RULERS, ERASERS, FELT PENS, PEN OR PENCIL HOLDERS, PENCILS, PENCIL SHARPENERS, PEN AND PENCIL CASES, PENS, AND WRITING IMPLEMENTS (U.S. CLS. 2, 5, 22, 23, 29, 37, 38 AND 50).

FIRST USE 5-0-2008; IN COMMERCE 5-0-2008.

3,681,453. AMERICAN GIRL, LLC, EL SEGUNDO, CA. SN 78-353,109. PUB. 4-11-2006, FILED 1-16-2004.

REBECCA

THE MARK CONSISTS OF STANDARD CHARACTERS WITHOUT CLAIM TO ANY PARTICULAR FONT, STYLE, SIZE, OR COLOR.

FOR CHILDREN'S PUBLICATIONS, NAMELY, BOOKS AND BOOKLETS FEATURING FICTIONAL AND NON-FICTIONAL STORIES OF AMERICAN HISTORY AND EVENTS IN AMERICAN HISTORY, AND MAPS, POSTCARDS, POSTERS, BOOKMARKS, TRADING CARDS, ACTIVITY AND CRAFT BOOKS, AND STATIONERY SETS COMPRISED OF STATIONERY, ENVELOPES, NOTES CARDS, AND STICKERS (U.S. CLS. 2, 5, 22, 23, 29, 37, 38 AND 50).

FIRST USE 5-31-2009; IN COMMERCE 5-31-2009.

CLASS 16—(Continued).

3,681,458. KOCH, JEREMY B., NEW YORK, NY. SN 78-400,340. PUB. 11-1-2005, FILED 4-12-2004.

WHAT'SNEXT

THE MARK CONSISTS OF STANDARD CHARACTERS WITHOUT CLAIM TO ANY PARTICULAR FONT, STYLE, SIZE, OR COLOR.

FOR MEN'S MAGAZINE DEALING WITH ISSUES OF CAREER TRANSITION AND PERSONAL GROWTH (U.S. CLS. 2, 5, 22, 23, 29, 37, 38 AND 50).

FIRST USE 4-3-2009; IN COMMERCE 4-3-2009.

3,681,519. WORLD BASEBALL CLASSIC, INC., NEW YORK, NY. SN 78-673,762. PUB. 11-21-2006, FILED 7-19-2005.

AQUI SE HABLA BEISBOL

THE MARK CONSISTS OF STANDARD CHARACTERS WITHOUT CLAIM TO ANY PARTICULAR FONT, STYLE, SIZE, OR COLOR.

THE FOREIGN WORDING IN THE MARK TRANSLATES INTO ENGLISH AS BASEBALL SPOKEN HERE.

FOR PAPER GOODS AND PRINTED MATTER, NAMELY, STICKERS, DECALS AND BUMPER STICKERS (U.S. CLS. 2, 5, 22, 23, 29, 37, 38 AND 50).

FIRST USE 3-0-2009; IN COMMERCE 3-0-2009.

3,681,521. IPME, LLLP, WESTMINSTER, CO. SN 78-676,035. PUB. 4-11-2006, FILED 7-22-2005.

Cash Flow Now, Ask Me How

THE MARK CONSISTS OF STANDARD CHARACTERS WITHOUT CLAIM TO ANY PARTICULAR FONT, STYLE, SIZE, OR COLOR.

FOR EDUCATIONAL PUBLICATIONS, NAMELY, MAGAZINES, BOOKS, BOOKLETS, PAMPHLETS, TRAINING MANUALS, NEWSLETTERS AND PERIODICAL REPORTS RELATING TO BUSINESS, FINANCE, AND REAL ESTATE INVESTMENTS, FINANCIAL IMPROVEMENT, REAL ESTATE MORTGAGE NOTES, COMMERCIAL PAPER, LOANS, AND OTHER FINANCIAL TRANSACTIONS (U.S. CLS. 2, 5, 22, 23, 29, 37, 38 AND 50).

FIRST USE 5-1-2009; IN COMMERCE 5-1-2009.

CLASS 16—(Continued).

3,681,532. LOGOS RESEARCH SYSTEMS, INC., BELLINGHAM, WA. SN 78-690,647. PUB. 5-2-2006, FILED 8-11-2005.

LEXHAM

THE MARK CONSISTS OF STANDARD CHARACTERS WITHOUT CLAIM TO ANY PARTICULAR FONT, STYLE, SIZE, OR COLOR.

FOR PRINTED PUBLICATIONS, NAMELY, BOOKS, MAGAZINES, AND TEXT BOOKS IN THE FIELD OF BIBLE STUDY (U.S. CLS. 2, 5, 22, 23, 29, 37, 38 AND 50). FIRST USE 6-15-2009; IN COMMERCE 6-15-2009.

3,681,539. CITY OF DANA POINT, DANA POINT, CA. SN 78-721,183. PUB. 2-20-2007, FILED 9-27-2005.

DANA POINT, HARBORING THE GOOD LIFE

THE MARK CONSISTS OF STANDARD CHARACTERS WITHOUT CLAIM TO ANY PARTICULAR FONT, STYLE, SIZE, OR COLOR.

NO CLAIM IS MADE TO THE EXCLUSIVE RIGHT TO USE "DANA POINT", APART FROM THE MARK AS SHOWN.

FOR PAPER GOODS, NAMELY, NEWSLETTERS, PAMPHLETS AND BROCHURES IN THE FIELDS OF SPORTS, LIFESTYLES AND TRAVEL; PENCILS (U.S. CLS. 2, 5, 22, 23, 29, 37, 38 AND 50).

FIRST USE 9-30-2005; IN COMMERCE 9-30-2005.

3,681,559. MEADWESTVACO CORPORATION, GLEN ALLEN, VA. SN 78-787,218. PUB. 8-15-2006, FILED 1-9-2006.

TECH LOCK

THE MARK CONSISTS OF STANDARD CHARACTERS WITHOUT CLAIM TO ANY PARTICULAR FONT, STYLE, SIZE, OR COLOR.

OWNER OF U.S. REG. NO. 1,927,684.

FOR FLEXIBLE RINGS SOLD AS AN INTEGRAL COMPONENT OF DATE PLANNERS AND STUDENT ASSIGNMENT BOOKS (U.S. CLS. 2, 5, 22, 23, 29, 37, 38 AND 50).

FIRST USE 9-16-2007; IN COMMERCE 9-16-2007.

CLASS 16—(Continued).

3,681,561. EVANS, RICHARD PAUL, SALT LAKE CITY, UT. SN 78-787,979. PUB. 8-29-2006, FILED 1-9-2006.

THE 5 LESSONS A MILLIONAIRE TAUGHT ME

THE MARK CONSISTS OF STANDARD CHARACTERS WITHOUT CLAIM TO ANY PARTICULAR FONT, STYLE, SIZE, OR COLOR.

FOR PRINTED PUBLICATIONS, NAMELY, BOOKS, MANUALS, GUIDES, PERIODICALS AND PAMPHLETS IN THE FIELD OF FINANCIAL AND WEALTH ENHANCEMENT (U.S. CLS. 2, 5, 22, 23, 29, 37, 38 AND 50). FIRST USE 1-20-2009; IN COMMERCE 1-20-2009.

3,681,611. SPANGLER, RANDAL, KANSAS CITY, MO. SN 78-936,980. PUB. 3-6-2007, FILED 7-25-2006.

TEACUP DRAGONS

THE MARK CONSISTS OF STANDARD CHARACTERS WITHOUT CLAIM TO ANY PARTICULAR FONT, STYLE, SIZE, OR COLOR.

FOR ART PICTURES AND PRINTS, PRINTED ART REPRODUCTIONS, CALENDARS (U.S. CLS. 2, 5, 22, 23, 29, 37, 38 AND 50).

FIRST USE 5-31-2006; IN COMMERCE 5-31-2006.

3,681,631. SMARTERVILLE PRODUCTIONS LLC, BALTIMORE, MD. SN 78-972,858. PUB. 10-16-2007, FILED 9-12-2006.

THE SURE THING FOR MATH SUCCESS!

THE MARK CONSISTS OF STANDARD CHARACTERS WITHOUT CLAIM TO ANY PARTICULAR FONT, STYLE, SIZE, OR COLOR.

FOR EDUCATIONAL ACTIVITY KITS CONSISTING PRIMARILY OF WORKBOOKS, BOOKS, FLASHCARDS, POSTERS, STICKERS, PARENT'S GUIDES, CD-ROMS, AUDIO CDS, AND DVD'S, ALL FOR EDUCATIONAL PURPOSES AND RELATING TO MATH (U.S. CLS. 2, 5, 22, 23, 29, 37, 38 AND 50).

FIRST USE 5-11-2006; IN COMMERCE 5-11-2006.

CLASS 17—RUBBER GOODS

CLASS 17—(Continued).

3,680,289. PARATA SYSTEMS, LLC, DURHAM, NC. SN 77-175,262. PUB. 4-8-2008, FILED 5-8-2007.

ONEPAC

THE MARK CONSISTS OF STANDARD CHARACTERS WITHOUT CLAIM TO ANY PARTICULAR FONT, STYLE, SIZE, OR COLOR.

FOR PLASTIC FILMS USED AS PACKAGING FOR PREPARING MEDICATION POUCHES CONTAINING SINGLE OR MULTIPLE MEDICATIONS IN DOSES OF USE FOR INDIVIDUAL PATIENTS (U.S. CLS. 1, 5, 12, 13, 35 AND 50).

FIRST USE 6-23-2009; IN COMMERCE 6-23-2009.

3,680,437. ENERGYSEAL AIR BARRIER SYSTEMS, MCCALL, ID. SN 77-294,385. PUB. 4-1-2008, FILED 10-2-2007.



NO CLAIM IS MADE TO THE EXCLUSIVE RIGHT TO USE "SEAMLESS SYSTEM DESIGN", APART FROM THE MARK AS SHOWN.

FOR URETHANE SPRAY FOAMS APPLIED AS INSULATION TO HOMES, COMMERCIAL BUILDINGS, AND INDUSTRIAL APPLICATIONS (U.S. CLS. 1, 5, 12, 13, 35 AND 50).

FIRST USE 5-0-2007; IN COMMERCE 5-0-2007.

CLASS 17—(Continued).

3,680,830. POURMIRZAIE, FEREDOUN, SAN RAMON, CA. SN 77-452,877. PUB. 10-28-2008, FILED 4-20-2008.

Gumlast

THE MARK CONSISTS OF STANDARD CHARACTERS WITHOUT CLAIM TO ANY PARTICULAR FONT, STYLE, SIZE, OR COLOR.

FOR PLASTIC COMPOSITE MATERIAL IN THE FORM OF PROFILES, BOARDS, SHEETS, BLOCKS, RODS, POWDER, AND PELLETS FOR USE IN MANUFACTURING; PLASTIC IN BARS, BLOCKS, PELLETS, RODS, SHEETS AND TUBES FOR GENERAL INDUSTRIAL USE; PLASTIC IN EXTRUDED FORM FOR GENERAL INDUSTRIAL USE; PLASTICS IN EXTRUDED FORM USED IN PRODUCTION; SEMI-PROCESSED PLASTIC IN THE FORM OF FILMS, SHEETS, TUBES, BARS, OR RODS; SEMI-WORKED SYNTHETIC PLASTIC AND SYNTHETIC RESINS AS SEMI-FINISHED PRODUCTS IN FORM OF PELLETS, RODS, FOILS, FOAMS, FIBERS, FILMS AND SHEETS; THERMOPLASTIC COMPOUNDS, THERMOPLASTIC ELASTOMER RESINS AND THERMOPLASTIC CONCENTRATES IN PELLET FORM FOR USE IN MANUFACTURING IN A WIDE VARIETY OF INDUSTRIES; THERMOPLASTIC ELASTOMER RESINS IN PELLET FORM FOR USE IN FURTHER MANUFACTURE; SEMI-FINISHED APERTURED PLASTIC FILM FOR USE IN MEDICAL AND HYGIENIC PRODUCTS; STUFFING COMPOSED OF POLYETHYLENE, RUBBER, OR PLASTIC FOR PILLOWS, CUSHIONS, COMFORTERS (U.S. CLS. 1, 5, 12, 13, 35 AND 50).

FIRST USE 1-15-2009; IN COMMERCE 2-5-2009.

3,680,836. PRIMESOURCE BUILDING PRODUCTS, INC., CARROLLTON, TX. SN 77-455,441. PUB. 3-10-2009, FILED 4-23-2008.

GRIP-RITE

THE MARK CONSISTS OF STANDARD CHARACTERS WITHOUT CLAIM TO ANY PARTICULAR FONT, STYLE, SIZE, OR COLOR.

OWNER OF U.S. REG. NOS. 2,995,884, 3,558,129, AND OTHERS.

FOR ADHESIVE TAPE FOR INDUSTRIAL AND COMMERCIAL USE IN THE NATURE OF TAPE FOR SEALING AND SECURING HOUSE WRAP (U.S. CLS. 1, 5, 12, 13, 35 AND 50).

FIRST USE 10-4-2008; IN COMMERCE 10-4-2008.

CLASS 17—(Continued).

3,680,837. PRIMESOURCE BUILDING PRODUCTS, INC., CARROLLTON, TX. SN 77-455,450. PUB. 3-10-2009, FILED 4-23-2008.



OWNER OF U.S. REG. NOS. 2,995,884, 3,558,129, AND OTHERS.

FOR ADHESIVE TAPE FOR INDUSTRIAL AND COMMERCIAL USE IN THE NATURE OF TAPE FOR SEALING AND SECURING HOUSE WRAP (U.S. CLS. 1, 5, 12, 13, 35 AND 50).

FIRST USE 10-4-2008; IN COMMERCE 10-4-2008.

CLASS 17—(Continued).

3,680,999. NEPTCO, INCORPORATED, PAWTUCKET, RI. SN 77-482,024. PUB. 10-21-2008, FILED 5-23-2008.

ARMORLINE

THE MARK CONSISTS OF STANDARD CHARACTERS WITHOUT CLAIM TO ANY PARTICULAR FONT, STYLE, SIZE, OR COLOR.

FOR TAPE FOR INDUSTRIAL OR COMMERCIAL USE, NAMELY, NON-METALLIC TAPE USED FOR HAULING, TOWING, PULLING, SEGREGATING OR SECURING BULKY MATERIALS (U.S. CLS. 1, 5, 12, 13, 35 AND 50).

FIRST USE 9-18-2008; IN COMMERCE 9-18-2008.

3,680,952. STUDCO BUILDING SYSTEMS US, LLC, WEBSTER, NY. SN 77-473,903. PUB. 3-24-2009, FILED 5-14-2008.



NO CLAIM IS MADE TO THE EXCLUSIVE RIGHT TO USE "SOUND ISOLATION SOLUTIONS", APART FROM THE MARK AS SHOWN.

THE MARK CONSISTS OF THE WORD "RESILMOUNT" SURROUNDED BY CIRCULAR LINES INDICATING SOUND WAVES, WITH "RESIL" IN THICK BOLD CAPITAL LETTERS AND "MOUNT" IN THIN CAPITAL LETTERS, AND WITH THE WORDS "SOUND ISOLATION SOLUTIONS" WRITTEN IN CAPITAL LETTERS WITHIN A BOX TO THE LOWER RIGHT OF THE WORD "RESILMOUNT".

FOR SOUND ISOLATION PRODUCTS FOR NOISE CONTROL, NAMELY, SOUND ABSORBING MATERIALS FOR BUILDINGS IN THE NATURE OF RESILIENT CLIPS FOR USE IN CONNECTION WITH BUILDING STRUCTURES SUCH AS METAL WALL STUDS, BRACKETS, CEILING HANGERS, FLOOR JOISTS AND FURRING CHANNELS (U.S. CLS. 1, 5, 12, 13, 35 AND 50).

FIRST USE 2-17-2009; IN COMMERCE 2-17-2009.

3,681,142. COOLEY GROUP HOLDINGS, INC., PAWTUCKET, RI. SN 77-525,840. PUB. 1-6-2009, FILED 7-18-2008.

COOLSHIELD

THE MARK CONSISTS OF STANDARD CHARACTERS WITHOUT CLAIM TO ANY PARTICULAR FONT, STYLE, SIZE, OR COLOR.

OWNER OF U.S. REG. NO. 2,934,462.

FOR POLYMER MATERIALS AND MEMBRANES AND REINFORCED POLYMER SUBSTRATES IN THE FORM OF SHEETS USED IN THE MANUFACTURE OF PROTECTIVE COVERINGS AND LINERS, SUCH AS LINERS FOR INDUSTRIAL TANKS, AND FOR GENERAL INDUSTRIAL USE INCLUDING USE IN THE SAFETY, MEDICAL, AND FOOD INDUSTRIES FOR THE MANUFACTURE OF TUBING, VENTING, AND DUCTING (U.S. CLS. 1, 5, 12, 13, 35 AND 50).

FIRST USE 4-0-2008; IN COMMERCE 4-0-2008.

CLASS 17—(Continued).

3,681,249. SPECIALTY CONSTRUCTION BRANDS, INC., SAINT PAUL, MN. SN 77-571,087. PUB. 2-17-2009, FILED 9-16-2008.

ACCUCOLOR 100

THE MARK CONSISTS OF STANDARD CHARACTERS WITHOUT CLAIM TO ANY PARTICULAR FONT, STYLE, SIZE, OR COLOR.

OWNER OF U.S. REG. NOS. 3,166,544, 3,313,302, AND OTHERS.

NO CLAIM IS MADE TO THE EXCLUSIVE RIGHT TO USE "100", APART FROM THE MARK AS SHOWN.

FOR SILICONE-BASED SEALANTS (U.S. CLS. 1, 5, 12, 13, 35 AND 50).

FIRST USE 12-22-2008; IN COMMERCE 12-22-2008.

CLASS 17—(Continued).

3,681,569. EARTHWORKS SYSTEMS, LLC, SOLON, OH. SN 78-819,190. PUB. 4-24-2007, FILED 2-20-2006.

GOODSHEET

THE MARK CONSISTS OF STANDARD CHARACTERS WITHOUT CLAIM TO ANY PARTICULAR FONT, STYLE, SIZE, OR COLOR.

FOR PLASTIC MATERIAL COMPOSED OF POLYVINYL CHLORIDE SHEETING FOR USE IN MAKING TRANSACTION, INFORMATION AND IDENTIFICATION CARDS AND SIGNS (U.S. CLS. 1, 5, 12, 13, 35 AND 50).

FIRST USE 6-30-2009; IN COMMERCE 6-30-2009.

3,681,608. TERRAFIX GEOSYNTHETICS INC., ETOBICOKE, ONTARIO, CANADA. SN 78-930,661. PUB. 10-7-2008, FILED 7-17-2006.

TERRACLAY

THE MARK CONSISTS OF STANDARD CHARACTERS WITHOUT CLAIM TO ANY PARTICULAR FONT, STYLE, SIZE, OR COLOR.

PRIORITY CLAIMED UNDER SEC. 44(D) ON CANADA APPLICATION NO. 1,286,826, FILED 1-20-2006, REG. NO. TMA714371, DATED 5-14-2008, EXPIRES 5-14-2023.

FOR GEOSYNTHETIC CLAY WATERPROOFING MEMBRANES USED IN BUILDING CONSTRUCTION, NAMELY, BUILDING FOUNDATIONS, GOLF COURSE PONDS, STORM WATER MANAGEMENT PONDS, RECREATIONAL PONDS, LANDFILL CLOSURES AND BASELINERS, DAMS, DIKES, VERTICAL TRENCH CUTOFF BARRIERS, GROUNDWATER PROTECTION COVERS, ENVIRONMENTAL PROTECTION BARRIERS UNDER ROADS AND RAILWAYS, AND ABOVE GROUND TANKS (U.S. CLS. 1, 5, 12, 13, 35 AND 50).

FIRST USE 1-11-2009; IN COMMERCE 1-11-2009.

3,681,484. NOK CORPORATION, TOKYO, JAPAN. SN 78-574,852. PUB. 10-28-2008, FILED 2-25-2005.

NO CLAIM IS MADE TO THE EXCLUSIVE RIGHT TO USE "SUPERIOR", APART FROM THE MARK AS SHOWN. THE COLOR(S) BLUE AND PURPLE IS/ARE CLAIMED AS A FEATURE OF THE MARK.

THE MARK CONSISTS OF THE STYLIZED WORD "SUPERIOR" IN THE COLORS BLUE AND PURPLE.

FOR RUBBER O-RINGS FOR AUTOMOBILES, INDUSTRIAL MACHINES, SEMICONDUCTORS AND LCD EQUIPMENT; RUBBER PIPE GASKETS FOR USE IN SEALING COOLING AND EXHAUST SYSTEM IN AUTOMOBILES, INDUSTRIAL MACHINES, SEMICONDUCTORS AND LCD EQUIPMENT; PACKINGS MADE OF RUBBER USED IN PRESSURIZED SECTIONS OF MACHINES TO SEAL GAS OR LIQUID; NON METAL OIL SEALS FOR USE IN SEALING OIL INSIDE INDUSTRIAL MACHINES; RAW OR SEMI-WORKED RUBBER (U.S. CLS. 1, 5, 12, 13, 35 AND 50).

FIRST USE 1-1-2001; IN COMMERCE 3-24-2005.

CLASS 18—LEATHER GOODS

3,680,067. BILLINGSLEY, SHERMAN JOY, NEW YORK, NY. SN 76-072,264. PUB. 5-2-2006, FILED 6-13-2000.

STORK CLUB

FOR BAGS, NAMELY, CLUTCH AND SHOULDER; WALLETS; PURSES (U.S. CLS. 1, 2, 3, 22 AND 41).

FIRST USE 2-24-2009; IN COMMERCE 2-24-2009.

CLASS 18—(Continued).

3,680,109. MPM PAN PACIFIC, INC., WEST COVINA, CA. SN 76-679,989. PUB. 12-9-2008, FILED 7-27-2007.

PORTAPET

THE MARK CONSISTS OF STANDARD CHARACTERS WITHOUT CLAIM TO ANY PARTICULAR FONT, STYLE, SIZE, OR COLOR.

FOR PET ACCESSORIES, NAMELY, CARRIERS, HARNESSSES, LEASHES, COLLARS, AND PET CLOTHING (U.S. CLS. 1, 2, 3, 22 AND 41).

FIRST USE 7-21-2007; IN COMMERCE 1-2-2009.

3,680,570. ABRAMS, MARTA LISA, LOS ANGELES, CA. AND ROSEMARIN, ALISSA, LOS ANGELES, CA. SN 77-335,870. PUB. 4-29-2008, FILED 11-22-2007.

MOODY MAMAS

THE MARK CONSISTS OF STANDARD CHARACTERS WITHOUT CLAIM TO ANY PARTICULAR FONT, STYLE, SIZE, OR COLOR.

FOR BABY CARRYING BAGS; BAGS FOR CARRYING BABIES' ACCESSORIES; COSMETIC BAGS SOLD EMPTY; DIAPER BAGS (U.S. CLS. 1, 2, 3, 22 AND 41).

FIRST USE 6-17-2009; IN COMMERCE 6-17-2009.

3,680,571. ABRAMS, MARTA LISA, LOS ANGELES, CA. AND ROSEMARIN, ALISSA, LOS ANGELES, CA. SN 77-335,872. PUB. 4-29-2008, FILED 11-22-2007.



MOODY MAMAS

FOR BABY CARRYING BAGS; BAGS FOR CARRYING BABIES' ACCESSORIES; COSMETIC BAGS SOLD EMPTY; DIAPER BAGS (U.S. CLS. 1, 2, 3, 22 AND 41).

FIRST USE 6-17-2009; IN COMMERCE 6-17-2009.

CLASS 18—(Continued).

3,680,696. FAMOUS STARS & STRAPS, INC., ONTARIO, CA. SN 77-386,085. PUB. 4-8-2008, FILED 1-31-2008.



OWNER OF U.S. REG. NOS. 2,704,738 AND 3,330,230. THE MARK CONSISTS OF A STYLIZED "F" WITH A SINGLE FIVE-POINT STAR IN THE CENTER.

FOR BACKPACKS; PURSES; WALLETS (U.S. CLS. 1, 2, 3, 22 AND 41).

FIRST USE 1-0-2000; IN COMMERCE 5-0-2004.

3,680,908. ALEX, INC., WEST HILLS, CA. SN 77-468,844. PUB. 12-16-2008, FILED 5-8-2008.

CHIC SAC

THE MARK CONSISTS OF STANDARD CHARACTERS WITHOUT CLAIM TO ANY PARTICULAR FONT, STYLE, SIZE, OR COLOR.

NO CLAIM IS MADE TO THE EXCLUSIVE RIGHT TO USE SACK, APART FROM THE MARK AS SHOWN.

FOR ALL PURPOSE CARRYING BAGS; HANDBAGS (U.S. CLS. 1, 2, 3, 22 AND 41).

FIRST USE 5-0-2008; IN COMMERCE 3-0-2009.

3,681,076. GRIFFIN, ROMINA, VAN NUYS, CA. SN 77-500,193. PUB. 3-10-2009, FILED 6-16-2008.



THE COLOR(S) BLACK AND RED IS/ARE CLAIMED AS

CLASS 18—(Continued).

A FEATURE OF THE MARK.

THE MARK CONSISTS OF THE COLORS RED AND BLACK. WITH THE COLOR BLACK APPEARING IN THE WORDING "LTANGO" AND THE COLOR RED IS ON THE LIPS AND ROSE DESIGN.

FOR CANVAS BAGS (U.S. CLS. 1, 2, 3, 22 AND 41).
FIRST USE 6-4-2009; IN COMMERCE 6-4-2009.

3,681,233. KAM MANUFACTURING, INC., VAN WERT, OH.
SN 77-564,551. PUB. 3-10-2009, FILED 9-8-2008.

BRANDY J COLLECTION

THE MARK CONSISTS OF STANDARD CHARACTERS WITHOUT CLAIM TO ANY PARTICULAR FONT, STYLE, SIZE, OR COLOR.

NO CLAIM IS MADE TO THE EXCLUSIVE RIGHT TO USE "COLLECTION", APART FROM THE MARK AS SHOWN.

THE NAME(S), PORTRAIT(S), AND/OR SIGNATURE(S) SHOWN IN THE MARK IDENTIFIES A LIVING INDIVIDUAL, WHOSE CONSENT(S) TO REGISTER IS SUBMITTED.

FOR HANDBAGS; PURSES; WALLETS; COSMETIC BAGS SOLD EMPTY; TOTE BAGS; BACKPACKS; DUFFEL BAGS; AND LUGGAGE (U.S. CLS. 1, 2, 3, 22 AND 41).

FIRST USE 10-31-2008; IN COMMERCE 10-31-2008.

3,681,365. HANDBAG MILAN, NEW YORK, NY. SN 77-608,376. PUB. 3-24-2009, FILED 11-5-2008.

Le gio

THE MARK CONSISTS OF THE STYLIZED TEXT "LE GIO".

THE ENGLISH TRANSLATION OF THE WORD "LE" IN THE MARK IS "THE".

FOR FASHION HANDBAGS (U.S. CLS. 1, 2, 3, 22 AND 41).

FIRST USE 6-1-2009; IN COMMERCE 6-1-2009.

CLASS 18—(Continued).

3,681,440. DISNEY ENTERPRISES, INC., BURBANK, CA. SN 77-977,609. PUB. 9-23-2008, FILED 2-4-2008.



OWNER OF U.S. REG. NOS. 1,536,967, 3,242,910, AND 3,341,092.

NO CLAIM IS MADE TO THE EXCLUSIVE RIGHT TO USE "STORE", APART FROM THE MARK AS SHOWN.

THE MARK CONSISTS OF A WORD AND IMAGE THAT INCLUDES AN OVAL AND STARS.

FOR BACKPACKS; BOOK BAGS; HANDBAGS; PURSES; TEXTILE SHOPPING BAGS; TOTE BAGS; UMBRELLAS; LUGGAGE TAGS (U.S. CLS. 1, 2, 3, 22 AND 41).

FIRST USE 5-28-2009; IN COMMERCE 5-28-2009.

3,681,474. CORLEY, CAROLE, GARDEN CITY, KS. SN 78-542,757. PUB. 3-28-2006, FILED 1-5-2005.

HEARTLIGHT

THE MARK CONSISTS OF STANDARD CHARACTERS WITHOUT CLAIM TO ANY PARTICULAR FONT, STYLE, SIZE, OR COLOR.

FOR PURSES, HANDBAGS, TOTE BAGS AND WALLETS (U.S. CLS. 1, 2, 3, 22 AND 41).

FIRST USE 6-12-2009; IN COMMERCE 6-12-2009.

CLASS 18—(Continued).

3,681,535. MARSTELLER, MARILYN ANDERSON, CINCINNATI, OH. SN 78-708,706. PUB. 6-13-2006, FILED 9-8-2005.

PURSE PERFECTOR

THE MARK CONSISTS OF STANDARD CHARACTERS WITHOUT CLAIM TO ANY PARTICULAR FONT, STYLE, SIZE, OR COLOR.

NO CLAIM IS MADE TO THE EXCLUSIVE RIGHT TO USE "PURSE", APART FROM THE MARK AS SHOWN.

FOR REMOVABLE INSERT FOR ALL-PURPOSE CARRYING BAGS AND PURSES TO ORGANIZE PERSONAL ARTICLES (U.S. CLS. 1, 2, 3, 22 AND 41).

FIRST USE 9-8-2005; IN COMMERCE 6-5-2009.

CLASS 19—(Continued).

3,680,562. VENEERCRETE, LLC, JENSEN BEACH, FL. SN 77-334,950. PUB. 4-29-2008, FILED 11-21-2007.

VENEERCRETE

THE MARK CONSISTS OF STANDARD CHARACTERS WITHOUT CLAIM TO ANY PARTICULAR FONT, STYLE, SIZE, OR COLOR.

FOR READY-MIX FORMULATIONS OF CEMENT FOR USE IN THE PRODUCTION OF BUILDING MATERIALS FOR USE BY PROFESSIONAL CONTRACTORS (U.S. CLS. 1, 12, 33 AND 50).

FIRST USE 7-16-2009; IN COMMERCE 7-16-2009.

CLASS 19—NON-METALLIC BUILDING MATERIALS

3,680,126. NUDO PRODUCTS INC., SPRINGFIELD, IL. SN 76-688,345. PUB. 12-9-2008, FILED 4-3-2008.

NCP-Allure

FOR PANELING, NAMELY, INTERIOR PANELING MADE OF ALUMINUM FACERS WITH THERMOPLASTIC CORE (U.S. CLS. 1, 12, 33 AND 50).

FIRST USE 3-1-2008; IN COMMERCE 3-1-2008.

3,680,617. COLLIER PETER, BILPIN, AUSTRALIA. SN 77-348,104. PUB. 5-6-2008, FILED 12-10-2007.

Builderscrete

THE MARK CONSISTS OF STANDARD CHARACTERS WITHOUT CLAIM TO ANY PARTICULAR FONT, STYLE, SIZE, OR COLOR.

FOR CONCRETE BLOCKS (U.S. CLS. 1, 12, 33 AND 50).

FIRST USE 2-1-2008; IN COMMERCE 2-1-2008.

3,680,424. COOPER, RICHARD P., BEND, OR. SN 77-288,427. PUB. 5-13-2008, FILED 9-25-2007.

HEAT ROCK

THE MARK CONSISTS OF STANDARD CHARACTERS WITHOUT CLAIM TO ANY PARTICULAR FONT, STYLE, SIZE, OR COLOR.

FOR BUILDING MATERIALS, NAMELY, HEATED WALL, FLOOR AND WALL BOARDS (U.S. CLS. 1, 12, 33 AND 50).

FIRST USE 3-27-2008; IN COMMERCE 3-27-2008.

3,680,725. UNITED STATES GYPSUM COMPANY, CHICAGO, IL. SN 77-400,706. PUB. 7-8-2008, FILED 2-19-2008.

NXG

THE MARK CONSISTS OF STANDARD CHARACTERS WITHOUT CLAIM TO ANY PARTICULAR FONT, STYLE, SIZE, OR COLOR.

FOR FLOORING UNDERLAYMENTS (U.S. CLS. 1, 12, 33 AND 50).

FIRST USE 6-6-2008; IN COMMERCE 6-6-2008.

CLASS 19—(Continued).

3,680,800. NORTH AMERICAN REFRACTORIES COMPANY, MOON TOWNSHIP, PA. SN 77-438,835. PUB. 9-23-2008, FILED 4-3-2008.

NARCOTUN

THE MARK CONSISTS OF STANDARD CHARACTERS WITHOUT CLAIM TO ANY PARTICULAR FONT, STYLE, SIZE, OR COLOR.

FOR DRY VIBRATABLE REFRACTORY MATERIALS FOR TUNDISH APPLICATIONS, NOT OF METAL (U.S. CLS. 1, 12, 33 AND 50).

FIRST USE 12-31-2004; IN COMMERCE 12-31-2004.

3,681,107. STANEK VINYL WINDOWS, CORP, DBA STANEK WINDOWS, CUYAHOGA HEIGHTS, OH. SN 77-516,835. PUB. 12-2-2008, FILED 7-8-2008.

ULTRAEXTREME

THE MARK CONSISTS OF STANDARD CHARACTERS WITHOUT CLAIM TO ANY PARTICULAR FONT, STYLE, SIZE, OR COLOR.

FOR VINYL WINDOWS (U.S. CLS. 1, 12, 33 AND 50).

FIRST USE 1-5-2009; IN COMMERCE 1-29-2009.

3,681,155. STONEXPRESS, INC., KENNESAW, GA. SN 77-531,420. PUB. 12-16-2008, FILED 7-25-2008.

STONESKIN

THE MARK CONSISTS OF STANDARD CHARACTERS WITHOUT CLAIM TO ANY PARTICULAR FONT, STYLE, SIZE, OR COLOR.

FOR LIMESTONE; MARBLE; TRAVERTINE FOR BUILDING AND CONSTRUCTION PURPOSES (U.S. CLS. 1, 12, 33 AND 50).

FIRST USE 4-1-2009; IN COMMERCE 4-1-2009.

CLASS 19—(Continued).

3,681,266. MAY MANUFACTURING, LLC, CHATTANOOGA, TN. SN 77-576,113. PUB. 3-24-2009, FILED 9-22-2008.



THE MARK CONSISTS OF THE WORDS "TIDALFIT" WITH A FIGURE SWIMMING OVER A BREAKING WAVE. FOR NON-METAL SWIMMING POOLS USED FOR EXERCISE (U.S. CLS. 1, 12, 33 AND 50).

FIRST USE 6-27-2008; IN COMMERCE 6-27-2008.

3,681,563. CARGILL, INCORPORATED, WAYZATA, MN. SN 78-793,901. PUB. 10-2-2007, FILED 1-18-2006.

PROTECTING PEOPLE, BRIDGES
AND ROADS

THE MARK CONSISTS OF STANDARD CHARACTERS WITHOUT CLAIM TO ANY PARTICULAR FONT, STYLE, SIZE, OR COLOR.

FOR ROCK OR SYNTHETIC AGGREGATE MATERIAL COMBINED WITH ADHESIVE AS APPLIED TO CONCRETE AND ASPHALT SUBSTRATES AND MATERIALS TO MAKE PAVEMENT THAT ABSORBS DEICING PREPARATIONS (U.S. CLS. 1, 12, 33 AND 50).

FIRST USE 6-30-2008; IN COMMERCE 6-30-2008.

CLASS 20—FURNITURE AND ARTICLES NOT OTHERWISE CLASSIFIED

3,680,133. WINNEBAGO INDUSTRIES, INC., FOREST CITY, IA. SN 76-690,007. PUB. 11-25-2008, FILED 5-27-2008.

IDEAL REST

THE MARK CONSISTS OF STANDARD CHARACTERS WITHOUT CLAIM TO ANY PARTICULAR FONT, STYLE, SIZE, OR COLOR.

FOR MATTRESSES AND CUSHIONS, NAMELY, MEMORY FOAM MATTRESSES, MEMORY FOAM CUSHIONS, AND MATTRESS CUSHIONS ALL FOR USE IN MOTOR HOMES AND RECREATIONAL VEHICLES (U.S. CLS. 2, 13, 22, 25, 32 AND 50).

FIRST USE 8-11-2008; IN COMMERCE 8-11-2008.

CLASS 20—(Continued).

3,680,286. CONAIR CORPORATION, STAMFORD, CT. SN 77-174,396. PUB. 10-30-2007, FILED 5-7-2007.

CONAIR

THE MARK CONSISTS OF STANDARD CHARACTERS WITHOUT CLAIM TO ANY PARTICULAR FONT, STYLE, SIZE, OR COLOR.
OWNER OF U.S. REG. NOS. 2,238,852 AND 3,481,647.
FOR BACK SUPPORT CUSHIONS NOT FOR MEDICAL PURPOSES (U.S. CLS. 2, 13, 22, 25, 32 AND 50).
FIRST USE 8-30-2000; IN COMMERCE 8-30-2000.

3,680,298. TAMARA MAGEL HOME, INC., NEW YORK, NY. SN 77-180,145. PUB. 10-30-2007, FILED 5-14-2007.

TAMARA MAGEL

THE MARK CONSISTS OF STANDARD CHARACTERS WITHOUT CLAIM TO ANY PARTICULAR FONT, STYLE, SIZE, OR COLOR.
THE NAME "TAMARA MAGEL" IDENTIFIES A LIVING INDIVIDUAL WHOSE CONSENT IS OF RECORD.
FOR FURNITURE (U.S. CLS. 2, 13, 22, 25, 32 AND 50).
FIRST USE 9-30-2008; IN COMMERCE 9-30-2008.

3,680,314. SERTA, INC., HOFFMAN ESTATES, IL. SN 77-185,652. PUB. 11-6-2007, FILED 5-21-2007.

PERFECT FIT

THE MARK CONSISTS OF STANDARD CHARACTERS WITHOUT CLAIM TO ANY PARTICULAR FONT, STYLE, SIZE, OR COLOR.
FOR OFFICE FURNITURE (U.S. CLS. 2, 13, 22, 25, 32 AND 50).
FIRST USE 4-1-2009; IN COMMERCE 4-1-2009.

CLASS 20—(Continued).

3,680,368. LEON, RICHARD J., OCEANSIDE, CA. SN 77-219,894. PUB. 12-11-2007, FILED 7-1-2007.

SensoryLid

THE COLOR(S) BROWN AND TAN IS/ARE CLAIMED AS A FEATURE OF THE MARK.
THE MARK CONSISTS OF THE WORD "SENSORYLID" WITH NO SPACE AND "SENSORY" IN BROWN AND "LID" IN TAN.
FOR PLASTIC LIDS (U.S. CLS. 2, 13, 22, 25, 32 AND 50).
FIRST USE 3-15-2009; IN COMMERCE 3-15-2009.

3,680,370. CHAVEZ, VALARIE L., ALBUQUERQUE, NM. SN 77-222,430. PUB. 12-18-2007, FILED 7-5-2007.

las cruces de la tierra

THE MARK CONSISTS OF STANDARD CHARACTERS WITHOUT CLAIM TO ANY PARTICULAR FONT, STYLE, SIZE, OR COLOR.
NO CLAIM IS MADE TO THE EXCLUSIVE RIGHT TO USE "CRUCES", APART FROM THE MARK AS SHOWN.
THE ENGLISH TRANSLATION OF "LAS CRUCES DE LA TIERRA" IN THE MARK IS "THE CROSSES OF THE EARTH"
FOR WORKS OF ART, NAMELY, CROSSES, OF WOOD (U.S. CLS. 2, 13, 22, 25, 32 AND 50).
FIRST USE 5-1-2007; IN COMMERCE 12-15-2008.

3,680,419. OVERSTOCK.COM, INC., SALT LAKE CITY, UT. SN 77-286,256. PUB. 2-5-2008, FILED 9-21-2007.

O.COM

THE MARK CONSISTS OF STANDARD CHARACTERS WITHOUT CLAIM TO ANY PARTICULAR FONT, STYLE, SIZE, OR COLOR.
FOR FURNITURE, SOLD SOLELY THROUGH AN ONLINE WEBSITE (U.S. CLS. 2, 13, 22, 25, 32 AND 50).
FIRST USE 7-6-2009; IN COMMERCE 7-6-2009.

CLASS 20—(Continued).

3,680,698. SISSOM, DAVID, HOLLYWOOD, FL. SN 77-387,956. PUB. 10-28-2008, FILED 2-4-2008.

Impressions

THE MARK CONSISTS OF STANDARD CHARACTERS WITHOUT CLAIM TO ANY PARTICULAR FONT, STYLE, SIZE, OR COLOR.

FOR CONVEX PLASTIC DOME WITH PERFUMED AIR INSIDE. WHEN THE DOME IS COMPRESSED, IT PUSHES THE SCENT OUT THROUGH A HOLE OR MEMBRANE; PLASTIC CONTAINER WITH A COVER THAT CAN BE LIFTED, ROTATED OR SLID TO EXPOSE AND RELEASE SCENT THROUGH A HOLE OR MEMBRANE. ALL OF THE FOREGOING GOODS MAY BE PLACED IN MAILERS OR STORE DISPLAYS (U.S. CLS. 2, 13, 22, 25, 32 AND 50).

FIRST USE 12-25-2007; IN COMMERCE 2-5-2009.

3,680,708. SPOT ME ID, INC., CELEBRATION, FL. SN 77-391,659. PUB. 6-24-2008, FILED 2-7-2008.

Spot Me ID

THE MARK CONSISTS OF STANDARD CHARACTERS WITHOUT CLAIM TO ANY PARTICULAR FONT, STYLE, SIZE, OR COLOR.

NO CLAIM IS MADE TO THE EXCLUSIVE RIGHT TO USE "ID", APART FROM THE MARK AS SHOWN.

FOR NON-METAL IDENTIFICATION BRACELETS (U.S. CLS. 2, 13, 22, 25, 32 AND 50).

FIRST USE 1-1-2008; IN COMMERCE 11-24-2008.

3,680,710. MADIX, INC., TERRELL, TX. SN 77-392,566. PUB. 6-24-2008, FILED 2-8-2008.

EASEL

THE MARK CONSISTS OF STANDARD CHARACTERS WITHOUT CLAIM TO ANY PARTICULAR FONT, STYLE, SIZE, OR COLOR.

FOR SHELVING (U.S. CLS. 2, 13, 22, 25, 32 AND 50).

FIRST USE 5-6-2009; IN COMMERCE 5-6-2009.

CLASS 20—(Continued).

3,680,795. S&F SUPPLIES INC., BROOKLYN, NY. SN 77-436,681. PUB. 3-3-2009, FILED 4-1-2008.

DURA BOND

THE MARK CONSISTS OF THE WORDS "DURA BOND" AND THREE-DIMENSIONAL SQUARE DESIGN.

FOR ADVERTISING SIGNS OF POLYETHYLENE (U.S. CLS. 2, 13, 22, 25, 32 AND 50).

FIRST USE 1-2-2008; IN COMMERCE 1-2-2008.

3,680,868. SLEEP INNOVATIONS, INC., WEST LONG BRANCH, NJ. SN 77-460,256. PUB. 9-30-2008, FILED 4-29-2008.

ECOTEMP

THE MARK CONSISTS OF STANDARD CHARACTERS WITHOUT CLAIM TO ANY PARTICULAR FONT, STYLE, SIZE, OR COLOR.

FOR MATTRESSES, MATTRESS TOPPERS AND PILLOWS (U.S. CLS. 2, 13, 22, 25, 32 AND 50).

FIRST USE 1-0-2008; IN COMMERCE 1-0-2008.

3,680,967. ALLSEATING CORPORATION, MISSISSAUGA, CANADA. SN 77-476,406. PUB. 10-21-2008, FILED 5-16-2008.

ADJUSTING YOUR NEEDS

THE MARK CONSISTS OF STANDARD CHARACTERS WITHOUT CLAIM TO ANY PARTICULAR FONT, STYLE, SIZE, OR COLOR.

FOR FURNITURE, NAMELY, CHAIRS (U.S. CLS. 2, 13, 22, 25, 32 AND 50).

FIRST USE 6-16-2008; IN COMMERCE 6-16-2008.

CLASS 20—(Continued).

3,680,994. DCI MARKETING, INC., MILWAUKEE, WI. SN 77-481,454. PUB. 8-19-2008, FILED 5-22-2008.

LIVEGUIDE

THE MARK CONSISTS OF STANDARD CHARACTERS WITHOUT CLAIM TO ANY PARTICULAR FONT, STYLE, SIZE, OR COLOR.

FOR POINT OF PURCHASE DISPLAYS (U.S. CLS. 2, 13, 22, 25, 32 AND 50).

FIRST USE 6-26-2009; IN COMMERCE 6-26-2009.

CLASS 20—(Continued).

3,681,150. FEMMED, INC., MINNETONKA, MN. SN 77-528,296. PUB. 12-9-2008, FILED 7-22-2008.

GOGIRL

THE MARK CONSISTS OF STANDARD CHARACTERS WITHOUT CLAIM TO ANY PARTICULAR FONT, STYLE, SIZE, OR COLOR.

FOR DISPOSABLE PORTABLE URINARY AID, NAMELY, A PLASTIC CONTAINER DEVICE PRIMARILY FOR USE BY FEMALES ENABLING USERS TO STAND WHILE URINATING (U.S. CLS. 2, 13, 22, 25, 32 AND 50).

FIRST USE 1-31-2009; IN COMMERCE 1-31-2009.

3,681,007. BLACK & DECKER CORPORATION, THE, TOWSON, MD. SN 77-483,569. PUB. 10-21-2008, FILED 5-27-2008.

WORKMATE

THE MARK CONSISTS OF STANDARD CHARACTERS WITHOUT CLAIM TO ANY PARTICULAR FONT, STYLE, SIZE, OR COLOR.

OWNER OF U.S. REG. NOS. 1,057,371 AND 3,103,734. FOR SAW HORSES (U.S. CLS. 2, 13, 22, 25, 32 AND 50). FIRST USE 12-31-2001; IN COMMERCE 12-31-2001.

3,681,008. BLACK & DECKER CORPORATION, THE, TOWSON, MD. SN 77-483,572. PUB. 10-21-2008, FILED 5-27-2008.

WORKMATE

THE MARK CONSISTS OF STANDARD CHARACTERS WITHOUT CLAIM TO ANY PARTICULAR FONT, STYLE, SIZE, OR COLOR.

OWNER OF U.S. REG. NOS. 1,057,371 AND 3,103,734. FOR TOOL BOXES PRIMARILY MADE OF PLASTIC (U.S. CLS. 2, 13, 22, 25, 32 AND 50). FIRST USE 12-31-2000; IN COMMERCE 12-31-2000.

3,681,167. PERKOWITZ, THOMAS M., ROUND LAKE, IL. SN 77-534,744. PUB. 12-23-2008, FILED 7-30-2008.

Nature's Creations

THE MARK CONSISTS OF STANDARD CHARACTERS WITHOUT CLAIM TO ANY PARTICULAR FONT, STYLE, SIZE, OR COLOR.

FOR WINDOW SHADES (U.S. CLS. 2, 13, 22, 25, 32 AND 50).

FIRST USE 5-16-2008; IN COMMERCE 1-20-2009.

3,681,313. SKI-EZE PRODUCTS INTERNATIONAL INC., BRIDGEPORT, CT. SN 77-589,789. PUB. 3-17-2009, FILED 10-9-2008.

SAV-A-SHOULDER

THE MARK CONSISTS OF STANDARD CHARACTERS WITHOUT CLAIM TO ANY PARTICULAR FONT, STYLE, SIZE, OR COLOR.

FOR SHOULDER CUSHION - USED TO ASSIST IN CARRYING HEAVY ITEMS (U.S. CLS. 2, 13, 22, 25, 32 AND 50).

FIRST USE 12-15-2008; IN COMMERCE 1-15-2009.

CLASS 20—(Continued).

3,681,337. JULIUS J. LARRY III, CHANNELVIEW, TX. SN 77-599,195. PUB. 3-17-2009, FILED 10-23-2008.

STEELWOODS

THE MARK CONSISTS OF STANDARD CHARACTERS WITHOUT CLAIM TO ANY PARTICULAR FONT, STYLE, SIZE, OR COLOR.

FOR CASKETS (U.S. CLS. 2, 13, 22, 25, 32 AND 50).
FIRST USE 3-15-2009; IN COMMERCE 3-15-2009.

3,681,338. BASSETT MIRROR COMPANY, INCORPORATED, BASSETT, VA. SN 77-599,275. PUB. 3-10-2009, FILED 10-23-2008.



THE MARK CONSISTS OF A SINGLE TREE WITH MULTIPLE LEAVES.
FOR FURNITURE (U.S. CLS. 2, 13, 22, 25, 32 AND 50).
FIRST USE 5-14-2009; IN COMMERCE 5-14-2009.

3,681,381. QVC, INC., WEST CHESTER, PA. SN 77-616,432. PUB. 3-31-2009, FILED 11-18-2008.

PEDICSOLUTIONS

THE MARK CONSISTS OF STANDARD CHARACTERS WITHOUT CLAIM TO ANY PARTICULAR FONT, STYLE, SIZE, OR COLOR.

FOR MATTRESSES (U.S. CLS. 2, 13, 22, 25, 32 AND 50).
FIRST USE 3-26-2009; IN COMMERCE 3-26-2009.

CLASS 20—(Continued).

3,681,389. SMITH & HAWKEN, LTD., NOVATO, CA. SN 77-618,783. PUB. 3-31-2009, FILED 11-20-2008.

BEXLEY

THE MARK CONSISTS OF STANDARD CHARACTERS WITHOUT CLAIM TO ANY PARTICULAR FONT, STYLE, SIZE, OR COLOR.

FOR FURNITURE (U.S. CLS. 2, 13, 22, 25, 32 AND 50).
FIRST USE 4-30-2009; IN COMMERCE 4-30-2009.

3,681,487. VENDOR DEVELOPMENT GROUP, INC., GOLDEN VALLEY, MN. SN 78-587,774. PUB. 4-10-2007, FILED 3-15-2005.

BALI WATERS

THE MARK CONSISTS OF STANDARD CHARACTERS WITHOUT CLAIM TO ANY PARTICULAR FONT, STYLE, SIZE, OR COLOR.

FOR PATIO FURNITURE AND CASUAL FURNITURE (U.S. CLS. 2, 13, 22, 25, 32 AND 50).
FIRST USE 3-31-2006; IN COMMERCE 3-31-2006.

3,681,515. THE CARTOON NETWORK, INC., ATLANTA, GA. SN 78-667,364. PUB. 5-2-2006, FILED 7-11-2005.

BEN 10

THE MARK CONSISTS OF STANDARD CHARACTERS WITHOUT CLAIM TO ANY PARTICULAR FONT, STYLE, SIZE, OR COLOR.

FOR PLASTIC CAKE DECORATIONS (U.S. CLS. 2, 13, 22, 25, 32 AND 50).
FIRST USE 4-1-2009; IN COMMERCE 4-1-2009.

CLASS 20—(Continued).

3,681,566. RAPER, DAVID W., HOLT, MO. SN 78-796,378.
PUB. 4-11-2006, FILED 1-20-2006.

CLASS 21—(Continued).

3,680,252. TAWARAYA LIMITED, CHARLESTOWN,
ST. CHRIST-NEVIS. SN 77-157,754. PUB. 1-8-2008, FILED
4-16-2007.

Boardbeds

THE MARK CONSISTS OF STANDARD CHARACTERS
WITHOUT CLAIM TO ANY PARTICULAR FONT, STYLE,
SIZE, OR COLOR.

FOR STORAGE RACKS FOR SKI AND SPORTS
EQUIPMENT (U.S. CLS. 2, 13, 22, 25, 32 AND 50).
FIRST USE 7-2-2009; IN COMMERCE 7-2-2009.

CLASS 21—HOUSEWARES AND GLASS

3,680,208. TONOGA, INC., PETERSBURGH, NY. SN 77-
126,987. PUB. 12-18-2007, FILED 3-9-2007.

ZEST FOR LIFE

THE MARK CONSISTS OF STANDARD CHARACTERS
WITHOUT CLAIM TO ANY PARTICULAR FONT, STYLE,
SIZE, OR COLOR.

FOR COOKING UTENSILS, NAMELY, FOOD PRE-
PARATION UTENSILS, NAMELY, FOOD SCOOPS; NON-
STICK LINERS FOR OVENS AND MICROWAVES; NON-
STICK MATS FOR FOOD PREPARATION, HANDLING,
COOKING AND STORAGE; BAKING SHEETS AND
PANS; CUTTING BOARDS; BAKEWARE (U.S. CLS. 2,
13, 23, 29, 30, 33, 40 AND 50).
FIRST USE 2-20-2007; IN COMMERCE 2-20-2007.

3,680,233. POLAR WARE COMPANY, KIEL, WI. SN 77-
148,828. PUB. 10-2-2007, FILED 4-4-2007.

GRIP-N-LIFT

THE MARK CONSISTS OF STANDARD CHARACTERS
WITHOUT CLAIM TO ANY PARTICULAR FONT, STYLE,
SIZE, OR COLOR.

FOR STEAM TABLE PANS FOR HOT AND COLD
FOOD SERVICE (U.S. CLS. 2, 13, 23, 29, 30, 33, 40 AND
50).
FIRST USE 5-31-2007; IN COMMERCE 5-31-2007.

MARC NEWSON

THE MARK CONSISTS OF STANDARD CHARACTERS
WITHOUT CLAIM TO ANY PARTICULAR FONT, STYLE,
SIZE, OR COLOR.

THE NAME "MARC NEWSON" IDENTIFIES A LIVING
INDIVIDUAL WHOSE CONSENT IS OF RECORD.

FOR HOUSEHOLD OR KITCHEN UTENSILS AND
CONTAINERS (NOT OF PRECIOUS METAL OR
COATED THEREWITH), NAMELY, GRATERS, SIEVES,
SPATULAS, STRAINERS, POT AND PAN SCRAPERS,
SKIMMERS, TURNERS, AND WHISKS; COMBS; BATH
SPONGES, BATH PRODUCTS, NAMELY, BODY
SPONGES, CLEANING SPONGES, SCRUB SPONGES;
FLOOR BRUSHES, FIREPLACE BRUSHES, PET
BRUSHES; BRUSH-MAKING MATERIALS (EXCEPT
PAINT BRUSHES); ARTICLES FOR CLEANING PUR-
POSES, NAMELY, POT CLEANING BRUSHES, DISH-
WASHING BRUSHES, STEEL WOOL FOR CLEANING,
CLEANING RAGS; UNWORKED OR SEMI-WORKED
GLASS (EXCEPT GLASS USED IN BUILDING),
NAMELY, GLASS DISHES, GLASS CARAFES, BEVER-
AGE GLASSWARE; GLASSWARE, PORCELAIN AND
EARTHENWARE NOT INCLUDED IN OTHER CLASSES,
NAMELY, GLASS STORAGE JARS, FIGURINES OF
PORCELAIN, TERRA-COTTA OR GLASS, GLASS
BOWLS, SIGNBOARDS OF PORCELAIN OR GLASS,
JUGS; PARTS AND FITTINGS FOR ALL THE AFORE-
SAID GOODS (U.S. CLS. 2, 13, 23, 29, 30, 33, 40 AND 50).
FIRST USE 11-1-2008; IN COMMERCE 11-1-2008.

3,680,326. BRADSHAW INTERNATIONAL, INC., RANCHO
CUCAMONGA, CA. SN 77-188,309. PUB. 12-16-2008, FILED
5-23-2007.

harmony

FOR BAKEWARE NOT FOR USE IN THE AVIATION
INDUSTRY (U.S. CLS. 2, 13, 23, 29, 30, 33, 40 AND 50).
FIRST USE 3-0-2006; IN COMMERCE 9-0-2006.

CLASS 21—(Continued).

3,680,582. HOME BOX OFFICE, INC., NEW YORK, NY. SN 77-338,468. PUB. 4-29-2008, FILED 11-28-2007.

IN TREATMENT

THE MARK CONSISTS OF STANDARD CHARACTERS WITHOUT CLAIM TO ANY PARTICULAR FONT, STYLE, SIZE, OR COLOR.
FOR MUGS (U.S. CLS. 2, 13, 23, 29, 30, 33, 40 AND 50).
FIRST USE 1-1-2008; IN COMMERCE 1-1-2008.

3,680,610. SHOWTIME NETWORKS INC., NEW YORK, NY. SN 77-347,076. PUB. 3-25-2008, FILED 12-7-2007.

THE DARK DEFENDER

THE MARK CONSISTS OF STANDARD CHARACTERS WITHOUT CLAIM TO ANY PARTICULAR FONT, STYLE, SIZE, OR COLOR.
FOR HOUSEWARES, NAMELY, MUGS, CUPS, AND DRINKING GLASSES (U.S. CLS. 2, 13, 23, 29, 30, 33, 40 AND 50).
FIRST USE 10-31-2007; IN COMMERCE 10-31-2007.

3,680,612. ALADDIN TEMP-RITE, LLC, HENDERSONVILLE, TN. SN 77-347,146. PUB. 9-30-2008, FILED 12-7-2007.

READY-CHILL

THE MARK CONSISTS OF STANDARD CHARACTERS WITHOUT CLAIM TO ANY PARTICULAR FONT, STYLE, SIZE, OR COLOR.
FOR THERMAL INSULATED CONTAINERS AND COVERS FOR FOOD OR BEVERAGE (U.S. CLS. 2, 13, 23, 29, 30, 33, 40 AND 50).
FIRST USE 4-24-2008; IN COMMERCE 4-24-2008.

CLASS 21—(Continued).

3,680,674. MEADWESTVACO CORPORATION, GLEN ALLEN, VA. SN 77-369,371. PUB. 5-6-2008, FILED 1-11-2008.

SINFONIA

THE MARK CONSISTS OF STANDARD CHARACTERS WITHOUT CLAIM TO ANY PARTICULAR FONT, STYLE, SIZE, OR COLOR.
FOR MANUALLY ACTUATED PUMP DISPENSERS FOR ATTACHMENT TO CONTAINERS FOR USE IN DISPENSING LIQUIDS (U.S. CLS. 2, 13, 23, 29, 30, 33, 40 AND 50).
FIRST USE 7-1-2009; IN COMMERCE 7-1-2009.

3,680,808. PIONEER PLASTICS, L.L.C., ROGER, AR. SN 77-440,548. PUB. 8-19-2008, FILED 4-4-2008.

CHOOSE GREEN

THE MARK CONSISTS OF STANDARD CHARACTERS WITHOUT CLAIM TO ANY PARTICULAR FONT, STYLE, SIZE, OR COLOR.
NO CLAIM IS MADE TO THE EXCLUSIVE RIGHT TO USE "GREEN", APART FROM THE MARK AS SHOWN.
FOR TRASH CANS MADE OF RECYCLABLE MATERIAL (U.S. CLS. 2, 13, 23, 29, 30, 33, 40 AND 50).
FIRST USE 8-29-2008; IN COMMERCE 8-29-2008.

3,680,834. WEAST, SUZANNE, DEL MAR, CA. SN 77-453,879. PUB. 9-30-2008, FILED 4-21-2008.

**MONKEY POTS WE HANG AROUND
THE BEST PATIOS**

THE MARK CONSISTS OF STANDARD CHARACTERS WITHOUT CLAIM TO ANY PARTICULAR FONT, STYLE, SIZE, OR COLOR.
NO CLAIM IS MADE TO THE EXCLUSIVE RIGHT TO USE "POTS", APART FROM THE MARK AS SHOWN.
FOR CERAMIC, PORCELAIN AND EARTHENWARE VASES, VESSELS, BOWLS, AND POTS; FLOWER BASKETS; FLOWER BOWLS; FLOWER POT HOLDERS; FLOWER POTS; FLOWER VASES AND BOWLS; HOLDERS FOR FLOWERS AND PLANTS; PLANT BASKETS; PLANTERS FOR FLOWERS AND PLANTS; SAUCERS FOR FLOWER POTS (U.S. CLS. 2, 13, 23, 29, 30, 33, 40 AND 50).
FIRST USE 12-1-2008; IN COMMERCE 12-1-2008.

CLASS 21—(Continued).

3,680,909. TOPCO ASSOCIATES, LLC, SKOKIE, IL. SN 77-469,049. PUB. 10-7-2008, FILED 5-8-2008.

NO FUSS COOKWARE

THE MARK CONSISTS OF STANDARD CHARACTERS WITHOUT CLAIM TO ANY PARTICULAR FONT, STYLE, SIZE, OR COLOR.

NO CLAIM IS MADE TO THE EXCLUSIVE RIGHT TO USE "COOKWARE", APART FROM THE MARK AS SHOWN.

FOR COOKWARE, NAMELY, SAUTÉ PANS, SAUTÉ PANS WITH GLASS LIDS, FRY PAN SETS, DUTCH OVENS (U.S. CLS. 2, 13, 23, 29, 30, 33, 40 AND 50).
FIRST USE 4-0-2009; IN COMMERCE 4-0-2009.



3,681,031. UNIVERSAL WATER SYSTEMS, LLC, ALBUQUERQUE, NM. SN 77-490,577. PUB. 10-28-2008, FILED 6-4-2008.

UNBOTTLE YOUR WATER

THE MARK CONSISTS OF STANDARD CHARACTERS WITHOUT CLAIM TO ANY PARTICULAR FONT, STYLE, SIZE, OR COLOR.

FOR DRINKING VESSELS; PORTABLE BEVERAGE COOLERS; PORTABLE BEVERAGE DISPENSERS (U.S. CLS. 2, 13, 23, 29, 30, 33, 40 AND 50).
FIRST USE 7-15-2009; IN COMMERCE 7-15-2009.



3,681,034. HEB GROCERY COMPANY, LP, SAN ANTONIO, TX. SN 77-490,735. PUB. 10-14-2008, FILED 6-4-2008.

HILL COUNTRY ESSENTIALS

THE MARK CONSISTS OF STANDARD CHARACTERS WITHOUT CLAIM TO ANY PARTICULAR FONT, STYLE, SIZE, OR COLOR.

OWNER OF U.S. REG. NOS. 2,151,066 AND 2,890,694.
FOR MANUAL TOOTHBRUSHES, DENTAL FLOSS (U.S. CLS. 2, 13, 23, 29, 30, 33, 40 AND 50).
FIRST USE 2-12-2009; IN COMMERCE 2-12-2009.

CLASS 21—(Continued).

3,681,072. RANIR, LLC, GRAND RAPIDS, MI. SN 77-499,739. PUB. 9-2-2008, FILED 6-16-2008.

INFINITY

THE MARK CONSISTS OF STANDARD CHARACTERS WITHOUT CLAIM TO ANY PARTICULAR FONT, STYLE, SIZE, OR COLOR.

FOR ELECTRIC TOOTHBRUSHES (U.S. CLS. 2, 13, 23, 29, 30, 33, 40 AND 50).
FIRST USE 2-11-2009; IN COMMERCE 2-11-2009.



3,681,177. DEXTER-RUSSELL, INC., SOUTHBRIDGE, MA. SN 77-540,189. PUB. 12-30-2008, FILED 8-6-2008.

COOL BLUE

THE MARK CONSISTS OF STANDARD CHARACTERS WITHOUT CLAIM TO ANY PARTICULAR FONT, STYLE, SIZE, OR COLOR.

FOR COOKING UTENSILS, NAMELY, TURNERS (U.S. CLS. 2, 13, 23, 29, 30, 33, 40 AND 50).
FIRST USE 2-0-2009; IN COMMERCE 2-0-2009.



3,681,271. JEAN-CLAUDE BOISSET WINES USA, INC., SAUSALITO, CA. SN 77-577,665. PUB. 2-10-2009, FILED 9-24-2008.

BARREL-TO-BARREL

THE MARK CONSISTS OF STANDARD CHARACTERS WITHOUT CLAIM TO ANY PARTICULAR FONT, STYLE, SIZE, OR COLOR.

FOR SERVING CONTAINERS FOR WINES (U.S. CLS. 2, 13, 23, 29, 30, 33, 40 AND 50).
FIRST USE 7-6-2009; IN COMMERCE 7-6-2009.

CLASS 21—(Continued).

3,681,411. RANIR, LLC, GRAND RAPIDS, MI. SN 77-640,362.
PUB. 3-31-2009, FILED 12-29-2008.

EasySpin

THE MARK CONSISTS OF STANDARD CHARACTERS WITHOUT CLAIM TO ANY PARTICULAR FONT, STYLE, SIZE, OR COLOR.

FOR ELECTRIC TOOTHBRUSHES (U.S. CLS. 2, 13, 23, 29, 30, 33, 40 AND 50).

FIRST USE 2-26-2009; IN COMMERCE 2-26-2009.

3,681,451. EARL, ROBERT I., ORLANDO, FL. SN 78-345,662.
PUB. 5-9-2006, FILED 12-26-2003.

CHEFS OF THE WORLD

THE MARK CONSISTS OF STANDARD CHARACTERS WITHOUT CLAIM TO ANY PARTICULAR FONT, STYLE, SIZE, OR COLOR.

NO CLAIM IS MADE TO THE EXCLUSIVE RIGHT TO USE "CHEFS", APART FROM THE MARK AS SHOWN.

FOR NON-METAL FOOD CONTAINERS; HOUSEHOLD KITCHEN UTENSILS, NAMELY, SPATULAS, WHISKS, PASTRY CUTTERS, BASTERS, DISHWASHING BRUSHES, FLOUR SIFTERS, CUTTING BOARDS; SERVING VESSELS, NAMELY, PLATTERS, TRAYS NOT OF PRECIOUS METAL, DISHES, BOWLS; COOKING VESSELS AND DINNERWARE, NAMELY, POTS, PANS, SAUCEPANS, NON-ELECTRIC WOKS (U.S. CLS. 2, 13, 23, 29, 30, 33, 40 AND 50).

FIRST USE 6-15-2009; IN COMMERCE 6-15-2009.

CLASS 22—CORDAGE AND FIBERS

CLASS 22—(Continued).

3,681,388. WHITE, RICK M., HERMOSA BEACH, CA. SN 77-617,846. PUB. 3-31-2009, FILED 11-19-2008.



THE MARK CONSISTS OF A SIDE SILHOUETTE OF A YOUNG TRAVELER.

FOR LAUNDRY BAGS (U.S. CLS. 1, 2, 7, 19, 22, 42 AND 50).

FIRST USE 6-1-2006; IN COMMERCE 4-1-2007.

CLASS 23—YARNS AND THREADS

3,680,772. SPOSTO, JORGE, MONTEVIDEO, URUGUAY. SN 77-425,211. PUB. 3-3-2009, FILED 3-18-2008.

Punta Yarns

THE MARK CONSISTS OF STANDARD CHARACTERS WITHOUT CLAIM TO ANY PARTICULAR FONT, STYLE, SIZE, OR COLOR.

OWNER OF U.S. REG. NO. 3,266,907.

NO CLAIM IS MADE TO THE EXCLUSIVE RIGHT TO USE "YARNS", APART FROM THE MARK AS SHOWN.

THE FOREIGN WORDING IN THE MARK TRANSLATES INTO ENGLISH AS "INNOVATION".

FOR YARNS (U.S. CL. 43).

FIRST USE 5-15-2008; IN COMMERCE 5-15-2008.

3,680,773. SPOSTO, JORGE, MONTEVIDEO, URUGUAY. SN 77-425,411. PUB. 3-10-2009, FILED 3-18-2008.



OWNER OF U.S. REG. NO. 3,266,907.

NO CLAIM IS MADE TO THE EXCLUSIVE RIGHT TO USE "YARNS" AND "URUGUAYAN NATURAL SPUN",

CLASS 23—(Continued).

APART FROM THE MARK AS SHOWN.
 THE COLOR(S) BLUE, WHITE IS/ARE CLAIMED AS A FEATURE OF THE MARK.
 THE MARK CONSISTS OF THE COLORS BLUE AND WHITE, WITH THE COLOR WHITE USED FOR THE WORDING, WHICH APPEARS AGAINST A BLUE RECTANGLE BACKGROUND. SCATTERED OVER THE WORDS "PUNTA YARNS" ARE CLOUD OR THREAD LIKE DESIGNS WHICH APPEAR BLUE AGAINST THE WHITE WORDING AND WHITE AGAINST THE BLUE BACKGROUND.
 THE FOREIGN WORDING IN THE MARK TRANSLATES INTO ENGLISH AS "INNOVATION".
 FOR YARNS (U.S. CL. 43).
 FIRST USE 5-18-2008; IN COMMERCE 5-18-2008.

CLASS 24—(Continued).

3,680,169. ORVIS, SUSAN, TORRANCE, CA. SN 77-048,615.
 PUB. 6-26-2007, FILED 11-21-2006.

3,681,180. TEIKEN LIMITED, CHUO-KU, OSAKA, JAPAN.
 SN 77-543,929. PUB. 12-23-2008, FILED 8-11-2008.



TEVIRON

THE MARK CONSISTS OF STANDARD CHARACTERS WITHOUT CLAIM TO ANY PARTICULAR FONT, STYLE, SIZE, OR COLOR.
 OWNER OF U.S. REG. NO. 673,598.
 FOR YARNS AND THREADS OF SYNTHETIC FIBERS (U.S. CL. 43).
 FIRST USE 8-15-2002; IN COMMERCE 8-15-2002.

THE MARK CONSISTS OF A VERTICAL RECTANGLE WITH THE HEAD OF A DOG AND THE STYLIZED TEXT OF THE WORDING "DUMBFLAG".
 FOR CLOTH FLAGS (U.S. CLS. 42 AND 50).
 FIRST USE 12-4-2007; IN COMMERCE 12-4-2007.

CLASS 24—FABRICS

3,680,104. HASBRO, INC., PAWTUCKET, RI. SN 76-677,368.
 PUB. 2-19-2008, FILED 5-24-2007.

3,680,798. HOMTEX, INC., VINEMONT, AL. SN 77-437,867.
 PUB. 8-19-2008, FILED 4-2-2008.

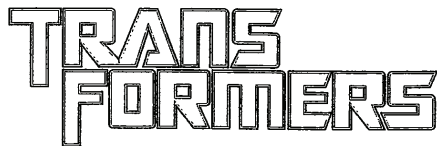

FOR TEXTILE AND TEXTILE GOODS, NAMELY, BATH LINEN, BED BLANKETS, BED LINEN, BED SHEETS, BED SPREADS, CURTAINS, DRAPERIES, TOWELS, PILLOW SHAMS, PLACE MATS NOT OF PAPER (U.S. CLS. 42 AND 50).
 FIRST USE 5-17-2007; IN COMMERCE 5-17-2007.

EUROFIT

THE MARK CONSISTS OF STANDARD CHARACTERS WITHOUT CLAIM TO ANY PARTICULAR FONT, STYLE, SIZE, OR COLOR.
 FOR BED COVERINGS, NAMELY, BED SHEETS, PILLOW CASES, MATTRESS COVERS, MATTRESS PADS, COMFORTERS AND BLANKETS (U.S. CLS. 42 AND 50).
 FIRST USE 6-22-2009; IN COMMERCE 6-22-2009.

CLASS 24—(Continued).

3,680,891. ARNHOELTER, KRISTEN, LOS ANGELES, CA. SN 77-466,515. PUB. 10-7-2008, FILED 5-6-2008.

The Official Curly Girl Towel

THE MARK CONSISTS OF STANDARD CHARACTERS WITHOUT CLAIM TO ANY PARTICULAR FONT, STYLE, SIZE, OR COLOR.

NO CLAIM IS MADE TO THE EXCLUSIVE RIGHT TO USE "TOWEL", APART FROM THE MARK AS SHOWN.

FOR TOWEL MADE OF 100% COTTON FABRIC, SPECIFICALLY DESIGNED TO USE WITH NATURALLY CURLY HAIR, ELIMINATING FRIZZ, ENCOURAGING MAXIMUM CURL FORMATION, AND REDUCING DRYING TIME (U.S. CLS. 42 AND 50).

FIRST USE 5-1-2009; IN COMMERCE 5-1-2009.

3,680,953. ACADEMY, LTD., KATY, TX. SN 77-474,268. PUB. 10-14-2008, FILED 5-14-2008.

O'RAGEOUS

THE MARK CONSISTS OF STANDARD CHARACTERS WITHOUT CLAIM TO ANY PARTICULAR FONT, STYLE, SIZE, OR COLOR.

FOR BEACH TOWELS (U.S. CLS. 42 AND 50).

FIRST USE 8-8-2008; IN COMMERCE 8-8-2008.

3,681,014. J.R. UNITED INDUSTRIES, INC., MIAMI, FL. SN 77-484,672. PUB. 10-21-2008, FILED 5-28-2008.

J.R. UNITED AT HOME

THE MARK CONSISTS OF STANDARD CHARACTERS WITHOUT CLAIM TO ANY PARTICULAR FONT, STYLE, SIZE, OR COLOR.

FOR BATH TOWELS; BEACH TOWELS; BED AND TABLE LINEN; BED BLANKETS; BED COVERS; BED SHEETS; BED SKIRTS; BED SPREADS; CHILDREN'S TOWELS; COVERLETS; FACE TOWELS; HAND TOWELS; HAND TOWELS OF TEXTILE; HOODED TOWELS; LARGE BATH TOWELS; SILK BED BLANKETS; TERRY TOWELS; TOWEL SETS (U.S. CLS. 42 AND 50).

FIRST USE 9-1-2008; IN COMMERCE 9-1-2008.

CLASS 24—(Continued).

3,681,160. FABRICUT, INC., TULSA, OK. SN 77-533,683. PUB. 1-13-2009, FILED 7-29-2008.



NO CLAIM IS MADE TO THE EXCLUSIVE RIGHT TO USE "ENVIRONMENT", APART FROM THE MARK AS SHOWN.

THE MARK CONSISTS OF THE LETTER E WITH A LEAF INSIDE THE TOP PORTION OF IT AND THE WORDS ENVIRONMENT PLUS CURVING AROUND THE BOTTOM.

FOR FABRICS FOR UPHOLSTERY, DRAPERY, BEDSPREADS AND DECORATIVE APPLICATIONS; WOVEN AND NON-WOVEN FABRICS FOR HOME AND COMMERCIAL INTERIORS (U.S. CLS. 42 AND 50).

FIRST USE 1-31-2008; IN COMMERCE 5-31-2008.

3,681,325. BARROW INDUSTRIES INC., NORWOOD, MA. SN 77-594,291. PUB. 3-10-2009, FILED 10-16-2008.



OWNER OF U.S. REG. NOS. 1,465,540, 2,414,468, AND OTHERS.

THE MARK CONSISTS OF THE LETTER "B" SHOWN ON A RECTANGULAR BACKGROUND HAVING ZIGZAG EDGES AND SUGGESTING A PIECE OF FABRIC CUT WITH PINKING SHEARS, WITH THE WORD "BARROW" SHOWN BENEATH.

FOR FABRICS FOR THE MANUFACTURE OF UPHOLSTERY, DRAPERIES AND FURNITURE SLIPCOVERS; TEXTILE FABRICS FOR HOME AND COMMERCIAL INTERIORS (U.S. CLS. 42 AND 50).

FIRST USE 3-15-2009; IN COMMERCE 3-15-2009.

CLASS 24—(Continued).

3,681,526. SURFACE, PARK RIDGE, NJ. SN 78-683,749. PUB. 4-25-2006, FILED 8-2-2005.

CLASS 25—(Continued).

3,680,066. BILLINGSLEY, SHERMANE JOY, NEW YORK, NY. SN 76-071,324. PUB. 5-2-2006, FILED 6-13-2000.

seaweaves

THE MARK CONSISTS OF STANDARD CHARACTERS WITHOUT CLAIM TO ANY PARTICULAR FONT, STYLE, SIZE, OR COLOR.

FOR BATH LINEN; BATH MITTS; BATH SHEETS; BATH TOWELS; BED BLANKETS; BED LINEN; BED SHEETS; BED SKIRTS; BED SPREADS; BLANKET THROWS; COMFORTERS; COVERLETS; CURTAINS; CURTAINS MADE OF TEXTILE FABRICS; DINING LINENS; DUVET COVERS; DUVETS; FABRIC TABLE RUNNERS; FACE TOWELS MADE OF TEXTILE MATERIALS; HAND TOWELS; HAND TOWELS OF TEXTILE; HAND-TOWELS MADE OF TEXTILE FABRICS; KITCHEN LINENS; KITCHEN TOWELS; LARGE BATH TOWELS; PILLOW CASES; PILLOW COVERS; PILLOW SHAMS; PILLOWCASES PILLOW SLIPS; PLACE MATS OF TEXTILE MATERIAL; PLASTIC PLACE MATS; SHOWER CURTAINS; SILK BED BLANKETS; SILK BLANKETS; TABLE CLOTHS NOT OF PAPER; TABLE LINEN; TABLE LINEN, NAMELY, COASTERS; TABLE MATS NOT OF PAPER; TEA TOWELS; TERRY TOWELS; TEXTILE NAPKINS; TEXTILE PLACE MATS; TEXTILE PRINTERS' BLANKETS; THROWS; TOWELS; TOWELS OF TEXTILE; VINYL PLACE MATS; WASH CLOTHS; WOOLLEN BLANKETS (U.S. CLS. 42 AND 50).
FIRST USE 7-13-2009; IN COMMERCE 7-13-2009.

CLASS 25—CLOTHING

3,680,065. BILLINGSLEY, SHERMANE JOY, NEW YORK, NY. SN 76-071,323. PUB. 5-2-2006, FILED 6-13-2000.

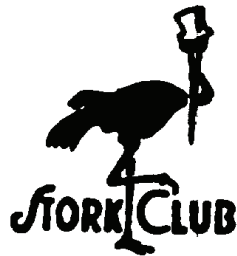

OWNER OF U.S. REG. NOS. 1,136,461, 1,368,856, AND 2,411,629.
FOR NECKTIES, SUSPENDERS, BELTS (U.S. CLS. 22 AND 39).
FIRST USE 2-24-2009; IN COMMERCE 2-24-2009.

STORK CLUB

OWNER OF U.S. REG. NOS. 1,136,461, 2,235,577, AND OTHERS.
FOR NECKTIES, SUSPENDERS, BELTS (U.S. CLS. 22 AND 39).
FIRST USE 2-24-2009; IN COMMERCE 2-24-2009.

3,680,070. KNIGHT CORPORATION, HONOLULU, HI. SN 76-313,960. PUB. 5-2-2006, FILED 9-18-2001.

BEVERLY HILLS GOLF CLUB

OWNER OF U.S. REG. NOS. 1,382,891, 2,130,807, AND OTHERS.
NO CLAIM IS MADE TO THE EXCLUSIVE RIGHT TO USE "GOLF CLUB", APART FROM THE MARK AS SHOWN.
FOR CLOTHING, NAMELY, SHIRTS, SHORTS, AND T-SHIRTS (U.S. CLS. 22 AND 39).
FIRST USE 12-9-2008; IN COMMERCE 12-9-2008.

3,680,081. ARMOUTH INTERNATIONAL INC., BROOKLYN, NY. SN 76-631,094. PUB. 11-29-2005, FILED 2-11-2005.

BEAR RIVER

THE MARK CONSISTS OF STANDARD CHARACTERS WITHOUT CLAIM TO ANY PARTICULAR FONT, STYLE, SIZE, OR COLOR.
FOR OUTERWEAR, NAMELY, THERMAL UNDERWEAR, SWEAT SHIRTS, SWEAT PANTS; FLANNEL SHIRTS, FLANNEL PAJAMAS, FLEECE PANTS, FLEECE SHIRTS, FLEECE JACKETS, AND QUILTED SHIRTS (U.S. CLS. 22 AND 39).
FIRST USE 5-0-2005; IN COMMERCE 5-0-2005.

CLASS 25—(Continued).

3,680,100. NIESSEN, CHRISTIAN, NEW YORK, NY. SN 76-675,421. PUB. 4-15-2008, FILED 4-12-2007.

NO EDITIONS

THE MARK CONSISTS OF STANDARD CHARACTERS WITHOUT CLAIM TO ANY PARTICULAR FONT, STYLE, SIZE, OR COLOR.

FOR CLOTHING AND APPAREL, NAMELY, PANTS, DRESSES, TOPS, SHIRTS, TIES, OUTERWEAR, JERSEYS, HEADWEAR, SCARVES, COATS, RAIN JACKETS, SWEATSHIRTS (U.S. CLS. 22 AND 39).

FIRST USE 10-25-2007; IN COMMERCE 10-25-2007.

3,680,105. LISSE GROUP (INTERNATIONAL) COMPANY LIMITED, SAN PO KONG, KOWLOON, HONG KONG. SN 76-679,355. PUB. 12-25-2007, FILED 7-10-2007.



Fil Doux

THE ENGLISH TRANSLATION OF "FIL DOUX" IN THE MARK IS "SOFT WIRE".

FOR MEN'S AND WOMEN'S KNITWEAR APPAREL AND ACCESSORIES, NAMELY, T-SHIRT, SHIRTS, PANTS, JACKETS, SWEATERS, SWEATSHIRTS, SKIRTS, DRESSES, TANK TOPS, CLOTHING TIES, SCARVES (U.S. CLS. 22 AND 39).

FIRST USE 10-4-2006; IN COMMERCE 7-1-2008.

3,680,121. BIGGS AND FEATHERBELLE, LLC, GAMBRILLS, MD. SN 76-686,420. PUB. 6-17-2008, FILED 2-1-2008.

BIGGS & FEATHERBELLE

THE MARK CONSISTS OF STANDARD CHARACTERS WITHOUT CLAIM TO ANY PARTICULAR FONT, STYLE, SIZE, OR COLOR.

FOR CLOTHING, NAMELY, SHIRTS AND HATS (U.S. CLS. 22 AND 39).

FIRST USE 3-1-2008; IN COMMERCE 3-1-2008.

CLASS 25—(Continued).

3,680,132. FUKUHARA, RYAN, FOREST GROVE, OR. SN 76-689,739. PUB. 10-28-2008, FILED 5-19-2008.



THE MARK CONSISTS OF THE WORDING "HIST8" REPEATED THREE TIMES VERTICALLY IN A PAINT DRIP GRAFFITI FONT WITH TWO DIAGONAL LINES TO EACH SIDE OF THE MIDDLE "HIST8".

FOR HAWAIIAN-THEMED URBAN CLOTHING, NAMELY, SHIRTS, SHORTS, T-SHIRTS, HATS, TANK TOPS, POLO SHIRTS, AND JERSEYS (U.S. CLS. 22 AND 39).

FIRST USE 3-15-2009; IN COMMERCE 5-15-2009.

3,680,140. LANCE ARMSTRONG FOUNDATION, AUSTIN, TX. SN 77-003,373. PUB. 5-8-2007, FILED 9-20-2006.

LIVESTRONG

THE MARK CONSISTS OF STANDARD CHARACTERS WITHOUT CLAIM TO ANY PARTICULAR FONT, STYLE, SIZE, OR COLOR.

OWNER OF U.S. REG. NO. 3,052,284.
FOR GLOVES; JOGGING PANTS; JOGGING SUITS; SCARVES; SHOES; TRACK SUITS; WARM UP SUITS (U.S. CLS. 22 AND 39).

FIRST USE 11-30-2007; IN COMMERCE 11-30-2007.

3,680,145. PRIMO LUXE, LONG ISLAND CITY, NY. SN 77-006,717. PUB. 12-11-2007, FILED 9-25-2006.

Primo Luxe

FOR GLOVES INCLUDING THOSE MADE OF SKIN, HIDE OR FUR (U.S. CLS. 22 AND 39).

FIRST USE 7-1-2008; IN COMMERCE 7-1-2008.

CLASS 25—(Continued).

3,680,146. M.J. SOFFE, LLC, FAYETTEVILLE, NC. SN 77-012,671. PUB. 11-6-2007, FILED 10-3-2006.



OWNER OF U.S. REG. NOS. 1,743,249 AND 3,053,916.
NO CLAIM IS MADE TO THE EXCLUSIVE RIGHT TO USE "DRY", APART FROM THE MARK AS SHOWN.
THE COLOR(S) RED AND BLUE IS/ARE CLAIMED AS A FEATURE OF THE MARK.

THE MARK CONSISTS OF THE WORD "SOFFE" WRITTEN IN RED CAPITAL LETTERS ANGLED UPWARDS FROM RIGHT TO LEFT WITH TWO HORIZONTAL BLUE LINES ABOVE AND BELOW THE WORD "SOFFE" AND THE WORD "DRI" WRITTEN IN BLUE LOWER CASE LETTERS BELOW THE WORD "SOFFE" WITH A BLUE SWEAT DROP NEXT TO THE WORD DRI.

FOR CLOTHING, NAMELY, T-SHIRTS, SHORTS, SWEAT SHORTS, TANK TOPS, WARM UP SUITS, AND POLO SHIRTS (U.S. CLS. 22 AND 39).

FIRST USE 3-1-2007; IN COMMERCE 3-1-2007.

3,680,173. NEW YORK-NEW YORK HOTEL & CASINO, LLC, LAS VEGAS, NV. SN 77-054,323. PUB. 8-14-2007, FILED 11-30-2006.

**NEW YORK
NEW YORK**
HOTEL & CASINO - LAS VEGAS

OWNER OF U.S. REG. NOS. 2,436,898, 2,915,641, AND OTHERS.

NO CLAIM IS MADE TO THE EXCLUSIVE RIGHT TO USE "HOTEL & CASINO" AND "LAS VEGAS", APART FROM THE MARK AS SHOWN.

THE MARK CONSISTS OF THE STYLIZED WORDS "NEW YORK" OVER THE STYLIZED WORDS "NEW YORK" WHICH IS CENTERED OVER THE STYLIZED WORDS "HOTEL & CASINO - LAS VEGAS".

FOR WEARING APPAREL, NAMELY, SHIRTS, T-SHIRTS, POLO SHIRTS, GOLF SHIRTS, TANK TOPS, SWEATERS, SHORTS, NIGHTSHIRTS, ROBES, UNDERGARMENTS, LEOTARDS, HATS, CAPS, VISORS, JACKETS, WARM-UP SUITS, JOGGING SUITS, SWEATSHIRTS, SWEAT PANTS, BEACH WEAR, NAMELY, BATHING SUITS, BEACH COVERALLS AND SANDALS (U.S. CLS. 22 AND 39).

FIRST USE 11-0-2008; IN COMMERCE 11-0-2008.

CLASS 25—(Continued).

3,680,214. LEGEND & LORE COUTURE INC., BROOKLYN, NY. SN 77-133,857. PUB. 9-18-2007, FILED 3-18-2007.

Legend & Lore Couture

THE MARK CONSISTS OF STANDARD CHARACTERS WITHOUT CLAIM TO ANY PARTICULAR FONT, STYLE, SIZE, OR COLOR.

NO CLAIM IS MADE TO THE EXCLUSIVE RIGHT TO USE "COUTURE", APART FROM THE MARK AS SHOWN.

FOR KNIT SHIRTS; OPEN-NECKED SHIRTS; PIQUE SHIRTS; POLO SHIRTS; SHORT-SLEEVED OR LONG-SLEEVED T-SHIRTS; SHORT-SLEEVED SHIRTS; SPORTS SHIRTS; SPORTS SHIRTS WITH SHORT SLEEVES; SWEAT SHIRTS; T-SHIRTS; DRESSES; EVENING DRESSES; SKIRTS AND DRESSES; LEATHER BELTS; LEATHER COATS; LEATHER HEADWEAR; LEATHER JACKETS; LEATHER PANTS; LEATHER SHOES; LEATHER SLIPPERS; ATHLETIC SHOES; BALLET SHOES; BEACH SHOES; CANVAS SHOES; DECKSHOES; INFANTS' SHOES AND BOOTS; INSOLES; RUNNING SHOES; SHOES; WOMEN'S SHOES; DRESS SHIRTS; MOCK TURTLE-NECK SWEATERS; SWEATERS; TURTLENECK SWEATERS; V-NECK SWEATERS; FUR HATS; HATS; BRIEFS; KNITTED UNDERWEAR; LADIES' UNDERWEAR; PERSPIRATION ABSORBENT UNDERWEAR CLOTHING; THERMAL UNDERWEAR; THONGS; UNDERWEAR; WOMEN'S UNDERWEAR; WOVEN OR KNITTED UNDERWEAR; BRAS; FITTED SWIMMING COSTUMES WITH BRA CUPS; SPORTS BRA; STRAPLESS BRAS; STRAPS FOR BRAS (U.S. CLS. 22 AND 39).

FIRST USE 5-15-2008; IN COMMERCE 6-1-2008.

3,680,228. WORTHEN, MICHELLE I., MUSKOGEE, OK. SN 77-144,778. PUB. 10-2-2007, FILED 3-30-2007.

FOR CLOTHING, NAMELY, SWEATERS, STOCKINGS, VISORS, BRAS, GIRDLES, UNDERWEAR, PAJAMAS, LINGERIE, SHOES, HATS, DRESSES, PANTS, SHIRTS, T-SHIRTS, SKIRTS, SHORTS, JACKETS, COATS, SOCKS, AND BLOUSES (U.S. CLS. 22 AND 39).

FIRST USE 6-22-2009; IN COMMERCE 6-22-2009.

CLASS 25—(Continued).

3,680,240. KRASS, EDGAR B., BRANDON, FL. SN 77-150,847.
PUB. 4-1-2008, FILED 4-6-2007.

ONE-ON-ONE DOUBLES

THE MARK CONSISTS OF STANDARD CHARACTERS WITHOUT CLAIM TO ANY PARTICULAR FONT, STYLE, SIZE, OR COLOR.

OWNER OF U.S. REG. NO. 3,043,596.

FOR CLOTHING, NAMELY, SHIRTS, T-SHIRTS, TANK TOPS, SWEATSHIRTS, PANTS, SWEATPANTS, SHORTS, WARM-UP SUITS, JACKETS, HATS AND SOCKS (U.S. CLS. 22 AND 39).

FIRST USE 3-18-2007; IN COMMERCE 3-18-2007.

3,680,255. RICHARDSON, ED, CHARLOTTE, NC. SN 77-158,040. PUB. 12-11-2007, FILED 4-16-2007.

**Hate the Player . . . Love
the Game**

THE MARK CONSISTS OF STANDARD CHARACTERS WITHOUT CLAIM TO ANY PARTICULAR FONT, STYLE, SIZE, OR COLOR.

FOR CLOTHING, NAMELY, SHIRTS, T-SHIRTS, POLO SHIRTS, BUTTON DOWN SHIRTS, LONG AND SHORT SLEEVED SHIRTS, SWEAT SHIRTS, NIGHT SHIRTS, TANK TOPS, BLOUSES, SPAGHETTI STRAP SHIRTS, TUBE TOPS, DRESSES, SKIRTS, BATHING SUITS, BIKINI TOPS, BIKINIS, TIGHTS, ATHLETIC JERSEYS, JUMPERS, TRACK SUITS, PANTS, SWEAT PANTS, DRESS PANTS, JEANS, KHAKIS, SHORTS, UNDERWEAR, THONGS, COATS, JACKETS, VESTS, SWEATERS, HATS, CAPS, BANDANNAS, DO-RAGS, VISORS, BEANIES, HEADBANDS, FOOTWEAR, SHOES, SANDALS, BOOTS, SLIPPERS, SOCKS, LEG WARMERS, ARM WARMERS, WRISTBANDS, BELTS, TIES, GLOVES, SCARVES, AND SWIM WEAR (U.S. CLS. 22 AND 39).

FIRST USE 1-3-2009; IN COMMERCE 1-3-2009.

CLASS 25—(Continued).

3,680,269. DANIEL VERROCHI, CANTON, MA. SN 77-165,065. PUB. 10-23-2007, FILED 4-25-2007.

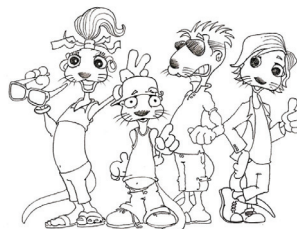

THE MARK CONSISTS OF FOUR CARTOON-STYLE OTTERS, DRESSED AND POSED LIKE PEOPLE, WITH TWO MALE, TWO FEMALES, WITH HUMAN-LIKE EXPRESSIONS. FROM LEFT TO RIGHT: A TALL FEMALE OTTER, WITH A PONY-TAIL HAIR-DO, MINI SHIRT, SHORTS EARRINGS, SANDALS, A BRACELET AND RIBBONS IN HER HAIR, HOLDING SUNGLASSES IN HER RIGHT HAND AND GIVING THE PEACE SIGN WITH THE LEFT; A SHORT MALE OTTER WEARING A BACKWARDS BASEBALL CAP, TANK-STYLE SHIRT, BAGGY JEANS, AND SNEAKERS, HOLDING UP ONE FINGER ON HIS LEFT HAND; A MALE OTTER WEARING SUNGLASSES, A COLLARED SHIRT, CARGO SHORTS AND SANDALS, POSED IN THREE-QUARTER PROFILE; AND A FEMALE OTTER WEARING A JACKET, T-SHIRT, PANTS AND SHOES, AND GIVING THE THUMB'S UP SIGN WITH HER LEFT HAND.

FOR SHIRTS; T-SHIRTS; SHOES; CAPS; JERSEYS; TOPS (U.S. CLS. 22 AND 39).

FIRST USE 3-9-2009; IN COMMERCE 3-9-2009.

3,680,272. MASON, DEREK, OAKLAND, CA. SN 77-166,718.
PUB. 10-23-2007, FILED 4-26-2007.

Stay Fitted



THE MARK CONSISTS OF A SILHOUETTE OF A MAN WITH THE WORDS "STAY FITTED" LOCATED ABOVE THE FIGURE.

FOR MEN'S, WOMEN'S AND CHILDREN'S CLOTHING, NAMELY, SHIRTS (U.S. CLS. 22 AND 39).

FIRST USE 7-14-2009; IN COMMERCE 7-14-2009.

CLASS 25—(Continued).

3,680,397. THE TRUSTEES OF THE CRYSTAL ROCK OLGA AUDIGIER IRREVOCABLE TRUST, A CALIFORNIA TRUST, THE TRUSTEES COMPRISING VINCENT AUDIGIER, A FRENCH CITIZEN, AND BLAISE E. ABERGEL, A FRENCH CITIZEN, BEVERLY HILLS, CA. SN 77-261,161. PUB. 10-28-2008, FILED 8-21-2007.

CRYSTAL ROCK BY CHRISTIAN
AUDIGIER

THE MARK CONSISTS OF STANDARD CHARACTERS WITHOUT CLAIM TO ANY PARTICULAR FONT, STYLE, SIZE, OR COLOR.

FOR CLOTHING, NAMELY, T-SHIRTS, DRESSES, JACKETS (U.S. CLS. 22 AND 39).

FIRST USE 12-0-2007; IN COMMERCE 12-0-2007.

3,680,399. KIRSTIE PIKES, GUNNISON, CO. SN 77-265,968. PUB. 3-18-2008, FILED 8-28-2007.

PROIS

THE MARK CONSISTS OF STANDARD CHARACTERS WITHOUT CLAIM TO ANY PARTICULAR FONT, STYLE, SIZE, OR COLOR.

THE WORDING "PROIS" HAS NO MEANING IN A FOREIGN LANGUAGE.

FOR JACKETS; PANTS; SHIRTS; VESTS; HEADGEAR, NAMELY, CAPS, HATS AND BEANIES; SWEATERS; COATS; SOCKS; THERMAL SOCKS; WOOLLEN SOCKS; GLOVES (U.S. CLS. 22 AND 39).

FIRST USE 2-1-2008; IN COMMERCE 2-1-2008.

3,680,417. RAGS UNLIMITED INC, GASTONIA, NC. SN 77-284,133. PUB. 3-11-2008, FILED 9-20-2007.

OBC

THE MARK CONSISTS OF STANDARD CHARACTERS WITHOUT CLAIM TO ANY PARTICULAR FONT, STYLE, SIZE, OR COLOR.

FOR ORANGE SKID RESISTANT BOOT AND SHOE COVER (U.S. CLS. 22 AND 39).

FIRST USE 3-30-2007; IN COMMERCE 3-30-2007.

CLASS 25—(Continued).

3,680,421. A. KIRSCH COMPANY LLC, WEST BLOOMFIELD, MI. SN 77-286,998. PUB. 3-11-2008, FILED 9-24-2007.

TOH!Z

THE MARK CONSISTS OF STANDARD CHARACTERS WITHOUT CLAIM TO ANY PARTICULAR FONT, STYLE, SIZE, OR COLOR.

FOR FOOTWEAR FOR WOMEN; WOMEN'S SHOES; SHOES (U.S. CLS. 22 AND 39).

FIRST USE 11-25-2008; IN COMMERCE 11-25-2008.

3,680,448. BLUE MARTINI RED MARTINI, INC., PRINCETON, NJ. SN 77-299,807. PUB. 4-1-2008, FILED 10-9-2007.

WMD Women Making Decisions

THE MARK CONSISTS OF STANDARD CHARACTERS WITHOUT CLAIM TO ANY PARTICULAR FONT, STYLE, SIZE, OR COLOR.

FOR APRONS; BLOUSES; JACKETS; JEANS; SHOES; T-SHIRTS; TOPS (U.S. CLS. 22 AND 39).

FIRST USE 9-8-2007; IN COMMERCE 10-10-2007.

CLASS 25—(Continued).

3,680,457. AMERICAN SPECIALTY HEALTH INCORPORATED, SAN DIEGO, CA. SN 77-302,068. PUB. 3-11-2008, FILED 10-11-2007.



THE COLOR(S) BLUE, LIGHT BLUE AND WHITE IS/ARE CLAIMED AS A FEATURE OF THE MARK.

THE MARK CONSISTS OF THE WORD "FIT" IN LARGE WHITE TYPE WITH A BLUE ARROW WITHIN THE LETTER "F" ABOVE THE WORDS "FITNESS IS TIMELESS." IN SMALLER WHITE TYPE EXCEPT THAT THE "F" IN "FITNESS", THE "I" IN "IS", AND THE "T" IN "TIMELESS" ARE IN LIGHT BLUE FONT; AND, ALL OF THE WORDS ARE SET IN A BLUE BACKGROUND.

FOR T-SHIRTS (U.S. CLS. 22 AND 39).
FIRST USE 10-11-2007; IN COMMERCE 1-1-2008.

3,680,490. ROC, LLC, FRANKLIN, TN. SN 77-315,585. PUB. 10-14-2008, FILED 10-29-2007.

REAL ORIGINAL COLORS

THE MARK CONSISTS OF STANDARD CHARACTERS WITHOUT CLAIM TO ANY PARTICULAR FONT, STYLE, SIZE, OR COLOR.

FOR CLOTHING, NAMELY, JACKETS, PANTS, SHORTS, DRESSES, SKIRTS, BLOUSES, AND TIES (U.S. CLS. 22 AND 39).
FIRST USE 5-1-2008; IN COMMERCE 6-1-2008.

CLASS 25—(Continued).

3,680,497. MCERON LTD., KOWLOON, HONG KONG. SN 77-318,037. PUB. 4-22-2008, FILED 10-31-2007.

DEGLINGOS

THE MARK CONSISTS OF STANDARD CHARACTERS WITHOUT CLAIM TO ANY PARTICULAR FONT, STYLE, SIZE, OR COLOR.

FOR SHIRTS; T-SHIRTS; SHORTS; PANTS; JACKETS; HATS; FOOTWEAR (U.S. CLS. 22 AND 39).
FIRST USE 5-27-2009; IN COMMERCE 5-27-2009.

3,680,511. PEEKABOO KIDS CLUB, LLC, SAN FRANCISCO, CA. SN 77-322,499. PUB. 4-15-2008, FILED 11-6-2007.

PEEKADOODLE

THE MARK CONSISTS OF STANDARD CHARACTERS WITHOUT CLAIM TO ANY PARTICULAR FONT, STYLE, SIZE, OR COLOR.

FOR CLOTHING AND FOOTWEAR FOR CHILDREN AND INFANTS, NAMELY, ATHLETIC SHOES, BABY BIBS NOT OF PAPER, BABY PANTS, BLOUSES, BODY SUITS, BOOTIES, CARDIGANS, CAPS, COATS, DIAPER PANTS, DRESSES, EXERCISE SUITS, FOOTWEAR, GLOVES, GOWNS, GYM SUITS, HATS, INFANT ONE PIECE UNDERWEAR AND OUTERWEAR, JACKETS, JEANS, JOGGING SUITS, JUMPERS, LEGGINGS, LEOTARDS, LOUNGEWEAR, OVERALLS, PANTS, POLO SHIRTS, ROBES, SACKS FOR INFANTS, SANDALS, SHIRTS, SHOES, SHORTS, SKIRTS, SLEEPWEAR, SLIPPERS, SMOCKS, SNEAKERS, SOCKS, SPORT SHIRTS, SWEATERS, SWEATSHIRTS, T-SHIRTS, TIGHTS, UNDERWEAR, WARM-UP SUITS (U.S. CLS. 22 AND 39).
FIRST USE 2-1-2008; IN COMMERCE 4-15-2008.

3,680,515. SEARS BRANDS, LLC, HOFFMAN ESTATES, IL. SN 77-322,859. PUB. 4-15-2008, FILED 11-6-2007.

ATTENTION

THE MARK CONSISTS OF STANDARD CHARACTERS WITHOUT CLAIM TO ANY PARTICULAR FONT, STYLE, SIZE, OR COLOR.

FOR FOOTWEAR (U.S. CLS. 22 AND 39).
FIRST USE 2-0-2009; IN COMMERCE 2-0-2009.

CLASS 25—(Continued).

3,680,517. CONWAY STORES, INC., NEW YORK, NY. SN 77-323,746. PUB. 4-22-2008, FILED 11-7-2007.

OUT OF ORDER

THE MARK CONSISTS OF STANDARD CHARACTERS WITHOUT CLAIM TO ANY PARTICULAR FONT, STYLE, SIZE, OR COLOR.

FOR MEN'S, LADY'S AND CHILDREN'S APPAREL, NAMELY, PANTS, SHIRTS, SKIRTS, SLACKS, JEANS, BLOUSES, COATS, JACKETS, T-SHIRTS, SOCKS, UNDERWEAR, TANK TOPS, SLEEP WEAR, ROBES, SWEATSHIRTS, SWEATERS AND LINGERIE (U.S. CLS. 22 AND 39).

FIRST USE 2-1-2009; IN COMMERCE 2-1-2009.

3,680,525. LIME, JOANN M., GLEN ELLEN, CA. SN 77-326,739. PUB. 10-14-2008, FILED 11-11-2007.

CLARY SAGE ORGANICS

THE MARK CONSISTS OF STANDARD CHARACTERS WITHOUT CLAIM TO ANY PARTICULAR FONT, STYLE, SIZE, OR COLOR.

NO CLAIM IS MADE TO THE EXCLUSIVE RIGHT TO USE "ORGANICS", APART FROM THE MARK AS SHOWN.

FOR CLOTHING FOR MEN AND WOMEN MADE IN WHOLE OR IN SIGNIFICANT PART OF ORGANIC FIBER FABRIC, NAMELY, COATS, OVERCOATS, JACKETS, CARDIGANS, WAISTCOATS, VESTS, DRESSES, CAFTANS, SKIRTS, PANTS, SLACKS, TROUSERS, JEANS, DUNGAREES, JUMPSUITS, COVERALLS, GYM SUITS, JOGGING SUITS, SWEAT PANTS, SHORTS, CAPRIS, TOPS, SWEATERS, PULLOVERS, POLO SHIRTS, JERSEYS, SHIRTS, BLOUSES, TUNICS, SWEATSHIRTS, HOODED TOPS, HOODED SWEATSHIRTS, SPORT BRAS, SPORT TOPS, HALTER TOPS, TANK TOPS, BODYSUITS, CAMISOLES, CHEMISES, UNDERSHIRTS, SLIPS, CORSETS, BRASSIERES, BRIEFS, BOXER SHORTS, UNDERPANTS, PANTIES, LINGERIE, NIGHTGOWNS, NIGHT SHIRTS, NEGLIGEEES, ROBES, PAJAMAS, APRONS, HOSIERY, TIGHTS, KNEE-HIGH STOCKINGS, LEGGINGS, SOCKS, SCARVES, SHAWLS, GLOVES, MITTENS, SASHES, BEACHWEAR, YOGA PANTS, YOGA SHIRTS (U.S. CLS. 22 AND 39).

FIRST USE 7-26-2008; IN COMMERCE 11-21-2008.

CLASS 25—(Continued).

3,680,538. DC COMICS, NEW YORK, NY. SN 77-329,791. PUB. 4-15-2008, FILED 11-14-2007.

THE DARK KNIGHT

THE MARK CONSISTS OF STANDARD CHARACTERS WITHOUT CLAIM TO ANY PARTICULAR FONT, STYLE, SIZE, OR COLOR.

OWNER OF U.S. REG. NO. 1,458,274.

FOR CLOTHING FOR MEN, WOMEN AND CHILDREN, NAMELY, SHIRTS, T-SHIRTS, SWEATSHIRTS, JOGGING SUITS, PANTS, SHORTS, TANK TOPS, RAINWEAR, JACKETS, COATS, RAINCOATS, ROBES, HATS, CAPS, SUNVISORS, BELTS, SLEEPWEAR, PAJAMAS, UNDERWEAR, SOCKS, SLIPPER SOCKS, SWIMWEAR AND MASQUERADE AND HALLOWEEN COSTUMES AND MASKS SOLD IN CONNECTION THEREWITH (U.S. CLS. 22 AND 39).

FIRST USE 12-1-2003; IN COMMERCE 12-1-2003.

3,680,548. WOLVERINE OUTDOORS, INC., ROCKFORD, MI. SN 77-331,795. PUB. 4-15-2008, FILED 11-16-2007.

GPHASE

THE MARK CONSISTS OF STANDARD CHARACTERS WITHOUT CLAIM TO ANY PARTICULAR FONT, STYLE, SIZE, OR COLOR.

FOR FOOTWEAR (U.S. CLS. 22 AND 39).

FIRST USE 6-9-2008; IN COMMERCE 6-9-2008.

3,680,552. CUPID FOUNDATIONS, INC., NEW YORK, NY. SN 77-334,009. PUB. 4-22-2008, FILED 11-20-2007.

FEEL COOL

THE MARK CONSISTS OF STANDARD CHARACTERS WITHOUT CLAIM TO ANY PARTICULAR FONT, STYLE, SIZE, OR COLOR.

FOR UNDERGARMENTS (U.S. CLS. 22 AND 39).

FIRST USE 2-5-2009; IN COMMERCE 2-5-2009.

CLASS 25—(Continued).

3,680,563. COOPER MARTIN, LLC, VAIL, CO. SN 77-334,978. PUB. 10-7-2008, FILED 11-21-2007.

COOPER MARTIN

THE MARK CONSISTS OF STANDARD CHARACTERS WITHOUT CLAIM TO ANY PARTICULAR FONT, STYLE, SIZE, OR COLOR.

THE NAME(S), PORTRAIT(S), AND/OR SIGNATURE(S) SHOWN IN THE MARK DOES NOT IDENTIFY A PARTICULAR LIVING INDIVIDUAL.

FOR PANTS (U.S. CLS. 22 AND 39).

FIRST USE 5-4-2009; IN COMMERCE 5-4-2009.

3,680,583. WINLORD INDUSTRIAL GROUP CO., LTD., WANCHAI, HONG KONG. SN 77-339,023. PUB. 12-30-2008, FILED 11-28-2007.

WINLORD

THE MARK CONSISTS OF STANDARD CHARACTERS WITHOUT CLAIM TO ANY PARTICULAR FONT, STYLE, SIZE, OR COLOR.

FOR CLOTHING, NAMELY, PANTS, SHIRTS, JACKETS AND SUITS; SUITINGS, NAMELY, BLAZERS, COATS, JACKETS, SKIRTS, SLACKS, SUITS, TAIL COATS AND TUXEDOS; OVERCOATS, JACKETS, ACCESSORIES, NAMELY, GLOVES, MITTENS, HATS, MUFFLERS, SCARVES AND SOCKS; NECKWEAR, NAMELY, TIES AND SCARVES, UNDERGARMENTS AND LINGERIE, NAMELY, BRAS, PANTIES, BOY SHORTS, THONGS, SLIPS, TEDDIES, NIGHTGOWNS AND PEIGNOIRS; LEISUREWEAR, NAMELY, DRESSING GOWNS, LOUNGEWEAR AND TRACK SUITS; SHIRTS AND BLOUSES; PAJAMAS; POWER STRETCH ARTICLES, NAMELY, CONTOUR FASHIONS, NAMELY, FOUNDATION GARMENTS, COMPRESSION GARMENTS, NAMELY, BRASSIERES, GIRDLES, AND ACTIVE WEAR, NAMELY, SHORTS, T-SHIRTS, SWEAT PANTS, SWEAT SHIRTS, SWIMSUITS FOR CYCLING, EXERCISING AND SWIMMING; DRESS WEAR, NAMELY, BLOUSES, BRIDAL WEAR, NAMELY, EVENING DRESSES, WEDDING GOWNS, BRIDAL PARTY GOWNS, EVENING WEAR, NAMELY, EVENING DRESSES, EVENING PANT SUITS, EVENING GOWNS AND PARTY DRESSES; WOMEN'S DAY WEAR, NAMELY, DRESSES, SLACKS, SKIRTS, SPORTSWEAR, NAMELY, TOPS, PANTS, RAIN JACKETS, COVERALLS AND UNIFORMS FOR BASEBALL, BASKETBALL, HOCKEY AND SOCCER; UNIFORMS FOR POLICE, SCHOOL, FIRE, SECURITY AND INSURANCE INDUSTRY PERSONNEL (U.S. CLS. 22 AND 39).

FIRST USE 6-26-2009; IN COMMERCE 6-26-2009.

CLASS 25—(Continued).

3,680,599. AMERICAN SPORT TEES, OOLTEWAH, TN. SN 77-344,350. PUB. 6-17-2008, FILED 12-5-2007.



NO CLAIM IS MADE TO THE EXCLUSIVE RIGHT TO USE "FIGHT WEAR", APART FROM THE MARK AS SHOWN.

THE MARK CONSISTS OF WORDS "TITLE SHOT FIGHT WEAR" SYMBOL IS A CIRCLE WITH INVERTED TRIANGLE, STARS IN TRIANGLE PATTERN WITH "TS" CENTERED IN INVERTED TRIANGLE.

FOR T-SHIRTS, SWEATSHIRTS, SHIRTS, SWEAT-PANTS, POLO SHIRTS, SPORT SHIRT, UNDERWEAR, G-STRINGS, HATS AND CAPS, BEANIES, SKULL CAPS, VISORS, SHORTS, TANK TOPS, MUSCLE TOP, JERSEYS, BRIEFS, THONG UNDERWEAR, BOY SHORTS, WRISTBANDS, SOCKS, BELTS AND JACKETS, GLOVES (U.S. CLS. 22 AND 39).

FIRST USE 1-15-2008; IN COMMERCE 2-10-2008.

3,680,618. PARAMOUNT PICTURES CORPORATION, HOLLYWOOD, CA. SN 77-348,292. PUB. 4-1-2008, FILED 12-10-2007.

CLOVERFIELD

THE MARK CONSISTS OF STANDARD CHARACTERS WITHOUT CLAIM TO ANY PARTICULAR FONT, STYLE, SIZE, OR COLOR.

OWNER OF U.S. REG. NO. 3,628,003.

FOR T-SHIRTS (U.S. CLS. 22 AND 39).

FIRST USE 2-15-2008; IN COMMERCE 2-15-2008.

3,680,622. JACKSON, EVANDER, BROOKLYN, NY. SN 77-348,564. PUB. 5-6-2008, FILED 12-10-2007.

12 TRYBEZ

THE MARK CONSISTS OF STANDARD CHARACTERS WITHOUT CLAIM TO ANY PARTICULAR FONT, STYLE, SIZE, OR COLOR.

FOR SHIRTS; T-SHIRTS; JEANS; HATS; BELTS; SHOES; SCARVES (U.S. CLS. 22 AND 39).

FIRST USE 0-0-2007; IN COMMERCE 0-0-2007.

CLASS 25—(Continued).

3,680,633. CUPID FOUNDATIONS, INC., NEW YORK, NY.
SN 77-350,996. PUB. 4-22-2008, FILED 12-13-2007.

CLASS 25—(Continued).

3,680,690. ROAD CLOTHING LIMITED, DERBYSHIRE S40
1LA, UNITED KINGDOM. SN 77-384,012. PUB. 10-7-2008,
FILED 1-30-2008.

EVEN LESS

THE MARK CONSISTS OF STANDARD CHARACTERS
WITHOUT CLAIM TO ANY PARTICULAR FONT, STYLE,
SIZE, OR COLOR.
FOR UNDERGARMENTS (U.S. CLS. 22 AND 39).
FIRST USE 2-5-2009; IN COMMERCE 2-5-2009.



3,680,642. THE GENERAL COUNCIL OF THE ASSEMBLIES
OF GOD, SPRINGFIELD, MO. SN 77-355,379. PUB. 11-4-
2008, FILED 12-19-2007.

FIRE INSTITUTE

THE MARK CONSISTS OF THE WORDS "MONKEE
GENES" IN STYLIZED FORM WITHIN AN OVAL AND A
REPRESENTATION OF A BANANA.
FOR ARTICLES OF CLOTHING, NAMELY, JEANS
(U.S. CLS. 22 AND 39).
FIRST USE 12-13-2006; IN COMMERCE 3-12-2008.

THE MARK CONSISTS OF STANDARD CHARACTERS
WITHOUT CLAIM TO ANY PARTICULAR FONT, STYLE,
SIZE, OR COLOR.
FOR CLOTHING, NAMELY, T-SHIRTS, SHIRTS,
SWEATSHIRTS, HEADWEAR (U.S. CLS. 22 AND 39).
FIRST USE 8-1-2007; IN COMMERCE 8-1-2007.

3,680,694. FAMOUS STARS & STRAPS, INC., ONTARIO, CA.
SN 77-386,080. PUB. 4-8-2008, FILED 1-31-2008.

FAMOUS STARS AND STRAPS

3,680,678. SMARTPAK EQUINE, LLC., PLYMOUTH, MA. SN
77-370,933. PUB. 12-2-2008, FILED 1-14-2008.

SmartSlim

THE MARK CONSISTS OF STANDARD CHARACTERS
WITHOUT CLAIM TO ANY PARTICULAR FONT, STYLE,
SIZE, OR COLOR.
FOR EQUESTRIAN APPAREL, NAMELY, PANTS AND
SHIRTS (U.S. CLS. 22 AND 39).
FIRST USE 4-30-2009; IN COMMERCE 4-30-2009.

THE MARK CONSISTS OF STANDARD CHARACTERS
WITHOUT CLAIM TO ANY PARTICULAR FONT, STYLE,
SIZE, OR COLOR.
OWNER OF U.S. REG. NOS. 2,675,218, 3,330,227, AND
3,360,316.
FOR CLOTHING, NAMELY, KNIT SHIRTS, PAJAMAS,
ROBES, SHORTS, SKIRTS, SOCKS AND UNDERWEAR
(U.S. CLS. 22 AND 39).
FIRST USE 1-0-2003; IN COMMERCE 5-0-2003.

CLASS 25—(Continued).

3,680,695. FAMOUS STARS & STRAPS, INC., ONTARIO, CA. SN 77-386,081. PUB. 4-8-2008, FILED 1-31-2008.



OWNER OF U.S. REG. NOS. 2,704,738 AND 3,330,230.
THE MARK CONSISTS OF A STYLIZED "F" WITH A SINGLE FIVE-POINT STAR IN THE CENTER.
FOR CLOTHING, NAMELY, KNIT SHIRTS, PAJAMAS, ROBES, SHORTS, SKIRTS, SOCKS AND UNDERWEAR (U.S. CLS. 22 AND 39).
FIRST USE 1-0-2000; IN COMMERCE 5-0-2003.

3,680,709. E.S. ORIGINALS, INC., NEW YORK, NY. SN 77-392,289. PUB. 4-29-2008, FILED 2-8-2008.

VISIBLE AIR

THE MARK CONSISTS OF STANDARD CHARACTERS WITHOUT CLAIM TO ANY PARTICULAR FONT, STYLE, SIZE, OR COLOR.

OWNER OF U.S. REG. NO. 2,595,789.
FOR FOOTWEAR (U.S. CLS. 22 AND 39).
FIRST USE 2-15-2009; IN COMMERCE 2-15-2009.

3,680,713. P4P LLC, ATLANTA, GA. SN 77-395,225. PUB. 6-24-2008, FILED 2-12-2008.

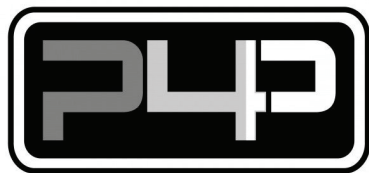

THE MARK CONSISTS OF THE STYLIZED TERM "P4P" ON A DOUBLE-BORDERED RECTANGLE WITH ROUNDED CORNERS.
FOR BANDANAS, T-SHIRTS, AND WRISTBANDS (U.S. CLS. 22 AND 39).
FIRST USE 1-17-2008; IN COMMERCE 1-17-2008.

CLASS 25—(Continued).

3,680,738. FAZE APPAREL, SAN FRANCISCO, CA. SN 77-404,461. PUB. 7-8-2008, FILED 2-22-2008.



THE COLOR(S) GOLD IS/ARE CLAIMED AS A FEATURE OF THE MARK.

THE MARK CONSISTS OF SEVEN GOLD LIGHTNING BOLTS CONNECTED AT THEIR END POINTS IN A TRIANGULAR SHAPE.

FOR A-SHIRTS; CANVAS SHOES; DENIMS; DRESS SHIRTS; LEATHER SHOES; LONG-SLEEVED SHIRTS; PANTS; POLO SHIRTS; SHIRTS; SHOES; SHORT-SLEEVED OR LONG-SLEEVED T-SHIRTS; SWEAT SHIRTS; T-SHIRTS; TEE SHIRTS; HATS; UNDERWEAR; SOCKS (U.S. CLS. 22 AND 39).
FIRST USE 12-14-2007; IN COMMERCE 12-14-2007.

3,680,753. SHAPIRO, MELISSA J, MIAMI, FL. SN 77-411,963. PUB. 12-16-2008, FILED 3-3-2008.

REST & RELAXATION

THE MARK CONSISTS OF STANDARD CHARACTERS WITHOUT CLAIM TO ANY PARTICULAR FONT, STYLE, SIZE, OR COLOR.

FOR WOMEN'S AND MEN'S CLOTHING, NAMELY, ROBES, SARONGS, BATHROBES, LOUNGEWEAR, BEACH COVERUPS, LINGERIE, SLEEPWEAR, UNDERWEAR, SHIRTS, BLOUSES, DRESSES, PANTS, SKIRTS, SLIPPERS (U.S. CLS. 22 AND 39).
FIRST USE 7-15-2009; IN COMMERCE 7-15-2009.

CLASS 25—(Continued).

3,680,758. COLLINS, WALI, NEW YORK, NY. SN 77-414,393.
PUB. 1-13-2009, FILED 3-6-2008.

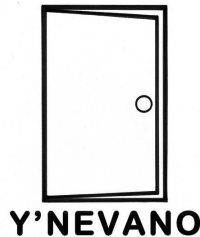

THE MARK CONSISTS OF THE TERM "Y'NEVANO" WHICH IS THE PHONETIC EQUIVALENT OF "YOU NEVER KNOW" AND A DOOR DESIGN IN WHICH THE DOOR IS SLIGHTLY OPEN.

FOR A-SHIRTS; BALLOON PANTS; BASEBALL CAPS; BASEBALL SHOES; BATHING CAPS; BUTTON-FRONT ALOHA SHIRTS; CAMP SHIRTS; CAP VISORS; CAPRI PANTS; CAPS; CAPS WITH VISORS; CARGO PANTS; CHEF'S HATS; DENIMS; DRESS SHIRTS; FUR HATS; GOLF CAPS; GOLF SHIRTS; HAT BANDS; HATS; HEADBANDS AGAINST SWEATING; HEADGEAR, NAMELY, HATS, CAPS; HOODED SWEAT SHIRTS; JOGGING PANTS; KNIT SHIRTS; KNITTED CAPS; LEATHER PANTS; LONG-SLEEVED SHIRTS; LOUNGE PANTS; NECKTIES; NIGHT SHIRTS; NON-DISPOSABLE CLOTH TRAINING PANTS; NURSE PANTS; OPEN-NECKED SHIRTS; PANTS; PAPER HATS FOR USE AS CLOTHING ITEMS; PETTI-PANTS; PIQUE SHIRTS; POLO SHIRTS; RUGBY SHIRTS; SEDGE HATS (SUGEGASA); SHIRT FRONTS; SHIRT YOKES; SHIRTS; SHIRTS FOR SUITS; SHORT-SLEEVED OR LONG-SLEEVED T-SHIRTS; SHORT-SLEEVED SHIRTS; SHOWER CAPS; SKI PANTS; SKULL CAPS; SLEEP SHIRTS; SMALL HATS; SNOW PANTS; SNOWBOARD PANTS; SPORT SHIRTS; SPORTS SHIRTS; SPORTS SHIRTS WITH SHORT SLEEVES; STOCKINGS; STRETCH PANTS; SWEAT BANDS; SWEAT JACKETS; SWEAT PANTS; SWEAT SHIRTS; SWEAT SHORTS; SWEAT SUITS; SWIM CAPS; SWIMMING CAPS; SWIMMING CAPS; T-SHIRTS; TAP PANTS; TEE SHIRTS; TOBOGGAN HATS, PANTS AND CAPS; TOE CAPS; TRACK PANTS; TRIATHLON CLOTHING, NAMELY, TRIATHLON TIGHTS, TRIATHLON SHORTS, TRIATHLON SINGLET, TRIATHLON SHIRTS, TRIATHLON SUITS; TROUSERS FOR SWEATING; WATERPROOF JACKETS AND PANTS; WIND PANTS; WIND SHIRTS; WOOLLY HATS; YOGA PANTS; YOGA SHIRTS (U.S. CLS. 22 AND 39).

FIRST USE 5-30-2008; IN COMMERCE 7-30-2008.

CLASS 25—(Continued).

3,680,762. STRADA SHOE LIMITADA, CAMPO BOM - RS, BRAZIL. SN 77-415,444. PUB. 7-22-2008, FILED 3-6-2008.

CIAO BELLA

THE MARK CONSISTS OF STANDARD CHARACTERS WITHOUT CLAIM TO ANY PARTICULAR FONT, STYLE, SIZE, OR COLOR.

THE FOREIGN WORDING IN THE MARK TRANSLATES INTO ENGLISH AS HELLO BEAUTIFUL.

FOR FOOTWEAR; FOOTWEAR FOR WOMEN (U.S. CLS. 22 AND 39).

FIRST USE 9-3-2008; IN COMMERCE 9-3-2008.

3,680,763. ALDA INC., DENVER, NC. SN 77-415,863. PUB. 9-16-2008, FILED 3-7-2008.

Apri Footwear

THE MARK CONSISTS OF STANDARD CHARACTERS WITHOUT CLAIM TO ANY PARTICULAR FONT, STYLE, SIZE, OR COLOR.

NO CLAIM IS MADE TO THE EXCLUSIVE RIGHT TO USE "FOOTWEAR", APART FROM THE MARK AS SHOWN.

THE FOREIGN WORDING IN THE MARK TRANSLATES INTO ENGLISH AS "YOU OPEN".

FOR FOOTWEAR (U.S. CLS. 22 AND 39).

FIRST USE 1-25-2009; IN COMMERCE 3-1-2009.

3,680,807. ALISON PARIS, OSPREY, FL. SN 77-440,354. PUB. 8-26-2008, FILED 4-4-2008.

T.I.A.G.

THE MARK CONSISTS OF STANDARD CHARACTERS WITHOUT CLAIM TO ANY PARTICULAR FONT, STYLE, SIZE, OR COLOR.

FOR CLOTHING, NAMELY, TEE SHIRTS, SWEAT SHIRTS, CAPS, HATS AND JACKETS (U.S. CLS. 22 AND 39).

FIRST USE 3-26-2008; IN COMMERCE 7-7-2008.

CLASS 25—(Continued).

3,680,819. PRECIOUS FORMALS INC., LEAGUE CITY, TX. SN 77-443,294. PUB. 9-23-2008, FILED 4-8-2008.

LUX GAL

THE MARK CONSISTS OF STANDARD CHARACTERS WITHOUT CLAIM TO ANY PARTICULAR FONT, STYLE, SIZE, OR COLOR.

NO CLAIM IS MADE TO THE EXCLUSIVE RIGHT TO USE "GAL", APART FROM THE MARK AS SHOWN.

FOR CLOTHING, NAMELY, LADIES HIGH FASHION EVENING WEAR, NAMELY, DRESSES, SHOES, WRAPS, SKIRTS (U.S. CLS. 22 AND 39).

FIRST USE 1-1-2009; IN COMMERCE 1-1-2009.

3,680,829. HILARY'S VANITY LLC, RESEDA, CA. SN 77-451,841. PUB. 9-23-2008, FILED 4-18-2008.



THE MARK CONSISTS OF A BAT.

FOR CLOTHING, NAMELY, ARM WARMERS, BELTS, BODYSUITS, BRAS, CATSUITS, COATS, CORSETS, COSTUMES FOR USE IN ROLE-PLAYING GAMES, CUFFS, G-STRINGS, HOSIERY, JACKETS, LEG WARMERS, LINGERIE, REMOVABLE COLLARS; DRESSES, PANTS, SHIRTS, SKIRTS AND TROUSERS MADE OF FABRIC, LEATHER, PATENT LEATHER, VINYL AND LATEX; GLOVES, SOCKS AND VESTS (U.S. CLS. 22 AND 39).

FIRST USE 11-30-2008; IN COMMERCE 9-30-2008.

3,680,841. NAVIGATORS, THE, COLORADO SPRINGS, CO. SN 77-456,132. PUB. 9-16-2008, FILED 4-23-2008.

NAVFUSION START A REACTION

THE MARK CONSISTS OF STANDARD CHARACTERS WITHOUT CLAIM TO ANY PARTICULAR FONT, STYLE, SIZE, OR COLOR.

FOR MEN'S, WOMEN'S AND CHILDREN'S CLOTHING, NAMELY, SHIRTS, T-SHIRTS, SWEATSHIRTS, POLO-STYLE SHIRTS, JACKETS, AND BASEBALL-STYLE CAPS (U.S. CLS. 22 AND 39).

FIRST USE 1-31-2007; IN COMMERCE 5-20-2009.

CLASS 25—(Continued).

3,680,847. COCOA LILLY CORPORATION, IRVINE, CA. SN 77-456,966. PUB. 9-16-2008, FILED 4-24-2008.

TOO FACED

THE MARK CONSISTS OF STANDARD CHARACTERS WITHOUT CLAIM TO ANY PARTICULAR FONT, STYLE, SIZE, OR COLOR.

FOR TOPS; HOODED SWEATSHIRTS; KNIT SHIRTS; LONG SLEEVED SHIRTS; SHIRTS; SHORT-SLEEVED OR LONG-SLEEVED T-SHIRTS; SLEEP SHIRTS; SWEAT SHIRTS; T-SHIRTS; YOGA SHIRTS; DENIM JACKETS; MEN AND WOMEN JACKETS; SWEAT JACKETS; BEACH SHOES; RUBBER SHOES (U.S. CLS. 22 AND 39).

FIRST USE 7-0-1999; IN COMMERCE 7-0-1999.

3,680,864. MCNEEL, THOMAS E., COSTA MESA, CA. SN 77-459,511. PUB. 9-23-2008, FILED 4-28-2008.

LOVE TRUE LOVE BY LOVE SURF LOVE

THE MARK CONSISTS OF STANDARD CHARACTERS WITHOUT CLAIM TO ANY PARTICULAR FONT, STYLE, SIZE, OR COLOR.

OWNER OF U.S. REG. NO. 2,974,608.
FOR BEACH COVER-UPS; SWIMSUITS (U.S. CLS. 22 AND 39).

FIRST USE 12-3-2008; IN COMMERCE 12-10-2008.

3,680,885. VERONICA CHONG, LLC, FRISCO, TX. SN 77-466,255. PUB. 10-7-2008, FILED 5-5-2008.

Nicaya

THE MARK CONSISTS OF STANDARD CHARACTERS WITHOUT CLAIM TO ANY PARTICULAR FONT, STYLE, SIZE, OR COLOR.

FOR SUITS; PANTS; JEANS; JACKETS; BLOUSES; SHIRTS; T-SHIRTS; TROUSERS (U.S. CLS. 22 AND 39).

FIRST USE 2-1-2009; IN COMMERCE 3-1-2009.

CLASS 25—(Continued).

3,680,892. JACKLIN, COLLEEN, PALM DESERT, CA. SN 77-466,642. PUB. 10-21-2008, FILED 5-6-2008.

LOVE RACING

THE MARK CONSISTS OF STANDARD CHARACTERS WITHOUT CLAIM TO ANY PARTICULAR FONT, STYLE, SIZE, OR COLOR.

NO CLAIM IS MADE TO THE EXCLUSIVE RIGHT TO USE "RACING", APART FROM THE MARK AS SHOWN.

FOR CLOTHING, NAMELY, HATS, BEANIES, SHIRTS, PANTS, SWEATSHIRTS, GLOVES, JACKETS, SCARVES, SOCKS, T-SHIRTS, SHORTS, SKIRTS, DRESSES, SWIM-SUITS (U.S. CLS. 22 AND 39).

FIRST USE 6-0-2008; IN COMMERCE 6-0-2008.

3,680,921. GRECCO,RICHARD J/GRASSO,SYLVIA L, DBA SICOTIC WEAR, VICTORVILLE, CA. SN 77-470,706. PUB. 10-14-2008, FILED 5-9-2008.



FOR A-SHIRTS; BED JACKETS; CAMP SHIRTS; DENIM JACKETS; DOWN JACKETS; DRESS SHIRTS; FISHERMEN'S JACKETS; FITTED SHOE OR BOOT COVERING TO PROTECT THE SHOES OR BOOT FROM WATER OR OTHER DAMAGE; GOLF SHIRTS; HEAVY JACKETS; HOODED SWEAT SHIRTS; JACKET LINERS; JACKETS; KNIT SHIRTS; LEATHER JACKETS; LONG-SLEEVED SHIRTS; MEN'S AND WOMEN'S JACKETS, COATS, TROUSERS, VESTS; NIGHT SHIRTS; OPEN-NECKED SHIRTS; PADDED JACKETS; POLO SHIRTS; RAIN JACKETS; RAINPROOF JACKETS; REVERSIBLE JACKETS; SHELL JACKETS; SHIRT FRONTS; SHIRT YOKES; SHIRTS; SHORT-SLEEVED OR LONG-SLEEVED T-SHIRTS; SHORT-SLEEVED SHIRTS; SKI AND SNOWBOARD SHOES AND PARTS THEREOF; SKI JACKETS; SLEEP SHIRTS; SLEEVED OR SLEEVELESS JACKETS; SPORT SHIRTS; SPORTS JACKETS; SPORTS SHIRTS; SPORTS SHIRTS WITH SHORT SLEEVES; STUFF JACKETS; SUEDE JACKETS; SWEAT JACKETS; SWEAT SHIRTS; T-SHIRTS; TEE SHIRTS; WIND RESISTANT JACKETS; WIND SHIRTS; WIND-JACKETS (U.S. CLS. 22 AND 39).

FIRST USE 1-10-2009; IN COMMERCE 1-10-2009.

CLASS 25—(Continued).

3,680,933. THE LOS ANGELES KINGS HOCKEY CLUB, L.P., EL SEGUNDO, CA. SN 77-472,104. PUB. 11-11-2008, FILED 5-12-2008.



OWNER OF U.S. REG. NOS. 1,718,268, 2,312,430, AND 2,390,231.

NO CLAIM IS MADE TO THE EXCLUSIVE RIGHT TO USE "LA", APART FROM THE MARK AS SHOWN.

THE MARK CONSISTS OF THE LETTERS "L" AND "A" IN A BOX AND A KINGS CROWN IN A DOWNSIDE TRIANGLE.

FOR CLOTHING, NAMELY, BANDANNAS, BOXER SHORTS, CAPS, CLOTH BIBS, COATS, FOOTWEAR, EAR MUFFS, GLOVES, HATS, HEADBANDS, JACKETS, JERSEYS, LEGGINGS, MITTENS, NIGHTSHIRTS, PAJAMAS, PANTS, RAIN WEAR, ROBES, SCARVES, SHIRTS, SHORTS, SUN VISORS, SWEATERS, SWEATPANTS, SWIM TRUNKS, T-SHIRTS, TIES, TOQUES, UNDERWEAR, WRISTBANDS (U.S. CLS. 22 AND 39).

FIRST USE 11-22-2008; IN COMMERCE 11-22-2008.

3,680,943. THE KINSEY INSTITUTE FOR RESEARCH IN SEX, GENDER, AND REPRODUCTION, INC., BLOOMINGTON, IN. SN 77-473,239. PUB. 10-21-2008, FILED 5-13-2008.

KINSEY CONFIDENTIAL

THE MARK CONSISTS OF STANDARD CHARACTERS WITHOUT CLAIM TO ANY PARTICULAR FONT, STYLE, SIZE, OR COLOR.

FOR CLOTHING, NAMELY, SHIRTS (U.S. CLS. 22 AND 39).

FIRST USE 7-1-2009; IN COMMERCE 7-1-2009.

CLASS 25—(Continued).

3,680,946. THE KINSEY INSTITUTE FOR RESEARCH IN SEX, GENDER, AND REPRODUCTION, INC., BLOOMINGTON, IN. SN 77-473,367. PUB. 10-14-2008, FILED 5-13-2008.

THE KINSEY INSTITUTE

THE MARK CONSISTS OF STANDARD CHARACTERS WITHOUT CLAIM TO ANY PARTICULAR FONT, STYLE, SIZE, OR COLOR.

FOR CLOTHING, NAMELY, SHIRTS, SWEATERS, VESTS, JACKETS, CAPS, HEADBANDS, SCARVES (U.S. CLS. 22 AND 39).

FIRST USE 1-0-2009; IN COMMERCE 1-0-2009.

CLASS 25—(Continued).

3,681,002. RIVA TEXTILES LLC, NEW YORK, NY. SN 77-482,274. PUB. 10-7-2008, FILED 5-23-2008.

YORKTOWN

THE MARK CONSISTS OF STANDARD CHARACTERS WITHOUT CLAIM TO ANY PARTICULAR FONT, STYLE, SIZE, OR COLOR.

FOR DRESS SHIRTS; NECKWEAR (U.S. CLS. 22 AND 39).

FIRST USE 6-1-2008; IN COMMERCE 8-1-2008.

3,680,958. MORE CUPCAKES, LLC, CHICAGO, IL. SN 77-475,631. PUB. 10-14-2008, FILED 5-15-2008.

taste MORE

THE MARK CONSISTS OF STANDARD CHARACTERS WITHOUT CLAIM TO ANY PARTICULAR FONT, STYLE, SIZE, OR COLOR.

FOR T-SHIRTS (U.S. CLS. 22 AND 39).

FIRST USE 10-1-2008; IN COMMERCE 10-1-2008.

3,681,003. WALSH, JOHN G., MENANDS, NY. SN 77-482,576. PUB. 10-21-2008, FILED 5-23-2008.

EDGARTOWN RETRIEVER

THE MARK CONSISTS OF STANDARD CHARACTERS WITHOUT CLAIM TO ANY PARTICULAR FONT, STYLE, SIZE, OR COLOR.

FOR NECKTIES (U.S. CLS. 22 AND 39).

FIRST USE 6-1-2009; IN COMMERCE 6-1-2009.

3,680,985. SILK THREADS, INC., IRVING, TX. SN 77-479,447. PUB. 8-5-2008, FILED 5-20-2008.

Nikki and Sebastian

THE MARK CONSISTS OF STANDARD CHARACTERS WITHOUT CLAIM TO ANY PARTICULAR FONT, STYLE, SIZE, OR COLOR.

THE NAMES "NIKKI" AND "SEBASTIAN" DO NOT IDENTIFY LIVING INDIVIDUALS.

FOR COATS FOR MEN AND WOMEN; DRESS SHIRTS; DRESS SUITS; DRESSES; DRESSING GOWNS; EVENING DRESSES; MEN'S SUITS, WOMEN'S SUITS; SKIRTS AND DRESSES; TUNICS; WEDDING DRESSES; WOMEN'S CEREMONIAL DRESSES (U.S. CLS. 22 AND 39).

FIRST USE 11-1-2008; IN COMMERCE 12-1-2008.

3,681,009. MARK ANTHONY INTERNATIONAL SRL, WEST INDIES, BARBADOS. SN 77-483,735. PUB. 10-14-2008, FILED 5-27-2008.

**IN A WORLD GONE SOFT,
SOMEONE'S GOT TO BE HARD.**

THE MARK CONSISTS OF STANDARD CHARACTERS WITHOUT CLAIM TO ANY PARTICULAR FONT, STYLE, SIZE, OR COLOR.

FOR CLOTHING, NAMELY, JACKETS (U.S. CLS. 22 AND 39).

FIRST USE 4-14-2008; IN COMMERCE 4-14-2008.

CLASS 25—(Continued).

3,681,018. CARLSON GRACIE, JR., CHICAGO, IL. SN 77-485,921. PUB. 10-21-2008, FILED 5-29-2008.



OWNER OF U.S. REG. NO. 3,038,911.
 THE MARK CONSISTS OF TWO BULLDOGS,
 FOR CLOTHING, NAMELY, T-SHIRTS, TANK TOPS,
 SWEAT PANTS, JACKETS, WARM-UP SUITS, SWEAT-
 SHIRTS, HATS; GIS, NAMELY, MARTIAL ARTS UNI-
 FORMS; AND SHOES (U.S. CLS. 22 AND 39).
 FIRST USE 5-30-2008; IN COMMERCE 5-30-2008.

3,681,032. RED WING SHOE COMPANY, INC., RED WING,
 MN. SN 77-490,612. PUB. 10-28-2008, FILED 6-4-2008.

DynaForce

THE MARK CONSISTS OF STANDARD CHARACTERS
 WITHOUT CLAIM TO ANY PARTICULAR FONT, STYLE,
 SIZE, OR COLOR.
 FOR FOOTWEAR AND ITS COMPONENT PARTS (U.S.
 CLS. 22 AND 39).
 FIRST USE 12-0-2008; IN COMMERCE 12-0-2008.

3,681,078. M & J IMPORTS INC., BROOKLYN, NY. SN 77-
 500,543. PUB. 11-11-2008, FILED 6-17-2008.

Salvatore Bellino

THE MARK CONSISTS OF STANDARD CHARACTERS
 WITHOUT CLAIM TO ANY PARTICULAR FONT, STYLE,
 SIZE, OR COLOR.
 THE NAME "SALVATORE BELLINO" DOES NOT IDENTIFY
 A LIVING INDIVIDUAL.
 FOR CLOTHING, NAMELY, COATS, PANTS, TROU-
 SERS, JACKETS, FLEECE PULLOVERS, BUSINESS
 SHIRTS, SUITS, SWEATERS, CARDIGAN SWEATERS,
 KNIT SHIRTS, PULLOVERS, SPORTS SHIRTS, POLO
 SHIRTS, T-SHIRTS, PAJAMAS, BATHROBES; CLOTH-
 ING ACCESSORIES, NAMELY, NECKTIES, GLOVES,
 SCARVES, SUSPENDERS AND HATS (U.S. CLS. 22
 AND 39).
 FIRST USE 6-10-2009; IN COMMERCE 6-10-2009.

CLASS 25—(Continued).

3,681,082. REBA REDD, PHILADELPHIA, PA. SN 77-503,006.
 PUB. 11-18-2008, FILED 6-19-2008.



THE MARK CONSISTS OF THE LINKED-TOGETHER
 LETTERS "C" AND "F" WITH THE WORDING "CRAZI
 FAITH" UNDERNEATH.
 FOR A-SHIRTS; ATHLETIC APPAREL, NAMELY,
 SHIRTS, PANTS, JACKETS, FOOTWEAR, HATS AND
 CAPS, ATHLETIC UNIFORMS; BUTTON-FRONT ALO-
 HA SHIRTS; CAMP SHIRTS; DRESS SHIRTS; GOLF
 SHIRTS; HOODED SWEAT SHIRTS; KNIT SHIRTS;
 LONG-SLEEVED SHIRTS; MOISTURE-WICKING
 SPORTS SHIRTS; NIGHT SHIRTS; OPEN-NECKED
 SHIRTS; PIQUE SHIRTS; POLO SHIRTS; RUGBY
 SHIRTS; SHIRT FRONTS; SHIRT YOKES; SHIRTS;
 SHIRTS FOR SUITS; SHORT-SLEEVED OR LONG-
 SLEEVED T-SHIRTS; SHORT-SLEEVED SHIRTS; SLEEP
 SHIRTS; SPORT SHIRTS; SPORTS SHIRTS; SPORTS
 SHIRTS WITH SHORT SLEEVES; SWEAT SHIRTS; T-
 SHIRTS; TEE SHIRTS; TRIATHLON CLOTHING,
 NAMELY, TRIATHLON TIGHTS, TRIATHLON SHORTS,
 TRIATHLON SINGLET, TRIATHLON SHIRTS,
 TRIATHLON SUITS; WEARABLE GARMENTS AND
 CLOTHING, NAMELY, SHIRTS; WIND SHIRTS; YOGA
 SHIRTS (U.S. CLS. 22 AND 39).
 FIRST USE 5-5-2008; IN COMMERCE 1-26-2009.

3,681,096. LAZY MAN, INC., GLENDALE, CA. SN 77-509,026.
 PUB. 10-21-2008, FILED 6-26-2008.

LazyMan Inc.

THE MARK CONSISTS OF STANDARD CHARACTERS
 WITHOUT CLAIM TO ANY PARTICULAR FONT, STYLE,
 SIZE, OR COLOR.
 NO CLAIM IS MADE TO THE EXCLUSIVE RIGHT TO
 USE "INC.", APART FROM THE MARK AS SHOWN.
 FOR BATHING SUITS; BELTS; BOARD SHORTS;
 BOXER SHORTS; HATS; HOODED SWEAT SHIRTS;
 JACKETS; LONG-SLEEVED SHIRTS; PANTS; POLO
 SHIRTS; ROBES; SHORT-SLEEVED SHIRTS; SHORTS;
 SWEAT PANTS; SWEAT SHIRTS; T-SHIRTS (U.S. CLS. 22
 AND 39).
 FIRST USE 10-15-2007; IN COMMERCE 9-12-2008.

CLASS 25—(Continued).

3,681,109. VEDANTE, BOULDER, CO. SN 77-517,675. PUB. 12-9-2008, FILED 7-9-2008.

Fashion that Reflects Well on you!

THE MARK CONSISTS OF STANDARD CHARACTERS WITHOUT CLAIM TO ANY PARTICULAR FONT, STYLE, SIZE, OR COLOR.

FOR APPAREL, NAMELY, MEN'S WOMEN'S AND CHILDREN'S TEE SHIRTS, SWEAT SHIRTS, PANTS, COATS, JACKETS, SHOES, SOCKS, KNIT SHIRTS, POLO SHIRTS (U.S. CLS. 22 AND 39).

FIRST USE 10-1-2007; IN COMMERCE 10-1-2007.

3,681,131. G & S COLLECTION INC., DBA GRACE IN LA, LOS ANGELES, CA. SN 77-522,950. PUB. 12-9-2008, FILED 7-15-2008.

GRACE IN LOS ANGELES

THE MARK CONSISTS OF STANDARD CHARACTERS WITHOUT CLAIM TO ANY PARTICULAR FONT, STYLE, SIZE, OR COLOR.

NO CLAIM IS MADE TO THE EXCLUSIVE RIGHT TO USE "LA", APART FROM THE MARK AS SHOWN.

FOR CLOTHING, NAMELY, PANTS, JEANS, SHORTS, SKIRTS, COVERALLS, SHIRTS, SUITS, SWEATERS, JACKETS, T-SHIRTS, TOPS, BLOUSES, VESTS, TANK TOPS, COATS, DRESSES, NECKTIES, BELTS, SWIMWEAR, RAINWEAR, SLEEPWEAR, NAMELY, NIGHTGOWNS, PAJAMAS, ROBES, SOCKS, HOSIERY, GLOVES, MITTENS, SCARVES, HEADWEAR (U.S. CLS. 22 AND 39).

FIRST USE 6-8-2009; IN COMMERCE 6-8-2009.

3,681,151. INDEPENDENT DESIGN GROUP LOS ANGELES, HOLLYWOOD, CA. SN 77-528,633. PUB. 12-16-2008, FILED 7-22-2008.

BIGENDER

THE MARK CONSISTS OF STANDARD CHARACTERS WITHOUT CLAIM TO ANY PARTICULAR FONT, STYLE, SIZE, OR COLOR.

FOR CLOTHING, NAMELY, SHORT-SLEEVED OR LONG-SLEEVED T-SHIRTS, SHIRTS, JEANS, TIES, UNDERWEAR, SOCKS (U.S. CLS. 22 AND 39).

FIRST USE 7-1-2009; IN COMMERCE 7-1-2009.

CLASS 25—(Continued).

3,681,153. STEVEN MADDEN, LTD., LONG ISLAND CITY, NY. SN 77-530,894. PUB. 11-11-2008, FILED 7-24-2008.



THE MARK CONSISTS OF PEACE SYMBOL, LOVE SYMBOL IN THE SHAPE OF A HEART AND THE DESIGN OF A WOMAN'S HIGH HEEL SHOE.

FOR FOOTWEAR (U.S. CLS. 22 AND 39).
FIRST USE 6-1-2008; IN COMMERCE 6-1-2008.

3,681,207. LOCASCIO, THOMAS, EAST NORWICH, NY. SN 77-553,191. PUB. 1-20-2009, FILED 8-22-2008.

Ageless Hippie

THE MARK CONSISTS OF STANDARD CHARACTERS WITHOUT CLAIM TO ANY PARTICULAR FONT, STYLE, SIZE, OR COLOR.

FOR ATHLETIC APPAREL, NAMELY, SHIRTS, PANTS, JACKETS, FOOTWEAR, HATS AND CAPS, ATHLETIC UNIFORMS; CAPS; GOLF SHIRTS; HOODED SWEAT SHIRTS; KNIT SHIRTS; LONG-SLEEVED SHIRTS; OPEN-NECKED SHIRTS; POLO SHIRTS; RUGBY SHIRTS; SHIRTS; SHORT-SLEEVED OR LONG-SLEEVED T-SHIRTS; SPORT SHIRTS (U.S. CLS. 22 AND 39).

FIRST USE 3-22-2009; IN COMMERCE 3-22-2009.

3,681,239. WILMSHURST, RICHARD, SUTTER CREEK, CA. SN 77-567,138. PUB. 2-10-2009, FILED 9-10-2008.

Gamehog Hunting Apparel

THE MARK CONSISTS OF STANDARD CHARACTERS WITHOUT CLAIM TO ANY PARTICULAR FONT, STYLE, SIZE, OR COLOR.

CLASS 25—(Continued).

NO CLAIM IS MADE TO THE EXCLUSIVE RIGHT TO USE "HUNTING APPAREL", APART FROM THE MARK AS SHOWN.

FOR CLOTHING, NAMELY, JACKETS, SHIRTS, SHORTS, PANTS, T-SHIRTS, SWEATSHIRTS, VESTS, CAPS, HATS (U.S. CLS. 22 AND 39).

FIRST USE 2-15-2009; IN COMMERCE 2-15-2009.

3,681,243. KYDD, PHILLIP, WARWICK, RI. SN 77-569,267.
PUB. 2-3-2009, FILED 9-12-2008.

CHILLAXIN ON VINEYARD TIME

THE MARK CONSISTS OF STANDARD CHARACTERS WITHOUT CLAIM TO ANY PARTICULAR FONT, STYLE, SIZE, OR COLOR.

FOR T-SHIRTS (U.S. CLS. 22 AND 39).
FIRST USE 6-16-2009; IN COMMERCE 6-16-2009.

3,681,285. PARSONS, CHARLES B., LONG BEACH, CA. SN 77-580,745. PUB. 2-17-2009, FILED 9-29-2008.

DANGEROUS DADS

THE MARK CONSISTS OF STANDARD CHARACTERS WITHOUT CLAIM TO ANY PARTICULAR FONT, STYLE, SIZE, OR COLOR.

FOR COATS; GLOVES; HATS; HEADWEAR; JACKETS; SHIRTS (U.S. CLS. 22 AND 39).
FIRST USE 2-0-2009; IN COMMERCE 2-0-2009.

3,681,319. SWIMMIN' THIGHWEAR, SIMI VALLEY, CA. SN 77-591,298. PUB. 3-31-2009, FILED 10-13-2008.

Swimmin' Thighwear

THE MARK CONSISTS OF STANDARD CHARACTERS WITHOUT CLAIM TO ANY PARTICULAR FONT, STYLE, SIZE, OR COLOR.

NO CLAIM IS MADE TO THE EXCLUSIVE RIGHT TO USE "SWIMMING", APART FROM THE MARK AS SHOWN.
FOR CLOTHING, NAMELY, SWIM SHORTS, TOPS (U.S. CLS. 22 AND 39).

FIRST USE 4-1-2009; IN COMMERCE 4-1-2009.

CLASS 25—(Continued).

3,681,330. GALLAGHER, PATRICK, CHINO, CA. SN 77-595,501. PUB. 3-17-2009, FILED 10-17-2008.



THE MARK CONSISTS OF THE STYLIZED WORDING "CAPITAL-G" WITH A POINTED "G" AND "" ABOVE INDICATING CAPITALIZATION.

FOR HATS; HOODED SWEAT SHIRTS; JACKETS; SWEATBANDS; SWEATERS; T-SHIRTS (U.S. CLS. 22 AND 39).

FIRST USE 1-28-2009; IN COMMERCE 6-13-2009.

3,681,350. SILVER, JASON, PORT WASHINGTON, NY. SN 77-601,619. PUB. 3-17-2009, FILED 10-27-2008.



THE MARK CONSISTS OF A SILHOUETTE OF A WOMAN HOLDING A BASEBALL BAT IN HER RIGHT HAND.

FOR HATS; JACKETS; PANTS; SHIRTS; SHORTS; SOCKS; SWEAT SHIRTS; UNDERWEAR (U.S. CLS. 22 AND 39).

FIRST USE 1-2-2009; IN COMMERCE 2-15-2009.

CLASS 25—(Continued).

3,681,359. STRETCH-O-RAMA, INC., NEW YORK, NY. SN 77-604,889. PUB. 3-17-2009, FILED 10-31-2008.

CLASS 25—(Continued).

3,681,425. DAN-MAR MFG., CO. INC., OWINGS MILLS, MD. SN 77-977,486. PUB. 10-14-2008, FILED 5-13-2008.

AMERICAN HAWK

bbzipper

THE MARK CONSISTS OF STANDARD CHARACTERS WITHOUT CLAIM TO ANY PARTICULAR FONT, STYLE, SIZE, OR COLOR.

FOR PANTS, JEANS, JUMPSUITS, SHORTS, SHIRTS, SWEATERS, VESTS, JACKETS, OVERALLS, SWIMSUITS, SOCKS, UNDERWEAR, T-SHIRTS, BLOUSES, SKIRTS, DRESSES, TIGHTS, HATS, CAPS, SCARVES, GLOVES, FOOTWEAR, SWEATSHIRTS, SWEATPANTS, COATS, THERMAL UNDERWEAR (U.S. CLS. 22 AND 39).

FIRST USE 3-2-2009; IN COMMERCE 3-2-2009.

THE MARK CONSISTS OF STANDARD CHARACTERS WITHOUT CLAIM TO ANY PARTICULAR FONT, STYLE, SIZE, OR COLOR.

FOR LADIES' PANTS AND SWEATERS (U.S. CLS. 22 AND 39).

FIRST USE 1-25-2009; IN COMMERCE 2-25-2009.

3,681,392. STREETRAGE LLC, DBA SYNDICATED CLOTHING, UNION, NJ. SN 77-620,323. PUB. 4-7-2009, FILED 11-23-2008.

3,681,435. DISNEY ENTERPRISES, INC., BURBANK, CA. SN 77-977,581. PUB. 9-23-2008, FILED 2-4-2008.



NO CLAIM IS MADE TO THE EXCLUSIVE RIGHT TO USE "NJ", APART FROM THE MARK AS SHOWN.

THE MARK CONSISTS OF THE STYLIZED LETTERS "NJ".

FOR HEADGEAR, NAMELY, HATS, CAPS (U.S. CLS. 22 AND 39).

FIRST USE 3-30-2009; IN COMMERCE 3-30-2009.

OWNER OF U.S. REG. NOS. 1,536,967, 3,242,910, AND 3,341,092.

NO CLAIM IS MADE TO THE EXCLUSIVE RIGHT TO USE "STORE", APART FROM THE MARK AS SHOWN.

THE MARK CONSISTS OF A WORD AND IMAGE THAT INCLUDES AN OVAL AND STARS.

FOR BEACH COVER-UPS; BEACHWEAR; BIKINIS; DRESSES; FOOTWEAR; HALLOWEEN COSTUMES; HEAD BANDS; HEAD WEAR; INFANTWEAR; JACKETS; NIGHT SHIRTS; NIGHT GOWNS; PAJAMAS; SANDALS; SHIRTS; SHOES; SKIRTS; SHORTS; SLEEPWEAR; SWEAT SHIRTS; SWIMSUITS; T-SHIRTS (U.S. CLS. 22 AND 39).

FIRST USE 5-28-2009; IN COMMERCE 5-28-2009.

CLASS 25—(Continued).

3,681,441. PREMIUM DENIM, LLC, CULVER CITY, CA. SN 77-977,612. PUB. 6-24-2008, FILED 3-6-2007.



THE MARK CONSISTS OF AN ABSTRACT DESIGN WITH ELEMENTS THAT RESEMBLE LEAVES.
 FOR CLOTHING AND ACTIVE WEAR, NAMELY, BLOUSES, BOTTOMS, DRESSES, JACKETS, JEANS, PANTS, SHIRTS, SHORTS, SKIRTS, TANK TOPS, VESTS, TOPS (U.S. CLS. 22 AND 39).
 FIRST USE 5-11-2005; IN COMMERCE 5-11-2005.

CLASS 25—(Continued).

3,681,454. ISAACSON, MICHAEL, BEL AIR, CA. SN 78-368,757. PUB. 5-20-2008, FILED 2-16-2004.

Chiaroscuro

THE MARK CONSISTS OF STANDARD CHARACTERS WITHOUT CLAIM TO ANY PARTICULAR FONT, STYLE, SIZE, OR COLOR.
 THE FOREIGN WORDING IN THE MARK TRANSLATES INTO ENGLISH AS LIGHTSHADE.
 FOR MEN'S, WOMEN'S AND CHILDREN'S WEARING APPAREL, NAMELY, SHIRTS (U.S. CLS. 22 AND 39).
 FIRST USE 5-7-2009; IN COMMERCE 5-7-2009.

3,681,445. MASACVA INC., NEW YORK, NY. SN 77-977,649. PUB. 10-9-2007, FILED 2-27-2007.



THE MARK CONSISTS OF A ROUND, STYLIZED FACE DESIGN.
 FOR MEN'S, WOMEN'S AND CHILDREN'S CLOTHING, NAMELY, SHIRTS, SHOES, BELTS, JACKETS, VESTS, PANTS, SCARVES, SKIRTS, TROUSERS AND T-SHIRTS (U.S. CLS. 22 AND 39).
 FIRST USE 10-11-2007; IN COMMERCE 10-11-2007.

3,681,470. PRESIDENT AND BOARD OF TRUSTEES OF SANTA CLARA COLLEGE, THE, SANTA CLARA, CA. SN 78-516,911. PUB. 12-27-2005, FILED 11-15-2004.



OWNER OF U.S. REG. NOS. 1,001,661, 1,003,069, AND 1,451,389.
 NO CLAIM IS MADE TO THE EXCLUSIVE RIGHT TO USE "SANTA CLARA", APART FROM THE MARK AS SHOWN.
 THE MARK CONSISTS OF A HORSE'S HEAD WITH THE WORDS "SANTA CLARA BRONCOS" BELOW IT.
 FOR APPAREL, NAMELY, T-SHIRTS (U.S. CLS. 22 AND 39).
 FIRST USE 7-14-2008; IN COMMERCE 7-14-2008.

CLASS 25—(Continued).

3,681,492. SIMS VIBRATION LABORATORY, INC., SHELTON, WA. SN 78-611,191. PUB. 5-23-2006, FILED 4-18-2005.

LimbSaver

THE MARK CONSISTS OF STANDARD CHARACTERS WITHOUT CLAIM TO ANY PARTICULAR FONT, STYLE, SIZE, OR COLOR.

OWNER OF U.S. REG. NO. 2,565,592.

FOR COATS, FOOTWEAR, GLOVES, HEADWEAR, JACKETS, MITTENS, PANTS, SHIRTS, SHORTS, SWEATERS, SWEAT SHIRTS, T-SHIRTS, VESTS (U.S. CLS. 22 AND 39).

FIRST USE 6-20-2007; IN COMMERCE 6-20-2007.

3,681,504. H. BEST LTD., NEW YORK, NY. SN 78-656,670. PUB. 3-21-2006, FILED 6-23-2005.



THE MARK CONSISTS OF A DESIGN OF A SICKLE. FOR UNDERWEAR (U.S. CLS. 22 AND 39).

FIRST USE 12-31-2004; IN COMMERCE 12-31-2004.

3,681,509. VIZ MEDIA, LLC, SAN FRANCISCO, CA. SN 78-663,735. PUB. 4-11-2006, FILED 7-5-2005.



FOR CLOTHING, NAMELY, SHIRTS, T-SHIRTS, SWEATSHIRTS, VESTS, JACKETS, CLOTHING BELTS, HEADWEAR, FOOTWEAR, JACKETS, GLOVES, HATS, PAJAMAS, UNDERGARMENTS, MASQUERADE COSTUMES, MASQUERADE COSTUMES WITH MASKS SOLD IN CONNECTION THEREWITH, TANK TOPS, UNDERWEAR, AND WRISTBANDS (U.S. CLS. 22 AND 39).

FIRST USE 9-27-2005; IN COMMERCE 9-27-2005.

CLASS 25—(Continued).

3,681,517. JLG INDUSTRIES, INC., MCCONNELLSBURG, PA. SN 78-669,815. PUB. 10-10-2006, FILED 7-13-2005.

JLG GEAR

THE MARK CONSISTS OF STANDARD CHARACTERS WITHOUT CLAIM TO ANY PARTICULAR FONT, STYLE, SIZE, OR COLOR.

OWNER OF U.S. REG. NOS. 982,250, 1,582,261, AND 2,829,437.

NO CLAIM IS MADE TO THE EXCLUSIVE RIGHT TO USE "GEAR", APART FROM THE MARK AS SHOWN.

FOR CLOTHING, NAMELY, T-SHIRTS, POLO SHIRTS, BUTTON-DOWN SHIRTS, JACKETS, CAPS (U.S. CLS. 22 AND 39).

FIRST USE 0-0-2005; IN COMMERCE 0-0-2005.

3,681,538. BOBBY MOSCOW, LLC, CLARKSTON, MI. SN 78-712,653. PUB. 5-2-2006, FILED 9-14-2005.

MADE IN CHICAGO

THE MARK CONSISTS OF STANDARD CHARACTERS WITHOUT CLAIM TO ANY PARTICULAR FONT, STYLE, SIZE, OR COLOR.

FOR SHIRTS (U.S. CLS. 22 AND 39).

FIRST USE 5-0-2009; IN COMMERCE 5-0-2009.

CLASS 25—(Continued).

3,681,581. LERNER, MICHAEL H., NEW YORK, NY. SN 78-839,136. PUB. 11-14-2006, FILED 3-16-2006.



THE COLORS GREEN IS CLAIMED AS A FEATURE OF THE MARK.

THE COLOR GREEN APPEARS INSIDE THE ENTIRE CIRCLE.

FOR CLOTHING, NAMELY, SHIRTS, T-SHIRTS, UNDER SHIRTS, NIGHT SHIRTS, RUGBY SHIRTS, POLO SHIRTS, CARDIGANS, JERSEYS, UNIFORMS, DRESS SHIRTS, PANTS, TROUSERS, SLACKS, JEANS, CULOTTES, CARGO PANTS, STRETCH PANTS, DENIM JEANS, OVERALLS, COVERALLS, JUMPERS, JUMP SUITS, SHORTS, BOXER SHORTS, TOPS, STRETCH TOPS, CROP TOPS, TANK TOPS, HALTER TOPS, SWEAT SHIRTS, SWEAT SHORTS, SWEAT PANTS, WRAPS, WARM-UP SUITS, JOGGING SUITS, TRACK SUITS, PLAY SUITS, BLOUSES, SKIRTS, DRESSES, GOWNS, SWEATERS, VESTS, FLEECE VESTS, PULLOVERS, SNOW SUITS, PARKAS, CAPES, ANORAKS, PONCHOS, JACKETS, REVERSIBLE JACKETS, SHELL JACKETS, COATS, BLAZERS, SUITS, TURTLENECKS, CLOTH SKI BIBS, SWIMWEAR, BEACHWEAR, TENNIS WEAR, SURF WEAR, SKI WEAR, LAYETTES, INFANTWEAR, INFANTS SLEEPERS, BOOTIES, BABY BIBS NOT OF PAPER, CLOTH DIAPERS, CAPS, SWIM CAPS, BERETS, BEANIES, HATS, VISORS, HEADBANDS, WRIST BANDS, SWEAT BANDS, HEADWEAR, EAR MUFFS, APRONS, SCARVES, BANDANAS, BELTS, SUSPENDERS, NECKWEAR, TIES, NECKERCHIEFS, ASCOTS, UNDERWEAR, THERMAL UNDERWEAR, LONG UNDERWEAR, BRIEFS, SWIM AND BATHING TRUNKS, BRAS, SPORTS BRAS, BRASSIERES, BUSTIERS, CORSETS, PANTIES, THONGS, G-STRINGS, GARTERS AND GARTER BELTS, TEDDIES, GIRDLES, FOUNDATION GARMENTS, SINGLETTS, SOCKS, LOUNGEWEAR, ROBES, SMOCKS, UNDERCLOTHES, PAJAMAS, SLEEPWEAR, NIGHT GOWNS, LINGERIE, CAMISOLES, NEG-LIGEEES, CHEMISES, CHEMISETTES, SLIPS, SARONGS, LEG WARMERS, HOSIERY, PANTYHOSE, BODY STOCKINGS, KNEE HIGHS, LEGGINGS, TIGHTS, LEOTARDS, BODY SUITS, UNITARDS, BODY SHAPERS, GLOVES, MITTENS, RAINWEAR, FOOTWEAR, SHOES, SNEAKERS, BOOTS, GALOSHES, SANDALS, FLIP-FLOPS, AND SLIPPERS (U.S. CLS. 22 AND 39).

FIRST USE 1-1-2008; IN COMMERCE 6-1-2009.

CLASS 25—(Continued).

3,681,636. O'KEEFFE, JOEL, MELBOURNE, AUSTRALIA. AND O'KEEFFE, RYAN, MELBOURNE, AUSTRALIA. SN 78-981,144. PUB. 3-18-2008, FILED 12-12-2005.

Airbourne

THE MARK CONSISTS OF STANDARD CHARACTERS WITHOUT CLAIM TO ANY PARTICULAR FONT, STYLE, SIZE, OR COLOR.

FOR CLOTHING, TO BE SOLD AS PROMOTIONAL MERCHANDISE FOR A MUSICAL GROUP, NAMELY, BANDANNAS, WRISTBANDS, UNDERWEAR, JERSEYS, PULLOVERS, T-SHIRTS, JACKETS, SHIRTS, HEADGEAR INCLUDING HATS, CAPS (U.S. CLS. 22 AND 39). FIRST USE 1-4-2006; IN COMMERCE 2-14-2007.

3,681,638. YARBOUGH, RICHARD, GLENDALE, AZ. SN 78-981,161. PUB. 9-11-2007, FILED 7-12-2006.

FOR BELIEVERS WITHOUT LIMITS

THE MARK CONSISTS OF STANDARD CHARACTERS WITHOUT CLAIM TO ANY PARTICULAR FONT, STYLE, SIZE, OR COLOR.

FOR CLOTHING, NAMELY, SHIRTS, WRIST BANDS (U.S. CLS. 22 AND 39). FIRST USE 12-5-2008; IN COMMERCE 12-5-2008.

CLASS 26—FANCY GOODS

CLASS 26—(Continued).

3,680,815. STEVE SEUNG CHOI, CARPENTERSVILLE, IL. SN 77-442,495. PUB. 9-9-2008, FILED 4-8-2008.

SOULMATE

THE MARK CONSISTS OF STANDARD CHARACTERS WITHOUT CLAIM TO ANY PARTICULAR FONT, STYLE, SIZE, OR COLOR.

FOR BARRETTES, HAIR-SLIDES, BEADS FOR HANDICRAFT WORK, BRAIDS, CLOWN WIGS, CROCHET HOOKS, HAIR ACCESSORIES, NAMELY, TWISTERS, HAIR ACCESSORIES, NAMELY, CLAW CLIPS, HAIR ACCESSORIES, NAMELY, SNAP CLIPS, HAIR BANDS, HAIR BOWS, HAIR BUCKLES, HAIR CLIPS, HAIR CURL CLIPS, NON-ELECTRIC HAIR CURLERS, HAIR EXTENSIONS, HAIR FROSTING CAPS, HAIR NETS, HAIR ORNAMENTS, HAIR ORNAMENTS IN THE NATURE OF HAIR WRAPS, HAIR ORNAMENTS IN THE FORM OF COMBS, HAIR PIECES, HAIR PINS, HAIR PINS AND GRIPS, HAIR RIBBONS, HAIR SCRUNCHIES, HAIR WRAPS, BONNETS AND CAPS USED AS APPLICATORS FOR HAIR CONDITIONERS, TAPE FOR FIXING WIGS, TOUPEES, WAVING PINS FOR THE HAIR, WIGS (U.S. CLS. 37, 39, 40, 42 AND 50).

FIRST USE 7-11-2008; IN COMMERCE 7-11-2008.

3,681,374. MCGIVNEY, JULIE M., WADING RIVER, NY. AND CONNOLLY, KERYN, FLORAL PARK, NY. SN 77-612,219. PUB. 3-24-2009, FILED 11-11-2008.

cute your boots

THE MARK CONSISTS OF STANDARD CHARACTERS WITHOUT CLAIM TO ANY PARTICULAR FONT, STYLE, SIZE, OR COLOR.

FOR BOOT AND SHOE ORNAMENTS NOT OF PRECIOUS METAL, NAMELY, DECORATIVE RIBBON WITH HOOKS ATTACHED (U.S. CLS. 37, 39, 40, 42 AND 50).

FIRST USE 11-15-2008; IN COMMERCE 11-15-2008.

CLASS 26—(Continued).

3,681,503. ACE CAFE LONDON LIMITED, LONDON, UNITED KINGDOM. SN 78-654,659. PUB. 10-3-2006, FILED 6-20-2005.



NO CLAIM IS MADE TO THE EXCLUSIVE RIGHT TO USE "LONDON", APART FROM THE MARK AS SHOWN.

THE MARK CONSISTS OF A BLACK CIRCLE CONTAINING THE WORDS "ACE CAFE LONDON" IN WHITE LETTERS SURROUNDING A SMALLER WHITE CIRCLE CONTAINING A BLACK CLUB INTERPOSED BY THE WORD "ACE".

FOR CLASPS FOR CLOTHING; BUCKLES FOR CLOTHING; BELT CLASPS AND BELT BUCKLES NOT OF PRECIOUS METAL; ORNAMENTAL NOVELTY PINS; EMBROIDERED PATCHES; CLOTH PATCHES FOR CLOTHING; CLOTHING ACCESSORIES, NAMELY, BROOCHES, BUTTONS, ADHESIVE PATCHES FOR CLOTHING NOT OF TEXTILE; HEAT ADHESIVE PATCHES FOR CLOTHING NOT OF TEXTILE; HAIR ORNAMENTS; COMPETITORS' NUMBERS NOT OF TEXTILE (U.S. CLS. 37, 39, 40, 42 AND 50).

FIRST USE 11-1-1997; IN COMMERCE 11-1-1997.

CLASS 27—FLOOR COVERINGS

3,680,654. MAYA ROMANOFF CORPORATION, SKOKIE, IL. SN 77-359,541. PUB. 5-13-2008, FILED 12-26-2007.

REMEMBER PARIS

THE MARK CONSISTS OF STANDARD CHARACTERS WITHOUT CLAIM TO ANY PARTICULAR FONT, STYLE, SIZE, OR COLOR.

NO CLAIM IS MADE TO THE EXCLUSIVE RIGHT TO USE "PARIS", APART FROM THE MARK AS SHOWN.

FOR WALL COVERING PRIMARILY OF SYNTHETIC FABRIC (U.S. CLS. 19, 20, 37, 42 AND 50).

FIRST USE 1-10-2008; IN COMMERCE 1-10-2008.

CLASS 27—(Continued).

3,680,835. EASY GRASS, LLC, MIAMI, FL. SN 77-454,993.
PUB. 3-3-2009, FILED 4-22-2008.



THE COLOR(S) GREY, GREEN, WHITE AND DARK GREEN IS/ARE CLAIMED AS A FEATURE OF THE MARK. THE TERM "EASY" IS IN THE COLOR GREY, THE TERM "GRASS" IS IN THE COLOR GREEN, THE ENTIRE TERM "EASYGRASS" IS OUTLINED IN THE COLOR WHITE, AND THE BLADES OF GRASS ARE IN THE COLOR DARK GREEN.

FOR ARTIFICIAL TURF (U.S. CLS. 19, 20, 37, 42 AND 50).
FIRST USE 1-30-2008; IN COMMERCE 1-30-2008.

3,680,925. VICEROY CERAMICS, INC., UPPER SANDUSKY, OH. SN 77-471,435. PUB. 11-4-2008, FILED 5-12-2008.

Vi-Fill

THE MARK CONSISTS OF STANDARD CHARACTERS WITHOUT CLAIM TO ANY PARTICULAR FONT, STYLE, SIZE, OR COLOR.

FOR ARTIFICIAL TURF FILL MADE FROM RECYCLED GLASS WASTE (U.S. CLS. 19, 20, 37, 42 AND 50).

FIRST USE 2-27-2009; IN COMMERCE 2-27-2009.

CLASS 28—TOYS AND SPORTING GOODS

CLASS 28—(Continued).

3,680,078. SAHA, PAMELA, BROOKLYN, NY. SN 76-595,216.
PUB. 3-21-2006, FILED 6-2-2004.

GLITTERINS

THE MARK CONSISTS OF STANDARD CHARACTERS WITHOUT CLAIM TO ANY PARTICULAR FONT, STYLE, SIZE, OR COLOR.

FOR TOYS, NAMELY, TOY ACTION FIGURES AND ACCESSORIES THEREFORE, TOY ANIMALS AND ACCESSORIES THEREFORE, BALLS, NAMELY, RUBBER ACTION BALLS, RUBBER BALLS, STRESS RELIEF BALLS FOR HAND EXERCISE, BENDABLE TOYS, TOY BUILDING BLOCKS, TOY BUILDING BLOCKS CAPABLE OF INTERCONNECTION, COLLECTABLE TOY FIGURES, CONSTRUCTION SETS, CONSTRUCTION TOYS, TOY COSTUMES, TOY FIGURES, TOY MASKS, MAGICAL TOYS, NAMELY, CARDS, PUZZLES, TOY HOUSEHOLD PRODUCTS, NAMELY, DISHES, UTENSILS, TOY LIGHTS, TOY MUSICAL INSTRUMENTS, TOY PRISMS, TOY SCIENTIFIC INSTRUMENTS AND KITS CONSISTING PRIMARILY OF TOY PRISMS, AND TOY MAGNIFYING GLASSES (U.S. CLS. 22, 23, 38 AND 50).

FIRST USE 5-15-2009; IN COMMERCE 5-15-2009.

3,680,111. HASBRO, INC., PAWTUCKET, RI. SN 76-680,280.
PUB. 12-25-2007, FILED 8-2-2007.

GIRAFFALAFF

THE MARK CONSISTS OF STANDARD CHARACTERS WITHOUT CLAIM TO ANY PARTICULAR FONT, STYLE, SIZE, OR COLOR.

FOR PARLOR GAMES (U.S. CLS. 22, 23, 38 AND 50).

FIRST USE 4-24-2009; IN COMMERCE 4-24-2009.

3,680,115. NIEMACKL, DOUGLAS J., TOPEKA, KS. SN 76-683,795. PUB. 4-15-2008, FILED 11-7-2007.

HIDE-A-BOW

THE MARK CONSISTS OF STANDARD CHARACTERS WITHOUT CLAIM TO ANY PARTICULAR FONT, STYLE, SIZE, OR COLOR.

FOR HUNTING BOW BLINDS (U.S. CLS. 22, 23, 38 AND 50).

FIRST USE 10-20-2007; IN COMMERCE 10-20-2007.

CLASS 28—(Continued).

3,680,137. SUMMIT PRODUCTS, LLC, TRUSSVILLE, AL. SN 76-692,558. PUB. 3-10-2009, FILED 9-3-2008.

MOTO HEADZ

THE MARK CONSISTS OF STANDARD CHARACTERS WITHOUT CLAIM TO ANY PARTICULAR FONT, STYLE, SIZE, OR COLOR.

FOR PLASTIC CHARACTER TOYS (U.S. CLS. 22, 23, 38 AND 50).

FIRST USE 11-1-2008; IN COMMERCE 11-1-2008.

3,680,196. MATTEL, INC., EL SEGUNDO, CA. SN 77-094,883. PUB. 5-20-2008, FILED 1-30-2007.

TRIO

THE MARK CONSISTS OF STANDARD CHARACTERS WITHOUT CLAIM TO ANY PARTICULAR FONT, STYLE, SIZE, OR COLOR.

FOR TOYS, GAMES AND PLAYTHINGS, NAMELY, CONSTRUCTION TOYS, TOY BUILDING BLOCKS, TOY CONSTRUCTION SETS, AND ACCESSORIES FOR ALL OF THE FOREGOING (U.S. CLS. 22, 23, 38 AND 50).

FIRST USE 7-21-2009; IN COMMERCE 7-21-2009.

3,680,250. BROWN, DAVID H., VISTA, CA. SN 77-156,623. PUB. 11-11-2008, FILED 4-13-2007.

BUDDHA

THE MARK CONSISTS OF STANDARD CHARACTERS WITHOUT CLAIM TO ANY PARTICULAR FONT, STYLE, SIZE, OR COLOR.

FOR BAGS FOR SKATEBOARDS; BALL BEARINGS FOR SKATEBOARDS; SKATEBOARD DECKS; SKATEBOARD GRIP TAPES; SKATEBOARD TRUCKS; SKATEBOARD WHEELS; SKATEBOARDS; BAGS ESPECIALLY DESIGNED FOR SURFBOARDS; KITS FOR BUILDING SURFBOARDS; SURFBOARD LEASHES; SURFBOARD WAX; SURFBOARDS; SKIM BOARDS (U.S. CLS. 22, 23, 38 AND 50).

FIRST USE 1-1-1995; IN COMMERCE 1-1-1995.

CLASS 28—(Continued).

3,680,295. JUMPING J-JAYS USA, LLC, FRISCO, TX. SN 77-179,634. PUB. 6-24-2008, FILED 5-13-2007.



THE MARK CONSISTS OF A DEPICTION OF A CASTLE WITH A SMILING FACE NEXT TO A SNOWFLAKE WITHIN A ROUNDED SQUARE WITH THE WORDS "INFLATA-COOL" BELOW THE DESIGN.

FOR EVAPORATIVE AIR COOLING APPARATUS BEING AN INTEGRAL COMPONENT OF INFLATABLE PLAY JUMPING STRUCTURES (U.S. CLS. 22, 23, 38 AND 50).

FIRST USE 8-1-2006; IN COMMERCE 4-1-2007.

3,680,334. MATTEL, INC., EL SEGUNDO, CA. SN 77-191,825. PUB. 4-22-2008, FILED 5-29-2007.

SWAMP RAIDER

THE MARK CONSISTS OF STANDARD CHARACTERS WITHOUT CLAIM TO ANY PARTICULAR FONT, STYLE, SIZE, OR COLOR.

FOR TOYS, GAMES AND PLAYTHINGS, NAMELY, RADIO-CONTROLLED TOY VEHICLES, TOY VEHICLES, AND ACCESSORIES FOR ALL OF THE FOREGOING (U.S. CLS. 22, 23, 38 AND 50).

FIRST USE 7-2-2009; IN COMMERCE 7-2-2009.

3,680,353. DAHLIN, CRAIG STEVEN, HUACHUCA CITY, AZ. SN 77-202,173. PUB. 11-20-2007, FILED 6-9-2007.

Baddleball

THE MARK CONSISTS OF STANDARD CHARACTERS WITHOUT CLAIM TO ANY PARTICULAR FONT, STYLE, SIZE, OR COLOR.

FOR INDOOR BASKETBALL GAME (U.S. CLS. 22, 23, 38 AND 50).

FIRST USE 2-2-2008; IN COMMERCE 2-2-2008.

CLASS 28—(Continued).

3,680,369. J2R2 ASSOCIATES, BELMONT, CA. SN 77-221,619. PUB. 12-11-2007, FILED 7-3-2007.

SureHitter

THE MARK CONSISTS OF STANDARD CHARACTERS WITHOUT CLAIM TO ANY PARTICULAR FONT, STYLE, SIZE, OR COLOR.
 FOR BASEBALL AND SOFTBALL TRAINING APPARATUS USED FOR IMPROVING HITTING SKILLS (U.S. CLS. 22, 23, 38 AND 50).
 FIRST USE 10-8-2007; IN COMMERCE 12-13-2007.

3,680,379. TAYLOR MADE GOLF COMPANY, INC., CARLSBAD, CA. SN 77-238,245. PUB. 11-13-2007, FILED 7-25-2007.

BURNER

THE MARK CONSISTS OF STANDARD CHARACTERS WITHOUT CLAIM TO ANY PARTICULAR FONT, STYLE, SIZE, OR COLOR.
 OWNER OF U.S. REG. NO. 1,481,695.
 FOR GOLF BALLS (U.S. CLS. 22, 23, 38 AND 50).
 FIRST USE 12-11-2007; IN COMMERCE 12-11-2007.

3,680,385. HOT STIX GOLF, LLC, SCOTTSDALE, AZ. SN 77-246,940. PUB. 7-1-2008, FILED 8-3-2007.



OWNER OF U.S. REG. NOS. 2,686,688, 2,686,693, AND 2,686,694.
 NO CLAIM IS MADE TO THE EXCLUSIVE RIGHT TO USE "GOLF", APART FROM THE MARK AS SHOWN.
 THE MARK CONSISTS OF THE LETTER "H" CONSISTING OF TWO PARALLEL LINES WITH A GOLF CLUB DIAGONALLY THROUGH THEM INSIDE OF A CIRCLE WITH THE PHRASE "HOT STIX GOLF" ON THE RIGHT SIDE.
 FOR GOLF EQUIPMENT, NAMELY, GOLF CLUBS (U.S. CLS. 22, 23, 38 AND 50).
 FIRST USE 1-0-2005; IN COMMERCE 1-0-2005.

CLASS 28—(Continued).

3,680,407. GREENMASTER INDUSTRIAL CORP., TAIPING, TAIWAN. SN 77-273,742. PUB. 9-30-2008, FILED 9-7-2007.

VELOZ FIT

THE MARK CONSISTS OF STANDARD CHARACTERS WITHOUT CLAIM TO ANY PARTICULAR FONT, STYLE, SIZE, OR COLOR.
 NO CLAIM IS MADE TO THE EXCLUSIVE RIGHT TO USE "FIT", APART FROM THE MARK AS SHOWN.
 THE ENGLISH TRANSLATION OF THE WORD "VELOZ" IN THE MARK IS "QUICK".
 FOR EXERCISE EQUIPMENT, NAMELY, ROWING MACHINES; EXERCISE EQUIPMENT, NAMELY, CHEST EXPANDERS; EXERCISE TREADMILLS; EXERCISING EQUIPMENT, NAMELY, WEIGHT LIFTING MACHINES; LEG WEIGHTS FOR EXERCISING; VIBRATING APPARATUS USED IN FITNESS AND EXERCISE PROGRAMS TO STIMULATE MUSCLES AND INCREASE STRENGTH AND PHYSICAL PERFORMANCE; EXERCISING EQUIPMENT, NAMELY, POWERED TREADMILLS FOR RUNNING; EXERCISE EQUIPMENT, NAMELY, ABDOMINAL BOARDS; AEROBIC STEP MACHINES; EXERCISE EQUIPMENT, NAMELY, STAIR-STEPPING MACHINES (U.S. CLS. 22, 23, 38 AND 50).
 FIRST USE 9-6-2007; IN COMMERCE 12-6-2007.

3,680,413. TECH 4 KIDS INC., MISSISSAUGA, ONTARIO, CANADA. SN 77-279,722. PUB. 9-30-2008, FILED 9-14-2007.

LULLALIGHT

THE MARK CONSISTS OF STANDARD CHARACTERS WITHOUT CLAIM TO ANY PARTICULAR FONT, STYLE, SIZE, OR COLOR.
 FOR TOY PROJECTORS (U.S. CLS. 22, 23, 38 AND 50).
 FIRST USE 2-28-2006; IN COMMERCE 2-28-2006.

3,680,526. ALTMAN, JEREMY, MARTINEZ, GA. SN 77-326,886. PUB. 4-8-2008, FILED 11-12-2007.

Wake Up

THE MARK CONSISTS OF STANDARD CHARACTERS WITHOUT CLAIM TO ANY PARTICULAR FONT, STYLE, SIZE, OR COLOR.
 FOR FISHING LURES (U.S. CLS. 22, 23, 38 AND 50).
 FIRST USE 7-25-2008; IN COMMERCE 7-25-2008.

CLASS 28—(Continued).

3,680,539. DC COMICS, NEW YORK, NY. SN 77-329,808. PUB. 4-15-2008, FILED 11-14-2007.

THE DARK KNIGHT

THE MARK CONSISTS OF STANDARD CHARACTERS WITHOUT CLAIM TO ANY PARTICULAR FONT, STYLE, SIZE, OR COLOR.

OWNER OF U.S. REG. NO. 1,458,274.

FOR TOYS AND SPORTING GOODS, INCLUDING GAMES AND PLAYTHINGS, NAMELY, ACTION FIGURES AND ACCESSORIES THEREFOR; PLUSH TOYS; BALLOONS; RIDE-ON TOYS; EQUIPMENT SOLD AS A UNIT FOR PLAYING CARD GAMES; TOY VEHICLES; DOLLS; FLYING DISCS; ELECTRONIC HAND-HELD GAME UNIT; A CARD GAME, A MANIPULATIVE GAME, A PARLOR GAME AND AN ACTION TYPE TARGET GAME; STAND ALONE VIDEO OUTPUT GAME MACHINES; JIGSAW AND MANIPULATIVE PUZZLES; WATER SQUIRTING TOYS; BALLS, NAMELY, PLAYGROUND BALLS; TOY BANKS; AND CHRISTMAS TREE ORNAMENTS (U.S. CLS. 22, 23, 38 AND 50).

FIRST USE 7-0-2008; IN COMMERCE 7-0-2008.

3,680,547. DAIWA SEIKO, INC., TOKYO, JAPAN. SN 77-331,788. PUB. 11-11-2008, FILED 11-16-2007.

ZAION

THE MARK CONSISTS OF STANDARD CHARACTERS WITHOUT CLAIM TO ANY PARTICULAR FONT, STYLE, SIZE, OR COLOR.

FOR FISHING REELS, FISHING RODS, FISHING LURES, FISHING LURES, FISHING TACKLE BOXES, FISHING SINKERS, FISHING FLOATS, FISHING LINES AND FISHING CREELS (U.S. CLS. 22, 23, 38 AND 50).

FIRST USE 7-0-2008; IN COMMERCE 7-0-2008.

CLASS 28—(Continued).

3,680,569. SHROOMBOB, LLC, BOZEMAN, MT. SN 77-335,858. PUB. 7-8-2008, FILED 11-22-2007.

ShroomBob

THE MARK CONSISTS OF STANDARD CHARACTERS WITHOUT CLAIM TO ANY PARTICULAR FONT, STYLE, SIZE, OR COLOR.

FOR SKIBOBS, SKI BIKES, AND DEVICES RESEMBLING BICYCLES WITH SKIS INSTEAD OF WHEELS, USED FOR SLIDING DOWN SNOW-COVERED SLOPES (U.S. CLS. 22, 23, 38 AND 50).

FIRST USE 12-31-2008; IN COMMERCE 12-31-2008.

3,680,651. HAJARI, KHOSRO B., WESLEY CHAPEL, FL. SN 77-358,956. PUB. 5-13-2008, FILED 12-24-2007.

TwisterNock

THE MARK CONSISTS OF STANDARD CHARACTERS WITHOUT CLAIM TO ANY PARTICULAR FONT, STYLE, SIZE, OR COLOR.

FOR ARCHERY EQUIPMENT, NAMELY, ARROW NOCK (U.S. CLS. 22, 23, 38 AND 50).

FIRST USE 12-23-2007; IN COMMERCE 2-10-2009.

3,680,662. LAUER TOYS INCORPORATED, ST. LOUIS, MO. SN 77-365,789. PUB. 12-9-2008, FILED 1-7-2008.

**THE MOST REALISTIC BABIES
EVER**

THE MARK CONSISTS OF STANDARD CHARACTERS WITHOUT CLAIM TO ANY PARTICULAR FONT, STYLE, SIZE, OR COLOR.

NO CLAIM IS MADE TO THE EXCLUSIVE RIGHT TO USE "THE MOST REALISTIC BABIES", APART FROM THE MARK AS SHOWN.

FOR DOLLS AND DOLL ACCESSORIES (U.S. CLS. 22, 23, 38 AND 50).

FIRST USE 6-0-2008; IN COMMERCE 6-0-2008.

CLASS 28—(Continued).

3,680,717. UNISEN, INC., IRVINE, CA. SN 77-396,446. PUB. 10-7-2008, FILED 2-13-2008.

HOT BAR

THE MARK CONSISTS OF STANDARD CHARACTERS WITHOUT CLAIM TO ANY PARTICULAR FONT, STYLE, SIZE, OR COLOR.

FOR OPERATING CONTROL PANEL SOLD AS AN INTEGRAL COMPONENT OF EXERCISE MACHINES, NAMELY, TREADMILLS (U.S. CLS. 22, 23, 38 AND 50).
FIRST USE 2-0-2008; IN COMMERCE 2-0-2008.

3,680,740. HORIZON GROUP USA, INC., WARREN, NJ. SN 77-405,048. PUB. 7-22-2008, FILED 2-25-2008.

META LAVA

THE MARK CONSISTS OF STANDARD CHARACTERS WITHOUT CLAIM TO ANY PARTICULAR FONT, STYLE, SIZE, OR COLOR.

FOR MOLDABLE MATERIAL IN THE NATURE OF TOY PUTTY, USED AS A TOY AND AMUSEMENT DEVICE (U.S. CLS. 22, 23, 38 AND 50).

FIRST USE 7-1-2008; IN COMMERCE 7-1-2008.

3,680,742. GIORDANO, MICHAEL P., ORLANDO, FL. SN 77-405,275. PUB. 11-11-2008, FILED 2-25-2008.

MIKEY'S TACKLE SHOP

THE MARK CONSISTS OF STANDARD CHARACTERS WITHOUT CLAIM TO ANY PARTICULAR FONT, STYLE, SIZE, OR COLOR.

NO CLAIM IS MADE TO THE EXCLUSIVE RIGHT TO USE "TACKLE SHOP", APART FROM THE MARK AS SHOWN.

FOR FISHING TACKLE (U.S. CLS. 22, 23, 38 AND 50).
FIRST USE 6-1-2009; IN COMMERCE 6-1-2009.

CLASS 28—(Continued).

3,680,768. STELLA HAMELIN HOLDINGS INC., MONTREAL, CANADA. SN 77-420,089. PUB. 10-7-2008, FILED 3-12-2008.

PLAYPOINT

THE MARK CONSISTS OF STANDARD CHARACTERS WITHOUT CLAIM TO ANY PARTICULAR FONT, STYLE, SIZE, OR COLOR.

FOR PLAYGROUND EQUIPMENT, NAMELY, PLAYGROUND STRUCTURES IN THE NATURE OF MERRY-GO-ROUNDS, SWING SETS, CLIMBING UNITS, SLIDES, SPRING-RIDERS, SEESAWS (U.S. CLS. 22, 23, 38 AND 50).

FIRST USE 2-29-2008; IN COMMERCE 2-29-2008.

3,680,822. STANLEY JIGS, INC., HUNTINGTON, TX. SN 77-445,748. PUB. 9-30-2008, FILED 4-11-2008.



THE MARK CONSISTS OF THE MARK IS THE WORD "SWIMMAX" IN WHICH THE BACKSLASH OF THE LETTER "X" EXTENDS INTO A FISH THAT UNDERLINES THE MARK.

FOR ARTIFICIAL FISHING LURES (U.S. CLS. 22, 23, 38 AND 50).

FIRST USE 7-25-2008; IN COMMERCE 7-25-2008.

3,680,848. TAYLOR MADE GOLF COMPANY, INC., CARLSBAD, CA. SN 77-457,253. PUB. 10-14-2008, FILED 4-24-2008.

STRATUS

THE MARK CONSISTS OF STANDARD CHARACTERS WITHOUT CLAIM TO ANY PARTICULAR FONT, STYLE, SIZE, OR COLOR.

FOR GOLF GLOVES (U.S. CLS. 22, 23, 38 AND 50).
FIRST USE 8-0-2008; IN COMMERCE 8-0-2008.

CLASS 28—(Continued).

3,680,869. TOY STATE INDUSTRIAL LTD., TSTE, KOW-
LOON, HONG KONG. SN 77-460,351. PUB. 9-30-2008,
FILED 4-29-2008.

GO YOUR OWN WAY

THE MARK CONSISTS OF STANDARD CHARACTERS
WITHOUT CLAIM TO ANY PARTICULAR FONT, STYLE,
SIZE, OR COLOR.

FOR TOY VEHICLES (U.S. CLS. 22, 23, 38 AND 50).
FIRST USE 1-20-2009; IN COMMERCE 1-20-2009.

3,680,872. GEOFFREY, LLC, WAYNE, NJ. SN 77-461,061.
PUB. 9-30-2008, FILED 4-29-2008.



OWNER OF U.S. REG. NOS. 2,469,154, 2,715,408, AND
2,794,853.

THE COLOR(S) GREEN AND LIGHT GREEN, BEIGE
AND BROWN IS/ARE CLAIMED AS A FEATURE OF THE
MARK.

THE MARK CONSISTS OF A REVERSED LETTER "R" IN
GREEN WITH A TREE LEAF IN LIGHT GREEN, WITHIN A
BEIGE CIRCLE, WITHIN A BROWN CIRCLE CONTAINING
THE WORDS "RECYCLE, RENEW, REUSE" AND "RE-
THINK" IN BEIGE LETTERS WITHIN ANOTHER BEIGE
CIRCLE ALL CONTAINED WITHIN A GREEN BORDER.

FOR TOYS, GAMES AND PLAYTHINGS, NAMELY,
NATURAL WOOD TOYS, NAMELY, WOOD ALPHABET
BLOCKS, WOOD TOY CARS, WOOD TOY TRAINS AND
WOOD TOY FIRE TRUCKS; NATURAL PLUSH TOYS
AND TOY ANIMALS; ORGANIC COTTON DOLLS (U.S.
CLS. 22, 23, 38 AND 50).
FIRST USE 4-30-2008; IN COMMERCE 4-30-2008.

CLASS 28—(Continued).

3,680,888. WILLIAMS JR., JAMES, EDDIE, MIAMI, FL. SN
77-466,364. PUB. 10-7-2008, FILED 5-5-2008.



THE COLOR(S) RED, YELLOW, BLACK, GRAY, WHITE,
LIGHT BLUE IS/ARE CLAIMED AS A FEATURE OF THE
MARK.

THE MARK CONSISTS OF THE WORD FOCUS REAC-
TION THE MAGNIFYING GLASS HANDLE IS TILTED IN
AN ANGLE WITH THE HANDLE ON THE LEFT SIDE AND
THE CIRCULAR GLASS ON THE RIGHT SIDE. THE
LETTERS "F", "O", "C", "U", "S", "R", "E" ARE OUTSIDE
OF THE CIRCULAR GLASS PORTION OF THE MAGNIFY-
ING GLASS THE LETTERS "A", "C", "T", "I", "O", "N" ARE
LOCATED IN THE CIRCULAR GLASS PART OF THE
MAGNIFYING GLASS THE CIRCULAR GLASS PORTION
OF THE MAGNIFYING GLASS IS SHADED WITH A LIGHT
BLUE TRANSPARENCY COVERING THE LETTERS
"A", "C", "T", "I", "O", "N" THE LETTERS ARE YELLOW
WITH A RED OUTLINE. THE MAGNIFYING GLASS IS
GRAY OUTLINED IN BLACK WITH A WHITE INNER
GLOW ON THE HANDLE.

FOR BOARD GAMES (U.S. CLS. 22, 23, 38 AND 50).
FIRST USE 5-15-2008; IN COMMERCE 4-20-2009.

3,680,896. LAMM, CONNIE, SEDALIA, MO. SN 77-466,956.
PUB. 10-7-2008, FILED 5-6-2008.

SMOOSH

THE MARK CONSISTS OF STANDARD CHARACTERS
WITHOUT CLAIM TO ANY PARTICULAR FONT, STYLE,
SIZE, OR COLOR.

FOR TOY MODELING DOUGH (U.S. CLS. 22, 23, 38
AND 50).
FIRST USE 10-10-2008; IN COMMERCE 11-23-2008.

CLASS 28—(Continued).

3,680,964. SHANDONG BCN SPORT INDUSTRY CO., LTD., SHANDONG PROVINCE, CHINA. SN 77-476,138. PUB. 10-21-2008, FILED 5-15-2008.



FOR BALLS FOR GAMES; BILLIARD TABLES; BILLIARD CUES; POOL CUE TIPS; BILLIARD MARKERS; CHALK FOR BILLIARD CUES; EXERCISE MACHINES; BODY-TRAINING APPARATUS; MAH-JONG; TABLES FOR TABLE TENNIS (U.S. CLS. 22, 23, 38 AND 50).
FIRST USE 8-18-2006; IN COMMERCE 5-20-2008.

CLASS 28—(Continued).

3,681,004. GRZESIAK, RAY, NEW LENOX, IL. SN 77-483,349. PUB. 12-16-2008, FILED 5-26-2008.



NO CLAIM IS MADE TO THE EXCLUSIVE RIGHT TO USE "WAKE SURFBOARDS", APART FROM THE MARK AS SHOWN.

THE COLOR(S) BLACK, GOLD AND GREY IS/ARE CLAIMED AS A FEATURE OF THE MARK.

THE MARK CONSISTS OF THE WORDS "ENDLESS BREAK WAKE SURFBOARDS" IN BLACK PRINT. AFTER THE WORD "ENDLESS" AND BEFORE THE WORD "BREAK" ARE GOLD PROPELLER BLADES OUTLINED IN BLACK WITH A GREY INTERIOR SPINNER OUTLINED IN BLACK AND THE LAST "S" ON "ENDLESS" FORMS A SWIRL THROUGH THE PROPELLER BLADES AS DOES THE "B" IN "BREAK".

FOR BAGS ESPECIALLY DESIGNED FOR SURFBOARDS; PADDLES FOR USE WITH SURFBOARDS; SURFBOARD CARRIER WORN ON THE BODY; SURFBOARD FINS; SURFBOARD HOLDER WORN ON THE BODY; SURFBOARD LEASHES; SURFBOARD STORAGE RACK; SURFBOARD WAX; SURFBOARDS (U.S. CLS. 22, 23, 38 AND 50).
FIRST USE 2-1-2008; IN COMMERCE 6-1-2008.

3,680,982. DENISE E. VARNER, PLYMOUTH, MI. SN 77-479,248. PUB. 10-21-2008, FILED 5-20-2008.

TRIMANIA

THE MARK CONSISTS OF STANDARD CHARACTERS WITHOUT CLAIM TO ANY PARTICULAR FONT, STYLE, SIZE, OR COLOR.

FOR GAMES, NAMELY, BOARD GAMES AND FLASH CARD GAMES THAT INCORPORATE ABBREVIATIONS (U.S. CLS. 22, 23, 38 AND 50).
FIRST USE 5-28-2009; IN COMMERCE 5-28-2009.

3,681,027. WAKEFERN FOOD CORP., KEASBEY, NJ. SN 77-488,282. PUB. 10-21-2008, FILED 6-2-2008.

MOUNTAIN VISTA EXPRESS

THE MARK CONSISTS OF STANDARD CHARACTERS WITHOUT CLAIM TO ANY PARTICULAR FONT, STYLE, SIZE, OR COLOR.

FOR TOY MODEL TRAIN SETS (U.S. CLS. 22, 23, 38 AND 50).
FIRST USE 11-23-2008; IN COMMERCE 11-23-2008.

CLASS 28—(Continued).

3,681,149. KUREHA CORPORATION, TOKYO, JAPAN. SN 77-528,249. PUB. 12-9-2008, FILED 7-22-2008.

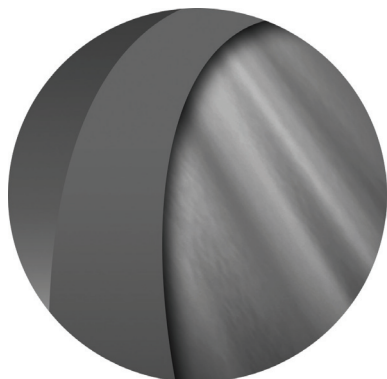

THE MARK CONSISTS OF THE REPRESENTATION OF A CIRCLE DEVICE FEATURING VARIOUS GRADATIONS OF SHADING AND A PROMINENT BAR AROUND THE CIRCUMFERENCE OF THE CIRCLE DEVICE.
FOR FISHING LINES (U.S. CLS. 22, 23, 38 AND 50).
FIRST USE 9-26-2008; IN COMMERCE 9-26-2008.

3,681,159. HUNTER'S SPECIALTIES, INC., CEDAR RAPIDS, IA. SN 77-533,669. PUB. 10-21-2008, FILED 7-29-2008.

YETI

THE MARK CONSISTS OF STANDARD CHARACTERS WITHOUT CLAIM TO ANY PARTICULAR FONT, STYLE, SIZE, OR COLOR.
FOR HUNTING GAME CALLS (U.S. CLS. 22, 23, 38 AND 50).
FIRST USE 6-2-2009; IN COMMERCE 6-2-2009.

3,681,240. ALTARATIONS, LLC, BLOWING ROCK, NC. SN 77-567,358. PUB. 1-27-2009, FILED 9-11-2008.

GRAB HER HAND. OPEN YOUR
HEART.

THE MARK CONSISTS OF STANDARD CHARACTERS WITHOUT CLAIM TO ANY PARTICULAR FONT, STYLE, SIZE, OR COLOR.
FOR DOLLS (U.S. CLS. 22, 23, 38 AND 50).
FIRST USE 11-2-2008; IN COMMERCE 11-2-2008.

CLASS 28—(Continued).

3,681,405. SOCIETE DES PRODUITS NESTLE S.A., VEVEY, SWITZERLAND. SN 77-627,239. PUB. 3-31-2009, FILED 12-5-2008.

TEASE ME

THE MARK CONSISTS OF STANDARD CHARACTERS WITHOUT CLAIM TO ANY PARTICULAR FONT, STYLE, SIZE, OR COLOR.
FOR PET TOYS (U.S. CLS. 22, 23, 38 AND 50).
FIRST USE 6-1-2009; IN COMMERCE 6-1-2009.

3,681,406. SOCIETE DES PRODUITS NESTLE S.A., VEVEY, SWITZERLAND. SN 77-627,248. PUB. 3-31-2009, FILED 12-5-2008.

ENGAGE ME

THE MARK CONSISTS OF STANDARD CHARACTERS WITHOUT CLAIM TO ANY PARTICULAR FONT, STYLE, SIZE, OR COLOR.
FOR PET TOYS (U.S. CLS. 22, 23, 38 AND 50).
FIRST USE 6-1-2009; IN COMMERCE 6-1-2009.

3,681,407. SOCIETE DES PRODUITS NESTLE S.A., VEVEY, SWITZERLAND. SN 77-627,251. PUB. 3-31-2009, FILED 12-5-2008.

COMFORT ME

THE MARK CONSISTS OF STANDARD CHARACTERS WITHOUT CLAIM TO ANY PARTICULAR FONT, STYLE, SIZE, OR COLOR.
FOR PET TOYS (U.S. CLS. 22, 23, 38 AND 50).
FIRST USE 6-1-2009; IN COMMERCE 6-1-2009.

CLASS 28—(Continued).

3,681,415. THE SISTERHOOD BOUTIQUE LLC, ATLANTA, GA. SN 77-976,868. PUB. 6-10-2008, FILED 10-28-2007.



NO CLAIM IS MADE TO THE EXCLUSIVE RIGHT TO USE "BOUTIQUE", APART FROM THE MARK AS SHOWN. THE MARK CONSISTS OF INTRICATE SWIRL PATTERNS DERIVED FROM MIRROR IMAGE OF TWO HIGHLY STYLIZED SWAN FORMS, OVERLAID WITH LACE, THAT ARE MIRROR IMAGES AND WHOSE HEADS TOUCH AT THE TOP, SITTING UPON HIGHLY STYLIZED MIRRORED WAVES OVERLAID WITH LACE. THE PHRASE "THE SISTERHOOD BOUTIQUE" IS HIGHLY STYLIZED.

FOR DOLLS; DOLLS AND ACCESSORIES THEREFOR (U.S. CLS. 22, 23, 38 AND 50).
FIRST USE 10-15-2007; IN COMMERCE 10-15-2007.

CLASS 28—(Continued).

3,681,595. BOEING MANAGEMENT COMPANY, SEAL BEACH, CA. SN 78-877,966. PUB. 11-14-2006, FILED 5-5-2006.

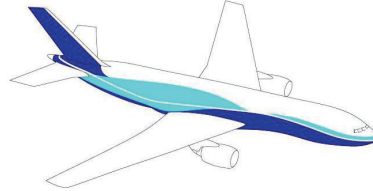

THE COLORS DARK BLUE, LIGHT BLUE AND WHITE ARE CLAIMED AS A FEATURE OF THE MARK.

THE COLOR LIGHT BLUE APPEARS IN THE IRREGULAR OVAL DESIGN, WITH A WAVY LINE ON THE MAIN BODY OF THE AIRPLANE, HORIZONTAL LINES ON THE JET ENGINES AND VERTICAL LINES ON THE VERTICAL STABILIZER; THE COLOR DARK BLUE APPEARS ON WAVY PORTION OF THE FUSELAGE EXTENDING THE LENGTH OF THE AIRPLANE SEPARATED BY A THIN WHITE STRIPE, THE HORIZONTAL BAR ON THE JET ENGINES, AND THE VERTICAL BAR ON THE VERTICAL STABILIZER, AND THE COLOR WHITE APPEARS ELSEWHERE ON THE AIRPLANE.

FOR TOY MODEL AIRPLANES, SCALE MODEL AIRPLANES FOR DISPLAY, TOY AND DISPLAY MODEL AIRPLANES IN KIT FORM (U.S. CLS. 22, 23, 38 AND 50).
FIRST USE 6-25-2009; IN COMMERCE 6-25-2009.

3,681,510. VIZ MEDIA, LLC, SAN FRANCISCO, CA. SN 78-664,007. PUB. 4-11-2006, FILED 7-5-2005.



FOR TOYS AND SPORTING GOODS, NAMELY, PLAY FIGURES AND ACCESSORIES THEREFOR, ACTION FIGURES AND ACCESSORIES THEREFOR, TOY FIGURES, ELECTRIC ACTION TOYS, MECHANICAL ACTION TOYS, DOLLS AND ACCESSORIES THEREFOR, DOLL PLAYSETS, PLUSH TOYS, STUFFED TOYS, PUPPETS, BOARD GAMES, CARD GAMES, JIGSAW PUZZLES, MANIPULATIVE GAMES, MUSICAL TOYS, TARGET GAMES, ACTION SKILL GAMES, FLYING DISKS, DISC TYPE TOSS TOYS, SKATEBOARDS, TOY SWORDS, AND PLAYING CARDS (U.S. CLS. 22, 23, 38 AND 50).
FIRST USE 9-15-2005; IN COMMERCE 9-15-2005.

3,681,621. MENDLESTEIN, RICHARD, ANSONIA, CT. SN 78-958,327. PUB. 4-24-2007, FILED 8-23-2006.



THE COLOR(S) RED AND BLACK IS/ARE CLAIMED AS A FEATURE OF THE MARK.

THE MARK CONSISTS OF THE LETTERS "AA" WITH THE FIRST "A" IN BLACK AND THE SECOND "A" IN RED, IN THE CENTER OF A CIRCULAR PATTERN COMPRISED OF THE WORD "DOUBLE" IN RED AT THE TOP OF THE CIRCULAR PATTERN AND THE WORD "ACES" IN BLACK AT THE BOTTOM OF THE CIRCULAR PATTERN WITH THE WORDS CONNECTED ON EACH SIDE BY PLAYING CARD DESIGNS OF DIAMONDS AND HEARTS IN RED AND CLUBS AND SPADES IN BLACK.

FOR GAMES AND PLAYTHINGS, NAMELY, CASINO GAMBLING TABLE PLAYING CARD GAMES (U.S. CLS. 22, 23, 38 AND 50).
FIRST USE 6-15-2008; IN COMMERCE 6-15-2008.

CLASS 28—(Continued).

3,681,635. DYE PRECISION, INC., SAN DIEGO, CA. SN 78-981,036. PUB. 6-10-2008, FILED 9-1-2006.

CLASS 29—(Continued).

3,680,529. BACHOCO S.A. DE C.V., CELAYA, GUANAJUATO, MEXICO. SN 77-327,343. PUB. 10-14-2008, FILED 11-12-2007.

RAIL

THE MARK CONSISTS OF STANDARD CHARACTERS WITHOUT CLAIM TO ANY PARTICULAR FONT, STYLE, SIZE, OR COLOR.

FOR PAINTBALL GUNS AND PARTS THEREFOR, NAMELY, GUN BARRELS, FITTINGS, GRIPS, TRIGGERS, FIRING MECHANISMS, LOADING MECHANISMS, FRAMES, STOCKS, NON-TELESCOPIC SIGHTS AND RELATED SIGHTING MECHANISMS (U.S. CLS. 22, 23, 38 AND 50).

FIRST USE 11-4-2006; IN COMMERCE 11-4-2006.

BACHOCO UN HUEVO DE BUENA GRANJA

THE MARK CONSISTS OF STANDARD CHARACTERS WITHOUT CLAIM TO ANY PARTICULAR FONT, STYLE, SIZE, OR COLOR.

OWNER OF U.S. REG. NOS. 2,742,553 AND 3,329,376. NO CLAIM IS MADE TO THE EXCLUSIVE RIGHT TO USE "UN HUEVO DE BUENA GRANJA", APART FROM THE MARK AS SHOWN.

THE FOREIGN WORDING IN THE MARK TRANSLATES INTO ENGLISH AS AN EGG FROM A GOOD FARM.

FOR EGGS (U.S. CL. 46).

FIRST USE 11-10-2007; IN COMMERCE 11-10-2007.

CLASS 29—MEATS AND PROCESSED FOODS

3,680,438. SUNOPTA FRUIT GROUP, INC., BUENA PARK, CA. SN 77-295,009. PUB. 3-11-2008, FILED 10-3-2007.

3,680,826. E.B. EXPRESS PROVISIONS, INC., NEWARK, NJ. SN 77-449,392. PUB. 10-7-2008, FILED 4-16-2008.

FIST A TWIST

THE MARK CONSISTS OF STANDARD CHARACTERS WITHOUT CLAIM TO ANY PARTICULAR FONT, STYLE, SIZE, OR COLOR.

FOR FRUIT-BASED SNACK FOODS (U.S. CL. 46).

FIRST USE 1-23-2009; IN COMMERCE 1-23-2009.

Ouro da Serra

THE MARK CONSISTS OF STANDARD CHARACTERS WITHOUT CLAIM TO ANY PARTICULAR FONT, STYLE, SIZE, OR COLOR.

THE FOREIGN WORDING IN THE MARK TRANSLATES INTO ENGLISH AS GOLD OF THE MOUNTAIN.

FOR PROCESSED AND PREPARED FOODS, NAMELY, OLIVES, PICKLES, GIARDINIERA, AND LUPINI BEANS (U.S. CL. 46).

FIRST USE 9-1-2008; IN COMMERCE 9-1-2008.

3,680,486. POWER HUNGRY FOODS LLC, SARTELL, MN. SN 77-313,381. PUB. 4-8-2008, FILED 10-25-2007.

3,680,827. SIGMA ALIMENTOS, S.A. DE C.V., SAN PEDRO GARZA GARCIA, MEXICO. SN 77-450,530. PUB. 7-29-2008, FILED 4-17-2008.

POWER HUNGRY FOODS

THE MARK CONSISTS OF STANDARD CHARACTERS WITHOUT CLAIM TO ANY PARTICULAR FONT, STYLE, SIZE, OR COLOR.

NO CLAIM IS MADE TO THE EXCLUSIVE RIGHT TO USE "FOODS", APART FROM THE MARK AS SHOWN.

FOR MEAT-BASED SNACK FOODS (U.S. CL. 46).

FIRST USE 3-2-2009; IN COMMERCE 3-2-2009.

CANASTO

THE MARK CONSISTS OF STANDARD CHARACTERS WITHOUT CLAIM TO ANY PARTICULAR FONT, STYLE, SIZE, OR COLOR.

THE ENGLISH TRANSLATION OF THE WORD "CANASTO" IN THE MARK IS LARGE BASKET.

FOR CHEESE (U.S. CL. 46).

FIRST USE 9-0-2008; IN COMMERCE 9-0-2008.

CLASS 29—(Continued).

3,680,894. SIMCO PLASTICS INC., DBA WEE BEE JAMMIN, COMMERCE TOWNSHIP, MI. SN 77-466,812. PUB. 10-14-2008, FILED 5-6-2008.

WEE BEE JAMMIN'

THE MARK CONSISTS OF STANDARD CHARACTERS WITHOUT CLAIM TO ANY PARTICULAR FONT, STYLE, SIZE, OR COLOR.
FOR JELLIES AND JAMS (U.S. CL. 46).
FIRST USE 8-0-2008; IN COMMERCE 12-0-2008.

CLASS 29—(Continued).

3,681,098. MANCHESTER FARMS, INC., DALZELL, SC. SN 77-510,994. PUB. 11-18-2008, FILED 6-30-2008.

RESTAURANT ROW

THE MARK CONSISTS OF STANDARD CHARACTERS WITHOUT CLAIM TO ANY PARTICULAR FONT, STYLE, SIZE, OR COLOR.
FOR FROZEN ENTREES AND MEAL KITS CONSISTING PRIMARILY OF MEAT, FISH, POULTRY OR VEGETABLES (U.S. CL. 46).
FIRST USE 1-0-2009; IN COMMERCE 2-0-2009.

3,680,895. SIMCO PLASTICS INC., DBA WEE BEE JAMMIN, COMMERCE TOWNSHIP, MI. SN 77-466,840. PUB. 10-14-2008, FILED 5-6-2008.

3,681,190. CHUDLEIGH'S LTD., MILTON, CANADA. SN 77-545,672. PUB. 11-25-2008, FILED 8-13-2008.



THE MARK CONSISTS OF "KEEPIN' IT REAL" IN A CIRCLE DESIGN SURROUNDING A BUMBLE BEE AND THE STYLIZED LETTERS "WBJ".
FOR JELLIES AND JAMS (U.S. CL. 46).
FIRST USE 8-0-2008; IN COMMERCE 12-0-2008.

BYOUNG

THE MARK CONSISTS OF STANDARD CHARACTERS WITHOUT CLAIM TO ANY PARTICULAR FONT, STYLE, SIZE, OR COLOR.
FOR FRUIT AND DAIRY BASED SNACK CUPS, EXCLUDING ICE CREAM, ICE MILK, AND FROZEN YOGURT (U.S. CL. 46).
FIRST USE 5-19-2009; IN COMMERCE 5-19-2009.

3,680,984. TOPCO ASSOCIATES, LLC, SKOKIE, IL. SN 77-479,342. PUB. 10-7-2008, FILED 5-20-2008.

BUCKLEY FARMS

THE MARK CONSISTS OF STANDARD CHARACTERS WITHOUT CLAIM TO ANY PARTICULAR FONT, STYLE, SIZE, OR COLOR.
NO CLAIM IS MADE TO THE EXCLUSIVE RIGHT TO USE "FARMS", APART FROM THE MARK AS SHOWN.
FOR CORNED BEEF (U.S. CL. 46).
FIRST USE 11-0-2008; IN COMMERCE 11-0-2008.

3,681,300. CAMACHO, RAFAEL, SAN DIEGO, CA. SN 77-587,371. PUB. 3-17-2009, FILED 10-7-2008.



NO CLAIM IS MADE TO THE EXCLUSIVE RIGHT TO USE "SEAFOODS MARISCOS MEXICANOS", APART FROM THE MARK AS SHOWN.
THE COLOR(S) DARK BLUE BLACK (FOR THE LETTERS) RED (EYES OF THE FISHES AND "I" DOTS) WHITE (CONTOUR OF THE FISHES) IS/ARE CLAIMED AS A FEATURE OF THE MARK.

CLASS 29—(Continued).

THE MARK CONSISTS OF THREE FISHES ONE OF THE IS JUMPING FROM THE WATER. AT THE TOP OF THE MARK IT SHOULD SAY: "MARI-MEX"(COLOR BLACK), UNDER THAT STATEMENT IT SHOULD SAY: SEAFOODS (COLOR BLACK) UNDE THE FISHES IT SHOULD APPEAR THE WORDS: "MARISCOS MEXICANOS" (COLOR BLACK AND THE DOTS OF LETTER "I" IN COLOR RED).

THE ENGLISH TRANSLATION OF "MARISCOS MEXICANOS" IN THE MARK IS "MEXICAN SEAFOOD".

FOR FROZEN SEAFOOD (U.S. CL. 46).
FIRST USE 6-1-2009; IN COMMERCE 6-1-2009.

3,681,376. HERMAN, BRANDAL, HONOLULU, HI. SN 77-612,606. PUB. 3-31-2009, FILED 11-12-2008.

Hawaiian Cowboy

THE MARK CONSISTS OF STANDARD CHARACTERS WITHOUT CLAIM TO ANY PARTICULAR FONT, STYLE, SIZE, OR COLOR.

NO CLAIM IS MADE TO THE EXCLUSIVE RIGHT TO USE "HAWAIIAN", APART FROM THE MARK AS SHOWN.

FOR DEHYDRATED FRUIT SNACKS; MEAT-BASED SNACK FOODS; NUT AND SEED-BASED SNACK BARS; POTATO-BASED SNACK FOODS; SNACK MIX CONSISTING OF WASABI PEAS, PROCESSED NUTS, DEHYDRATED FRUIT AND/OR RAISINS; SNACK MIX CONSISTING PRIMARILY OF PROCESSED FRUITS, PROCESSED NUTS AND/OR RAISINS (U.S. CL. 46).

FIRST USE 6-1-2009; IN COMMERCE 6-1-2009.

CLASS 30—STAPLE FOODS

3,680,130. JOHNSON, THOMAS W., ENCINITAS, CA. SN 76-689,093. PUB. 9-23-2008, FILED 4-28-2008.

GARMAPA ROY

THE MARK CONSISTS OF STANDARD CHARACTERS WITHOUT CLAIM TO ANY PARTICULAR FONT, STYLE, SIZE, OR COLOR.

FOR PROCESSED SEASONING WITH GARLIC, MANGO AND PAPAAYA (U.S. CL. 46).

FIRST USE 5-26-2009; IN COMMERCE 5-26-2009.

CLASS 30—(Continued).

3,680,157. AUTHENTIC SPECIALTY FOODS, INC., CHINO, CA. SN 77-036,476. PUB. 10-30-2007, FILED 11-3-2006.

LA VIC

THE MARK CONSISTS OF STANDARD CHARACTERS WITHOUT CLAIM TO ANY PARTICULAR FONT, STYLE, SIZE, OR COLOR.

OWNER OF U.S. REG. NO. 3,417,088.

FOR SALSA (U.S. CL. 46).

FIRST USE 9-0-2006; IN COMMERCE 9-0-2006.

3,680,220. ORIGINAL V LLC, MIDDLETON, WI. SN 77-139,200. PUB. 9-25-2007, FILED 3-23-2007.

VIAMO

THE MARK CONSISTS OF STANDARD CHARACTERS WITHOUT CLAIM TO ANY PARTICULAR FONT, STYLE, SIZE, OR COLOR.

FOR WHOLE BEAN COFFEE, GROUND COFFEE, BREWED COFFEE, INSTANT COFFEE, READY TO DRINK COFFEE, BREWED ESPRESSO, CAPPUCCINO AND COFFEE BASED BEVERAGES CONTAINING MILK, NAMELY, LATTE (U.S. CL. 46).

FIRST USE 3-20-2007; IN COMMERCE 3-20-2007.

3,680,282. MANE, INC., MILFORD, OH. SN 77-172,357. PUB. 4-1-2008, FILED 5-3-2007.

SENSORA

THE MARK CONSISTS OF STANDARD CHARACTERS WITHOUT CLAIM TO ANY PARTICULAR FONT, STYLE, SIZE, OR COLOR.

FOR PALATABILITY SYSTEMS CONSISTING PRIMARILY OF FLAVORING ADDITIVES FOR NON-NUTRITIONAL PURPOSES TO IMPROVE THE PALATABILITY OF ANIMAL FEED AND PET FOOD (U.S. CL. 46).

FIRST USE 2-24-2009; IN COMMERCE 2-24-2009.

CLASS 30—(Continued).

3,680,381. MAKKOS OF BROOKLYN, LTD., NEW YORK, NY. SN 77-238,498. PUB. 5-6-2008, FILED 7-25-2007.



NO CLAIM IS MADE TO THE EXCLUSIVE RIGHT TO USE "NEW YORK CHURROS", APART FROM THE MARK AS SHOWN.

FOR FRIED DOUGH SNACKS, NAMELY, CHURROS (U.S. CL. 46).
FIRST USE 7-9-2007; IN COMMERCE 8-16-2007.

3,680,401. ICON MANAGEMENT SYSTEMS, INC., PHOENIX, AZ. SN 77-270,445. PUB. 2-26-2008, FILED 9-3-2007.

BRIZZA

THE MARK CONSISTS OF STANDARD CHARACTERS WITHOUT CLAIM TO ANY PARTICULAR FONT, STYLE, SIZE, OR COLOR.

FOR PIZZA (U.S. CL. 46).
FIRST USE 2-12-2009; IN COMMERCE 2-12-2009.

3,680,445. NATIONAL FOOD COMPANY, N.F.C. SA, THESI PATIMA, GREECE. SN 77-299,069. PUB. 4-1-2008, FILED 10-9-2007.

POLIS CINNAMON BUN CHIPS

THE MARK CONSISTS OF STANDARD CHARACTERS WITHOUT CLAIM TO ANY PARTICULAR FONT, STYLE, SIZE, OR COLOR.

NO CLAIM IS MADE TO THE EXCLUSIVE RIGHT TO USE "CINNAMON BUN CHIPS", APART FROM THE MARK AS SHOWN.

FOR FLOUR-BASED CHIPS (U.S. CL. 46).
FIRST USE 4-30-2008; IN COMMERCE 4-30-2008.

CLASS 30—(Continued).

3,680,485. TOPCO ASSOCIATES, LLC, SKOKIE, IL. SN 77-313,108. PUB. 3-18-2008, FILED 10-25-2007.

CHIP-A-RIFFIC

THE MARK CONSISTS OF STANDARD CHARACTERS WITHOUT CLAIM TO ANY PARTICULAR FONT, STYLE, SIZE, OR COLOR.

FOR COOKIES (U.S. CL. 46).
FIRST USE 9-0-2008; IN COMMERCE 9-0-2008.

3,680,629. WYNDHAM RESORT DEVELOPMENT CORPORATION, ORLANDO, FL. SN 77-350,026. PUB. 5-13-2008, FILED 12-12-2007.

WORLDMARK BLEND

THE MARK CONSISTS OF STANDARD CHARACTERS WITHOUT CLAIM TO ANY PARTICULAR FONT, STYLE, SIZE, OR COLOR.

OWNER OF U.S. REG. NOS. 1,940,673 AND 3,133,841.
NO CLAIM IS MADE TO THE EXCLUSIVE RIGHT TO USE "BLEND", APART FROM THE MARK AS SHOWN.
FOR COFFEE (U.S. CL. 46).
FIRST USE 1-0-2008; IN COMMERCE 1-0-2008.

3,680,679. ARGENTO FOODS LLC, ALPHARETTA, GA. SN 77-371,224. PUB. 12-2-2008, FILED 1-14-2008.

Chimichurri del Mono

THE MARK CONSISTS OF STANDARD CHARACTERS WITHOUT CLAIM TO ANY PARTICULAR FONT, STYLE, SIZE, OR COLOR.

NO CLAIM IS MADE TO THE EXCLUSIVE RIGHT TO USE "CHIMICHURRI", APART FROM THE MARK AS SHOWN.

THE FOREIGN WORDING IN THE MARK TRANSLATES INTO ENGLISH AS CHIMICHURRI OF THE MONKEY.
FOR BARBECUE SAUCE (U.S. CL. 46).
FIRST USE 7-1-2009; IN COMMERCE 7-1-2009.

CLASS 30—(Continued).

3,680,721. YOOGO CORPORATION, DBA TUTTIMELON, SAN FRANCISCO, CA. SN 77-399,905. PUB. 4-7-2009, FILED 2-19-2008.



THE COLOR(S) ORANGE, LIGHT ORANGE, PINK, LIGHT PINK, GREEN, LIGHT GREEN AND WHITE IS/ARE CLAIMED AS A FEATURE OF THE MARK.

THE MARK CONSISTS OF THE WORDING "TUTTIMELON" IN STYLIZED FORM WITH A STYLIZED DEPICTION OF A PEACH TO THE LEFT OF THE WORDING. THE COLOR PINK APPEARS IN THE WORD "TUTTI". THE COLOR GREEN APPEARS IN THE WORD "MELON" AND THE LEAVES OF THE PEACH. THE COLOR ORANGE APPEARS IN THE PEACH. THE COLOR LIGHT PINK APPEARS IN THE DOT OVER THE LETTER "I" IN THE WORD "TUTTI". THE COLOR LIGHT GREEN APPEARS IN THE "O" IN THE WORD "MELON" AND IN THE LINE ON THE LEAVES OF THE PEACH. THE COLOR LIGHT ORANGE APPEARS IN THE PEACH. THE COLOR WHITE APPEARS IN THE SHADING IN THE PEACH, THE CIRCLE IN THE MIDDLE OF THE PEACH, THE CIRCLE IN THE MIDDLE OF THE DOT OVER THE LETTER "I", THE CIRCLE IN THE MIDDLE OF THE LETTER "O" AND THE LINE ON THE LEAVES OF THE PEACH.

FOR FROZEN YOGURT (U.S. CL. 46).
FIRST USE 1-1-2009; IN COMMERCE 1-1-2009.

CLASS 30—(Continued).

3,680,743. ANDREW P. NESTING, EL PASO, TX. AND TERRY L. BACA, EL PASO, TX. SN 77-405,392. PUB. 7-22-2008, FILED 2-25-2008.

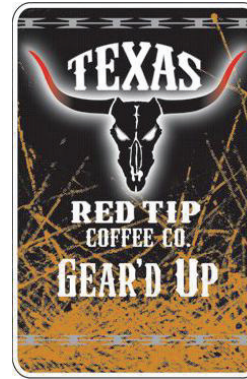

NO CLAIM IS MADE TO THE EXCLUSIVE RIGHT TO USE "TEXAS" AND "COFFEE CO.", APART FROM THE MARK AS SHOWN.

THE COLOR(S) BLACK, RED, TAN, WHITE, COPPER, AND GREY IS/ARE CLAIMED AS A FEATURE OF THE MARK.

THE MARK CONSISTS OF A BLACK BULL'S SKULL WITH RED TIPPED HORNS, WITH TAN AND BLACK IN THE REMAINING PORTIONS OF THE HORNS WITH WHITE EYES OUTLINED IN GREY. THE SKULL HAS A WHITE CROOKED LINE AT THE TOP AND A WHITE OVAL LIKE PORTION EXTENDING FROM THE EYES DOWN TO THE BOTTOM OF THE SKULL. THE STYLIZED WORDING "TEXAS", "RED TIP COFFEE CO." AND "GEAR'D UP" IS IN WHITE. THE BACKGROUND IS IN BLACK WITH THE BOTTOM HALF PORTION COVERED WITH RANDOM COPPER COLOR LINES. THE TOP AND BOTTOM PORTION OF THE MARK CONSISTS OF A GREY HORIZONTAL BARBWIRE-LIKE DESIGN.

FOR GROUND COFFEE BEANS (U.S. CL. 46).
FIRST USE 2-22-2008; IN COMMERCE 2-22-2008.

3,680,785. HAIN CELESTIAL GROUP, INC., THE, MELVILLE, NY. SN 77-434,744. PUB. 10-21-2008, FILED 3-28-2008.



NO CLAIM IS MADE TO THE EXCLUSIVE RIGHT TO USE "ALL NATURAL", "GLUTEN FREE" AND "CAFE", APART FROM THE MARK AS SHOWN.

FOR GLUTEN FREE FROZEN ENTREES CONSISTING PRIMARILY OF PASTA OR RICE (U.S. CL. 46).
FIRST USE 6-9-2008; IN COMMERCE 6-9-2008.

CLASS 30—(Continued).

3,680,852. THE DWAYNE A. ROSCOE AND JOHN R. ROSCOE PARTNERSHIP, LONG BEACH, CA. SN 77-457,556. PUB. 9-23-2008, FILED 4-24-2008.

Kranky Kookys

THE MARK CONSISTS OF STANDARD CHARACTERS WITHOUT CLAIM TO ANY PARTICULAR FONT, STYLE, SIZE, OR COLOR.

NO CLAIM IS MADE TO THE EXCLUSIVE RIGHT TO USE "COOKIES", APART FROM THE MARK AS SHOWN. FOR BAKERY GOODS (U.S. CL. 46). FIRST USE 10-18-2008; IN COMMERCE 11-3-2008.

3,680,857. R. L. ALBERT & SON, INC., GREENWICH, CT. SN 77-458,422. PUB. 9-23-2008, FILED 4-25-2008.

MY SWEET VALENTINE

THE MARK CONSISTS OF STANDARD CHARACTERS WITHOUT CLAIM TO ANY PARTICULAR FONT, STYLE, SIZE, OR COLOR.

FOR CANDY (U.S. CL. 46). FIRST USE 10-0-2008; IN COMMERCE 10-0-2008.

3,680,901. FACENTE, BRUCE, WEST WARWICK, RI. SN 77-467,773. PUB. 10-14-2008, FILED 5-7-2008.

Time Capsule Candy

THE MARK CONSISTS OF STANDARD CHARACTERS WITHOUT CLAIM TO ANY PARTICULAR FONT, STYLE, SIZE, OR COLOR.

NO CLAIM IS MADE TO THE EXCLUSIVE RIGHT TO USE "CANDY", APART FROM THE MARK AS SHOWN. FOR CANDY (U.S. CL. 46). FIRST USE 1-27-2009; IN COMMERCE 1-27-2009.

CLASS 30—(Continued).

3,680,903. THE COCA-COLA COMPANY, ATLANTA, GA. SN 77-468,302. PUB. 10-7-2008, FILED 5-7-2008.

NATURE'S PERFECT SWEETNESS

THE MARK CONSISTS OF STANDARD CHARACTERS WITHOUT CLAIM TO ANY PARTICULAR FONT, STYLE, SIZE, OR COLOR.

FOR NATURAL SWEETENERS (U.S. CL. 46). FIRST USE 8-18-2008; IN COMMERCE 8-18-2008.

3,681,016. JOHNSON, MICHAEL SCOTT, ST. PAUL, MN. SN 77-485,638. PUB. 10-21-2008, FILED 5-28-2008.

UNPEELED

THE MARK CONSISTS OF STANDARD CHARACTERS WITHOUT CLAIM TO ANY PARTICULAR FONT, STYLE, SIZE, OR COLOR.

FOR SUGARED GREEN TEA BEVERAGE INFUSED WITH LIVE AND ACTIVE CULTURES (U.S. CL. 46). FIRST USE 3-11-2008; IN COMMERCE 5-20-2009.

3,681,100. TACO JOHN'S SEASONINGS LIMITED PARTNERSHIP, CHEYENNE, WY. SN 77-512,155. PUB. 12-9-2008, FILED 7-1-2008.

RANCH CHICKEN SNACKARITO

THE MARK CONSISTS OF STANDARD CHARACTERS WITHOUT CLAIM TO ANY PARTICULAR FONT, STYLE, SIZE, OR COLOR.

NO CLAIM IS MADE TO THE EXCLUSIVE RIGHT TO USE "RANCH CHICKEN", APART FROM THE MARK AS SHOWN.

FOR BURRITO FOR CONSUMPTION ON OR OFF THE PREMISES (U.S. CL. 46). FIRST USE 9-8-2008; IN COMMERCE 9-8-2008.

CLASS 30—(Continued).

3,681,127. VARSAM, GEORGE, FLUSHING, NY. SN 77-522,284. PUB. 12-9-2008, FILED 7-15-2008.

A GOURMET CHEF IN A JAR

THE MARK CONSISTS OF STANDARD CHARACTERS WITHOUT CLAIM TO ANY PARTICULAR FONT, STYLE, SIZE, OR COLOR.

FOR SPICES, SEASONINGS AND SEASONING MIXES (U.S. CL. 46).

FIRST USE 12-22-2008; IN COMMERCE 12-22-2008.

CLASS 30—(Continued).

3,681,255. VENUS WAFERS, INC., HINGHAM, MA. SN 77-573,060. PUB. 2-10-2009, FILED 9-18-2008.

NUTRAVITA

THE MARK CONSISTS OF STANDARD CHARACTERS WITHOUT CLAIM TO ANY PARTICULAR FONT, STYLE, SIZE, OR COLOR.

FOR CRACKERS (U.S. CL. 46).

FIRST USE 11-0-2008; IN COMMERCE 1-0-2009.

3,681,143. GOSSETT, GREGORY, OGDEN, UT. SN 77-526,477. PUB. 12-16-2008, FILED 7-18-2008.

LOVE GUM

THE MARK CONSISTS OF STANDARD CHARACTERS WITHOUT CLAIM TO ANY PARTICULAR FONT, STYLE, SIZE, OR COLOR.

NO CLAIM IS MADE TO THE EXCLUSIVE RIGHT TO USE "GUM", APART FROM THE MARK AS SHOWN.

FOR CHEWING GUM (U.S. CL. 46).

FIRST USE 1-1-1994; IN COMMERCE 1-1-1994.

3,681,395. FUNCTIONAL TECHNOLOGIES CORPORATION, VANCOUVER, CANADA. SN 77-621,131. PUB. 3-31-2009, FILED 11-24-2008.

PHYTERRA

THE MARK CONSISTS OF STANDARD CHARACTERS WITHOUT CLAIM TO ANY PARTICULAR FONT, STYLE, SIZE, OR COLOR.

FOR YEAST (U.S. CL. 46).

FIRST USE 6-0-2009; IN COMMERCE 6-0-2009.

3,681,168. CADBURY ADAMS USA LLC, PARSIPPANY, NJ. SN 77-535,105. PUB. 12-2-2008, FILED 7-30-2008.

UBER BUBBLE

THE MARK CONSISTS OF STANDARD CHARACTERS WITHOUT CLAIM TO ANY PARTICULAR FONT, STYLE, SIZE, OR COLOR.

NO CLAIM IS MADE TO THE EXCLUSIVE RIGHT TO USE "BUBBLE", APART FROM THE MARK AS SHOWN.

THE ENGLISH TRANSLATION OF THE WORD "UBER" IN THE MARK IS ABOVE OR OVER.

FOR CHEWING GUM (U.S. CL. 46).

FIRST USE 5-4-2009; IN COMMERCE 5-4-2009.

3,681,403. PAPAS, ALEX, LANTANA, FL. SN 77-625,576. PUB. 4-7-2009, FILED 12-3-2008.

KABANG

THE MARK CONSISTS OF STANDARD CHARACTERS WITHOUT CLAIM TO ANY PARTICULAR FONT, STYLE, SIZE, OR COLOR.

FOR CANDY THAT CONTAINS VITAMINS AND NUTRITIONAL SUPPLEMENTS (U.S. CL. 46).

FIRST USE 2-1-2009; IN COMMERCE 4-1-2009.

CLASS 30—(Continued).

3,681,476. PHOENIX INTANGIBLES HOLDING COMPANY, GREENVILLE, DE. SN 78-545,582. PUB. 3-28-2006, FILED 1-11-2005.

CLASS 30—(Continued).

3,681,592. HERSHEY CHOCOLATE & CONFECTIONERY CORPORATION, WHEAT RIDGE, CO. SN 78-867,713. PUB. 10-10-2006, FILED 4-24-2006.

MARKET DISTRICT

THE MARK CONSISTS OF STANDARD CHARACTERS WITHOUT CLAIM TO ANY PARTICULAR FONT, STYLE, SIZE, OR COLOR.

FOR PASTA (U.S. CL. 46).
FIRST USE 1-16-2009; IN COMMERCE 1-16-2009.



3,681,478. PHOENIX INTANGIBLES HOLDING COMPANY, GREENVILLE, DE. SN 78-550,621. PUB. 3-28-2006, FILED 1-20-2005.

KISSES FROM ME!

THE MARK CONSISTS OF STANDARD CHARACTERS WITHOUT CLAIM TO ANY PARTICULAR FONT, STYLE, SIZE, OR COLOR.

OWNER OF U.S. REG. NOS. 1,396,853 AND 2,416,701.
FOR CANDY (U.S. CL. 46).
FIRST USE 9-23-2005; IN COMMERCE 9-23-2005.

GIANT EAGLE MARKET DISTRICT

THE MARK CONSISTS OF STANDARD CHARACTERS WITHOUT CLAIM TO ANY PARTICULAR FONT, STYLE, SIZE, OR COLOR.

OWNER OF U.S. REG. NOS. 1,287,433, 2,638,558, AND OTHERS.
FOR PASTA (U.S. CL. 46).
FIRST USE 1-16-2009; IN COMMERCE 1-16-2009.



3,681,491. NABAVI, PARVIZ, LAHAINA, HI. SN 78-610,653. PUB. 3-28-2006, FILED 4-18-2005.

3,681,596. JIE CHEN, IVANHOE, AUSTRALIA. SN 78-881,045. PUB. 3-25-2008, FILED 5-11-2006.

TNT**SIMPATICO**

THE MARK CONSISTS OF STANDARD CHARACTERS WITHOUT CLAIM TO ANY PARTICULAR FONT, STYLE, SIZE, OR COLOR.

FOR PROCESSED HERBS, SPICES AND SPICE RUBS (U.S. CL. 46).
FIRST USE 6-13-2009; IN COMMERCE 6-13-2009.

THE MARK CONSISTS OF STANDARD CHARACTERS WITHOUT CLAIM TO ANY PARTICULAR FONT, STYLE, SIZE, OR COLOR.

FOR TEA, NAMELY, DRIED HERBAL TEA BLENDS AND TISANES SOLD IN DISC FORM, SPECIFICALLY EXCLUDING PREPARED BEVERAGES (U.S. CL. 46).
FIRST USE 3-31-2006; IN COMMERCE 3-31-2006.

CLASS 30—(Continued).

3,681,614. SWEETS DIMENSION, S.A. DE C.V., AGUASCALIENTES, MEXICO. SN 78-946,512. PUB. 10-16-2007, FILED 8-7-2006.



NO CLAIM IS MADE TO THE EXCLUSIVE RIGHT TO USE "SWEETS", APART FROM THE MARK AS SHOWN.

THE COLOR(S) BLACK, WHITE, PURPLE AND RED IS/ARE CLAIMED AS A FEATURE OF THE MARK.

THE MARK CONSISTS OF THE WORDING "SWEETS DIMENSION" WITHIN A STRIPED OVAL DESIGN. THE WORD "SWEETS" IS DISPLAYED IN THE COLOR PURPLE FRAMED BY WHITE AND BLACK OUTLINING AND HIGHLIGHTS. THE WORD "DIMENSION" IS DISPLAYED IN THE COLOR RED FRAMED BY WHITE AND BLACK OUTLINING AND HIGHLIGHTS. THE OVAL DESIGN IS OUTLINED IN BLACK AND CONTAINS RED AND WHITE STRIPES.

FOR CANDIES; GUMMY CANDIES (U.S. CL. 46).
FIRST USE 6-19-2009; IN COMMERCE 6-19-2009.

3,681,619. BEAR NAKED, INC., BATTLE CREEK, MI. SN 78-956,185. PUB. 4-17-2007, FILED 8-21-2006.



OWNER OF U.S. REG. NOS. 2,800,495 AND 3,161,484.
THE MARK CONSISTS OF A BEAR CLAW MARK IN A CIRCLE.

FOR GRANOLA CEREALS, GRANOLA-BASED SNACK BARS, CEREAL BASED SNACK BARS ALSO CONTAINING FRUIT, NUTS AND/OR RAISINS; OAT-MEAL, ROLLED OATS AND BREAKFAST CEREALS (U.S. CL. 46).

FIRST USE 9-0-2005; IN COMMERCE 9-0-2005.

CLASS 31—NATURAL AGRICULTURAL PRODUCTS**CLASS 31—(Continued).**

3,680,131. EASON, HARVEY J., CEDAREDDGE, CO. SN 76-689,427. PUB. 10-7-2008, FILED 5-7-2008.

GARDEN IN A CAN

THE MARK CONSISTS OF STANDARD CHARACTERS WITHOUT CLAIM TO ANY PARTICULAR FONT, STYLE, SIZE, OR COLOR.

FOR KITS CONTAINING VEGETABLE SEEDS (U.S. CLS. 1 AND 46).

FIRST USE 10-9-2008; IN COMMERCE 10-9-2008.

3,680,398. ALABAMA FARMERS COOPERATIVE, INC., DECATUR, AL. SN 77-264,271. PUB. 5-13-2008, FILED 8-24-2007.

Good for the Earth... Good for You.

THE MARK CONSISTS OF STANDARD CHARACTERS WITHOUT CLAIM TO ANY PARTICULAR FONT, STYLE, SIZE, OR COLOR.

FOR LIVE PLANTS, NAMELY, VEGETABLES, FRUIT PLANTS AND HERB PLANTS (U.S. CLS. 1 AND 46).

FIRST USE 1-0-2007; IN COMMERCE 1-0-2007.

3,680,748. HORTECH, INC., SPRING LAKE, MI. SN 77-409,782. PUB. 1-20-2009, FILED 2-29-2008.

Shade Serene Mix

THE MARK CONSISTS OF STANDARD CHARACTERS WITHOUT CLAIM TO ANY PARTICULAR FONT, STYLE, SIZE, OR COLOR.

NO CLAIM IS MADE TO THE EXCLUSIVE RIGHT TO USE "SHADE" OR "MIX", APART FROM THE MARK AS SHOWN.

FOR LIVING PLANTS (U.S. CLS. 1 AND 46).
FIRST USE 9-1-2007; IN COMMERCE 6-0-2008.

CLASS 31—(Continued).

3,680,774. SOCIETE DES PRODUITS NESTLE S.A., VEVEY, SWITZERLAND. SN 77-426,401. PUB. 6-3-2008, FILED 3-19-2008.

CHOP HOUSE

THE MARK CONSISTS OF STANDARD CHARACTERS WITHOUT CLAIM TO ANY PARTICULAR FONT, STYLE, SIZE, OR COLOR.

OWNER OF U.S. REG. NO. 3,233,297.
FOR PET FOOD (U.S. CLS. 1 AND 46).
FIRST USE 6-20-2009; IN COMMERCE 6-20-2009.

3,681,001. HEB GROCERY COMPANY, LP, SAN ANTONIO, TX. SN 77-482,198. PUB. 10-14-2008, FILED 5-23-2008.

H-E-B BARKER'S DOZEN BAKERY

THE MARK CONSISTS OF STANDARD CHARACTERS WITHOUT CLAIM TO ANY PARTICULAR FONT, STYLE, SIZE, OR COLOR.

OWNER OF U.S. REG. NOS. 1,167,845, 1,530,250, AND OTHERS.

NO CLAIM IS MADE TO THE EXCLUSIVE RIGHT TO USE "BAKERY", APART FROM THE MARK AS SHOWN.

FOR DOG TREATS (U.S. CLS. 1 AND 46).
FIRST USE 10-29-2008; IN COMMERCE 10-29-2008.

3,681,043. THE HONEST KITCHEN, INC., SAN DIEGO, CA. SN 77-493,423. PUB. 10-14-2008, FILED 6-6-2008.

KEEN

THE MARK CONSISTS OF STANDARD CHARACTERS WITHOUT CLAIM TO ANY PARTICULAR FONT, STYLE, SIZE, OR COLOR.

FOR PET FOOD (U.S. CLS. 1 AND 46).
FIRST USE 9-0-2008; IN COMMERCE 9-0-2008.

CLASS 31—(Continued).

3,681,081. MELTON-JOHNSON, BRENNAN W., SAN LUIS OBISPO, CA. AND MELTON-JOHNSON, JENNIFER M., SAN LUIS OBISPO, CA. SN 77-502,001. PUB. 3-10-2009, FILED 6-18-2008.

MUTTOS

THE MARK CONSISTS OF STANDARD CHARACTERS WITHOUT CLAIM TO ANY PARTICULAR FONT, STYLE, SIZE, OR COLOR.

THE ENGLISH TRANSLATION OF THE WORD "MUTTOS" IN THE MARK IS TO GRUMBLE OR MUTTER.
FOR PET FOOD (U.S. CLS. 1 AND 46).
FIRST USE 9-23-2008; IN COMMERCE 9-23-2008.

3,681,083. ITAUEIRA AGROPECUARIA S/A, FORTALEZA, BRAZIL. SN 77-503,519. PUB. 11-11-2008, FILED 6-19-2008.

MELONREI

THE MARK CONSISTS OF STANDARD CHARACTERS WITHOUT CLAIM TO ANY PARTICULAR FONT, STYLE, SIZE, OR COLOR.

FOR FRESH FRUITS (U.S. CLS. 1 AND 46).
FIRST USE 10-16-2008; IN COMMERCE 10-16-2008.

3,681,123. GARDEN STATE BULB COMPANY, VINELAND, NJ. SN 77-521,721. PUB. 12-2-2008, FILED 7-14-2008.

Blends of Beauty

THE MARK CONSISTS OF STANDARD CHARACTERS WITHOUT CLAIM TO ANY PARTICULAR FONT, STYLE, SIZE, OR COLOR.

FOR BULBS FOR AGRICULTURAL PURPOSES; BULBS FOR HORTICULTURAL PURPOSES; FLOWER BULBS; FLOWER BULBS AND CORMS; FLOWER SEEDS; FLOWERS; LIVE FLOWER ARRANGEMENTS; LIVE FLOWERING PLANTS; LIVE FLOWERS; LIVE PLANTS; LIVING PLANTS; NATURAL PLANTS AND FLOWERS; PLANT SEEDS; SEEDS AND BULBS; SEEDS FOR FLOWERS; VEGETABLE SEEDS FOR PLANTING (U.S. CLS. 1 AND 46).

FIRST USE 9-1-2008; IN COMMERCE 9-1-2008.

CLASS 31—(Continued).

3,681,179. GELSEY, ANDREW, WEST BLOOMFIELD, MI. SN 77-543,689. PUB. 3-24-2009, FILED 8-11-2008.



NO CLAIM IS MADE TO THE EXCLUSIVE RIGHT TO USE "BISCOTTI FOR DOGS", APART FROM THE MARK AS SHOWN.

THE MARK CONSISTS OF A PICTURE OF A DOG DRESSED UP AS A WAITER HOLDING A PLATE ON HIS RIGHT HAND. ON TOP OF HIS HEAD A PICTURE OF A GLOBE APPEARS AND ON THE TOP OF THE GLOBE THERE ARE TWO CHAIRS AND A TABLE. ON THE BOTTOM THERE IS A BANNER WITH THE STYLIZED TEXT "BARKSCOTTI "THE BISCOTTI FOR DOGS"".

FOR DOG TREATS (U.S. CLS. 1 AND 46).
FIRST USE 6-15-2008; IN COMMERCE 11-4-2008.

3,681,546. HISHTIL LTD., NECHALIM, ISRAEL. SN 78-734,755. PUB. 9-26-2006, FILED 10-17-2005.



NO CLAIM IS MADE TO THE EXCLUSIVE RIGHT TO USE "SWEET RAISIN TOMATOES", APART FROM THE MARK AS SHOWN.

THE COLORS RED, GREEN, DARK GREEN, AND WHITE ARE CLAIMED AS A FEATURE OF THE MARK.

THE WORD "TOMACCIO" APPEARS IN WHITE ON A DARK GREEN RECTANGLE WITH A WHITE BORDER. THIS RECTANGLE IS POSITIONED IN THE CENTER OF A GREEN OVAL WITH A DARK GREEN BORDER. THE WORDS "SWEET RAISIN TOMATOES" APPEAR IN WHITE ON THE GREEN OVAL, BENEATH THE RECTANGLE. SEVEN RED TOMATOES WITH DARK GREEN LEAVES APPEAR ON THE GREEN OVAL ABOVE THE RECTANGLE.

FOR AGRICULTURAL SEEDS; BULBS FOR AGRICULTURAL PURPOSES; PLANT SEEDS; AND LIVING PLANTS (U.S. CLS. 1 AND 46).
FIRST USE 2-28-2009; IN COMMERCE 2-28-2009.

CLASS 31—(Continued).

3,681,547. DEL MONTE CORPORATION, SAN FRANCISCO, CA. SN 78-737,505. PUB. 12-19-2006, FILED 10-20-2005.

DEL MONTE ROSE

THE MARK CONSISTS OF STANDARD CHARACTERS WITHOUT CLAIM TO ANY PARTICULAR FONT, STYLE, SIZE, OR COLOR.

OWNER OF U.S. REG. NOS. 2,581,586, 2,978,898, AND OTHERS.

FOR FRESH FRUITS; FRESH VEGETABLES (U.S. CLS. 1 AND 46).

FIRST USE 2-20-2009; IN COMMERCE 2-27-2009.

3,681,625. MARICOPA PACKERS, L.P., LOS ANGELES, CA. SN 78-969,981. PUB. 5-1-2007, FILED 9-8-2006.



OWNER OF U.S. REG. NOS. 2,608,239, 2,969,464, AND OTHERS.

NO CLAIM IS MADE TO THE EXCLUSIVE RIGHT TO USE "FROM CALIFORNIA", "EZ PEEL", "SEEDLESS", AND "SUPER SWEET", APART FROM THE MARK AS SHOWN.

FOR FRESH FRUIT (U.S. CLS. 1 AND 46).
FIRST USE 11-0-2001; IN COMMERCE 11-0-2001.

CLASS 31—(Continued).

3,681,626. MARICOPA PACKERS, L.P., LOS ANGELES, CA. SN 78-969,984. PUB. 5-1-2007, FILED 9-8-2006.

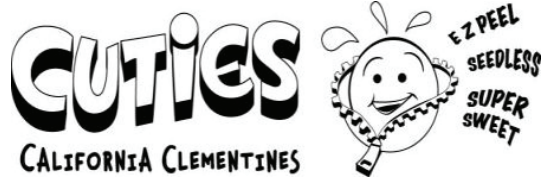

OWNER OF U.S. REG. NOS. 2,608,239, 2,969,464, AND OTHERS.

NO CLAIM IS MADE TO THE EXCLUSIVE RIGHT TO USE "CALIFORNIA CLEMENTINES", "EZ PEEL", "SEEDLESS", AND "SUPER SWEET", APART FROM THE MARK AS SHOWN.

FOR FRESH FRUITS (U.S. CLS. 1 AND 46).
FIRST USE 10-0-2006; IN COMMERCE 10-0-2006.

3,681,627. MARICOPA PACKERS, L.P., LOS ANGELES, CA. SN 78-969,988. PUB. 5-1-2007, FILED 9-8-2006.



OWNER OF U.S. REG. NOS. 2,608,239, 2,969,464, AND OTHERS.

NO CLAIM IS MADE TO THE EXCLUSIVE RIGHT TO USE "CALIFORNIA MANDARINS", "EZ PEEL", "SEEDLESS", AND "SUPER SWEET", APART FROM THE MARK AS SHOWN.

FOR FRESH FRUITS (U.S. CLS. 1 AND 46).
FIRST USE 11-0-2001; IN COMMERCE 11-0-2001.

CLASS 32—LIGHT BEVERAGES

3,680,087. BEST OF WHAT'S AROUND, LLC, CHARLOTTESVILLE, VA. SN 76-654,703. PUB. 10-10-2006, FILED 2-7-2006.

BEST OF WHAT'S AROUND

THE MARK CONSISTS OF STANDARD CHARACTERS WITHOUT CLAIM TO ANY PARTICULAR FONT, STYLE, SIZE, OR COLOR.

FOR FRUIT JUICES, FRUIT DRINKS, AND VEGETABLE JUICES (U.S. CLS. 45, 46 AND 48).
FIRST USE 6-15-2009; IN COMMERCE 6-15-2009.

CLASS 32—(Continued).

3,680,261. MORRIS, RODNEY J, HUMBLE, TX. SN 77-160,035. PUB. 9-23-2008, FILED 4-18-2007.

EXTREME FOCUS

THE MARK CONSISTS OF STANDARD CHARACTERS WITHOUT CLAIM TO ANY PARTICULAR FONT, STYLE, SIZE, OR COLOR.

FOR ENERGY DRINKS (U.S. CLS. 45, 46 AND 48).
FIRST USE 3-1-2009; IN COMMERCE 3-1-2009.

3,680,307. STRIPES LLC, DBA SSP PARTNERS, CORPUS CHRISTI, TX. SN 77-184,386. PUB. 4-29-2008, FILED 5-18-2007.



THE MARK CONSISTS OF THE HEAD OF A MONKEY WITH A STRAW IN ITS HEAD CENTERED OVER THE WORDS "RASPA CHANGO".

THE ENGLISH TRANSLATION OF "RASPA CHANGO" IS SLUSH MONKEY.

FOR CARBONATED, NON-ALCOHOLIC FROZEN FLAVORED BEVERAGES; NON-ALCOHOLIC FROZEN FRUIT-FLAVORED BEVERAGES (U.S. CLS. 45, 46 AND 48).

FIRST USE 6-4-2007; IN COMMERCE 6-4-2007.

CLASS 32—(Continued).

3,680,309. STRIPES LLC, DBA SSP PARTNERS, CORPUS CHRISTI, TX. SN 77-184,628. PUB. 4-29-2008, FILED 5-18-2007.

SLUSH MONKEY

THE MARK CONSISTS OF STANDARD CHARACTERS WITHOUT CLAIM TO ANY PARTICULAR FONT, STYLE, SIZE, OR COLOR.

FOR CARBONATED, NON-ALCOHOLIC FROZEN FLAVORED BEVERAGES; NON-ALCOHOLIC FROZEN FRUIT-FLAVORED BEVERAGES (U.S. CLS. 45, 46 AND 48).

FIRST USE 6-4-2007; IN COMMERCE 6-4-2007.

3,680,310. STRIPES LLC, DBA SSP PARTNERS, CORPUS CHRISTI, TX. SN 77-184,660. PUB. 4-29-2008, FILED 5-18-2007.

RASPA CHANGO

THE MARK CONSISTS OF STANDARD CHARACTERS WITHOUT CLAIM TO ANY PARTICULAR FONT, STYLE, SIZE, OR COLOR.

THE ENGLISH TRANSLATION OF "RASPA CHANGO" IS SLUSH MONKEY.

FOR CARBONATED, NON-ALCOHOLIC FROZEN FLAVORED BEVERAGES; NON-ALCOHOLIC FROZEN FRUIT-FLAVORED BEVERAGES (U.S. CLS. 45, 46 AND 48).

FIRST USE 6-4-2007; IN COMMERCE 6-4-2007.

3,680,330. NORTH AMERICAN BEVERAGES, LTD., WACO, TX. SN 77-189,296. PUB. 4-22-2008, FILED 5-24-2007.

BIG RED JAK

THE MARK CONSISTS OF STANDARD CHARACTERS WITHOUT CLAIM TO ANY PARTICULAR FONT, STYLE, SIZE, OR COLOR.

OWNER OF U.S. REG. NOS. 1,628,539 AND 1,628,540. NO CLAIM IS MADE TO THE EXCLUSIVE RIGHT TO USE "RED", APART FROM THE MARK AS SHOWN.

FOR ENERGY DRINKS (U.S. CLS. 45, 46 AND 48). FIRST USE 7-1-2007; IN COMMERCE 7-1-2007.

CLASS 32—(Continued).

3,680,356. NESTLE WATERS, ISSY-LES-MOULINEAUX, FRANCE. SN 77-206,438. PUB. 9-23-2008, FILED 6-14-2007.



OWNER OF U.S. REG. NOS. 1,132,921, 2,385,179, AND OTHERS.

NO CLAIM IS MADE TO THE EXCLUSIVE RIGHT TO USE "SOURCE", APART FROM THE MARK AS SHOWN.

THE COLOR(S) GREEN, YELLOW, WHITE AND GOLD IS/ARE CLAIMED AS A FEATURE OF THE MARK.

THE MARK CONSISTS OF A CONFIGURATION OF A THREE DIMENSIONAL GREEN BOTTLE WITH A BANDEROLE WITH A GREEN CIRCLE AND YELLOW SIDE BANDS, OUTLINED IN WHITE, WITH "PERRIER" IN WHITE, A SECOND WHITE BANDEROLE CAN BE SEEN THROUGH THE FRONT OF THE BOTTLE, AND THE SECOND WHITE BANDEROLE SHOWS "SOURCE PERRIER SP" AND DESIGN IN GREEN AND A GOLD BOTTLE CAP.

FOR MINERAL WATER; FLAVOURED WATER (U.S. CLS. 45, 46 AND 48).

FIRST USE 3-31-2007; IN COMMERCE 3-31-2007.

3,680,434. TOPCO ASSOCIATES, LLC, SKOKIE, IL. SN 77-293,981. PUB. 9-9-2008, FILED 10-2-2007.

FRESH & FRUITY

THE MARK CONSISTS OF STANDARD CHARACTERS WITHOUT CLAIM TO ANY PARTICULAR FONT, STYLE, SIZE, OR COLOR.

FOR REFRIGERATED FRUIT JUICES (U.S. CLS. 45, 46 AND 48).

FIRST USE 4-0-2008; IN COMMERCE 4-0-2008.

CLASS 32—(Continued).

3,680,586. COAST BEVERAGE GROUP, LLC, ORANGE, CA.
SN 77-339,398. PUB. 4-15-2008, FILED 11-28-2007.



THE MARK CONSISTS OF THE WORD "PRE" WHICH HAS ABOVE IT A SERIES OF LINES THAT RADIATE OUT IN THE FORM OF A SEMI-CIRCLE.

FOR BOTTLED WATER; FLAVORED WATERS (U.S. CLS. 45, 46 AND 48).

FIRST USE 8-1-2008; IN COMMERCE 5-1-2009.

CLASS 32—(Continued).

3,680,887. GO FAST SPORTS & BEVERAGE COMPANY, DENVER, CO. SN 77-466,296. PUB. 3-10-2009, FILED 5-5-2008.

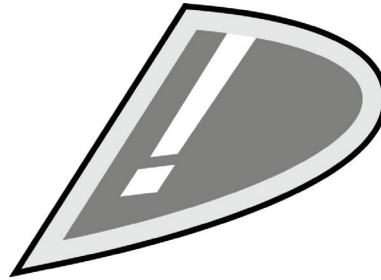

THE MARK CONSISTS OF AN INCOMPLETE OVAL WITH AN EXCLAMATION POINT INSIDE.

FOR ENERGY DRINKS; SPORTS DRINKS (U.S. CLS. 45, 46 AND 48).

FIRST USE 6-3-2008; IN COMMERCE 6-3-2008.

3,680,657. PA LAREDO INC., LAREDO, TX. SN 77-360,679.
PUB. 9-16-2008, FILED 12-28-2007.

Smoothie City

THE MARK CONSISTS OF STANDARD CHARACTERS WITHOUT CLAIM TO ANY PARTICULAR FONT, STYLE, SIZE, OR COLOR.

NO CLAIM IS MADE TO THE EXCLUSIVE RIGHT TO USE "SMOOTHIE", APART FROM THE MARK AS SHOWN.

FOR FRUIT DRINKS AND JUICES; SMOOTHIES (U.S. CLS. 45, 46 AND 48).

FIRST USE 1-12-2009; IN COMMERCE 1-12-2009.

3,681,116. LIFT BRIDGE BREWING TECHNOLOGIES, LLC, STILLWATER, MN. SN 77-521,027. PUB. 1-13-2009, FILED 7-14-2008.

Farm Girl Saison

3,680,821. SIERRA NEVADA BREWING CO., CHICO, CA. SN 77-444,494. PUB. 9-2-2008, FILED 4-9-2008.

LIGHTFOOT

THE MARK CONSISTS OF STANDARD CHARACTERS WITHOUT CLAIM TO ANY PARTICULAR FONT, STYLE, SIZE, OR COLOR.

FOR BEER (U.S. CLS. 45, 46 AND 48).

FIRST USE 7-7-2009; IN COMMERCE 7-7-2009.

THE MARK CONSISTS OF STANDARD CHARACTERS WITHOUT CLAIM TO ANY PARTICULAR FONT, STYLE, SIZE, OR COLOR.

NO CLAIM IS MADE TO THE EXCLUSIVE RIGHT TO USE "SAISON", APART FROM THE MARK AS SHOWN.

THE ENGLISH TRANSLATION OF "SAISON" IS "SEASON".

FOR BEER (U.S. CLS. 45, 46 AND 48).

FIRST USE 10-7-2007; IN COMMERCE 9-6-2008.

CLASS 32—(Continued).

3,681,146. SOL ELIXIRS, LLC, GLENVIEW, IL. SN 77-527,588.
 PUB. 3-10-2009, FILED 7-21-2008.

Solixir

THE MARK CONSISTS OF STANDARD CHARACTERS WITHOUT CLAIM TO ANY PARTICULAR FONT, STYLE, SIZE, OR COLOR.

FOR FRUIT BEVERAGES; FRUIT-FLAVORED BEVERAGES; FRUIT-FLAVOURED BEVERAGES; NON-ALCOHOLIC BEVERAGES CONTAINING FRUIT JUICES; NON-ALCOHOLIC BEVERAGES WITH TEA FLAVOR; NON-ALCOHOLIC BEVERAGES, NAMELY, CARBONATED BEVERAGES; NON-ALCOHOLIC FRUIT JUICE BEVERAGES (U.S. CLS. 45, 46 AND 48).
 FIRST USE 4-6-2009; IN COMMERCE 4-6-2009.

3,681,315. ASPEN SKIING COMPANY, ASPEN, CO. SN 77-589,887. PUB. 3-3-2009, FILED 10-9-2008.



OWNER OF U.S. REG. NOS. 2,628,176 AND 3,485,374.
 NO CLAIM IS MADE TO THE EXCLUSIVE RIGHT TO USE "PILSNER", APART FROM THE MARK AS SHOWN.
 THE COLOR(S) BURGUNDY AND WHITE IS/ARE CLAIMED AS A FEATURE OF THE MARK.
 THE MARK CONSISTS OF THE WORD "AJAX" DISPLAYED ABOVE THE SMALLER "PILSNER" BOTH IN WHITE AND SURROUNDED BY A BURGUNDY DIAMOND SHAPE.
 FOR BEER (U.S. CLS. 45, 46 AND 48).
 FIRST USE 11-25-2008; IN COMMERCE 11-25-2008.

CLASS 32—(Continued).

3,681,394. PEPSICO, INC., PURCHASE, NY. SN 77-620,877.
 PUB. 2-3-2009, FILED 11-24-2008.



OWNER OF U.S. REG. NOS. 824,150, 3,045,794, AND OTHERS.
 THE MARK CONSISTS OF A GLOBE DEVICE CONTAINING THREE FIELDS WHEREBY THE MIDDLE FIELD DIVIDES THE GLOBE AND BENEATH THE GLOBE DEVICE IS THE WORD "PEPSI" IN STYLIZED LETTERS.
 FOR SOFT DRINKS (U.S. CLS. 45, 46 AND 48).
 FIRST USE 3-2-2009; IN COMMERCE 3-2-2009.

3,681,471. HERBALIFE INTERNATIONAL, INC., LOS ANGELES, CA. SN 78-526,845. PUB. 12-6-2005, FILED 12-3-2004.

FUEL GOOD!

THE MARK CONSISTS OF STANDARD CHARACTERS WITHOUT CLAIM TO ANY PARTICULAR FONT, STYLE, SIZE, OR COLOR.
 FOR NON-ALCOHOLIC BEVERAGES, NAMELY, SPORTS DRINKS, ENERGY DRINKS, EFFERVESCENT DRINKS AND SOFT DRINKS; SYRUPS, MIXES, POWDERS, CONCENTRATES AND EFFERVESCENT TABLETS USED IN THE PREPARATION OF SOFT DRINKS, ENERGY DRINKS, SPORTS DRINKS AND EFFERVESCENT DRINKS (U.S. CLS. 45, 46 AND 48).
 FIRST USE 4-15-2005; IN COMMERCE 4-15-2005.

CLASS 32—(Continued).

3,681,534. BOLTHOUSE JUICE PRODUCTS, LLC, BAKERSFIELD, CA. SN 78-697,153. PUB. 2-24-2009, FILED 8-22-2005.

BOM DIA

THE MARK CONSISTS OF STANDARD CHARACTERS WITHOUT CLAIM TO ANY PARTICULAR FONT, STYLE, SIZE, OR COLOR.

THE FOREIGN WORDING IN THE MARK TRANSLATES INTO ENGLISH AS GOOD MORNING.

FOR FRUIT DRINKS; FRUIT JUICES; VEGETABLE JUICE; VEGETABLE JUICES (U.S. CLS. 45, 46 AND 48).
FIRST USE 10-0-2006; IN COMMERCE 10-0-2006.

CLASS 33—WINES AND SPIRITS

3,680,089. SOCIÉTÉ CHARENTAISE D'ENTREPÔT, LA ROCHELLE 17000, FRANCE. SN 76-657,492. PUB. 4-22-2008, FILED 3-27-2006.



THE MARK CONSISTS OF THE LETTERS "PEAR" FOLLOWED BY THE DESIGN OF A PEAR FOLLOWED BY THE LETTERS "DISE".

FOR APERITIFS WITH A DISTILLED ALCOHOLIC LIQUOR BASE, PREPARED ALCOHOLIC COCKTAIL, DISTILLED SPIRITS, LIQUORS AND COGNAC (U.S. CLS. 47 AND 49).
FIRST USE 1-0-2007; IN COMMERCE 1-0-2007.

3,680,161. JOAQUIN REBOLLEDO, S.A., OURENSE, SPAIN. SN 77-043,183. PUB. 3-4-2008, FILED 11-14-2006.



Joaquín Rebollo

THE NAME "JOAQUÍN REBOLLEDO" DOES NOT IDENTIFY A LIVING INDIVIDUAL.
THE COLOR(S) BLACK AND GOLD IS/ARE CLAIMED AS A FEATURE OF THE MARK.

CLASS 33—(Continued).

THE MARK CONSISTS OF A GOLDEN SHIELD BELOW WHICH CAN BE READ "JOAQUIN REBOLLEDO", IN BLACK COLOR, EXCEPT THE FIRST LETTER "J", THAT IS REPRESENTED IN THE SAME GOLDEN COLOR AS THE SHIELD.

FOR WINE (U.S. CLS. 47 AND 49).
FIRST USE 5-19-2008; IN COMMERCE 5-19-2008.

3,680,170. HOURGLASS WINE COMPANY, INC., ST. HELENA, CA. SN 77-049,812. PUB. 6-19-2007, FILED 11-22-2006.

36 24 36

THE MARK CONSISTS OF STANDARD CHARACTERS WITHOUT CLAIM TO ANY PARTICULAR FONT, STYLE, SIZE, OR COLOR.

FOR WINE (U.S. CLS. 47 AND 49).
FIRST USE 2-0-2007; IN COMMERCE 2-0-2007.

3,680,187. ROMERO & MILLER, LLC, BEL AIR, MD. SN 77-075,499. PUB. 7-17-2007, FILED 1-3-2007.

CHARLA

THE MARK CONSISTS OF STANDARD CHARACTERS WITHOUT CLAIM TO ANY PARTICULAR FONT, STYLE, SIZE, OR COLOR.

THE FOREIGN WORDING IN THE MARK TRANSLATES INTO ENGLISH AS CHAT.

FOR WINE (U.S. CLS. 47 AND 49).
FIRST USE 7-1-2009; IN COMMERCE 7-1-2009.

3,680,212. FISHER VINEYARDS, SANTA ROSA, CA. SN 77-130,276. PUB. 9-18-2007, FILED 3-13-2007.

UNRESERVED

THE MARK CONSISTS OF STANDARD CHARACTERS WITHOUT CLAIM TO ANY PARTICULAR FONT, STYLE, SIZE, OR COLOR.

FOR WINES (U.S. CLS. 47 AND 49).
FIRST USE 6-8-2009; IN COMMERCE 6-8-2009.

CLASS 33—(Continued).

3,680,425. ADMIRAL WINE & LIQUOR CO., INC., CEDAR GROVE, NJ. SN 77-288,697. PUB. 12-2-2008, FILED 9-25-2007.

SIELO BLU

THE MARK CONSISTS OF STANDARD CHARACTERS WITHOUT CLAIM TO ANY PARTICULAR FONT, STYLE, SIZE, OR COLOR.

THE FOREIGN WORDING IN THE MARK TRANSLATES INTO ENGLISH AS BLUE.

FOR WINE (U.S. CLS. 47 AND 49).

FIRST USE 6-1-2007; IN COMMERCE 6-1-2007.

CLASS 33—(Continued).

3,680,516. MAXSPIRITS GROUP, S.A., PROVINCE OF COLON, PANAMA. SN 77-323,314. PUB. 10-14-2008, FILED 11-7-2007.

VIÑA DON ROYO

THE MARK CONSISTS OF STANDARD CHARACTERS WITHOUT CLAIM TO ANY PARTICULAR FONT, STYLE, SIZE, OR COLOR.

NO CLAIM IS MADE TO THE EXCLUSIVE RIGHT TO USE "VINA", APART FROM THE MARK AS SHOWN.

THE MARK "VIÑA DON ROYO" IS TRANSLATED AS "VINEYARD SIR ROYO."

FOR ALCOHOLIC BEVERAGES EXCEPT BEERS (U.S. CLS. 47 AND 49).

FIRST USE 6-9-2009; IN COMMERCE 6-9-2009.

3,680,478. DIAGEO CHATEAU & ESTATE WINES COMPANY, NAPA, CA. SN 77-310,245. PUB. 4-8-2008, FILED 10-22-2007.

**E.Y.O.B. ENJOY YOUR OWN
BACKYARD**

THE MARK CONSISTS OF STANDARD CHARACTERS WITHOUT CLAIM TO ANY PARTICULAR FONT, STYLE, SIZE, OR COLOR.

FOR WINES (U.S. CLS. 47 AND 49).

FIRST USE 3-1-2007; IN COMMERCE 3-1-2007.

3,680,567. IMPORTADORA Y EXPORTADORA BATRA, S.A. DE C.V., MEXICO, D.F., MEXICO. SN 77-335,561. PUB. 3-11-2008, FILED 11-21-2007.

FAT ASS

THE MARK CONSISTS OF STANDARD CHARACTERS WITHOUT CLAIM TO ANY PARTICULAR FONT, STYLE, SIZE, OR COLOR.

FOR TEQUILA (U.S. CLS. 47 AND 49).

FIRST USE 9-0-2008; IN COMMERCE 2-19-2009.

3,680,510. FIRESTONE VINEYARD, L.P., SANTA BARBARA, CA. SN 77-322,308. PUB. 4-22-2008, FILED 11-6-2007.

T ANCHOR

THE MARK CONSISTS OF STANDARD CHARACTERS WITHOUT CLAIM TO ANY PARTICULAR FONT, STYLE, SIZE, OR COLOR.

FOR WINES (U.S. CLS. 47 AND 49).

FIRST USE 6-30-2009; IN COMMERCE 6-30-2009.

3,680,584. VIÑEDOS Y BODEGAS PABLO, S.C. ALMONACID DE LA SIERRA, SPAIN. SN 77-339,095. PUB. 4-15-2008, FILED 11-28-2007.

ALGAIREN

THE MARK CONSISTS OF STANDARD CHARACTERS WITHOUT CLAIM TO ANY PARTICULAR FONT, STYLE, SIZE, OR COLOR.

FOR WINES (U.S. CLS. 47 AND 49).

FIRST USE 12-0-2007; IN COMMERCE 12-0-2007.

CLASS 33—(Continued).

3,680,627. VINIFICADORA ACONCAGUA S.A., SAN ISIDRO, ARGENTINA. SN 77-349,677. PUB. 4-22-2008, FILED 12-12-2007.

CAMPO NEGRO

THE MARK CONSISTS OF STANDARD CHARACTERS WITHOUT CLAIM TO ANY PARTICULAR FONT, STYLE, SIZE, OR COLOR.

THE FOREIGN WORDING IN THE MARK TRANSLATES INTO ENGLISH AS "BLACK COUNTRYSIDE".

FOR WINES (U.S. CLS. 47 AND 49).
FIRST USE 5-10-2008; IN COMMERCE 5-17-2008.

CLASS 33—(Continued).

3,680,689. WALSH, BERNARD, URGLIN, IRELAND. SN 77-382,582. PUB. 6-17-2008, FILED 1-28-2008.

WRITER'S TEARS

THE MARK CONSISTS OF STANDARD CHARACTERS WITHOUT CLAIM TO ANY PARTICULAR FONT, STYLE, SIZE, OR COLOR.

FOR SPIRITS AND LIQUEURS; WHISKEY (U.S. CLS. 47 AND 49).

FIRST USE 6-15-2009; IN COMMERCE 6-15-2009.

3,680,665. WHEATLEY, TERRY, HUGHSON, CA. SN 77-366,401. PUB. 10-21-2008, FILED 1-8-2008.

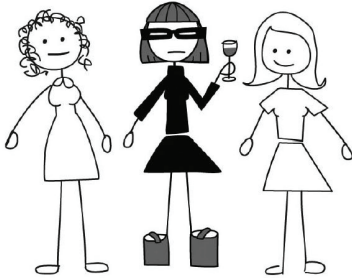

THE MARK CONSISTS OF AN IMAGE OF THREE GIRLS. FOR WINE (U.S. CLS. 47 AND 49).
FIRST USE 5-14-2008; IN COMMERCE 5-14-2008.

3,680,764. E. REMY MARTIN & CO, 16100 COGNAC, FRANCE. SN 77-418,822. PUB. 12-9-2008, FILED 3-11-2008.

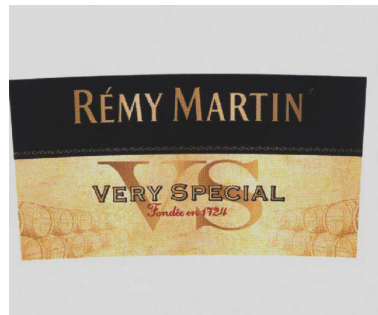

OWNER OF U.S. REG. NOS. 749,501, 1,027,514, AND OTHERS.

NO CLAIM IS MADE TO THE EXCLUSIVE RIGHT TO USE "VS" AND "VERY SPECIAL" AND "FONDÉE EN 1724", APART FROM THE MARK AS SHOWN.

THE NAME "RÉMY MARTIN" DOES NOT IDENTIFY A LIVING INDIVIDUAL.

THE COLOR(S) BLACK, GOLD, RED, BEIGE AND SEPIA IS/ARE CLAIMED AS A FEATURE OF THE MARK.

THE MARK CONSISTS OF A MODIFIED RECTANGLE WITH THE UPPER PORTION IN BLACK CONTAINING THE CENTRALIZED WORDING "RÉMY MARTIN" IN GOLD AND A FRIEZE IN GOLD TOWARDS THE BOTTOM OF THE RECTANGLE. THE LOWER PORTION IS IN BEIGE CONTAINING THE CENTRALIZED WORDING "VERY SPECIAL" IN GOLD OVER THE WORDING "FONDÉE EN 1724" IN RED SUPERIMPOSED OVER THE LETTERING "VS" IN GOLD. ON EITHER SIDE OF THE WORDING ARE REPRESENTATIONS OF STACKED BARRELS SHOWN IN SEPIA TONES GRADUALLY FADING TOWARDS THE CENTER.

THE ENGLISH TRANSLATION OF THE WORD "FONDÉE EN" IN THE MARK IS FOUNDED IN.

FOR COGNAC AND BRANDY (U.S. CLS. 47 AND 49).
FIRST USE 6-1-2008; IN COMMERCE 6-1-2008.

3,680,672. PENNSYLVANIA PURE DISTILLERIES, LLC, GLENSHAW, PA. SN 77-367,586. PUB. 5-27-2008, FILED 1-9-2008.

Boyd & Blair

THE MARK CONSISTS OF STANDARD CHARACTERS WITHOUT CLAIM TO ANY PARTICULAR FONT, STYLE, SIZE, OR COLOR.

FOR DISTILLED SPIRITS (U.S. CLS. 47 AND 49).
FIRST USE 8-15-2008; IN COMMERCE 8-15-2008.

CLASS 33—(Continued).

3,680,796. MAVEN BRANDS, LLC, ATLANTA, GA. SN 77-437,535. PUB. 2-17-2009, FILED 4-2-2008.

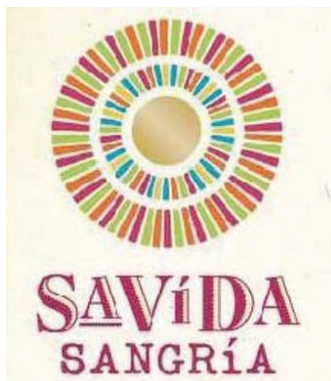

NO CLAIM IS MADE TO THE EXCLUSIVE RIGHT TO USE "SANGRIA", APART FROM THE MARK AS SHOWN. THE COLOR(S) RED, WHITE, GREEN, ORANGE, BLUE AND YELLOW IS/ARE CLAIMED AS A FEATURE OF THE MARK.

THE MARK CONSISTS OF THE WORD "SAVIDA" IN RED WITH WHITE HIGHLIGHTS, THE WORD "SANGRIA" IN RED, AND A SUNBURST DESIGN IN WHICH THE CENTER IS YELLOW AND THE RAYS ARE ARRANGED IN AN OUTER CIRCLE IN RANDOMLY GROUPED COLOR PATTERNS OF RED, ORANGE AND GREEN AND IN AN INNER CIRCLE IN RANDOMLY GROUPED COLOR PATTERNS OF RED, GREEN, BLUE, ORANGE AND YELLOW.

FOR SANGRIA (U.S. CLS. 47 AND 49).
FIRST USE 6-16-2009; IN COMMERCE 6-16-2009.

3,680,839. SAGATIBA BRASIL S.A., SAO PAULO, BRAZIL. SN 77-456,034. PUB. 10-21-2008, FILED 4-23-2008.

SAGATIBA PRECIOSA

THE MARK CONSISTS OF STANDARD CHARACTERS WITHOUT CLAIM TO ANY PARTICULAR FONT, STYLE, SIZE, OR COLOR.

OWNER OF U.S. REG. NOS. 3,319,421, 3,332,443, AND 3,340,845.

THE ENGLISH TRANSLATION OF THE WORD "SAGATIBA" IN THE MARK IS NEVER ENDING EPIC TALE.

THE ENGLISH TRANSLATION OF THE WORD "PRECIOSA" IN THE MARK IS PRECIOUS.

FOR ALCOHOLIC BEVERAGES MADE FROM A DISTILLED LIQUEUR PRODUCED FROM SUGAR CANE AND REFERRED TO AS CACHACA (U.S. CLS. 47 AND 49).

FIRST USE 0-0-2007; IN COMMERCE 6-30-2009.

CLASS 33—(Continued).

3,680,960. JAQK, INC., SAN FRANCISCO, CA. SN 77-476,024. PUB. 10-14-2008, FILED 5-15-2008.

BONE DANCE

THE MARK CONSISTS OF STANDARD CHARACTERS WITHOUT CLAIM TO ANY PARTICULAR FONT, STYLE, SIZE, OR COLOR.

FOR WINE (U.S. CLS. 47 AND 49).
FIRST USE 10-8-2008; IN COMMERCE 10-8-2008.

3,680,961. JAQK, INC., SAN FRANCISCO, CA. SN 77-476,037. PUB. 10-14-2008, FILED 5-15-2008.

PEARL HANDLE

THE MARK CONSISTS OF STANDARD CHARACTERS WITHOUT CLAIM TO ANY PARTICULAR FONT, STYLE, SIZE, OR COLOR.

FOR WINE (U.S. CLS. 47 AND 49).
FIRST USE 10-8-2008; IN COMMERCE 10-8-2008.

3,680,963. JAQK, INC., SAN FRANCISCO, CA. SN 77-476,055. PUB. 10-14-2008, FILED 5-15-2008.

SOLDIERS OF FORTUNE

THE MARK CONSISTS OF STANDARD CHARACTERS WITHOUT CLAIM TO ANY PARTICULAR FONT, STYLE, SIZE, OR COLOR.

FOR WINE (U.S. CLS. 47 AND 49).
FIRST USE 10-8-2008; IN COMMERCE 10-0-2008.

CLASS 33—(Continued).

3,681,022. COGNAC ONE, LLC, NEW YORK, NY. SN 77-487,096. PUB. 10-28-2008, FILED 5-30-2008.

MARLY

THE MARK CONSISTS OF STANDARD CHARACTERS WITHOUT CLAIM TO ANY PARTICULAR FONT, STYLE, SIZE, OR COLOR.
FOR WINE; FRUIT WINE; GRAPE WINE; WHITE WINE (U.S. CLS. 47 AND 49).
FIRST USE 3-0-2009; IN COMMERCE 3-0-2009.

3,681,028. JDR ENTERPRISES, LLC, CEDAR SPRINGS, MI. SN 77-489,453. PUB. 10-28-2008, FILED 6-3-2008.

SHARKWATER

THE MARK CONSISTS OF STANDARD CHARACTERS WITHOUT CLAIM TO ANY PARTICULAR FONT, STYLE, SIZE, OR COLOR.
FOR VODKA BASED LIQUEUR (U.S. CLS. 47 AND 49).
FIRST USE 3-30-2009; IN COMMERCE 3-30-2009.

3,681,182. ARDILL SERVICES PTY LTD, TA REILLY'S WINES, KENT TOWN, AUSTRALIA. SN 77-544,390. PUB. 1-20-2009, FILED 8-12-2008.

BARKING MAD

THE MARK CONSISTS OF STANDARD CHARACTERS WITHOUT CLAIM TO ANY PARTICULAR FONT, STYLE, SIZE, OR COLOR.
FOR ALCOHOLIC BEVERAGES, NAMELY, WINE (U.S. CLS. 47 AND 49).
FIRST USE 0-0-2003; IN COMMERCE 0-0-2003.

CLASS 33—(Continued).

3,681,199. PENMARA WINES PTY LTD, CAMPERDOWN, AUSTRALIA. SN 77-548,952. PUB. 3-3-2009, FILED 8-17-2008.

The Lifesaver

THE MARK CONSISTS OF STANDARD CHARACTERS WITHOUT CLAIM TO ANY PARTICULAR FONT, STYLE, SIZE, OR COLOR.
PRIORITY CLAIMED UNDER SEC. 44(D) ON AUSTRALIA APPLICATION NO. 10986264, FILED 8-13-2008.
FOR RED WINE; TABLE WINES; WHITE WINE; WINE (U.S. CLS. 47 AND 49).
FIRST USE 5-14-2009; IN COMMERCE 5-14-2009.

3,681,238. METEOR VINEYARD, LLC, NAPA, CA. SN 77-567,058. PUB. 1-27-2009, FILED 9-10-2008.

METEOR VINEYARD

THE MARK CONSISTS OF STANDARD CHARACTERS WITHOUT CLAIM TO ANY PARTICULAR FONT, STYLE, SIZE, OR COLOR.
NO CLAIM IS MADE TO THE EXCLUSIVE RIGHT TO USE "VINEYARD", APART FROM THE MARK AS SHOWN.
FOR WINES (U.S. CLS. 47 AND 49).
FIRST USE 10-29-2008; IN COMMERCE 10-29-2008.

3,681,277. METEOR VINEYARD, LLC, NAPA, CA. SN 77-579,704. PUB. 2-3-2009, FILED 9-26-2008.



METEOR
VINEYARD

NO CLAIM IS MADE TO THE EXCLUSIVE RIGHT TO USE "VINEYARD", APART FROM THE MARK AS SHOWN.
THE MARK CONSISTS OF A FLYING METEOR ABOVE THE LETTER "T" IN THE WORD "METEOR".
FOR WINES (U.S. CLS. 47 AND 49).
FIRST USE 10-29-2008; IN COMMERCE 10-29-2008.

CLASS 33—(Continued).

3,681,280. METEOR VINEYARD, LLC, NAPA, CA. SN 77-579,734. PUB. 2-3-2009, FILED 9-26-2008.

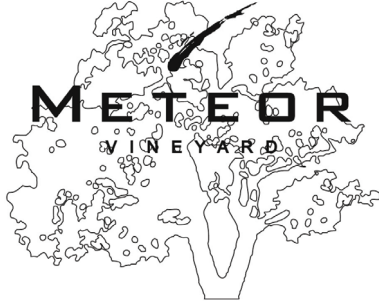

NO CLAIM IS MADE TO THE EXCLUSIVE RIGHT TO USE "VINEYARD", APART FROM THE MARK AS SHOWN. THE MARK CONSISTS OF THE WORDS "METEOR VINEYARD" WITH A FLYING METEOR OVER THE LETTER "T" SUPERIMPOSED OVER THE IMAGE OF A TREE.

FOR WINES (U.S. CLS. 47 AND 49).
FIRST USE 10-29-2008; IN COMMERCE 10-29-2008.

3,681,298. UNITED STATES DISTILLED PRODUCTS COMPANY, PRINCETON, MN. SN 77-586,095. PUB. 3-3-2009, FILED 10-6-2008.

MR. STACKS

THE MARK CONSISTS OF STANDARD CHARACTERS WITHOUT CLAIM TO ANY PARTICULAR FONT, STYLE, SIZE, OR COLOR.
FOR DISTILLED SPIRITS (U.S. CLS. 47 AND 49).
FIRST USE 5-28-2009; IN COMMERCE 5-28-2009.

3,681,299. HEIMBUCH ESTATE VINEYARDS AND WINERY, L.L.C., DBA HEIMBUCH ESTATE, HARWOOD, MD. SN 77-586,368. PUB. 3-31-2009, FILED 10-6-2008.

Thanksgiving Farm

THE MARK CONSISTS OF STANDARD CHARACTERS WITHOUT CLAIM TO ANY PARTICULAR FONT, STYLE, SIZE, OR COLOR.
FOR WINE (U.S. CLS. 47 AND 49).
FIRST USE 5-22-2009; IN COMMERCE 5-22-2009.

CLASS 33—(Continued).

3,681,346. GENERATIONS OF SONOMA, LLC, SONOMA, CA. SN 77-600,901. PUB. 3-17-2009, FILED 10-27-2008.

HIGHWAYMAN

THE MARK CONSISTS OF STANDARD CHARACTERS WITHOUT CLAIM TO ANY PARTICULAR FONT, STYLE, SIZE, OR COLOR.

FOR WINE (U.S. CLS. 47 AND 49).
FIRST USE 5-29-2009; IN COMMERCE 5-29-2009.

3,681,353. UNITED STATES DISTILLED PRODUCTS COMPANY, PRINCETON, MN. SN 77-604,013. PUB. 3-3-2009, FILED 10-30-2008.

SAMPIR

THE MARK CONSISTS OF STANDARD CHARACTERS WITHOUT CLAIM TO ANY PARTICULAR FONT, STYLE, SIZE, OR COLOR.

FOR DISTILLED SPIRITS (U.S. CLS. 47 AND 49).
FIRST USE 6-9-2009; IN COMMERCE 6-9-2009.

3,681,386. PAPER MOON VINEYARDS, LLC, VERMILION, OH. SN 77-617,615. PUB. 3-31-2009, FILED 11-19-2008.



THE MARK CONSISTS OF AN IMAGE OF A CRESCENT MOON HANGING ON A STRING IN FRONT OF A WINDOW.

FOR WINE (U.S. CLS. 47 AND 49).
FIRST USE 2-21-2009; IN COMMERCE 2-21-2009.

CLASS 33—(Continued).

3,681,408. INTERCONTINENTAL PACKAGING CO., ST. PAUL, MN. SN 77-631,401. PUB. 3-17-2009, FILED 12-11-2008.

SANGRIANA

THE MARK CONSISTS OF STANDARD CHARACTERS WITHOUT CLAIM TO ANY PARTICULAR FONT, STYLE, SIZE, OR COLOR.

FOR WINES (U.S. CLS. 47 AND 49).
FIRST USE 2-28-2009; IN COMMERCE 3-31-2009.

3,681,452. LA RURAL VIÑEDOS Y BODEGAS S.A. LTDA., COQUIMBITO, MAIPU, ARGENTINA. SN 78-352,061. PUB. 7-5-2005, FILED 1-14-2004.

RUTINI

THE MARK CONSISTS OF STANDARD CHARACTERS WITHOUT CLAIM TO ANY PARTICULAR FONT, STYLE, SIZE, OR COLOR.

OWNER OF ARGENTINA REG. NO. 1,635,065, DATED 6-3-1997, RENEWED AS REG. NO. 2,213,713, DATED 7-14-2008, EXPIRES 2-11-2018.

FOR WINES (U.S. CLS. 47 AND 49).
FIRST USE 9-15-2008; IN COMMERCE 9-15-2008.

3,681,494. TEQUILA SAUZA, S.A. DE C.V., ZAPOPAN JALISCO, MEXICO. SN 78-614,476. PUB. 1-31-2006, FILED 4-22-2005.

SAUZA NUESTRO TEQUILA

THE MARK CONSISTS OF STANDARD CHARACTERS WITHOUT CLAIM TO ANY PARTICULAR FONT, STYLE, SIZE, OR COLOR.

OWNER OF U.S. REG. NOS. 1,057,158, 2,551,587, AND

CLASS 33—(Continued).

OTHERS.

NO CLAIM IS MADE TO THE EXCLUSIVE RIGHT TO USE "TEQUILA", APART FROM THE MARK AS SHOWN.

THE ENGLISH TRANSLATION OF THE WORD "NUESTRO" IN THE MARK IS OUR.

FOR TEQUILA (U.S. CLS. 47 AND 49).
FIRST USE 7-0-2006; IN COMMERCE 7-0-2006.

3,681,570. CAYUSE VINEYARDS, L.L.C., WALLA WALLA, WA. SN 78-819,494. PUB. 10-10-2006, FILED 2-21-2006.

THE STICKMAN

THE MARK CONSISTS OF STANDARD CHARACTERS WITHOUT CLAIM TO ANY PARTICULAR FONT, STYLE, SIZE, OR COLOR.

FOR WINE (U.S. CLS. 47 AND 49).
FIRST USE 7-22-2005; IN COMMERCE 7-22-2005.

3,681,571. CAYUSE VINEYARDS, L.L.C., WALLA WALLA, WA. SN 78-819,540. PUB. 10-10-2006, FILED 2-21-2006.

FREE ELECTRON

THE MARK CONSISTS OF STANDARD CHARACTERS WITHOUT CLAIM TO ANY PARTICULAR FONT, STYLE, SIZE, OR COLOR.

FOR WINE (U.S. CLS. 47 AND 49).
FIRST USE 7-22-2005; IN COMMERCE 7-22-2005.

CLASS 33—(Continued).

3,681,601. VINA CASA SILVA S.A., SAN FERNANDO, CHILE. SN 78-895,902. PUB. 11-13-2007, FILED 5-30-2006.

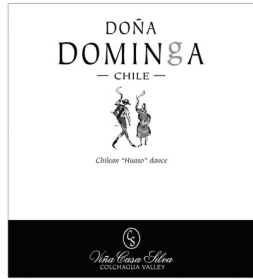

OWNER OF U.S. REG. NOS. 2,507,776 AND 2,792,220.
 NO CLAIM IS MADE TO THE EXCLUSIVE RIGHT TO USE "CHILE" OR "COLCHAGUA VALLEY", APART FROM THE MARK AS SHOWN.
 THE MARK CONSISTS OF THE WORDING "DOÑA DOMINGA CHILE" ABOVE A STYLIZED DRAWING OF TWO DANCERS HOLDING HANDKERCHIEFS ABOVE THE WORDING "CHILEAN "HUASO" DANCE" ABOVE A STYLIZED "CS" WITHIN AN OVAL ABOVE THE WORDING "VINA CASA SILVA COLCHAGUA VALLEY".
 THE FOREIGN WORDING IN THE MARK TRANSLATES INTO ENGLISH AS SILVA HOUSE WINERY.
 FOR WINE (U.S. CLS. 47 AND 49).
 FIRST USE 6-30-2009; IN COMMERCE 6-30-2009.

3,681,606. CORE GROUPE, LLC, MIAMI, FL. SN 78-927,069. PUB. 4-24-2007, FILED 7-11-2006.

DZIAQ LIQUEUR

THE MARK CONSISTS OF STANDARD CHARACTERS WITHOUT CLAIM TO ANY PARTICULAR FONT, STYLE, SIZE, OR COLOR.
 NO CLAIM IS MADE TO THE EXCLUSIVE RIGHT TO USE "LIQUEUR", APART FROM THE MARK AS SHOWN.
 FOR ALCOHOLIC BEVERAGES, NAMELY, LIQUEURS, VODKA-BASED LIQUEURS, VODKA (U.S. CLS. 47 AND 49).
 FIRST USE 4-3-2009; IN COMMERCE 4-3-2009.

CLASS 34—SMOKERS' ARTICLES

CLASS 34—(Continued).

3,680,345. TRADEMARKS LLC, RICHMOND, VA. SN 77-199,726. PUB. 10-30-2007, FILED 6-6-2007.



OWNER OF U.S. REG. NOS. 594,798, 1,062,895, AND OTHERS.
 NO CLAIM IS MADE TO THE EXCLUSIVE RIGHT TO USE "FILTER", "FULL FLAVOR" AND "20 CLASS A CIGARETTES", APART FROM THE MARK AS SHOWN.
 THE MARK CONSISTS OF A RECTANGLE DESIGN WITH A HORIZONTAL STRIPE PATTERN COVERING THE TOP THREE-QUARTERS OF THE RECTANGLE, THE WORDING "L&M FILTER FULL FLAVOR 20 CLASS A CIGARETTES" AND A CREST DESIGN WITH THE LETTERS "L&M" IN THE CENTER.
 FOR CIGARETTES (U.S. CLS. 2, 8, 9 AND 17).
 FIRST USE 9-11-2007; IN COMMERCE 9-11-2007.

3,680,346. TRADEMARKS LLC, RICHMOND, VA. SN 77-199,736. PUB. 10-30-2007, FILED 6-6-2007.



OWNER OF U.S. REG. NOS. 594,798, 1,062,895, AND OTHERS.
 NO CLAIM IS MADE TO THE EXCLUSIVE RIGHT TO USE "FILTER", "LIGHTS" AND "20 CLASS A CIGARETTES", APART FROM THE MARK AS SHOWN.
 THE MARK CONSISTS OF A RECTANGLE DESIGN WITH A HORIZONTAL STRIPE PATTERN COVERING THE TOP THREE-QUARTERS OF THE RECTANGLE, THE WORDING "L&M FILTER LIGHTS 20 CLASS A CIGARETTES", AND A CREST DESIGN WITH THE LETTERS "L&M" IN THE CENTER.
 FOR CIGARETTES (U.S. CLS. 2, 8, 9 AND 17).
 FIRST USE 9-11-2007; IN COMMERCE 9-11-2007.

CLASS 34—(Continued).

3,680,347. TRADEMARKS LLC, RICHMOND, VA. SN 77-199,739. PUB. 10-30-2007, FILED 6-6-2007.



OWNER OF U.S. REG. NOS. 594,798, 1,062,895, AND OTHERS.

NO CLAIM IS MADE TO THE EXCLUSIVE RIGHT TO USE "FILTER", "LIGHTS" AND "20 CLASS A CIGARETTES", APART FROM THE MARK AS SHOWN.

THE COLOR(S) BLUE, SILVER, RED AND WHITE IS/ARE CLAIMED AS A FEATURE OF THE MARK.

THE MARK CONSISTS OF A RECTANGLE DESIGN WITH A DARK BLUE AND LIGHT BLUE HORIZONTAL STRIPE PATTERN COVERING THE TOP THREE-QUARTERS OF THE RECTANGLE, WHITE COVERING THE BOTTOM QUARTER, THE LETTERS "L&M" IN WHITE, THE WORDING "FILTER" IN SILVER, THE WORDING "LIGHTS" IN LIGHT BLUE, THE WORDING "20 CLASS A CIGARETTES" IN DARK BLUE, AND A SILVER CREST DESIGN WITH THE LETTERS "L&M" IN WHITE IN THE CENTER OF A RED BACKGROUND.

FOR CIGARETTES (U.S. CLS. 2, 8, 9 AND 17). FIRST USE 9-11-2007; IN COMMERCE 9-11-2007.

CLASS 34—(Continued).

3,680,348. TRADEMARKS LLC, RICHMOND, VA. SN 77-199,742. PUB. 10-30-2007, FILED 6-6-2007.

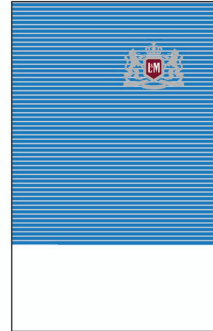

OWNER OF U.S. REG. NOS. 594,798, 1,062,895, AND OTHERS.

THE COLOR(S) BLUE, SILVER, RED AND WHITE IS/ARE CLAIMED AS A FEATURE OF THE MARK.

THE MARK CONSISTS OF A RECTANGLE DESIGN WITH A DARK BLUE AND LIGHT BLUE HORIZONTAL STRIPE PATTERN COVERING THE TOP THREE-QUARTERS OF THE RECTANGLE, WHITE COVERING THE BOTTOM QUARTER, AND A SILVER CREST DESIGN WITH THE LETTERS L&M IN WHITE IN THE CENTER OF A RED BACKGROUND.

FOR CIGARETTES (U.S. CLS. 2, 8, 9 AND 17). FIRST USE 9-11-2007; IN COMMERCE 9-11-2007.

3,680,349. TRADEMARKS LLC, RICHMOND, VA. SN 77-199,746. PUB. 10-30-2007, FILED 6-6-2007.



OWNER OF U.S. REG. NOS. 594,798, 1,062,895, AND OTHERS.

NO CLAIM IS MADE TO THE EXCLUSIVE RIGHT TO USE "FILTER", "MENTHOL" AND "20 CLASS A CIGARETTES", APART FROM THE MARK AS SHOWN.

THE MARK CONSISTS OF A RECTANGLE DESIGN WITH A HORIZONTAL STRIPE PATTERN COVERING THE TOP THREE-QUARTERS OF THE RECTANGLE, THE WORDING "L&M FILTER MENTHOL 20 CLASS A CIGARETTES", AND A CREST DESIGN WITH THE LETTERS L&M IN THE CENTER.

FOR CIGARETTES (U.S. CLS. 2, 8, 9 AND 17). FIRST USE 9-11-2007; IN COMMERCE 9-11-2007.

CLASS 34—(Continued).

3,680,350. TRADEMARKS LLC, RICHMOND, VA. SN 77-199,749. PUB. 10-30-2007, FILED 6-6-2007.



OWNER OF U.S. REG. NOS. 594,798, 1,062,895, AND OTHERS.

NO CLAIM IS MADE TO THE EXCLUSIVE RIGHT TO USE "FILTER", "MENTHOL" AND "20 CLASS A CIGARETTES", APART FROM THE MARK AS SHOWN.

THE COLOR(S) GREEN, BLUE, SILVER AND WHITE IS/ARE CLAIMED AS A FEATURE OF THE MARK.

THE MARK CONSISTS OF A RECTANGLE DESIGN WITH A DARK GREEN AND LIGHT GREEN HORIZONTAL STRIPE PATTERN COVERING THE TOP THREE-QUARTERS OF THE RECTANGLE AND WHITE COVERING THE BOTTOM QUARTER, THE LETTERS "L&M" IN WHITE, THE WORDING "FILTER" IN SILVER, THE WORDING "MENTHOL" IN GREEN, THE WORDING "20 CLASS A CIGARETTES" IN BLUE, AND A SILVER CREST DESIGN WITH THE LETTERS "L&M" IN WHITE IN THE CENTER OF A BLUE BACKGROUND.

FOR CIGARETTES (U.S. CLS. 2, 8, 9 AND 17). FIRST USE 9-11-2007; IN COMMERCE 9-11-2007.

CLASS 34—(Continued).

3,680,351. TRADEMARKS LLC, RICHMOND, VA. SN 77-199,750. PUB. 10-30-2007, FILED 6-6-2007.

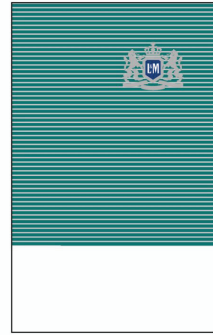

OWNER OF U.S. REG. NOS. 594,798, 1,062,895, AND OTHERS.

THE COLOR(S) GREEN, BLUE, SILVER AND WHITE IS/ARE CLAIMED AS A FEATURE OF THE MARK.

THE MARK CONSISTS OF A RECTANGLE DESIGN WITH A DARK GREEN AND LIGHT GREEN HORIZONTAL STRIPE PATTERN COVERING THE TOP THREE-QUARTERS OF THE RECTANGLE AND WHITE COVERING THE BOTTOM QUARTER, AND A SILVER CREST DESIGN WITH THE LETTERS L&M IN WHITE IN THE CENTER OF A BLUE BACKGROUND.

FOR CIGARETTES (U.S. CLS. 2, 8, 9 AND 17). FIRST USE 9-11-2007; IN COMMERCE 9-11-2007.

3,680,360. ZIPPMARK, INC., WILMINGTON, DE. SN 77-209,871. PUB. 11-25-2008, FILED 6-19-2007.

BLU

THE MARK CONSISTS OF STANDARD CHARACTERS WITHOUT CLAIM TO ANY PARTICULAR FONT, STYLE, SIZE, OR COLOR.

OWNER OF U.S. REG. NOS. 3,299,190 AND 3,469,390. FOR LIGHTERS NOT OF PRECIOUS METAL; LIGHTERS OF PRECIOUS METAL (U.S. CLS. 2, 8, 9 AND 17). FIRST USE 3-16-2007; IN COMMERCE 3-16-2007.

CLASS 34—(Continued).

3,680,591. GALLAHER LIMITED, WEYBRIDGE, SURREY, UNITED KINGDOM. SN 77-341,374. PUB. 10-14-2008, FILED 11-30-2007.

OLD HOLBORN

THE MARK CONSISTS OF STANDARD CHARACTERS WITHOUT CLAIM TO ANY PARTICULAR FONT, STYLE, SIZE, OR COLOR.

FOR TOBACCO, WHETHER MANUFACTURED OR UNMANUFACTURED; SMOKING TOBACCO; PIPE TOBACCO; HAND ROLLING TOBACCO; CHEWING TOBACCO; SNUS TOBACCO; CIGARETTES; CIGARS; CIGARILLOS; CIGARETTES CONTAINING TOBACCO SUBSTITUTES NOT FOR MEDICINAL OR CURATIVE PURPOSES; TOBACCO SUBSTITUTES NOT FOR MEDICAL OR CURATIVE PURPOSES; SNUFF; CIGARETTE PAPERS; CIGARETTE TUBES AND MATCHES (U.S. CLS. 2, 8, 9 AND 17).

FIRST USE 6-0-2008; IN COMMERCE 6-0-2008.

3,680,778. TRADEMARKS LLC, RICHMOND, VA. SN 77-430,476. PUB. 9-23-2008, FILED 3-25-2008.



OWNER OF U.S. REG. NOS. 594,798, 1,062,895, AND OTHERS.

NO CLAIM IS MADE TO THE EXCLUSIVE RIGHT TO USE "FILTER", "MENTHOL LIGHTS 100'S" AND "20 CLASS A CIGARETTES", APART FROM THE MARK AS SHOWN.

THE MARK CONSISTS OF A RECTANGLE DESIGN WITH A HORIZONTAL STRIPE PATTERN COVERING THE TOP THREE-QUARTERS OF THE RECTANGLE, THE LETTERS "L&M", THE WORDING "FILTER", THE WORDING "MENTHOL LIGHTS 100'S", THE WORDING "20 CLASS A CIGARETTES", AND A CREST DESIGN WITH THE LETTERS "L&M" IN THE CENTER.

FOR CIGARETTES (U.S. CLS. 2, 8, 9 AND 17).
FIRST USE 9-10-2008; IN COMMERCE 9-10-2008.

CLASS 34—(Continued).

3,681,354. JACOBS, ROSALIE ANN, HOGANSBURG, NY. SN 77-604,146. PUB. 3-24-2009, FILED 10-30-2008.

**QUALITY TOBACCO AT A PRICE
YOU'LL LOVE**

THE MARK CONSISTS OF STANDARD CHARACTERS WITHOUT CLAIM TO ANY PARTICULAR FONT, STYLE, SIZE, OR COLOR.

FOR CIGARETTES; ROLL YOUR OWN TOBACCO; SMOKING TOBACCO (U.S. CLS. 2, 8, 9 AND 17).

FIRST USE 12-4-2008; IN COMMERCE 12-4-2008.

3,681,432. BAHAMA MAMAS, LLC, LAS VEGAS, NV. SN 77-977,575. PUB. 7-8-2008, FILED 2-21-2008.

BAHAMA MAMAS

THE MARK CONSISTS OF STANDARD CHARACTERS WITHOUT CLAIM TO ANY PARTICULAR FONT, STYLE, SIZE, OR COLOR.

FOR CIGAR BANDS; CIGAR BOXES NOT OF PRECIOUS METAL; CIGARS; TOBACCO; CIGAR BOXES (U.S. CLS. 2, 8, 9 AND 17).

FIRST USE 4-1-2009; IN COMMERCE 4-1-2009.

3,681,480. CUBAN CIGAR BRANDS, N.V., FORT LAUDERDALE, FL. SN 78-554,795. PUB. 2-19-2008, FILED 1-27-2005.

CLASSIC COLLECTION

THE MARK CONSISTS OF STANDARD CHARACTERS WITHOUT CLAIM TO ANY PARTICULAR FONT, STYLE, SIZE, OR COLOR.

FOR CIGARS, LITTLE CIGARS, PIPE TOBACCO AND SMOKELESS TOBACCO (U.S. CLS. 2, 8, 9 AND 17).

FIRST USE 7-21-2005; IN COMMERCE 7-21-2005.

CLASS 34—(Continued).

3,681,528. CROSS FARMS, INC., WILMINGTON, DE. SN 78-687,925. PUB. 4-18-2006, FILED 8-8-2005.

AMERICAN STEEL

THE MARK CONSISTS OF STANDARD CHARACTERS WITHOUT CLAIM TO ANY PARTICULAR FONT, STYLE, SIZE, OR COLOR.

FOR CIGARETTES, TOBACCO, CIGARS, CIGARETTE LIGHTERS NOT OF PRECIOUS METAL, CIGARETTE PAPERS, CIGARETTE TUBES, AND MATCHES (U.S. CLS. 2, 8, 9 AND 17).

FIRST USE 4-1-2009; IN COMMERCE 4-1-2009.

3,681,554. FUENTE MARKETING LTD., TORTOLA, BR. VIRGIN ISLANDS. SN 78-771,343. PUB. 7-4-2006, FILED 12-12-2005.

QUEEN B

THE MARK CONSISTS OF STANDARD CHARACTERS WITHOUT CLAIM TO ANY PARTICULAR FONT, STYLE, SIZE, OR COLOR.

FOR CIGARS (U.S. CLS. 2, 8, 9 AND 17).

FIRST USE 7-2-2009; IN COMMERCE 7-2-2009.

SERVICE MARKS**CLASS 35—ADVERTISING AND BUSINESS**

3,680,073. EVERYTHING FOR A DOLLAR STORE (CANADA) INC., MARKHAM, ONTARIO. SN 76-494,624. PUB. 2-17-2009, FILED 2-28-2003.

**CLASS 35—(Continued).**

PRIORITY CLAIMED UNDER SEC. 44(D) ON CANADA APPLICATION NO. 1164595, FILED 1-13-2003, REG. NO. TMA709,929, DATED 3-19-2008, EXPIRES 3-19-2023.

OWNER OF U.S. REG. NO. 2,050,085.

NO CLAIM IS MADE TO THE EXCLUSIVE RIGHT TO USE "EVERYTHING FOR A DOLLAR STORE", APART FROM THE MARK AS SHOWN.

FOR RETAIL STORE SERVICES FEATURING A WIDE VARIETY OF DISCOUNT CONSUMER AND HOUSEHOLD MERCHANDISE OF OTHERS (U.S. CLS. 100, 101 AND 102).

FIRST USE 12-15-2008; IN COMMERCE 12-15-2008.

3,680,076. BELL, ELIZABETH ANN, CLEARWATER, FL. SN 76-520,272. PUB. 1-20-2004, FILED 6-6-2003.

ZIPITZ

FOR DIRECT MAIL ADVERTISING SERVICES, NAMELY, MASS MAILINGS OF CATALOGS, BROCHURES, PROMOTIONAL MATERIALS, AND THE LIKE (U.S. CLS. 100, 101 AND 102).

FIRST USE 4-5-2004; IN COMMERCE 4-5-2004.

3,680,101. STATON HOLDING, INC., DBA STATON D/B/A STATON WHOLESALE D/B/A STATON CORPORATE AND CASUAL, DALLAS, TX. SN 76-675,758. PUB. 10-23-2007, FILED 4-17-2007.



THE MARK CONSISTS OF A SHOPPING BAG WITH STYLIZED "E".

FOR COMPUTERIZED ON-LINE RETAIL STORE SERVICES IN THE FIELD OF CLOTHING (U.S. CLS. 100, 101 AND 102).

FIRST USE 7-1-2007; IN COMMERCE 7-1-2007.

CLASS 35—(Continued).

3,680,107. TODD LABS, LLC, ARROYO GRANDE, CA. SN 76-679,474. PUB. 4-22-2008, FILED 7-13-2007.

MYTRUST

THE MARK CONSISTS OF STANDARD CHARACTERS WITHOUT CLAIM TO ANY PARTICULAR FONT, STYLE, SIZE, OR COLOR.

FOR CONDUCTING INCENTIVE AWARD PROGRAMS FOR THE BENEFIT OF PERSONS WITH SPECIAL NEEDS TO PROMOTE THE SALE OF PRODUCTS OR SERVICES SPECIFICALLY DIRECTED TOWARDS PERSONS WITH SPECIAL NEEDS AND TO ALLOW MEMBERS TO REDEEM AWARDS FROM A VARIETY OF VENDORS THROUGH A CENTRALIZED INTERNET PORTAL (U.S. CLS. 100, 101 AND 102).

FIRST USE 7-8-2009; IN COMMERCE 7-8-2009.

CLASS 35—(Continued).

3,680,163. ANDY GOULD MANAGEMENT, INC., LOS ANGELES, CA. SN 77-045,975. PUB. 10-2-2007, FILED 11-16-2006.

 **SPECTACLE**
ENTERTAINMENT GROUP

NO CLAIM IS MADE TO THE EXCLUSIVE RIGHT TO USE "ENTERTAINMENT GROUP", APART FROM THE MARK AS SHOWN.

THE MARK CONSISTS OF THE WORDS "SPECTACLE ENTERTAINMENT GROUP" AND INTERLOCKING CIRCLES.

FOR PERSONAL MANAGEMENT SERVICES FOR ENTERTAINERS; TALENT AGENCY SERVICES (U.S. CLS. 100, 101 AND 102).

FIRST USE 4-6-2006; IN COMMERCE 4-6-2006.

3,680,112. AUTOMED TECHNOLOGIES, INC., BUFFALO GROVE, IL. SN 76-682,757. PUB. 9-23-2008, FILED 10-10-2007.

RxWorks Suite

THE MARK CONSISTS OF STANDARD CHARACTERS WITHOUT CLAIM TO ANY PARTICULAR FONT, STYLE, SIZE, OR COLOR.

NO CLAIM IS MADE TO THE EXCLUSIVE RIGHT TO USE "SUITE", APART FROM THE MARK AS SHOWN.

FOR WHOLESALE DISTRIBUTORSHIP SERVICES IN THE FIELD OF PHARMACEUTICALS, MEDICAL AND HEALTHCARE PRODUCTS, ALL FOR USE BY HUMANS, FEATURING INVENTORY SUPPLY CHAIN MANAGEMENT AND INFORMATION MANAGEMENT CAPABILITIES, INCLUDING AUTOMATED PRODUCT DISPENSING, PERSONNEL WORKFLOW AND SYSTEM INTERFACES (U.S. CLS. 100, 101 AND 102).

FIRST USE 10-31-2007; IN COMMERCE 10-31-2007.

3,680,188. WPP PROPERTIES, NEW YORK, CA. SN 77-077,770. PUB. 11-18-2008, FILED 1-8-2007.

THE LAST MILE

THE MARK CONSISTS OF STANDARD CHARACTERS WITHOUT CLAIM TO ANY PARTICULAR FONT, STYLE, SIZE, OR COLOR.

FOR BUSINESS MARKETING CONSULTING IN THE FIELD OF BRAND CREATION AND BRAND DEVELOPMENT; MARKET RESEARCH AND ANALYSIS IN THE FIELD OF BRAND CREATION AND DEVELOPMENT; EVENT MARKETING AND MANAGEMENT, NAMELY, MANAGEMENT OF CONVENTIONS, SPORTING EXHIBITIONS, FESTIVALS, MEETINGS, AND THE LIKE; SPORTS AND ENTERTAINMENT MARKETING, NAMELY, PROMOTING SPORTS COMPETITIONS AND EVENTS OF OTHERS; INTERACTIVE ADVERTISING AND MARKETING; ADVERTISING AGENCY SERVICES; SALES PROMOTION SERVICES (U.S. CLS. 100, 101 AND 102).

FIRST USE 8-1-2007; IN COMMERCE 8-1-2007.

CLASS 35—(Continued).

3,680,211. WAL-MART STORES, INC., BENTONVILLE, AR. SN 77-129,996. PUB. 9-4-2007, FILED 3-13-2007.



THE MARK CONSISTS OF A DESIGN OF THREE RAYS CENTERED TO CREATE A HALF-CIRCLE. FOR ONLINE RETAIL DEPARTMENT STORE SERVICES (U.S. CLS. 100, 101 AND 102). FIRST USE 11-20-2007; IN COMMERCE 11-20-2007.

3,680,221. PROJECT EVERGREEN FOUNDATION, INC., NEW PRAGUE, MN. SN 77-139,279. PUB. 10-7-2008, FILED 3-23-2007.



*Yard Enthusiasts
of America*

NO CLAIM IS MADE TO THE EXCLUSIVE RIGHT TO USE "YARD ENTHUSIASTS OF AMERICA", APART FROM THE MARK AS SHOWN.

THE MARK CONSISTS OF THE WORD "YEA" SHOWN INSIDE A DESIGN CONSISTING OF PETALS SURROUNDING A FLOWER CENTER ALL SURROUNDED BY A SPLASH DESIGN. THIS PART OF THE MARK IS FOLLOWED BY A VERTICAL BAR THEN FOLLOWED BY THE WORDS "YARD ENTHUSIASTS OF AMERICA".

FOR CLUB SERVICES, NAMELY, PROMOTING THE INTERESTS OF YARD ENTHUSIASTS (U.S. CLS. 100, 101 AND 102).

FIRST USE 11-1-2007; IN COMMERCE 11-1-2007.

3,680,227. JACQUES, FRANCIS L., NORTH SMITHFIELD, RI. SN 77-143,751. PUB. 11-6-2007, FILED 3-29-2007.

BUXTON HOLLOW FARM

THE MARK CONSISTS OF STANDARD CHARACTERS WITHOUT CLAIM TO ANY PARTICULAR FONT, STYLE, SIZE, OR COLOR.

NO CLAIM IS MADE TO THE EXCLUSIVE RIGHT TO USE "FARM", APART FROM THE MARK AS SHOWN.

"BUXTON HOLLOW" DOES NOT IDENTIFY A LIVING INDIVIDUAL.

FOR RETAIL STORE SERVICES FEATURING WINES, WINE ACCESSORIES, CLOTHING, GIFTS, AND FARM PRODUCTS (U.S. CLS. 100, 101 AND 102).

FIRST USE 6-17-2005; IN COMMERCE 6-17-2005.

CLASS 35—(Continued).

3,680,245. TOYS IN BABELAND, LLC, SEATTLE, WA. SN 77-154,689. PUB. 9-23-2008, FILED 4-12-2007.

Arouse Your Curiosity

THE MARK CONSISTS OF STANDARD CHARACTERS WITHOUT CLAIM TO ANY PARTICULAR FONT, STYLE, SIZE, OR COLOR.

FOR ONLINE RETAIL STORE SERVICES AND RETAIL STORE SERVICES FEATURING SEXUAL AIDS, SEX TOYS, NAMELY, RUBBER, PLASTIC, LEATHER, GLASS AND METAL ITEMS FOR PENETRATION AND RECEPTACLE, EROTIC CLOTHING AND OTHER ADULT-ORIENTED PRODUCTS, NAMELY, VIBRATORS, LOTIONS, PUBLICATIONS AND VIDEOS (U.S. CLS. 100, 101 AND 102).

FIRST USE 6-1-2007; IN COMMERCE 6-1-2007.

3,680,273. PRIME TIME BUTCHER, INC., WOODBURY, NY. SN 77-167,802. PUB. 10-30-2007, FILED 4-27-2007.

**YOUR VIRTUAL NEIGHBORHOOD
BUTCHER SHOP**

THE MARK CONSISTS OF STANDARD CHARACTERS WITHOUT CLAIM TO ANY PARTICULAR FONT, STYLE, SIZE, OR COLOR.

NO CLAIM IS MADE TO THE EXCLUSIVE RIGHT TO USE "VIRTUAL" AND "BUTCHER SHOP", APART FROM THE MARK AS SHOWN.

FOR COMPUTERIZED ON-LINE ORDERING SERVICES IN THE FIELD OF FOODS AND GIFTS; COMPUTERIZED ON-LINE RETAIL STORE SERVICES IN THE FIELD OF FOODS AND GIFTS (U.S. CLS. 100, 101 AND 102).

FIRST USE 3-0-2006; IN COMMERCE 3-5-2009.

3,680,335. BRIGHTHOUSE, LLC, ATLANTA, GA. SN 77-192,190. PUB. 10-16-2007, FILED 5-29-2007.

BOTH

THE MARK CONSISTS OF STANDARD CHARACTERS WITHOUT CLAIM TO ANY PARTICULAR FONT, STYLE, SIZE, OR COLOR.

FOR PROVIDING OUTSOURCING SERVICES TO BUSINESSES (U.S. CLS. 100, 101 AND 102).

FIRST USE 9-1-2008; IN COMMERCE 9-1-2008.

CLASS 35—(Continued).

3,680,357. COLDWATER CREEK INC., SANDPOINT, ID. SN 77-207,791. PUB. 4-29-2008, FILED 6-15-2007.

ONECREEK

THE MARK CONSISTS OF STANDARD CHARACTERS WITHOUT CLAIM TO ANY PARTICULAR FONT, STYLE, SIZE, OR COLOR.

OWNER OF U.S. REG. NOS. 2,217,173, 2,740,447, AND OTHERS.

FOR CATALOG ORDERING SERVICE FEATURING BEDDING, BLANKETS, LINEN, DRAPERIES, PILLOWS, WALL COVERINGS, RUGS, DOORMATS AND OTHER FLOOR COVERINGS, TOWELS, WALL HANGINGS, ARTIST'S MATERIALS AND SUPPLIES, ARTWORK, BATHROOM ACCESSORIES AND DECORATIONS, BEDROOM ACCESSORIES AND DECORATIONS, SOAP, BATH PRODUCTS, BEDROOM FURNITURE, LIVING ROOM ACCESSORIES AND DECORATIONS, SLIPPERS, BATH ROBES, TABLES, CANDLES, CANDLE HOLDERS, BIRDFEEDERS, MIRRORS, LAMPS, PLANTERS AND PLANT HOLDERS, COASTERS, NAPKIN RINGS, PLATE HOLDERS, PAPER WEIGHTS, VASES, WREATHS, PICTURE FRAMES, FOUNTAINS, GLASSES, PITCHERS AND OTHER HOUSE WARES, JEWELRY, PURSES, WATCHES, BELTS, SUNGLASSES, EYEGLASSES, SHOES AND CLOTHING; MAIL ORDER SERVICES FEATURING BEDDING, BLANKETS, LINEN, DRAPERIES, PILLOWS, WALL COVERINGS, RUGS, DOORMATS AND OTHER FLOOR COVERINGS, TOWELS, WALL HANGINGS, ARTIST'S MATERIALS AND SUPPLIES, ARTWORK, BATHROOM ACCESSORIES AND DECORATIONS, BEDROOM ACCESSORIES AND DECORATIONS, SOAP, BATH PRODUCTS, BEDROOM FURNITURE, LIVING ROOM ACCESSORIES AND DECORATIONS, SLIPPERS, BATH ROBES, TABLES, CANDLES, CANDLE HOLDERS, BIRDFEEDERS, MIRRORS, LAMPS, PLANTERS AND PLANT HOLDERS, COASTERS, NAPKIN RINGS, PLATE HOLDERS, PAPER WEIGHTS, VASES, FURNITURE, WREATHS, PICTURE FRAMES, FOUNTAINS, GLASSES, PITCHERS AND OTHER HOUSE WARES, JEWELRY, PURSES, WATCHES, BELTS, SUNGLASSES, EYEGLASSES, LINGERIE, SWIMSUITS, SHOES AND CLOTHING; ON-LINE ORDERING SERVICES FEATURING BEDDING, BLANKETS, LINEN, DRAPERIES, PILLOWS, WALL COVERINGS, RUGS, DOORMATS AND OTHER FLOOR COVERINGS, TOWELS, WALL HANGINGS, ARTIST'S MATERIALS AND SUPPLIES, ARTWORK, BATHROOM ACCESSORIES AND DECORATIONS, BEDROOM ACCESSORIES AND DECORATIONS, SOAP, BATH PRODUCTS, BEDROOM FURNITURE, LIVING ROOM ACCESSORIES AND DECORATIONS, SLIPPERS, BATH ROBES, TABLES, CANDLES, CANDLE HOLDERS, BIRDFEEDERS, MIRRORS, LAMPS, PLANTERS AND PLANT HOLDERS, COASTERS, NAPKIN RINGS, PLATE HOLDERS, PAPER WEIGHTS, VASES, FURNITURE, WREATHS, PICTURE FRAMES, FOUNTAINS, GLASSES, PITCHERS AND OTHER HOUSE WARES, JEWELRY, PURSES, WATCHES, BELTS, SUNGLASSES, EYEGLASSES, LINGERIE, SWIMSUITS, SHOES AND CLOTHING; CUSTOMER LOYALTY SERVICES AND

CLASS 35—(Continued).

CUSTOMER CLUB SERVICES, FOR COMMERCIAL, PROMOTIONAL AND/OR ADVERTISING PURPOSES; RETAIL STORE SERVICES IN THE FIELD OF BEDDING, BLANKETS, LINEN, DRAPERIES, PILLOWS, WALL COVERINGS, RUGS, DOORMATS AND OTHER FLOOR COVERINGS, TOWELS, WALL HANGINGS, ARTIST'S MATERIALS AND SUPPLIES, ARTWORK, BATHROOM ACCESSORIES AND DECORATIONS, BEDROOM ACCESSORIES AND DECORATIONS, SOAP, BATH PRODUCTS, BEDROOM FURNITURE, LIVING ROOM ACCESSORIES AND DECORATIONS, SLIPPERS, BATH ROBES, TABLES, CANDLES, CANDLE HOLDERS, BIRDFEEDERS, MIRRORS, LAMPS, PLANTERS AND PLANT HOLDERS, COASTERS, NAPKIN RINGS, PLATE HOLDERS, PAPER WEIGHTS, VASES, FURNITURE, WREATHS, PICTURE FRAMES, FOUNTAINS, GLASSES, PITCHERS AND OTHER HOUSE WARES, JEWELRY, PURSES, WATCHES, BELTS, SUNGLASSES, EYEGLASSES, LINGERIE, SWIMSUITS, SHOES AND CLOTHING FEATURING A BONUS INCENTIVE PROGRAM FOR CUSTOMERS (U.S. CLS. 100, 101 AND 102). FIRST USE 8-10-2008; IN COMMERCE 8-10-2008.

3,680,362. ADVANCE E-MARKETING, INC., BROOKLYN, NY. SN 77-212,098. PUB. 4-8-2008, FILED 6-21-2007.

ILN

THE MARK CONSISTS OF STYLIZED LETTERS "I" "L" AND "N".

FOR ADVERTISING AND MARKETING OF LEGAL SERVICES FOR OTHERS (U.S. CLS. 100, 101 AND 102). FIRST USE 8-14-2007; IN COMMERCE 8-14-2007.

3,680,376. WEST PENN ALLEGHENY HEALTH SYSTEM, PITTSBURGH, PA. SN 77-234,493. PUB. 9-23-2008, FILED 8-20-2007.

FUSION SC

THE MARK CONSISTS OF STANDARD CHARACTERS WITHOUT CLAIM TO ANY PARTICULAR FONT, STYLE, SIZE, OR COLOR.

NO CLAIM IS MADE TO THE EXCLUSIVE RIGHT TO USE "SC", APART FROM THE MARK AS SHOWN.

FOR HEALTHCARE PROCUREMENT SERVICES, NAMELY, PURCHASING PRODUCTS AND HEALTHCARE SERVICES FOR OTHERS (U.S. CLS. 100, 101 AND 102).

FIRST USE 5-7-2007; IN COMMERCE 5-7-2007.

CLASS 35—(Continued).

3,680,378. C10, INC., MILL VALLEY, CA. SN 77-236,264. PUB. 2-17-2009, FILED 7-23-2007.

VARSIYPIX

THE MARK CONSISTS OF STANDARD CHARACTERS WITHOUT CLAIM TO ANY PARTICULAR FONT, STYLE, SIZE, OR COLOR.

FOR ON-LINE RETAIL STORE SERVICES FEATURING PHOTOGRAPHS IN THE FIELD OF SPORTS (U.S. CLS. 100, 101 AND 102).

FIRST USE 7-13-2007; IN COMMERCE 7-13-2007.

3,680,382. MITCH-STUART, INC., NORTH MIAMI BEACH, FL. SN 77-242,149. PUB. 2-24-2009, FILED 7-30-2007.

PERFECT PLACES

THE MARK CONSISTS OF STANDARD CHARACTERS WITHOUT CLAIM TO ANY PARTICULAR FONT, STYLE, SIZE, OR COLOR.

FOR SERVICES FOR BUSINESSES, NAMELY, PLANNING, ARRANGING AND CONDUCTING EMPLOYEE, CUSTOMER AND CLIENT INCENTIVE PROGRAMS TO PROMOTE EMPLOYEE, CUSTOMER AND CLIENT GOODWILL, LOYALTY AND RETENTION, BY REWARDING EMPLOYEES, CUSTOMERS AND CLIENTS WITH TRAVEL INCENTIVES (U.S. CLS. 100, 101 AND 102).

FIRST USE 4-12-2007; IN COMMERCE 5-30-2007.

3,680,393. MINKIN, PATRICIA, COSTA MESA, CA. SN 77-253,039. PUB. 7-8-2008, FILED 8-11-2007.

UNDER MY UMBRELLA

THE MARK CONSISTS OF STANDARD CHARACTERS WITHOUT CLAIM TO ANY PARTICULAR FONT, STYLE, SIZE, OR COLOR.

FOR RETAIL STORE SERVICES FEATURING INFANTS', CHILDRENS' AND MATERNITY CLOTHING AND ACCESSORIES (U.S. CLS. 100, 101 AND 102).

FIRST USE 9-1-2007; IN COMMERCE 9-1-2007.

CLASS 35—(Continued).

3,680,404. GILT GROUPE, INC., NEW YORK, NY. SN 77-271,728. PUB. 10-14-2008, FILED 9-5-2007.

GILT GROUPE

THE MARK CONSISTS OF STANDARD CHARACTERS WITHOUT CLAIM TO ANY PARTICULAR FONT, STYLE, SIZE, OR COLOR.

NO CLAIM IS MADE TO THE EXCLUSIVE RIGHT TO USE "GROUPE", APART FROM THE MARK AS SHOWN.

THE ENGLISH TRANSLATION OF THE WORD "GROUPE" IN THE MARK IS "GROUP".

FOR ON-LINE RETAIL STORE SERVICES FEATURING LUXURY AND FASHION CLOTHING, APPAREL, FOOTWEAR, CLOTHING ACCESSORIES, COSMETICS, LINENS, ELECTRONICS, AND RELATED GOODS SOLD AT DISCOUNT PRICES (U.S. CLS. 100, 101 AND 102).

FIRST USE 11-13-2007; IN COMMERCE 11-13-2007.

3,680,410. JOHN HENRY HOLDINGS, LLC, PHOENIX, AZ. SN 77-276,395. PUB. 11-18-2008, FILED 9-11-2007.



THE MARK CONSISTS OF THREE TRIANGLES POSITIONED WITH ONE ON THE LEFT, ONE ON THE RIGHT AND ONE ON THE BOTTOM. THE APEX OF EACH TRIANGLE FACES INWARD WITH A SOLID SPACE BETWEEN THE THREE TRIANGLES IN THE CENTER OF THE MARK.

FOR BUSINESS CONSULTING SERVICES RELATING TO SUPPLY CHAIN; TRANSPORTATION LOGISTICS SERVICES, NAMELY, ARRANGING THE TRANSPORTATION OF GOODS FOR OTHERS; COMPUTERIZED TRACKING AND TRACING OF PACKAGES IN TRANSIT; INFORMATION MANAGEMENT SERVICES, NAMELY, SHIPMENT PROCESSING, PREPARING SHIPPING DOCUMENTS AND INVOICES, TRACKING DOCUMENTS, PACKAGES AND FREIGHT OVER COMPUTER NETWORKS, INTRANETS AND INTERNETS (U.S. CLS. 100, 101 AND 102).

FIRST USE 4-1-2009; IN COMMERCE 4-1-2009.

CLASS 35—(Continued).

3,680,415. ADVUS CORPORATION, NEW YORK, NY. SN 77-280,579. PUB. 3-11-2008, FILED 9-16-2007.

performancewatch

THE MARK CONSISTS OF STANDARD CHARACTERS WITHOUT CLAIM TO ANY PARTICULAR FONT, STYLE, SIZE, OR COLOR.

FOR BUSINESS CONSULTING AND BUSINESS INFORMATION FOR ENTERPRISES; ANALYSES AND APPRAISALS OF ENTERPRISES; ASSISTANCE TO INDUSTRIAL OR COMMERCIAL ENTERPRISES IN THE RUNNING OF THEIR BUSINESS; HELP IN THE MANAGEMENT OF BUSINESS AFFAIRS OR COMMERCIAL FUNCTIONS OF AN INDUSTRIAL OR COMMERCIAL ENTERPRISE (U.S. CLS. 100, 101 AND 102).

FIRST USE 8-1-2008; IN COMMERCE 8-1-2008.

3,680,430. EXD3, PAHRUMP, NV. SN 77-292,809. PUB. 3-18-2008, FILED 10-1-2007.

eXD3

THE MARK CONSISTS OF STANDARD CHARACTERS WITHOUT CLAIM TO ANY PARTICULAR FONT, STYLE, SIZE, OR COLOR.

FOR ON-LINE RETAIL STORE SERVICES AND RETAIL STORE SERVICES FEATRING BOBBLE HEAD DOLLS AND TOY COLLECTIBLES; ADVERTISING SERVICES FOR THIRD PARTIES IN CONNECTION WITH THE COMMERCIALIZATION AND SALE OF TOY COLLECTIBLES (U.S. CLS. 100, 101 AND 102).

FIRST USE 2-25-2009; IN COMMERCE 5-7-2009.

3,680,441. BRISCO LLC, JACKSONVILLE, FL. SN 77-295,755. PUB. 9-23-2008, FILED 10-4-2007.

M-EDG

THE MARK CONSISTS OF STANDARD CHARACTERS WITHOUT CLAIM TO ANY PARTICULAR FONT, STYLE, SIZE, OR COLOR.

THE WORDING "M-EDG" HAS NO MEANING IN A FOREIGN LANGUAGE.

FOR BUSINESS CONSULTATION IN THE FIELD OF COMMERCIALIZATION OF MEDICAL VENTURES (U.S. CLS. 100, 101 AND 102).

FIRST USE 1-1-2008; IN COMMERCE 1-1-2008.

CLASS 35—(Continued).

3,680,458. ALTITUDE MARKETING, LLC, COOPERSBURG, PA. SN 77-302,779. PUB. 3-31-2009, FILED 10-12-2007.

ALTITUDE MARKETING

THE MARK CONSISTS OF STANDARD CHARACTERS WITHOUT CLAIM TO ANY PARTICULAR FONT, STYLE, SIZE, OR COLOR.

NO CLAIM IS MADE TO THE EXCLUSIVE RIGHT TO USE "MARKETING", APART FROM THE MARK AS SHOWN.

FOR BUSINESS MARKETING CONSULTING SERVICES, NAMELY, STRATEGIC MARKETING COMMUNICATIONS FOR SMALL AND MIDSIZE TECHNOLOGY-ORIENTED BUSINESSES (U.S. CLS. 100, 101 AND 102).

FIRST USE 10-31-2007; IN COMMERCE 10-31-2007.

3,680,480. ASSOCIATION OF CLINICAL RESEARCH PROFESSIONALS, ALEXANDRIA, VA. SN 77-311,754. PUB. 9-23-2008, FILED 10-24-2007.



OWNER OF U.S. REG. NO. 2,286,029.

NO CLAIM IS MADE TO THE EXCLUSIVE RIGHT TO USE "ASSOCIATION OF CLINICAL RESEARCH PROFESSIONALS", APART FROM THE MARK AS SHOWN.

FOR ASSOCIATION SERVICES, NAMELY, PROMOTING THE INTERESTS OF CLINICAL PHARMACOLOGY PROFESSIONALS, CLINICAL MONITORS AND RESEARCH ASSOCIATES, NURSES, PHARMACISTS, PHARMACOLOGISTS, PHYSICIANS, AND REGULATORY PROFESSIONALS (U.S. CLS. 100, 101 AND 102).

FIRST USE 12-3-2007; IN COMMERCE 12-3-2007.

CLASS 35—(Continued).

3,680,494. FFS HOLDINGS, LLC, KENNESAW, GA. SN 77-317,256. PUB. 9-30-2008, FILED 10-30-2007.



OWNER OF U.S. REG. NO. 3,020,488.

NO CLAIM IS MADE TO THE EXCLUSIVE RIGHT TO USE "FLIP FLOP SHOPS", APART FROM THE MARK AS SHOWN.

THE MARK CONSISTS OF THE COLOR BLACK APPEARING IN THE OUTERMOST CIRCLE AND THE DESIGN OF THE "FLIP FLOP", THE COLOR ORANGE APPEARING IN THE BACKGROUND OF THE TOP HALF OF THE INNERMOST CIRCLE, THE COLOR BLUE APPEARING IN THE BACKGROUND OF THE LOWER HALF OF THE INNERMOST CIRCLE, AND THE COLOR WHITE APPEARING IN THE BORDER OF THE INNER CONCENTRIC CIRCLE, THE OUTLINE OF THE SANDALS, AND THE WORDS "FLIP FLOP SHOPS".

FOR RETAIL STORE AND ONLINE RETAIL STORE SERVICES FEATURING FLIP FLOP SANDALS, SLIPPERS, AND RELATED ACCESSORIES, NAMELY, APPAREL, HANDBAGS AND JEWELRY (U.S. CLS. 100, 101 AND 102).

FIRST USE 10-31-2007; IN COMMERCE 10-31-2007.

3,680,498. CLEANER'S SUPPLY, INC., CONKLIN, NY. SN 77-318,338. PUB. 11-11-2008, FILED 10-31-2007.

THE BEST THING TO HAPPEN
TO DRY CLEANING SINCE THE
SPOT

THE MARK CONSISTS OF STANDARD CHARACTERS WITHOUT CLAIM TO ANY PARTICULAR FONT, STYLE, SIZE, OR COLOR.

FOR WHOLESALE DISTRIBUTORSHIP SERVICES IN THE FIELD OF LAUNDRY AND DRY CLEANING SUPPLIES (U.S. CLS. 100, 101 AND 102).

FIRST USE 10-18-2001; IN COMMERCE 10-18-2001.

CLASS 35—(Continued).

3,680,503. LIVE GAMER, INC., NEW YORK, NY. SN 77-320,378. PUB. 4-22-2008, FILED 11-2-2007.

LIVE GAMER

THE MARK CONSISTS OF STANDARD CHARACTERS WITHOUT CLAIM TO ANY PARTICULAR FONT, STYLE, SIZE, OR COLOR.

FOR ON-LINE TRADING SERVICES TO FACILITATE THE SALE OF VIRTUAL GOODS AND SERVICES BY OTHERS VIA A COMPUTER NETWORK AND PROVIDING EVALUATIVE FEEDBACK AND RATINGS OF SELLERS' GOODS AND SERVICES, THE VALUE AND PRICES OF SELLERS' GOODS AND SERVICES, BUYERS' AND SELLERS' PERFORMANCE, DELIVERY, AND OVERALL TRADING EXPERIENCE IN CONNECTION THEREWITH; PROVIDING CUSTOMER SUPPORT SERVICES CONCERNING ONLINE ACCOUNT MANAGEMENT AND USE OF ONLINE SERVICES (U.S. CLS. 100, 101 AND 102).

FIRST USE 4-0-2008; IN COMMERCE 4-0-2008.

3,680,512. PEEKABOO KIDS CLUB, LLC, SAN FRANCISCO, CA. SN 77-322,514. PUB. 4-15-2008, FILED 11-6-2007.

PEEKADOODLE

THE MARK CONSISTS OF STANDARD CHARACTERS WITHOUT CLAIM TO ANY PARTICULAR FONT, STYLE, SIZE, OR COLOR.

FOR RETAIL STORE SERVICES FEATURING CLOTHING, TOYS AND BOOKS, CHILDREN AND INFANT FURNITURE, DIAPER BAGS, FEEDING SETS, DIAPERS, CARRIERS AND COVERS, HIGH-CHAIRS, PACIFIERS, GROOMING PRODUCTS ACCESSORIES, PARENTING AND FAMILY ORIENTED BOOKS (U.S. CLS. 100, 101 AND 102).

FIRST USE 4-15-2008; IN COMMERCE 4-15-2008.

3,680,523. GRIDPOINT, INC., ARLINGTON, VA. SN 77-325,906. PUB. 9-30-2008, FILED 11-9-2007.

GRIDPOINT SMARTGRID PLATFORM

THE MARK CONSISTS OF STANDARD CHARACTERS WITHOUT CLAIM TO ANY PARTICULAR FONT, STYLE, SIZE, OR COLOR.

OWNER OF U.S. REG. NOS. 3,320,099, 3,341,158, AND 3,341,169.

CLASS 35—(Continued).

NO CLAIM IS MADE TO THE EXCLUSIVE RIGHT TO USE "SMARTGRID PLATFORM", APART FROM THE MARK AS SHOWN.

FOR ENERGY USAGE MANAGEMENT; PROVIDING INFORMATION IN THE FIELD OF ENERGY USAGE MANAGEMENT (U.S. CLS. 100, 101 AND 102).

FIRST USE 11-30-2007; IN COMMERCE 11-30-2007.

CLASS 35—(Continued).

3,680,572. KLEBER & ASSOCIATES, INC., ATLANTA, GA. SN 77-336,351. PUB. 4-15-2008, FILED 11-26-2007.

3,680,530. TAR HEELS TRADING COMPANY, LLC, PHILADELPHIA, PA. SN 77-327,832. PUB. 4-22-2008, FILED 11-13-2007.

RIGHT AT HOME

CRO COSTPRO

THE MARK CONSISTS OF STANDARD CHARACTERS WITHOUT CLAIM TO ANY PARTICULAR FONT, STYLE, SIZE, OR COLOR.

NO CLAIM IS MADE TO THE EXCLUSIVE RIGHT TO USE "HOME", APART FROM THE MARK AS SHOWN.

FOR ADVERTISING SERVICES IN THE FIELDS OF HOME IMPROVEMENT AND RESTORATION (U.S. CLS. 100, 101 AND 102).

FIRST USE 7-6-2009; IN COMMERCE 7-6-2009.

THE MARK CONSISTS OF STANDARD CHARACTERS WITHOUT CLAIM TO ANY PARTICULAR FONT, STYLE, SIZE, OR COLOR.

NO CLAIM IS MADE TO THE EXCLUSIVE RIGHT TO USE "CRO", APART FROM THE MARK AS SHOWN.

FOR PROVIDING A WEBSITE FEATURING BUSINESS MANAGEMENT INFORMATION (U.S. CLS. 100, 101 AND 102).

FIRST USE 5-0-2008; IN COMMERCE 5-0-2008.

3,680,592. CONTINUOUS LEARNING GROUP, INC., CORAOPOLIS, PA. SN 77-341,670. PUB. 10-14-2008, FILED 11-30-2007.

3,680,551. GRANT COMPANY, L.L.C., THE, OVERLAND PARK, KS. SN 77-333,474. PUB. 4-29-2008, FILED 11-19-2007.

CLIQUE FACTOR

MAKE-IT

THE MARK CONSISTS OF STANDARD CHARACTERS WITHOUT CLAIM TO ANY PARTICULAR FONT, STYLE, SIZE, OR COLOR.

FOR CONSULTATION AND ASSESSMENT SERVICES IN THE FIELD OF PRODUCTIVITY IMPROVEMENT AND ENHANCEMENT BY DETERMINING AND COORDINATING COMMUNICATION, PERSONALITY, AND LEARNING OR WORK STYLES (U.S. CLS. 100, 101 AND 102).

FIRST USE 4-0-2008; IN COMMERCE 4-0-2008.

THE MARK CONSISTS OF STANDARD CHARACTERS WITHOUT CLAIM TO ANY PARTICULAR FONT, STYLE, SIZE, OR COLOR.

FOR BUSINESS SERVICES, NAMELY, BUSINESS ORGANIZATIONAL CONSULTING FOR ENCOURAGING BEHAVIORAL CHANGE IN EMPLOYEES (U.S. CLS. 100, 101 AND 102).

FIRST USE 4-1-2007; IN COMMERCE 6-26-2009.

CLASS 35—(Continued).

3,680,603. INTELLIGENT NUTRIENTS, LLC, MINNEAPOLIS, MN. SN 77-344,800. PUB. 10-7-2008, FILED 12-5-2007.

INTELLIGENT NUTRIENTS

THE MARK CONSISTS OF STANDARD CHARACTERS WITHOUT CLAIM TO ANY PARTICULAR FONT, STYLE, SIZE, OR COLOR.

OWNER OF U.S. REG. NOS. 1,983,856, 2,426,159, AND OTHERS.

FOR WHOLESALE DISTRIBUTORSHIP, RETAIL STORE, ON-LINE RETAIL STORE AND MAIL ORDER STORE SERVICES FEATURING HAIR AND SKIN CARE PRODUCTS, COSMETICS, PERSONAL HYGIENE PREPARATIONS, HOUSEHOLD CLEANING PREPARATIONS, CLEANERS, CANDLES, PHARMACEUTICAL PREPARATIONS, LOTIONS, OILS, PERSONAL LUBRICANTS, CHOLESTEROL REDUCERS, COUGH LOZENGES, DECONGESTANTS, LAXATIVES AND LIP BALM (U.S. CLS. 100, 101 AND 102).

FIRST USE 6-11-2008; IN COMMERCE 6-11-2008.

3,680,607. NEJAD, AFSHIN, DBA SEARCHENGINEPROJECTS.COM, ANAHEIM, CA. SN 77-345,102. PUB. 5-6-2008, FILED 12-5-2007.

SearchEngineProjects

THE MARK CONSISTS OF STANDARD CHARACTERS WITHOUT CLAIM TO ANY PARTICULAR FONT, STYLE, SIZE, OR COLOR.

FOR BUSINESS MARKETING CONSULTING SERVICES; MARKET RESEARCH CONSULTATION; ON-LINE ADVERTISING AND MARKETING SERVICES; PROMOTION, ADVERTISING AND MARKETING OF ON-LINE WEBSITES; ADVERTISING AND PUBLICITY SERVICES, NAMELY, PROMOTING THE GOODS, SERVICES, BRAND IDENTITY AND COMMERCIAL INFORMATION AND NEWS OF THIRD PARTIES THROUGH PRINT, AUDIO, VIDEO, DIGITAL AND ON-LINE MEDIUM; ADVERTISING, MARKETING AND PROMOTION SERVICES; PROMOTING THE GOODS AND SERVICES OF OTHERS THROUGH SEARCH ENGINE REFERRAL TRAFFIC ANALYSIS AND REPORTING (U.S. CLS. 100, 101 AND 102).

FIRST USE 4-1-2009; IN COMMERCE 5-1-2009.

CLASS 35—(Continued).

3,680,619. GERBIG SNELL/WEISHEIMER ADVERTISING, LLC, WESTERVILLE, OH. SN 77-348,360. PUB. 5-6-2008, FILED 12-10-2007.

INTERSECTING BRAND

THE MARK CONSISTS OF STANDARD CHARACTERS WITHOUT CLAIM TO ANY PARTICULAR FONT, STYLE, SIZE, OR COLOR.

FOR ADVERTISING AGENCY AND MARKETING SERVICES, NAMELY, BUSINESS MARKETING CONSULTING (U.S. CLS. 100, 101 AND 102).

FIRST USE 11-1-2007; IN COMMERCE 11-1-2007.

3,680,628. AMERICAN SPECIALTY HEALTH INCORPORATED, SAN DIEGO, CA. SN 77-349,990. PUB. 10-21-2008, FILED 12-12-2007.



THE MARK CONSISTS OF THE DESIGN OF THE WORDS "CHOOSEHEALTHY" WHERE THE "C" IN "CHOOSEHEALTHY" IS SURROUNDED BY RADIATING RECTANGULAR BARS OF DIFFERENT LENGTHS THAT FORM A SEMICIRCULAR OBJECT, WHICH IS THEN SURROUNDED BY THREE ARCED ARROWS POINTING IN A CLOCKWISE DIRECTION. THE WORD "HEALTHY" IS IN BOLD FACE TYPE.

FOR ADMINISTRATION OF A PROGRAM FOR ENABLING PARTICIPANTS TO OBTAIN DISCOUNTS ON GOODS AND SERVICES, NAMELY, A PROGRAM THAT OFFERS DISCOUNTED ACCESS TO A NETWORK OF PROVIDERS OF COMPLEMENTARY AND ALTERNATIVE MEDICINE AND DISCOUNTED ACCESS TO HEALTH PRODUCTS (U.S. CLS. 100, 101 AND 102).

FIRST USE 12-12-2007; IN COMMERCE 3-1-2008.

3,680,635. RICHRELEVANCE, INC., SAN FRANCISCO, CA. SN 77-351,432. PUB. 4-29-2008, FILED 12-13-2007.

richreach

THE MARK CONSISTS OF STANDARD CHARACTERS WITHOUT CLAIM TO ANY PARTICULAR FONT, STYLE, SIZE, OR COLOR.

FOR ADVERTISING SERVICES; INTERNET ADVERTISING SERVICES (U.S. CLS. 100, 101 AND 102).

FIRST USE 6-10-2009; IN COMMERCE 6-10-2009.

CLASS 35—(Continued).

3,680,680. KELLWOOD COMPANY, CHESTERFIELD, MO. SN 77-372,502. PUB. 4-8-2008, FILED 1-15-2008.

VINCE

THE MARK CONSISTS OF STANDARD CHARACTERS WITHOUT CLAIM TO ANY PARTICULAR FONT, STYLE, SIZE, OR COLOR.

OWNER OF U.S. REG. NO. 2,929,250. FOR RETAIL STORE SERVICES AND ONLINE RETAIL STORE SERVICES FEATURING APPAREL AND ACCESSORIES (U.S. CLS. 100, 101 AND 102). FIRST USE 11-30-2008; IN COMMERCE 11-30-2008.

CLASS 35—(Continued).

3,680,688. RODRIGUEZ, REBECCA WINTERS, CANYON LAKE, TX. SN 77-380,311. PUB. 12-30-2008, FILED 1-25-2008.



THE COLOR(S) LIGHT BLUE AND DARK BLUE IS/ARE CLAIMED AS A FEATURE OF THE MARK.

THE MARK CONSISTS OF A LIGHT BLUE PULSATING STAR OVER THE DARK BLUE WORDS "SACRED PASSAGES". FOR ONLINE RETAIL STORE SERVICES IN THE FIELD OF GIFTS FOR THE TERMINALLY ILL AND THEIR FAMILIES (U.S. CLS. 100, 101 AND 102). FIRST USE 2-1-2008; IN COMMERCE 5-5-2009.

3,680,681. BARRELMAKER ENTERPRISES, LLC, FREMONT, MI. SN 77-372,937. PUB. 12-2-2008, FILED 1-16-2008.



NO CLAIM IS MADE TO THE EXCLUSIVE RIGHT TO USE "ENTERPRISES, LLC", APART FROM THE MARK AS SHOWN.

THE MARK CONSISTS OF A CIRCLE AS THE BACKGROUND TO A SHADOW MAN IN THE MIDDLE OF THE CIRCLE WORKING ON A BARREL THAT HAS BANDING STRAPS. TO THE RIGHT OF THE ICON IS THE COMPANY NAME: "BARRELMAKER ENTERPRISES, LLC", WITH THE WORD "BARRELMAKER" STACKED OVER THE WORDS "ENTERPRISES, LLC". THE WORD "BARRELMAKER" IS IN SLIGHTLY LARGER TEXT THAN THE WORDS "ENTERPRISE, LLC".

FOR PROVIDING COMPARATIVE INFORMATION AND ADVERTISING SERVICES FOR PRODUCTS AND SERVICES SOLD VIA THE INTERNET (U.S. CLS. 100, 101 AND 102).

FIRST USE 12-17-2008; IN COMMERCE 12-17-2008.

3,680,692. PENG, LISA, SHANGHAI, CHINA. SN 77-384,873. PUB. 10-14-2008, FILED 1-30-2008.



THE COLOR(S) BLUE, PINK, AND YELLOW IS/ARE CLAIMED AS A FEATURE OF THE MARK.

THE MARK CONSISTS OF THE COLORS BLUE, PINK, AND YELLOW, WITH THE COLOR BLUE APPEARING IN THE SQUARE BACKGROUND OF THE WORDING "BABRINLO" AND IN THE NON-LATIN CHARACTERS, THE COLOR PINK APPEARING IN THE LETTERS "B", "B", AND "L" OF THE WORD "BABRINLO" AND THE COLOR YELLOW APPEARING IN THE LETTERS "A", "RIN", AND "O" OF THE WORD "BABRINLO".

THE NON-LATIN CHARACTERS IN THE MARK TRANSLITERATE TO "BAO BAO PAI NA" AND THIS MEANS "TREASURE TREASURE SEND GIVE" IN ENGLISH.

FOR ASSISTANCE IN BUSINESS MANAGEMENT AND PRODUCT COMMERCIALIZATION, WITHIN THE FRAMEWORK OF A FRANCHISE CONTRACT; SALES PROMOTION FOR THIRD PARTIES; PROCUREMENT, NAMELY, PURCHASING WEAPONS, OFFICE FURNITURE, GARMENTS FOR OTHERS; PUBLICITY AND SALES PROMOTION SERVICES; PROVIDING TELEVISION ADVERTISING FOR OTHERS; PRESENTATION OF GOODS ON COMMUNICATION MEDIA FOR RETAIL PURPOSES; COMMERCIAL INFORMATION AND ADVICE FOR CONSUMERS; INFORMATION IN BUSINESS MATTERS; BUSINESS RESEARCH; ASSISTANCE IN MANAGEMENT OF BUSINESS ACTIVITIES (U.S. CLS. 100, 101 AND 102).

FIRST USE 10-15-2008; IN COMMERCE 10-15-2008.

CLASS 35—(Continued).

3,680,697. TRA GLOBAL, INC., DBA TRA, INC., NEW YORK, NY. SN 77-386,323. PUB. 12-9-2008, FILED 2-1-2008.

Media TRAnalytics

THE MARK CONSISTS OF STANDARD CHARACTERS WITHOUT CLAIM TO ANY PARTICULAR FONT, STYLE, SIZE, OR COLOR.

NO CLAIM IS MADE TO THE EXCLUSIVE RIGHT TO USE "MEDIA", APART FROM THE MARK AS SHOWN.

FOR PROVIDING ONLINE DATABASE FOR ACCESSING, DOWNLOADING, VIEWING AND MANIPULATING DATA TO CREATE REPORTS IN THE FIELDS OF MARKET RESEARCH, ADVERTISING RESEARCH, CONSUMER AND BEHAVIOR RESEARCH, AND MEDIA RESEARCH, NAMELY, DATA CONCERNING CONSUMER AUDIENCE VIEWERSHIP, ADVERTISING SALES EFFECTIVENESS, AND SELECTION OF MEDIA TO OPTIMIZE SALES RESULTS (U.S. CLS. 100, 101 AND 102).

FIRST USE 4-24-2008; IN COMMERCE 4-24-2008.

CLASS 35—(Continued).

3,680,734. TRACFONE WIRELESS, INC., MIAMI, FL. SN 77-402,915. PUB. 8-26-2008, FILED 2-21-2008.

NET⁴10
NO BILLS. NO CONTRACTS. NO EVIL.

OWNER OF U.S. REG. NOS. 3,118,250, 3,253,506, AND OTHERS.

THE MARK CONSISTS OF THE WORDS "NET 10" "NO BILLS.NO CONTRACTS.NO EVIL". WITH A SMALLER TRIANGLE POINTING TOWARDS THE "1" IN "10" OVER THE LARGER TRIANGLE POINTING TOWARDS THE "1" IN "10".

FOR DISTRIBUTORSHIP SERVICES FEATURING CELLULAR TELEPHONES, PREPAID AIR TIME CELLULAR TELEPHONES AND PREPAID AIR TIME DEBIT CARDS, AND SOFTWARE FOR CONTROLLING AND MONITORING PREPAID AIR TIME CELLULAR SERVICES, ON-LINE RETAIL STORE SERVICES FEATURING CELLULAR TELEPHONES, PREPAID WIRELESS AIR TIME CARDS, CELLULAR TELEPHONE ACCESSORIES AND WIRELESS SERVICES (U.S. CLS. 100, 101 AND 102).

FIRST USE 8-31-2007; IN COMMERCE 10-31-2007.

3,680,718. REACHLOCAL, INC., WOODLAND HILLS, CA. SN 77-397,307. PUB. 2-17-2009, FILED 2-14-2008.

TOTALTRACK

THE MARK CONSISTS OF STANDARD CHARACTERS WITHOUT CLAIM TO ANY PARTICULAR FONT, STYLE, SIZE, OR COLOR.

FOR BUSINESS AND ADVERTISING SERVICES, NAMELY, TRACKING OF RESPONSES TO ADVERTISEMENTS FOR OTHERS, MONITORING AND ASSESSING THE EFFECTIVENESS OF ADVERTISING FOR OTHERS, TRACKING WEBSITES OF OTHERS TO PROVIDE DETAILS ABOUT USER CLICK TRAFFIC OR VISITS TO WEBSITES (U.S. CLS. 100, 101 AND 102).

FIRST USE 4-1-2007; IN COMMERCE 5-1-2007.

3,680,749. INTERSIGN CORPORATION, CHATTANOOGA, TN. SN 77-410,145. PUB. 10-21-2008, FILED 2-29-2008.

GET YOUR SIGN ON

THE MARK CONSISTS OF STANDARD CHARACTERS WITHOUT CLAIM TO ANY PARTICULAR FONT, STYLE, SIZE, OR COLOR.

NO CLAIM IS MADE TO THE EXCLUSIVE RIGHT TO USE "SIGN", APART FROM THE MARK AS SHOWN.

FOR CATALOG ORDERING SERVICES IN THE FIELD OF SIGNS; ELECTRONIC CATALOG SERVICES IN THE FIELD OF SIGNS; MAIL ORDER CATALOG SERVICES IN THE FIELD OF SIGNS; ONLINE RETAIL STORE SERVICES FEATURING SIGNS; RETAIL STORE SERVICES FEATURING SIGNS (U.S. CLS. 100, 101 AND 102).

FIRST USE 1-12-2009; IN COMMERCE 1-12-2009.

CLASS 35—(Continued).

3,680,751. EMERALD BABY, ROCHESTER, NY. SN 77-410,451. PUB. 8-5-2008, FILED 2-29-2008.

Emerald Baby

THE MARK CONSISTS OF STANDARD CHARACTERS WITHOUT CLAIM TO ANY PARTICULAR FONT, STYLE, SIZE, OR COLOR.

NO CLAIM IS MADE TO THE EXCLUSIVE RIGHT TO USE "BABY", APART FROM THE MARK AS SHOWN.

FOR RETAIL MUSIC AND RECORD STORES; ONLINE RETAIL STORE SERVICES FEATURING RECORDED MUSIC AND RINGTONES TO BE DOWNLOADED, AND AN ONLINE RETAIL SHOPPING STORE WEBSITE IN THE FIELD OF INFANT AND TODDLER MUSIC WITH COMPACT DISCS, BABY ITEMS OF BLANKETS, BOOKS, CLOTHING, GIFT BASKETS AND NURSERY DECORATIONS; PROMOTING THE GOODS AND SERVICES OF OTHERS BY PROVIDING A WEB SITE FEATURING COUPONS, REBATES, PRODUCT REVIEWS, LINKS TO THE RETAIL WEB SITES OF OTHERS, AND DISCOUNT INFORMATION (U.S. CLS. 100, 101 AND 102).

FIRST USE 7-1-2008; IN COMMERCE 7-1-2008.

3,680,754. ASSOCIATION OF NATIONAL ADVERTISERS, INC., NEW YORK, NY. SN 77-412,745. PUB. 2-10-2009, FILED 3-4-2008.

ANA ALLIANCE FOR FAMILY ENTERTAINMENT

THE MARK CONSISTS OF STANDARD CHARACTERS WITHOUT CLAIM TO ANY PARTICULAR FONT, STYLE, SIZE, OR COLOR.

NO CLAIM IS MADE TO THE EXCLUSIVE RIGHT TO USE "ALLIANCE FOR FAMILY ENTERTAINMENT", APART FROM THE MARK AS SHOWN.

FOR CHARITABLE SERVICES, NAMELY, PROVIDING TACTICAL SUPPORT IN THE NATURE OF PROMOTION SERVICES AND ADMINISTRATION AND MANAGEMENT OF PROMOTIONAL PROGRAMS FOR INDIVIDUALS AND ORGANIZATIONS THAT PROMOTE PUBLIC AND ENTERTAINMENT INDUSTRY AWARENESS OF THE NEED FOR THE CREATION, PRODUCTION, DISTRIBUTION AND CONSUMPTION OF WHOLESOME FAMILY ENTERTAINMENT (U.S. CLS. 100, 101 AND 102).

FIRST USE 9-18-2008; IN COMMERCE 9-18-2008.

CLASS 35—(Continued).

3,680,761. RADIO ONE, INC., LANHAM, MD. SN 77-415,350. PUB. 11-11-2008, FILED 3-6-2008.

HELLO BEAUTIFUL

THE MARK CONSISTS OF STANDARD CHARACTERS WITHOUT CLAIM TO ANY PARTICULAR FONT, STYLE, SIZE, OR COLOR.

FOR PROVIDING CONSUMER INFORMATION IN THE FIELDS OF PRODUCT REVIEWS IN THE AREAS OF COSMETICS, JEWELRY, CLOTHING AND ACCESSORIES, SHOES, ELECTRONICS, BEDDING, HOME ACCENTS AND DÉCOR, PERFUMES, AND HANDBAGS, FASHION SHOWS, TRAVEL RESOURCES, BEAUTY TIPS AND INFORMATION FROM HEALTH AND RELATIONSHIP EXPERTS VIA THE INTERNET (U.S. CLS. 100, 101 AND 102).

FIRST USE 5-1-2008; IN COMMERCE 5-1-2008.

3,680,765. AKINS, THEODORA, VICKSBURG, MI. SN 77-418,873. PUB. 10-21-2008, FILED 3-11-2008.

REDNECK SWAP MEET

THE MARK CONSISTS OF STANDARD CHARACTERS WITHOUT CLAIM TO ANY PARTICULAR FONT, STYLE, SIZE, OR COLOR.

NO CLAIM IS MADE TO THE EXCLUSIVE RIGHT TO USE "SWAP MEET", APART FROM THE MARK AS SHOWN.

FOR ONLINE AUCTION SERVICES; ONLINE BUSINESS NETWORKING SERVICES; PROVIDING A WEB SITE THAT FEATURES AN ONLINE MARKET FOR USERS TO LIST OFFERED OR WANTED PERSONAL AND BUSINESS ASSETS AND SKILLS FOR HIRE, RENT, SALE OR AUCTION TRANSACTED ON THE BASIS OF PREDEFINED PERFORMANCE AND CLOSING TERMS AND CONDITIONS; DISSEMINATION OF ADVERTISING FOR OTHERS VIA AN ON-LINE COMMUNICATIONS NETWORK ON THE INTERNET; DISSEMINATION OF ADVERTISING FOR OTHERS VIA THE INTERNET; INTERNET ADVERTISING SERVICES; ON-LINE TRADING SERVICES IN WHICH SELLER POSTS PRODUCTS TO BE AUCTIONED AND BIDDING IS DONE VIA THE INTERNET; ORGANISATION OF INTERNET AUCTIONS; THE BRINGING TOGETHER, FOR THE BENEFIT OF OTHERS, OF A VARIETY OF GOODS AND SERVICES, ENABLING CUSTOMERS TO CONVENIENTLY VIEW AND PURCHASE THOSE GOODS AND SERVICES FROM AN INTERNET WEBSITE PARTICULARLY SPECIALIZING IN THE MARKETING OF THE SALE OF GOODS AND SERVICES OF OTHERS; ARRANGING AND CONDUCTING SWAP MEETS IN THE FIELD OF VEHICLE AND PARTS THEREFOR; FLEA MARKETS (U.S. CLS. 100, 101 AND 102).

FIRST USE 1-26-2008; IN COMMERCE 6-1-2008.

CLASS 35—(Continued).

3,680,787. SUSTAINABILITY FOR EDUCATORS & THE ENVIRONMENT, INC., KENT, OH. SN 77-434,812. PUB. 3-17-2009, FILED 3-28-2008.



NO CLAIM IS MADE TO THE EXCLUSIVE RIGHT TO USE EITHER ITERATION OF THE UNIVERSAL RECYCLING SYMBOL OR OF "CLUB", APART FROM THE MARK AS SHOWN.

THE MARK CONSISTS OF CONCENTRIC CIRCLES CONTAINING A WORM IN THE SHAPE OF A "W" IN THE CENTER, WRIGGLING IN GRASS. THE LETTERS "WWC" ARE ARRAYED TO FORM EYES ("W'S) AND THE MOUTH ("C") OF A FACE WITH TWO LEAVES AT TOP, EXTENDING BEYOND THE BOUNDARIES OF THE CIRCLES AND DOUBLING AS HAIR. BETWEEN THE CONCENTRIC CIRCLES ARE TWO ITERATIONS OF THE TEXT "THE WORM WRANGLERS CLUB" SEPARATED BY TWO ITERATIONS OF THE UNIVERSAL SYMBOL FOR RECYCLING, ALL WRAPPING IN A CIRCULAR FASHION.

FOR CLUB SERVICES, NAMELY, PROMOTING THE INTERESTS OF ENVIRONMENTALISTS (U.S. CLS. 100, 101 AND 102).

FIRST USE 5-15-2008; IN COMMERCE 5-15-2008.

3,680,793. AMERICAN AUTOMOBILE ASSOCIATION, INC., HEATHROW, FL. SN 77-435,685. PUB. 1-27-2009, FILED 3-31-2008.

AAA SHOPLOCATOR

THE MARK CONSISTS OF STANDARD CHARACTERS WITHOUT CLAIM TO ANY PARTICULAR FONT, STYLE, SIZE, OR COLOR.

OWNER OF U.S. REG. NOS. 829,265 AND 2,900,596.

NO CLAIM IS MADE TO THE EXCLUSIVE RIGHT TO USE "SHOP LOCATOR", APART FROM THE MARK AS SHOWN.

FOR ON-LINE BUSINESS DIRECTORIES FEATURING MOTOR VEHICLE REPAIR SHOPS, PROVIDED VIA AN INTERACTIVE WEBSITE; MAKING VEHICLE REPAIR APPOINTMENTS VIA AN INTERACTIVE WEBSITE (U.S. CLS. 100, 101 AND 102).

FIRST USE 2-0-2009; IN COMMERCE 2-0-2009.

CLASS 35—(Continued).

3,680,794. BASEBALL EXPRESS, INC., SAN ANTONIO, TX. SN 77-435,982. PUB. 10-14-2008, FILED 3-31-2008.

ALL SOFTBALL ALL THE TIME

THE MARK CONSISTS OF STANDARD CHARACTERS WITHOUT CLAIM TO ANY PARTICULAR FONT, STYLE, SIZE, OR COLOR.

FOR RETAIL STORE SERVICES FEATURING SPORTING GOODS; MAIL ORDER SERVICES FEATURING SPORTING GOODS; ONLINE RETAIL STORES SERVICES FEATURING SPORTING GOODS (U.S. CLS. 100, 101 AND 102).

FIRST USE 7-31-2006; IN COMMERCE 7-31-2006.

3,680,802. MARKETTEAM, INC., MISSION VIEJO, CA. SN 77-439,079. PUB. 3-10-2009, FILED 4-3-2008.

ADVENTURER'S CLUB

THE MARK CONSISTS OF STANDARD CHARACTERS WITHOUT CLAIM TO ANY PARTICULAR FONT, STYLE, SIZE, OR COLOR.

NO CLAIM IS MADE TO THE EXCLUSIVE RIGHT TO USE "CLUB", APART FROM THE MARK AS SHOWN.

FOR ADVERTISING AND PROMOTION SERVICES, NAMELY, FOOD AND BEVERAGE PROMOTIONS AT RESTAURANTS, BARS AND LOUNGES; CONDUCTING EMPLOYEE INCENTIVE PROGRAMS FOR BARTENDERS AND WAIT STAFF TO PROMOTE FOOD AND BEVERAGE SALES (U.S. CLS. 100, 101 AND 102).

FIRST USE 4-17-2008; IN COMMERCE 4-17-2008.

CLASS 35—(Continued).

3,680,811. LIFE OF CIRCLE LIMITED, CENTRAL, HONG KONG. SN 77-441,185. PUB. 9-2-2008, FILED 4-7-2008.

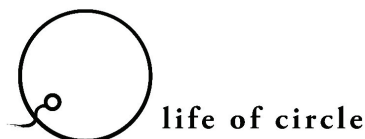

FOR LOGISTICS MANAGEMENT IN THE FIELD OF ADVERTISING PROMOTION GOODS; PROCURING OF CONTRACTS FOR THE PURCHASE AND SALE OF GOODS; RETAIL JEWELRY STORES; RETAIL OUTLETS FEATURING WATCHES, PRECIOUS METALS, HARDWARE OF METAL, HOUSEHOLD GOODS; RETAIL DEPARTMENT STORES; SUPERMARKETS; PROMOTING THE GOODS AND SERVICES OF OTHERS BY MEANS OF OPERATING AN ON-LINE SHOPPING MALL WITH LINKS TO THE RETAIL WEB SITES OF OTHERS; MAIL ORDER SERVICES FEATURING JEWELRY, WATCHES, PRECIOUS METALS, HARDWARE OF METAL, HOUSEHOLD GOODS; RETAIL STORE SERVICES, AVAILABLE THROUGH COMPUTER COMMUNICATIONS AND INTERACTIVE TELEVISION, FEATURING JEWELRY, WATCHES, PRECIOUS METALS, HARDWARE OF METAL, HOUSEHOLD GOODS; ADVERTISING SERVICES; COMMERCIAL INFORMATION AND DIRECTORY AGENCY; BUSINESS APPRAISALS; GOODS IMPORT-EXPORT AGENCIES; SALES PROMOTION FOR THIRD PARTIES; PROCUREMENT, NAMELY, PURCHASING JEWELRY, WATCHES, PRECIOUS METALS, HARDWARE OF METAL, HOUSEHOLD GOODS FOR OTHERS; PERSONNEL MANAGEMENT CONSULTATION; COMPILATION AND SYSTEMIZATION OF INFORMATION INTO COMPUTER DATABASES; ACCOUNTANCY SERVICES; RENTAL OF VENDING MACHINES (U.S. CLS. 100, 101 AND 102).

FIRST USE 6-28-2000; IN COMMERCE 6-28-2002.

CLASS 35—(Continued).

3,680,818. COUNCIL FOR AFFORDABLE QUALITY HEALTHCARE, INC., WASHINGTON, DC. SN 77-443,013. PUB. 10-7-2008, FILED 4-8-2008.



OWNER OF U.S. REG. NOS. 2,822,405 AND 2,878,549. NO CLAIM IS MADE TO THE EXCLUSIVE RIGHT TO USE "UNIVERSAL PROVIDER", APART FROM THE MARK AS SHOWN.

THE COLOR(S) BLUE AND LIGHT BLUE IS/ARE CLAIMED AS A FEATURE OF THE MARK.

THE MARK CONSISTS OF THE WORDING "UNIVERSAL PROVIDER DATASOURCE" IN LIGHT BLUE AND A STAR DESIGN, WHICH IS BLUE ON THE RIGHT SIDE AND LIGHT BLUE ON THE LEFT SIDE. THE WHITE IN THE MARK IS USED FOR BACKGROUND PURPOSES ONLY; IT IS NOT A FEATURE OF THE MARK.

FOR PROVIDING A SECURE, ONLINE DATABASE FEATURING INFORMATION REGARDING THE PROFESSIONAL CREDENTIALS OF PHYSICIANS AND OTHER HEALTHCARE PROVIDERS THAT CAN BE USED BY HEALTH PLANS, HOSPITALS AND MANAGED CARE ORGANIZATIONS FOR CREDENTIALING, CREATING PROVIDER DIRECTORIES, NETWORK DEVELOPMENT, CLAIMS PROCESSING AND OTHER PROVIDER RELATIONS ACTIVITIES (U.S. CLS. 100, 101 AND 102).

FIRST USE 9-2-2008; IN COMMERCE 9-2-2008.

3,680,850. DONLEN GOVERNMENT SERVICES, INC., NORTHBROOK, IL. SN 77-457,379. PUB. 10-28-2008, FILED 4-24-2008.



OWNER OF U.S. REG. NOS. 3,033,780 AND 3,075,313. NO CLAIM IS MADE TO THE EXCLUSIVE RIGHT TO USE "TELEMATICS" AND "DRIVING FLEET PERFORMANCE", APART FROM THE MARK AS SHOWN.

THE MARK CONSISTS OF THE WORDS "DONLEN TELEMATICS DRIVING FLEET PERFORMANCE" WITH A STYLIZED ARROW DRAWN TO LOOK LIKE A ROAD POINTING AT THE TERMS "DONLEN TELEMATICS".

FOR PROVIDING TRACKING SERVICES AND REPORTING INFORMATION DERIVED FROM GPS TECHNOLOGY TO OPERATORS OF FLEET VEHICLES CONCERNING TRACKING OF ASSETS IN TRANSIT, NAMELY, DRIVER AND VEHICLE ACTIONS FOR BUSINESS PURPOSES; BUSINESS CONSULTATION IN THE FIELD OF VEHICLE INFORMATION SERVICES, NAMELY, BUSINESS CONSULTATION IN THE FIELD OF GPS TECHNOLOGY USED TO TRACK DRIVER AND VEHICLE ACTIONS (U.S. CLS. 100, 101 AND 102).

FIRST USE 4-21-2008; IN COMMERCE 6-6-2008.

CLASS 35—(Continued).

3,680,858. MEDARC, LLC, VICTORIA, TX. SN 77-458,463. PUB. 9-23-2008, FILED 4-25-2008.

MEDARC

THE MARK CONSISTS OF STANDARD CHARACTERS WITHOUT CLAIM TO ANY PARTICULAR FONT, STYLE, SIZE, OR COLOR.

FOR PROVIDING AN INTERNET-BASED DATABASE OF PATIENT MEDICAL INFORMATION DESIGNED TO FACILITATE PATIENT-AUTHORIZED, HIPAA-COMPLIANT SHARING AND MAINTENANCE OF PATIENT MEDICAL INFORMATION AMONGST A PATIENT'S DOCTORS SUCH THAT THIS INFORMATION CAN BE DIRECTLY INSERTED INTO THE DOCTOR'S MEDICAL REPORTS AS A MEANS OF INCREASING MEDICAL RECORD GENERATION EFFICIENCY AND ACCURACY (U.S. CLS. 100, 101 AND 102).

FIRST USE 4-1-2009; IN COMMERCE 4-1-2009.

3,680,861. VISA INTERNATIONAL SERVICE ASSOCIATION, FOSTER CITY, CA. SN 77-458,711. PUB. 3-17-2009, FILED 4-25-2008.

VISA SAVINGSEDGE

THE MARK CONSISTS OF STANDARD CHARACTERS WITHOUT CLAIM TO ANY PARTICULAR FONT, STYLE, SIZE, OR COLOR.

OWNER OF U.S. REG. NOS. 1,071,114, 1,180,479, AND OTHERS.

FOR PROMOTING THE SALE OF THE GOODS AND SERVICES OF OTHERS BY PROVIDING DISCOUNTS AND INCENTIVES IN THE NATURE OF REBATES, FOR THOSE USING PAYMENT CARDS TO PAY FOR SUCH SALES (U.S. CLS. 100, 101 AND 102).

FIRST USE 9-22-2008; IN COMMERCE 9-22-2008.

CLASS 35—(Continued).

3,680,862. VISA INTERNATIONAL SERVICE ASSOCIATION, FOSTER CITY, CA. SN 77-458,723. PUB. 9-30-2008, FILED 4-25-2008.

SAVINGSEDGE

THE MARK CONSISTS OF STANDARD CHARACTERS WITHOUT CLAIM TO ANY PARTICULAR FONT, STYLE, SIZE, OR COLOR.

FOR PROMOTING THE SALE OF THE GOODS AND SERVICES OF OTHERS BY PROVIDING DISCOUNTS AND INCENTIVES IN THE NATURE OF REBATES, FOR THOSE USING PAYMENT CARDS TO PAY FOR SUCH SALES (U.S. CLS. 100, 101 AND 102).

FIRST USE 9-22-2008; IN COMMERCE 9-22-2008.

3,680,905. MOLLYGUARD CORPORATION, SAN FRANCISCO, CA. SN 77-468,684. PUB. 10-7-2008, FILED 5-7-2008.

EVENTBRITE

THE MARK CONSISTS OF STANDARD CHARACTERS WITHOUT CLAIM TO ANY PARTICULAR FONT, STYLE, SIZE, OR COLOR.

FOR PROVIDING ON-LINE EVENT REGISTRATION SERVICES FOR ATTENDANCE AT CONFERENCES, CONVENTIONS, MEETINGS, ALUMNI REUNIONS, TRADE SHOWS, WORKSHOPS, CLASSES, SOCIAL EVENTS AND MIXERS (U.S. CLS. 100, 101 AND 102).

FIRST USE 10-31-2006; IN COMMERCE 10-31-2006.

3,680,913. ARAMARK CORPORATION, PHILADELPHIA, PA. SN 77-469,328. PUB. 3-3-2009, FILED 5-8-2008.

PROVISIONS ON DEMAND

THE MARK CONSISTS OF STANDARD CHARACTERS WITHOUT CLAIM TO ANY PARTICULAR FONT, STYLE, SIZE, OR COLOR.

NO CLAIM IS MADE TO THE EXCLUSIVE RIGHT TO USE "PROVISIONS", APART FROM THE MARK AS SHOWN.

FOR RETAIL CONVENIENCE STORES; RETAIL CONVENIENCE STORE SERVICES (U.S. CLS. 100, 101 AND 102).

FIRST USE 8-0-2008; IN COMMERCE 8-0-2008.

CLASS 35—(Continued).

3,680,914. TOWNSON 3 MUSIC LLC, ROCKLAND, MA. SN 77-469,922. PUB. 10-14-2008, FILED 5-9-2008.

ANALOG PLANET

THE MARK CONSISTS OF STANDARD CHARACTERS WITHOUT CLAIM TO ANY PARTICULAR FONT, STYLE, SIZE, OR COLOR.

NO CLAIM IS MADE TO THE EXCLUSIVE RIGHT TO USE "ANALOG", APART FROM THE MARK AS SHOWN.

FOR ADMINISTRATION OF CULTURAL AND EDUCATIONAL EXCHANGE PROGRAMS; ADVERTISING VIA ELECTRONIC MEDIA AND SPECIFICALLY THE INTERNET; CATALOG ORDERING SERVICE FEATURING AUDIO EQUIPMENT AND ELECTRONICS; COMPUTERIZED ON-LINE ORDERING SERVICES IN THE FIELD OF AUDIO EQUIPMENT AND ELECTRONICS; COMPUTERIZED ON-LINE RETAIL STORE SERVICES IN THE FIELD OF AUDIO EQUIPMENT AND ELECTRONICS; CONDUCTING AN ON-LINE TRADE SHOW EXHIBITION, IN THE FIELD OF AUDIO EQUIPMENT AND ELECTRONICS; CONDUCTING AN ON-LINE TRADESHOW EXHIBITION, IN THE FIELD OF AUDIO EQUIPMENT AND ELECTRONICS; CONSULTATION AND ADVICE FOR THE PURCHASE OF MUSICAL INSTRUMENTS AND SOUND RECORDING DEVICES; COOPERATIVE ADVERTISING AND MARKETING SERVICES BY WAY OF SOLICITATION, CUSTOMER SERVICE AND PROVIDING MARKETING INFORMATION VIA WEB SITES ON A GLOBAL COMPUTER NETWORK; CUSTOMER SERVICE IN THE FIELD OF AUDIO EQUIPMENT AND ELECTRONICS; CUSTOMER SERVICES, NAMELY, PROVIDING CUSTOMER SERVICE AND PRODUCT INQUIRY SERVICES VIA TELEPHONE AND E-MAIL FOR OTHERS; DEALERSHIPS IN THE FIELD OF AUDIO EQUIPMENT AND ELECTRONICS; ELECTRONIC CATALOG SERVICES FEATURING AUDIO EQUIPMENT AND ELECTRONICS; INFORMATION, ADVISORY AND CONSULTANCY SERVICES RELATING TO BUSINESS AND MANAGEMENT OR BUSINESS ADMINISTRATION, INCLUDING SUCH SERVICES PROVIDED ON LINE OR VIA THE INTERNET; INTERNET ADVERTISING SERVICES; MUSIC SELECTION SERVICES FOR USE IN ADVERTISING; ON-LINE ADVERTISING AND MARKETING SERVICES; ON-LINE ORDERING SERVICES FEATURING AUDIO EQUIPMENT AND ELECTRONICS; ON-LINE RETAIL STORE SERVICES FEATURING DOWNLOADABLE PRE-RECORDED MUSIC AND VIDEO; ON-LINE RETAIL STORE SERVICES FEATURING AUDIO EQUIPMENT AND ELECTRONICS; OPERATING AN ONLINE SHOPPING SITE IN THE FIELD OF AUDIO EQUIPMENT AND ELECTRONICS; OPERATING ON-LINE MARKETPLACES FEATURING AUDIO EQUIPMENT AND ELECTRONICS; RETAIL MUSIC AND RECORD STORES; RETAIL OUTLETS FEATURING AUDIO EQUIPMENT AND ELECTRONICS; RETAIL SHOPS FEATURING AUDIO EQUIPMENT AND ELECTRONICS; RETAIL STORE SERVICES FEATURING AUDIO EQUIPMENT AND ELECTRONICS; RETAIL STORE SERVICES, AVAILABLE THROUGH COMPUTER COMMUNICATIONS AND INTERACTIVE TELEVISION, FEATURING AUDIO EQUIPMENT AND ELECTRONICS; RETAIL STORES FEATURING AUDIO EQUIPMENT AND ELECTRONICS; RETAIL AUDIO EQUIPMENT AND ELECTRONICS STORES (U.S. CLS. 100, 101 AND 102).

FIRST USE 12-1-2008; IN COMMERCE 12-1-2008.

CLASS 35—(Continued).

3,680,915. SCHILL, RANDY T., CHARLOTTE, NC. SN 77-470,010. PUB. 10-14-2008, FILED 5-9-2008.

COASTPOINT

THE MARK CONSISTS OF STANDARD CHARACTERS WITHOUT CLAIM TO ANY PARTICULAR FONT, STYLE, SIZE, OR COLOR.

FOR BUSINESS MANAGEMENT CONSULTANCY AS WELL AS DEVELOPMENT OF PROCESSES FOR THE ANALYSIS AND THE IMPLEMENTATION OF STRATEGY PLANS AND MANAGEMENT PROJECTS; BUSINESS CONSULTING SERVICES IN THE FIELD OF ORGANIZATIONAL CHANGE MANAGEMENT; BUSINESS CONSULTING SERVICES, NAMELY, PROVIDING ASSISTANCE IN THE DEVELOPMENT OF BUSINESS STRATEGIES AND CREATIVE IDEATION; BUSINESS PROCESS RE-ENGINEERING SERVICES; ADVISORY SERVICES RELATING TO BUSINESS MANAGEMENT AND BUSINESS OPERATIONS; BUSINESS MANAGEMENT CONSULTING WITH RELATION TO STRATEGY, MARKETING, SALES, OPERATION, BUSINESSES, MARKET TRENDS AND ACTIONS (U.S. CLS. 100, 101 AND 102).

FIRST USE 4-26-2009; IN COMMERCE 4-26-2009.

3,680,917. OMAHA STEAKS INTERNATIONAL, INC., OMAHA, NE. SN 77-470,189. PUB. 10-7-2008, FILED 5-9-2008.

WHY GRILLS EXIST

THE MARK CONSISTS OF STANDARD CHARACTERS WITHOUT CLAIM TO ANY PARTICULAR FONT, STYLE, SIZE, OR COLOR.

FOR ON-LINE RETAIL STORE SERVICES FEATURING FOOD AND FOOD RELATED ITEMS; MAIL ORDER CATALOG SERVICES FEATURING FOOD AND FOOD RELATED ITEMS; TELEPHONE SHOP-AT-HOME SERVICES IN THE FIELD OF FOOD AND FOOD RELATED ITEMS; RETAIL STORE SERVICES FEATURING FOOD AND FOOD RELATED ITEMS (U.S. CLS. 100, 101 AND 102).

FIRST USE 5-9-2008; IN COMMERCE 5-9-2008.

CLASS 35—(Continued).

3,680,918. MPHASIZE, LLC, NORWALK, CT. SN 77-470,271. PUB. 10-7-2008, FILED 5-9-2008.

MPHASIZE

THE MARK CONSISTS OF STANDARD CHARACTERS WITHOUT CLAIM TO ANY PARTICULAR FONT, STYLE, SIZE, OR COLOR.

FOR ASSISTANCE, ADVISORY SERVICES AND CONSULTANCY WITH REGARD TO BUSINESS PLANNING, BUSINESS ANALYSIS, BUSINESS MANAGEMENT, AND BUSINESS ORGANIZATION; MANAGEMENT AND BUSINESS CONSULTING SERVICES IN THE FIELD OF MARKETING AND SALES (U.S. CLS. 100, 101 AND 102). FIRST USE 7-30-2008; IN COMMERCE 7-30-2008.

CLASS 35—(Continued).

3,680,920. LIVEMERCIAL, INC., VALPARAISO, IN. SN 77-470,666. PUB. 10-21-2008, FILED 5-9-2008.

RECRUITV

THE MARK CONSISTS OF STANDARD CHARACTERS WITHOUT CLAIM TO ANY PARTICULAR FONT, STYLE, SIZE, OR COLOR.

FOR ADVERTISING, MARKETING AND PROMOTION SERVICES; ADVERTISING VIA ELECTRONIC MEDIA FOR OTHERS; ADVERTISING AND COMMERCIAL INFORMATION SERVICES; DISSEMINATION OF ADVERTISING FOR OTHERS; ADVERTISING SERVICES, NAMELY, CREATING CORPORATE AND BRAND IDENTITY FOR OTHERS; ADVERTISING PRODUCTION SERVICES; PREPARATION AND REALIZATION OF MEDIA AND ADVERTISING PLANS AND CONCEPTS; ADVERTISING AND PROMOTION SERVICES AND RELATED CONSULTING; ADVERTISING AND PUBLICITY SERVICES, NAMELY, PROMOTING THE GOODS, SERVICES, BRAND IDENTITY AND COMMERCIAL INFORMATION AND NEWS OF THIRD PARTIES THROUGH VIDEO, DIGITAL AND ON-LINE MEDIUM; ADVERTISING SERVICES, NAMELY, PRODUCTION OF VIDEOS AND ADVERTISING FOR PERSONNEL RECRUITMENT; VIDEO PRODUCTION SERVICES IN THE FIELD OF EMPLOYMENT RECRUITING; RECRUITMENT ADVERTISING AGENCY SERVICES; PERSONNEL CONSULTANCY; PERSONNEL PLACEMENT AND RECRUITMENT; PRODUCTION AND DISTRIBUTION OF VIDEO ADVERTISING; VIDEO PRODUCTION SERVICES; BUSINESS MARKETING SERVICES, NAMELY, PROVIDING LEAD GENERATION; TARGETED LEAD GENERATION, NAMELY, PROMOTING THE GOODS AND SERVICES OF OTHERS BY PROVIDING WEBSITE, VIDEO STREAMING TECHNOLOGY; SEARCH ENGINE MARKETING; ONLINE MEDIA; AND AFFILIATE NETWORKS; INTERNET-BASED SERVICES, NAMELY, ORDER TAKING; PROVIDING ON-LINE BUSINESS INTELLIGENCE DATA, SALES AND MARKETING LEAD GENERATION AND LEAD MANAGEMENT DATA TO OTHERS; PROMOTING THE GOODS AND SERVICES OF OTHERS BY PROVIDING A WEBSITE WITH BUILT-IN LEAD GENERATION TECHNOLOGY TO PROVIDE SALES LEADS TO OTHERS; PROVIDING CUSTOMIZED CUSTOMER SERVICE SUPPORT IN THE ABOVE FIELD; ORDER PLACEMENT SERVICES, NAMELY, ORDER-TAKING SERVICES FOR OTHERS (U.S. CLS. 100, 101 AND 102).

FIRST USE 6-1-2008; IN COMMERCE 6-1-2008.

3,680,919. UNIVISION COMMUNICATIONS INC., LOS ANGELES, CA. SN 77-470,536. PUB. 9-16-2008, FILED 5-9-2008.



PIENSA VERDE ACTÚA VERDE

NO CLAIM IS MADE TO THE EXCLUSIVE RIGHT TO USE "VERDE", APART FROM THE MARK AS SHOWN.

THE COLOR(S) LIGHT GREEN, DARK GREEN, AND WHITE IS/ARE CLAIMED AS A FEATURE OF THE MARK.

THE MARK CONSISTS OF THE PHRASE "PIENSA VERDE ACTUA VERDE" WITH A SQUARE IN THE MIDDLE OF THE PHRASE WITHIN WHICH APPEARS A PLANT BRANCH DESIGN WITH 5 LEAFs. THE WORDS "VERDE" AND "ACTUA" ARE IN LIGHT GREEN. THE WORDS "PIENSA" AND "VERDE" AND THE SQUARE IN THE MIDDLE ARE IN DARK GREEN. THE PLANT DESIGN APPEARS IN THE COLOR WHITE.

THE FOREIGN WORDING IN THE MARK TRANSLATES INTO ENGLISH AS THINK GREEN ACT GREEN.

FOR PRODUCTION OF TELEVISION COMMERCIALS AND PUBLIC SERVICE ANNOUNCEMENTS, NAMELY, THE PRODUCTION OF TELEVISED PUBLIC SERVICE ANNOUNCEMENTS FOCUSED ON PROTECTING OUR NATURAL ENVIRONMENT (U.S. CLS. 100, 101 AND 102).

FIRST USE 11-30-2008; IN COMMERCE 11-30-2008.

CLASS 35—(Continued).

3,680,924. LIVEMERCIAL, INC., VALPARAISO, IN. SN 77-470,961. PUB. 11-11-2008, FILED 5-9-2008.



THE MARK CONSISTS OF THE LETTERS "RECRUI" IN ONE FONT AND THE LETTERS "TV" IMPOSED ON A RECTANGULAR BACKGROUND IN ANOTHER FONT.

FOR ADVERTISING, MARKETING AND PROMOTION SERVICES; ADVERTISING VIA ELECTRONIC MEDIA FOR OTHERS; ADVERTISING AND COMMERCIAL INFORMATION SERVICES; DISSEMINATION OF ADVERTISING FOR OTHERS; ADVERTISING SERVICES, NAMELY, CREATING CORPORATE AND BRAND IDENTITY FOR OTHERS; ADVERTISING PRODUCTION SERVICES; PREPARATION AND REALIZATION OF MEDIA AND ADVERTISING PLANS AND CONCEPTS; ADVERTISING AND PROMOTION SERVICES AND RELATED CONSULTING; ADVERTISING AND PUBLICITY SERVICES, NAMELY, PROMOTING THE GOODS, SERVICES, BRAND IDENTITY AND COMMERCIAL INFORMATION AND NEWS OF THIRD PARTIES THROUGH VIDEO, DIGITAL AND ON-LINE MEDIUM; ADVERTISING SERVICES, NAMELY, PRODUCTION OF VIDEOS AND ADVERTISING FOR PERSONNEL RECRUITMENT; VIDEO PRODUCTION SERVICES IN THE FIELD OF EMPLOYMENT RECRUITING; RECRUITMENT ADVERTISING AGENCY SERVICES; PERSONNEL CONSULTANCY; PERSONNEL PLACEMENT AND RECRUITMENT; PRODUCTION AND DISTRIBUTION OF VIDEO ADVERTISING; VIDEO PRODUCTION SERVICES; BUSINESS MARKETING SERVICES, NAMELY, PROVIDING LEAD GENERATION; TARGETED LEAD GENERATION, NAMELY, PROMOTING THE GOODS AND SERVICES OF OTHERS BY PROVIDING WEBSITE, VIDEO STREAMING TECHNOLOGY; SEARCH ENGINE MARKETING; ONLINE MEDIA; AND AFFILIATE NETWORKS; INTERNET-BASED SERVICES, NAMELY, ORDER TAKING; PROVIDING ON-LINE BUSINESS INTELLIGENCE DATA, SALES AND MARKETING LEAD GENERATION AND LEAD MANAGEMENT DATA TO OTHERS; PROMOTING THE GOODS AND SERVICES OF OTHERS BY PROVIDING A WEBSITE WITH BUILT-IN LEAD GENERATION TECHNOLOGY TO PROVIDE SALES LEADS TO OTHERS; PROVIDING CUSTOMIZED CUSTOMER SERVICE SUPPORT IN THE ABOVE FIELD; ORDER PLACEMENT SERVICES, NAMELY, ORDER-TAKING SERVICES FOR OTHERS (U.S. CLS. 100, 101 AND 102).
FIRST USE 6-1-2008; IN COMMERCE 6-1-2008.

CLASS 35—(Continued).

3,680,931. RUSHTON ATLANTIC, LLC, CHESHIRE, SK 8 5AF, UNITED KINGDOM. SN 77-471,868. PUB. 10-14-2008, FILED 5-12-2008.

RUSHTON INTERNATIONAL

THE MARK CONSISTS OF STANDARD CHARACTERS WITHOUT CLAIM TO ANY PARTICULAR FONT, STYLE, SIZE, OR COLOR.

NO CLAIM IS MADE TO THE EXCLUSIVE RIGHT TO USE "INTERNATIONAL", APART FROM THE MARK AS SHOWN.

FOR BUSINESS APPRAISALS AND EVALUATIONS IN BUSINESS MATTERS (U.S. CLS. 100, 101 AND 102).

FIRST USE 12-31-1974; IN COMMERCE 12-31-1974.

3,680,935. BOBAK SAUSAGE COMPANY, CHICAGO, IL. SN 77-472,352. PUB. 10-21-2008, FILED 5-12-2008.

SAUSAGEOLOGY

THE MARK CONSISTS OF STANDARD CHARACTERS WITHOUT CLAIM TO ANY PARTICULAR FONT, STYLE, SIZE, OR COLOR.

FOR WHOLESALE FOOD DISTRIBUTORSHIP SERVICES; RETAIL GROCERY STORE AND RETAIL DELICATESSEN SERVICES (U.S. CLS. 100, 101 AND 102).

FIRST USE 3-0-2008; IN COMMERCE 3-0-2008.

3,680,936. BOBAK SAUSAGE COMPANY, CHICAGO, IL. SN 77-472,364. PUB. 10-21-2008, FILED 5-12-2008.

SAUSAGEOLOGIST

THE MARK CONSISTS OF STANDARD CHARACTERS WITHOUT CLAIM TO ANY PARTICULAR FONT, STYLE, SIZE, OR COLOR.

FOR WHOLESALE FOOD DISTRIBUTORSHIP SERVICES; RETAIL GROCERY STORE AND RETAIL DELICATESSEN SERVICES (U.S. CLS. 100, 101 AND 102).

FIRST USE 3-0-2008; IN COMMERCE 3-0-2008.

CLASS 35—(Continued).

3,680,937. LUTZ, ELLEN, PHILADELPHIA, PA. SN 77-472,548. PUB. 10-14-2008, FILED 5-12-2008.

CLEAN MARKETS

THE MARK CONSISTS OF STANDARD CHARACTERS WITHOUT CLAIM TO ANY PARTICULAR FONT, STYLE, SIZE, OR COLOR.

FOR PROVIDING MARKETING STRATEGY TO COMPANIES THAT ARE PROVIDING OR INTEND TO PROVIDE ENVIRONMENTALLY SUSTAINABLE PRODUCTS AND SERVICES (U.S. CLS. 100, 101 AND 102).
FIRST USE 6-15-2008; IN COMMERCE 7-8-2008.

3,680,998. RAYDA DEVELOPMENT CORP., NEWARK, DE. SN 77-481,970. PUB. 1-20-2009, FILED 5-23-2008.

privat  target

FOR OPERATING ONLINE MARKETPLACES FOR SELLERS AND BUYERS OF FINANCIAL SERVICES, BUSINESS PEOPLE, INVENTORS AND INVESTORS; ADVERTISING AND ADVERTISEMENT SERVICES; CUSTOMER LOYALTY SERVICES AND CUSTOMER CLUB SERVICES FOR COMMERCIAL, PROMOTIONAL AND ADVERTISING PURPOSES; PROMOTING THE GOODS AND SERVICES OF OTHERS (U.S. CLS. 100, 101 AND 102).
FIRST USE 1-26-2009; IN COMMERCE 1-26-2009.

CLASS 35—(Continued).

3,681,057. VISIONSERVE ALLIANCE, INC., ST. LOUIS, MO. SN 77-496,121. PUB. 11-4-2008, FILED 6-11-2008.

VISIONSERVE ALLIANCE

THE MARK CONSISTS OF STANDARD CHARACTERS WITHOUT CLAIM TO ANY PARTICULAR FONT, STYLE, SIZE, OR COLOR.

NO CLAIM IS MADE TO THE EXCLUSIVE RIGHT TO USE "ALLIANCE", APART FROM THE MARK AS SHOWN.

FOR PROMOTING THE INTERESTS OF ORGANIZATIONS AND PERSONS WHO SERVE THOSE WITH BLINDNESS AND VISUAL IMPAIRMENT, AS WELL AS THEIR CLIENTS, THROUGH ADVOCACY, LEGISLATION, EDUCATION, AND PROMOTING LEADERSHIP DEVELOPMENT, ETHICAL MANAGEMENT, IMPROVEMENT OF SERVICES, AND PROFESSIONAL GROWTH IN THE FIELD; PROMOTING PUBLIC AWARENESS OF THE HIGH INCIDENCE OF VISION LOSS AND BLINDNESS AND THE NEED FOR VISION REHABILITATION SERVICES AND SUPPORT (U.S. CLS. 100, 101 AND 102).

FIRST USE 10-0-2008; IN COMMERCE 10-0-2008.

3,681,062. BDI, PHARMA, INC., COLUMBIA, SC. SN 77-497,170. PUB. 11-4-2008, FILED 6-12-2008.

SECURIFLU

THE MARK CONSISTS OF STANDARD CHARACTERS WITHOUT CLAIM TO ANY PARTICULAR FONT, STYLE, SIZE, OR COLOR.

FOR WHOLESALE DISTRIBUTORSHIPS FEATURING VACCINES; WHOLESALE STORES FEATURING VACCINES (U.S. CLS. 100, 101 AND 102).

FIRST USE 5-1-2009; IN COMMERCE 5-1-2009.

3,681,079. CHILDREN'S CANCER RESEARCH FUND, MINNEAPOLIS, MN. SN 77-500,880. PUB. 11-11-2008, FILED 6-17-2008.

COMPLETE THE CURE

THE MARK CONSISTS OF STANDARD CHARACTERS WITHOUT CLAIM TO ANY PARTICULAR FONT, STYLE, SIZE, OR COLOR.

FOR PROMOTING PUBLIC AWARENESS OF CHILDHOOD CANCERS (U.S. CLS. 100, 101 AND 102).

FIRST USE 8-29-2008; IN COMMERCE 8-29-2008.

CLASS 35—(Continued).

3,681,099. GUITAR CENTER, INC., WESTLAKE VILLAGE, CA. SN 77-511,649. PUB. 11-18-2008, FILED 6-30-2008.



OWNER OF U.S. REG. NOS. 1,290,481, 3,053,666, AND OTHERS.

NO CLAIM IS MADE TO THE EXCLUSIVE RIGHT TO USE "CENTER", APART FROM THE MARK AS SHOWN.

THE MARK CONSISTS OF THE WORDS "GUITAR CENTER" WHICH APPEAR WITHIN A DRAWING OF A GUITAR PICK. THE "G" OF "GUITAR" IS A FANCIFUL "G" IN THE FORM OF THE DRAWING OF A GUITAR.

FOR RETAIL STORE SERVICES AND ON-LINE RETAIL STORE SERVICES FEATURING GUITARS, AMPLIFIERS, KEYBOARDS, PERCUSSION PRO-AUDIO, DRUMS, SHEET MUSIC, MUSIC BOOKS AND ACCESSORIES AND PRODUCTS RELATED THERETO (U.S. CLS. 100, 101 AND 102).

FIRST USE 4-1-2009; IN COMMERCE 4-1-2009.

3,681,104. WAL-MART STORES, INC., BENTONVILLE, AR. SN 77-513,839. PUB. 9-30-2008, FILED 7-2-2008.



OWNER OF U.S. REG. NOS. 1,783,039, 3,373,555, AND OTHERS.

THE MARK CONSISTS OF THE WORDING, "WAL-MART" AND "SAVE MONEY. LIVE BETTER.", FOLLOWED BY A DESIGN OF SIX RAYS SYMMETRICALLY CENTERED AROUND A CIRCLE TO RESEMBLE A SPARK.

FOR RETAIL BAKERY SHOPS; RETAIL DELICATESSEN SERVICES; RETAIL GROCERY STORES; RETAIL PHARMACY SERVICES; RETAIL STORES FEATURING A WIDE VARIETY OF CONSUMER GOODS (U.S. CLS. 100, 101 AND 102).

FIRST USE 6-24-2008; IN COMMERCE 6-24-2008.

CLASS 35—(Continued).

3,681,113. XENITH, LLC, LOWELL, MA. SN 77-519,904. PUB. 12-16-2008, FILED 7-11-2008.

ONE PLAYER, ONE HELMET

THE MARK CONSISTS OF STANDARD CHARACTERS WITHOUT CLAIM TO ANY PARTICULAR FONT, STYLE, SIZE, OR COLOR.

FOR PROMOTING PUBLIC AWARENESS OF THE NEED FOR SAFETY IN SPORTS AND OTHER POTENTIALLY HAZARDOUS ACTIVITIES (U.S. CLS. 100, 101 AND 102).

FIRST USE 11-30-2008; IN COMMERCE 11-30-2008.

3,681,125. HARGRODER COMPANIES, INC., LAFAYETTE, LA. SN 77-521,935. PUB. 12-9-2008, FILED 7-14-2008.

**EVALSCORE
WE'VE GOT YOUR NUMBER**

THE MARK CONSISTS OF STANDARD CHARACTERS WITHOUT CLAIM TO ANY PARTICULAR FONT, STYLE, SIZE, OR COLOR.

FOR BUSINESS EVALUATION OF EMPLOYMENT, INSURANCE HISTORY AND CREDENTIALS OF INDIVIDUALS; DATA PROCESSING SERVICES; EMPLOYMENT VERIFICATION (U.S. CLS. 100, 101 AND 102).

FIRST USE 12-1-2008; IN COMMERCE 12-1-2008.

3,681,162. CLARK, SCHAEFER, HACKETT & CO., CINCINNATI, OH. SN 77-533,976. PUB. 12-23-2008, FILED 7-29-2008.

STRENGTH IN NUMBERS

THE MARK CONSISTS OF STANDARD CHARACTERS WITHOUT CLAIM TO ANY PARTICULAR FONT, STYLE, SIZE, OR COLOR.

FOR ACCOUNTING SERVICES (U.S. CLS. 100, 101 AND 102).

FIRST USE 8-1-2008; IN COMMERCE 8-1-2008.

CLASS 35—(Continued).

3,681,175. DIGI-KEY CORPORATION, THIEF RIVER FALLS, MN. SN 77-538,641. PUB. 12-23-2008, FILED 8-4-2008.

THE POWER OF NOW

THE MARK CONSISTS OF STANDARD CHARACTERS WITHOUT CLAIM TO ANY PARTICULAR FONT, STYLE, SIZE, OR COLOR.

FOR CATALOG ORDERING SERVICE FEATURING ELECTRONIC COMPONENTS AND HARDWARE; COMPUTERIZED ON-LINE ORDERING SERVICES IN THE FIELD OF ELECTRONIC COMPONENTS AND HARDWARE; ELECTRONIC CATALOG SERVICES FEATURING ELECTRONIC COMPONENTS AND HARDWARE; MAIL ORDER CATALOG SERVICES FEATURING ELECTRONIC COMPONENTS AND HARDWARE; MAIL ORDER SERVICES FEATURING ELECTRONIC COMPONENTS AND HARDWARE; ON-LINE ORDERING SERVICES FEATURING ELECTRONIC COMPONENTS AND HARDWARE; OPERATING AN ON-LINE SHOPPING SITE IN THE FIELD OF ELECTRONIC COMPONENTS AND HARDWARE (U.S. CLS. 100, 101 AND 102).

FIRST USE 4-23-2009; IN COMMERCE 4-23-2009.

3,681,176. DIGI-KEY CORPORATION, THIEF RIVER FALLS, MN. SN 77-538,658. PUB. 12-23-2008, FILED 8-4-2008.

RIGHT SIZE RIGHT NOW

THE MARK CONSISTS OF STANDARD CHARACTERS WITHOUT CLAIM TO ANY PARTICULAR FONT, STYLE, SIZE, OR COLOR.

FOR CATALOG ORDERING SERVICE FEATURING ELECTRONIC COMPONENTS AND HARDWARE; COMPUTERIZED ON-LINE ORDERING SERVICES IN THE FIELD OF ELECTRONIC COMPONENTS AND HARDWARE; ELECTRONIC CATALOG SERVICES FEATURING ELECTRONIC COMPONENTS AND HARDWARE; MAIL ORDER CATALOG SERVICES FEATURING ELECTRONIC COMPONENTS AND HARDWARE; MAIL ORDER SERVICES FEATURING ELECTRONIC COMPONENTS AND HARDWARE; ON-LINE ORDERING SERVICES FEATURING ELECTRONIC COMPONENTS AND HARDWARE; OPERATING AN ON-LINE SHOPPING SITE IN THE FIELD OF ELECTRONIC COMPONENTS AND HARDWARE (U.S. CLS. 100, 101 AND 102).

FIRST USE 4-24-2009; IN COMMERCE 4-24-2009.

CLASS 35—(Continued).

3,681,186. LIQUOR EXPO, INC., GRENADA, CA. SN 77-544,782. PUB. 1-6-2009, FILED 8-12-2008.

LIQUOR EXPO

THE MARK CONSISTS OF STANDARD CHARACTERS WITHOUT CLAIM TO ANY PARTICULAR FONT, STYLE, SIZE, OR COLOR.

NO CLAIM IS MADE TO THE EXCLUSIVE RIGHT TO USE "LIQUOR", APART FROM THE MARK AS SHOWN.

FOR RETAIL STORES FEATURING ALCOHOLIC AND NON-ALCOHOLIC BEVERAGES (U.S. CLS. 100, 101 AND 102).

FIRST USE 11-1-2008; IN COMMERCE 11-1-2008.

3,681,198. C10, INC., MILL VALLEY, CA. SN 77-548,116. PUB. 1-6-2009, FILED 8-15-2008.

PLAYACTIONPIX

THE MARK CONSISTS OF STANDARD CHARACTERS WITHOUT CLAIM TO ANY PARTICULAR FONT, STYLE, SIZE, OR COLOR.

FOR ON-LINE RETAIL STORE SERVICES FEATURING PHOTOGRAPHS IN THE FIELD OF SPORTS (U.S. CLS. 100, 101 AND 102).

FIRST USE 11-7-2008; IN COMMERCE 11-7-2008.

3,681,205. FM LEGAL CIRCLE SERVICES PVT. LTD., NOIDA, INDIA. SN 77-551,676. PUB. 1-13-2009, FILED 8-20-2008.



NO CLAIM IS MADE TO THE EXCLUSIVE RIGHT TO USE "LEGAL", APART FROM THE MARK AS SHOWN.

THE MARK CONSISTS OF THE WORDS "LEGAL CIRCLE" INSIDE TWO SEMI-CIRCLES.

FOR OUTSOURCING OF LEGAL SERVICES (U.S. CLS. 100, 101 AND 102).

FIRST USE 9-1-2007; IN COMMERCE 9-1-2007.

CLASS 35—(Continued).

3,681,218. GREENCODE TECHNOLOGIES, INC., MIRAMAR, FL. SN 77-559,717. PUB. 1-20-2009, FILED 9-1-2008.

give yourself to the world

THE MARK CONSISTS OF STANDARD CHARACTERS WITHOUT CLAIM TO ANY PARTICULAR FONT, STYLE, SIZE, OR COLOR.

FOR ON-LINE TRADING SERVICES TO FACILITATE THE SALE OF GOODS AND SERVICES BY OTHERS VIA A COMPUTER NETWORK AND PROVIDING EVALUATIVE FEEDBACK AND RATINGS OF SELLERS' GOODS AND SERVICES, THE VALUE AND PRICES OF SELLERS' GOODS AND SERVICES, BUYERS' AND SELLERS' PERFORMANCE, DELIVERY, AND OVERALL TRADING EXPERIENCE IN CONNECTION THEREWITH; ADVERTISING AND ADVERTISEMENT SERVICES (U.S. CLS. 100, 101 AND 102).

FIRST USE 1-1-2009; IN COMMERCE 1-1-2009.

3,681,242. METALLURG VANADIUM CORPORATION, CAMBRIDGE, OH. SN 77-568,578. PUB. 1-27-2009, FILED 9-12-2008.

METGREEN

THE MARK CONSISTS OF STANDARD CHARACTERS WITHOUT CLAIM TO ANY PARTICULAR FONT, STYLE, SIZE, OR COLOR.

FOR DISTRIBUTORSHIPS IN THE FIELD OF METAL ALLOYS AND SPECIALTY METAL PRODUCTS (U.S. CLS. 100, 101 AND 102).

FIRST USE 3-10-2009; IN COMMERCE 3-10-2009.

3,681,258. KHILAWAN, REENA NATASHA, WILMINGTON, CA. SN 77-573,356. PUB. 2-10-2009, FILED 9-18-2008.

Aahchoo

THE MARK CONSISTS OF STANDARD CHARACTERS WITHOUT CLAIM TO ANY PARTICULAR FONT, STYLE, SIZE, OR COLOR.

FOR ADVERTISING, MARKETING AND PROMOTION SERVICES (U.S. CLS. 100, 101 AND 102).

FIRST USE 9-1-2008; IN COMMERCE 9-1-2008.

CLASS 35—(Continued).

3,681,262. CONTINENTAL COMMERCIAL PRODUCTS, DBA CONTINENTAL, BRIDGETON, MO. SN 77-574,291. PUB. 2-10-2009, FILED 9-19-2008.

PROTECT PRESERVE CONSERVE

THE MARK CONSISTS OF STANDARD CHARACTERS WITHOUT CLAIM TO ANY PARTICULAR FONT, STYLE, SIZE, OR COLOR.

FOR DISTRIBUTORSHIP SERVICES IN THE FIELD OF CLEANING PRODUCTS AND SUPPLIES AND SANITARY MAINTENANCE PRODUCTS AND SUPPLIES; ELECTRONIC CATALOG SERVICES AND MAIL ORDER CATALOG SERVICES, BOTH IN THE FIELD OF CLEANING PRODUCTS AND SUPPLIES AND SANITARY MAINTENANCE PRODUCTS AND SUPPLIES (U.S. CLS. 100, 101 AND 102).

FIRST USE 10-31-2008; IN COMMERCE 10-31-2008.

3,681,263. CONTINENTAL COMMERCIAL PRODUCTS, DBA CONTINENTAL, BRIDGETON, MO. SN 77-574,300. PUB. 2-10-2009, FILED 9-19-2008.

IT'S NOT ENOUGH JUST TO
MAKE BETTER PRODUCTS.
WE'RE FINDING WAYS TO MAKE
BETTER PRODUCTS...BETTER

THE MARK CONSISTS OF STANDARD CHARACTERS WITHOUT CLAIM TO ANY PARTICULAR FONT, STYLE, SIZE, OR COLOR.

FOR DISTRIBUTORSHIP SERVICES IN THE FIELD OF CLEANING PRODUCTS AND SUPPLIES AND SANITARY MAINTENANCE PRODUCTS AND SUPPLIES; ELECTRONIC CATALOG SERVICES AND MAIL ORDER CATALOG SERVICES, BOTH IN THE FIELD OF CLEANING PRODUCTS AND SUPPLIES AND SANITARY MAINTENANCE PRODUCTS AND SUPPLIES (U.S. CLS. 100, 101 AND 102).

FIRST USE 10-31-2008; IN COMMERCE 10-31-2008.

3,681,275. LOVE UNITED, LLC, LAKELAND, FL. SN 77-578,987. PUB. 2-17-2009, FILED 9-25-2008.

Love United

THE MARK CONSISTS OF STANDARD CHARACTERS WITHOUT CLAIM TO ANY PARTICULAR FONT, STYLE, SIZE, OR COLOR.

FOR ON-LINE RETAIL STORE SERVICES FEATURING PET PRODUCTS; RETAIL STORE SERVICES FEATURING PET PRODUCTS (U.S. CLS. 100, 101 AND 102).

FIRST USE 12-1-2008; IN COMMERCE 12-1-2008.

CLASS 35—(Continued).

3,681,286. GREENSPRING MEDIA GROUP INC, MINNEAPOLIS, MN. SN 77-580,798. PUB. 3-3-2009, FILED 9-29-2008.

MINNESOTA MONTHLY FOOD &
WINE EXPERIENCE

THE MARK CONSISTS OF STANDARD CHARACTERS WITHOUT CLAIM TO ANY PARTICULAR FONT, STYLE, SIZE, OR COLOR.

OWNER OF U.S. REG. NO. 2,098,793.

NO CLAIM IS MADE TO THE EXCLUSIVE RIGHT TO USE "MINNESOTA MONTHLY FOOD & WINE", APART FROM THE MARK AS SHOWN.

FOR ARRANGING AND CONDUCTING TRADE SHOW EXHIBITIONS IN THE FIELD OF FOOD AND WINE (U.S. CLS. 100, 101 AND 102).

FIRST USE 2-26-2009; IN COMMERCE 2-26-2009.

3,681,287. SELECT INTELLECTUAL, LLC, PITTSBURGH, PA. SN 77-581,260. PUB. 12-23-2008, FILED 9-29-2008.

ROADWORTHY

THE MARK CONSISTS OF STANDARD CHARACTERS WITHOUT CLAIM TO ANY PARTICULAR FONT, STYLE, SIZE, OR COLOR.

FOR BUSINESS SERVICES, NAMELY, PROVIDING PERSONNEL SELECTION AND ASSESSMENT SERVICES BY IDENTIFYING, AND SCREENING OF EMPLOYMENT SKILLS OF TRUCK DRIVER CANDIDATES (U.S. CLS. 100, 101 AND 102).

FIRST USE 10-8-2007; IN COMMERCE 10-8-2007.

3,681,289. OBELISK HOME LLC, SPRINGFIELD, MO. SN 77-581,976. PUB. 2-24-2009, FILED 9-30-2008.

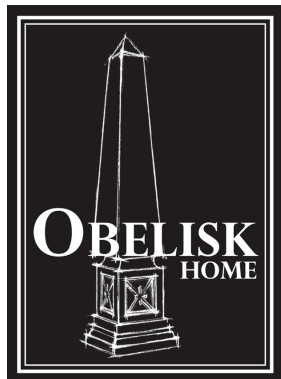
**CLASS 35—(Continued).**

NO CLAIM IS MADE TO THE EXCLUSIVE RIGHT TO USE "HOME", APART FROM THE MARK AS SHOWN.

THE MARK CONSISTS OF "OBELISK HOME". THE ICON WITHIN THE MARK IS A TAPERED SHAFT WITH A PYRAMIDAL TOP.

FOR RETAIL FURNITURE STORES; RETAIL STORE AND ON-LINE RETAIL STORE SERVICES FEATURING HOME FURNISHINGS; RETAIL STORES FEATURING HOME FURNISHINGS (U.S. CLS. 100, 101 AND 102).

FIRST USE 11-7-2008; IN COMMERCE 11-7-2008.

3,681,310. HELPHIVE, INC., SHORELINE, WA. SN 77-588,999. PUB. 3-17-2009, FILED 10-8-2008.

HelpHive

THE MARK CONSISTS OF STANDARD CHARACTERS WITHOUT CLAIM TO ANY PARTICULAR FONT, STYLE, SIZE, OR COLOR.

FOR INFOMEDIARY SERVICES, NAMELY, FACILITATING TRANSACTIONS BETWEEN BUYERS AND SELLERS BY CREATING AN ON-LINE COMMUNITY AND MARKETPLACE FOR BUYERS TO FIND INFORMATION ABOUT LOCAL SERVICE PROVIDERS AND LOCAL SERVICE PROVIDERS TO PROMOTE AND MARKET THEIR SERVICES TO BUYERS (U.S. CLS. 100, 101 AND 102).

FIRST USE 11-1-2008; IN COMMERCE 5-4-2009.

3,681,311. SOUTH CAROLINA DEPARTMENT OF AGRICULTURE, COLUMBIA, SC. SN 77-589,157. PUB. 3-3-2009, FILED 10-9-2008.

PALMETTOVORE

THE MARK CONSISTS OF STANDARD CHARACTERS WITHOUT CLAIM TO ANY PARTICULAR FONT, STYLE, SIZE, OR COLOR.

FOR PROMOTING PUBLIC AWARENESS OF THE BENEFITS OF BUYING FOODS GROWN, PROCESSED, AND PRODUCED IN SOUTH CAROLINA (U.S. CLS. 100, 101 AND 102).

FIRST USE 5-17-2009; IN COMMERCE 5-17-2009.

CLASS 35—(Continued).

3,681,332. NEW DAY BUSINESS ADVISORS LLC, APEX, NC. SN 77-596,338. PUB. 3-31-2009, FILED 10-20-2008.



THE COLOR(S) YELLOW, BLACK, AND WHITE IS/ARE CLAIMED AS A FEATURE OF THE MARK.

THE MARK CONSISTS OF A STYLIZED SUN DESIGN, COMPOSED OF TWO PIECES THAT FORM A SPIRAL TOGETHER IN THE CENTER TO BECOME ONE, THE OUTLINE OF THE SUN DESIGN IN BLACK, THE INSIDE OF THE SUN DESIGN IN YELLOW, TRANSPOSED ON A WHITE BACKGROUND, WITH THE LETTERS "NDBA" IN BLACK STYLIZED LETTERING BELOW THE STYLIZED SUN DESIGN, THE BROKEN LINES ARE NOT A PART OF THE MARK AND SERVE ONLY TO SHOW THE POSITION OF THE MARK.

FOR BUSINESS CONSULTING RELATING TO BUSINESS OPERATIONS, ORGANIZATION, AND DEVELOPMENT; PUBLIC RELATIONS; HUMAN RESOURCES MANAGEMENT; TAX PLANNING SERVICES; ACCOUNTING SERVICES (U.S. CLS. 100, 101 AND 102).

FIRST USE 10-20-2008; IN COMMERCE 10-20-2008.

3,681,343. IT WORLDWIDE, LLC, NEW YORK, NY. SN 77-599,925. PUB. 3-17-2009, FILED 10-24-2008.

it. Worldwide

THE MARK CONSISTS OF STANDARD CHARACTERS WITHOUT CLAIM TO ANY PARTICULAR FONT, STYLE, SIZE, OR COLOR.

FOR MARKETING SERVICES, NAMELY, CONCEPT AND BRAND DEVELOPMENT SERVICES IN THE FIELD OF CONSUMER GOODS (U.S. CLS. 100, 101 AND 102).

FIRST USE 11-1-2008; IN COMMERCE 11-1-2008.

CLASS 35—(Continued).

3,681,369. CHEMGLASS, INC., VINELAND, NJ. SN 77-609,925. PUB. 3-24-2009, FILED 11-7-2008.



OWNER OF U.S. REG. NO. 1,697,454.

NO CLAIM IS MADE TO THE EXCLUSIVE RIGHT TO USE "LIFE SCIENCES", APART FROM THE MARK AS SHOWN.

THE MARK CONSISTS OF STYLIZED LETTERS "CG CHEMGLASS LIFE SCIENCES" AND A PARTIAL HELIX DESIGN.

FOR WHOLESALE AND RETAIL DISTRIBUTORSHIP OF SCIENTIFIC LABORATORY GLASSWARE AND PLASTICS AND LABORATORY EQUIPMENT FOR CELL CULTURE, CHEMISTRY AND LIFE SCIENCES APPLICATIONS (U.S. CLS. 100, 101 AND 102).

FIRST USE 1-5-2009; IN COMMERCE 1-5-2009.

3,681,370. CHEMGLASS, INC., VINELAND, NJ. SN 77-609,977. PUB. 3-24-2009, FILED 11-7-2008.



OWNER OF U.S. REG. NO. 1,697,454.

NO CLAIM IS MADE TO THE EXCLUSIVE RIGHT TO USE "LIFE SCIENCES", APART FROM THE MARK AS SHOWN.

THE COLOR(S) TEAL, BLUE AND GREEN IS/ARE CLAIMED AS A FEATURE OF THE MARK.

THE MARK CONSISTS OF STYLIZED LETTERS "CG CHEMGLASS LIFE SCIENCES" AND A PARTIAL HELIX DESIGN, WHEREIN THERE IS A HORIZONTAL TRANSITION OF COLOR IN THE LETTERS FROM TEAL TO BLUE, AND THE HELIX HAS GREEN CURVED RAILS AND BLUE CONNECTORS.

FOR WHOLESALE AND RETAIL DISTRIBUTORSHIP OF SCIENTIFIC LABORATORY GLASSWARE AND PLASTICS AND LABORATORY EQUIPMENT FOR CELL CULTURE, CHEMISTRY AND LIFE SCIENCES APPLICATIONS (U.S. CLS. 100, 101 AND 102).

FIRST USE 1-5-2009; IN COMMERCE 1-5-2009.

CLASS 35—(Continued).

3,681,401. MARX, DAVID P., DBA FRONT RUNNER CONSULTING, CRYSTAL LAKE, IL. SN 77-623,700. PUB. 4-7-2009, FILED 12-1-2008.

Front Runner Consulting

THE MARK CONSISTS OF STANDARD CHARACTERS WITHOUT CLAIM TO ANY PARTICULAR FONT, STYLE, SIZE, OR COLOR.

NO CLAIM IS MADE TO THE EXCLUSIVE RIGHT TO USE "CONSULTING", APART FROM THE MARK AS SHOWN.

FOR EXECUTIVE RECRUITING SERVICES (U.S. CLS. 100, 101 AND 102).

FIRST USE 12-1-2008; IN COMMERCE 12-1-2008.

3,681,404. WAKEBY FIRE AND ASSOCIATES, LLC, MASH-PEE, MA. SN 77-625,920. PUB. 4-7-2009, FILED 12-3-2008.

Doggone Easy

THE MARK CONSISTS OF STANDARD CHARACTERS WITHOUT CLAIM TO ANY PARTICULAR FONT, STYLE, SIZE, OR COLOR.

FOR ADVERTISING, MARKETING AND PROMOTION SERVICES (U.S. CLS. 100, 101 AND 102).

FIRST USE 1-20-2009; IN COMMERCE 1-20-2009.

3,681,469. GENERAL ELECTRIC COMPANY, SCHENECTADY, NY. SN 78-512,450. PUB. 11-8-2005, FILED 11-5-2004.

ECOMAGINATION

THE MARK CONSISTS OF STANDARD CHARACTERS WITHOUT CLAIM TO ANY PARTICULAR FONT, STYLE, SIZE, OR COLOR.

FOR REMOTE TRACKING OF, MONITORING OF, AND LOCATING LAND VEHICLES AND TRAILERS, AND PROVIDING BUSINESS, INVENTORY, AND MAINTENANCE IN CONNECTION THEREWITH (U.S. CLS. 100, 101 AND 102).

FIRST USE 5-0-2007; IN COMMERCE 5-0-2007.

CLASS 35—(Continued).

3,681,486. THIRALAND, LLC, FRENCHTOWN, NJ. SN 78-585,051. PUB. 4-25-2006, FILED 3-10-2005.

AGORABAY

THE MARK CONSISTS OF STANDARD CHARACTERS WITHOUT CLAIM TO ANY PARTICULAR FONT, STYLE, SIZE, OR COLOR.

FOR PROVIDING A WEBSITE FEATURING CONSUMER INFORMATION TO AID IN MAKING PURCHASING DECISIONS ABOUT HOME CONTENTS; PROVIDING CONSUMER INFORMATION TO AID IN MAKING PURCHASING DECISIONS TO MEMBERS ABOUT THE CONTENTS OF HOMES; PROVIDING A WEB SITE WHICH FEATURES INFORMATION ABOUT OR ADVERTISEMENTS FOR THE GOODS AND SERVICES OF OTHERS ON A GLOBAL COMPUTER NETWORK; DISSEMINATION OF ADVERTISING; BUSINESS MARKETING SERVICES, DIRECT MARKETING SERVICES VIA A GLOBAL COMPUTER NETWORK; ADVERTISING, MARKETING AND PROMOTION SERVICES (U.S. CLS. 100, 101 AND 102).

FIRST USE 7-18-2009; IN COMMERCE 7-18-2009.

3,681,495. BEYOND THE BEAN LIMITED, BRISTOL, UNITED KINGDOM. SN 78-616,737. PUB. 3-21-2006, FILED 4-26-2005.

Beyond the Bean

THE MARK CONSISTS OF STANDARD CHARACTERS WITHOUT CLAIM TO ANY PARTICULAR FONT, STYLE, SIZE, OR COLOR.

FOR MAIL ORDER, TELEPHONE ORDER, AND ONLINE RETAIL SERVICES FEATURING RESTAURANT AND CAFE SUPPLIES (U.S. CLS. 100, 101 AND 102).

FIRST USE 2-28-2006; IN COMMERCE 5-14-2009.

CLASS 35—(Continued).

3,681,499. ORLANDO BATHING SUIT, LLC, ORLANDO, FL. SN 78-630,289. PUB. 2-14-2006, FILED 5-16-2005.

CLASS 35—(Continued).

3,681,548. INTERNAL COMBUSTION, LLC, RYE, NY. SN 78-740,630. PUB. 9-2-2008, FILED 10-26-2005.

JUST ADD WATER

THE MARK CONSISTS OF STANDARD CHARACTERS WITHOUT CLAIM TO ANY PARTICULAR FONT, STYLE, SIZE, OR COLOR.

OWNER OF U.S. REG. NOS. 1,247,767, 1,247,985, AND 1,252,566.

FOR ELECTRONIC CATALOG SERVICES AND MAIL ORDER CATALOG SERVICES, AND ON-LINE RETAIL STORE SERVICES ALL FEATURING SWIMWEAR, CLOTHING, SHOES AND SUNGLASSES (U.S. CLS. 100, 101 AND 102).

FIRST USE 4-30-2009; IN COMMERCE 4-30-2009.

INTERNAL COMBUSTION

THE MARK CONSISTS OF STANDARD CHARACTERS WITHOUT CLAIM TO ANY PARTICULAR FONT, STYLE, SIZE, OR COLOR.

FOR DEVELOPING, CREATING AND DISSEMINATING STRATEGIC MARKETING COMMUNICATIONS ON BEHALF OF OTHERS, INCLUDING DVD'S, CDS, CD-ROMS, AND STREAMING AUDIO AND VIDEO CONTENT, FOR USE BY A BUSINESS INSIDE ITS ORGANIZATION AND WITH ITS BUSINESS PARTNERS; AND BUSINESS MARKETING CONSULTING IN THE FIELD OF ASSISTING BUSINESS ORGANIZATIONS TO MARKET THEMSELVES BY MEANS OF THE FOREGOING SERVICES (U.S. CLS. 100, 101 AND 102).

FIRST USE 1-1-2002; IN COMMERCE 1-1-2002.

3,681,533. INTEGRATED GROUP ASSETS, INC., DALLAS, TX. SN 78-695,643. PUB. 5-2-2006, FILED 8-18-2005.

3,681,552. TURNKEY FINANCIAL SOLUTIONS, LP, FLOWER MOUND, TX. SN 78-758,619. PUB. 10-10-2006, FILED 11-21-2005.

LOTTO SILVER+

THE MARK CONSISTS OF STANDARD CHARACTERS WITHOUT CLAIM TO ANY PARTICULAR FONT, STYLE, SIZE, OR COLOR.

NO CLAIM IS MADE TO THE EXCLUSIVE RIGHT TO USE "LOTTO", APART FROM THE MARK AS SHOWN.

FOR LICENSING OF LOTTERY GAMES TO THE LOTTERY INDUSTRY (U.S. CLS. 100, 101 AND 102).

FIRST USE 11-30-2005; IN COMMERCE 2-28-2008.

CHAIN LINK

THE MARK CONSISTS OF STANDARD CHARACTERS WITHOUT CLAIM TO ANY PARTICULAR FONT, STYLE, SIZE, OR COLOR.

FOR NEGOTIATING OF COMMERCIAL TRANSACTIONS FOR THE ACQUISITION OF COMMERCIAL FOOD SERVICE EQUIPMENT ON BEHALF OF THIRD PARTIES; PROVIDING TECHNICAL ASSISTANCE IN THE ESTABLISHMENT AND/OR OPERATION OF COMMERCIAL CHAIN FOOD SERVICE OPERATIONS (U.S. CLS. 100, 101 AND 102).

FIRST USE 10-0-2006; IN COMMERCE 10-0-2006.

CLASS 35—(Continued).

3,681,564. XMA, L.L.C., MIDWEST CITY, OK. SN 78-795,307.
PUB. 4-10-2007, FILED 1-19-2006.

XMA

THE MARK CONSISTS OF STANDARD CHARACTERS WITHOUT CLAIM TO ANY PARTICULAR FONT, STYLE, SIZE, OR COLOR.

OWNER OF U.S. REG. NOS. 3,151,235 AND 3,199,165.
FOR ONLINE RETAIL STORE SERVICES AND RETAIL STORE SERVICES FEATURING SPORTS APPAREL, FITNESS EQUIPMENT, SPORTING GOODS, WEIGHTS, MATS, WORKOUT EQUIPMENT, JEWELRY, GIFTS, AND NOVELTY ITEMS (U.S. CLS. 100, 101 AND 102).

FIRST USE 7-1-2003; IN COMMERCE 7-1-2003.

3,681,602. THATSMYTRUCK.COM, L.L.C., ANKENY, IA. SN 78-900,406. PUB. 5-8-2007, FILED 6-5-2006.



THE COLOR(S) RED, BLACK, WHITE AND GRAY IS/ARE CLAIMED AS A FEATURE OF THE MARK.

THE MARK CONSISTS OF STYLIZED WORDING "THATSMYTRUCK" IN THE COLOR RED WITH WHITE SHADING IN THE MIDDLE OF THE LETTERS OF THE WORDING; THE TRUCK DESIGN IS IN THE COLORS GRAY AND BLACK AND ".COM" PORTION THAT APPEARS IN FRONT OF THE TRUCK IS IN THE COLOR BLACK; A THIN BLACK AND WHITE CHECKERED FLAG BEGINS FROM LEFT TO RIGHT UNDER THE LETTER "T" AND WAVES THROUGH THE MIDDLE PORTION OF THE RED WORDING IN THE MARK AND ENDS AT THE REAR OF THE TRUCK DESIGN; FIVE GRAY LINES PROJECTING SPEED COME OFF OF THE TRUCK DESIGN AND GRAY SHADOWS APPEAR AS OUTLINING FOR THE WORDING "THATSMYTRUCK".

FOR ON-LINE RETAIL OUTLET FEATURING PRODUCTS FOR OPERATORS AND OWNERS OF TRUCKS AND AUTOS FOR INDIVIDUAL, COMMERCIAL, FLEET AND GOVERNMENTAL APPLICATIONS, NAMELY, TRUCK ACCESSORIES, TRUCK AND AUTO PARTS, PICK UP BOX COVERS, CARGO STRAPS AND CARGO BARS, PICKUP BED LINERS, PICKUP REPLACEMENT BED CAPS, PICKUP BED RAILS, PICKUP TRUCK AND SUV ACCESSORIES, AUTOMOTIVE ACCESSORIES, WINDOW TREATMENTS IN THE NATURE OF ADVERTISING PLACEMENTS AND LOGO WINDOW SCREENS, FRONT-END ENHANCEMENTS IN THE NATURE OF GRILL GUARDS OR REPLACEMENT GRILLS, TOWING ACCESSORIES, CLEANERS, POLISHES, APPLICATION TOOLS FOR AUTOMOTIVE DETAILING, TOOL BOXES AND WORK RACKS, FLOOR MATS, HOOD SHIELDS, AND BODY AND FRAME SUSPENSION LIFTS (U.S. CLS. 100, 101 AND 102).

FIRST USE 6-5-2006; IN COMMERCE 6-1-2009.

CLASS 36—INSURANCE AND FINANCIAL**CLASS 36—(Continued).**

3,680,084. APPLE BANK FOR SAVINGS, NEW YORK, NY. SN 76-649,039. PUB. 7-4-2006, FILED 10-24-2005.

APPLEBANKDIRECT

THE MARK CONSISTS OF STANDARD CHARACTERS WITHOUT CLAIM TO ANY PARTICULAR FONT, STYLE, SIZE, OR COLOR.

OWNER OF U.S. REG. NOS. 1,286,422, 2,795,846, AND OTHERS.

FOR BANKING SERVICES (U.S. CLS. 100, 101 AND 102).

FIRST USE 2-3-2009; IN COMMERCE 2-3-2009.

3,680,098. FIRST UTAH BANK, SALT LAKE CITY, UT. SN 76-671,491. PUB. 3-11-2008, FILED 1-18-2007.

FIRST PROLINE

THE MARK CONSISTS OF STANDARD CHARACTERS WITHOUT CLAIM TO ANY PARTICULAR FONT, STYLE, SIZE, OR COLOR.

FOR CHECKING ACCOUNT AND LOAN SERVICES FEATURING A LINE OF CREDIT TO BUSINESSES AND PROFESSIONALS (U.S. CLS. 100, 101 AND 102).

FIRST USE 7-30-2007; IN COMMERCE 7-30-2007.

3,680,124. WOMEN'S BASKETBALL COACHES ASSOCIATION, INC., LILBURN, GA. SN 76-688,071. PUB. 9-2-2008, FILED 3-26-2008.



THE COLOR(S) PINK, GRAY, BLACK AND WHITE IS/ARE CLAIMED AS A FEATURE OF THE MARK.

THE MARK CONSISTS OF THE LETTER "WBCA" IN A STYLIZED GRAY FONT ABOVE THE WORD "PINK" IN A STYLIZED PINK FONT, ADJACENT TO THE WORD "ZONE" IN A STYLIZED GRAY FONT BLACK WHEREIN THE WORDS "PINK ZONE" ARE OUTLINED IN WHITE AND BLACK.

FOR CHARITABLE FUND RAISING SERVICES (U.S. CLS. 100, 101 AND 102).

FIRST USE 6-1-2008; IN COMMERCE 8-1-2008.

CLASS 36—(Continued).

3,680,125. WOMEN'S BASKETBALL COACHES ASSOCIATION, INC., LILBURN, GA. SN 76-688,072. PUB. 9-2-2008, FILED 3-26-2008.

CLASS 36—(Continued).

3,680,232. JACKSON NATIONAL LIFE INSURANCE COMPANY, LANSING, MI. SN 77-146,606. PUB. 10-2-2007, FILED 4-2-2007.

PINK ZONE

THE MARK CONSISTS OF STANDARD CHARACTERS WITHOUT CLAIM TO ANY PARTICULAR FONT, STYLE, SIZE, OR COLOR.
FOR CHARITABLE FUND RAISING SERVICES (U.S. CLS. 100, 101 AND 102).
FIRST USE 6-1-2008; IN COMMERCE 8-1-2008.

JACKSON ACCUMULATOR UL

3,680,179. GE MONEY BANK, SALT LAKE CITY, UT. SN 77-067,569. PUB. 9-25-2007, FILED 12-19-2006.

THE MARK CONSISTS OF STANDARD CHARACTERS WITHOUT CLAIM TO ANY PARTICULAR FONT, STYLE, SIZE, OR COLOR.
OWNER OF U.S. REG. NOS. 1,489,625, 2,338,319, AND OTHERS.
NO CLAIM IS MADE TO THE EXCLUSIVE RIGHT TO USE "ACCUMULATOR UL", APART FROM THE MARK AS SHOWN.
FOR FINANCIAL SERVICES, NAMELY, UNDERWRITING UNIVERSAL LIFE INSURANCE (U.S. CLS. 100, 101 AND 102).
FIRST USE 7-30-2007; IN COMMERCE 7-30-2007.

FLASHSETTLE

THE MARK CONSISTS OF STANDARD CHARACTERS WITHOUT CLAIM TO ANY PARTICULAR FONT, STYLE, SIZE, OR COLOR.
FOR FINANCIAL MANAGEMENT, NAMELY, FINANCIAL LEDGER SETTLEMENT SERVICES (U.S. CLS. 100, 101 AND 102).
FIRST USE 11-0-2007; IN COMMERCE 11-0-2007.

3,680,238. PATH PARTNERS, LOS ANGELES, CA. SN 77-150,123. PUB. 10-9-2007, FILED 4-5-2007.

3,680,231. JACKSON NATIONAL LIFE INSURANCE COMPANY, LANSING, MI. SN 77-146,598. PUB. 10-2-2007, FILED 4-2-2007.

JACKSON ASSURE WHOLE LIFE

PATH PARTNERS

THE MARK CONSISTS OF STANDARD CHARACTERS WITHOUT CLAIM TO ANY PARTICULAR FONT, STYLE, SIZE, OR COLOR.
OWNER OF U.S. REG. NOS. 1,489,625, 2,338,319, AND OTHERS.
NO CLAIM IS MADE TO THE EXCLUSIVE RIGHT TO USE "ASSURE WHOLE LIFE", APART FROM THE MARK AS SHOWN.
FOR FINANCIAL SERVICES, NAMELY, UNDERWRITING SIMPLIFIED ISSUE WHOLE LIFE INSURANCE (U.S. CLS. 100, 101 AND 102).
FIRST USE 6-4-2007; IN COMMERCE 6-4-2007.

THE MARK CONSISTS OF STANDARD CHARACTERS WITHOUT CLAIM TO ANY PARTICULAR FONT, STYLE, SIZE, OR COLOR.
FOR CHARITABLE FUNDRAISING SERVICES (U.S. CLS. 100, 101 AND 102).
FIRST USE 11-0-2007; IN COMMERCE 11-0-2007.

CLASS 36—(Continued).

3,680,241. STEMMONS FOUNDATION, LOS COLINAS, TX.
SN 77-151,029. PUB. 4-1-2008, FILED 4-6-2007.



THE MARK CONSISTS OF A CARTOON-LIKE HOUSE HAVING A CHIMNEY, TWO WINDOWS AND AN OPEN DOOR. THERE IS A YARD EXTENDING IN FRONT OF THE HOUSE WITH A SIDEWALK LEADING UP TO THE DOOR. THERE IS A DOG ON THE LEFT SIDE OF THE SIDEWALK AND A CAT ON THE RIGHT SIDE OF THE SIDEWALK NEAR THE CORNER OF THE HOUSE. THE WORDS "CORKY'S COTTAGE" ARE PRESENTED IN A STYLIZED FONT BELOW THE PICTURE.

FOR CHARITABLE FOUNDATION SERVICES, NAMELY, CHARITABLE FUNDRAISING TO SUPPORT FACILITIES THAT RESCUE AND PROVIDE HOUSING FOR DOGS, CATS AND OTHER DOMESTICATED HOUSE PETS AND WHICH ARE NOT INVOLVED WITH PET EUTHANASIA (U.S. CLS. 100, 101 AND 102).

FIRST USE 12-0-2008; IN COMMERCE 12-0-2008.

3,680,253. KELLER WILLIAMS REALTY, INC., AUSTIN, TX.
SN 77-157,903. PUB. 10-16-2007, FILED 4-16-2007.

**KELLER WILLIAMS LUXURY
HOMES**

THE MARK CONSISTS OF STANDARD CHARACTERS WITHOUT CLAIM TO ANY PARTICULAR FONT, STYLE, SIZE, OR COLOR.

NO CLAIM IS MADE TO THE EXCLUSIVE RIGHT TO USE "LUXURY HOMES", APART FROM THE MARK AS SHOWN.

FOR REAL ESTATE BROKERAGE SERVICES (U.S. CLS. 100, 101 AND 102).

FIRST USE 4-16-2007; IN COMMERCE 4-16-2007.

CLASS 36—(Continued).

3,680,264. IRON POINT PARTNERS, LLC, WASHINGTON, D.C., DC. SN 77-163,045. PUB. 10-23-2007, FILED 4-23-2007.

IRON POINT PARTNERS

THE MARK CONSISTS OF STANDARD CHARACTERS WITHOUT CLAIM TO ANY PARTICULAR FONT, STYLE, SIZE, OR COLOR.

NO CLAIM IS MADE TO THE EXCLUSIVE RIGHT TO USE "PARTNERS", APART FROM THE MARK AS SHOWN. FOR INVESTMENT MANAGEMENT AND INVESTMENT FUND SERVICES (U.S. CLS. 100, 101 AND 102).

FIRST USE 5-11-2009; IN COMMERCE 5-11-2009.

3,680,265. IRON POINT PARTNERS, LLC, WASHINGTON, DC. SN 77-163,051. PUB. 10-23-2007, FILED 4-23-2007.

**IRON POINT REAL ESTATE
PARTNERS**

THE MARK CONSISTS OF STANDARD CHARACTERS WITHOUT CLAIM TO ANY PARTICULAR FONT, STYLE, SIZE, OR COLOR.

NO CLAIM IS MADE TO THE EXCLUSIVE RIGHT TO USE "REAL ESTATE PARTNERS", APART FROM THE MARK AS SHOWN.

FOR REAL ESTATE INVESTMENT FUND SERVICES (U.S. CLS. 100, 101 AND 102).

FIRST USE 5-11-2009; IN COMMERCE 5-11-2009.

CLASS 36—(Continued).

3,680,325. PATH PARTNERS, LOS ANGELES, CA. SN 77-188,273. PUB. 10-16-2007, FILED 5-23-2007.



THE MARK CONSISTS OF THE WORDS "PATH PARTNERS", WITH THE WORD "PATH" WRITTEN IN BLOCK LETTERS ABOVE THE WORD "PARTNERS", AND THE LETTER "A" IN THE WORD "PARTNERS" IS WRITTEN IN THE DESIGN OF A HOUSE.
FOR CHARITABLE FUNDRAISING SERVICES (U.S. CLS. 100, 101 AND 102).
FIRST USE 11-0-2007; IN COMMERCE 11-0-2007.

3,680,414. COMPASS BANCSHARES, INC., BIRMINGHAM, AL. SN 77-279,733. PUB. 3-11-2008, FILED 9-14-2007.

**COMPASS BUSINESSCLASS
PREFERRED**

THE MARK CONSISTS OF STANDARD CHARACTERS WITHOUT CLAIM TO ANY PARTICULAR FONT, STYLE, SIZE, OR COLOR.
OWNER OF U.S. REG. NOS. 1,604,027, 3,086,445, AND OTHERS.
NO CLAIM IS MADE TO THE EXCLUSIVE RIGHT TO USE "PREFERRED", APART FROM THE MARK AS SHOWN.
FOR BANKING SERVICES (U.S. CLS. 100, 101 AND 102).
FIRST USE 3-0-2008; IN COMMERCE 3-0-2008.

CLASS 36—(Continued).

3,680,472. SUNTRUST BANKS, INC., ORLANDO, FL. SN 77-308,689. PUB. 11-18-2008, FILED 10-19-2007.

Official Bank of Music

THE MARK CONSISTS OF STANDARD CHARACTERS WITHOUT CLAIM TO ANY PARTICULAR FONT, STYLE, SIZE, OR COLOR.
NO CLAIM IS MADE TO THE EXCLUSIVE RIGHT TO USE "BANK OF MUSIC", APART FROM THE MARK AS SHOWN.
FOR BANKING SERVICES (U.S. CLS. 100, 101 AND 102).
FIRST USE 5-29-2009; IN COMMERCE 5-29-2009.

3,680,473. SUNTRUST BANKS, INC., ORLANDO, FL. SN 77-308,696. PUB. 11-18-2008, FILED 10-19-2007.



NO CLAIM IS MADE TO THE EXCLUSIVE RIGHT TO USE "BANK OF MUSIC", APART FROM THE MARK AS SHOWN.
THE MARK CONSISTS OF THE STYLIZED WORDS "OFFICIAL BANK OF MUSIC" WITH A MUSIC NOTE REPRESENTING THE "I" IN "MUSIC".
FOR BANKING SERVICES (U.S. CLS. 100, 101 AND 102).
FIRST USE 1-9-2009; IN COMMERCE 1-9-2009.

3,680,557. BARCLAYS CAPITAL INC., NEW YORK, NY. SN 77-334,480. PUB. 4-29-2008, FILED 11-20-2007.

ROQS

THE MARK CONSISTS OF STANDARD CHARACTERS WITHOUT CLAIM TO ANY PARTICULAR FONT, STYLE, SIZE, OR COLOR.
FOR INVESTMENT RESEARCH SERVICES (U.S. CLS. 100, 101 AND 102).
FIRST USE 3-3-2008; IN COMMERCE 3-3-2008.

CLASS 36—(Continued).

3,680,561. INDUSTRIAL BANK OF KOREA, CHUNG-GU, SEOUL, REPUBLIC OF KOREA. SN 77-334,897. PUB. 9-16-2008, FILED 11-21-2007.



Industrial Bank of Korea

NO CLAIM IS MADE TO THE EXCLUSIVE RIGHT TO USE "INDUSTRIAL BANK OF KOREA", APART FROM THE MARK AS SHOWN.

THE MARK CONSISTS OF THE WORDING "INDUSTRIAL BANK OF KOREA" AND A DESIGN OF THE LETTERING "IBK."

FOR DEVELOPMENTAL FINANCING SERVICES; INTERNATIONAL FINANCING; MILITARY FINANCING; SAFETY DEPOSIT BOX SERVICES, NAMELY, DEPOSITS OF VALUABLES; FINANCIAL INVESTMENT AGENCY, NAMELY, FINANCIAL INVESTMENT IN THE FIELD OF REAL ESTATE, SECURITIES, HOME-EQUITY LOANS, INSTALLMENT LOANS, STUDENT LOANS; SECURITY SERVICES, NAMELY, GUARANTEEING LOANS, LOAN ASSOCIATION SERVICES IN THE NATURE OF A LOAN WITHDRAWING AGENCY; DEBIT-CARD SERVICES, NAMELY, ISSUING OF DEBIT CARDS; LEASE PURCHASE FINANCING; FINANCIAL SERVICES IN THE FIELD OF MONEY LENDING, NAMELY, LENDING AGAINST SECURITY; FINANCIAL GUARANTEE AND SURETY; COMMERCIAL FINANCING SERVICES; MUTUAL FUND BROKERAGE, MUTUAL FUND DISTRIBUTION, MUTUAL FUND INVESTMENT, ESTABLISHING MUTUAL FUNDS FOR OTHERS; CHECK VERIFICATION; FINANCING FOR NEW TECHNOLOGICAL BUSINESS; LOAN SERVICES IN THE FIELD OF COMMERCIAL AND CONSUMER CREDIT LOANS; ISSUING OF CREDIT CARDS; TRUST BUSINESS, NAMELY, ESTATE TRUST MANAGEMENT AND FINANCIAL TRUST OPERATIONS; FINANCIAL CLEARING HOUSE; ISSUING OF TRAVELER'S CHECKS; ARRANGING OF LOANS; BANKING; RENT COLLECTION; LEASE-PURCHASE FINANCING; FUNDS INVESTMENT; MORTGAGE BANKING; SAVINGS BANK; PAWNBROKERAGE; ELECTRONIC FUNDS TRANSFER; STOCKS AND BONDS BROKERAGE; SECURITY BROKERAGE; BONDING SERVICES, NAMELY, BOND PURCHASE AND BOND WITHDRAWING AGENCY; ISSUING OF BANK CHECKS AND CREDIT CARDS; FINANCIAL ADMINISTRATION OF RETIREMENT PLAN, NAMELY, RETIREMENT PAYMENT SERVICES; INVESTMENT FINANCING SERVICES; FACTORING AGENCIES; INSTALLMENT LOANS; FINANCING SERVICES, NAMELY, FINANCING OF INSTALLMENT LOANS; MONETARY EXCHANGE; HOME BANKING; HEALTH INSURANCE UNDERWRITING; SURETY SERVICES, NAMELY, JEWEL SURETY; APPRAISALS FOR INSURANCE CLAIMS OF PERSONAL PROPERTY AND REAL ESTATE; INSURANCE AGENCIES; INSURANCE CONSULTATION; PROVIDING INFORMATION IN INSURANCE MATTERS, NAMELY, INSURANCE STATISTICS AND INSURANCE ASSESSMENT; INSURANCE BROKERAGE SOCIAL SECURITY INSURANCE UNDERWRITING; INDUSTRIAL DISASTER INSURANCE UNDERWRITING; ACCIDENT INSURANCE UNDERWRITING; MUTUAL INSURANCE BROKERAGE; PENSION INSURANCE UNDERWRITING; SPORTS INSURANCE UNDERWRITING; MEDICAL-CARE INSURANCE UNDERWRITING; CAR INSURANCE UNDERWRITING; AVIATION INSURANCE UNDERWRITING; MARINE INSURANCE UNDERWRITING; SURETY INSURANCE UNDERWRITING; FIRE INSURANCE UNDERWRITING; LIABILITY INSURANCE UNDERWRITING; PURCHASERS' CREDIT INSURANCE UNDERWRITING; BURGLARY INSURANCE UNDERWRITING; LIFE INSURANCE BROKERAGE AND UNDERWRITING; REINSURANCE UNDERWRITING; FINANCIAL

CLASS 36—(Continued).

RESEARCH; STOCK EXCHANGE PRICE QUOTATIONS; STOCK EXCHANGE EVALUATION; STOCK INVESTMENT CONSULTANCY; FINANCIAL EVALUATION OF INSURANCE PURPOSES AND REAL ESTATE; FINANCIAL MANAGEMENT; FINANCIAL ANALYSIS, FINANCIAL CONSULTANCY; FINANCIAL INFORMATION AND EVALUATIONS; BUSINESS LIQUIDATION SERVICES; LEASING OF BUILDINGS; REAL ESTATE AGENCIES; BUILDING MANAGEMENT, NAMELY, DEPARTMENT STORE MANAGEMENT, SUPERMARKET MANAGEMENT, AND CONVENIENCE STORES MANAGEMENT; REAL ESTATE APPRAISAL; REAL ESTATE MANAGEMENT; LEASING OF REAL ESTATE; REAL ESTATE BROKERAGE; RENTAL OF OFFICE SPACE; APARTMENT HOUSE MANAGEMENT; RENTAL OF APARTMENTS; HOUSING AGENCY; LEASING OF FARMS; ANTIQUES APPRAISAL; ART APPRAISAL; JEWELRY APPRAISAL; OLD CURRENCY APPRAISAL, NAMELY, COIN APPRAISAL; POSTAGE STAMPS APPRAISAL; CHARITABLE FUND RAISING; CUSTOMS BROKERAGE (U.S. CLS. 100, 101 AND 102).

FIRST USE 1-14-2007; IN COMMERCE 1-14-2007.

3,680,590. AMERICAN NATIONAL PROPERTY & CASUALTY INSURANCE COMPANY, SPRINGFIELD, MO. SN 77-340,843. PUB. 4-29-2008, FILED 11-30-2007.

WE TAKE A PERSONAL
INTEREST - PROTECTING WHAT
YOU VALUE MOST

THE MARK CONSISTS OF STANDARD CHARACTERS WITHOUT CLAIM TO ANY PARTICULAR FONT, STYLE, SIZE, OR COLOR.

FOR INSURANCE UNDERWRITING SERVICES FOR ALL TYPES OF INSURANCE; FINANCIAL AND INVESTMENT SERVICES, NAMELY, MANAGEMENT AND BROKERAGE IN THE FIELDS OF STOCKS, BONDS, OPTIONS, COMMODITIES, FUTURES AND OTHER SECURITIES, AND THE INVESTMENT OF FUNDS OF OTHERS (U.S. CLS. 100, 101 AND 102).

FIRST USE 2-0-2009; IN COMMERCE 2-0-2009.

3,680,601. THE FIRST NATIONAL BANK OF JEFFERSONVILLE, JEFFERSONVILLE, NY. SN 77-344,693. PUB. 10-21-2008, FILED 12-5-2007.

JEFF BANK

THE MARK CONSISTS OF STANDARD CHARACTERS WITHOUT CLAIM TO ANY PARTICULAR FONT, STYLE, SIZE, OR COLOR.

NO CLAIM IS MADE TO THE EXCLUSIVE RIGHT TO USE "BANK", APART FROM THE MARK AS SHOWN.

THE NAME(S), PORTRAIT(S), AND/OR SIGNATURE(S) SHOWN IN THE MARK DOES NOT IDENTIFY A PARTICULAR LIVING INDIVIDUAL.

FOR BANKING SERVICES (U.S. CLS. 100, 101 AND 102).

FIRST USE 8-13-1996; IN COMMERCE 8-13-1996.

CLASS 36—(Continued).

3,680,620. IMPOSSIBLE POSSIBILITIES, FORT WORTH, TX. SN 77-348,361. PUB. 5-6-2008, FILED 12-10-2007.

CLASS 36—(Continued).

3,680,641. SCOTTSDALE INSURANCE COMPANY, SCOTTSDALE, AZ. SN 77-355,363. PUB. 5-6-2008, FILED 12-19-2007.

BE AN ELEMENT OF CHANGE



THE MARK CONSISTS OF STANDARD CHARACTERS WITHOUT CLAIM TO ANY PARTICULAR FONT, STYLE, SIZE, OR COLOR.
FOR CHARITABLE FUND RAISING (U.S. CLS. 100, 101 AND 102).
FIRST USE 6-20-2008; IN COMMERCE 6-20-2008.

THE MARK CONSISTS OF SHADED OVAL CONTAINING FOUR LINES AT A DOWNWARD LEFT DIAGONAL AND FOUR LINES AT A DOWNWARD RIGHT DIAGONAL, INTERSECTING AT THE BOTTOM OF THE OVAL.
FOR INSURANCE SERVICES, NAMELY, UNDERWRITING DIRECTORS, OFFICERS, PROFESSIONAL LIABILITY AND SPECIALTY INSURANCE (U.S. CLS. 100, 101 AND 102).
FIRST USE 3-31-2008; IN COMMERCE 3-31-2008.

3,680,621. IMPOSSIBLE POSSIBILITIES, FORT WORTH, TX. SN 77-348,364. PUB. 5-6-2008, FILED 12-10-2007.

3,680,653. AENTRA, MIAMI, FL. SN 77-359,520. PUB. 9-23-2008, FILED 12-26-2007.

IMPOSSIBLE POSSIBILITIES

THE MARK CONSISTS OF STANDARD CHARACTERS WITHOUT CLAIM TO ANY PARTICULAR FONT, STYLE, SIZE, OR COLOR.
FOR CHARITABLE FUND RAISING (U.S. CLS. 100, 101 AND 102).
FIRST USE 6-20-2008; IN COMMERCE 6-20-2008.

aentra

3,680,632. SOCIETE DES PRODUITS NESTLE S.A., VEVEY, SWITZERLAND. SN 77-350,839. PUB. 4-29-2008, FILED 12-13-2007.

A LIFETIME OF HEALTH AND HAPPINESS

THE MARK CONSISTS OF STANDARD CHARACTERS WITHOUT CLAIM TO ANY PARTICULAR FONT, STYLE, SIZE, OR COLOR.
FOR CREDIT CARD AND DEBIT CARD SERVICES; FINANCIAL SERVICES, NAMELY, THE DISTRIBUTION, FULFILLMENT, SERVICING AND ELECTRONIC PROCESSING OF RETAIL PAYMENT TRANSACTIONS; CASH ACCEPTANCE TRANSACTION SERVICES FOR SUPPORTING THE FUNDING OF PREPAID CREDIT CARDS AND DEBIT CARDS; CHECKING ACCOUNT SERVICES, AND SAVINGS ACCOUNT SERVICES; CREDIT AND DEBIT CARD SERVICES, NAMELY, PROVIDING MAGNETICALLY ENCODED CREDIT OR DEBIT CARDS HAVING A PREDETERMINED VALUE LIMIT (U.S. CLS. 100, 101 AND 102).
FIRST USE 4-30-2008; IN COMMERCE 6-1-2008.

THE MARK CONSISTS OF STANDARD CHARACTERS WITHOUT CLAIM TO ANY PARTICULAR FONT, STYLE, SIZE, OR COLOR.
FOR INSURANCE UNDERWRITING IN THE FIELD OF HEALTH INSURANCE FOR ANIMALS AND PETS (U.S. CLS. 100, 101 AND 102).
FIRST USE 9-25-2008; IN COMMERCE 9-25-2008.

CLASS 36—(Continued).

3,680,664. BANK OF THE WEST, SAN FRANCISCO, CA. SN 77-366,289. PUB. 10-7-2008, FILED 1-8-2008.

BANK OF THE WEST INSURED
CASH RESERVES

THE MARK CONSISTS OF STANDARD CHARACTERS WITHOUT CLAIM TO ANY PARTICULAR FONT, STYLE, SIZE, OR COLOR.

OWNER OF U.S. REG. NOS. 1,233,009, 3,032,184, AND OTHERS.

NO CLAIM IS MADE TO THE EXCLUSIVE RIGHT TO USE "INSURED CASH RESERVES", APART FROM THE MARK AS SHOWN.

FOR FINANCIAL SERVICES, NAMELY, INVESTMENT BANKING SERVICES AND ASSET MANAGEMENT SERVICES (U.S. CLS. 100, 101 AND 102).
FIRST USE 3-1-2008; IN COMMERCE 3-1-2008.

3,680,687. LONE PINE CAPITAL LLC, GREENWICH, CT. SN 77-379,259. PUB. 6-10-2008, FILED 1-24-2008.

LONE HIMALAYAN PINE

THE MARK CONSISTS OF STANDARD CHARACTERS WITHOUT CLAIM TO ANY PARTICULAR FONT, STYLE, SIZE, OR COLOR.

OWNER OF U.S. REG. NO. 2,959,166.

FOR FINANCIAL SERVICES, NAMELY, INVESTMENT ADVISORY SERVICES, INVESTMENT MANAGEMENT SERVICES AND ASSET MANAGEMENT SERVICES (U.S. CLS. 100, 101 AND 102).
FIRST USE 2-0-2008; IN COMMERCE 2-0-2008.

CLASS 36—(Continued).

3,680,699. VICTOR M. KASATSHKO, TARPON SPRINGS, FL. SN 77-389,119. PUB. 6-17-2008, FILED 2-5-2008.



THE MARK CONSISTS OF A RIBBON COMPRISING THE LETTER "L".

FOR CHARITABLE FUNDRAISING SERVICES (U.S. CLS. 100, 101 AND 102).

FIRST USE 12-4-2008; IN COMMERCE 1-10-2009.

3,680,703. GAMCO INVESTORS, INC., RYE, NY. SN 77-390,489. PUB. 6-24-2008, FILED 2-6-2008.

HEALTHCARE AND WELLNESSRX
TRUST

THE MARK CONSISTS OF STANDARD CHARACTERS WITHOUT CLAIM TO ANY PARTICULAR FONT, STYLE, SIZE, OR COLOR.

NO CLAIM IS MADE TO THE EXCLUSIVE RIGHT TO USE "HEALTHCARE" AND "TRUST", APART FROM THE MARK AS SHOWN.

FOR INVESTMENT MANAGEMENT (U.S. CLS. 100, 101 AND 102).

FIRST USE 6-9-2009; IN COMMERCE 6-9-2009.

3,680,704. DEUTSCHE BANK AKTIENGESELLSCHAFT, FRANKFURT AM MAIN, FED REP GERMANY. SN 77-391,178. PUB. 6-24-2008, FILED 2-7-2008.

CLIENTSCOPE

THE MARK CONSISTS OF STANDARD CHARACTERS WITHOUT CLAIM TO ANY PARTICULAR FONT, STYLE, SIZE, OR COLOR.

FOR FINANCIAL SERVICES, NAMELY, PROVIDING ASSISTANCE TO FINANCIAL PROFESSIONALS IN THE MANAGEMENT OF RETIREMENT PLANS OR ACCOUNTS (U.S. CLS. 100, 101 AND 102).

FIRST USE 3-24-2008; IN COMMERCE 3-24-2008.

CLASS 36—(Continued).

3,680,736. GENERAL CABLE TECHNOLOGIES CORPORATION, HIGHLAND HEIGHTS, KY. SN 77-403,771. PUB. 2-17-2009, FILED 2-22-2008.

GENASSURANCE

THE MARK CONSISTS OF STANDARD CHARACTERS WITHOUT CLAIM TO ANY PARTICULAR FONT, STYLE, SIZE, OR COLOR.

FOR WARRANTY PROGRAM, NAMELY, PROVIDING EXTENDED WARRANTIES ON WIRE AND CABLE (U.S. CLS. 100, 101 AND 102).

FIRST USE 6-0-2008; IN COMMERCE 6-0-2008.

3,680,755. PROPERTY REFINEMENT, DRIFTWOOD, TX. SN 77-412,902. PUB. 7-22-2008, FILED 3-4-2008.

CHANGING THE FACE OF REAL ESTATE

THE MARK CONSISTS OF STANDARD CHARACTERS WITHOUT CLAIM TO ANY PARTICULAR FONT, STYLE, SIZE, OR COLOR.

FOR REAL ESTATE INVESTMENT (U.S. CLS. 100, 101 AND 102).

FIRST USE 1-16-2004; IN COMMERCE 1-16-2004.

3,680,766. ASSET-MAP, INC., RADNOR, PA. SN 77-419,006. PUB. 2-17-2009, FILED 3-11-2008.

ASSET-MAP

THE MARK CONSISTS OF STANDARD CHARACTERS WITHOUT CLAIM TO ANY PARTICULAR FONT, STYLE, SIZE, OR COLOR.

FOR FINANCIAL PLANNING (U.S. CLS. 100, 101 AND 102).

FIRST USE 4-30-2002; IN COMMERCE 4-30-2002.

CLASS 36—(Continued).

3,680,771. JUST PRICE INDUSTRIES, PASADENA, CA. SN 77-422,862. PUB. 1-6-2009, FILED 3-14-2008.

Just Price BestFIT

NO CLAIM IS MADE TO THE EXCLUSIVE RIGHT TO USE "JUST PRICE", APART FROM THE MARK AS SHOWN.

FOR TECHNOLOGY BASED FINANCIAL SOLUTIONS TO SERVE THE NEEDS OF LOW AND MODERATE INCOME CONSUMERS, NAMELY, PROVIDING ONLINE FINANCIAL INFORMATION AND ONLINE MORTGAGE LENDING SERVICES (U.S. CLS. 100, 101 AND 102).

FIRST USE 11-29-2007; IN COMMERCE 11-29-2007.

3,680,780. SAMENA CAPITAL, UGLAND HOUSE, CAYMAN ISLANDS. SN 77-431,678. PUB. 9-23-2008, FILED 3-26-2008.

SAMENA

THE MARK CONSISTS OF STANDARD CHARACTERS WITHOUT CLAIM TO ANY PARTICULAR FONT, STYLE, SIZE, OR COLOR.

FOR FINANCIAL SERVICES, NAMELY, INVESTMENT MANAGEMENT SERVICES; INVESTMENT ADVISORY SERVICES; HEDGE FUND INVESTMENT SERVICES (U.S. CLS. 100, 101 AND 102).

FIRST USE 3-0-2008; IN COMMERCE 3-0-2008.

3,680,784. ENVESTNET ASSET MANAGEMENT, INC., CHICAGO, IL. SN 77-434,714. PUB. 3-17-2009, FILED 3-28-2008.

SUSTAINABILITY PLATFORM

THE MARK CONSISTS OF STANDARD CHARACTERS WITHOUT CLAIM TO ANY PARTICULAR FONT, STYLE, SIZE, OR COLOR.

NO CLAIM IS MADE TO THE EXCLUSIVE RIGHT TO USE "SUSTAINABILITY", APART FROM THE MARK AS SHOWN.

FOR INVESTMENT MANAGEMENT AND INVESTING CONSULTING SERVICES (U.S. CLS. 100, 101 AND 102).

FIRST USE 3-3-2008; IN COMMERCE 3-3-2008.

CLASS 36—(Continued).

3,680,786. BANK OF THE WEST, SAN FRANCISCO, CA. SN 77-434,765. PUB. 9-30-2008, FILED 3-28-2008.

BEST OF THE WEST CHECKING

THE MARK CONSISTS OF STANDARD CHARACTERS WITHOUT CLAIM TO ANY PARTICULAR FONT, STYLE, SIZE, OR COLOR.

NO CLAIM IS MADE TO THE EXCLUSIVE RIGHT TO USE "CHECKING", APART FROM THE MARK AS SHOWN. FOR FINANCIAL SERVICES, NAMELY, BANKING AND CHECKING SERVICES (U.S. CLS. 100, 101 AND 102).

FIRST USE 4-28-2008; IN COMMERCE 4-28-2008.

3,680,789. SAMENA CAPITAL, CAYMAN ISLANDS, CAYMAN ISLANDS. SN 77-435,519. PUB. 9-30-2008, FILED 3-31-2008.

SAMENA CAPITAL

THE MARK CONSISTS OF STANDARD CHARACTERS WITHOUT CLAIM TO ANY PARTICULAR FONT, STYLE, SIZE, OR COLOR.

NO CLAIM IS MADE TO THE EXCLUSIVE RIGHT TO USE "CAPITAL", APART FROM THE MARK AS SHOWN.

FOR FINANCIAL SERVICES, NAMELY, INVESTMENT MANAGEMENT SERVICES; INVESTMENT ADVISORY SERVICES AND HEDGE FUND INVESTMENT SERVICES (U.S. CLS. 100, 101 AND 102).

FIRST USE 3-0-2008; IN COMMERCE 3-0-2008.

3,680,797. HARRIS NATIONAL ASSOCIATION, DBA HARRIS TRUST AND SAVINGS BANK, CHICAGO, IL. SN 77-437,652. PUB. 3-10-2009, FILED 4-2-2008.

HARRIS EVERYDAY BENEFITS

THE MARK CONSISTS OF STANDARD CHARACTERS WITHOUT CLAIM TO ANY PARTICULAR FONT, STYLE, SIZE, OR COLOR.

OWNER OF U.S. REG. NOS. 1,008,229, 3,215,200, AND OTHERS.

NO CLAIM IS MADE TO THE EXCLUSIVE RIGHT TO USE "BENEFITS", APART FROM THE MARK AS SHOWN.

THE NAME SHOWN IN THE MARK DOES NOT IDENTIFY A PARTICULAR LIVING INDIVIDUAL.

FOR DEBIT CARD SERVICES (U.S. CLS. 100, 101 AND 102).

FIRST USE 7-31-2008; IN COMMERCE 7-31-2008.

CLASS 36—(Continued).

3,680,803. EDWARD D. JONES & CO., LP, ST. LOUIS, MO. SN 77-439,194. PUB. 2-10-2009, FILED 4-3-2008.

EDWARD JONES ADVISORY SOLUTIONS

THE MARK CONSISTS OF STANDARD CHARACTERS WITHOUT CLAIM TO ANY PARTICULAR FONT, STYLE, SIZE, OR COLOR.

OWNER OF U.S. REG. NOS. 1,944,000, 2,707,277, AND 2,743,882.

NO CLAIM IS MADE TO THE EXCLUSIVE RIGHT TO USE "ADVISORY SOLUTIONS", APART FROM THE MARK AS SHOWN.

THE NAME SHOWN IN THE MARK DOES NOT IDENTIFY A PARTICULAR LIVING INDIVIDUAL.

FOR SECURITIES BROKERAGE; FINANCIAL PLANNING AND INVESTMENT ADVISORY SERVICES (U.S. CLS. 100, 101 AND 102).

FIRST USE 5-15-2009; IN COMMERCE 5-15-2009.

3,680,845. ASSET-MAP, INC., RADNOR, PA. SN 77-456,745. PUB. 2-17-2009, FILED 4-24-2008.



THE MARK CONSISTS OF A REPRESENTATION OF A HUMAN FIGURE HOLDING UP AN EGG.

FOR FINANCIAL PLANNING (U.S. CLS. 100, 101 AND 102).

FIRST USE 4-17-2008; IN COMMERCE 4-17-2008.

3,680,846. THE TYLER UGOLYN FOUNDATION, RIDGEFIELD, CT. SN 77-456,810. PUB. 12-23-2008, FILED 4-24-2008.

I JUST LOVE PLAYING THE GAME

CLASS 36—(Continued).

THE MARK CONSISTS OF STANDARD CHARACTERS WITHOUT CLAIM TO ANY PARTICULAR FONT, STYLE, SIZE, OR COLOR.

FOR CHARITABLE FOUNDATION WHICH PROVIDES SUPPORT TO YOUTH BASKETBALL BY RE-FURBISHING BASKETBALL COURTS AND PROVIDING FINANCIAL SUPPORT FOR BASKETBALL CLINICS AND BASKETBALL EDUCATIONAL PROGRAMS (U.S. CLS. 100, 101 AND 102).

FIRST USE 4-10-2009; IN COMMERCE 4-10-2009.



3,680,874. KENNETH E. LAROE, EUSTIS, FL. SN 77-461,998.
PUB. 12-9-2008, FILED 4-30-2008.



THE MARK CONSISTS OF THREE LEAF-LIKE DESIGNS ARRANGED IN A CIRCULAR PATTERN.

FOR FINANCIAL SERVICES, NAMELY, BANKING SERVICES; BANKING SERVICES, NAMELY, PROVISION OF CERTIFICATE OF DEPOSIT ACCOUNTS, CHECKING ACCOUNTS, SAVINGS ACCOUNTS, MONEY MARKET ACCOUNTS, COMMERCIAL LOANS AND CONSUMER LOANS, CREDIT CARD SERVICES AND ELECTRONIC CREDIT CARD TRANSACTIONS; FINANCIAL SERVICES, NAMELY, COMMERCIAL AND CONSUMER FINANCING; REAL ESTATE AND MORTGAGE BROKERAGE; FIDUCIARY SERVICES, NAMELY, FIDUCIARY REPRESENTATIVE SERVICES; FINANCIAL INVESTMENT SERVICES IN THE FIELD OF SECURITIES AND MUTUAL FUND INVESTMENT; BROKERAGE SERVICES IN THE FIELD OF SECURITIES, INVESTMENT FUNDS, COMMODITIES, FUTURE MARKETS, AND FOREIGN EXCHANGE; ON-LINE BROKERAGE SERVICES IN THE FIELD OF SECURITIES, INVESTMENT FUNDS, COMMODITIES, FUTURES MARKETS, AND FOREIGN EXCHANGE; TRADING SERVICES, NAMELY, COMMODITY AND SECURITIES TRADING AND INVESTMENT SERVICES FOR OTHERS, AND ON-LINE COMMODITY AND SECURITIES BROKERAGE AND SECURITIES TRADING SERVICES FOR OTHERS; INVESTMENT ADVISORY AND CONSULTING SERVICES; SECURITIES BROKERAGE AND SECURITIES TRADING SERVICES

CLASS 36—(Continued).

FOR OTHERS; ELECTRONIC PAYMENT SERVICES, NAMELY, ELECTRONIC PROCESSING AND TRANSMISSION OF BILL PAYMENT DATA; FINANCIAL TRANSACTION SERVICES, NAMELY, PROVIDING SECURE FINANCIAL TRANSACTIONS FOR ELECTRONIC PROCESSING OF ELECTRONIC CASH TRANSACTIONS, ELECTRONIC CREDIT CARD TRANSACTIONS, ELECTRONIC DEBIT TRANSACTIONS, ELECTRONIC CHECK PROCESSING TRANSACTIONS AND ELECTRONIC TRANSMISSION OF BILL PAYMENT DATA VIA A GLOBAL COMPUTER NETWORK AND USING A MOBILE DEVICE AT POINT OF SALE; INSURANCE SERVICES, NAMELY, UNDERWRITING AND BROKERAGE OF PROPERTY, CASUALTY AND LIFE INSURANCE POLICIES AND ANNUITY CONTRACTS; INVESTMENT SERVICES, NAMELY, ASSET MANAGEMENT SERVICES; FINANCIAL EVALUATION FOR INSURANCE PURPOSES; FINANCIAL SERVICES, NAMELY, SAVINGS PROGRAMS FOR YOUTHS; INSURANCE AND FINANCIAL INFORMATION AND CONSULTANCY SERVICES (U.S. CLS. 100, 101 AND 102).

FIRST USE 2-17-2009; IN COMMERCE 2-17-2009.



3,680,877. KENNETH E. LAROE, EUSTIS, FL. SN 77-464,017.
PUB. 12-9-2008, FILED 5-2-2008.



THE COLOR(S) YELLOW, BLUE, AND GREEN IS/ARE CLAIMED AS A FEATURE OF THE MARK.

THE MARK CONSISTS OF THREE LEAF-LIKE DESIGNS ARRANGED IN A CIRCULAR PATTERN, ONE BEING YELLOW, ONE BLUE, AND ONE GREEN.

FOR FINANCIAL SERVICES, NAMELY, BANKING SERVICES; BANKING SERVICES, NAMELY, PROVISION OF CERTIFICATE OF DEPOSIT ACCOUNTS, CHECKING ACCOUNTS, SAVINGS ACCOUNTS, MONEY MARKET ACCOUNTS, COMMERCIAL LOANS AND CONSUMER LOANS, CREDIT CARD SERVICES AND ELECTRONIC CREDIT CARD TRANSACTIONS; FINANCIAL SERVICES, NAMELY, COMMERCIAL AND CONSUMER FINANCING; REAL ESTATE AND MORTGAGE BROKERAGE; FIDUCIARY SERVICES, NAMELY, FIDUCIARY REPRESENTATIVE SERVICES; FINANCIAL INVESTMENT SERVICES IN THE FIELD OF SECURITIES AND MUTUAL FUND INVESTMENT; BROKERAGE SERVICES IN THE FIELD OF SECURITIES, INVESTMENT FUNDS, COMMODITIES, FUTURE MARKETS, AND FOREIGN EXCHANGE; ON-LINE BROKERAGE SERVICES IN THE FIELD OF SECURITIES, INVESTMENT FUNDS, COMMODITIES, FUTURES MARKETS, AND FOREIGN EXCHANGE; TRADING SERVICES, NAMELY, COMMODITY AND SECURITIES TRADING AND INVESTMENT SERVICES FOR OTHERS, AND ON-LINE COMMODITY AND SECURITIES BROKERAGE AND SECURITIES TRADING SERVICES FOR OTHERS; INVESTMENT ADVISORY AND CONSULTING SERVICES; SECURITIES BROKERAGE AND SECURITIES TRADING SERVICES

CLASS 36—(Continued).

FOR OTHERS; ELECTRONIC PAYMENT SERVICES, NAMELY, ELECTRONIC PROCESSING AND TRANSMISSION OF BILL PAYMENT DATA; FINANCIAL TRANSACTION SERVICES, NAMELY, PROVIDING SECURE FINANCIAL TRANSACTIONS FOR ELECTRONIC PROCESSING OF ELECTRONIC CASH TRANSACTIONS, ELECTRONIC CREDIT CARD TRANSACTIONS, ELECTRONIC DEBIT TRANSACTIONS, ELECTRONIC CHECK PROCESSING TRANSACTIONS AND ELECTRONIC TRANSMISSION OF BILL PAYMENT DATA VIA A GLOBAL COMPUTER NETWORK AND USING A MOBILE DEVICE AT POINT OF SALE; INSURANCE SERVICES, NAMELY, UNDERWRITING AND BROKERAGE OF PROPERTY, CASUALTY AND LIFE INSURANCE POLICIES AND ANNUITY CONTRACTS; INVESTMENT SERVICES, NAMELY, ASSET MANAGEMENT SERVICES; FINANCIAL EVALUATION FOR INSURANCE PURPOSES; FINANCIAL SERVICES, NAMELY, SAVINGS PROGRAMS FOR YOUTHS; INSURANCE AND FINANCIAL INFORMATION AND CONSULTANCY SERVICES (U.S. CLS. 100, 101 AND 102).

FIRST USE 2-17-2009; IN COMMERCE 2-17-2009.

3,680,880. REVIEWMY401K.COM, LLC. BRADENTON, FL. SN 77-464,803. PUB. 10-7-2008, FILED 5-2-2008.

THE SMARTEST INVESTMENT
FOR YOUR INVESTMENT

THE MARK CONSISTS OF STANDARD CHARACTERS WITHOUT CLAIM TO ANY PARTICULAR FONT, STYLE, SIZE, OR COLOR.

FOR INVESTMENT ADVISORY SERVICES; PROVIDING INFORMATION AND ADVICE IN THE FIELD OF FINANCE, FINANCIAL INVESTMENTS, FINANCIAL VALUATIONS, AND THE FINANCIAL ASPECTS OF RETIREMENT; FINANCIAL INFORMATION PROVIDED BY ELECTRONIC MEANS (U.S. CLS. 100, 101 AND 102).

FIRST USE 7-15-2008; IN COMMERCE 8-8-2008.

3,680,890. PROCORP INSURANCE SOLUTIONS, SACRAMENTO, CA. SN 77-466,407. PUB. 10-7-2008, FILED 5-6-2008.

PROCORP

THE MARK CONSISTS OF STANDARD CHARACTERS WITHOUT CLAIM TO ANY PARTICULAR FONT, STYLE, SIZE, OR COLOR.

FOR INSURANCE AGENCIES; INSURANCE AGENCY AND BROKERAGE; FINANCIAL RISK MANAGEMENT (U.S. CLS. 100, 101 AND 102).

FIRST USE 0-0-2008; IN COMMERCE 0-0-2008.

CLASS 36—(Continued).

3,680,904. W.I.N.O.S., INC., BLOWING ROCK, NC. SN 77-468,387. PUB. 9-23-2008, FILED 5-7-2008.

MAKING A DIFFERENCE WITH
EVERY SIP

THE MARK CONSISTS OF STANDARD CHARACTERS WITHOUT CLAIM TO ANY PARTICULAR FONT, STYLE, SIZE, OR COLOR.

FOR CHARITABLE FUNDRAISING; PHILANTHROPIC SERVICES, NAMELY, CHARITABLE DONATION OF FUNDS (U.S. CLS. 100, 101 AND 102).

FIRST USE 7-0-2008; IN COMMERCE 7-0-2008.

3,680,940. WESTBOUND BANK, KATY, TX. SN 77-473,128. PUB. 10-21-2008, FILED 5-13-2008.

NELDA NEW EASY LIVE
DEPOSIT ATM

THE MARK CONSISTS OF STANDARD CHARACTERS WITHOUT CLAIM TO ANY PARTICULAR FONT, STYLE, SIZE, OR COLOR.

NO CLAIM IS MADE TO THE EXCLUSIVE RIGHT TO USE "NEW" OR "LIVE DEPOSIT ATM", APART FROM THE MARK AS SHOWN.

FOR BANKING AND FINANCING SERVICES, NAMELY, AUTOMATIC TELLER MACHINE SERVICES (U.S. CLS. 100, 101 AND 102).

FIRST USE 7-20-2008; IN COMMERCE 7-20-2008.

3,680,969. ST. LOUIS COMMUNITY CREDIT UNION, ST. LOUIS, MO. SN 77-476,606. PUB. 10-21-2008, FILED 5-16-2008.

C U EXCEL

THE MARK CONSISTS OF STANDARD CHARACTERS WITHOUT CLAIM TO ANY PARTICULAR FONT, STYLE, SIZE, OR COLOR.

FOR CREDIT UNION SERVICES (U.S. CLS. 100, 101 AND 102).

FIRST USE 7-14-2008; IN COMMERCE 7-14-2008.

CLASS 36—(Continued).

3,680,973. ENVIRONMENTAL DATA RESOURCES, INC., MILFORD, CT. SN 77-477,570. PUB. 10-21-2008, FILED 5-19-2008.

BRIKI

THE MARK CONSISTS OF STANDARD CHARACTERS WITHOUT CLAIM TO ANY PARTICULAR FONT, STYLE, SIZE, OR COLOR.

FOR PROVIDING INFORMATION IN THE FIELD OF REAL PROPERTY VIA INTERACTIVE ONLINE WEBSITES (U.S. CLS. 100, 101 AND 102).

FIRST USE 5-26-2009; IN COMMERCE 5-26-2009.

CLASS 36—(Continued).

3,681,005. COASTAL CAROLINA BANCSHARES, INC., MYRTLE BEACH, SC. SN 77-483,508. PUB. 1-27-2009, FILED 5-27-2008.



NO CLAIM IS MADE TO THE EXCLUSIVE RIGHT TO USE "COASTAL CAROLINA NATIONAL BANK", APART FROM THE MARK AS SHOWN.

THE MARK CONSISTS OF A PELICAN IN FLIGHT LOCATED BELOW A SEMI-CIRCLE AND ABOVE THE WORDING "COASTAL CAROLINA" IN A STYLIZED FONT. THE WORDING "NATIONAL BANK" APPEARS IN A STYLIZED FONT BELOW THE WORDING "COASTAL CAROLINA".

FOR BANKING AND FINANCING SERVICES; BANKING CONSULTATION; INVESTMENT BANKING SERVICES; ISSUANCE OF BANK CHECKS; MERCHANT BANKING AND INVESTMENT BANKING SERVICES; MORTGAGE BANKING; ON-LINE BANKING SERVICES; SAVINGS BANK SERVICES (U.S. CLS. 100, 101 AND 102).

FIRST USE 6-8-2009; IN COMMERCE 6-8-2009.

3,680,992. MICHAEL W. FENDLEY, LITTLE ROCK, AR. SN 77-481,316. PUB. 10-21-2008, FILED 5-22-2008.

WEALTH IS NOT IN YOUR
BANK-WEALTH IS THE
GENEROSITY IN YOUR HEART

3,681,006. PIONEER VALLEY FEDERAL CREDIT UNION, SPRINGFIELD, MA. SN 77-483,568. PUB. 10-28-2008, FILED 5-27-2008.

CU ON THE GO

THE MARK CONSISTS OF STANDARD CHARACTERS WITHOUT CLAIM TO ANY PARTICULAR FONT, STYLE, SIZE, OR COLOR.

FOR CHARITABLE FUND RAISING; CHARITABLE FUND RAISING SERVICES; CHARITABLE FUND RAISING SERVICES, NAMELY, BY PROVIDING INDIVIDUALS WITH THE INFORMATION AND OPPORTUNITY TO MAKE MONETARY DONATIONS TO THEIR FAVORITE CHARITY (U.S. CLS. 100, 101 AND 102).

FIRST USE 4-3-2009; IN COMMERCE 4-3-2009.

THE MARK CONSISTS OF STANDARD CHARACTERS WITHOUT CLAIM TO ANY PARTICULAR FONT, STYLE, SIZE, OR COLOR.

FOR BANKING SERVICES (U.S. CLS. 100, 101 AND 102).

FIRST USE 7-31-2008; IN COMMERCE 7-31-2008.

CLASS 36—(Continued).

3,681,010. GLOBAL CURRENTS INVESTMENT MANAGEMENT LLC, BALTIMORE, MD. SN 77-483,802. PUB. 11-25-2008, FILED 5-27-2008.



NO CLAIM IS MADE TO THE EXCLUSIVE RIGHT TO USE "INVESTMENT MANAGEMENT", APART FROM THE MARK AS SHOWN.

THE MARK CONSISTS OF INTERLOCKING LETTERS "G" AND "C", TOGETHER WITH THE WORDS "GLOBAL CURRENTS INVESTMENT MANAGEMENT".

FOR FINANCIAL ASSET MANAGEMENT SERVICES, NAMELY, INVESTMENT MANAGEMENT SERVICES FOR INDIVIDUALS AND INSTITUTIONAL INVESTORS (U.S. CLS. 100, 101 AND 102).

FIRST USE 5-1-2008; IN COMMERCE 5-1-2008.

3,681,035. PARAGON REAL ESTATE ADVISORS, INC., SEATTLE, WA. SN 77-491,131. PUB. 10-28-2008, FILED 6-4-2008.

TAKING THE TOTAL VIEW TO
UNDERSTAND THE TOTAL
OPPORTUNITY

THE MARK CONSISTS OF STANDARD CHARACTERS WITHOUT CLAIM TO ANY PARTICULAR FONT, STYLE, SIZE, OR COLOR.

FOR REAL ESTATE BROKERAGE (U.S. CLS. 100, 101 AND 102).

FIRST USE 3-1-2008; IN COMMERCE 10-17-2008.

CLASS 36—(Continued).

3,681,036. BEIJING COMPASS TECHNOLOGY DEVELOPMENT CO., LTD., CHAO YANG, BEIJING, CHINA. SN 77-491,292. PUB. 10-28-2008, FILED 6-4-2008.

Rainstock

FOR FINANCIAL AND INVESTMENT SERVICES, NAMELY, MANAGEMENT AND BROKERAGE IN THE FIELDS OF STOCKS, BONDS, OPTIONS, COMMODITIES, FUTURES AND OTHER SECURITIES, AND THE INVESTMENT OF FUNDS OF OTHERS; FINANCIAL CONSULTANCY; FINANCIAL INFORMATION AND EVALUATIONS; FINANCIAL PLANNING AND INVESTMENT ADVISORY SERVICES; INSURANCE SERVICES, NAMELY, WRITING PROPERTY AND CASUALTY INSURANCE; PAWN BROKERAGE; PAWN SHOPS; PROVIDING FINANCIAL INFORMATION; REAL ESTATE MANAGEMENT; STOCK EXCHANGE PRICE QUOTATIONS (U.S. CLS. 100, 101 AND 102).

FIRST USE 5-28-2006; IN COMMERCE 4-16-2009.

3,681,044. TOGETHER IN HOPE, HOUSTON, TX. SN 77-493,557. PUB. 11-11-2008, FILED 6-7-2008.

Together In Hope

THE MARK CONSISTS OF STANDARD CHARACTERS WITHOUT CLAIM TO ANY PARTICULAR FONT, STYLE, SIZE, OR COLOR.

FOR CHARITABLE FUND RAISING (U.S. CLS. 100, 101 AND 102).

FIRST USE 6-1-2009; IN COMMERCE 6-1-2009.

3,681,052. GEORGE, DAVID, HOUSTON, TX. SN 77-495,377. PUB. 11-4-2008, FILED 6-10-2008.

CallPopHear

THE MARK CONSISTS OF STANDARD CHARACTERS WITHOUT CLAIM TO ANY PARTICULAR FONT, STYLE, SIZE, OR COLOR.

FOR FINANCIAL SERVICES, NAMELY, FINANCIAL ADVICE AND CONSULTANCY SERVICES, DEBT MANAGEMENT CONSULTATION AND COUNSELING SERVICES (U.S. CLS. 100, 101 AND 102).

FIRST USE 6-0-2009; IN COMMERCE 6-0-2009.

CLASS 36—(Continued).

3,681,053. GEORGE, DAVID, HOUSTON, TX. SN 77-495,403.
PUB. 11-4-2008, FILED 6-10-2008.

CLASS 36—(Continued).

3,681,114. GEORGE, DAVID, HOUSTON, TX. SN 77-520,111.
PUB. 11-4-2008, FILED 7-11-2008.

BudgetScore

THE MARK CONSISTS OF STANDARD CHARACTERS WITHOUT CLAIM TO ANY PARTICULAR FONT, STYLE, SIZE, OR COLOR.

FOR FINANCIAL SERVICES, NAMELY, FINANCIAL ADVICE AND CONSULTANCY SERVICES, DEBT MANAGEMENT CONSULTATION AND COUNSELING SERVICES (U.S. CLS. 100, 101 AND 102).

FIRST USE 6-0-2009; IN COMMERCE 6-0-2009.

BudgetPoints

THE MARK CONSISTS OF STANDARD CHARACTERS WITHOUT CLAIM TO ANY PARTICULAR FONT, STYLE, SIZE, OR COLOR.

FOR FINANCIAL SERVICES, NAMELY, FINANCIAL ADVICE AND CONSULTANCY SERVICES, DEBT MANAGEMENT CONSULTATION AND COUNSELING SERVICES, CREDIT REPAIR AND RESTORATION (U.S. CLS. 100, 101 AND 102).

FIRST USE 6-0-2009; IN COMMERCE 6-0-2009.

3,681,061. CRE BOCA OPCO, LLC, NEW YORK, NY. SN 77-496,744. PUB. 3-31-2009, FILED 6-11-2008.

MOMENTIS

THE MARK CONSISTS OF STANDARD CHARACTERS WITHOUT CLAIM TO ANY PARTICULAR FONT, STYLE, SIZE, OR COLOR.

FOR REAL ESTATE SERVICES, NAMELY, LEASING AND MANAGING COMMERCIAL AND RESIDENTIAL PROPERTY; REAL ESTATE BROKERAGE FOR COMMERCIAL AND RESIDENTIAL PROPERTY (U.S. CLS. 100, 101 AND 102).

FIRST USE 11-18-2008; IN COMMERCE 11-18-2008.

3,681,117. BRITTON-GALLAGHER & ASSOCIATES, INC., CLEVELAND, OH. SN 77-521,096. PUB. 1-6-2009, FILED 7-14-2008.

NEW SCIENCE INSURANCE

3,681,112. AMERICAN AIRLINES FEDERAL CREDIT UNION, DFW AIRPORT, TX. SN 77-519,326. PUB. 12-2-2008, FILED 7-10-2008.

BENEFITS BEYOND BANKING BENEFITS YOU DESERVE

THE MARK CONSISTS OF STANDARD CHARACTERS WITHOUT CLAIM TO ANY PARTICULAR FONT, STYLE, SIZE, OR COLOR.

FOR CREDIT UNION SERVICES (U.S. CLS. 100, 101 AND 102).

FIRST USE 6-21-2008; IN COMMERCE 6-21-2008.

THE MARK CONSISTS OF STANDARD CHARACTERS WITHOUT CLAIM TO ANY PARTICULAR FONT, STYLE, SIZE, OR COLOR.

NO CLAIM IS MADE TO THE EXCLUSIVE RIGHT TO USE "INSURANCE", APART FROM THE MARK AS SHOWN.

FOR INSURANCE SERVICES, NAMELY, WRITING PROPERTY AND CASUALTY POLICIES AND GROUP HEALTH INSURANCE POLICIES (U.S. CLS. 100, 101 AND 102).

FIRST USE 9-0-2008; IN COMMERCE 9-0-2008.

CLASS 36—(Continued).

3,681,118. BRITTON-GALLAGHER & ASSOCIATES, INC., CLEVELAND, OH. SN 77-521,106. PUB. 1-6-2009, FILED 7-14-2008.

INSURING LIFE SCIENCES
 MEDICAL DEVICES IMPLANTS
 BIOMEDICAL PHARMACEUTICALS
 NANO TECHNOLOGY
 NUTRACEUTICALS AS SCIENCE
 LOOKS FORWARD

THE MARK CONSISTS OF STANDARD CHARACTERS WITHOUT CLAIM TO ANY PARTICULAR FONT, STYLE, SIZE, OR COLOR.

NO CLAIM IS MADE TO THE EXCLUSIVE RIGHT TO USE "INSURING LIFE SCIENCES MEDICAL DEVICES IMPLANTS BIOMEDICAL PHARMACEUTICALS NANO TECHNOLOGY NUTRACEUTICALS AND SCIENCE", APART FROM THE MARK AS SHOWN.

FOR INSURANCE SERVICES, NAMELY, WRITING PROPERTY AND CASUALTY POLICIES AND GROUP HEALTH INSURANCE POLICIES (U.S. CLS. 100, 101 AND 102).

FIRST USE 9-0-2008; IN COMMERCE 9-0-2008.

CLASS 36—(Continued).

3,681,132. BRITTON-GALLAGHER & ASSOCIATES, INC., CLEVELAND, OH. SN 77-523,190. PUB. 1-6-2009, FILED 7-16-2008.



THE MARK CONSISTS OF THE WORDS "NEW SCIENCE INSURANCE" AND THE DESIGN OF A HANDLED MAGNIFYING GLASS SURROUNDED BY CONCENTRIC BROKEN CIRCLES WHERE THE LETTER "N" OVERLIES PART OF THE CONCENTRIC BROKEN CIRCLES.

FOR INSURANCE SERVICES, NAMELY, WRITING PROPERTY AND CASUALTY POLICIES AND GROUP HEALTH INSURANCE POLICIES (U.S. CLS. 100, 101 AND 102).

FIRST USE 9-0-2008; IN COMMERCE 9-0-2008.

3,681,133. BRITTON-GALLAGHER & ASSOCIATES, INC., CLEVELAND, OH. SN 77-523,199. PUB. 1-6-2009, FILED 7-16-2008.



THE MARK CONSISTS OF THE DESIGN OF A HANDLED MAGNIFYING GLASS SURROUNDED BY CONCENTRIC BROKEN CIRCLES.

FOR INSURANCE SERVICES, NAMELY, WRITING PROPERTY AND CASUALTY POLICIES AND GROUP HEALTH INSURANCE POLICIES (U.S. CLS. 100, 101 AND 102).

FIRST USE 9-0-2008; IN COMMERCE 9-0-2008.

3,681,124. HARGRODER COMPANIES, INC., LAFAYETTE, LA. SN 77-521,901. PUB. 12-9-2008, FILED 7-14-2008.

IPI

THE MARK CONSISTS OF STANDARD CHARACTERS WITHOUT CLAIM TO ANY PARTICULAR FONT, STYLE, SIZE, OR COLOR.

FOR PROVIDING INFORMATION IN INSURANCE MATTERS IN THE NATURE OF AN INDEX OF ACTUAL INSURANCE PAYMENT HISTORY OF INSURED INDIVIDUALS TO INSURANCE COMPANIES FOR THEIR INSURANCE POLICIES THAT WILL BE USED AS A VALUABLE INDICATOR OF LOSS, WHICH WILL INCORPORATE A DETAILED HISTORY OF INSURED NOTICE OF CANCELLATIONS, CANCELLATIONS, NON-RENEWALS, REINSTATEMENTS, AND OTHER INSURANCE PAYMENT HISTORY AS REPORTED BY INSURERS AND AGGREGATED FOR A SUMMATION OF ACTUAL PAYMENT PERFORMANCE AND SUBSEQUENT PERFORMANCE SCORING (U.S. CLS. 100, 101 AND 102).

FIRST USE 12-1-2008; IN COMMERCE 12-1-2008.

3,681,172. PREMIER MONEY SOURCE, INC., NEWPORT BEACH, CA. SN 77-536,966. PUB. 3-3-2009, FILED 8-1-2008.

PREMIER MONEY SOURCE

THE MARK CONSISTS OF STANDARD CHARACTERS WITHOUT CLAIM TO ANY PARTICULAR FONT, STYLE,

CLASS 36—(Continued).

SIZE, OR COLOR.

NO CLAIM IS MADE TO THE EXCLUSIVE RIGHT TO USE "MONEY SOURCE", APART FROM THE MARK AS SHOWN.

FOR LOAN BROKERAGE AND MORTGAGE LENDING (U.S. CLS. 100, 101 AND 102).

FIRST USE 9-30-2008; IN COMMERCE 9-30-2008.



3,681,189. GREAT-WEST LIFE & ANNUITY INSURANCE COMPANY, GREENWOOD VILLAGE, CO. SN 77-545,111. PUB. 2-17-2009, FILED 8-12-2008.

CLASS 36—(Continued).

THE MARK CONSISTS OF STANDARD CHARACTERS WITHOUT CLAIM TO ANY PARTICULAR FONT, STYLE, SIZE, OR COLOR.

OWNER OF U.S. REG. NOS. 717,683, 840,187, AND OTHERS.

FOR INSURANCE SERVICES, NAMELY, WRITING AND UNDERWRITING AUTOMOBILE INSURANCE AND PROVIDING ANCILLARY SERVICES THERETO, NAMELY, ADMINISTRATION AND CLAIMS ADJUSTMENT (U.S. CLS. 100, 101 AND 102).

FIRST USE 1-26-2009; IN COMMERCE 1-26-2009.



3,681,229. ENYFCU HOLDINGS, LLC, FERNDALE, NY. SN 77-564,178. PUB. 2-24-2009, FILED 9-8-2008.

SOLUTION(K)

THE MARK CONSISTS OF STANDARD CHARACTERS WITHOUT CLAIM TO ANY PARTICULAR FONT, STYLE, SIZE, OR COLOR.

FOR INVESTMENT AND FINANCIAL SERVICES, NAMELY, MANAGEMENT AND BROKERAGE OF STOCKS, OPTIONS AND BONDS THAT ARE SUPPORTED BY AN AUTOMATIC FUND DESELECTION PROCESS (U.S. CLS. 100, 101 AND 102).

FIRST USE 1-0-2009; IN COMMERCE 1-0-2009.



3,681,193. OVERSEAS SAVE CHINESE CHILDREN FOUNDATION, TOLEDO, OH. SN 77-547,334. PUB. 1-6-2009, FILED 8-14-2008.

RATEHOUND

THE MARK CONSISTS OF STANDARD CHARACTERS WITHOUT CLAIM TO ANY PARTICULAR FONT, STYLE, SIZE, OR COLOR.

FOR PROVIDING FINANCIAL SERVICES, NAMELY, LOAN ANALYSIS AND OPTIMIZATION IN THE FIELD OF MONEY LENDING (U.S. CLS. 100, 101 AND 102).

FIRST USE 1-9-2009; IN COMMERCE 1-9-2009.



3,681,231. HIGHMARK INC., PITTSBURGH, PA. SN 77-564,510. PUB. 3-10-2009, FILED 9-8-2008.

OSCCF

THE MARK CONSISTS OF STANDARD CHARACTERS WITHOUT CLAIM TO ANY PARTICULAR FONT, STYLE, SIZE, OR COLOR.

FOR CHARITABLE SERVICES, NAMELY, PROVIDING FINANCIAL ASSISTANCE TO MEET THE PHYSICAL, PSYCHOLOGICAL, SOCIAL AND OTHER SPECIAL NEEDS OF CHILDREN (U.S. CLS. 100, 101 AND 102).

FIRST USE 10-27-2008; IN COMMERCE 10-27-2008.



3,681,217. ALLSTATE INSURANCE COMPANY, NORTH-BROOK, IL. SN 77-558,783. PUB. 1-6-2009, FILED 8-29-2008.

HIGHMARK DIRECT

THE MARK CONSISTS OF STANDARD CHARACTERS WITHOUT CLAIM TO ANY PARTICULAR FONT, STYLE, SIZE, OR COLOR.

OWNER OF U.S. REG. NOS. 2,157,238, 2,609,989, AND OTHERS.

NO CLAIM IS MADE TO THE EXCLUSIVE RIGHT TO USE "DIRECT", APART FROM THE MARK AS SHOWN.

FOR INDIVIDUAL AND GROUP HEALTH AND GROUP DISABILITY INSURANCE UNDERWRITING AND ADMINISTRATION SERVICES, THE ADMINISTRATION OF EMPLOYEE WELFARE BENEFIT PLANS, DENTAL AND VISION INSURANCE UNDERWRITING AND ADMINISTRATION, UNDERWRITING AND ADMINISTRATION OF LONG TERM CARE AND CATASTROPHIC MEDICAL INSURANCE TO BE PROVIDED VIA A RETAIL FACILITY WITH FACE TO FACE INTERACTION AND CUSTOMER SERVICE FUNCTIONALITY (U.S. CLS. 100, 101 AND 102).

FIRST USE 3-1-2009; IN COMMERCE 3-1-2009.

ALLSTATE MONEYSAVER

CLASS 36—(Continued).

3,681,241. PROASSURANCE CORPORATION, BIRMINGHAM, AL. SN 77-568,400. PUB. 2-17-2009, FILED 9-12-2008.

TREATED FAIRLY

THE MARK CONSISTS OF STANDARD CHARACTERS WITHOUT CLAIM TO ANY PARTICULAR FONT, STYLE, SIZE, OR COLOR.

FOR INSURANCE SERVICES, NAMELY, PROPERTY AND CASUALTY INSURANCE SERVICES (U.S. CLS. 100, 101 AND 102).

FIRST USE 9-5-2008; IN COMMERCE 10-6-2008.

3,681,245. BALLOU PLUM WEALTH ADVISORS, LLC, LAFAYETTE, CA. SN 77-569,983. PUB. 2-10-2009, FILED 9-15-2008.

Vision Clarity Achievement

THE MARK CONSISTS OF STANDARD CHARACTERS WITHOUT CLAIM TO ANY PARTICULAR FONT, STYLE, SIZE, OR COLOR.

FOR PRIVATE WEALTH MANAGEMENT AND PERSONAL FINANCIAL PLANNING SERVICES (U.S. CLS. 100, 101 AND 102).

FIRST USE 1-1-2009; IN COMMERCE 1-1-2009.

3,681,296. PROASSURANCE CORPORATION, BIRMINGHAM, AL. SN 77-585,619. PUB. 2-24-2009, FILED 10-3-2008.



THE MARK CONSISTS OF A CURLED RECTANGLE. FOR INSURANCE SERVICES, NAMELY, PROPERTY AND CASUALTY INSURANCE SERVICES (U.S. CLS. 100, 101 AND 102).

FIRST USE 9-5-2008; IN COMMERCE 10-6-2008.

CLASS 36—(Continued).

3,681,326. STANDING STONE NATIONAL BANK, LANCASTER, OH. SN 77-594,813. PUB. 3-10-2009, FILED 10-17-2008.

THERE WHEN IT COUNTS.

THE MARK CONSISTS OF STANDARD CHARACTERS WITHOUT CLAIM TO ANY PARTICULAR FONT, STYLE, SIZE, OR COLOR.

FOR ATM BANKING SERVICES; BANKING; BANKING AND FINANCING SERVICES; BANKING SERVICES; ELECTRONIC BANKING VIA A GLOBAL COMPUTER NETWORK; HOME BANKING; INVESTMENT BANKING SERVICES; ISSUANCE OF BANK CHECKS; ISSUING OF BANK CHEQUES; MERCHANT BANKING AND INVESTMENT BANKING SERVICES; MORTGAGE BANKING; MORTGAGE BANKING SERVICES, NAMELY, ORIGINATION, ACQUISITION, SERVICING, SECURITIZATION AND BROKERAGE OF MORTGAGE LOANS; MORTGAGE SERVICES, NAMELY, BUYER PRE-QUALIFICATION OF MORTGAGES FOR MORTGAGE BROKERS AND BANKS; ON-LINE BANKING SERVICES; PROVIDING BANK ACCOUNT INFORMATION BY TELEPHONE; SAVINGS BANK SERVICES (U.S. CLS. 100, 101 AND 102).

FIRST USE 1-15-2009; IN COMMERCE 1-15-2009.

3,681,327. FIRST HORIZON NATIONAL COPROPRATION, MEMPHIS, TN. SN 77-594,868. PUB. 3-10-2009, FILED 10-17-2008.

Powering Your Dreams

THE MARK CONSISTS OF STANDARD CHARACTERS WITHOUT CLAIM TO ANY PARTICULAR FONT, STYLE, SIZE, OR COLOR.

FOR BANKING SERVICES, CREDIT CARD SERVICES, MORTGAGE BROKERAGE, MORTGAGE LENDING SERVICES AND A HOUSE MARK FOR A FULL LINE OF FINANCIAL SERVICES, INSURANCE SERVICES AND SECURITIES BROKERAGE SERVICES (U.S. CLS. 100, 101 AND 102).

FIRST USE 2-9-2009; IN COMMERCE 2-9-2009.

CLASS 36—(Continued).

3,681,348. PAULO PORTUGAL LLC, LADERA RANCH, CA. SN 77-601,087. PUB. 3-24-2009, FILED 10-27-2008.

MyLifeMyBusiness

THE MARK CONSISTS OF STANDARD CHARACTERS WITHOUT CLAIM TO ANY PARTICULAR FONT, STYLE, SIZE, OR COLOR.
FOR FINANCIAL ADVISORY AND CONSULTANCY SERVICES (U.S. CLS. 100, 101 AND 102).
FIRST USE 3-1-2009; IN COMMERCE 3-1-2009.

3,681,378. NATIONAL AUTOMOBILE DEALERS ASSOCIATION, MCLEAN, VA. SN 77-614,182. PUB. 3-31-2009, FILED 11-13-2008.

NADA APPRAISALPRO

THE MARK CONSISTS OF STANDARD CHARACTERS WITHOUT CLAIM TO ANY PARTICULAR FONT, STYLE, SIZE, OR COLOR.
OWNER OF U.S. REG. NOS. 1,998,445 AND 3,039,108.
FOR ONLINE WEBSITES AND DATABASES PROVIDING INFORMATION FOR DETERMINING THE VALUE OF USED VEHICLES (U.S. CLS. 100, 101 AND 102).
FIRST USE 3-2-2009; IN COMMERCE 3-2-2009.

3,681,398. AMERICAN INTERNATIONAL GROUP, INC., NEW YORK, NY. SN 77-622,833. PUB. 3-24-2009, FILED 11-26-2008.



THE MARK CONSISTS OF TWO SEMI-CIRCULAR GRAPHIC ELEMENTS.
FOR INSURANCE UNDERWRITING IN THE FIELD OF PERSONAL AUTOMOBILE INSURANCE, HOMEOWNERS AND PERSONAL UMBRELLA INSURANCE (U.S. CLS. 100, 101 AND 102).
FIRST USE 1-2-2009; IN COMMERCE 1-5-2009.

CLASS 36—(Continued).

3,681,409. SUNTRUST BANKS, INC., ORLANDO, FL. SN 77-631,766. PUB. 3-10-2009, FILED 12-12-2008.

Solid Choice Checking

THE MARK CONSISTS OF STANDARD CHARACTERS WITHOUT CLAIM TO ANY PARTICULAR FONT, STYLE, SIZE, OR COLOR.
NO CLAIM IS MADE TO THE EXCLUSIVE RIGHT TO USE "CHECKING", APART FROM THE MARK AS SHOWN.
FOR CHECKING ACCOUNT SERVICES (U.S. CLS. 100, 101 AND 102).
FIRST USE 4-27-2009; IN COMMERCE 4-27-2009.

3,681,417. DIAMOND RESORTS HOLDINGS, LAS VEGAS, NV. SN 77-977,208. PUB. 10-28-2008, FILED 10-4-2007.



THE MARK CONSISTS OF THREE UPWARD CURVING ARCS.
FOR REAL ESTATE EQUITY SHARING, NAMELY, MANAGING AND ARRANGING FOR CO-OWNERSHIP OF REAL ESTATE; REAL ESTATE SERVICES, NAMELY, RENTAL OF SHORT-TERM FURNISHED APARTMENTS; REAL ESTATE TIME-SHARING; VACATION REAL ESTATE TIME SHARE EXCHANGE SERVICES; VACATION REAL ESTATE TIME-SHARING; VACATION REAL ESTATE TIMESHARE SERVICES (U.S. CLS. 100, 101 AND 102).
FIRST USE 10-1-2007; IN COMMERCE 10-1-2007.

3,681,463. RISK MANAGEMENT RESOURCES, LLC, CALIFON, NJ. SN 78-477,450. PUB. 11-21-2006, FILED 9-1-2004.



CLASS 36—(Continued).

NO CLAIM IS MADE TO THE EXCLUSIVE RIGHT TO USE "RISK MANAGEMENT RESOURCES", APART FROM THE MARK AS SHOWN.

THE COLOR(S) BLUE AND YELLOW ARE CLAIMED AS A FEATURE OF THE MARK.

THE COLOR BLUE APPEARS IN THE WORDS "RISK MANAGEMENT", THREE OF THE PUZZLE PIECES AND THE BACKGROUND BINARY CODE. THE COLOR YELLOW APPEARS IN THE WORD "RESOURCES" AND IN ONE OF THE PUZZLE PIECES.

FOR RISK MANAGEMENT SERVICES IN THE FIELD OF PHARMACEUTICALS AND HEALTHCARE PRODUCTS; AND RISK MANAGEMENT SERVICES IN THE FIELD OF EPIDEMIOLOGY SERVICES FOR PHARMACEUTICALS AND HEALTHCARE PRODUCTS (U.S. CLS. 100, 101 AND 102).

FIRST USE 1-1-2004; IN COMMERCE 1-1-2004.

3,681,567. JACKSON NATIONAL LIFE INSURANCE COMPANY, LANSING, MI. SN 78-803,538. PUB. 10-3-2006, FILED 1-31-2006.

RETIREMENT LATITUDES

THE MARK CONSISTS OF STANDARD CHARACTERS WITHOUT CLAIM TO ANY PARTICULAR FONT, STYLE, SIZE, OR COLOR.

NO CLAIM IS MADE TO THE EXCLUSIVE RIGHT TO USE "RETIREMENT", APART FROM THE MARK AS SHOWN.

FOR ANNUITY UNDERWRITING SERVICES, NAMELY, A VARIABLE ANNUITY (U.S. CLS. 100, 101 AND 102).

FIRST USE 7-31-2006; IN COMMERCE 7-31-2006.

3,681,572. LUMBEE TRIBE OF NORTH CAROLINA. PEMBROKE, NC. SN 78-820,897. PUB. 4-15-2008, FILED 2-22-2006.



NO CLAIM IS MADE TO THE EXCLUSIVE RIGHT TO USE "NORTH CAROLINA", APART FROM THE MARK AS SHOWN.

THE COLOR(S) RED, YELLOW, BLACK AND WHITE IS/ARE CLAIMED AS A FEATURE OF THE MARK.

THE MARK CONSISTS OF THE CIRCULAR SHAPE OF

CLASS 36—(Continued).

THE LUMBEE LOGO, WHICH IS SYMBOLIC OF THE CIRCLE OF LIFE AND IT EMPHASIZES THE IMPORTANCE OF EACH LUMBEE BEING A WHOLE PERSON. THE FOUR PARTS OF THE CIRCLE REPRESENT THE FOUR QUALITIES OF A BALANCED LIFE: THE SPIRITUAL, THE EMOTIONAL, THE PHYSICAL, AND THE INTELLECT. THE COLORS AND LOCATION OF THE COLORS REPRESENT THE FOUR DIRECTIONS - EAST (YELLOW), SOUTH (RED), WEST (BLACK) AND NORTH (WHITE). IT IS THE BELIEF THAT TOGETHER THEY NOT ONLY REPRESENT A WELL-BALANCED INDIVIDUAL, BUT ALSO A COMPLETE HUMAN BEING. THIS BALANCE AND COMPLETENESS IS UNIVERSAL AND REPRESENTS THE EQUALITY OF ALL HUMANKIND, THUS THE COLORS - RED, YELLOW, BLACK AND WHITE. THE LUMBEE PINE CONE PATCHWORK SURROUNDING THE CIRCLE OF LIFE REPRESENTS THE PRIDE, POWER AND WILL OF THE LUMBEE TRIBE. THE FOUR DIRECTIONS, COLORS AND LUMBEE PINE CONE PATCHWORK ARE CENTRAL FEATURES OF THE LUMBEE LOGO AND PORTRAY THE COMING TOGETHER OF THE OLD AND NEW TRADITIONS IN ONE SYMBOL OF UNITY FOR THE "LUMBEE TRIBE OF NORTH CAROLINA".

FOR CHARITABLE SERVICES, NAMELY, PROVIDING MORTGAGE ASSISTANCE FOR LOW INCOME FAMILIES AND RESIDENTIAL REHABILITATIVE SERVICES; CHARITABLE SERVICES, NAMELY, PROVIDING FINANCIAL ASSISTANCE FOR TRIBAL MEMBERS IN NEED OF FINANCIAL ASSISTANCE IN MEETING THEIR ENERGY NEEDS (U.S. CLS. 100, 101 AND 102).

FIRST USE 1-1-2006; IN COMMERCE 1-1-2007.

CLASS 37—CONSTRUCTION AND REPAIR

3,680,075. HONDA GIKEN KOGYO KABUSHIKI KAISHA, TA HONDA MOTOR CO., LTD., MINATO-KU, TOKYO, JAPAN. SN 76-512,804. PUB. 7-12-2005, FILED 5-8-2003.



FOR REPAIR AND INSTALLATION SERVICES, NAMELY, REPAIR AND MAINTENANCE OF MOTORCYCLES (U.S. CLS. 100, 103 AND 106).

FIRST USE 11-0-1989; IN COMMERCE 1-0-2008.

3,680,135. TUBCRAFT, WOODBRIDGE, VA. SN 76-691,492. PUB. 12-23-2008, FILED 7-22-2008.



THE COLOR(S) BLUE, GRAY, WHITE, BLACK AND BEIGE IS/ARE CLAIMED AS A FEATURE OF THE MARK.

THE MARK CONSISTS OF A RECTANGLE HAVING A BLUE OUTER BORDER AND A THIN WHITE INNER BORDER. INSIDE THE RECTANGLE IS A MAN REGLAZ-

CLASS 37—(Continued).

ING A BATHTUB WITH A SPRAYER. TO THE RIGHT OF THE RECTANGLE APPEARS THE WORDING "TUBCRAFT A GREAT ALTERNATIVE, REMODEL WITHOUT REPLACEMENT" IN BLUE STYLIZED LETTERING ON TWO SEPARATE LINES. THE FIRST LINE CONTAINS THE WORDING "TUBCRAFT" IN LARGE AND BOLD LETTERING. THE SECOND LINE CONTAINS THE WORDING "A GREAT ALTERNATIVE, REMODEL WITHOUT REPLACEMENT" IN SMALL STYLIZED LETTERING. A THIN HORIZONTAL LINE APPEARS BETWEEN THE FIRST AND SECOND LINE WORDINGS. THE COLOR BLUE APPEARS IN THE BATHTUB, SPRAY MIST, MAN'S UNIFORM, AND THE WORDING "TUBCRAFT A GREAT ALTERNATIVE, REMODEL WITHOUT REPLACEMENT". THE COLOR GRAY APPEARS IN THE SPRAYER AND THE BACKGROUND OF THE RECTANGLE. THE COLOR WHITE APPEARS IN THE INNER BORDER OF THE RECTANGLE, AND IN THE LIGHTING EFFECT ON THE SPRAYER AND THE MAN. THE COLOR BLACK APPEARS IN THE MAN'S SHOES AND THE SPRAYER HOSE. THE COLOR BEIGE APPEARS IN THE MAN'S SKIN.

FOR BATHTUB REGLAZING (U.S. CLS. 100, 103 AND 106).

FIRST USE 3-17-2009; IN COMMERCE 3-17-2009.

3,680,165. CERTA PROPAINTERS, LTD., OAKS, PA. SN 77-046,679. PUB. 1-13-2009, FILED 11-17-2006.



THE MARK CONSISTS OF A MAPLE LEAF WITH A SOLID BAR TO THE RIGHT OF THE LEAF AND THE WORD "BORN IN CANADA SPREADING ALL OVER THE WORLD."

FOR HOUSE PAINTING; PAINTING; PAINTING IN THE FIELD OF RESIDENTIAL AND COMMERCIAL BUILDINGS (U.S. CLS. 100, 103 AND 106).

FIRST USE 4-1-2005; IN COMMERCE 4-1-2005.

3,680,224. ABC, INC., FARGO, ND. SN 77-142,473. PUB. 10-23-2007, FILED 3-28-2007.

**CLASS 37—(Continued).**

OWNER OF U.S. REG. NOS. 1,617,977, 2,197,851, AND OTHERS.

NO CLAIM IS MADE TO THE EXCLUSIVE RIGHT TO USE "SUNROOMS", APART FROM THE MARK AS SHOWN.

THE MARK CONSISTS OF AN EXTERIOR ELEVATION VIEW OF A GABLE END SUNROOM IN THE BACKGROUND AND WITH THE WORDS "ABC SUNROOMS" IN STACKED RELATION IN THE FOREGROUND. ABOVE THE WORD "ABC" IS A CARICATURE OF A DUCK WEARING AN OVERCOAT, NECKTIE AND A HAT, WITH AN OUTSTRETCHED ARM AND WITH THE INDEX FINGER EXTENDED.

FOR INSTALLATION OF SUNROOMS (U.S. CLS. 100, 103 AND 106).

FIRST USE 1-12-2007; IN COMMERCE 1-12-2007.

3,680,722. MOBILE AIR, INC., MADISON HEIGHTS, MI. SN 77-399,963. PUB. 8-26-2008, FILED 2-19-2008.

MOBILE AIR FORCE

THE MARK CONSISTS OF STANDARD CHARACTERS WITHOUT CLAIM TO ANY PARTICULAR FONT, STYLE, SIZE, OR COLOR.

FOR DRYING AND DEHUMIDIFICATION SERVICES FOR STRUCTURES, BUILDING CONTENTS AND MANUFACTURING PLANTS THAT HAVE BEEN DAMAGED OR DESTROYED BY WATER (U.S. CLS. 100, 103 AND 106).

FIRST USE 3-0-2007; IN COMMERCE 3-0-2007.

3,680,770. PIONEER DRILLING COMPANY, SAN ANTONIO, TX. SN 77-420,800. PUB. 10-21-2008, FILED 3-13-2008.

PIONEER WELL SERVICES

THE MARK CONSISTS OF STANDARD CHARACTERS WITHOUT CLAIM TO ANY PARTICULAR FONT, STYLE, SIZE, OR COLOR.

OWNER OF U.S. REG. NO. 3,217,824.

NO CLAIM IS MADE TO THE EXCLUSIVE RIGHT TO USE "WELL SERVICES", APART FROM THE MARK AS SHOWN.

FOR OIL AND GAS WELL SERVICING, NAMELY, OIL AND GAS WELL MAINTENANCE AND REPAIR; OIL AND GAS WELL COMPLETION AND WORKOVER SERVICES, NAMELY, PREPARING WELLS FOR PRODUCTION AND CLEANING, REPAIRING AND MAINTAINING RE-ENTERED WELLS; PLUGGING AND ABANDONMENT OF OIL AND GAS WELLS; RENTAL OF OIL AND GAS WELL EQUIPMENT AND FISHING TOOLS (U.S. CLS. 100, 103 AND 106).

FIRST USE 9-4-2008; IN COMMERCE 9-4-2008.

CLASS 37—(Continued).

3,680,825. DYAL COMPASS, LLC, BOSTON, MA. SN 77-447,401. PUB. 3-3-2009, FILED 4-14-2008.



THE MARK CONSISTS OF A LARGE OUTER STAR AND A SMALL INNER STAR. BOTH STARS ARE ENCOMPASSED BY TWO CIRCLE. THE WORDING "DYALCOMPASS" APPEARS TO THE RIGHT OF THE LARGE OUTER STAR.

FOR REAL ESTATE DEVELOPMENT (U.S. CLS. 100, 103 AND 106).

FIRST USE 4-0-2008; IN COMMERCE 2-0-2009.

3,680,870. JUNK BEE GONE OF MINNESOTA, INC., LINO LAKES, MN. SN 77-460,556. PUB. 9-30-2008, FILED 4-29-2008.

SUPER BEE DISPOSAL

THE MARK CONSISTS OF STANDARD CHARACTERS WITHOUT CLAIM TO ANY PARTICULAR FONT, STYLE, SIZE, OR COLOR.

NO CLAIM IS MADE TO THE EXCLUSIVE RIGHT TO USE "DISPOSAL", APART FROM THE MARK AS SHOWN.

FOR WASTE DISPOSAL FOR OTHERS (U.S. CLS. 100, 103 AND 106).

FIRST USE 5-2-2009; IN COMMERCE 5-2-2009.

3,680,955. J AND N ENTERPRISES, INC., VALPARAISO, IN. SN 77-474,783. PUB. 1-6-2009, FILED 5-15-2008.

SENSIT TECHNOLOGIES

THE MARK CONSISTS OF STANDARD CHARACTERS WITHOUT CLAIM TO ANY PARTICULAR FONT, STYLE, SIZE, OR COLOR.

OWNER OF U.S. REG. NO. 1,622,204.

NO CLAIM IS MADE TO THE EXCLUSIVE RIGHT TO USE "TECHNOLOGIES", APART FROM THE MARK AS SHOWN.

FOR MAINTENANCE AND REPAIR OF GAS DETECTION INSTRUMENTS (U.S. CLS. 100, 103 AND 106).

FIRST USE 1-1-2009; IN COMMERCE 1-1-2009.

CLASS 37—(Continued).

3,681,148. RICHARD SCOTT INC., DBA BROADWAY AUTO CLINIC, ALBANY, NY. SN 77-528,192. PUB. 1-20-2009, FILED 7-22-2008.

NEW YORK MINUTE OIL CHANGE

THE MARK CONSISTS OF STANDARD CHARACTERS WITHOUT CLAIM TO ANY PARTICULAR FONT, STYLE, SIZE, OR COLOR.

NO CLAIM IS MADE TO THE EXCLUSIVE RIGHT TO USE "OIL CHANGE", APART FROM THE MARK AS SHOWN.

FOR VEHICLE GREASING; VEHICLE LUBRICATION; VEHICLE MAINTENANCE; VEHICLE MAINTENANCE CONSULTATION (U.S. CLS. 100, 103 AND 106).

FIRST USE 11-26-2008; IN COMMERCE 11-26-2008.

3,681,216. CENTEX CORPORATION, DALLAS, TX. SN 77-558,729. PUB. 11-25-2008, FILED 8-29-2008.

A Better Way to a Better Home

THE MARK CONSISTS OF STANDARD CHARACTERS WITHOUT CLAIM TO ANY PARTICULAR FONT, STYLE, SIZE, OR COLOR.

FOR CONSTRUCTION SERVICES, NAMELY, PLANNING, LAYING OUT AND CONSTRUCTION OF RESIDENTIAL COMMUNITIES (U.S. CLS. 100, 103 AND 106).

FIRST USE 11-1-2008; IN COMMERCE 11-1-2008.

3,681,333. CAVALIER SERVICES, INC., AKA CAVALIER SERVICES, FAIRFAX, VA. SN 77-596,919. PUB. 3-17-2009, FILED 10-21-2008.

CavGreen

THE MARK CONSISTS OF STANDARD CHARACTERS WITHOUT CLAIM TO ANY PARTICULAR FONT, STYLE, SIZE, OR COLOR.

FOR JANITORIAL SERVICES (U.S. CLS. 100, 103 AND 106).

FIRST USE 2-10-2009; IN COMMERCE 2-10-2009.

CLASS 37—(Continued).

3,681,360. COMFORT SERVICES, INC., WEST COLUMBIA, SC. SN 77-605,047. PUB. 3-24-2009, FILED 10-31-2008.



NO CLAIM IS MADE TO THE EXCLUSIVE RIGHT TO USE "SERVICES", APART FROM THE MARK AS SHOWN. THE MARK CONSISTS OF THREE ARCUATE SECTORS WITHIN A CIRCULAR BOUNDARY WITH THREE DECORATIVE SWIRLS SURROUNDING THE WORDS "COMFORT SERVICES" AND "FRESHER CLEANER GREENER". FOR INSTALLATION, MAINTENANCE AND REPAIR OF RESIDENTIAL HEATING AND AIR CONDITIONING EQUIPMENT (U.S. CLS. 100, 103 AND 106). FIRST USE 1-1-2009; IN COMMERCE 1-1-2009.

CLASS 37—(Continued).

3,681,568. CLOCKWORK IP, LLC, SARASOTA, FL. SN 78-808,121. PUB. 10-17-2006, FILED 2-6-2006.



THE DESIGN PORTION OF THE MARK CONSISTS OF A STYLIZED PLUMBER DRESSED AS CUPID WEARING A HALO. FOR REPAIR, MAINTENANCE, AND INSTALLATION SERVICES IN THE FIELD OF PLUMBING (U.S. CLS. 100, 103 AND 106). FIRST USE 3-13-2008; IN COMMERCE 3-13-2008.

3,681,536. QUALITY AIRCRAFT PART, INC., MIAMI GARDENS, FL. SN 78-709,857. PUB. 6-6-2006, FILED 9-9-2005.



NO CLAIM IS MADE TO THE EXCLUSIVE RIGHT TO USE "AIRCRAFT PARTS, INC.", APART FROM THE MARK AS SHOWN. THE MARK CONSISTS OF THE WORDS "QUALITY AIRCRAFT PARTS, INC." UNDERLINED, WITH THE WORDS "QUALITY IS OUR NAME" IN SMALLER FONT BELOW THE LINE. THE "Q" IN "QUALITY" IS STYLIZED SO THAT THE SMOKE FROM ONE AIRCRAFT DRAWS THE O PORTION OF THE "Q" AND THE SMOKE FROM A SECOND AIRCRAFT DRAWS THE TAIL OF THE "Q". THE MARK ALSO CONTAINS THE SAME STYLIZED "Q" ABOVE THE WORD PORTION OF THE MARK. FOR AIRCRAFT COMPONENTS REPAIR (U.S. CLS. 100, 103 AND 106). FIRST USE 2-13-1987; IN COMMERCE 2-13-1987.

CLASS 38—COMMUNICATION

3,680,377. AVAYA INC., BASKING RIDGE, NJ. SN 77-234,926. PUB. 1-20-2009, FILED 7-20-2007.

UCAN

THE MARK CONSISTS OF STANDARD CHARACTERS WITHOUT CLAIM TO ANY PARTICULAR FONT, STYLE, SIZE, OR COLOR. FOR TELECOMMUNICATION CONSULTATION FOR ENTERPRISES, NAMELY, PROVIDING AN ON-LINE TEST TO DETERMINE THE EXTENT OF USAGE OF UNIFIED COMMUNICATIONS WITHIN AN ENTERPRISE AND WHAT IMPROVEMENTS CAN BE MADE TO THE ENTERPRISE'S UNIFIED COMMUNICATION ABILITIES (U.S. CLS. 100, 101 AND 104). FIRST USE 9-4-2007; IN COMMERCE 9-4-2007.

CLASS 38—(Continued).

3,680,387. SKYTERRA LP, RESTON, VA. SN 77-249,735. PUB. 4-29-2008, FILED 8-8-2007.

SMART

THE MARK CONSISTS OF STANDARD CHARACTERS WITHOUT CLAIM TO ANY PARTICULAR FONT, STYLE, SIZE, OR COLOR.

FOR TRANSMISSION AND RECEPTION OF INFORMATION BY ELECTRONIC COMMUNICATION NETWORKS, NAMELY, TRANSMISSION AND RECEPTION OF VOICE, VIDEO, DATA, MULTI-MEDIA, AND DOCUMENTS VIA SATELLITE, TERRESTRIAL AND WIRELESS TELECOMMUNICATIONS, COMPUTERS, COMPUTER NETWORKS, AND THE INTERNET; PUSH-TO-TALK AND PUSH-TO-TRACK COMMUNICATIONS SERVICES, NAMELY, COMMUNICATION VIA TELECOMMUNICATIONS NETWORKS; TELECOMMUNICATIONS GATEWAY SERVICES, NAMELY, BASE STATION SERVICES AND BASE STATION CONTROLLER SERVICES; ELECTRONIC TRANSMISSION AND RECEPTION OF MESSAGES AND DATA; TELECOMMUNICATIONS BACKHAUL SERVICES, NAMELY, TELECOMMUNICATIONS ROUTING AND JUNCTION SERVICES, AND TRANSMISSION OF ROUTING DATA FOR USE IN ANALYZING OR SELECTING ROUTING PATHS TO MANAGE COMMUNICATIONS (U.S. CLS. 100, 101 AND 104).

FIRST USE 8-6-2007; IN COMMERCE 8-6-2007.

3,680,625. V-ENABLE, INC., SAN DIEGO, CA. SN 77-349,482. PUB. 5-6-2008, FILED 12-11-2007.

MORE THAN A NUMBER!

THE MARK CONSISTS OF STANDARD CHARACTERS WITHOUT CLAIM TO ANY PARTICULAR FONT, STYLE, SIZE, OR COLOR.

FOR VOICE ACTIVATED TELECOMMUNICATION SERVICES, NAMELY, DATA TRANSMISSION AND RECEPTION SERVICES VIA TELECOMMUNICATION MEANS; ELECTRONIC EXCHANGE OF VOICE, DATA, AND GRAPHICS ACCESSIBLE VIA COMPUTER AND TELECOMMUNICATION NETWORKS; TELECOMMUNICATION SERVICES, NAMELY, PERSONAL COMMUNICATION SERVICES; LOCAL AND LONG DISTANCE TRANSMISSION OF VOICE, DATA, AND GRAPHICS ACCESSIBLE VIA COMPUTER AND TELECOMMUNICATION NETWORKS; LOCAL AND LONG DISTANCE TELEPHONE SERVICES; MOBILE TELEPHONE COMMUNICATION SERVICES (U.S. CLS. 100, 101 AND 104).

FIRST USE 2-11-2009; IN COMMERCE 2-11-2009.

CLASS 38—(Continued).

3,681,093. COA NETWORK, INC., PISCATAWAY, NJ. SN 77-508,422. PUB. 11-18-2008, FILED 6-26-2008.

iTeleCenter

THE MARK CONSISTS OF STANDARD CHARACTERS WITHOUT CLAIM TO ANY PARTICULAR FONT, STYLE, SIZE, OR COLOR.

FOR LOCAL AND LONG DISTANCE TELEPHONE SERVICES; TELECOMMUNICATION SERVICES IN THE NATURE OF PROVIDING TELEPHONE SERVICES WITH VARIOUS TELEPHONE FEATURES, NAMELY, A DEDICATED TOLL-FREE NUMBER, VOICEMAIL, MULTIPLE MAILBOX EXTENSIONS, TELEPHONE MESSAGE NOTIFICATION, FAX CAPABILITIES, DETAILED CALL REPORTS, CALL WAITING, CALL IDENTIFICATION, CALL FORWARDING, AND MESSAGE WAITING; TELECOMMUNICATIONS SERVICES, NAMELY, PROVIDING TOLL-FREE MNEMONIC TELEPHONE NUMBERS; TELEPHONE COMMUNICATION SERVICES; TELEPHONE SERVICES AND TELETEXT SERVICES (U.S. CLS. 100, 101 AND 104).

FIRST USE 4-0-2008; IN COMMERCE 4-0-2008.

3,681,314. EMC TELECOM CORPORATION, AKA EMC TELECOM, MESA, AZ. SN 77-589,845. PUB. 3-3-2009, FILED 10-9-2008.

A New Breed of Telecom

THE MARK CONSISTS OF STANDARD CHARACTERS WITHOUT CLAIM TO ANY PARTICULAR FONT, STYLE, SIZE, OR COLOR.

FOR COMMUNICATION SERVICES, NAMELY, TRANSMISSION OF VOICE, AUDIO, VISUAL IMAGES AND DATA BY TELECOMMUNICATIONS NETWORKS, WIRELESS COMMUNICATION NETWORKS, THE INTERNET, INFORMATION SERVICES NETWORKS AND DATA NETWORKS (U.S. CLS. 100, 101 AND 104).

FIRST USE 5-1-2008; IN COMMERCE 1-1-2009.

3,681,562. VOICEWRITE DIGITAL, INC., NEW ORLEANS, LA. SN 78-793,046. PUB. 6-24-2008, FILED 1-17-2006.



NO CLAIM IS MADE TO THE EXCLUSIVE RIGHT TO USE "DIGITAL DICTATION SYSTEM", APART FROM THE MARK AS SHOWN.

THE COLOR(S) GOLD, BLUE AND BLACK IS/ARE

CLASS 38—(Continued).

CLAIMED AS A FEATURE OF THE MARK.

THE COLOR GOLD, BEARING PMS #116C, APPEARS IN THE LETTER "L" OF "LAW" AND THE LETTER "W" OF "WRITE". THE COLOR BLUE, BEARING PMS #293, APPEARS IN THE OUTLINE OF THE LETTER "L" OF "LAW," AND THE OUTLINE THE LETTER "W" OF "WRITE". THE COLOR BLUE, BEARING PMS #293, APPEARS IN THE LETTERS "A" AND "W" OF "LAW" AND "R", "I", "T", AND "E" OF "WRITE". THE COLOR BLUE, BEARING PMS #293, APPEARS IN THE MULTI-LEVEL BARS WHICH FOLLOW THE WORD "LAWWRITE". THE COLOR BLACK APPEARS AS THE COLOR OF LETTERING FOR "DIGITAL DICTATION SYSTEM".

FOR ELECTRONIC EXCHANGE OF DATA STORED IN DATABASES ACCESSIBLE VIA TELECOMMUNICATION NETWORKS TO PRODUCE SOUND RECORDINGS AND TRANSCRIBE DICTATION FOR USE IN THE LEGAL FIELD; NONE OF THE AFORESAID RELATED TO LEGAL RESEARCH (U.S. CLS. 100, 101 AND 104).

FIRST USE 3-30-2001; IN COMMERCE 11-30-2001.

3,681,632. QUICK TECHNOLOGIES, INC., CARROLLTON, TX. SN 78-977,010. PUB. 1-8-2008, FILED 2-15-2005.

THE MARK CONSISTS OF STANDARD CHARACTERS WITHOUT CLAIM TO ANY PARTICULAR FONT, STYLE, SIZE, OR COLOR.

FOR ELECTRONIC TRANSMISSION OF DATA AND DOCUMENTS VIA COMPUTER TERMINALS; AND ELECTRONIC MAIL SERVICES (U.S. CLS. 100, 101 AND 104).

FIRST USE 10-0-2007; IN COMMERCE 10-0-2007.

CLASS 39—TRANSPORTATION AND STORAGE

3,680,550. SHAFFER, MARK T., SAN LUIS OBISPO, CA. SN 77-332,469. PUB. 4-29-2008, FILED 11-18-2007.

THE MARK CONSISTS OF STANDARD CHARACTERS WITHOUT CLAIM TO ANY PARTICULAR FONT, STYLE, SIZE, OR COLOR.

FOR RENTAL OF GPS-EQUIPPED VEHICLES, NAMELY, SCOOTERS, ELECTRIC CARS AND BICYCLES; RENTAL OF CARS; RENTAL OF ELECTRIC CARS (U.S. CLS. 100 AND 105).

FIRST USE 11-18-2007; IN COMMERCE 7-10-2009.

CLASS 39—(Continued).

3,680,638. VISCAPE LTD., ARLINGTON, VA. SN 77-353,781. PUB. 5-13-2008, FILED 12-17-2007.

LIVE IT. LOVE IT. SHARE IT.

THE MARK CONSISTS OF STANDARD CHARACTERS WITHOUT CLAIM TO ANY PARTICULAR FONT, STYLE, SIZE, OR COLOR.

FOR PROVIDING AN ON-LINE COMPUTER DATABASE IN THE FIELD OF TRAVEL INFORMATION SERVICES; PROVIDING INFORMATION, NEWS AND COMMENTARY IN THE FIELD OF TRAVEL; TRAVEL INFORMATION SERVICES; PROVIDING A WEBSITE AND WEBSITE LINKS TO ONLINE CITY GUIDES, MAP IMAGES, VIDEOS, BLOGS, REVIEWS, AND GEOGRAPHIC INFORMATION FOR USE BY TRAVELERS; PROVIDING A WEBSITE FOR ELECTRONIC STORAGE OF DIGITAL PHOTOGRAPHS; PROVIDING REVIEWS OF RENTAL AND VACATION PROPERTIES, SECOND HOMES, TRAVEL, DESTINATIONS, VACATION ACTIVITIES, EVENTS, AND TRIPS (U.S. CLS. 100 AND 105).

FIRST USE 10-2-2008; IN COMMERCE 10-2-2008.

3,680,640. VIACOM INTERNATIONAL INC., NEW YORK, NY. SN 77-354,307. PUB. 5-6-2008, FILED 12-18-2007.

NICKELODEON FAMILY CRUISE

THE MARK CONSISTS OF STANDARD CHARACTERS WITHOUT CLAIM TO ANY PARTICULAR FONT, STYLE, SIZE, OR COLOR.

NO CLAIM IS MADE TO THE EXCLUSIVE RIGHT TO USE "FAMILY CRUISE", APART FROM THE MARK AS SHOWN.

FOR PASSENGER CRUISE SHIP SERVICES (U.S. CLS. 100 AND 105).

FIRST USE 10-1-2008; IN COMMERCE 10-1-2008.

CLASS 39—(Continued).

3,681,000. SAFEWAY INSURANCE COMPANY, WEST-MONT, IL. SN 77-482,099. PUB. 10-28-2008, FILED 5-23-2008.

TEMPUS AVIATION

THE MARK CONSISTS OF STANDARD CHARACTERS WITHOUT CLAIM TO ANY PARTICULAR FONT, STYLE, SIZE, OR COLOR.

NO CLAIM IS MADE TO THE EXCLUSIVE RIGHT TO USE "AVIATION", APART FROM THE MARK AS SHOWN.

FOR AVIATION MANAGEMENT SERVICES, NAMELY, THE LEASING OF JETS (U.S. CLS. 100 AND 105).

FIRST USE 9-22-2008; IN COMMERCE 9-22-2008.

3,681,054. UNITED PARCEL SERVICE OF AMERICA, INC., ATLANTA, GA. SN 77-495,985. PUB. 9-16-2008, FILED 6-11-2008.

WHATEVER SPEED YOU NEED

THE MARK CONSISTS OF STANDARD CHARACTERS WITHOUT CLAIM TO ANY PARTICULAR FONT, STYLE, SIZE, OR COLOR.

FOR TRANSPORTATION AND DELIVERY SERVICES BY AIR, ROAD, RAIL AND SEA (U.S. CLS. 100 AND 105).

FIRST USE 9-0-2008; IN COMMERCE 9-0-2008.

3,681,092. MICROSOFT CORPORATION, REDMOND, WA. SN 77-508,258. PUB. 10-14-2008, FILED 6-25-2008.

LIVE MESH

THE MARK CONSISTS OF STANDARD CHARACTERS WITHOUT CLAIM TO ANY PARTICULAR FONT, STYLE, SIZE, OR COLOR.

PRIORITY CLAIMED UNDER SEC. 44(D) ON FED REP GERMANY APPLICATION NO. 302008009672, FILED 2-14-2008.

NO CLAIM IS MADE TO THE EXCLUSIVE RIGHT TO USE "MESH", APART FROM THE MARK AS SHOWN.

FOR PHYSICAL STORAGE OF ELECTRONICALLY-STORED FILES AND DOCUMENTS; ELECTRONIC STORAGE OF FILES AND DOCUMENTS FOR OTHERS (U.S. CLS. 100 AND 105).

FIRST USE 4-22-2008; IN COMMERCE 4-22-2008.

CLASS 39—(Continued).

3,681,111. ZOOMPOOL, INC., SANTA CRUZ, CA. SN 77-518,821. PUB. 12-2-2008, FILED 7-10-2008.

zoompool

THE MARK CONSISTS OF STANDARD CHARACTERS WITHOUT CLAIM TO ANY PARTICULAR FONT, STYLE, SIZE, OR COLOR.

FOR CARPOOLING SERVICES, NAMELY, MATCHING DRIVERS OF MOTOR VEHICLES WITH INDIVIDUALS NEEDING RIDES (U.S. CLS. 100 AND 105).

FIRST USE 3-17-2008; IN COMMERCE 9-1-2008.

3,681,166. ZOOMPOOL, INC., SANTA CRUZ, CA. SN 77-534,662. PUB. 12-9-2008, FILED 7-30-2008.



THE MARK CONSISTS OF THE STYLIZED TEXT "Z" ENCLOSED IN TWO CIRCLES.

FOR CARPOOLING SERVICES, NAMELY, MATCHING DRIVERS OF MOTOR VEHICLES WITH INDIVIDUALS NEEDING RIDES (U.S. CLS. 100 AND 105).

FIRST USE 3-17-2008; IN COMMERCE 9-1-2008.

3,681,335. COBRA ELECTRONICS CORPORATION, CHICAGO, IL. SN 77-598,203. PUB. 3-17-2009, FILED 10-22-2008.



THE MARK CONSISTS OF THE WORD "AURA" IN A FANCIFUL FONT WITH THREE RADIATING ARCS OFF OF THE INITIAL "A".

FOR PROVIDING A DATABASE FEATURING ROAD AND TRAFFIC INFORMATION, NAMELY, LOCATIONS OF TRAFFIC CONTROL AND MONITORING DEVICES IN THE NATURE OF SPEED DETECTION AND RED LIGHT ENFORCEMENT (U.S. CLS. 100 AND 105).

FIRST USE 11-13-2008; IN COMMERCE 12-23-2008.

CLASS 39—(Continued).

3,681,384. SAFEWAY INSURANCE COMPANY, WEST-MONT, IL. SN 77-616,973. PUB. 3-31-2009, FILED 11-18-2008.

TIME FLIES...KEEP UP!

THE MARK CONSISTS OF STANDARD CHARACTERS WITHOUT CLAIM TO ANY PARTICULAR FONT, STYLE, SIZE, OR COLOR.
FOR AVIATION MANAGEMENT SERVICES, NAMELY, THE LEASING OF JETS (U.S. CLS. 100 AND 105).
FIRST USE 9-22-2008; IN COMMERCE 9-22-2008.

3,681,410. REMOTIAN SYSTEMS, INC., MESA, AZ. SN 77-635,484. PUB. 3-31-2009, FILED 12-17-2008.

Tripware

THE MARK CONSISTS OF STANDARD CHARACTERS WITHOUT CLAIM TO ANY PARTICULAR FONT, STYLE, SIZE, OR COLOR.
FOR BOOKING OF SEATS FOR TRAVEL; ORGANIZATION OF TRAVEL; PROVIDING AN ON-LINE COMPUTER DATABASE IN THE FIELD OF TRAVEL INFORMATION SERVICES; TRAVEL BOOKING AGENCIES; TRAVEL INFORMATION SERVICES (U.S. CLS. 100 AND 105).
FIRST USE 2-1-2009; IN COMMERCE 2-1-2009.

3,681,489. LE CORRE, VINCENT B., PARIS, FRANCE. SN 78-607,245. PUB. 5-16-2006, FILED 4-12-2005.

GOVIA

THE MARK CONSISTS OF STANDARD CHARACTERS WITHOUT CLAIM TO ANY PARTICULAR FONT, STYLE, SIZE, OR COLOR.
FOR ARRANGING TRAVEL TOURS; TRAVEL INFORMATION; TOURIST AGENCY SERVICES (U.S. CLS. 100 AND 105).
FIRST USE 3-24-2002; IN COMMERCE 3-24-2002.

CLASS 39—(Continued).

3,681,505. TTX COMPANY, CHICAGO, IL. SN 78-657,623. PUB. 3-21-2006, FILED 6-24-2005.

MOVING THE HIGHWAY BY RAIL

THE MARK CONSISTS OF STANDARD CHARACTERS WITHOUT CLAIM TO ANY PARTICULAR FONT, STYLE, SIZE, OR COLOR.
FOR FREIGHT TRANSPORTATION SERVICES BY TRAIN (U.S. CLS. 100 AND 105).
FIRST USE 6-5-2009; IN COMMERCE 6-5-2009.

3,681,525. BELLER, IRIS L., BROOKLYN, NY. SN 78-683,609. PUB. 4-18-2006, FILED 8-2-2005.

TRACK TO TRACK

THE MARK CONSISTS OF STANDARD CHARACTERS WITHOUT CLAIM TO ANY PARTICULAR FONT, STYLE, SIZE, OR COLOR.
FOR TRANSPORTATION OF HORSES BY TRUCKS AND TRAILERS (U.S. CLS. 100 AND 105).
FIRST USE 2-0-2006; IN COMMERCE 2-0-2006.

3,681,584. SEDONA SOUL ADVENTURES, INC., SEDONA, AZ. SN 78-847,018. PUB. 10-21-2008, FILED 3-27-2006.

SOUL ADVENTURES

THE MARK CONSISTS OF STANDARD CHARACTERS WITHOUT CLAIM TO ANY PARTICULAR FONT, STYLE, SIZE, OR COLOR.
NO CLAIM IS MADE TO THE EXCLUSIVE RIGHT TO USE "ADVENTURES", APART FROM THE MARK AS SHOWN.
FOR ARRANGING AND COORDINATING TRAVEL ARRANGEMENTS FOR INDIVIDUALS AND GROUPS, NAMELY, DESTINATIONS STAYS FOR SPIRITUAL VACATIONS AND RETREATS (U.S. CLS. 100 AND 105).
FIRST USE 2-1-2009; IN COMMERCE 2-1-2009.

CLASS 40—MATERIAL TREATMENT

CLASS 40—(Continued).

3,680,739. COSMED GROUP, INC., JAMESTOWN, RI. SN 77-404,629. PUB. 10-21-2008, FILED 2-24-2008.

EO ENHANCED

THE MARK CONSISTS OF STANDARD CHARACTERS WITHOUT CLAIM TO ANY PARTICULAR FONT, STYLE, SIZE, OR COLOR.

NO CLAIM IS MADE TO THE EXCLUSIVE RIGHT TO USE "EO", APART FROM THE MARK AS SHOWN.

FOR STERILIZATION SERVICES IN THE FIELDS OF FOODSTUFFS AND PACKAGING FOR CONSUMER PRODUCTS (U.S. CLS. 100, 103 AND 106).

FIRST USE 5-0-2008; IN COMMERCE 5-0-2008.

3,681,236. JAYARAM, NIKHIL S., DBA MOTIVE RETOUCHING, LOS ANGELES, CA. AND WEINSTEIN, JOSHUA L., DBA MOTIVE RETOUCHING, LOS ANGELES, CA. SN 77-566,149. PUB. 2-24-2009, FILED 9-9-2008.



NO CLAIM IS MADE TO THE EXCLUSIVE RIGHT TO USE "RETOUCHING DOT COM", APART FROM THE MARK AS SHOWN.

THE MARK CONSISTS OF A STYLIZED LETTER "M" THAT BEGINS THE WORD "MOTIVE", IN LOWER CASE LETTERS. THE "M" IS STYLED IN A DIRTY-TO-CLEAN LOOK. IMMEDIATELY UNDERNEATH "MOTIVE" IS THE WORD "RETOUCHING" IN ALL CAPS. BOTH WORDS ARE THE SAME OVERALL WIDTH. TO THE RIGHT OF THESE WORDS, THE TERM "DOT COM" IS PLACED VERTICALLY, WITH THE BOTTOMS OF THE LETTERS FACING TOWARDS THE WORDS "MOTIVE" AND "RETOUCHING", WITH THE "D" AS THE TOPMOST LETTER, AND THE TERM IN ALL CAPS.

FOR PHOTOGRAPHIC RETOUCHING (U.S. CLS. 100, 103 AND 106).

FIRST USE 9-22-2008; IN COMMERCE 9-22-2008.

3,681,541. HALLIBURTON ENERGY SERVICES, INC., CARROLLTON, TX. SN 78-724,310. PUB. 5-30-2006, FILED 9-30-2005.

SHALESTIM**CLASS 40—(Continued).**

THE MARK CONSISTS OF STANDARD CHARACTERS WITHOUT CLAIM TO ANY PARTICULAR FONT, STYLE, SIZE, OR COLOR.

FOR OIL AND GAS WELL FRACTURING AND STIMULATION SERVICES THAT HELP TO REDUCE WATER FLOW WHILE ENHANCING OIL AND GAS PRODUCTION (U.S. CLS. 100, 103 AND 106).

FIRST USE 7-31-2006; IN COMMERCE 7-31-2006.

CLASS 41—EDUCATION AND ENTERTAINMENT

3,680,085. FULL HOUSE RESORTS, INC., LAS VEGAS, NV. SN 76-649,873. PUB. 3-27-2007, FILED 11-7-2005.

FULL HOUSE RESORT AND CASINO

THE MARK CONSISTS OF STANDARD CHARACTERS WITHOUT CLAIM TO ANY PARTICULAR FONT, STYLE, SIZE, OR COLOR.

NO CLAIM IS MADE TO THE EXCLUSIVE RIGHT TO USE "RESORT AND CASINO", APART FROM THE MARK AS SHOWN.

FOR HEALTH CLUB SERVICES, NAMELY, PROVIDING INSTRUCTION AND EQUIPMENT IN THE FIELD OF PHYSICAL EXERCISE; CASINO SERVICES; ENTERTAINMENT SERVICES, NAMELY, MUSICAL AND COMEDY NIGHTCLUB SERVICES, LIVE SPORTING EVENTS, CONCERTS, LIVE MUSIC AND COMEDY PERFORMANCES; PROVIDING ON-LINE INFORMATION IN THE FIELDS OF HEALTH CLUB SERVICES, CASINO SERVICES AND ENTERTAINMENT SERVICES VIA A GLOBAL COMPUTER NETWORK (U.S. CLS. 100, 101 AND 107).

FIRST USE 7-10-2009; IN COMMERCE 7-10-2009.

3,680,141. DISCOVERY GREEN CONSERVANCY, HOUSTON, TX. SN 77-003,782. PUB. 5-8-2007, FILED 9-20-2006.

DISCOVERY GREEN

THE MARK CONSISTS OF STANDARD CHARACTERS WITHOUT CLAIM TO ANY PARTICULAR FONT, STYLE, SIZE, OR COLOR.

NO CLAIM IS MADE TO THE EXCLUSIVE RIGHT TO USE "GREEN", APART FROM THE MARK AS SHOWN.

FOR EDUCATIONAL, RECREATIONAL, AND ENTERTAINMENT SERVICES, NAMELY, OPERATING AND PROVIDING A RECREATIONAL PARK LOCATED IN HOUSTON, TEXAS AND PROVIDING EDUCATIONAL AND PROMOTIONAL INFORMATION TO ACTUAL AND POTENTIAL ATTENDEES RELATED THERETO (U.S. CLS. 100, 101 AND 107).

FIRST USE 2-23-2008; IN COMMERCE 4-13-2008.

CLASS 41—(Continued).

3,680,159. CHLOE LOVE FOUNDATION, VENICE, CA. SN 77-039,161. PUB. 8-26-2008, FILED 11-8-2006.



NO CLAIM IS MADE TO THE EXCLUSIVE RIGHT TO USE "FOUNDATION INC", APART FROM THE MARK AS SHOWN.

THE COLOR(S) TEAL, PURPLE, RED, BLACK AND WHITE IS/ARE CLAIMED AS A FEATURE OF THE MARK. THE MARK CONSISTS OF THE WORDING "CHLOE LOVE FOUNDATION INC GIVING SPECIAL A NEW MEANING" AND THE DESIGN OF A HEART. "CHLOE LOVE" IS TEAL, "FOUNDATION INC" IS PURPLE, "GIVING SPECIAL A NEW MEANING" IS BLACK. THE HEART IS RED WITH BLACK OUTLINING AND WHITE SHADING. THE SQUARE BORDER IS BLACK.

FOR EDUCATIONAL LECTURES AND EDUCATIONAL SPEAKERS PROVIDED BY A NON-PROFIT FOUNDATION, IN THE FIELD OF SPECIAL NEEDS CHILDREN (U.S. CLS. 100, 101 AND 107).

FIRST USE 0-0-2006; IN COMMERCE 0-0-2006.

CLASS 41—(Continued).

3,680,205. NEW LINE PRODUCTIONS, INC., NEW YORK, NY. SN 77-120,712. PUB. 8-21-2007, FILED 3-2-2007.

FRIDAY THE 13TH

THE MARK CONSISTS OF STANDARD CHARACTERS WITHOUT CLAIM TO ANY PARTICULAR FONT, STYLE, SIZE, OR COLOR.

OWNER OF U.S. REG. NO. 1,791,417.

FOR ENTERTAINMENT SERVICES, NAMELY, A SERIES OF MOTION PICTURES AND TELEVISION PROGRAMS FEATURING COMEDY, DRAMA, ACTION, ADVENTURE AND/OR ANIMATION; AND FOR PROVIDING A WEBSITE FEATURING INFORMATION IN THE FIELD OF ENTERTAINMENT (U.S. CLS. 100, 101 AND 107).

FIRST USE 5-9-1980; IN COMMERCE 5-9-1980.

3,680,206. MACHINE TOOL SERVICE AND TRAINING GROUP, INC., WAUKESHA, WI. SN 77-124,256. PUB. 3-4-2008, FILED 3-7-2007.

3,680,168. SIRUVAI INC, PLANO, TX. SN 77-048,089. PUB. 9-18-2007, FILED 11-20-2006.



NO CLAIM IS MADE TO THE EXCLUSIVE RIGHT TO USE "USA", APART FROM THE MARK AS SHOWN.

THE COLOR(S) BLUE AND GREEN IS/ARE CLAIMED AS A FEATURE OF THE MARK.

THE MARK CONSISTS OF BLUE LEAF FOLLOWED BY GREEN LEAF FOLLOWED BY BLUE LETTERS.

FOR EDUCATION SERVICES, NAMELY, PROVIDING TUTORING IN THE FIELDS OF MATH, ENGLISH (U.S. CLS. 100, 101 AND 107).

FIRST USE 7-1-2008; IN COMMERCE 7-1-2008.

SLYDRITE

THE MARK CONSISTS OF STANDARD CHARACTERS WITHOUT CLAIM TO ANY PARTICULAR FONT, STYLE, SIZE, OR COLOR.

FOR EDUCATION AND TRAINING SERVICES, NAMELY, CONDUCTING COURSES, SEMINARS AND WORKSHOPS IN THE FIELD OF INSTALLATION, INSPECTION AND MAINTENANCE OF LINEAR BEARING MATERIAL FOR COMMERCIAL AND INDUSTRIAL MACHINERY (U.S. CLS. 100, 101 AND 107).

FIRST USE 6-17-2004; IN COMMERCE 6-17-2004.

CLASS 41—(Continued).

3,680,207. MAJOR LEAGUE BASEBALL PROPERTIES, INC., NEW YORK, NY. SN 77-125,032. PUB. 10-7-2008, FILED 3-7-2007.

MLB NETWORK

THE MARK CONSISTS OF STANDARD CHARACTERS WITHOUT CLAIM TO ANY PARTICULAR FONT, STYLE, SIZE, OR COLOR.

OWNER OF U.S. REG. NOS. 2,806,936, 2,971,015, AND OTHERS.

NO CLAIM IS MADE TO THE EXCLUSIVE RIGHT TO USE "NETWORK", APART FROM THE MARK AS SHOWN.

FOR ENTERTAINMENT SERVICES, NAMELY, BASEBALL, AND BASEBALL RELATED GAMES, COMPETITIONS AND EXHIBITIONS RENDERED LIVE, THROUGH BROADCAST MEDIA INCLUDING TELEVISION, SUBSCRIPTION TELEVISION, CABLE TELEVISION, VIDEO, VIDEO-ON-DEMAND, SATELLITE, DIGITAL TELEVISION, MOBILE PHONE, OR VIA A GLOBAL COMPUTER NETWORK; ENTERTAINMENT SERVICES, NAMELY, PROVISION, PRODUCTION, AND DISTRIBUTION OF PROGRAMMING BROADCAST VIA TELEVISION, SUBSCRIPTION TELEVISION, CABLE TELEVISION, VIDEO, VIDEO-ON-DEMAND, SATELLITE, DIGITAL TELEVISION, MOBILE PHONE, OR VIA A GLOBAL COMPUTER NETWORK; PROVIDING INFORMATION AND INFORMATIONAL MESSAGES IN THE FIELDS OF SPORTS, ENTERTAINMENT, LIFESTYLE AND NEWS THROUGH BROADCAST MEDIA INCLUDING TELEVISION, SUBSCRIPTION TELEVISION, CABLE TELEVISION, VIDEO, VIDEO-ON-DEMAND, SATELLITE, DIGITAL TELEVISION, MOBILE PHONE, OR VIA A GLOBAL COMPUTER NETWORK; EDUCATIONAL SERVICES IN THE NATURE OF SPORTS SKILLS PROGRAMS, OFFERED LIVE; ORGANIZING AND CONDUCTING CONTESTS, SWEEPSTAKES; PROVIDING ON-LINE NEWSLETTERS IN THE FIELDS OF SPORTS, ENTERTAINMENT, LIFESTYLE AND NEWS (U.S. CLS. 100, 101 AND 107).
FIRST USE 7-14-2008; IN COMMERCE 7-14-2008.

3,680,222. WORLD WRESTLING ENTERTAINMENT, INC., STAMFORD, CT. SN 77-141,655. PUB. 9-2-2008, FILED 3-27-2007.

MICHELLE MCCOOL

THE MARK CONSISTS OF STANDARD CHARACTERS WITHOUT CLAIM TO ANY PARTICULAR FONT, STYLE, SIZE, OR COLOR.

THE NAME SHOWN IN THE MARK IDENTIFIES "MICHELLE MCCOOL" A LIVING INDIVIDUAL WHOSE CONSENT IS OF RECORD.

FOR ENTERTAINMENT SERVICES, NAMELY, WRESTLING EXHIBITIONS AND PERFORMANCES BY A PROFESSIONAL WRESTLER AND ENTERTAINER; PROVIDING WRESTLING NEWS AND INFORMATION VIA A GLOBAL COMPUTER NETWORK (U.S. CLS. 100, 101 AND 107).

FIRST USE 3-3-2005; IN COMMERCE 3-3-2005.

CLASS 41—(Continued).

3,680,260. FORM FONTS, SAN DIEGO, CA. SN 77-158,915. PUB. 2-26-2008, FILED 4-17-2007.

SHAREDNET

THE MARK CONSISTS OF STANDARD CHARACTERS WITHOUT CLAIM TO ANY PARTICULAR FONT, STYLE, SIZE, OR COLOR.

FOR ON-LINE LIBRARY SERVICES, NAMELY, PROVIDING ELECTRONIC LIBRARY SERVICES WHICH FEATURE ARCHITECTURAL MODELS, TEXTURES, PHOTOGRAPHS AND PICTURES VIA AN ONLINE COMPUTER NETWORK (U.S. CLS. 100, 101 AND 107).

FIRST USE 11-30-2006; IN COMMERCE 2-5-2007.

3,680,268. THIAM, ALIAUNE, ATLANTA, GA. SN 77-164,681. PUB. 4-29-2008, FILED 4-24-2007.



NO CLAIM IS MADE TO THE EXCLUSIVE RIGHT TO USE "DISTRIBUTION", APART FROM THE MARK AS SHOWN.

THE MARK CONSISTS OF THE WORDING "KONLIVE" WITH THE "I" IMBEDDED WITHIN A MAN HOLDING A MICROPHONE AND THE WORDING "DISTRIBUTION".

FOR ENTERTAINMENT SERVICES, NAMELY, AUDIO RECORDING AND PRODUCTION; MUSIC PRODUCTION SERVICES; RECORD PRODUCTION; VIDEO-TAPE PRODUCTION; SOUND RECORDING STUDIOS; ENTERTAINMENT, NAMELY, LIVE PERFORMANCES BY A MUSICAL ARTIST; ENTERTAINMENT, NAMELY, LIVE MUSIC CONCERTS; ENTERTAINMENT SERVICES, NAMELY, PROVIDING PRERECORDED MUSIC, INFORMATION IN THE FIELD OF MUSIC, AND COMMENTARY AND ARTICLES ABOUT MUSIC, ALL ON-LINE VIA A GLOBAL COMPUTER NETWORK; ENTERTAINMENT SERVICES, NAMELY, PROVIDING A WEB SITE FEATURING MUSICAL PERFORMANCES, MUSICAL VIDEOS, RELATED FILM CLIPS, PHOTOGRAPHS, AND OTHER MULTIMEDIA MATERIALS (U.S. CLS. 100, 101 AND 107).

FIRST USE 5-1-2006; IN COMMERCE 5-1-2006.

CLASS 41—(Continued).

3,680,274. ANA LOMBA EARLY LANGUAGES LLC, PRINCETON JUNCTION, NJ. SN 77-169,033. PUB. 10-23-2007, FILED 4-30-2007.

ANA LOMBA EARLY LANGUAGES

THE MARK CONSISTS OF STANDARD CHARACTERS WITHOUT CLAIM TO ANY PARTICULAR FONT, STYLE, SIZE, OR COLOR.

NO CLAIM IS MADE TO THE EXCLUSIVE RIGHT TO USE "EARLY LANGUAGES", APART FROM THE MARK AS SHOWN.

THE NAME(S), PORTRAIT(S), AND/OR SIGNATURE(S) SHOWN IN THE MARK IDENTIFIES "ANA LOMBA", WHOSE CONSENT(S) TO REGISTER IS MADE OF RECORD.

FOR EDUCATIONAL SERVICES, NAMELY, DEVELOPING CURRICULUM FOR OTHERS IN THE FIELD OF LANGUAGES FOR CHILDREN AND BILINGUAL EDUCATION (U.S. CLS. 100, 101 AND 107).

FIRST USE 7-1-2009; IN COMMERCE 7-1-2009.

3,680,276. ANA LOMBA EARLY LANGUAGES LLC, PRINCETON JUNCTION, NJ. SN 77-169,211. PUB. 10-23-2007, FILED 4-30-2007.

ANA LOMBA'S EASY IMMERSION

THE MARK CONSISTS OF STANDARD CHARACTERS WITHOUT CLAIM TO ANY PARTICULAR FONT, STYLE, SIZE, OR COLOR.

THE NAME "ANA LOMBA" IN THE MARK IDENTIFIES A LIVING INDIVIDUAL WHOSE CONSENT IS OF RECORD.

FOR EDUCATIONAL SERVICES, NAMELY, DEVELOPING CURRICULUM FOR OTHERS IN THE FIELD OF LANGUAGES FOR CHILDREN AND BILINGUAL EDUCATION (U.S. CLS. 100, 101 AND 107).

FIRST USE 7-1-2007; IN COMMERCE 7-1-2009.

CLASS 41—(Continued).

3,680,293. FINISHRICH, INC., NEW YORK, NY. SN 77-177,301. PUB. 9-25-2007, FILED 5-10-2007.

FIGHT FOR YOUR MONEY

THE MARK CONSISTS OF STANDARD CHARACTERS WITHOUT CLAIM TO ANY PARTICULAR FONT, STYLE, SIZE, OR COLOR.

FOR EDUCATIONAL SERVICES, NAMELY, CONDUCTING SEMINARS IN THE FIELDS OF INVESTMENT ADVICE AND FINANCIAL PLANNING (U.S. CLS. 100, 101 AND 107).

FIRST USE 6-1-2009; IN COMMERCE 6-1-2009.

3,680,294. MISS MEGHAN MEDIA, INC., NEW YORK, NY. SN 77-178,656. PUB. 3-25-2008, FILED 5-11-2007.

SHOE THERAPY

THE MARK CONSISTS OF STANDARD CHARACTERS WITHOUT CLAIM TO ANY PARTICULAR FONT, STYLE, SIZE, OR COLOR.

NO CLAIM IS MADE TO THE EXCLUSIVE RIGHT TO USE "SHOE", APART FROM THE MARK AS SHOWN.

FOR ENTERTAINMENT SERVICES IN THE NATURE OF AN ONGOING TELEVISION SERIES IN THE FIELD OF SHOES (U.S. CLS. 100, 101 AND 107).

FIRST USE 8-0-2007; IN COMMERCE 8-0-2007.

3,680,327. QI MOUNTAIN, INC., GREENVILLE, SC. SN 77-188,686. PUB. 4-15-2008, FILED 5-23-2007.

QI MOTION

THE MARK CONSISTS OF STANDARD CHARACTERS WITHOUT CLAIM TO ANY PARTICULAR FONT, STYLE, SIZE, OR COLOR.

NO CLAIM IS MADE TO THE EXCLUSIVE RIGHT TO USE "MOTION", APART FROM THE MARK AS SHOWN.

THE FOREIGN WORDING IN THE MARK TRANSLATES INTO ENGLISH AS 'LIFE FORCE' OR 'SPIRITUAL ENERGY'.

FOR YOGA INSTRUCTION; PROVIDING FITNESS AND EXERCISE FACILITIES; MEDITATION TRAINING (U.S. CLS. 100, 101 AND 107).

FIRST USE 11-11-2007; IN COMMERCE 11-11-2007.

CLASS 41—(Continued).

3,680,339. BALTIMORE & OHIO RAILROAD MUSEUM, BALTIMORE, MD. SN 77-196,761. PUB. 11-27-2007, FILED 6-4-2007.

CLASS 41—(Continued).

3,680,372. BALTIMORE & OHIO RAILROAD MUSEUM, BALTIMORE, MD. SN 77-225,514. PUB. 11-20-2007, FILED 7-10-2007.

CHOO CHOO BLUE

THE MARK CONSISTS OF STANDARD CHARACTERS WITHOUT CLAIM TO ANY PARTICULAR FONT, STYLE, SIZE, OR COLOR.

NO CLAIM IS MADE TO THE EXCLUSIVE RIGHT TO USE "CHOO CHOO", APART FROM THE MARK AS SHOWN.

FOR ENTERTAINMENT IN THE NATURE OF ONGOING TELEVISION PROGRAMS IN THE FIELD OF CHILDREN'S EDUCATIONAL PROGRAMMING (U.S. CLS. 100, 101 AND 107).

FIRST USE 1-1-2009; IN COMMERCE 1-1-2009.

BRAIN TRAIN

THE MARK CONSISTS OF STANDARD CHARACTERS WITHOUT CLAIM TO ANY PARTICULAR FONT, STYLE, SIZE, OR COLOR.

NO CLAIM IS MADE TO THE EXCLUSIVE RIGHT TO USE "TRAIN", APART FROM THE MARK AS SHOWN.

FOR ENTERTAINMENT IN THE NATURE OF ONGOING TELEVISION PROGRAMS IN THE FIELD OF CHILDREN'S EDUCATIONAL PROGRAMMING (U.S. CLS. 100, 101 AND 107).

FIRST USE 1-1-2009; IN COMMERCE 1-1-2009.

3,680,340. THE LIBRARY SQUARE FOUNDATION FOR ART, CULTURE AND SCIENCE, SALT LAKE CITY, UT. SN 77-197,009. PUB. 4-29-2008, FILED 6-4-2007.

THE LEO

THE MARK CONSISTS OF STANDARD CHARACTERS WITHOUT CLAIM TO ANY PARTICULAR FONT, STYLE, SIZE, OR COLOR.

FOR INFORMAL EDUCATIONAL SERVICES, NAMELY, PROVIDING CLASSES AND LEARNING PROGRAMS WITH THE USE OF EXHIBITS IN THE FIELDS OF ART, CULTURE, AND SCIENCE (U.S. CLS. 100, 101 AND 107).

FIRST USE 9-30-2008; IN COMMERCE 9-30-2008.

3,680,409. ROSS, ROBERT, DR., NEW YORK, NY. SN 77-275,798. PUB. 3-4-2008, FILED 9-10-2007.

UMHS

3,680,371. JACK HERNANDEZ, BOYNTON BEACH, FL. SN 77-223,456. PUB. 12-25-2007, FILED 7-6-2007.

LUNASOL

THE MARK CONSISTS OF STANDARD CHARACTERS WITHOUT CLAIM TO ANY PARTICULAR FONT, STYLE, SIZE, OR COLOR.

THE ENGLISH TRANSLATION OF THE MARK IS MOON-SUN.

FOR ARRANGING AND CONDUCTING OF CONCERTS; CONCERT BOOKING; ENTERTAINMENT, NAMELY, LIVE MUSIC CONCERTS (U.S. CLS. 100, 101 AND 107).

FIRST USE 5-15-2007; IN COMMERCE 6-20-2007.

THE MARK CONSISTS OF STANDARD CHARACTERS WITHOUT CLAIM TO ANY PARTICULAR FONT, STYLE, SIZE, OR COLOR.

FOR EDUCATING AT UNIVERSITY OR COLLEGES; EDUCATIONAL SERVICES, NAMELY, PROVIDING COURSES OF INSTRUCTION AT THE UNIVERSITY, COLLEGE AND VOCATIONAL LEVEL, AND DISTRIBUTION OF COURSE MATERIAL IN CONNECTION THEREWITH; EDUCATIONAL SERVICES, NAMELY, PROVIDING COURSES AND INSTRUCTION TO STUDENTS TO BECOME MEDICAL DOCTORS, NURSES, NURSE'S AIDES, LABORATORY TECHNICIANS, RADIOLOGY TECHNICIANS AND OTHER PROFESSIONALS IN THE FIELD OF HEALTH AND SCIENCE (U.S. CLS. 100, 101 AND 107).

FIRST USE 10-13-2007; IN COMMERCE 10-13-2007.

CLASS 41—(Continued).

3,680,423. WORLD WRESTLING ENTERTAINMENT, INC., STAMFORD, CT. SN 77-288,361. PUB. 3-11-2008, FILED 9-25-2007.

MARYSE

THE MARK CONSISTS OF STANDARD CHARACTERS WITHOUT CLAIM TO ANY PARTICULAR FONT, STYLE, SIZE, OR COLOR.

FOR ENTERTAINMENT SERVICES, NAMELY, WRESTLING EXHIBITIONS AND PERFORMANCES BY A PROFESSIONAL WRESTLER AND ENTERTAINER; PROVIDING WRESTLING NEWS AND INFORMATION VIA A GLOBAL COMPUTER NETWORK (U.S. CLS. 100, 101 AND 107).

FIRST USE 9-22-2006; IN COMMERCE 9-22-2006.

3,680,431. TRAFFIC AUDIT BUREAU FOR MEDIA MEASUREMENT, INC., NEW YORK, NY. SN 77-293,326. PUB. 5-6-2008, FILED 10-1-2007.



NO CLAIM IS MADE TO THE EXCLUSIVE RIGHT TO USE "OUT OF HOME MEDIA MEASUREMENT", APART FROM THE MARK AS SHOWN.

FOR PLANNING AND CONDUCTING EDUCATIONAL SEMINARS AND WORKSHOPS IN THE FIELD OF OUT-OF-HOME MEDIA AUDITING, MARKET, ADVERTISING, CONSUMER RESEARCH AND CONSULTING (U.S. CLS. 100, 101 AND 107).

FIRST USE 4-14-2008; IN COMMERCE 2-2-2009.

3,680,439. DEHN, MICHAEL, STREAMWOOD, IL. SN 77-295,194. PUB. 4-15-2008, FILED 10-3-2007.

TICKET PULSE

THE MARK CONSISTS OF STANDARD CHARACTERS WITHOUT CLAIM TO ANY PARTICULAR FONT, STYLE, SIZE, OR COLOR.

NO CLAIM IS MADE TO THE EXCLUSIVE RIGHT TO USE "TICKET", APART FROM THE MARK AS SHOWN.

FOR PROVIDING INFORMATION ABOUT BUYING, SELLING AND EXCHANGING OF TICKETS FOR SHOWS AND OTHER ENTERTAINMENT EVENTS VIA THE INTERNET (U.S. CLS. 100, 101 AND 107).

FIRST USE 7-7-2009; IN COMMERCE 7-7-2009.

CLASS 41—(Continued).

3,680,460. CARDENAS, ANTHONY J, CHICO, CA. SN 77-305,683. PUB. 9-9-2008, FILED 10-17-2007.

Muscle-Brain Integration

THE MARK CONSISTS OF STANDARD CHARACTERS WITHOUT CLAIM TO ANY PARTICULAR FONT, STYLE, SIZE, OR COLOR.

FOR DANCE INSTRUCTION; MARTIAL ARTS INSTRUCTION; PHYSICAL FITNESS INSTRUCTION; YOGA INSTRUCTION (U.S. CLS. 100, 101 AND 107).

FIRST USE 2-1-2004; IN COMMERCE 6-1-2006.

3,680,506. HANNIBAL BASEBALL INVESTMENT GROUP, LLC, SACRAMENTO, CA. SN 77-321,136. PUB. 4-15-2008, FILED 11-5-2007.

HANNIBAL CAVEMEN

THE MARK CONSISTS OF STANDARD CHARACTERS WITHOUT CLAIM TO ANY PARTICULAR FONT, STYLE, SIZE, OR COLOR.

FOR ENTERTAINMENT IN THE NATURE OF BASEBALL GAMES (U.S. CLS. 100, 101 AND 107).

FIRST USE 1-1-2008; IN COMMERCE 6-4-2009.

3,680,514. ARD RI ENTERTAINMENT LTD., DUBLIN 2, IRELAND. SN 77-322,693. PUB. 4-22-2008, FILED 11-6-2007.

THE HIGH KINGS

THE MARK CONSISTS OF STANDARD CHARACTERS WITHOUT CLAIM TO ANY PARTICULAR FONT, STYLE, SIZE, OR COLOR.

FOR ENTERTAINMENT SERVICES, NAMELY, ENTERTAINMENT IN THE NATURE OF LIVE PERFORMANCES BY A MUSICAL GROUP, LIVE MUSIC CONCERTS, AND PROVIDING TELEVISION PROGRAMS IN THE FIELD OF MUSIC; ENTERTAINMENT SERVICES, NAMELY, PRODUCTION OF MUSICAL SHOWS, PHOTOGRAPHS IN THE FIELD OF MUSIC (U.S. CLS. 100, 101 AND 107).

FIRST USE 1-13-2008; IN COMMERCE 1-13-2008.

CLASS 41—(Continued).

3,680,521. NATIONAL AUDUBON SOCIETY, INC., NEW YORK, NY. SN 77-324,911. PUB. 10-14-2008, FILED 11-8-2007.

TOGETHER GREEN

THE MARK CONSISTS OF STANDARD CHARACTERS WITHOUT CLAIM TO ANY PARTICULAR FONT, STYLE, SIZE, OR COLOR.

NO CLAIM IS MADE TO THE EXCLUSIVE RIGHT TO USE "GREEN", APART FROM THE MARK AS SHOWN.

FOR EDUCATIONAL SERVICES, NAMELY, PROVIDING A WEB SITE FEATURING EDUCATIONAL INFORMATION AND CONDUCTING FELLOWSHIP PROGRAMS, WORKSHOPS, CONFERENCE PROGRAMS AND TRAINING COURSES ALL IN THE FIELD OF WILDLIFE AND ENVIRONMENTAL CONSERVATION AND PRESERVATION (U.S. CLS. 100, 101 AND 107).

FIRST USE 4-15-2008; IN COMMERCE 4-15-2008.

CLASS 41—(Continued).

3,680,524. PEBBLE BEACH COMPANY, PEBBLE BEACH, CA. SN 77-326,279. PUB. 3-3-2009, FILED 11-9-2007.

PEBBLE BEACH

THE MARK CONSISTS OF STANDARD CHARACTERS WITHOUT CLAIM TO ANY PARTICULAR FONT, STYLE, SIZE, OR COLOR.

OWNER OF U.S. REG. NOS. 1,065,027, 1,884,513, AND OTHERS.

FOR ENTERTAINMENT SERVICES, NAMELY, WINE AND FOOD TASTINGS; CONDUCTING ENTERTAINMENT EXHIBITIONS IN THE NATURE OF WINE AND FOOD FESTIVALS; ARRANGING AND CONDUCTING CLASSES, SEMINARS AND WORKSHOPS IN THE FIELDS OF WINE, WINERIES, COOKING, CHEFS AND FOOD, AND DISTRIBUTION OF COURSE MATERIALS IN CONNECTION THEREWITH; EDUCATIONAL DEMONSTRATIONS; PROVIDING INFORMATION, NEWS AND COMMENTARY IN THE FIELD OF RECREATION AND LEISURE ACTIVITIES; ENTERTAINMENT SERVICES IN THE NATURE OF AN AUTOMOBILE SHOW AND EXHIBIT; GOLF RESORT SERVICES; GOLF COURSES; GOLF AND TENNIS INSTRUCTION; RENTAL OF GOLF EQUIPMENT; PROVIDING A WEBSITE THROUGH WHICH GOLFERS RESERVE TEE TIMES AT GOLF COURSES; PROVIDING A WEBSITE THROUGH WHICH GOLFERS LOCATE INFORMATION ABOUT GOLF COURSES AND GOLF TOURNAMENTS; PROVIDING INFORMATION IN THE FIELDS OF GOLF, GOLF RESORTS, GOLF INSTRUCTION, GOLF COURSES, AND GOLF TOURNAMENTS; ENTERTAINMENT IN THE NATURE OF GOLF AND TENNIS TOURNAMENTS; ORGANIZING AND CONDUCTING POLO AND RUGBY CONTESTS AND SAILING REGATTAS; COUNTRY CLUBS; PROVIDING FACILITIES FOR RECREATION ACTIVITIES; RECREATION SERVICES IN THE NATURE OF PROVIDING GOLF AND TENNIS FACILITIES; AND PROVIDING ONLINE NEWSLETTERS IN THE FIELDS OF RECREATION AND LEISURE ACTIVITIES, GOLF RESORTS, SPORTS, ENTERTAINMENT, CULTURE, TOURISM, CUISINE AND HISTORY (U.S. CLS. 100, 101 AND 107).

FIRST USE 0-0-1919; IN COMMERCE 0-0-1919.

3,680,540. VIBRANT BRAINS LLC, SAN FRANCISCO, CA. SN 77-329,929. PUB. 10-14-2008, FILED 11-14-2007.

VIBRANTBRAINS NEUROBICS
CIRCUIT

THE MARK CONSISTS OF STANDARD CHARACTERS WITHOUT CLAIM TO ANY PARTICULAR FONT, STYLE, SIZE, OR COLOR.

NO CLAIM IS MADE TO THE EXCLUSIVE RIGHT TO USE "NEUROBICS CIRCUIT", APART FROM THE MARK AS SHOWN.

FOR COGNITIVE TRAINING REGIMEN INCORPORATING THE USE OF SOFTWARE PROGRAMS (U.S. CLS. 100, 101 AND 107).

FIRST USE 12-1-2007; IN COMMERCE 12-1-2007.

CLASS 41—(Continued).

3,680,560. HOME BOX OFFICE, INC., NEW YORK, NY. SN 77-334,896. PUB. 10-14-2008, FILED 11-21-2007.

EASTBOUND AND DOWN

THE MARK CONSISTS OF STANDARD CHARACTERS WITHOUT CLAIM TO ANY PARTICULAR FONT, STYLE, SIZE, OR COLOR.

FOR ENTERTAINMENT SERVICES IN THE NATURE OF AN ONGOING TELEVISION PROGRAM FEATURING COMEDY; INTERACTIVE ONLINE ENTERTAINMENT IN THE NATURE OF A WEBSITE CONTAINING PHOTOGRAPHIC, VIDEO AND PROSE PRESENTATIONS, RELATED FILM CLIPS AND OTHER MULTIMEDIA MATERIALS FEATURING AN ONGOING COMEDY TELEVISION SERIES (U.S. CLS. 100, 101 AND 107).

FIRST USE 2-15-2009; IN COMMERCE 2-5-2009.

3,680,588. CAPTAIN MUSIC, INC., MERRITT ISLAND, FL. SN 77-339,566. PUB. 4-29-2008, FILED 11-29-2007.

TROPICAL MOTIVATION

THE MARK CONSISTS OF STANDARD CHARACTERS WITHOUT CLAIM TO ANY PARTICULAR FONT, STYLE, SIZE, OR COLOR.

FOR ENTERTAINMENT SERVICES, NAMELY, PROVIDING LIVE MUSICAL PERFORMANCES (U.S. CLS. 100, 101 AND 107).

FIRST USE 8-22-2008; IN COMMERCE 8-22-2008.

3,680,606. THE SINCLAIR GROUP NEVADA, LLC., INCLINE VILLAGE, NV. SN 77-344,984. PUB. 11-25-2008, FILED 12-5-2007.

PROCESS AVAILABILITY LEADER

THE MARK CONSISTS OF STANDARD CHARACTERS WITHOUT CLAIM TO ANY PARTICULAR FONT, STYLE, SIZE, OR COLOR.

NO CLAIM IS MADE TO THE EXCLUSIVE RIGHT TO USE "PROCESS AVAILABILITY", APART FROM THE MARK AS SHOWN.

FOR BUSINESS TRAINING; TRAINING IN THE USE AND OPERATION OF MANUFACTURING EQUIPMENT; TRAINING SERVICES IN THE FIELD OF INDUSTRIAL PLANT OPERATIONS (U.S. CLS. 100, 101 AND 107).

FIRST USE 10-31-2007; IN COMMERCE 2-29-2008.

CLASS 41—(Continued).

3,680,613. ID ANALYTICS, INC., SAN DIEGO, CA. SN 77-347,248. PUB. 10-7-2008, FILED 12-7-2007.

id:analytics

OWNER OF U.S. REG. NO. 2,916,055.
SEC. 2(F).

FOR PROVIDING NEWSLETTERS IN THE FIELD OF IDENTITY SECURITY VIA E-MAIL; ARRANGING AND CONDUCTING SEMINARS AND CONFERENCES IN THE FIELD OF IDENTITY SECURITY (U.S. CLS. 100, 101 AND 107).

FIRST USE 7-17-2008; IN COMMERCE 7-17-2008.

3,680,623. SHAFRAN, JOSHUA, CAPE CORAL, FL. SN 77-348,995. PUB. 10-7-2008, FILED 12-11-2007.

IWIQ

THE MARK CONSISTS OF STANDARD CHARACTERS WITHOUT CLAIM TO ANY PARTICULAR FONT, STYLE, SIZE, OR COLOR.

FOR EDUCATION SERVICES, NAMELY, PROVIDING WORKSHOPS AND SEMINARS IN THE FIELD OF PERSONAL DEVELOPMENT, SALES MOTIVATION AND MAKING MONEY ON THE INTERNET; PROFESSIONAL COACHING SERVICES IN THE FIELD OF PERSONAL DEVELOPMENT, SALES MOTIVATION AND MAKING MONEY ON THE INTERNET; EDUCATION SERVICES, NAMELY, MENTORING IN THE FIELD OF PERSONAL DEVELOPMENT, SALES MOTIVATION AND MAKING MONEY ON THE INTERNET (U.S. CLS. 100, 101 AND 107).

FIRST USE 5-0-2003; IN COMMERCE 5-0-2003.

3,680,652. SPIRITSEARCH COMPANY, MINNEAPOLIS, MN. SN 77-359,331. PUB. 10-7-2008, FILED 12-26-2007.

SPIRITSEARCH

THE MARK CONSISTS OF STANDARD CHARACTERS WITHOUT CLAIM TO ANY PARTICULAR FONT, STYLE, SIZE, OR COLOR.

FOR PROVIDING ADULT EDUCATION IN A NON-RELIGIOUS ENVIRONMENT, NAMELY, PROVIDING SEMINARS AND RETREATS IN THE FIELD OF SPIRITUALITY, MOTIVATION AND SELF-IMPROVEMENT (U.S. CLS. 100, 101 AND 107).

FIRST USE 3-29-2004; IN COMMERCE 3-29-2004.

CLASS 41—(Continued).

3,680,663. MCDONALD'S CORPORATION, OAK BROOK, IL. SN 77-366,264. PUB. 4-29-2008, FILED 1-8-2008.

UNDER THE ARCHES

THE MARK CONSISTS OF STANDARD CHARACTERS WITHOUT CLAIM TO ANY PARTICULAR FONT, STYLE, SIZE, OR COLOR.

FOR EDUCATION SERVICES, NAMELY, PROVIDING LANGUAGE CLASSES, INSTRUCTION AND TRAINING (U.S. CLS. 100, 101 AND 107).

FIRST USE 3-30-2007; IN COMMERCE 3-30-2007.

3,680,668. SAMUEL J. KUNTZ, DBA MY TOWN PHOTOGRAPHY, SEATTLE, WA. SN 77-366,583. PUB. 5-27-2008, FILED 1-8-2008.

My Town Photography

THE MARK CONSISTS OF STANDARD CHARACTERS WITHOUT CLAIM TO ANY PARTICULAR FONT, STYLE, SIZE, OR COLOR.

NO CLAIM IS MADE TO THE EXCLUSIVE RIGHT TO USE "PHOTOGRAPHY", APART FROM THE MARK AS SHOWN.

FOR AERIAL PHOTOGRAPHY; PHOTOGRAPHY; PHOTOGRAPHY SERVICES; PORTRAIT PHOTOGRAPHY; PROVIDING FACILITIES FOR PRODUCING VIDEO, CINEMA AND PHOTOGRAPHY PRODUCTIONS (U.S. CLS. 100, 101 AND 107).

FIRST USE 7-16-2008; IN COMMERCE 7-16-2008.

3,680,737. CO-LABS, INC., BOULDER, CO. SN 77-404,256. PUB. 2-10-2009, FILED 2-22-2008.

CO-LABS

THE MARK CONSISTS OF STANDARD CHARACTERS WITHOUT CLAIM TO ANY PARTICULAR FONT, STYLE, SIZE, OR COLOR.

FOR PUBLISHING OF EDUCATIONAL MATERIALS REGARDING THE SCIENTIFIC AND ECONOMIC VALUE OF FEDERALLY FUNDED LABORATORIES (U.S. CLS. 100, 101 AND 107).

FIRST USE 6-19-2007; IN COMMERCE 7-23-2008.

CLASS 41—(Continued).

3,680,746. GIRL SCOUTS OF THE UNITED STATES OF AMERICA, NEW YORK, NY. SN 77-406,742. PUB. 9-30-2008, FILED 2-26-2008.

GIRLTOPIA

THE MARK CONSISTS OF STANDARD CHARACTERS WITHOUT CLAIM TO ANY PARTICULAR FONT, STYLE, SIZE, OR COLOR.

FOR EDUCATIONAL AND TRAINING SERVICES, NAMELY, CONDUCTING PROGRAMS AND ACTIVITIES FOR GIRLS AND YOUNG WOMEN TO PROMOTE SOCIAL, PHYSICAL AND INTELLECTUAL GROWTH AND DEVELOPMENT (U.S. CLS. 100, 101 AND 107).

FIRST USE 2-0-2008; IN COMMERCE 2-0-2008.

3,680,775. RASCH, MORGANA S., LOS ANGELES, CA. SN 77-427,167. PUB. 9-30-2008, FILED 3-20-2008.

FINANCIAL ALCHEMY

THE MARK CONSISTS OF STANDARD CHARACTERS WITHOUT CLAIM TO ANY PARTICULAR FONT, STYLE, SIZE, OR COLOR.

NO CLAIM IS MADE TO THE EXCLUSIVE RIGHT TO USE "FINANCIAL", APART FROM THE MARK AS SHOWN.

FOR PERSONAL COACHING SERVICES IN THE FIELDS OF CAREER MANAGEMENT AND ADVANCEMENT, GOAL MANIFESTATION, PERSONAL AND PROFESSIONAL GROWTH AND DEVELOPMENT, SELF-HELP, AND WELLNESS; LIFE COACHING SERVICES IN THE FIELDS OF CAREER MANAGEMENT AND ADVANCEMENT, GOAL MANIFESTATION, PERSONAL AND PROFESSIONAL GROWTH AND DEVELOPMENT, SELF-HELP, AND WELLNESS; PROFESSIONAL COACHING SERVICES IN THE FIELDS OF CAREER MANAGEMENT AND ADVANCEMENT, GOAL MANIFESTATION, PERSONAL AND PROFESSIONAL GROWTH AND DEVELOPMENT, SELF-HELP, AND WELLNESS; EXECUTIVE COACHING SERVICES IN THE FIELDS OF CAREER MANAGEMENT AND DEVELOPMENT, GOAL MANIFESTATION, AND PERSONAL AND PROFESSIONAL GROWTH AND DEVELOPMENT; BUSINESS COACHING SERVICES IN THE FIELDS OF CAREER MANAGEMENT AND DEVELOPMENT, GOAL MANIFESTATION, AND PERSONAL AND PROFESSIONAL GROWTH AND DEVELOPMENT; CORPORATE COACHING SERVICES IN THE FIELDS OF CAREER MANAGEMENT AND DEVELOPMENT, GOAL

CLASS 41—(Continued).

MANIFESTATION, AND PERSONAL AND PROFESSIONAL GROWTH AND DEVELOPMENT; EDUCATIONAL SERVICES, NAMELY, CONDUCTING CLASSES, SEMINARS, WORKSHOPS, CONFERENCES AND LECTURES, ALL IN THE FIELDS OF CAREER MANAGEMENT AND ADVANCEMENT, GOAL MANIFESTATION, PERSONAL AND PROFESSIONAL GROWTH AND DEVELOPMENT, SELF-HELP, AND WELLNESS, AND PROVIDING COURSE MATERIALS IN CONNECTION THEREWITH; PERSONAL COACH TRAINING; LIFE COACH TRAINING; PROFESSIONAL COACH TRAINING; EXECUTIVE COACH TRAINING; BUSINESS COACH TRAINING; CORPORATE COACH TRAINING; AND EDUCATIONAL SERVICES, NAMELY, CONDUCTING CLASSES, SEMINARS, WORKSHOPS, CONFERENCES AND LECTURES, ALL IN THE FIELDS OF TRAINING PERSONAL COACHES, LIFE COACHES, PROFESSIONAL COACHES, EXECUTIVE COACHES, BUSINESS COACHES, AND CORPORATE COACHES, AND PROVIDING COURSE MATERIALS IN CONNECTION THEREWITH (U.S. CLS. 100, 101 AND 107).

FIRST USE 6-7-2003; IN COMMERCE 6-7-2003.



3,680,777. LAB-AIDS INC, RONKONKOMA, NY. SN 77-428,466. PUB. 8-5-2008, FILED 3-21-2008.

Experiencing Science

THE MARK CONSISTS OF STANDARD CHARACTERS WITHOUT CLAIM TO ANY PARTICULAR FONT, STYLE, SIZE, OR COLOR.

NO CLAIM IS MADE TO THE EXCLUSIVE RIGHT TO USE "SCIENCE", APART FROM THE MARK AS SHOWN.

FOR PROVIDING SCIENCE EDUCATIONAL MENTORING SERVICES AND PROGRAMS (U.S. CLS. 100, 101 AND 107).

FIRST USE 1-1-2009; IN COMMERCE 1-1-2009.

CLASS 41—(Continued).

3,680,824. D.O.G. INC., DBA BIRMINGHAM CONSULTING, LONG BEACH, CA. SN 77-447,373. PUB. 1-27-2009, FILED 4-14-2008.

THE ESTEEM PRINCIPLE

THE MARK CONSISTS OF STANDARD CHARACTERS WITHOUT CLAIM TO ANY PARTICULAR FONT, STYLE, SIZE, OR COLOR.

NO CLAIM IS MADE TO THE EXCLUSIVE RIGHT TO USE "ESTEEM", APART FROM THE MARK AS SHOWN.

FOR EDUCATIONAL SERVICES, NAMELY, CONDUCTING CLASSES, SEMINARS AND TRAINING IN THE FIELDS OF INTERPERSONAL COMMUNICATION, HEALTH, SELF-ESTEEM AND WELL-BEING, DRUG PREVENTION, PROBLEM-SOLVING, LIFE TRANSITION ADJUSTMENT, AND DIVERSITY; LIFE COACHING SERVICES IN THE FIELDS OF INTERPERSONAL COMMUNICATION, HEALTH, SELF-ESTEEM AND WELL-BEING, DRUG PREVENTION, PROBLEM-SOLVING, LIFE TRANSITION ADJUSTMENT, AND DIVERSITY (U.S. CLS. 100, 101 AND 107).

FIRST USE 4-0-2008; IN COMMERCE 4-0-2008.



3,680,843. COMMUNITY PARTNERS FBO AMAZING KIDS!, LOS ANGELES, CA. SN 77-456,327. PUB. 11-11-2008, FILED 4-23-2008.

LAUNCH MY DREAM!

THE MARK CONSISTS OF STANDARD CHARACTERS WITHOUT CLAIM TO ANY PARTICULAR FONT, STYLE, SIZE, OR COLOR.

FOR PROVIDING CHARITABLE SERVICES, NAMELY, AN INITIATIVE THAT PROVIDES EDUCATIONAL RESOURCES IN THE FORM OF CAREER-FOCUSED MENTORING SERVICES AND CAREER AND PERSONAL DEVELOPMENT CURRICULUM PROVIDED VIA THE INTERNET, BOOKS, CDS, CD-ROMS, VIDEOCASSETTES AND DVDS TO HIGH POTENTIAL CHILDREN TO ASSIST THEM IN ACHIEVING THEIR CAREER AND LIFE GOALS; ENTERTAINMENT SERVICES, NAMELY, AN ON-GOING DOCUMENTARY-STYLE SERIES BROADCAST OVER TELEVISION, SATELLITE, CABLE, AND THE INTERNET FEATURING TRUE STORIES ABOUT HIGH POTENTIAL CHILDREN ACHIEVING THEIR CAREER AND LIFE GOALS (U.S. CLS. 100, 101 AND 107).

FIRST USE 4-22-2008; IN COMMERCE 4-22-2008.

CLASS 41—(Continued).

3,680,867. BAER, ALEXANDER R., CINCINNATI, OH. SN 77-460,017. PUB. 9-23-2008, FILED 4-28-2008.



THE COLOR(S) BLUE AND BLACK IS/ARE CLAIMED AS A FEATURE OF THE MARK.

THE MARK CONSISTS OF THE WORD "RECURRENCE" IN BLACK OUTLINED IN LIGHT BLUE WITH ALL CAPS AND IN BOLD TYPE. THE SYMBOL CONSISTS OF A CIRCLE WITH ARROWS POINTING IN SEVERAL DIRECTIONS BEHIND THE WORD IN BLACK AND OUTLINED IN LIGHT BLUE. THE BACKGROUND IS IN BLACK.

FOR ENTERTAINMENT, NAMELY, LIVE PERFORMANCES BY A MUSICAL BAND; MULTIMEDIA ENTERTAINMENT SERVICES IN THE NATURE OF RECORDING, PRODUCTION AND POST-PRODUCTION SERVICES IN THE FIELDS OF MUSIC, VIDEO, AND FILMS (U.S. CLS. 100, 101 AND 107).

FIRST USE 1-5-2009; IN COMMERCE 1-12-2009.

CLASS 41—(Continued).

3,680,930. ADTP, INC., NEW MARKET, AL. SN 77-471,850. PUB. 10-14-2008, FILED 5-12-2008.



THE COLOR(S) GREEN, BLUE IS/ARE CLAIMED AS A FEATURE OF THE MARK.

THE MARK CONSISTS OF GREEN WING FOLLOWED BY THE BLUE CAPITAL LETTERS "ADTP".

FOR TRAINING SERVICES, NAMELY, ONLINE TRAINING SERVICES FOR FREIGHT DELIVERY DRIVERS (U.S. CLS. 100, 101 AND 107).

FIRST USE 12-30-2007; IN COMMERCE 12-30-2007.

3,680,934. THE LOS ANGELES KINGS HOCKEY CLUB, L.P., EL SEGUNDO, CA. SN 77-472,125. PUB. 11-11-2008, FILED 5-12-2008.

3,680,886. REY, JOE, PORTLAND, OR. SN 77-466,295. PUB. 9-30-2008, FILED 5-5-2008.

POPOLOGY

THE MARK CONSISTS OF STANDARD CHARACTERS WITHOUT CLAIM TO ANY PARTICULAR FONT, STYLE, SIZE, OR COLOR.

FOR EDUCATIONAL AND ENTERTAINMENT SERVICES, NAMELY, A CONTINUING PROGRAM ABOUT MUSIC VIDEOS ACCESSIBLE BY RADIO, TELEVISION, SATELLITE, AUDIO, VIDEO AND COMPUTER NETWORKS; ENTERTAINMENT SERVICES, NAMELY, PROVIDING A WEB SITE FEATURING MUSICAL PERFORMANCES, MUSICAL VIDEOS, RELATED FILM CLIPS, PHOTOGRAPHS, AND OTHER MULTIMEDIA MATERIALS (U.S. CLS. 100, 101 AND 107).

FIRST USE 7-20-2006; IN COMMERCE 7-11-2001.



OWNER OF U.S. REG. NOS. 921,757, 2,350,641, AND 2,398,313.

NO CLAIM IS MADE TO THE EXCLUSIVE RIGHT TO USE "LA", APART FROM THE MARK AS SHOWN.

THE STIPPLING IS FOR SHADING PURPOSES ONLY. THE MARK CONSISTS OF THE LETTERS "L" AND "A" IN A BOX AND A KINGS CROWN IN A DOWNSIDE TRIANGLE.

FOR ENTERTAINMENT SERVICES, NAMELY, ICE HOCKEY EXHIBITIONS (U.S. CLS. 100, 101 AND 107).

FIRST USE 11-22-2008; IN COMMERCE 11-22-2008.

CLASS 41—(Continued).

3,680,942. PIRANHA ENTERTAINMENT LLC, SEATTLE, WA. SN 77-473,188. PUB. 3-24-2009, FILED 5-13-2008.

XARM

THE MARK CONSISTS OF STANDARD CHARACTERS WITHOUT CLAIM TO ANY PARTICULAR FONT, STYLE, SIZE, OR COLOR.

FOR ENTERTAINMENT IN THE NATURE OF A CONTINUING MEDIA SERIES FEATURING A SPORT THAT CONTAINS ELEMENTS OF, BUT NOT LIMITED TO, ARM WRESTLING, BOXING, KICK BOXING, AND MARTIAL ARTS AND A SPORTS COMPETITION BASED ON SUCH SPORT DISTRIBUTED VIA VARIOUS PLATFORMS ACROSS MULTIPLE FORMS OF TRANSMISSION MEDIA; ARRANGING, ORGANIZING, CONDUCTING AND EXHIBITING SPORTS COMPETITIONS; ENTERTAINMENT SERVICES, NAMELY, MUSICAL PERFORMANCES PROVIDED DURING INTERVALS AS SPORTS EVENTS; FAN CLUBS; SPORTS NEWS AND INFORMATION; PUBLICATIONS OF TEXTS (U.S. CLS. 100, 101 AND 107).

FIRST USE 5-30-2008; IN COMMERCE 5-30-2008.

3,680,947. PROFESSIONAL TRANSLATING SERVICES, INC., MIAMI, FL. SN 77-473,436. PUB. 10-14-2008, FILED 5-13-2008.

PTS

THE MARK CONSISTS OF STANDARD CHARACTERS WITHOUT CLAIM TO ANY PARTICULAR FONT, STYLE, SIZE, OR COLOR.

FOR TRANSLATION SERVICES (U.S. CLS. 100, 101 AND 107).

FIRST USE 6-1-2008; IN COMMERCE 6-1-2008.

CLASS 41—(Continued).

3,680,974. COVENANT RELIANCE PRODUCERS, LLC, NASHVILLE, TN. SN 77-477,835. PUB. 3-17-2009, FILED 5-19-2008.

PRODUCERS EQUITY GROUP

THE MARK CONSISTS OF STANDARD CHARACTERS WITHOUT CLAIM TO ANY PARTICULAR FONT, STYLE, SIZE, OR COLOR.

NO CLAIM IS MADE TO THE EXCLUSIVE RIGHT TO USE "EQUITY GROUP", APART FROM THE MARK AS SHOWN.

FOR EDUCATIONAL SERVICES, NAMELY, CONDUCTING SEMINARS AND WORKSHOPS IN THE FIELD OF ESTATE PLANNING, INSURANCE AND ANNUITIES AND DISTRIBUTION OF COURSE MATERIAL IN CONNECTION THEREWITH (U.S. CLS. 100, 101 AND 107).

FIRST USE 1-5-2009; IN COMMERCE 1-5-2009.

3,680,995. INTENTIONALLY URBAN MAGAZINE, LLC, PORTLAND, OR. SN 77-481,590. PUB. 10-28-2008, FILED 5-22-2008.

IN|UR

THE MARK CONSISTS OF THE INITIALS "IN" AND "UR" SEPARATED BY A VERTICAL LINE.

FOR ON-LINE JOURNALS, NAMELY, BLOGS IN THE FIELDS OF MUSIC, FILM, PARENTING, FASHION, BEAUTY, YOGA, SPORTS, HEALTH, RESEARCH, NUTRITION, RECIPES, LIFESTYLE, COMMUTING AND TRANSPORTATION, BUSINESS, ENVIRONMENTALISM, NON-PROFIT ORGANIZATIONS, SHOPPING, FINANCE AND INVESTMENT, SEX AND RELATIONSHIPS, DATING, ADVICE, HOME AND GARDEN, QUEER-THEMED ISSUES, REAL ESTATE, COMPLEMENTARY AND ALTERNATIVE MEDICINE, AND GREEN, ORGANIC, AND SUSTAINABLE PRODUCTS; AND PROVIDING ON-LINE E-ZINES IN THE FIELDS OF MUSIC, FILM, PARENTING, FASHION, BEAUTY, YOGA, SPORTS, HEALTH, RESEARCH, NUTRITION, RECIPES, LIFESTYLE, COMMUTING AND TRANSPORTATION, BUSINESS, ENVIRONMENTALISM, NON-PROFIT ORGANIZATIONS, SHOPPING, FINANCE AND INVESTMENT, SEX AND RELATIONSHIPS, DATING, ADVICE, HOME AND GARDEN, QUEER-THEMED ISSUES, REAL ESTATE, COMPLEMENTARY AND ALTERNATIVE MEDICINE, AND GREEN, ORGANIC, AND SUSTAINABLE PRODUCTS (U.S. CLS. 100, 101 AND 107).

FIRST USE 1-1-2008; IN COMMERCE 6-1-2008.

CLASS 41—(Continued).

3,680,997. INTENTIONALLY URBAN MAGAZINE, LLC, PORTLAND, OR. SN 77-481,640. PUB. 10-28-2008, FILED 5-22-2008.

Intentionally Urban

THE MARK CONSISTS OF STANDARD CHARACTERS WITHOUT CLAIM TO ANY PARTICULAR FONT, STYLE, SIZE, OR COLOR.

FOR ON-LINE JOURNALS, NAMELY, BLOGS IN THE FIELDS OF MUSIC, FILM, PARENTING, FASHION, BEAUTY, YOGA, SPORTS, HEALTH, RESEARCH, NUTRITION, RECIPES, LIFESTYLE, COMMUTING AND TRANSPORTATION, BUSINESS, ENVIRONMENTALISM, NON-PROFIT ORGANIZATIONS, SHOPPING, FINANCE AND INVESTMENT, SEX AND RELATIONSHIPS, DATING, ADVICE, HOME AND GARDEN, QUEER-THEMED ISSUES, REAL ESTATE, COMPLEMENTARY AND ALTERNATIVE MEDICINE, AND GREEN, ORGANIC, AND SUSTAINABLE PRODUCTS; AND PROVIDING ON-LINE E-ZINES IN THE FIELDS OF MUSIC, FILM, PARENTING, FASHION, BEAUTY, YOGA, SPORTS, HEALTH, RESEARCH, NUTRITION, RECIPES, LIFESTYLE, COMMUTING AND TRANSPORTATION, BUSINESS, ENVIRONMENTALISM, NON-PROFIT ORGANIZATIONS, SHOPPING, FINANCE AND INVESTMENT, SEX AND RELATIONSHIPS, DATING, ADVICE, HOME AND GARDEN, QUEER-THEMED ISSUES, REAL ESTATE, COMPLEMENTARY AND ALTERNATIVE MEDICINE, AND GREEN, ORGANIC, AND SUSTAINABLE PRODUCTS (U.S. CLS. 100, 101 AND 107).
FIRST USE 1-1-2008; IN COMMERCE 6-1-2008.

3,681,023. ROCKET GAMING SYSTEMS, LLC, GROVE, OK. SN 77-487,145. PUB. 10-28-2008, FILED 5-30-2008.

GOLD SERIES

THE MARK CONSISTS OF STANDARD CHARACTERS WITHOUT CLAIM TO ANY PARTICULAR FONT, STYLE, SIZE, OR COLOR.

NO CLAIM IS MADE TO THE EXCLUSIVE RIGHT TO USE "SERIES", APART FROM THE MARK AS SHOWN.
FOR GAMBLING SERVICES (U.S. CLS. 100, 101 AND 107).
FIRST USE 7-12-2009; IN COMMERCE 7-12-2009.

CLASS 41—(Continued).

3,681,024. GAME SHOW NETWORK, LLC, SANTA MONICA, CA. SN 77-487,332. PUB. 10-28-2008, FILED 5-30-2008.

CATCH 21

THE MARK CONSISTS OF STANDARD CHARACTERS WITHOUT CLAIM TO ANY PARTICULAR FONT, STYLE, SIZE, OR COLOR.

FOR ENTERTAINMENT IN THE NATURE OF ON-GOING TELEVISION GAME SHOWS; ENTERTAINMENT SERVICES, NAMELY, PROVIDING ON-LINE COMPUTER GAMES (U.S. CLS. 100, 101 AND 107).
FIRST USE 8-23-2002; IN COMMERCE 8-23-2002.

3,681,046. NATIONAL ASSOCIATION OF ESTATE PLANNERS & COUNCILS, CLEVELAND, OH. SN 77-494,323. PUB. 11-18-2008, FILED 6-9-2008.

NAEPC ESTATE PLANNING HALL OF FAME

THE MARK CONSISTS OF STANDARD CHARACTERS WITHOUT CLAIM TO ANY PARTICULAR FONT, STYLE, SIZE, OR COLOR.

NO CLAIM IS MADE TO THE EXCLUSIVE RIGHT TO USE "ESTATE PLANNING HALL OF FAME", APART FROM THE MARK AS SHOWN.

FOR EDUCATIONAL SERVICES, NAMELY, PROVIDING INCENTIVES TO PROFESSIONALS TO DEMONSTRATE EXCELLENCE IN THE FIELD OF ESTATE PLANNING, PROVIDING INCENTIVES TO PROFESSIONALS TO DEMONSTRATE EXCELLENCE IN THE FIELD OF ESTATE PLANNING THROUGH THE ISSUANCE OF AWARDS, ORGANIZING AND CONDUCTING PROGRAMS, TO RECOGNIZE, CELEBRATE AND RECORD THE ACHIEVEMENTS OF ESTATE PLANNERS (U.S. CLS. 100, 101 AND 107).
FIRST USE 6-5-2009; IN COMMERCE 6-5-2009.

3,681,067. WALKER, MICAH SHARAI, HOUSTON, TX. SN 77-498,078. PUB. 12-9-2008, FILED 6-13-2008.

VERSE CITY

THE MARK CONSISTS OF STANDARD CHARACTERS WITHOUT CLAIM TO ANY PARTICULAR FONT, STYLE, SIZE, OR COLOR.

FOR ENTERTAINMENT, NAMELY, LIVE PERFORMANCES BY A MUSICAL BAND (U.S. CLS. 100, 101 AND 107).
FIRST USE 9-19-2006; IN COMMERCE 9-19-2006.

CLASS 41—(Continued).

3,681,071. WEQ LLC, KENT, OH. SN 77-498,560. PUB. 11-4-2008, FILED 6-13-2008.

WEQ

THE MARK CONSISTS OF STANDARD CHARACTERS WITHOUT CLAIM TO ANY PARTICULAR FONT, STYLE, SIZE, OR COLOR.

FOR EDUCATION SERVICES, NAMELY, PROVIDING LECTURES, WORKSHOPS AND SEMINARS IN THE FIELDS OF INCREASING BUSINESS PERFORMANCE, MOTIVATION, PERSONAL AND PROFESSIONAL DEVELOPMENT, LEADERSHIP, SALES AND SERVICE; PERSONAL COACHING SERVICES IN THE FIELD OF MOTIVATION, PERSONAL DEVELOPMENT, LEADERSHIP, SALES AND SERVICE; PROFESSIONAL COACHING SERVICES IN THE FIELD OF INCREASING BUSINESS PERFORMANCE, MOTIVATION, PROFESSIONAL DEVELOPMENT, LEADERSHIP, SALES AND SERVICE (U.S. CLS. 100, 101 AND 107).
FIRST USE 9-0-2008; IN COMMERCE 9-0-2008.

3,681,084. RCR ENTERPRISES LLC, WELCOME, NC. SN 77-506,108. PUB. 11-18-2008, FILED 6-24-2008.



NO CLAIM IS MADE TO THE EXCLUSIVE RIGHT TO USE "MOTORSPORTS", APART FROM THE MARK AS SHOWN.

THE NAME "CHILDRESS HOWARD" DOES NOT IDENTIFY A LIVING INDIVIDUAL.

THE MARK CONSISTS OF THE STYLIZED WORDS "CHILDRESS HOWARD MOTORSPORTS"; THE WORD "CHILDRESS" IS UNDERLINED; A STYLIZED CHECKERED RACING FLAG APPEARS TO LEFT OF THE WORD "HOWARD"; THE WORD "MOTORSPORTS" IS BOXED; AN ARC APPEARS TO THE RIGHT BRACKETING ALL OTHER ELEMENTS OF THE MARK.

FOR ENTERTAINMENT SERVICES IN THE NATURE OF AUTOMOBILE RACING AND EXHIBITIONS (U.S. CLS. 100, 101 AND 107).
FIRST USE 1-31-2008; IN COMMERCE 8-31-2008.

CLASS 41—(Continued).

3,681,085. RCR ENTERPRISES LLC, WELCOME, NC. SN 77-506,111. PUB. 11-18-2008, FILED 6-24-2008.

**CHILDRESS HOWARD
MOTORSPORTS**

THE MARK CONSISTS OF STANDARD CHARACTERS WITHOUT CLAIM TO ANY PARTICULAR FONT, STYLE, SIZE, OR COLOR.

NO CLAIM IS MADE TO THE EXCLUSIVE RIGHT TO USE "MOTORSPORTS", APART FROM THE MARK AS SHOWN.

THE NAME "CHILDRESS HOWARD" DOES NOT IDENTIFY A LIVING INDIVIDUAL.

FOR ENTERTAINMENT SERVICES IN THE NATURE OF AUTOMOBILE RACING AND EXHIBITIONS (U.S. CLS. 100, 101 AND 107).

FIRST USE 1-31-2008; IN COMMERCE 8-31-2008.

3,681,101. SOUTHWESTERN/GREAT AMERICAN, INC., DBA THE SOUTHWESTERN COMPANY, NASHVILLE, TN. SN 77-512,305. PUB. 10-14-2008, FILED 7-1-2008.

MR. MEDIOCRITY

THE MARK CONSISTS OF STANDARD CHARACTERS WITHOUT CLAIM TO ANY PARTICULAR FONT, STYLE, SIZE, OR COLOR.

FOR EDUCATIONAL SERVICES, NAMELY, CONDUCTING SEMINARS, LECTURES, AND WORKSHOPS IN THE FIELD OF DIRECT SALES; EDUCATIONAL AND ENTERTAINMENT SERVICES, NAMELY, PROVIDING MOTIVATIONAL SPEAKING SERVICES IN THE FIELD OF DIRECT SALES (U.S. CLS. 100, 101 AND 107).

FIRST USE 0-0-1974; IN COMMERCE 0-0-1974.

3,681,154. MONTES, JILLIAN, STUART, FL. SN 77-531,105. PUB. 1-6-2009, FILED 7-24-2008.

sobo

THE MARK CONSISTS OF THE WORDING "SOBO" IN STYLIZED FONT.

FOR PROVIDING DANCE AND AEROBIC EXERCISE INSTRUCTION FOR PERSONAL DEVELOPMENT (U.S. CLS. 100, 101 AND 107).

FIRST USE 9-20-2008; IN COMMERCE 9-20-2008.

CLASS 41—(Continued).

3,681,170. AEC SCIENCE & TECHNOLOGY, LLC, CHADDS FORD, PA. SN 77-535,787. PUB. 2-3-2009, FILED 7-31-2008.

**THE NATIONAL HIGH
PERFORMANCE BUILDING
CONFERENCE**

THE MARK CONSISTS OF STANDARD CHARACTERS WITHOUT CLAIM TO ANY PARTICULAR FONT, STYLE, SIZE, OR COLOR.

NO CLAIM IS MADE TO THE EXCLUSIVE RIGHT TO USE "NATIONAL" AND "BUILDING CONFERENCE", APART FROM THE MARK AS SHOWN.

FOR ORGANIZING AND CONDUCTING CONFERENCES AND EXHIBITIONS RELATING TO THE APPLICATION OF INFORMATION TECHNOLOGY BY ARCHITECTS, ENGINEERS AND CONSTRUCTION CONTRACTORS (U.S. CLS. 100, 101 AND 107).

FIRST USE 9-4-2008; IN COMMERCE 9-4-2008.

CLASS 41—(Continued).

3,681,197. C10, INC., MILL VALLEY, CA. SN 77-548,113. PUB. 1-6-2009, FILED 8-15-2008.

PLAYACTIONPIX

THE MARK CONSISTS OF STANDARD CHARACTERS WITHOUT CLAIM TO ANY PARTICULAR FONT, STYLE, SIZE, OR COLOR.

FOR WEBSITE FEATURING NON-DOWNLOADABLE PHOTOGRAPHS IN THE FIELD OF SPORTS (U.S. CLS. 100, 101 AND 107).

FIRST USE 11-7-2008; IN COMMERCE 11-7-2008.

3,681,274. LAMB, CORY, KINGSTON, IL. SN 77-578,706. PUB. 3-3-2009, FILED 9-25-2008.

3,681,194. POLYGON ENTERTAINMENT, SAN RAFAEL, CA. SN 77-547,477. PUB. 12-23-2008, FILED 8-14-2008.

Polygon Entertainment

THE MARK CONSISTS OF STANDARD CHARACTERS WITHOUT CLAIM TO ANY PARTICULAR FONT, STYLE, SIZE, OR COLOR.

NO CLAIM IS MADE TO THE EXCLUSIVE RIGHT TO USE "ENTERTAINMENT", APART FROM THE MARK AS SHOWN.

FOR ENTERTAINMENT SERVICES, NAMELY, PRODUCTION OF SPECIAL EFFECTS INCLUDING MODEL-MAKING SERVICES, COMPUTER-GENERATED IMAGERY AND COMPUTER-GENERATED GRAPHICS FOR THE PRODUCTION OF MOTION PICTURES, VIDEOS, AND MOVIE TRAILERS; PRODUCTION AND DISTRIBUTION OF MOTION PICTURES (U.S. CLS. 100, 101 AND 107).

FIRST USE 4-16-2007; IN COMMERCE 4-16-2007.



NO CLAIM IS MADE TO THE EXCLUSIVE RIGHT TO USE "RACING", APART FROM THE MARK AS SHOWN.

THE STIPPLING IS FOR SHADING PURPOSES ONLY. THE MARK CONSISTS OF THE STYLIZED TEXT "BAD RATTITUDE RACING" WITH THREE RATS HOLDING MACHINE GUNS.

FOR ENTERTAINMENT IN THE NATURE OF AUTOMOBILE RACES (U.S. CLS. 100, 101 AND 107).

FIRST USE 6-5-2005; IN COMMERCE 6-5-2005.

CLASS 41—(Continued).

3,681,278. CAPITAL LIFEWORKS, WASHINGTON, DC. SN 77-579,714. PUB. 3-3-2009, FILED 9-26-2008.



THE STIPLING IS FOR SHADING PURPOSES.
THE MARK CONSISTS OF THE STYLIZED TEXT "CAPITAL LIFEWORKS" WITH TWO INTERSECTING CIRCLE IN THE END.

FOR PERSONAL COACHING SERVICES IN THE FIELD OF LIFE COACHING (U.S. CLS. 100, 101 AND 107).

FIRST USE 10-0-2008; IN COMMERCE 10-0-2008.

3,681,279. ISLES INC., TRENTON, NJ. SN 77-579,716. PUB. 2-17-2009, FILED 9-26-2008.

SPIRIT WALK

THE MARK CONSISTS OF STANDARD CHARACTERS WITHOUT CLAIM TO ANY PARTICULAR FONT, STYLE, SIZE, OR COLOR.

FOR PROVIDING ASSISTANCE, PERSONAL TRAINING AND PHYSICAL FITNESS CONSULTATION TO INDIVIDUALS TO HELP THEM MAKE PHYSICAL FITNESS, STRENGTH, CONDITIONING, AND EXERCISE IMPROVEMENT IN THEIR DAILY LIVING; PROVIDING INFORMATION ON PHYSICAL EXERCISE (U.S. CLS. 100, 101 AND 107).

FIRST USE 5-0-2006; IN COMMERCE 5-0-2006.

3,681,336. SHOWCORE, INC., EAGAN, MN. SN 77-598,382. PUB. 3-17-2009, FILED 10-22-2008.

SHOWCOREVISION

THE MARK CONSISTS OF STANDARD CHARACTERS WITHOUT CLAIM TO ANY PARTICULAR FONT, STYLE, SIZE, OR COLOR.

FOR ENTERTAINMENT, NAMELY, LIGHTING PRODUCTION; RENTAL OF STAGE AND MOVIE EQUIPMENT, NAMELY, CAMERA EQUIPMENT, LIGHTING EQUIPMENT AND GRIP EQUIPMENT (U.S. CLS. 100, 101 AND 107).

FIRST USE 10-1-2008; IN COMMERCE 10-1-2008.

CLASS 41—(Continued).

3,681,339. VEACH, DALE, LOCUST GROVE, GA. SN 77-599,745. PUB. 3-17-2009, FILED 10-24-2008.

Elad music production studios

THE MARK CONSISTS OF STANDARD CHARACTERS WITHOUT CLAIM TO ANY PARTICULAR FONT, STYLE, SIZE, OR COLOR.

NO CLAIM IS MADE TO THE EXCLUSIVE RIGHT TO USE "MUSIC PRODUCTION STUDIOS", APART FROM THE MARK AS SHOWN.

FOR PRODUCTION OF SOUND AND MUSIC VIDEO RECORDINGS (U.S. CLS. 100, 101 AND 107).

FIRST USE 11-9-2008; IN COMMERCE 11-9-2008.

3,681,356. NATIONAL ASSOCIATION OF SECONDARY SCHOOL PRINCIPALS, RESTON, VA. SN 77-604,170. PUB. 2-3-2009, FILED 10-30-2008.

NASC NATIONAL COUNCILS OF EXCELLENCE

THE MARK CONSISTS OF STANDARD CHARACTERS WITHOUT CLAIM TO ANY PARTICULAR FONT, STYLE, SIZE, OR COLOR.

OWNER OF U.S. REG. NO. 2,182,008.

NO CLAIM IS MADE TO THE EXCLUSIVE RIGHT TO USE "NATIONAL", APART FROM THE MARK AS SHOWN.

FOR EDUCATION SERVICES, NAMELY, PROVIDING CLASSES, SEMINARS AND WORKSHOPS IN THE FIELD OF STUDENT LEADERSHIP; PROVIDING RECOGNITION AND INCENTIVES BY THE WAY OF AWARDS TO DEMONSTRATE EXCELLENCE IN THE FIELD OF STUDENT LEADERSHIP (U.S. CLS. 100, 101 AND 107).

FIRST USE 2-15-2007; IN COMMERCE 2-15-2007.

CLASS 41—(Continued).

3,681,375. ANGEL, DAVID W, DBA THE WILLING, AURORA, IL. AND COOPER, KENT S, DBA THE WILLING, SOUTH ELGIN, IL. AND SMITH, DANIEL E, DBA THE WILLING, PLANO, IL. AND GOUGH, CHRIS J, DBA THE WILLING, DEKALB, IL. AND KRAHENBUHL, JOHN D, DBA THE WILLING, ST. CHARLES, IL. AND WIGSTONE, RICH A, DBA THE WILLING, PLANO, IL. SN 77-612,396. PUB. 3-31-2009, FILED 11-11-2008.

The Willing

THE MARK CONSISTS OF STANDARD CHARACTERS WITHOUT CLAIM TO ANY PARTICULAR FONT, STYLE, SIZE, OR COLOR.

FOR ENTERTAINMENT IN THE NATURE OF MUSICAL GROUP; ENTERTAINMENT SERVICES IN THE NATURE OF LIVE MUSICAL PERFORMANCES (U.S. CLS. 100, 101 AND 107).

FIRST USE 1-14-2009; IN COMMERCE 4-4-2009.

3,681,431. GUITAR CENTER, INC., WESTLAKE VILLAGE, CA. SN 77-977,557. PUB. 4-15-2008, FILED 8-23-2007.

DRUM PADS

THE MARK CONSISTS OF STANDARD CHARACTERS WITHOUT CLAIM TO ANY PARTICULAR FONT, STYLE, SIZE, OR COLOR.

NO CLAIM IS MADE TO THE EXCLUSIVE RIGHT TO USE "DRUM", APART FROM THE MARK AS SHOWN.

FOR ENTERTAINMENT SERVICES, NAMELY, WELL-KNOWN DRUMMERS PLAYING DRUMS IN THEIR PREFERRED REHEARSAL STUDIOS BROADCAST VIA ONLINE SHOWS, RADIO BROADCASTS, TELEVISION BROADCASTS, CABLE TELEVISION BROADCASTS, AND WEBCASTS (U.S. CLS. 100, 101 AND 107).

FIRST USE 12-24-2008; IN COMMERCE 12-24-2008.

3,681,459. BOURDON, JUSTIN, DRIPPING SPRINGS, TX. SN 78-412,097. PUB. 10-4-2005, FILED 5-3-2004.



FOR MUSIC PRODUCTION SERVICES; ENTERTAINMENT, NAMELY, LIVE PERFORMANCES BY A MUSICAL BAND (U.S. CLS. 100, 101 AND 107).

FIRST USE 1-1-2000; IN COMMERCE 12-1-2004.

CLASS 41—(Continued).

3,681,481. BIERMANN PRODUCTIONS LLC, WICHITA, KS. SN 78-560,635. PUB. 4-25-2006, FILED 2-4-2005.

EVENTCHOICE HD

THE MARK CONSISTS OF STANDARD CHARACTERS WITHOUT CLAIM TO ANY PARTICULAR FONT, STYLE, SIZE, OR COLOR.

NO CLAIM IS MADE TO THE EXCLUSIVE RIGHT TO USE "HD", APART FROM THE MARK AS SHOWN.

FOR ENTERTAINMENT SERVICES, NAMELY, PRODUCTION AND DISTRIBUTION OF TELEVISION PROGRAMMING (U.S. CLS. 100, 101 AND 107).

FIRST USE 3-20-2009; IN COMMERCE 3-20-2009.

3,681,490. BTA, INC., JACKSON, WY. SN 78-608,125. PUB. 1-17-2006, FILED 4-13-2005.

RULE #1

THE MARK CONSISTS OF STANDARD CHARACTERS WITHOUT CLAIM TO ANY PARTICULAR FONT, STYLE, SIZE, OR COLOR.

FOR CONDUCTING WORKSHOPS, SEMINARS AND LECTURES IN THE FIELD OF FINANCIAL INVESTING (U.S. CLS. 100, 101 AND 107).

FIRST USE 8-16-2008; IN COMMERCE 8-16-2008.

3,681,523. BRAINSTORMS, INC., SANTA FE, NM. SN 78-680,604. PUB. 4-10-2007, FILED 7-28-2005.

COPYGURU

THE MARK CONSISTS OF STANDARD CHARACTERS WITHOUT CLAIM TO ANY PARTICULAR FONT, STYLE, SIZE, OR COLOR.

FOR EDUCATIONAL SERVICES, NAMELY, INSTRUCTION IN THE FIELD OF WRITING ADVERTISING COPY VIA THE INTERNET (U.S. CLS. 100, 101 AND 107).

FIRST USE 5-1-2009; IN COMMERCE 5-1-2009.

CLASS 41—(Continued).

3,681,537. CHOPRA, RAJ K., WESTBURY, NY. SN 78-710,482.
PUB. 5-23-2006, FILED 9-9-2005.

Vitagram

THE MARK CONSISTS OF STANDARD CHARACTERS WITHOUT CLAIM TO ANY PARTICULAR FONT, STYLE, SIZE, OR COLOR.

FOR PROVIDING NEWSLETTERS VIA E-MAIL IN THE FIELD OF NUTRITIONAL THERAPIES (U.S. CLS. 100, 101 AND 107).

FIRST USE 9-26-2005; IN COMMERCE 9-26-2005.

3,681,589. DIRECTV, INC., EL SEGUNDO, CA. SN 78-860,463.
PUB. 10-10-2006, FILED 4-12-2006.

GOOD TV. BETTER TV. DIRECTV.

THE MARK CONSISTS OF STANDARD CHARACTERS WITHOUT CLAIM TO ANY PARTICULAR FONT, STYLE, SIZE, OR COLOR.

OWNER OF U.S. REG. NOS. 2,418,301, 2,698,197, AND OTHERS.

FOR DISTRIBUTION OF TELEVISION PROGRAMS FOR OTHERS; ENTERTAINMENT SERVICES, NAMELY, PROVIDING ON-LINE COMPUTER GAMES; ENTERTAINMENT SERVICES, NAMELY, PROVIDING PRERECORDED MUSIC, INFORMATION IN THE FIELD OF MUSIC, AND COMMENTARY AND ARTICLES ABOUT MUSIC, ALL ON-LINE VIA A GLOBAL COMPUTER NETWORK; ENTERTAINMENT, NAMELY, A CONTINUING DRAMATIC, COMIC AND NEWS SHOW BROADCAST OVER TELEVISION, SATELLITE, AUDIO, AND VIDEO MEDIA; ENTERTAINMENT, NAMELY, LIVE MUSIC CONCERTS; PROGRAMMING ON A GLOBAL COMPUTER NETWORK; PROVIDING A COMPUTER GAME THAT MAY BE ACCESSED NETWORK-WIDE BY NETWORK USERS; PROVIDING INFORMATION ON-LINE RELATING TO COMPUTER GAMES AND COMPUTER ENHANCEMENTS FOR GAMES; PUBLICATION OF ELECTRONIC NEWSPAPERS ACCESSIBLE VIA A GLOBAL COMPUTER NETWORK; TELEVISION PRODUCTION; TELEVISION PROGRAMMING; TELEVISION SHOW PRODUCTION (U.S. CLS. 100, 101 AND 107).

FIRST USE 4-26-2006; IN COMMERCE 4-26-2006.

CLASS 41—(Continued).

3,681,597. LOESER, SHAUN W., SHERMAN OAKS, CA. SN 78-882,252. PUB. 7-24-2007, FILED 5-12-2006.

Santasia

THE MARK CONSISTS OF STANDARD CHARACTERS WITHOUT CLAIM TO ANY PARTICULAR FONT, STYLE, SIZE, OR COLOR.

FOR ENTERTAINMENT IN THE NATURE OF LIVE PERFORMANCES BY A COMEDY TROUPE; ENTERTAINMENT IN THE NATURE OF ON-GOING TELEVISION PROGRAMS IN THE FIELD OF COMEDY; ENTERTAINMENT IN THE NATURE OF THEATER PRODUCTIONS; ENTERTAINMENT IN THE NATURE OF VISUAL AND AUDIO PERFORMANCES, AND MUSICAL, VARIETY, NEWS AND COMEDY SHOWS (U.S. CLS. 100, 101 AND 107).

FIRST USE 12-1-2001; IN COMMERCE 12-1-2001.

3,681,622. TIME INC., NEW YORK, NY. SN 78-958,428. PUB. 10-17-2006, FILED 8-23-2006.

PEOPLE

THE MARK CONSISTS OF STANDARD CHARACTERS WITHOUT CLAIM TO ANY PARTICULAR FONT, STYLE, SIZE, OR COLOR.

OWNER OF U.S. REG. NOS. 2,522,247 AND 2,697,635.

FOR PROVIDING ONLINE INFORMATION ON A VARIETY OF TOPICS, NAMELY, CELEBRITIES, CELEBRITY NEWS, POPULAR CULTURE, CURRENT EVENTS AND TOPICS OF GENERAL INTEREST; PROVIDING AN ONLINE MAGAZINE FEATURING ENTERTAINMENT-ORIENTED TEXT, GRAPHICS, AUDIO AND VIDEO; ENTERTAINMENT IN THE NATURE OF ON-GOING TELEVISION PROGRAMS IN THE FIELD OF CELEBRITIES, CELEBRITY NEWS, POPULAR CULTURE, CURRENT EVENTS AND TOPICS OF GENERAL INTEREST (U.S. CLS. 100, 101 AND 107).

FIRST USE 3-15-2000; IN COMMERCE 3-15-2000.

3,681,641. HANLON, TIMOTHY J., DEERFIELD, IL. SN 78-981,197. PUB. 4-1-2008, FILED 7-21-2006.

FORGOTTEN SPORTS

THE MARK CONSISTS OF STANDARD CHARACTERS WITHOUT CLAIM TO ANY PARTICULAR FONT, STYLE, SIZE, OR COLOR.

CLASS 41—(Continued).

NO CLAIM IS MADE TO THE EXCLUSIVE RIGHT TO USE "SPORTS", APART FROM THE MARK AS SHOWN.

FOR PROVIDING A WEBSITE FEATURING SPORTING INFORMATION, SPORTS, PERSONALITIES, PLAYERS, THE SPORTS BUSINESS, TEAMS OR TEAM FRANCHISES (U.S. CLS. 100, 101 AND 107).

FIRST USE 1-13-2008; IN COMMERCE 1-13-2008.

CLASS 42—SCIENTIFIC AND COMPUTER SERVICES

3,680,118. MSM PROTEIN TECHNOLOGIES, INC., MEDFORD, MA. SN 76-684,570. PUB. 4-29-2008, FILED 12-3-2007.



THE MARK CONSISTS OF STANDARD CHARACTERS WITHOUT CLAIM TO ANY PARTICULAR FONT, STYLE, SIZE, OR COLOR.

FOR CUSTOM DESIGN AND DEVELOPMENT OF CHEMICAL REAGENTS, NAMELY, CUSTOM DESIGN AND DEVELOPMENT OF ANTIBODIES FOR LABORATORY OR MEDICAL RESEARCH OR FOR THERAPEUTIC USE (U.S. CLS. 100 AND 101).

FIRST USE 2-7-2008; IN COMMERCE 11-14-2008.

3,680,122. MEGA STAR MEDIA INC., RENO, NV. SN 76-686,571. PUB. 9-23-2008, FILED 2-6-2008.

JUMP SWITCH MEDIA

THE MARK CONSISTS OF STANDARD CHARACTERS WITHOUT CLAIM TO ANY PARTICULAR FONT, STYLE, SIZE, OR COLOR.

NO CLAIM IS MADE TO THE EXCLUSIVE RIGHT TO USE "MEDIA", APART FROM THE MARK AS SHOWN.

FOR COMPUTER SERVICES, NAMELY, DESIGNING SOFTWARE AND HOSTING AND DEVELOPING WEB SITES FOR OTHERS (U.S. CLS. 100 AND 101).

FIRST USE 1-8-2008; IN COMMERCE 6-15-2009.

CLASS 42—(Continued).

3,680,136. GEOTECHNICAL & ENVIRONMENTAL SERVICES, INC., LAS VEGAS, NV. SN 76-692,003. PUB. 3-17-2009, FILED 8-12-2008.

WE MAKE THE GROUND WORK FOR YOU

THE MARK CONSISTS OF STANDARD CHARACTERS WITHOUT CLAIM TO ANY PARTICULAR FONT, STYLE, SIZE, OR COLOR.

FOR GEOTECHNICAL ENGINEERING SERVICES; MATERIALS TESTING AND EVALUATION SERVICES; ENVIRONMENTAL SERVICES, NAMELY, ENGINEERING SERVICES AND CONSULTATION FOR THE DETECTION OF CONTAMINANTS IN THE SOIL AND GROUND WATER (U.S. CLS. 100 AND 101).

FIRST USE 8-14-2008; IN COMMERCE 8-14-2008.

3,680,279. VIEWZI, INC., DALLAS, TX. SN 77-170,663. PUB. 10-21-2008, FILED 5-2-2007.



THE MARK CONSISTS OF STANDARD CHARACTERS WITHOUT CLAIM TO ANY PARTICULAR FONT, STYLE, SIZE, OR COLOR.

FOR COMPUTER SERVICES, NAMELY, PROVIDING SEARCH ENGINES FOR OBTAINING DATA ON A GLOBAL COMPUTER NETWORK (U.S. CLS. 100 AND 101).

FIRST USE 6-0-2008; IN COMMERCE 6-0-2008.

3,680,301. SYMANTEC CORPORATION, CUPERTINO, CA. SN 77-181,655. PUB. 4-1-2008, FILED 5-15-2007.

TURN IT ON. KEEP IT ON.

THE MARK CONSISTS OF STANDARD CHARACTERS WITHOUT CLAIM TO ANY PARTICULAR FONT, STYLE, SIZE, OR COLOR.

FOR COMPUTER VIRUS PROTECTION SERVICES; NETWORK AND INTERNET SECURITY SERVICES, NAMELY, RESTRICTING ACCESS TO AND BY COMPUTER NETWORKS TO AND OF UNDESIRED WEB SITES, MEDIA AND INDIVIDUALS AND FACILITIES AND PROVIDING FOR THE BACKUP OF SUCH DATA; AND PROVIDING INFORMATION IN THE FIELDS OF GLOBAL COMPUTER NETWORK AND LOCAL AREA NETWORK SECURITY, PREVENTING COMPUTER VIRUSES, COMPUTER HARDWARE AND SOFTWARE APPLICATIONS IN SECURITY (U.S. CLS. 100 AND 101).

FIRST USE 7-0-2007; IN COMMERCE 7-0-2007.

CLASS 42—(Continued).

3,680,336. THERACLONE SCIENCES, INC., SEATTLE, WA.
SN 77-193,531. PUB. 4-29-2008, FILED 5-30-2007.

I-STAR

THE MARK CONSISTS OF STANDARD CHARACTERS WITHOUT CLAIM TO ANY PARTICULAR FONT, STYLE, SIZE, OR COLOR.

FOR PHARMACEUTICAL RESEARCH AND DEVELOPMENT SERVICES IN THE FIELD OF THERAPEUTIC ANTIBODIES (U.S. CLS. 100 AND 101).

FIRST USE 4-0-2006; IN COMMERCE 4-0-2006.

3,680,482. FORM & FUNCTION DESIGN GROUP, LLC, BEVERLY HILLS, CA. SN 77-312,658. PUB. 4-8-2008, FILED 10-24-2007.



NO CLAIM IS MADE TO THE EXCLUSIVE RIGHT TO USE "DESIGN", APART FROM THE MARK AS SHOWN.

THE COLOR(S) BLUE-GREEN, BLACK AND WHITE IS/ARE CLAIMED AS A FEATURE OF THE MARK.

THE MARK CONSISTS OF THE LETTERS "F" "F" AND THE WORDS "VALUE" "DESIGN" IN A STYLIZED T-SHAPED LOGO. THE COLOR BLUE-GREEN APPEARS IN THE LETTERS "F" AND "F" AND THE WORD "DESIGN". THE COLOR BLACK APPEARS IN THE STYLIZED T-DESIGN AND THE WORD "VALUE". THE COLOR WHITE APPEARS IN THE BACKGROUND.

FOR INTERIOR DESIGN SERVICES; GRAPHIC DESIGN SERVICES; DESIGN FOR OTHERS IN THE FIELD OF INTERIOR AND EXTERIOR BUILDING DESIGNING (U.S. CLS. 100 AND 101).

FIRST USE 10-10-2007; IN COMMERCE 10-10-2007.

CLASS 42—(Continued).

3,680,499. NATIONAL ENERGY PARTNERS, LP, DALLAS, TX. SN 77-318,468. PUB. 8-19-2008, FILED 10-31-2007.



NO CLAIM IS MADE TO THE EXCLUSIVE RIGHT TO USE "NATIONAL ENERGY PARTNERS, LP", APART FROM THE MARK AS SHOWN.

THE MARK CONSISTS OF TWO ELLIPSES EACH MADE UP OF CONTINUOUS LINES; ONE ELLIPSE IS SMALLER THAN AND INSIDE A LARGER ELLIPSE, IN THE CENTER OF THE MARK AND SURROUNDED BY BOTH ELLIPSES APPEAR THE CAPITAL LETTERS "NEP"; BETWEEN THE TWO ELLIPSES AND ABOVE THE LETTERS "NEP" LIE THE WORDS "NATIONAL ENERGY" IN CAPITAL LETTERS; AND BETWEEN THE TWO ELLIPSES AND BELOW THE LETTERS "NEP" LIE THE WORDS "PARTNERS, LP" IN CAPITAL LETTERS.

FOR EXPLORATION AND SEARCHING OF OIL AND GAS (U.S. CLS. 100 AND 101).

FIRST USE 6-26-2007; IN COMMERCE 6-26-2007.

3,680,531. MYBODYSITE, LLC, LAKE WORTH, FL. SN 77-328,229. PUB. 10-14-2008, FILED 11-13-2007.

BODYSITE.COM

THE MARK CONSISTS OF STANDARD CHARACTERS WITHOUT CLAIM TO ANY PARTICULAR FONT, STYLE, SIZE, OR COLOR.

FOR HOSTING AN ONLINE COMMUNITY WEB SITE FEATURING HEALTH, BEAUTY, AND FITNESS (U.S. CLS. 100 AND 101).

FIRST USE 9-10-2005; IN COMMERCE 6-1-2006.

CLASS 42—(Continued).

3,680,559. GENERITON CO., LTD., HSINCHU CITY, TAIWAN. SN 77-334,851. PUB. 10-21-2008, FILED 11-21-2007.

Generit^{on}

PRIORITY CLAIMED UNDER SEC. 44(D) ON TAIWAN APPLICATION NO. 096037713, FILED 8-7-2007.

THE MARK CONSISTS OF THE WORD "GENERITON" WHEREIN LETTERS OF "IT" ARE IN ITALIC TYPE, WITH A SQUARE SHADING IN THE BACKGROUND.

FOR ADVISORY SERVICES IN THE FIELD OF PRODUCT DEVELOPMENT AND QUALITY IMPROVEMENT OF SOFTWARE; APPLICATION SERVICE PROVIDER FEATURING SOFTWARE FOR USE IN DATABASE MANAGEMENT; APPLICATION SERVICE PROVIDER FEATURING SOFTWARE FOR USE AS A SPREADSHEET; APPLICATION SERVICE PROVIDER FEATURING SOFTWARE FOR WORD PROCESSING; APPLICATION SERVICE PROVIDER, NAMELY, HOSTING COMPUTER SOFTWARE APPLICATIONS OF OTHERS; APPLICATION SERVICE PROVIDER FEATURING SOFTWARE FOR PROVIDING AN ON-LINE DATABASE IN THE FIELD OF TRANSACTION PROCESSING TO UPLOAD TRANSACTIONAL DATA, PROVIDE STATISTICAL ANALYSIS, AND PRODUCE NOTIFICATIONS AND REPORTS; APPLICATION SERVICE PROVIDER, NAMELY, PROVIDING, HOSTING, MANAGING, DEVELOPING, AND MAINTAINING APPLICATIONS, SOFTWARE, WEBSITES, AND DATABASES IN THE FIELDS OF PERSONAL PRODUCTIVITY, WIRELESS COMMUNICATION, MOBILE INFORMATION ACCESS, AND REMOTE DATA MANAGEMENT FOR WIRELESS DELIVERY OF CONTENT TO HANDHELD COMPUTERS, LAPTOPS AND MOBILE ELECTRONIC DEVICES; COMPILING DATA FOR RESEARCH PURPOSES IN THE FIELD OF MEDICAL SCIENCE AND MEDICAL CONSULTANCY; COMPUTER AIDED DESIGN FOR OTHERS; COMPUTER COLOCATION SERVICES, NAMELY, PROVIDING FACILITIES FOR THE LOCATION OF COMPUTER SERVERS WITH THE EQUIPMENT OF OTHERS; COMPUTER CONSULTATION; COMPUTER CONSULTATION IN THE FIELD OF COMPUTER SECURITY; COMPUTER GRAPHICS SERVICES; COMPUTER HARDWARE DEVELOPMENT; COMPUTER MONITORING SERVICE WHICH TRACKS HARDWARE PERFORMANCE AND PROCESSES AND SENDS OUT HISTORICAL REPORTS AND ALERTS; COMPUTER NETWORK DESIGN FOR OTHERS; COMPUTER NETWORK DESIGN AND COMPUTER SOFTWARE DESIGN; COMPUTER PROGRAMMING IN THE MEDICAL FIELD; COMPUTER PROGRAMMING; COMPUTER SECURITY SERVICE, NAMELY, RESTRICTING ACCESS TO AND BY COMPUTER NETWORKS TO AND OF UNDESIRED WEB SITES, MEDIA AND INDIVIDUALS AND FACILITIES; COMPUTER SECURITY SERVICE, NAMELY, HARD DRIVE ERASURE; COMPUTER SERVICE, ACTING AS AN APPLICATION SERVICE PROVIDER IN THE FIELD OF KNOWLEDGE MANAGEMENT TO HOST COMPUTER APPLICATION SOFTWARE FOR CREATING SEARCHABLE DATABASES OF INFORMATION AND DATA TO ALLOW USERS TO PERFORM, ONLINE, THE COLLECTING AND ANALYZING OF DIFFERENT TYPES OF OPINION SURVEYS; COMPUTER SERVICE, NAMELY, ACTING AS AN APPLICATION SERVICE PROVIDER IN THE FIELD OF KNOWLEDGE MANAGEMENT TO HOST COMPUTER APPLICATION SOFTWARE FOR CREATING SEARCHABLE DATABASES OF INFORMATION AND DATA; COMPUTER SERVICE, NAMELY, ACTING AS AN APPLICATION SERVICE PROVIDER IN THE FIELD OF KNOWLEDGE MANAGEMENT TO HOST COMPUTER APPLICATION SOFTWARE FOR SEARCHING AND RETRIEVING INFORMATION FROM DATABASES AND COMPUTER NETWORKS; COMPUTER SERVICE, NAMELY, ACTING AS AN APPLICATION SERVICE PROVIDER IN THE FIELD OF KNOWLEDGE MANAGEMENT TO HOST COMPUTER APPLICATION SOFTWARE FOR THE COLLECTION, EDITING, ORGANIZING, MODIFYING, BOOK MARKING, TRANSMISSION, STORAGE AND

CLASS 42—(Continued).

SHARING OF DATA AND INFORMATION; COMPUTER SERVICES IN THE NATURE OF CUSTOMIZED WEB PAGES FEATURING USER-DEFINED INFORMATION, PERSONAL PROFILES AND INFORMATION; COMPUTER SERVICES, NAMELY, CREATING AND MAINTAINING WEB SITES FOR OTHERS; COMPUTER SERVICES, NAMELY, DATA RECOVERY SERVICES; COMPUTER SERVICES, NAMELY, DESIGNING AND IMPLEMENTING NETWORK WEB PAGES FOR OTHERS; COMPUTER SERVICES, NAMELY, DESIGNING AND IMPLEMENTING WEB SITES FOR OTHERS; COMPUTER SERVICES, NAMELY, MONITORING AND REPORTING ON THE PERFORMANCE, AVAILABILITY, AND ERRORS OF WEBSITES OF OTHERS; COMPUTER SERVICES, NAMELY, DATABASE DEVELOPMENT SERVICES, NAMELY, CONFIGURATION AND CUSTOMIZATION OF COMPUTER DATABASES CONTAINING INFORMATION REGARDING PUBLIC HEALTH CARE ELIGIBILITY; COMPUTER SERVICES, NAMELY, ELECTRONICALLY GATHERING, ANALYZING AND FORMATTING DATA TO TRACK, LOCATE, MONITOR AND LOG OPERATIONS IN THE OIL INDUSTRY; COMPUTER SERVICES, NAMELY, REMOTE MANAGEMENT OF COMPUTER APPLICATIONS FOR OTHERS; COMPUTER SERVICES, NAMELY, DIGITAL FORMATTING AND COMPRESSION OF MUSIC AND IMAGES, NAMELY, PROCESSING OF DIGITAL MUSIC AND VIDEO IMAGES INTO DOWNLOADABLE PRODUCTS; COMPUTER SERVICES, NAMELY, MONITORING THE PERFORMANCE OF PARTICIPANTS AT SPORTING EVENTS BY TRACKING A COMPUTER CHIP WORN BY A SPORTING PARTICIPANT; COMPUTER SERVICES, NAMELY, PROVIDING SEARCH PLATFORMS TO ALLOW USERS TO REQUEST CONTENT FROM AND RECEIVE CONTENT TO A MOBILE DEVICE; COMPUTER SERVICES, NAMELY, INTERACTIVE HOSTING SERVICES WHICH ALLOW THE USER TO PUBLISH AND SHARE THEIR OWN CONTENT AND IMAGES ONLINE; COMPUTER SITE DESIGN; COMPUTER SOFTWARE CONSULTATION; COMPUTER SOFTWARE DESIGN FOR OTHERS; COMPUTER SYSTEMS ANALYSIS; CONDUCTING ENGINEERING SURVEYS; CONSULTANCY IN THE FIELD OF SOFTWARE DESIGN; CONSULTANCY PERTAINING TO PHARMACOLOGY; CONSULTING SERVICES IN THE FIELD OF ARCHITECTURAL DESIGN; COSMETICS RESEARCH; COSMETICS RESEARCH FOR OTHERS; COURT REPORTING; CREATION OF CONTROL PROGRAMS FOR AUTOMATED MEASUREMENT, ASSEMBLY, ADJUSTMENT, AND RELATED VISUALIZATION; CREATION OF CONTROL PROGRAMS FOR ELECTRIC OPERATION CONTROL AND DRIVE MODULES; CROSS-PLATFORM CONVERSION OF DIGITAL CONTENT INTO OTHER FORMS OF DIGITAL CONTENT; CUSTOM DESIGN AND DEVELOPMENT OF CHEMICAL REAGENTS AND BIOCHEMICAL ASSAYS; CUSTOM DESIGN AND ENGINEERING OF TELEPHONY SYSTEMS, CABLE TELEVISION SYSTEMS AND FIBER OPTICS; CUSTOM DESIGN OF WEARABLE APPAREL BASED ON PERSONAL SELECTIONS MADE BY THE CUSTOMER; CUSTOMIZATION OF COMPUTER HARDWARE AND SOFTWARE; CUSTOM DESIGN OF PAPER GOODS BASED ON PERSONAL SELECTIONS MADE BY THE CUSTOMER; CUSTOMIZATION OF COMPUTER HARDWARE AND SOFTWARE; DATA AUTOMATION AND COLLECTION SERVICE USING PROPRIETARY SOFTWARE TO EVALUATE, ANALYZE AND COLLECT SERVICE DATA; DATA CONVERSION OF COMPUTER PROGRAM DATA OR INFORMATION; DATA MINING; DATA WAREHOUSING; DATABASE DEVELOPMENT SERVICES; DESIGN AND DEVELOPMENT OF MULTIMEDIA PRODUCTS; DESIGN AND DEVELOPMENT OF NETWORKS; DESIGN AND DEVELOPMENT OF ON-LINE COMPUTER SOFTWARE SYSTEMS; DESIGN AND DEVELOPMENT OF COMPUTER HARDWARE AND SOFTWARE; DESIGN AND DEVELOPMENT OF WIRELESS COMMUNICATION SYSTEMS FOR TRANSMISSION AND RECEPTION OF VOICE, DATA AND VIDEO; DESIGN AND TESTING FOR NEW PRODUCT DEVELOPMENT; DESIGN AND TESTING OF NEW PRODUCTS FOR OTHERS; DESIGN OF OPTICAL AND MICROOPTICAL COMPONENTS; DESIGN OF SPECIALTY INTERIOR AND EXTERIOR ENVIRONMENT SETTINGS; DESIGN, DEVELOPMENT AND IMPLEMENTATION OF SOFTWARE; DESIGNING OF MACHINES, APPARATUS, INSTRUMENTS OR SYSTEMS COMPOSED OF

CLASS 42—(Continued).

SUCH MACHINES, APPARATUS AND INSTRUMENTS; DESIGNING PLANT COMPONENTS AND EQUIPMENT FOR NUCLEAR POWER PLANTS; DEVELOPMENT AND TESTING OF OCCUPANT PROTECTION SYSTEMS FOR MOTOR VEHICLES; DEVELOPMENT OF COMPUTER PROGRAMS RECORDED ON DATA MEDIA DESIGNED FOR USE IN CONSTRUCTION AND AUTOMATED MANUFACTURING; DNA ANALYSIS SERVICES; DUPLICATING COMPUTER PROGRAMS; ELABORATION AND MAINTENANCE OF WEB SITES FOR THIRD PARTIES; GEOLOGICAL SURVEYS OR RESEARCH; GEOPHYSICAL EXPLORATION FOR THE OIL, GAS AND MINING INDUSTRIES; GRAPHIC ART DESIGN; HOSTING OF DIGITAL CONTENT ON THE INTERNET; HOSTING THE WEB SITES OF OTHERS ON A COMPUTER SERVER FOR A GLOBAL COMPUTER NETWORK; INTERIOR DECORATING; LEASING COMPUTER FACILITIES; LEASING OF COMPUTERS; MEASUREMENT EVALUATIONS; MONITORING OF COMMERCIAL AND INDUSTRIAL SITES FOR DETECTION OF VOLATILE AND NON-VOLATILE ORGANIC COMPOUNDS; MONITORING THE COMPUTER SYSTEMS OF OTHERS FOR TECHNICAL PURPOSES AND PROVIDING BACK-UP COMPUTER PROGRAMS AND FACILITIES; PHARMACEUTICAL PRODUCT EVALUATION; PHARMACEUTICAL RESEARCH AND DEVELOPMENT; PHARMACEUTICAL RESEARCH SERVICES; PHOTOGRAMMETRY; PREPARING ENVIRONMENTAL COMPLIANCE REPORTS; PROVIDING COMPUTER PROGRAMMING SERVICES TO CUSTOMERS THAT ENABLES THEM TO PROVIDE VIDEO AND AUDIO CONTENT ON THEIR WEBSITES; PROVIDING TECHNOLOGY INFORMATION IN THE OIL AND GAS INDUSTRY; PROVIDING TEMPORARY USE OF NON-DOWNLOADABLE COMPUTER SOFTWARE FOR PREPARING SHIPPING DOCUMENTS OVER COMPUTER NETWORKS, INTRANETS AND THE INTERNET; PROVIDING TEMPORARY USE OF NON-DOWNLOADABLE COMPUTER SOFTWARE FOR TRACKING DOCUMENTS OVER COMPUTER NETWORKS, INTRANETS AND THE INTERNET; QUALITY CONTROL FOR OTHERS; RADON DETECTING; RECOVERY OF COMPUTER DATA; RESEARCH IN THE FIELD OF INTELLIGENCE AND SECURITY; RESEARCH RELATING TO MECHANICAL ENGINEERING; SCIENTIFIC INVESTIGATIONS FOR MEDICAL PURPOSES; SCIENTIFIC STUDY AND RESEARCH IN THE FIELD OF REPRODUCTION, HUSBANDRY, AND GENERAL HEALTH OF ANIMAL; SEARCHING AND RETRIEVING INFORMATION, SITES, AND OTHER RESOURCES AVAILABLE ON COMPUTER NETWORKS FOR OTHERS; SET DESIGN FOR THEATRICAL ENTERPRISES; SOFTWARE AUTHORIZING; STRUCTURAL AND FUNCTIONAL ANALYSIS OF GENOMES; SURVEYING; SURVEYING OF OIL BEDS AND FIELDS; SURVEYING OF OIL-BEARING SEAMS; TESTING OF FILTERS; TESTING OF RAW MATERIALS; TESTING OR RESEARCH ON CIVIL ENGINEERING; MOTOR CLUBS; MOTORCYCLE CLUBS; PHILANTHROPIC SERVICES IN THE AREA OF DONATIONS OF FOOD, CLOTHING, AND/OR MEDICINE; PROVIDING AN INTERACTIVE COMPUTER DATABASE; PROVIDING COMPUTER SOFTWARE THAT MAY BE DOWNLOADED FROM A GLOBAL COMPUTER NETWORK (U.S. CLS. 100 AND 101).

FIRST USE 1-8-2009; IN COMMERCE 1-8-2009.

CLASS 42—(Continued).

3,680,609. IAC SEARCH & MEDIA, INC., OAKLAND, CA. SN 77-346,758. PUB. 10-7-2008, FILED 12-7-2007.

ASKERASER

THE MARK CONSISTS OF STANDARD CHARACTERS WITHOUT CLAIM TO ANY PARTICULAR FONT, STYLE, SIZE, OR COLOR.

FOR PROVIDING TEMPORARY USE OF NON-DOWNLOADABLE SOFTWARE FOR DELETING INTERNET SEARCH HISTORY (U.S. CLS. 100 AND 101).

FIRST USE 12-11-2007; IN COMMERCE 12-11-2007.

3,680,614. ID ANALYTICS, INC., SAN DIEGO, CA. SN 77-347,250. PUB. 10-7-2008, FILED 12-7-2007.

'id:analytics

OWNER OF U.S. REG. NO. 2,916,055.
SEC. 2(F).

FOR APPLICATION SERVICE PROVIDER (ASP) FEATURING SOFTWARE IN THE FIELD OF IDENTITY FRAUD AND PROTECTION THEREFROM (U.S. CLS. 100 AND 101).

FIRST USE 3-12-2008; IN COMMERCE 3-12-2008.

3,680,626. CYTH SYSTEMS, LLC, SAN DIEGO, CA. SN 77-349,587. PUB. 5-6-2008, FILED 12-11-2007.

Testcare

THE MARK CONSISTS OF STANDARD CHARACTERS WITHOUT CLAIM TO ANY PARTICULAR FONT, STYLE, SIZE, OR COLOR.

FOR DESIGN FOR OTHERS IN THE FIELD OF COMPUTER NETWORKS, SOFTWARE, AND ENGINEERING FOR THE AUTOMATED TESTING AND MANUFACTURING AUTOMATION INDUSTRIES; ENGINEERING SERVICES, NAMELY, ENGINEERING FOR THE AUTOMATED TESTING AND MANUFACTURING AUTOMATION INDUSTRIES (U.S. CLS. 100 AND 101).

FIRST USE 5-1-2007; IN COMMERCE 7-1-2007.

CLASS 42—(Continued).

3,680,639. VISCAPE LTD., ARLINGTON, VA. SN 77-353,801.
PUB. 5-13-2008, FILED 12-17-2007.

LIVE IT. LOVE IT. SHARE IT.

THE MARK CONSISTS OF STANDARD CHARACTERS WITHOUT CLAIM TO ANY PARTICULAR FONT, STYLE, SIZE, OR COLOR.

FOR REAL ESTATE RESEARCH SERVICES; COMPUTER SERVICES, NAMELY, HOSTING AN ON-LINE COMMUNITY FOR REGISTERED USERS TO OBTAIN COMMENTS AND REVIEWS FROM PEERS REGARDING TRAVEL, DESTINATIONS, VACATION ACTIVITIES, EVENTS, TRIPS, VACATION PROPERTIES AND LOCATIONS, TO FORM VIRTUAL COMMUNITIES, AND TO ENGAGE IN SOCIAL NETWORKING, AND HOSTING ONLINE WEB FACILITIES FOR OTHERS FOR CONDUCTING VIRTUAL TOURS OF VACATION PROPERTIES, SECOND HOMES, AND VACATION LOCATIONS; PROVIDING A WEBSITE THAT GIVES USERS THE ABILITY TO UPLOAD, EXCHANGE AND SHARE PHOTOS, VIDEOS, AND VIDEO LOGS (U.S. CLS. 100 AND 101).

FIRST USE 4-30-2009; IN COMMERCE 4-30-2009.

3,680,715. VAST.COM, INC., SAN FRANCISCO, CA. SN 77-395,346. PUB. 3-3-2009, FILED 2-12-2008.

VAST

THE MARK CONSISTS OF STANDARD CHARACTERS WITHOUT CLAIM TO ANY PARTICULAR FONT, STYLE, SIZE, OR COLOR.

FOR COMPUTER SERVICES, NAMELY, PROVIDING A SEARCH ENGINE ON THE INTERNET, INTRANETS, EXTRANETS AND/OR OTHER COMMUNICATION NETWORKS; PROVIDING ON-LINE NON-DOWNLOADABLE SOFTWARE FOR USE IN STRUCTURING SEARCH ENGINE RESULTS; DATA MINING IN THE NATURE OF EXTRACTION AND RETRIEVAL OF INFORMATION AND DATA BY MEANS OF THE INTERNET, INTRANETS, EXTRANETS AND OTHER COMMUNICATION NETWORKS; CREATING INDEXES OF INFORMATION, INDEXES OF WEB SITES AND INDEXES OF OTHER INFORMATION SOURCES IN CONNECTION WITH THE INTERNET, INTRANETS, EXTRANETS AND OTHER COMMUNICATION NETWORKS; PROVIDING SEARCH ENGINE RESULTS INFORMATION RELATING TO AVAILABLE REAL PROPERTY, GOODS, AND SERVICES FROM SEARCHABLE INDEXES AND DATABASES FEATURING TEXT, ELECTRONIC DOCUMENTS, GRAPHICS AND AUDIO VISUAL INFORMATION, BY MEANS OF INTERNET, INTRANETS, EXTRANETS AND OTHER COMMUNICATION NETWORKS (U.S. CLS. 100 AND 101).

FIRST USE 2-9-2007; IN COMMERCE 2-15-2007.

CLASS 42—(Continued).

3,680,727. DECISIONSTEP, INC., BELTSVILLE, MD. SN 77-401,298. PUB. 11-4-2008, FILED 2-20-2008.

SHOP TOGETHER

THE MARK CONSISTS OF STANDARD CHARACTERS WITHOUT CLAIM TO ANY PARTICULAR FONT, STYLE, SIZE, OR COLOR.

OWNER OF U.S. REG. NO. 2,673,600.

NO CLAIM IS MADE TO THE EXCLUSIVE RIGHT TO USE "SHOP", APART FROM THE MARK AS SHOWN.

FOR APPLICATION SERVICE PROVIDER (ASP), NAMELY, HOSTING COMPUTER SOFTWARE APPLICATIONS OF OTHERS (U.S. CLS. 100 AND 101).

FIRST USE 6-22-2009; IN COMMERCE 6-22-2009.

3,680,744. CRUIZIN, INC., HARTLAND, WI. SN 77-405,515.
PUB. 7-8-2008, FILED 2-25-2008.



THE MARK CONSISTS OF A MEANDERING HIGHWAY WITH DIVIDING LINE, DEPICTED WITHIN AN INCOMPLETE CIRCLE.

FOR COMPUTER SERVICES, NAMELY, CREATING AN ONLINE COMMUNITY FOR REGISTERED USERS TO SHARE INFORMATION ABOUT BACK ROAD TOURING ROUTES AND POINTS OF INTEREST, TO FORM VIRTUAL COMMUNITIES AND TO ENGAGE IN SOCIAL NETWORKING (U.S. CLS. 100 AND 101).

FIRST USE 3-20-2009; IN COMMERCE 3-20-2009.

CLASS 42—(Continued).

3,680,883. HEALTHCARE ACCREDITATION COLLOQUIUM, INC., THE, COLUMBUS, OH. SN 77-465,734. PUB. 10-7-2008, FILED 5-5-2008.

THAC

THE MARK CONSISTS OF STANDARD CHARACTERS WITHOUT CLAIM TO ANY PARTICULAR FONT, STYLE, SIZE, OR COLOR.

FOR ACCREDITATION SERVICES, NAMELY, DEVELOPING, EVALUATING, AND TESTING STANDARDS FOR HEALTHCARE PROVIDERS FOR PURPOSE OF ACCREDITATION; AND ACCREDITATION SERVICES, NAMELY, SETTING AND PROVIDING STANDARDS IN THE FIELD OF HEALTHCARE FOR THE PURPOSE OF ACCREDITATION (U.S. CLS. 100 AND 101).
FIRST USE 6-24-2009; IN COMMERCE 6-24-2009.

3,680,932. THE INVENTION MACHINE, LLC, CHICAGO, IL. SN 77-472,044. PUB. 10-14-2008, FILED 5-12-2008.

CREATING SOLUTIONS FOR
LIFE'S UNDISCOVERED
PROBLEMS

THE MARK CONSISTS OF STANDARD CHARACTERS WITHOUT CLAIM TO ANY PARTICULAR FONT, STYLE, SIZE, OR COLOR.

FOR RESEARCH AND DEVELOPMENT FOR NEW PRODUCTS FOR OTHERS (U.S. CLS. 100 AND 101).
FIRST USE 7-21-2008; IN COMMERCE 7-21-2008.

3,680,948. PTZ INSURANCE BROKERS LTD., OAKVILLE, CANADA. SN 77-473,440. PUB. 10-14-2008, FILED 5-13-2008.

PetPoint Lite

THE MARK CONSISTS OF STANDARD CHARACTERS WITHOUT CLAIM TO ANY PARTICULAR FONT, STYLE, SIZE, OR COLOR.

OWNER OF U.S. REG. NOS. 3,375,905 AND 3,401,107.
FOR PROVIDING NON-DOWNLOADABLE COMPUTER SOFTWARE FOR USE BY ANIMAL WELFARE ORGANIZATIONS TO MANAGE AND ORGANIZE THE INTAKE, TREATMENT, AND PLACEMENT OF LOST OR ABANDONED ANIMALS (U.S. CLS. 100 AND 101).
FIRST USE 5-20-2008; IN COMMERCE 5-20-2008.

CLASS 42—(Continued).

3,680,950. CODEFLARE, LLC, PLANO, TX. SN 77-473,857. PUB. 10-14-2008, FILED 5-14-2008.

TILESTACK

THE MARK CONSISTS OF STANDARD CHARACTERS WITHOUT CLAIM TO ANY PARTICULAR FONT, STYLE, SIZE, OR COLOR.

FOR COMPUTER SERVICES, NAMELY, PROVIDING TEMPORARY USE OF ONLINE NON-DOWNLOADABLE SOFTWARE USED TO CREATE CUSTOMIZED COMPUTER WEB APPLICATIONS FOR UTILITARIAN OR ENTERTAINMENT PURPOSES AND THEN POST, DOWNLOAD OR OTHERWISE SHARE THE CUSTOMIZED COMPUTER WEB APPLICATIONS WITH OTHERS VIA THE INTERNET OR OTHER COMMUNICATION NETWORK (U.S. CLS. 100 AND 101).
FIRST USE 3-0-2008; IN COMMERCE 3-0-2008.

3,680,951. CODEFLARE, LLC, PLANO, TX. SN 77-473,885. PUB. 10-14-2008, FILED 5-14-2008.

YOUR CREATIVE PLAYGROUND

THE MARK CONSISTS OF STANDARD CHARACTERS WITHOUT CLAIM TO ANY PARTICULAR FONT, STYLE, SIZE, OR COLOR.

FOR COMPUTER SERVICES, NAMELY, PROVIDING TEMPORARY USE OF ONLINE NON-DOWNLOADABLE SOFTWARE USED TO CREATE CUSTOMIZED COMPUTER WEB APPLICATIONS FOR UTILITARIAN OR ENTERTAINMENT PURPOSES AND THEN POST, DOWNLOAD OR OTHERWISE SHARE THE CUSTOMIZED COMPUTER WEB APPLICATIONS WITH OTHERS VIA THE INTERNET OR OTHER COMMUNICATION NETWORK (U.S. CLS. 100 AND 101).
FIRST USE 3-0-2008; IN COMMERCE 3-0-2008.

CLASS 42—(Continued).

3,680,965. IZZYPAGES.COM, LLC, DENVER, CO. SN 77-476,150. PUB. 10-14-2008, FILED 5-15-2008.

IZZY PAGES

THE MARK CONSISTS OF STANDARD CHARACTERS WITHOUT CLAIM TO ANY PARTICULAR FONT, STYLE, SIZE, OR COLOR.

NO CLAIM IS MADE TO THE EXCLUSIVE RIGHT TO USE "PAGES", APART FROM THE MARK AS SHOWN.

FOR HOSTING AN ON-LINE COMMUNITY WEB SITE FEATURING RESOURCES, ONLINE NETWORKING, AND CUSTOMIZED WEB PAGES FEATURING USER-DEFINED INFORMATION, PERSONAL PROFILES AND INFORMATION FOR SKILLED PROFESSIONALS (U.S. CLS. 100 AND 101).

FIRST USE 3-0-2009; IN COMMERCE 3-0-2009.

CLASS 42—(Continued).

3,680,991. THE CHIEF INFORMATION GROUP, INC., FALLS CHURCH, VA. SN 77-481,026. PUB. 10-14-2008, FILED 5-22-2008.

**MAKING YOUR INFORMATION
WORK FOR YOU**

THE MARK CONSISTS OF STANDARD CHARACTERS WITHOUT CLAIM TO ANY PARTICULAR FONT, STYLE, SIZE, OR COLOR.

FOR CONSULTATION SERVICES IN THE FIELDS OF SELECTION, IMPLEMENTATION AND USE OF COMPUTER HARDWARE AND SOFTWARE SYSTEMS FOR OTHERS; INFORMATION TECHNOLOGY CONSULTATION (U.S. CLS. 100 AND 101).

FIRST USE 6-0-2007; IN COMMERCE 6-0-2007.

3,680,970. RAINWAVE, LLC, AUBURN, AL. SN 77-476,982. PUB. 3-3-2009, FILED 5-16-2008.

RAINWAVE

THE MARK CONSISTS OF STANDARD CHARACTERS WITHOUT CLAIM TO ANY PARTICULAR FONT, STYLE, SIZE, OR COLOR.

FOR RAINFALL INFORMATION SERVICES, NAMELY, MEASURING AND RECORDING RAINFALL INFORMATION (U.S. CLS. 100 AND 101).

FIRST USE 7-15-2008; IN COMMERCE 7-15-2008.

3,680,971. RAINWAVE, LLC, AUBURN, AL. SN 77-476,991. PUB. 3-3-2009, FILED 5-16-2008.



THE MARK CONSISTS OF THE WORD "RAIN" WHICH IS SOLID BLACK AND CONTAINS THE LETTER "I" TOPPED WITH FOUR RAINDROPS AND THE WORD "WAVE" WHICH IS BLACK AND WHITE AND CONSISTS OF A POOL OF WATER RIPPLES.

FOR RAINFALL INFORMATION SERVICES, NAMELY, MEASURING AND RECORDING RAINFALL INFORMATION (U.S. CLS. 100 AND 101).

FIRST USE 7-15-2008; IN COMMERCE 7-15-2008.

3,681,029. INTERNATIONAL ASSOCIATION OF PLUMBING AND MECHANICAL OFFICIALS, ONTARIO, CA. SN 77-489,578. PUB. 11-4-2008, FILED 6-3-2008.

**FIRST IN FAST, TRUSTED
CERTIFICATION**

THE MARK CONSISTS OF STANDARD CHARACTERS WITHOUT CLAIM TO ANY PARTICULAR FONT, STYLE, SIZE, OR COLOR.

FOR EVALUATION OF PLUMBING AND MECHANICAL PRODUCTS FOR PURPOSES OF CERTIFICATION (U.S. CLS. 100 AND 101).

FIRST USE 8-0-2008; IN COMMERCE 8-0-2008.

3,681,050. JOHN T. MORGAN, CHARLOTTE, NC. SN 77-495,090. PUB. 11-4-2008, FILED 6-10-2008.

JUICE

THE MARK CONSISTS OF STANDARD CHARACTERS WITHOUT CLAIM TO ANY PARTICULAR FONT, STYLE, SIZE, OR COLOR.

FOR INDOOR AND OUTDOOR LIGHTING DESIGN (U.S. CLS. 100 AND 101).

FIRST USE 10-1-2008; IN COMMERCE 4-1-2009.

CLASS 42—(Continued).

3,681,065. JOHN T. MORGAN, CHARLOTTE, NC. SN 77-497,453. PUB. 11-4-2008, FILED 6-12-2008.



NO CLAIM IS MADE TO THE EXCLUSIVE RIGHT TO USE "LIGHTNING", APART FROM THE MARK AS SHOWN. THE MARK CONSISTS OF SPLASH WITH LIGHTENING BOLT RUNNING THROUGH IT, THE WORD "JUICE" WRITTEN BELOW IT, AND THE WORDS "100% LIGHTNING" WRITTEN IN SMALLER FONT BELOW THAT. FOR INDOOR AND OUTDOOR LIGHTING DESIGN (U.S. CLS. 100 AND 101).

FIRST USE 10-1-2008; IN COMMERCE 4-1-2009.

3,681,185. CODEFLARE, LLC, PLANO, TX. SN 77-544,688. PUB. 1-13-2009, FILED 8-12-2008.

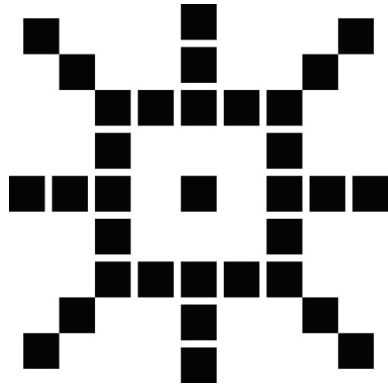

THE MARK CONSISTS OF A SYMMETRICAL PATTERN OF SOLID SQUARES, NAMELY, ONE SOLID SQUARE CENTERED WITHIN A LARGER OPEN SQUARE THAT IS BORDERED BY SOLID SQUARES. TWO SOLID SQUARES EXTEND DIAGONALLY FROM EACH CORNER OF THE BORDER, AND TWO SOLID SQUARES EXTEND PERPENDICULARLY FROM THE CENTER OF EACH SIDE OF THE BORDER.

FOR COMPUTER SERVICES, NAMELY, PROVIDING TEMPORARY USE OF ONLINE NON-DOWNLOADABLE SOFTWARE USED TO CREATE CUSTOMIZED WEB APPLICATIONS FOR UTILITARIAN OR ENTERTAINMENT PURPOSES AND THEN POST, DOWNLOAD OR OTHERWISE SHARE THE CUSTOMIZED COMPUTER WEB APPLICATIONS WITH OTHERS VIA THE INTERNET OR OTHER COMMUNICATION NETWORK (U.S. CLS. 100 AND 101).

FIRST USE 3-0-2008; IN COMMERCE 3-0-2008.

CLASS 42—(Continued).

3,681,211. RGI TECHNOLOGIES, LLC, DBA VIDEOCHAMP, LLC, CARROLLTON, TX. SN 77-555,848. PUB. 2-3-2009, FILED 8-26-2008.



NO CLAIM IS MADE TO THE EXCLUSIVE RIGHT TO USE "VIDEO" AND "YOUR GAME FILM", APART FROM THE MARK AS SHOWN.

THE COLOR(S) ORANGE, BLACK, SILVER WHITE IS/ARE CLAIMED AS A FEATURE OF THE MARK.

THE MARK CONSISTS OF THE TEXT "VIDEO CHAMP" IN ORANGE, OUTLINED IN BLACK, WITH THE BLACK TEXT "YOUR GAME FILM DELIVERED" BELOW IT. BETWEEN THE WORDS "VIDEO" AND "CHAMP" IS A DESIGN OF A BLACK CIRCLE, SHADED IN SILVER, CONTAINING A YELLOW TRIANGLE.

FOR PROVIDING ONLINE NON-DOWNLOADABLE COMPUTER SOFTWARE FOR USE IN THE ENCRYPTION AND DECRYPTION OF DIGITAL FILES, INCLUDING AUDIO, VIDEO, TEXT, BINARY, STILL IMAGES, GRAPHICS AND MULTIMEDIA FILES (U.S. CLS. 100 AND 101).

FIRST USE 10-8-2008; IN COMMERCE 10-8-2008.

3,681,281. TEKNON CORPORATION, DBA SYMMETRY SOFTWARE, SCOTTSALE, AZ. SN 77-579,922. PUB. 3-10-2009, FILED 9-26-2008.

payroll goddess

THE MARK CONSISTS OF STANDARD CHARACTERS WITHOUT CLAIM TO ANY PARTICULAR FONT, STYLE, SIZE, OR COLOR.

NO CLAIM IS MADE TO THE EXCLUSIVE RIGHT TO USE "PAYROLL", APART FROM THE MARK AS SHOWN.

FOR PROVIDING TEMPORARY USE OF ONLINE, NON-DOWNLOADABLE SOFTWARE WHICH ALLOWS THE USER TO MAKE PAYROLL-RELATED CALCULATIONS VIA THE INTERNET (U.S. CLS. 100 AND 101).

FIRST USE 1-22-2009; IN COMMERCE 1-22-2009.

CLASS 42—(Continued).

3,681,393. Z DESIGN GROUP LLC, BOULDER, CO. SN 77-620,818. PUB. 4-7-2009, FILED 11-24-2008.



NO CLAIM IS MADE TO THE EXCLUSIVE RIGHT TO USE "DESIGN GROUP", APART FROM THE MARK AS SHOWN.

THE MARK CONSISTS OF A "Z" OUTLINED BY GEOMETRIC SHAPES ABOVE THE WORDS "Z DESIGN GROUP".

FOR ARCHITECTURAL AND INTERIOR DESIGN SERVICES (U.S. CLS. 100 AND 101).

FIRST USE 1-1-2009; IN COMMERCE 1-1-2009.

3,681,428. ZABECOR PHARMACEUTICALS, LLC, BALA CYNWYD, PA. SN 77-977,527. PUB. 9-23-2008, FILED 4-16-2008.

The Future of siRNA

THE MARK CONSISTS OF STANDARD CHARACTERS WITHOUT CLAIM TO ANY PARTICULAR FONT, STYLE, SIZE, OR COLOR.

FOR MEDICAL AND SCIENTIFIC RESEARCH SERVICES RELATED TO ANTI-INFLAMMATORIES AND PAIN RELIEF MEDICATIONS (U.S. CLS. 100 AND 101).

FIRST USE 4-16-2008; IN COMMERCE 4-16-2008.

3,681,582. COLLABORATIVE SOLUTIONS, LLC, HERNDON, VA. SN 78-843,299. PUB. 11-14-2006, FILED 3-22-2006.

Cynergy

THE MARK CONSISTS OF STANDARD CHARACTERS WITHOUT CLAIM TO ANY PARTICULAR FONT, STYLE, SIZE, OR COLOR.

FOR DESIGN AND DEVELOPMENT OF ONLINE COMPUTER SOFTWARE SYSTEMS (U.S. CLS. 100 AND 101).

FIRST USE 4-1-2005; IN COMMERCE 4-1-2005.

CLASS 42—(Continued).

3,681,624. XLLERATE CONSULTING, LLC, GARLAND, TX. SN 78-966,619. PUB. 10-28-2008, FILED 9-3-2006.

XLLERATE

THE MARK CONSISTS OF STANDARD CHARACTERS WITHOUT CLAIM TO ANY PARTICULAR FONT, STYLE, SIZE, OR COLOR.

FOR COMPUTER SOFTWARE DESIGN, DEVELOPMENT, CUSTOMIZATION, CONSULTING, MAINTENANCE AND TECHNICAL SUPPORT SERVICES FOR OTHERS, AND CONSULTING ON SELECTION AND INTEGRATION OF COMPUTER HARDWARE AND SOFTWARE, IN THE FIELDS OF AUTOMATING MANUAL BUSINESS PRACTICES, DOCUMENTING BUSINESS PROCESSES, MANAGING AND INTEGRATING DATABASES, PROVIDING STATISTICAL ANALYSES, NOTIFICATIONS AND REPORTS, AND PROVIDING REAL-TIME, INTEGRATED BUSINESS MANAGEMENT TOOLS; CONSULTATION SERVICES IN THE FIELD OF OFFICE AND WORKPLACE AUTOMATION (U.S. CLS. 100 AND 101).

FIRST USE 9-7-2005; IN COMMERCE 9-7-2005.

3,681,634. WORLD INSPECTION NETWORK INTERNATIONAL, INC., SEATTLE, WA. SN 78-980,635. PUB. 10-28-2008, FILED 8-17-2005.

WIN

THE MARK CONSISTS OF STANDARD CHARACTERS WITHOUT CLAIM TO ANY PARTICULAR FONT, STYLE, SIZE, OR COLOR.

OWNER OF U.S. REG. NO. 1,833,028.
FOR EVALUATION AND TESTING OF REAL ESTATE FOR THE PRESENCE OF HAZARDOUS MATERIAL; INSPECTIONS OF RESIDENTIAL PROPERTY, SWIMMING POOLS AND HOT TUBS; AND INSPECTIONS OF NEW AND EXISTING HOMES FOR HOME BUYERS AND SELLERS AND PROVIDING REPORTS BASED ON THE INSPECTION RESULTS (U.S. CLS. 100 AND 101).

FIRST USE 1-1-2006; IN COMMERCE 1-1-2006.

CLASS 43—HOTEL AND RESTAURANT SERVICES

3,680,083. RUBEN, MARSHALL S., HARTFORD, CT. SN 76-642,901. PUB. 4-11-2006, FILED 7-15-2005.

RED STATE COFFEE

CLASS 43—(Continued).

THE MARK CONSISTS OF STANDARD CHARACTERS WITHOUT CLAIM TO ANY PARTICULAR FONT, STYLE, SIZE, OR COLOR.

NO CLAIM IS MADE TO THE EXCLUSIVE RIGHT TO USE "COFFEE", APART FROM THE MARK AS SHOWN.

FOR RETAIL RESTAURANT SERVICES, NAMELY, RESTAURANT SERVICES SPECIALIZING IN COFFEE AND TEA DRINKS AND LIGHT FOOD (U.S. CLS. 100 AND 101).

FIRST USE 6-30-2009; IN COMMERCE 6-30-2009.

3,680,128. YUNG, YUEN L., AUSTIN, TX. SN 76-688,969. PUB. 9-23-2008, FILED 4-24-2008.

HOW DO YOU ROLL?

THE MARK CONSISTS OF STANDARD CHARACTERS WITHOUT CLAIM TO ANY PARTICULAR FONT, STYLE, SIZE, OR COLOR.

FOR RESTAURANT SERVICES (U.S. CLS. 100 AND 101).

FIRST USE 10-27-2008; IN COMMERCE 10-27-2008.

3,680,144. LESRIDGE HOLDINGS, LLC, DENTON, TX. SN 77-006,713. PUB. 5-15-2007, FILED 9-25-2006.



NO CLAIM IS MADE TO THE EXCLUSIVE RIGHT TO USE "CAFE" AND "COFFEE" AND "WINE" AND "MUSIC" AND "ART", APART FROM THE MARK AS SHOWN.

THE COLOR(S) BLACK, WHITE, BROWN, MAROON, TAN AND ORANGE IS/ARE CLAIMED AS A FEATURE OF THE MARK.

THE MARK CONSIST OF THE WORDING "CAFE DU LUXE" IN BLACK, "COFFEE" IN BROWN, "WINE" IN MAROON, "MUSIC" IN TAN, "ART" IN ORANGE AND A DESIGN OF COFFEE CUP IN WHITE WITH A BROWN BACKGROUND, A WINE GLASS AND BOTTLE IN WHITE WITH A MAROON BACKGROUND, A MUSICAL NOTE IN WHITE WITH A TAN BACKGROUND AND A FACE IN WHITE WITH AN ORANGE BACKGROUND, AND THREE STARS IN ORANGE, BLACK AND MAROON.

THE FOREIGN WORDING IN THE MARK TRANSLATES INTO ENGLISH AS CAFE OF THE RICH.

FOR COFFEE SHOPS; COFFEE-HOUSE AND SNACK-BAR SERVICES; WINE BARS (U.S. CLS. 100 AND 101).

FIRST USE 8-1-2009; IN COMMERCE 8-1-2009.

CLASS 43—(Continued).

3,680,317. MAMBO SEAFOOD #1, INC., HOUSTON, TX. SN 77-187,308. PUB. 11-13-2007, FILED 5-22-2007.

MAMBO OASIS

THE MARK CONSISTS OF STANDARD CHARACTERS WITHOUT CLAIM TO ANY PARTICULAR FONT, STYLE, SIZE, OR COLOR.

OWNER OF U.S. REG. NOS. 2,580,025, 2,677,416, AND OTHERS.

FOR RESTAURANT SERVICES (U.S. CLS. 100 AND 101).

FIRST USE 5-15-2009; IN COMMERCE 5-15-2009.

3,680,344. GDG ENTERPRISES LLC, PHOENIX, AZ. SN 77-199,667. PUB. 5-27-2008, FILED 6-6-2007.

GRIGIO

THE MARK CONSISTS OF STANDARD CHARACTERS WITHOUT CLAIM TO ANY PARTICULAR FONT, STYLE, SIZE, OR COLOR.

OWNER OF U.S. REG. NO. 3,288,105.

THE FOREIGN WORDING IN THE MARK TRANSLATES INTO ENGLISH AS GREY.

FOR RESTAURANT AND BAR SERVICES (U.S. CLS. 100 AND 101).

FIRST USE 7-14-2006; IN COMMERCE 11-1-2006.

3,680,355. CJ'S BBQ NO. 1, LLC, LAS VEGAS, NV. SN 77-203,217. PUB. 5-13-2008, FILED 6-11-2007.

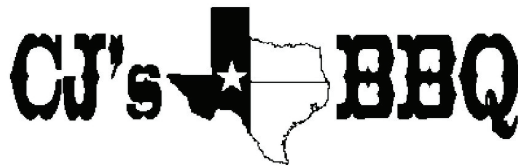

NO CLAIM IS MADE TO THE EXCLUSIVE RIGHT TO USE "BARBECUE" AND THE PICTORIAL REPRESENTATION OF THE STATE OF TEXAS, APART FROM THE MARK AS SHOWN.

THE MARK CONSISTS OF A STYLIZED PRESENTATION OF "CJ'S TEXAS BBQ" THAT INCLUDES A DESIGN OF THE STATE OF TEXAS IN SUBSTITUTION FOR THE WORD TEXAS.

FOR RESTAURANT AND BAR SERVICES, TAKE-OUT RESTAURANT SERVICES, TAVERN SERVICES, SERVING FOOD AND DRINKS, CATERING OF FOOD AND DRINKS, ALL FEATURING BARBEQUE FARE (U.S. CLS. 100 AND 101).

FIRST USE 7-17-2009; IN COMMERCE 7-17-2009.

CLASS 43—(Continued).

3,680,363. ROLLO, JONATHAN, BEVERLY HILLS, CA. SN 77-214,902. PUB. 9-16-2008, FILED 6-25-2007.

BECAUSE GREEN IS GOOD

THE MARK CONSISTS OF STANDARD CHARACTERS WITHOUT CLAIM TO ANY PARTICULAR FONT, STYLE, SIZE, OR COLOR.

FOR CAFE-RESTAURANTS; CARRY-OUT RESTAURANTS; RESTAURANT SERVICES; RESTAURANTS; TAKE-OUT RESTAURANT SERVICES; FAST-FOOD RESTAURANTS; PREPARATION OF FOOD AND BEVERAGES; SERVING FOOD AND DRINKS; SERVING OF FOOD AND DRINK/BEVERAGES (U.S. CLS. 100 AND 101).

FIRST USE 12-31-2007; IN COMMERCE 12-31-2007.

3,680,479. SBE ENTERTAINMENT GROUP, LLC, LOS ANGELES, CA. SN 77-311,414. PUB. 4-15-2008, FILED 10-23-2007.

SLS HOTEL

THE MARK CONSISTS OF STANDARD CHARACTERS WITHOUT CLAIM TO ANY PARTICULAR FONT, STYLE, SIZE, OR COLOR.

NO CLAIM IS MADE TO THE EXCLUSIVE RIGHT TO USE "HOTEL", APART FROM THE MARK AS SHOWN.

FOR HOTEL SERVICES; HOTEL SERVICES FOR PREFERRED CUSTOMERS; HOTELS; RESORT HOTELS (U.S. CLS. 100 AND 101).

FIRST USE 11-1-2008; IN COMMERCE 11-1-2008.

3,680,545. SODALICIOUS, LLC, PORTLAND, OR. SN 77-331,382. PUB. 9-9-2008, FILED 11-16-2007.

SODACHEF

THE MARK CONSISTS OF STANDARD CHARACTERS WITHOUT CLAIM TO ANY PARTICULAR FONT, STYLE, SIZE, OR COLOR.

FOR PROVIDING ONLINE INFORMATION IN THE FIELDS OF COOKING AND FOOD RECIPES (U.S. CLS. 100 AND 101).

FIRST USE 6-1-2007; IN COMMERCE 6-1-2007.

CLASS 43—(Continued).

3,680,637. VISCAPE LTD., ARLINGTON, VA. SN 77-353,649. PUB. 5-13-2008, FILED 12-17-2007.

VISCAPE

THE MARK CONSISTS OF STANDARD CHARACTERS WITHOUT CLAIM TO ANY PARTICULAR FONT, STYLE, SIZE, OR COLOR.

FOR PROVIDING TRAVEL LODGING INFORMATION SERVICES FOR TRAVELERS (U.S. CLS. 100 AND 101).

FIRST USE 2-13-2009; IN COMMERCE 2-13-2009.

3,680,669. ROSIE'S PLATE, LLC, RALEIGH, NC. SN 77-367,173. PUB. 3-17-2009, FILED 1-9-2008.



NO CLAIM IS MADE TO THE EXCLUSIVE RIGHT TO USE "SERVING FRESH FOODS FOR SPECIAL DIETS", APART FROM THE MARK AS SHOWN.

THE COLOR(S) WHITE, LIME GREEN AND DARK GREEN IS/ARE CLAIMED AS A FEATURE OF THE MARK.

THE MARK CONSISTS OF A LIME-GREEN ELLIPSE WITH THE WORDS "ROSIE'S PLATE" WRITTEN IN A WHITE, HANDWRITING-STYLE FONT, UNDERNEATH OF WHICH IS WRITTEN "SERVING FRESH FOODS FOR SPECIAL DIETS" IN ALL-LOWERCASE LETTERS, WITH THE WORDS "SERVING" AND "FOR" APPEARING IN A WHITE SANS-SERIF FONT, AND THE WORDS "FRESH FOODS" AND "SPECIAL DIETS" APPEARING IN A DARK-GREEN SANS-SERIF FONT.

FOR KITCHEN SERVICES FOR THE PRODUCTION OF MADE-TO-ORDER MEALS, SNACKS, AND DESSERTS PREPARED WITHOUT GLUTEN, SHELLFISH, OR PEANUTS FOR TAKE-OUT OR DELIVERY (U.S. CLS. 100 AND 101).

FIRST USE 5-29-2008; IN COMMERCE 5-29-2008.

CLASS 43—(Continued).

3,680,711. TGI FRIDAY'S OF MINNESOTA, INC., CARROLLTON, TX. SN 77-393,845. PUB. 10-21-2008, FILED 2-11-2008.

TGIF

THE MARK CONSISTS OF STANDARD CHARACTERS WITHOUT CLAIM TO ANY PARTICULAR FONT, STYLE, SIZE, OR COLOR.

OWNER OF U.S. REG. NOS. 925,656, 2,963,202, AND OTHERS.

FOR RESTAURANT AND BAR SERVICES (U.S. CLS. 100 AND 101).

FIRST USE 7-25-1975; IN COMMERCE 7-25-1975.

3,680,728. S.B. RESTAURANT CO., LA MIRADA, CA. SN 77-401,308. PUB. 12-30-2008, FILED 2-20-2008.

ELEPHANT BAR
GLOBAL GRILL / WOK KITCHEN

THE MARK CONSISTS OF STANDARD CHARACTERS WITHOUT CLAIM TO ANY PARTICULAR FONT, STYLE, SIZE, OR COLOR.

OWNER OF U.S. REG. NOS. 1,439,560, 2,925,313, AND OTHERS.

NO CLAIM IS MADE TO THE EXCLUSIVE RIGHT TO USE "BAR," "GLOBAL GRILL" AND "WOK KITCHEN", APART FROM THE MARK AS SHOWN.

FOR BAR AND RESTAURANT SERVICES (U.S. CLS. 100 AND 101).

FIRST USE 6-15-2009; IN COMMERCE 6-15-2009.

3,680,733. FN HOLDINGS, L.L.C., RICHMOND, VA. SN 77-402,866. PUB. 10-21-2008, FILED 2-21-2008.



OWNER OF U.S. REG. NOS. 2,189,615 AND 2,200,094.

NO CLAIM IS MADE TO THE EXCLUSIVE RIGHT TO USE "NEW YORK CAFE", APART FROM THE MARK AS SHOWN.

THE MARK CONSISTS OF THE WORD "DOMINIC'S" IN CAPITALIZED LETTERS, WITH THE LETTER "O" CONSISTING OF A FILLED-IN CIRCLE, ABOVE THE WORDS "OF NEW YORK" IN CAPITALIZED LETTERS, ALL TO THE LEFT OF THE WORD "CAFE" IN FANCIFUL TYPE AND ENCIRCLED INSIDE OF AN OBLONG SHAPE.

FOR RESTAURANT SERVICES (U.S. CLS. 100 AND 101).

FIRST USE 8-31-2007; IN COMMERCE 8-31-2007.

CLASS 43—(Continued).

3,680,741. MARRIOTT INTERNATIONAL, INC., BETHESDA, MD. SN 77-405,155. PUB. 5-20-2008, FILED 2-25-2008.

CRYSTAL SHORES

THE MARK CONSISTS OF STANDARD CHARACTERS WITHOUT CLAIM TO ANY PARTICULAR FONT, STYLE, SIZE, OR COLOR.

FOR HOTEL SERVICES; RESTAURANT, BAR AND COCKTAIL LOUNGE SERVICES; RESORT LODGING SERVICES; AND RESERVATIONS SERVICES FOR HOTEL ACCOMMODATIONS (U.S. CLS. 100 AND 101).

FIRST USE 3-6-2009; IN COMMERCE 3-6-2009.

3,680,873. DAVID WU INVESTMENTS, INC., TAMPA, FL. SN 77-461,458. PUB. 10-7-2008, FILED 4-30-2008.

CHICKEN TOO

THE MARK CONSISTS OF STANDARD CHARACTERS WITHOUT CLAIM TO ANY PARTICULAR FONT, STYLE, SIZE, OR COLOR.

NO CLAIM IS MADE TO THE EXCLUSIVE RIGHT TO USE "CHICKEN", APART FROM THE MARK AS SHOWN.

FOR RESTAURANT SERVICES (U.S. CLS. 100 AND 101).

FIRST USE 6-30-2009; IN COMMERCE 6-30-2009.

3,680,899. KS TACOMA HOTEL, LLC, PORTLAND, OR. SN 77-467,103. PUB. 10-7-2008, FILED 5-6-2008.

WORLD GLASS

THE MARK CONSISTS OF STANDARD CHARACTERS WITHOUT CLAIM TO ANY PARTICULAR FONT, STYLE, SIZE, OR COLOR.

FOR HOTEL, RESTAURANT AND BAR SERVICES (U.S. CLS. 100 AND 101).

FIRST USE 6-30-2009; IN COMMERCE 6-30-2009.

CLASS 43—(Continued).

3,680,944. MAVERICK RESTAURANT GROUP LLC, MCLEAN, VA. SN 77-473,244. PUB. 12-23-2008, FILED 5-13-2008.

INOX

THE MARK CONSISTS OF STANDARD CHARACTERS WITHOUT CLAIM TO ANY PARTICULAR FONT, STYLE, SIZE, OR COLOR.

FOR RESTAURANT, BAR, AND CATERING SERVICES (U.S. CLS. 100 AND 101).
FIRST USE 2-5-2009; IN COMMERCE 2-5-2009.

3,680,979. ENERGY KITCHEN INC., NEW YORK, NY. SN 77-478,647. PUB. 10-21-2008, FILED 5-20-2008.

ENERGY KITCHEN GO HEALTHY

THE MARK CONSISTS OF STANDARD CHARACTERS WITHOUT CLAIM TO ANY PARTICULAR FONT, STYLE, SIZE, OR COLOR.

OWNER OF U.S. REG. NOS. 2,891,673, 3,311,053, AND OTHERS.

NO CLAIM IS MADE TO THE EXCLUSIVE RIGHT TO USE "KITCHEN" AND "HEALTHY", APART FROM THE MARK AS SHOWN.

FOR RESTAURANT SERVICES (U.S. CLS. 100 AND 101).

FIRST USE 4-1-2009; IN COMMERCE 4-1-2009.

3,680,986. C. TOMLINSON INC., ORLANDO, FL. SN 77-479,761. PUB. 1-13-2009, FILED 5-20-2008.



NO CLAIM IS MADE TO THE EXCLUSIVE RIGHT TO USE "CAFE", APART FROM THE MARK AS SHOWN.

CLASS 43—(Continued).

THE COLOR(S) GREEN, PINK, WHITE, GRAY, BROWN AND BLACK IS/ARE CLAIMED AS A FEATURE OF THE MARK.

THE MARK CONSISTS OF THE STYLIZED IMAGE OF CARTOON GLOBE CHARACTER WITH WHITE HANDS, GRAY SHOES, A BLACK MOUTH, A PINK TONGUE, BLACK AND GREEN EYES, AND A GREEN GLOBE BODY WITH SOME BROWN TO INDICATE MOUNTAINOUS REGIONS, AND WITH THE TERMS "GREEN DAY CAFE" IN GREEN APPEARING ABOVE THE CHARACTER.

FOR CAFE AND RESTAURANT SERVICES; FAST-FOOD RESTAURANTS (U.S. CLS. 100 AND 101).

FIRST USE 8-1-2008; IN COMMERCE 8-1-2008.

3,681,019. ZEUS INDUSTRIAL PRODUCTS, INC., ORANGEBURG, SC. SN 77-486,602. PUB. 3-3-2009, FILED 5-29-2008.

EDISTO MANOR

THE MARK CONSISTS OF STANDARD CHARACTERS WITHOUT CLAIM TO ANY PARTICULAR FONT, STYLE, SIZE, OR COLOR.

NO CLAIM IS MADE TO THE EXCLUSIVE RIGHT TO USE "EDISTO", APART FROM THE MARK AS SHOWN.

FOR RESORT LODGING SERVICES (U.S. CLS. 100 AND 101).

FIRST USE 12-8-2008; IN COMMERCE 12-8-2008.

3,681,222. BOARDHOUSE SANDWICHES, INC., LAS VEGAS, NV. SN 77-560,839. PUB. 1-20-2009, FILED 9-2-2008.

BOARDHOUSE

THE MARK CONSISTS OF STANDARD CHARACTERS WITHOUT CLAIM TO ANY PARTICULAR FONT, STYLE, SIZE, OR COLOR.

FOR RESTAURANT SERVICES; DELICATESSENS; FAST-FOOD RESTAURANTS AND SNACKBARS (U.S. CLS. 100 AND 101).

FIRST USE 5-23-2009; IN COMMERCE 5-23-2009.

CLASS 43—(Continued).

3,681,252. WOOD ROYALTY MANAGEMENT COMPANY, WILMINGTON, DE. SN 77-571,799. PUB. 2-10-2009, FILED 9-17-2008.



OWNER OF U.S. REG. NOS. 2,419,973, 3,459,526, AND OTHERS.

NO CLAIM IS MADE TO THE EXCLUSIVE RIGHT TO USE "CAFE & BAKERY", APART FROM THE MARK AS SHOWN.

THE MARK CONSISTS OF THE WORDS "JAZZMAN'S CAFE & BAKERY" WITH A HORIZONTAL CURVED LINE SHOWN THROUGH THE LETTERS "JAZZ" AND FORMING PART OF THE LETTER "A".

FOR CONTRACT FOOD SERVICES; PREPARATION OF FOOD AND BEVERAGES; SERVING FOOD AND DRINKS (U.S. CLS. 100 AND 101).

FIRST USE 6-29-2009; IN COMMERCE 6-29-2009.

3,681,297. MURPHY ADAMS RESTAURANT GROUP, LP, AUSTIN, TX. SN 77-585,896. PUB. 3-3-2009, FILED 10-6-2008.



OWNER OF U.S. REG. NOS. 2,885,139, 3,001,024, AND 3,240,221.

NO CLAIM IS MADE TO THE EXCLUSIVE RIGHT TO USE "ASIAN HOUSE", APART FROM THE MARK AS SHOWN.

THE NAME "MAMA FU'S" DOES NOT IDENTIFY A LIVING INDIVIDUAL.

THE MARK CONSISTS OF THE STYLIZED WORDING "MAMA FU'S ASIAN HOUSE" AND A STYLIZED BOWL WITH CHOPSTICKS.

FOR RESTAURANT SERVICES (U.S. CLS. 100 AND 101).

FIRST USE 10-9-2008; IN COMMERCE 10-9-2008.

CLASS 43—(Continued).

3,681,351. THE CORYN GROUP II, LLC, NEWTOWN SQUARE, PA. SN 77-602,684. PUB. 3-24-2009, FILED 10-29-2008.



NO CLAIM IS MADE TO THE EXCLUSIVE RIGHT TO USE "WELLNESS & SPA RESORTS", APART FROM THE MARK AS SHOWN.

THE MARK CONSISTS OF A STYLIZED SUN ABOVE THE WORDS "ZOËTRY WELLNESS & SPA RESORTS".

FOR RESORT HOTELS; HOTEL AND RESTAURANT SERVICES; HOTEL AND RESTAURANT RESERVATION SERVICES; PROVIDING PERSONALIZED INFORMATION ABOUT HOTELS AND TEMPORARY ACCOMMODATIONS FOR TRAVEL VIA THE INTERNET AND PHONE; HEALTH RESORT SERVICES, NAMELY, PROVIDING FOOD AND LODGING THAT SPECIALIZE IN PROMOTING PATRONS' GENERAL HEALTH AND WELL-BEING (U.S. CLS. 100 AND 101).

FIRST USE 12-20-2008; IN COMMERCE 12-20-2008.

3,681,366. RANDALL RESIDENCE, LLC, LAWTON, MI. SN 77-608,558. PUB. 3-24-2009, FILED 11-6-2008.

RANDALL RESIDENCE

THE MARK CONSISTS OF STANDARD CHARACTERS WITHOUT CLAIM TO ANY PARTICULAR FONT, STYLE, SIZE, OR COLOR.

NO CLAIM IS MADE TO THE EXCLUSIVE RIGHT TO USE "RESIDENCE", APART FROM THE MARK AS SHOWN.

FOR PROVIDING ASSISTED LIVING FACILITIES (U.S. CLS. 100 AND 101).

FIRST USE 9-17-2008; IN COMMERCE 9-17-2008.

CLASS 43—(Continued).

3,681,367. RANDALL RESIDENCE, LLC, LAWTON, MI. SN 77-608,575. PUB. 3-24-2009, FILED 11-6-2008.

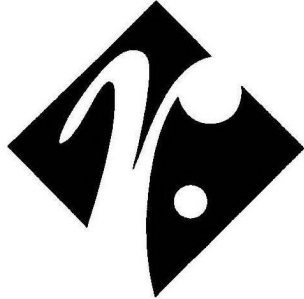

THE MARK CONSISTS OF THE LETTER "R" AND A DOT SUPERIMPOSED OVER A DIAMOND SHAPE.
FOR PROVIDING ASSISTED LIVING FACILITIES (U.S. CLS. 100 AND 101).
FIRST USE 9-17-2008; IN COMMERCE 9-17-2008.

3,681,380. QIP HOLDER LLC, DENVER, CO. SN 77-615,608. PUB. 2-17-2009, FILED 11-17-2008.

CHOOSE 2

THE MARK CONSISTS OF STANDARD CHARACTERS WITHOUT CLAIM TO ANY PARTICULAR FONT, STYLE, SIZE, OR COLOR.
FOR RESTAURANT SERVICES (U.S. CLS. 100 AND 101).
FIRST USE 1-18-2009; IN COMMERCE 1-18-2009.

3,681,514. MONSTER DADDY, LLC, GREENVILLE, SC. SN 78-666,482. PUB. 3-21-2006, FILED 7-8-2005.

WE CHILL 'EM YOU KILL 'EM

THE MARK CONSISTS OF STANDARD CHARACTERS WITHOUT CLAIM TO ANY PARTICULAR FONT, STYLE, SIZE, OR COLOR.
FOR RESTAURANT AND BAR SERVICES (U.S. CLS. 100 AND 101).
FIRST USE 10-4-2005; IN COMMERCE 1-5-2009.

CLASS 44—MEDICAL, BEAUTY AND AGRICULTURAL SERVICES**CLASS 44—(Continued).**

3,680,097. ELVEBAKK, RANVEIG, SAN FRANCISCO, CA. SN 76-671,041. PUB. 10-14-2008, FILED 1-4-2007.

The Food Tree

THE MARK CONSISTS OF STANDARD CHARACTERS WITHOUT CLAIM TO ANY PARTICULAR FONT, STYLE, SIZE, OR COLOR.
FOR WEIGHT REDUCTION DIET PLANNING AND SUPERVISION AND DIETARY AND NUTRITIONAL GUIDANCE (U.S. CLS. 100 AND 101).
FIRST USE 1-22-2009; IN COMMERCE 1-22-2009.

3,680,119. DEBARTOLO, H.M. JR.M.D.,S.C., SUGAR GROVE, IL. SN 76-685,581. PUB. 4-7-2009, FILED 1-7-2008.

Lite Lift

THE MARK CONSISTS OF STANDARD CHARACTERS WITHOUT CLAIM TO ANY PARTICULAR FONT, STYLE, SIZE, OR COLOR.
NO CLAIM IS MADE TO THE EXCLUSIVE RIGHT TO USE "LIFT", APART FROM THE MARK AS SHOWN.
FOR LESS EXTENSIVE NON-LIGHT AND NON-LASER BASED FACELIFT SURGERY (U.S. CLS. 100 AND 101).
FIRST USE 1-7-2008; IN COMMERCE 1-7-2008.

3,680,305. HAMS AND FAD LIMITED, LONDON, UNITED KINGDOM. SN 77-182,407. PUB. 11-6-2007, FILED 5-16-2007.

PIMPS & PINUPS

THE MARK CONSISTS OF STANDARD CHARACTERS WITHOUT CLAIM TO ANY PARTICULAR FONT, STYLE, SIZE, OR COLOR.
FOR HAIRDRESSING SALONS (U.S. CLS. 100 AND 101).
FIRST USE 10-2-2008; IN COMMERCE 10-2-2008.

CLASS 44—(Continued).

3,680,331. COMPREHENSIVE HEALTH SERVICES, INC., VIENNA, VA. SN 77-189,658. PUB. 9-30-2008, FILED 5-24-2007.

HYBRIDRX

THE MARK CONSISTS OF STANDARD CHARACTERS WITHOUT CLAIM TO ANY PARTICULAR FONT, STYLE, SIZE, OR COLOR.

FOR WORKSITE PHARMACY SERVICES, NAMELY, THE DISPENSING OF PHARMACEUTICALS FOR EMPLOYEES, RETIREES, AND THEIR DEPENDENTS; MEDICAL AND HEALTH CARE SERVICES, NAMELY, PROVIDING WORKSITE PHYSICIAN AVAILABLE TO WRITE PRESCRIPTIONS AND PROVIDING A WORKSITE PHARMACIST WHO SPECIALIZES IN ONSITE DISEASE MANAGEMENT AND HEALTH COACHING (U.S. CLS. 100 AND 101).
FIRST USE 6-16-2008; IN COMMERCE 6-16-2008.

CLASS 44—(Continued).

3,680,597. GOLDEN, JOSEPH, HOPLAND, CA. SN 77-343,628. PUB. 4-15-2008, FILED 12-4-2007.

GOLDEN VINEYARDS

THE MARK CONSISTS OF STANDARD CHARACTERS WITHOUT CLAIM TO ANY PARTICULAR FONT, STYLE, SIZE, OR COLOR.

OWNER OF U.S. REG. NO. 3,095,004.
NO CLAIM IS MADE TO THE EXCLUSIVE RIGHT TO USE "VINEYARDS", APART FROM THE MARK AS SHOWN.
FOR VINEYARD AND WINERY SERVICES, NAMELY, THE CULTIVATION OF GRAPES FOR OTHERS (U.S. CLS. 100 AND 101).
FIRST USE 1-1-2002; IN COMMERCE 1-1-2002.

3,680,659. THE QUILLIAN TATTOO, INC., ALLENTOWN, PA. SN 77-361,757. PUB. 6-3-2008, FILED 12-31-2007.

3,680,527. THE YOUNG MEN'S CHRISTIAN ASSOCIATION OF METROPOLITAN MILWAUKEE, INC., MILWAUKEE, WI. SN 77-327,229. PUB. 5-20-2008, FILED 11-12-2007.

HEALTHY LIFESTYLE VILLAGE

THE MARK CONSISTS OF STANDARD CHARACTERS WITHOUT CLAIM TO ANY PARTICULAR FONT, STYLE, SIZE, OR COLOR.

NO CLAIM IS MADE TO THE EXCLUSIVE RIGHT TO USE "HEALTHY LIFESTYLE", APART FROM THE MARK AS SHOWN.
FOR CLINICAL MEDICAL SERVICES (U.S. CLS. 100 AND 101).
FIRST USE 11-14-2007; IN COMMERCE 11-14-2007.



THE COLOR(S) RED, WHITE AND BLACK IS/ARE CLAIMED AS A FEATURE OF THE MARK.

THE MARK CONSISTS OF A FIVE-POINT STAR, WHICH HAS A WHITE BORDER, WITH THE LEFT-HALF OF THE STAR BEING BLACK AND THE RIGHT HALF BEING RED. IN THE CENTER OF THE STAR IS A STYLIZED LETTER "Q" IN THE FORM OF A TATTOO NEEDLE. BELOW THE STAR IS THE WORD "QUILLIAN" STYLIZED, WITH THE LETTER "Q" BEING RED AND THE REMAINING LETTERS BEING WHITE. THE STAR AND THE WORD "QUILLIAN" ARE ON A BLACK BACKGROUND. THE STYLIZED LETTER "Q" IN THE FORM OF A TATTOO NEEDLE APPEARS IN WHITE.

THE WORDING "QUILLIAN" HAS NO MEANING IN A FOREIGN LANGUAGE.
FOR TATTOO PARLOR AND BODY PIERCING SERVICES (U.S. CLS. 100 AND 101).
FIRST USE 7-31-2003; IN COMMERCE 7-31-2003.

CLASS 44—(Continued).

3,680,720. ACQUA DI ROMA, INC., SAN FRANCISCO, CA. SN 77-399,148. PUB. 10-21-2008, FILED 2-17-2008.

Q

THE MARK CONSISTS OF STANDARD CHARACTERS WITHOUT CLAIM TO ANY PARTICULAR FONT, STYLE, SIZE, OR COLOR.

FOR HEALTH SPA SERVICES FOR HEALTH AND WELLNESS OF BODY AND SPIRIT, FEATURING, MASSAGES, FACIALS AND BODY WRAPS; FACIAL TREATMENT SERVICES, NAMELY, COSMETIC PEELS; BODY WELLNESS MANAGEMENT CONSULTATION (U.S. CLS. 100 AND 101).

FIRST USE 9-4-2008; IN COMMERCE 9-4-2008.

3,681,047. CENTER FOR COGNITIVE FITNESS & INNOVATIVE THERAPIES, SANTA BARBARA, CA. SN 77-494,619. PUB. 11-4-2008, FILED 6-9-2008.

CFIT

THE MARK CONSISTS OF STANDARD CHARACTERS WITHOUT CLAIM TO ANY PARTICULAR FONT, STYLE, SIZE, OR COLOR.

FOR HEALTH CARE SERVICES, NAMELY, THERAPIES FOR SUSTAINING/OPTIMIZING NORMAL MENTAL FUNCTION (U.S. CLS. 100 AND 101).

FIRST USE 3-31-2009; IN COMMERCE 3-31-2009.

3,681,144. XASE XETECHE CORPORATION, DBA XASE XETECHE CORPORATION, LEAGUE CITY, TX. SN 77-526,708. PUB. 1-27-2009, FILED 7-20-2008.



Flawless Features

NO CLAIM IS MADE TO THE EXCLUSIVE RIGHT TO USE "FEATURES", APART FROM THE MARK AS SHOWN.

THE MARK CONSISTS OF THE LETTERS "F", "F", "M" INSIDE A CIRCLE AND THE WORDING "FLAWLESS FEATURES" APPEARING TO THE RIGHT OF THE CIRCLE.

FOR CONSULTATION SERVICES IN THE FIELD OF MAKEUP, NAMELY, ON-LINE MAKEUP CONSULTATION SERVICES AND IN-PERSON MAKEUP CONSULTATION AND APPLICATION SERVICES (U.S. CLS. 100 AND 101).

FIRST USE 8-1-2008; IN COMMERCE 8-1-2008.

CLASS 44—(Continued).

3,681,219. THE TRUSTEES OF THE UNIVERSITY OF PENNSYLVANIA, PHILADELPHIA, PA. SN 77-560,017. PUB. 1-20-2009, FILED 9-2-2008.

PENN PASSPORT

THE MARK CONSISTS OF STANDARD CHARACTERS WITHOUT CLAIM TO ANY PARTICULAR FONT, STYLE, SIZE, OR COLOR.

OWNER OF U.S. REG. NOS. 1,773,208, 2,143,894, AND OTHERS.

SEC. 2(F) AS TO "PENN".

FOR MEDICAL AND VETERINARY SERVICES (U.S. CLS. 100 AND 101).

FIRST USE 9-1-2008; IN COMMERCE 9-1-2008.

3,681,302. MASDON PROFESSIONAL SERVICES, INC. DBA ENJOY YOUR LIFE FAMILY SERVICES, INC., CARROLLTON, TX. SN 77-588,150. PUB. 3-31-2009, FILED 10-8-2008.



NO CLAIM IS MADE TO THE EXCLUSIVE RIGHT TO USE "FAMILY SERVICES, INC.", APART FROM THE MARK AS SHOWN.

THE COLOR(S) RED AND BLACK IS/ARE CLAIMED AS A FEATURE OF THE MARK.

THE MARK CONSISTS OF THE WORDING "ENJOY YOUR LIFE" IN RED STYLIZED FONT WITH THE WORDING "FAMILY SERVICES, INC." DIRECTLY BELOW AND IN SMALLER BLACK STYLIZED FONT. TO THE LEFT OF THE WORDING IS A DESIGN OF A FIGURE MADE OF TWO HUMAN FORMS WHERE THEIR BACKS ARE TO ONE ANOTHER AND THEY HAVE ARCHED THEIR BACKS SO THAT THEIR HEADS ARE TOUCHING AND ALSO BOTH OF THEIR HANDS ARE TOUCHING THE OTHER. THE BOTTOM PORTION OF THEIR BODIES FORMS THE OUTLINE OF A HEART. THE FEMALE FORM ON THE LEFT IS RED AND BLACK WHILE THE MALE FORM ON THE RIGHT IS BLACK.

FOR MEDICAL COUNSELING; MENTAL HEALTH COUNSELING AND PSYCHOTHERAPY AS IT RELATES TO RELATIONSHIPS; PSYCHOLOGICAL COUNSELING; PSYCHOTHERAPY AND PSYCHOTHERAPY COUNSELING FOR CHILDREN AND ADULTS IN INDIVIDUAL AND FAMILY SESSIONS; PSYCHOTHERAPY SERVICES (U.S. CLS. 100 AND 101).

FIRST USE 2-10-2009; IN COMMERCE 2-18-2009.

CLASS 44—(Continued).

3,681,318. HOUSTON, SHERARD, BOCA RATON, FL. SN 77-590,972. PUB. 3-10-2009, FILED 10-12-2008.

CLASS 44—(Continued).

3,681,345. GREENBERG, STEPHEN, T., WOODBURY, NY. SN 77-600,855. PUB. 3-17-2009, FILED 10-27-2008.

DOCTORS 365

Glisten

THE MARK CONSISTS OF STANDARD CHARACTERS WITHOUT CLAIM TO ANY PARTICULAR FONT, STYLE, SIZE, OR COLOR.

NO CLAIM IS MADE TO THE EXCLUSIVE RIGHT TO USE "DOCTORS", APART FROM THE MARK AS SHOWN, FOR PHYSICIAN SERVICES; URGENT MEDICAL CARE CENTERS (U.S. CLS. 100 AND 101).

FIRST USE 11-1-2008; IN COMMERCE 11-1-2008.

THE MARK CONSISTS OF STANDARD CHARACTERS WITHOUT CLAIM TO ANY PARTICULAR FONT, STYLE, SIZE, OR COLOR.

FOR BEAUTY SPA SERVICES, NAMELY, COSMETIC BODY CARE (U.S. CLS. 100 AND 101).

FIRST USE 1-1-2009; IN COMMERCE 1-1-2009.

3,681,320. MG BROWN INVESTMENT GROUP, LLC, HOUSTON, TX. SN 77-591,500. PUB. 1-6-2009, FILED 10-13-2008.

3,681,488. CAREIN' CONNECTIONS UNLIMITED, ST. CHARLES, IL. SN 78-602,674. PUB. 5-9-2006, FILED 4-6-2005.



Arena of Dreams

OWNER OF U.S. REG. NOS. 3,388,093, 3,452,378, AND OTHERS.

THE MARK CONSISTS OF A FANCIFUL HAND WITHIN A MEDALLION WITH CONCENTRIC CIRCLES.

FOR MEDICAL, PHYSICAL REHABILITATION AND PHYSICAL THERAPY SERVICES (U.S. CLS. 100 AND 101).

FIRST USE 9-0-2008; IN COMMERCE 9-0-2008.

THE MARK CONSISTS OF STANDARD CHARACTERS WITHOUT CLAIM TO ANY PARTICULAR FONT, STYLE, SIZE, OR COLOR.

FOR PROVIDING PHYSICAL AND OCCUPATIONAL THERAPY WITH THE USE OF EQUINE AND AQUATIC PROGRAMS (U.S. CLS. 100 AND 101).

FIRST USE 4-6-2005; IN COMMERCE 4-6-2005.

CLASS 44—(Continued).

3,681,573. MESHBESHER HEALTH CORPORATION, CLEARWATER, FL. SN 78-820,999. PUB. 10-10-2006, FILED 2-22-2006.

Dr Betsy

THE MARK CONSISTS OF STANDARD CHARACTERS WITHOUT CLAIM TO ANY PARTICULAR FONT, STYLE, SIZE, OR COLOR.

THE NAME "DR. BETSY" IDENTIFIES A LIVING INDIVIDUAL WHOSE CONSENT IS OF RECORD.

FOR PROVIDING INFORMATION THROUGH WEB SITES AND WEB-BASED INFORMATION VIA THE INTERNET IN THE FIELD OF NATURAL HEALTH, DIET, NUTRITION, PERFECT WEIGHT AND OTHER HEALTH RELATED TOPICS; PROVIDING WEB-BASED PROFESSIONAL ASSOCIATE CONSULTING AND PRIVATE PERSONAL CONSULTATION SERVICES IN THE FIELD OF PREVENTATIVE HEALTH, NUTRITION, NATURAL HEALTH AND HEALTHY LIFESTYLE SOLUTIONS AND PROGRAMS, PERFECT WEIGHT SOLUTIONS AND PROGRAMS (U.S. CLS. 100 AND 101).

FIRST USE 6-1-2009; IN COMMERCE 6-1-2009.

3,681,586. MESHBESHER HEALTH CORPORATION, CLEARWATER, FL. SN 78-852,061. PUB. 5-8-2007, FILED 4-2-2006.

Blood Money

THE MARK CONSISTS OF STANDARD CHARACTERS WITHOUT CLAIM TO ANY PARTICULAR FONT, STYLE, SIZE, OR COLOR.

FOR PROVIDING A WEB SITE INCORPORATING A SEARCHABLE COMPUTER DATABASE OF HEALTH-RELATED INFORMATION, NAMELY, ARTICLES, INFORMATIONAL AND INSTRUCTIONAL BULLETINS AND MANUALS, TECHNICAL BULLETINS AND MANUALS, QUESTIONNAIRES, GRAPHS, RESEARCH RESULTS, RESEARCH INFORMATION, CASE HISTORIES, STATISTICS IN THE NATURE OF HEALTH, NUTRITION, HEALTH EFFECTS OF ECOLOGICAL AND ENVIRONMENTAL SAFETY AND RISKS, DIET AND DRUG STATISTICS AND NEWSLETTERS AND LINKS TO RELATED WEB-SITES IN THE FIELDS OF NATURAL HEALTH, NUTRITION, XENOBIOTICS AND XENOBIOLGY, TOXICOLOGY, DRUGS AND PHARMACOLOGY, ALLERGY AND HEALTH EFFECTS OF IMMUNOLOGY OF NATURAL AND SYNTHETIC FOODS AND SUBSTANCES, CHEMICALS, CHEMISTRY, ORGANIC CHEMISTRY, BIOCHEMISTRY, PATHOLOGY, ANATOMY, PHYSIOLOGY, HISTOLOGY, MICROBIOLOGY, BIOLOGY, CLINICAL LABORATORY TECHNOLOGY, MEDICINE, SURGERY AND EMERGENCY PROCEDURES (U.S. CLS. 100 AND 101).

FIRST USE 5-30-2008; IN COMMERCE 5-30-2008.

CLASS 45—PERSONAL AND LEGAL SERVICES

CLASS 45—(Continued).

3,680,242. LAU, KAWAI, BELLEVUE, WA. SN 77-151,595. PUB. 3-10-2009, FILED 4-9-2007.

PATENTIQUE

THE MARK CONSISTS OF STANDARD CHARACTERS WITHOUT CLAIM TO ANY PARTICULAR FONT, STYLE, SIZE, OR COLOR.

FOR LEGAL SERVICES AND CONSULTING IN THE FIELDS OF INTELLECTUAL PROPERTY, PATENTS, TRADEMARKS, COPYRIGHTS, TRADE SECRETS, KNOW-HOW, LICENSING OF INTELLECTUAL PROPERTY, LICENSING OF PATENTS, LICENSING OF TRADEMARKS, LICENSING OF COPYRIGHTS, LICENSING OF TRADE SECRETS AND LICENSING OF KNOW-HOW; INTELLECTUAL PROPERTY MANAGEMENT CONSULTING; PATENT AND INDUSTRIAL PROPERTY SERVICES, NAMELY, PATENT AND TRADEMARK PROSECUTION SERVICES, PATENT AGENT SERVICES, PATENT AND TRADEMARK LICENSING SERVICES AND CONSULTING, PATENT AND TRADEMARK PORTFOLIO MANAGEMENT AND ANALYSIS, PATENT AND TRADEMARK LITIGATION SERVICES, PATENT AND TRADEMARK LITIGATION SUPPORT SERVICES, PATENT AND TRADEMARK ANALYSIS, AND PATENT AND TRADEMARK SEARCH SERVICES (U.S. CLS. 100 AND 101).

FIRST USE 5-1-2007; IN COMMERCE 5-1-2007.

3,680,296. CARING FOR PEOPLE SERVICES INC, OMAHA, NE. SN 77-179,885. PUB. 4-29-2008, FILED 5-14-2007.

Caring for People Services

THE MARK CONSISTS OF STANDARD CHARACTERS WITHOUT CLAIM TO ANY PARTICULAR FONT, STYLE, SIZE, OR COLOR.

NO CLAIM IS MADE TO THE EXCLUSIVE RIGHT TO USE "SERVICES", APART FROM THE MARK AS SHOWN.

FOR PERSONAL CARE ASSISTANCE OF ACTIVITIES OF DAILY LIVING, SUCH AS BATHING, GROOMING AND PERSONAL MOBILITY FOR MENTALLY OR PHYSICALLY CHALLENGED PEOPLE (U.S. CLS. 100 AND 101).

FIRST USE 11-17-2004; IN COMMERCE 2-16-2005.

CLASS 45—(Continued).

3,680,342. VONDERHEIDE, GREGORY J., WESLEY CHAPEL, FL. SN 77-197,492. PUB. 11-20-2007, FILED 6-5-2007.

Memorial Tree

THE MARK CONSISTS OF STANDARD CHARACTERS WITHOUT CLAIM TO ANY PARTICULAR FONT, STYLE, SIZE, OR COLOR.

FOR FUNERAL ARRANGEMENT SERVICES (U.S. CLS. 100 AND 101).

FIRST USE 6-22-2008; IN COMMERCE 6-22-2008.

3,680,386. BETTA, INC., SANTA MONICA, CA. SN 77-249,231. PUB. 2-19-2008, FILED 8-7-2007.

CLOSET COUTURE

THE MARK CONSISTS OF STANDARD CHARACTERS WITHOUT CLAIM TO ANY PARTICULAR FONT, STYLE, SIZE, OR COLOR.

NO CLAIM IS MADE TO THE EXCLUSIVE RIGHT TO USE "COUTURE", APART FROM THE MARK AS SHOWN.

FOR ONLINE SOCIAL NETWORKING SERVICES; PROVIDING FASHION INFORMATION (U.S. CLS. 100 AND 101).

FIRST USE 10-1-2008; IN COMMERCE 10-1-2008.

3,680,418. DOGSTER, INC., SAN FRANCISCO, CA. SN 77-284,611. PUB. 3-10-2009, FILED 9-20-2007.

DOGSTER

THE MARK CONSISTS OF STANDARD CHARACTERS WITHOUT CLAIM TO ANY PARTICULAR FONT, STYLE, SIZE, OR COLOR.

OWNER OF U.S. REG. NOS. 2,923,333 AND 3,089,438.
FOR ASSISTING IN LOCATING LOST PETS; PROVIDING PET IDENTIFICATION TAGS; PROVIDING AN INTERACTIVE WEB SITE TO ASSIST PERSONS IN LOCATING LOST PETS; MAINTAINING A REGISTRY OF PETS TO ASSIST PERSONS IN LOCATING LOST PETS; PROVIDING AN ON-LINE SEARCHABLE DATABASE FEATURING DISASTER PREPAREDNESS FOR PETS (U.S. CLS. 100 AND 101).

FIRST USE 4-1-2009; IN COMMERCE 4-1-2009.

CLASS 45—(Continued).

3,680,440. HURON CONSULTING GROUP INC., CHICAGO, IL. SN 77-295,308. PUB. 2-10-2009, FILED 10-3-2007.

V3LOCITY

THE MARK CONSISTS OF STANDARD CHARACTERS WITHOUT CLAIM TO ANY PARTICULAR FONT, STYLE, SIZE, OR COLOR.

FOR LEGAL CONSULTING SERVICES, NAMELY, PROCESSING, REVIEW OF DOCUMENTS AND EVIDENCE, AND HOSTING OF DOCUMENTS IN AN ELECTRONIC REPOSITORY SPECIFICALLY TAILORED TO THE LEGAL REVIEW AND ANALYSIS OF A DOCUMENT COLLECTION, ALL FOR LEGAL AND REGULATORY COMPLIANCE DEPARTMENTS (U.S. CLS. 100 AND 101).

FIRST USE 11-1-2007; IN COMMERCE 11-1-2007.

3,680,615. ID ANALYTICS, INC., SAN DIEGO, CA. SN 77-347,252. PUB. 10-7-2008, FILED 12-7-2007.

'id:analytics

OWNER OF U.S. REG. NO. 2,916,055.
SEC. 2(F).

FOR CONSULTING SERVICES IN THE FIELD OF IDENTITY FRAUD; IDENTITY THEFT PROTECTION SERVICES THAT PROVIDE FRAUD PREVENTION AND PROTECTION BY MONITORING FINANCIAL DATA BASED UPON IDENTITY INFORMATION; ASSISTING COMPANIES, ORGANIZATIONS, ACADEMIC INSTITUTIONS, AND GOVERNMENT AGENCIES TO RECOGNIZE, ASSESS, SCREEN, MONITOR, VALIDATE AND PREVENT THE MISUSE OR THEFT OF PERSONAL IDENTITY INFORMATION AND FINANCIAL INFORMATION (U.S. CLS. 100 AND 101).

FIRST USE 3-12-2008; IN COMMERCE 3-12-2008.

3,680,667. FONTAINE, KATHRYN DOMINIS, SAN ANTONIO, TX. SN 77-366,530. PUB. 5-20-2008, FILED 1-8-2008.

NEVER STOP SEARCH

THE MARK CONSISTS OF STANDARD CHARACTERS WITHOUT CLAIM TO ANY PARTICULAR FONT, STYLE, SIZE, OR COLOR.

FOR MISSING CHILD RECOVERY SERVICE, NAMELY, REGISTRATION OF CHILDREN, NAMELY, COLLECTING, ORGANIZING AND PROVIDING CHILD-SPECIFIC INFORMATION USEFUL IN FINDING MISSING CHILDREN (U.S. CLS. 100 AND 101).

FIRST USE 1-8-2008; IN COMMERCE 1-8-2008.

CLASS 45—(Continued).

3,681,224. SUPERSOCIAL INC., BURKE, VA. SN 77-561,870. PUB. 1-20-2009, FILED 9-3-2008.

CLASS 45—(Continued).

3,681,225. FIRST CALL FAMILIES, SANDY, OR. SN 77-562,185. PUB. 2-3-2009, FILED 9-4-2008.

Supersocial

THE MARK CONSISTS OF STANDARD CHARACTERS WITHOUT CLAIM TO ANY PARTICULAR FONT, STYLE, SIZE, OR COLOR.

FOR COMPUTER DATING SERVICES; DATING SERVICES; INTERNET BASED SOCIAL NETWORKING, INTRODUCTION, AND DATING SERVICES; INTERNET-BASED DATING, SOCIAL INTRODUCTION AND SOCIAL NETWORKING SERVICES; MARRIAGE PARTNER INTRODUCTION OR DATING SERVICES; PROVIDING A WEB SITE FEATURING INFORMATION AND CONTENT IN THE FIELDS OF PERSONAL RELATIONSHIPS, DATING AND FASHION; WEB SITE SERVICES FEATURING ON-LINE DATING CLUB (U.S. CLS. 100 AND 101).

FIRST USE 4-27-2004; IN COMMERCE 2-9-2009.

Responder Life

THE MARK CONSISTS OF STANDARD CHARACTERS WITHOUT CLAIM TO ANY PARTICULAR FONT, STYLE, SIZE, OR COLOR.

NO CLAIM IS MADE TO THE EXCLUSIVE RIGHT TO USE "RESPONDER", APART FROM THE MARK AS SHOWN.

FOR MINISTERIAL SERVICES (U.S. CLS. 100 AND 101).

FIRST USE 12-1-2008; IN COMMERCE 1-1-2009.

* * * * *

PRIOR UNITED STATES CLASSIFICATION

APPLICATION IN ONE CLASS

COLLECTIVE MEMBERSHIP MARKS

CLASS 200—COLLECTIVE MEMBERSHIP

3,680,702. CRIMSON CIRCLE IP, INC., GOLDEN, CO. SN 77-390,153. PUB. 7-1-2008, FILED 2-6-2008.

SHAUMBRA INSPIRED

THE MARK CONSISTS OF STANDARD CHARACTERS WITHOUT CLAIM TO ANY PARTICULAR FONT, STYLE, SIZE, OR COLOR.

THE WORDING "SHAUMBRA" HAS NO MEANING IN A FOREIGN LANGUAGE.

FOR INDICATING MEMBERSHIP IN AN ASSOCIATION OF CRIMSON CIRCLE AFFILIATES, KNOWN AS SHAUMBRA, DEDICATED TO TEACHING AND INSPIRING SPIRITUAL CONSCIOUSNESS (U.S. CL. 200).

FIRST USE 3-13-2009; IN COMMERCE 3-13-2009.

3,680,705. CRIMSON CIRCLE IP, INC., GOLDEN, CO. SN 77-391,364. PUB. 6-24-2008, FILED 2-7-2008.



THE COLOR(S) RED AND BLACK IS/ARE CLAIMED AS A FEATURE OF THE MARK.

THE MARK CONSISTS OF THE WORDING "SHAUMBRA INSPIRED" ALONG WITH A STYLIZED DEPICTION OF A BUTTERFLY. THE COLOR BLACK APPEARS IN THE WORDING "SHAUMBRA" AND IN THE DARKER SHADED AREAS OF THE BUTTERFLY; THE COLOR RED APPEARS IN THE WORDING "INSPIRED" AND IN THE LIGHTER SHADED AREAS OF THE BUTTERFLY.

THE WORDING "SHAUMBRA" HAS NO MEANING IN A FOREIGN LANGUAGE.

FOR INDICATING MEMBERSHIP IN AN ASSOCIATION OF CRIMSON CIRCLE AFFILIATES, KNOWN AS SHAUMBRA, DEDICATED TO TEACHING AND INSPIRING SPIRITUAL CONSCIOUSNESS (U.S. CL. 200).

FIRST USE 3-13-2009; IN COMMERCE 3-13-2009.

CERTIFICATION MARKS

CLASS B—SERVICES

3,680,817. SUPPLEMENT RX, LLC, PARK CITY, UT. SN 77-442,585. PUB. 9-30-2008, FILED 4-8-2008.

FITNESS AND SPORTS
NUTRITION SPECIALIST (FSNS)

THE MARK CONSISTS OF STANDARD CHARACTERS WITHOUT CLAIM TO ANY PARTICULAR FONT, STYLE, SIZE, OR COLOR.

NO CLAIM IS MADE TO THE EXCLUSIVE RIGHT TO USE "FITNESS AND SPORTS NUTRITION SPECIALIST", APART FROM THE MARK AS SHOWN.

THE CERTIFICATION MARK, AS INTENDED TO BE USED BY AUTHORIZED PERSONS, IS INTENDED TO CERTIFY THAT THE PERSON DISPLAYING THE MARK HAS ATTAINED A LEVEL OF KNOWLEDGE AND HAS COMPLETED CERTAIN EDUCATIONAL REQUIREMENTS, TRAINING AND EXAMINATION(S) ADMINISTERED AND APPROVED BY THE CERTIFIER AND HAS AGREED TO ADHERE TO THE CERTIFIER'S STANDARDS FOR PROFESSIONAL RESPONSIBILITY.

FOR EDUCATIONAL AND INFORMATIONAL SERVICES, NAMELY, PROVIDING INSTRUCTION IN THE FIELD OF NUTRITION AND INFORMATION ON NUTRITION (U.S. CL. B).

FIRST USE 1-19-2009; IN COMMERCE 1-19-2009.

* * * * *

SUPPLEMENTAL REGISTER

These registrations are not subject to opposition.

SECTION 1.— INTERNATIONAL CLASSIFICATION

The short titles associated below with the international class numbers are terms designed merely for quick identification and are not an official part of the international classification. The full names of international classes are given in section 6.1 of the trademark rules of practice.

The designation "U.S. Cl." appearing in this section refers to the U.S. class in effect prior to Sep. 1, 1973 rather than the international class which applies to applications filed on or after that date. For adoption of international classification see notice in the OFFICIAL GAZETTE of Jun. 26, 1973 (911 O.G. TM 210).

Application in more than one class

3,681,643. ONTARIO LOTTERY AND GAMING CORPORATION, TORONTO, ONTARIO, CANADA. SN 76-575,174. FILED P.R. 2-10-2004; AM. S.R. 7-20-2009.

CLASS 43—HOTEL AND RESTAURANT SERVICES

FOR RESORT HOTELS, SPA SERVICES, NAMELY, PROVIDING TEMPORARY ACCOMMODATIONS OR MEALS TO CLIENTS OF A HEALTH OR BEAUTY SPA; RESTAURANTS; HOTELS; OPERATION OF A CONVENTION CENTRE, NAMELY, PROVIDING CONVENTION FACILITIES (U.S. CLS. 100 AND 101).

NIAGARA FALLSVIEW CASINO RESORT

THE MARK CONSISTS OF STANDARD CHARACTERS WITHOUT CLAIM TO ANY PARTICULAR FONT, STYLE, SIZE, OR COLOR.

PRIORITY CLAIMED UNDER SEC. 44(D) ON CANADA APPLICATION NO. 1186122, FILED 8-11-2003, REG. NO. TMA682865, DATED 3-5-2007, EXPIRES 3-5-2022.

NO CLAIM IS MADE TO THE EXCLUSIVE RIGHT TO USE "NIAGARA" AND "CASINO RESORT", APART FROM THE MARK AS SHOWN.

3,681,645. ASIS INTERNATIONAL, INC., ALEXANDRIA, VA. SN 76-978,989. FILED P.R. 3-12-2008; AM. S.R. 6-15-2009.

CSO ROUNDTABLE

THE MARK CONSISTS OF STANDARD CHARACTERS WITHOUT CLAIM TO ANY PARTICULAR FONT, STYLE, SIZE, OR COLOR.

NO CLAIM IS MADE TO THE EXCLUSIVE RIGHT TO USE "ROUNDTABLE", APART FROM THE MARK AS SHOWN.

CLASS 35—ADVERTISING AND BUSINESS

FOR ORGANIZATION OF TRADE SHOWS AND INDUSTRY EXPOSITIONS IN ALL INDUSTRIES; RETAIL STORE SERVICES, FEATURING GENERAL MERCHANDISE INCLUDING NOVELTY ITEMS, FOOD AND CLOTHING (U.S. CLS. 100, 101 AND 102).

CLASS 35—ADVERTISING AND BUSINESS

FOR PROVIDE EXECUTIVE LEVEL BUSINESS CONFERENCES; BUSINESS NETWORKING FOR TOP SECURITY PROFESSIONAL MEMBERS TO HELP THEM PERFORM THEIR JOB RESPONSIBILITIES AND ADVANCE THEIR CAREERS; PROVIDING BUSINESS INFORMATION IN THE NATURE OF BEST PRACTICES, AND POLICIES AND PROCEDURES FOR SECURITY PROFESSIONALS PROVIDED VIA THE GLOBAL COMPUTER NETWORK (U.S. CLS. 100, 101 AND 102).
FIRST USE 9-0-2007; IN COMMERCE 9-0-2007.

CLASS 36—INSURANCE AND FINANCIAL

FOR SHOPPING CENTER SERVICES, NAMELY, RENTAL OF SHOPPING CENTER SPACE (U.S. CLS. 100, 101 AND 102).

CLASS 41—EDUCATION AND ENTERTAINMENT

FOR ENTERTAINMENT IN THE NATURE OF LIVE VISUAL AND AUDIO PERFORMANCES BY MUSICAL INDIVIDUALS AND GROUPS, VARIETY INDIVIDUALS AND GROUPS, DANCE INDIVIDUALS AND GROUPS, AND COMEDY INDIVIDUALS AND GROUPS; ENTERTAINMENT IN THE NATURE OF CIRCUSES; ENTERTAINMENT IN THE NATURE OF BOXING CONTESTS AND OTHER COMPETITIONS IN THE FIELD OF ATHLETICS; ENTERTAINMENT IN THE NATURE OF FASHION SHOWS; CASINOS; LOTTERY SERVICES; GAMING SERVICES, NAMELY, CONDUCTING AND PROVIDING FACILITIES FOR SPECIAL EVENTS FEATURING CASINO AND GAMING CONTESTS AND TOURNAMENTS (U.S. CLS. 100, 101 AND 107).

CLASS 41—EDUCATION AND ENTERTAINMENT

FOR EDUCATION SEMINARS IN THE FIELD OF SECURITY INFORMATION AND SERVICES; ON-LINE SERVICES, NAMELY, PROVIDING ONLINE PUBLICATIONS IN THE NATURE OF REPORTS, WHITE PAPERS, PAMPHLETS FEATURING BEST PRACTICES, AND PAMPHLETS FEATURING POLICIES AND PROCEDURES FOR SECURITY PROFESSIONALS (U.S. CLS. 100, 101 AND 107).
FIRST USE 9-0-2007; IN COMMERCE 9-0-2007.

3,681,653. BACKHUS GMBH, EDEWECHT, FED REP GER-
MANY. SN 77-341,522. FILED P.R. 11-30-2007; AM. S.R. 4-
16-2009.

EcoEngineers

THE MARK CONSISTS OF STANDARD CHARACTERS
WITHOUT CLAIM TO ANY PARTICULAR FONT, STYLE,
SIZE, OR COLOR.

CLASS 7—MACHINERY

FOR SELF-PROPELLED MACHINES AND PARTS THEREOF FOR COMPOSTING VARIOUS FEEDSTOCK LIKE GREEN WASTE, ORGANIC RESIDUALS, SLUDGE, AGRICULTURAL WASTES, PRODUCT OF SOIL AND SUBSTRATA, TREATMENT OF DREDGED MATERIAL, BLENDING SOILS, MECHANICAL BIOLOGICAL TREATMENT OF MUNICIPAL SOLID WASTE, BIO REMEDIATION AND RECLUTIVATION; COMPOST TURNER MACHINES, POWER OPERATED COVER WINDER IN THE NATURE OF MACHINES, AND PARTS THEREOF FOR COMPOSTING VARIOUS FEEDSTOCK LIKE GREEN WASTE, ORGANIC RESIDUALS, SLUDGE, AGRICULTURAL WASTES, PRODUCT OF SOIL AND SUBSTRATA, TREATMENT OF DREDGED MATERIAL, BLENDING SOILS, MECHANICAL BIOLOGICAL TREATMENT OF MUNICIPAL SOLID WASTE, BIO REMEDIATION AND RECLUTIVATION; SIDE CONVEYORS, WATER INJECTION SPRAYHEADS AND PIPING AS PARTS OF POWER OPERATED COMPOST TURNERS IN CLASS 7, AND GEARS AND ENCLOSED DRIVES FOR INDUSTRIAL MACHINERY SUCH AS POWER OPERATED COMPOST TURNERS AND POWER OPERATED COVER WINDERS, AND PARTS THEREOF FOR COMPOSTING VARIOUS FEEDSTOCK LIKE GREEN WASTE, ORGANIC RESIDUALS, SLUDGE, AGRICULTURAL WASTES, PRODUCT OF SOIL AND SUBSTRATA, TREATMENT OF DREDGED MATERIAL, BLENDING SOILS, MECHANICAL BIOLOGICAL TREATMENT OF MUNICIPAL SOLID WASTE, BIO REMEDIATION AND RECLUTIVATION (U.S. CLS. 13, 19, 21, 23, 31, 34 AND 35).

FIRST USE 1-1-2008; IN COMMERCE 1-15-2008.

CLASS 37—CONSTRUCTION AND REPAIR

FOR INSTALLATION, MAINTENANCE AND REPAIR OF SELF-PROPELLED MACHINES FOR COMPOSTING AND GREEN CUTTING OF BIO WASTE, PRODUCT OF SOIL AND SUBSTRATA, TREATMENT OF DREDGED MATERIAL, SLUDGE TREATMENT, TREATMENT OF ORGANIC RESIDUALS, TREATMENT OF AGRICULTURAL WASTE, MECHANICAL-BIOLOGICAL TREATMENT OF MUNICIPAL SOIL WASTE, BIO REMEDIATION, RECLUTIVATION, SOIL DECONTAMINATION AND SOIL BLENDING; INSTALLATION, MAINTENANCE AND REPAIR OF MECHANICAL DEVICES AND FOR COMPOSTING AND GREEN CUTTING OF BIO WASTE, PRODUCT OF SOIL AND SUBSTRATA, TREATMENT OF DREDGED MATERIAL, SLUDGE TREATMENT, TREATMENT OF ORGANIC RESIDUALS, TREATMENT OF AGRICULTURAL WASTE, MECHANICAL-BIOLOGICAL TREATMENT OF MUNICIPAL SOIL WASTE, BIO REMEDIATION, RECLUTIVATION, SOIL DECONTAMINATION AND SOIL BLENDING; INSTALLATION, MAINTENANCE AND REPAIR OF MACHINES, NAMELY, AUTOMOTIVE MACHINES, MECHANICAL DEVICES, AND EQUIPMENT COMPOSED THEREOF FOR COMPOSTING, SOIL DECONTAMINATION, AND SOIL BLENDING (U.S. CLS. 100, 103 AND 106).

FIRST USE 1-1-2008; IN COMMERCE 1-15-2008.

CLASS 41—EDUCATION AND ENTERTAINMENT

FOR PRACTICAL TRAINING, IN PARTICULAR IN RESPECT TO COUNSELING EXPERTISE, PROCESS ENGINEERING AND SALES SKILLS (U.S. CLS. 100, 101 AND 107).

FIRST USE 1-1-2008; IN COMMERCE 1-15-2008.

3,681,654. IFORMATA LLC, DAYTON, OH. SN 77-360,281.
FILED P.R. 12-27-2007; AM. S.R. 5-8-2009.

TELEPRESENCE EXCHANGE

THE MARK CONSISTS OF STANDARD CHARACTERS
WITHOUT CLAIM TO ANY PARTICULAR FONT, STYLE,
SIZE, OR COLOR.

CLASS 37—CONSTRUCTION AND REPAIR

FOR NETWORKING SERVICES, NAMELY, INSTALLATION OF TELECOMMUNICATIONS AND DATA NETWORKING HARDWARE, NAMELY, DEVICES FOR TRANSPORTING AND AGGREGATING VOICE, DATA, AND VIDEO COMMUNICATIONS ACROSS MULTIPLE NETWORK INFRASTRUCTURES AND COMMUNICATIONS PROTOCOLS (U.S. CLS. 100, 103 AND 106).

FIRST USE 1-3-2008; IN COMMERCE 1-3-2008.

CLASS 38—COMMUNICATION

FOR AUDIO AND VIDEO TELECONFERENCING SERVICES; PROVISION OF SERVICES FOR THE ELECTRONIC EXCHANGE OF AUDIO, VIDEO AND DATA VIA TELECOMMUNICATIONS NETWORK, NAMELY, REAL TIME EXCHANGE OF AUDIO, VIDEO AND DATA ACCESSIBLE DURING AN AUDIO AND VIDEO TELECONFERENCE EXCHANGE (U.S. CLS. 100, 101 AND 104).

FIRST USE 1-3-2008; IN COMMERCE 1-3-2008.

3,681,656. THE GOURMET ENTERTAINMENT NETWORK, L.L.C., SOUTH BLOOMINGVILLE, OH. SN 77-398,182. FILED P.R. 2-15-2008; AM. S.R. 7-14-2009.

GOURMET ENTERTAINMENT NETWORK

THE MARK CONSISTS OF STANDARD CHARACTERS WITHOUT CLAIM TO ANY PARTICULAR FONT, STYLE, SIZE, OR COLOR.

CLASS 35—ADVERTISING AND BUSINESS

FOR BUSINESS CONSULTING SERVICES (U.S. CLS. 100, 101 AND 102).
FIRST USE 7-14-2009; IN COMMERCE 7-14-2009.

CLASS 45—PERSONAL AND LEGAL SERVICES

FOR PERSONAL CHEF SERVICES (U.S. CLS. 100 AND 101).
FIRST USE 3-22-2009; IN COMMERCE 3-22-2009.

3,681,664. MATHENA, INC., EL RENO, OK. SN 77-420,042. FILED P.R. 3-12-2008; AM. S.R. 12-22-2008.

THE MUD-GAS PRESSURE CONTROL EXPERTS

THE MARK CONSISTS OF STANDARD CHARACTERS WITHOUT CLAIM TO ANY PARTICULAR FONT, STYLE, SIZE, OR COLOR.

NO CLAIM IS MADE TO THE EXCLUSIVE RIGHT TO USE "MUD-GAS PRESSURE CONTROL", APART FROM THE MARK AS SHOWN.

CLASS 7—MACHINERY

FOR CENTRIFUGAL PUMPS; PETROLEUM INDUSTRY POWER-OPERATED EQUIPMENT FOR DRILLING FLUID PROCESSING AND SOLIDS CONTROL, NAMELY, SHAKERS; POWER OPERATED PRESSURE CONTROL EQUIPMENT FOR USE IN DRILLING OIL, NAMELY, CHOKES AND DEGASSERS FOR EXTRACTING GAS FROM FLUID DURING OIL PRODUCTION AND DUAL MUD GAS SEPARATORS FOR HORIZONTAL DRILLING BEING COMPONENTS OF MANIFOLDS (U.S. CLS. 13, 19, 21, 23, 31, 34 AND 35).
FIRST USE 11-30-2005; IN COMMERCE 11-30-2005.

CLASS 11—ENVIRONMENTAL CONTROL APPARATUS

FOR IGNITION SYSTEMS COMPRISED OF A GAS SUPPLY TUBE WITH A NOZZLE AND AN ELECTRICAL IGNITER TO CREATE A FLAME AT THE NOZZLE FOR OIL AND GAS DRILLING AND PRODUCTION OPERATIONS, NAMELY, FOR IGNITING WASTE GASES BEING DISCHARGED FROM A WELL; MUD GAS SEPARATORS, NAMELY, SEPARATORS FOR THE CLEANING AND PURIFICATION OF DRILLING MUD; GAS EXTRACTION DEVICES, NAMELY, DEGASSER OF GAS AND EXTRACTORS OF LIQUID FOR USE IN EXTRACTING GASES FROM DRILLING FLUIDS; AND PRESSURE CONTROL EQUIPMENT, NAMELY, CHOKES AND DEGASSERS FOR SEPARATING GAS FROM FLUID DURING OIL PRODUCTION; POWER OPERATED PRESSURE CONTROL EQUIPMENT FOR USE IN DRILLING OIL, NAMELY, CHOKES, AND DEGASSERS FOR EXTRACTING GAS FROM FLUID DURING OIL PRODUCTION AND DUAL MUD GAS SEPARATORS FOR HORIZONTAL DRILLING (U.S. CLS. 13, 21, 23, 31 AND 34).

FIRST USE 11-30-2005; IN COMMERCE 11-30-2005.

CLASS 37—CONSTRUCTION AND REPAIR

FOR RENTAL OF OIL AND GAS WELL DRILLING, PRODUCTION AND WORK-OVER EQUIPMENT (U.S. CLS. 100, 103 AND 106).

FIRST USE 11-30-2005; IN COMMERCE 11-30-2005.

3,681,671. DAYTON SUPERIOR CORPORATION, DAYTON, OH. SN 77-448,111. FILED P.R. 4-15-2008; AM. S.R. 1-24-2009.

EARTH FRIENDLY

THE MARK CONSISTS OF STANDARD CHARACTERS WITHOUT CLAIM TO ANY PARTICULAR FONT, STYLE, SIZE, OR COLOR.

CLASS 1—CHEMICALS

FOR CONCRETE FORM AND MOLD RELEASE COMPOUNDS FOR USE IN CONCRETE FABRICATION; CHEMICAL PREPARATIONS FOR CURING, HARDENING AND BOND BREAKING FOR USE IN CONCRETE FORMULATIONS; CONCRETE CURING PREPARATIONS, CHEMICAL PREPARATIONS FOR SEALING AND DUST PROOFING CONCRETE; AND CONCRETE BOND BREAKERS (U.S. CLS. 1, 5, 6, 10, 26 AND 46).
FIRST USE 8-0-2007; IN COMMERCE 8-0-2007.

CLASS 2—PAINTS

FOR COATINGS IN THE NATURE OF SEALANTS FOR DUST PROOFING CONCRETE; CONCRETE GLOSS PREPARATIONS, NAMELY, ACRYLIC GLOSS COATING FOR USE ON CONCRETE (U.S. CLS. 6, 11 AND 16).
FIRST USE 8-0-2007; IN COMMERCE 8-0-2007.

3,681,678. MERGENT, INC., FORT MILL, SC. SN 77-469,091.
FILED P.R. 5-8-2008; AM. S.R. 7-21-2009.

3,681,690. VINTAGE WINE ESTATES, INC., WINDSOR, CA.
SN 77-531,715. FILED P.R. 7-25-2008; AM. S.R. 7-2-2009.

INDEXIS

THE MARK CONSISTS OF STANDARD CHARACTERS WITHOUT CLAIM TO ANY PARTICULAR FONT, STYLE, SIZE, OR COLOR.

CLASS 36—INSURANCE AND FINANCIAL

FOR FINANCIAL INFORMATION IN THE NATURE OF HISTORICAL STATISTICAL DATA USED TO FORM THE BASIS OF INVESTMENT PRODUCTS (U.S. CLS. 100, 101 AND 102).
FIRST USE 9-22-2008; IN COMMERCE 9-22-2008.

CLASS 42—SCIENTIFIC AND COMPUTER SERVICES

FOR DESIGNING, PROGRAMMING, AND PROVIDING TEMPORARY USE OF NON-DOWNLOADABLE COMPUTER SOFTWARE FOR CUSTOM INDEX DEVELOPMENT FOR INVESTMENT PRODUCTS (U.S. CLS. 100 AND 101).
FIRST USE 9-22-2008; IN COMMERCE 9-22-2008.

3,681,684. MODA MILAN INC., POMPANO BEACH, FL. SN 77-497,050. FILED P.R. 6-12-2008; AM. S.R. 7-28-2009.

MODA MILAN

THE MARK CONSISTS OF STANDARD CHARACTERS WITHOUT CLAIM TO ANY PARTICULAR FONT, STYLE, SIZE, OR COLOR.

CLASS 9—ELECTRICAL AND SCIENTIFIC APPARATUS

FOR EYEWARE, NAMELY, GLASSES, SUNGLASSES, FRAMES, READING GLASSES ACCESSORIES, NAMELY, EYEGGLASS CHAINS, CASES, COVERS, NECKLACES AND CLEANING CLOTHS (U.S. CLS. 21, 23, 26, 36 AND 38).
FIRST USE 5-29-2008; IN COMMERCE 12-21-2008.

CLASS 25—CLOTHING

FOR CLOTHING AND HEADGEAR, NAMELY, T-SHIRTS, CAPS, HATS, SHIRTS, PANTS DRESSES (U.S. CLS. 22 AND 39).
FIRST USE 5-29-2008; IN COMMERCE 12-24-2008.

VINTAGE WINE ESTATES

THE MARK CONSISTS OF STANDARD CHARACTERS WITHOUT CLAIM TO ANY PARTICULAR FONT, STYLE, SIZE, OR COLOR.

NO CLAIM IS MADE TO THE EXCLUSIVE RIGHT TO USE "VINTAGE WINE", APART FROM THE MARK AS SHOWN.

CLASS 33—WINES AND SPIRITS

FOR WINE (U.S. CLS. 47 AND 49).
FIRST USE 7-1-2009; IN COMMERCE 7-1-2009.

CLASS 35—ADVERTISING AND BUSINESS

FOR RETAIL STORE SERVICES, MAIL ORDER CATALOG SERVICES AND COMPUTERIZED ONLINE RETAIL STORE SERVICES FEATURING WINE AND WINE RELATED PRODUCTS (U.S. CLS. 100, 101 AND 102).
FIRST USE 1-1-2009; IN COMMERCE 1-1-2009.

3,681,699. HUGO VOGELSANG MASCHINENBAU GMBH, ESSEN, FED REP GERMANY. SN 77-556,204. FILED P.R. 8-26-2008; AM. S.R. 7-9-2009.

VOGELSANG

THE MARK CONSISTS OF STANDARD CHARACTERS WITHOUT CLAIM TO ANY PARTICULAR FONT, STYLE, SIZE, OR COLOR.

OWNER OF ERP N CMNTY TM OFC REG. NO. 006025456, DATED 5-20-2008, EXPIRES 6-14-2017.

CLASS 7—MACHINERY

FOR ROTARY PUMPS, THICK MATTER PUMPS, CLARIFIED SLUDGE PUMPS, SLURRY PUMPS, SLURRY EFFLUENT PUMPS, WATERING PUMPS, VACUUM PUMPS, WATER PUMPS, SEWAGE PUMPS, INCLUDING ELECTRIC, HYDRAULIC AND MECHANICAL DRIVE UNITS AND ELECTRONIC CONTROL AND REGULATING INSTALLATIONS THEREFOR; CRUSHING APPARATUS, NAMELY, SHREDDERS FOR FIBROUS AND COARSE SUBSTANCES IN LIQUIDS AND SUSPENSIONS; SEPARATORS FOR HARD AND HEAVY SUBSTANCES IN LIQUIDS; COMBINATION APPARATUS CONSISTING OF MIXERS, WORMS AND PUMPS, CRUSHERS, SEPARATORS AND DRYERS FOR USE IN BIOGAS INSTALLATIONS AND RESIDUAL MATERIAL PROCESSING INSTALLATIONS, VACUUM DISPOSAL INSTALLATIONS AND WATER SUPPLY INSTALLATIONS, MAINLY CONSISTING OF ROTARY PUMPS, PIPELINES, SHUT-OFF VALVES, COUPLINGS AND HOSES, DRIVE UNITS AND ELECTRONIC SWITCHING, REGULATING AND RECORDING INSTALLATIONS, SLURRY TANKERS FOR LOW-LOSS LIQUID MANURE DISTRIBUTION FOR ATTACHING TO TANKERS, WATERING AND IRRIGATION INSTALLATIONS, NAMELY, AGRICULTURAL IRRIGATION UNITS, SOIL INJECTION APPARATUS, NAMELY, TANKER-HOOKED BOOMS FITTED WITH GRUBBERS, DISK WHEELS OR TINES FOR INJECTING LIQUID MANURE INTO SOIL (U.S. CLS. 13, 19, 21, 23, 31, 34 AND 35).

CLASS 12—VEHICLES

FOR TANKERS (U.S. CLS. 19, 21, 23, 31, 35 AND 44).

CLASS 37—CONSTRUCTION AND REPAIR

FOR INSTALLATION, MAINTENANCE AND REPAIR OF TECHNICAL PRODUCTS, NAMELY, PUMPS, DRIVE UNITS, CONTROLS AND REGULATORS FOR PUMPS AND DRIVE UNITS, SHREDDERS, SEPARATORS, COMBINATION APPARATUS CONSISTING OF MIXERS, WORMS AND PUMPS, CRUSHERS, SEPARATORS, DRYERS, MANURE SLURRY SPREADERS, VACUUM DISPOSAL INSTALLATIONS AND WATER SUPPLY INSTALLATIONS, MAINLY CONSISTING OF ROTARY PUMPS, PIPELINES, SHUT-OFF VALVES, COUPLINGS AND HOSES, DRIVE UNITS AND ELECTRONIC SWITCHING, REGULATING AND RECORDING INSTALLATIONS, AGRICULTURAL IRRIGATION UNITS, TANKER-HOOKED BOOMS FITTED WITH GRUBBERS, DISK WHEELS OR TINES FOR INJECTING LIQUID MANURE INTO SOIL, AND TANKERS IN THE FIELD OF AGRICULTURE, INDUSTRY, CLARIFYING TECHNOLOGY, MUNICIPAL SERVICES, ENVIRONMENTAL TECHNOLOGY, DISPOSAL TECHNOLOGY (U.S. CLS. 100, 103 AND 106).

3,681,703. NOVEDA TECHNOLOGIES, INC., BRANCBURG, NJ. SN 77-576,361. FILED P.R. 9-23-2008; AM. S.R. 7-2-2009.

31 TANNERY PROJECT

THE MARK CONSISTS OF STANDARD CHARACTERS WITHOUT CLAIM TO ANY PARTICULAR FONT, STYLE, SIZE, OR COLOR.

CLASS 37—CONSTRUCTION AND REPAIR

FOR INSTALLATION AND MAINTENANCE OF COMPUTER SYSTEMS, SOLD AS A UNIT, CONSISTING OF COMPUTER HARDWARE, SOFTWARE, METERS AND SENSORS WHICH ARE USED TO COLLECT, MEASURE, MONITOR, ANALYZE, DIAGNOSE, RECORD AND TRANSMIT DATA FROM PHOTOVOLTAIC ENERGY SYSTEMS, CONVENTIONAL ENERGY SYSTEMS AND BUILDING MECHANICAL AND ENVIRONMENTAL SYSTEMS TO ALLOW REMOTE REAL TIME VIEWING OF GRAPHIC DISPLAYS OF SUCH ENERGY SYSTEMS DATA BY BUILDING OWNERS ON THEIR WEBSITES (U.S. CLS. 100, 103 AND 106).

FIRST USE 6-28-2005; IN COMMERCE 6-28-2005.

CLASS 42—SCIENTIFIC AND COMPUTER SERVICES

FOR DESIGN AND DEVELOPMENT OF COMPUTER SYSTEMS, SOLD AS A UNIT, CONSISTING OF COMPUTER HARDWARE, SOFTWARE, METERS AND SENSORS WHICH ARE USED TO COLLECT, MEASURE, MONITOR, ANALYZE, DIAGNOSE, RECORD AND TRANSMIT DATA FROM PHOTOVOLTAIC ENERGY SYSTEMS, CONVENTIONAL ENERGY SYSTEMS AND BUILDING MECHANICAL AND ENVIRONMENTAL SYSTEMS TO ALLOW REMOTE REAL TIME VIEWING OF GRAPHIC DISPLAYS OF SUCH ENERGY SYSTEMS DATA BY BUILDING OWNERS ON THEIR WEBSITES (U.S. CLS. 100 AND 101).

FIRST USE 6-28-2005; IN COMMERCE 6-28-2005.

3,681,705. FRANKEN-INDUSTRIE GMBH & CO. KG, VEITSHÖCHHEIM, FED REP GERMANY. SN 77-578,473. FILED P.R. 9-25-2008; AM. S.R. 6-29-2009.

WEGMANN automotive

THE MARK CONSISTS OF STANDARD CHARACTERS WITHOUT CLAIM TO ANY PARTICULAR FONT, STYLE, SIZE, OR COLOR.

PRIORITY CLAIMED UNDER SEC. 44(D) ON FED REP GERMANY APPLICATION NO. 302008025379, FILED 4-17-2008, REG. NO. 302008025379, DATED 7-31-2008, EXPIRES 4-30-2018.

NO CLAIM IS MADE TO THE EXCLUSIVE RIGHT TO USE "AUTOMOTIVE" , APART FROM THE MARK AS SHOWN.

CLASS 6—METAL GOODS

FOR SAFETY SEALS MADE OF METAL ALLOYS (U.S. CLS. 2, 12, 13, 14, 23, 25 AND 50).

CLASS 12—VEHICLES

FOR BALANCING WEIGHTS FOR VEHICLE WHEELS (U.S. CLS. 19, 21, 23, 31, 35 AND 44).

3,681,707. TRILEGIANT CORPORATION, NORWALK, CT.
SN 77-579,613. FILED P.R. 9-26-2008; AM. S.R. 6-29-2009.

IDENTITY PROTECTION SUPPORT SERVICE

THE MARK CONSISTS OF STANDARD CHARACTERS WITHOUT CLAIM TO ANY PARTICULAR FONT, STYLE, SIZE, OR COLOR.

OWNER OF U.S. REG. NOS. 2,857,046 AND 2,901,189.
NO CLAIM IS MADE TO THE EXCLUSIVE RIGHT TO USE "SUPPORT SERVICE", APART FROM THE MARK AS SHOWN.

CLASS 35—ADVERTISING AND BUSINESS

FOR PROVIDING SUPPORT SERVICES, NAMELY, ASSISTING WITH MONITORING MEMBER CREDIT REPORTS AND NOTIFYING THE CREDIT BUREAUS WITH CHANGES THEREIN AND PROVIDING MEMBER ALERT INFORMATION ALL IN THE FIELD OF IDENTITY THEFT PROTECTION AND PREVENTION; ASSISTING CONSUMERS WITH CREDIT MONITORING REPORTS AND PROVIDING CONSUMER ALERT INFORMATION IN THE EVENT OF IDENTITY THEFT (U.S. CLS. 100, 101 AND 102).
FIRST USE 11-30-2008; IN COMMERCE 11-30-2008.

CLASS 36—INSURANCE AND FINANCIAL

FOR FINANCIAL SERVICES, NAMELY, CREDIT REPAIR AND RESTORATION IN THE NATURE OF HELPING MEMBERS IN DOCUMENTING AND REPAIRING DAMAGE, CLEARING CREDIT RECORDS CAUSED BY IDENTITY THEFT AND RECOVERING FINANCIAL LOSSES FROM IDENTITY THEFT, NAMELY, FRAUD REIMBURSEMENT SERVICES (U.S. CLS. 100, 101 AND 102).
FIRST USE 11-30-2008; IN COMMERCE 11-30-2008.

3,681,733. GREEN SCHOOLS ALLIANCE, INC., NEW YORK, NY. SN 77-601,252. FILED P.R. 10-27-2008; AM. S.R. 7-6-2009.

Green Cup Challenge

THE MARK CONSISTS OF STANDARD CHARACTERS WITHOUT CLAIM TO ANY PARTICULAR FONT, STYLE, SIZE, OR COLOR.

CLASS 35—ADVERTISING AND BUSINESS

FOR CHARITABLE SERVICES, NAMELY, PROMOTING AWARENESS ABOUT ENVIRONMENTAL ISSUES, RESOURCES CONSERVATION, GREENHOUSE GAS EMISSIONS REDUCTION AND CLIMATE CHANGE ISSUES TO STUDENTS BY ORGANIZING INTERSCHOOL CONTESTS (U.S. CLS. 100, 101 AND 102).
FIRST USE 1-0-2006; IN COMMERCE 1-0-2006.

CLASS 41—EDUCATION AND ENTERTAINMENT

FOR EDUCATION SERVICES, NAMELY, ORGANIZING INTERSCHOOL CONTESTS FOR THE PURPOSE OF SUPPORTING AND PROMOTING STUDENT EFFORTS TO CONSERVE RESOURCES BY BUILDING AWARENESS ABOUT THE ENVIRONMENT, RESOURCES CONSERVATION, THE REDUCTION OF GREENHOUSE GAS EMISSIONS AND CLIMATE CHANGE (U.S. CLS. 100, 101 AND 107).

FIRST USE 1-0-2006; IN COMMERCE 1-0-2006.

3,681,738. SOVREMENNIY COMMERCHESKIY FLOT, SAINT PETERSBURG, RUSSIAN FED.. SN 77-607,029. FILED P.R. 11-4-2008; AM. S.R. 6-19-2009.

SEABORNE ENERGY SOLUTIONS

THE MARK CONSISTS OF STANDARD CHARACTERS WITHOUT CLAIM TO ANY PARTICULAR FONT, STYLE, SIZE, OR COLOR.

NO CLAIM IS MADE TO THE EXCLUSIVE RIGHT TO USE "SEABORNE", APART FROM THE MARK AS SHOWN.

CLASS 35—ADVERTISING AND BUSINESS

FOR LOGISTICS MANAGEMENT IN THE FIELD OF SEABORNE TRANSPORTATION (U.S. CLS. 100, 101 AND 102).

FIRST USE 0-0-2007; IN COMMERCE 0-0-2007.

CLASS 39—TRANSPORTATION AND STORAGE

FOR LEASING OF SHIPS AND SEABORNE VESSELS; MARITIME TOWAGE SERVICES; PROVIDING INFORMATION IN THE FIELDS OF SEABORNE TRANSPORTATION AND WAREHOUSING AND STORAGE OF GOODS; VESSEL AND BOAT CHARTERING SERVICES; SHIP BROKERAGE SERVICES; FREIGHT TRANSPORTATION SERVICES, NAMELY, TRANSPORTING AND DELIVERING THE GOODS AND SERVICES OF OTHERS VIA SHIPS AND/OR SEABORNE VESSELS; WAREHOUSE STORAGE SERVICES; MANAGEMENT AND MAINTENANCE SERVICES FOR MARITIME TRANSPORT AND/OR SEA FLEETS; CONSULTING SERVICES IN THE FIELD OF SHIPPING (U.S. CLS. 100 AND 105).

FIRST USE 0-0-2007; IN COMMERCE 0-0-2007.

3,681,763. DUPAGE LIGHTING SERVICE AND REPAIR, INC., ELGIN, IL. SN 77-681,392. FILED P.R. 3-2-2009; AM. S.R. 7-29-2009.

Sustainable Lighting Solutions

THE MARK CONSISTS OF STANDARD CHARACTERS WITHOUT CLAIM TO ANY PARTICULAR FONT, STYLE, SIZE, OR COLOR.

CLASS 35—ADVERTISING AND BUSINESS

FOR BUSINESS CONSULTING SERVICES FOR THE ELECTRIC ENERGY INDUSTRY; CONSULTATION IN THE FIELD OF ENERGY EFFICIENCY; ENERGY AUDITING; INFORMATION IN THE FIELD OF ENERGY EFFICIENCY; PROCESSING ENERGY UTILITY CUSTOMER REBATES FOR UTILITY COMPANIES (U.S. CLS. 100, 101 AND 102).

FIRST USE 7-1-2009; IN COMMERCE 7-1-2009.

CLASS 37—CONSTRUCTION AND REPAIR

FOR ELECTRICAL REPAIRS AND INSTALLATION OF LIGHTING, RELAMPS, RETROFITS, EXIT SIGNS, OCCUPANCY SENSORS AND EMERGENCY LIGHTING SYSTEMS (U.S. CLS. 100, 103 AND 106).

FIRST USE 7-1-2009; IN COMMERCE 7-1-2009.

CLASS 39—TRANSPORTATION AND STORAGE

FOR DISTRIBUTION SERVICES, NAMELY, DELIVERY OF LIGHTING FIXTURES (U.S. CLS. 100 AND 105).

FIRST USE 7-1-2009; IN COMMERCE 7-1-2009.

CLASS 42—SCIENTIFIC AND COMPUTER SERVICES

FOR DESIGN FOR OTHERS IN THE FIELD OF LIGHTING (U.S. CLS. 100 AND 101).

FIRST USE 7-1-2009; IN COMMERCE 7-1-2009.

3,681,775. AMERICAN NURSES CREDENTIALING CENTER, SILVER SPRING, MD. SN 77-713,968. FILED P.R. 4-14-2009; AM. S.R. 7-27-2009.

INSTITUTE FOR
CREDENTIALING INNOVATION

THE MARK CONSISTS OF STANDARD CHARACTERS WITHOUT CLAIM TO ANY PARTICULAR FONT, STYLE, SIZE, OR COLOR.

OWNER OF U.S. REG. NOS. 2,950,651 AND 2,993,743.

CLASS 16—PAPER GOODS AND PRINTED MATTER

FOR BOOKS IN THE FIELD OF NURSING (U.S. CLS. 2, 5, 22, 23, 29, 37, 38 AND 50).

FIRST USE 5-0-2005; IN COMMERCE 5-0-2005.

CLASS 41—EDUCATION AND ENTERTAINMENT

FOR EDUCATIONAL SERVICES, NAMELY, CONDUCTING CONFERENCES, SEMINARS, AND WORKSHOPS IN THE FIELD OF NURSING AND THE DISTRIBUTION OF COURSE MATERIALS IN CONNECTION THEREWITH; AND BOOK PUBLISHING (U.S. CLS. 100, 101 AND 107).

FIRST USE 10-25-2005; IN COMMERCE 10-25-2005.

CLASS 44—MEDICAL, BEAUTY AND AGRICULTURAL SERVICES

FOR CONSULTING IN THE FIELD OF NURSING (U.S. CLS. 100 AND 101).

FIRST USE 4-0-2005; IN COMMERCE 4-0-2005.

3,681,779. CRISPIN CIDER COMPANY, MINNEAPOLIS, MN. SN 77-716,260. FILED P.R. 4-17-2009; AM. S.R. 7-27-2009.

ARTISANAL RESERVE

THE MARK CONSISTS OF STANDARD CHARACTERS WITHOUT CLAIM TO ANY PARTICULAR FONT, STYLE, SIZE, OR COLOR.

CLASS 32—LIGHT BEVERAGES

FOR BEER, ALE AND LAGER; BEER, ALE AND PORTER; BEER, ALE, LAGER, STOUT AND PORTER; BEER, ALE, LAGER, STOUT, PORTER, SHANDY; BEER-BASED COOLERS; FLAVORED BEERS; GINGER BEER; MALT BEER (U.S. CLS. 45, 46 AND 48).

FIRST USE 4-1-2009; IN COMMERCE 6-1-2009.

CLASS 33—WINES AND SPIRITS

FOR HARD CIDER (U.S. CLS. 47 AND 49).

FIRST USE 4-1-2009; IN COMMERCE 6-1-2009.

3,681,783. FAULTLESS STARCH/BON AMI COMPANY, KANSAS CITY, MO. SN 77-721,904. FILED P.R. 4-24-2009; AM. S.R. 7-28-2009.

ACAI BERRY & WHITE TEA

THE MARK CONSISTS OF STANDARD CHARACTERS WITHOUT CLAIM TO ANY PARTICULAR FONT, STYLE, SIZE, OR COLOR.

CLASS 4—LUBRICANTS AND FUELS

FOR CANDLES (U.S. CLS. 1, 6 AND 15).

FIRST USE 2-3-2009; IN COMMERCE 2-3-2009.

CLASS 11—ENVIRONMENTAL CONTROL APPARATUS

FOR ROOM FRAGRANCE DIFFUSERS (U.S. CLS. 13, 21, 23, 31 AND 34).

FIRST USE 2-3-2009; IN COMMERCE 2-3-2009.

3,681,784. FAULTLESS STARCH/BON AMI COMPANY, KANSAS CITY, MO. SN 77-721,944. FILED P.R. 4-24-2009; AM. S.R. 7-28-2009.

3,681,786. FAULTLESS STARCH/BON AMI COMPANY, KANSAS CITY, MO. SN 77-722,000. FILED P.R. 4-24-2009; AM. S.R. 7-28-2009.

CURRENT & POMEGRANATE

PASSION FRUIT & FIG

THE MARK CONSISTS OF STANDARD CHARACTERS WITHOUT CLAIM TO ANY PARTICULAR FONT, STYLE, SIZE, OR COLOR.

THE MARK CONSISTS OF STANDARD CHARACTERS WITHOUT CLAIM TO ANY PARTICULAR FONT, STYLE, SIZE, OR COLOR.

CLASS 4—LUBRICANTS AND FUELS

CLASS 4—LUBRICANTS AND FUELS

FOR CANDLES (U.S. CLS. 1, 6 AND 15).
FIRST USE 2-3-2009; IN COMMERCE 2-3-2009.

FOR CANDLES (U.S. CLS. 1, 6 AND 15).
FIRST USE 2-3-2009; IN COMMERCE 2-3-2009.

CLASS 11—ENVIRONMENTAL CONTROL APPARATUS

CLASS 11—ENVIRONMENTAL CONTROL APPARATUS

FOR ROOM FRAGRANCE DIFFUSERS (U.S. CLS. 13, 21, 23, 31 AND 34).
FIRST USE 2-3-2009; IN COMMERCE 2-3-2009.

FOR ROOM FRAGRANCE DIFFUSERS (U.S. CLS. 13, 21, 23, 31 AND 34).
FIRST USE 2-3-2009; IN COMMERCE 2-3-2009.

3,681,785. FAULTLESS STARCH/BON AMI COMPANY, KANSAS CITY, MO. SN 77-721,985. FILED P.R. 4-24-2009; AM. S.R. 7-28-2009.

3,681,792. BIG BOOM BRANDS, LLC, WEST PALM BEACH, FL. SN 77-723,623. FILED P.R. 4-28-2009; AM. S.R. 7-23-2009.

LEMONGRASS GINGER

Healthy Natural Systems

THE MARK CONSISTS OF STANDARD CHARACTERS WITHOUT CLAIM TO ANY PARTICULAR FONT, STYLE, SIZE, OR COLOR.

THE MARK CONSISTS OF STANDARD CHARACTERS WITHOUT CLAIM TO ANY PARTICULAR FONT, STYLE, SIZE, OR COLOR.

NO CLAIM IS MADE TO THE EXCLUSIVE RIGHT TO USE "SYSTEMS", APART FROM THE MARK AS SHOWN.

CLASS 4—LUBRICANTS AND FUELS

CLASS 5—PHARMACEUTICALS

FOR CANDLES (U.S. CLS. 1, 6 AND 15).
FIRST USE 2-3-2009; IN COMMERCE 2-3-2009.

FOR DIETARY AND NUTRITIONAL SUPPLEMENTS (U.S. CLS. 6, 18, 44, 46, 51 AND 52).
FIRST USE 1-1-2007; IN COMMERCE 1-1-2007.

CLASS 11—ENVIRONMENTAL CONTROL APPARATUS

CLASS 9—ELECTRICAL AND SCIENTIFIC APPARATUS

FOR ROOM FRAGRANCE DIFFUSERS (U.S. CLS. 13, 21, 23, 31 AND 34).
FIRST USE 2-3-2009; IN COMMERCE 2-3-2009.

FOR DOWNLOADABLE ELECTRONIC PUBLICATIONS IN THE NATURE OF PERIODICALS, BOOKS, E-BOOKS, MAGAZINES, NEWSLETTERS, PAMPHLETS AND BROCHURES IN THE FIELD OF HEALTH, DIETS, DRUGS AND FOOD (U.S. CLS. 21, 23, 26, 36 AND 38).
FIRST USE 1-1-2007; IN COMMERCE 1-1-2007.

CLASS 44—MEDICAL, BEAUTY AND AGRICULTURAL SERVICES

FOR PROVIDING A WEB SITE FEATURING INFORMATION ON HEALTH AND NUTRITION; PROVIDING A WEBSITE FEATURING INFORMATION CONCERNING ALTERNATIVE HEALTH AND HEALING; PROVIDING INFORMATION ABOUT DIETARY SUPPLEMENTS AND NUTRITION (U.S. CLS. 100 AND 101).
FIRST USE 1-1-2007; IN COMMERCE 1-1-2007.

* * * * *

SECTION 2.— INTERNATIONAL CLASSIFICATION

The short titles associated below with the international class numbers are terms designed merely for quick identification and are not an official part of the international classification. The full names of international classes are given in section 6.1 of the trademark rules of practice.

The designation "U.S. Cl." appearing in this section refers to the U.S. class in effect prior to Sep. 1, 1973 rather than the international class which applies to applications filed on or after that date. For adoption of international classification see notice in the OFFICIAL GAZETTE of Jun. 26, 1973 (911 O.G. TM 210).

Application in one class

CLASS 1—CHEMICALS

3,681,708. HUMBOLDT WHOLESALE, INC., EUREKA, CA. SN 77-582,594. FILED P.R. 9-30-2008; AM. S.R. 3-24-2009.

Humboldt Wholesale

THE MARK CONSISTS OF STANDARD CHARACTERS WITHOUT CLAIM TO ANY PARTICULAR FONT, STYLE, SIZE, OR COLOR.

NO CLAIM IS MADE TO THE EXCLUSIVE RIGHT TO USE "WHOLESALE", APART FROM THE MARK AS SHOWN.

FOR FERTILIZERS FOR HYDROPONIC AND SOIL GARDENING; PLANTING SOIL AND SOIL ADDITIVES FOR HYDROPONIC AND SOIL GARDENING (U.S. CLS. 1, 5, 6, 10, 26 AND 46).

FIRST USE 4-20-2005; IN COMMERCE 4-29-2005.

CLASS 3—COSMETICS AND CLEANING PREPARATIONS

3,681,652. L'OREAL, PARIS, FRANCE. SN 77-324,625. FILED P.R. 11-8-2007; AM. S.R. 7-7-2009.

BEAUTY TUBES

THE MARK CONSISTS OF STANDARD CHARACTERS WITHOUT CLAIM TO ANY PARTICULAR FONT, STYLE, SIZE, OR COLOR.

PRIORITY CLAIMED UNDER SEC. 44(D) ON FRANCE APPLICATION NO. 073535664, FILED 11-6-2007, REG. NO. 073535664, DATED 11-6-2007, EXPIRES 11-6-2017.

FOR MASCARAS (U.S. CLS. 1, 4, 6, 50, 51 AND 52).
FIRST USE 10-0-2008; IN COMMERCE 10-0-2008.

CLASS 3—(Continued).

3,681,666. PETKIND PET PRODUCTS INC., WHITE ROCK, CANADA. SN 77-427,893. FILED P.R. 3-20-2008; AM. S.R. 7-13-2009.

FUR + BODY

THE MARK CONSISTS OF STANDARD CHARACTERS WITHOUT CLAIM TO ANY PARTICULAR FONT, STYLE, SIZE, OR COLOR.

FOR HAIR SHAMPOO; HAIR SHAMPOOS AND CONDITIONERS; PET SHAMPOO; SHAMPOO-CONDITIONERS; SHAMPOOS; CONDITIONERS; HAIR CONDITIONER; HAIR CONDITIONERS; NON-MEDICATED GROOMING PREPARATIONS FOR PETS, NAMELY, SHAMPOOS, CONDITIONERS, DEODORIZERS, PERFUMES, SOAPS, SKIN TREATMENTS, NAMELY, ANTI-FLEA CREAM, ANTI-ITCH CREAM, DRY SKIN CREAM, DRY SKIN CONDITIONER, SKIN LOTION, GEL, OIL, CONDITIONING SPRAY, MAINTENANCE SPRAY; DEODORIZERS FOR PETS; PET FRAGRANCES; PET ODOR REMOVERS; DEODORANTS FOR ANIMALS (U.S. CLS. 1, 4, 6, 50, 51 AND 52).

FIRST USE 5-6-2009; IN COMMERCE 5-6-2009.

3,681,679. ABERCROMBIE & FITCH TRADING CO., NEW ALBANY, OH. SN 77-471,908. FILED P.R. 5-12-2008; AM. S.R. 7-2-2009.

WAKELY

THE MARK CONSISTS OF STANDARD CHARACTERS WITHOUT CLAIM TO ANY PARTICULAR FONT, STYLE, SIZE, OR COLOR.

FOR FRAGRANCES FOR PERSONAL USE; PERFUME (U.S. CLS. 1, 4, 6, 50, 51 AND 52).
FIRST USE 10-0-2008; IN COMMERCE 10-0-2008.

CLASS 3—(Continued).

3,681,685. PLAYTEX PRODUCTS, INC., WESTPORT, CT. SN 77-502,186. FILED P.R. 6-18-2008; AM. S.R. 2-17-2009.

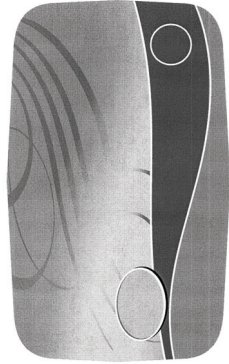

THE MARK CONSISTS OF A RECTANGULAR SHAPE WITH NUMEROUS WAVY LINES, A CIRCLE, AND AN OVAL.
FOR DISPOSABLE TOWELETTES AND WIPES IMPREGNATED WITH COMPOUNDS FOR PERSONAL HYGIENE USE (U.S. CLS. 1, 4, 6, 50, 51 AND 52).
FIRST USE 4-0-2008; IN COMMERCE 4-0-2008.

CLASS 3—(Continued).

3,681,687. PLAYTEX PRODUCTS, INC., WESTPORT, CT. SN 77-502,248. FILED P.R. 6-18-2008; AM. S.R. 2-17-2009.



THE MARK CONSISTS OF A ROUNDED, RECTANGULAR SHAPE, SURROUNDED BY ANOTHER RECTANGULAR SHAPE. THE MARK ALSO CONTAINS NUMEROUS WAVY LINES, A CIRCLE, AND AN OVAL.
FOR DISPOSABLE TOWELETTES AND WIPES IMPREGNATED WITH COMPOUNDS FOR PERSONAL HYGIENE USE (U.S. CLS. 1, 4, 6, 50, 51 AND 52).
FIRST USE 4-0-2008; IN COMMERCE 4-0-2008.

3,681,686. PLAYTEX PRODUCTS, INC., WESTPORT, CT. SN 77-502,229. FILED P.R. 6-18-2008; AM. S.R. 2-17-2009.

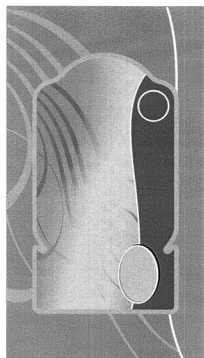

THE MARK CONSISTS OF A ROUNDED, RECTANGULAR SHAPE, SURROUNDED BY ANOTHER RECTANGULAR SHAPE. THE MARK ALSO CONTAINS NUMEROUS WAVY LINES, A CIRCLE, AND AN OVAL.
FOR DISPOSABLE TOWELETTES AND WIPES IMPREGNATED WITH COMPOUNDS FOR PERSONAL HYGIENE USE (U.S. CLS. 1, 4, 6, 50, 51 AND 52).
FIRST USE 4-0-2008; IN COMMERCE 4-0-2008.

3,681,688. PLAYTEX PRODUCTS, INC., WESTPORT, CT. SN 77-502,264. FILED P.R. 6-18-2008; AM. S.R. 2-17-2009.

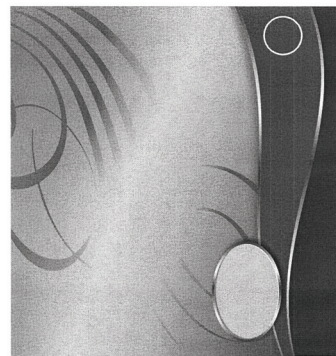

THE MARK CONSISTS OF A SQUARE SHAPE WITH NUMEROUS WAVY LINES, A CIRCLE, AND AN OVAL.
FOR DISPOSABLE TOWELETTES AND WIPES IMPREGNATED WITH COMPOUNDS FOR PERSONAL HYGIENE USE (U.S. CLS. 1, 4, 6, 50, 51 AND 52).
FIRST USE 4-0-2008; IN COMMERCE 4-0-2008.

CLASS 3—(Continued).

3,681,689. JOHN PAUL MITCHELL SYSTEMS, SANTA CLARITA, CA. SN 77-525,131. FILED 7-17-2008.

EXTRA-BODY FIRM FINISHING SPRAY

THE MARK CONSISTS OF STANDARD CHARACTERS WITHOUT CLAIM TO ANY PARTICULAR FONT, STYLE, SIZE, OR COLOR.

OWNER OF U.S. REG. NOS. 2,235,492, 2,236,269, AND 2,809,580.

NO CLAIM IS MADE TO THE EXCLUSIVE RIGHT TO USE "FIRM FINISHING SPRAY", APART FROM THE MARK AS SHOWN.

FOR HAIR SPRAY (U.S. CLS. 1, 4, 6, 50, 51 AND 52).
FIRST USE 1-1-2008; IN COMMERCE 1-1-2008.

3,681,770. DEMETER F.L. INC., GREAT NECK, NY. SN 77-697,121. FILED P.R. 3-23-2009; AM. S.R. 7-2-2009.

VINTAGE NATURALS

THE MARK CONSISTS OF STANDARD CHARACTERS WITHOUT CLAIM TO ANY PARTICULAR FONT, STYLE, SIZE, OR COLOR.

FOR FRAGRANCE FOR PERSONAL USE (U.S. CLS. 1, 4, 6, 50, 51 AND 52).

FIRST USE 3-16-2009; IN COMMERCE 3-16-2009.

CLASS 4—LUBRICANTS AND FUELS

3,681,723. TYLER CANDLE COMPANY, L.L.C., TYLER, TX. SN 77-593,975. FILED P.R. 10-16-2008; AM. S.R. 6-19-2009.

FRAGRANCE FUELS

THE MARK CONSISTS OF STANDARD CHARACTERS WITHOUT CLAIM TO ANY PARTICULAR FONT, STYLE, SIZE, OR COLOR.

NO CLAIM IS MADE TO THE EXCLUSIVE RIGHT TO USE "FUELS", APART FROM THE MARK AS SHOWN.

FOR LAMP FUEL (U.S. CLS. 1, 6 AND 15).
FIRST USE 6-1-2006; IN COMMERCE 6-1-2006.

CLASS 5—PHARMACEUTICALS**CLASS 5—(Continued).**

3,681,681. SOCIETE DES PRODUITS NESTLE, S.A., 1800 VEVEY, SWITZERLAND. SN 77-479,428. FILED P.R. 5-20-2008; AM. S.R. 6-29-2009.

AS HEALTHY AS FRESH

THE MARK CONSISTS OF STANDARD CHARACTERS WITHOUT CLAIM TO ANY PARTICULAR FONT, STYLE, SIZE, OR COLOR.

FOR BABY FOOD (U.S. CLS. 6, 18, 44, 46, 51 AND 52).
FIRST USE 1-30-2009; IN COMMERCE 1-30-2009.

3,681,740. PENN HERB COMPANY, LTD., PHILADELPHIA, PA. SN 77-617,447. FILED P.R. 11-19-2008; AM. S.R. 7-10-2009.

Herbal Detox

THE MARK CONSISTS OF STANDARD CHARACTERS WITHOUT CLAIM TO ANY PARTICULAR FONT, STYLE, SIZE, OR COLOR.

NO CLAIM IS MADE TO THE EXCLUSIVE RIGHT TO USE "HERBAL", APART FROM THE MARK AS SHOWN.

FOR DIETARY AND NUTRITIONAL SUPPLEMENTS; DIETARY FOOD SUPPLEMENTS; DIETARY SUPPLEMENTS; DIETARY SUPPLEMENTS FOR HUMAN CONSUMPTION; HERBAL SUPPLEMENTS; HERBS FOR MEDICINAL PURPOSES; NATURAL HERBAL SUPPLEMENTS (U.S. CLS. 6, 18, 44, 46, 51 AND 52).

FIRST USE 6-1-2009; IN COMMERCE 6-1-2009.

CLASS 6—METAL GOODS

CLASS 6—(Continued).

3,681,717. PADRY LLC, ROSWELL, GA. SN 77-589,676. FILED P.R. 10-9-2008; AM. S.R. 7-13-2009.

Longlife Steel Buildings

THE MARK CONSISTS OF STANDARD CHARACTERS WITHOUT CLAIM TO ANY PARTICULAR FONT, STYLE, SIZE, OR COLOR.

NO CLAIM IS MADE TO THE EXCLUSIVE RIGHT TO USE "STEEL BUILDINGS", APART FROM THE MARK AS SHOWN.

FOR PRE-ENGINEERED STEEL BUILDINGS, PREFABRICATED STEEL BUILDINGS, PRE-ENGINEERED METAL BUILDINGS, PREFABRICATED METAL BUILDINGS, PRE-ENGINEERED ARCHED METAL BUILDINGS, PREFABRICATED ARCHED METAL BUILDINGS, PRE-ENGINEERED ARCHED STEEL BUILDINGS, PREFABRICATED ARCHED STEEL BUILDINGS, AND COMPONENTS THEREFORE, NAMELY, METAL FRAMES, METAL SHEETING, METAL GIRTS, METAL PURLINS, AND STEEL PANELS (U.S. CLS. 2, 12, 13, 14, 23, 25 AND 50).

FIRST USE 7-8-2009; IN COMMERCE 7-8-2009.

CLASS 7—MACHINERY

3,681,680. WEAVER, DAVID L., COATESVILLE, PA. SN 77-472,344. FILED P.R. 5-12-2008; AM. S.R. 3-25-2009.

SCROLLING FLOOR

THE MARK CONSISTS OF STANDARD CHARACTERS WITHOUT CLAIM TO ANY PARTICULAR FONT, STYLE, SIZE, OR COLOR.

NO CLAIM IS MADE TO THE EXCLUSIVE RIGHT TO USE "FLOOR", APART FROM THE MARK AS SHOWN.

FOR CONVEYOR FLOOR SYSTEMS PRIMARILY COMPRISED OF CONVEYERS FOR THE CARGO AREA IN TRUCKS AND TRAILERS ATTACHED TO TRUCKS TO UNLOAD BULK COMMODITY CARGO (U.S. CLS. 13, 19, 21, 23, 31, 34 AND 35).

FIRST USE 6-20-2009; IN COMMERCE 6-20-2009.

CLASS 9—ELECTRICAL AND SCIENTIFIC APPARATUS**CLASS 9—(Continued).**

3,681,662. WEINER, GABRIEL I., LOS ANGELES, CA. SN 77-417,834. FILED P.R. 3-10-2008; AM. S.R. 7-27-2009.

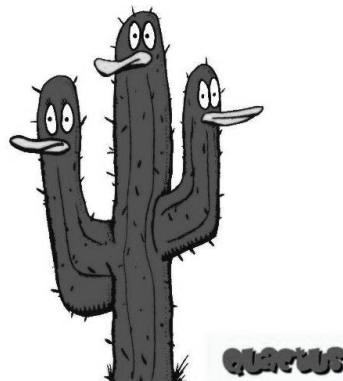

THE MARK CONSISTS OF A DESIGN OF A CACTUS WITH THREE DUCK BILLS AND EYES LOCATED TO THE LEFT OF THE STYLIZED WORDING "QUACTUS".

FOR AUDIO RECORDINGS FEATURING MUSIC; DOWNLOADABLE MP3 FILES, MP3 RECORDINGS, ONLINE DISCUSSION BOARDS, WEBCASTS AND PODCASTS FEATURING MUSIC, AUDIO BOOKS AND NEWS BROADCASTS; DOWNLOADABLE MUSICAL SOUND RECORDINGS; DOWNLOADABLE RING TONES, GRAPHICS AND MUSIC VIA A GLOBAL COMPUTER NETWORK AND WIRELESS DEVICES; DOWNLOADABLE VIDEO RECORDINGS FEATURING MUSIC; DOWNLOADABLE MUSIC VIA THE INTERNET AND WIRELESS DEVICES; SOUND RECORDINGS FEATURING MUSIC; VIDEO RECORDINGS FEATURING MUSIC; VISUAL RECORDINGS AND AUDIO VISUAL RECORDINGS FEATURING MUSIC AND ANIMATION (U.S. CLS. 21, 23, 26, 36 AND 38).

FIRST USE 2-18-2008; IN COMMERCE 2-18-2008.

3,681,677. SQUIRE BOONE CAVERNS, INC., NEW ALBANY, IN. SN 77-465,487. FILED P.R. 5-5-2008; AM. S.R. 7-29-2009.

MAGNET ELLIPSOIDS

THE MARK CONSISTS OF STANDARD CHARACTERS WITHOUT CLAIM TO ANY PARTICULAR FONT, STYLE, SIZE, OR COLOR.

NO CLAIM IS MADE TO THE EXCLUSIVE RIGHT TO USE "MAGNET", APART FROM THE MARK AS SHOWN.

FOR NOVELTY ITEMS, NAMELY, MAGNETS (U.S. CLS. 21, 23, 26, 36 AND 38).

FIRST USE 11-7-2008; IN COMMERCE 11-7-2008.

CLASS 9—(Continued).

3,681,716. WATCHDOG GROUP LC, ST. LOUIS, MO. SN 77-588,784. FILED P.R. 10-8-2008; AM. S.R. 7-8-2009.

CLASS 9—(Continued).

3,681,748. NANOMETRICS INCORPORATED, MILPITAS, CA. SN 77-653,441. FILED P.R. 1-21-2009; AM. S.R. 6-22-2009.

COLOR CASE

THE MARK CONSISTS OF STANDARD CHARACTERS WITHOUT CLAIM TO ANY PARTICULAR FONT, STYLE, SIZE, OR COLOR.

NO CLAIM IS MADE TO THE EXCLUSIVE RIGHT TO USE "CASE", APART FROM THE MARK AS SHOWN.

FOR CONTACT LENS CASES (U.S. CLS. 21, 23, 26, 36 AND 38).

FIRST USE 2-2-2009; IN COMMERCE 2-2-2009.

NANODIFFRACT

3,681,729. 3E TECHNOLOGIES INTERNATIONAL, INC., ROCKVILLE, MD. SN 77-597,246. FILED P.R. 10-21-2008; AM. S.R. 7-22-2009.

RAPID RESPONSE VIDEO-TO-VEHICLE KIT

THE MARK CONSISTS OF STANDARD CHARACTERS WITHOUT CLAIM TO ANY PARTICULAR FONT, STYLE, SIZE, OR COLOR.

NO CLAIM IS MADE TO THE EXCLUSIVE RIGHT TO USE "KIT", APART FROM THE MARK AS SHOWN.

FOR PORTABLE COMMUNICATIONS KIT, COMPRISING A VIDEO CAMERA, VIDEO MONITOR, LAPTOP COMPUTER, ANTENNA, AND ASSOCIATED CABLES AND SOFTWARE (U.S. CLS. 21, 23, 26, 36 AND 38).

FIRST USE 10-28-2008; IN COMMERCE 10-28-2008.

THE MARK CONSISTS OF STANDARD CHARACTERS WITHOUT CLAIM TO ANY PARTICULAR FONT, STYLE, SIZE, OR COLOR.

FOR OPTICAL CRITICAL DIMENSION (OCD) COMPUTER SOFTWARE USED FOR MODELING AND ANALYSIS OF PHYSICAL STRUCTURES ON SEMICONDUCTOR WAFERS AND OTHER SUBSTRATES WITH MICROSCOPIC FEATURES, CONTAINS A GRAPHICAL USER INTERFACE (GUI) WHICH ALLOWS THE USER TO MODEL THE STRUCTURES IN 2D AND 3D, AS WELL AS PERFORM SENSITIVITY STUDIES AND OTHER ANALYTICAL FUNCTIONS, AND CONTAINS AT ITS CORE A POWERFUL OCD ENGINE FOR FAST AND RELIABLE OCD MODELING AND ANALYSIS (U.S. CLS. 21, 23, 26, 36 AND 38).

FIRST USE 12-28-2007; IN COMMERCE 11-21-2008.

CLASS 9—(Continued).

3,681,774. REMOTE PHYSICAL MONITORING LLC, WICHITA, KS. SN 77-710,687. FILED P.R. 4-9-2009; AM. S.R. 7-28-2009.

Remote Intelligent Multi Sensors

THE MARK CONSISTS OF STANDARD CHARACTERS WITHOUT CLAIM TO ANY PARTICULAR FONT, STYLE, SIZE, OR COLOR.

NO CLAIM IS MADE TO THE EXCLUSIVE RIGHT TO USE "SENSORS", APART FROM THE MARK AS SHOWN.

FOR ACCESS CONTROL AND ALARM MONITORING SYSTEMS; COMPUTER HARDWARE AND SOFTWARE SYSTEM FOR REMOTELY MONITORING ENVIRONMENTAL CONDITIONS AND CONTROLLING DEVICES WITHIN A BUILDING, FACILITY, GROUNDS, OR DESIGNATED SPATIAL AREA; ELECTRONIC DATA RELAYS FOR SENSORS; ELECTRONIC DEVICES, NAMELY, ENERGY METERS FOR TRACKING AND MONITORING ENERGY USAGE; ENVIRONMENTAL MONITORING SYSTEM COMPRISED OF METERS AND SENSORS THAT MEASURE PRESSURE, HUMIDITY, TEMPERATURE AND INCLUDES ALARM AND REPORTING FUNCTIONS; ENVIRONMENTALLY FRIENDLY AUTOMATION SYSTEMS, NAMELY, EMBEDDED OPERATING SYSTEMS AND PC BASED SOFTWARE, FOR MONITORING SPECIFIED CONDITIONS AND CONTROLLING RESPECTIVE INNOVATIVE DEVICES WITHIN A DESIGNATED AREA; HOME AND OFFICE AUTOMATION SYSTEMS COMPRISING WIRELESS AND WIRED CONTROLLERS, CONTROLLED DEVICES, AND SOFTWARE FOR LIGHTING, HVAC, SECURITY, SAFETY AND OTHER HOME AND OFFICE MONITORING AND CONTROL APPLICATIONS; LEAK DETECTING DEVICE FOR WATER SUPPLIED HOME APPLIANCES CONSISTING OF WATER SENSOR, CONTROL UNIT WITH AUDIBLE ALARM AND WATER VALVES; SECURITY AND FIRE ALARMS; SMOKE ALARMS; VOLTAGE MONITOR MODULES; WIRELESS CONTROLLER TO MONITOR AND CONTROL THE FUNCTIONING OF OTHER ELECTRONIC DEVICES; WIRELESS REMOTE TEMPERATURE AND HUMIDITY MONITORS FOR BUILDING MAINTENANCE (U.S. CLS. 21, 23, 26, 36 AND 38).

FIRST USE 11-2-2006; IN COMMERCE 5-1-2007.

CLASS 9—(Continued).

3,681,777. GOLDTECH, INC., SADDLE RIVER, NJ. SN 77-714,068. FILED P.R. 4-15-2009; AM. S.R. 7-24-2009.

360° DIGITAL

NO CLAIM IS MADE TO THE EXCLUSIVE RIGHT TO USE "DIGITAL", APART FROM THE MARK AS SHOWN.

THE MARK CONSISTS OF THE NUMBERS "360" FOLLOWED BY THE DEGREE SYMBOL AND THE WORD DIGITAL.

FOR DIGITAL ANTENNAS (U.S. CLS. 21, 23, 26, 36 AND 38).

FIRST USE 6-29-2009; IN COMMERCE 6-29-2009.

3,681,787. CROSS POINT INDUSTRIES, INC., ENCINITAS, CA. SN 77-722,196. FILED P.R. 4-24-2009; AM. S.R. 7-28-2009.

TEXTALERT

THE MARK CONSISTS OF STANDARD CHARACTERS WITHOUT CLAIM TO ANY PARTICULAR FONT, STYLE, SIZE, OR COLOR.

FOR ELECTRONIC VIDEO SURVEILLANCE PRODUCTS, NAMELY, ELECTRONIC COMPONENTS OF SECURITY SYSTEMS (U.S. CLS. 21, 23, 26, 36 AND 38).

FIRST USE 11-1-2008; IN COMMERCE 11-1-2008.

3,681,807. BILANTIC SOFTWARE, LLC, ALBERTSON, NY. SN 78-680,591. FILED P.R. 7-28-2005; AM. S.R. 7-27-2009.

CIPHERWIZARD

THE MARK CONSISTS OF STANDARD CHARACTERS WITHOUT CLAIM TO ANY PARTICULAR FONT, STYLE, SIZE, OR COLOR.

FOR COMPUTER SOFTWARE FOR ENCRYPTION AND DECRYPTION OF ELECTRONIC DOCUMENTS (U.S. CLS. 21, 23, 26, 36 AND 38).

FIRST USE 6-8-2004; IN COMMERCE 11-29-2004.

CLASS 10—MEDICAL APPARATUS

3,681,661. INOGEN, INC., GOLETA, CA. SN 77-411,829.
FILED P.R. 3-3-2008; AM. S.R. 7-13-2009.

CLASS 10—(Continued).

3,681,711. THE SEABERG COMPANY, INC., AKA SAM
MEDICAL PRODUCTS, PORTLAND, OR. SN 77-587,164.
FILED P.R. 10-7-2008; AM. S.R. 6-25-2009.

**INTELLIGENT DELIVERY
TECHNOLOGY**

THE MARK CONSISTS OF STANDARD CHARACTERS WITHOUT CLAIM TO ANY PARTICULAR FONT, STYLE, SIZE, OR COLOR.

NO CLAIM IS MADE TO THE EXCLUSIVE RIGHT TO USE "DELIVERY TECHNOLOGY", APART FROM THE MARK AS SHOWN.

FOR OXYGEN MONITORING SENSORS USED IN CONNECTION WITH OXYGEN CONCENTRATORS FOR USE BY PATIENTS SUFFERING FROM CHRONIC OBSTRUCTIVE PULMONARY DISEASE (COPD) AND OTHER RESPIRATORY DISORDERS (U.S. CLS. 26, 39 AND 44).

FIRST USE 1-0-2008; IN COMMERCE 1-0-2008.



3,681,701. ROEDER, RICK, MONROVIA, CA. SN 77-562,959.
FILED P.R. 9-5-2008; AM. S.R. 6-17-2009.

ALTERNATING LEG PRESSURE

THE MARK CONSISTS OF STANDARD CHARACTERS WITHOUT CLAIM TO ANY PARTICULAR FONT, STYLE, SIZE, OR COLOR.

FOR APPARATUS FOR APPLICATION OF INTERMITTENT COMPRESSION TO THE LEGS OF A PAIENT, USED FOR AUGMENTING BLOOD FLOW (U.S. CLS. 26, 39 AND 44).

FIRST USE 11-28-1995; IN COMMERCE 11-28-1995.

THE COLOR(S) OLIVE DRAB IS/ARE CLAIMED AS A FEATURE OF THE MARK.

THE MARK CONSISTS OF THE COLOR OLIVE DRAB (PANTONE # 5605 U) AS APPLIED TO THE ENTIRE EXTERIOR SURFACE OF THE GOODS. THE DOTTED OUTLINE OF THE GOODS IS INTENDED TO SHOW THE POSITION OF THE MARK AND IS NOT PART OF THE MARK. THE GOODS ARE SHOWN FORESHORTENED IN THE DRAWING, WITH A PORTION OF THE GOODS OMITTED AS SHOWN, AND THE OMITTED PORTION OF THE GOODS IS SUBSTANTIALLY SIMILAR TO THE PORTIONS IMMEDIATELY ADJACENT TO THE OMISION.

FOR ORTHOPEDIC SPLINTS (U.S. CLS. 26, 39 AND 44).

FIRST USE 12-31-2000; IN COMMERCE 12-31-2000.

CLASS 10—(Continued).

3,681,712. THE SEABERG COMPANY, INC., AKA SAM MEDICAL PRODUCTS, PORTLAND, OR. SN 77-587,387. FILED P.R. 10-7-2008; AM. S.R. 6-25-2009.

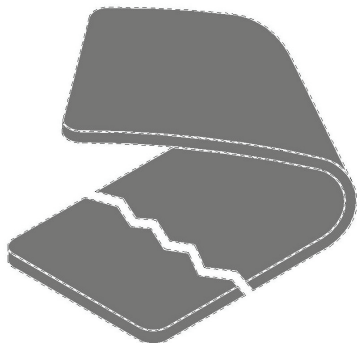

THE COLOR(S) CHARCOAL IS/ARE CLAIMED AS A FEATURE OF THE MARK.

THE MARK CONSISTS OF THE COLOR CHARCOAL (PANTONE # 431 U) AS APPLIED TO THE ENTIRE EXTERIOR SURFACE OF THE GOODS. THE DOTTED OUTLINE OF THE GOODS IS INTENDED TO SHOW THE POSITION OF THE MARK AND IS NOT PART OF THE MARK. THE GOODS ARE SHOWN FORESHORTENED IN THE DRAWING, WITH A PORTION OF THE GOODS OMITTED AS SHOWN, AND THE OMITTED PORTION OF THE GOODS IS SUBSTANTIALLY SIMILAR TO THE PORTIONS IMMEDIATELY ADJACENT TO THE OMISSION.

FOR ORTHOPEDIC SPLINTS (U.S. CLS. 26, 39 AND 44).

FIRST USE 12-31-1988; IN COMMERCE 12-31-1988.

3,681,754. IZI MEDICAL PRODUCTS, LLC, BALTIMORE, MD. SN 77-661,433. FILED P.R. 2-2-2009; AM. S.R. 6-25-2009.

INDICATOR

THE MARK CONSISTS OF STANDARD CHARACTERS WITHOUT CLAIM TO ANY PARTICULAR FONT, STYLE, SIZE, OR COLOR.

FOR IDENTIFICATION MARKERS, NAMELY, A SELF-ADHESIVE SUBSTRATE THAT IS ATTACHED TO THE SKIN FOR USE WITH RADIOGRAPHIC PROCEDURES (U.S. CLS. 26, 39 AND 44).

FIRST USE 5-21-2008; IN COMMERCE 5-21-2008.

CLASS 12—VEHICLES

CLASS 12—(Continued).

3,681,695. KUBAN, JOHN, DBA DECKJET WATERCRAFT LLC., ELKHORN, WI. SN 77-548,789. FILED P.R. 8-16-2008; AM. S.R. 7-13-2009.

AMERICAN JETBOARD

THE MARK CONSISTS OF STANDARD CHARACTERS WITHOUT CLAIM TO ANY PARTICULAR FONT, STYLE, SIZE, OR COLOR.

FOR PERSONAL WATERCRAFT, NAMELY, JET POWERED SURFBOARDS, JET POWERED KAYAKS, JET POWERED BOATS (U.S. CLS. 19, 21, 23, 31, 35 AND 44).

FIRST USE 6-1-2009; IN COMMERCE 6-1-2009.

3,681,759. TIM HAYS, DBA HAYS MACHINE WORKS, MATTHEWS, NC. SN 77-672,312. FILED P.R. 2-17-2009; AM. S.R. 6-29-2009.

Convertible Clutch

THE MARK CONSISTS OF STANDARD CHARACTERS WITHOUT CLAIM TO ANY PARTICULAR FONT, STYLE, SIZE, OR COLOR.

NO CLAIM IS MADE TO THE EXCLUSIVE RIGHT TO USE "CLUTCH", APART FROM THE MARK AS SHOWN.

FOR CLUTCH MECHANISMS FOR MOTOR CARS (U.S. CLS. 19, 21, 23, 31, 35 AND 44).

FIRST USE 6-1-2008; IN COMMERCE 6-1-2008.

CLASS 16—PAPER GOODS AND PRINTED MATTER

CLASS 16—(Continued).

3,681,721. LOVETT, DAVID, EWA BEACH, HI. SN 77-593,630.
FILED P.R. 10-15-2008; AM. S.R. 8-3-2009.



THE STIPPLING IS FOR SHADING PURPOSES ONLY.
THE MARK CONSISTS OF THE STYLIZED TEXT "NO STINKY BUTTS . CLEAN YOUR BUTTS NOSTINKY-BUTTS.COM" WITH AN ARROW DESIGN ELEMENT BETWEEN THE WORDS "CLEAN" AND "YOUR" AND A CIGARETTE BUTT DESIGN ELEMENT THAT IS SWEATING AND FARTING WITH ARMS, A FACE ON THE BUTT PART WITH EYES, A MOUTH, AND EYEBROWS, WHICH IS ON TOP OF AN OVAL DESIGN ELEMENT.
FOR PRINTED PAPER SIGNS; STICKERS (U.S. CLS. 2, 5, 22, 23, 29, 37, 38 AND 50).
FIRST USE 10-15-2008; IN COMMERCE 10-15-2008.

3,681,764. EMMIS PUBLISHING, L.P., INDIANAPOLIS, IN.
SN 77-681,960. FILED P.R. 3-3-2009; AM. S.R. 7-14-2009.

OBJECT LESSON

THE MARK CONSISTS OF STANDARD CHARACTERS WITHOUT CLAIM TO ANY PARTICULAR FONT, STYLE, SIZE, OR COLOR.
FOR MAGAZINE COLUMN ON A WIDE VARIETY OF TOPICS OF GENERAL INTEREST (U.S. CLS. 2, 5, 22, 23, 29, 37, 38 AND 50).
FIRST USE 2-20-2009; IN COMMERCE 2-20-2009.

CLASS 16—(Continued).

3,681,769. GUIDEPOSTS A CHURCH CORPORATION, CARMEL, NY. SN 77-693,508. FILED P.R. 3-18-2009; AM. S.R. 7-23-2009.

MAKING MARRIAGE WORK

THE MARK CONSISTS OF STANDARD CHARACTERS WITHOUT CLAIM TO ANY PARTICULAR FONT, STYLE, SIZE, OR COLOR.

FOR MAGAZINE COLUMN FEATURING PERSONAL, SPIRITUAL, POSITIVE AND FAITH-FILLED INFORMATION REGARDING RELATIONSHIPS (U.S. CLS. 2, 5, 22, 23, 29, 37, 38 AND 50).
FIRST USE 1-31-2005; IN COMMERCE 1-31-2005.

CLASS 18—LEATHER GOODS

3,681,750. ACCESSORIES BY JOANN HUTH, INC., BRYN MAWR, PA. SN 77-654,374. FILED P.R. 1-22-2009; AM. S.R. 7-21-2009.

Transfer Bag

THE MARK CONSISTS OF STANDARD CHARACTERS WITHOUT CLAIM TO ANY PARTICULAR FONT, STYLE, SIZE, OR COLOR.

NO CLAIM IS MADE TO THE EXCLUSIVE RIGHT TO USE "BAG", APART FROM THE MARK AS SHOWN.
FOR HANDBAGS (U.S. CLS. 1, 2, 3, 22 AND 41).
FIRST USE 1-1-2008; IN COMMERCE 1-1-2008.

CLASS 19—NON-METALLIC BUILDING MATERIALS

CLASS 19—(Continued).

3,681,696. TARKETT INC., FARNHAM, CANADA. SN 77-550,684. FILED P.R. 8-19-2008; AM. S.R. 5-27-2009.



THE MARK CONSISTS OF A CLOSED FIGURE FORMED BY 4 ARCS.

FOR FLOORING PRODUCTS, NAMELY, SOLID VINYL TILES (U.S. CLS. 1, 12, 33 AND 50).

FIRST USE 6-11-2007; IN COMMERCE 6-11-2007.

CLASS 20—FURNITURE AND ARTICLES NOT OTHERWISE CLASSIFIED

3,681,648. URCUTE ENTERTAINMENT, LLC, BRIDGEPORT, CT. SN 77-246,116. FILED P.R. 8-3-2007; AM. S.R. 12-31-2008.

RED CARPET RUNWAY

THE MARK CONSISTS OF STANDARD CHARACTERS WITHOUT CLAIM TO ANY PARTICULAR FONT, STYLE, SIZE, OR COLOR.

NO CLAIM IS MADE TO THE EXCLUSIVE RIGHT TO USE "CARPET RUNWAY", APART FROM THE MARK AS SHOWN.

FOR ENTERTAINMENT PARTY PACKAGE KITS COMPRISING RED CARPET AND CONTAINING DECORATIONS PROPS, BACKDROPS, AND LIGHTING TO BE USED FOR ENTERTAINMENT PURPOSES (U.S. CLS. 2, 13, 22, 25, 32 AND 50).

FIRST USE 3-15-2008; IN COMMERCE 3-15-2008.

CLASS 20—(Continued).

3,681,714. BATESVILLE SERVICES, INC., BATESVILLE, IN. SN 77-588,521. FILED P.R. 10-8-2008; AM. S.R. 7-28-2009.

PEARL ESSENCE

THE MARK CONSISTS OF STANDARD CHARACTERS WITHOUT CLAIM TO ANY PARTICULAR FONT, STYLE, SIZE, OR COLOR.

FOR CASKETS (U.S. CLS. 2, 13, 22, 25, 32 AND 50).
FIRST USE 9-30-2008; IN COMMERCE 10-12-2008.

3,681,715. BATESVILLE SERVICES, INC., BATESVILLE, IN. SN 77-588,529. FILED P.R. 10-8-2008; AM. S.R. 7-28-2009.

PEARL

THE MARK CONSISTS OF STANDARD CHARACTERS WITHOUT CLAIM TO ANY PARTICULAR FONT, STYLE, SIZE, OR COLOR.

FOR CASKETS (U.S. CLS. 2, 13, 22, 25, 32 AND 50).
FIRST USE 9-30-2008; IN COMMERCE 10-12-2008.

3,681,744. ENJOY PLASTICS USA, INC., VERNON, CA. SN 77-624,978. FILED P.R. 12-2-2008; AM. S.R. 7-23-2009.

GAME CADDY

THE MARK CONSISTS OF STANDARD CHARACTERS WITHOUT CLAIM TO ANY PARTICULAR FONT, STYLE, SIZE, OR COLOR.

FOR PLASTIC SHELVING (U.S. CLS. 2, 13, 22, 25, 32 AND 50).

FIRST USE 7-6-2009; IN COMMERCE 7-6-2009.

CLASS 25—CLOTHING

CLASS 25—(Continued).

3,681,719. CATHEY, TRACY, INGLEWOOD, CA. SN 77-591,272. FILED P.R. 10-13-2008; AM. S.R. 7-10-2009.

GIRLBALL

THE MARK CONSISTS OF STANDARD CHARACTERS WITHOUT CLAIM TO ANY PARTICULAR FONT, STYLE, SIZE, OR COLOR.

FOR CLOTHING, NAMELY, SWEAT SUITS, SWEAT PANTS, PANTS, T-SHIRTS, HEADBANDS, WRIST BANDS, SHIRTS, JACKETS, SWEATERS, SOCKS, HATS, BEANIES, GLOVES, SCARVES, UNDERGARMENTS, BELTS, SLEEPWEAR, WRAPS (U.S. CLS. 22 AND 39).

FIRST USE 6-23-2009; IN COMMERCE 6-23-2009.

3,681,766. RAG'S STYLE, LOS ANGELES, CA. SN 77-683,103. FILED P.R. 3-4-2009; AM. S.R. 7-16-2009.

LAFINE

THE MARK CONSISTS OF STANDARD CHARACTERS WITHOUT CLAIM TO ANY PARTICULAR FONT, STYLE, SIZE, OR COLOR.

FOR CAPS; HOODED SWEAT SHIRTS; SHORT-SLEEVED OR LONG-SLEEVED T-SHIRTS; SWEAT PANTS; T-SHIRTS (U.S. CLS. 22 AND 39).

FIRST USE 5-1-2007; IN COMMERCE 5-1-2007.

3,681,768. KAYSER-ROTH CORPORATION, GREENSBORO, NC. SN 77-693,109. FILED P.R. 3-17-2009; AM. S.R. 7-9-2009.

NO-SLIP TOP

THE MARK CONSISTS OF STANDARD CHARACTERS WITHOUT CLAIM TO ANY PARTICULAR FONT, STYLE, SIZE, OR COLOR.

FOR CLOTHING, NAMELY, SOCKS (U.S. CLS. 22 AND 39).

FIRST USE 6-20-2009; IN COMMERCE 6-20-2009.

CLASS 25—(Continued).

3,681,782. TWEEN BRANDS INVESTMENT, LLC, NEW ALBANY, OH. SN 77-718,878. FILED P.R. 4-21-2009; AM. S.R. 7-27-2009.

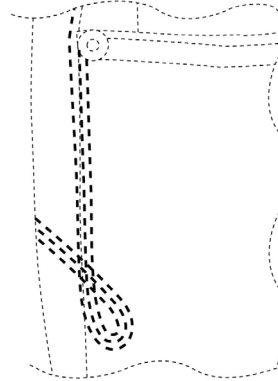

THE MARK CONSISTS OF 3 STITCH ROWS THAT DESCEND AND LOOP AT THE BOTTOM, SHOWN IN THE DRAWING AS EMBOLDENED DOTTED LINES. THE NON-EMBOLDENED BROKEN LINES ARE NOT PART OF THE MARK AND SERVES TO SHOW THE POSITION OR PLACEMENT OF THE MARK.

FOR PANTS; SHORTS; SKIRTS (U.S. CLS. 22 AND 39). FIRST USE 9-1-2007; IN COMMERCE 9-1-2007.

3,681,803. JEE WON KIM, LOS ANGELES, CA. SN 77-726,571. FILED 4-30-2009.

MAGISTERIAL

THE MARK CONSISTS OF STANDARD CHARACTERS WITHOUT CLAIM TO ANY PARTICULAR FONT, STYLE, SIZE, OR COLOR.

FOR A-SHIRTS; ATHLETIC APPAREL, NAMELY, SHIRTS, PANTS, JACKETS, FOOTWEAR, HATS AND CAPS, ATHLETIC UNIFORMS; HOODED SWEAT SHIRTS; LONG-SLEEVED SHIRTS (U.S. CLS. 22 AND 39).

FIRST USE 4-16-2007; IN COMMERCE 4-16-2007.

CLASS 27—FLOOR COVERINGS

CLASS 27—(Continued).

3,681,808. TAC-FAST SYSTEMS CANADA LIMITED, RICHMOND HILL, CANADA. SN 78-758,347. FILED P.R. 11-21-2005; AM. S.R. 7-27-2009.

AREA RUG IN A BOX

THE MARK CONSISTS OF STANDARD CHARACTERS WITHOUT CLAIM TO ANY PARTICULAR FONT, STYLE, SIZE, OR COLOR.

PRIORITY CLAIMED UNDER SEC. 44(D) ON CANADA APPLICATION NO. 1279257, FILED 11-10-2005.

OWNER OF CANADA REG. NO. TMA727,201, DATED 10-28-2008, EXPIRES 10-28-2023.

NO CLAIM IS MADE TO THE EXCLUSIVE RIGHT TO USE "AREA RUG", APART FROM THE MARK AS SHOWN.

FOR CARPET MODULES, NAMELY, CARPET TILES AND FASTENING ANCHOR PLATES SOLD AS A UNIT FOR AREA RUG ASSEMBLY (U.S. CLS. 19, 20, 37, 42 AND 50).

CLASS 28—(Continued).

3,681,646. HANES, CHARLES M. III, LOUISVILLE, CO. SN 77-049,894. FILED P.R. 11-22-2006; AM. S.R. 7-31-2009.

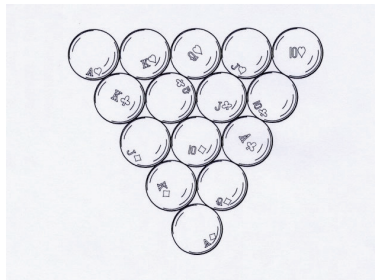

THE MARK CONSISTS OF ARRANGEMENT OF RACKED POOL-LIKE BALLS CONTAINING PLAYING CARD SYMBOLS.

FOR BILLIARD GAME PLAYING EQUIPMENT, NAMELY, BILLIARD BALLS (U.S. CLS. 22, 23, 38 AND 50).

FIRST USE 1-15-2009; IN COMMERCE 1-15-2009.

3,681,674. CALLAWAY GOLF COMPANY, CARLSBAD, CA. SN 77-461,223. FILED P.R. 4-29-2008; AM. S.R. 6-30-2009.

Crimson Series

THE MARK CONSISTS OF STANDARD CHARACTERS WITHOUT CLAIM TO ANY PARTICULAR FONT, STYLE, SIZE, OR COLOR.

NO CLAIM IS MADE TO THE EXCLUSIVE RIGHT TO USE "SERIES", APART FROM THE MARK AS SHOWN.

FOR GOLF CLUBS (U.S. CLS. 22, 23, 38 AND 50).

FIRST USE 9-16-2008; IN COMMERCE 9-16-2008.

CLASS 28—TOYS AND SPORTING GOODS

3,681,642. UNIVERSAL CITY STUDIOS LLLP, UNIVERSAL CITY, CA. SN 75-077,987. FILED P.R. 3-25-1996; AM. S.R. 7-15-2009.

FRANKENSTEIN

OWNER OF U.S. REG. NO. 1,178,108.

FOR TOYS AND GAMES, NAMELY, ACTION FIGURES AND ACCESSORIES THEREFOR; BALLOONS; BATHTUB TOYS; TOY BUILDING BLOCKS; DOLLS AND ACCESSORIES THEREFOR; DOLL CLOTHING; BOARD GAMES, CARD GAMES; PLAY COSMETICS FOR CHILDREN; COSTUME MASKS; MINIATURE DIE CAST VEHICLES, TOY AIRPLANES AND HELICOPTERS, BATTERY OPERATED REMOTE CONTROLLED TOY VEHICLES; FLYING DISKS; INFLATABLE VINYL FIGURES; JIGSAW PUZZLES; KITES; MARBLES; INDOOR SLUMBER AND PLAY TENTS; PLUSH TOYS; HAND HELD PUPPETS; SIT-IN AND RIDE-ON TOY VEHICLES; TRAIN SETS; PLAY SHAVING KITS; SKATEBOARDS, ROLLERSKATES; TOY BANKS; WATER SQUIRTING TOYS, TOY PISTOLS, TARGET SETS; CHRISTMAS TREE ORNAMENTS; PINBALL AND ARCADE GAME MACHINES, HAND HELD UNIT FOR PLAYING ELECTRONIC GAMES (U.S. CLS. 22, 23, 38 AND 50).

FIRST USE 1-31-1996; IN COMMERCE 1-31-1996.

3,681,683. ANGEL PLAYING CARDS CO., LTD., CHUO-KU OSAKA, JAPAN. SN 77-496,468. FILED P.R. 6-11-2008; AM. S.R. 7-9-2009.

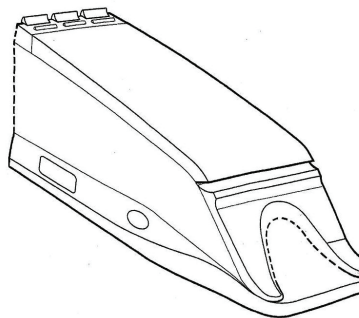

THE MARK CONSISTS OF A CONFIGURATION OF THE

CLASS 28—(Continued).

GOODS FEATURING A CARD SHOE WITH THE FOLLOWING FEATURES: (A) THE PLACEMENT OF SIX GENERALLY RECTANGULAR BUTTONS IN TWO ROWS OF THREE ON THE BACK PORTION OF THE TOP SURFACE; (B) A CURVED SECTION OF THE TOP SURFACE MEETING THE INCLINED FRONT SURFACE; (C) TWO ROUNDED AND CURVED PROTRUSIONS NEAR THE BOTTOM ON THE FRONT SURFACE; (D) AN OUTWARD PROTRUSION ALONG THE BOTTOM SIDES OF THE GENERALLY RECTANGULAR ELONGATED PARALLELEPIPED; AND (E) THE PLACEMENT OF A RECTANGULAR DISPLAY AND AN OVAL BUTTON ALONG ONE SIDE OF THE OUTWARD PROTRUSION ALONG THE BOTTOM SIDE OF THE GENERALLY RECTANGULAR ELONGATED PARALLELEPIPED. THE MATTER SHOWN IN BROKEN LINES IS NOT PART OF THE MARK AND SERVES ONLY TO SHOW POSITION AND PLACEMENT OF THE MARK.

FOR TABLE GAMING EQUIPMENT, NAMELY, A DEVICE COMPRISED PRIMARILY OF A PLAYING CARD DISPENSING DEVICE AND CONTAINING A CARD READING AND SCANNING FUNCTION FOR SECURITY PURPOSES (U.S. CLS. 22, 23, 38 AND 50).

FIRST USE 0-0-2005; IN COMMERCE 6-2-2008.

3,681,765. EVANS, BRAD, MONROVIA, CA. SN 77-683,056. FILED P.R. 3-4-2009; AM. S.R. 7-27-2009.

COORDINATION BAG

THE MARK CONSISTS OF THE STYLIZED TEXT "COORDINATIONBAG".

FOR SPORTING GOODS, NAMELY, A SPORTS TRAINING DEVICE TO IMPROVE STRENGTH, TONING, CONDITIONING, BALANCE, AND PROPRIOCEPTION (U.S. CLS. 22, 23, 38 AND 50).

FIRST USE 6-10-2008; IN COMMERCE 6-10-2008.

3,681,788. TWIN CITIES TRIVIA CHALLENGE, LLC, BROOKLYN PARK, MN. SN 77-722,573. FILED 4-26-2009.

Live Team Trivia

THE MARK CONSISTS OF STANDARD CHARACTERS WITHOUT CLAIM TO ANY PARTICULAR FONT, STYLE, SIZE, OR COLOR.

NO CLAIM IS MADE TO THE EXCLUSIVE RIGHT TO USE "TRIVIA", APART FROM THE MARK AS SHOWN.

FOR TRIVIA GAME PLAYED WITH CARDS AND GAME COMPONENTS (U.S. CLS. 22, 23, 38 AND 50).

FIRST USE 2-20-2009; IN COMMERCE 2-20-2009.

CLASS 29—MEATS AND PROCESSED FOODS

CLASS 29—(Continued).

3,681,760. JARVIS, SUZI, BEREA, KY. SN 77-677,022. FILED P.R. 2-24-2009; AM. S.R. 7-21-2009.

Famous Bluegrass Beer Cheese

THE MARK CONSISTS OF STANDARD CHARACTERS WITHOUT CLAIM TO ANY PARTICULAR FONT, STYLE, SIZE, OR COLOR.

NO CLAIM IS MADE TO THE EXCLUSIVE RIGHT TO USE "BEER CHEESE", APART FROM THE MARK AS SHOWN.

FOR CHEESE, NAMELY, BEER CHEESE (U.S. CL. 46). FIRST USE 2-25-2009; IN COMMERCE 2-25-2009.

3,681,789. ZI HE, WU, ROME, NY. SN 77-722,742. FILED 4-27-2009.

PERFECT COCONUT JAM

THE MARK CONSISTS OF STANDARD CHARACTERS WITHOUT CLAIM TO ANY PARTICULAR FONT, STYLE, SIZE, OR COLOR.

NO CLAIM IS MADE TO THE EXCLUSIVE RIGHT TO USE "COCONUT JAM", APART FROM THE MARK AS SHOWN.

FOR JAMS AND JELLIES, NAMELY, COCONUT JAM (U.S. CL. 46).

FIRST USE 4-1-2009; IN COMMERCE 4-24-2009.

3,681,794. MOUNT OLIVE PICKLE COMPANY, INC., MT. OLIVE, NC. SN 77-723,918. FILED P.R. 4-28-2009; AM. S.R. 7-23-2009.

pepperPAK

THE MARK CONSISTS OF STANDARD CHARACTERS WITHOUT CLAIM TO ANY PARTICULAR FONT, STYLE, SIZE, OR COLOR.

OWNER OF U.S. REG. NO. 3,542,304.

FOR PROCESSED PEPPERS (U.S. CL. 46).

FIRST USE 12-31-2008; IN COMMERCE 12-31-2008.

CLASS 30—STAPLE FOODS

CLASS 30—(Continued).

3,681,657. FUSION GOURMET, INC., GARDENA, CA. SN 77-403,355. FILED P.R. 2-21-2008; AM. S.R. 7-7-2009.

Sofiato

THE MARK CONSISTS OF STANDARD CHARACTERS WITHOUT CLAIM TO ANY PARTICULAR FONT, STYLE, SIZE, OR COLOR.

FOR COOKIES; PASTRIES; CRACKERS; CANDIES; WAFERS (U.S. CL. 46).
FIRST USE 6-1-2005; IN COMMERCE 9-1-2006.

3,681,692. SILVER PALATE KITCHENS, INC., CRESSKILL, NJ. SN 77-541,423. FILED P.R. 8-7-2008; AM. S.R. 7-28-2009.

GRAIN BERRY

THE MARK CONSISTS OF STANDARD CHARACTERS WITHOUT CLAIM TO ANY PARTICULAR FONT, STYLE, SIZE, OR COLOR.

FOR BREAKFAST AND PROCESSED CEREAL, MUFFIN MIXES, PANCAKE MIXES, CRACKERS (U.S. CL. 46).
FIRST USE 6-9-2009; IN COMMERCE 6-9-2009.

3,681,757. ARGO TEA, INC., CHICAGO, IL. SN 77-666,340. FILED P.R. 2-9-2009; AM. S.R. 7-24-2009.

RED VELVET

THE MARK CONSISTS OF STANDARD CHARACTERS WITHOUT CLAIM TO ANY PARTICULAR FONT, STYLE, SIZE, OR COLOR.

FOR TEA-BASED BEVERAGES (U.S. CL. 46).
FIRST USE 12-31-2007; IN COMMERCE 12-31-2007.

CLASS 30—(Continued).

3,681,758. ARGO TEA, INC., CHICAGO, IL. SN 77-666,576. FILED P.R. 2-9-2009; AM. S.R. 7-3-2009.

MOJITEA

THE MARK CONSISTS OF STANDARD CHARACTERS WITHOUT CLAIM TO ANY PARTICULAR FONT, STYLE, SIZE, OR COLOR.

FOR TEA-BASED BEVERAGES (U.S. CL. 46).
FIRST USE 12-31-2004; IN COMMERCE 12-31-2004.

3,681,795. RALCORP FROZEN BAKERY PRODUCTS, INC., WESTMONT, IL. SN 77-724,094. FILED 4-28-2009.

DESSERT SAMPLERS

THE MARK CONSISTS OF STANDARD CHARACTERS WITHOUT CLAIM TO ANY PARTICULAR FONT, STYLE, SIZE, OR COLOR.

NO CLAIM IS MADE TO THE EXCLUSIVE RIGHT TO USE "DESSERT", APART FROM THE MARK AS SHOWN.
FOR CAKES (U.S. CL. 46).
FIRST USE 2-9-2009; IN COMMERCE 2-9-2009.

CLASS 34—SMOKERS' ARTICLES

3,681,675. LIDL STIFTUNG & CO. KG, 74167 NECKAR-SULM, FED REP GERMANY. SN 77-464,306. FILED P.R. 5-2-2008; AM. S.R. 7-20-2009.

TEMPLETON

THE MARK CONSISTS OF STANDARD CHARACTERS WITHOUT CLAIM TO ANY PARTICULAR FONT, STYLE, SIZE, OR COLOR.

OWNER OF FED REP GERMANY REG. NO. 2004985, DATED 10-14-1991, EXPIRES 2-28-2011.
FOR CIGARS; CIGARETTES; TOBACCO (U.S. CLS. 2, 8, 9 AND 17).

SERVICE MARKS**CLASS 35—ADVERTISING AND BUSINESS**

CLASS 35—(Continued).

3,681,659. STROKIN, LLC, CHASKA, MN. SN 77-408,811.
FILED P.R. 2-28-2008; AM. S.R. 7-10-2009.

VALUE CLUB AMERICA

THE MARK CONSISTS OF STANDARD CHARACTERS WITHOUT CLAIM TO ANY PARTICULAR FONT, STYLE, SIZE, OR COLOR.

NO CLAIM IS MADE TO THE EXCLUSIVE RIGHT TO USE "CLUB", APART FROM THE MARK AS SHOWN.

FOR CUSTOMER LOYALTY SERVICES AND PROGRAMS, FOR COMMERCIAL, PROMOTIONAL AND/OR ADVERTISING PURPOSES (U.S. CLS. 100, 101 AND 102).
FIRST USE 12-31-1994; IN COMMERCE 12-31-1994.

3,681,660. STROKIN, LLC, CHASKA, MN. SN 77-408,814.
FILED P.R. 2-28-2008; AM. S.R. 7-10-2009.

VALUE CLUB

THE MARK CONSISTS OF STANDARD CHARACTERS WITHOUT CLAIM TO ANY PARTICULAR FONT, STYLE, SIZE, OR COLOR.

NO CLAIM IS MADE TO THE EXCLUSIVE RIGHT TO USE "CLUB", APART FROM THE MARK AS SHOWN.

FOR CUSTOMER LOYALTY SERVICES AND PROGRAMS, FOR COMMERCIAL, PROMOTIONAL AND/OR ADVERTISING PURPOSES (U.S. CLS. 100, 101 AND 102).
FIRST USE 1-31-1995; IN COMMERCE 1-31-1995.

3,681,665. FIRST TO THE FINISH KIM AND MIKE VIANO SPORTS INC., CARLINVILLE, IL. SN 77-425,042. FILED P.R. 3-18-2008; AM. S.R. 7-13-2009.

TEAM MARKETPLACE

THE MARK CONSISTS OF STANDARD CHARACTERS WITHOUT CLAIM TO ANY PARTICULAR FONT, STYLE, SIZE, OR COLOR.

FOR MAIL ORDER CATALOG SERVICES FEATURING SPORTS APPAREL (U.S. CLS. 100, 101 AND 102).
FIRST USE 7-0-2008; IN COMMERCE 7-0-2008.

CLASS 35—(Continued).

3,681,667. FINANCIAL OPERATIONS NETWORKS LLC, ATLANTA, GA. SN 77-428,495. FILED P.R. 3-21-2008; AM. S.R. 12-12-2008.

THE ACCOUNTS RECEIVABLE NETWORK

THE MARK CONSISTS OF STANDARD CHARACTERS WITHOUT CLAIM TO ANY PARTICULAR FONT, STYLE, SIZE, OR COLOR.

NO CLAIM IS MADE TO THE EXCLUSIVE RIGHT TO USE "ACCOUNTS RECEIVABLE", APART FROM THE MARK AS SHOWN.

FOR PROVIDING INFORMATION IN THE FIELDS OF BUSINESS MANAGEMENT AND BUSINESS ORGANIZATION VIA THE INTERNET (U.S. CLS. 100, 101 AND 102).
FIRST USE 3-3-2008; IN COMMERCE 3-3-2008.

3,681,669. MILL CREEK TOWN CENTER BUSINESS ASSOCIATION, SEATTLE, WA. SN 77-431,409. FILED 3-25-2008.

MILL CREEK TOWN CENTER

THE MARK CONSISTS OF STANDARD CHARACTERS WITHOUT CLAIM TO ANY PARTICULAR FONT, STYLE, SIZE, OR COLOR.

FOR ADVERTISING, MARKETING AND PROMOTION SERVICES; ARRANGING AND CONDUCTING MARKETING PROMOTIONAL EVENTS FOR OTHERS; SHOPPERS' GUIDE INFORMATION; PROVIDING AN ONLINE DIRECTORY INFORMATION SERVICE FEATURING INFORMATION REGARDING AREA BUSINESSES (U.S. CLS. 100, 101 AND 102).
FIRST USE 12-0-2003; IN COMMERCE 12-0-2003.

3,681,672. KEMPA GROUP REALTY, INC., HOMER GLEN, IL. SN 77-451,754. FILED P.R. 4-18-2008; AM. S.R. 7-15-2009.

BUILDER CLEARINGHOUSE

THE MARK CONSISTS OF STANDARD CHARACTERS WITHOUT CLAIM TO ANY PARTICULAR FONT, STYLE, SIZE, OR COLOR.

FOR REAL ESTATE AUCTIONS AND ONLINE AUCTION SERVICES (U.S. CLS. 100, 101 AND 102).
FIRST USE 2-1-2008; IN COMMERCE 2-1-2008.

CLASS 35—(Continued).

3,681,673. ACCENT ENERGY GROUP LLC, DUBLIN, OH. SN 77-459,762. FILED P.R. 4-28-2008; AM. S.R. 7-16-2009.

ENERGY PRICE PROTECTOR

THE MARK CONSISTS OF STANDARD CHARACTERS WITHOUT CLAIM TO ANY PARTICULAR FONT, STYLE, SIZE, OR COLOR.

FOR ONLINE ENERGY MANAGEMENT SERVICES, NAMELY, PROVIDING A SERVICE THAT ALLOWS RESIDENTIAL AND COMMERCIAL CUSTOMERS TO PURCHASE A PROTECTION PLAN AT AN AGREED TO PRICE, TERM AND AMOUNT TO REDUCE RISKS ASSOCIATED WITH INCREASING ENERGY COSTS (U.S. CLS. 100, 101 AND 102).

FIRST USE 7-10-2009; IN COMMERCE 7-10-2009.

3,681,682. BBY SOLUTIONS, INC., RICHFIELD, MN. SN 77-494,117. FILED P.R. 6-9-2008; AM. S.R. 7-11-2009.

EZTRADEIN

THE MARK CONSISTS OF STANDARD CHARACTERS WITHOUT CLAIM TO ANY PARTICULAR FONT, STYLE, SIZE, OR COLOR.

FOR PROVIDING ONLINE EXCHANGE SERVICES, NAMELY, TRADE-IN BARTERING OF MERCHANDISE FOR CONSUMERS AND BUSINESSES; PROVIDING INFORMATION VIA THE INTERNET FIELD OF CONSUMER AND BUSINESS MERCHANDISE; AND DISSEMINATION OF ADVERTISING FOR OTHERS VIA AN ON-LINE ELECTRONIC COMMUNICATIONS NETWORK (U.S. CLS. 100, 101 AND 102).

FIRST USE 8-27-2004; IN COMMERCE 8-27-2004.

3,681,694. TAAM, ANDREW M.O., DBA HAWAIIAN FIGHTGEAR-HFG LLC, HONOLULU, HI. SN 77-547,774. FILED P.R. 8-15-2008; AM. S.R. 7-16-2009.

Hawaiian Fightgear

THE MARK CONSISTS OF STANDARD CHARACTERS WITHOUT CLAIM TO ANY PARTICULAR FONT, STYLE, SIZE, OR COLOR.

FOR WHOLESALE AND RETAIL STORE SERVICES FEATURING CLOTHING (U.S. CLS. 100, 101 AND 102).

FIRST USE 2-6-2006; IN COMMERCE 2-6-2006.

CLASS 35—(Continued).

3,681,698. THE NATIONAL PRESS CLUB OF WASHINGTON, D.C., INC., WASHINGTON, DC. SN 77-556,003. FILED P.R. 8-26-2008; AM. S.R. 7-17-2009.

**THE WORLD'S LEADING
PROFESSIONAL ORGANIZATION
FOR JOURNALISTS**

THE MARK CONSISTS OF STANDARD CHARACTERS WITHOUT CLAIM TO ANY PARTICULAR FONT, STYLE, SIZE, OR COLOR.

NO CLAIM IS MADE TO THE EXCLUSIVE RIGHT TO USE "ORGANIZATION", APART FROM THE MARK AS SHOWN.

FOR ASSOCIATION SERVICES, NAMELY, PROMOTING THE INTERESTS OF JOURNALISTS (U.S. CLS. 100, 101 AND 102).

FIRST USE 7-0-2008; IN COMMERCE 7-0-2008.

3,681,718. HISPANIC ASSOCIATION ON CORPORATE RESPONSIBILITY, AKA HACR, WASHINGTON, DC. SN 77-591,161. FILED P.R. 10-13-2008; AM. S.R. 7-16-2009.

Corporate Executives Forum

THE MARK CONSISTS OF STANDARD CHARACTERS WITHOUT CLAIM TO ANY PARTICULAR FONT, STYLE, SIZE, OR COLOR.

NO CLAIM IS MADE TO THE EXCLUSIVE RIGHT TO USE "FORUM", APART FROM THE MARK AS SHOWN.

FOR PROMOTING PUBLIC INTEREST IN EDUCATION, RECOGNITION, CAREER ADVANCEMENT, AND LEADERSHIP FOR ELITE MANAGERS AND EXECUTIVES IN CORPORATIONS AND PROFESSIONAL SERVICE FIRMS; PROVIDING INFORMATION ABOUT THE CORPORATE WORLD, CORPORATE CULTURE, AND THE CORPORATE SECTOR (U.S. CLS. 100, 101 AND 102).

FIRST USE 12-12-2006; IN COMMERCE 12-12-2006.

3,681,720. LEE ENTERPRISES INCORPORATED, DAVENPORT, IA. SN 77-593,194. FILED P.R. 10-15-2008; AM. S.R. 7-22-2009.

SELLITWI.COM

THE MARK CONSISTS OF STANDARD CHARACTERS WITHOUT CLAIM TO ANY PARTICULAR FONT, STYLE, SIZE, OR COLOR.

FOR PROVIDING AN ON-LINE SEARCHABLE DATABASE FEATURING CLASSIFIED AD LISTINGS (U.S. CLS. 100, 101 AND 102).

FIRST USE 7-15-2009; IN COMMERCE 7-15-2009.

CLASS 35—(Continued).

3,681,745. FOY, BRIAN T, FORMERLY TACTICAL TECHNOLOGY LLC, GIG HARBOR, WA. SN 77-628,163. FILED P.R. 12-7-2008; AM. S.R. 8-3-2009.

Tactical Technology LLC

THE MARK CONSISTS OF STANDARD CHARACTERS WITHOUT CLAIM TO ANY PARTICULAR FONT, STYLE, SIZE, OR COLOR.

NO CLAIM IS MADE TO THE EXCLUSIVE RIGHT TO USE "LLC", APART FROM THE MARK AS SHOWN.

FOR BUSINESS ADVISORY SERVICES, CONSULTANCY AND INFORMATION; BUSINESS CONSULTATION AND MANAGEMENT REGARDING MARKETING ACTIVITIES AND LAUNCHING OF NEW PRODUCTS; BUSINESS CONSULTATION SERVICES; BUSINESS CONSULTING AND INFORMATION SERVICES; BUSINESS CONSULTING SERVICES, NAMELY, PROVIDING ASSISTANCE IN DEVELOPMENT OF BUSINESS STRATEGIES AND CREATIVE IDEATION; BUSINESS MANAGEMENT AND CONSULTATION; BUSINESS MANAGEMENT AND CONSULTATION IN THE FIELD OF FIREARMS, LAW ENFORCEMENT AND MILITARY TACTICS AND EMERGENCY MEDICINE; BUSINESS MANAGEMENT CONSULTANCY AND ADVISORY SERVICES; BUSINESS MANAGEMENT CONSULTATION IN THE FIELD OF EXECUTIVE AND LEADERSHIP DEVELOPMENT; BUSINESS ORGANIZATION CONSULTING; BUSINESS RESEARCH CONSULTATION (U.S. CLS. 100, 101 AND 102).

FIRST USE 0-0-2007; IN COMMERCE 0-0-2007.

3,681,767. D&N IPROPERTIES LLC, ALTAMONTE SPRINGS, FL. SN 77-683,177. FILED P.R. 3-4-2009; AM. S.R. 7-24-2009.

CIRCULAR MARKETING

THE MARK CONSISTS OF STANDARD CHARACTERS WITHOUT CLAIM TO ANY PARTICULAR FONT, STYLE, SIZE, OR COLOR.

NO CLAIM IS MADE TO THE EXCLUSIVE RIGHT TO USE "MARKETING", APART FROM THE MARK AS SHOWN.

FOR ONLINE BUSINESS MARKETING CONSULTATION (U.S. CLS. 100, 101 AND 102).

FIRST USE 1-2-2009; IN COMMERCE 2-9-2009.

CLASS 35—(Continued).

3,681,802. BALTIMORE CONFECTIONS, LLC, OLNEY, MD. SN 77-726,528. FILED 4-30-2009.

BALTIMORE CONFECTIONS

THE MARK CONSISTS OF STANDARD CHARACTERS WITHOUT CLAIM TO ANY PARTICULAR FONT, STYLE, SIZE, OR COLOR.

NO CLAIM IS MADE TO THE EXCLUSIVE RIGHT TO USE "CONFECTIONS", APART FROM THE MARK AS SHOWN.

FOR ON-LINE ORDERING SERVICES FEATURING BAKERY GOODS (U.S. CLS. 100, 101 AND 102).

FIRST USE 8-1-2008; IN COMMERCE 8-1-2008.

3,681,806. FLASH DIRECT & MEMORY SOLUTIONS LLC, LAKE FOREST, CA. SN 77-761,310. FILED 6-16-2009.

Flash Direct

THE MARK CONSISTS OF STANDARD CHARACTERS WITHOUT CLAIM TO ANY PARTICULAR FONT, STYLE, SIZE, OR COLOR.

FOR WHOLESALE DISTRIBUTORSHIPS FEATURING PRINTED USB FLASH DRIVES (U.S. CLS. 100, 101 AND 102).

FIRST USE 8-28-2008; IN COMMERCE 9-26-2008.

CLASS 36—INSURANCE AND FINANCIAL

3,681,649. RADIATION ONCOLOGY INSTITUTE, FAIRFAX, VA. SN 77-254,889. FILED P.R. 8-14-2007; AM. S.R. 7-9-2009.

RADIATION ONCOLOGY INSTITUTE

THE MARK CONSISTS OF STANDARD CHARACTERS WITHOUT CLAIM TO ANY PARTICULAR FONT, STYLE, SIZE, OR COLOR.

NO CLAIM IS MADE TO THE EXCLUSIVE RIGHT TO USE "INSTITUTE", APART FROM THE MARK AS SHOWN.

FOR CHARITABLE FUND RAISING; PROVIDING GRANTS IN THE FIELD OF CANCER RESEARCH; ACCEPTING AND ADMINISTERING MONETARY CHARITABLE CONTRIBUTIONS (U.S. CLS. 100, 101 AND 102).

FIRST USE 8-0-2008; IN COMMERCE 8-0-2008.

CLASS 36—(Continued).

3,681,731. GUESTLOGIX INC., TORONTO, CANADA. SN 77-598,215. FILED P.R. 10-22-2008; AM. S.R. 7-8-2009.

IN-FLIGHT BOX OFFICE

THE MARK CONSISTS OF STANDARD CHARACTERS WITHOUT CLAIM TO ANY PARTICULAR FONT, STYLE, SIZE, OR COLOR.

FOR FINANCIAL TRANSACTION SERVICES, NAMELY, PROVIDING SECURE COMMERCIAL TRANSACTIONS AND PAYMENT OPTIONS USING A MOBILE DEVICE AT A POINT OF SALE (U.S. CLS. 100, 101 AND 102).

FIRST USE 7-1-2009; IN COMMERCE 7-1-2009.

3,681,735. SIMASKO, PATRICK M., MOUNT CLEMENS, MI. SN 77-604,781. FILED P.R. 10-31-2008; AM. S.R. 7-30-2009.

VETERANS ASSISTANCE ASSOCIATION

THE MARK CONSISTS OF STANDARD CHARACTERS WITHOUT CLAIM TO ANY PARTICULAR FONT, STYLE, SIZE, OR COLOR.

NO CLAIM IS MADE TO THE EXCLUSIVE RIGHT TO USE "ASSOCIATION", APART FROM THE MARK AS SHOWN.

FOR FINANCIAL SERVICES, NAMELY, ESTATE PLANNING, FINANCIAL MANAGEMENT, PORTFOLIO MANAGEMENT, MEDICAID PLANNING, BENEFITS COUNSELING, VETERAN BENEFITS CONSULTING AND FINANCIAL COUNSELING SERVICES (U.S. CLS. 100, 101 AND 102).

FIRST USE 10-31-2008; IN COMMERCE 10-31-2008.

3,681,742. REAL ESTATE PRESS, LLC., OCALA, FL. SN 77-619,838. FILED P.R. 11-21-2008; AM. S.R. 7-22-2009.

Housing Alerts

THE MARK CONSISTS OF STANDARD CHARACTERS WITHOUT CLAIM TO ANY PARTICULAR FONT, STYLE, SIZE, OR COLOR.

FOR PROVIDING INFORMATION IN THE FIELD OF REAL ESTATE VIA THE INTERNET (U.S. CLS. 100, 101 AND 102).

FIRST USE 7-10-2006; IN COMMERCE 7-10-2006.

CLASS 36—(Continued).

3,681,743. REAL ESTATE PRESS, LLC., OCALA, FL. SN 77-620,330. FILED P.R. 11-23-2008; AM. S.R. 7-22-2009.

Automatic Appreciation

THE MARK CONSISTS OF STANDARD CHARACTERS WITHOUT CLAIM TO ANY PARTICULAR FONT, STYLE, SIZE, OR COLOR.

NO CLAIM IS MADE TO THE EXCLUSIVE RIGHT TO USE "APPRECIATION", APART FROM THE MARK AS SHOWN.

FOR PROVIDING INFORMATION IN THE FIELD OF REAL ESTATE VIA THE INTERNET (U.S. CLS. 100, 101 AND 102).

FIRST USE 7-10-2006; IN COMMERCE 7-10-2006.

3,681,749. CASH ZONE OHIO, DBA CASH BIZ, CINCINNATI, OH. AND CASH ZONE, DBA CASH BIZ, CINCINNATI, OH. AND CASH ZONE, DBA CASH BIZ, CINCINNATI, OH. SN 77-654,321. FILED P.R. 1-22-2009; AM. S.R. 7-30-2009.

CASH BIZ

THE MARK CONSISTS OF STANDARD CHARACTERS WITHOUT CLAIM TO ANY PARTICULAR FONT, STYLE, SIZE, OR COLOR.

NO CLAIM IS MADE TO THE EXCLUSIVE RIGHT TO USE "CASH", APART FROM THE MARK AS SHOWN.

FOR FINANCIAL SERVICES, NAMELY, MONEY LENDING (U.S. CLS. 100, 101 AND 102).

FIRST USE 2-2-2009; IN COMMERCE 2-2-2009.

3,681,751. AMAXX RISK SOLUTIONS INC, MANSFIELD CENTER, CT. SN 77-654,721. FILED P.R. 1-22-2009; AM. S.R. 6-23-2009.

WORKERS' COMPENSATION TOOL KIT

THE MARK CONSISTS OF STANDARD CHARACTERS WITHOUT CLAIM TO ANY PARTICULAR FONT, STYLE, SIZE, OR COLOR.

OWNER OF U.S. REG. NOS. 3,332,923 AND 3,433,542. FOR PROVIDING INFORMATION IN THE FIELD OF WORKERS' COMPENSATION (U.S. CLS. 100, 101 AND 102).

FIRST USE 11-14-2008; IN COMMERCE 1-21-2009.

CLASS 36—(Continued).

3,681,752. AMAXX RISK SOLUTIONS INC, MANSFIELD CENTER, CT. SN 77-654,809. FILED P.R. 1-22-2009; AM. S.R. 6-23-2009.

NATIONAL WORKERS'
COMPENSATION MANAGEMENT
SCORE

THE MARK CONSISTS OF STANDARD CHARACTERS WITHOUT CLAIM TO ANY PARTICULAR FONT, STYLE, SIZE, OR COLOR.

FOR PROVIDING INFORMATION IN THE FIELD OF WORKERS' COMPENSATION (U.S. CLS. 100, 101 AND 102).

FIRST USE 11-17-2008; IN COMMERCE 1-22-2009.

3,681,755. RETIREE INC., LEAWOOD, KS. SN 77-661,690. FILED P.R. 2-2-2009; AM. S.R. 7-28-2009.

Retiree Inc.

THE MARK CONSISTS OF STANDARD CHARACTERS WITHOUT CLAIM TO ANY PARTICULAR FONT, STYLE, SIZE, OR COLOR.

NO CLAIM IS MADE TO THE EXCLUSIVE RIGHT TO USE "INC.", APART FROM THE MARK AS SHOWN.

FOR FINANCIAL ADVISORY AND CONSULTANCY SERVICES; PROVIDING A WEB SITE THAT ASSISTS FINANCIAL PROFESSIONALS IN THE MANAGEMENT OF RETIREMENT ACCOUNTS; PROVIDING INFORMATION AND ADVICE IN THE FIELD OF FINANCE, FINANCIAL INVESTMENTS, FINANCIAL VALUATIONS, AND THE FINANCIAL ASPECTS OF RETIREMENT (U.S. CLS. 100, 101 AND 102).

FIRST USE 11-6-2008; IN COMMERCE 11-6-2008.

3,681,756. RETIREMENT BENCHMARK LLC, LEAWOOD, KS. SN 77-661,703. FILED P.R. 2-2-2009; AM. S.R. 7-28-2009.

Income Director

THE MARK CONSISTS OF STANDARD CHARACTERS WITHOUT CLAIM TO ANY PARTICULAR FONT, STYLE, SIZE, OR COLOR.

FOR FINANCIAL PLANNING AND INVESTMENT ADVISORY SERVICES (U.S. CLS. 100, 101 AND 102).

FIRST USE 11-6-2008; IN COMMERCE 11-6-2008.

CLASS 36—(Continued).

3,681,771. ALEXANDER HAAS MARTIN, INC., ATLANTA, GA. SN 77-700,146. FILED P.R. 3-26-2009; AM. S.R. 7-27-2009.

America's Most Effective Fundraising Counsel

THE MARK CONSISTS OF STANDARD CHARACTERS WITHOUT CLAIM TO ANY PARTICULAR FONT, STYLE, SIZE, OR COLOR.

NO CLAIM IS MADE TO THE EXCLUSIVE RIGHT TO USE "FUNDRAISING COUNSEL", APART FROM THE MARK AS SHOWN.

FOR FINANCIAL CONSULTATION IN THE FIELD OF FUNDRAISING CONSULTING SERVICES FOR NON PROFIT AND CHARITABLE ORGANIZATIONS (U.S. CLS. 100, 101 AND 102).

FIRST USE 2-1-2009; IN COMMERCE 2-1-2009.

3,681,790. CARUSO, PAUL, NORTH LAS VEGAS, NV. SN 77-722,912. FILED P.R. 4-27-2009; AM. S.R. 7-22-2009.

BAIL BONDS OF LAS VEGAS

THE MARK CONSISTS OF STANDARD CHARACTERS WITHOUT CLAIM TO ANY PARTICULAR FONT, STYLE, SIZE, OR COLOR.

NO CLAIM IS MADE TO THE EXCLUSIVE RIGHT TO USE "BAIL BONDS", APART FROM THE MARK AS SHOWN.

FOR BAIL BONDING (U.S. CLS. 100, 101 AND 102).

FIRST USE 12-0-1999; IN COMMERCE 12-0-1999.

CLASS 37—CONSTRUCTION AND REPAIR

3,681,644. BARNETT ENTERPRISES CORP., LAKEWOOD, CO. SN 76-694,443. FILED P.R. 11-24-2008; AM. S.R. 7-30-2009.

THE WORLD'S GREENEST CARPET CLEANER

THE MARK CONSISTS OF STANDARD CHARACTERS WITHOUT CLAIM TO ANY PARTICULAR FONT, STYLE, SIZE, OR COLOR.

NO CLAIM IS MADE TO THE EXCLUSIVE RIGHT TO USE "CARPET CLEANER", APART FROM THE MARK AS SHOWN.

FOR CARPET, RUG, AND AIR DUCT CLEANING (U.S. CLS. 100, 103 AND 106).

FIRST USE 10-15-2008; IN COMMERCE 10-15-2008.

CLASS 37—(Continued).

3,681,726. P.H.E., INC., DBA MCCARTHY'S ONE HOUR HEATING & AIR CONDITIONING, BENJAMIN FRANKLIN PLUMBING, & MISTER SPARKY, OMAHA, NE. SN 77-595,082. FILED P.R. 10-17-2008; AM. S.R. 7-23-2009.

Your On Time Service Company

THE MARK CONSISTS OF STANDARD CHARACTERS WITHOUT CLAIM TO ANY PARTICULAR FONT, STYLE, SIZE, OR COLOR.

FOR ELECTRICAL CONTRACTING; INSTALLATION AND REPAIR OF AIR CONDITIONING APPARATUS; INSTALLATION, REPAIR AND MAINTENANCE OF HEATING EQUIPMENT; PLUMBING AND GAS AND WATER INSTALLATION (U.S. CLS. 100, 103 AND 106).
FIRST USE 12-1-2007; IN COMMERCE 12-1-2007.

CLASS 39—TRANSPORTATION AND STORAGE

3,681,722. THE STATE OF CONNECTICUT, DEPARTMENT OF TRANSPORTATION, NEWINGTON, CT. SN 77-593,871. FILED P.R. 10-16-2008; AM. S.R. 7-16-2009.

CONNECTICUT COMMUTER SERVICES

THE MARK CONSISTS OF STANDARD CHARACTERS WITHOUT CLAIM TO ANY PARTICULAR FONT, STYLE, SIZE, OR COLOR.

NO CLAIM IS MADE TO THE EXCLUSIVE RIGHT TO USE "COMMUTER SERVICES", APART FROM THE MARK AS SHOWN.

FOR TRANSPORTATION SERVICES, NAMELY, TRANSPORTATION OF PASSENGERS BY GROUND AND RAIL; PROVIDING INFORMATION TO THE PUBLIC AND EMPLOYERS REGARDING TRANSPORTATION INTO AND OUT OF THE STATE OF CONNECTICUT, NAMELY, INFORMATION REGARDING VANPOOLS, CARPOOLS, RIDE SHARING AND SHUTTLE SERVICES AND PARK AND RIDE LOCATIONS, DAILY TRAFFIC AND ROAD CONSTRUCTION, AND TRAIN, BUS AND FERRY TRANSIT SCHEDULES (U.S. CLS. 100 AND 105).

FIRST USE 9-12-2008; IN COMMERCE 9-12-2008.

CLASS 39—(Continued).

3,681,730. MANNA FREIGHT SYSTEMS, INC., MENDOTA HEIGHTS, MN. SN 77-597,432. FILED P.R. 10-21-2008; AM. S.R. 7-17-2009.

ScheduleMyDelivery.com

THE MARK CONSISTS OF STANDARD CHARACTERS WITHOUT CLAIM TO ANY PARTICULAR FONT, STYLE, SIZE, OR COLOR.

FOR FREIGHT TRANSPORTATION OF GOODS BY AIR, TRAIN, OR TRUCK (U.S. CLS. 100 AND 105).
FIRST USE 5-1-2008; IN COMMERCE 5-1-2008.

CLASS 40—MATERIAL TREATMENT

3,681,804. GLASS ART IMAGING, LLC, GREER, SC. SN 77-726,972. FILED P.R. 5-1-2009; AM. S.R. 7-28-2009.

GLASS ART

THE MARK CONSISTS OF STANDARD CHARACTERS WITHOUT CLAIM TO ANY PARTICULAR FONT, STYLE, SIZE, OR COLOR.

FOR LASER IMAGING SERVICES FEATURING LASER IMAGING ON GRANITE PROTECTED WITH GLASS SEALER FOR MONUMENTS AND MEMORIALS (U.S. CLS. 100, 103 AND 106).

FIRST USE 12-1-2005; IN COMMERCE 12-7-2005.

CLASS 41—EDUCATION AND ENTERTAINMENT

3,681,655. GALKIN, KATHLEEN, ASHBURN, VA. SN 77-397,700. FILED P.R. 2-14-2008; AM. S.R. 7-3-2008.

MOMMY BOOTCAMP

THE MARK CONSISTS OF STANDARD CHARACTERS WITHOUT CLAIM TO ANY PARTICULAR FONT, STYLE, SIZE, OR COLOR.

NO CLAIM IS MADE TO THE EXCLUSIVE RIGHT TO USE "BOOTCAMP", APART FROM THE MARK AS SHOWN. FOR EDUCATIONAL SERVICES, NAMELY, CONDUCTING CLASSES IN THE FIELD OF EXERCISE FOR MOTHERS (U.S. CLS. 100, 101 AND 107).

FIRST USE 3-1-2008; IN COMMERCE 3-1-2008.

CLASS 41—(Continued).

3,681,663. HOLOGRAPHIC HEALTH, INC., WAYNESVILLE, NC. SN 77-419,988. FILED P.R. 3-12-2008; AM. S.R. 7-20-2009.

HOLOTHERAPY

THE MARK CONSISTS OF STANDARD CHARACTERS WITHOUT CLAIM TO ANY PARTICULAR FONT, STYLE, SIZE, OR COLOR.

OWNER OF U.S. REG. NOS. 2,077,057 AND 3,515,785.
FOR CONDUCTING SEMINARS AND WORKSHOPS CONCERNING HOLISTIC HEALTH CARE (U.S. CLS. 100, 101 AND 107).

FIRST USE 4-0-2005; IN COMMERCE 4-0-2005.

3,681,668. CONTINUUM WORLDWIDE CORPORATION, OMAHA, NE. SN 77-429,434. FILED P.R. 3-24-2008; AM. S.R. 7-20-2009.

NATIONAL ASSOCIATION
OPERATIONAL RISK MANAGEMENT

THE MARK CONSISTS OF STANDARD CHARACTERS WITHOUT CLAIM TO ANY PARTICULAR FONT, STYLE, SIZE, OR COLOR.

FOR EDUCATIONAL SERVICES, NAMELY, DEVELOPING AND CONDUCTING COURSES, CONFERENCES, CLASSES, SEMINARS, AND WORKSHOPS IN THE FIELD OF ORGANIZATIONAL RISK MANAGEMENT AND DISTRIBUTION OF EDUCATIONAL MATERIALS AND PUBLICATIONS IN CONNECTION THEREWITH; AND EDUCATIONAL TESTING, NAMELY, TESTING AND EVALUATING PROFESSIONALS TO DETERMINE THEIR LEVEL OF EDUCATION IN THE FIELD OF ORGANIZATIONAL RISK MANAGEMENT (U.S. CLS. 100, 101 AND 107).

FIRST USE 7-16-2009; IN COMMERCE 7-16-2009.

CLASS 41—(Continued).

3,681,676. RONDEAU, PAUL ERIC, WATERFORD, VA. SN 77-465,134. FILED P.R. 5-3-2008; AM. S.R. 2-20-2009.

Citizen College

THE MARK CONSISTS OF STANDARD CHARACTERS WITHOUT CLAIM TO ANY PARTICULAR FONT, STYLE, SIZE, OR COLOR.

NO CLAIM IS MADE TO THE EXCLUSIVE RIGHT TO USE "COLLEGE", APART FROM THE MARK AS SHOWN.

FOR EDUCATION SERVICES, NAMELY, PROVIDING LIVE AND ON-LINE CLASSES, AND WORKSHOPS IN THE FIELD OF PERSONAL SKILLS IN EXERCISING FAITH, FAMILY, AND FREEDOM AS CITIZENS IN A DEMOCRATIC SOCIETY, AND PRINTABLE MATERIALS DISTRIBUTED THEREWITH; EDUCATIONAL AND ENTERTAINMENT SERVICES, NAMELY, A CONTINUING PROGRAM ABOUT PERSONAL SKILLS IN EXERCISING FAITH, FAMILY, AND FREEDOM AS CITIZENS IN DEMOCRATIC SOCIETY ACCESSIBLE BY RADIO, TELEVISION, SATELLITE, AUDIO, VIDEO AND COMPUTER NETWORKS; EDUCATIONAL SERVICES, NAMELY, CONDUCTING INFORMAL ON-LINE PROGRAMS IN THE FIELDS OF FAMILY MANAGEMENT AND CITIZEN SKILLS, AND PRINTABLE MATERIALS DISTRIBUTED THEREWITH; EDUCATIONAL SERVICES, NAMELY, CONDUCTING SEMINARS, LECTURES, TELESEMINARS, TELECLASSES, AND WORKSHOPS IN PERSONAL AWARENESS; EDUCATIONAL SERVICES, NAMELY, DEVELOPING, ARRANGING, AND CONDUCTING EDUCATIONAL CONFERENCES AND PROGRAMS AND PROVIDING COURSES OF INSTRUCTION IN THE FIELD OF SKILLS TO BE ACTIVE IN THE DEMOCRATIC PROCESS, COMMUNITY INVOLVEMENT, PERSONAL AND FAMILY MANAGEMENT; ORGANIZATION OF EXHIBITIONS FOR CULTURAL OR EDUCATIONAL PURPOSES (U.S. CLS. 100, 101 AND 107).

FIRST USE 11-1-2008; IN COMMERCE 11-1-2008.

3,681,693. VATTEROTT EDUCATIONAL CENTERS, INC., BERKELEY, MO. SN 77-545,780. FILED P.R. 8-13-2008; AM. S.R. 7-1-2009.

SALON COSMETIQUE

THE MARK CONSISTS OF STANDARD CHARACTERS WITHOUT CLAIM TO ANY PARTICULAR FONT, STYLE, SIZE, OR COLOR.

THE ENGLISH TRANSLATION OF "SALON COSMETIQUE" IN THE MARK IS COSMETIC SALON.

FOR EDUCATIONAL SERVICES, NAMELY, CONDUCTING PROFESSIONAL TRAINING IN THE FIELD OF BEAUTY TREATMENT (U.S. CLS. 100, 101 AND 107).

FIRST USE 7-0-2008; IN COMMERCE 7-0-2008.

CLASS 41—(Continued).

3,681,704. ANN MCGEE-COOPER AND ASSOCIATES, INC., DALLAS, TX. SN 77-577,956. FILED P.R. 9-24-2008; AM. S.R. 7-2-2009.

SERVANT LEADERSHIP LEARNING COMMUNITY

THE MARK CONSISTS OF STANDARD CHARACTERS WITHOUT CLAIM TO ANY PARTICULAR FONT, STYLE, SIZE, OR COLOR.

FOR PROVIDING GROUP COACHING AND LEARNING FORUMS IN THE FIELD OF LEADERSHIP DEVELOPMENT (U.S. CLS. 100, 101 AND 107).

FIRST USE 0-0-2000; IN COMMERCE 0-0-2005.

3,681,710. HIGHWAY 46 HOLDINGS, LLC, LAKE MARY, FL. SN 77-585,479. FILED P.R. 10-3-2008; AM. S.R. 7-9-2009.

BACK STAGE AT ROUTE 46

THE MARK CONSISTS OF STANDARD CHARACTERS WITHOUT CLAIM TO ANY PARTICULAR FONT, STYLE, SIZE, OR COLOR.

FOR ENTERTAINMENT SERVICES, NAMELY, ARRANGING AND CONDUCTING CONCERTS AND EVENTS AT OUTDOOR VENUES (U.S. CLS. 100, 101 AND 107).

FIRST USE 10-24-2008; IN COMMERCE 10-24-2008.

3,681,713. SEVEN-STAR, INC., ASHEVILLE, NC. SN 77-587,552. FILED 10-7-2008.

Green Cities

THE MARK CONSISTS OF STANDARD CHARACTERS WITHOUT CLAIM TO ANY PARTICULAR FONT, STYLE, SIZE, OR COLOR.

FOR ARRANGING AND CONDUCTING EDUCATIONAL CONFERENCES; CONDUCTING WORKSHOPS AND SEMINARS IN SUSTAINABILITY; EDUCATIONAL SERVICES, NAMELY, DEVELOPING, ARRANGING, AND CONDUCTING EDUCATIONAL CONFERENCES AND PROGRAMS AND PROVIDING COURSES OF INSTRUCTION IN THE FIELD OF SUSTAINABILITY; WORKSHOPS AND SEMINARS IN THE FIELD OF SUSTAINABILITY (U.S. CLS. 100, 101 AND 107).

FIRST USE 1-5-2005; IN COMMERCE 1-5-2005.

CLASS 41—(Continued).

3,681,727. RACING SPEED ASSOCIATES, LLC, DAYTONA, FL. SN 77-596,439. FILED P.R. 10-20-2008; AM. S.R. 7-27-2009.

America's Premier Short Track Series

THE MARK CONSISTS OF STANDARD CHARACTERS WITHOUT CLAIM TO ANY PARTICULAR FONT, STYLE, SIZE, OR COLOR.

NO CLAIM IS MADE TO THE EXCLUSIVE RIGHT TO USE "SHORT TRACK SERIES", APART FROM THE MARK AS SHOWN.

FOR ENTERTAINMENT SERVICES, NAMELY, ORGANIZING, PRESENTING AND SANCTIONING AUTOMOBILE RACES (U.S. CLS. 100, 101 AND 107).

FIRST USE 9-3-2008; IN COMMERCE 9-3-2008.

3,681,737. SANDBERG LTD, PINEHURST, NC. SN 77-604,850. FILED P.R. 10-31-2008; AM. S.R. 7-25-2009.

InstantAnswers

THE MARK CONSISTS OF STANDARD CHARACTERS WITHOUT CLAIM TO ANY PARTICULAR FONT, STYLE, SIZE, OR COLOR.

FOR PROVIDING A WEB SITE FEATURING EDUCATIONAL INSTRUCTIONS ABOUT LEARNING HOW TO USE YOUR PERSONAL COMPUTER PROGRAMS (U.S. CLS. 100, 101 AND 107).

FIRST USE 3-1-2009; IN COMMERCE 3-10-2009.

3,681,739. UNIVERSITY OF WASHINGTON, SEATTLE, WA. SN 77-612,356. FILED P.R. 11-11-2008; AM. S.R. 7-27-2009.

INSTITUTE FOR SIMULATION AND INTERPROFESSIONAL STUDIES

THE MARK CONSISTS OF STANDARD CHARACTERS WITHOUT CLAIM TO ANY PARTICULAR FONT, STYLE, SIZE, OR COLOR.

NO CLAIM IS MADE TO THE EXCLUSIVE RIGHT TO USE "INSTITUTE", APART FROM THE MARK AS SHOWN. FOR EDUCATION SERVICES, NAMELY, CLASSES, SEMINARS AND WORKSHOPS, AND TRAINING SERVICES IN THE FIELD OF MEDICAL SIMULATION TECHNOLOGY TO IMPROVE HEALTH CARE EDUCATION (U.S. CLS. 100, 101 AND 107).

FIRST USE 9-29-2008; IN COMMERCE 9-29-2008.

CLASS 41—(Continued).

3,681,741. PAVE TECH, INC., PRIOR LAKE, MN. SN 77-618,439. FILED P.R. 11-20-2008; AM. S.R. 2-13-2009.

HARDSCAPE OUTFITTERS

THE MARK CONSISTS OF STANDARD CHARACTERS WITHOUT CLAIM TO ANY PARTICULAR FONT, STYLE, SIZE, OR COLOR.

OWNER OF U.S. REG. NO. 3,568,762.

FOR EDUCATION SERVICES, NAMELY, CLASSES OFFERED TO RETAIL DEALERS IN THE SEGMENTAL PAVING AND WALL BLOCK INDUSTRIES, IN THE FIELD OF THE USE AND MARKETING OF SEGMENTAL PAVING AND WALL BLOCK PRODUCTS AND SERVICES, AND DISTRIBUTION OF COURSE MATERIALS IN CONNECTION THEREWITH (U.S. CLS. 100, 101 AND 107).

FIRST USE 8-21-2008; IN COMMERCE 8-21-2008.

CLASS 41—(Continued).

3,681,747. NATIONAL EHEALTH COLLABORATIVE, INC., ALEXANDRIA, VA. SN 77-644,976. FILED P.R. 1-7-2009; AM. S.R. 6-19-2009.

**NATIONAL EHEALTH
COLLABORATIVE**

THE MARK CONSISTS OF STANDARD CHARACTERS WITHOUT CLAIM TO ANY PARTICULAR FONT, STYLE, SIZE, OR COLOR.

FOR PROMOTING PUBLIC AWARENESS IN THE FIELD OF ELECTRONIC HEALTH RECORDS AND NATIONWIDE SHARING OF ELECTRONIC HEALTH RECORDS; DEVELOPMENT OF VOLUNTARY STANDARDS FOR ELECTRONIC HEALTH RECORDS; ACCREDITATION SERVICES, NAMELY, SETTING AND PROVIDING STANDARDS FOR NATIONWIDE SHARING OF ELECTRONIC HEALTH RECORDS; AND PROVIDING INFORMATION IN THE FIELD OF ELECTRONIC HEALTH RECORDS AND NATIONWIDE SHARING OF ELECTRONIC HEALTH RECORDS (U.S. CLS. 100, 101 AND 107).

FIRST USE 1-0-2009; IN COMMERCE 1-0-2009.

3,681,772. SEEKING CONSULTANTS, INC., JAMAICA, NY. SN 77-701,285. FILED P.R. 3-27-2009; AM. S.R. 7-2-2009.

**Emotionally Intelligent
Weight Loss**

THE MARK CONSISTS OF STANDARD CHARACTERS WITHOUT CLAIM TO ANY PARTICULAR FONT, STYLE, SIZE, OR COLOR.

NO CLAIM IS MADE TO THE EXCLUSIVE RIGHT TO USE "WEIGHT LOSS", APART FROM THE MARK AS SHOWN.

FOR EDUCATION SERVICES, NAMELY, PROVIDING CLASSES, SEMINARS, WORKSHOPS AND ONLINE SEMINARS IN THE FIELD OF WEIGHT LOSS AND DISTRIBUTION OF COURSE MATERIAL IN CONNECTION THEREWITH (U.S. CLS. 100, 101 AND 107).

FIRST USE 1-16-2009; IN COMMERCE 1-16-2009.

3,681,746. MILLER, INGRID, IRVINE, CA. SN 77-643,955. FILED P.R. 1-6-2009; AM. S.R. 7-6-2009.

IRONPLANNER

THE MARK CONSISTS OF STANDARD CHARACTERS WITHOUT CLAIM TO ANY PARTICULAR FONT, STYLE, SIZE, OR COLOR.

FOR PROVIDING PERSONAL AND ONLINE TRAINING, COACHING, AND CONSULTING SERVICES TO TRIATHLETES IN THE FIELD OF TRIATHLONS (U.S. CLS. 100, 101 AND 107).

FIRST USE 4-30-2008; IN COMMERCE 10-0-2008.

3,681,773. 10TH ILLINOIS VOLUNTEER CAVALRY REGIMENT NFP, LOWPOINT, IL. SN 77-702,374. FILED P.R. 3-30-2009; AM. S.R. 6-26-2009.

**10th Illinois Volunteer
Cavalry Regiment**

THE MARK CONSISTS OF STANDARD CHARACTERS WITHOUT CLAIM TO ANY PARTICULAR FONT, STYLE,

CLASS 41—(Continued).

SIZE, OR COLOR.

NO CLAIM IS MADE TO THE EXCLUSIVE RIGHT TO USE "ILLINOIS", APART FROM THE MARK AS SHOWN.

FOR ENTERTAINMENT IN THE NATURE OF CIVIL WAR RE-ENACTMENTS FEATURING VISUAL AND AUDIO PERFORMANCES, AND MUSICAL, VARIETY, NEWS AND COMEDY SHOWS (U.S. CLS. 100, 101 AND 107).

FIRST USE 6-26-2006; IN COMMERCE 6-26-2006.

3,681,780. REAL ESTATE BUSINESS SERVICES, INC., LOS ANGELES, CA. SN 77-717,563. FILED P.R. 4-20-2009; AM. S.R. 7-31-2009.

FORMS TUTOR

THE MARK CONSISTS OF STANDARD CHARACTERS WITHOUT CLAIM TO ANY PARTICULAR FONT, STYLE, SIZE, OR COLOR.

NO CLAIM IS MADE TO THE EXCLUSIVE RIGHT TO USE "TUTOR", APART FROM THE MARK AS SHOWN.

FOR EDUCATIONAL SERVICES, NAMELY, ONLINE TRAINING SERVICES IN THE USE AND COMPLETION OF FORMS IN THE FIELD OF REAL ESTATE (U.S. CLS. 100, 101 AND 107).

FIRST USE 4-1-2008; IN COMMERCE 4-1-2008.

3,681,781. ALABAMA BASS BUDDY TRAIL, FORT PAYNE, AL. SN 77-718,456. FILED P.R. 4-21-2009; AM. S.R. 4-21-2009.



NO CLAIM IS MADE TO THE EXCLUSIVE RIGHT TO USE "BASS BUDDY TRAIL", APART FROM THE MARK AS SHOWN.

THE MARK CONSISTS OF THE STYLIZED WORDS "ALABAMA BASS BUDDY TRAIL WEISS LOGAN MARTIN NEELY HENRY GUNTERSVILLE". AN IMAGE OF FOUR LAKES BELOW.

FOR ENTERTAINMENT IN THE NATURE OF FISHING TOURNAMENTS (U.S. CLS. 100, 101 AND 107).

FIRST USE 11-1-2008; IN COMMERCE 11-1-2008.

CLASS 41—(Continued).

3,681,797. BICKMORE & ASSOCIATES, INC., DBA BICKMORE RISK SERVICES, SACRAMENTO, CA. SN 77-725,794. FILED P.R. 4-30-2009; AM. S.R. 7-28-2009.

THE MARK CONSISTS OF THE WORDING "RMUNIVERSITY" WITH "UNIVERSITY" IN ITALICS.

FOR EDUCATION SERVICES, NAMELY, PROVIDING ONLINE CLASSES IN THE FIELD OF RISK MANAGEMENT (U.S. CLS. 100, 101 AND 107).

FIRST USE 9-1-2007; IN COMMERCE 9-1-2007.

3,681,805. THE SALVATION ARMY, LONG BEACH, CA. SN 77-730,497. FILED P.R. 5-6-2009; AM. S.R. 7-21-2009.

Future Officers Fellowship

THE MARK CONSISTS OF STANDARD CHARACTERS WITHOUT CLAIM TO ANY PARTICULAR FONT, STYLE, SIZE, OR COLOR.

FOR RELIGIOUS AND CHARITABLE EDUCATIONAL SERVICES, NAMELY, CONDUCTING SOCIAL AND EDUCATIONAL PROGRAMS, NAMELY, CONFERENCES, CLASSES, WORKSHOPS AND MENTORING FOR FUTURE OFFICERS OF THE SALVATION ARMY IN THE FIELDS OF SPIRITUAL, MENTAL, AND SOCIAL GROWTH, LEADERSHIP AND OFFICER TRAINING (U.S. CLS. 100, 101 AND 107).

FIRST USE 11-9-2007; IN COMMERCE 11-9-2007.

CLASS 42—SCIENTIFIC AND COMPUTER SERVICES

3,681,651. CENTRAL DYNAMICS CORP., DBA CENDYN, BOCA RATON, FL. SN 77-299,974. FILED P.R. 10-9-2007; AM. S.R. 8-4-2009.

THE COLOR(S) ORANGE AND BLUE IS/ARE CLAIMED AS A FEATURE OF THE MARK.

THE MARK CONSISTS OF A STYLIZED, CURSIVE ORANGE LETTER "E" IN FRONT OF THE WORD "POSTCARD" - WHICH IS IN THE COLOR BLUE.

FOR APPLICATION SERVICE PROVIDER FEATURING SOFTWARE FOR CREATING MARKETING TOOLS IN THE NATURE OF ELECTRONIC POSTCARDS AND ONLINE PHOTO GALLERIES FOR USE BY HOTELS (U.S. CLS. 100 AND 101).

FIRST USE 9-28-2004; IN COMMERCE 9-28-2004.

CLASS 42—(Continued).

3,681,658. IE DISCOVERY, INC., AUSTIN, TX. SN 77-403,444.
FILED P.R. 2-22-2008; AM. S.R. 6-29-2009.

AUTOREVIEW

THE MARK CONSISTS OF STANDARD CHARACTERS WITHOUT CLAIM TO ANY PARTICULAR FONT, STYLE, SIZE, OR COLOR.

FOR COMPUTER SERVICES, NAMELY, PROVIDING TECHNOLOGY IN THE NATURE OF NON-DOWNLOADABLE SOFTWARE FOR AUTOMATED REVIEW OF ELECTRONIC FILES, USED PRIMARILY FOR DOCUMENT MANAGEMENT, ELECTRONIC DOCUMENT DISCOVERY AND LITIGATION SUPPORT, ALLOWING FOR THE AUTOMATIC REVIEW AND FILTERING OF DIGITAL DATA ONLINE FROM E-MAILS, ELECTRONIC DOCUMENTS, IMAGED HARD-COPY DOCUMENTS, AND OTHER DATA (U.S. CLS. 100 AND 101).

FIRST USE 2-25-2005; IN COMMERCE 2-25-2005.

CLASS 42—(Continued).

3,681,697. MADHUKAR, GAWANDE SANDESH, STAMFORD, CT. SN 77-555,460. FILED P.R. 8-25-2008; AM. S.R. 6-11-2009.

ETL Interface Architecture

THE MARK CONSISTS OF STANDARD CHARACTERS WITHOUT CLAIM TO ANY PARTICULAR FONT, STYLE, SIZE, OR COLOR.

NO CLAIM IS MADE TO THE EXCLUSIVE RIGHT TO USE "ARCHITECTURE", APART FROM THE MARK AS SHOWN.

FOR RESEARCH, DESIGN AND DEVELOPMENT SERVICES IN THE FIELD OF COMPUTER ARCHITECTURES FOR OTHERS, NAMELY, RESEARCH, DESIGN AND DEVELOPMENT OF THE INTERACTION OF COMPUTER HARDWARE AND COMPUTER SOFTWARE SYSTEMS FOR INFORMATION STORAGE AND RETRIEVAL (U.S. CLS. 100 AND 101).

FIRST USE 12-23-2006; IN COMMERCE 12-23-2006.

3,681,728. WOMBLE CARLYLE SANDRIDGE & RICE, PLLC, WINSTON-SALEM, NC. SN 77-596,959. FILED P.R. 10-21-2008; AM. S.R. 7-29-2009.

BIPARTISAN BUSINESS ADVOCATES

THE MARK CONSISTS OF STANDARD CHARACTERS WITHOUT CLAIM TO ANY PARTICULAR FONT, STYLE, SIZE, OR COLOR.

FOR LEGAL SERVICES (U.S. CLS. 100 AND 101).

FIRST USE 1-0-2009; IN COMMERCE 1-0-2009.

3,681,670. EASY2.COM, INC., CLEVELAND, OH. SN 77-433,948. FILED P.R. 3-28-2008; AM. S.R. 7-14-2009.

MYO

THE MARK CONSISTS OF STANDARD CHARACTERS WITHOUT CLAIM TO ANY PARTICULAR FONT, STYLE, SIZE, OR COLOR.

FOR PROVIDING TEMPORARY USE OF ON-LINE NONDOWNLOADABLE SOFTWARE DEVELOPMENT TOOLS FOR THE CREATION, DISPLAY, MANAGEMENT, MONITORING AND SYNDICATION OF ONLINE AND OFFLINE PRODUCT DEMONSTRATIONS, PRODUCT INSTRUCTIONS, AND TRAINING LESSONS; PROVIDING TEMPORARY USE OF ON-LINE NON-DOWNLOADABLE SOFTWARE DEVELOPMENT TOOLS FOR THE CREATION, DISPLAY, MANAGEMENT, MONITORING AND SYNDICATION OF ONLINE AND OFFLINE PRODUCT SELECTORS AND BUYING GUIDES, AND PRODUCT IMAGES AND MEDIA (U.S. CLS. 100 AND 101).

FIRST USE 7-0-2006; IN COMMERCE 7-0-2006.

3,681,732. GREENPAGES, INC., KITTERY, ME. SN 77-600,940. FILED P.R. 10-27-2008; AM. S.R. 7-20-2009.

GREEN IT

THE MARK CONSISTS OF STANDARD CHARACTERS WITHOUT CLAIM TO ANY PARTICULAR FONT, STYLE, SIZE, OR COLOR.

NO CLAIM IS MADE TO THE EXCLUSIVE RIGHT TO USE "IT", APART FROM THE MARK AS SHOWN.

FOR INFORMATION TECHNOLOGY CONSULTATION SERVICES; COMPUTER NETWORK CONSULTATION, DESIGN AND INSTALLATION SERVICES; COMPUTER SOFTWARE DEVELOPMENT, DESIGN AND INSTALLATION SERVICES (U.S. CLS. 100 AND 101).

FIRST USE 8-30-2008; IN COMMERCE 8-30-2008.

CLASS 42—(Continued).

3,681,734. RICK CODY, DBA CODY GLOBAL CONSULTING, INC., GEORGETOWN, TX. SN 77-603,270. FILED P.R. 10-29-2008; AM. S.R. 7-16-2009.

3-Point Optimization Process

THE MARK CONSISTS OF STANDARD CHARACTERS WITHOUT CLAIM TO ANY PARTICULAR FONT, STYLE, SIZE, OR COLOR.

FOR ANALYSIS SERVICES FOR OIL FIELD EXPLORATION; TECHNOLOGY CONSULTATION IN THE FIELD OF OIL AND GAS EXPLORATION AND PRODUCTION (U.S. CLS. 100 AND 101).

FIRST USE 9-18-2008; IN COMMERCE 9-18-2008.

3,681,736. GLOBAL HEALTHCARE EXCHANGE, LLC, LOUISVILLE, CO. SN 77-604,808. FILED P.R. 10-31-2008; AM. S.R. 7-16-2009.

ONDEMAND AP

THE MARK CONSISTS OF STANDARD CHARACTERS WITHOUT CLAIM TO ANY PARTICULAR FONT, STYLE, SIZE, OR COLOR.

NO CLAIM IS MADE TO THE EXCLUSIVE RIGHT TO USE "AP", APART FROM THE MARK AS SHOWN.

FOR COMPUTER SERVICES, NAMELY, AN APPLICATION SERVICE PROVIDER FEATURING INTERACTIVE ONLINE SOFTWARE IN THE FIELD OF ACCOUNTING, AND SPECIFICALLY, FOR VIEWING, ANALYZING AND AUTOMATING WORKFLOW IN A HEALTHCARE ORGANIZATION'S ACCOUNTS PAYABLE DEPARTMENT, NAMELY, INVOICING, DISCOUNT OPTIMIZATION, CONTRACT PRICE VALIDATION, WORKFLOW MANAGEMENT, DISCREPANCY MANAGEMENT, TRACKING, AUDITING, WEB PORTALS, PAPERLESS PROCESSING AND DATA TRANSFORMATIONS INCLUDING CONVERSION TO EDI FORMATION (U.S. CLS. 100 AND 101).

FIRST USE 4-24-2009; IN COMMERCE 4-24-2009.

CLASS 42—(Continued).

3,681,776. INTERIOR SYSTEMS, INC., MILWAUKEE, WI. SN 77-714,035. FILED P.R. 4-15-2009; AM. S.R. 7-24-2009.

The Greatest Seating & Décor Company in the World

THE MARK CONSISTS OF STANDARD CHARACTERS WITHOUT CLAIM TO ANY PARTICULAR FONT, STYLE, SIZE, OR COLOR.

FOR INTERIOR DESIGN SERVICES (U.S. CLS. 100 AND 101).

FIRST USE 10-9-2007; IN COMMERCE 4-10-2008.

3,681,791. CIVIL ENGINEERING CERTIFICATION, INC., RESTON, VA. SN 77-723,093. FILED P.R. 4-27-2009; AM. S.R. 7-23-2009.

Academy of Geo-Professionals

THE MARK CONSISTS OF STANDARD CHARACTERS WITHOUT CLAIM TO ANY PARTICULAR FONT, STYLE, SIZE, OR COLOR.

NO CLAIM IS MADE TO THE EXCLUSIVE RIGHT TO USE "ACADEMY", APART FROM THE MARK AS SHOWN.

FOR TESTING, ANALYSIS, AND EVALUATION OF THE KNOWLEDGE, SKILLS AND ABILITIES OF OTHERS FOR THE PURPOSE OF CERTIFICATION IN THE FIELD OF GEOTECHNICAL ENGINEERING (U.S. CLS. 100 AND 101).

FIRST USE 11-1-2008; IN COMMERCE 11-1-2008.

3,681,796. BICKMORE & ASSOCIATES, INC., DBA BICKMORE RISK SERVICES, SACRAMENTO, CA. SN 77-725,749. FILED P.R. 4-30-2009; AM. S.R. 7-28-2009.

RMAnalytics

THE MARK CONSISTS OF THE WORDING "RMANALYTICS" WITH "ANALYTICS" IN ITALICS.

FOR PROVIDING TEMPORARY USE OF ON-LINE NON-DOWNLOADABLE SOFTWARE FOR SURVEYING AND ASSESSMENT OF RISK MANAGEMENT LEVELS WITHIN AN ORGANIZATION (U.S. CLS. 100 AND 101).

FIRST USE 9-1-2007; IN COMMERCE 9-1-2007.

CLASS 42—(Continued).

3,681,798. BICKMORE & ASSOCIATES, INC., DBA BICKMORE RISK SERVICES, SACRAMENTO, CA. SN 77-725,807. FILED P.R. 4-30-2009; AM. S.R. 7-28-2009.

RMMetrics

THE MARK CONSISTS OF THE WORDING "RMMETRICS" WITH "METRICS" IN ITALICS.

FOR PROVIDING USE OF ON-LINE NON-DOWNLOADABLE SOFTWARE FOR SURVEYING AND ASSESSMENT OF RISK MANAGEMENT LEVELS WITHIN AN ORGANIZATION (U.S. CLS. 100 AND 101).

FIRST USE 9-1-2007; IN COMMERCE 9-1-2007.

3,681,799. BICKMORE & ASSOCIATES, INC., DBA BICKMORE RISK SERVICES, SACRAMENTO, CA. SN 77-725,829. FILED P.R. 4-30-2009; AM. S.R. 7-28-2009.

RMAssessment

THE MARK CONSISTS OF THE WORDING "RMASSASSEMENT" WITH "ASSESSMENT" IN ITALICS.

FOR PROVIDING USE OF ON-LINE NON-DOWNLOADABLE SOFTWARE FOR SURVEYING AND ASSESSMENT OF RISK MANAGEMENT LEVELS WITHIN AN ORGANIZATION, AND FOR CATALOGING RISK MANAGEMENT PROTOCOLS (U.S. CLS. 100 AND 101).

FIRST USE 9-1-2007; IN COMMERCE 9-1-2007.

3,681,800. BICKMORE & ASSOCIATES, INC., DBA BICKMORE RISK SERVICES, SACRAMENTO, CA. SN 77-725,838. FILED P.R. 4-30-2009; AM. S.R. 7-28-2009.

RMSurvey

THE MARK CONSISTS OF THE WORDING "RMSURVEY" WITH "SURVEY" IN ITALICS.

FOR PROVIDING TEMPORARY USE OF ON-LINE NON-DOWNLOADABLE SOFTWARE FOR SURVEYING AND ASSESSMENT OF RISK MANAGEMENT LEVELS WITHIN AN ORGANIZATION (U.S. CLS. 100 AND 101).

FIRST USE 9-1-2007; IN COMMERCE 9-1-2007.

CLASS 42—(Continued).

3,681,801. BICKMORE & ASSOCIATES, INC., DBA BICKMORE RISK SERVICES, SACRAMENTO, CA. SN 77-725,851. FILED P.R. 4-30-2009; AM. S.R. 7-28-2009.

RMPerformance

THE MARK CONSISTS OF THE WORDING "RMPERFORMANCE" WITH "PERFORMANCE" IN ITALICS.

FOR PROVIDING USE OF ON-LINE NON-DOWNLOADABLE SOFTWARE FOR SURVEYING AND ASSESSMENT OF RISK MANAGEMENT LEVELS WITHIN AN ORGANIZATION (U.S. CLS. 100 AND 101).

FIRST USE 9-1-2007; IN COMMERCE 9-1-2007.

CLASS 43—HOTEL AND RESTAURANT SERVICES

3,681,647. ZUMO SMOOTHIE BARS INTERNATIONAL LIMITED, DUBLIN 7, IRELAND. SN 77-142,320. FILED P.R. 3-28-2007; AM. S.R. 7-8-2009.

ZUMO SMOOTHIE BAR

THE MARK CONSISTS OF STANDARD CHARACTERS WITHOUT CLAIM TO ANY PARTICULAR FONT, STYLE, SIZE, OR COLOR.

PRIORITY CLAIMED UNDER SEC. 44(D) ON ERPNCMNTY TM OFC APPLICATION NO. 005607197, FILED 1-11-2007, REG. NO. 005607197, DATED 1-29-2008, EXPIRES 1-11-2017.

NO CLAIM IS MADE TO THE EXCLUSIVE RIGHT TO USE "SMOOTHIE BAR" , APART FROM THE MARK AS SHOWN.

THE ENGLISH TRANSLATION OF THE WORD "ZUMO" IN THE MARK IS "JUICE".

FOR SERVICES FOR SERVING FOOD AND DRINK; SNACK BAR SERVICES; BAR AND BISTRO SERVICES; JUICE BAR SERVICES (U.S. CLS. 100 AND 101).

CLASS 43—(Continued).

3,681,650. RTD INVESTMENTS, LLC, ROSWELL, NM. SN 77-259,154. FILED P.R. 8-20-2007; AM. S.R. 7-17-2009.

New Mexico Burrito Company

THE MARK CONSISTS OF STANDARD CHARACTERS WITHOUT CLAIM TO ANY PARTICULAR FONT, STYLE, SIZE, OR COLOR.

NO CLAIM IS MADE TO THE EXCLUSIVE RIGHT TO USE "BURRITO COMPANY", APART FROM THE MARK AS SHOWN.

FOR FAST-FOOD RESTAURANTS (U.S. CLS. 100 AND 101).

FIRST USE 12-1-2007; IN COMMERCE 3-1-2008.

3,681,702. INTERIM FURNISHINGS, SUDBURY, MA. SN 77-566,448. FILED P.R. 9-10-2008; AM. S.R. 7-21-2009.

Interim Furnishings

THE MARK CONSISTS OF STANDARD CHARACTERS WITHOUT CLAIM TO ANY PARTICULAR FONT, STYLE, SIZE, OR COLOR.

NO CLAIM IS MADE TO THE EXCLUSIVE RIGHT TO USE "FURNISHINGS", APART FROM THE MARK AS SHOWN.

FOR RENTAL OF FURNITURE (U.S. CLS. 100 AND 101).

FIRST USE 5-1-2007; IN COMMERCE 5-1-2007.

CLASS 44—MEDICAL, BEAUTY AND AGRICULTURAL SERVICES

3,681,691. MEDQIA, LOS ANGELES, CA. SN 77-539,111. FILED P.R. 8-5-2008; AM. S.R. 5-4-2009.

Fissure Integrity Score

THE MARK CONSISTS OF STANDARD CHARACTERS WITHOUT CLAIM TO ANY PARTICULAR FONT, STYLE, SIZE, OR COLOR.

FOR MEDICAL SERVICES, NAMELY, IMAGE ANALYSIS OF LUNG FISSURES IN THE FIELD OF RADIOLOGY (U.S. CLS. 100 AND 101).

FIRST USE 11-1-2006; IN COMMERCE 11-1-2006.

CLASS 44—(Continued).

3,681,700. MEDQIA, LOS ANGELES, CA. SN 77-560,202. FILED P.R. 9-2-2008; AM. S.R. 5-4-2009.

Target Lobe Atelectasis Score

THE MARK CONSISTS OF STANDARD CHARACTERS WITHOUT CLAIM TO ANY PARTICULAR FONT, STYLE, SIZE, OR COLOR.

FOR MEDICAL IMAGING SERVICES (U.S. CLS. 100 AND 101).

FIRST USE 11-1-2006; IN COMMERCE 11-1-2006.

3,681,706. VIENNA PEDIATRIC DENTISTRY, P.C., DBA VIENNAPEDIATRIC DENTISTRY, VIENNA, VA. SN 77-578,740. FILED P.R. 9-25-2008; AM. S.R. 6-28-2009.

Vienna Pediatric Dentistry

THE MARK CONSISTS OF STANDARD CHARACTERS WITHOUT CLAIM TO ANY PARTICULAR FONT, STYLE, SIZE, OR COLOR.

NO CLAIM IS MADE TO THE EXCLUSIVE RIGHT TO USE "PEDIATRIC DENTISTRY", APART FROM THE MARK AS SHOWN.

FOR PEDODONTIST SERVICES (U.S. CLS. 100 AND 101).

FIRST USE 9-15-2007; IN COMMERCE 9-15-2007.

3,681,709. EDWARD LEWIS TOBINICK M.D., A MEDICAL CORPORATION, LOS ANGELES, CA. SN 77-584,675. FILED P.R. 10-2-2008; AM. S.R. 7-6-2009.

Alzheimer Action Guide

THE MARK CONSISTS OF STANDARD CHARACTERS WITHOUT CLAIM TO ANY PARTICULAR FONT, STYLE, SIZE, OR COLOR.

NO CLAIM IS MADE TO THE EXCLUSIVE RIGHT TO USE "GUIDE", APART FROM THE MARK AS SHOWN.

FOR PROVIDING MEDICAL INFORMATION PERTAINING TO ALZHEIMER'S DISEASE AND DEMENTIA (U.S. CLS. 100 AND 101).

FIRST USE 10-1-2008; IN COMMERCE 10-1-2008.

CLASS 44—(Continued).

3,681,724. COLON HEALTH CENTERS OF AMERICA, LLC, MENDENHALL, PA. SN 77-594,387. FILED P.R. 10-16-2008; AM. S.R. 7-23-2009.

INTEGRATED VIRTUAL COLONOSCOPY

THE MARK CONSISTS OF STANDARD CHARACTERS WITHOUT CLAIM TO ANY PARTICULAR FONT, STYLE, SIZE, OR COLOR.

NO CLAIM IS MADE TO THE EXCLUSIVE RIGHT TO USE "VIRTUAL COLONOSCOPY", APART FROM THE MARK AS SHOWN.

FOR MEDICAL SERVICES; HEALTHCARE; HEALTHCARE SERVICES, NAMELY COLONOSCOPY SCREENING; HEALTHCARE AND MEDICAL SERVICES, NAMELY, PATHOLOGY SERVICES FOR THE DIAGNOSIS AND TREATMENT OF DISEASES; MEDICAL DIAGNOSTIC TESTING; MEDICAL AND PHARMACEUTICAL CONSULTATION; MEDICAL ASSISTANCE CONSULTANCY PROVIDED BY DOCTORS AND OTHER SPECIALIZED MEDICAL PERSONNEL; MEDICAL COUNSELING; MEDICAL IMAGING SERVICES; PROVIDING INFORMATION, ADVICE AND DATA ON MEDICAL IMAGING; PROVIDING MEDICAL INFORMATION, CONSULTANCY AND ADVISORY SERVICES; MEDICAL INFORMATION, NAMELY, CONSUMER-AUTHORIZED CLINICAL LABORATORY TESTING SERVICES THAT REPORT RESULTS DIRECTLY TO THE PATIENT (U.S. CLS. 100 AND 101).

FIRST USE 9-30-2008; IN COMMERCE 9-30-2008.

3,681,725. COLON HEALTH CENTERS OF AMERICA, LLC, MENDENHALL, PA. SN 77-594,394. FILED P.R. 10-16-2008; AM. S.R. 7-23-2009.

INTEGRATED CT COLONOGRAPHY

THE MARK CONSISTS OF STANDARD CHARACTERS WITHOUT CLAIM TO ANY PARTICULAR FONT, STYLE, SIZE, OR COLOR.

NO CLAIM IS MADE TO THE EXCLUSIVE RIGHT TO USE "CT COLONOGRAPHY", APART FROM THE MARK AS SHOWN.

FOR MEDICAL SERVICES; HEALTHCARE; HEALTHCARE SERVICES, NAMELY, COLONOSCOPY SCREENING; HEALTHCARE AND MEDICAL SERVICES, NAMELY, PATHOLOGY SERVICES FOR THE DIAGNOSIS AND TREATMENT OF DISEASES; MEDICAL DIAGNOSTIC TESTING; MEDICAL AND PHARMACEUTICAL CONSULTATION; MEDICAL ASSISTANCE CONSULTANCY PROVIDED BY DOCTORS AND OTHER SPECIALIZED MEDICAL PERSONNEL; MEDICAL COUNSELING; MEDICAL IMAGING SERVICES; PROVIDING INFORMATION, ADVICE AND DATA ON MEDICAL IMAGING; PROVIDING MEDICAL INFORMATION, CONSULTANCY AND ADVISORY SERVICES; MEDICAL INFORMATION, NAMELY, CONSUMER-AUTHORIZED CLINICAL LABORATORY TESTING SERVICES THAT REPORT RESULTS DIRECTLY TO THE PATIENT (U.S. CLS. 100 AND 101).

FIRST USE 5-20-2009; IN COMMERCE 5-20-2009.

CLASS 44—(Continued).

3,681,753. SOUTH BEACH CLINIC, LLC, MIAMI BEACH, FL. SN 77-655,061. FILED P.R. 1-23-2009; AM. S.R. 7-27-2009.

SOUTH BEACH CLINIC

THE MARK CONSISTS OF STANDARD CHARACTERS WITHOUT CLAIM TO ANY PARTICULAR FONT, STYLE, SIZE, OR COLOR.

NO CLAIM IS MADE TO THE EXCLUSIVE RIGHT TO USE "CLINIC", APART FROM THE MARK AS SHOWN.

FOR HEALTHCARE (U.S. CLS. 100 AND 101).
FIRST USE 12-10-2007; IN COMMERCE 12-10-2007.

3,681,761. KOSTIDIS, JOHN N., DBA SPINAL RELIEF CENTERS, VALPARAISO, IN. AND KOSTIDIS, NICK J., DBA SPINAL RELIEF CENTERS, VALPARAISO, IN. SN 77-679,615. FILED P.R. 2-27-2009; AM. S.R. 8-5-2009.

Spinal Relief Centers

THE MARK CONSISTS OF STANDARD CHARACTERS WITHOUT CLAIM TO ANY PARTICULAR FONT, STYLE, SIZE, OR COLOR.

FOR CHIROPRACTIC SERVICES; HEALTH CARE; OCCUPATIONAL THERAPY SERVICES; PHYSICAL REHABILITATION; PHYSICAL THERAPY; PHYSICAL THERAPY EVALUATION AND TREATMENT OF MUSCULO-SKELETAL CONDITIONS; PHYSICAL THERAPY EVALUATION, IDENTIFICATION, AND MANAGEMENT OF MOVEMENT DYSFUNCTION TO RESTORE, MAINTAIN, AND PROMOTE OPTIMAL PHYSICAL FUNCTION PREVENTING THE ONSET, SYMPTOMS AND PROGRESSION OF IMPAIRMENTS, FUNCTIONAL LIMITATIONS, AND DISABILITIES RESULTING FROM DISEASE, DISORDERS, CONDITIONS, OR INJURIES; PROVIDING PHYSICAL REHABILITATION FACILITIES (U.S. CLS. 100 AND 101).

FIRST USE 2-26-2009; IN COMMERCE 2-26-2009.

CLASS 44—(Continued).

3,681,762. BURRIS, KELLY, DBA THE BURRIS LIFE COACH, HENDERSON, NV. SN 77-680,918. FILED P.R. 3-1-2009; AM. S.R. 8-5-2009.

CLASS 44—(Continued).

3,681,778. LILIKOI WELLNESS, LLC, MILL VALLEY, CA. SN 77-715,100. FILED P.R. 4-16-2009; AM. S.R. 7-24-2009.

Subconscious Restructuring

LILIKOI

THE MARK CONSISTS OF STANDARD CHARACTERS WITHOUT CLAIM TO ANY PARTICULAR FONT, STYLE, SIZE, OR COLOR.

FOR CONSULTING SERVICES IN THE FIELD OF MENTAL FITNESS; CONSULTING SERVICES IN THE FIELD OF MENTAL HEALTH AND WELLNESS; MENTAL HEALTH COUNSELING AND PSYCHOTHERAPY AS IT RELATES TO RELATIONSHIPS; MENTAL HEALTH SERVICES; PROVIDING A WEB SITE FEATURING INFORMATION IN THE FIELD OF MENTAL HEALTH AND WELLNESS (U.S. CLS. 100 AND 101).
FIRST USE 2-7-2009; IN COMMERCE 2-7-2009.

THE MARK CONSISTS OF STANDARD CHARACTERS WITHOUT CLAIM TO ANY PARTICULAR FONT, STYLE, SIZE, OR COLOR.

THE ENGLISH TRANSLATION OF "LILIKOI" IN THE MARK IS PASSION FRUIT.
FOR COUNSELING SERVICES IN THE FIELDS OF NUTRITION AND LIFESTYLE WELLNESS, WEIGHT CONTROL, STRESS MANAGEMENT AND PREVENTATIVE MEDICINE (U.S. CLS. 100 AND 101).
FIRST USE 4-1-2009; IN COMMERCE 4-1-2009.

* * * * *

PRIOR UNITED STATES CLASSIFICATION

APPLICATION IN ONE CLASS

CERTIFICATION MARKS

CLASS A—GOODS

3,681,793. METAL CONSTRUCTION ASSOCIATION, GLENVIEW, IL. SN 77-723,737. FILED P.R. 4-28-2009; AM. S.R. 7-28-2009.

THE CERTIFICATION MARK, AS USED BY PERSONS AUTHORIZED BY THE CERTIFIER, CERTIFIES THAT METAL COMPOSITE MATERIAL BEARING THE MARK HAS MET SPECIFIC MCA DEVELOPED STANDARDS OF COMPETENCE IN THE FIELD OF PREMIUM METAL COMPOSITE MATERIAL MANUFACTURE.

FOR METAL COMPOSITE MATERIAL (U.S. CL. A).
FIRST USE 6-1-2007; IN COMMERCE 6-1-2007.

Premium MCM Fabricator

THE MARK CONSISTS OF STANDARD CHARACTERS WITHOUT CLAIM TO ANY PARTICULAR FONT, STYLE, SIZE, OR COLOR.

* * * * *

TRADEMARK REGISTRATIONS RENEWED

The designation "U.S. Cl." appearing in this section refers to the U.S. class in effect prior to Sep. 1, 1973 rather than the international class which applies to applications filed on or after that date. For adoption of international classification see notice in the OFFICIAL GAZETTE of Jun. 26, 1973 (911 O.G. TM 210).

257,599.	FEATHEREST (STYLIZED). U.S. CL. 32. (INT. CL. 20). REG. 6-11-1929.	855,794.	CITYPROOF. U.S. CL. 12. (INT. CL. 19). REG. 9-3-1968.
260,656.	MASTERSEAL. U.S. CL. 12. (INT. CLS. 6, 17 AND 19). REG. 8-27-1929.	857,355.	TOYO AND DESIGN. U.S. CL. 13. (INT. CL. 6). REG. 9-24-1968.
264,917.	SAVADAY. U.S. CL. 2. (INT. CL. 21). REG. 12-10-1929.	862,999.	AMETEK (STYLIZED). U.S. CL. 13. (INT. CL. 6). REG. 1-7-1969.
368,070.	QUINSANA (STYLIZED). U.S. CL. 18. (INT. CL. 5). REG. 6-6-1939.	863,511.	421. U.S. CL. 31. (INT. CL. 11). REG. 1-14-1969.
368,868.	LOU ANA. U.S. CL. 46. (INT. CL. 29). REG. 7-4-1939.	863,578.	THERMOLAM. U.S. CL. 42. (INT. CLS. 22, 24, 26 AND 27). REG. 1-14-1969.
369,326.	STURDIWHEAT (STYLIZED). U.S. CL. 46. (INT. CLS. 1, 5, 29, 30, 31 AND 32). REG. 7-18-1939.	863,986.	TRACHEOFLEX. U.S. CL. 44. (INT. CL. 10). REG. 1-21-1969.
370,194.	SUNVIEW. U.S. CL. 46. (INT. CL. 31). REG. 8-22-1939.	865,930.	WURLITZER MEANS MUSIC TO MILLIONS. U.S. CL. 101. (INT. CL. 35). REG. 3-4-1969.
370,285.	THE TRADER. U.S. CL. 38. (INT. CL. 16). REG. 8-22-1939.	866,015.	CHARVET. U.S. CLS. 3, 28 AND 39 ONLY. (INT. CLS. 14, 18 AND 25). REG. 3-11-1969.
370,634.	BIRELEY'S AND DESIGN. U.S. CL. 45. (INT. CL. 32). REG. 8-29-1939.	866,405.	RIDGID (STYLIZED). U.S. CL. 38. (INT. CL. 16). REG. 3-11-1969.
374,045.	BIOTONE (STYLIZED). U.S. CL. 44. (INT. CL. 10). REG. 12-26-1939.	868,197.	VOLT. U.S. CL. 36. (INT. CL. 9). REG. 4-15-1969.
442,798.	WH AND DESIGN. U.S. CL. 13. (INT. CL. 6). REG. 5-31-1949.	868,198.	STAX. U.S. CL. 36. (INT. CL. 9). REG. 4-15-1969.
504,046.	BURLINGTON (STYLIZED). U.S. CL. 42. (INT. CLS. 22, 24, 26 AND 27). REG. 11-16-1948.	869,913.	FALCON-FOAM. U.S. CL. 12. (INT. CL. 17). REG. 5-27-1969.
507,088.	ALLIED PRINTING TRADES COUNCIL UNION LABEL AND DESIGN. U.S. CL. 38. (INT. CL. 16). REG. 2-22-1949.	871,738.	TUNNEL RAM. U.S. CL. 23. (INT. CL. 7). REG. 6-24-1969.
507,349.	BUNTING. U.S. CL. 14. (INT. CL. 6). REG. 3-8-1949.	872,052.	ROBROY AND DESIGN. U.S. CL. 21. (INT. CL. 9). REG. 7-1-1969.
508,951.	TRIFARI AND DESIGN. U.S. CL. 28. (INT. CLS. 8 AND 14). REG. 4-26-1949.	872,406.	SEA SPEN AND DESIGN. U.S. CL. 6. (INT. CL. 1). REG. 7-8-1969.
511,998.	JACQUES FATH. U.S. CL. 51. (INT. CL. 3). REG. 7-5-1949.	872,421.	ZESTON. U.S. CL. 12. (INT. CL. 17). REG. 7-8-1969.
512,195.	CARPENTER. U.S. CL. 14. (INT. CL. 6). REG. 7-12-1949.	872,428.	DANIEL. U.S. CLS. 13 AND 26. (INT. CLS. 6 AND 9). REG. 7-8-1969.
512,553.	BULL DOG. U.S. CL. 35. (INT. CLS. 7, 12 AND 17). REG. 7-19-1949.	872,527.	RINGER. U.S. CL. 23. (INT. CL. 7). REG. 7-8-1969.
514,054.	KARBALOY. U.S. CL. 6. (INT. CL. 1). REG. 8-23-1949.	872,563.	ION X CHANGER (STYLIZED). U.S. CL. 31. (INT. CL. 11). REG. 7-8-1969.
515,900.	SIMPLEX. U.S. CL. 44. (INT. CL. 10). REG. 10-4-1949.	872,779.	ZIEBART AND DESIGN. U.S. CL. 106. (INT. CL. 40). REG. 7-8-1969.
668,428.	POLYCAST. U.S. CL. 44. (INT. CL. 5). REG. 10-14-1958.	873,001.	REVONOC. U.S. CL. 35. (INT. CL. 17). REG. 7-15-1969.
672,502.	STARBRITE. U.S. CL. 37. (INT. CL. 16). REG. 1-13-1959.	873,134.	VITAPAN. U.S. CL. 44. (INT. CLS. 5 AND 10). REG. 7-15-1969.
681,350.	SECURITY. U.S. CL. 12. (INT. CLS. 6, 17 AND 19). REG. 7-7-1959.	876,556.	INDEPENDENT JOURNAL. U.S. CL. 38. (INT. CL. 16). REG. 9-9-1969.
681,746.	AUTOGAP. U.S. CL. 21. (INT. CL. 7). REG. 7-14-1959.	878,538.	MISCELLANEOUS DESIGN. U.S. CL. 23 ONLY. (INT. CLS. 9 AND 12). REG. 10-14-1969.
681,947.	ULTRA SHEEN. U.S. CL. 51. (INT. CL. 3). REG. 7-14-1959.	878,575.	SWINGING WONDER. U.S. CL. 22. (INT. CL. 28). REG. 10-14-1969.
682,171.	"BOKUMATIC". U.S. CL. 23. (INT. CL. 7). REG. 7-21-1959.	881,579.	ALGLAS. U.S. CL. 16. (INT. CL. 1). REG. 12-2-1969.
682,500.	SKODA AND DESIGN. U.S. CL. 23. (INT. CLS. 6, 7, 8, 9, 11, 12, 16, 21 AND 28). REG. 7-28-1959.	882,109.	REIMERS (STYLIZED). U.S. CL. 34 ONLY. (INT. CLS. 7 AND 11). REG. 12-9-1969.
683,522.	LOAD RATED. U.S. CL. 13. (INT. CLS. 6, 7, 11, 17, 20 AND 21). REG. 8-18-1959.	890,471.	COPELAND. U.S. CL. 31. (INT. CL. 11). REG. 5-5-1970.
683,893.	SYNFLEX. U.S. CL. 13. (INT. CL. 17). REG. 8-25-1959.	893,739.	HERCUMILE. U.S. CL. 35. (INT. CL. 12). REG. 6-30-1970.
684,304.	PERMENTRY. U.S. CL. 12. (INT. CLS. 6 AND 19). REG. 9-1-1959.	1,095,910.	HITCHHIKER. INT. CL. 12. (U.S. CLS. 19, 21, 23, 31, 35 AND 44). REG. 7-11-1978.
684,353.	TIGAN. U.S. CL. 18. (INT. CL. 5). REG. 9-1-1959.	1,106,942.	GEORGETTE KLINGER. INT. CL. 3. (U.S. CLS. 1, 4, 6, 50, 51 AND 52). REG. 11-28-1978.
685,394.	PACEMAKER. U.S. CL. 13. (INT. CL. 11). REG. 9-22-1959.	1,110,829.	PANCAKE WINDOW. INT. CL. 9. (U.S. CL. 26). REG. 1-9-1979.
689,801.	SUBARU. U.S. CL. 19. (INT. CL. 12). REG. 12-15-1959.	1,111,633.	PRO-ARC. INT. CL. 7. (U.S. CL. 34). REG. 1-23-1979.
695,508.	CON DET. U.S. CL. 6. (INT. CL. 1). REG. 4-5-1960.	1,112,193.	BODINE. INT. CL. 9. (U.S. CL. 26). REG. 1-30-1979.
698,515.	MISCELLANEOUS DESIGN. U.S. CL. 22. (INT. CL. 28). REG. 5-31-1960.	1,112,481.	THIS IS THE LIFE. INT. CL. 41. (U.S. CL. 107). REG. 1-30-1979.
		1,112,483.	THE EXECUTIVE TECHNIQUE. INT. CL. 41. (U.S. CLS. 100, 101 AND 107). REG. 1-30-1979.
		1,112,602.	P (STYLIZED). INT. CLS. 6 AND 7. (U.S. CLS. 13 AND 23). REG. 2-6-1979.
		1,114,920.	LIFETIME. INT. CL. 21. (U.S. CL. 15). REG. 3-13-1979.

- 1,116,815. PANCREASE. INT. CL. 5. (U.S. CLS. 6, 18, 44, 46, 51 AND 52). REG. 4-24-1979.
- 1,119,383. COTEAU. INT. CL. 31. (U.S. CL. 1). REG. 5-29-1979.
- 1,119,526. FILTERMAT. INT. CL. 7. (U.S. CL. 23). REG. 6-5-1979.
- 1,121,161. IMAGE BANK (STYLIZED). INT. CL. 35. (U.S. CLS. 100, 101 AND 102). REG. 6-26-1979.
- 1,121,285. LOCK DOCTOR. INT. CLS. 6 AND 37. (U.S. CLS. 13 AND 103). REG. 7-3-1979.
- 1,121,687. AC-DI-SOL (STYLIZED). INT. CL. 1. (U.S. CL. 6). REG. 7-10-1979.
- 1,122,096. ANITA'S AND DESIGN. INT. CL. 42. (U.S. CL. 100). REG. 7-10-1979.
- 1,122,304. WILD TRAC. INT. CL. 12. (U.S. CL. 35). REG. 7-17-1979.
- 1,122,364. SOUNDINGS. INT. CL. 16. (U.S. CLS. 2, 5, 22, 23, 29, 37, 38 AND 50). REG. 7-17-1979.
- 1,122,500. HARBOR SWEETS. INT. CLS. 30 AND 42. (U.S. CLS. 46 AND 101). REG. 7-17-1979.
- 1,122,575. WATERWORKS AND DESIGN. INT. CL. 42. (U.S. CL. 101). REG. 7-17-1979.
- 1,122,758. THE PINK PANTHER. INT. CLS. 16, 25 AND 28. (U.S. CLS. 2, 5, 22, 23, 29, 37, 38, 39 AND 50). REG. 7-24-1979.
- 1,122,932. SWEET SLOOPS. INT. CL. 30. (U.S. CL. 46). REG. 7-24-1979.
- 1,122,933. SAND DOLLARS. INT. CL. 30. (U.S. CL. 46). REG. 7-24-1979.
- 1,123,014. PYRO SPECTACULARS. INT. CL. 41. (U.S. CL. 107). REG. 7-24-1979.
- 1,123,115. YOUNGER. INT. CL. 9 ONLY. (U.S. CLS. 21, 23, 26, 36 AND 38). REG. 7-31-1979.
- 1,123,214. OILMEN'S. INT. CL. 12. (U.S. CLS. 19, 21, 23, 31, 35 AND 44). REG. 7-31-1979.
- 1,123,274. GOLD LABEL. INT. CL. 17. (U.S. CL. 1). REG. 7-31-1979.
- 1,123,275. WHITE LABEL. INT. CL. 17. (U.S. CL. 1). REG. 7-31-1979.
- 1,123,292. CHEMGRATE AND DESIGN. INT. CL. 19. (U.S. CL. 12). REG. 7-31-1979.
- 1,123,389. CAL-BEST AND DESIGN. INT. CLS. 29 AND 31. (U.S. CL. 46). REG. 7-31-1979.
- 1,123,471. PACT. INT. CL. 40. (U.S. CL. 106). REG. 7-31-1979.
- 1,123,520. P AND DESIGN. INT. CLS. 1, 9 AND 16. (U.S. CLS. 5, 21 AND 37). REG. 8-7-1979.
- 1,123,748. GIANNI VERSACE (STYLIZED). INT. CL. 25. (U.S. CL. 39). REG. 8-7-1979.
- 1,124,692. G AND DESIGN. INT. CL. 11. (U.S. CLS. 13, 21, 23, 31 AND 34). REG. 9-4-1979.
- 1,125,142. CEZINC (STYLIZED). INT. CL. 6. (U.S. CLS. 2, 12, 13, 14, 23, 25 AND 50). REG. 9-18-1979.
- 1,128,704. TANGO. INT. CL. 28. (U.S. CL. 22). REG. 1-1-1980.
- 1,128,756. CREDIT CARD SENTINEL (STYLIZED). INT. CL. 35. (U.S. CL. 101). REG. 1-1-1980.
- 1,130,146. ABC AND DESIGN. INT. CL. 42. (U.S. CL. 100). REG. 1-29-1980.
- 1,135,012. DIMARZIO AND DESIGN. INT. CL. 9 ONLY. (U.S. CL. 13). REG. 5-13-1980.
- 1,136,262. WILD FLOWERS. INT. CL. 25. (U.S. CL. 39). REG. 5-27-1980.
- 1,136,943. GIURLANI. INT. CL. 29. (U.S. CL. 46). REG. 6-17-1980.
- 1,137,030. LAS VEGAS FUNJET. INT. CL. 39. (U.S. CL. 105). REG. 6-17-1980.
- 1,445,272. ALUMNI. INT. CL. 25. (U.S. CL. 39). REG. 6-30-1987.
- 1,483,533. ARMAND BASI BARCELONASTANDARD CHARACTER MARK INT. CL. 25. (U.S. CL. 39). REG. 4-5-1988.
- 1,490,799. B-LOK. INT. CL. 6. (U.S. CL. 25). REG. 6-7-1988.
- 1,505,279. AMERA AND DESIGN. INT. CL. 42. (U.S. CL. 101). REG. 9-20-1988.
- 1,506,891. INTEGRAFLAME. INT. CL. 9. (U.S. CL. 21). REG. 10-4-1988.
- 1,507,990. TURBO STEAM AND DESIGN. INT. CL. 11. (U.S. CL. 34). REG. 10-11-1988.
- 1,510,764. CABLE X. INT. CL. 9. (U.S. CLS. 21 AND 26). REG. 11-1-1988.
- 1,512,399. MISCELLANEOUS DESIGN. INT. CL. 9. (U.S. CL. 26). REG. 11-15-1988.
- 1,515,751. ST. PETER PROJECTS, INC.. INT. CL. 36. (U.S. CL. 102). REG. 12-6-1988.
- 1,519,628. COMPUTER BLUE. INT. CL. 9. (U.S. CL. 21). REG. 1-10-1989.
- 1,520,737. RESPIRONICS INC.. INT. CL. 10. (U.S. CLS. 26, 39 AND 44). REG. 1-17-1989.
- 1,523,564. KIX AND DESIGN. INT. CL. 25. (U.S. CL. 39). REG. 2-7-1989.
- 1,523,819. PLASTIC-PLATE. INT. CLS. 37 AND 40. (U.S. CLS. 103 AND 106). REG. 2-7-1989.
- 1,524,715. BERIO. INT. CLS. 29 AND 30. (U.S. CL. 46). REG. 2-14-1989.
- 1,527,856. TOTAL MAINTENANCE SYSTEM. INT. CLS. 9 AND 16 ONLY. (U.S. CL. 38). REG. 3-7-1989.
- 1,530,886. DELIGRAPHICS. INT. CL. 20. (U.S. CL. 50). REG. 3-21-1989.
- 1,531,625. SPOONER. INT. CL. 7. (U.S. CL. 23). REG. 3-28-1989.
- 1,532,494. CRUZOR. INT. CL. 1. (U.S. CL. 1). REG. 4-4-1989.
- 1,536,804. SUNNY 98.5 (STYLIZED). INT. CL. 38. (U.S. CL. 104). REG. 4-25-1989.
- 1,537,889. PHARMACIST FORMULA AND DESIGN. INT. CL. 5. (U.S. CLS. 18 AND 41). REG. 5-9-1989.
- 1,538,537. AMONG FRIENDS. INT. CL. 41. (U.S. CL. 107). REG. 5-9-1989.
- 1,539,271. TIMELESS TREASURES. INT. CL. 14. (U.S. CL. 28). REG. 5-16-1989.
- 1,542,411. TIMESTANDARD CHARACTER MARK INT. CLS. 12 AND 25. (U.S. CLS. 19, 21, 23, 31, 35, 39 AND 44). REG. 6-6-1989.
- 1,542,444. T & C AND DESIGN. INT. CL. 14. (U.S. CL. 28). REG. 6-6-1989.
- 1,542,517. VIROLOGY & AIDS ABSTRACTS. INT. CL. 16. (U.S. CL. 38). REG. 6-6-1989.
- 1,543,760. CURTIS AND DESIGN. INT. CL. 29. (U.S. CL. 46). REG. 6-13-1989.
- 1,543,877. AEROSOURCE. INT. CLS. 37 AND 42. (U.S. CLS. 101 AND 103). REG. 6-13-1989.
- 1,543,910. MISCELLANEOUS DESIGN. INT. CL. 41. (U.S. CL. 107). REG. 6-13-1989.
- 1,546,338. TRAVEL AMERICA AT HALFPRIICE. INT. CL. 16. (U.S. CL. 38). REG. 7-4-1989.
- 1,546,692. FIRST TEAM AND DESIGN. INT. CL. 36. (U.S. CLS. 101 AND 102). REG. 7-4-1989.
- 1,546,884. ST P AND DESIGN. INT. CL. 42. (U.S. CL. 100). REG. 7-4-1989.
- 1,546,927. PHOTEC (STYLIZED). INT. CL. 1. (U.S. CL. 6). REG. 7-11-1989.
- 1,546,953. GENERAL ALUM & CHEMICAL CORPORATION AND DESIGN. INT. CL. 1. (U.S. CL. 6). REG. 7-11-1989.
- 1,547,135. RADALARM. INT. CL. 9. (U.S. CL. 26). REG. 7-11-1989.
- 1,547,230. BESTWATER (STYLIZED). INT. CL. 11. (U.S. CL. 31). REG. 7-11-1989.
- 1,547,270. COUPLERMATESTANDARD CHARACTER MARK INT. CL. 12. (U.S. CL. 19). REG. 7-11-1989.
- 1,547,319. STILOLINEA (STYLIZED). INT. CL. 16. (U.S. CLS. 2, 5, 22, 23, 29, 37, 38 AND 50). REG. 7-11-1989.
- 1,547,446. VELUX. INT. CL. 22. (U.S. CL. 50). REG. 7-11-1989.
- 1,547,521. FUNRISE. INT. CL. 28. (U.S. CL. 22). REG. 7-11-1989.
- 1,547,584. SAN GIORGIO FETTUCINI FLORENTINE AND DESIGN. INT. CL. 30. (U.S. CL. 46). REG. 7-11-1989.
- 1,547,617. CA' DEL PAZZO (STYLIZED). INT. CL. 33. (U.S. CL. 47). REG. 7-11-1989.
- 1,547,635. MED-STAFF INCORPORATED AND DESIGN. INT. CL. 35. (U.S. CL. 101). REG. 7-11-1989.
- 1,547,844. HIIVOL. INT. CL. 1. (U.S. CL. 6). REG. 7-18-1989.
- 1,548,077. FAIL-DRY. INT. CL. 9. (U.S. CLS. 21 AND 26). REG. 7-18-1989.
- 1,548,172. MIROLIN. INT. CL. 11. (U.S. CLS. 13, 21, 23, 31 AND 34). REG. 7-18-1989.
- 1,548,214. PROWLER. INT. CL. 12. (U.S. CLS. 19, 21, 23, 31, 35 AND 44). REG. 7-18-1989.
- 1,548,244. TERRA (STYLIZED). INT. CL. 16. (U.S. CL. 38). REG. 7-18-1989.
- 1,548,323. LOCKERACK. INT. CL. 20. (U.S. CL. 32). REG. 7-18-1989.
- 1,548,331. DOUBLETALK. INT. CL. 20. (U.S. CL. 50). REG. 7-18-1989.
- 1,548,539. WICK'S. INT. CL. 30. (U.S. CL. 46). REG. 7-18-1989.
- 1,548,567. ADANTE. INT. CL. 34. (U.S. CL. 17). REG. 7-18-1989.
- 1,548,568. MISCELLANEOUS DESIGN. INT. CL. 34. (U.S. CL. 17). REG. 7-18-1989.

- 1,548,569. JPB AND DESIGN. INT. CL. 34. (U.S. CL. 17). REG. 7-18-1989.
- 1,548,608. MAPFRE. INT. CL. 36. (U.S. CLS. 100, 101 AND 102). REG. 7-18-1989.
- 1,548,613. AMCORP AND DESIGN. INT. CL. 36. (U.S. CLS. 101 AND 102). REG. 7-18-1989.
- 1,548,715. USPA. INT. CL. 42. (U.S. CL. 100). REG. 7-18-1989.
- 1,548,747. RESPIRATORY PROTECTOR. INT. CL. 11. (U.S. CL. 34). REG. 7-18-1989.
- 1,548,794. NANOCEM. INT. CL. 1. (U.S. CL. 6). REG. 7-25-1989.
- 1,548,881. LITEX (STYLIZED). INT. CL. 7. (U.S. CL. 23). REG. 7-25-1989.
- 1,548,995. FILAC. INT. CL. 9. (U.S. CL. 26). REG. 7-25-1989.
- 1,549,018. FORMSMITH. INT. CL. 9. (U.S. CL. 38). REG. 7-25-1989.
- 1,549,121. SUISAKU (STYLIZED). INT. CL. 16. (U.S. CLS. 2 AND 50). REG. 7-25-1989.
- 1,549,373. SEE'S CANDIES AND DESIGN. INT. CL. 30. (U.S. CL. 46). REG. 7-25-1989.
- 1,549,434. JPB. INT. CL. 34. (U.S. CL. 17). REG. 7-25-1989.
- 1,549,454. MISCELLANEOUS DESIGN. INT. CLS. 35, 36, 38 AND 42. (U.S. CLS. 100, 101, 102 AND 104). REG. 7-25-1989.
- 1,549,531. THE FOUR LADS. INT. CL. 41. (U.S. CL. 107). REG. 7-25-1989.
- 1,549,576. SHOPWORTH A STORE WORTH SHOPPING AND DESIGN. INT. CL. 42. (U.S. CLS. 100 AND 101). REG. 7-25-1989.
- 1,549,676. TECRA. INT. CLS. 1, 9 AND 10 ONLY. (U.S. CLS. 6, 26 AND 44). REG. 8-1-1989.
- 1,549,711. MULCH MAGIC. INT. CL. 2. (U.S. CL. 6). REG. 8-1-1989.
- 1,549,884. MOREL AND DESIGN. INT. CL. 9. (U.S. CL. 21). REG. 8-1-1989.
- 1,549,979. EZE-GRIP. INT. CL. 9. (U.S. CLS. 21 AND 26). REG. 8-1-1989.
- 1,550,134. SMART SHOPPER. INT. CL. 16. (U.S. CL. 2). REG. 8-1-1989.
- 1,550,135. SMART SHOPPER. INT. CL. 16. (U.S. CL. 37). REG. 8-1-1989.
- 1,550,239. LIA BIJOU. INT. CL. 25. (U.S. CLS. 22 AND 39). REG. 8-1-1989.
- 1,550,374. BREW-MAGIC. INT. CL. 30. (U.S. CL. 46). REG. 8-1-1989.
- 1,550,424. FRESH 'N' QUICK. INT. CL. 31. (U.S. CL. 46). REG. 8-1-1989.
- 1,550,480. JUAN PABLO BARONES. INT. CL. 34. (U.S. CL. 17). REG. 8-1-1989.
- 1,550,481. JUAN PABLO BARONES (STYLIZED). INT. CL. 34. (U.S. CL. 17). REG. 8-1-1989.
- 1,550,687. GRIP 'N' STRIP. INT. CL. 3. (U.S. CLS. 6 AND 52). REG. 8-8-1989.
- 1,550,926. WORKSAVER OUTSIDER. INT. CL. 16. (U.S. CL. 29). REG. 8-8-1989.
- 1,551,147. WAVELENGTH FRIES. INT. CL. 29. (U.S. CL. 46). REG. 8-8-1989.
- 1,551,344. MENNO-HOF AND DESIGN. INT. CL. 41. (U.S. CL. 107). REG. 8-8-1989.
- 1,551,794. SYNCHROMED. INT. CL. 10. (U.S. CL. 44). REG. 8-15-1989.
- 1,551,816. MAGNA M (STYLIZED). INT. CL. 12. (U.S. CL. 19). REG. 8-15-1989.
- 1,552,298. SKUNKMOBILE. INT. CL. 41. (U.S. CL. 107). REG. 8-15-1989.
- 1,552,534. WITCO (STYLIZED). INT. CL. 8. (U.S. CL. 23). REG. 8-22-1989.
- 1,552,577. VARI-CONE. INT. CL. 9. (U.S. CL. 26). REG. 8-22-1989.
- 1,552,719. CCS. INT. CL. 9. (U.S. CL. 21). REG. 8-22-1989.
- 1,552,872. ACCROLOM. INT. CL. 17. (U.S. CL. 1). REG. 8-22-1989.
- 1,553,062. CARVERS CHOICE. INT. CL. 29. (U.S. CL. 46). REG. 8-22-1989.
- 1,553,288. SPARROW AND DESIGN. INT. CLS. 41 AND 42. (U.S. CLS. 100, 101 AND 107). REG. 8-22-1989.
- 1,553,462. MAGNA-BULB. INT. CL. 6. (U.S. CL. 13). REG. 8-29-1989.
- 1,553,464. ARMSTRONG. INT. CLS. 7 AND 11. (U.S. CLS. 23, 31 AND 34). REG. 8-29-1989.
- 1,553,626. LAMPTRONIX. INT. CL. 11. (U.S. CL. 21). REG. 8-29-1989.
- 1,554,183. COCO'S BAKERY RESTAURANT. INT. CL. 42. (U.S. CL. 100). REG. 8-29-1989.
- 1,554,659. JIST. INT. CLS. 16 AND 41. (U.S. CLS. 38 AND 107). REG. 9-5-1989.
- 1,554,703. RAIN-RUN. INT. CL. 19. (U.S. CL. 12). REG. 9-5-1989.
- 1,555,351. THE LICENSING JOURNAL. INT. CL. 16. (U.S. CL. 38). REG. 9-5-1989.
- 1,556,228. CAPT'N NEMO'S AND DESIGN. INT. CL. 42. (U.S. CL. 100). REG. 9-12-1989.
- 1,556,654. OS-9. INT. CL. 9. (U.S. CL. 38). REG. 9-19-1989.
- 1,557,540. MEMOREX. INT. CL. 3. (U.S. CLS. 6, 21, 29 AND 52). REG. 9-26-1989.
- 1,557,637. FLEXBAR. INT. CL. 7. (U.S. CL. 23). REG. 9-26-1989.
- 1,557,703. PRAVDA RECORDS (STYLIZED). INT. CL. 9. (U.S. CL. 36). REG. 9-26-1989.
- 1,557,903. LUNDBERG. INT. CL. 16. (U.S. CL. 38). REG. 9-26-1989.
- 1,558,362. FIRESIDE. INT. CL. 34. (U.S. CL. 8). REG. 9-26-1989.
- 1,558,816. SQLWINDOWS. INT. CL. 9. (U.S. CL. 38). REG. 10-3-1989.
- 1,559,818. FRESH-TRAK. INT. CL. 17. (U.S. CL. 1). REG. 10-10-1989.
- 1,559,851. VERSA-TUFF. INT. CL. 20. (U.S. CLS. 12 AND 13). REG. 10-10-1989.
- 1,560,041. CALAVO. INT. CL. 29. (U.S. CL. 46). REG. 10-10-1989.
- 1,560,327. SILVER MASTER (STYLIZED). INT. CL. 1. (U.S. CL. 6). REG. 10-17-1989.
- 1,560,434. MISCELLANEOUS DESIGN. INT. CL. 5. (U.S. CLS. 18 AND 51). REG. 10-17-1989.
- 1,560,435. BUG-N-BURN. INT. CL. 5. (U.S. CLS. 18 AND 51). REG. 10-17-1989.
- 1,560,840. MISCELLANEOUS DESIGN. INT. CL. 16. (U.S. CLS. 2, 5, 22, 23, 29, 37, 38 AND 50). REG. 10-17-1989.
- 1,561,877. SPEAKON. INT. CL. 9. (U.S. CLS. 21, 23, 26, 36 AND 38). REG. 10-24-1989.
- 1,562,191. BOJI. INT. CL. 20. (U.S. CL. 50). REG. 10-24-1989.
- 1,562,404. BADIA AND DESIGN. INT. CLS. 29 AND 30. (U.S. CL. 46). REG. 10-24-1989.
- 1,562,488. LEGACY. INT. CL. 34. (U.S. CL. 17). REG. 10-24-1989.
- 1,562,560. COBANK. INT. CL. 36. (U.S. CL. 102). REG. 10-24-1989.
- 1,562,890. PRIPORT. INT. CLS. 1, 2 AND 9. (U.S. CLS. 6, 11 AND 26). REG. 10-31-1989.
- 1,563,674. LS LEGACY AND DESIGN. INT. CL. 34. (U.S. CLS. 2, 8, 9 AND 17). REG. 10-31-1989.
- 1,566,410. LT3. INT. CL. 40. (U.S. CL. 106). REG. 11-14-1989.
- 1,566,994. ORIX. INT. CL. 11. (U.S. CL. 21). REG. 11-21-1989.
- 1,567,022. MISCELLANEOUS DESIGN. INT. CL. 12. (U.S. CL. 19). REG. 11-21-1989.
- 1,568,116. PULSE AND DESIGN. INT. CL. 9. (U.S. CLS. 21 AND 26). REG. 11-28-1989.
- 1,570,533. KAEPOX. INT. CL. 2. (U.S. CLS. 1 AND 16). REG. 12-12-1989.
- 1,571,423. MISCELLANEOUS DESIGN. INT. CL. 42. (U.S. CL. 101). REG. 12-12-1989.
- 1,572,427. WETTER WATER AND DESIGN. INT. CL. 37. (U.S. CLS. 100 AND 103). REG. 12-19-1989.
- 1,574,038. PROGRAMMER'S PARADISE. INT. CL. 42. (U.S. CL. 101). REG. 12-26-1989.
- 1,575,759. AARON'S COMPUTER RELIEF. INT. CL. 42. (U.S. CLS. 100 AND 101). REG. 1-2-1990.
- 1,576,669. CUSTOM CUTS AND DESIGN. INT. CL. 31. (U.S. CL. 46). REG. 1-9-1990.
- 1,576,767. SOLANA. INT. CL. 36. (U.S. CLS. 100, 101 AND 102). REG. 1-9-1990.
- 1,577,678. GOSHEN COACH. INT. CL. 12. (U.S. CL. 19). REG. 1-16-1990.
- 1,578,445. SIKAFLEX. INT. CLS. 1 AND 2. (U.S. CLS. 5, 12 AND 16). REG. 1-23-1990.
- 1,580,375. PAJAM. INT. CL. 31. (U.S. CL. 1). REG. 1-30-1990.
- 1,580,705. SVSU. INT. CL. 42. (U.S. CL. 101). REG. 1-30-1990.
- 1,580,707. SAGINAW VALLEY STATE UNIVERSITY 1963 AND DESIGN. INT. CL. 42. (U.S. CL. 101). REG. 1-30-1990.
- 1,589,695. PRIME. INT. CL. 5. (U.S. CL. 18). REG. 4-3-1990.
- 1,592,978. ROLLABELS. INT. CL. 16. (U.S. CL. 37). REG. 4-24-1990.
- 1,593,466. SAGINAW VALLEY STATE UNIVERSITY AND DESIGN. INT. CL. 41. (U.S. CL. 107). REG. 4-24-1990.

- 1,594,222. DECLAR. INT. CL. 17. (U.S. CL. 35). REG. 5-1-1990.
- 1,595,134. VAREO. INT. CL. 9. (U.S. CLS. 21 AND 26). REG. 5-8-1990.
- 1,595,391. HYDROFLEX. INT. CL. 19. (U.S. CL. 12). REG. 5-8-1990.
- 1,596,133. MISCELLANEOUS DESIGN. INT. CL. 9. (U.S. CL. 13). REG. 5-15-1990.
- 1,596,233. MISCELLANEOUS DESIGN. INT. CL. 11. (U.S. CL. 13). REG. 5-15-1990.
- 1,596,503. MAGNUM. INT. CL. 21. (U.S. CL. 23). REG. 5-15-1990.
- 1,598,964. CINEMARK THEATRES. INT. CL. 41. (U.S. CL. 107). REG. 5-29-1990.
- 1,600,036. SATURDAY MATINEE. INT. CL. 42. (U.S. CLS. 100 AND 101). REG. 6-5-1990.
- 1,600,474. "IF WE CAN'T GUARANTEE IT, WE WON'T SELL IT!". INT. CLS. 9, 12 AND 42. (U.S. CLS. 19, 21 AND 101). REG. 6-12-1990.
- 1,603,060. PIER HOUSE AND DESIGN. INT. CL. 42. (U.S. CL. 100). REG. 6-19-1990.
- 1,603,880. MISCELLANEOUS DESIGN. INT. CL. 28. (U.S. CL. 22). REG. 6-26-1990.
- 1,604,336. ACES. INT. CL. 5. (U.S. CL. 18). REG. 7-3-1990.
- 1,604,364. DOUBLE KOTE. INT. CL. 7. (U.S. CL. 23). REG. 7-3-1990.
- 1,604,678. POLYBLEND. INT. CL. 19. (U.S. CL. 12). REG. 7-3-1990.
- 2,111,024. WATER DOCTOR. INT. CL. 11. (U.S. CLS. 13, 21, 23, 31 AND 34). REG. 11-4-1997.
- 2,177,116. DIOVAN. INT. CL. 5. (U.S. CLS. 6, 18, 44, 46, 51 AND 52). REG. 7-28-1998.
- 2,189,417. WORLDSPAN AND DESIGN. INT. CL. 42. (U.S. CLS. 100 AND 101). REG. 9-15-1998.
- 2,199,231. M-15. INT. CL. 9. (U.S. CLS. 21, 23, 26, 36 AND 38). REG. 10-27-1998.
- 2,200,047. MISCELLANEOUS DESIGN. INT. CL. 41. (U.S. CLS. 100, 101 AND 107). REG. 10-27-1998.
- 2,200,887. M-25. INT. CL. 9. (U.S. CLS. 21, 23, 26, 36 AND 38). REG. 11-3-1998.
- 2,200,888. M-5. INT. CL. 9. (U.S. CLS. 21, 23, 26, 36 AND 38). REG. 11-3-1998.
- 2,200,891. MA-7. INT. CL. 9. (U.S. CLS. 21, 23, 26, 36 AND 38). REG. 11-3-1998.
- 2,204,782. M-7. INT. CL. 9. (U.S. CLS. 21, 23, 26, 36 AND 38). REG. 11-24-1998.
- 2,208,505. BON-STITCH AND DESIGN. INT. CL. 18 ONLY. (U.S. CLS. 1, 2, 3, 22 AND 41). REG. 12-8-1998.
- 2,214,259. QUICKGUARD. INT. CL. 19. (U.S. CLS. 1, 12, 33 AND 50). REG. 12-29-1998.
- 2,216,132. SE RACING. INT. CL. 12. (U.S. CLS. 19, 21, 23, 31, 35 AND 44). REG. 1-5-1999.
- 2,216,895. HEALTHY GOURMET'S CHOICE BRAND AND DESIGN. INT. CL. 29. (U.S. CL. 46). REG. 1-12-1999.
- 2,218,462. ACROFLEX. INT. CL. 2. (U.S. CLS. 6, 11 AND 16). REG. 1-19-1999.
- 2,218,800. MILK FED. INT. CL. 25. (U.S. CLS. 22 AND 39). REG. 1-19-1999.
- 2,219,615. CUSHION FIT. INT. CL. 14. (U.S. CLS. 2, 27, 28 AND 50). REG. 1-19-1999.
- 2,219,616. PHOTOVISTA. INT. CL. 9. (U.S. CLS. 21, 23, 26, 36 AND 38). REG. 1-19-1999.
- 2,221,047. MISCELLANEOUS DESIGN. INT. CL. 9. (U.S. CLS. 21, 23, 26, 36 AND 38). REG. 2-2-1999.
- 2,221,114. UREA 2000PLUS (STYLIZED). INT. CLS. 37 AND 42 ONLY. (U.S. CLS. 100, 101, 103 AND 106). REG. 2-2-1999.
- 2,221,115. UREA 2000 PLUS (STYLIZED). INT. CLS. 6, 37 AND 42. (U.S. CLS. 2, 12, 13, 14, 23, 25, 50, 100, 101, 103 AND 106). REG. 2-2-1999.
- 2,221,355. SVC. U.S. CL. 200. REG. 2-2-1999.
- 2,222,606. TOTAL SECURITY. INT. CL. 6. (U.S. CLS. 2, 12, 13, 14, 23, 25 AND 50). REG. 2-9-1999.
- 2,223,225. + PLUS AND DESIGN. INT. CL. 10. (U.S. CLS. 26, 39 AND 44). REG. 2-9-1999.
- 2,223,536. WATER ENVIRONMENT FEDERATION PRESERVING & ENHANCING THE GLOBAL WATER ENVIRONMENT AND DESIGN. INT. CLS. 35 AND 42. (U.S. CLS. 100, 101 AND 102). REG. 2-16-1999.
- 2,224,058. WHERE WE DON'T MARK IT UP JUST TO MARK IT DOWN AND CALL IT A SALE. INT. CL. 35. (U.S. CLS. 100, 101 AND 102). REG. 2-16-1999.
- 2,225,826. TBC-BRINADD. INT. CL. 1. (U.S. CLS. 1, 5, 6, 10, 26 AND 46). REG. 2-23-1999.
- 2,226,185. ON THE MOVE INT. CL. 39. (U.S. CLS. 100 AND 105). REG. 2-23-1999.
- 2,227,141. THE INSIDE PITCH. INT. CL. 41. (U.S. CLS. 100, 101 AND 107). REG. 3-2-1999.
- 2,230,664. LIFESTYLES NUTRIA. INT. CL. 5. (U.S. CLS. 6, 18, 44, 46, 51 AND 52). REG. 3-9-1999.
- 2,231,320. A+ FABRICS AND DESIGN. INT. CL. 25. (U.S. CLS. 22 AND 39). REG. 3-16-1999.
- 2,231,697. BEEF USA AND DESIGN. INT. CL. 16. (U.S. CLS. 2, 5, 22, 23, 29, 37, 38 AND 50). REG. 3-16-1999.
- 2,234,097. IRIODIN PEARLPRINT. INT. CL. 2. (U.S. CLS. 6, 11 AND 16). REG. 3-23-1999.
- 2,234,227. S AND DESIGN. INT. CL. 14. (U.S. CLS. 2, 27, 28 AND 50). REG. 3-23-1999.
- 2,234,394. CRUNCH MASTER AND DESIGN. INT. CLS. 29 AND 30. (U.S. CL. 46). REG. 3-23-1999.
- 2,236,747. ADAPTABAK. INT. CL. 10. (U.S. CLS. 26, 39 AND 44). REG. 4-6-1999.
- 2,237,511. MISCELLANEOUS DESIGN. INT. CL. 9. (U.S. CLS. 21, 23, 26, 36 AND 38). REG. 4-6-1999.
- 2,241,331. DON'T SWEAT THE SMALL STUFF. INT. CL. 16. (U.S. CLS. 2, 5, 22, 23, 29, 37, 38 AND 50). REG. 4-20-1999.
- 2,243,855. MAX. INT. CL. 1. (U.S. CLS. 1, 5, 6, 10, 26 AND 46). REG. 5-4-1999.
- 2,245,310. UPPER CRUST AND DESIGN. INT. CL. 42. (U.S. CLS. 100 AND 101). REG. 5-18-1999.
- 2,245,493. PIPEMASTER. INT. CL. 9. (U.S. CLS. 21, 23, 26, 36 AND 38). REG. 5-18-1999.
- 2,246,975. STRAIGHTER SMOOTHER HAIR. INT. CL. 3. (U.S. CLS. 1, 4, 6, 50, 51 AND 52). REG. 5-25-1999.
- 2,246,987. SCENTS-U-ALL AND DESIGN. INT. CLS. 3, 4, 14, 21 AND 35. (U.S. CLS. 1, 2, 4, 6, 13, 15, 23, 27, 28, 29, 30, 33, 40, 50, 51, 52, 100, 101 AND 102). REG. 5-25-1999.
- 2,247,032. ALTA. INT. CL. 41. (U.S. CLS. 100, 101 AND 107). REG. 5-25-1999.
- 2,247,204. AE AND DESIGN. INT. CL. 35. (U.S. CLS. 100, 101 AND 102). REG. 5-25-1999.
- 2,247,243. CIRIS. INT. CL. 9. (U.S. CLS. 21, 23, 26, 36 AND 38). REG. 5-25-1999.
- 2,247,303. LIST INDUSTRIES INC.. INT. CLS. 6 AND 7. (U.S. CLS. 2, 12, 13, 14, 19, 21, 23, 25, 31, 34, 35 AND 50). REG. 5-25-1999.
- 2,247,673. BODY BALANCE FOR PERFORMANCE. INT. CL. 41. (U.S. CLS. 100, 101 AND 107). REG. 5-25-1999.
- 2,247,720. BODY BALANCE FOR PERFORMANCE AND DESIGN. INT. CL. 41. (U.S. CLS. 100, 101 AND 107). REG. 5-25-1999.
- 2,247,842. MISCELLANEOUS DESIGN. INT. CL. 42. (U.S. CLS. 100 AND 101). REG. 5-25-1999.
- 2,247,980. UNIFLEX. INT. CL. 7. (U.S. CLS. 13, 19, 21, 23, 31, 34 AND 35). REG. 5-25-1999.
- 2,248,052. OCELOT. INT. CL. 28. (U.S. CLS. 22, 23, 38 AND 50). REG. 5-25-1999.
- 2,248,460. TEXAS HEART. INT. CL. 42. (U.S. CLS. 100 AND 101). REG. 6-1-1999.
- 2,249,067. ARGEN. INT. CL. 5. (U.S. CLS. 6, 18, 44, 46, 51 AND 52). REG. 6-1-1999.
- 2,249,235. SUPER 600. INT. CL. 19. (U.S. CLS. 1, 12, 33 AND 50). REG. 6-1-1999.
- 2,249,401. RAINBOW. INT. CL. 9. (U.S. CLS. 21, 23, 26, 36 AND 38). REG. 6-1-1999.
- 2,250,203. MISTERART. INT. CL. 35. (U.S. CLS. 100, 101 AND 102). REG. 6-1-1999.
- 2,250,548. GPI GUM PRODUCTS INTERNATIONAL AND DESIGN. INT. CL. 30. (U.S. CL. 46). REG. 6-1-1999.
- 2,250,841. TANCAP. INT. CL. 9. (U.S. CLS. 21, 23, 26, 36 AND 38). REG. 6-8-1999.
- 2,251,393. RED ROCK TECHNOLOGIES. INT. CL. 9. (U.S. CLS. 21, 23, 26, 36 AND 38). REG. 6-8-1999.
- 2,252,471. APPLICATION ENGINEERED. INT. CL. 12. (U.S. CLS. 19, 21, 23, 31, 35 AND 44). REG. 6-15-1999.
- 2,252,532. FORMULA CARBIDES FROM KWIK-WAY AND DESIGN. INT. CL. 7. (U.S. CLS. 13, 19, 21, 23, 31, 34 AND 35). REG. 6-15-1999.
- 2,252,597. TDL AND DESIGN. INT. CL. 9. (U.S. CLS. 21, 23, 26, 36 AND 38). REG. 6-15-1999.
- 2,253,174. NSDI YOUR BEST DEFENSE AND DESIGN. INT. CL. 41. (U.S. CLS. 100, 101 AND 107). REG. 6-15-1999.

- 2,253,545. AMI. INT. CL. 41. (U.S. CLS. 100, 101 AND 107). REG. 6-15-1999.
- 2,253,922. THE ORIGINAL PETER AUSTIN BRICK KETTLE BREWING SYSTEM. INT. CL. 21. (U.S. CLS. 2, 13, 23, 29, 30, 33, 40 AND 50). REG. 6-15-1999.
- 2,254,080. EM RECYCLER. INT. CL. 6. (U.S. CLS. 2, 12, 13, 14, 23, 25 AND 50). REG. 6-15-1999.
- 2,254,553. SOIL SCREW. INT. CL. 6. (U.S. CLS. 2, 12, 13, 14, 23, 25 AND 50). REG. 6-15-1999.
- 2,255,061. INTERNATIONAL ASSOCIATION OF ELECTRICAL INSPECTORS. U.S. CL. 200. REG. 6-22-1999.
- 2,255,106. ROADS SCHOLAR. INT. CL. 36. (U.S. CLS. 100, 101 AND 102). REG. 6-22-1999.
- 2,256,059. PERCSCOPE. INT. CL. 10. (U.S. CLS. 26, 39 AND 44). REG. 6-22-1999.
- 2,256,284. THE CONVENIENCE STORES OF THE METAL INDUSTRY. INT. CL. 35. (U.S. CLS. 100, 101 AND 102). REG. 6-29-1999.
- 2,256,453. J DR. JEFF AND DESIGN. INT. CL. 3. (U.S. CLS. 1, 4, 6, 50, 51 AND 52). REG. 6-29-1999.
- 2,256,466. BACKPACKERS' CACHE AND DESIGN. INT. CL. 21. (U.S. CLS. 2, 13, 23, 29, 30, 33, 40 AND 50). REG. 6-29-1999.
- 2,256,493. LOS ANGELES LAKERS AND DESIGN. INT. CL. 18. (U.S. CLS. 1, 2, 3, 22 AND 41). REG. 6-29-1999.
- 2,256,568. MEMPHIS CHAMPIONSHIP BARBECUE AND DESIGN. INT. CL. 42. (U.S. CLS. 100 AND 101). REG. 6-29-1999.
- 2,256,636. RAINBOW CHUBS. INT. CL. 16. (U.S. CLS. 2, 5, 22, 23, 29, 37, 38 AND 50). REG. 6-29-1999.
- 2,256,870. YUKON AND DESIGN. INT. CL. 25. (U.S. CLS. 22 AND 39). REG. 6-29-1999.
- 2,257,099. INCHLINE. INT. CL. 9. (U.S. CLS. 21, 23, 26, 36 AND 38). REG. 6-29-1999.
- 2,257,142. LONG BOW GOLF CLUB AND DESIGN. INT. CL. 28. (U.S. CLS. 22, 23, 38 AND 50). REG. 6-29-1999.
- 2,257,299. SAMANTHA SPRINGS. INT. CL. 32. (U.S. CLS. 45, 46 AND 48). REG. 6-29-1999.
- 2,257,410. CHEF'S PRIDE. INT. CL. 16. (U.S. CLS. 2, 5, 22, 23, 29, 37, 38 AND 50). REG. 6-29-1999.
- 2,257,872. EZ MONEY. INT. CL. 36. (U.S. CLS. 100, 101 AND 102). REG. 6-29-1999.
- 2,257,895. TEAM SHERIFF RACING. INT. CL. 41. (U.S. CLS. 100, 101 AND 107). REG. 6-29-1999.
- 2,258,322. BLADE. INT. CL. 12. (U.S. CL. 19). REG. 7-6-1999.
- 2,258,348. AUTO LOCK. INT. CL. 8. (U.S. CLS. 23, 28 AND 44). REG. 7-6-1999.
- 2,258,440. THE WOODBRIDGE GROUP. INT. CLS. 35, 40 AND 42. (U.S. CLS. 100, 101, 102, 103 AND 106). REG. 7-6-1999.
- 2,258,601. LIPOMED. INT. CLS. 5 AND 42. (U.S. CLS. 6, 18, 44, 46, 51, 52, 100 AND 101). REG. 7-6-1999.
- 2,258,692. TC AND DESIGN. INT. CL. 3. (U.S. CLS. 1, 4, 6, 50, 51 AND 52). REG. 7-6-1999.
- 2,258,695. GOLDWATER'S. INT. CLS. 16, 29 AND 30 ONLY. (U.S. CLS. 2, 5, 22, 23, 29, 37, 38, 46 AND 50). REG. 7-6-1999.
- 2,258,732. VIEWLOADER. INT. CL. 28. (U.S. CLS. 22, 23, 38 AND 50). REG. 7-6-1999.
- 2,259,021. FOLD EMS. INT. CL. 16. (U.S. CLS. 2, 5, 22, 23, 29, 37, 38 AND 50). REG. 7-6-1999.
- 2,259,379. KOESTER COMFORT PLUS AND DESIGN. INT. CL. 16. (U.S. CLS. 2, 5, 22, 23, 29, 37, 38 AND 50). REG. 7-6-1999.
- 2,259,768. LIFESAVER (STYLIZED). INT. CL. 9. (U.S. CLS. 21, 23, 26, 36 AND 38). REG. 7-6-1999.
- 2,259,785. BLACK COYOTE. INT. CL. 28 ONLY. (U.S. CLS. 22, 23, 38 AND 50). REG. 7-6-1999.
- 2,260,044. DALLAS IS DIVERSITY. INT. CLS. 16 AND 41. (U.S. CLS. 2, 5, 22, 23, 29, 37, 38, 50, 100, 101 AND 107). REG. 7-6-1999.
- 2,260,069. MISTO. INT. CL. 30. (U.S. CL. 46). REG. 7-6-1999.
- 2,260,079. FAUS FLOOR. INT. CL. 19. (U.S. CLS. 1, 12, 33 AND 50). REG. 7-6-1999.
- 2,260,188. PATAGONIA. INT. CLS. 35 AND 42. (U.S. CLS. 100, 101 AND 102). REG. 7-13-1999.
- 2,260,196. AMPLICOR HIV-1 MONITOR. INT. CLS. 1 AND 5. (U.S. CLS. 1, 5, 6, 10, 18, 26, 44, 46, 51 AND 52). REG. 7-13-1999.
- 2,260,224. KTU. INT. CL. 38. (U.S. CLS. 100, 101 AND 104). REG. 7-13-1999.
- 2,260,281. A PROMISE TO KEEP. INT. CLS. 9 AND 16. (U.S. CLS. 2, 5, 21, 22, 23, 26, 29, 36, 37, 38 AND 50). REG. 7-13-1999.
- 2,260,282. ELITE BROKERAGE. INT. CL. 36. (U.S. CLS. 100, 101 AND 102). REG. 7-13-1999.
- 2,260,294. SURVEY1. INT. CL. 9. (U.S. CLS. 21, 23, 26, 36 AND 38). REG. 7-13-1999.
- 2,260,305. HAN-EASY LOCK. INT. CL. 9. (U.S. CLS. 21, 23, 26, 36 AND 38). REG. 7-13-1999.
- 2,260,361. PARTNERS FOR SUCCESS. INT. CL. 35. (U.S. CLS. 100, 101 AND 102). REG. 7-13-1999.
- 2,260,385. BIG APPLE BAGELS. INT. CLS. 30, 35 AND 42. (U.S. CLS. 46, 100, 101 AND 102). REG. 7-13-1999.
- 2,260,451. DIAMOND GRADE. INT. CL. 17. (U.S. CLS. 1, 5, 12, 13, 35 AND 50). REG. 7-13-1999.
- 2,260,473. SEXPO. INT. CL. 35. (U.S. CLS. 100, 101 AND 102). REG. 7-13-1999.
- 2,260,561. JOBSITE. INT. CL. 16. (U.S. CLS. 2, 5, 22, 23, 29, 37, 38 AND 50). REG. 7-13-1999.
- 2,260,626. APPLIED BIOSYSTEMS. INT. CL. 1. (U.S. CLS. 1, 5, 6, 10, 26 AND 46). REG. 7-13-1999.
- 2,260,658. WHITE STAG. INT. CL. 18. (U.S. CLS. 1, 2, 3, 22 AND 41). REG. 7-13-1999.
- 2,260,679. WHITE STAG (STYLIZED). INT. CL. 18. (U.S. CLS. 1, 2, 3, 22 AND 41). REG. 7-13-1999.
- 2,260,704. 1ST FOODS. INT. CL. 5. (U.S. CLS. 6, 18, 44, 46, 51 AND 52). REG. 7-13-1999.
- 2,260,826. RED ROCK TECHNOLOGIES AND DESIGN. INT. CL. 9. (U.S. CLS. 21, 23, 26, 36 AND 38). REG. 7-13-1999.
- 2,260,848. SHC DIRECT. INT. CL. 35. (U.S. CLS. 100, 101 AND 102). REG. 7-13-1999.
- 2,260,858. Q-GARD. INT. CL. 9. (U.S. CLS. 21, 23, 26, 36 AND 38). REG. 7-13-1999.
- 2,260,869. ACME TRANSFORMER. INT. CL. 9. (U.S. CLS. 21, 23, 26, 36 AND 38). REG. 7-13-1999.
- 2,260,883. AMI ANEMIA MANAGEMENT INSTITUTE. INT. CL. 41. (U.S. CLS. 100, 101 AND 107). REG. 7-13-1999.
- 2,260,945. FRELONGOLD. INT. CL. 4. (U.S. CLS. 1, 6 AND 15). REG. 7-13-1999.
- 2,260,990. CEMBEX. INT. CL. 35. (U.S. CLS. 100, 101 AND 102). REG. 7-13-1999.
- 2,261,144. HEALTHTEK VENTURES. INT. CL. 35. (U.S. CLS. 100, 101 AND 102). REG. 7-13-1999.
- 2,261,211. MILE HIGH. INT. CL. 30. (U.S. CL. 46). REG. 7-13-1999.
- 2,261,259. TETRA OMEGA ANTIOXIDANTS. INT. CL. 5. (U.S. CLS. 6, 18, 44, 46, 51 AND 52). REG. 7-13-1999.
- 2,261,303. WORLD GOLF VILLAGE AND DESIGN. INT. CL. 14. (U.S. CLS. 2, 27, 28 AND 50). REG. 7-13-1999.
- 2,261,361. U S AIRWAYS SHUTTLE AND DESIGN. INT. CL. 39. (U.S. CLS. 100 AND 105). REG. 7-13-1999.
- 2,261,383. PCPOS. INT. CL. 9. (U.S. CLS. 21, 23, 26, 36 AND 38). REG. 7-13-1999.
- 2,261,437. MPORT. INT. CL. 10. (U.S. CLS. 26, 39 AND 44). REG. 7-13-1999.
- 2,261,510. HYDROFLEX. INT. CL. 9. (U.S. CLS. 21, 23, 26, 36 AND 38). REG. 7-13-1999.
- 2,261,585. ANYWHERE. INT. CL. 28. (U.S. CLS. 22, 23, 38 AND 50). REG. 7-13-1999.
- 2,261,660. ENTELLIGENCE. INT. CL. 35. (U.S. CLS. 100, 101 AND 102). REG. 7-13-1999.
- 2,261,664. ICEPRESSO. INT. CL. 32. (U.S. CLS. 45, 46 AND 48). REG. 7-13-1999.
- 2,261,718. GENERAL FOODS INTERNATIONAL. INT. CL. 30. (U.S. CL. 46). REG. 7-13-1999.
- 2,261,806. PONCHO PUNCH. INT. CL. 30. (U.S. CL. 46). REG. 7-20-1999.
- 2,261,831. BALANCE (STYLIZED). INT. CL. 35 ONLY. (U.S. CLS. 100, 101 AND 102). REG. 7-20-1999.
- 2,261,834. BALANCE. INT. CLS. 35 AND 42. (U.S. CLS. 100, 101 AND 102). REG. 7-20-1999.
- 2,261,839. DYNETICS. INT. CLS. 9 AND 40 ONLY. (U.S. CLS. 21, 23, 26, 36, 38, 100, 103 AND 106). REG. 7-20-1999.
- 2,261,976. TORINO PASTICCERIA AND DESIGN. INT. CL. 30. (U.S. CL. 46). REG. 7-20-1999.
- 2,262,102. INTREL (STYLIZED). INT. CL. 24. (U.S. CLS. 42 AND 50). REG. 7-20-1999.
- 2,262,147. TBII. INT. CL. 9. (U.S. CLS. 21, 23, 26, 36 AND 38). REG. 7-20-1999.

- 2,262,209. ECOHEAT. INT. CL. 11. (U.S. CLS. 13, 21, 23, 31 AND 34). REG. 7-20-1999.
- 2,262,239. DIRECTION AND DESIGN. INT. CL. 16. (U.S. CLS. 2, 5, 22, 23, 29, 37, 38 AND 50). REG. 7-20-1999.
- 2,262,270. THE ORIGINAL CELEBRATED CURIOUSLY STRONG MINTS. INT. CL. 30. (U.S. CL. 46). REG. 7-20-1999.
- 2,262,297. A. JAFFE UNITY RING. INT. CL. 14. (U.S. CLS. 2, 27, 28 AND 50). REG. 7-20-1999.
- 2,262,316. PARTNERS NATIONAL HEALTH PLANS OF NORTH CAROLINA, INC.. INT. CL. 36. (U.S. CLS. 100, 101 AND 102). REG. 7-20-1999.
- 2,262,385. SUPER LUBE. INT. CL. 4. (U.S. CLS. 1, 6 AND 15). REG. 7-20-1999.
- 2,262,538. CAFFE ORIGINS (STYLIZED). INT. CL. 30. (U.S. CL. 46). REG. 7-20-1999.
- 2,262,588. BRIGHTON AND DESIGN. INT. CL. 35. (U.S. CLS. 100, 101 AND 102). REG. 7-20-1999.
- 2,262,785. NUTRITION FOR LIFE INTERNATIONAL. INT. CLS. 35 AND 41. (U.S. CLS. 100, 101, 102 AND 107). REG. 7-20-1999.
- 2,262,833. BROWN GOLD. INT. CL. 30. (U.S. CL. 46). REG. 7-20-1999.
- 2,262,948. INCENTIVE EXCHANGE. INT. CL. 35. (U.S. CLS. 100, 101 AND 102). REG. 7-20-1999.
- 2,262,980. THE REAL SOURCE. INT. CL. 35. (U.S. CLS. 100, 101 AND 102). REG. 7-20-1999.
- 2,263,050. SNAPEASE. INT. CL. 9. (U.S. CLS. 21, 23, 26, 36 AND 38). REG. 7-20-1999.
- 2,263,092. THE LEGAL RUNAROUND. INT. CL. 41. (U.S. CLS. 100, 101 AND 107). REG. 7-20-1999.
- 2,263,095. EXPRESSNEWS.COM. INT. CL. 35 ONLY. (U.S. CLS. 100, 101 AND 102). REG. 7-20-1999.
- 2,263,139. WALTER AND DESIGN. INT. CL. 9. (U.S. CLS. 21, 23, 26, 36 AND 38). REG. 7-20-1999.
- 2,263,176. 100% PURE FLORIDA AND DESIGN. U.S. CL. A. REG. 7-20-1999.
- 2,263,222. MASTERCHEF AND DESIGN. INT. CL. 29. (U.S. CL. 46). REG. 7-20-1999.
- 2,263,291. NORTHERN CHEF. INT. CL. 29. (U.S. CL. 46). REG. 7-20-1999.
- 2,263,361. FRONTIER. INT. CLS. 3, 5, 29 AND 30. (U.S. CLS. 1, 4, 6, 18, 44, 46, 50, 51 AND 52). REG. 7-20-1999.
- 2,263,463. SMARTVEYOR. INT. CL. 7. (U.S. CLS. 13, 19, 21, 23, 31, 34 AND 35). REG. 7-20-1999.
- 2,263,495. MORE THAN A GAME. INT. CL. 41. (U.S. CLS. 100, 101 AND 107). REG. 7-20-1999.
- 2,263,526. MISCELLANEOUS DESIGN. INT. CL. 9. (U.S. CLS. 21, 23, 26, 36 AND 38). REG. 7-20-1999.
- 2,263,621. CITIBUSINESS. INT. CL. 36. (U.S. CLS. 100, 101 AND 102). REG. 7-20-1999.
- 2,263,674. FXPARTNER. INT. CL. 36 ONLY. (U.S. CLS. 100, 101 AND 102). REG. 7-20-1999.
- 2,263,736. DETROIT SHOCK AND DESIGN. INT. CL. 25. (U.S. CLS. 22 AND 39). REG. 7-20-1999.
- 2,263,771. KAYEM PREMIUM QUALITY DELI AND DESIGN. INT. CL. 29. (U.S. CL. 46). REG. 7-20-1999.
- 2,263,899. SURE-GRIP. INT. CL. 7. (U.S. CLS. 13, 19, 21, 23, 31, 34 AND 35). REG. 7-27-1999.
- 2,263,919. NEWPORT. INT. CL. 9. (U.S. CLS. 21, 23, 26, 36 AND 38). REG. 7-27-1999.
- 2,264,042. MASARICA. INT. CL. 30. (U.S. CL. 46). REG. 7-27-1999.
- 2,264,046. SMART FUEL AND DESIGN. INT. CL. 5. (U.S. CLS. 6, 18, 44, 46, 51 AND 52). REG. 7-27-1999.
- 2,264,078. FLORACOLOR. INT. CL. 35. (U.S. CLS. 100, 101 AND 102). REG. 7-27-1999.
- 2,264,093. THOROUGHbred TIMES STALLION DIRECTORY. INT. CLS. 16 AND 42. (U.S. CLS. 2, 5, 22, 23, 29, 37, 38, 50, 100 AND 101). REG. 7-27-1999.
- 2,264,094. REPTILES. INT. CLS. 16 AND 42. (U.S. CLS. 2, 5, 22, 23, 29, 37, 38, 50, 100 AND 101). REG. 7-27-1999.
- 2,264,215. MISCELLANEOUS DESIGN. INT. CL. 39. (U.S. CLS. 100 AND 105). REG. 7-27-1999.
- 2,264,243. S SPOTCO AND DESIGN. INT. CL. 35. (U.S. CLS. 100, 101 AND 102). REG. 7-27-1999.
- 2,264,269. LOGO GEAR AND DESIGN. INT. CLS. 40 AND 42. (U.S. CLS. 100, 101, 103 AND 106). REG. 7-27-1999.
- 2,264,316. THE HARTFORD. INT. CLS. 5, 6, 8, 14, 16, 18, 21, 24, 25, 26 AND 28 ONLY. (U.S. CLS. 1, 2, 3, 5, 6, 12, 13, 14, 18, 22, 23, 25, 27, 28, 29, 30, 33, 37, 38, 39, 40, 41, 42, 44, 46, 50, 51 AND 52). REG. 7-27-1999.
- 2,264,440. CENTRAL PARKING CORPORATION. INT. CLS. 35 AND 39. (U.S. CLS. 100, 101, 102 AND 105). REG. 7-27-1999.
- 2,264,483. AXR. INT. CL. 16. (U.S. CLS. 2, 5, 22, 23, 29, 37, 38 AND 50). REG. 7-27-1999.
- 2,264,485. NATURE'S GIFT AND DESIGN. INT. CL. 1. (U.S. CLS. 1, 5, 6, 10, 26 AND 46). REG. 7-27-1999.
- 2,264,838. HR MATTERS. INT. CLS. 16 AND 42. (U.S. CLS. 2, 5, 22, 23, 29, 37, 38, 50, 100 AND 101). REG. 7-27-1999.
- 2,265,120. OCEANIC. INT. CL. 29. (U.S. CL. 46). REG. 7-27-1999.
- 2,265,594. A AND DESIGN. INT. CL. 41. (U.S. CLS. 100, 101 AND 107). REG. 7-27-1999.
- 2,265,662. SAFE WHITE. INT. CL. 16. (U.S. CLS. 2, 5, 22, 23, 29, 37, 38 AND 50). REG. 7-27-1999.
- 2,265,697. SOFT CLICK (STYLIZED). INT. CL. 16. (U.S. CLS. 2, 5, 22, 23, 29, 37, 38 AND 50). REG. 7-27-1999.
- 2,265,807. PAINT FOR ARTS & CRAFTS AND DESIGN. INT. CL. 16. (U.S. CLS. 2, 5, 22, 23, 29, 37, 38 AND 50). REG. 7-27-1999.
- 2,265,922. TRUST HAND CRAFTED FOR PREMIUM PERFORMANCE BY XANAX AND DESIGN. INT. CL. 28. (U.S. CLS. 22, 23, 38 AND 50). REG. 8-3-1999.
- 2,265,935. THE POCKET COACH. INT. CLS. 9 AND 16. (U.S. CLS. 2, 5, 21, 22, 23, 26, 29, 36, 37, 38 AND 50). REG. 8-3-1999.
- 2,266,115. FORMULA ABRASIVES FROM KWIK-WAY AND DESIGN. INT. CL. 7. (U.S. CLS. 13, 19, 21, 23, 31, 34 AND 35). REG. 8-3-1999.
- 2,266,257. DATA EXCHANGE CORPORATION. INT. CL. 37. (U.S. CLS. 100, 103 AND 106). REG. 8-3-1999.
- 2,266,270. CMRS STIMULUS. INT. CL. 41. (U.S. CLS. 100, 101 AND 107). REG. 8-3-1999.
- 2,266,332. AMERICANS FOR FAIR TAXATION. INT. CL. 42. (U.S. CLS. 100 AND 101). REG. 8-3-1999.
- 2,266,402. MISCELLANEOUS DESIGN. INT. CLS. 25 AND 41. (U.S. CLS. 22, 39, 100, 101 AND 107). REG. 8-3-1999.
- 2,266,828. CENTRAL FIREPLACE. INT. CL. 11. (U.S. CLS. 13, 21, 23, 31 AND 34). REG. 8-3-1999.
- 2,266,863. LIFE SEAL. INT. CL. 17. (U.S. CLS. 1, 5, 12, 13, 35 AND 50). REG. 8-3-1999.
- 2,266,907. MULTI-MILE. INT. CL. 12. (U.S. CLS. 19, 21, 23, 31, 35 AND 44). REG. 8-3-1999.
- 2,267,104. WE TRAVEL THE ENVIRONMENTAL WORLD. INT. CL. 37. (U.S. CLS. 100, 103 AND 106). REG. 8-3-1999.
- 2,267,105. GET TO KNOW US BEFORE ALL HELL BREAKS LOOSE. INT. CL. 37. (U.S. CLS. 100, 103 AND 106). REG. 8-3-1999.
- 2,267,232. WHITE OAK AND DESIGN. INT. CLS. 41 AND 42. (U.S. CLS. 100, 101 AND 107). REG. 8-3-1999.
- 2,267,340. MASTER CHEF. INT. CL. 29. (U.S. CL. 46). REG. 8-3-1999.
- 2,267,508. BOOKETTE. INT. CL. 42. (U.S. CLS. 100 AND 101). REG. 8-3-1999.
- 2,267,654. LOOK. INT. CL. 36. (U.S. CLS. 100, 101 AND 102). REG. 8-3-1999.
- 2,267,718. GOOD CENTS. INT. CL. 42. (U.S. CLS. 100 AND 101). REG. 8-3-1999.
- 2,267,861. WHOLEAVES AND DESIGN. INT. CL. 31. (U.S. CLS. 1 AND 46). REG. 8-3-1999.
- 2,268,049. CORPORATE ASSETS INC.. INT. CL. 35. (U.S. CLS. 100, 101 AND 102). REG. 8-10-1999.
- 2,268,263. VACOFLEX. INT. CL. 6. (U.S. CLS. 2, 12, 13, 14, 23, 25 AND 50). REG. 8-10-1999.
- 2,268,687. LUCIEN ALBRECHT. INT. CL. 33. (U.S. CLS. 47 AND 49). REG. 8-10-1999.
- 2,268,825. C.R. CHICKS. INT. CL. 42. (U.S. CLS. 100 AND 101). REG. 8-10-1999.
- 2,268,869. TERRA-MULCH. INT. CL. 31. (U.S. CLS. 1 AND 46). REG. 8-10-1999.
- 2,268,870. TERRA MULCH AND DESIGN. INT. CL. 31. (U.S. CLS. 1 AND 46). REG. 8-10-1999.
- 2,269,046. WORLDPROOF. INT. CL. 18. (U.S. CLS. 1, 2, 3, 22 AND 41). REG. 8-10-1999.
- 2,269,122. L DE L AND DESIGN. INT. CL. 3. (U.S. CLS. 1, 4, 6, 50, 51 AND 52). REG. 8-10-1999.

- 2,269,541. WNBA AND DESIGN. INT. CL. 28. (U.S. CLS. 22, 23, 38 AND 50). REG. 8-10-1999.
- 2,269,837. DETROIT SHOCK AND DESIGN. INT. CL. 41. (U.S. CLS. 100, 101 AND 107). REG. 8-10-1999.
- 2,269,872. SPILLSOLV. INT. CL. 1. (U.S. CLS. 1, 5, 6, 10, 26 AND 46). REG. 8-10-1999.
- 2,270,105. SUNWA (STYLIZED). INT. CL. 7. (U.S. CLS. 13, 19, 21, 23, 31, 34 AND 35). REG. 8-17-1999.
- 2,270,745. KANSAS CITY KITTY DREAM BOOK AND DESIGN. INT. CL. 16. (U.S. CLS. 2, 5, 22, 23, 29, 37, 38 AND 50). REG. 8-17-1999.
- 2,270,802. MISCELLANEOUS DESIGN. INT. CL. 41. (U.S. CLS. 100, 101 AND 107). REG. 8-17-1999.
- 2,271,024. SEMPERMED SUPREME. INT. CL. 10. (U.S. CLS. 26, 39 AND 44). REG. 8-17-1999.
- 2,271,348. THE GLOBAL CLASSROOM. INT. CL. 39. (U.S. CLS. 100 AND 105). REG. 8-24-1999.
- 2,271,497. SEMIVAC. INT. CL. 6. (U.S. CLS. 2, 12, 13, 14, 23, 25 AND 50). REG. 8-24-1999.
- 2,271,897. MISCELLANEOUS DESIGN. INT. CL. 9. (U.S. CLS. 21, 23, 26, 36 AND 38). REG. 8-24-1999.
- 2,271,949. LONGBOW GOLF CLUB AND DESIGN. INT. CL. 41. (U.S. CLS. 100, 101 AND 107). REG. 8-24-1999.
- 2,272,344. JOSEFINA. INT. CL. 42. (U.S. CLS. 100 AND 101). REG. 8-24-1999.
- 2,272,505. WILLOWBE WOODS CAMPFIRE STORIES. INT. CL. 16. (U.S. CLS. 2, 5, 22, 23, 29, 37, 38 AND 50). REG. 8-24-1999.
- 2,272,597. DIVIDENDS. INT. CL. 20. (U.S. CLS. 2, 13, 22, 25, 32 AND 50). REG. 8-24-1999.
- 2,272,683. POINTSFINDER. INT. CL. 9. (U.S. CLS. 21, 23, 26, 36 AND 38). REG. 8-24-1999.
- 2,272,726. RRPAS. INT. CL. 9. (U.S. CLS. 21, 23, 26, 36 AND 38). REG. 8-24-1999.
- 2,272,799. NY AND DESIGN. INT. CL. 25. (U.S. CLS. 22 AND 39). REG. 8-24-1999.
- 2,273,129. TELEVISION GAMES. INT. CL. 41. (U.S. CLS. 100, 101 AND 107). REG. 8-24-1999.
- 2,273,213. TIGER SHARK AND DESIGN. INT. CL. 28 ONLY. (U.S. CLS. 22, 23, 38 AND 50). REG. 8-31-1999.
- 2,273,218. L S D I LINE SHARE DEVICES INC. AND DESIGN. INT. CL. 9. (U.S. CLS. 21, 23, 26, 36 AND 38). REG. 8-31-1999.
- 2,273,608. ADSI. INT. CL. 9. (U.S. CLS. 21, 23, 26, 36 AND 38). REG. 8-31-1999.
- 2,273,813. MANAGING YOUR CAREER. INT. CL. 16. (U.S. CLS. 2, 5, 22, 23, 29, 37, 38 AND 50). REG. 8-31-1999.
- 2,273,851. NOTHING TO IT! AND DESIGN. INT. CL. 41. (U.S. CLS. 100, 101 AND 107). REG. 8-31-1999.
- 2,273,928. FIDELITY RETIREMENT RESERVES. INT. CL. 36. (U.S. CLS. 100, 101 AND 102). REG. 8-31-1999.
- 2,273,994. SARANAC. INT. CL. 16. (U.S. CLS. 2, 5, 22, 23, 29, 37, 38 AND 50). REG. 8-31-1999.
- 2,274,146. A ACME TRANSFORMER AND DESIGN. INT. CL. 9. (U.S. CLS. 21, 23, 26, 36 AND 38). REG. 8-31-1999.
- 2,274,291. CHOICEONE. INT. CL. 36. (U.S. CLS. 100, 101 AND 102). REG. 8-31-1999.
- 2,274,491. SIA AND DESIGN. INT. CL. 42. (U.S. CLS. 100 AND 101). REG. 8-31-1999.
- 2,274,546. ELLIOT. INT. CL. 35. (U.S. CLS. 100, 101 AND 102). REG. 8-31-1999.
- 2,274,792. MISCELLANEOUS DESIGN. INT. CL. 41. (U.S. CLS. 100, 101 AND 107). REG. 8-31-1999.
- 2,274,982. LYCRA AND DESIGN. INT. CL. 25. (U.S. CLS. 22 AND 39). REG. 8-31-1999.
- 2,274,994. VELOURS. INT. CL. 21. (U.S. CLS. 2, 13, 23, 29, 30, 33, 40 AND 50). REG. 8-31-1999.
- 2,275,292. CTS AND DESIGN. INT. CL. 35. (U.S. CLS. 100, 101 AND 102). REG. 9-7-1999.
- 2,275,800. "EVERY PIECE OF JEWELRY HAS A STORY TO TELL ...". INT. CL. 35. (U.S. CLS. 100, 101 AND 102). REG. 9-7-1999.
- 2,275,811. PRO-METER. INT. CL. 7. (U.S. CLS. 13, 19, 21, 23, 31, 34 AND 35). REG. 9-7-1999.
- 2,276,047. FAAST (STYLIZED). INT. CL. 9. (U.S. CLS. 21, 23, 26, 36 AND 38). REG. 9-7-1999.
- 2,276,439. MANAGING COMMUNICATIONS FOR YOUR FUTURE. INT. CL. 9. (U.S. CLS. 21, 23, 26, 36 AND 38). REG. 9-7-1999.
- 2,277,318. SOCIETY OF ST. VINCENT DE PAUL U.S.A. ST V D E P AND DESIGN. INT. CLS. 35 AND 42. (U.S. CLS. 100, 101 AND 102). REG. 9-14-1999.
- 2,277,346. AMERICAN PRODUCTIVITY & QUALITY CENTER. INT. CL. 16. (U.S. CLS. 2, 5, 22, 23, 29, 37, 38 AND 50). REG. 9-14-1999.
- 2,277,395. MASI. INT. CL. 12. (U.S. CLS. 19, 21, 23, 31, 35 AND 44). REG. 9-14-1999.
- 2,277,502. NFB NATIONAL FEDERATION OF THE BLIND AND DESIGN. INT. CLS. 21 AND 25 ONLY. (U.S. CLS. 2, 13, 22, 23, 29, 30, 33, 39, 40 AND 50). REG. 9-14-1999.
- 2,277,577. PRO TAPER (STYLIZED). INT. CL. 12. (U.S. CLS. 19, 21, 23, 31, 35 AND 44). REG. 9-14-1999.
- 2,277,925. CHOICE ONE (STYLIZED). INT. CL. 36. (U.S. CLS. 100, 101 AND 102). REG. 9-14-1999.
- 2,278,257. VERSACE. INT. CL. 42. (U.S. CLS. 100 AND 101). REG. 9-14-1999.
- 2,279,043. MISCELLANEOUS DESIGN. INT. CL. 39. (U.S. CLS. 100 AND 105). REG. 9-21-1999.
- 2,279,137. J.P. AND DESIGN. INT. CL. 14. (U.S. CLS. 2, 27, 28 AND 50). REG. 9-21-1999.
- 2,280,114. TENDER SALT. INT. CL. 29. (U.S. CL. 46). REG. 9-21-1999.
- 2,280,244. MISCELLANEOUS DESIGN. INT. CL. 17. (U.S. CLS. 1, 5, 12, 13, 35 AND 50). REG. 9-28-1999.
- 2,280,279. VACODYM. INT. CLS. 6, 7 AND 9. (U.S. CLS. 2, 12, 13, 14, 19, 21, 23, 25, 26, 31, 34, 35, 36, 38 AND 50). REG. 9-28-1999.
- 2,281,416. MILLENNIUM HEALTHCARE CONSULTING, INC.. INT. CL. 35. (U.S. CLS. 100, 101 AND 102). REG. 9-28-1999.
- 2,281,438. REALLY RIGHT STUFF (STYLIZED). INT. CL. 9. (U.S. CLS. 21, 23, 26, 36 AND 38). REG. 9-28-1999.
- 2,281,800. NURTURING STRENGTHS THAT LAST A LIFETIME. INT. CL. 42. (U.S. CLS. 100 AND 101). REG. 9-28-1999.
- 2,281,832. SIROCO. INT. CL. 33. (U.S. CLS. 47 AND 49). REG. 9-28-1999.
- 2,281,844. DOUBLE DIAMOND ATHLETIC CLUB. INT. CL. 41. (U.S. CLS. 100, 101 AND 107). REG. 9-28-1999.
- 2,281,972. FERRIS STATE UNIVERSITY. INT. CLS. 16, 21, 25 AND 41. (U.S. CLS. 2, 5, 13, 22, 23, 29, 30, 33, 37, 38, 39, 40, 50, 100, 101 AND 107). REG. 9-28-1999.
- 2,282,220. PROGRAM-A-STREAM. INT. CL. 9. (U.S. CLS. 21, 23, 26, 36 AND 38). REG. 9-28-1999.
- 2,282,946. ALLEGRO. INT. CLS. 7, 9 AND 11. (U.S. CLS. 13, 19, 21, 23, 26, 31, 34, 35, 36 AND 38). REG. 10-5-1999.
- 2,283,080. MISCELLANEOUS DESIGN. INT. CLS. 36 AND 37. (U.S. CLS. 100, 101, 102, 103 AND 106). REG. 10-5-1999.
- 2,283,402. BROADWAY BOUND. INT. CL. 41. (U.S. CLS. 100, 101 AND 107). REG. 10-5-1999.
- 2,283,977. PROFORME. INT. CL. 21. (U.S. CLS. 2, 13, 23, 29, 30, 33, 40 AND 50). REG. 10-5-1999.
- 2,284,254. FIRE STORM. INT. CL. 6. (U.S. CLS. 2, 12, 13, 14, 23, 25 AND 50). REG. 10-5-1999.
- 2,284,708. WILLIAMSBURG. INT. CL. 24. (U.S. CLS. 42 AND 50). REG. 10-12-1999.
- 2,284,720. AT-MAR. INT. CLS. 9 AND 40. (U.S. CLS. 21, 23, 26, 36, 38, 100, 103 AND 106). REG. 10-12-1999.
- 2,284,957. MAESTROSOFT. INT. CL. 9. (U.S. CLS. 21, 23, 26, 36 AND 38). REG. 10-12-1999.
- 2,285,158. CHALET (STYLIZED). INT. CL. 12. (U.S. CLS. 19, 21, 23, 31, 35 AND 44). REG. 10-12-1999.
- 2,285,446. INSTANT AWARD SYSTEM. INT. CL. 42. (U.S. CLS. 100 AND 101). REG. 10-12-1999.
- 2,285,687. INTIYAN. INT. CL. 29. (U.S. CL. 46). REG. 10-12-1999.
- 2,285,737. ELECTRIC EYE ENTERTAINMENT. INT. CL. 9 ONLY. (U.S. CLS. 21, 23, 26, 36 AND 38). REG. 10-12-1999.
- 2,285,852. BLACK TAIL MAG. INT. CLS. 41 AND 42. (U.S. CLS. 100, 101 AND 107). REG. 10-12-1999.
- 2,286,052. RESORT BOOKINGS AND DESIGN. INT. CL. 35. (U.S. CLS. 100, 101 AND 102). REG. 10-12-1999.
- 2,286,382. IF YOU DON'T TAKE CARE OF YOUR BODY, WHERE ARE YOU GOING TO LIVE?. INT. CL. 3. (U.S. CLS. 1, 4, 6, 50, 51 AND 52). REG. 10-12-1999.
- 2,286,617. ROYAL II. INT. CL. 11. (U.S. CLS. 13, 21, 23, 31 AND 34). REG. 10-12-1999.
- 2,286,706. ETHERTRAK. INT. CL. 9. (U.S. CLS. 21, 23, 26, 36 AND 38). REG. 10-12-1999.
- 2,286,912. MEMORIAL. INT. CL. 28. (U.S. CLS. 22, 23, 38 AND 50). REG. 10-19-1999.

- 2,287,107. RAINFOREST. INT. CL. 11. (U.S. CLS. 13, 21, 23, 31 AND 34). REG. 10-19-1999.
- 2,287,192. REDI-FORM. INT. CL. 6. (U.S. CLS. 2, 12, 13, 14, 23, 25 AND 50). REG. 10-19-1999.
- 2,287,337. COLINK. INT. CL. 36. (U.S. CLS. 100, 101 AND 102). REG. 10-19-1999.
- 2,287,935. EXFIL. INT. CL. 35. (U.S. CLS. 100, 101 AND 102). REG. 10-19-1999.
- 2,288,421. BID ALERT. INT. CLS. 16 AND 35. (U.S. CLS. 2, 5, 22, 23, 29, 37, 38, 50, 100, 101 AND 102). REG. 10-26-1999.
- 2,288,625. TERC. INT. CL. 16. (U.S. CLS. 2, 5, 22, 23, 29, 37, 38 AND 50). REG. 10-26-1999.
- 2,288,991. LEAFSHIELD. INT. CL. 1. (U.S. CLS. 1, 5, 6, 10, 26 AND 46). REG. 10-26-1999.
- 2,289,177. FEMHRT. INT. CL. 5. (U.S. CLS. 6, 18, 44, 46, 51 AND 52). REG. 10-26-1999.
- 2,289,179. BIG TICKET TELEVISION AND DESIGN. INT. CL. 41. (U.S. CLS. 100, 101 AND 107). REG. 10-26-1999.
- 2,289,994. CAMPERS FOR CHRIST MINISTRIES AND DESIGN. INT. CL. 42. (U.S. CLS. 100 AND 101). REG. 11-2-1999.
- 2,290,011. MISCELLANEOUS DESIGN. INT. CL. 5. (U.S. CLS. 6, 18, 44, 46, 51 AND 52). REG. 11-2-1999.
- 2,291,065. ASCO GENERAL CONTROLS CP COMBUSTION PRODUCTS DISTRIBUTOR AND DESIGN. INT. CL. 35. (U.S. CLS. 100, 101 AND 102). REG. 11-9-1999.
- 2,291,143. MR. W. INT. CL. 35. (U.S. CLS. 100, 101 AND 102). REG. 11-9-1999.
- 2,291,220. KV AND DESIGN. INT. CL. 9. (U.S. CLS. 21, 23, 26, 36 AND 38). REG. 11-9-1999.
- 2,291,481. THE DELUXE STAND UP STAPLER AND DESIGN. INT. CL. 16. (U.S. CLS. 2, 5, 22, 23, 29, 37, 38 AND 50). REG. 11-9-1999.
- 2,291,569. THE SURVIVOR FLOORING SYSTEM. INT. CL. 27. (U.S. CLS. 19, 20, 37, 42 AND 50). REG. 11-9-1999.
- 2,291,813. POLY-C. INT. CL. 5. (U.S. CLS. 6, 18, 44, 46, 51 AND 52). REG. 11-16-1999.
- 2,292,077. CROESUS AND DESIGN. INT. CL. 5. (U.S. CLS. 6, 18, 44, 46, 51 AND 52). REG. 11-16-1999.
- 2,292,146. SUMIDRILL. INT. CL. 7. (U.S. CLS. 13, 19, 21, 23, 31, 34 AND 35). REG. 11-16-1999.
- 2,292,221. TWISTER. . . RIDE IT OUT. INT. CL. 41. (U.S. CLS. 100, 101 AND 107). REG. 11-16-1999.
- 2,292,317. MISCELLANEOUS DESIGN. INT. CL. 3. (U.S. CLS. 1, 4, 6, 50, 51 AND 52). REG. 11-16-1999.
- 2,294,052. SUMITURN. INT. CL. 7. (U.S. CLS. 13, 19, 21, 23, 31, 34 AND 35). REG. 11-23-1999.
- 2,294,097. HURRICANE. INT. CL. 7. (U.S. CLS. 13, 19, 21, 23, 31, 34 AND 35). REG. 11-23-1999.
- 2,294,133. FIT AND DESIGN. INT. CLS. 6, 7 AND 8. (U.S. CLS. 2, 12, 13, 14, 19, 21, 23, 25, 28, 31, 34, 35, 44 AND 50). REG. 11-23-1999.
- 2,294,175. THE WINGED M. INT. CL. 16. (U.S. CLS. 2, 5, 22, 23, 29, 37, 38 AND 50). REG. 11-23-1999.
- 2,294,176. MULTNOMAH ATHLETIC CLUB. INT. CL. 42. (U.S. CLS. 100 AND 101). REG. 11-23-1999.
- 2,294,445. SAFETEMP. INT. CL. 1. (U.S. CLS. 1, 5, 6, 10, 26 AND 46). REG. 11-23-1999.
- 2,294,854. AMES COLOR-FILE. INT. CL. 16. (U.S. CLS. 2, 5, 22, 23, 29, 37, 38 AND 50). REG. 11-30-1999.
- 2,295,162. TLG (STYLIZED). INT. CL. 9. (U.S. CLS. 21, 23, 26, 36 AND 38). REG. 11-30-1999.
- 2,295,390. M AND DESIGN. INT. CL. 25. (U.S. CLS. 22 AND 39). REG. 11-30-1999.
- 2,295,393. M AND DESIGN. INT. CL. 41. (U.S. CLS. 100, 101 AND 107). REG. 11-30-1999.
- 2,295,394. MULTNOMAH ATHLETIC CLUB. INT. CL. 41. (U.S. CLS. 100, 101 AND 107). REG. 11-30-1999.
- 2,295,398. M AND DESIGN. INT. CL. 42. (U.S. CLS. 100 AND 101). REG. 11-30-1999.
- 2,295,717. CHRISTINE MADDEN. INT. CL. 35. (U.S. CLS. 100, 101 AND 102). REG. 11-30-1999.
- 2,295,953. ARNOLD & PORTER. INT. CL. 42. (U.S. CLS. 100 AND 101). REG. 11-30-1999.
- 2,296,198. SKYLARK OLDE WORLD. INT. CL. 29. (U.S. CL. 46). REG. 11-30-1999.
- 2,297,039. ADIRONDACK. INT. CL. 16. (U.S. CLS. 2, 5, 22, 23, 29, 37, 38 AND 50). REG. 11-30-1999.
- 2,297,201. SCOTTS NO-QUIBBLE GUARANTEE. INT. CL. 36. (U.S. CLS. 100, 101 AND 102). REG. 12-7-1999.
- 2,297,235. ACR. INT. CL. 42. (U.S. CLS. 100 AND 101). REG. 12-7-1999.
- 2,297,278. PLATINUM HOME MORTGAGE CORPORATION. INT. CL. 36. (U.S. CLS. 100, 101 AND 102). REG. 12-7-1999.
- 2,297,499. MISCELLANEOUS DESIGN. INT. CL. 9. (U.S. CLS. 21, 23, 26, 36 AND 38). REG. 12-7-1999.
- 2,297,662. LONG BOW GOLF CLUB AND DESIGN. INT. CL. 25. (U.S. CLS. 22 AND 39). REG. 12-7-1999.
- 2,297,820. MISCELLANEOUS DESIGN. INT. CLS. 16 AND 41. (U.S. CLS. 2, 5, 22, 23, 29, 37, 38, 50, 100, 101 AND 107). REG. 12-7-1999.
- 2,298,648. NAAC. INT. CL. 1. (U.S. CLS. 1, 5, 6, 10, 26 AND 46). REG. 12-7-1999.
- 2,298,901. RITZ-CARLTON. INT. CL. 36. (U.S. CLS. 100, 101 AND 102). REG. 12-7-1999.
- 2,299,319. AIG RISK MANAGEMENT. INT. CL. 36. (U.S. CLS. 100, 101 AND 102). REG. 12-14-1999.
- 2,299,342. APQC. INT. CL. 41. (U.S. CLS. 100, 101 AND 107). REG. 12-14-1999.
- 2,299,564. MULTNOMAH ATHLETIC CLUB. INT. CL. 25. (U.S. CLS. 22 AND 39). REG. 12-14-1999.
- 2,299,654. PELLET-FLAME. INT. CL. 4. (U.S. CLS. 1, 6 AND 15). REG. 12-14-1999.
- 2,299,871. NEOLOID. INT. CL. 5. (U.S. CLS. 6, 18, 44, 46, 51 AND 52). REG. 12-14-1999.
- 2,299,940. VANADIS 4. INT. CL. 6. (U.S. CLS. 2, 12, 13, 14, 23, 25 AND 50). REG. 12-14-1999.
- 2,301,076. CASSANO. INT. CL. 34. (U.S. CLS. 2, 8, 9 AND 17). REG. 12-14-1999.
- 2,301,280. TEQUILERIA (STYLIZED). INT. CL. 42. (U.S. CLS. 100 AND 101). REG. 12-21-1999.
- 2,301,297. A AND DESIGN. INT. CL. 38. (U.S. CLS. 100, 101 AND 104). REG. 12-21-1999.
- 2,301,329. IT. INT. CL. 9. (U.S. CLS. 21, 23, 26, 36 AND 38). REG. 12-21-1999.
- 2,301,501. NUPARENT AND DESIGN. INT. CL. 41. (U.S. CLS. 100, 101 AND 107). REG. 12-21-1999.
- 2,301,629. THE CPA JOURNAL. INT. CL. 16. (U.S. CLS. 2, 5, 22, 23, 29, 37, 38 AND 50). REG. 12-21-1999.
- 2,301,762. MISSION SPRINGS. INT. CL. 41. (U.S. CLS. 100, 101 AND 107). REG. 12-21-1999.
- 2,301,907. QUADREL. INT. CL. 9. (U.S. CLS. 21, 23, 26, 36 AND 38). REG. 12-21-1999.
- 2,302,010. ROCK MAGIC. INT. CL. 2. (U.S. CLS. 6, 11 AND 16). REG. 12-21-1999.
- 2,302,879. STERLING AUTOBODY. INT. CL. 37. (U.S. CLS. 100, 103 AND 106). REG. 12-21-1999.
- 2,303,120. MISCELLANEOUS DESIGN. INT. CLS. 9, 37, 40, 41 AND 42 ONLY. (U.S. CLS. 21, 23, 26, 36, 38, 100, 101, 103, 106 AND 107 ONLY). REG. 12-28-1999.
- 2,303,540. THE COOLER AND DESIGN. INT. CL. 41 ONLY. (U.S. CLS. 100, 101 AND 107). REG. 12-28-1999.
- 2,303,791. TEMPO GRAPHICS. INT. CL. 42. (U.S. CLS. 100 AND 101). REG. 12-28-1999.
- 2,303,897. MISCELLANEOUS DESIGN. INT. CL. 36. (U.S. CLS. 100, 101 AND 102). REG. 12-28-1999.
- 2,304,343. TREASURES FROM THE SEA (STYLIZED). INT. CL. 29. (U.S. CL. 46). REG. 12-28-1999.
- 2,304,585. VECTRAK. INT. CL. 9. (U.S. CLS. 21, 23, 26, 36 AND 38). REG. 12-28-1999.
- 2,304,612. TEMPTELLER. INT. CL. 10. (U.S. CLS. 26, 39 AND 44). REG. 12-28-1999.
- 2,305,099. CAFE TACUBA. INT. CL. 16. (U.S. CLS. 2, 5, 22, 23, 29, 37, 38 AND 50). REG. 1-4-2000.
- 2,305,286. HOLI-UP AND DESIGN. INT. CL. 5. (U.S. CLS. 6, 18, 44, 46, 51 AND 52). REG. 1-4-2000.
- 2,305,357. SUPERIOR AND DESIGN. INT. CL. 1. (U.S. CLS. 1, 5, 6, 10, 26 AND 46). REG. 1-4-2000.
- 2,305,386. GATEWAY ACADEMY. INT. CL. 42. (U.S. CLS. 100 AND 101). REG. 1-4-2000.
- 2,305,425. THE COOLER AND DESIGN. INT. CL. 41 ONLY. (U.S. CLS. 100, 101 AND 107). REG. 1-4-2000.
- 2,305,505. ABA AMERICAN BUS ASSOCIATION AND DESIGN. INT. CL. 42. (U.S. CLS. 100 AND 101). REG. 1-4-2000.
- 2,305,583. LAGUNA TUMBLERS. INT. CL. 21. (U.S. CLS. 2, 13, 23, 29, 30, 33, 40 AND 50). REG. 1-4-2000.
- 2,306,518. PERVERSIVE.SQL. INT. CL. 9. (U.S. CLS. 21, 23, 26, 36 AND 38). REG. 1-4-2000.
- 2,307,105. STAY N PLAY PET RANCH AND DESIGN. INT. CLS. 35, 41 AND 42. (U.S. CLS. 100, 101, 102 AND 107). REG. 1-11-2000.

- 2,307,454. KYDZSTRONG. INT. CL. 20. (U.S. CLS. 2, 13, 22, 25, 32 AND 50). REG. 1-11-2000.
- 2,307,455. KYDZTUFF. INT. CL. 20. (U.S. CLS. 2, 13, 22, 25, 32 AND 50). REG. 1-11-2000.
- 2,307,479. IMPO-AID. INT. CL. 10. (U.S. CLS. 26, 39 AND 44). REG. 1-11-2000.
- 2,307,634. MISCELLANEOUS DESIGN. INT. CL. 33. (U.S. CLS. 47 AND 49). REG. 1-11-2000.
- 2,307,750. DATASTOP. INT. CL. 9. (U.S. CLS. 21, 23, 26, 36 AND 38). REG. 1-11-2000.
- 2,308,328. AWHONN ASSOCIATION OF WOMEN'S HEALTH, OBSTETRIC AND NEONATAL NURSES AND DESIGN. INT. CL. 42. (U.S. CLS. 100 AND 101). REG. 1-18-2000.
- 2,308,390. POSITIVELY NO DANCING. INT. CL. 42. (U.S. CLS. 100 AND 101). REG. 1-18-2000.
- 2,309,123. HOMEWORK. INT. CLS. 9 AND 16. (U.S. CLS. 2, 5, 21, 22, 23, 26, 29, 36, 37, 38 AND 50). REG. 1-18-2000.
- 2,310,217. BIBS. INT. CL. 37. (U.S. CLS. 100, 103 AND 106). REG. 1-25-2000.
- 2,310,637. MISCELLANEOUS DESIGN. INT. CL. 42. (U.S. CLS. 100 AND 101). REG. 1-25-2000.
- 2,311,243. SOYSENTIALS (STYLIZED). INT. CL. 5. (U.S. CLS. 6, 18, 44, 46, 51 AND 52). REG. 1-25-2000.
- 2,311,350. HOLLAND & KNIGHT. INT. CL. 42. (U.S. CLS. 100 AND 101). REG. 1-25-2000.
- 2,311,771. MSDS VAULT (STYLIZED). INT. CL. 42. (U.S. CLS. 100 AND 101). REG. 1-25-2000.
- 2,311,825. MISCELLANEOUS DESIGN. INT. CL. 39. (U.S. CLS. 100 AND 105). REG. 1-25-2000.
- 2,313,111. NORTON'S FLOWERS & GIFTS. INT. CLS. 35 AND 42. (U.S. CLS. 100, 101 AND 102). REG. 2-1-2000.
- 2,313,266. FIRSTCREDIT. INT. CL. 36. (U.S. CLS. 100, 101 AND 102). REG. 2-1-2000.
- 2,314,521. A-AAKEY MINI STORAGE AND DESIGN. INT. CL. 39. (U.S. CLS. 100 AND 105). REG. 2-1-2000.
- 2,314,548. STAKEOUT. INT. CL. 6. (U.S. CLS. 2, 12, 13, 14, 23, 25 AND 50). REG. 2-1-2000.
- 2,315,459. HUPFER. INT. CLS. 12 AND 20. (U.S. CLS. 2, 13, 19, 21, 22, 23, 25, 31, 32, 35, 44 AND 50). REG. 2-8-2000.
- 2,316,726. SAVINGS PASSPORT. INT. CL. 16. (U.S. CLS. 2, 5, 22, 23, 29, 37, 38 AND 50). REG. 2-8-2000.
- 2,316,727. VITAMIN WORLD SAVINGS PASSPORT. INT. CL. 16. (U.S. CLS. 2, 5, 22, 23, 29, 37, 38 AND 50). REG. 2-8-2000.
- 2,317,677. IN CLOVER AND DESIGN. INT. CL. 5. (U.S. CLS. 6, 18, 44, 46, 51 AND 52). REG. 2-15-2000.
- 2,317,678. CONNECTIN AND DESIGN. INT. CL. 5. (U.S. CLS. 6, 18, 44, 46, 51 AND 52). REG. 2-15-2000.
- 2,318,099. SADDLE RIVER INN. INT. CL. 42. (U.S. CLS. 100 AND 101). REG. 2-15-2000.
- 2,318,216. EUROPASTE. INT. CL. 4. (U.S. CLS. 1, 6 AND 15). REG. 2-15-2000.
- 2,318,526. ENERGYGAUGE (STYLIZED). INT. CLS. 9, 16 AND 42. (U.S. CLS. 2, 5, 21, 22, 23, 26, 29, 36, 37, 38, 50, 100 AND 101). REG. 2-15-2000.
- 2,320,541. FS.IX AND DESIGN. INT. CL. 9. (U.S. CLS. 21, 23, 26, 36 AND 38). REG. 2-22-2000.
- 2,320,589. THE PERFECT PAIR. INT. CL. 15. (U.S. CLS. 2, 21 AND 36). REG. 2-22-2000.
- 2,320,634. RESEARCH FOR LIFE. INT. CLS. 36 AND 42. (U.S. CLS. 100, 101 AND 102). REG. 2-22-2000.
- 2,321,031. RGK FOUNDATION. INT. CL. 36. (U.S. CLS. 100, 101 AND 102). REG. 2-22-2000.
- 2,321,181. MICROWAVE OVEN WORLD. INT. CL. 35. (U.S. CLS. 100, 101 AND 102). REG. 2-22-2000.
- 2,321,182. GRIDDLE WORLD. INT. CL. 35. (U.S. CLS. 100, 101 AND 102). REG. 2-22-2000.
- 2,321,241. ACTIO REGULATOR. INT. CL. 35. (U.S. CLS. 100, 101 AND 102). REG. 2-22-2000.
- 2,321,376. RANGE WORLD. INT. CL. 35. (U.S. CLS. 100, 101 AND 102). REG. 2-22-2000.
- 2,321,389. S SPECIALTY EQUIPMENT AND DESIGN. INT. CL. 7. (U.S. CLS. 13, 19, 21, 23, 31, 34 AND 35). REG. 2-22-2000.
- 2,321,734. MIXER WORLD. INT. CL. 35. (U.S. CLS. 100, 101 AND 102). REG. 2-22-2000.
- 2,321,737. FREEZER WORLD. INT. CL. 35. (U.S. CLS. 100, 101 AND 102). REG. 2-22-2000.
- 2,321,820. OVEN WORLD. INT. CL. 35. (U.S. CLS. 100, 101 AND 102). REG. 2-22-2000.
- 2,321,821. BLENDER WORLD. INT. CL. 35. (U.S. CLS. 100, 101 AND 102). REG. 2-22-2000.
- 2,321,875. PIZZA EQUIPMENT WORLD. INT. CL. 35. (U.S. CLS. 100, 101 AND 102). REG. 2-22-2000.
- 2,322,353. GOING WITH THE FLOW. INT. CL. 17. (U.S. CLS. 1, 5, 12, 13, 35 AND 50). REG. 2-22-2000.
- 2,322,385. SLEEPY'S INCREDIBLE PRICE GUARANTEE. INT. CL. 35. (U.S. CLS. 100, 101 AND 102). REG. 2-22-2000.
- 2,325,077. INTERNEWS NETWORK. INT. CLS. 41 AND 42. (U.S. CLS. 100, 101 AND 107). REG. 3-7-2000.
- 2,325,219. THE ADVANCED SPORTS TAPE ENDURA TAPE AND DESIGN. INT. CL. 5. (U.S. CLS. 6, 18, 44, 46, 51 AND 52). REG. 3-7-2000.
- 2,326,691. NATIONAL SPORTS CENTER FOR THE DISABLED. INT. CL. 41. (U.S. CLS. 100, 101 AND 107). REG. 3-7-2000.
- 2,326,817. MISCELLANEOUS DESIGN. INT. CL. 42. (U.S. CLS. 100 AND 101). REG. 3-7-2000.
- 2,327,528. INTERNEWS. INT. CLS. 41 AND 42. (U.S. CLS. 100, 101 AND 107). REG. 3-14-2000.
- 2,329,175. ICCM. INT. CL. 35. (U.S. CLS. 100, 101 AND 102). REG. 3-14-2000.
- 2,329,365. QUICKMAP. INT. CL. 16. (U.S. CLS. 2, 5, 22, 23, 29, 37, 38 AND 50). REG. 3-14-2000.
- 2,329,738. LONG VINEYARDS (STYLIZED). INT. CL. 33. (U.S. CLS. 47 AND 49). REG. 3-14-2000.
- 2,330,661. NOBODY CARES FOR EYES MORE THAN PEARLE. INT. CL. 42. (U.S. CLS. 100 AND 101). REG. 3-21-2000.
- 2,330,851. ARMAG CORPORATION (STYLIZED). INT. CLS. 6 AND 13. (U.S. CLS. 2, 9, 12, 13, 14, 23, 25 AND 50). REG. 3-21-2000.
- 2,332,089. PLASTI-GRIP. INT. CL. 17. (U.S. CLS. 1, 5, 12, 13, 35 AND 50). REG. 3-21-2000.
- 2,332,326. TRIM-GARD. INT. CL. 12. (U.S. CLS. 19, 21, 23, 31, 35 AND 44). REG. 3-21-2000.
- 2,332,502. ANESTHESIA DESK REFERENCE. INT. CL. 16. (U.S. CLS. 2, 5, 22, 23, 29, 37, 38 AND 50). REG. 3-21-2000.
- 2,333,383. TROPIC BEACH. INT. CL. 32. (U.S. CLS. 45, 46 AND 48). REG. 3-21-2000.
- 2,333,424. BUDWEISER KING OF THE ROCKIES AND DESIGN. INT. CL. 32. (U.S. CLS. 45, 46 AND 48). REG. 3-21-2000.
- 2,333,751. IMG. INT. CL. 41. (U.S. CLS. 100, 101 AND 107). REG. 3-21-2000.
- 2,334,365. INSTA SET. INT. CL. 22. (U.S. CLS. 1, 2, 7, 19, 22, 42 AND 50). REG. 3-28-2000.
- 2,335,096. THE ITCH ERASER. INT. CL. 5. (U.S. CLS. 6, 18, 44, 46, 51 AND 52). REG. 3-28-2000.
- 2,335,325. PAINTER'S-PAK (STYLIZED). INT. CL. 16. (U.S. CLS. 2, 5, 22, 23, 29, 37, 38 AND 50). REG. 3-28-2000.
- 2,335,395. GROWING UP READY. INT. CLS. 9 AND 16. (U.S. CLS. 2, 5, 21, 22, 23, 26, 29, 36, 37, 38 AND 50). REG. 3-28-2000.
- 2,335,605. UNIQUE. INT. CL. 35. (U.S. CLS. 100, 101 AND 102). REG. 3-28-2000.
- 2,335,740. HOEGANAES. INT. CL. 6. (U.S. CLS. 2, 12, 13, 14, 23, 25 AND 50). REG. 3-28-2000.
- 2,336,759. IDEAL PH. INT. CL. 1. (U.S. CLS. 1, 5, 6, 10, 26 AND 46). REG. 3-28-2000.
- 2,337,565. INTERCLAD AND DESIGN. INT. CL. 37. (U.S. CLS. 100, 103 AND 106). REG. 4-4-2000.
- 2,337,710. MISCELLANEOUS DESIGN. INT. CL. 25 ONLY. (U.S. CLS. 22 AND 39 ONLY). REG. 4-4-2000.
- 2,341,356. AP LOGIC AND DESIGN. INT. CL. 35. (U.S. CLS. 100, 101 AND 102). REG. 4-11-2000.
- 2,341,357. AP LOGIC. INT. CL. 35. (U.S. CLS. 100, 101 AND 102). REG. 4-11-2000.
- 2,341,436. MAI MANAGEMENT ASSOCIATES, INC. (STYLIZED). INT. CLS. 35 AND 41. (U.S. CLS. 100, 101, 102 AND 107). REG. 4-11-2000.
- 2,341,567. WAYBACK. INT. CL. 41. (U.S. CLS. 100, 101 AND 107). REG. 4-11-2000.
- 2,343,181. AMERICAN BILLING SERVICE. INT. CL. 36. (U.S. CLS. 100, 101 AND 102). REG. 4-18-2000.
- 2,345,697. PASSPORT HEALTH COMMUNICATIONS, INC.. INT. CL. 42. (U.S. CLS. 100 AND 101). REG. 4-25-2000.
- 2,346,012. ERKIE. INT. CL. 16. (U.S. CLS. 2, 5, 22, 23, 29, 37, 38 AND 50). REG. 4-25-2000.
- 2,346,116. WOW. INT. CL. 13. (U.S. CLS. 2 AND 9). REG. 4-25-2000.

- 2,346,908. MULTIMEDIAPLACE.COM. INT. CL. 42. (U.S. CLS. 100 AND 101). REG. 5-2-2000.
- 2,347,941. DR5 (STYLIZED). INT. CL. 9. (U.S. CLS. 21, 23, 26, 36 AND 38). REG. 5-9-2000.
- 2,350,009. RIVERSWEET. INT. CL. 31. (U.S. CLS. 1 AND 46). REG. 5-16-2000.
- 2,350,101. MOLINE TOOL WORKS. INT. CL. 8. (U.S. CLS. 23, 28 AND 44). REG. 5-16-2000.
- 2,350,449. SARCRYL. INT. CL. 1. (U.S. CLS. 1, 5, 6, 10, 26 AND 46). REG. 5-16-2000.
- 2,351,217. MASTERWOOD AND DESIGN. INT. CL. 7. (U.S. CLS. 13, 19, 21, 23, 31, 34 AND 35). REG. 5-23-2000.
- 2,352,008. PALACIO SERRANO CASA RESTAURANT & CANTINA AND DESIGN. INT. CL. 42. (U.S. CLS. 100 AND 101). REG. 5-23-2000.
- 2,353,139. P-NUT BUTTER D-LITE. INT. CL. 30. (U.S. CL. 46). REG. 5-30-2000.
- 2,353,216. AQUA LOGIC. INT. CLS. 11 AND 16. (U.S. CLS. 2, 5, 13, 21, 22, 23, 29, 31, 34, 37, 38 AND 50). REG. 5-30-2000.
- 2,353,372. SAFEPOINT. INT. CL. 9. (U.S. CLS. 21, 23, 26, 36 AND 38). REG. 5-30-2000.
- 2,353,674. P&T'S FORMKIT.COM AND DESIGN. INT. CL. 42. (U.S. CLS. 100 AND 101). REG. 5-30-2000.
- 2,354,584. FISHER. INT. CL. 7. (U.S. CLS. 13, 19, 21, 23, 31, 34 AND 35). REG. 6-6-2000.
- 2,354,591. COMM-WORKS AND DESIGN. INT. CL. 37. (U.S. CLS. 100, 103 AND 106). REG. 6-6-2000.
- 2,354,960. FILM CRASH AND DESIGN. INT. CL. 41. (U.S. CLS. 100, 101 AND 107). REG. 6-6-2000.
- 2,355,346. ULTRAPURE WATER. INT. CL. 16. (U.S. CLS. 2, 5, 22, 23, 29, 37, 38 AND 50). REG. 6-6-2000.
- 2,355,598. TEDDYOLOGY. INT. CL. 41 ONLY. (U.S. CLS. 100, 101 AND 107). REG. 6-6-2000.
- 2,359,743. KODAWOOL. INT. CL. 16. (U.S. CLS. 2, 5, 22, 23, 29, 37, 38 AND 50). REG. 6-20-2000.
- 2,360,512. THE AEGIS TECHNOLOGIES GROUP. INT. CL. 42. (U.S. CLS. 100 AND 101). REG. 6-20-2000.
- 2,361,615. HYNAP. INT. CL. 4. (U.S. CLS. 1, 6 AND 15). REG. 6-27-2000.
- 2,361,698. OPTIMAL OUTCOME. INT. CL. 36. (U.S. CLS. 100, 101 AND 102). REG. 6-27-2000.
- 2,361,902. DYNA TORQUE. INT. CL. 7. (U.S. CLS. 13, 19, 21, 23, 31, 34 AND 35). REG. 6-27-2000.
- 2,362,387. ERICA BROOKE. INT. CL. 25. (U.S. CLS. 22 AND 39). REG. 6-27-2000.
- 2,362,388. JAMIE NICOLE. INT. CL. 25. (U.S. CLS. 22 AND 39). REG. 6-27-2000.
- 2,362,489. UNIRETIC. INT. CL. 5. (U.S. CLS. 6, 18, 44, 46, 51 AND 52). REG. 6-27-2000.
- 2,362,504. SDM. INT. CL. 12. (U.S. CLS. 19, 21, 23, 31, 35 AND 44). REG. 6-27-2000.
- 2,363,071. M AND DESIGN. INT. CL. 25. (U.S. CLS. 22 AND 39). REG. 6-27-2000.
- 2,363,258. APOLLO'S CHARIOT (STYLIZED). INT. CL. 41. (U.S. CLS. 100, 101 AND 107). REG. 6-27-2000.
- 2,363,302. FRESH EXPRESS AND DESIGN. INT. CL. 29. (U.S. CL. 46). REG. 6-27-2000.
- 2,363,722. IMPERIAL WHITETAIL. INT. CL. 31. (U.S. CLS. 1 AND 46). REG. 7-4-2000.
- 2,364,739. MISCELLANEOUS DESIGN. INT. CL. 35. (U.S. CLS. 100, 101 AND 102). REG. 7-4-2000.
- 2,364,760. MISCELLANEOUS DESIGN. INT. CL. 42. (U.S. CLS. 100 AND 101). REG. 7-4-2000.
- 2,365,067. PANBIO. INT. CL. 5. (U.S. CLS. 6, 18, 44, 46, 51 AND 52). REG. 7-4-2000.
- 2,365,489. GREEN HARVEST. INT. CL. 29. (U.S. CL. 46). REG. 7-4-2000.
- 2,365,636. ARMAG. INT. CLS. 6 AND 13. (U.S. CLS. 2, 9, 12, 13, 14, 23, 25 AND 50). REG. 7-11-2000.
- 2,365,763. SPECTRUM 41. INT. CL. 9. (U.S. CLS. 21, 23, 26, 36 AND 38). REG. 7-11-2000.
- 2,366,234. VERMATIC. INT. CL. 6. (U.S. CLS. 2, 12, 13, 14, 23, 25 AND 50). REG. 7-11-2000.
- 2,366,474. PLUTO CORPORATION AND DESIGN. INT. CL. 35. (U.S. CLS. 100, 101 AND 102). REG. 7-11-2000.
- 2,366,531. PEE WEE'Z. INT. CL. 32. (U.S. CLS. 45, 46 AND 48). REG. 7-11-2000.
- 2,366,877. KNOWLEDGE PREDATES CAPITAL. INT. CL. 42. (U.S. CLS. 100 AND 101). REG. 7-11-2000.
- 2,367,620. HOT STICKS AND DESIGN. INT. CL. 15. (U.S. CLS. 2, 21 AND 36). REG. 7-18-2000.
- 2,368,055. DON'T BE A NICO-TEEN!. INT. CL. 41. (U.S. CLS. 100, 101 AND 107). REG. 7-18-2000.
- 2,371,044. BLOCKHEAD'S MEXICAN DINER. INT. CL. 42. (U.S. CLS. 100 AND 101). REG. 7-25-2000.

* * * * *

TRADEMARK REGISTRATIONS CANCELED

The designation "U.S. Cl." appearing in this section refers to the U.S. class in effect prior to Sep. 1, 1973 rather than the international class which applies to applications filed on or after that date. For adoption of international classification see notice in the OFFICIAL GAZETTE of Jun. 26, 1973 (911 O.G. TM 210).

SECTION 7(D)

- 1,934,305. COMFO TOPS (STYLIZED). INT. CL. 25. REG. 1-7-1995.
2,681,796. SMERRY AND DESIGN. INT. CL. 3. REG. 1-28-2003.
2,689,257. TOMATOFEST. INT. CL. 30. REG. 2-18-2003.
2,701,502. CLUEPAD. INT. CL. 9. REG. 3-25-2003.
2,702,629. ABC. INT. CL. 3. REG. 4-1-2003.
2,767,479. HOPEMEDIA PRODUCTIONS. INT. CLS. 9, 16 AND 41. REG. 9-23-2003.
2,875,725. SEXAMIX. INT. CL. 10. REG. 8-17-2004.
2,954,201. NATREL NUTRITION 24. INT. CLS. 5 AND 32. REG. 5-24-2005.
3,093,948. STRATIS CONSULTINGSTANDARD CHARACTER MARK INT. CL. 35. REG. 5-16-2006.
3,133,802. MISCELLANEOUS DESIGN. INT. CL. 35. REG. 8-22-2006.
3,178,511. WIMAX GLOBAL COMFORUMSTANDARD CHARACTER MARK INT. CL. 41. REG. 11-28-2006.
3,216,614. STRATEGIC IMPROVEMENT SOLUTIONS-STANDARD CHARACTER MARK INT. CL. 35. REG. 3-6-2007.
3,225,152. CCDI (STYLIZED). INT. CL. 42. REG. 4-3-2007.
3,248,965. ONECAP WWW.ONECAP.COM AND DESIGN. INT. CL. 36. REG. 6-5-2007.
3,268,849. FALCON HILLSTANDARD CHARACTER MARK INT. CL. 33. REG. 7-24-2007.
3,309,270. SAFEGUARD GOSTANDARD CHARACTER MARK INT. CL. 12. REG. 10-9-2007.
3,325,152. ID IDESIGN AND DESIGN. INT. CLS. 6, 20 AND 21. REG. 10-30-2007.
3,355,289. TRI TRANSTEK RECYCLING INCORPORATED AND DESIGN. INT. CL. 40. REG. 12-18-2007.
3,355,736. ECHO BEAR CATSTANDARD CHARACTER MARK INT. CL. 7. REG. 12-18-2007.
3,355,742. CRARY BEAR CATSTANDARD CHARACTER MARK INT. CL. 7. REG. 12-18-2007.
3,383,325. PREDATOR TRAILCAMS AND DESIGN. INT. CL. 9. REG. 2-12-2008.
3,394,937. VISTA MEDIASTANDARD CHARACTER MARK INT. CL. 35. REG. 3-11-2008.
3,437,931. GOAL SCHEDULERSTANDARD CHARACTER MARK INT. CL. 9. REG. 5-27-2008.
3,437,933. OPTIMUM GOAL SCHEDULINGSTANDARD CHARACTER MARK INT. CL. 9. REG. 5-27-2008.
3,473,229. READY WALLSTANDARD CHARACTER MARK INT. CL. 6. REG. 7-22-2008.
3,481,849. GOOD MANNERS ARE CONTAGIOUS, PASS IT ONISTANDARD CHARACTER MARK INT. CL. 16. REG. 8-5-2008.
3,483,663. TIMES SQUARE ARTS CENTER AND DESIGN. INT. CLS. 35 AND 41. REG. 8-12-2008.
3,484,665. NORTHLAND DOWNEY INSURANCE GROUP INSURANCE & FINANCIAL PLANNING AND DESIGN. INT. CL. 36. REG. 8-12-2008.
3,511,792. FIREFLYSTANDARD CHARACTER MARK INT. CL. 33. REG. 10-7-2008.
3,522,859. VISATAXESSTANDARD CHARACTER MARK INT. CL. 35. REG. 10-21-2008.

- 3,588,137. COLONOXSTANDARD CHARACTER MARK INT. CL. 5. REG. 3-10-2009.
3,608,179. ACCELE-GROSTANDARD CHARACTER MARK INT. CL. 1. REG. 4-21-2009.
3,610,747. FEMININE MYSTERIESSTANDARD CHARACTER MARK INT. CLS. 3 AND 35. REG. 4-28-2009.

SECTION 8

- 251,048. WM AND DESIGN. U.S. CL. 39. REG. 12-25-1928.
392,022. BRAZEN. U.S. CL. 51. REG. 12-2-1941.
862,380. SUPER-FREEZE. U.S. CL. 31. REG. 12-24-1968.
866,015. CHARVET. U.S. CL. 41, ONLY. REG. 3-11-1969.
1,045,844. SERVO MED AND DESIGN. INT. CL. 10. REG. 8-10-1976.
1,252,863. SWATCH QUARTZ (STYLIZED). INT. CL. 14. REG. 10-4-1983.
1,396,062. PAPILLON (STYLIZED). INT. CL. 33. REG. 6-3-1986.
1,517,704. U-TEK POLYFOAM AND DESIGN. INT. CL. 1. REG. 12-27-1988.
1,517,707. MICRO-LIME. INT. CLS. 1 AND 40. REG. 12-27-1988.
1,517,715. PERSONAL TOUCH. INT. CLS. 2 AND 20. REG. 12-27-1988.
1,517,717. CT. INT. CL. 2. REG. 12-27-1988.
1,517,718. OMNILAM. INT. CL. 2. REG. 12-27-1988.
1,517,722. HYPO-ACNEGENIC. INT. CL. 3. REG. 12-27-1988.
1,517,724. IBIS. INT. CL. 3. REG. 12-27-1988.
1,517,725. TYP. INT. CL. 3. REG. 12-27-1988.
1,517,733. BENCHMARK. INT. CL. 3. REG. 12-27-1988.
1,517,735. KISSING KOOLERS. INT. CL. 3. REG. 12-27-1988.
1,517,736. MICROFLOR. INT. CL. 4. REG. 12-27-1988.
1,517,737. LUBRIFILM. INT. CL. 4. REG. 12-27-1988.
1,517,744. JUDGE. INT. CL. 5. REG. 12-27-1988.
1,517,749. SULFA-MAX. INT. CL. 5. REG. 12-27-1988.
1,517,753. INSECT-A-GUIDE. INT. CL. 5. REG. 12-27-1988.
1,517,757. KAWNEER SEALAIR. INT. CL. 6. REG. 12-27-1988.
1,517,764. KAR TITE ALLOY. INT. CL. 6. REG. 12-27-1988.
1,517,769. TYING-THE-KNOT. INT. CL. 6. REG. 12-27-1988.
1,517,770. NYCOAT. INT. CL. 6. REG. 12-27-1988.
1,517,776. OCEAN PRO PRODUCTS CA., U.S.A. (STYLIZED). INT. CLS. 7 AND 12. REG. 12-27-1988.
1,517,778. BLACK MAX. INT. CL. 7. REG. 12-27-1988.
1,517,783. PRESTEX. INT. CL. 7. REG. 12-27-1988.
1,517,785. WESTERN. INT. CL. 7. REG. 12-27-1988.
1,517,786. RIBBON SAVER. INT. CL. 7. REG. 12-27-1988.
1,517,789. ROL-A-TAMP. INT. CL. 7. REG. 12-27-1988.
1,517,806. ROYAL. INT. CL. 9. REG. 12-27-1988.
1,517,809. REXTRAC AND DESIGN. INT. CL. 9. REG. 12-27-1988.
1,517,810. DISCOM (STYLIZED). INT. CL. 9. REG. 12-27-1988.
1,517,827. ATOMCOMP. INT. CL. 9. REG. 12-27-1988.
1,517,828. PENCIL PUSHERS. INT. CL. 9. REG. 12-27-1988.
1,517,849. TECHNISERVE. INT. CL. 9. REG. 12-27-1988.

- 1,517,853. ACD APPLIED COMPUTING DEVICES, INC. (STYLIZED). INT. CL. 9. REG. 12-27-1988.
- 1,517,854. FASTDOC. INT. CL. 9. REG. 12-27-1988.
- 1,517,856. MY FIRST SONY. INT. CL. 9. REG. 12-27-1988.
- 1,517,858. EVENT-LINK AND DESIGN. INT. CL. 9. REG. 12-27-1988.
- 1,517,864. MISTIFIER. INT. CL. 9. REG. 12-27-1988.
- 1,517,865. R (STYLIZED). INT. CL. 9. REG. 12-27-1988.
- 1,517,867. FRED. INT. CL. 9. REG. 12-27-1988.
- 1,517,868. EVOLV (STYLIZED). INT. CL. 9. REG. 12-27-1988.
- 1,517,871. T-TALKER. INT. CL. 9. REG. 12-27-1988.
- 1,517,872. REMRAD. INT. CL. 9. REG. 12-27-1988.
- 1,517,876. PREFERRED CARE. INT. CL. 10. REG. 12-27-1988.
- 1,517,878. FASCINATION. INT. CL. 10. REG. 12-27-1988.
- 1,517,879. SPECTRACATH STP. INT. CL. 10. REG. 12-27-1988.
- 1,517,883. ULTRA CLEAN. INT. CL. 11. REG. 12-27-1988.
- 1,517,884. DORF COLONIAL CLASSIC. INT. CL. 11. REG. 12-27-1988.
- 1,517,885. DORF COLONIAL. INT. CL. 11. REG. 12-27-1988.
- 1,517,887. PREMIER. INT. CL. 11. REG. 12-27-1988.
- 1,517,902. COMMANDER (STYLIZED). INT. CL. 12. REG. 12-27-1988.
- 1,517,910. PETER BRAMS (STYLIZED). INT. CL. 14. REG. 12-27-1988.
- 1,517,914. SPACE PERCUSSION. INT. CL. 15. REG. 12-27-1988.
- 1,517,917. IDEA. INT. CL. 16. REG. 12-27-1988.
- 1,517,927. MAGAZINE WEEK. INT. CL. 16. REG. 12-27-1988.
- 1,517,931. CM CELLULAR MARKETING. INT. CL. 16. REG. 12-27-1988.
- 1,517,940. LAND USE LAW & ZONING DIGEST. INT. CL. 16. REG. 12-27-1988.
- 1,517,941. LOTUS SELECTS. INT. CLS. 16 AND 42. REG. 12-27-1988.
- 1,517,951. BAND-TYPE. INT. CL. 16. REG. 12-27-1988.
- 1,517,957. EXTRA-GARD. INT. CL. 16. REG. 12-27-1988.
- 1,517,958. HOMESHOW MAGAZINE (STYLIZED). INT. CL. 16. REG. 12-27-1988.
- 1,517,965. COMMUNITY COUPON BOOK. INT. CL. 16. REG. 12-27-1988.
- 1,517,968. O AND DESIGN. INT. CLS. 16 AND 23. REG. 12-27-1988.
- 1,517,979. A WISH YOU WERE HERE BOOK. INT. CL. 16. REG. 12-27-1988.
- 1,517,980. DESIGNERS SHOWCASE. INT. CL. 16. REG. 12-27-1988.
- 1,517,983. AMSTRAD. INT. CL. 16. REG. 12-27-1988.
- 1,517,986. CHAPTER ONE (STYLIZED). INT. CL. 16. REG. 12-27-1988.
- 1,517,987. LITTLE STITCHES AND DESIGN. INT. CL. 16. REG. 12-27-1988.
- 1,517,995. "FIREFLITE". INT. CL. 17. REG. 12-27-1988.
- 1,517,998. SPORTABOUT. INT. CL. 18. REG. 12-27-1988.
- 1,517,999. MADE FOR A BANK OF DISTINCTION BY CUSTOM SEWING & SALES (STYLIZED). INT. CL. 18. REG. 12-27-1988.
- 1,518,001. NOVAE. INT. CLS. 18 AND 25. REG. 12-27-1988.
- 1,518,003. GEONARDI. INT. CL. 18. REG. 12-27-1988.
- 1,518,011. STAIN SHIELD AND DESIGN. INT. CL. 19. REG. 12-27-1988.
- 1,518,017. BISON BASEBALL. INT. CL. 20. REG. 12-27-1988.
- 1,518,024. TENDERAIR. INT. CL. 20. REG. 12-27-1988.
- 1,518,025. TENDER. INT. CL. 20. REG. 12-27-1988.
- 1,518,026. TENDERGEL. INT. CL. 20. REG. 12-27-1988.
- 1,518,027. TENDERFLO. INT. CL. 20. REG. 12-27-1988.
- 1,518,037. WESTERN SUNSET. INT. CL. 21. REG. 12-27-1988.
- 1,518,047. COCO BAY AND DESIGN. INT. CL. 25. REG. 12-27-1988.
- 1,518,050. KRIZIA JEANS AND DESIGN. INT. CL. 25. REG. 12-27-1988.
- 1,518,052. LONG BEACH BLUES FESTIVAL AND DESIGN. INT. CLS. 25 AND 26. REG. 12-27-1988.
- 1,518,055. RANDY KEMPER. INT. CL. 25. REG. 12-27-1988.
- 1,518,063. ELITE AND DESIGN. INT. CLS. 25 AND 28. REG. 12-27-1988.
- 1,518,073. FRIGHT STUFF AND DESIGN. INT. CL. 25. REG. 12-27-1988.
- 1,518,074. ORAM AND DESIGN. INT. CL. 25. REG. 12-27-1988.
- 1,518,076. BUGLE BOY AND DESIGN. INT. CL. 25. REG. 12-27-1988.
- 1,518,084. GOLF NUT SOCIETY OF AMERICA AND DESIGN. INT. CL. 25. REG. 12-27-1988.
- 1,518,085. MISCELLANEOUS DESIGN. INT. CL. 25. REG. 12-27-1988.
- 1,518,086. BUNJEEZ AND DESIGN. INT. CL. 26. REG. 12-27-1988.
- 1,518,088. RAM. INT. CL. 26. REG. 12-27-1988.
- 1,518,093. MISCELLANEOUS DESIGN. INT. CL. 28. REG. 12-27-1988.
- 1,518,094. AQUA EXPLORER AND DESIGN. INT. CL. 28. REG. 12-27-1988.
- 1,518,101. SNURFER (STYLIZED). INT. CL. 28. REG. 12-27-1988.
- 1,518,102. MISCELLANEOUS DESIGN. INT. CL. 28. REG. 12-27-1988.
- 1,518,107. VIEW-MASTER. INT. CL. 28. REG. 12-27-1988.
- 1,518,113. ALL SEASON. INT. CL. 28. REG. 12-27-1988.
- 1,518,119. KIDGLOVES AND DESIGN. INT. CL. 28. REG. 12-27-1988.
- 1,518,121. HOT TRAX. INT. CL. 28. REG. 12-27-1988.
- 1,518,130. MISCELLANEOUS DESIGN. INT. CL. 28. REG. 12-27-1988.
- 1,518,137. TRUCKINS. INT. CL. 28. REG. 12-27-1988.
- 1,518,142. RACK'EM UP. INT. CL. 28. REG. 12-27-1988.
- 1,518,143. TECMO BOWL (STYLIZED). INT. CL. 28. REG. 12-27-1988.
- 1,518,146. FILL 'N FRY. INT. CLS. 29 AND 30. REG. 12-27-1988.
- 1,518,147. BEARDSLEY. INT. CL. 29. REG. 12-27-1988.
- 1,518,152. SOUND SEAFOOD. INT. CL. 29. REG. 12-27-1988.
- 1,518,157. AMERICAN BEAUTY AND DESIGN. INT. CL. 29. REG. 12-27-1988.
- 1,518,163. CHEF AMERICA COOKING WHAT AMERICA LOVES. INT. CL. 30. REG. 12-27-1988.
- 1,518,168. GRANDEZZA (STYLIZED). INT. CL. 30. REG. 12-27-1988.
- 1,518,173. GREAT HARVEST BREAD CO. MILLERS AND BAKERS OF GREAT PLAINS WHEAT AND DESIGN. INT. CL. 30. REG. 12-27-1988.
- 1,518,174. TAMALINDA. INT. CL. 30. REG. 12-27-1988.
- 1,518,175. CASTELETS. INT. CL. 30. REG. 12-27-1988.
- 1,518,186. DANESI CAFFE' AND DESIGN. INT. CL. 30. REG. 12-27-1988.
- 1,518,190. ALL SEASONS AND DESIGN. INT. CL. 31. REG. 12-27-1988.
- 1,518,191. CAROUSEL AND DESIGN. INT. CL. 31. REG. 12-27-1988.
- 1,518,194. DIET MINUTE MAID. INT. CL. 32. REG. 12-27-1988.
- 1,518,197. ICY AND DESIGN. INT. CL. 33. REG. 12-27-1988.
- 1,518,198. POGGIO ROSSO CHIANTI CLASSICO AND DESIGN. INT. CL. 33. REG. 12-27-1988.
- 1,518,199. MISCELLANEOUS DESIGN. INT. CL. 33. REG. 12-27-1988.
- 1,518,204. IMIS. INT. CL. 35. REG. 12-27-1988.
- 1,518,205. COMPUSYSTEM. INT. CL. 35. REG. 12-27-1988.
- 1,518,207. MISCELLANEOUS DESIGN. INT. CL. 35. REG. 12-27-1988.
- 1,518,210. IBA HEALTHCARE PLAN AND DESIGN. INT. CL. 35. REG. 12-27-1988.
- 1,518,211. RICHMOND RELOCATION SERVICES AND DESIGN. INT. CL. 35. REG. 12-27-1988.
- 1,518,213. USA UNISHIPERS ASSOCIATION AND DESIGN. INT. CL. 35. REG. 12-27-1988.
- 1,518,217. STRATEGIS. INT. CLS. 35 AND 36. REG. 12-27-1988.
- 1,518,218. WALRUS RESEARCH. INT. CL. 35. REG. 12-27-1988.
- 1,518,219. MISCELLANEOUS DESIGN. INT. CLS. 35 AND 36. REG. 12-27-1988.
- 1,518,220. BOXDATA. INT. CL. 35. REG. 12-27-1988.
- 1,518,221. LIAISON. INT. CLS. 35 AND 42. REG. 12-27-1988.
- 1,518,223. TRIAL FOR HIRE. INT. CL. 35. REG. 12-27-1988.

- 1,518,230. S & H GIFT SAVER CARD AND DESIGN. INT. CL. 35. REG. 12-27-1988.
- 1,518,233. WESTERN ACCOUNTING SERVICES. INT. CL. 35. REG. 12-27-1988.
- 1,518,243. WASHINGTON NATIONAL CLASSIC CARE. INT. CL. 36. REG. 12-27-1988.
- 1,518,244. MILLERS MUTUAL INSURANCE INC. 1877 AND DESIGN. INT. CL. 36. REG. 12-27-1988.
- 1,518,246. MISCELLANEOUS DESIGN. INT. CL. 36. REG. 12-27-1988.
- 1,518,250. AMHS IMS (STYLIZED). INT. CL. 36. REG. 12-27-1988.
- 1,518,256. PF PRIME FINANCIAL AND DESIGN. INT. CL. 36. REG. 12-27-1988.
- 1,518,257. EAST BOSTON SAVINGS BANK W N AND DESIGN. INT. CL. 36. REG. 12-27-1988.
- 1,518,259. THE MILWAUKEE HEART. INT. CL. 36. REG. 12-27-1988.
- 1,518,264. FIRST INTERSTATE PREFERRED BANCARD. INT. CL. 36. REG. 12-27-1988.
- 1,518,265. PAINWEBBER ADVANTAGE ANNUITY. INT. CL. 36. REG. 12-27-1988.
- 1,518,269. MISCELLANEOUS DESIGN. INT. CL. 36. REG. 12-27-1988.
- 1,518,272. FIRST COLONIAL CLUB. INT. CL. 36. REG. 12-27-1988.
- 1,518,273. THE BETTER WAY TO BUY, SELL OR RENT. INT. CL. 36. REG. 12-27-1988.
- 1,518,278. NMLS. INT. CL. 36. REG. 12-27-1988.
- 1,518,279. LANDESGIROKASSE. INT. CL. 36. REG. 12-27-1988.
- 1,518,283. FORCE FINANCING OPTIONS AND RESOURCES WITH CREDIT ENHANCEMENT. AND DESIGN. INT. CL. 36. REG. 12-27-1988.
- 1,518,284. GROWING WITH YOU FOR MORE THAN A CENTURY. INT. CL. 36. REG. 12-27-1988.
- 1,518,298. MISCELLANEOUS DESIGN. INT. CLS. 37 AND 42. REG. 12-27-1988.
- 1,518,300. MISCELLANEOUS DESIGN. INT. CL. 37. REG. 12-27-1988.
- 1,518,302. VARICAST. INT. CL. 37. REG. 12-27-1988.
- 1,518,303. ATLANTIC AND DESIGN. INT. CL. 37. REG. 12-27-1988.
- 1,518,305. CHEMLAWN GUARANTEES RESULTS. INT. CL. 37. REG. 12-27-1988.
- 1,518,308. RIGHTAIR AND DESIGN. INT. CL. 37. REG. 12-27-1988.
- 1,518,309. FHYNES. INT. CL. 37. REG. 12-27-1988.
- 1,518,311. GOOD RIDDANCE. INT. CL. 37. REG. 12-27-1988.
- 1,518,318. 1 CELLULAR ONE AND DESIGN. INT. CL. 38. REG. 12-27-1988.
- 1,518,322. RTP-U.S.A.. INT. CL. 38. REG. 12-27-1988.
- 1,518,327. ICS. INT. CL. 39. REG. 12-27-1988.
- 1,518,328. CNG. INT. CL. 39. REG. 12-27-1988.
- 1,518,330. WHEN YOU NEED A STORAGE CONTAINER. INT. CL. 39. REG. 12-27-1988.
- 1,518,333. M-M MOISHE'S MINI-STORAGE AND DESIGN. INT. CL. 39. REG. 12-27-1988.
- 1,518,336. QUICKEE AND DESIGN. INT. CL. 39. REG. 12-27-1988.
- 1,518,341. BWI (STYLIZED). INT. CL. 39. REG. 12-27-1988.
- 1,518,343. SUN*SATIONAL. INT. CL. 39. REG. 12-27-1988.
- 1,518,346. CALIFORNIA DREAMIN'. INT. CL. 39. REG. 12-27-1988.
- 1,518,347. PRO INSIGNIA. INT. CL. 40. REG. 12-27-1988.
- 1,518,348. DYNAMIC GAS PULSE LOADING. INT. CL. 40. REG. 12-27-1988.
- 1,518,350. ROADSIDE AMERICA (STYLIZED). INT. CL. 41. REG. 12-27-1988.
- 1,518,357. "REKINDLE THE SPIRIT". INT. CL. 41. REG. 12-27-1988.
- 1,518,358. SUCCESSFUL STEPS TO EARLY LEARNING (STYLIZED). INT. CL. 41. REG. 12-27-1988.
- 1,518,361. INSTITUTE FOR LEARNING STRATEGIES, INC. KEY TO SUCCESSFUL LEARNING IFLS AND DESIGN. INT. CL. 41. REG. 12-27-1988.
- 1,518,375. KING PUTT. INT. CL. 41. REG. 12-27-1988.
- 1,518,376. MID-CONTINENT RAILWAY MUSEUM AND DESIGN. INT. CL. 41. REG. 12-27-1988.
- 1,518,377. TEENAGE CONNECTION AND DESIGN. INT. CL. 41. REG. 12-27-1988.
- 1,518,380. MECHANIC TO MECHANIC VIDEO TRAINING PROGRAM AND DESIGN. INT. CL. 41. REG. 12-27-1988.
- 1,518,395. SIMPLY DELICIOUS. INT. CL. 41. REG. 12-27-1988.
- 1,518,398. SPEEDY SIGN-A-RAMA, USA AND DESIGN. INT. CL. 42. REG. 12-27-1988.
- 1,518,400. FAT JACK'S PIZZA AND DESIGN. INT. CL. 42. REG. 12-27-1988.
- 1,518,401. PRECISION FITTING METHOD. INT. CL. 42. REG. 12-27-1988.
- 1,518,404. THE GRINDER MAN AND DESIGN. INT. CL. 42. REG. 12-27-1988.
- 1,518,406. GOLD LABEL. INT. CL. 42. REG. 12-27-1988.
- 1,518,408. C TOWN (STYLIZED). INT. CL. 42. REG. 12-27-1988.
- 1,518,416. THE GOLD COUPON. INT. CL. 42. REG. 12-27-1988.
- 1,518,429. MIDA DENTAL PLANS AND DESIGN. INT. CL. 42. REG. 12-27-1988.
- 1,518,437. MISCELLANEOUS DESIGN. INT. CL. 42. REG. 12-27-1988.
- 1,518,443. CVN INSIDER AND DESIGN. INT. CL. 42. REG. 12-27-1988.
- 1,518,455. JWF AND DESIGN. INT. CL. 42. REG. 12-27-1988.
- 1,518,457. FOR YOU FROM SPIEGEL. INT. CL. 42. REG. 12-27-1988.
- 1,518,459. BROWN BAG DELI. INT. CL. 42. REG. 12-27-1988.
- 1,518,463. MARY ELLEN. INT. CL. 42. REG. 12-27-1988.
- 1,518,465. TOWN & COUNTRY. INT. CL. 42. REG. 12-27-1988.
- 1,518,467. SANTA FE EAST. INT. CL. 42. REG. 12-27-1988.
- 1,518,468. CCN COMMUNITY CARE NETWORK AND DESIGN. INT. CL. 42. REG. 12-27-1988.
- 1,518,479. HIVAGEN. INT. CL. 42. REG. 12-27-1988.
- 1,518,480. WORLD HARVEST CHURCH. INT. CL. 42. REG. 12-27-1988.
- 1,518,497. PETER PANDA AND DESIGN. INT. CL. 42. REG. 12-27-1988.
- 1,518,498. FAST-FAX. INT. CL. 42. REG. 12-27-1988.
- 1,518,502. GENESIS. INT. CL. 42. REG. 12-27-1988.
- 1,518,511. DOWNSIDE RISK. INT. CL. 42. REG. 12-27-1988.
- 1,518,515. ROBOMAT. INT. CL. 42. REG. 12-27-1988.
- 1,518,521. EVOLUTION MARINE AND DESIGN. INT. CL. 42. REG. 12-27-1988.
- 1,518,528. REFLECTIONS AND DESIGN. INT. CL. 42. REG. 12-27-1988.
- 1,518,530. BRASS CONNECTION. INT. CL. 42. REG. 12-27-1988.
- 1,518,534. THAT'S MY BEAR. INT. CL. 42. REG. 12-27-1988.
- 1,518,536. THE MENEMSHA TRADER. INT. CL. 42. REG. 12-27-1988.
- 1,518,541. AND DESIGN. U.S. CL. 200. REG. 12-27-1988.
- 1,518,546. ASSOCIATION OF TELEMESSAGING SERVICES INTERNATIONAL, INC.. INT. CLS. 16 AND 41. REG. 12-27-1988.
- 1,518,548. AMERICA'S PREMIUM WOOD FINISHES AND DESIGN. INT. CL. 2. REG. 12-27-1988.
- 1,518,554. ULTRABRITE. INT. CL. 6. REG. 12-27-1988.
- 1,518,556. FLUIDYER. INT. CL. 7. REG. 12-27-1988.
- 1,518,558. CAM SUPPORT. INT. CL. 9. REG. 12-27-1988.
- 1,518,563. MISCELLANEOUS DESIGN. INT. CL. 12. REG. 12-27-1988.
- 1,518,566. MISCELLANEOUS DESIGN. INT. CL. 16. REG. 12-27-1988.
- 1,518,568. DIRECTORY OF CE, PHOTOGRAPHY & MAJOR APPLIANCE RETAILERS & DISTRIBUTORS. INT. CL. 16. REG. 12-27-1988.
- 1,518,581. PRO GOAL. INT. CL. 28. REG. 12-27-1988.
- 1,518,589. NATIONAL CINEMA NETWORK. INT. CL. 35. REG. 12-27-1988.
- 1,518,596. SUNDAY NIGHT JAZZ. INT. CL. 41. REG. 12-27-1988.
- 1,518,597. NEWSCALL. INT. CL. 42. REG. 12-27-1988.

- 1,518,598. AMERICAN CHIROPRACTIC CENTERS. INT. CL. 42. REG. 12-27-1988.
- 1,527,856. TOTAL MAINTENANCE SYSTEM. INT. CL. 37 ONLY. REG. 3-7-1989.
- 1,815,435. FINELINE. INT. CL. 21. REG. 1-4-1994.
- 1,850,845. AMR AND DESIGN. INT. CL. 35. REG. 8-23-1994.
- 1,956,636. PET PAWS. INT. CL. 25. REG. 2-13-1996.
- 2,038,399. BRUDERHOF. U.S. CL. 200. REG. 2-18-1997.
- 2,065,977. THE BEST OF TWO WORLDS. INT. CL. 5. REG. 5-27-1997.
- 2,208,505. BON-STITCH AND DESIGN. INT. CL. 17 ONLY. REG. 12-8-1998.
- 2,212,174. R RAVAZZOLO AND DESIGN. INT. CLS. 18 AND 25. REG. 12-22-1998.
- 2,213,552. NASBA. INT. CL. 10. REG. 12-29-1998.
- 2,213,568. I WORLD. INT. CL. 35. REG. 12-29-1998.
- 2,213,598. MISCELLANEOUS DESIGN. INT. CLS. 6, 11, 12, 20 AND 21. REG. 12-29-1998.
- 2,213,618. BIG CITY WRAPS. INT. CL. 42. REG. 12-29-1998.
- 2,213,631. TECHNICS. INT. CL. 25. REG. 12-29-1998.
- 2,213,634. MEETING WEB (STYLIZED). INT. CL. 9. REG. 12-29-1998.
- 2,213,637. CDX (STYLIZED). INT. CLS. 7 AND 8. REG. 12-29-1998.
- 2,213,641. SWIVEL GLIDE. INT. CL. 7. REG. 12-29-1998.
- 2,213,662. SOLIQS. INT. CLS. 1, 3, 5, 29, 30, 31, 32 AND 40. REG. 12-29-1998.
- 2,213,667. PANGAEA. INT. CL. 41. REG. 12-29-1998.
- 2,213,670. FASTNET. INT. CL. 42. REG. 12-29-1998.
- 2,213,674. MELVIN MILK. INT. CL. 28. REG. 12-29-1998.
- 2,213,682. INCYTE. INT. CL. 1. REG. 12-29-1998.
- 2,213,683. EXCYTE. INT. CL. 1. REG. 12-29-1998.
- 2,213,685. IPP IN-PERSON PAYMENTS AND DESIGN. INT. CLS. 16 AND 36. REG. 12-29-1998.
- 2,213,696. RE-INNOVATION. INT. CL. 35. REG. 12-29-1998.
- 2,213,740. MICROCELL (STYLIZED). INT. CL. 9. REG. 12-29-1998.
- 2,213,749. CORPORATE RELOCATION SERVICES "A COMMITMENT TO EXCELLENCE" AND DESIGN. INT. CLS. 36, 39 AND 42. REG. 12-29-1998.
- 2,213,755. COLONIAL SMOOTH. INT. CL. 19. REG. 12-29-1998.
- 2,213,769. FIVE SEASONS SPORTS COUNTRY CLUB. INT. CL. 41. REG. 12-29-1998.
- 2,213,773. THE GIZMO WYSIWYG WHAT YOU SEE IS WHAT YOU GET AND DESIGN. INT. CL. 36. REG. 12-29-1998.
- 2,213,776. MOLASSES PURIFIER. INT. CL. 3. REG. 12-29-1998.
- 2,213,782. ELECTRONIC - BOARDROOM T&MV INC. AND DESIGN. INT. CLS. 16, 35 AND 41. REG. 12-29-1998.
- 2,213,787. IMAGE. INT. CL. 9. REG. 12-29-1998.
- 2,213,802. RESTORE FAMILY BEHAVIORAL HEALTH AND DESIGN. INT. CL. 42. REG. 12-29-1998.
- 2,213,816. FUTON EXPRES'. INT. CL. 35. REG. 12-29-1998.
- 2,213,818. ED FUND A SERVICE OF THE CALIFORNIA STUDENT AID COMMISSION AND DESIGN. INT. CLS. 35 AND 36. REG. 12-29-1998.
- 2,213,828. PAKERSON (STYLIZED). INT. CL. 25. REG. 12-29-1998.
- 2,213,843. TRADEMARKS, ETC.. INT. CLS. 35 AND 42. REG. 12-29-1998.
- 2,213,852. ESP AND DESIGN. INT. CLS. 9 AND 42. REG. 12-29-1998.
- 2,213,860. KARTA. INT. CL. 42. REG. 12-29-1998.
- 2,213,864. SKYSTREAM. INT. CL. 9. REG. 12-29-1998.
- 2,213,870. RS MEANS AND DESIGN. INT. CLS. 9 AND 16. REG. 12-29-1998.
- 2,213,887. AFFINITY AND DESIGN. INT. CL. 11. REG. 12-29-1998.
- 2,213,890. CONCERTAINER. INT. CLS. 6 AND 19. REG. 12-29-1998.
- 2,213,915. DIGITALCHOICE. INT. CL. 38. REG. 12-29-1998.
- 2,213,932. CONTROL PLUS ACCOUNT. INT. CL. 36. REG. 12-29-1998.
- 2,213,949. RUFF HEWN JEWELRY AND DESIGN. INT. CLS. 6, 14 AND 26. REG. 12-29-1998.
- 2,213,961. ICTM (STYLIZED). INT. CL. 16. REG. 12-29-1998.
- 2,213,962. A AND DESIGN. INT. CL. 9. REG. 12-29-1998.
- 2,213,975. SMARTGLAS. INT. CL. 9. REG. 12-29-1998.
- 2,213,987. THE CATACOMBS PRESS. INT. CL. 16. REG. 12-29-1998.
- 2,214,010. 141 AND DESIGN. INT. CL. 35. REG. 12-29-1998.
- 2,214,015. CREDIT AMERICA USED CAR CENTER. INT. CL. 35. REG. 12-29-1998.
- 2,214,022. CAROLINE BALLOU. INT. CL. 14. REG. 12-29-1998.
- 2,214,031. THE MARINERS. INT. CL. 41. REG. 12-29-1998.
- 2,214,033. SILOC. INT. CLS. 5 AND 10. REG. 12-29-1998.
- 2,214,035. HERBS FOR HORSES AND DESIGN. INT. CL. 31. REG. 12-29-1998.
- 2,214,041. ORSETTO BY CASAL THAUERO AND DESIGN. INT. CL. 33. REG. 12-29-1998.
- 2,214,047. JAGO AND DESIGN. INT. CL. 25. REG. 12-29-1998.
- 2,214,053. GLY-KIT. INT. CL. 9. REG. 12-29-1998.
- 2,214,056. DEJA ZOO (STYLIZED). INT. CL. 35. REG. 12-29-1998.
- 2,214,060. THINKPRINT. INT. CLS. 9 AND 42. REG. 12-29-1998.
- 2,214,066. FAMILY PRACTICE RECERTIFICATION. INT. CL. 16. REG. 12-29-1998.
- 2,214,068. IT'S ABOUT TIME. INT. CL. 36. REG. 12-29-1998.
- 2,214,082. THE NEXT PHASE IN LOUDSPEAKER TECHNOLOGY. INT. CL. 9. REG. 12-29-1998.
- 2,214,092. ORCA. INT. CL. 32. REG. 12-29-1998.
- 2,214,098. FAMILIES THRU INTERNATIONAL ADOPTION. INT. CL. 42. REG. 12-29-1998.
- 2,214,116. MAXFIELD PARRISH. INT. CL. 3. REG. 12-29-1998.
- 2,214,117. MAXFIELD PARRISH. INT. CL. 20. REG. 12-29-1998.
- 2,214,121. DUKES OF PALL MALL. INT. CL. 3. REG. 12-29-1998.
- 2,214,123. EYES. INT. CL. 28. REG. 12-29-1998.
- 2,214,129. COME AND WORSHIP. INT. CL. 9. REG. 12-29-1998.
- 2,214,146. RAPID RESPONSE. INT. CL. 10. REG. 12-29-1998.
- 2,214,159. THE CROSSROADS GROUP. INT. CL. 36. REG. 12-29-1998.
- 2,214,184. CUSHMAX. INT. CL. 24. REG. 12-29-1998.
- 2,214,185. INNONSENSE. INT. CL. 10. REG. 12-29-1998.
- 2,214,195. DUSTPRO. INT. CL. 7. REG. 12-29-1998.
- 2,214,205. BABYFACE. INT. CL. 25. REG. 12-29-1998.
- 2,214,213. BLUES BUSTER. INT. CL. 30. REG. 12-29-1998.
- 2,214,214. DEPTH RECHARGER. INT. CL. 30. REG. 12-29-1998.
- 2,214,215. SILK THREAD. INT. CL. 30. REG. 12-29-1998.
- 2,214,216. MIGHTY JOE YANG. INT. CL. 30. REG. 12-29-1998.
- 2,214,217. MIND OVER MUDDLE. INT. CL. 30. REG. 12-29-1998.
- 2,214,218. VIRTUAL BUDDHA. INT. CL. 30. REG. 12-29-1998.
- 2,214,227. DATANITE. INT. CL. 1. REG. 12-29-1998.
- 2,214,236. TROPICAL FOREST FOUNDATION AND DESIGN. INT. CL. 41. REG. 12-29-1998.
- 2,214,237. ARMADILLO. INT. CL. 14. REG. 12-29-1998.
- 2,214,241. TEXAS RED, THE WONDER WOLF AND DESIGN. INT. CL. 16. REG. 12-29-1998.
- 2,214,256. OLD TOWN RESORTS AND DESIGN. INT. CL. 35. REG. 12-29-1998.
- 2,214,260. CEDSHIM (STYLIZED). INT. CL. 19. REG. 12-29-1998.
- 2,214,274. MISCELLANEOUS DESIGN. INT. CL. 42. REG. 12-29-1998.
- 2,214,280. GASWORK.COM. INT. CL. 35. REG. 12-29-1998.
- 2,214,289. MINNESOTA FAVORITES. INT. CL. 42. REG. 12-29-1998.
- 2,214,303. SKY CHIEFS AND DESIGN. INT. CLS. 16 AND 25. REG. 12-29-1998.
- 2,214,308. LIGHT TOWER. INT. CL. 9. REG. 12-29-1998.
- 2,214,310. HOMEPAY PLUS. INT. CL. 36. REG. 12-29-1998.
- 2,214,312. SIMOPT. INT. CL. 9. REG. 12-29-1998.

- 2,214,314. PERMAPAD AND DESIGN. INT. CL. 19. REG. 12-29-1998.
- 2,214,322. SHANTY CREEK. INT. CLS. 25, 41 AND 42. REG. 12-29-1998.
- 2,214,334. STAMP VAULT. INT. CL. 35. REG. 12-29-1998.
- 2,214,350. KEYS. INT. CL. 42. REG. 12-29-1998.
- 2,214,354. EPIDROME. INT. CL. 9. REG. 12-29-1998.
- 2,214,377. PFA AND DESIGN. INT. CL. 41. REG. 12-29-1998.
- 2,214,384. SCOTT'S EMULSION AND DESIGN. INT. CL. 5. REG. 12-29-1998.
- 2,214,386. SEA BREEZE. INT. CL. 11. REG. 12-29-1998.
- 2,214,388. SAFE ETCH. INT. CL. 40. REG. 12-29-1998.
- 2,214,391. 9403. INT. CL. 9. REG. 12-29-1998.
- 2,214,415. FORBES FORTY. INT. CL. 36. REG. 12-29-1998.
- 2,214,423. DENTAL ASSOCIATES FOR KIDS ONLY AND DESIGN. INT. CL. 42. REG. 12-29-1998.
- 2,214,427. JUST DANCIN' AND DESIGN. INT. CL. 41. REG. 12-29-1998.
- 2,214,437. BIRTH PILLOW. INT. CL. 20. REG. 12-29-1998.
- 2,214,444. LOVE AND DESIGN. INT. CL. 25. REG. 12-29-1998.
- 2,214,446. GUESTVIEW. INT. CL. 9. REG. 12-29-1998.
- 2,214,449. THE SMARTER SOLUTION AND DESIGN. INT. CL. 5. REG. 12-29-1998.
- 2,214,457. CREATIVE WEDDINGS AND DESIGN. INT. CL. 41. REG. 12-29-1998.
- 2,214,461. ORIGINAL HEROES. INT. CLS. 16 AND 25. REG. 12-29-1998.
- 2,214,466. RAINWATER'S. INT. CL. 35. REG. 12-29-1998.
- 2,214,467. RUN CHICAGO. INT. CL. 41. REG. 12-29-1998.
- 2,214,469. GONE HUNTING. INT. CL. 25. REG. 12-29-1998.
- 2,214,470. CENTRELLE. INT. CL. 20. REG. 12-29-1998.
- 2,214,476. TACONE WRAPS (STYLIZED). INT. CLS. 25, 30 AND 42. REG. 12-29-1998.
- 2,214,479. BEYOND WORDS CENTER FOR SOCIAL SKILLS TRAINING AND DESIGN. INT. CL. 41. REG. 12-29-1998.
- 2,214,484. IMAGE INSIGHT. INT. CL. 41. REG. 12-29-1998.
- 2,214,493. NBA ALL-STAR WEEKEND. INT. CL. 25. REG. 12-29-1998.
- 2,214,509. SOLARLED. INT. CL. 9. REG. 12-29-1998.
- 2,214,510. PILOTLED. INT. CL. 9. REG. 12-29-1998.
- 2,214,511. WEDGELED. INT. CL. 9. REG. 12-29-1998.
- 2,214,516. MISS PATTY CAKE AND DESIGN. INT. CL. 9. REG. 12-29-1998.
- 2,214,531. MO'S. INT. CL. 21. REG. 12-29-1998.
- 2,214,533. TAKE COMFORT IN WOOL. INT. CL. 35. REG. 12-29-1998.
- 2,214,543. JONES WEAR SPORT. INT. CL. 25. REG. 12-29-1998.
- 2,214,571. POWER OF HOUSTON. INT. CL. 42. REG. 12-29-1998.
- 2,214,575. BURWASH BRAND HORSE GEAR AND DESIGN. INT. CLS. 18 AND 22. REG. 12-29-1998.
- 2,214,578. SPINAL CONCEPTS. INT. CL. 10. REG. 12-29-1998.
- 2,214,589. MAGNITUDE AND DESIGN. INT. CL. 35. REG. 12-29-1998.
- 2,214,598. DEMENTIA (STYLIZED). INT. CL. 25. REG. 12-29-1998.
- 2,214,605. MAGIC MELT. INT. CL. 1. REG. 12-29-1998.
- 2,214,609. FINALLY FRIDAY. INT. CL. 25. REG. 12-29-1998.
- 2,214,612. VAN ROBERTS. INT. CL. 24. REG. 12-29-1998.
- 2,214,618. THE HARTFORD AND DESIGN. INT. CL. 36. REG. 12-29-1998.
- 2,214,627. SPRI SHEET MEMBRANE AND COMPONENT SUPPLIERS TO THE COMMERCIAL ROOFING INDUSTRY AND DESIGN. INT. CLS. 16, 41 AND 42. REG. 12-29-1998.
- 2,214,631. OPSITE IV3000 AND DESIGN. INT. CL. 5. REG. 12-29-1998.
- 2,214,640. RIBBONS AND RAINBOWS. INT. CL. 16. REG. 12-29-1998.
- 2,214,659. ARTHRITIS REPORT. INT. CL. 16. REG. 12-29-1998.
- 2,214,663. PEACH PITCH AND DESIGN. INT. CL. 28. REG. 12-29-1998.
- 2,214,669. TWIN MARQUIS AND DESIGN. INT. CLS. 29 AND 30. REG. 12-29-1998.
- 2,214,673. ST SMITH'S TRANSFER CORPORATION HALL-MARK OF SERVICE AND DESIGN. INT. CL. 28. REG. 12-29-1998.
- 2,214,681. CHOCODERM. INT. CL. 30. REG. 12-29-1998.
- 2,214,685. THE BIG BURRITO THE HUNGER STOPS HERE! AND DESIGN. INT. CL. 42. REG. 12-29-1998.
- 2,214,693. 'BOUT TIME. INT. CL. 29. REG. 12-29-1998.
- 2,214,694. E-Z-D. INT. CL. 16. REG. 12-29-1998.
- 2,214,697. NUTRITION NEWS. INT. CL. 16. REG. 12-29-1998.
- 2,214,702. PEACH MELBA BURST. INT. CL. 32. REG. 12-29-1998.
- 2,214,710. PAGEGRABBER. INT. CL. 16. REG. 12-29-1998.
- 2,214,712. RUBY RED GRAPEFRUIT BURST. INT. CL. 32. REG. 12-29-1998.
- 2,214,719. SIDEBERN'S. INT. CL. 42. REG. 12-29-1998.
- 2,214,726. MEAN MACHINE. INT. CL. 28. REG. 12-29-1998.
- 2,214,745. TEXAS HEAT RANCH. INT. CL. 30. REG. 12-29-1998.
- 2,214,748. SOURCEONE. INT. CL. 42. REG. 12-29-1998.
- 2,214,763. HIGH PURITY SECURITY. INT. CL. 40. REG. 12-29-1998.
- 2,214,768. HAMBURGER STYLE GARDENBURGER. INT. CL. 29. REG. 12-29-1998.
- 2,214,771. ULTRASOUND. INT. CL. 41. REG. 12-29-1998.
- 2,214,783. DOGZILLA AND DESIGN. INT. CL. 42. REG. 12-29-1998.
- 2,214,788. COINPAK. INT. CL. 16. REG. 12-29-1998.
- 2,214,793. J.W.B.. INT. CLS. 18 AND 25. REG. 12-29-1998.
- 2,214,810. RUSH HOUR. INT. CL. 41. REG. 12-29-1998.
- 2,214,842. EZ SHELF. INT. CL. 6. REG. 12-29-1998.
- 2,214,843. LET'S GO SKIING, AMERICA!. INT. CL. 42. REG. 12-29-1998.
- 2,214,848. MAD DOGS AND DESIGN. INT. CL. 14. REG. 12-29-1998.
- 2,214,859. PORTAMATIC. INT. CL. 7. REG. 12-29-1998.
- 2,214,864. INTERNET CHAMBER OF COMMERCE. INT. CL. 35. REG. 12-29-1998.
- 2,214,870. WINDRIDER. INT. CL. 12. REG. 12-29-1998.
- 2,214,873. AQUA-LEAN. INT. CL. 11. REG. 12-29-1998.
- 2,214,881. ALERO. INT. CL. 12. REG. 12-29-1998.
- 2,214,882. PRCA GREAT LAKES CIRCUIT FINALS RODEO AND DESIGN. INT. CL. 25. REG. 12-29-1998.
- 2,214,900. PORTRAIT. INT. CL. 9. REG. 12-29-1998.
- 2,214,902. PURAGUARD. INT. CL. 11. REG. 12-29-1998.
- 2,214,913. DODII DEFENDER OF DIGNITY IN ILLNESS AND DESIGN. INT. CL. 16. REG. 12-29-1998.
- 2,214,919. KIDCT. INT. CL. 9. REG. 12-29-1998.
- 2,214,923. AVALANCHE BLUE. INT. CL. 33. REG. 12-29-1998.
- 2,214,924. CORNFETTI. INT. CL. 30. REG. 12-29-1998.
- 2,214,928. BARGING THROUGH AMERICA. INT. CLS. 39 AND 41. REG. 12-29-1998.
- 2,214,943. WAVERUNNER. INT. CL. 32. REG. 12-29-1998.
- 2,214,947. SOLUX. INT. CL. 11. REG. 12-29-1998.
- 2,214,954. MAXIMIZER. INT. CL. 7. REG. 12-29-1998.
- 2,214,962. NETSCAPE ENTERPRISE SERVER. INT. CL. 9. REG. 12-29-1998.
- 2,214,969. ROYAL WOOD. INT. CL. 20. REG. 12-29-1998.
- 2,214,970. PRESIDENT ELECT. INT. CL. 28. REG. 12-29-1998.
- 2,214,976. MISCELLANEOUS DESIGN. INT. CL. 16. REG. 12-29-1998.
- 2,214,977. SEEMAP. INT. CLS. 16 AND 41. REG. 12-29-1998.
- 2,214,984. TCP. INT. CL. 9. REG. 12-29-1998.
- 2,214,985. FASHION FOR COMPASSION. INT. CLS. 25 AND 36. REG. 12-29-1998.
- 2,214,987. COMFORM (STYLIZED). INT. CL. 10. REG. 12-29-1998.
- 2,214,994. COBE CARDIOVASCULAR AND DESIGN. INT. CLS. 9 AND 10. REG. 12-29-1998.
- 2,215,002. THE BEAUTIFUL MACHINE. INT. CL. 35. REG. 12-29-1998.
- 2,215,025. FIRSTWAVE. INT. CL. 42. REG. 12-29-1998.
- 2,215,026. YOUNGEVITY. INT. CL. 3. REG. 12-29-1998.
- 2,215,037. NATIVE CALIFORNIAN. INT. CL. 31. REG. 12-29-1998.
- 2,215,038. HI TECH EURO STRETCH. INT. CL. 24. REG. 12-29-1998.
- 2,215,042. GINSENG ONCE. INT. CL. 5. REG. 12-29-1998.

- 2,215,043. INTEGRITY. INT. CL. 2. REG. 12-29-1998.
 2,215,048. A SALSA FOR EVERY TASTE. INT. CL. 30. REG. 12-29-1998.
 2,215,049. MAPLE STREET MUSIC AND DESIGN. INT. CL. 9. REG. 12-29-1998.
 2,215,067. PROFOLIO. INT. CL. 36. REG. 12-29-1998.
 2,215,080. FOPPAPEDRETTI. INT. CL. 20. REG. 12-29-1998.
 2,215,083. DESIGN IT YOUR WAY. INT. CL. 40. REG. 12-29-1998.
 2,215,095. METALLIC POWER. INT. CL. 9. REG. 12-29-1998.
 2,215,101. STYLMARK. INT. CLS. 6 AND 11. REG. 12-29-1998.
 2,215,102. STYLMARK AND DESIGN. INT. CLS. 6 AND 11. REG. 12-29-1998.
 2,215,103. VIRTUA SQUAD. INT. CL. 9. REG. 12-29-1998.
 2,215,105. OLIGOSPHERE. INT. CL. 5. REG. 12-29-1998.
 2,215,113. PEAKCARE (STYLIZED). INT. CL. 9. REG. 12-29-1998.
 2,215,114. MUSIC STREET. INT. CL. 41. REG. 12-29-1998.
 2,215,130. SANTA BARBARA EXCLUSIVES. INT. CL. 25. REG. 12-29-1998.
 2,215,164. SHOCK POCKET. INT. CL. 9. REG. 12-29-1998.
 2,215,170. URLIVE. INT. CL. 42. REG. 12-29-1998.
 2,215,171. AIRQUEST. INT. CL. 9. REG. 12-29-1998.
 2,215,174. CEMFLEX. INT. CL. 19. REG. 12-29-1998.
 2,215,176. GET HEALTHY, PITTSBURGH!. INT. CLS. 35 AND 42. REG. 12-29-1998.
 2,215,177. ROAD DESTROY. INT. CL. 25. REG. 12-29-1998.
 2,215,188. PASTRY PERFECT. INT. CL. 11. REG. 12-29-1998.
 2,215,193. IDEAL DISPENSER CO. COIN OPERATED VENDERS AND DESIGN. INT. CL. 11. REG. 12-29-1998.
 2,215,204. WEACARIBE. INT. CL. 9. REG. 12-29-1998.
 2,215,211. MONSTER MICROPHONE. INT. CL. 9. REG. 12-29-1998.
 2,215,223. DOCUCAST. INT. CL. 9. REG. 12-29-1998.
 2,215,226. THBO. INT. CL. 5. REG. 12-29-1998.
 2,215,235. CATANIA AND DESIGN. INT. CL. 28. REG. 12-29-1998.
 2,215,239. PC PARADISE. INT. CL. 35. REG. 12-29-1998.
 2,215,242. BRUEGEL. INT. CL. 32. REG. 12-29-1998.
 2,215,244. OUR CUSTOMERS DEFINE QUALITY WE MAKE IT HAPPEN. INT. CL. 40. REG. 12-29-1998.
 2,215,245. BUILDER'S QUICK-DRAW. INT. CL. 9. REG. 12-29-1998.
 2,215,256. MCDANDEE. INT. CL. 18. REG. 12-29-1998.
 2,215,259. JOEL WILLIAMS (STYLIZED). INT. CL. 18. REG. 12-29-1998.
 2,215,268. SEAWEST AND DESIGN. INT. CL. 29. REG. 12-29-1998.
 2,215,269. LA AND DESIGN. INT. CL. 41. REG. 12-29-1998.
 2,215,279. STUDIO 205. INT. CL. 25. REG. 12-29-1998.
 2,215,282. REFINEDPOWER. INT. CL. 1. REG. 12-29-1998.
 2,215,295. MURRAY. INT. CL. 28. REG. 12-29-1998.
 2,215,298. I AM YOUR CHILD AND DESIGN. INT. CL. 41. REG. 12-29-1998.
 2,215,299. I AM YOUR CHILD. INT. CL. 16. REG. 12-29-1998.
 2,215,308. SAFETYCOAT. INT. CL. 1. REG. 12-29-1998.
 2,215,332. ARCO. INT. CL. 28. REG. 12-29-1998.
 2,215,345. VISTA. INT. CL. 16. REG. 12-29-1998.
 2,215,357. J KARA. INT. CL. 25. REG. 12-29-1998.
 2,215,362. XCEED. INT. CL. 37. REG. 12-29-1998.
 2,215,371. BAYINSIDER.COM. INT. CL. 41. REG. 12-29-1998.
 2,215,372. LES BEBES DU PARADIS. INT. CL. 25. REG. 12-29-1998.
 2,215,373. SMILECAM. INT. CL. 41. REG. 12-29-1998.
 2,215,375. ARIUS. INT. CL. 14. REG. 12-29-1998.
 2,215,382. WE KNOW THE TERRITORY. INT. CL. 42. REG. 12-29-1998.
 2,215,383. OX66. INT. CL. 7. REG. 12-29-1998.
 2,215,384. MISCELLANEOUS DESIGN. INT. CL. 32. REG. 12-29-1998.
 2,215,388. LIFTOFF. INT. CL. 9. REG. 12-29-1998.
 2,215,393. I WANT TO KNOW. INT. CL. 16. REG. 12-29-1998.
 2,215,400. J LAXMI NEW YORK. INT. CL. 25. REG. 12-29-1998.
 2,215,402. COOLCATALOGS. INT. CL. 35. REG. 12-29-1998.
 2,215,405. ATLANTIC OVERTURES. INT. CL. 20. REG. 12-29-1998.
 2,215,406. LES GESTES ESSENTIELS. INT. CL. 3. REG. 12-29-1998.
 2,215,425. BRUTE FORCE. INT. CL. 28. REG. 12-29-1998.
 2,215,428. POWRTHREAD. INT. CL. 7. REG. 12-29-1998.
 2,215,430. DURAFRAME. INT. CL. 12. REG. 12-29-1998.
 2,215,433. VERSA-DECK. INT. CL. 19. REG. 12-29-1998.
 2,215,435. EDDIE BAUER COFFEE & SHOP. INT. CL. 35. REG. 12-29-1998.
 2,215,438. MAYOR'S CUP AND DESIGN. INT. CL. 36. REG. 12-29-1998.
 2,215,441. IF YOU KNOW, YOU GOTTA NANO!. INT. CL. 28. REG. 12-29-1998.
 2,215,449. BAOBAB. INT. CL. 33. REG. 12-29-1998.
 2,215,454. DOXIT. INT. CL. 38. REG. 12-29-1998.
 2,215,463. THE ONE BOOK YELLOW PAGES (STYLIZED). INT. CL. 16. REG. 12-29-1998.
 2,215,466. NANO AND DESIGN. INT. CL. 28. REG. 12-29-1998.
 2,215,481. UNITED TREATS. INT. CL. 30. REG. 12-29-1998.
 2,215,482. CALIPER. INT. CL. 31. REG. 12-29-1998.
 2,215,491. SLEDGE HAMMER. INT. CL. 3. REG. 12-29-1998.
 2,215,509. MISCELLANEOUS DESIGN. INT. CL. 3. REG. 12-29-1998.
 2,215,510. MISCELLANEOUS DESIGN. INT. CL. 3. REG. 12-29-1998.
 2,215,516. TRUFLEX. INT. CL. 28. REG. 12-29-1998.
 2,215,522. COUNTERBALANCE. INT. CL. 42. REG. 12-29-1998.
 2,215,531. ST. JOHN. INT. CL. 21. REG. 12-29-1998.
 2,215,544. MISCELLANEOUS DESIGN. INT. CL. 10. REG. 12-29-1998.
 2,215,554. GREATEST VARIETY. INT. CL. 31. REG. 12-29-1998.
 2,215,568. GERENCIA ELECTRONICA. INT. CL. 36. REG. 12-29-1998.
 2,215,577. ORIGINAL SWEDISH ALMOND TORTE. INT. CL. 30. REG. 12-29-1998.
 2,215,580. HEAT TECHNOLOGY PRODUCTS. INT. CL. 35. REG. 12-29-1998.
 2,215,586. DUSTALARM (STYLIZED). INT. CL. 9. REG. 12-29-1998.
 2,215,587. MAYA TOURS. INT. CL. 42. REG. 12-29-1998.
 2,215,588. FIRST CHOICE FOR ROOFING. INT. CL. 35. REG. 12-29-1998.
 2,215,589. FLOWERS FOR ALL OCCASIONS. INT. CL. 16. REG. 12-29-1998.
 2,215,591. BEAUDRY AND DESIGN. INT. CL. 14. REG. 12-29-1998.
 2,215,595. HYDROCARBON SHEARING. INT. CLS. 37 AND 40. REG. 12-29-1998.
 2,215,607. 24 HOUR AGENT. INT. CL. 36. REG. 12-29-1998.
 2,215,631. RELIABILITY-CENTERED DESIGN. INT. CL. 41. REG. 12-29-1998.
 2,258,695. GOLDWATER'S. INT. CL. 32 ONLY. REG. 7-6-1999.
 2,263,674. FXPARTNER. INT. CL. 9 ONLY. REG. 7-20-1999.
 2,264,316. THE HARTFORD. INT. CLS. 3, 9, 11 AND 20 ONLY. REG. 7-27-1999.
 2,277,502. NFB NATIONAL FEDERATION OF THE BLIND AND DESIGN. INT. CL. 28 ONLY. REG. 9-14-1999.
 2,303,540. THE COOLER AND DESIGN. INT. CL. 25 ONLY. REG. 12-28-1999.
 2,305,425. THE COOLER AND DESIGN. INT. CL. 25 ONLY. REG. 1-4-2000.
 2,313,674. DN DE NEEF (STYLIZED). INT. CL. 42 ONLY. REG. 2-1-2000.
 2,355,598. TEDDYOLOGY. INT. CL. 42 ONLY. REG. 6-6-2000.
 2,598,296. MECC-USA AND DESIGN. INT. CLS. 11 AND 42 ONLY. REG. 7-23-2002.
 2,636,704. OFF THE FRAME. INT. CL. 16. REG. 10-15-2002.
 2,646,444. STORYSAK. INT. CL. 9 ONLY. REG. 11-5-2002.
 2,647,058. LA'DEE HUSTLE BY HUSTLEWEAR. INT. CL. 25. REG. 11-5-2002.

- 2,647,059. LIL HUSTLE BY HUSTLEWEAR. INT. CL. 25. REG. 11-5-2002.
- 2,659,539. NATIONAL TRUST FOR HISTORIC PRESERVATION AND DESIGN. INT. CL. 2 ONLY. REG. 12-10-2002.
- 2,664,900. THE BENCHMARK SERIES. INT. CL. 36. REG. 12-24-2002.
- 2,664,901. VANCOUVER GRIZZLIES AND DESIGN. INT. CL. 25. REG. 12-24-2002.
- 2,664,902. CHEVILLOTTE LES SIGNES. INT. CL. 14. REG. 12-24-2002.
- 2,664,903. PLANETE CABLE AND DESIGN. INT. CLS. 38 AND 41. REG. 12-24-2002.
- 2,664,904. MEDIAWAY. INT. CL. 9. REG. 12-24-2002.
- 2,664,905. CAS CUSTOMER ALIGNMENT SURVEY AND DESIGN. INT. CL. 16. REG. 12-24-2002.
- 2,664,908. ATLANTA CASUALTY GROUP. INT. CL. 36. REG. 12-24-2002.
- 2,664,909. PORT. INT. CL. 18. REG. 12-24-2002.
- 2,664,910. SINCE 1936 INFLIGHT NEWSPAPERS TIME-SPEEDS BY WHEN YOU READ AS YOU FLY AND DESIGN. INT. CL. 35. REG. 12-24-2002.
- 2,664,912. ATLANTIC SHORES HEALTHCARE, INC. AND DESIGN. INT. CLS. 35 AND 42. REG. 12-24-2002.
- 2,664,913. ATLANTIC SHORES HEALTHCARE, INC. AND DESIGN. INT. CLS. 35 AND 42. REG. 12-24-2002.
- 2,664,917. COMMERCE CAPITAL MARKETS. INT. CL. 36. REG. 12-24-2002.
- 2,664,919. CHUNKY TRUCKS. INT. CL. 28. REG. 12-24-2002.
- 2,664,920. PVS. INT. CL. 35. REG. 12-24-2002.
- 2,664,921. THE NAVIGATOR HEALTH INSURANCE PLAN. INT. CL. 36. REG. 12-24-2002.
- 2,664,925. ISIS-INT. INT. CLS. 9 AND 16. REG. 12-24-2002.
- 2,664,926. WAKAIR. INT. CLS. 6, 7 AND 9. REG. 12-24-2002.
- 2,664,927. ELEZZUM. INT. CL. 5. REG. 12-24-2002.
- 2,664,929. MAS MUSICA (STYLIZED). INT. CL. 41. REG. 12-24-2002.
- 2,664,930. GET INVOLVED. INT. CL. 35. REG. 12-24-2002.
- 2,664,933. ART 50. INT. CL. 5. REG. 12-24-2002.
- 2,664,935. TRUCK, RACE, CYCLE AND REC. MARKET-PLACE. INT. CL. 35. REG. 12-24-2002.
- 2,664,936. RO-BUST. INT. CL. 7. REG. 12-24-2002.
- 2,664,937. WWW.1-JOBS.COM. INT. CL. 35. REG. 12-24-2002.
- 2,664,939. MISCELLANEOUS DESIGN. INT. CLS. 9, 16, 35, 37, 38, 41 AND 42. REG. 12-24-2002.
- 2,664,944. LE SOURIRE DE REIMS. INT. CL. 33. REG. 12-24-2002.
- 2,664,950. SALUTE OLEG CASSINI. INT. CL. 25. REG. 12-24-2002.
- 2,664,951. MISTER WEB. INT. CL. 41. REG. 12-24-2002.
- 2,664,952. PUSHING THE ARTFORM. INT. CL. 14. REG. 12-24-2002.
- 2,664,954. CGI CONSULTING GROUP, INC.. INT. CL. 36. REG. 12-24-2002.
- 2,664,956. THE CENTER FOR EXCELLENCE AND DESIGN. INT. CL. 41. REG. 12-24-2002.
- 2,664,957. CENTER FOR EXCELLENCE. INT. CL. 41. REG. 12-24-2002.
- 2,664,958. STORYMIME. INT. CL. 41. REG. 12-24-2002.
- 2,664,962. DAY 1 01/01/0001 AND DESIGN. INT. CL. 25. REG. 12-24-2002.
- 2,664,964. FC INTERNATIONAL. INT. CL. 42. REG. 12-24-2002.
- 2,664,965. DB-TRAINING SETTING THE STANDARD IN DATABASE TRAINING AND DESIGN. INT. CL. 41. REG. 12-24-2002.
- 2,664,969. TELEM@N AND DESIGN. INT. CLS. 38, 41 AND 42. REG. 12-24-2002.
- 2,664,971. ROUX ROUX AND DESIGN. INT. CL. 6. REG. 12-24-2002.
- 2,664,973. FLEXET INFINITY. INT. CL. 1. REG. 12-24-2002.
- 2,664,975. INSTABOOK. INT. CLS. 16 AND 35. REG. 12-24-2002.
- 2,664,976. INFORMASERV AND DESIGN. INT. CL. 42. REG. 12-24-2002.
- 2,664,978. CO-DESIGN (STYLIZED). INT. CLS. 35 AND 41. REG. 12-24-2002.
- 2,664,981. SUPERFARE.COM AND DESIGN. INT. CL. 39. REG. 12-24-2002.
- 2,664,985. PROFLO. INT. CL. 11. REG. 12-24-2002.
- 2,664,986. PARJARDO (STYLIZED). INT. CL. 25. REG. 12-24-2002.
- 2,664,988. FUNEL. INT. CLS. 3 AND 5. REG. 12-24-2002.
- 2,664,990. MULTIMANIA. INT. CLS. 9, 38 AND 41. REG. 12-24-2002.
- 2,664,991. SITESNAPS (STYLIZED). INT. CL. 42. REG. 12-24-2002.
- 2,664,992. TEMPEST MESSENGER SYSTEM. INT. CL. 9. REG. 12-24-2002.
- 2,664,995. TERIAKA. INT. CLS. 5, 29, 30 AND 31. REG. 12-24-2002.
- 2,664,996. 1-877-SENDVNS. INT. CLS. 36, 38 AND 39. REG. 12-24-2002.
- 2,664,998. E-BUSINESS IN E-TIME. INT. CL. 35. REG. 12-24-2002.
- 2,664,999. TEXAS BEEF AND DESIGN. INT. CL. 29. REG. 12-24-2002.
- 2,665,003. MISCELLANEOUS DESIGN. INT. CLS. 1, 2, 3, 5, 29, 30 AND 32. REG. 12-24-2002.
- 2,665,004. IMYOURMUSIC.COM. INT. CLS. 35, 38 AND 41. REG. 12-24-2002.
- 2,665,005. PLATINO. INT. CLS. 7, 9 AND 11. REG. 12-24-2002.
- 2,665,007. AUTOTESTER. INT. CLS. 9 AND 35. REG. 12-24-2002.
- 2,665,009. E SHIRTS GAMMA GARB AND DESIGN. INT. CLS. 25 AND 35. REG. 12-24-2002.
- 2,665,010. FORMSECURE. INT. CL. 9. REG. 12-24-2002.
- 2,665,012. O'NEIL MOTORSPORTS. INT. CL. 41. REG. 12-24-2002.
- 2,665,014. VIETSCAPE. INT. CL. 42. REG. 12-24-2002.
- 2,665,016. SOY.N.ERGY AND DESIGN. INT. CL. 30. REG. 12-24-2002.
- 2,665,017. MUSICAL ESCAPES. INT. CL. 9. REG. 12-24-2002.
- 2,665,020. ZIP N' RIDE. INT. CL. 25. REG. 12-24-2002.
- 2,665,023. BIOHUMIN. INT. CLS. 1 AND 42. REG. 12-24-2002.
- 2,665,030. WAVESPLITTER. INT. CL. 9. REG. 12-24-2002.
- 2,665,033. THE MEDIA TECHNOLOGY CENTERS AND DESIGN. INT. CL. 36. REG. 12-24-2002.
- 2,665,034. SEIZE THE TRADE. INT. CL. 36. REG. 12-24-2002.
- 2,665,036. DURACOIL. INT. CL. 26. REG. 12-24-2002.
- 2,665,037. E-BUSINESS WORLD. INT. CLS. 16 AND 42. REG. 12-24-2002.
- 2,665,041. SIGMAKALON. INT. CLS. 1, 2, 16, 19, 27 AND 35. REG. 12-24-2002.
- 2,665,044. BANKSIA. INT. CL. 33. REG. 12-24-2002.
- 2,665,045. BODY BREEZE. INT. CLS. 18, 24 AND 25. REG. 12-24-2002.
- 2,665,049. CYPRESS. INT. CL. 19. REG. 12-24-2002.
- 2,665,050. WEBANK BPM. INT. CLS. 9, 35, 38 AND 42. REG. 12-24-2002.
- 2,665,051. PURE HOME (STYLIZED). INT. CL. 24. REG. 12-24-2002.
- 2,665,052. QUICKEN. INT. CL. 21. REG. 12-24-2002.
- 2,665,053. JOAYO. INT. CL. 28. REG. 12-24-2002.
- 2,665,054. ACTIVE RESEARCH QUARTERLY. INT. CL. 35. REG. 12-24-2002.
- 2,665,056. VERACOM. INT. CL. 42. REG. 12-24-2002.
- 2,665,059. ZED. INT. CL. 41. REG. 12-24-2002.
- 2,665,060. 727 T. H. W. AND DESIGN. INT. CL. 35. REG. 12-24-2002.
- 2,665,062. BEAU TEMPS AND DESIGN. INT. CL. 25. REG. 12-24-2002.
- 2,665,063. WEBTRAIL. INT. CL. 35. REG. 12-24-2002.
- 2,665,064. W AND DESIGN. INT. CLS. 9, 38 AND 42. REG. 12-24-2002.
- 2,665,065. THAI SPICE AND DESIGN. INT. CL. 42. REG. 12-24-2002.
- 2,665,066. PEOPLELINK. INT. CL. 38. REG. 12-24-2002.
- 2,665,073. CINNIBAKE. INT. CL. 35. REG. 12-24-2002.
- 2,665,076. DB (STYLIZED). INT. CL. 6. REG. 12-24-2002.
- 2,665,077. ECHOFLOW. INT. CL. 10. REG. 12-24-2002.
- 2,665,078. EKAM. INT. CL. 42. REG. 12-24-2002.
- 2,665,081. CUSTOM AXIS. INT. CL. 12. REG. 12-24-2002.

- 2,665,082. WHERE NEXT GENERATION NETWORKING STARTS. INT. CL. 41. REG. 12-24-2002.
- 2,665,083. TEKNEO. INT. CL. 9. REG. 12-24-2002.
- 2,665,084. CALA VILLA (STYLIZED). INT. CL. 30. REG. 12-24-2002.
- 2,665,086. SLENDERONE. INT. CL. 42. REG. 12-24-2002.
- 2,665,087. THE CHILDREN'S HOUR ACADEMY "A PILGRIMAGE OF CHILDHOOD" AND DESIGN. INT. CL. 41. REG. 12-24-2002.
- 2,665,090. THIS IS NUTS!. INT. CL. 30. REG. 12-24-2002.
- 2,665,093. ONETTA. INT. CL. 9. REG. 12-24-2002.
- 2,665,098. ZOOMP. INT. CL. 25. REG. 12-24-2002.
- 2,665,100. SKI EUROPE (STYLIZED). INT. CL. 39. REG. 12-24-2002.
- 2,665,101. QUADRO SWITCH. INT. CL. 10. REG. 12-24-2002.
- 2,665,103. SPRINGBOARD VENTURES. INT. CL. 35. REG. 12-24-2002.
- 2,665,104. SAVES. INT. CLS. 25 AND 41. REG. 12-24-2002.
- 2,665,108. INLETS. INT. CLS. 9, 16 AND 41. REG. 12-24-2002.
- 2,665,110. INSTA-BOUTIQUE. INT. CL. 9. REG. 12-24-2002.
- 2,665,112. US INFOBOTICS. INT. CL. 9. REG. 12-24-2002.
- 2,665,114. BENDER. INT. CLS. 25 AND 35. REG. 12-24-2002.
- 2,665,119. DESCUBRAMOS LA PALABRA. INT. CL. 41. REG. 12-24-2002.
- 2,665,120. WWW.CHANNELCORP.COM. INT. CL. 41. REG. 12-24-2002.
- 2,665,121. CITY OF LA MIRADA SATE OF CALIFORNIA 1960 AND DESIGN. INT. CLS. 35, 36 AND 42. REG. 12-24-2002.
- 2,665,123. THE RACER'S MARKET AND DESIGN. INT. CL. 35. REG. 12-24-2002.
- 2,665,124. CLICK MOVIE AND DESIGN. INT. CL. 38. REG. 12-24-2002.
- 2,665,125. LFS. INT. CLS. 35 AND 36. REG. 12-24-2002.
- 2,665,127. MIST-AWAY (STYLIZED). INT. CL. 11. REG. 12-24-2002.
- 2,665,132. JINENKAN. INT. CL. 41. REG. 12-24-2002.
- 2,665,133. JULY FOURTH THE BAND (STYLIZED). INT. CL. 41. REG. 12-24-2002.
- 2,665,134. SAY AHH.COM AND DESIGN. INT. CL. 35. REG. 12-24-2002.
- 2,665,137. XANTOSCREEN. INT. CLS. 1, 5 AND 42. REG. 12-24-2002.
- 2,665,138. LOSHALEGRO. INT. CL. 9. REG. 12-24-2002.
- 2,665,140. QH AND DESIGN. INT. CL. 33. REG. 12-24-2002.
- 2,665,141. DIGITAL GARDEN AND DESIGN. INT. CL. 42. REG. 12-24-2002.
- 2,665,142. SENATOR AQUA-LINER. INT. CL. 16. REG. 12-24-2002.
- 2,665,144. POWER220 (STYLIZED). INT. CL. 9. REG. 12-24-2002.
- 2,665,145. AUDIOBASKET.COM. INT. CL. 38. REG. 12-24-2002.
- 2,665,146. S AND DESIGN. INT. CL. 42. REG. 12-24-2002.
- 2,665,147. ZENSYS. INT. CLS. 9 AND 16. REG. 12-24-2002.
- 2,665,153. PROUT AG PERFORMING BUSINESS AND DESIGN. INT. CLS. 9 AND 42. REG. 12-24-2002.
- 2,665,155. TENNIS MASTERS CUP AND DESIGN. INT. CLS. 18, 25, 28, 38 AND 41. REG. 12-24-2002.
- 2,665,156. WHATEVER IT TAKES. INT. CL. 37. REG. 12-24-2002.
- 2,665,157. OREX. INT. CL. 10. REG. 12-24-2002.
- 2,665,160. GINJA. INT. CLS. 3, 18 AND 25. REG. 12-24-2002.
- 2,665,164. FIRE POINT AND DESIGN. INT. CL. 9. REG. 12-24-2002.
- 2,665,165. FIRE POINT. INT. CL. 9. REG. 12-24-2002.
- 2,665,167. THE LIBRARY II. INT. CL. 42. REG. 12-24-2002.
- 2,665,172. THE U.S. PLAYING CARD .CO ORIGINAL FANBACK POKER NO. 9 A DOUGHERTY REG. U.S. PAT. OFF. & TM.LINOID FINISH TALLY-HO PLAYING CARDS NO. 9 LINOID FINISH MADE IN U.S.A. TALLY-HO POKER 9 AND DESIGN. INT. CL. 16. REG. 12-24-2002.
- 2,665,175. BUILDINGREPORTS.COM AND DESIGN. INT. CL. 42. REG. 12-24-2002.
- 2,665,176. ROOFERS' HELPER. INT. CLS. 3 AND 24. REG. 12-24-2002.
- 2,665,181. MFC. INT. CL. 9. REG. 12-24-2002.
- 2,665,184. KINETIC LEARNING CENTER. INT. CL. 41. REG. 12-24-2002.
- 2,665,185. THE LARK LETTER. INT. CL. 16. REG. 12-24-2002.
- 2,665,186. WRITE SMART. INT. CL. 41. REG. 12-24-2002.
- 2,665,188. MYSPEECH AND DESIGN. INT. CL. 42. REG. 12-24-2002.
- 2,665,189. HOMEVALUENOW.COM. INT. CL. 36. REG. 12-24-2002.
- 2,665,191. CATAPULTA. INT. CL. 35. REG. 12-24-2002.
- 2,665,194. FRANCO FERRARO. INT. CL. 25. REG. 12-24-2002.
- 2,665,197. MAGIC GARDEN. INT. CL. 9. REG. 12-24-2002.
- 2,665,200. GELSUS RESEARCH & CONSULTING, INC.. INT. CL. 42. REG. 12-24-2002.
- 2,665,202. AEROTEK CLINICAL SOLUTIONS. INT. CL. 35. REG. 12-24-2002.
- 2,665,205. ABC IMAGING PHOTO GRAPHICS PRINTING INTERNET AND DESIGN. INT. CLS. 35, 37, 40 AND 42. REG. 12-24-2002.
- 2,665,206. THE APOSTOLIC CHURCH ONE FOLD AND ONE SHEPHERD JOHN 10:16 AND DESIGN. INT. CL. 42. REG. 12-24-2002.
- 2,665,207. FITSIMONS AND DESIGN. INT. CL. 41. REG. 12-24-2002.
- 2,665,211. HAWAIIAN RAINFOREST. INT. CL. 3. REG. 12-24-2002.
- 2,665,212. MONTREUX FESTIVAL ON TOUR. INT. CL. 41. REG. 12-24-2002.
- 2,665,213. DE MANCHI. INT. CL. 25. REG. 12-24-2002.
- 2,665,215. PRESTON. INT. CL. 20. REG. 12-24-2002.
- 2,665,216. MAKE ME PERFECT. INT. CL. 42. REG. 12-24-2002.
- 2,665,217. F. A. P. FINE AUTO PARTS AND DESIGN. INT. CLS. 7 AND 12. REG. 12-24-2002.
- 2,665,218. TOTAL MERCHANDISING SYSTEM. INT. CL. 7. REG. 12-24-2002.
- 2,665,219. E-MOCION (STYLIZED). INT. CLS. 9 AND 38. REG. 12-24-2002.
- 2,665,221. HOURGLASS COLLECTION. INT. CL. 35. REG. 12-24-2002.
- 2,665,223. VENOM (STYLIZED). INT. CL. 9. REG. 12-24-2002.
- 2,665,224. ADLER (STYLIZED). INT. CL. 14. REG. 12-24-2002.
- 2,665,225. THE HERBY BOX YOUR NETWORK INTERNET 1ST AND DESIGN. INT. CL. 9. REG. 12-24-2002.
- 2,665,231. RACER R COMPUTER AND DESIGN. INT. CL. 9. REG. 12-24-2002.
- 2,665,232. VAYBEE. INT. CL. 38. REG. 12-24-2002.
- 2,665,235. BAESCH COMPUTER CONSULTING "EXCELLENCE IN COMPUTER CONSULTING" AND DESIGN. INT. CL. 42. REG. 12-24-2002.
- 2,665,236. JC RESORTS GOLF. INT. CLS. 35, 41 AND 42. REG. 12-24-2002.
- 2,665,237. DEEZ NUTZ. INT. CL. 28. REG. 12-24-2002.
- 2,665,241. VIRTUAL FUN CENTER. INT. CL. 28. REG. 12-24-2002.
- 2,665,244. YO BITES APPLES WITH ATTITUDE! AND DESIGN. INT. CL. 29. REG. 12-24-2002.
- 2,665,245. MISCELLANEOUS DESIGN. INT. CL. 29. REG. 12-24-2002.
- 2,665,247. BRANDON TOWNCENTER. INT. CLS. 35 AND 36. REG. 12-24-2002.
- 2,665,248. ASX AUSTRALIAN STOCK EXCHANGE AND DESIGN. INT. CLS. 9, 16, 35, 36, 38, 41 AND 42. REG. 12-24-2002.
- 2,665,249. LOCOMOTION.COM. INT. CLS. 38 AND 41. REG. 12-24-2002.
- 2,665,250. KINGS BREW MIDLANDS DRAUGHT NEW ROOT BEER WORLD NEW WORLD BEVERAGE COMPANY AND DESIGN. INT. CL. 32. REG. 12-24-2002.
- 2,665,251. TIRA. INT. CL. 14. REG. 12-24-2002.
- 2,665,252. KARIS. INT. CL. 14. REG. 12-24-2002.
- 2,665,253. LYRIS. INT. CL. 14. REG. 12-24-2002.
- 2,665,254. CHANGING THE DYNAMICS OF INFORMATION ACCESS. INT. CLS. 9 AND 41. REG. 12-24-2002.

- 2,665,255. PUNCH BLAST SODA.COM. INT. CL. 32. REG. 12-24-2002.
- 2,665,259. FDXX VSD (STYLIZED). INT. CLS. 7 AND 8. REG. 12-24-2002.
- 2,665,261. LIFE'S A GAME... GAME ON!. INT. CL. 41. REG. 12-24-2002.
- 2,665,262. MEGLO. INT. CLS. 16, 35, 38 AND 42. REG. 12-24-2002.
- 2,665,263. INVERLINK. INT. CL. 36. REG. 12-24-2002.
- 2,665,266. ARMOCLEAR. INT. CL. 1. REG. 12-24-2002.
- 2,665,268. ZEMI MUSIC AND DESIGN. INT. CLS. 35 AND 41. REG. 12-24-2002.
- 2,665,272. THE HUMANE SOCIETY OF THE UNITED STATES AND DESIGN. INT. CLS. 16, 36 AND 42. REG. 12-24-2002.
- 2,665,274. PADINA. INT. CLS. 9 AND 42. REG. 12-24-2002.
- 2,665,275. MUSTANG SURVIVAL ENDURANCE AND DESIGN. INT. CL. 9. REG. 12-24-2002.
- 2,665,276. SASO (STYLIZED). INT. CL. 9. REG. 12-24-2002.
- 2,665,278. IGO ALERTS. INT. CLS. 36 AND 42. REG. 12-24-2002.
- 2,665,279. DDS DISCOUNT DUMPSTER SERVICES, LLC AND DESIGN. INT. CL. 42. REG. 12-24-2002.
- 2,665,280. SWISSQUOTE AND DESIGN. INT. CLS. 35 AND 36. REG. 12-24-2002.
- 2,665,284. TAKE OUT EXPRESS AND DESIGN. INT. CL. 42. REG. 12-24-2002.
- 2,665,285. NTER AND DESIGN. INT. CL. 42. REG. 12-24-2002.
- 2,665,287. VOICE OF THE PROFESSIONAL REMODELING INDUSTRY. INT. CLS. 16 AND 42. REG. 12-24-2002.
- 2,665,290. REVOLVER. INT. CL. 3. REG. 12-24-2002.
- 2,665,292. SURFTV. INT. CL. 41. REG. 12-24-2002.
- 2,665,293. SWIPSY. INT. CL. 9. REG. 12-24-2002.
- 2,665,296. SATLAN. INT. CL. 9. REG. 12-24-2002.
- 2,665,297. BUBAR. INT. CLS. 9, 16 AND 41. REG. 12-24-2002.
- 2,665,298. CREEK RATZ. INT. CL. 42. REG. 12-24-2002.
- 2,665,300. LA COSTA SPA. INT. CL. 41. REG. 12-24-2002.
- 2,665,302. GEMPRIVILEGE. INT. CLS. 16 AND 42. REG. 12-24-2002.
- 2,665,303. WBSLOGIC. INT. CLS. 35 AND 41. REG. 12-24-2002.
- 2,665,304. LEVELWORLD.COM. INT. CLS. 25 AND 35. REG. 12-24-2002.
- 2,665,306. CELLTREX. INT. CLS. 9 AND 38. REG. 12-24-2002.
- 2,665,311. CITRUS PLUS. INT. CL. 1. REG. 12-24-2002.
- 2,665,316. MULTICOMM. INT. CL. 9. REG. 12-24-2002.
- 2,665,317. AMMA. INT. CL. 6. REG. 12-24-2002.
- 2,665,319. CN AND DESIGN. INT. CLS. 16, 39 AND 41. REG. 12-24-2002.
- 2,665,321. WIDEPENTELPHONE. INT. CL. 38. REG. 12-24-2002.
- 2,665,323. MIST-TROL. INT. CL. 1. REG. 12-24-2002.
- 2,665,324. TRAIL LITE 2000. INT. CL. 2. REG. 12-24-2002.
- 2,665,325. AX-IT. INT. CL. 1. REG. 12-24-2002.
- 2,665,326. BANCO DE CHILE. INT. CL. 36. REG. 12-24-2002.
- 2,665,328. WITCH. INT. CL. 3. REG. 12-24-2002.
- 2,665,330. YOUR FIRST CHOICE FOR JOBS IN SAN DIEGO. INT. CLS. 35 AND 41. REG. 12-24-2002.
- 2,665,332. FORESTWEB. INT. CL. 42. REG. 12-24-2002.
- 2,665,334. HERBAL HAIR & SCALP CONITIONER NATURAL OASIS AND DESIGN. INT. CL. 5. REG. 12-24-2002.
- 2,665,336. REGENT INTERNATIONAL HOTELS. INT. CL. 42. REG. 12-24-2002.
- 2,665,337. ENSTAGE. INT. CLS. 9, 35 AND 42. REG. 12-24-2002.
- 2,665,344. FIRST CHOICE DANISH BUTTER COOKIES & CHOCOLATE CHIP COOKIES PRODUCT OF DENMARK NATURALLY FLAVORED RIPPENSA CLASSICS AND DESIGN. INT. CL. 30. REG. 12-24-2002.
- 2,665,345. LONG DISTANCE TELEPHONE CALLS (LANDLINE OR WIRELESS) THAT SHOULD BE LOCAL CALLS (STYLIZED). INT. CL. 38. REG. 12-24-2002.
- 2,665,347. MISCELLANEOUS DESIGN. INT. CL. 36. REG. 12-24-2002.
- 2,665,349. MISCELLANEOUS DESIGN. INT. CLS. 35, 36 AND 42. REG. 12-24-2002.
- 2,665,351. CARTESIS SFM. INT. CL. 9. REG. 12-24-2002.
- 2,665,354. STATLASE. INT. CL. 10. REG. 12-24-2002.
- 2,665,356. CLARUS AND DESIGN. INT. CL. 21. REG. 12-24-2002.
- 2,665,359. CELESTIAL CAR CARE *ULTRA WASH 'N' SHINE* AND DESIGN. INT. CL. 3. REG. 12-24-2002.
- 2,665,361. ASSIGNED CANDIDATE PROFILES. INT. CL. 35. REG. 12-24-2002.
- 2,665,362. SENOR CELLULAR AND DESIGN. INT. CLS. 35 AND 38. REG. 12-24-2002.
- 2,665,363. CLASSIFIED.TECHNOLOGIES AND DESIGN. INT. CL. 35. REG. 12-24-2002.
- 2,665,364. ACE DECOY ANCHORS. INT. CL. 28. REG. 12-24-2002.
- 2,665,366. POWERFUL TOOLS MAKE POWERFUL PEOPLE. INT. CLS. 35, 38 AND 42. REG. 12-24-2002.
- 2,665,367. CASTLE GROVE. INT. CLS. 29 AND 30. REG. 12-24-2002.
- 2,665,368. LIFEALBUM. INT. CL. 9. REG. 12-24-2002.
- 2,665,369. ILOCUS. INT. CL. 35. REG. 12-24-2002.
- 2,665,370. SEA REALTY AND DESIGN. INT. CL. 36. REG. 12-24-2002.
- 2,665,375. MOLECUTHANE. INT. CL. 13. REG. 12-24-2002.
- 2,665,376. R. FRANCO AND DESIGN. INT. CL. 28. REG. 12-24-2002.
- 2,665,377. KNOW BEFORE YOU GO. INT. CL. 35. REG. 12-24-2002.
- 2,665,379. ETGROUP ENABLING TECHNOLOGIES GROUP AND DESIGN. INT. CL. 42. REG. 12-24-2002.
- 2,665,381. WAVE SPLITTER AND DESIGN. INT. CL. 9. REG. 12-24-2002.
- 2,665,383. TESTU AND DESIGN. INT. CL. 41. REG. 12-24-2002.
- 2,665,384. STATUSONE. INT. CL. 42. REG. 12-24-2002.
- 2,665,385. CBPI. INT. CL. 19. REG. 12-24-2002.
- 2,665,386. MY BARPOINT. INT. CL. 35. REG. 12-24-2002.
- 2,665,388. NORTH AMERICAN SOLUTIONS, INC.. INT. CL. 35. REG. 12-24-2002.
- 2,665,391. HIVERWORLD. INT. CLS. 9 AND 42. REG. 12-24-2002.
- 2,665,392. ZING INTERACTIVE MEDIA. INT. CLS. 35 AND 41. REG. 12-24-2002.
- 2,665,394. FORTY MILE CREEK. INT. CL. 25. REG. 12-24-2002.
- 2,665,397. NITRO NELLIE. INT. CL. 9. REG. 12-24-2002.
- 2,665,398. ZIG. INT. CL. 1. REG. 12-24-2002.
- 2,665,399. WET FILM WIZARD. INT. CLS. 6 AND 9. REG. 12-24-2002.
- 2,665,400. 706. INT. CL. 9. REG. 12-24-2002.
- 2,665,401. HEALTHYEXTENSIONS (STYLIZED). INT. CL. 35. REG. 12-24-2002.
- 2,665,402. JXP ANIME. INT. CL. 9. REG. 12-24-2002.
- 2,665,403. JXP CARTOONS. INT. CL. 35. REG. 12-24-2002.
- 2,665,404. DIGITALATOMS AND DESIGN. INT. CLS. 9 AND 35. REG. 12-24-2002.
- 2,665,411. INSTITUTIONAL REAL ESTATE JOINS THE DIGITAL REVOLUTION. INT. CLS. 35, 36 AND 41. REG. 12-24-2002.
- 2,665,413. SINGH S MADAN. INT. CL. 25. REG. 12-24-2002.
- 2,665,415. MISCELLANEOUS DESIGN. INT. CLS. 17, 22 AND 40. REG. 12-24-2002.
- 2,665,416. SMARTAVERAGE32. INT. CL. 9. REG. 12-24-2002.
- 2,665,420. H HIGH DEFINITION IMAGING AND DESIGN. INT. CL. 9. REG. 12-24-2002.
- 2,665,425. SHIFTING SANDS. INT. CL. 19. REG. 12-24-2002.
- 2,665,426. CRUSTI CROC. INT. CLS. 29 AND 30. REG. 12-24-2002.
- 2,665,427. PATCHGEAR BY THE PATCH GIRLS! THE GIRLS WITH TOO MUCH ATTITUDE!! AND DESIGN. INT. CL. 26. REG. 12-24-2002.
- 2,665,428. ALMATEC. INT. CLS. 6, 20 AND 37. REG. 12-24-2002.

- 2,665,429. DIGITAL CONTAINER. INT. CL. 42. REG. 12-24-2002.
- 2,665,431. COLEMAN OUTDOORS. INT. CL. 25. REG. 12-24-2002.
- 2,665,433. TC-2. INT. CLS. 3 AND 28. REG. 12-24-2002.
- 2,665,435. INTERVENTION THEATRE. INT. CL. 41. REG. 12-24-2002.
- 2,665,436. THE KNOW HOW TO KNOW HOW. INT. CL. 41. REG. 12-24-2002.
- 2,665,437. SURGIGUARD. INT. CL. 10. REG. 12-24-2002.
- 2,665,438. SECURITY KEY WEST AND DESIGN. INT. CL. 34. REG. 12-24-2002.
- 2,665,439. KEY WEST EXTRAS AND DESIGN. INT. CL. 34. REG. 12-24-2002.
- 2,665,441. MISCELLANEOUS DESIGN. INT. CLS. 9 AND 41. REG. 12-24-2002.
- 2,665,442. BEARHEAR DESIGNS CRUMCATCHER THE ULTIMATE WATERPROOF CAR SEAT APRON AND DESIGN. INT. CL. 25. REG. 12-24-2002.
- 2,665,444. CASCAL. INT. CLS. 11, 35, 37, 39, 40 AND 42. REG. 12-24-2002.
- 2,665,445. FURRYTAILS. INT. CL. 28. REG. 12-24-2002.
- 2,665,449. EVERYTHING YOU'D NEVER EXPECT FROM A LUMBER COMPANY. INT. CL. 35. REG. 12-24-2002.
- 2,665,451. VIRAGE. INT. CL. 9. REG. 12-24-2002.
- 2,665,452. YOUR PARTNER IN BUSINESS. INT. CL. 36. REG. 12-24-2002.
- 2,665,454. THE POWER OF C AND DESIGN. INT. CL. 42. REG. 12-24-2002.
- 2,665,457. AUGUST 5, 2001 BRICKYARD 400 AND DESIGN. INT. CL. 41. REG. 12-24-2002.
- 2,665,459. MEDITERRANEUM TRADE MARK AMORE AND DESIGN. INT. CL. 29. REG. 12-24-2002.
- 2,665,460. FARMLAND. INT. CLS. 35 AND 42. REG. 12-24-2002.
- 2,665,461. MISCELLANEOUS DESIGN. INT. CL. 21. REG. 12-24-2002.
- 2,665,465. SPOREVER. INT. CLS. 12, 18, 22, 25, 28, 38, 41 AND 42. REG. 12-24-2002.
- 2,665,469. SNPCHIP. INT. CL. 38. REG. 12-24-2002.
- 2,665,470. ALLOCATING4PROFIT. INT. CL. 42. REG. 12-24-2002.
- 2,665,471. PRIMEKEY MORTGAGE UNLOCK YOUR DREAMS AND DESIGN. INT. CL. 36. REG. 12-24-2002.
- 2,665,472. NATIONAL MORTGAGE WEEKLY. INT. CL. 16. REG. 12-24-2002.
- 2,665,475. LOVE YOUR BODY LOVE YOUR MIND. INT. CL. 32. REG. 12-24-2002.
- 2,665,476. CALL OR CLICK SAME GREAT SERVICE! WWW.DIRECTSUPPLY.NET AND DESIGN. INT. CL. 35. REG. 12-24-2002.
- 2,665,480. AG48N. INT. CL. 12. REG. 12-24-2002.
- 2,665,485. 51 SOUND PRODUCTIONS. INT. CL. 41. REG. 12-24-2002.
- 2,665,486. AUTHORIZED WIRELESS. INT. CLS. 35 AND 38. REG. 12-24-2002.
- 2,665,489. CPAYS. INT. CLS. 9, 16, 38 AND 42. REG. 12-24-2002.
- 2,665,490. DRAKE KRYTERION. INT. CLS. 9, 16 AND 41. REG. 12-24-2002.
- 2,665,491. FLORIDA SPACE INSTITUTE AND DESIGN. INT. CLS. 16, 25, 41 AND 42. REG. 12-24-2002.
- 2,665,492. MONREALE. INT. CL. 31. REG. 12-24-2002.
- 2,665,493. CUT AND RUN. INT. CL. 28. REG. 12-24-2002.
- 2,665,496. D C S DESIGN CENTER SOLUTIONS AND DESIGN. INT. CL. 35. REG. 12-24-2002.
- 2,665,500. DYNHANCEMENTZ "YOUR KEY TO DYNAMIC CHANGE" AND DESIGN. INT. CL. 42. REG. 12-24-2002.
- 2,665,504. MICROGREENS AND DESIGN. INT. CLS. 31 AND 35. REG. 12-24-2002.
- 2,665,506. YUM YUM. INT. CL. 25. REG. 12-24-2002.
- 2,665,507. FLAGSTICKY. INT. CL. 28. REG. 12-24-2002.
- 2,665,509. WE'RE NOT SO TOUGH HI-COUNTRY BEEF JERKY AND DESIGN. INT. CL. 29. REG. 12-24-2002.
- 2,665,512. ITT INDUSTRIES ENGINEERED FOR LIFE AND DESIGN. INT. CLS. 35, 41 AND 42. REG. 12-24-2002.
- 2,665,513. SWIRL & SOOTHE. INT. CL. 10. REG. 12-24-2002.
- 2,665,515. KING KONGA. INT. CL. 41. REG. 12-24-2002.
- 2,665,517. UBET SHIRAZ. INT. CL. 33. REG. 12-24-2002.
- 2,665,524. MATRIX DATA SOLUTIONS. INT. CL. 42. REG. 12-24-2002.
- 2,665,528. RE 2000. INT. CLS. 6 AND 7. REG. 12-24-2002.
- 2,665,529. LIQUENT XTENT. INT. CL. 9. REG. 12-24-2002.
- 2,665,530. MISCELLANEOUS DESIGN. INT. CL. 42. REG. 12-24-2002.
- 2,665,531. OZARK FLUORINE SPECIALTIES AND DESIGN. INT. CLS. 1, 40 AND 42. REG. 12-24-2002.
- 2,665,532. AME APPLIED MOLECULAR EVOLUTION (STYLIZED). INT. CL. 42. REG. 12-24-2002.
- 2,665,533. BAY QA RECRUITING AND DESIGN. INT. CL. 35. REG. 12-24-2002.
- 2,665,534. BERNSTEIN INVESTMENT RESEARCH AND MANAGEMENT AND DESIGN. INT. CL. 36. REG. 12-24-2002.
- 2,665,535. TECHNOLOGY YOU CAN LIVE WITH. INT. CL. 35. REG. 12-24-2002.
- 2,665,537. FLEXCHECK. INT. CLS. 6, 9 AND 17. REG. 12-24-2002.
- 2,665,538. MATIS AND DESIGN. INT. CL. 40. REG. 12-24-2002.
- 2,665,540. TIRES & MORE AND DESIGN. INT. CL. 35. REG. 12-24-2002.
- 2,665,544. ZIFF DAVIS MEDIA CIO INSIGHT. INT. CLS. 16 AND 42. REG. 12-24-2002.
- 2,665,545. SPEEDWAY 240. INT. CL. 8. REG. 12-24-2002.
- 2,665,546. SILVER SPEEDWAY 240. INT. CL. 8. REG. 12-24-2002.
- 2,665,547. HUMANOPTICS (STYLIZED). INT. CLS. 5, 9 AND 10. REG. 12-24-2002.
- 2,665,550. NEXTSTEP DSL, INC. AND DESIGN. INT. CL. 38. REG. 12-24-2002.
- 2,665,551. SPEC AND DESIGN. INT. CL. 42. REG. 12-24-2002.
- 2,665,552. TRANSPOTRACK. INT. CL. 39. REG. 12-24-2002.
- 2,665,553. MEDITERRANEUM. INT. CL. 33. REG. 12-24-2002.
- 2,665,555. FLEXTERMS. INT. CL. 36. REG. 12-24-2002.
- 2,665,556. MISCELLANEOUS DESIGN. INT. CL. 30. REG. 12-24-2002.
- 2,665,559. THE POOL PROFESSOR. INT. CL. 9. REG. 12-24-2002.
- 2,665,560. PSI PROBLEMS SOLUTIONS INNOVATIONS AND DESIGN. INT. CL. 41. REG. 12-24-2002.
- 2,665,561. ERIE SEAWOLVES AND DESIGN. INT. CL. 25. REG. 12-24-2002.
- 2,665,563. STEPHANE MARAIS. INT. CLS. 3, 38 AND 42. REG. 12-24-2002.
- 2,665,565. GOLD COIN AND DESIGN. INT. CL. 34. REG. 12-24-2002.
- 2,665,566. TELEVISION YOU CAN TRUST. INT. CL. 38. REG. 12-24-2002.
- 2,665,569. LISTONE GIORDANO MARGARITELLI AND DESIGN. INT. CL. 19. REG. 12-24-2002.
- 2,665,573. BEACONSCHOOLS AND DESIGN. INT. CL. 35. REG. 12-24-2002.
- 2,665,582. MESSAGE DE TENDRESSE (STYLIZED). INT. CL. 3. REG. 12-24-2002.
- 2,665,583. X AND DESIGN. INT. CL. 35. REG. 12-24-2002.
- 2,665,586. COMBINATURE. INT. CLS. 1, 5 AND 42. REG. 12-24-2002.
- 2,665,587. JON WARREN LENTZ. INT. CL. 35. REG. 12-24-2002.
- 2,665,589. VALIANEX. INT. CL. 5. REG. 12-24-2002.
- 2,665,591. CORPORUM. INT. CLS. 35, 41 AND 42. REG. 12-24-2002.
- 2,665,592. INLET COVE CAPITAL. INT. CL. 36. REG. 12-24-2002.
- 2,665,594. VISUAL CADLINKS. INT. CL. 9. REG. 12-24-2002.

- 2,665,595. CSX WORLD CRANE SERVICES AND DESIGN. INT. CL. 35. REG. 12-24-2002.
- 2,665,598. CRF BOX < > AND DESIGN. INT. CL. 38. REG. 12-24-2002.
- 2,665,600. GET THE PICTURE?. INT. CL. 9. REG. 12-24-2002.
- 2,665,601. MISCELLANEOUS DESIGN. INT. CLS. 9, 35, 38 AND 42. REG. 12-24-2002.
- 2,665,603. RF TRAINING CO. YOUR INDUSTRY LEADER IN EDUCATION. AND DESIGN. INT. CL. 41. REG. 12-24-2002.
- 2,665,604. MI COMPARE. INT. CL. 36. REG. 12-24-2002.
- 2,665,605. PROCOURSE. INT. CL. 9. REG. 12-24-2002.
- 2,665,606. GET MONSTER. INT. CL. 35. REG. 12-24-2002.
- 2,665,607. CM (STYLIZED). INT. CL. 42. REG. 12-24-2002.
- 2,665,609. GATEWAY TANKERS. INT. CL. 39. REG. 12-24-2002.
- 2,665,612. CXM. INT. CLS. 35, 36 AND 42. REG. 12-24-2002.
- 2,665,613. RAINDANCE. INT. CL. 38. REG. 12-24-2002.
- 2,665,614. MEGASCOPE. INT. CL. 9. REG. 12-24-2002.
- 2,665,615. PROTECT IT AND DESIGN. INT. CLS. 6 AND 17. REG. 12-24-2002.
- 2,665,617. VACCARI. INT. CL. 33. REG. 12-24-2002.
- 2,665,619. CSX WORLD CRANE SERVICES AND DESIGN. INT. CL. 35. REG. 12-24-2002.
- 2,665,620. TEASE FREE KIDS. INT. CL. 41. REG. 12-24-2002.
- 2,665,621. THUNDERVOLTZ. INT. CL. 28. REG. 12-24-2002.
- 2,665,624. TRACKMON (STYLIZED). INT. CL. 9. REG. 12-24-2002.
- 2,665,625. ICHEX. INT. CL. 9. REG. 12-24-2002.
- 2,665,627. ENJOY THE SAME GREAT SMOKE FOR LESS. INT. CL. 34. REG. 12-24-2002.
- 2,665,628. INNER OCEAN. INT. CL. 41. REG. 12-24-2002.
- 2,665,630. ECONATIONAL. INT. CL. 16. REG. 12-24-2002.
- 2,665,631. SPRING COMMUNICATIONS. INT. CL. 41. REG. 12-24-2002.
- 2,665,632. LAKEPORT PREMIUM LAGER AND DESIGN. INT. CL. 32. REG. 12-24-2002.
- 2,665,633. MISCELLANEOUS DESIGN. INT. CL. 9. REG. 12-24-2002.
- 2,665,634. DISKONKEY AND DESIGN. INT. CL. 9. REG. 12-24-2002.
- 2,665,639. E-DTF (STYLIZED). INT. CL. 42. REG. 12-24-2002.
- 2,665,642. SMARTSERV. INT. CL. 9. REG. 12-24-2002.
- 2,665,645. DIAMOND M RANCH AND DESIGN. INT. CLS. 41 AND 42. REG. 12-24-2002.
- 2,665,647. MEN'S JOURNAL ADVENTURE TEAM AND DESIGN. INT. CLS. 16 AND 41. REG. 12-24-2002.
- 2,665,648. CLIFFORD THE BIG RED DOG. INT. CL. 20. REG. 12-24-2002.
- 2,665,652. ESLEECK COTTON 100. INT. CL. 16. REG. 12-24-2002.
- 2,665,656. PAINPOWERFIT (STYLIZED). INT. CL. 41. REG. 12-24-2002.
- 2,665,657. MISCELLANEOUS DESIGN. INT. CL. 41. REG. 12-24-2002.
- 2,665,658. FT FLASH TECHNOLOGY AND DESIGN. INT. CL. 9. REG. 12-24-2002.
- 2,665,660. RAINDANCE COMMUNICATIONS. INT. CL. 38. REG. 12-24-2002.
- 2,665,661. BLUE RIDGE AND DESIGN. INT. CL. 16. REG. 12-24-2002.
- 2,665,671. SELEXTRAC (STYLIZED). INT. CL. 1. REG. 12-24-2002.
- 2,665,672. A AND DESIGN. INT. CL. 9. REG. 12-24-2002.
- 2,665,673. PRIME INSURANCE SERVICES AND DESIGN. INT. CL. 36. REG. 12-24-2002.
- 2,665,674. ARKIDATA CORPORATION. INT. CL. 9. REG. 12-24-2002.
- 2,665,676. EDOARDO BIANCHI BIANCHI AND DESIGN. INT. CLS. 9, 25 AND 28. REG. 12-24-2002.
- 2,665,679. ISSANNIWARE AND DESIGN. INT. CL. 9. REG. 12-24-2002.
- 2,665,682. ETERNO BOARD. INT. CL. 16. REG. 12-24-2002.
- 2,665,683. JINYIN USA. INT. CL. 35. REG. 12-24-2002.
- 2,665,684. JINYIN. INT. CL. 35. REG. 12-24-2002.
- 2,665,685. CHILL JAM. INT. CL. 29. REG. 12-24-2002.
- 2,665,686. ROTOR-MATIC. INT. CL. 37. REG. 12-24-2002.
- 2,665,687. HOT GIRLS AND DESIGN. INT. CL. 25. REG. 12-24-2002.
- 2,665,688. AMERIPLAN VETERINARY CARE AND DESIGN. INT. CL. 36. REG. 12-24-2002.
- 2,665,689. GINGER LUXE AND DESIGN. INT. CL. 3. REG. 12-24-2002.
- 2,665,692. CHANGING THE WORLD...ONE LEADER AT A TIME. INT. CL. 41. REG. 12-24-2002.
- 2,665,693. JUANOLA AND DESIGN. INT. CLS. 5 AND 30. REG. 12-24-2002.
- 2,665,695. VANDERBILT AND DESIGN. INT. CLS. 16, 21, 25 AND 41. REG. 12-24-2002.
- 2,665,703. ELATOS. INT. CL. 10. REG. 12-24-2002.
- 2,665,705. PLANTAN. INT. CL. 1. REG. 12-24-2002.
- 2,665,707. OXY-DRY ECOCLEAN AND DESIGN. INT. CL. 1. REG. 12-24-2002.
- 2,665,708. VIDESENCE. INT. CL. 11. REG. 12-24-2002.
- 2,665,712. ALYSIS SEAFOOD. INT. CLS. 29 AND 31. REG. 12-24-2002.
- 2,665,713. MEGA MOLD AND MACHINE CORPORATION. INT. CL. 40. REG. 12-24-2002.
- 2,665,714. ISLAND VACATIONS AND DESIGN. INT. CLS. 39 AND 42. REG. 12-24-2002.
- 2,665,715. O&CO. AND DESIGN. INT. CL. 29. REG. 12-24-2002.
- 2,665,717. SANDISK AND DESIGN. INT. CL. 9. REG. 12-24-2002.
- 2,665,721. MAMANATAL. INT. CL. 3. REG. 12-24-2002.
- 2,665,723. COMPACTINT. INT. CLS. 1 AND 2. REG. 12-24-2002.
- 2,665,727. INTELLISHOE. INT. CL. 25. REG. 12-24-2002.
- 2,665,729. AQUAMAGIC AND DESIGN. INT. CL. 16. REG. 12-24-2002.
- 2,665,730. STARMAN'S. INT. CLS. 32 AND 33. REG. 12-24-2002.
- 2,665,731. ABQ DOG AND DESIGN. INT. CL. 42. REG. 12-24-2002.
- 2,665,736. SHB AND DESIGN. INT. CL. 42. REG. 12-24-2002.
- 2,665,740. ADVANCED RESPIRATORY AND DESIGN. INT. CL. 10. REG. 12-24-2002.
- 2,665,742. FIGARO'S RESTAURANT SUPPLY. INT. CL. 35. REG. 12-24-2002.
- 2,665,743. THE SPIRIT OF '76. INT. CL. 41. REG. 12-24-2002.
- 2,665,745. DEXLIPOTAM. INT. CL. 5. REG. 12-24-2002.
- 2,665,749. M AND DESIGN. INT. CLS. 7 AND 11. REG. 12-24-2002.
- 2,665,754. PATIENT RELATIONSHIP MANAGEMENT...RETURN TO THE POINT OF CARING (STYLIZED). INT. CLS. 35 AND 41. REG. 12-24-2002.
- 2,665,756. MISCELLANEOUS DESIGN. INT. CL. 42. REG. 12-24-2002.
- 2,665,758. DON FRANCISCO PRESENTA. INT. CL. 41. REG. 12-24-2002.
- 2,665,759. PATIENT RELATIONSHIP MANAGEMENT...A BUSINESS SOLUTION TO IMPROVE CLINICAL AND FINANCIAL OUTCOMES (STYLIZED). INT. CLS. 35 AND 41. REG. 12-24-2002.
- 2,665,770. URIDIUM AND DESIGN. INT. CL. 9. REG. 12-24-2002.
- 2,665,773. CHROMA-CHEM ULTRA AND DESIGN. INT. CL. 2. REG. 12-24-2002.
- 2,665,774. MARDI GRAS CARNIVAL. INT. CL. 30. REG. 12-24-2002.
- 2,665,777. TROUSERSETC. NEW YORK (STYLIZED). INT. CL. 25. REG. 12-24-2002.
- 2,665,778. SOMETIMES THE SPARK THAT CHANGES A COMPANY HAS TO COME FROM THE OUTSIDE. INT. CL. 35. REG. 12-24-2002.
- 2,665,779. MV-10 (STYLIZED). INT. CL. 35. REG. 12-24-2002.
- 2,665,780. POWER TO MOVE YOUR BUSINESS FORWARD. INT. CL. 35. REG. 12-24-2002.
- 2,665,781. COLLEGE OF E AND DESIGN. INT. CL. 41. REG. 12-24-2002.
- 2,665,784. REMOTE VIDEO PATROL AND DESIGN. INT. CL. 37. REG. 12-24-2002.
- 2,665,788. CALTOOL. INT. CL. 9. REG. 12-24-2002.
- 2,665,789. MISCELLANEOUS DESIGN. INT. CLS. 35, 38 AND 42. REG. 12-24-2002.

- 2,665,794. RESEARCH-DESK. INT. CL. 9. REG. 12-24-2002.
 2,665,797. MYTHICAL MANGO. INT. CL. 30. REG. 12-24-2002.
 2,665,798. DRAGONFRUIT POTION. INT. CL. 30. REG. 12-24-2002.
 2,665,800. THE ART OF ORGANIZATION. INT. CL. 9. REG. 12-24-2002.
 2,665,803. MEDI MULTI MEDIA. INT. CLS. 35, 38 AND 42. REG. 12-24-2002.
 2,665,804. SYMPATHICA. INT. CLS. 29 AND 30. REG. 12-24-2002.
 2,665,805. MISCELLANEOUS DESIGN. INT. CL. 9. REG. 12-24-2002.
 2,665,806. SHOT TO HELL. INT. CL. 41. REG. 12-24-2002.
 2,665,808. J. A. WOOLLAM CO.. INT. CL. 42. REG. 12-24-2002.
 2,665,810. ECO BUDDY. INT. CL. 28. REG. 12-24-2002.
 2,665,812. BAYLINE PRODUCTIONS. INT. CL. 41. REG. 12-24-2002.
 2,665,813. THE CASCADES AT ST. LUCIE WEST. INT. CL. 37. REG. 12-24-2002.
 2,665,820. SALES.MAT. INT. CLS. 27, 35 AND 37. REG. 12-24-2002.
 2,665,823. TBW THERMO BALANCED WRITING FOR OPTIMAL RECORDING AND DESIGN. INT. CL. 9. REG. 12-24-2002.
 2,665,824. IST CHOICE AND DESIGN. INT. CLS. 35 AND 42. REG. 12-24-2002.
 2,665,825. MWH MONTGOMERY WATSON HARZA AND DESIGN. INT. CLS. 35, 36, 37, 38, 40 AND 42. REG. 12-24-2002.
 2,665,827. CLASSICO LINEAPIU'. INT. CLS. 23, 24 AND 25. REG. 12-24-2002.
 2,665,829. HAROLD ELLIS. INT. CL. 40. REG. 12-24-2002.
 2,665,830. PARS. INT. CL. 11. REG. 12-24-2002.
 2,665,831. AWARDS OF THE AMERICAS. INT. CL. 35. REG. 12-24-2002.
 2,665,832. NAPCM. INT. CL. 42. REG. 12-24-2002.
 2,665,834. TRANCE AND DESIGN. INT. CL. 25. REG. 12-24-2002.
 2,665,835. ZBESTOFFER.COM (STYLIZED). INT. CL. 35. REG. 12-24-2002.
 2,665,838. DUOSORB. INT. CLS. 11 AND 12. REG. 12-24-2002.
 2,665,842. ENVIRONMENTS GROUP. INT. CL. 42. REG. 12-24-2002.
 2,665,843. GOETTAS RECORDS AND DESIGN. INT. CL. 9. REG. 12-24-2002.
 2,665,844. ROAD MANAGER COMPLIANCE JUST GOT SIMPLER. AND DESIGN. INT. CL. 42. REG. 12-24-2002.
 2,665,845. ROAD MANAGER AND DESIGN. INT. CL. 42. REG. 12-24-2002.
 2,665,853. LINSANG MANUFACTURING AND DESIGN. INT. CLS. 35, 37, 39, 40 AND 42. REG. 12-24-2002.
 2,665,854. UBTRIPPIN' AND DESIGN. INT. CL. 35. REG. 12-24-2002.
 2,665,855. THEY CAN'T. WE DO.. INT. CLS. 35, 38 AND 42. REG. 12-24-2002.
 2,665,856. NAIAD PRESS. INT. CL. 16. REG. 12-24-2002.
 2,665,857. IS. INT. CL. 7. REG. 12-24-2002.
 2,665,860. LIVING GIFT REVERSE MORTGAGES. INT. CL. 36. REG. 12-24-2002.
 2,665,861. HEART CENTER OF THE ROCKIES AND DESIGN. INT. CL. 42. REG. 12-24-2002.
 2,665,867. NOT RESPONSIBLE. INT. CL. 25. REG. 12-24-2002.
 2,665,868. DOUGH NUTTY. INT. CLS. 39 AND 43. REG. 12-24-2002.
 2,665,871. MONITOR SPYDER. INT. CL. 9. REG. 12-24-2002.
 2,665,874. AFRICAN MARKETPLACE, INC.. INT. CL. 35. REG. 12-24-2002.
 2,665,876. FACE TO FACE INTERNATIONAL. INT. CL. 42. REG. 12-24-2002.
 2,665,877. DIGITAL EDUCATION THE NEXT DIMENSION AND DESIGN. INT. CL. 41. REG. 12-24-2002.
 2,665,880. BLUETRONICS. INT. CLS. 9, 38 AND 42. REG. 12-24-2002.
 2,665,886. MISCELLANEOUS DESIGN. INT. CL. 9. REG. 12-24-2002.
 2,665,887. ... AND THE THIRD LITTLE PIG USED BRICK-SERVER. INT. CL. 9. REG. 12-24-2002.
 2,665,891. SYNDICATE DIRECT. INT. CL. 36. REG. 12-24-2002.
 2,665,892. MISCELLANEOUS DESIGN. INT. CLS. 40 AND 42. REG. 12-24-2002.
 2,665,893. SILVANA SILVANA USA AND DESIGN. INT. CL. 18. REG. 12-24-2002.
 2,665,895. 3-D VISIX. INT. CL. 38. REG. 12-24-2002.
 2,665,896. SECTORNET. INT. CL. 42. REG. 12-24-2002.
 2,665,897. IIBIC (STYLIZED). INT. CLS. 9 AND 42. REG. 12-24-2002.
 2,665,898. F FOREMOST AND DESIGN. INT. CL. 29. REG. 12-24-2002.
 2,665,902. BABY CREPE. INT. CL. 24. REG. 12-24-2002.
 2,665,903. EARTHLIGHT'S HOOK, LINE & SAUCER. INT. CL. 20. REG. 12-24-2002.
 2,665,904. FIBRECENTER. INT. CL. 9. REG. 12-24-2002.
 2,665,908. THE RATCHET ANNUITY. INT. CL. 36. REG. 12-24-2002.
 2,665,910. EHN AND DESIGN. INT. CLS. 5, 29, 30 AND 35. REG. 12-24-2002.
 2,665,911. YS (STYLIZED). INT. CL. 35. REG. 12-24-2002.
 2,665,912. H.H.. INT. CL. 11. REG. 12-24-2002.
 2,665,913. SEALOGICA. INT. CL. 5. REG. 12-24-2002.
 2,665,914. PMI CAREERHEADQUARTERS AND DESIGN. INT. CL. 35. REG. 12-24-2002.
 2,665,915. CAMINO REAL FOODS. INT. CL. 30. REG. 12-24-2002.
 2,665,916. THE FOUNDATION INCUBATOR AND DESIGN. INT. CL. 35. REG. 12-24-2002.
 2,665,921. TECH-CLEAN. INT. CL. 1. REG. 12-24-2002.
 2,665,922. BIG HORN AND DESIGN. INT. CL. 12. REG. 12-24-2002.
 2,665,924. TEMPO DRY WIPES. INT. CL. 16. REG. 12-24-2002.
 2,665,925. ISD AND DESIGN. INT. CL. 42. REG. 12-24-2002.
 2,665,927. AXAD. INT. CLS. 9, 16 AND 42. REG. 12-24-2002.
 2,665,929. NCJOBSPOT.COM. INT. CL. 35. REG. 12-24-2002.
 2,665,930. RICHMOND (STYLIZED). INT. CLS. 25 AND 41. REG. 12-24-2002.
 2,665,933. PLAY 'N VIEW. INT. CL. 28. REG. 12-24-2002.
 2,665,935. BRANDCHARISMA. INT. CL. 35. REG. 12-24-2002.
 2,665,936. PRECISION ROOFING. INT. CL. 37. REG. 12-24-2002.
 2,665,938. KEYMAN'S NET. INT. CL. 35. REG. 12-24-2002.
 2,665,939. U.S. CHEMICAL STORAGE AND DESIGN. INT. CL. 6. REG. 12-24-2002.
 2,665,940. PURE FUN! JUICE AND DESIGN. INT. CL. 32. REG. 12-24-2002.
 2,665,941. THE ZEN OF FOOD AND DESIGN. INT. CL. 35. REG. 12-24-2002.
 2,665,942. ETP INC. AND DESIGN. INT. CLS. 35, 41 AND 42. REG. 12-24-2002.
 2,665,943. HARTMANEW. INT. CL. 19. REG. 12-24-2002.
 2,665,947. MISCELLANEOUS DESIGN. INT. CL. 3. REG. 12-24-2002.
 2,665,949. E-OPER8. INT. CL. 35. REG. 12-24-2002.
 2,665,950. E-MATURE. INT. CL. 35. REG. 12-24-2002.
 2,665,951. POWERSPRING. INT. CLS. 35 AND 42. REG. 12-24-2002.
 2,665,952. HBA HIGH BANDWIDTH ACCESS (STYLIZED). INT. CL. 9. REG. 12-24-2002.
 2,665,954. MANDISA AND DESIGN. INT. CLS. 30 AND 32. REG. 12-24-2002.
 2,665,956. SHREDFORCE. INT. CL. 40. REG. 12-24-2002.
 2,665,957. BRIGHTLINE. INT. CL. 6. REG. 12-24-2002.
 2,665,958. CMS AND DESIGN. INT. CL. 36. REG. 12-24-2002.
 2,665,963. STELLA MARINA. INT. CLS. 18 AND 25. REG. 12-24-2002.
 2,665,964. ISI EST. 1959 INSURANCE SPECIALISTS, INC. AND DESIGN. INT. CL. 36. REG. 12-24-2002.
 2,665,967. THE NIMBUS GLOBAL GROUP, INC.. INT. CL. 35. REG. 12-24-2002.

- 2,665,968. STAYONLINE. INT. CLS. 38 AND 42. REG. 12-24-2002.
- 2,665,969. GUMBALL. INT. CL. 37. REG. 12-24-2002.
- 2,665,970. G AND DESIGN. INT. CL. 37. REG. 12-24-2002.
- 2,665,972. LEADCLIENT. INT. CL. 35. REG. 12-24-2002.
- 2,665,973. CARCLIENT. INT. CL. 35. REG. 12-24-2002.
- 2,665,974. FLOSPRAY. INT. CL. 1. REG. 12-24-2002.
- 2,665,976. RUN WITH THE BAND. INT. CL. 42. REG. 12-24-2002.
- 2,665,977. THE SUPERIOR PERFORMANCE SERIES. INT. CL. 35. REG. 12-24-2002.
- 2,665,978. EXCELLENCE AS A WAY OF LIFE, EVERYDAY. INT. CL. 35. REG. 12-24-2002.
- 2,665,979. THE ABC'S OF EXCEPTIONAL CLIENT SERVICE (STYLIZED). INT. CL. 35. REG. 12-24-2002.
- 2,665,980. PREFERRED TRADE AND DESIGN. INT. CLS. 9 AND 36. REG. 12-24-2002.
- 2,665,981. OBA-1 MADE IN USA. INT. CL. 10. REG. 12-24-2002.
- 2,665,983. HDD RODEO. INT. CL. 35. REG. 12-24-2002.
- 2,665,986. SYNCRA. INT. CLS. 41 AND 42. REG. 12-24-2002.
- 2,665,987. THE GRAND CANAL SHOPPES AND DESIGN. INT. CL. 41. REG. 12-24-2002.
- 2,665,988. SAMSARA SHINE. INT. CL. 3. REG. 12-24-2002.
- 2,665,990. SPIROLLI. INT. CL. 8. REG. 12-24-2002.
- 2,665,991. FIDDLEHEAD CERAMICS AND DESIGN. INT. CL. 19. REG. 12-24-2002.
- 2,666,001. THE RELENTLESS PURSUIT OF INVESTMENT EXCELLENCE. INT. CL. 36. REG. 12-24-2002.
- 2,666,002. SADRY. INT. CLS. 29, 30 AND 32. REG. 12-24-2002.
- 2,666,003. MISCELLANEOUS DESIGN. INT. CLS. 40 AND 42. REG. 12-24-2002.
- 2,666,004. MUSCLEGRAM. INT. CL. 38. REG. 12-24-2002.
- 2,666,005. RASTA AND DESIGN. INT. CL. 25. REG. 12-24-2002.
- 2,666,006. LIL LIPSTEIN, JAFFE & LAWSON L.L.P. AND DESIGN. INT. CL. 42. REG. 12-24-2002.
- 2,666,007. S.P.Q. INT. CL. 35. REG. 12-24-2002.
- 2,666,016. MBC MILLER BROS. COAL AND DESIGN. INT. CL. 37. REG. 12-24-2002.
- 2,666,017. VIKTORY FOR KIDS AND DESIGN. INT. CL. 36. REG. 12-24-2002.
- 2,666,024. REFRIGERATOR ART. INT. CL. 14. REG. 12-24-2002.
- 2,666,026. CALIFORNIA RESTAURANT ASSOCIATION SINCE 1906 AND DESIGN. INT. CL. 42. REG. 12-24-2002.
- 2,666,029. FLOR DE LOS REYES. INT. CL. 34. REG. 12-24-2002.
- 2,666,033. COAGULATION S.A.R.P.. INT. CL. 5. REG. 12-24-2002.
- 2,666,034. TONE E. FLY. INT. CL. 41. REG. 12-24-2002.
- 2,666,037. LUNCHBOX. INT. CL. 31. REG. 12-24-2002.
- 2,666,040. GPCM. INT. CL. 9. REG. 12-24-2002.
- 2,666,041. FBBH AND DESIGN. INT. CL. 36. REG. 12-24-2002.
- 2,666,043. SC AND DESIGN. INT. CL. 36. REG. 12-24-2002.
- 2,666,049. BAWANGHUA AND DESIGN. INT. CL. 30. REG. 12-24-2002.
- 2,666,053. DORI TOMATOES. INT. CL. 29. REG. 12-24-2002.
- 2,666,057. THE NEW WAY TO THINK FILM. INT. CLS. 35 AND 42. REG. 12-24-2002.
- 2,666,060. REBUILDING THE WALL. INT. CL. 9. REG. 12-24-2002.
- 2,666,061. GREAT INVENTIONS INTO THREE DIMENSIONS!. INT. CL. 42. REG. 12-24-2002.
- 2,666,062. PAMPERED PATIENT. INT. CL. 10. REG. 12-24-2002.
- 2,666,064. PROFEN FORTE. INT. CL. 5. REG. 12-24-2002.
- 2,666,066. TAI-CHI FLEECE. INT. CL. 24. REG. 12-24-2002.
- 2,666,067. SS AND DESIGN. INT. CL. 9. REG. 12-24-2002.
- 2,666,069. DIBOC. INT. CL. 1. REG. 12-24-2002.
- 2,666,071. LAROS. INT. CL. 14. REG. 12-24-2002.
- 2,666,073. THE HARRIS WEALTH WATCH. INT. CL. 16. REG. 12-24-2002.
- 2,666,074. STAR SOUNDS RECORDING STUDIOS. INT. CL. 41. REG. 12-24-2002.
- 2,666,076. BULK FACTORS (STYLIZED). INT. CL. 5. REG. 12-24-2002.
- 2,666,081. JUNIOR TRUCKER. INT. CL. 8. REG. 12-24-2002.
- 2,666,084. TEMPLEMAIL. INT. CL. 38. REG. 12-24-2002.
- 2,666,085. LIVE YOUR ULTIMATE VISION. INT. CLS. 35 AND 36. REG. 12-24-2002.
- 2,666,087. GOWASABI. INT. CL. 35. REG. 12-24-2002.
- 2,666,088. SERVIVENSA. INT. CL. 39. REG. 12-24-2002.
- 2,666,089. BABY WORLD AND DESIGN. INT. CL. 35. REG. 12-24-2002.
- 2,666,092. AEROTECH KALMAR LABORATORIES AK AND DESIGN. INT. CLS. 35 AND 42. REG. 12-24-2002.
- 2,666,093. MEAL TICKET RECORDS AND DESIGN. INT. CL. 35. REG. 12-24-2002.
- 2,666,098. AUTUMN GALA. INT. CL. 31. REG. 12-24-2002.
- 2,666,099. TESLAFT. INT. CL. 6. REG. 12-24-2002.
- 2,666,101. MARKETSOFT AND DESIGN. INT. CL. 9. REG. 12-24-2002.
- 2,666,104. DIET BLAST. INT. CL. 5. REG. 12-24-2002.
- 2,666,106. HMEI HODGES MANAGEMENT ENTERPRISE INC. AND DESIGN. INT. CL. 36. REG. 12-24-2002.
- 2,666,111. O'HALLORAN CO. OHALLMURAIN AND DESIGN. INT. CL. 20. REG. 12-24-2002.
- 2,666,112. GLAMOUR GEAR COSMETIC CRAZE AND DESIGN. INT. CL. 28. REG. 12-24-2002.
- 2,666,114. HUNDREDS OF LINES. NO WAITING.. INT. CL. 10. REG. 12-24-2002.
- 2,666,120. COME TASTE THE FUTURE. INT. CLS. 1 AND 42. REG. 12-24-2002.
- 2,666,122. DOLLAR WORKS AND DESIGN. INT. CL. 36. REG. 12-24-2002.
- 2,666,123. M MOORE AND DESIGN. INT. CL. 21. REG. 12-24-2002.
- 2,666,124. RHYNO PRODUCTIONS, INC. AND DESIGN. INT. CL. 41. REG. 12-24-2002.
- 2,666,125. MISCELLANEOUS DESIGN. INT. CL. 29. REG. 12-24-2002.
- 2,666,127. CERESTAT. INT. CL. 5. REG. 12-24-2002.
- 2,666,132. YOUR AFTERNOON WAKE UP CALL. INT. CL. 32. REG. 12-24-2002.
- 2,666,133. WOODWARD RAMPS & RAILS. INT. CL. 28. REG. 12-24-2002.
- 2,666,135. AQURON. INT. CL. 1. REG. 12-24-2002.
- 2,666,138. TAILORED LIFE. INT. CLS. 35 AND 42. REG. 12-24-2002.
- 2,666,139. MIGHTY RIVERS. INT. CL. 37. REG. 12-24-2002.
- 2,666,141. AEROLAN. INT. CL. 9. REG. 12-24-2002.
- 2,666,142. THE DEBT MEDIATOR RESOURCES KNOWLEDGE TIME TECHNOLOGY AND DESIGN. INT. CL. 36. REG. 12-24-2002.
- 2,666,146. THE GROVE AND DESIGN. INT. CL. 35. REG. 12-24-2002.
- 2,666,147. ONQ AND DESIGN. INT. CL. 9. REG. 12-24-2002.
- 2,666,153. BY RICKY AND JAMES. INT. CL. 25. REG. 12-24-2002.
- 2,666,154. A GREAT CATCH CHRISTIAN DATING SERVICE AND DESIGN. INT. CL. 42. REG. 12-24-2002.
- 2,666,157. AMACIS VISIBILITY (STYLIZED). INT. CL. 9. REG. 12-24-2002.
- 2,666,161. DEWOLFSON DOWN AND DESIGN. INT. CL. 35. REG. 12-24-2002.
- 2,666,167. ACCUSNAP. INT. CL. 9. REG. 12-24-2002.
- 2,666,168. ESTIVALIA. INT. CL. 3. REG. 12-24-2002.
- 2,666,171. STARS & STRIPES. INT. CL. 35. REG. 12-24-2002.
- 2,666,172. THUMBS-UP AWARD. INT. CL. 35. REG. 12-24-2002.
- 2,666,175. NETSUDS. INT. CL. 35. REG. 12-24-2002.
- 2,666,178. TOUR DE GEORGIA AND DESIGN. INT. CLS. 35, 36 AND 41. REG. 12-24-2002.
- 2,666,180. L-IP. INT. CL. 6. REG. 12-24-2002.
- 2,666,188. ABOLENGO JEANS. INT. CL. 25. REG. 12-24-2002.
- 2,666,190. RECRUIT ENGINE. INT. CL. 9. REG. 12-24-2002.

- 2,666,194. COMPASS FILMS INTERNATIONAL. INT. CL. 9. REG. 12-24-2002.
- 2,666,198. R R AND DESIGN. INT. CL. 43. REG. 12-24-2002.
- 2,666,200. SENTRY. INT. CL. 19. REG. 12-24-2002.
- 2,666,201. MEDICO DE FAMILIA. INT. CL. 41. REG. 12-24-2002.
- 2,666,202. NECKWORKS. INT. CL. 25. REG. 12-24-2002.
- 2,666,203. CADENT. INT. CL. 42. REG. 12-24-2002.
- 2,666,207. LOGICENGINE. INT. CL. 42. REG. 12-24-2002.
- 2,666,212. RIO. INT. CL. 42. REG. 12-24-2002.
- 2,666,214. INCOG INC. INT. CL. 9. REG. 12-24-2002.
- 2,666,217. MITIE CLEAN. INT. CL. 3. REG. 12-24-2002.
- 2,666,218. CARELAB BY CARESHARP.COM AND DESIGN. INT. CL. 37. REG. 12-24-2002.
- 2,666,219. QUICK TALK. INT. CLS. 16 AND 38. REG. 12-24-2002.
- 2,666,220. CODE CORNER AND DESIGN. INT. CL. 16. REG. 12-24-2002.
- 2,666,222. Y (STYLIZED). INT. CL. 33. REG. 12-24-2002.
- 2,666,223. GFSG AND DESIGN. INT. CL. 36. REG. 12-24-2002.
- 2,666,224. KIDS UNLEASHED AND DESIGN. INT. CL. 41. REG. 12-24-2002.
- 2,666,225. SCHIFF 60 OVER 60 YEARS OF GUARANTEED QUALITY AND DESIGN. INT. CL. 5. REG. 12-24-2002.
- 2,666,226. POZERS [POZ'ER] N. ONE WHO POSES (STYLIZED). INT. CL. 28. REG. 12-24-2002.
- 2,666,227. COUCH POTATO AND DESIGN. INT. CL. 28. REG. 12-24-2002.
- 2,666,231. STATE FARM BUSINESS INSURANCE AUTO LIFE FIRE AND DESIGN. INT. CL. 36. REG. 12-24-2002.
- 2,666,233. FARM TO MARKET. INT. CL. 31. REG. 12-24-2002.
- 2,666,241. VERY BEARY. INT. CL. 35. REG. 12-24-2002.
- 2,666,249. AMERICA OGGI AND DESIGN. INT. CL. 16. REG. 12-24-2002.
- 2,666,251. LUCERO BRANDS. INT. CL. 29. REG. 12-24-2002.
- 2,666,253. NTV. INT. CL. 38. REG. 12-24-2002.
- 2,666,254. ANVIL MORTGAGE AND DESIGN. INT. CL. 36. REG. 12-24-2002.
- 2,666,255. TMC BIOMETRITECH AND DESIGN. INT. CL. 41. REG. 12-24-2002.
- 2,666,257. COLLAR SOCKS. INT. CL. 18. REG. 12-24-2002.
- 2,666,259. WALKING THE MOURNER'S PATH. INT. CL. 44. REG. 12-24-2002.
- 2,666,260. THE TODD MUNDT SHOW AND DESIGN. INT. CL. 41. REG. 12-24-2002.
- 2,666,261. DIGI 35. INT. CL. 9. REG. 12-24-2002.
- 2,666,264. TELETAXI. INT. CL. 16. REG. 12-24-2002.
- 2,666,265. TELETAXI AND DESIGN. INT. CL. 16. REG. 12-24-2002.
- 2,666,266. COUNTRY FRESH AND DESIGN. INT. CL. 29. REG. 12-24-2002.
- 2,666,268. OUCH. INT. CL. 44. REG. 12-24-2002.
- 2,666,269. BABY JOE MESI. INT. CLS. 35, 36 AND 41. REG. 12-24-2002.
- 2,666,270. CARIBBEAN QUEEN. INT. CL. 30. REG. 12-24-2002.
- 2,666,271. T & T PASTEL COLLECTION. INT. CL. 26. REG. 12-24-2002.
- 2,666,272. TWC AND DESIGN. INT. CL. 35. REG. 12-24-2002.
- 2,666,277. ERBI AND DESIGN. INT. CL. 28. REG. 12-24-2002.
- 2,666,278. EAA X-FLYER. INT. CLS. 28 AND 41. REG. 12-24-2002.
- 2,666,279. YOU KNOW TV. NOW. EXPERIENCE JOY.. INT. CL. 38. REG. 12-24-2002.
- 2,666,280. E-KETUBAH.COM AND DESIGN. INT. CL. 16. REG. 12-24-2002.
- 2,666,282. FIBRE SOFT. INT. CL. 16. REG. 12-24-2002.
- 2,666,284. FLAME F/X. INT. CL. 11. REG. 12-24-2002.
- 2,666,285. AB BANDSTAND. INT. CL. 9. REG. 12-24-2002.
- 2,666,288. THE FAST TRACK BECKONS. INT. CL. 42. REG. 12-24-2002.
- 2,666,293. PERFORMANCE FROM EXPERIENCE. INT. CL. 42. REG. 12-24-2002.
- 2,666,295. VALLEY CARE CHOICES. INT. CL. 44. REG. 12-24-2002.
- 2,666,296. MHS CASTER & EQUIPMENT CO.. INT. CLS. 6, 12 AND 20. REG. 12-24-2002.
- 2,666,299. ANNA CLAIRE. INT. CL. 21. REG. 12-24-2002.
- 2,666,301. BUSY BODY / GYMS TO GO. INT. CL. 35. REG. 12-24-2002.
- 2,666,309. BOLT PSEUDO-EPHEDRINE. INT. CL. 5. REG. 12-24-2002.
- 2,666,310. BONE-A-FIDE. INT. CL. 41. REG. 12-24-2002.
- 2,666,311. NTI AND DESIGN. INT. CL. 7. REG. 12-24-2002.
- 2,666,313. GROUND POUNDER. INT. CL. 9. REG. 12-24-2002.
- 2,666,314. JAPANESE SUPER AV IDOL. INT. CL. 9. REG. 12-24-2002.
- 2,666,315. SUCCESS BY DESIGN. INT. CL. 42. REG. 12-24-2002.
- 2,666,316. MOTHER MOON. INT. CL. 3. REG. 12-24-2002.
- 2,666,317. ISLAND BOUQUET. INT. CL. 3. REG. 12-24-2002.
- 2,666,319. BELLRINGER. INT. CL. 16. REG. 12-24-2002.
- 2,666,325. IT TASTES AS GOOD AS IT LOOKS. INT. CL. 30. REG. 12-24-2002.
- 2,666,326. UNIQO AND DESIGN. INT. CL. 12. REG. 12-24-2002.
- 2,666,328. MOCCASIN SPRINGS. INT. CL. 32. REG. 12-24-2002.
- 2,666,332. LENDINGSCOPE. INT. CL. 35. REG. 12-24-2002.
- 2,666,333. LENDINGSCORE. INT. CL. 35. REG. 12-24-2002.
- 2,666,334. LENDINGSHIELD. INT. CL. 35. REG. 12-24-2002.
- 2,666,335. LENDINGSPY. INT. CL. 35. REG. 12-24-2002.
- 2,666,338. DVI AND DESIGN. INT. CL. 36. REG. 12-24-2002.
- 2,666,340. PUT YOUR VOTE TO WORK. INT. CL. 25. REG. 12-24-2002.
- 2,666,341. AGRIZIDE. INT. CL. 5. REG. 12-24-2002.
- 2,666,347. DOUBLE SHOCK POWER. INT. CL. 18. REG. 12-24-2002.
- 2,666,353. ONE LEG UP. INT. CL. 11. REG. 12-24-2002.
- 2,666,355. SILVER MAPLE POWER. INT. CL. 28. REG. 12-24-2002.
- 2,666,356. BLACK CHERRY POWER. INT. CL. 28. REG. 12-24-2002.
- 2,666,363. MISCELLANEOUS DESIGN. INT. CLS. 25 AND 43. REG. 12-24-2002.
- 2,666,364. COMPETE SUCCEED DOMINATE. INT. CL. 42. REG. 12-24-2002.
- 2,666,365. INFOWORLD. INT. CL. 16. REG. 12-24-2002.
- 2,666,369. BIGGER VALUE. BETTER TIME.. INT. CL. 41. REG. 12-24-2002.
- 2,666,370. 90:00 MINUTES. INT. CL. 16. REG. 12-24-2002.
- 2,666,372. GRANDFORM. INT. CL. 24. REG. 12-24-2002.
- 2,666,374. MW MANN WIRELESS, LTD. AND DESIGN. INT. CLS. 37 AND 38. REG. 12-24-2002.
- 2,666,376. NEW RUSH IN THE ROCKIES. INT. CL. 41. REG. 12-24-2002.
- 2,666,377. AVISION. INT. CL. 9. REG. 12-24-2002.
- 2,666,383. AGILIX. INT. CL. 42. REG. 12-24-2002.
- 2,666,384. MEDBILL EXPRESS. INT. CL. 35. REG. 12-24-2002.
- 2,666,387. TOFI AND DESIGN. INT. CL. 30. REG. 12-24-2002.
- 2,666,389. I140. INT. CL. 9. REG. 12-24-2002.
- 2,666,395. MISCELLANEOUS DESIGN. INT. CL. 35. REG. 12-24-2002.
- 2,666,398. SUMMITSOFT. INT. CL. 9. REG. 12-24-2002.
- 2,666,399. SANTA CRUZ. INT. CL. 9. REG. 12-24-2002.
- 2,666,402. K 399. INT. CL. 31. REG. 12-24-2002.
- 2,666,403. K 317. INT. CL. 31. REG. 12-24-2002.
- 2,666,405. K 340. INT. CL. 31. REG. 12-24-2002.
- 2,666,406. MISCELLANEOUS DESIGN. INT. CLS. 29 AND 30. REG. 12-24-2002.
- 2,666,407. MISCELLANEOUS DESIGN. INT. CLS. 29 AND 30. REG. 12-24-2002.
- 2,666,409. ARTEZANOS. INT. CL. 19. REG. 12-24-2002.
- 2,666,421. COVERAGEXPRESS. INT. CL. 36. REG. 12-24-2002.
- 2,666,423. THE REEL AWARDS. INT. CL. 41. REG. 12-24-2002.
- 2,666,426. SMART SENSORS CREATING NEW MARKETS. INT. CL. 9. REG. 12-24-2002.

- 2,666,427. BLACK MAGIC. INT. CL. 13. REG. 12-24-2002.
2,666,428. CORAL CALCIUM 1. INT. CL. 5. REG. 12-24-2002.
2,666,429. FITS YOU INCREDIBLY. INT. CL. 25. REG. 12-24-2002.
2,666,433. SCOTT THOMAS MAKERS OF FINE FURNITURE AND DESIGN. INT. CL. 20. REG. 12-24-2002.
2,666,437. ERGO EX. INT. CL. 7. REG. 12-24-2002.
2,666,439. NOTEPRO. INT. CL. 9. REG. 12-24-2002.
2,666,440. LIQUI-LABEL. INT. CL. 9. REG. 12-24-2002.
2,666,442. MISCELLANEOUS DESIGN. INT. CL. 11. REG. 12-24-2002.
2,666,447. SIR WINSTON GEORGE. INT. CL. 25. REG. 12-24-2002.
2,666,451. MISCELLANEOUS DESIGN. INT. CL. 6. REG. 12-24-2002.
2,666,454. SEASONS REFLECTIONS. INT. CL. 35. REG. 12-24-2002.
2,666,455. DEJA VU. INT. CL. 14. REG. 12-24-2002.
2,666,456. CHEAP HOOKER FISHING LURES. INT. CL. 25. REG. 12-24-2002.
2,666,457. M'PINGO. INT. CL. 42. REG. 12-24-2002.
2,666,463. BRINGING DESIGN, FUNCTION AND QUALITY TOGETHER FOR YOU. INT. CL. 42. REG. 12-24-2002.
2,666,464. MANTELCRAFT AND DESIGN. INT. CLS. 19 AND 20. REG. 12-24-2002.
2,666,469. BRIGHTSTAR. INT. CL. 41. REG. 12-24-2002.
2,666,473. ACRUE. INT. CL. 28. REG. 12-24-2002.
2,666,475. ELECTRA. INT. CL. 11. REG. 12-24-2002.
2,666,479. SKY RANCH AND DESIGN. INT. CL. 21. REG. 12-24-2002.
2,666,480. COUNTRY ROCK AND DESIGN. INT. CL. 19. REG. 12-24-2002.
2,666,483. THE LIGHT OF LIFE. INT. CL. 41. REG. 12-24-2002.
2,666,484. HQ AND DESIGN. INT. CL. 42. REG. 12-24-2002.
2,666,487. SKY RANCH. INT. CL. 21. REG. 12-24-2002.
2,666,495. AURELIO SEBASTIANI. INT. CL. 15. REG. 12-24-2002.
2,666,496. CAPRICCIO. INT. CL. 15. REG. 12-24-2002.
2,666,498. TIMBERLINE TOTAL SOLUTIONS. INT. CL. 35. REG. 12-24-2002.
2,666,499. AGI THINK TANK TASK FORCE AGENCY. INT. CLS. 9, 35 AND 42. REG. 12-24-2002.
2,666,501. ESHARE NETAGENT. INT. CL. 9. REG. 12-24-2002.
2,666,502. NETAGENT. INT. CL. 9. REG. 12-24-2002.
2,666,504. REFRACTANCE WINDOW. INT. CL. 11. REG. 12-24-2002.
2,666,505. MISCELLANEOUS DESIGN. INT. CL. 42. REG. 12-24-2002.
2,666,506. JANIE AND DESIGN. INT. CLS. 16 AND 21. REG. 12-24-2002.
2,666,507. PRINT IT UP AND DESIGN. INT. CL. 42. REG. 12-24-2002.
2,666,508. A BLIND DATE WITH THE WORLD. INT. CL. 39. REG. 12-24-2002.
2,666,509. BRIDGINGSOLUTIONS LLC WEB SOLUTIONS ILLUMINATING YOUR VISION AND DESIGN. INT. CL. 42. REG. 12-24-2002.
2,666,510. DEUK. INT. CLS. 35, 36, 41 AND 42. REG. 12-24-2002.
2,666,511. E-BLOTTER. INT. CLS. 9 AND 36. REG. 12-24-2002.
2,666,512. HAFNER AND DESIGN. INT. CL. 29. REG. 12-24-2002.
2,666,513. USING THE PAST TO CREATE THE FUTURE. INT. CL. 36. REG. 12-24-2002.
2,666,514. ATG. INT. CLS. 9 AND 12. REG. 12-24-2002.
2,666,515. ATG AND DESIGN. INT. CLS. 9 AND 12. REG. 12-24-2002.
2,666,517. EXPERTLAW. INT. CLS. 35 AND 42. REG. 12-24-2002.
2,666,522. PHEASY (STYLIZED). INT. CL. 9. REG. 12-24-2002.
2,666,523. JODYE HEN. INT. CLS. 18 AND 25. REG. 12-24-2002.
2,666,526. CASTELL GRES AND DESIGN. INT. CL. 19. REG. 12-24-2002.
2,666,527. CREUSOT LOIRE. INT. CLS. 6 AND 40. REG. 12-24-2002.
2,666,528. MYTHRYN. INT. CL. 42. REG. 12-24-2002.
2,666,529. MISCELLANEOUS DESIGN. INT. CL. 42. REG. 12-24-2002.
2,666,530. MYTHRYN AND DESIGN. INT. CL. 42. REG. 12-24-2002.
2,666,531. NELA TERNES REGISTER GROUP AND DESIGN. INT. CL. 40. REG. 12-24-2002.
2,666,533. MISCELLANEOUS DESIGN. INT. CL. 35. REG. 12-24-2002.
2,666,536. ULTRACORP. INT. CL. 35. REG. 12-24-2002.
2,666,537. PAULA CHAMBERS REAL ESTATE WORTH A LATTE AND DESIGN. INT. CL. 36. REG. 12-24-2002.
2,666,538. ADFAX. INT. CL. 35. REG. 12-24-2002.
2,666,539. MISCELLANEOUS DESIGN. INT. CL. 41. REG. 12-24-2002.
2,666,540. DIGIBLINK, INC. (STYLIZED). INT. CL. 42. REG. 12-24-2002.
2,666,543. M3-SYSTEM (STYLIZED). INT. CLS. 40 AND 42. REG. 12-24-2002.
2,666,544. CALCI-LEAN. INT. CL. 5. REG. 12-24-2002.
2,666,546. DAYSOUNDS. INT. CL. 41. REG. 12-24-2002.
2,666,550. TELZIR. INT. CL. 5. REG. 12-24-2002.
2,666,551. CANE COZY. INT. CL. 18. REG. 12-24-2002.
2,666,553. WRITE CAPITAL MANAGEMENT AND DESIGN. INT. CL. 36. REG. 12-24-2002.
2,666,555. EL RANCHO DE JONAS J AND DESIGN. INT. CL. 42. REG. 12-24-2002.
2,666,556. CHOCK EXPRESS. INT. CLS. 29 AND 30. REG. 12-24-2002.
2,666,557. PORT-A-BELL. INT. CL. 15. REG. 12-24-2002.
2,666,558. A MU RUI AND DESIGN. INT. CL. 3. REG. 12-24-2002.
2,666,559. CASH&CREAM. INT. CL. 25. REG. 12-24-2002.
2,666,561. TEXASBOYZ. INT. CL. 41. REG. 12-24-2002.
2,666,564. DESIGN ALTERNATIVES AND DESIGN. INT. CLS. 36, 37 AND 42. REG. 12-24-2002.
2,666,565. THE RELATIONSHIP BETWEEN TECHNOLOGY AND YOU. INT. CLS. 35, 37 AND 42. REG. 12-24-2002.
2,666,567. SYSTOLE. INT. CL. 35. REG. 12-24-2002.
2,666,568. HARMONY ISLE. INT. CL. 35. REG. 12-24-2002.
2,666,569. THE ADVENTURE PAGES (STYLIZED). INT. CLS. 16, 35 AND 42. REG. 12-24-2002.
2,666,570. PC3D. INT. CL. 9. REG. 12-24-2002.
2,666,571. NOW WE'RE TALKING!. INT. CL. 38. REG. 12-24-2002.
2,666,573. BAIHER HAND-CUT CRYSTAL AND DESIGN. INT. CL. 21. REG. 12-24-2002.
2,666,579. MISCELLANEOUS DESIGN. INT. CL. 42. REG. 12-24-2002.
2,666,580. LEON RUSSELL. INT. CL. 41. REG. 12-24-2002.
2,666,582. BEAUTY INDIVIDUALIZED ORGANICS. INT. CL. 3. REG. 12-24-2002.
2,666,584. AD ANTONIO DESIGNS (STYLIZED). INT. CL. 16. REG. 12-24-2002.
2,666,585. PRESENTATIONPRO. INT. CL. 9. REG. 12-24-2002.
2,666,586. DOGZILLA. INT. CL. 29. REG. 12-24-2002.
2,666,587. ENVIROMENTAL H2O AND DESIGN. INT. CL. 40. REG. 12-24-2002.
2,666,589. CHICKA-CHICKA-DOODLE. INT. CL. 24. REG. 12-24-2002.
2,666,590. FUTURESQ. INT. CL. 42. REG. 12-24-2002.
2,666,591. NON-LINEAR PRODUCTIONS. INT. CL. 41. REG. 12-24-2002.
2,666,593. E.SPIRE EZ LD. INT. CL. 38. REG. 12-24-2002.
2,666,594. D.H.D DREAM HOUSE DESIGNS, P.C. AND DESIGN. INT. CL. 42. REG. 12-24-2002.
2,666,598. BP BENEFITSPower (STYLIZED). INT. CL. 42. REG. 12-24-2002.
2,666,599. LUME. INT. CL. 41. REG. 12-24-2002.
2,666,600. LOAN WOLF \$ \$ AND DESIGN. INT. CL. 36. REG. 12-24-2002.

- 2,666,604. JUST RIDE ME. INT. CLS. 25 AND 39. REG. 12-24-2002.
- 2,666,605. KID-CARE, INC AND DESIGN. INT. CL. 43. REG. 12-24-2002.
- 2,666,606. SMARTFORCE LEARNING SOLUTIONS FOR THE HUMAN ENTERPRISE (STYLIZED). INT. CLS. 9 AND 41. REG. 12-24-2002.
- 2,666,607. RINCON CUSTOM. INT. CL. 15. REG. 12-24-2002.
- 2,666,608. BON TEMPS KENNELS OUR PRIDE PERMITS NOTHING LESS THAN EXCELLENCE (STYLIZED). INT. CL. 42. REG. 12-24-2002.
- 2,666,609. EARTHMASS. INT. CLS. 9 AND 41. REG. 12-24-2002.
- 2,666,610. GUADALUPANA WEDDING CHAPEL. INT. CL. 42. REG. 12-24-2002.
- 2,666,611. FASTER. INT. CL. 6. REG. 12-24-2002.
- 2,666,612. PREDAZORD. INT. CL. 28. REG. 12-24-2002.
- 2,666,613. PURISSIMO. INT. CL. 29. REG. 12-24-2002.
- 2,666,615. HIRESHARP. INT. CL. 35. REG. 12-24-2002.
- 2,666,619. ROYAL TREASURE AND DESIGN. INT. CL. 16. REG. 12-24-2002.
- 2,666,622. MISCELLANEOUS DESIGN. INT. CL. 28. REG. 12-24-2002.
- 2,666,625. HELPING OUR CLIENTS MAKE THE INDOORS A BETTER PLACE TO BE. INT. CL. 40. REG. 12-24-2002.
- 2,666,627. PLUM PUDDING. INT. CL. 31. REG. 12-24-2002.
- 2,666,628. HAIR GRAM AND DESIGN. INT. CL. 5. REG. 12-24-2002.
- 2,666,629. S AND DESIGN. INT. CL. 42. REG. 12-24-2002.
- 2,666,632. POETIC MEDIA. INT. CLS. 41 AND 42. REG. 12-24-2002.
- 2,666,635. TIME IS GOLDEN AND DESIGN. INT. CL. 9. REG. 12-24-2002.
- 2,666,636. MEDIA MAKER. INT. CL. 9. REG. 12-24-2002.
- 2,666,637. THE VETERANS OBSERVER V.O. AND DESIGN. INT. CL. 16. REG. 12-24-2002.
- 2,666,638. BIOCONSCIOUS MEDICINE. INT. CL. 44. REG. 12-24-2002.
- 2,666,641. A CAROLING WE GO. INT. CL. 21. REG. 12-24-2002.
- 2,666,642. PETRO-N-PROVISIONS. INT. CLS. 35 AND 43. REG. 12-24-2002.
- 2,666,643. MISCELLANEOUS DESIGN. INT. CLS. 9, 35 AND 42. REG. 12-24-2002.
- 2,666,644. ENVINTA. INT. CLS. 9, 35 AND 42. REG. 12-24-2002.
- 2,666,645. BORDERSHIELD (STYLIZED). INT. CLS. 41 AND 42. REG. 12-24-2002.
- 2,666,646. LOCO MOCHI. INT. CL. 30. REG. 12-24-2002.
- 2,666,649. MEDD SQUAD (STYLIZED). INT. CL. 35. REG. 12-24-2002.
- 2,666,650. GREEN CASCADE MIX. INT. CL. 31. REG. 12-24-2002.
- 2,666,651. THE FORTUNE BUILDER PROGRAM. INT. CL. 41. REG. 12-24-2002.
- 2,666,653. LAND IN HAND AND DESIGN. INT. CL. 44. REG. 12-24-2002.
- 2,666,655. EAGLE VALLEY PLUMBING. INT. CL. 37. REG. 12-24-2002.
- 2,666,657. ENVIRONMENTAL SKINCARE. INT. CL. 3. REG. 12-24-2002.
- 2,666,659. LIGHTNING DOWNLOAD. INT. CL. 9. REG. 12-24-2002.
- 2,666,660. HOG POWER. INT. CL. 7. REG. 12-24-2002.
- 2,666,661. REAL EQUITY ASSETS, INC. AND DESIGN. INT. CL. 36. REG. 12-24-2002.
- 2,666,663. EL PASO MERCHANT ENERGY. INT. CL. 39. REG. 12-24-2002.
- 2,666,664. EL PASO MERCHANT ENERGY. INT. CL. 40. REG. 12-24-2002.
- 2,666,665. EL PASO MERCHANT ENERGY. INT. CL. 36. REG. 12-24-2002.
- 2,666,666. GENERATOR ON OFF SAFETY EQUIPMENT AND DESIGN. INT. CL. 9. REG. 12-24-2002.
- 2,666,667. OFF MUSIC ROW. INT. CL. 41. REG. 12-24-2002.
- 2,666,668. WEBDANCERS. INT. CL. 42. REG. 12-24-2002.
- 2,666,671. PARENTSHACK. INT. CL. 42. REG. 12-24-2002.
- 2,666,673. ARL AND DESIGN. INT. CL. 44. REG. 12-24-2002.
- 2,666,679. SIMPLY ID INNOVATION IN IDENTIFICATION AND DESIGN. INT. CL. 9. REG. 12-24-2002.
- 2,666,680. AKDO INTERTRADE. INT. CL. 35. REG. 12-24-2002.
- 2,666,682. FACEPLANT. INT. CLS. 9 AND 41. REG. 12-24-2002.
- 2,666,684. LIVING BOLDLY. INT. CL. 41. REG. 12-24-2002.
- 2,666,685. MDCC. INT. CLS. 20, 21, 25, 28 AND 35. REG. 12-24-2002.
- 2,666,688. WISE CHOICE (STYLIZED). INT. CL. 30. REG. 12-24-2002.
- 2,666,689. 2JP. INT. CL. 41. REG. 12-24-2002.
- 2,666,699. NEW FOUND GLORY. INT. CL. 41. REG. 12-24-2002.
- 2,666,700. INVINTAGE DESIGNS. INT. CL. 42. REG. 12-24-2002.
- 2,666,701. BABBELINKS. INT. CL. 41. REG. 12-24-2002.
- 2,666,705. SIMPLYSWISS. INT. CL. 35. REG. 12-24-2002.
- 2,666,706. XTREME REMOTE. INT. CL. 35. REG. 12-24-2002.
- 2,666,707. MISCELLANEOUS DESIGN. INT. CLS. 9 AND 42. REG. 12-24-2002.
- 2,666,708. JJ (STYLIZED). INT. CL. 25. REG. 12-24-2002.
- 2,666,709. JOVOCOP. INT. CLS. 25 AND 28. REG. 12-24-2002.
- 2,666,713. PROTON. INT. CL. 16. REG. 12-24-2002.
- 2,666,714. OLD RUSSIA. INT. CL. 35. REG. 12-24-2002.
- 2,666,716. USE THE GOOD DISHES. INT. CLS. 9, 16 AND 41. REG. 12-24-2002.
- 2,666,718. PLANSTOCK. INT. CL. 9. REG. 12-24-2002.
- 2,666,720. MTH AND DESIGN. INT. CLS. 6 AND 19. REG. 12-24-2002.
- 2,666,723. MISCELLANEOUS DESIGN. INT. CLS. 35, 36, 37, 39, 41 AND 42. REG. 12-24-2002.
- 2,666,724. ALL READY. INT. CL. 16. REG. 12-24-2002.
- 2,666,725. THE SCIENCE OF COMFORT. INT. CL. 42. REG. 12-24-2002.
- 2,666,728. CRY CHILD RELIEF AND YOU. INT. CL. 42. REG. 12-24-2002.
- 2,666,730. VIATORES. INT. CL. 9. REG. 12-24-2002.
- 2,666,731. PRIMUS KNOWLEDGE SOLUTIONS. INT. CL. 9. REG. 12-24-2002.
- 2,666,732. YOUNG CHA'S COMPLIANCE DOSE PACK (STYLIZED). INT. CL. 20. REG. 12-24-2002.
- 2,666,733. WILDERNESS WATER. U.S. CL. A. REG. 12-24-2002.
- 2,666,734. PHYSIOSTATION. INT. CL. 9. REG. 12-24-2002.
- 2,666,735. THE CHICKEN MAN AND DESIGN. INT. CL. 25. REG. 12-24-2002.
- 2,666,736. GIGGLEPANTS. INT. CL. 28. REG. 12-24-2002.
- 2,666,737. EVENING SPARKLE. INT. CL. 28. REG. 12-24-2002.
- 2,666,738. ECI EARLY CHILDHOOD ESRB INTERACTIVE AND DESIGN. U.S. CL. B. REG. 12-24-2002.
- 2,666,740. NETROPA. INT. CLS. 9 AND 42. REG. 12-24-2002.
- 2,666,741. NOBODY BEATS OUR EGGS. INT. CL. 29. REG. 12-24-2002.
- 2,666,743. PERSUASION POINTS DELIVERED. INT. CL. 35. REG. 12-24-2002.
- 2,666,747. SFN. INT. CL. 36. REG. 12-24-2002.
- 2,666,748. CARVE SHARP. INT. CL. 21. REG. 12-24-2002.
- 2,666,749. STYLIN' DENIM. INT. CL. 28. REG. 12-24-2002.
- 2,666,752. BOXPAK. INT. CL. 16. REG. 12-24-2002.
- 2,666,755. NEWBORN CHANNEL AND DESIGN. INT. CL. 9. REG. 12-24-2002.
- 2,666,757. PRO-LITE AND DESIGN. INT. CL. 6. REG. 12-24-2002.
- 2,666,759. VINA MULTISERVICE XCHANGE. INT. CL. 9. REG. 12-24-2002.
- 2,666,761. MARINA DISTRICT BAY HARBOR AND DESIGN. INT. CL. 37. REG. 12-24-2002.
- 2,666,762. CAPITALCARS.COM. INT. CL. 35. REG. 12-24-2002.
- 2,666,764. AVANSYS A DIVISION OF HUAWEI AND DESIGN. INT. CL. 35. REG. 12-24-2002.
- 2,666,765. SOUTHERN FARM BUREAU CLASSIC. INT. CL. 41. REG. 12-24-2002.
- 2,666,770. DANCIN' ON AIR. INT. CL. 9. REG. 12-24-2002.
- 2,666,773. WINSVCD. INT. CL. 9. REG. 12-24-2002.

- 2,666,775. GLOBAL MARKETING & DEVELOPMENT SOLUTIONS. INT. CLS. 35 AND 42. REG. 12-24-2002.
- 2,666,778. FEEL-FREE CLOTHING ATTITUDE AND DESIGN. INT. CL. 25. REG. 12-24-2002.
- 2,666,781. OCEAN HAMMOCK. INT. CLS. 25, 28, 36, 41 AND 42. REG. 12-24-2002.
- 2,666,783. COEUR DE SUISSE. INT. CL. 30. REG. 12-24-2002.
- 2,666,784. MISCELLANEOUS DESIGN. INT. CL. 9. REG. 12-24-2002.
- 2,666,785. TASQ. INT. CL. 35. REG. 12-24-2002.
- 2,666,786. THE HELPING HANDS. INT. CLS. 9, 25, 28 AND 38. REG. 12-24-2002.
- 2,666,787. AIRFIBER AND DESIGN. INT. CL. 9. REG. 12-24-2002.
- 2,666,789. KISSED BY THE MIST. INT. CLS. 16 AND 25. REG. 12-24-2002.
- 2,666,790. PAVEMENT POUNDERS. INT. CL. 28. REG. 12-24-2002.
- 2,666,791. HAND POLICE. INT. CL. 16. REG. 12-24-2002.
- 2,666,795. 5 AND DESIGN. INT. CL. 28. REG. 12-24-2002.
- 2,666,796. 5 STAR. INT. CL. 28. REG. 12-24-2002.
- 2,666,797. AGILEVISION. INT. CL. 9. REG. 12-24-2002.
- 2,666,799. MEDI AND DESIGN. INT. CL. 42. REG. 12-24-2002.
- 2,666,800. PHENATAN. INT. CL. 5. REG. 12-24-2002.
- 2,666,802. NEXITY. INT. CL. 36. REG. 12-24-2002.
- 2,666,804. CANCEL CHRISTMAS. INT. CL. 16. REG. 12-24-2002.
- 2,666,805. THE BRAND CALLED YOU. INT. CL. 9. REG. 12-24-2002.
- 2,666,806. CHARITY GIFT AND DESIGN. INT. CL. 36. REG. 12-24-2002.
- 2,666,807. GHOST FACE AND DESIGN. INT. CLS. 20 AND 28. REG. 12-24-2002.
- 2,666,808. ATECH AND DESIGN. INT. CL. 9. REG. 12-24-2002.
- 2,666,809. REMOTE RESPONSE. INT. CL. 35. REG. 12-24-2002.
- 2,666,811. EXECUTIVE ARTIST. INT. CL. 35. REG. 12-24-2002.
- 2,666,815. GALACTIC CIRCUS PLAY FOR FUN & PRIZES AND DESIGN. INT. CLS. 41 AND 42. REG. 12-24-2002.
- 2,666,818. SURVEYEXPERT. INT. CL. 9. REG. 12-24-2002.
- 2,666,819. KENZIE. INT. CL. 28. REG. 12-24-2002.
- 2,666,820. MUSTANG SYSTEMS INCORPORATED. INT. CL. 42. REG. 12-24-2002.
- 2,666,821. DREAMSICLES FLYING CIRCUS. INT. CL. 20. REG. 12-24-2002.
- 2,666,823. TALKING WITH YOUR CHILD CONVERSATIONS FOR LIFE. INT. CL. 16. REG. 12-24-2002.
- 2,666,824. THE DIGITAL GENERATION. INT. CLS. 9, 21, 30, 36 AND 38. REG. 12-24-2002.
- 2,666,825. OMNI BUILDERS RISK AND DESIGN. INT. CLS. 9 AND 36. REG. 12-24-2002.
- 2,666,826. WIN A COW FREE ! AND DESIGN. INT. CLS. 18 AND 25. REG. 12-24-2002.
- 2,666,829. SALESDOGS. INT. CL. 16. REG. 12-24-2002.
- 2,666,830. MARTHA' S FLOWERS. INT. CL. 31. REG. 12-24-2002.
- 2,666,831. VENTURE 80+. INT. CLS. 5 AND 31. REG. 12-24-2002.
- 2,666,832. INTERLIANCE CAPITAL. INT. CLS. 35 AND 36. REG. 12-24-2002.
- 2,666,834. SO-COOL. INT. CL. 9. REG. 12-24-2002.
- 2,666,838. IL NIDO. INT. CL. 28. REG. 12-24-2002.
- 2,666,839. YARDNERD. INT. CL. 16. REG. 12-24-2002.
- 2,666,841. CATALINA CATCH. INT. CL. 29. REG. 12-24-2002.
- 2,666,843. EPLOIDS.COM. INT. CLS. 29, 30 AND 35. REG. 12-24-2002.
- 2,666,845. SUNCADDY. INT. CL. 9. REG. 12-24-2002.
- 2,666,846. ESSENTIAL PLEASURES. INT. CL. 3. REG. 12-24-2002.
- 2,666,847. STRAT I. INT. CL. 16. REG. 12-24-2002.
- 2,666,848. USAGREEMENTS. INT. CL. 35. REG. 12-24-2002.
- 2,666,849. BURN-PROOF (STYLIZED). INT. CL. 9. REG. 12-24-2002.
- 2,666,850. OBSIDIAN AND DESIGN. INT. CL. 25. REG. 12-24-2002.
- 2,666,851. MISCELLANEOUS DESIGN. INT. CL. 42. REG. 12-24-2002.
- 2,666,852. PARTY DRESS. INT. CL. 31. REG. 12-24-2002.
- 2,666,853. CYBER FIBER. INT. CLS. 37 AND 42. REG. 12-24-2002.
- 2,666,855. XPENSEWISE. INT. CLS. 9, 35, 36 AND 42. REG. 12-24-2002.
- 2,666,857. BON BON CAT AND DESIGN. INT. CL. 16. REG. 12-24-2002.
- 2,666,858. BON BON CAT AND DESIGN. INT. CL. 16. REG. 12-24-2002.
- 2,666,860. HEARTLINK. INT. CL. 16. REG. 12-24-2002.
- 2,666,862. EAGLEHAWK. INT. CL. 42. REG. 12-24-2002.
- 2,666,863. TEINT JEUNE. INT. CL. 3. REG. 12-24-2002.
- 2,666,865. SUSPEND-A-PAK. INT. CL. 17. REG. 12-24-2002.
- 2,666,866. DOTNSF. INT. CL. 16. REG. 12-24-2002.
- 2,666,867. DIGITAL VIDEO CHOICE. INT. CL. 41. REG. 12-24-2002.
- 2,666,868. AGING SUCCESSFULLY WITH DOCTOR DAVID. INT. CL. 9. REG. 12-24-2002.
- 2,666,869. OVERSWING. INT. CL. 28. REG. 12-24-2002.
- 2,666,870. TERRAPIN FOUNDATION. INT. CL. 41. REG. 12-24-2002.
- 2,666,871. AREAEXPERT. INT. CLS. 35 AND 42. REG. 12-24-2002.
- 2,666,872. SNIPPITS. INT. CL. 16. REG. 12-24-2002.
- 2,666,873. EDENTOWN. INT. CL. 35. REG. 12-24-2002.
- 2,666,875. MISCELLANEOUS DESIGN. INT. CL. 3. REG. 12-24-2002.
- 2,666,878. NORTHPOINT SELLING CUSTOMER CONNECTIVE ARCHITECTURE AND DESIGN. INT. CLS. 35 AND 41. REG. 12-24-2002.
- 2,666,879. DALLAS'S BEST NEW HOME ADDRESS. INT. CL. 37. REG. 12-24-2002.
- 2,666,880. ORLANDO'S BEST NEW HOME ADDRESS. INT. CL. 37. REG. 12-24-2002.
- 2,666,882. BRIGHT DISCOVERY. INT. CL. 28. REG. 12-24-2002.
- 2,666,883. GENE FUNCTION FACTORY. INT. CL. 42. REG. 12-24-2002.
- 2,666,884. BRANDSPHERE. INT. CLS. 9, 35, 38 AND 41. REG. 12-24-2002.
- 2,666,888. SCHWAB PORTFOLIO CONSULTATION. INT. CL. 36. REG. 12-24-2002.
- 2,666,889. HOTBODS. INT. CL. 10. REG. 12-24-2002.
- 2,666,890. HOTAUDIT. INT. CL. 35. REG. 12-24-2002.
- 2,666,891. T L HOELL BOOKS. INT. CL. 16. REG. 12-24-2002.
- 2,666,892. THE BIG CHILL. INT. CL. 16. REG. 12-24-2002.
- 2,666,893. A CELEBRATION OF ITALIAN AMERICAN LIFE. INT. CL. 16. REG. 12-24-2002.
- 2,666,895. BACKHOME. INT. CLS. 11, 18, 20 AND 21. REG. 12-24-2002.
- 2,666,896. FORCE VALIDATOR. INT. CL. 9. REG. 12-24-2002.
- 2,666,897. BAKER'S CONCEPT. INT. CL. 21. REG. 12-24-2002.
- 2,666,898. WORKFLOWNAVIGATOR. INT. CL. 42. REG. 12-24-2002.
- 2,666,902. AMERISERV TRUST AND FINANCIAL SERVICES. INT. CL. 36. REG. 12-24-2002.
- 2,666,904. MISCELLANEOUS DESIGN. INT. CLS. 3 AND 25. REG. 12-24-2002.
- 2,666,907. ELEXXI. INT. CL. 25. REG. 12-24-2002.
- 2,666,908. MIDWAY SPORTS ASYLUM. INT. CL. 9. REG. 12-24-2002.
- 2,666,909. TRACK VISION. INT. CL. 35. REG. 12-24-2002.
- 2,666,912. INFORMAGIC. INT. CL. 35. REG. 12-24-2002.
- 2,666,913. MISCELLANEOUS DESIGN. INT. CL. 28. REG. 12-24-2002.
- 2,666,914. WFN. INT. CL. 42. REG. 12-24-2002.
- 2,666,915. XM MUSIC LAB. INT. CL. 41. REG. 12-24-2002.
- 2,666,918. GRANDE COMPASS. INT. CL. 38. REG. 12-24-2002.
- 2,666,920. GUARDIAN. INT. CL. 9. REG. 12-24-2002.
- 2,666,921. EONME.COM. INT. CL. 35. REG. 12-24-2002.
- 2,666,923. WFN DYNAMAP. INT. CL. 42. REG. 12-24-2002.

- 2,666,928. DRESSINGSIMLOOKSTAILOR (STYLIZED). INT. CL. 9. REG. 12-24-2002.
- 2,666,934. HARPER'S DELI TREAT. INT. CL. 31. REG. 12-24-2002.
- 2,666,935. COMPOSER. INT. CL. 9. REG. 12-24-2002.
- 2,666,936. MY FOOT. INT. CL. 42. REG. 12-24-2002.
- 2,666,937. YOUR SOURCE FOR OPERATIONAL EXCELLENCE. INT. CL. 16. REG. 12-24-2002.
- 2,666,939. REACHING HEARTS INTERNATIONAL. INT. CL. 41. REG. 12-24-2002.
- 2,666,940. HOLIDAY MAGIC. INT. CL. 28. REG. 12-24-2002.
- 2,666,945. BXA. INT. CL. 35. REG. 12-24-2002.
- 2,666,946. SPNR. INT. CL. 9. REG. 12-24-2002.
- 2,666,950. E CAP. INT. CL. 19. REG. 12-24-2002.
- 2,666,951. INNOVATIVE THERAPIES FOR THE NEW MILLENNIUM. INT. CL. 5. REG. 12-24-2002.
- 2,666,952. TERESI DYNO-DRAGS. INT. CL. 25. REG. 12-24-2002.
- 2,666,954. CHROMATONE. INT. CL. 9. REG. 12-24-2002.
- 2,666,956. DEALSPIN. INT. CL. 35. REG. 12-24-2002.
- 2,666,957. STAR FINANCIAL NETWORK. INT. CL. 36. REG. 12-24-2002.
- 2,666,964. YOUR WIRELESS WINDOW TO THE FINANCIAL WORLD. INT. CL. 42. REG. 12-24-2002.
- 2,666,965. CLEARLY SUPERIOR (STYLIZED). INT. CL. 37. REG. 12-24-2002.
- 2,666,966. CHEQUEONCE. INT. CL. 9. REG. 12-24-2002.
- 2,666,971. ONWARD SOHO. INT. CL. 35. REG. 12-24-2002.
- 2,666,972. LOOKITMED. INT. CLS. 35 AND 42. REG. 12-24-2002.
- 2,666,975. KUAI KE LI AND DESIGN. INT. CL. 29. REG. 12-24-2002.
- 2,666,976. FIRM OF CHOICE. INT. CL. 42. REG. 12-24-2002.
- 2,666,977. REAGAN COUNTRY. INT. CL. 25. REG. 12-24-2002.
- 2,666,979. REAGAN COUNTRY AND DESIGN. INT. CL. 25. REG. 12-24-2002.
- 2,666,980. ONWARD SOHO (STYLIZED). INT. CL. 35. REG. 12-24-2002.
- 2,666,981. DEPLOY AND ENJOY. INT. CL. 9. REG. 12-24-2002.
- 2,666,982. BACKPACK. INT. CL. 36. REG. 12-24-2002.
- 2,666,987. FB. INT. CL. 9. REG. 12-24-2002.
- 2,666,989. COLLET. INT. CL. 36. REG. 12-24-2002.
- 2,666,991. MISCELLANEOUS DESIGN. INT. CL. 9. REG. 12-24-2002.
- 2,666,992. PARTNER-NOW. INT. CL. 35. REG. 12-24-2002.
- 2,666,999. BEST HARVEST VEGETABLES. INT. CL. 29. REG. 12-24-2002.
- 2,667,002. HANDSHAKE. INT. CL. 9. REG. 12-24-2002.
- 2,667,005. MISCELLANEOUS DESIGN. INT. CL. 42. REG. 12-24-2002.
- 2,667,008. SINCE 1865 BERTOLLI LUCCA GENTILE AL PALATO EXTRA VIRGIN GENTLE & MILD FIRST COLD PRESSING AND DESIGN. INT. CL. 29. REG. 12-24-2002.
- 2,667,012. TRUE FOR ECOMMERCE. INT. CL. 9. REG. 12-24-2002.
- 2,667,013. E NOZZLES AND DESIGN. INT. CL. 35. REG. 12-24-2002.
- 2,667,015. ACE CENTER. INT. CL. 42. REG. 12-24-2002.
- 2,667,016. SCHOOL WALK FOR DIABETES AN EVENT OF AMERICAN DIABETES ASSOCIATION. AND DESIGN. INT. CL. 36. REG. 12-24-2002.
- 2,667,019. EXCITE MY. INT. CL. 29. REG. 12-24-2002.
- 2,667,020. NEULEVEL. INT. CLS. 35 AND 42. REG. 12-24-2002.
- 2,667,021. TWICE UP. INT. CL. 32. REG. 12-24-2002.
- 2,667,023. DOT. INT. CLS. 20, 24 AND 40. REG. 12-24-2002.
- 2,667,025. NATURAL ELEMENTS. INT. CLS. 24 AND 27. REG. 12-24-2002.
- 2,667,027. MISCELLANEOUS DESIGN. INT. CLS. 9 AND 28. REG. 12-24-2002.
- 2,667,029. LINGERIE PURSE, ELEGANT ACCESSORIES THAT TOUCH THE BODY AND SOUL OF A WOMAN. INT. CL. 18. REG. 12-24-2002.
- 2,667,031. BOOKREEL. INT. CL. 41. REG. 12-24-2002.
- 2,667,032. SONORA AND DESIGN. INT. CL. 42. REG. 12-24-2002.
- 2,667,033. DREAM SHEET. INT. CL. 24. REG. 12-24-2002.
- 2,667,037. ORGANIZIQ. INT. CL. 9. REG. 12-24-2002.
- 2,667,038. MANAGIQ. INT. CL. 9. REG. 12-24-2002.
- 2,667,039. SECURIQ. INT. CL. 9. REG. 12-24-2002.
- 2,667,040. XIINO (STYLIZED). INT. CL. 9. REG. 12-24-2002.
- 2,667,041. EASSIST GLOBAL SOLUTIONS. INT. CL. 35. REG. 12-24-2002.
- 2,667,042. BIORAL. INT. CL. 5. REG. 12-24-2002.
- 2,667,046. SPIRALTOP. INT. CL. 7. REG. 12-24-2002.
- 2,667,047. VINYLCEIL. INT. CL. 19. REG. 12-24-2002.
- 2,667,048. SUCCESSFUL STRATEGIES FOR SCHOOL LEADERS. INT. CL. 41. REG. 12-24-2002.
- 2,667,051. MIND ELEMENTS AND DESIGN. INT. CL. 25. REG. 12-24-2002.
- 2,667,052. STOP THE FUNERAL. INT. CLS. 21, 25 AND 42. REG. 12-24-2002.
- 2,667,053. LEFT BEHIND (STYLIZED). INT. CL. 41. REG. 12-24-2002.
- 2,667,054. 211.NET. INT. CL. 35. REG. 12-24-2002.
- 2,667,055. MISCELLANEOUS DESIGN. INT. CL. 9. REG. 12-24-2002.
- 2,667,056. DRAGONWISH. INT. CL. 9. REG. 12-24-2002.
- 2,667,059. CUTICLE CUSHIONER. INT. CL. 3. REG. 12-24-2002.
- 2,667,060. VANS PAR. INT. CL. 5. REG. 12-24-2002.
- 2,667,063. F AND DESIGN. INT. CL. 42. REG. 12-24-2002.
- 2,667,064. MISCELLANEOUS DESIGN. INT. CL. 30. REG. 12-24-2002.
- 2,667,065. H 2COCO (STYLIZED). INT. CL. 32. REG. 12-24-2002.
- 2,667,066. PC PAL STARLIGHT CHILDREN'S FOUNDATION AND DESIGN. INT. CL. 9. REG. 12-24-2002.
- 2,667,067. NEIGHBORNOTES. INT. CLS. 35 AND 42. REG. 12-24-2002.
- 2,667,068. PLAYING FOOTSYE. INT. CL. 25. REG. 12-24-2002.
- 2,667,069. OP 1 AND DESIGN. INT. CL. 10. REG. 12-24-2002.
- 2,667,070. MYRIAD. INT. CL. 23. REG. 12-24-2002.
- 2,667,072. LEADERX. INT. CL. 35. REG. 12-24-2002.
- 2,667,074. MAKING THEM PAY. INT. CL. 16. REG. 12-24-2002.
- 2,667,076. COFFEE THAT MELTS IN YOUR MOUTH. INT. CL. 30. REG. 12-24-2002.
- 2,667,077. MISCELLANEOUS DESIGN. INT. CL. 9. REG. 12-24-2002.
- 2,667,079. COBBLEKIDS. INT. CL. 16. REG. 12-24-2002.
- 2,667,085. MYNFO. INT. CL. 35. REG. 12-24-2002.
- 2,667,086. MY FAVORITE MUSIC. INT. CL. 9. REG. 12-24-2002.
- 2,667,090. PROC-LOGXACT. INT. CL. 9. REG. 12-24-2002.
- 2,667,091. MORTGAGE MOVER. INT. CL. 39. REG. 12-24-2002.
- 2,667,092. ROCKIN' BOPPIN' BIRDS. INT. CL. 41. REG. 12-24-2002.
- 2,667,093. YOU'RE A GROWTH COMPANY. WORK WITH A LAW FIRM YOU WON'T OUTGROW.. INT. CL. 42. REG. 12-24-2002.
- 2,667,094. WRAPTURE. INT. CL. 25. REG. 12-24-2002.
- 2,667,095. I-GISTICS. INT. CL. 35. REG. 12-24-2002.
- 2,667,096. SNEAKY BASTARDS. INT. CL. 35. REG. 12-24-2002.
- 2,667,097. WATER TORPEDO. INT. CL. 28. REG. 12-24-2002.
- 2,667,098. ISOTONER TOO!. INT. CL. 25. REG. 12-24-2002.
- 2,667,100. WELL MANICURED. INT. CL. 8. REG. 12-24-2002.
- 2,667,102. POLIMENTO ITALIANO ESSENCIAL. INT. CL. 35. REG. 12-24-2002.
- 2,667,108. MAXX-ALUM. INT. CL. 20. REG. 12-24-2002.
- 2,667,109. DIRECTIONS TO SOLUTIONS. INT. CL. 36. REG. 12-24-2002.
- 2,667,110. HAIRPOP. INT. CL. 3. REG. 12-24-2002.
- 2,667,112. PINE. INT. CLS. 38, 41 AND 42. REG. 12-24-2002.
- 2,667,113. FLASH FREEZE. INT. CL. 3. REG. 12-24-2002.
- 2,667,120. N NUTRIEN HAIR (STYLIZED). INT. CL. 3. REG. 12-24-2002.
- 2,667,121. SIMON BUSINESS NETWORK AND DESIGN. INT. CL. 35. REG. 12-24-2002.

- 2,667,124. SCULPTURED GOTHIC. INT. CL. 19. REG. 12-24-2002.
- 2,667,125. POINT2 INTERACTIVE ADVERTISING. INT. CL. 35. REG. 12-24-2002.
- 2,667,127. MISCELLANEOUS DESIGN. INT. CLS. 16, 35 AND 36. REG. 12-24-2002.
- 2,667,130. BEYOND WORDS. INT. CL. 20. REG. 12-24-2002.
- 2,667,131. TSUNAMI AND DESIGN. INT. CL. 9. REG. 12-24-2002.
- 2,667,135. TRACK STAX. INT. CL. 28. REG. 12-24-2002.
- 2,667,136. IRON BOOSTER. INT. CL. 1. REG. 12-24-2002.
- 2,667,137. PERFECT COMPLEXION SERUM. INT. CL. 3. REG. 12-24-2002.
- 2,667,138. GLOWTEX. INT. CL. 24. REG. 12-24-2002.
- 2,667,139. URBAN SAVER. INT. CL. 35. REG. 12-24-2002.
- 2,667,141. 5-POINT PLEDGE. INT. CL. 35. REG. 12-24-2002.
- 2,667,142. IPREVENT. INT. CL. 9. REG. 12-24-2002.
- 2,667,143. MISCELLANEOUS DESIGN. INT. CL. 9. REG. 12-24-2002.
- 2,667,144. MONICSNET. INT. CL. 9. REG. 12-24-2002.
- 2,667,146. AIREON. INT. CLS. 9 AND 12. REG. 12-24-2002.
- 2,667,147. PLAY TODAY. WORK MANANA. INT. CL. 32. REG. 12-24-2002.
- 2,667,148. PLAY TODAY. WORK MANANA. INT. CL. 21. REG. 12-24-2002.
- 2,667,153. POWER POCKETS. INT. CL. 16. REG. 12-24-2002.
- 2,667,155. SEA FORCE. INT. CL. 28. REG. 12-24-2002.
- 2,667,157. EXPERIENCE JEVIC. INT. CL. 39. REG. 12-24-2002.
- 2,667,158. THE ABBEY OF GETHSEMANI ORA ET LABORA AND DESIGN. INT. CL. 21. REG. 12-24-2002.
- 2,667,162. SPORTGYM. INT. CL. 27. REG. 12-24-2002.
- 2,667,164. ROAD RATS. INT. CL. 28. REG. 12-24-2002.
- 2,667,168. POWER POUCH. INT. CL. 32. REG. 12-24-2002.
- 2,667,169. JOAN VASS STYLE. INT. CL. 25. REG. 12-24-2002.
- 2,667,170. GET SMART. INT. CL. 36. REG. 12-24-2002.
- 2,667,178. A STORY OF DISCOVERY, EXPLORATION, AND SETTLEMENT. INT. CLS. 36, 37, 41 AND 42. REG. 12-24-2002.
- 2,667,179. SENSU BEANS. INT. CL. 30. REG. 12-24-2002.
- 2,667,181. WHISTLE EXPRESS AND DESIGN. INT. CL. 35. REG. 12-24-2002.
- 2,667,182. LIGHTING THE WAY TO LEARNING. INT. CL. 41. REG. 12-24-2002.
- 2,667,183. MISCELLANEOUS DESIGN. INT. CL. 35. REG. 12-24-2002.
- 2,667,186. ALLISON ROSE. INT. CL. 20. REG. 12-24-2002.
- 2,667,188. A GREAT PLACE TO BE. INT. CL. 39. REG. 12-24-2002.
- 2,667,189. PHOTO INVESTIGATOR. INT. CL. 9. REG. 12-24-2002.
- 2,667,190. IN-PSYCH. INT. CL. 9. REG. 12-24-2002.
- 2,667,191. 800PILLOWS.COM. INT. CL. 35. REG. 12-24-2002.
- 2,667,192. BLVD WEST. INT. CL. 35. REG. 12-24-2002.
- 2,667,195. SUITCASE BEAR ADVENTURES. INT. CL. 28. REG. 12-24-2002.
- 2,667,196. GOLDEN JEANS LEGEND. INT. CL. 3. REG. 12-24-2002.
- 2,667,203. LOVE & BEACH. INT. CL. 3. REG. 12-24-2002.
- 2,667,204. PHROGG PERCUSSION. INT. CLS. 15 AND 28. REG. 12-24-2002.
- 2,667,205. LITTLE FLAG BOY. INT. CL. 6. REG. 12-24-2002.
- 2,667,206. EBONIX. INT. CL. 14. REG. 12-24-2002.
- 2,667,210. DRAGONCLOUD TEA AND DESIGN. INT. CL. 30. REG. 12-24-2002.
- 2,667,212. S AND DESIGN. INT. CL. 25. REG. 12-24-2002.
- 2,667,213. TACOMA WINE CLASSIC AND DESIGN. INT. CL. 36. REG. 12-24-2002.
- 2,667,214. NEW JEANS. INT. CL. 3. REG. 12-24-2002.
- 2,667,215. PERFORMANCE NOW. INT. CL. 36. REG. 12-24-2002.
- 2,667,216. PREPARE 2B UPGRADE AND DESIGN. INT. CL. 16. REG. 12-24-2002.
- 2,667,219. QUICK PRO. INT. CL. 35. REG. 12-24-2002.
- 2,667,221. VAL-U SPOT AND DESIGN. INT. CL. 35. REG. 12-24-2002.
- 2,667,225. CONVERSATIONS IN CARE. INT. CL. 41. REG. 12-24-2002.
- 2,667,227. ZAMICLIN. INT. CL. 42. REG. 12-24-2002.
- 2,667,230. A SITE FOR MORE EYES. INT. CL. 36. REG. 12-24-2002.
- 2,667,235. CONSTRUCTION JILL. INT. CL. 28. REG. 12-24-2002.
- 2,667,236. CINESUITE. INT. CL. 9. REG. 12-24-2002.
- 2,667,240. LA BRISA. INT. CL. 11. REG. 12-24-2002.
- 2,667,241. SOUTH SEAS COLLECTION. INT. CL. 11. REG. 12-24-2002.
- 2,667,243. HDN. INT. CL. 42. REG. 12-24-2002.
- 2,667,245. BBA FILTRATION. INT. CLS. 11 AND 24. REG. 12-24-2002.
- 2,667,246. PATH BLITZER. INT. CL. 28. REG. 12-24-2002.
- 2,667,247. PHROGG PERCUSSION AND DESIGN. INT. CLS. 15 AND 28. REG. 12-24-2002.
- 2,667,249. STARSEAL. INT. CL. 16. REG. 12-24-2002.
- 2,667,252. HEAVENLY RICHES. INT. CL. 25. REG. 12-24-2002.
- 2,667,253. OAKLAWN. INT. CL. 19. REG. 12-24-2002.
- 2,667,254. THOROBID AND DESIGN. INT. CL. 9. REG. 12-24-2002.
- 2,667,256. INSURANCESOUTH. INT. CL. 36. REG. 12-24-2002.
- 2,667,258. MORTGAGEMATES. INT. CL. 36. REG. 12-24-2002.
- 2,667,259. THE WOMANLY ART OF LOVING'S SEXERCISE. INT. CL. 9. REG. 12-24-2002.
- 2,667,261. LIFEPEPKS. INT. CL. 35. REG. 12-24-2002.
- 2,667,262. CELESTIAL. INT. CL. 11. REG. 12-24-2002.
- 2,667,265. SEMAPHORE. INT. CL. 41. REG. 12-24-2002.
- 2,667,266. BELGIE BEAR. INT. CL. 28. REG. 12-24-2002.
- 2,667,267. MISCELLANEOUS DESIGN. INT. CL. 35. REG. 12-24-2002.
- 2,667,268. NOVAFORUM. INT. CLS. 35 AND 42. REG. 12-24-2002.
- 2,667,269. SYSDINE AND DESIGN. INT. CL. 9. REG. 12-24-2002.
- 2,667,271. USERSPACE. INT. CL. 42. REG. 12-24-2002.
- 2,667,272. WHEATIES ENERGY CRUNCH. INT. CL. 30. REG. 12-24-2002.
- 2,667,275. POCHILD PRODUCTIONS. INT. CL. 41. REG. 12-24-2002.
- 2,667,276. PREVENT. INT. CL. 9. REG. 12-24-2002.
- 2,667,277. DECIDIA. INT. CL. 42. REG. 12-24-2002.
- 2,667,280. ALOHA MAILBOX. INT. CL. 6. REG. 12-24-2002.
- 2,667,281. L2X SMARTXML. INT. CL. 9. REG. 12-24-2002.
- 2,667,282. COMPLIANCE ENGINE. INT. CL. 42. REG. 12-24-2002.
- 2,667,283. NEXT STARS. INT. CL. 25. REG. 12-24-2002.
- 2,667,284. VITANIACIN. INT. CL. 3. REG. 12-24-2002.
- 2,667,286. UPSITEDOWN. INT. CL. 9. REG. 12-24-2002.
- 2,667,287. LE VILLAGE. INT. CL. 32. REG. 12-24-2002.
- 2,667,288. SECRET KEEPER. INT. CL. 9. REG. 12-24-2002.
- 2,667,291. BAF FORMULA. INT. CL. 5. REG. 12-24-2002.
- 2,667,292. BD AND DESIGN. INT. CL. 9. REG. 12-24-2002.
- 2,667,297. RESCUE RODS. INT. CL. 28. REG. 12-24-2002.
- 2,667,298. JOY FOR JOINTS.. INT. CLS. 5 AND 32. REG. 12-24-2002.
- 2,667,299. AXE APOLLO. INT. CL. 3. REG. 12-24-2002.
- 2,667,301. LI'L SHERIFF. INT. CL. 28. REG. 12-24-2002.
- 2,667,302. NANOBOTZ. INT. CL. 16. REG. 12-24-2002.
- 2,667,303. EL PRIMO POLITO (STYLIZED). INT. CL. 16. REG. 12-24-2002.
- 2,667,305. SNOWSHOES. INT. CL. 42. REG. 12-24-2002.
- 2,667,308. LA NOW. INT. CL. 35. REG. 12-24-2002.
- 2,667,310. RETIREMENT BEGINS HERE.. INT. CL. 36. REG. 12-24-2002.
- 2,667,312. ACTIVATE!. INT. CL. 9. REG. 12-24-2002.
- 2,667,314. WORLDISMYSANDBOX.COM. INT. CL. 42. REG. 12-24-2002.
- 2,667,317. WHERE STORAGE AND NETWORKING MEET. INT. CL. 9. REG. 12-24-2002.
- 2,667,318. MISCELLANEOUS DESIGN. INT. CL. 6. REG. 12-24-2002.
- 2,667,322. CONVATEC CONNECTIONS. INT. CL. 42. REG. 12-24-2002.

- 2,667,323. RIGHTSPRO. INT. CL. 9. REG. 12-24-2002.
2,667,324. VELOCITY. INT. CL. 3. REG. 12-24-2002.
2,667,326. HEBA. INT. CL. 5. REG. 12-24-2002.
2,667,327. STAR FN SECURITIES AND DESIGN. INT. CL. 36. REG. 12-24-2002.
2,667,328. AMERICAN COSMONAUT. INT. CL. 9. REG. 12-24-2002.
2,667,331. THE SWEETEST THING. INT. CL. 3. REG. 12-24-2002.
2,667,335. MOMENT TO MOMENT (STYLIZED). INT. CL. 16. REG. 12-24-2002.
2,667,336. LEAVE NO TEACHER BEHIND. INT. CL. 16. REG. 12-24-2002.
2,667,338. ROTO-DIG. INT. CL. 7. REG. 12-24-2002.
2,667,339. EXOTIC SANDS. INT. CL. 3. REG. 12-24-2002.
2,667,340. PATENTMAX (STYLIZED). INT. CL. 9. REG. 12-24-2002.
2,667,343. VILLAMA. INT. CL. 9. REG. 12-24-2002.
2,667,347. SLK DESIGNS AND DESIGN. INT. CL. 16. REG. 12-24-2002.
2,667,348. CREATE YOUR OWN. INT. CL. 30. REG. 12-24-2002.
2,667,349. MULTIPLICITY. INT. CL. 27. REG. 12-24-2002.
2,667,350. ELITE FORCES: NAVY SEALS. INT. CL. 9. REG. 12-24-2002.
2,667,353. HOT PINK. INT. CLS. 18 AND 25. REG. 12-24-2002.
2,667,355. ONEPIN. INT. CL. 35. REG. 12-24-2002.
2,667,356. IMAGE MED. INT. CLS. 9 AND 42. REG. 12-24-2002.
2,667,358. LONG ISLAND BUSINESS ALMANAC. INT. CL. 16. REG. 12-24-2002.
2,667,359. NEW YORK MUSIC AWARDS. INT. CL. 41. REG. 12-24-2002.
2,667,360. FLORIDA MUSIC AWARDS. INT. CL. 41. REG. 12-24-2002.
2,667,362. ARTWORKSDIRECT.COM. INT. CL. 35. REG. 12-24-2002.
2,667,363. BANNERBLIND. INT. CL. 20. REG. 12-24-2002.
2,667,366. MISCELLANEOUS DESIGN. INT. CL. 7. REG. 12-24-2002.
2,667,367. NUTRITION FOR SUSTAINED ENERGY (STYLIZED). INT. CL. 30. REG. 12-24-2002.
2,667,371. THE CUSTOM BENEFITS NETWORK. INT. CL. 36. REG. 12-24-2002.
2,667,372. MOVING PICTURES ABOUT MEDICINE. INT. CL. 44. REG. 12-24-2002.
2,667,378. ADVENTURE TRAVEL TRADE ASSOCIATION. INT. CL. 35. REG. 12-24-2002.
2,667,379. ADVENTURE TRAVEL SOCIETY. INT. CL. 35. REG. 12-24-2002.
2,667,380. MOISTURE CONTROL. INT. CL. 1. REG. 12-24-2002.
2,667,383. RASTER MANAGER. INT. CL. 9. REG. 12-24-2002.
2,667,386. MERCHANTS NET BANKER. INT. CL. 36. REG. 12-24-2002.
2,667,387. THEATREWAREHOUSE. INT. CL. 41. REG. 12-24-2002.
2,667,390. CAVUSFOOT ORTHOTIC. INT. CL. 10. REG. 12-24-2002.
2,667,391. PUNCHLISTMANAGER.NET. INT. CL. 9. REG. 12-24-2002.
2,667,392. CONTRACTMAKER (STYLIZED). INT. CL. 42. REG. 12-24-2002.
2,667,397. SERVICE LOGIC SOFTWARE. INT. CL. 9. REG. 12-24-2002.
2,667,399. COLE. INT. CL. 28. REG. 12-24-2002.
2,667,400. GOLFURNITURE. INT. CL. 20. REG. 12-24-2002.
2,667,401. WICKER WEAVE. INT. CLS. 20 AND 21. REG. 12-24-2002.
2,667,404. THE GARDEN & GREENHOUSE THE SHOPPER AND BUYERS GUIDE MAGAZINE. INT. CL. 16. REG. 12-24-2002.
2,667,405. FDXCHANGE. INT. CL. 36. REG. 12-24-2002.
2,667,407. ECCONTINENCE (STYLIZED). INT. CL. 42. REG. 12-24-2002.
2,667,408. ALBACORE SPECIAL. INT. CL. 28. REG. 12-24-2002.
2,667,409. SINGLE POINT OF CONTACT. INT. CL. 35. REG. 12-24-2002.
2,667,411. SEA MILES. INT. CL. 36. REG. 12-24-2002.
2,667,412. CONTROLLED EXPANSION. INT. CL. 10. REG. 12-24-2002.
2,667,413. EL RIQUISIMO. INT. CL. 30. REG. 12-24-2002.
2,667,417. WIATRACKER. INT. CL. 9. REG. 12-24-2002.
2,667,421. DIRECT-TO-DVD. INT. CL. 9. REG. 12-24-2002.
2,667,422. LUCCESE. INT. CL. 29. REG. 12-24-2002.
2,667,424. WEATHERTAPE. INT. CL. 17. REG. 12-24-2002.
2,667,425. THIK & CLEAR (STYLIZED). INT. CLS. 5 AND 30. REG. 12-24-2002.
2,667,426. F CARRIERE. INT. CL. 35. REG. 12-24-2002.
2,667,427. AUTHENTIC HANDMADE MEXICAN FOOD. INT. CL. 42. REG. 12-24-2002.
2,667,428. RIBS EXPRESS. INT. CL. 43. REG. 12-24-2002.
2,667,429. RODA MANUFACTURING, INC.. INT. CL. 7. REG. 12-24-2002.
2,667,430. LOSS PREVENTION & SECURITY JOURNAL. INT. CL. 16. REG. 12-24-2002.
2,667,435. KOREAN UNIVERSITY STUDENTS. INT. CL. 9. REG. 12-24-2002.
2,667,436. KOREAN COLLEGE STUDENTS. INT. CL. 9. REG. 12-24-2002.
2,667,437. KOREAN SUPER MODELS. INT. CL. 9. REG. 12-24-2002.
2,667,438. KOREAN AMATEUR GIRLS. INT. CL. 9. REG. 12-24-2002.
2,667,439. E-WATCH. INT. CL. 9. REG. 12-24-2002.
2,667,441. ME-ZINE. INT. CL. 42. REG. 12-24-2002.
2,667,443. THE GUILD OF CARILLONNEURS IN NORTH AMERICA. INT. CL. 16. REG. 12-24-2002.
2,667,445. AMERICAN FAMILY FUNDS. INT. CL. 36. REG. 12-24-2002.
2,667,446. AMERICA'S FAVORITE DOWN PAYMENT GIFT PROGRAM. INT. CL. 36. REG. 12-24-2002.
2,667,447. GINGER BERGAMOT. INT. CLS. 3 AND 4. REG. 12-24-2002.
2,667,449. THE ORIGINAL SCRUNCHIE CAP. INT. CL. 25. REG. 12-24-2002.
2,667,450. EZ SLIDER. INT. CL. 28. REG. 12-24-2002.
2,667,452. WILLAPA STRINGS. INT. CL. 41. REG. 12-24-2002.
2,667,453. NEWTECMARKET. INT. CL. 35. REG. 12-24-2002.
2,667,516. QIA. INT. CL. 42 ONLY. REG. 12-31-2002.
2,671,250. LINGUISTICS AND LANGUAGE BEHAVIOR ABSTRACTS. INT. CL. 9 ONLY. REG. 1-7-2003.
2,675,805. JOKE AND DESIGN. INT. CL. 20 ONLY. REG. 1-21-2003.
2,675,965. STYLECREST AND DESIGN. INT. CL. 37 ONLY. REG. 1-21-2003.
2,676,043. WBA. INT. CL. 6 ONLY. REG. 1-21-2003.
2,676,077. INTERFLEX AND DESIGN. INT. CLS. 37 AND 42 ONLY. REG. 1-21-2003.
2,676,166. CIRPACK AND DESIGN. INT. CL. 38 ONLY. REG. 1-21-2003.
2,678,284. TRIDENT FOR KIDS. INT. CL. 30. REG. 1-21-2003.
2,678,386. BARBIE. INT. CL. 8 ONLY. REG. 1-21-2003.
2,679,582. OPTUM. INT. CL. 16 ONLY. REG. 1-28-2003.
2,682,202. RHINO LININGS. INT. CL. 7 ONLY. REG. 2-4-2003.
2,682,531. GENEANET AND DESIGN. INT. CL. 9 ONLY. REG. 2-4-2003.
2,683,902. RECLAIM. INT. CLS. 6 AND 25 ONLY. REG. 2-4-2003.
2,695,008. QUORN AND DESIGN. INT. CL. 16 ONLY. REG. 3-11-2003.
2,731,057. MASTRO. INT. CLS. 30 AND 32 ONLY. REG. 7-1-2003.
2,733,905. GREATDOMAINS. INT. CL. 36 ONLY. REG. 7-8-2003.
2,734,092. SNAPSPLIT. INT. CL. 6 ONLY. REG. 7-8-2003.
2,735,041. THE MOTHER CHURCH OF COUNTRY MUSIC. INT. CL. 41 ONLY. REG. 7-8-2003.
2,735,270. PLANET MOTHERHOOD. INT. CLS. 3, 5, 18, 30 AND 32 ONLY. REG. 7-8-2003.
2,735,324. 1 AND DESIGN. INT. CLS. 35, 40 AND 42 ONLY. REG. 7-8-2003.

- 2,735,419. S THE SKAGIT SKAGIT VALLEY CASINO RESORT AND DESIGN. INT. CL. 16 ONLY. REG. 7-8-2003.
- 2,736,981. DYEEX (STYLIZED). INT. CL. 5 ONLY. REG. 7-15-2003.
- 2,737,832. THE XY FACTOR. INT. CL. 41 ONLY. REG. 7-15-2003.
- 2,738,104. ALCOS. INT. CLS. 35 AND 42 ONLY. REG. 7-15-2003.
- 2,739,035. LEGAL SKIN. INT. CL. 41 ONLY. REG. 7-15-2003.
- 2,739,462. TORINO 2006. INT. CLS. 35 AND 41 ONLY. REG. 7-22-2003.
- 2,739,492. BEIJING 2008. INT. CLS. 16 AND 35 ONLY. REG. 7-22-2003.
- 2,739,511. NOMINET. INT. CL. 35 ONLY. REG. 7-22-2003.
- 2,739,668. THE MAIN INGREDIENTS. INT. CLS. 11, 16, 20 AND 24 ONLY. REG. 7-22-2003.
- 2,739,729. HEALTHCARE YOU CAN BANK ON. INT. CL. 44 ONLY. REG. 7-22-2003.
- 2,740,041. PAINEDU. INT. CL. 41 ONLY. REG. 7-22-2003.
- 2,740,894. KARAOKE.COM. INT. CL. 16 ONLY. REG. 7-29-2003.
- 2,741,364. MISCELLANEOUS DESIGN. INT. CL. 28 ONLY. REG. 7-29-2003.
- 2,741,655. JUST CLAIMS AND DESIGN. INT. CL. 16 ONLY. REG. 7-29-2003.
- 2,741,907. MICRO AEROSOL. INT. CL. 11 ONLY. REG. 7-29-2003.
- 2,742,153. MISCELLANEOUS DESIGN. INT. CL. 41 ONLY. REG. 7-29-2003.
- 2,742,391. QMS. INT. CLS. 40 AND 42 ONLY. REG. 7-29-2003.
- 2,742,997. TEAMSTERS UNITY - PRIDE STRENGTH INTERNATIONAL BROTHERHOOD OF TEAMSTERS AND DESIGN. INT. CL. 25 ONLY. REG. 7-29-2003.
- 2,743,139. ZOOM. INT. CL. 5 ONLY. REG. 7-29-2003.
- 2,743,619. TT BAGATT AND DESIGN. INT. CL. 18 ONLY. REG. 7-29-2003.
- 2,745,629. ENDERMO. INT. CL. 9 ONLY. REG. 8-5-2003.
- 2,747,287. MOTOTECH. INT. CLS. 7, 9 AND 21 ONLY. REG. 8-5-2003.
- 2,747,911. BIOOSCILLATOR. INT. CLS. 35 AND 41 ONLY. REG. 8-5-2003.
- 2,748,337. DEALS DEVELOPMENT, EXPANSION AND LOCATION SOLUTIONS. INT. CL. 35 ONLY. REG. 8-5-2003.
- 2,749,080. AMANDARI. INT. CL. 3 ONLY. REG. 8-12-2003.
- 2,749,295. LE SIRENUSE ALBERGO DI POSITANO AND DESIGN. INT. CL. 35 ONLY. REG. 8-12-2003.
- 2,750,703. REGENCY GRANDE. INT. CL. 19 ONLY. REG. 8-12-2003.
- 2,750,944. FIBERTONE. INT. CL. 25 ONLY. REG. 8-12-2003.
- 2,751,636. NATIONAL COWBOY AND WESTERN HERITAGE MUSEUM. INT. CL. 30 ONLY. REG. 8-19-2003.
- 2,751,688. MOTIVANO. INT. CL. 39 ONLY. REG. 8-19-2003.
- 2,751,716. OLYMPUS. INT. CL. 40 ONLY. REG. 8-19-2003.
- 2,751,753. MONKEY BALL AND DESIGN. INT. CL. 28 ONLY. REG. 8-19-2003.
- 2,753,960. MISCELLANEOUS DESIGN. INT. CL. 35 ONLY. REG. 8-19-2003.
- 2,755,148. IMEDEEN SYSTEMIC SKIN SOLUTION INNER STRENGTH OUTER BEAUTY AND DESIGN. INT. CL. 3 ONLY. REG. 8-26-2003.
- 2,755,470. WEATHER-NET. INT. CLS. 17 AND 24 ONLY. REG. 8-26-2003.
- 2,757,860. MISCELLANEOUS DESIGN. INT. CL. 39 ONLY. REG. 9-2-2003.
- 2,758,081. NET 2 MOBILE GRX-GPRS ROAMING EXCHANGE AND DESIGN. INT. CL. 9 ONLY. REG. 9-2-2003.
- 2,763,561. PETAN. INT. CL. 17 ONLY. REG. 9-16-2003.
- 2,763,655. AIRE SERV. INT. CL. 11 ONLY. REG. 9-16-2003.
- 2,763,656. MISCELLANEOUS DESIGN. INT. CL. 11 ONLY. REG. 9-16-2003.
- 2,767,323. PLEXIGLAS ELIT. INT. CL. 1 ONLY. REG. 9-23-2003.
- 2,767,770. MISCELLANEOUS DESIGN. INT. CL. 36 ONLY. REG. 9-23-2003.
- 2,770,908. PANAMSAT. INT. CL. 35 ONLY. REG. 10-7-2003.
- 2,774,410. FX2B. INT. CLS. 9, 16, 35, 38, 41 AND 42 ONLY. REG. 10-21-2003.
- 2,778,176. X AND DESIGN. INT. CL. 42 ONLY. REG. 10-28-2003.
- 2,787,196. ALCOS AND DESIGN. INT. CLS. 35 AND 42 ONLY. REG. 11-25-2003.
- 2,802,634. HEALTH SYSTEM ONE. INT. CL. 36 ONLY. REG. 1-6-2004.
- 2,805,438. VISUAL SCIENCES. INT. CL. 35 ONLY. REG. 1-13-2004.
- 2,824,285. MISCELLANEOUS DESIGN. INT. CL. 25 ONLY. REG. 3-23-2004.
- 2,831,094. MISSOURI RIVER ENERGY SERVICES. INT. CL. 36 ONLY. REG. 4-13-2004.
- 2,844,461. S'ERGO. INT. CL. 41 ONLY. REG. 5-25-2004.
- 2,849,421. BUFFALO EXCHANGE AND DESIGN. INT. CL. 24 ONLY. REG. 6-1-2004.
- 2,859,438. MISCELLANEOUS DESIGN. INT. CL. 16 ONLY. REG. 7-6-2004.

SECTION 18

- 1,602,940. THE DEL-VIKINGS (STYLIZED). INT. CL. 41. REG. 6-19-1990.
- 1,692,202. ICEBERG SPRINGS WATER. INT. CLS. 32 AND 42. REG. 6-9-1992.
- 1,717,772. MAX & CO.. INT. CL. 9. REG. 9-22-1992.
- 1,815,840. OSHO. INT. CL. 16. REG. 1-11-1994.
- 2,174,607. OSHO. INT. CL. 42. REG. 7-21-1998.
- 2,180,173. OSHO. INT. CL. 9. REG. 8-11-1998.
- 2,322,901. OSHO REBALANCING. INT. CL. 16. REG. 2-29-2000.
- 2,942,913. STARTONES. INT. CL. 9. REG. 4-19-2005.
- 3,218,728. BLACK MOUNTAINSTANDARD CHARACTER MARK INT. CL. 29. REG. 3-13-2007.

INADVERTENTLY ISSUED REGISTRATION NUMBERS

- 3,550,310. SERRAZYMESTANDARD CHARACTER MARK INT. CL. 5. REG. 12-23-2008. RESTORED TO SN 78-967,424.
- 3,552,395. THE "WOW!...WHAT A SUB!!!" BOYZ SUBS & STEAKS AND DESIGN. INT. CL. 43. REG. 12-30-2008. RESTORED TO SN 76-579,951.
- 3,554,243. RAICO (STYLIZED). INT. CLS. 6, 7 AND 19. REG. 12-30-2008. RESTORED TO SN 79-025,264.
- 3,561,310. JUBII (STYLIZED). INT. CLS. 9, 18, 25, 35, 36, 39, 41, 42, 43 AND 45. REG. 1-13-2009. RESTORED TO SN 79-048,190.
- 3,621,419. TOPAZSTANDARD CHARACTER MARK INT. CL. 34. REG. 5-19-2009. RESTORED TO SN 77-238,137.
- 3,653,160. MISSION IMPAWSIBLESTANDARD CHARACTER MARK INT. CL. 41. REG. 7-14-2009. RESTORED TO SN 77-379,371.
- 3,654,998. TORICADESTANDARD CHARACTER MARK INT. CL. 5. REG. 7-14-2009. RESTORED TO SN 79-060,084.

TRADEMARK REGISTRATIONS AMENDED, CORRECTED, ETC.

The designation "U.S. Cl." appearing in this section refers to the U.S. class in effect prior to Sep. 1, 1973 rather than the international class which applies to applications filed on or after that date. For adoption of international classification see notice in the OFFICIAL GAZETTE of Jun. 26, 1973 (911 O.G. TM 210).

Any change to the registration will be indicated at the bottom of each entry under ELEMENTS AMENDED, CORRECTED OR RESTRICTED. With the exception of changes to the goods and services, additions to the registration will appear in asterisks and deletions of the registration will appear in brackets. Elements which are only changed will be listed with no punctuation. As to the goods/services statement, amendments to the goods/services will appear in asterisks and deletions will appear in brackets. In addition if any change to the goods/services occurs, the element "Goods/Services" will be listed under ELEMENTS AMENDED, CORRECTED OR RESTRICTED.

256,633. REG. 5-21-1929. SENSIENT FLAVORS LLC (DELAWARE LIMITED LIABILITY COMPANY) 5600 W. RAYMOND STREET, INDIANAPOLIS, IN, 46241, SN 71-277,568. FILED 1-4-1929. PRINCIPAL REGISTER.

FOR ON-SITE CLEANING AND WAXING SERVICES FOR VEHICLES AND BUILDINGS.
FIRST USE 8-0-1966; IN COMMERCE 8-18-1967.

OLD ANTIQUE

ELEMENTS AMENDED
MARK

THE MARK CONSISTS OF STANDARD CHARACTERS WITHOUT CLAIM TO ANY PARTICULAR FONT, STYLE, SIZE, OR COLOR.

INT. CL. 32/U.S. CL. 45

FOR CARBONATED BEVERAGES, NONALCOHOLIC, NONCEREAL, AND MALTLESS; GINGER ALE, AND GINGERALE EXTRACT.

FIRST USE 11-1-1928; IN COMMERCE 11-1-1928.

ELEMENTS AMENDED
ASSIGNMENT/NAME CHANGE
MARK

1,111,207. REG. 1-16-1979. IMO INDUSTRIES INC. (DELAWARE CORPORATION) 1009 LENOX DRIVE, BUILDING FOUR WEST, LAWRENCEVILLE, NJ., SN 73-135,945. FILED 8-1-1977. PRINCIPAL REGISTER.

GTS

560,428. REG. 6-24-1952. TBC BRANDS, LLC (DELAWARE LIMITED LIABILITY COMPANY) 639 ISBELL ROAD, SUITE 390, RENO, NV, 89509, SN 71-597,256. FILED 5-11-1950. PRINCIPAL REGISTER.

THE MARK CONSISTS OF STANDARD CHARACTERS WITHOUT CLAIM TO ANY PARTICULAR FONT, STYLE, SIZE, OR COLOR.

INT. CL. 7/U.S. CL. 23

FOR GEARED TWIN SCREW ROTARY FLOW PUMPS.
FIRST USE 11-30-1976; IN COMMERCE 11-30-1976.

Multi-Mile

ELEMENTS AMENDED
MARK

INT. CL. 12/U.S. CL. 35

FOR VEHICLE TIRES.

FIRST USE 0-0-1935; IN COMMERCE 0-0-1935.

ELEMENTS AMENDED
MARK

1,307,677. REG. 12-4-1984. OMAHA STANDARD, INC. (IOWA CORPORATION) 3501 SOUTH 11TH STREET, COUNCIL BLUFFS, IA, 51501, SN 73-437,705. FILED 8-4-1983. PRINCIPAL REGISTER.

AMERICAN ROLL-OFF

871,508. REG. 6-17-1969. SPARKLE INTERNATIONAL, INC. (OHIO CORPORATION) 26851 RICHMOND ROAD, CLEVELAND, OH, 44146, SN 72-285,070. FILED 11-16-1967. PRINCIPAL REGISTER.



SparkleWash

NO CLAIM IS MADE TO THE EXCLUSIVE RIGHT TO USE "ROLL-OFF", APART FROM THE MARK AS SHOWN.
INT. CL. 7/U.S. CL. 23

FOR WASTE MATERIAL BODY LOADING/UNLOADING UNITS FOR MOUNTING ON TRUCKS.
FIRST USE 7-29-1983; IN COMMERCE 7-29-1983.

THE WORD "WASH" IS DISCLAIMED APART FROM THE MARK AS SHOWN.
INT. CL. 37/U.S. CL. 103

ELEMENTS AMENDED
OWNER NAME

1,478,715. REG. 3-1-1988. MAPEI INC. (CANADA CORPORATION) 2900 DE L'AVENUE FRANCIS-HUGHES, LAVAL, QUEBEC, CANADA, H7L 3J5, SN 73-665,255. FILED 6-8-1987. PRINCIPAL REGISTER.

ULTRACOLOR

INT. CL. 19/U.S. CL. 12
FOR GROUTING COMPOUND FOR CERAMIC TILES.
FIRST USE 2-3-1987; IN COMMERCE 2-3-1987.

ELEMENTS AMENDED
MARK

1,510,135. REG. 10-25-1988. MAPEI INC. (CANADA CORPORATION) 2900 DE L'AVENUE FRANCIS-HUGHES, LAVAL (PROVINCE OF QUEBEC), CANADA, H7L 3J5, SN 73-665,253. FILED 6-8-1987. PRINCIPAL REGISTER.

ULTRAFLEX

INT. CL. 19/U.S. CL. 12
FOR POLYMER MODIFIED THINSET MORTAR FOR CERAMIC TILES.
FIRST USE 7-1-1986; IN COMMERCE 8-1-1986.

ELEMENTS AMENDED
MARK

1,595,883. REG. 5-15-1990. MAPEI INC. (CANADA CORPORATION) 2900 FRANCIS-HUGHES AVENUE, LAVAL, QUEBEC, CANADA, H7J 3J5, SN 73-595,029. FILED 4-24-1986. PRINCIPAL REGISTER.

ULTRAMASTIC

PRIORITY CLAIMED UNDER SEC. 44(D) ON CANADA APPLICATION NO. 557292, FILED 2-13-1986, REG. NO. 353579, DATED 3-23-1989.

INT. CL. 1/U.S. CL. 5
FOR ADHESIVE FOR CERAMICS AND TILES, FLOOR AND WALL.
FIRST USE 6-15-1985; IN COMMERCE 6-15-1985.

ELEMENTS AMENDED
MARK

1,641,838. REG. 4-23-1991. LE CORDON BLEU INTERNATIONAL B.V. (NETHERLANDS CORPORATION) STRAWINSKYLAAN 3105, 7TH FLOOR, AMSTERDAM, NETHERLANDS, 1077ZX, SN 74-800,155. FILED 7-15-1985. PRINCIPAL REGISTER.

LE CORDON BLEU DE PARIS

PRIORITY CLAIMED UNDER SEC. 44(D) ON FRANCE APPLICATION NO. 727812, FILED 1-15-1985, REG. NO. 1295952, DATED 1-15-1985.

OWNER OF U.S. REG. NOS. 786,557, 1,243,897 AND OTHERS.

NO CLAIM IS MADE TO THE EXCLUSIVE RIGHT TO USE "DE PARIS", APART FROM THE MARK AS SHOWN. THE ENGLISH TRANSLATION OF THE WORDS "LE CORDON BLEU" IN THE MARK IS "THE BLUE RIBBON".
SEC. 2(F).

INT. CL. 1/U.S. CLS. 1

FOR [PLASTIC MOLDING COMPOUND].

INT. CL. 4/U.S. CLS. 1, 6 AND 15

FOR [FUEL FOR COOKING, NAMELY, FUEL] OIL AND GAS; FIREWOOD, CHARCOAL, COOKING COAL COBBLES; LAMP OIL [; CANDLES; WICKS].

INT. CL. 5/U.S. CLS. 6, 18, 44, 46, 51 AND 52

FOR [KITCHEN CLEANING PRODUCTS WITH DISINFECTANT AND SANITIZING PROPERTIES, NAMELY, CLEANSERS, DISHWASHING DETERGENTS; FUNGICIDES; HERBICIDES; ALL PURPOSE DISINFECTANTS; BANDAGES FOR SKIN WOUNDS; APPETITE SUPPRESSANT AND DIET FOOD FOR MEDICAL USE;] HERB TEAS [AND HERBS FOR MEDICAL USE ; MINERAL WATERS FOR MEDICAL USE].
FIRST USE ; IN COMMERCE .

INT. CL. 9/U.S. CLS. 21, 23, 26, 36 AND 38

FOR [AUTOMATIC VENDING MACHINES; CASH REGISTERS; CALCULATING MACHINES; TELEVISION SETS; RADIO-SETS; RADIOS INCORPORATING CLOCKS; RADIOS WITH CASSETTE TAPE RECORDER; PUBLIC ADDRESS SYSTEMS COMPRISED OF MICROPHONES, SPEAKERS, AMPLIFIERS AND MIXING BOARDS; RECORD PLAYERS; HIFI AUDIO SYSTEMS COMPRISED OF RECORD CHANGERS, TURNTABLES, SPEAKERS, TUNERS, TAPE DECKS, COMPACT DISK PLAYERS, AMPLIFIERS, EQUALIZERS; SPEAKER SYSTEMS; AUDIO AND VIDEO TAPE RECORDERS, PLAYERS AND DECKS; VIDEO PROJECTORS; VIDEO CAMERAS; TELEVISION CAMERAS; VIDEO DISC PLAYERS; AUDIO AND] VIDEO TAPES AND DISCS; [BATTERIES; TELEPHONES; TELEPHONE AMPLIFIERS; LENSES; GLASSES AND SPECTACLES; VIDEO PROJECTION DISPLAYS; BLANK AND] PRERECORDED VIDEO CASSETTES; [COMPACT DISC PLAYERS; MAGNETICALLY ENCODED CARDS; DIGITAL SCALES FOR COOKING; KITCHEN SCALES ; HEAT SENSORS; PERSONAL COMPUTERS FOR HOME AND BUSINESS USE; MINI-COMPUTERS; MAINFRAME COMPUTERS; COMPUTER PRINTERS; WORD PROCESSORS; DATA COLLECTORS; FACSIMILE TRANSMITTERS AND RECEIVERS; TIME RECORDERS; SLIDE PROCESSING APPARATUS; MICROPHONES; HUMIDITY SENSORS; GAS SENSORS, TEMPERATURE SENSORS; BATTERY OPERATED CLEANERS; CAMERAS; MOVIE PROJECTORS; ELECTRONIC CONTROLLERS FOR HOME APPLIANCES; BUZZERS; BELLS; SIRENS; SENSORS FOR SMOKE; SENSORS FOR HEAT; HOME SECURITY SYSTEMS COMPRISING TELEVISION MONITORS, CAMERAS, BURGLAR ALARMS; FIRE EXTINGUISHERS].
FIRST USE ; IN COMMERCE .

INT. CL. 14/U.S. CLS. 2, 27, 28 AND 50

FOR [JEWELRY;] WATCHES AND CLOCKS [; SALT BOXES, BOWLS, TEA SETS AND COFFEE SETS, TRAYS, DISHES, JUGS, BOTTLE STANDS, DISH RACKS AND STANDS; KNIFE RACKS AND STANDS] (ALL THESE ARTICLES BEING OF SILVER OR SILVER COATED).
FIRST USE ; IN COMMERCE .

INT. CL. 17/U.S. CLS. 1, 12, 26, 35, 37 AND 42

FOR PLASTIC IN EXTRUDED FORM FOR USE IN MANUFACTURING; FLEXIBLE PIPES, NOT OF METAL AND ASBESTOS COVERINGS FOR INDUSTRIAL AND HOUSEHOLD USE.

INT. CL. 20/U.S. CL. 32

FOR KITCHEN AND HOUSEHOLD FURNITURE; MIRRORS, PICTURE FRAMES.

INT. CL. 22/U.S. CLS. 1, 7, 22 AND 50

FOR LAUNDRY AND STORAGE BAGS FOR USE IN KITCHENS; ROPES; STRINGS; TENTS; AWNINGS; TARPULINS; SAILS; GENERAL UTILITY STORAGE CANVAS SACKS AND BAGS; PADDING AND STUFFING MATERIALS (EXCEPT OF RUBBER OR PLASTICS) FOR USE IN PACKING, STORAGE, MANUFACTURING AND SEWING; RAW FIBROUS TEXTILE MATERIALS.

INT. CL. 24/U.S. CLS. 42 AND 50

FOR [BED COVERS, TABLE CLOTHS; COVERS FOR TABLE-TOP KITCHEN APPLIANCES, NAMELY, MICROWAVE OVENS, TOASTERS, MIX-MASTERS, BLENDERS; BED CLOTHES, NAMELY, SHEETS, PILLOW CASES AND BLANKETS;] TOWELS; TEXTILE NAPKINS [AND DISH CLOTHS].

INT. CL. 25/U.S. CLS. 22 AND 39

FOR [FOOTWEAR,] HEADWEAR; ARTICLES OF CLOTHING, NAMELY PULLOVERS, [DRESSES, SKIRTS, SHIRTS,] JACKETS, COATS, [SOCKS AND TIGHTS, UNDERWEAR;] APRONS, [OVERALLS,] COVERALLS FOR USE WHILE COOKING.
FIRST USE ; IN COMMERCE .

INT. CL. 28/U.S. CLS. 22, 23, 38 AND 50

FOR [SPORTS BALLS AND BALLOONS; TABLE TENNIS AND TENNIS RACKETS; ARCHERY BOWS; BILLIARDS EQUIPMENT, NAMELY, BALLS, CUES, CUE RACKS, CHALK AND TABLES; FENCING AND BOXING GLOVES; DOLLS AND DOLL CLOTHING; TOY COOKWARE;] TEDDY BEARS [; SKIS; ROLLER AND ICE SKATES; FISHING RODS; GOLF CLUBS; CRICKET BATS; SURFBOARDS; NONELECTRIC CHRISTMAS TREE DECORATIONS].
FIRST USE ; IN COMMERCE .

INT. CL. 31/U.S. CLS. 1 AND 46

FOR LIVING ANIMALS; LIVE PLANTS AND FLOWERS; TREES; AGRICULTURAL GRAINS AND SEEDS; FLOWER BULBS; FOODSTUFF FOR ANIMALS; MALT.

INT. CL. 32/U.S. CLS. 45, 46 AND 48

FOR MINERAL AND AERATED WATERS] ; FRUIT DRINKS EXCEPT FRUIT AND VEGETABLE JUICES; [FRUIT DRINKS CONTAINING WATER AND SODA WATER] .
FIRST USE ; IN COMMERCE .

INT. CL. 34/U.S. CLS. 2, 8, 9 AND 17

FOR [CHEWING AND SMOKING TOBACCOS;] MATCHES [; NONELECTRIC LIGHTERS, CIGAR AND CIGARETTE-HOLDERS, CIGAR-CUTTERS , PIPES AND PIPE-CLEANERS, CIGAR AND CIGARETTE-CASES (NONE OF THESE ITEMS BEING OF PRECIOUS METAL)].
FIRST USE ; IN COMMERCE .

INT. CL. 41/U.S. CLS. 100, 101 AND 107

FOR EDUCATIONAL [AND ENTERTAINMENT] SERVICES, NAMELY, CONDUCTING SCHOOLS AND COURSES IN THE FIELD OF COOKING AND OENOLGY AT ALL LEVELS; PUBLISHING OF BOOKS AND MAGAZINES; [BOOK LENDING SERVICES; ANIMAL TRAINING; PRODUCTION OF RADIO AND TELEVISION SHOWS FOR OTHERS; PRODUCTION AND DISTRIBUTION OF FILMS FOR OTHERS; RENTAL OF STAGE SCENERY; NEWSPAPER DELIVERY AND SUBSCRIPTION SERVICES].
FIRST USE ; IN COMMERCE .

INT. CL. 42/U.S. CLS. 100 AND 101

FOR [HOTEL AND] RESTAURANT SERVICES; [REST HOMES AND CONVALESCENT HOME SERVICES; SOCIAL ESCORT SERVICES; MATRIMONIAL AGENCY SERVICES; BEAUTY AND HAIRDRESSING SALON SERVICES; UNDERTAKING AND CREMATORIUM SERVICES; HOTEL RESERVATION SERVICES; ENGINEERING SERVICES; OIL AND GAS PROSPECTING AND DRILLING SERVICES; BIOLOGICAL LABORATORY TESTING SERVICES; RENTAL OF FARM EQUIPMENT, CLOTHING, BEDDING AND VENDING MACHINES; PRINTING SERVICES].
FIRST USE ; IN COMMERCE .

ELEMENTS AMENDED
GOODS/SERVICES

1,673,994. REG. 2-4-1992. OMAHA STANDARD, INC. (IOWA CORPORATION) 3501 SOUTH 11TH STREET, COUNCIL BLUFFS, IA, 51501, SN 74-147,627. FILED 3-14-1991. PRINCIPAL REGISTER.



OWNER OF U.S. REG. NO. 1,307,677.
NO CLAIM IS MADE TO THE EXCLUSIVE RIGHT TO USE "ROLL-OFF", APART FROM THE MARK AS SHOWN.
INT. CL. 7/U.S. CL. 23
FOR WASTE MATERIAL BODY LOADING/UNLOADING UNITS FOR MOUNTING ON TRUCKS.
FIRST USE 8-1-1985; IN COMMERCE 8-1-1985.

ELEMENTS AMENDED
OWNER NAME

1,679,409. REG. 3-17-1992. MAPEI INC. (CANADA CORPORATION) 2900 FRANCIS-HUGHES AVENUE, VIMONT, LAVAL, PROVINCE OF QUEBEC, CANADA, H7L 3J5, SN 73-835,237. FILED 10-30-1989. PRINCIPAL REGISTER.

GRANIRAPID

PRIORITY CLAIMED UNDER SEC. 44(D) ON CANADA APPLICATION NO. 636212, FILED 7-12-1989, REG. NO. TMA379244, DATED 2-1-1991.
INT. CL. 19/U.S. CL. 12
FOR TWO COMPONENT FAST-SETTING MORTAR FOR THE INSTALLATION OF AGGLOMERATED MARBLE AND GRANITE NATURAL STONES AND IMPERVIOUS PORCELAIN TILES.

ELEMENTS AMENDED
MARK

1,730,337. REG. 11-3-1992. MAPEI INC. (CANADA CORPORATION) 2900 FRANCIS HUGHES, LAVAL, PROVINCE OF QUEBEC, CANADA, H7L 3J5, SN 74-075,047. FILED 7-2-1990. PRINCIPAL REGISTER.

ULTRAPLAN

INT. CL. 19/U.S. CL. 12
FOR CEMENT; NAMELY, PORTLAND CEMENT WITH AUTOMATIC SMOOTH FINISH CHARACTERISTICS.
FIRST USE 2-1-1990; IN COMMERCE 2-1-1990.

ELEMENTS AMENDED
MARK

1,759,395. REG. 3-23-1993. WATSON PHARMACEUTICALS, INC. (NEVADA CORPORATION) 132-A BUSINESS CENTER DRIVE, CORONA, CA, 91720. SN 74-160,395. FILED 4-24-1991. PRINCIPAL REGISTER.

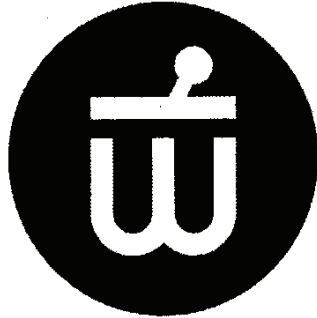

INT. CL. 5/U.S. CL. 18
 FOR PHARMACEUTICAL PREPARATIONS FOR THE TREATMENT OF PAIN, ARTHRITIS, SWELLING, FEVER, COUGHING, ANXIETY, TENSION, INSOMNIA, MENTAL AND EMOTIONAL DISORDERS, HYPERTENSION, HEART ARRHYTHMIA AND ANGINA; AND FOR CONTRACEPTION AND HORMONE REPLACEMENT .
 FIRST USE 12-31-1985; IN COMMERCE 12-31-1985.

ELEMENTS AMENDED
 MARK

1,832,210. REG. 4-19-1994. MAPEI INC. (CANADA CORPORATION) 2900 FRANCIS-HUGHES AVENUE, LAVAL, QUEBEC H7L 3J5, CANADA,, SN 74-250,694. FILED 2-27-1992. PRINCIPAL REGISTER.

NOVOPLAN

INT. CL. 19/U.S. CL. 12
 FOR CEMENTITIOUS SELF-SMOOTHING COMPOUND TO LEVEL AND REPAIR INTERIOR CONCRETE.
 FIRST USE 9-6-1993; IN COMMERCE 9-6-1993.

ELEMENTS AMENDED
 MARK

2,007,109. REG. 10-8-1996. FOSSIL, INC. (DELAWARE CORPORATION) 2280 N. GREENVILLE AVENUE, RICHARDSON, TX, 750824412. SN 74-635,459. FILED 2-17-1995. PRINCIPAL REGISTER.

FLEX-O-MATIC

INT. CL. 9/U.S. CLS. 21, 23, 26, 36 AND 38
 FOR EYEGLASSES [AND EYEGLASS CASES].
 FIRST USE 5-0-1995; IN COMMERCE 5-0-1995.

ELEMENTS AMENDED
 GOODS/SERVICES

2,112,561. REG. 11-11-1997. OMAHA STANDARD, INC. (IOWA CORPORATION) 3501 SOUTH 11TH STREET, COUNCIL BLUFFS, IA, 51501, SN 74-451,810. FILED 10-28-1993. PRINCIPAL REGISTER.

DOUBLE SHUTTLE

NO CLAIM IS MADE TO THE EXCLUSIVE RIGHT TO USE "DOUBLE", APART FROM THE MARK AS SHOWN.
 INT. CL. 12/U.S. CLS. 19, 21, 23, 31, 35 AND 44
 FOR TRAILER AND TRUCK BODIES USED FOR SUPPORTING AND TRANSPORTING TWO CONTAINERS OR RECEPTACLES.
 FIRST USE 7-11-1997; IN COMMERCE 7-11-1997.

ELEMENTS AMENDED
 OWNER NAME

2,130,256. REG. 1-20-1998. FOSSIL, INC. (DELAWARE CORPORATION) 2280 N. GREENVILLE AVENUE, RICHARDSON, TX, 75082, SN 75-207,740. FILED 12-4-1996. PRINCIPAL REGISTER.



OWNER OF U.S. REG. NOS. 1,467,255, 1,766,792 AND OTHERS.

NO CLAIM IS MADE TO THE EXCLUSIVE RIGHT TO USE "AUTHENTIC" AND "GENUINE", APART FROM THE MARK AS SHOWN.

INT. CL. 9/U.S. CLS. 21, 23, 26, 36 AND 38
 FOR SUNGLASSES.

FIRST USE 7-0-1994; IN COMMERCE 7-0-1994.

INT. CL. 14/U.S. CLS. 2, 27, 28 AND 50
 FOR WATCHES.

FIRST USE 7-0-1989; IN COMMERCE 7-0-1989.

INT. CL. 18/U.S. CLS. 1, 2, 3, 22 AND 41

FOR LEATHER KEY FOBS, HANDBAGS, COIN PURSES, TOTE BAGS, PURSES, BILLFOLDS AND WALLETS.

FIRST USE 8-0-1989; IN COMMERCE 8-0-1989.

INT. CL. 25/U.S. CLS. 22 AND 39

FOR BELTS, CLOTHING, NAMELY, T-SHIRTS, SHIRTS[, CAPS, SHORTS, PANTS AND JACKETS].

FIRST USE 8-0-1991; IN COMMERCE 8-0-1991.

ELEMENTS AMENDED
 GOODS/SERVICES

2,162,299. REG. 6-2-1998. "DR. MARTENS" INTERNATIONAL TRADING GMBH (DELAWARE CORPORATION) AHORNSTRASSE 8A, D-82166 GRÄFELFING, FED REP GERMANY., SN 74-572,375. FILED 9-12-1994. PRINCIPAL REGISTER.

DR. MARTENS

PRIORITY CLAIMED UNDER SEC. 44(D) ON FED REP GERMANY APPLICATION NO. M77381/14WZ, FILED 3-16-1994, REG. NO. 2063547, DATED 4-29-1994.

OWNER OF U.S. REG. NOS. 1,454,323 AND 1,798,791.

"DR. MARTENS" IS NOT THE NAME OF A PARTICULAR LIVING INDIVIDUAL.

INT. CL. 14/U.S. CLS. 2, 27, 28 AND 50

FOR WATCHES[, JEWELRY].

FIRST USE 4-0-1994; IN COMMERCE 7-8-1994.

INT. CL. 16/U.S. CLS. 2, 5, 22, 23, 29, 37, 38 AND 50

FOR STATIONERY [AND OFFICE REQUISITES (EXCEPT FURNITURE), NAMELY, STATIONERY, NOTE-PADS, NOTEBOOKS, RING BINDERS, LEVER ARCH FILES, CLIPBOARDS, STATIONERY AND FILE ELASTICATED FOLDERS, DIARIES WITH LOCKS; DIARIES, EXERCISE BOOKS; ADDRESS BOOKS, DESKTOP AND PERSONAL ORGANIZERS, PENS, PENCILS, PENCIL CASES, PEN SETS, CORRESPONDENCE TINBOXES, ERASERS, DRAFTING, DRAWING, AND UNGRADUATED RULERS, PENCIL SHARPENERS].

FIRST USE 6-27-1994; IN COMMERCE 7-11-1995.

ELEMENTS AMENDED
GOODS/SERVICES

2,231,697. REG. 3-16-1999. NATIONAL CATTLEMEN'S BEEF ASSOCIATION (COLORADO NOT FOR PROFIT CORPORATION) 9110 E. NICHOLS AVE., CENTENNIAL, CO, 80112, SN 75-363,905. FILED 9-26-1997. PRINCIPAL REGISTER.



NO CLAIM IS MADE TO THE EXCLUSIVE RIGHT TO USE "BEEF USA", APART FROM THE MARK AS SHOWN. INT. CL. 16/U.S. CLS. 2, 5, 22, 23, 29, 37, 38 AND 50

FOR PRINTED MATTER, NAMELY, POSTERS, GUIDES, NEWSLETTERS, BROCHURES, MAGAZINES, AND PRINTED EDUCATIONAL AND TEACHING MATERIALS, ALL REGARDING OR PERTINENT TO THE CATTLE INDUSTRY, BEEF AND BEEF PRODUCTS.

FIRST USE 2-1-1997; IN COMMERCE 2-1-1997.

ELEMENTS AMENDED
OWNER NAME
OWNER ADDRESS

2,260,892. REG. 7-13-1999. GLAS WELD SYSTEMS, INC. (OREGON CORPORATION) POST OFFICE BOX 5755, BEND, OR, 97708, SN 75-477,446. FILED 4-30-1998. PRINCIPAL REGISTER.

PROVAC

THE MARK CONSISTS OF STANDARD CHARACTERS WITHOUT CLAIM TO ANY PARTICULAR FONT, STYLE, SIZE, OR COLOR.

INT. CL. 8/U.S. CLS. 23, 28 AND 44

FOR HAND-HELD TOOL WITH A CYLINDER WITH A PLUNGER FOR INSERTING RESIN INTO CRACKS IN WINDSHIELDS OR OTHER LAMINATED GLASS.

FIRST USE 0-0-1988; IN COMMERCE 0-0-1988.

ELEMENTS AMENDED
MARK

2,261,361. REG. 7-13-1999. US AIRWAYS, INC. (DELAWARE CORPORATION) 111 W. RIO SALADO PARKWAY, TEMPE, AZ, 85281, SN 75-190,981. FILED 11-1-1996. PRINCIPAL REGISTER.

U-S AIRWAYS *Shuttle*

OWNER OF U.S. REG. NOS. 1,243,867, 1,771,895 AND OTHERS.

NO CLAIM IS MADE TO THE EXCLUSIVE RIGHT TO USE "AIRWAYS" AND "SHUTTLE", APART FROM THE MARK AS SHOWN.

AS TO "U.S.".

INT. CL. 39/U.S. CLS. 100 AND 105

FOR TRANSPORTATION SERVICES OF PERSONS, PROPERTY AND MAIL BY AIR.

FIRST USE 2-28-1997; IN COMMERCE 2-28-1997.

ELEMENTS AMENDED
MARK

2,274,836. REG. 8-31-1999. OMAHA STANDARD, INC. (IOWA CORPORATION) 3501 SOUTH 11TH STREET, COUNCIL BLUFFS, IA, 51501, SN 75-292,652. FILED 5-15-1997. PRINCIPAL REGISTER.

HOOK-ALL

INT. CL. 7/U.S. CLS. 13, 19, 21, 23, 31, 34 AND 35

FOR MECHANICAL LOADING AND UNLOADING MECHANISM, NAMELY, HOISTS, WINCHES, CABLES, CHAINS, HOOKS, GRAPPLES, BOOMS AND MOTORS.

FIRST USE 4-12-1999; IN COMMERCE 4-12-1999.

INT. CL. 12/U.S. CLS. 19, 21, 23, 31, 35 AND 44

FOR TRUCKS AND TRAILERS INCORPORATING HOISTING MECHANISMS FOR LOADING, TRANSPORTING AND UNLOADING CONTAINER BODIES, FLATBEDS, SPREADERS, TANKS, AND MACHINERY.

FIRST USE 4-12-1999; IN COMMERCE 4-12-1999.

ELEMENTS AMENDED
OWNER NAME

2,321,150. REG. 2-22-2000. NATIONAL AUDUBON SOCIETY, INC. (NEW YORK NOT-FOR-PROFIT CORPORATION) 700 BROADWAY, NEW YORK, NY, 10003, SN 75-617,352. FILED 1-8-1999. PRINCIPAL REGISTER.

AUDUBON VERMONT

THE MARK CONSISTS OF STANDARD CHARACTERS WITHOUT CLAIM TO ANY PARTICULAR FONT, STYLE, SIZE, OR COLOR.

OWNER OF U.S. REG. NO. 1,954,847.

NO CLAIM IS MADE TO THE EXCLUSIVE RIGHT TO USE "VERMONT", APART FROM THE MARK AS SHOWN. INT. CL. 42/U.S. CLS. 100 AND 101

FOR WILDLIFE AND ENVIRONMENTAL CONSERVATION AND PRESERVATION SERVICES, SCIENTIFIC RESEARCH, AND ASSOCIATION SERVICES; NAMELY PROMOTING PUBLIC INTEREST IN WILDLIFE PRESERVATION AND ENVIRONMENTAL CONSERVATION.

FIRST USE 9-0-1997; IN COMMERCE 5-0-1998.

ELEMENTS AMENDED
MARK

2,397,734. REG. 10-24-2000. DR. MARTENS INTERNATIONAL TRADING GMBH (DELAWARE CORPORATION) AHORNSTRASSE 8A, D-82166 GRÄFELFING, FED REP GERMANY., SN 75-825,726. FILED 10-18-1999. PRINCIPAL REGISTER.

DOC MARTENS

PRIORITY CLAIMED UNDER SEC. 44(D) ON FED REP GERMANY APPLICATION NO. 39921863.7, FILED 4-16-1999, REG. NO. 39921863, DATED 4-16-1999.

OWNER OF U.S. REG. NOS. 1,454,323, 2,162,299 AND OTHERS.

THE NAME "DOC MARTENS" DOES NOT IDENTIFY A LIVING INDIVIDUAL.

INT. CL. 25/U.S. CLS. 22 AND 39

FOR FOOTWEAR [AND APPAREL, NAMELY, COATS, JACKETS, ANORAKS, PARKAS, T-SHIRTS, POLO-SHIRTS, SHIRTS, BLOUSES, TANK TOPS, VESTS, SWEATERS, SWEATSHIRTS, SWEATPANTS, OVERALLS, PANTS, JEANS, SHORTS, DRESSES, SKIRTS, GLOVES, BELTS, SOCKS, HATS AND CAPS].

FIRST USE ; IN COMMERCE .

ELEMENTS AMENDED
GOODS/SERVICES

2,416,348. REG. 12-26-2000. DR. MARTENS INTERNATIONAL TRADING GMBH (DELAWARE CORPORATION) AHORNSTRASSE 8A, D-82166 GRÄFELFING, FED REP GERMANY., SN 75-601,577. FILED 12-8-1998. PRINCIPAL REGISTER.

DM'S DR. MARTENS

INT. CL. 18/U.S. CLS. 1, 2, 3, 22 AND 41

FOR [LUGGAGE, BRIEFCASES, BUSINESS AND CREDIT CARD CASES, FANNY PACKS, PURSES,] HANDBAGS, [WALLETS, BACKPACKS, AND BAGS, NAMELY, ATHLETIC BAGS, BOOK BAGS, BRIEF BAGS, DUFFEL BAGS,] SCHOOL BAGS, [TRAVEL BAGS,] SHOULDER BAGS[, AND TOTE BAGS].

FIRST USE 10-0-1998; IN COMMERCE 10-0-1998.

ELEMENTS AMENDED
GOODS/SERVICES

2,546,925. REG. 3-12-2002. MILWAUKEE BREWERS BASEBALL CLUB, LIMITED PARTNERSHIP (WISCONSIN LIMITED PARTNERSHIP) MILLER PARK, ONE BREWERS WAY, MILWAUKEE, WI, 53214, SN 76-219,278. FILED 3-2-2001. PRINCIPAL REGISTER.



OWNER OF U.S. REG. NOS. 1,062,749, 2,136,439 AND OTHERS.

INT. CL. 16/U.S. CLS. 2, 5, 22, 23, 29, 37, 38 AND 50

FOR PAPER GOODS AND PRINTED MATTER, NAMELY, POSTERS, STICKERS, DECALS, BUMPER STICKERS, SCOREBOOKS, SCORECARDS, PRINTED BASEBALL GAME PROGRAMS, MAGAZINES AND BOOKS FEATURING BASEBALL, [BOOK COVERS,] CALENDARS, GREETING CARDS, [GIFT WRAPPING PAPER, PAPER GIFT AND PARTY BAGS, PAPER COASTERS,] PAPER NAPKINS, [PAPER TABLE-CLOTHS,] PAPER PARTY GOODS, PENS, PENCILS, AND NON-ELECTRIC ERASERS.

FIRST USE 4-3-2000; IN COMMERCE 4-3-2000.

ELEMENTS CORRECTED
OWNER NAME

2,552,622. REG. 3-26-2002. CONVENTION NEWS COMPANY, INC., THE (NEW JERSEY CORPORATION) P.O. BOX 277, 214 FRANKLIN AVENUE, MIDLAND PARK, NJ, 07432, SN 76-290,177. FILED 7-25-2001. PRINCIPAL REGISTER.

AIN REPORTS

OWNER OF U.S. REG. NO. 1,588,833.
NO CLAIM IS MADE TO THE EXCLUSIVE RIGHT TO USE "REPORTS", APART FROM THE MARK AS SHOWN. INT. CL. 42/U.S. CLS. 100 AND 101

FOR COMPUTER SERVICES, NAMELY PROVIDING [WEEKLY] ON-LINE REPORTS IN THE FIELD OF BUSINESS AVIATION, COMMERCIAL AVIATION AND REGIONAL AVIATION.

FIRST USE 9-0-2000; IN COMMERCE 9-0-2000.

ELEMENTS CORRECTED
OWNER NAME

2,580,635. REG. 6-18-2002. E.ON SVERIGE AB (SWEDEN CORPORATION) CARL GUSTAFS VAG 1, MALMO, SWEDEN, 205 09, AND GDF SUEZ (FRANCE SOCIETE ANONYME) 16-26 RUE DU DOCTEUR LANCEREAUX, PARIS, FRANCE, 75008, SN 75-746,431. FILED 7-9-1999. PRINCIPAL REGISTER.

2,628,578. REG. 10-1-2002. TURBO ENGINEERING INTERNATIONAL CORPORATION (CONNECTICUT CORPORATION) 610 HAYDEN STATION ROAD, WINDSOR, CT, 06095, SN 75-619,772. FILED 1-8-1999. PRINCIPAL REGISTER.

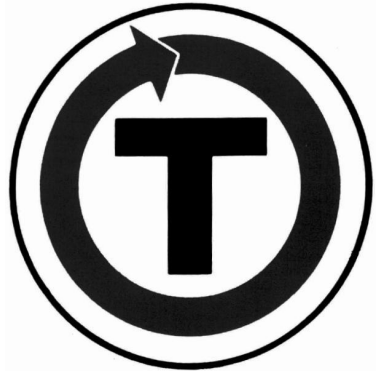

PRIORITY CLAIMED UNDER SEC. 44(D) ON FRANCE APPLICATION NO. 99768204, FILED 1-11-1999, REG. NO. 99768204, DATED 1-11-1999.

NO CLAIM IS MADE TO THE EXCLUSIVE RIGHT TO USE "STORAGE", APART FROM THE MARK AS SHOWN. THE COLOR(S) RED AND BLUE IS/ARE CLAIMED AS A FEATURE OF THE MARK.

THE MARK CONSISTS OF LETTERS "LRC" SHOWN IN RED WITH THE TERM "STORAGE" APPEARING BLUE.

INT. CL. 35/U.S. CLS. 100, 101 AND 102

FOR [OPERATION FOR OTHERS OF UNDERGROUND CAVITIES FOR STORING NATURAL GASES; AND BUSINESS MANAGEMENT SERVICES FOR NATURAL SUPPLIERS].

FIRST USE ; IN COMMERCE .

INT. CL. 37/U.S. CLS. 100, 103 AND 106

FOR [CONSTRUCTING UNDERGROUND CAVITIES FOR STORING NATURAL GASES; AND, SUPERVISING AND MANAGING THE CONSTRUCTION OF UNDERGROUND CAVITIES FOR STORING NATURAL GASES].

FIRST USE ; IN COMMERCE .

INT. CL. 39/U.S. CLS. 100 AND 105

FOR [RENTAL OF NATURAL GAS STORAGE CAVITIES FOR STORING NATURAL GAS].

FIRST USE ; IN COMMERCE .

INT. CL. 42/U.S. CLS. 100 AND 101

FOR PROVIDING INFORMATION ON CONSTRUCTING UNDERGROUND CAVITIES FOR STORING NATURAL GASES; [GEOLOGICAL SURVEYING, RESEARCH AND PROSPECTING; ANALYSIS OF NATURAL GAS DEPOSITS, TECHNOLOGICAL CONSULTATION AND RESEARCH IN THE FIELD OF BUILDING UNDERGROUND CAVITIES FOR STORING NATURAL GASES; MATERIAL TESTING; LAND SURVEYING; ENGINEERING; PROSPECTING AND SURVEYING OF NATURAL GAS DEPOSITS; AND TECHNICAL PROJECT STUDIES IN THE FIELD OF NATURAL GAS DEPOSITS].

FIRST USE ; IN COMMERCE .

ELEMENTS AMENDED
OWNER NAME
OWNER ADDRESS
CITIZENSHIP
ENTITY

INT. CL. 7/U.S. CLS. 13, 19, 21, 23, 31, 34 AND 35
FOR PARTS OF TURBOMACHINES, NAMELY, STEAM TURBINES AND OIL PUMPS.
FIRST USE 7-0-1999; IN COMMERCE 7-0-1999.

ELEMENTS AMENDED
MARK
[LINING;STIPPLING STATEMENT]

2,665,488. REG. 12-24-2002. MAUNA LANI RESORT (OPERATION), INC. (HAWAII CORPORATION) 68-1400 MAUNA LANI DRIVE, SUITE 102, KOHALA COAST, HI, 967439727, SN 76-211,732. FILED 2-20-2001. PRINCIPAL REGISTER.

THE MAUNA LANI BAY HOTEL AND BUNGALOWS

NO CLAIM IS MADE TO THE EXCLUSIVE RIGHT TO USE "HOTEL AND BUNGALOWS", APART FROM THE MARK AS SHOWN.

"MAUNA" IS DEFINED AS "MOUNTAIN, MOUNTAINOUS REGION; MOUNTAINOUS". "LANI" IS DEFINED AS "SKY, HEAVEN; HEAVENLY, SPIRITUAL".

INT. CL. 42/U.S. CLS. 100 AND 101

FOR RESORT HOTELS.

FIRST USE 0-0-1990; IN COMMERCE 0-0-1990.

ELEMENTS CORRECTED
OWNER NAME

2,697,734. REG. 3-18-2003. VITAMIN COTTAGE TWO (COLORADO LIMITED LIABILITY COMPANY) 12612 W. ALAMEDA PARKWAY, LAKEWOOD, CO, 80228, SN 76-416,962. FILED 6-6-2002. PRINCIPAL REGISTER.



NO CLAIM IS MADE TO THE EXCLUSIVE RIGHT TO USE "VITAMIN" AND "NATURAL GROCERS", APART FROM THE MARK AS SHOWN.

INT. CL. 5/U.S. CLS. 6, 18, 44, 46, 51 AND 52
 FOR VITAMIN AND MINERAL SUPPLEMENTS.
 FIRST USE 6-1-2000; IN COMMERCE 6-1-2000.
 INT. CL. 35/U.S. CLS. 100, 101 AND 102
 FOR RETAIL GROCERY STORE AND MAIL ORDER SERVICES FEATURING VITAMIN AND MINERAL SUPPLEMENTS.
 FIRST USE 6-1-2000; IN COMMERCE 6-1-2000.

ELEMENTS CORRECTED
 OWNER NAME

2,724,623. REG. 6-10-2003. ZIMMER, INC. (DELAWARE CORPORATION) 345 E. MAIN STREET, WARSAW, IN, 46580, SN 75-782,692. FILED 8-23-1999. PRINCIPAL REGISTER.

ITST

THE MARK CONSISTS OF STANDARD CHARACTERS WITHOUT CLAIM TO ANY PARTICULAR FONT, STYLE, SIZE, OR COLOR.

INT. CL. 10/U.S. CLS. 26, 39 AND 44
 FOR ORTHOPEDIC IMPLANTS, NAMELY, INTRAMEDULLARY NAIL; AND SURGICAL INSTRUMENTS THEREFORE.
 FIRST USE 1-25-2002; IN COMMERCE 1-25-2002.

ELEMENTS AMENDED
 MARK

2,725,628. REG. 6-10-2003. PATTON SURGICAL CORPORATION (DELAWARE CORPORATION) BLDG. 2, SUITE 420, 6300 BRIDGE POINT PARKWAY, AUSTIN, TX, 78730, SN 76-337,930. FILED 11-14-2001. PRINCIPAL REGISTER.

PASSPORT

INT. CL. 10/U.S. CLS. 26, 39 AND 44

FOR SURGICAL TROCARS AND CANNULAS.
 FIRST USE 1-31-2003; IN COMMERCE 1-31-2003.

ELEMENTS CORRECTED
 OWNER NAME
 OWNER ADDRESS

2,730,370. REG. 6-24-2003. OTTO JOS. KLIER MUSIKINSTRUMENTE INH. HEIDI FABER E.K. (FED REP GERMANY CORPORATION) REICHBRUNSTRASSE 4, FORCHHEIM, FED REP GERMANY, D91301, SN 76-339,895. FILED 11-19-2001. PRINCIPAL REGISTER.

Otto Jos. Klier

THE MARK DOES NOT IDENTIFY A LIVING INDIVIDUAL.

INT. CL. 15/U.S. CLS. 2, 21 AND 36
 FOR MUSICAL INSTRUMENTS, NAMELY VIOLINS, VIOLAS, CELLOS.
 FIRST USE 12-31-1970; IN COMMERCE 12-31-1970.

ELEMENTS CORRECTED
 OWNER NAME
 ENTITY

2,733,014. REG. 7-1-2003. UNITED BUSINESS BROKERS, INC. (UTAH CORPORATION) 6985 SOUTH UNION PARK, SUITE 650, MIDVALE, UT, 84047, SN 76-290,066. FILED 7-25-2001. PRINCIPAL REGISTER.

UNITED BUSINESS CAPITAL

NO CLAIM IS MADE TO THE EXCLUSIVE RIGHT TO USE "BUSINESS CAPITAL", APART FROM THE MARK AS SHOWN.

INT. CL. 36/U.S. CLS. 100, 101 AND 102
 FOR EQUIPMENT FINANCING SERVICES.
 FIRST USE 8-0-2001; IN COMMERCE 8-0-2001.

ELEMENTS CORRECTED
 GOODS/SERVICES

2,737,861. REG. 7-15-2003. PCI-SIG (OREGON CORPORATION) 3855 SW 153RD DRIVE, BEAVERTON, OR, 97006, SN 76-210,602. FILED 2-8-2001. PRINCIPAL REGISTER.

PCI-SIG

THE MARK CONSISTS OF STANDARD CHARACTERS WITHOUT CLAIM TO ANY PARTICULAR FONT, STYLE, SIZE, OR COLOR.

INT. CL. 35/U.S. CLS. 100, 101 AND 102

FOR PROVIDING CONSUMER PRODUCT INFORMATION, NAMELY, PROVIDING INFORMATION TO CONSUMERS REGARDING THE PRODUCT STANDARDS OF THE GOODS THEY USE.
FIRST USE 3-3-2000; IN COMMERCE 3-3-2000.

ELEMENTS AMENDED
MARK



2,737,958. REG. 7-15-2003. HEALTH MAINTENANCE PROGRAMS, INC. (NEW YORK CORPORATION) 7 WESTCHESTER PLAZA, ELMSFORD, NY, 10523, SN 76-231,334. FILED 3-27-2001. PRINCIPAL REGISTER.

ULTRATHIONE 1000 SPORTS

NO CLAIM IS MADE TO THE EXCLUSIVE RIGHT TO USE "1000 SPORTS", APART FROM THE MARK AS SHOWN.
INT. CL. 5/U.S. CLS. 6, 18, 44, 46, 51 AND 52
FOR VITAMIN AND MINERAL FOOD SUPPLEMENTS CONTAINING GLUTATHIONE AND INSTRUCTION BOOKLET SOLD AS A UNIT THEREWITH.
FIRST USE 1-1-2003; IN COMMERCE 1-1-2003.

ELEMENTS CORRECTED
GOODS/SERVICES



2,740,094. REG. 7-22-2003. DEPARTMENT OF TECHNICAL AND ADULT EDUCATION (GEORGIA STATE AGENCY) 1800 CENTURY PLACE, SUITE 300, ATLANTA, GA, 30345, SN 76-446,735. FILED 9-3-2002. PRINCIPAL REGISTER.

CWDS CERTIFIED WAREHOUSING AND DISTRIBUTION SPECIALIST

NO CLAIM IS MADE TO THE EXCLUSIVE RIGHT TO USE "CERTIFIED WAREHOUSING AND DISTRIBUTION SPECIALIST", APART FROM THE MARK AS SHOWN.
INT. CL. 41/U.S. CLS. 100, 101 AND 107
FOR EDUCATIONAL SERVICES, NAMELY, PROVIDING COURSES OF INSTRUCTION IN THE FIELD OF WAREHOUSING AND DISTRIBUTION.
FIRST USE 3-0-2001; IN COMMERCE 3-0-2001.

ELEMENTS CORRECTED
OWNER NAME

2,751,537. REG. 8-19-2003. AMERICAN MEDIA OPERATIONS, INC. (DELAWARE CORPORATION) 1000 AMERICAN MEDIA WAY, ATTN: LEGAL DEPARTMENT, BOCA RATON, FL, 33464-100, SN 75-116,088. FILED 6-7-1996. PRINCIPAL REGISTER.



OWNER OF U.S. REG. NO. 1,224,966.
INT. CL. 41/U.S. CLS. 100, 101 AND 107
FOR PROVIDING INFORMATION AND NEWS IN THE FIELDS OF ENTERTAINMENT AND CURRENT EVENTS REPORTING VIA THE GLOBAL COMPUTER NETWORK.
FIRST USE 8-4-1996; IN COMMERCE 8-4-1996.

ELEMENTS AMENDED
OWNER ADDRESS
MARK
[LINING/STIPPLING STATEMENT]



2,794,293. REG. 12-16-2003. CARE-A-LOT, INC. (VIRGINIA CORPORATION) 1617 DIAMOND SPRINGS ROAD, VIRGINIA BEACH, VA, 23455, SN 76-483,510. FILED 1-21-2003. PRINCIPAL REGISTER.



OWNER OF U.S. REG. NO. 2,121,339.
NO CLAIM IS MADE TO THE EXCLUSIVE RIGHT TO USE "PET SUPPLY WAREHOUSE", APART FROM THE MARK AS SHOWN.
INT. CL. 35/U.S. CLS. 100, 101 AND 102
FOR MAIL ORDER CATALOGUE SERVICES FEATURING PET SUPPLIES; RETAIL STORE SERVICES FEATURING PET SUPPLIES; AND WHOLESALE DISTRIBUTORSHIPS FEATURING PET SUPPLIES.
FIRST USE 5-1-2002; IN COMMERCE 5-1-2002.

ELEMENTS AMENDED
MARK



2,898,471. REG. 11-2-2004. GENERATION PARTNERS MANAGEMENT LLC (DELAWARE LIMITED LIABILITY COMPANY) 551 FIFTH AVENUE, 31ST FLOOR, NEW YORK, NY, 10176, SN 76-021,804. FILED 4-7-2000. PRINCIPAL REGISTER.

CAPITAL FOR THE NEXT GENERATION

INT. CL. 36/U.S. CLS. 100, 101 AND 102

FOR INVESTMENT AND VENTURE CAPITAL FINANCING SERVICES AND RELATED FINANCIAL SERVICES, NAMELY, MERCHANT BANKING, PORTFOLIO MANAGEMENT AND FINANCIAL ADVISORY.
FIRST USE 11-0-1999; IN COMMERCE 11-0-1999.

ELEMENTS CORRECTED
ENTITY

2,911,733. REG. 12-14-2004. ACCESS PUBLIC RELATIONS, LLC (CALIFORNIA LIMITED LIABILITY COMPANY) 101 HOWARD STREET SECOND FLOOR, SAN FRANCISCO, CA, 941051616, SN 78-231,528. FILED 3-28-2003. PRINCIPAL REGISTER.

ONMESSAGE

INT. CL. 41/U.S. CLS. 100, 101 AND 107
FOR TRAINING AND EDUCATIONAL SERVICES, NAMELY CONDUCTING CLASSES IN THE FIELD OF PUBLIC RELATIONS AND MEDIA RELATIONS.
FIRST USE 4-15-2003; IN COMMERCE 4-15-2003.

ELEMENTS CORRECTED
ENTITY

2,998,041. REG. 9-20-2005. ADVANCED BEAUTY SYSTEMS, INC. (TEXAS CORPORATION) 5720 LBJ FREEWAY, SUITE 400, DALLAS, TX, 75240, SN 78-460,240. FILED 8-2-2004. PRINCIPAL REGISTER.

SHEA SOFT

THE MARK CONSISTS OF STANDARD CHARACTERS WITHOUT CLAIM TO ANY PARTICULAR FONT, STYLE, SIZE, OR COLOR.

NO CLAIM IS MADE TO THE EXCLUSIVE RIGHT TO USE "SHEA", APART FROM THE MARK AS SHOWN.

INT. CL. 3/U.S. CLS. 1, 4, 6, 50, 51 AND 52

FOR PERFUMERY, COSMETICS AND TOILETRIES, NAMELY, [PERFUME, EAU DE PARFUM, EAU DE TOILETTE, COLOGNE, BATH OIL,] BODY LOTION, [SHOWER GEL, BATH GEL, BUBBLE BATH, CLEANSING SHOWER CREAM,] AFTER-SHOWER/BATH BODY CREAM, [DUSTING POWDER, BODY CLEANSING LOTION, BODY CLEANSING CREAM, FACIAL CLEANSING LOTION, FACIAL CLEANSING CREAM, FACIAL CLEANSING GEL, FOAMING CLEANSING BODY LOTION, FOAMING CLEANSING BODY CREAM,] SKIN MOISTURIZING LOTION, SKIN MOISTURIZING CREAM, SKIN MOISTURIZING BALM, [SKIN MOISTURIZING GEL, FACIAL MOISTURIZING LOTION, FACIAL MOISTURIZING CREAM,] FACIAL

MOISTURIZING GEL,] BODY BALM, [BODY CLEANSING SCRUB,] MOISTURIZING FOOT BALM, [BODY SPRAY, BODY MIST, LIQUID BATH SOAK, POWDERED BATH SOAK, BODY EXFOLIATING CLEANSER,] HAND CREAM, FOOT CREAM [, MASSAGE OIL, SELF-TANNING BRONZING LOTION, SELF-TANNING BRONZING CREAM, EXFOLIATING FACIAL MASQUE, CLEANSING FACIAL MASQUE, MOISTURIZING FACIAL MASQUE, LIQUID BODY WASH, CLEANSING BAR, FRAGRANCED SOAP, BATH SALTS, HAIR SHAMPOO, HAIR CONDITIONER, HAIR GEL, HAIR MOUSSE, HAIR COLOR, AND HAIRSPRAY].
FIRST USE 1-4-2004; IN COMMERCE 1-4-2004.

ELEMENTS AMENDED
GOODS/SERVICES

3,018,090. REG. 11-22-2005. OXXON THERAPEUTICS LIMITED (UNITED KINGDOM LIMITED COMPANY (CORPORATION)) 2ND FLOOR, FLOREY HOUSE, 3 ROBERT ROBINSON AVENUE OXFORD SCIENCE PARK, OXFORD OX4 4GP, UNITED KINGDOM., SN 79-003,837. FILED 4-28-2004. PRINCIPAL REGISTER.

OXXON THERAPEUTICS

THE MARK CONSISTS OF STANDARD CHARACTERS WITHOUT CLAIM TO ANY PARTICULAR FONT, STYLE, SIZE, OR COLOR.

PRIORITY DATE OF 3-10-2004 IS CLAIMED.

OWNER OF INTERNATIONAL REGISTRATION 0828840 DATED 4-28-2004, EXPIRES 4-28-2014.

NO CLAIM IS MADE TO THE EXCLUSIVE RIGHT TO USE "THERAPEUTICS", APART FROM THE MARK AS SHOWN.

INT. CL. 5/U.S. CLS. 6, 18, 44, 46, 51 AND 52

FOR PHARMACEUTICAL PREPARATIONS FOR THE TREATMENT AND PREVENTION OF CANCER, HEPATITIS, AIDS, MALARIA, INFLUENZA, EPSTEIN-BAR VIRUS, MEASLES, TUBERCULOSIS, TOXOPLASMOSIS, HERPES, MELANOMAS AND INFECTIOUS DISEASES IN GENERAL; VACCINES FOR THE TREATMENT AND PREVENTION OF CANCER, HEPATITIS, AIDS, MALARIA, INFLUENZA, EPSTEIN-BAR VIRUS, MEASLES, TUBERCULOSIS, TOXOPLASMOSIS, HERPES, MELANOMAS AND INFECTIOUS DISEASES IN GENERAL; BIOLOGICAL PREPARATIONS FOR THE TREATMENT AND PREVENTION OF CANCER, HEPATITIS, AIDS, MALARIA, INFLUENZA, EPSTEIN-BAR VIRUS, MEASLES, TUBERCULOSIS, TOXOPLASMOSIS, HERPES, MELANOMAS AND INFECTIOUS DISEASES IN GENERAL.

FIRST USE ; IN COMMERCE .

INT. CL. 9/U.S. CLS. 21, 23, 26, 36 AND 38

FOR ELECTRONIC PUBLICATIONS, NAMELY, BOOKS, MAGAZINES, MANUALS, NEWSLETTERS, BROCHURES, PAMPHLETS, PERIODICALS FEATURING INFORMATION IN THE FIELD OF SCIENTIFIC RESEARCH, HEALTH CARE MAINTENANCE, CLINICAL RESEARCH, DISEASE MANAGEMENT AND PHARMACEUTICAL ISSUES RECORDED ON CD ROMS, OPTICAL DISCS, DVDS AND DOWNLOADABLE FROM A GLOBAL COMMUNICATIONS NETWORK.

FIRST USE ; IN COMMERCE .

INT. CL. 16/U.S. CLS. 2, 5, 22, 23, 29, 37, 38 AND 50

FOR PRINTED PUBLICATIONS IN THE FIELD OF SCIENTIFIC RESEARCH, HEALTH CARE MAINTENANCE, CLINICAL RESEARCH, DISEASE MANAGEMENT AND PHARMACEUTICAL ISSUES, NAMELY, BOOKS, BOOKLETS, NEWSLETTERS, BROCHURES, MAGAZINES AND MANUALS; STATIONERY.

FIRST USE ; IN COMMERCE .

INT. CL. 42/U.S. CLS. 100 AND 101

FOR SCIENTIFIC RESEARCH; CONSULTANCY IN THE FIELD OF SCIENTIFIC RESEARCH; PROVIDING INFORMATION RELATING TO SCIENTIFIC RESEARCH; PRODUCT RESEARCH AND DEVELOPMENT FOR OTHERS.
FIRST USE ; IN COMMERCE .

FOR EDUCATIONAL SERVICES, NAMELY CONDUCTING CLASSES, WORKSHOPS, SEMINARS AND CONFERENCES IN CONNECTION WITH PAINTING, WALL COVERING, AND SPECIFICATION STANDARDS RELATING TO PAINTING AND WALL COVERING.
FIRST USE 2-0-1997; IN COMMERCE 2-0-1997.

ELEMENTS CORRECTED
OWNER ADDRESS

ELEMENTS CORRECTED
ENTITY

3,020,240. REG. 11-29-2005. ADVANCED BEAUTY SYSTEMS, INC. (TEXAS CORPORATION) 5720 LBJ FREEWAY, SUITE 400, DALLAS, TX, 75240, SN 78-460,263. FILED 8-2-2004. PRINCIPAL REGISTER.

3,031,132. REG. 12-20-2005. MASTER PAINTERS INSTITUTE, INC. (CANADA BRITISH COLUMBIA CORPORATION) 4090 GRAVELY STREET, BURNABY, BRITISH COLUMBIA V5C 3T6, CANADA., SN 76-587,365. FILED 4-15-2004. PRINCIPAL REGISTER.



THE COLOR(S) ORANGE, GREEN, BROWN, YELLOW IS/ ARE CLAIMED AS A FEATURE OF THE MARK.
THE COLORS ORANGE, GREEN, BROWN, YELLOW APPEAR IN THE RECTANGULAR BAND EXTENDING BENEATH THE WORD PORTION OF THE MARK.
INT. CL. 3/U.S. CLS. 1, 4, 6, 50, 51 AND 52
FOR HAIR CARE STYLING AND PREPARATION PRODUCTS, NAMELY, SHAMPOOS, RELAXERS, CONDITIONERS, SETTING LOTIONS, HAIR SPRAY [, HAIR COLORS, HAIR TINTING PREPARATIONS, HAIR HIGHLIGHT PREPARATIONS, HAIR DYES,] AND STYLING GELS.
FIRST USE 1-4-2004; IN COMMERCE 1-4-2004.

ELEMENTS AMENDED
GOODS/SERVICES

3,025,415. REG. 12-13-2005. MASTER PAINTERS INSTITUTE, INC. (CANADA BRITISH COLUMBIA CORPORATION) 4090 GRAVELY STREET, BUMABY, BRITISH COLUMBIA V5C 3T6, CANADA., SN 76-587,367. FILED 4-15-2004. PRINCIPAL REGISTER.



INT. CL. 9/U.S. CLS. 21, 23, 26, 36 AND 38
FOR ELECTRONIC PUBLICATIONS PROVIDED IN CD-ROM FORMAT, NAMELY, BOOKS, MANUALS AND OTHER WRITTEN WORKS, NAMELY, HANDBOOKS, INFORMATION BULLETINS, PAMPHLETS AND LEAFLETS REGARDING PAINTING, WALL COVERING AND SPECIFICATION STANDARDS, RELATING TO PAINTING AND WALL COVERING.
FIRST USE 2-0-1997; IN COMMERCE 2-0-1997.
INT. CL. 16/U.S. CLS. 2, 5, 22, 23, 29, 37, 38 AND 50
FOR BOOKS, MANUALS AND OTHER WRITTEN WORKS, NAMELY, HANDBOOKS, INFORMATION BULLETINS, PAMPHLETS, AND LEAFLETS REGARDING PAINTING, WALL COVERING AND SPECIFICATION STANDARDS RELATING TO PAINTING AND WALL COVERING.
FIRST USE 2-0-1997; IN COMMERCE 2-0-1997.
INT. CL. 41/U.S. CLS. 100, 101 AND 107

THE MARK CONSISTS OF STANDARD CHARACTERS WITHOUT CLAIM TO ANY PARTICULAR FONT, STYLE, SIZE, OR COLOR.
INT. CL. 9/U.S. CLS. 21, 23, 26, 36 AND 38
FOR ELECTRONIC PUBLICATIONS PROVIDED IN CD-ROM FORMAT, NAMELY, BOOKS, MANUALS AND OTHER WRITTEN WORKS, NAMELY, HANDBOOKS, INFORMATION BULLETINS, PAMPHLETS AND LEAFLETS REGARDING PAINTING, WALL COVERING AND SPECIFICATION STANDARDS, RELATING TO PAINTING AND WALL COVERING.
FIRST USE 2-0-1997; IN COMMERCE 2-0-1997.
INT. CL. 16/U.S. CLS. 2, 5, 22, 23, 29, 37, 38 AND 50
FOR BOOKS, MANUALS AND OTHER WRITTEN WORKS, NAMELY, HANDBOOKS, INFORMATION BULLETINS, PAMPHLETS, AND LEAFLETS REGARDING PAINTING, WALL COVERING AND SPECIFICATION STANDARDS RELATING TO PAINTING AND WALL COVERING
FIRST USE 2-0-1997; IN COMMERCE 2-0-1997.
INT. CL. 41/U.S. CLS. 100, 101 AND 107
FOR EDUCATIONAL SERVICES, NAMELY CONDUCTING CLASSES, WORKSHOPS, SEMINARS AND CONFERENCES IN CONNECTION WITH PAINTING, WALL COVERING, AND SPECIFICATION STANDARDS RELATING TO PAINTING AND WALL COVERING.
FIRST USE 2-0-1997; IN COMMERCE 2-0-1997.

ELEMENTS CORRECTED
ENTITY

3,094,585. REG. 5-23-2006. N.C.S. DISTRIBUTION, INC. (ILLINOIS CORPORATION) 10 PLAZA DRIVE, WESTMONT, IL, 60559, SN 76-378,310. FILED 3-4-2002. PRINCIPAL REGISTER.

FIREMAN'S FRIEND

SEC. 2(F).
INT. CL. 21/U.S. CLS. 2, 13, 23, 29, 30, 33, 40 AND 50

FOR WIPING CLOTHS.
FIRST USE 0-0-1978; IN COMMERCE 0-0-1978.

3,120,110. REG. 7-25-2006. HUHTAMAKI FINANCE B.V.
(NETHERLANDS CORPORATION) JUPITERSTRAAT
102, 2132 HE, HOOFDDORP, NETHERLANDS., SN 78-
675,988. FILED 7-22-2005. PRINCIPAL REGISTER.

ELEMENTS AMENDED
OWNER NAME

3,104,398. REG. 6-13-2006. OMAHA STANDARD, INC. (IOWA
CORPORATION) 3501 SOUTH 11TH STREET, COUNCIL
BLUFFS, IA, 51501, SN 76-573,337. FILED 2-2-2004. PRIN-
CIPAL REGISTER.



AMERICAN HAWK

THE MARK CONSISTS OF STANDARD CHARACTERS
WITHOUT CLAIM TO ANY PARTICULAR FONT, STYLE,
SIZE, OR COLOR.

THE MARK CONSISTS OF THE SAILS OF A SAILBOAT.
INT. CL. 16/U.S. CLS. 2, 5, 22, 23, 29, 37, 38 AND 50
FOR PRINTS AND PUBLICATIONS, NAMELY SALES
BROCHURES, LEAFLETS, AND CATALOGS IN THE
FIELD OF TABLEWARE, LIDS, CUPS, CONTAINERS,
FOOD AND BEVERAGE CARRIERS, AND TRAYS.
FIRST USE 12-0-2004; IN COMMERCE 12-0-2004.

NO CLAIM IS MADE TO THE EXCLUSIVE RIGHT TO
USE "AMERICAN", APART FROM THE MARK AS SHOWN.
INT. CL. 7/U.S. CLS. 13, 19, 21, 23, 31, 34 AND 35

ELEMENTS CORRECTED
OWNER NAME
OWNER ADDRESS
CITIZENSHIP

FOR CRANES FOR HANDLING BULK WASTE MA-
TERIAL.
FIRST USE 11-0-1997; IN COMMERCE 11-0-1997.

ELEMENTS AMENDED
OWNER NAME

3,133,195. REG. 8-22-2006. ASIAINSPECTION (HONG KONG
LIMITED COMPANY) RM 5, 19/F, NAM WO HONG
BUILDING, 148 WING LOK STREET, SHUENG WAN,
HONG KONG., SN 78-976,827. FILED 9-2-2004. PRINCIPAL
REGISTER.

3,112,010. REG. 7-4-2006. HUHTAMAKI FINANCE B.V.
(NETHERLANDS CORPORATION) JUPITERSTRAAT
102, 2132 HE, HOOFDDORP, NETHERLANDS., SN 78-
675,993. FILED 7-22-2005. PRINCIPAL REGISTER.

HUHTAMAKI

AsiaInspection

THE MARK CONSISTS OF STANDARD CHARACTERS
WITHOUT CLAIM TO ANY PARTICULAR FONT, STYLE,
SIZE, OR COLOR.

THE MARK CONSISTS OF STANDARD CHARACTERS
WITHOUT CLAIM TO ANY PARTICULAR FONT, STYLE,
SIZE, OR COLOR.

INT. CL. 16/U.S. CLS. 2, 5, 22, 23, 29, 37, 38 AND 50
FOR PRINTS AND PUBLICATIONS, NAMELY, SALES
BROCHURES, LEAFLETS, AND CATALOGS IN THE
FIELD OF TABLEWARE, LIDS, CUPS, CONTAINERS,
FOOD AND BEVERAGE CARRIERS, AND TRAYS.
FIRST USE 12-0-2004; IN COMMERCE 12-0-2004.

OWNER OF HONG KONG REG. NO. 300280331, DATED 3-
7-2005.

ELEMENTS CORRECTED
OWNER ADDRESS
CITIZENSHIP

INT. CL. 35/U.S. CLS. 100, 101 AND 102
FOR [ADVERTISEMENT SERVICES; SUBSCRIPTION
TO COMPUTER SERVICE, NAMELY, SUBSCRIPTION
TO GLOBAL NETWORKS;] CONDUCTING PUBLIC
OPINION POLLS [; PERSONNEL RECRUITMENT,
NAMELY, ONLINE RECRUITMENT OF STAFF AND
INVESTIGATORS].
FIRST USE ; IN COMMERCE .
INT. CL. 42/U.S. CLS. 100 AND 101

FOR HOSTING OF DIGITAL CONTENT ON THE INTERNET; LICENSING OF INTELLECTUAL PROPERTY; COPYRIGHT MANAGEMENT; DATABASE DEVELOPMENT SERVICES, NAMELY, CONSTRUCTION, DESIGN AND OPERATION OF TECHNICAL DATA BANKS AND DATABASES.
FIRST USE ; IN COMMERCE .

3,237,711. REG. 5-1-2007. SSANGYONG MOTOR COMPANY (REPUBLIC OF KOREA CORPORATION) 10F, YEOSAM B/D 648-23, YOKSAM-DONG, GANGNAM-GU; SEOUL, REPUBLIC OF KOREA., SN 79-027,432. FILED 3-25-2005. PRINCIPAL REGISTER.

ELEMENTS AMENDED
GOODS/SERVICES

KYRON

3,202,376. REG. 1-23-2007. ROBERT KARTHÄUSER (FED REP GERMANY INDIVIDUAL) WERDERSTRABE 12, 12105 BERLIN, FED REP GERMANY., SN 79-018,658. FILED 7-28-2005. PRINCIPAL REGISTER.

PRIORITY DATE OF 12-29-2004 IS CLAIMED.
OWNER OF INTERNATIONAL REGISTRATION 0894843 DATED 3-25-2005, EXPIRES 3-25-2015.
INT. CL. 12/U.S. CLS. 19, 21, 23, 31, 35 AND 44

RUWATCH

FOR SPORTS UTILITY VEHICLES; MULTI PURPOSE VEHICLES, NAMELY, BUSES, DUMP TRUCKS, PASSENGER CARS IN THE NATURE AUTOMOBILES, PASSENGER CARS FOR MORE THAN 7 PASSENGERS, SPORTS CARS, MOTORCYCLES, TRAILERS, AND TRUCKS; AUTOMOBILE WHEELS; TRACTORS FOR AGRICULTURAL PURPOSES; SAFETY DEVICES FOR AUTOMOBILES, NAMELY, AIR BAGS; WINDSHIELD WIPERS; HOODS FOR AUTO MOBILE ENGINES, HORNS FOR AUTOMOBILES, AUTOMOBILE ACCESSORIES, NAMELY, AIR PUMPS; LUGGAGE NETS FOR AUTOMOBILES, ANTI-THEFT ALARMS FOR AUTOMOBILES; DOORS FOR AUTOMOBILES; DIRECTION SIGNALS FOR AUTOMOBILES, ANTI-GLARE DEVICES FOR AUTOMOBILES, NAMELY, VEHICLE BODY PARTS MADE OF METAL, PLASTIC AND/OR FIBERGLASS, USED TO REDUCE AND/OR PREVENT THE REFLECTION OF LIGHT FROM THE VEHICLE BODY, SAID GOODS NOT BEING PARTS OF LIGHTING APPARATUS; REARVIEW MIRRORS FOR AUTOMOBILES; BUMPERS FOR AUTOMOBILES; AUTOMOBILE BODIES; AUTOMOBILE CHASSIS; SKI CARRIERS FOR CARS; PARTS OF AUTOMOBILES, NAMELY, MOTORIZED ELEVATING AND POWER TAILGATES; SEAT COVERS FOR AUTOMOBILES; WINDSHIELDS FOR AUTOMOBILES; SAFETY SEATS FOR CHILDREN FOR USE IN AUTOMOBILES; STEERING WHEELS FOR AUTOMOBILES; AUTOMOBILE SEATS; AUTOMOBILE RUNNING BOARDS; UNDER-CARRIAGES FOR AUTOMOBILES; SUN SHIELDS IN THE NATURE OF BLINDS ADAPTED FOR AUTOMOBILES; AUTOMOBILE WINDOWS; TORSION BARS FOR AUTOMOBILES; REVERSING ALARMS IN THE NATURE OF BACK-UP WARNING ALARMS FOR AUTOMOBILES; HEAD-RESTS FOR AUTOMOBILE SEATS; SAFETY BELTS FOR AUTOMOBILE SEATS; BALANCE WEIGHTS FOR AUTOMOBILE WHEELS; RIMS FOR AUTOMOBILE WHEELS; AUTOMOBILE WHEEL SPOKES; SPOKE CLIPS FOR AUTOMOBILE WHEELS; BANDS FOR AUTOMOBILE WHEEL HUBS; MUD-GUARDS FOR TRUCKS; TIRES FOR VEHICLE WHEELS; INNER TUBES FOR WHEELS; DIESEL ENGINE FOR LAND VEHICLES; RUBBER BELTS FOR LAND VEHICLE TRANSMISSIONS; DRIVING CHAINS FOR LAND VEHICLE TIRES; GEAR BOXES FOR LAND VEHICLES; TRANSMISSIONS FOR LAND VEHICLES; TRANSMISSION CHAINS FOR LAND VEHICLES; CLUTCHES FOR LAND VEHICLES; TORQUE CONVERTERS FOR LAND VEHICLES; LEATHER SAFETY BELTS FOR LAND VEHICLES; LAND VEHICLE SUSPENSION PARTS, NAMELY, SPIRAL SPRINGS FOR VEHICLES; AIR SPRINGS FOR VEHICLE SUSPENSION COMPONENTS FOR CUSHIONING DRIVER'S SEATS AND CABS; LAMINATED LEAF-SPRINGS FOR LAND VEHICLE SUSPENSION; DISK BRAKES FOR LAND VEHICLES; BAND BRAKES FOR LAND VEHICLES; BRAKE LININGS FOR LAND VEHICLES; BRAKE SHOES FOR LAND VEHICLES; [WHEEL BEARINGS FOR LAND VEHICLES; COUPLINGS FOR LAND VEHICLES; AXLE JOURNALS FOR LAND VEHICLES;] ALTERNATING CURRENT MOTORS FOR LAND VEHICLES; DIRECT CURRENT MOTORS FOR LAND VEHICLES; GASOLINE ENGINES FOR LAND VEHICLES; ELECTRIC MOTORS FOR LAND VEHICLES; [AXLES FOR LAND VEHICLES,] CONNECTING RODS FOR LAND VEHICLES OTHER THAN PARTS OF MOTORS

THE MARK CONSISTS OF STANDARD CHARACTERS WITHOUT CLAIM TO ANY PARTICULAR FONT, STYLE, SIZE, OR COLOR.
OWNER OF INTERNATIONAL REGISTRATION 0871046 DATED 7-28-2005, EXPIRES 7-28-2015.
INT. CL. 37/U.S. CLS. 100, 103 AND 106
FOR REPAIR OF HOROLOGICAL INSTRUMENTS.

ELEMENTS CORRECTED
MARK TYPE
[GOODS/SERVICES]
[INTERNATIONAL CLASS(ES)]

3,230,812. REG. 4-17-2007. STRICKLAND'S MARKETING CORP. (OHIO CORPORATION) 172 CONGER AVENUE, AKRON, OH, 44303, SN 78-522,404. FILED 11-24-2004. PRINCIPAL REGISTER.

ARCTIC TWISTER

THE MARK CONSISTS OF STANDARD CHARACTERS WITHOUT CLAIM TO ANY PARTICULAR FONT, STYLE, SIZE, OR COLOR.
INT. CL. 30/U.S. CL. 46
FOR ICE CREAM CONFECTIONS CONTAINING FRUITS, NUTS, CANDIES, BAKERY ITEMS, SUCH AS COOKIES AND BROWNIES, OR FLAVORED SYRUPS; FROZEN CUSTARD CONFECTIONS CONTAINING FRUITS, NUTS, CANDIES, BAKERY ITEMS, SUCH AS COOKIES AND BROWNIES, OR FLAVORED SYRUP.
FIRST USE 12-31-2004; IN COMMERCE 12-31-2004.

ELEMENTS CORRECTED
OWNER NAME

AND ENGINES; AIR TURBINES FOR LAND VEHICLES; HYDRAULIC TURBINES FOR LAND VEHICLES; STEAM ENGINES FOR LAND VEHICLES; STEAM TURBINES FOR LAND VEHICLES; GAS TURBINES FOR LAND VEHICLES; ROLLER CHAINS FOR LAND VEHICLES; JET ENGINES FOR LAND VEHICLES; TURBO PROP ENGINES FOR LAND VEHICLES; TURBOJET ENGINES FOR LAND VEHICLES; RAIL ANTI-SHOCKING MATERIALS FOR VEHICLES, NAMELY, SHOCK ABSORBERS; BRAKE SEGMENTS FOR MOTOR VEHICLES; CRANKCASES FOR LAND VEHICLE COMPONENTS OTHER THAN FOR ENGINES.
FIRST USE ; IN COMMERCE .

ELEMENTS CORRECTED
GOODS/SERVICES

FOR WOMEN'S CLOTHING NAMELY, DRESSES, [BLOUSES, TOPS, BOTTOMS, SKIRTS, PANTS, SUITS, LINGERIE AND JACKETS, AND SPORTSWEAR, NAMELY, SWEATERS, T-SHIRTS].
FIRST USE 2-0-2005; IN COMMERCE 2-0-2005.

ELEMENTS CORRECTED
GOODS/SERVICES

3,278,136. REG. 8-7-2007. ASIAINSPECTION (HONG KONG LIMITED COMPANY) RM 5, 19/F, NAM WO HONG BUILDING, 148 WING LOK STREET, SHUENG WAN, HONG KONG., SN 78-477,598. FILED P.R. 9-2-2004; AM. S.R. 3-24-2006. SUPPLEMENTAL REGISTER.

3,237,752. REG. 5-1-2007. OMAHA STANDARD, INC. (IOWA CORPORATION) 3501 SOUTH 11TH STREET, COUNCIL BLUFFS, IA, 51501, SN 76-520,270. FILED 6-6-2003. PRINCIPAL REGISTER.



INT. CL. 7/U.S. CLS. 13, 19, 21, 23, 31, 34 AND 35
FOR MECHANICAL LOADING AND UNLOADING MECHANISM, NAMELY, HOISTS, WINCHES, CABLES, CHAINS, HOOKS, GRAPPLES, BOOMS AND MOTORS.
FIRST USE 9-30-1977; IN COMMERCE 9-30-1977.
INT. CL. 12/U.S. CLS. 19, 21, 23, 31, 35 AND 44
FOR TRUCKS AND TRAILERS INCORPORATING HOISTING MECHANISMS FOR LOADING, TRANSPORTING AND UNLOADING CONTAINER BODIES, FLATBEDS, SPREADERS, TANKS, AND MACHINERY.
FIRST USE 9-30-1977; IN COMMERCE 9-30-1977.

ELEMENTS AMENDED
OWNER NAME

CHINA INSPECTION

THE MARK CONSISTS OF STANDARD CHARACTERS WITHOUT CLAIM TO ANY PARTICULAR FONT, STYLE, SIZE, OR COLOR.

INT. CL. 35/U.S. CLS. 100, 101 AND 102
FOR [FRANCHISING, NAMELY, CONSULTATION AND ASSISTANCE IN BUSINESS MANAGEMENT, ORGANIZATION AND PROMOTION;] COMMERCIAL INFORMATION IN THE FIELD OF PRODUCT ORDERS PROCESSING, MANUFACTURING PLACES, MANUFACTURING MEANS AND CONSEQUENCES OF THE PRODUCTS MANUFACTURING ON ECOLOGY; DATA PROCESSING SERVICES, NAMELY, DATA INPUT, FORMATTING, COMPILATION AND PROCESSING OF DATA RELATING TO PRODUCT ORDERS PROCESSING, MANUFACTURING PLACES, MANUFACTURING MEANS AND CONSEQUENCES OF THE PRODUCTS MANUFACTURING ON ECOLOGY; BUSINESS INVESTIGATION.
FIRST USE 0-0-2000; IN COMMERCE 0-0-2000.

INT. CL. 42/U.S. CLS. 100 AND 101
FOR PREPARING ENVIRONMENTAL COMPLIANCE REPORTS AND REVIEWING STANDARDS AND PRACTICES TO ASSURE COMPLIANCE WITH ENVIRONMENTAL LAWS AND REGULATIONS; PROVIDING QUALITY ASSURANCE SERVICES IN THE FIELD OF MANUFACTURING, VIA PHOTOGRAPHS, CALIBRATION, MATCHING, COUNT AND BENCHMARKING.
FIRST USE 0-0-2000; IN COMMERCE 0-0-2000.

ELEMENTS AMENDED
GOODS/SERVICES

3,259,242. REG. 7-3-2007. MAGGY LONDON INTERNATIONAL, LTD. (NEW YORK CORPORATION) 530 SEVENTH AVENUE, NEW YORK, NY, 10018, SN 78-584,219. FILED 3-10-2005. PRINCIPAL REGISTER.



THE MARK CONSISTS OF STANDARD CHARACTERS WITHOUT CLAIM TO ANY PARTICULAR FONT, STYLE, SIZE, OR COLOR.
INT. CL. 25/U.S. CLS. 22 AND 39

3,318,619. REG. 10-23-2007. POSDATA CO., LTD. (REPUBLIC OF KOREA JOINT STOCK COMPANY) 276-2, SEOHYUNDONG, BUNDANG-GU., SEONGNAM-SI, KYEONGGI-DO, 463-775, REPUBLIC OF KOREA., SN 79-027,790. FILED 8-6-2005. PRINCIPAL REGISTER.



PRIORITY DATE OF 7-18-2005 IS CLAIMED.
OWNER OF INTERNATIONAL REGISTRATION 0895772 DATED 8-6-2005, EXPIRES 8-6-2015.
INT. CL. 9/U.S. CLS. 21, 23, 26, 36 AND 38

FOR BASE STATION REPEATERS FOR WIRELESS COMMUNICATION SYSTEMS; BASE STATION SYSTEMS FOR WIRELESS COMMUNICATION IN THE NATURE OF WIRELESS TRANSMITTERS AND RECEIVERS FOR USE WITH WIRELESS TELEPHONES; BASE STATION CONTROLLERS FOR WIRELESS COMMUNICATION COMPRISED OF SWITCHING, EMBEDDING COMPUTER AND PERIPHERAL HARDWARE AND SOFTWARE FOR SYSTEM OPERATION; WIRELESS COMMUNICATIONS SYSTEM COMPONENTS, NAMELY, BASE STATION CONTROLLERS; DIGITAL SIGNAL PROCESSORS; APPARATUS FOR RECORDING, TRANSMISSION OR REPRODUCTION OF SOUND OR IMAGES IN PARTICULAR MOBILE AND BASE STATIONS, FOR USE IN THE FIELD OF RADIO COMMUNICATIONS, WHICH CONFORM TO THE DECT DIGITAL EUROPEAN CORDLESS TELEPHONE STANDARD, COMPRISED OF RADIOS AND PARTS THEREFOR; ELECTRONIC CONTROLLER FOR ADJUSTING TIME BETWEEN BASE STATIONS FOR WIRELESS COMMUNICATION SYSTEMS; APPARATUS FOR TRANSMISSION AND RECEIVING OF WIRELESS COMMUNICATIONS; BATTERY CHARGERS FOR RADIO SETS; COMPUTER SOFTWARE AND PROGRAMS FOR WIRELESS CONTENT DELIVERY; COMPUTER SOFTWARE FOR SENDING SIGNALS AND MESSAGES TO AND FROM AND FOR THE TESTING OF WIRELESS COMMUNICATIONS STATIONS AND WIRELESS TERMINALS; COMPUTER SOFTWARE FOR USE AS AN OPERATING SYSTEM IN A WIRELESS COMMUNICATIONS SYSTEM, SPECIFICALLY FOR ESTABLISHING AN INTERFACE BETWEEN A COMPUTER THAT IS USED FOR PROCESSING, RECORDING AND ARCHIVING COLLECTED DATA AND A MOBILE COMMUNICATIONS DEVICE, SUCH AS A TEST PHONE, THAT HAS BEEN CONFIGURED TO COLLECT SUCH DATA FROM RECEIVED ELECTROMAGNETIC SIGNALS; COMPUTER SOFTWARE FOR USE AS AN OPERATING SYSTEM WHICH ENABLES THE SYNCHRONIZATION OF DATA BETWEEN A REMOTE WIRELESS COMMUNICATIONS STATION AND A FIXED OR REMOTE WIRELESS COMMUNICATIONS STATION AND FOR ENABLING ONE-WAY AND/OR TWO-WAY WIRELESS CONNECTIVITY TO DATA, INCLUDING CORPORATE DATA; MODEM CARDS FOR USE IN COMMUNICATIONS SYSTEMS; INTEGRATED CIRCUITS; INTEGRATED CIRCUITS FOR USE IN COMMUNICATIONS SYSTEMS; WIRELESS LOCAL AREA NETWORK COMPUTER CARDS FOR CONNECTING PORTABLE COMPUTER DEVICES TO COMPUTER NETWORKS; MODEMS FOR USE IN CELLULAR COMMUNICATIONS SYSTEMS; SIGNAL REPEATERS FOR WIRELESS COMMUNICATIONS SYSTEMS; REPEATERS FOR CELLULAR COMMUNICATIONS SYSTEMS, NAMELY, PERSONAL COMMUNICATIONS SYSTEMS, WCDMA (WIDEBAND CODE DIVISION MULTIPLE ACCESS) AND UMTS (UNIVERSAL MOBILE TELECOMMUNICATIONS SYSTEMS); REPEATERS FOR SATELLITE AND TERRESTRIAL DMB (DIGITAL MULTIMEDIA BROADCASTING); COMMUNICATIONS SERVERS FOR WIRELESS MESSAGING SERVICES; INTERNET PHONE GATEWAY FOR WIRELESS INTERNET COMMUNICATION COMPRISED OF WIRELESS INTEGRATED CIRCUITS, INTEGRATED CIRCUITS SOFTWARE, TRANSMITTERS, RECEIVERS, AND NETWORK INTERFACE DEVICES FOR USE WITH INTERNET PHONE; COMPUTER TERMINALS IN THE NATURE OF PORTABLE DATA TERMINALS FOR WIRELESS INTERNET; MOBILE TELEPHONES; TELEPHONES FOR DIGITAL MULTIMEDIA BROADCAST; [DIGITAL MULTIMEDIA BROADCASTING ANALYZER AND SIGNAL GENERATOR;] GLOBAL POSITIONING SYSTEM (GPS) FOR USE IN VEHICLES CONSISTING OF COMPUTERS, COMPUTER SOFTWARE, TRANSMITTERS, RECEIVERS, AND NETWORK INTERFACE DEVICES; NAVIGATION APPARATUS FOR VEHICLES IN THE NATURE OF ON-BOARD COMPUTERS; PORTABLE

MULTIMEDIA PLAYERS; MULTIMEDIA PLAYER; VIDEO DISK PLAYERS; GATEWAY ROUTERS IN THE NATURE OF COMPUTER CONTROL HARDWARE; NETWORK CAMERAS FOR USE IN WIRELESS COMMUNICATION COMPRISED OF CAMERAS AND NETWORK INTERFACE DEVICE; WIRELESS LAN (LOCAL AREA NETWORK) ACCESS POINTS FOR CONNECTING NETWORK COMPUTER USERS; COMPUTER NETWORK ROUTERS; WIRELESS LAN (LOCAL AREA NETWORK) HARDWARE; DISPLAY APPARATUS FOR MONITORING, IN PARTICULAR PLASMA DISPLAY PANEL; LIQUID CRYSTAL DISPLAYS .
FIRST USE ; IN COMMERCE .

INT. CL. 35/U.S. CLS. 100, 101 AND 102

FOR ADMINISTRATION AND MANAGEMENT OF TELECOMMUNICATION SYSTEMS AND TELECOMMUNICATION NETWORKS FOR OTHERS.
FIRST USE ; IN COMMERCE .

INT. CL. 38/U.S. CLS. 100, 101 AND 104

FOR WIRELESS DIGITAL MESSAGING SERVICES IN THE NATURE OF SERVICES THAT ENABLE A USER TO SEND AND/OR RECEIVE MESSAGES THROUGH A WIRELESS DATA NETWORK; ONE-WAY AND TWO-WAY PAGING SERVICES; PROVIDING VOICE COMMUNICATION SERVICES VIA THE INTERNET; WIRELESS ELECTRONIC TRANSMISSION OF VOICE SIGNALS OR IMAGES TO WIRELESS MOBILE APPARATUS, SUCH AS MOBILE PHONES OR PERSONAL DIGITAL ASSISTANTS (PDA); TRANSMISSION OF SOUND AND VISION THROUGH A WIRELESS INTERNET COMMUNICATIONS SYSTEM VIA SATELLITE; WIRELESS DIGITAL MESSAGING SERVICES; RENTAL OF TELECOMMUNICATION EQUIPMENT AND ELECTRONIC COMMUNICATIONS NETWORK EQUIPMENT; ELECTRONIC, ELECTRIC, AND DIGITAL TRANSMISSION OF DATA, IMAGES AND VOICE SIGNALS; TRANSMISSION OF SOUND AND VISION VIA SATELLITE; COMMUNICATIONS VIA FIBER-OPTIC NETWORKS; DATA COMMUNICATION BY ELECTRONIC MAIL; PAGING SERVICES; WIRELESS BROADBAND COMMUNICATION SERVICES; PROVIDING VAN (VALUE ADDED NETWORK) COMMUNICATIONS, NAMELY VOICE COMMUNICATION SERVICES, PAGING SERVICES; ELECTRONIC MESSAGE SENDING; RENTAL OF EQUIPMENT FOR TELECOMMUNICATIONS, NAMELY MESSAGE SENDING APPARATUS; ELECTRONIC MAIL SERVICES; PROVIDING FACILITIES AND EQUIPMENT FOR VIDEO CONFERENCING; SATELLITE TRANSMISSION SERVICES; PROVIDING INFORMATION IN THE FIELD OF TELECOMMUNICATIONS; COMMUNICATION BY TELEGRAMS; DATA COMMUNICATION BY ELECTRONIC MAIL; RENTAL OF TELECOMMUNICATION EQUIPMENT, NAMELY TELEPHONES; INTERNATIONAL TELEPHONE SERVICES; COMMUNICATIONS BY MOBILE TELEPHONE; COMPUTER AIDED TRANSMISSION OF MESSAGES AND IMAGES; COMMUNICATIONS BY COMPUTER TERMINALS; NEWS AGENCIES, NAMELY THE TRANSMISSION OF NEWS ITEMS TO NEWS REPORTING ORGANIZATIONS; RENTAL OF TELECOMMUNICATION EQUIPMENT, NAMELY FACSIMILE MACHINES; ELECTRONIC TRANSMISSION OF FACSIMILE COMMUNICATIONS AND DATA FEATURING ENCRYPTION AND DECRYPTION; COMMUNICATIONS BY MEANS OF MOBILE PHONES; PROVIDING MULTIPLE-USER ACCESS TO A GLOBAL COMPUTER INFORMATION NETWORK; PROVIDING TELECOMMUNICATIONS CONNECTIONS TO A GLOBAL COMPUTER NETWORK; PROVIDING ON-LINE ELECTRONIC BULLETIN BOARDS FOR TRANSMISSION OF MESSAGES AMONG USERS IN THE FIELD OF GENERAL INTEREST; TELECOMMUNICATIONS ROUTING AND JUNCTION SERVICES; AUDIO AND VIDEO TELECONFERENCING SERVICES; AUDIO BROADCASTING IN THE FIELD OF EDUCATION; RADIO BROADCASTING; CABLE TELEVISION BROADCASTING; BROADCASTING PROGRAMS VIA A GLOBAL COMPUTER NETWORK; TELEVISION BROADCASTING.
FIRST USE ; IN COMMERCE .

ELEMENTS CORRECTED
GOODS/SERVICES

3,330,342. REG. 11-6-2007. DR. MARTENS INTERNATIONAL TRADING GMBH (DELAWARE CORPORATION) AHORNSTRASSE 8A, D-82166 GRÄFELFING, FED REP GERMANY., SN 78-111,258. FILED 2-26-2002. PRINCIPAL REGISTER.

3,372,962. REG. 1-22-2008. NTH DEGREE DESIGN & VISUAL FX, INC. (FLORIDA CORPORATION) 1060 CHASE DRIVE, WINTER GARDEN, FL, 34787, SN 78-821,951. FILED 2-23-2006. PRINCIPAL REGISTER.

DM'S

OWNER OF U.S. REG. NOS. 299,819, 2,416,348 AND OTHERS.

INT. CL. 25/U.S. CLS. 22 AND 39

FOR CLOTHING, NAMELY, [COATS,] JACKETS, [ANORAKS, PARKAS,] T-SHIRTS, [POLO SHIRTS, LONG AND SHORT SLEEVED SHIRTS, BLOUSES, TANK TOPS, SWEATERS,] SWEATSHIRTS, [SWEAT-PANTS, PANTS, JEANS, SHORTS, SKIRTS, DRESSES, VESTS, WAISTCOATS,] BELTS, SOCKS, HATS, [GLOVES,] AND CAPS.

FIRST USE 11-30-2006; IN COMMERCE 11-30-2006.

ELEMENTS AMENDED
GOODS/SERVICES



3,333,010. REG. 11-6-2007. AMERICAN HEALTH PARTNERS LLC (OKLAHOMA LIMITED LIABILITY COMPANY) 405 N. MERIDIAN AVENUE, OKLAHOMA CITY, OK, 73107, SN 78-628,076. FILED P.R. 5-11-2005; AM. S.R. 9-12-2007. SUPPLEMENTAL REGISTER.

AMERICAN HEALTH PARTNERS

THE MARK CONSISTS OF STANDARD CHARACTERS WITHOUT CLAIM TO ANY PARTICULAR FONT, STYLE, SIZE, OR COLOR.

INT. CL. 35/U.S. CLS. 100, 101 AND 102

FOR BUSINESS CONSULTING SERVICES RELATING TO PRODUCT DISTRIBUTION, LOGISTICS, REVERSE LOGISTICS, SUPPLY CHAIN, AND PRODUCTION SYSTEMS AND DISTRIBUTION SOLUTIONS, * EXCLUDING VITAMINS, HERBS, MINERALS, DIETARY SUPPLEMENTS, AND NUTRITIONAL SUPPLEMENTS *; BUSINESS MANAGEMENT SERVICES, NAMELY, MANAGING LOGISTICS, REVERSE LOGISTICS, SUPPLY CHAIN SERVICES, SUPPLY CHAIN VISIBILITY AND SYNCHRONIZATION, SUPPLY AND DEMAND FORECASTING AND PRODUCT DISTRIBUTION PROCESSES FOR OTHERS BUT EXCLUDING ESTABLISHMENT AND OPERATION OF COST CONTAINMENT PROGRAMS * AND THE SALE OF VITAMINS, HERBS, MINERALS, DIETARY SUPPLEMENTS, AND NUTRITIONAL SUPPLEMENTS *; AND MARKET RESEARCH SERVICES, * EXCLUDING VITAMINS, HERBS, MINERALS, DIETARY SUPPLEMENTS, AND NUTRITIONAL SUPPLEMENTS *.

FIRST USE 8-31-2004; IN COMMERCE 8-31-2004.

ELEMENTS AMENDED
GOODS/SERVICES

THE MARK CONSISTS OF STANDARD CHARACTERS WITHOUT CLAIM TO ANY PARTICULAR FONT, STYLE, SIZE, OR COLOR.

INT. CL. 9/U.S. CLS. 21, 23, 26, 36 AND 38

FOR PRERECORDED VIDEO, AUDIO-VIDEO AND MULTIMEDIA CASSETTES, DISCS, CINEMATOGRAPHIC FILM, VHS TAPES, DVDS, USB KEYS, CDS AND ELECTRONIC MEDIA FEATURING ANIMATION; COMPUTER SOFTWARE FEATURING STEREOSCOPIC THREE DIMENSIONAL RIDES.

FIRST USE 8-31-2002; IN COMMERCE 8-31-2002.

INT. CL. 41/U.S. CLS. 100, 101 AND 107

FOR SPECIAL EFFECTS ANIMATION SERVICES FOR FILM, VIDEO AND ELECTRONIC MEDIA; VIDEO EDITING; ANIMATION AND COMPUTER ANIMATION PRODUCTION SERVICES; PRODUCTION OF VIDEO AND CREATION OF VISUAL EFFECTS FOR OTHERS FOR USE IN DVDS AND ON WEBSITES; PRODUCTION AND CREATION OF ANIMATION AND COMPUTER GENERATED IMAGES FOR FILMS, VIDEOTAPES, CDS, DVDS AND OTHER ELECTRONIC MEDIA; PRODUCTION OF VIDEO DISCS FOR OTHERS FEATURING STEREOSCOPIC THREE DIMENSIONAL RIDES; AND PRODUCING DVDS AND CDS FOR OTHERS * ; EXCLUDING THE PLANNING, ARRANGING OR CONDUCTING OF TRADESHOW AND CONFERENCE EXHIBITS, ROAD TOUR SHOWS, TRUCK TOUR SHOWS AND CONFERENCES AND MEETINGS TO THE ORDER AND SPECIFICATION OF OTHERS *.

FIRST USE 8-31-2002; IN COMMERCE 8-31-2002.

INT. CL. 42/U.S. CLS. 100 AND 101

FOR ANIMATION AND SPECIAL-EFFECTS DESIGN FOR OTHERS * ; EXCLUDING THE PLANNING, ARRANGING OR CONDUCTING OF TRADESHOW AND CONFERENCE EXHIBITS, ROAD TOUR SHOWS, TRUCK TOUR SHOWS AND CONFERENCES AND MEETINGS TO THE ORDER AND SPECIFICATION OF OTHERS *.

FIRST USE 8-31-2002; IN COMMERCE 8-31-2002.

ELEMENTS AMENDED
GOODS/SERVICES

3,417,048. REG. 4-29-2008. THE TRAVELERS INDEMNITY COMPANY (CONNECTICUT CORPORATION) ONE TOWER SQUARE, HARTFORD, CT, 06183, SN 77-131,466. FILED 3-15-2007. PRINCIPAL REGISTER.



OWNER OF U.S. REG. NO. 1,161,313.
THE MARK CONSIST OF AN UPRIGHT, OPEN UMBRELLA WITH HANDLE TURNED TO LEFT.
INT. CL. 36/U.S. CLS. 100, 101 AND 102

FOR INSURANCE UNDERWRITING SERVICES [FOR ALL TYPES OF INSURANCE,] * IN THE FIELDS OF PROPERTY AND CASUALTY, FIRE, ALLIED LINES, FARMOWNERS MULTIPLE PERIL, HOMEOWNERS MULTIPLE PERIL, COMMERCIAL MULTIPLE PERIL, OCEAN MARINE, INLAND MARINE, EARTHQUAKE, WORKERS' COMPENSATION, OTHER LIABILITY, PRODUCT LIABILITY, PRIVATE PASSENGER AUTO LIABILITY, COMMERCIAL AUTO LIABILITY, AUTO PHYSICAL DAMAGE, FIDELITY, SURETY, BURGLARY AND THEFT, BOILER AND MACHINERY, LIFE AND REINSURANCE; * INSURANCE CLAIMS SERVICES AND ADMINISTRATION [,] * ; * INSURANCE CLAIMS PROCESSING [,] * ; * INSURANCE CLAIMS ADJUSTING [,] * ; * INSURANCE AGENCY AND BROKERAGE * SERVICES * [,] PROVIDING INFORMATION IN INSURANCE MATTERS [,] RISK MANAGEMENT AND RISK MANAGEMENT CONSULTATION.
FIRST USE 0-0-1961; IN COMMERCE 0-0-1961.

ELEMENTS AMENDED
GOODS/SERVICES

3,417,049. REG. 4-29-2008. THE TRAVELERS INDEMNITY COMPANY (CONNECTICUT CORPORATION) ONE TOWER SQUARE, HARTFORD, CT, 06103, SN 77-131,469. FILED 3-15-2007. PRINCIPAL REGISTER.



OWNER OF U.S. REG. NO. 1,161,313.
THE COLOR(S) RED IS/ARE CLAIMED AS A FEATURE OF THE MARK.
THE MARK CONSISTS OF AN UPRIGHT, OPEN UMBRELLA WITH HANDLE TURNED TO THE LEFT.
INT. CL. 36/U.S. CLS. 100, 101 AND 102

FOR INSURANCE UNDERWRITING SERVICES [FOR ALL TYPES OF INSURANCE,] * IN THE FIELDS OF PROPERTY AND CASUALTY, FIRE, ALLIED LINES, FARMOWNERS MULTIPLE PERIL, HOMEOWNERS MULTIPLE PERIL, COMMERCIAL MULTIPLE PERIL, OCEAN MARINE, INLAND MARINE, EARTHQUAKE, WORKERS' COMPENSATION, OTHER LIABILITY, PRODUCT LIABILITY, PRIVATE PASSENGER AUTO LIABILITY, COMMERCIAL AUTO LIABILITY, AUTO PHYSICAL DAMAGE, FIDELITY, SURETY, BURGLARY AND THEFT, BOILER AND MACHINERY, LIFE AND REINSURANCE; * INSURANCE CLAIMS SERVICES AND ADMINISTRATION [,] * ; * INSURANCE CLAIMS PROCESSING [,] * ; * INSURANCE CLAIMS ADJUSTING [,] * ; * INSURANCE AGENCY AND BROKERAGE * SERVICES, NAMELY, POLICYHOLDER SERVICES AND SERVICES TO AGENTS AND BROKERS; * [,] PROVIDING INFORMATION IN INSURANCE MATTERS[,] * ; 8 RISK MANAGEMENT AND RISK MANAGEMENT CONSULTATION.
FIRST USE 0-0-1961; IN COMMERCE 0-0-1961.

ELEMENTS AMENDED
GOODS/SERVICES

3,419,804. REG. 4-29-2008. BREATHABLEBABY, LLC (MINNESOTA LIMITED LIABILITY COMPANY) 1593 WEXFORD CIRCLE, EAGAN, MN, 55122, SN 78-457,511. FILED 7-27-2004. PRINCIPAL REGISTER.

BREATHABLEBABY

THE MARK CONSISTS OF STANDARD CHARACTERS WITHOUT CLAIM TO ANY PARTICULAR FONT, STYLE, SIZE, OR COLOR.

INT. CL. 24/U.S. CLS. 42 AND 50
FOR CRIB ACCESSORIES, NAMELY, CRIB PADS, CRIB BUMPERS, CRIB BUMPER PADS, CRIB LINERS, AND CRIB CANOPIES; MATTRESS PADS; MATTRESS COVERS; CONTOURED MATTRESS COVERS; BED SHEETS; CONTOURED BED SHEETS; PILLOW CASES; PILLOW COVERS; PILLOW SHAMS; DIAPER CHANGING PADS NOT OF PAPER; BURP PADS NOT OF PAPER; BED AND CRIB BLANKETS; RECEIVING BLANKETS; AND COMFORTERS.

FIRST USE 1-1-2008; IN COMMERCE 1-1-2008.
INT. CL. 28/U.S. CLS. 22, 23, 38 AND 50
FOR CRIB TOYS; CRIB MOBILES; INFANT ACTION CRIB TOYS; INFANT TOYS; INFANT DEVELOPMENT TOYS; BABY MULTIPLE ACTIVITY TOYS; CHILDREN'S MULTIPLE ACTIVITY TOYS; INFLATABLE TOYS; MUSICAL TOYS; PLUSH TOYS; TOY STUFFED ANIMALS; SOFT SCULPTURE TOYS; CHILDREN'S MOBILES; TOY MOBILES; BATH TOYS; ATTACHABLE TOYS, NAMELY, TOYS DESIGNED TO BE ATTACHED TO CAR SEATS, ATTACHED TO STROLLERS, ATTACHED TO CRIBS, ATTACHED TO CRADLES, AND ATTACHED TO HIGH CHAIRS; TOYS, NAMELY, INFANT PLAY MATS AND ACTIVITY MATS.
FIRST USE 1-1-2008; IN COMMERCE 1-1-2008.

ELEMENTS AMENDED
CITIZENSHIP
ENTITY

3,426,773. REG. 5-13-2008. CLEARWATER MANAGEMENT COMPANY (UK) LIMITED (UNITED KINGDOM LIMITED COMPANY) 62A DISCOVERY CENTRE, NORTH EAST SECTOR, BOURNEMOUTH INTERNATIONAL AIRPORT, CHRISTCHURCH, UNITED KINGDOM. BH23 6DD, SN 78-551,885. FILED 1-21-2005. PRINCIPAL REGISTER.

3,426,789. REG. 5-13-2008. JOINTVITALITY, INC. (COLORADO CORPORATION) 7447 E. BERRY AVENUE, SUITE 150, GREENWOOD VILLAGE, CO. 80111, SN 78-634,022. FILED 5-20-2005. PRINCIPAL REGISTER.

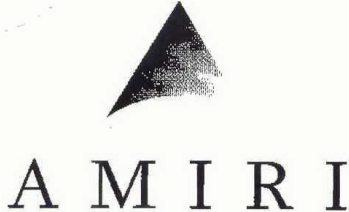

PRIORITY CLAIMED UNDER SEC. 44(D) ON ERPN CMNTY TM OFC APPLICATION NO. 3963964, FILED 7-30-2004, REG. NO. 3963964, DATED 2-2-2006, EXPIRES 7-30-2014. THE STIPLING IS A FEATURE OF THE MARK.

INT. CL. 36/U.S. CLS. 100, 101 AND 102
 FOR REAL ESTATE SERVICES NAMELY REAL ESTATE BROKERAGE, REAL ESTATE LEASING, AND REAL ESTATE MANAGEMENT; BROKERAGE NAMELY BROKERAGE OF AIRCRAFT, AIRCRAFT PARTS AND AIRCRAFT RELATED PRODUCTS; BROKERAGE OF BOATS, BOAT PARTS, AND BOAT RELATED PRODUCTS.

INT. CL. 37/U.S. CLS. 100, 103 AND 106
 FOR REAL ESTATE DEVELOPMENT.

ELEMENTS CORRECTED
 OWNER NAME

3,426,788. REG. 5-13-2008. JOINTVITALITY, INC. (COLORADO CORPORATION) 7447 E. BERRY AVENUE, SUITE 150, GREENWOOD VILLAGE, CO. 80111, SN 78-634,009. FILED 5-20-2005. PRINCIPAL REGISTER.

JOINTVITALITY

THE MARK CONSISTS OF STANDARD CHARACTERS WITHOUT CLAIM TO ANY PARTICULAR FONT, STYLE, SIZE, OR COLOR.

OWNER OF U.S. REG. NO. 3,303,708.
 INT. CL. 44/U.S. CLS. 100 AND 101
 FOR MEDICAL SERVICES, NAMELY, PROVIDING TREATMENT FOR THE JOINTS TO EASE PAIN AND SLOW AGING OF THE JOINTS .
 FIRST USE 3-1-2005; IN COMMERCE 4-15-2005.

ELEMENTS CORRECTED
 OWNER NAME
 OWNER ADDRESS

KNEEVITALITY

THE MARK CONSISTS OF STANDARD CHARACTERS WITHOUT CLAIM TO ANY PARTICULAR FONT, STYLE, SIZE, OR COLOR.

OWNER OF U.S. REG. NO. 3,303,708.
 INT. CL. 44/U.S. CLS. 100 AND 101
 FOR MEDICAL SERVICES, NAMELY, PROVIDING TREATMENT FOR THE KNEE TO EASE PAIN AND SLOW AGING OF THE KNEE .
 FIRST USE 3-1-2005; IN COMMERCE 4-15-2005.

ELEMENTS CORRECTED
 OWNER NAME
 OWNER ADDRESS

3,426,790. REG. 5-13-2008. JOINTVITALITY, INC. (COLORADO CORPORATION) 7447 E. BERRY AVENUE, SUITE 150, GREENWOOD VILLAGE, CO. 80111, SN 78-634,149. FILED 5-20-2005. PRINCIPAL REGISTER.

HIPVITALITY

THE MARK CONSISTS OF STANDARD CHARACTERS WITHOUT CLAIM TO ANY PARTICULAR FONT, STYLE, SIZE, OR COLOR.

OWNER OF U.S. REG. NO. 3,303,708.
 INT. CL. 44/U.S. CLS. 100 AND 101
 FOR MEDICAL SERVICES, NAMELY, PROVIDING TREATMENT FOR THE HIP TO EASE PAIN AND SLOW AGING OF THE HIP .
 FIRST USE 3-1-2005; IN COMMERCE 4-15-2005.

ELEMENTS CORRECTED
 OWNER NAME
 OWNER ADDRESS

3,426,791. REG. 5-13-2008. JOINTVITALITY, INC. (COLORADO CORPORATION) 7447 E. BERRY AVENUE, SUITE 150, CO. 80111, SN 78-634,161. FILED 5-20-2005. PRINCIPAL REGISTER.

SHOULDERVITALITY

THE MARK CONSISTS OF STANDARD CHARACTERS WITHOUT CLAIM TO ANY PARTICULAR FONT, STYLE, SIZE, OR COLOR.

OWNER OF U.S. REG. NO. 3,303,708.
 INT. CL. 44/U.S. CLS. 100 AND 101

FOR MEDICAL SERVICES, NAMELY, PROVIDING TREATMENT FOR THE SHOULDER TO EASE PAIN AND SLOW AGING OF THE SHOULDER. FIRST USE 3-1-2005; IN COMMERCE 4-15-2005.

3,435,949. REG. 5-27-2008. JOINTVITALITY, INC. (COLORADO CORPORATION) 7447 E. BERRY AVENUE, SUITE 150, GREENWOOD VILLAGE, CO. 80111, SN 78-634,195. FILED 5-20-2005. PRINCIPAL REGISTER.

ELEMENTS CORRECTED
OWNER NAME
OWNER ADDRESS

DISKVITALITY

3,426,792. REG. 5-13-2008. JOINTVITALITY, INC. (COLORADO CORPORATION) 7447 E. BERRY AVENUE, SUITE 150, GREENWOOD VILLAGE, CO. 80111, SN 78-634,174. FILED 5-20-2005. PRINCIPAL REGISTER.

THE MARK CONSISTS OF STANDARD CHARACTERS WITHOUT CLAIM TO ANY PARTICULAR FONT, STYLE, SIZE, OR COLOR.

OWNER OF U.S. REG. NO. 3,303,708.
INT. CL. 44/U.S. CLS. 100 AND 101

FOR MEDICAL SERVICES, NAMELY, A PHYSICIAN PERFORMED PROCEDURE INVOLVING INJECTING MEDICATION INTO AREAS OF THE SPINE TO EASE BACK PAIN.

FIRST USE 3-1-2005; IN COMMERCE 4-15-2005.

ELBOWVITALITY

ELEMENTS CORRECTED
OWNER NAME
OWNER ADDRESS

THE MARK CONSISTS OF STANDARD CHARACTERS WITHOUT CLAIM TO ANY PARTICULAR FONT, STYLE, SIZE, OR COLOR.

OWNER OF U.S. REG. NO. 3,303,708.
INT. CL. 44/U.S. CLS. 100 AND 101

FOR MEDICAL SERVICES, NAMELY, PROVIDING TREATMENT FOR THE ELBOW TO EASE PAIN AND SLOW AGING OF THE ELBOW .

FIRST USE 3-1-2005; IN COMMERCE 4-15-2005.

3,440,499. REG. 6-3-2008. VERSUS, L.P. (DELAWARE LIMITED PARTNERSHIP) ONE COMCAST CENTER, PHILADELPHIA, PA, 19103, SN 77-319,274. FILED 11-1-2007. PRINCIPAL REGISTER.

ELEMENTS CORRECTED
OWNER NAME
OWNER ADDRESS



VERSUS COUNTRY

3,428,864. REG. 5-13-2008. CENTER FOR FIDUCIARY STUDIES, LLC (PENNSYLVANIA LIMITED LIABILITY COMPANY) 1ST FLOOR, 438 DIVISION STREET, SEWICKLEY, PA, 15143, SN 77-007,239. FILED P.R. 9-26-2006; AM. S.R. 8-10-2007. SUPPLEMENTAL REGISTER.

ACCREDITED FIDUCIARY INVESTMENT MANAGER

OWNER OF U.S. REG. NOS. 3,270,348, 3,346,266 AND OTHERS.

THE COLOR(S) RED AND BLACK IS/ARE CLAIMED AS A FEATURE OF THE MARK.

THE MARK CONSISTS OF THE STYLIZED WORDS MADE TO APPEAR AS IF WRITTEN IN WOOD "VERSUS COUNTRY" IN THE COLOR RED BELOW THE STYLIZED LETTERS "VS." IN THE COLOR RED WHICH LETTERS ARE ON A BLACK CIRCULAR BACKGROUND AND OUTLINED WITH AN INCOMPLETE CIRCLE IN THE COLOR RED.

INT. CL. 41/U.S. CLS. 100, 101 AND 107

FOR ENTERTAINMENT IN THE NATURE OF AN ONGOING BLOCK OF TELEVISION PROGRAMMING FEATURING HUNTING AND FISHING PROGRAMS; PROVIDING INFORMATION ON-LINE IN THE FIELD OF ENTERTAINMENT CONCERNING TELEVISION PROGRAMS.

FIRST USE 9-15-2007; IN COMMERCE 9-15-2007.

THE MARK CONSISTS OF STANDARD CHARACTERS WITHOUT CLAIM TO ANY PARTICULAR FONT, STYLE, SIZE, OR COLOR.

THE CERTIFICATION MARK, AS USED BY PERSONS AUTHORIZED BY THE CERTIFIER, CERTIFIES THAT THE SERVICES PROVIDED BY CERTIFIED PEOPLE IN THE FINANCIAL SERVICES, ESTATE-PLANNING, ESTATE TRUST MANAGEMENT, WEALTH MANAGEMENT, FIDUCIARY REPRESENTATIVES AND ADMINISTRATION OF EMPLOYEE BENEFIT PLANS HAVE MET CERTAIN LEVELS OF EXPERIENCE, EDUCATION, ETHICS AND TESTS OF COMPETENCY AND STANDARDS.

INT. CL. B /U.S. CL. B

FOR FINANCIAL SERVICES, ESTATE-PLANNING, ESTATE TRUST MANAGEMENT, WEALTH MANAGEMENT, FIDUCIARY REPRESENTATIVES, AND ADMINISTRATION OF EMPLOYEE BENEFIT PLANS.

FIRST USE 2-19-2008; IN COMMERCE 2-19-2008.

ELEMENTS CORRECTED
CERTIFICATION STATEMENT

ELEMENTS AMENDED
MARK
DESCRIPTION OF MARK

3,455,298. REG. 6-24-2008. SKOOKUM CREEK TOBACCO CO., INC. (UNITED STATES A WHOLLY OWNED ENTERPRISE OF THE SQUAXIN ISLAND TRIBE, A FEDERALLY RECOGNIZED TRIBE, INCORPORATED UNDER TRIBAL LAW) 1041 W STATE ROUTE 108, SHELTON, WA, 98584, SN 78-668,121. FILED 7-12-2005. PRINCIPAL REGISTER.

Premis

THE MARK CONSISTS OF STANDARD CHARACTERS WITHOUT CLAIM TO ANY PARTICULAR FONT, STYLE, SIZE, OR COLOR.

INT. CL. 34/U.S. CLS. 2, 8, 9 AND 17
FOR CIGARETTES.

FIRST USE 3-31-2006; IN COMMERCE 4-25-2008.

ELEMENTS CORRECTED
CITIZENSHIP
ENTITY

3,459,897. REG. 7-1-2008. QINGWEN XU (SOUTH AFRICA INDIVIDUAL) 710 DOCUMMUN ST., LOS ANGELES, CA, 90012, SN 77-393,302. FILED P.R. 2-10-2008; AM. S.R. 5-21-2008. SUPPLEMENTAL REGISTER.

JOHNSON

THE MARK CONSISTS OF STANDARD CHARACTERS WITHOUT CLAIM TO ANY PARTICULAR FONT, STYLE, SIZE, OR COLOR.

INT. CL. 18/U.S. CLS. 1, 2, 3, 22 AND 41

FOR ALL PURPOSE SPORT BAGS; ALL-PURPOSE ATHLETIC BAGS; ALL-PURPOSE CARRYING BAGS; ANIMAL GAME BAGS; ATHLETIC BAGS; [BABY CARRYING BAGS;] BACKPACKS, BOOK BAGS, SPORTS BAGS, BUM BAGS, WALLETS AND HANDBAGS; BAGS AND HOLDALLS FOR SPORTS CLOTHING; [BAGS FOR CARRYING BABIES' ACCESSORIES;] BAGS FOR SPORTS; BAGS FOR UMBRELLAS; BARREL BAGS; BEACH BAGS; BELT BAGS; BELT BAGS AND HIP BAGS; BOOK BAGS; BOSTON BAGS; BUM BAGS; CANTLE BAGS; CANVAS SHOPPING BAGS; CARRY-ALL BAGS; CARRY-ON BAGS; CHALK BAGS; CHARM BAGS (OMAMORI-IRE); CLUTCH BAGS; [COSMETIC BAGS SOLD EMPTY; DIAPER BAGS;] DUFFEL BAGS; DUFFEL BAGS FOR TRAVEL; DUFFLE BAGS; FEED BAGS FOR ANIMALS; FLEXIBLE BAGS FOR GARMENTS; GARMENT BAGS FOR TRAVEL; GENERAL PURPOSE BAGS FOR CARRYING YOGA EQUIPMENT; GLADSTONE BAGS; GYM BAGS; HIKING BAGS; HORSE TAIL BAGS; HUNTERS' GAME BAGS; HUNTING BAGS; KEY BAGS; KIT BAGS; LEATHER AND IMITATION LEATHER BAGS; LEATHER BAGS FOR MERCHANDISE PACKAGING; LEATHER BAGS, SUITCASES AND WALLETS; LEATHER SHOPPING BAGS; MAKE-UP BAGS SOLD EMPTY; MEN'S CLUTCH BAGS; MESH SHOPPING BAGS; MESSENGER BAGS; OVER-NIGHT BAGS; PET ACCESSORIES, NAMELY, CANVAS, VINYL AND LEATHER POUCHES FOR HOLDING DISPOSABLE BAGS TO PLACE PET WASTE IN; PET ACCESSORIES, NAMELY, SPECIALLY DESIGNED CANVAS, VINYL OR LEATHER BAGS ATTACHED TO ANIMAL LEASHES FOR HOLDING SMALL ITEMS SUCH AS KEYS, CREDIT CARDS, MONEY OR DISPOSABLE BAGS FOR DISPOSING OF PET WASTE; POMMEL BAGS; POUCHES AND BAGS SOLD EMPTY FOR ATTACHMENT TO BACKPACKS; ROLL BAGS; SADDLE

HORN BAGS; SADDLERY, NAMELY, HORN BAGS; SCHOOL BAGS; SCHOOL BOOK BAGS; SHAVING BAGS SOLD EMPTY; SHOE BAGS FOR TRAVEL; SHOPPING BAGS MADE OF SKIN; SHOPPING BAGS WITH WHEELS ATTACHED; SHOULDER BAGS; SLING BAGS; [SLING BAGS FOR CARRYING INFANTS;] SMALL BAGS FOR MEN; SOUVENIR BAGS; SPORT BAGS; SPORTS BAGS; SPORTSMAN'S HUNTING BAGS; STRING BAGS FOR SHOPPING; SUIT BAGS; TEXTILE SHOPPING BAGS; [TOILETRY BAGS SOLD EMPTY;] TOOL BAGS SOLD EMPTY; TOTE BAGS; TRAVEL BAGS; TRAVELING BAGS; TRAVELLING BAGS; WAIST BAGS; WASH BAGS FOR CARRYING TOILETRIES; WHEELED BAGS; WHEELED DUFFLE BAGS; WHEELED MESSENGER BAGS; WHEELED TOTE BAGS; WINE BAGS WITH HANDLES FOR CARRYING OR HOLDING WINE; WRIST MOUNTED CARRYALL BAGS; WRISTLET BAGS * EXCLUDING BABY CARRYING BAGS, BAGS FOR CARRYING BABIES' ACCESSORIES, COSMETIC BAGS SOLD EMPTY, DIAPER BAGS, SLING BAGS FOR CARRYING INFANTS, AND TOILETRY BAGS SOLD EMPTY. *

FIRST USE 5-1-2007; IN COMMERCE 6-1-2007.

ELEMENTS AMENDED
GOODS/SERVICES

3,465,182. REG. 7-15-2008. L'ARENA DES CANADIENS INC. (THROUGH ITS DIVISION GILLET ENTERTAINMENT GROUP) (CANADA CORPORATION) 7TH FLOOR, 1275 RUE SAINT-ANTOINE OUEST, MONTREAL, QUEBEC, CANADA, H3C5L2, SN 77-069,064. FILED 12-21-2006. PRINCIPAL REGISTER.



PRIORITY CLAIMED UNDER SEC. 44(D) ON CANADA APPLICATION NO. 1307507, FILED 6-29-2006, REG. NO. TMA699,027, DATED 10-19-2007, EXPIRES 10-19-2022.

NO CLAIM IS MADE TO THE EXCLUSIVE RIGHT TO USE "MUSIC AND ARTS FESTIVAL", APART FROM THE MARK AS SHOWN.

INT. CL. 41/U.S. CLS. 100, 101 AND 107

FOR ENTERTAINMENT SERVICES, NAMELY, LIVE MUSIC CONCERTS AND MUSIC PRODUCTION EVENTS.

ELEMENTS CORRECTED
FOREIGN APPLICATION NO.
FOREIGN APPLICATION FILING DATE
PRIORITY CLAIMED STATEMENT

3,466,033. REG. 7-15-2008. PAUL CAPITAL ADVISORS, LLC (DELAWARE LIMITED LIABILITY COMPANY) 50 CALIFORNIA STREET, SAN FRANCISCO, CA. 94111, SN 77-236,910. FILED 7-24-2007. PRINCIPAL REGISTER.

PAUL CAPITAL

THE MARK CONSISTS OF STANDARD CHARACTERS WITHOUT CLAIM TO ANY PARTICULAR FONT, STYLE, SIZE, OR COLOR.

NO CLAIM IS MADE TO THE EXCLUSIVE RIGHT TO USE "CAPITAL", APART FROM THE MARK AS SHOWN.

INT. CL. 36/U.S. CLS. 100, 101 AND 102

FOR FINANCIAL SERVICES, NAMELY, PRIVATE EQUITY CAPITAL INVESTMENT MANAGEMENT AND ADVISORY SERVICES.
FIRST USE 11-0-1990; IN COMMERCE 2-0-1991.

3,488,352. REG. 8-19-2008. SE ELECTRONICS INTERNATIONAL, INC. (CALIFORNIA CORPORATION) 5850 COMMERCE BLVD., SUITE C1, ROHNERT PARK, CA, 94928. SN 77-376,826. FILED 1-21-2008. PRINCIPAL REGISTER.

ELEMENTS AMENDED
MARK

Reflexion Filter

THE MARK CONSISTS OF STANDARD CHARACTERS WITHOUT CLAIM TO ANY PARTICULAR FONT, STYLE, SIZE, OR COLOR.

NO CLAIM IS MADE TO THE EXCLUSIVE RIGHT TO USE "REFLECTION", APART FROM THE MARK AS SHOWN.

INT. CL. 17/U.S. CLS. 1, 5, 12, 13, 35 AND 50

FOR ACOUSTIC PRODUCTS, NAMELY, SOUND ABSORBERS, SOUND DIFFUSERS AND ACOUSTICAL PANELS IN THE NATURE OF MODULAR, EXPANDABLE, PORTABLE PARTIAL AND COMPLETE SOUND ENCLOSURES FUNCTIONING AS SOUND BARRIERS.

FIRST USE 1-19-2006; IN COMMERCE 1-19-2006.

ELEMENTS CORRECTED
OWNER NAME

3,482,545. REG. 8-5-2008. WIGWAM MILLS, INC. (WISCONSIN CORPORATION) P.O. BOX 818, 3402 CROCKER AVENUE, SHEBOYGAN, WI, 530820818, SN 78-962,633. FILED 8-29-2006. PRINCIPAL REGISTER.

3,494,647. REG. 9-2-2008. THE TRAVELERS INDEMNITY COMPANY (CONNECTICUT CORPORATION) ONE TOWER SQUARE, HARTFORD, CT, 06183, SN 77-146,213. FILED 4-2-2007. PRINCIPAL REGISTER.

WIGWAM

TRAVELERS 

OWNER OF U.S. REG. NOS. 543,445, 1,221,849 AND OTHERS.

INT. CL. 3/U.S. CLS. 1, 4, 6, 50, 51 AND 52

FOR NON-MEDICATED FOOT CARE LOTIONS, GELS, SOAPS, SOAKS AND SPRAYS; SOAPS AND DETERGENT FOR WASHING KNITTED TEXTILE PRODUCTS.

FIRST USE 6-3-2008; IN COMMERCE 6-3-2008.

INT. CL. 25/U.S. CLS. 22 AND 39

FOR MEN'S, WOMEN'S AND CHILDREN'S SOCKS AND HOSIERY FOR THE FEET AND LEGS; SOCKS; HEADWEAR, NAMELY, KNITTED HATS, SKI HATS, AND CAPS; EARMUFFS; HEADBANDS; ATHLETIC MASKS IN THE NATURE OF CLOTHING, NAMELY, KNITTED SKI MASKS, HEAD AND FACE MASKS, AND ANTI-COLD MASKS; NECK WEAR, NAMELY, KNITTED SCARVES, NECK WARMERS, AND DICKIES; GLOVES AND MITTENS FOR CLOTHING, NAMELY, KNITTED ANTI-COLD GLOVES, MITTENS AND GLOVE LINERS FOR USE IN OUTDOOR ACTIVITIES; GLOVES AND MITTENS FOR CLOTHING, NAMELY, KNITTED ANTI-HEAT GLOVES, MITTENS, AND GLOVE LINERS FOR USE IN OUTDOOR ACTIVITIES, AND NOT INTENDED FOR USE TO PROTECT INDIVIDUALS FROM GRAVE INJURY SUCH AS FIRE PROTECTION.
FIRST USE 1-21-2008; IN COMMERCE 1-21-2008.

ELEMENTS CORRECTED
GOODS/SERVICES

OWNER OF U.S. REG. NOS. 1,161,313, 1,611,053 AND 2,438,690.

THE MARK CONSISTS OF THE WORD "TRAVELERS" WITH AN UMBRELLA AT THE END OF THE WORD.

INT. CL. 35/U.S. CLS. 100, 101 AND 102

FOR PROMOTING THE SALE OF GOODS AND/OR SERVICES OF OTHERS THROUGH THE DEVELOPMENT AND DISTRIBUTION OF PRINTED MATERIAL; DIRECT MAIL MARKETING SERVICES FOR OTHERS IN THE FIELD OF INSURANCE; BUSINESS COUNSELING IN REGARD TO COST MANAGEMENT; EMPLOYMENT REHABILITATION SERVICES, NAMELY, MEDICAL COST CONTROL MANAGEMENT, BUSINESS CONSULTATION IN THE FIELD OF WORKERS' COMPENSATION, EMPLOYEE BENEFITS AND EMPLOYMENT RETURN-TO-WORK PLACEMENT SERVICES.

FIRST USE 2-27-2007; IN COMMERCE 2-27-2007.

INT. CL. 36/U.S. CLS. 100, 101 AND 102

FOR [INSURANCE AND FINANCIAL SERVICES, NAMELY,] INSURANCE UNDERWRITING SERVICES [FOR ALL TYPES OF INSURANCE,] * IN THE FIELDS OF PROPERTY AND CASUALTY, FIRE, ALLIED LINES, FARMOWNERS MULTIPLE PERIL, HOMEOWNERS MULTIPLE PERIL, COMMERCIAL MULTIPLE PERIL, OCEAN MARINE, INLAND MARINE, EARTHQUAKE, WORKERS' COMPENSATION, OTHER LIABILITY, PRODUCT LIABILITY, PRIVATE PASSENGER AUTO LIABILITY, COMMERCIAL AUTO LIABILITY, AUTO PHYSICAL DAMAGE, FIDELITY, SURETY, BURGLARY AND THEFT, BOILER AND MACHINERY, AND REINSURANCE; *VCLAIMS ADJUSTMENT IN THE FIELD OF INSURANCE [,] * ; * INSURANCE CLAIMS PROCESSING AND ADMINISTRATION; RISK CON-

TROL AND LOSS PREVENTION CONSULTATION; RISK CONTROL AND LOSS PREVENTION SERVICES, NAMELY, RISK MANAGEMENT; ELECTRONIC PROCESSING OF INSURANCE CLAIMS AND PAYMENT DATA; INSURANCE AGENCY AND BROKERAGE SERVICES *, NAMELY, POLICYHOLDER SERVICES AND SERVICES TO AGENTS AND BROKERS * ; PROVIDING INFORMATION IN INSURANCE MATTERS; AND MEDICAL CARE COORDINATION, NAMELY, ASSISTING EMPLOYERS AND PROVIDERS IN PROCESSING MEDICAL CLAIM FORMS AND PAYMENT OF MEDICAL CLAIMS.

FIRST USE 2-27-2007; IN COMMERCE 2-27-2007.
INT. CL. 41/U.S. CLS. 100, 101 AND 107

FOR EDUCATIONAL SERVICES, NAMELY, PROVIDING TRAINING PROGRAMS IN THE FIELD OF INSURANCE.

FIRST USE 2-27-2007; IN COMMERCE 2-27-2007.
INT. CL. 42/U.S. CLS. 100 AND 101

FOR PROVIDING ON-LINE NON-DOWNLOADABLE SOFTWARE IN THE FIELD OF INSURANCE.

FIRST USE 2-27-2007; IN COMMERCE 2-27-2007.

ELEMENTS AMENDED
GOODS/SERVICES

3,509,016. REG. 9-30-2008. REIMA HOLDING OY (FINLAND JOINT-STOCK COMPANY) JÄMINTIE 14, FI-38700 KANKAANPÄÄ, FINLAND., SN 79-048,687. FILED 11-27-2007. PRINCIPAL REGISTER.



OWNER OF INTERNATIONAL REGISTRATION 0900616 DATED 8-24-2006, EXPIRES 8-24-2016.

OWNER OF U.S. REG. NOS. 1,923,777 AND 2,687,921.
THE ENGLISH TRANSLATION OF "REMA" IS "BRISK".
INT. CL. 9/U.S. CLS. 21, 23, 26, 36 AND 38

FOR PROTECTIVE CLOTHING, NAMELY, CLOTHING FOR PROTECTION AGAINST ACCIDENTS, IRRADIATION AND FIRE; MOBILE PHONE CASES; DIRECTIONAL COMPASS CASES.

FIRST USE ; IN COMMERCE .
INT. CL. 24/U.S. CLS. 42 AND 50

FOR TEXTILE FABRICS FOR THE MANUFACTURE OF CLOTHING.

FIRST USE ; IN COMMERCE .
INT. CL. 25/U.S. CLS. 22 AND 39

FOR CLOTHING, NAMELY, JACKETS, COATS, SWEATERS, PANTS, OVERALLS, SHIRTS, T-SHIRTS, VESTS, GLOVES AND MITTENS, SPORT SHIRTS, SPORT JACKETS, SPORT COATS, SPORT TROUSERS, SPORT OVERALLS, SPORT SUITS, SUITS, PARKAS, WAISTCOATS, SLACKS, KNIT SHIRT, KNIT SWEATERS, KNIT PANTS, SOCKS, STOCKINGS, UNDERWEAR, HEADWEAR; FOOTWEAR * EXCEPT SHOE INSOLES *.

FIRST USE ; IN COMMERCE .

ELEMENTS CORRECTED
GOODS/SERVICES

3,512,396. REG. 10-7-2008. TPI HOLDINGS, INC. (DELAWARE CORPORATION) 5775 DUNWOODY ROAD, BLDG. B 100, ATLANTA, GA, 30342, SN 77-434,423. FILED 3-28-2008. PRINCIPAL REGISTER.

AUTOTRADER

THE MARK CONSISTS OF STANDARD CHARACTERS WITHOUT CLAIM TO ANY PARTICULAR FONT, STYLE, SIZE, OR COLOR.

OWNER OF U.S. REG. NOS. 1,247,037, 2,390,815 AND OTHERS.

INT. CL. 16/U.S. CLS. 2, 5, 22, 23, 29, 37, 38 AND 50
FOR [PERIOD] * PERIODIC * MAGAZINE FEATURING CLASSIFIED AND DISPLAY ADVERTISING .

FIRST USE 2-5-2007; IN COMMERCE 2-5-2007.

INT. CL. 35/U.S. CLS. 100, 101 AND 102

FOR PROMOTING THE GOODS OF OTHERS BY PREPARING, PLACING AND DISSEMINATING ADVERTISING IN PERIODIC PUBLICATIONS, NAMELY, MAGAZINES.

FIRST USE 2-5-2007; IN COMMERCE 2-5-2007.

ELEMENTS CORRECTED
GOODS/SERVICES

3,514,695. REG. 10-14-2008. CRITICAL SIGNAL TECHNOLOGIES (DELAWARE CORPORATION) 22600 HAGGERTY ROAD, FARMINGTON HILLS, MI, 48335, SN 77-076,227. FILED 1-4-2007. PRINCIPAL REGISTER.



Critical Signal Technologies

Protecting Home, Life and Health

NO CLAIM IS MADE TO THE EXCLUSIVE RIGHT TO USE "TECHNOLOGIES", APART FROM THE MARK AS SHOWN.

THE PORTION OF THE MARK COMPRISED OF A CROSS DESIGN IS NOT DISPLAYED IN THE COLOR RED OR A COLORABLE IMITATION THEREOF; AND IS NOT USED AND WILL NOT BE USED IN THE COLOR RED OR A COLORABLE IMITATION THEREOF.

INT. CL. 44/U.S. CLS. 100 AND 101

FOR PERSONAL EMERGENCY MEDICAL RESPONSE SERVICES.

FIRST USE 8-1-2006; IN COMMERCE 8-1-2006.

ELEMENTS AMENDED
DESCRIPTION OF MARK

3,516,706. REG. 10-14-2008. AAP BIOMATERIALS GMBH & CO. KG (FED REP GERMANY GMBH & CO. KG) LAGERSTRASSE 11-15, 64807 DIEBURG, FED REP GERMANY., SN 79-046,258. FILED 5-10-2007. PRINCIPAL REGISTER.

3,523,266. REG. 10-28-2008. THE SUNRIDER CORPORATION (UTAH CORPORATION) 1625 ABALONE AVENUE, TORRANCE, CA, 90501, SN 77-259,995. FILED 8-20-2007. PRINCIPAL REGISTER.

CalciFix

SUNERGY

THE MARK CONSISTS OF STANDARD CHARACTERS WITHOUT CLAIM TO ANY PARTICULAR FONT, STYLE, SIZE, OR COLOR.

PRIORITY DATE OF 11-10-2006 IS CLAIMED.

OWNER OF INTERNATIONAL REGISTRATION 0943521 DATED 5-10-2007, EXPIRES 5-10-2017.

INT. CL. 5/U.S. CLS. 6, 18, 44, 46, 51 AND 52

FOR [PHARMACEUTICAL AND VETERINARY PRODUCTS AND PREPARATIONS FOR THE TREATMENT OF DISEASES, NAMELY, SKINCARE AND EYE DISEASES, TO BE DISTRIBUTED IN NANO SOLUTIONS;] FILLING MATERIALS FOR TEETH AND DENTAL CASTING MATERIAL; ALL PURPOSE DISINFECTANTS; CERAMICS FOR TEETH AND BONES; BONE CEMENT [WITH PHARMACEUTICALLY ACTIVE INGREDIENTS] FOR ORTHOPAEDIC AND SURGICAL APPLICATIONS; BONE CEMENT [WITHOUT PHARMACEUTICALLY ACTIVE INGREDIENTS] FOR ORTHOPAEDIC AND SURGICAL APPLICATIONS; DENTAL CEMENT; [BIOLOGICAL PREPARATIONS FOR HUMAN MEDICAL PURPOSES;] DENTAL CERAMICS FOR USE AS TEETH AND BONE FILLING MATERIAL; [ANESTHETICS, NAMELY, LOCAL ANESTHETICS, TOPICAL ANESTHETICS; ANTISEPTICS; ANTIBIOTICS; PHARMACEUTICAL INGREDIENTS, NAMELY, ANTI-BACTERIAL PHARMACEUTICALS AND ASTRINGENTS;] DIETETIC PRODUCTS FOR MEDICAL USE, NAMELY, DIETETIC FOOD AND SUGAR, [MINERAL FOOD SUPPLEMENTS]; [BABY FOOD;] CONTRAST MEDIUM FOR MEDICAL USE; STYPTICS; MEDICAL VULNERARY SPONGES IMPREGNATED WITH WOUND-HEALING COMPOUNDS FOR MEDICAL USE; MEDICAL AND SURGICAL PLASTERS; BANDAGES FOR SKIN WOUNDS, ADHESIVE BANDAGES; AND FUNGICIDES.

FIRST USE ; IN COMMERCE .

INT. CL. 10/U.S. CLS. 26, 39 AND 44

FOR SURGICAL IMPLANTS COMPRISING ARTIFICIAL MATERIALS, NAMELY, BONE IMPLANTS, JAW IMPLANTS, ARTIFICIAL LIMBS, EYES, TEETH; PROSTHESES FOR LIMB, BREAST, HAND, DENTAL PROSTHESES; CERAMIC IMPLANTS FOR DENTISTRY, BONES; BONE CEMENT APPLICATION DEVICES; ORTHOPAEDIC PRODUCTS, NAMELY, ORTHOPAEDIC JOINT IMPLANTS, FOR DENTISTRY, BONES; SURGICAL SEWING MATERIALS, NAMELY, NEEDLES AND ARTIFICIAL AND NATURAL SEWING THREAD; SURGICAL SPONGES; AND INSTRUMENTS FOR SURGICAL AND DENTAL USE, NAMELY, MEDICAL SAWS, PUMPS, PINS, AND WIRES.

FIRST USE ; IN COMMERCE .

ELEMENTS CORRECTED
GOODS/SERVICES

THE MARK CONSISTS OF STANDARD CHARACTERS WITHOUT CLAIM TO ANY PARTICULAR FONT, STYLE, SIZE, OR COLOR.

INT. CL. 3/U.S. CLS. 1, 4, 6, 50, 51 AND 52

FOR NON-MEDICATED TOPICAL SKIN BALMS, *AND* OILS [, CREAMS, LOTIONS AND MOISTURIZERS; NON-MEDICATED MOUTH WASHES AND MOUTH DROPS] .

FIRST USE 10-0-1982; IN COMMERCE 10-0-1982.

INT. CL. 5/U.S. CLS. 6, 18, 44, 46, 51 AND 52

FOR [HERBAL SKIN PREPARATIONS, NAMELY, BALMS, OILS, CREAMS, LOTIONS AND MOISTURIZERS FOR HEALTH PURPOSES; HERBAL LOZENGES FOR HEALTH PURPOSES;] HERBAL PREPARATIONS TO BE APPLIED TO THE MOUTH IN THE FORMS OF DROPS [AND WASHES] FOR HEALTH PURPOSES; HERBAL NUTRITIONAL AND DIETARY SUPPLEMENTS IN THE FORMS OF TABLETS, CAPSULES, POWDERS, LIQUIDS, GELS AND CONCENTRATES; VITAMINS; FIBER FOR USE AS A DIETARY AND NUTRITIONAL SUPPLEMENT [AND AS AN ADDITIVE FOR FOOD PRODUCTS]; HERBAL SUPPLEMENTS IN THE FORMS OF TABLETS, CAPSULES, LIQUIDS, POWDERS, AND GEL CAPSULES; HERBAL FOOD CONCENTRATES, NAMELY, POWDERED NUTRITIONAL SUPPLEMENT DRINK MIX AND HERBAL DIETARY DRINK MIX IN POWDERED FORM.

FIRST USE 1-0-1986; IN COMMERCE 1-0-1986.

INT. CL. 29/U.S. CL. 46

FOR PRESERVED, DRIED, COOKED AND PROCESSED FRUITS AND VEGETABLES IN THE FORM OF A POWDER OR CONCENTRATE; [FRUIT-BASED ORGANIC FOOD BARS] .

FIRST USE 7-0-1988; IN COMMERCE 7-0-1988.

INT. CL. 30/U.S. CL. 46

FOR [NON-MEDICATED LOZENGES; FRUIT SAUCES EXCLUDING CRANBERRY SAUCE AND APPLE SAUCE;] HERBAL FOOD BEVERAGES AND HERBAL TEAS; PROCESSED HERBS; TEA; [SAUCES; CONDIMENT SAUCES;] CEREAL-BASED SNACK FOODS.

FIRST USE 10-0-1982; IN COMMERCE 10-0-1982.

INT. CL. 32/U.S. CLS. 45, 46 AND 48

FOR [MINERAL AND AERATED WATERS; NON-ALCOHOLIC DRINKS, NAMELY, FLAVORED WATERS AND SOFT DRINKS; FRUIT DRINKS AND FRUIT JUICES;]CONCENTRATES, [SYRUPS] AND POWDERS USED IN THE PREPARATION OF SOFT DRINKS.

FIRST USE 8-0-2000; IN COMMERCE 8-0-2000.

ELEMENTS AMENDED
GOODS/SERVICES

3,532,413. REG. 11-11-2008. GMA NETWORK, INCORPORATED (PHILIPPINES CORPORATION) EDSA COR. TIMOG AVE., DILIMAN, QUEZON CITY, PHILIPPINES, 1103, SN 78-546,020. FILED 1-12-2005. PRINCIPAL REGISTER.



NO CLAIM IS MADE TO THE EXCLUSIVE RIGHT TO USE THE INDIVIDUAL WORDS "PINOY" AND "TV", APART FROM THE MARK AS SHOWN.

THE COLOR(S) BLUE FOR THE LETTERS "GMA". RED FOR "PINOY TV". RED, YELLOW, BLUE, GREEN FOR RAINBOW-HEART DESIGN. IS/ARE CLAIMED AS A FEATURE OF THE MARK.

THE MARK CONSISTS OF WORDS "GMA", ALL CAPITALS WITH THE RAINBOW-HEART DESIGN ON THE RIGHT HAND PORTION. THE WORDS "PINOY TV" IS IN SCRIPT AND APPEARS AT THE BOTTOM OF THE DESIGN.

THE ENGLISH TRANSLATION OF "PINOY" IS "A PERSON OR OBJECT OF PHILIPPINE ANCESTRY OR ORIGIN".

INT. CL. 38/U.S. CLS. 100, 101 AND 104

FOR BROADCASTING AND TRANSMISSION OF PREMIUM PAY TELEVISION AND RADIO PROGRAMMING * DIRECTED PRIMARILY TO THE FILIPINO AUDIENCE *.

FIRST USE 7-1-2005; IN COMMERCE 8-1-2005.

INT. CL. 41/U.S. CLS. 100, 101 AND 107

FOR PRODUCTION OF PREMIUM PAY TELEVISION AND RADIO PROGRAMMING * DIRECTED PRIMARILY TO THE FILIPINO AUDIENCE *.

FIRST USE 7-1-2005; IN COMMERCE 8-1-2005.

ELEMENTS CORRECTED

GOODS/SERVICES

3,550,292. REG. 12-23-2008. W. DÖLLKEN & CO. GMBH (FED REP GERMANY CORPORATION) BEISENSTR. 50, GLADBECK, FED REP GERMANY, D-45964, SN 78-937,121. FILED 7-25-2006. PRINCIPAL REGISTER.

DOELLKENFLEX

THE MARK CONSISTS OF STANDARD CHARACTERS WITHOUT CLAIM TO ANY PARTICULAR FONT, STYLE, SIZE, OR COLOR.

PRIORITY CLAIMED UNDER SEC. 44(D) ON CANADA APPLICATION NO. 1309545, FILED 7-18-2006, REG. NO. TMA701050, DATED 11-16-2007, EXPIRES 11-16-2022.

INT. CL. 19/U.S. CLS. 1, 12, 33 AND 50

FOR BUILDING MATERIALS, NAMELY, EDGE-BANDING MADE OF WOOD AND PLASTIC.

FIRST USE 10-16-2000; IN COMMERCE 10-16-2000.

INT. CL. 20/U.S. CLS. 2, 13, 22, 25, 32 AND 50

FOR FURNITURE PARTS, NAMELY, EDGE-BANDING CONSISTING OF WOOD AND PLASTIC VENEERS FOR USE IN MANUFACTURE OF FURNITURE.

FIRST USE 10-16-2000; IN COMMERCE 10-16-2000.

ELEMENTS CORRECTED

OWNER NAME

3,551,894. REG. 12-23-2008. WORLD CLASS LEARNING MATERIALS INC. (MARYLAND CORPORATION) P.O. BOX 929, 406 MAIN STREET, REISTERTOWN, MD, 211360929, SN 78-680,507. FILED 7-28-2005. PRINCIPAL REGISTER.



THE MARK CONSISTS OF THE WORD "GAIN" APPEARING ABOVE THE WORDS "GAIN ADVANTAGE IN NUMBERS". THE LETTER "I" IN THE WORD "GAIN" CONSISTS OF FOUR SQUARES STACKED UPON EACH OTHER AND AN UPWARD POINTING TRIANGLE AT THE TOP AND A DOWNWARD POINTING TRIANGLE AT THE BOTTOM.

INT. CL. 16/U.S. CLS. 2, 5, 22, 23, 29, 37, 38 AND 50

FOR INSTRUCTIONAL AND TEACHING MATERIALS, NAMELY PRINTED NUMBER, LETTER, AND WORD FLASH CARDS; CUBES, PRISMS AND HINGED PRISMS FOR USE IN TEACHING MATHEMATICS, GEOMETRY AND SPATIAL RELATIONSHIPS, AND AWARENESS.

FIRST USE 1-1-2006; IN COMMERCE 1-1-2006.

INT. CL. 28/U.S. CLS. 22, 23, 38 AND 50

FOR EDUCATIONAL TOY CONSTRUCTION KITS COMPRISING STICKS, SWIVEL CONNECTORS AND CIRCLES.

FIRST USE 1-1-2006; IN COMMERCE 1-1-2006.

ELEMENTS CORRECTED

DESCRIPTION OF MARK

MARK

[COLOR DESCRIPTION STATEMENT]

[TRANSLITERATION STATEMENT]

3,554,904. REG. 12-30-2008. EURO-PRO OPERATING LLC (DELAWARE LIMITED LIABILITY COMPANY) 1210 WASHINGTON STREET, WEST NEWTON, MA, 02465, SN 77-265,285. FILED 8-27-2007. PRINCIPAL REGISTER.

THE PROOF IS ON THE PAD

THE MARK CONSISTS OF STANDARD CHARACTERS WITHOUT CLAIM TO ANY PARTICULAR FONT, STYLE, SIZE, OR COLOR.

INT. CL. 7/U.S. CLS. 13, 19, 21, 23, 31, 34 AND 35

FOR MULTI-PURPOSE STEAM CLEANING MACHINES AND PARTS AND ACCESSORIES THEREFOR.

FIRST USE 7-0-2007; IN COMMERCE 7-0-2007.

ELEMENTS CORRECTED

MARK

3,555,286. REG. 12-30-2008. WORLD CLASS LEARNING MATERIALS INC. (MARYLAND CORPORATION) 406 MAIN STREET, P.O. BOX 929, REISTERSTOWN, MD, 211360929. SN 78-656,783. FILED 6-23-2005. PRINCIPAL REGISTER.

3,558,985. REG. 1-6-2009. PAPP INTERNATIONAL, INC. (CANADA CORPORATION) 3755 HICKMORE, MONTREAL, QUEBEC, CANADA, H4T 1S5, AND PAPP INTERNATIONAL, INC. (CANADA CORPORATION) 3755 HICKMORE, MONTREAL, QUEBEC, CANADA, H4T 1S5, SN 78-605,172. FILED 4-8-2005. PRINCIPAL REGISTER.

GAIN MATH SYSTEM



THE MARK CONSISTS OF STANDARD CHARACTERS WITHOUT CLAIM TO ANY PARTICULAR FONT, STYLE, SIZE, OR COLOR.

NO CLAIM IS MADE TO THE EXCLUSIVE RIGHT TO USE "MATH SYSTEM", APART FROM THE MARK AS SHOWN.

INT. CL. 16/U.S. CLS. 2, 5, 22, 23, 29, 37, 38 AND 50

FOR INSTRUCTIONAL AND TEACHING MATERIALS, NAMELY, PRINTED NUMBER, LETTER, AND WORD FLASH CARDS; CUBES, PRISMS AND HINGED PRISMS FOR USE IN TEACHING MATHEMATICS, GEOMETRY AND SPATIAL RELATIONSHIPS, AND AWARENESS.

FIRST USE 1-1-2006; IN COMMERCE 1-1-2006.

ELEMENTS CORRECTED
MARK

NO CLAIM IS MADE TO THE EXCLUSIVE RIGHT TO USE "BOOKS", APART FROM THE MARK AS SHOWN.

THE MARK CONSISTS OF THE WORD MARK "BEAVER BOOKS" WITH A MAPLE LEAF AND AN ILLUSTRATION OF A BEAVER HOLDING A BOOK.

INT. CL. 16/U.S. CLS. 2, 5, 22, 23, 29, 37, 38 AND 50

FOR CHILDREN'S ACTIVITY BOOKS, EDUCATIONAL WORKBOOKS, STORY BOOKS, PICTURE BOOKS, PEN AND ACTIVITY BOOKS, ACTIVITY CARDS, NUMBER CHARTS; AND MARKERS.

FIRST USE 12-31-2005; IN COMMERCE 12-31-2005.

INT. CL. 41/U.S. CLS. 100, 101 AND 107

FOR PUBLICATION OF BOOKS, CHARTS AND OTHER PRINTED MATTER.

FIRST USE 12-31-2005; IN COMMERCE 12-31-2005.

ELEMENTS AMENDED
MARK

3,555,488. REG. 12-30-2008. MELINDA MYERS, LLC (WISCONSIN LIMITED LIABILITY COMPANY) 2642 S. 16TH STREET, P.O. BOX 370331, MILWAUKEE, WI, 53215, SN 78-980,782. FILED 2-8-2005. PRINCIPAL REGISTER.

3,559,073. REG. 1-6-2009. CENTER FOR VALUE-BASED MEDICINE, LLC (PENNSYLVANIA LIMITED LIABILITY COMPANY) P.O. BOX 335, FLOURTOWN, PA, 19031, SN 78-840,878. FILED 3-20-2006. PRINCIPAL REGISTER.

GROWING AMONG FRIENDS

VALUERX

THE MARK CONSISTS OF STANDARD CHARACTERS WITHOUT CLAIM TO ANY PARTICULAR FONT, STYLE, SIZE, OR COLOR.

INT. CL. 16/U.S. CLS. 2, 5, 22, 23, 29, 37, 38 AND 50

FOR PRINTED INSTRUCTIONAL AND EDUCATIONAL MATERIALS RELATING TO THE FIELDS OF HORTICULTURE AND GARDENING .

FIRST USE 9-24-2006; IN COMMERCE 9-24-2006.

INT. CL. 41/U.S. CLS. 100, 101 AND 107

FOR EDUCATIONAL SERVICES, NAMELY, PROVIDING LIVE AND BROADCAST SEMINARS AND SPEAKING ENGAGEMENTS AND LIVE WORKSHOPS IN THE FIELDS OF GARDENING AND HORTICULTURE.

FIRST USE 3-31-2007; IN COMMERCE 3-31-2007.

INT. CL. 44/U.S. CLS. 100 AND 101

FOR CONSULTATION RELATING TO THE FIELDS OF HORTICULTURE AND GARDENING.

FIRST USE 3-31-2007; IN COMMERCE 3-31-2007.

ELEMENTS CORRECTED
OWNER NAME

THE MARK CONSISTS OF STANDARD CHARACTERS WITHOUT CLAIM TO ANY PARTICULAR FONT, STYLE, SIZE, OR COLOR.

INT. CL. 35/U.S. CLS. 100, 101 AND 102

FOR PROVIDING DATABASES FEATURING INFORMATION IN THE FIELD OF HEALTH CARE ECONOMICS, NAMELY, THE STUDY OF THE DISTRIBUTION OF HEALTH CARE SERVICES TO PATIENTS AND HEALTH CARE UTILIZATION AND REVIEW SERVICES; PROVIDING DATABASES FEATURING INFORMATION IN THE FIELD OF PATIENT BENEFIT QUANTIFICATION, NAMELY, DATA COMPILING AND ANALYZING IN THE FIELD OF INSURANCE; PROVIDING ECONOMIC ANALYSIS SERVICES IN THE FIELD OF THE DISTRIBUTION OF HEALTH CARE SERVICES TO PATIENTS; AND PROVIDING ECONOMIC ANALYSIS SERVICES IN THE FIELD OF HEALTH CARE PATIENTS' DISABILITIES AS THEY RELATE TO CALCULATING HEALTH CARE BENEFITS .

FIRST USE 9-11-2008; IN COMMERCE 9-11-2008.

ELEMENTS CORRECTED
MARK

3,562,286. REG. 1-13-2009. AMERICAN VALVE, INC. (NORTH CAROLINA CORPORATION) 4321 PIEDMONT PARKWAY, GREENSBORO, NC, 27410, SN 77-360,673. FILED 12-28-2007. PRINCIPAL REGISTER.

VIPERLOK

THE MARK CONSISTS OF STANDARD CHARACTERS WITHOUT CLAIM TO ANY PARTICULAR FONT, STYLE, SIZE, OR COLOR.
INT. CL. 11/U.S. CLS. 13, 21, 23, 31 AND 34
FOR VALVES AND FITTINGS FOR USE IN PLUMBING SYSTEMS.
FIRST USE 5-2-2008; IN COMMERCE 5-2-2008.

ELEMENTS CORRECTED
MARK

3,565,325. REG. 1-20-2009. BEVERAGES UNLIMITED LLC (ST.CHRIST-NEVIS LIMITED LIABILITY COMPANY) PO BOX 636, CHARLESTOWN, ST.CHRIST-NEVIS., SN 77-170,231. FILED 5-1-2007. PRINCIPAL REGISTER.

CRAZYHORSE

THE MARK CONSISTS OF STANDARD CHARACTERS WITHOUT CLAIM TO ANY PARTICULAR FONT, STYLE, SIZE, OR COLOR.
INT. CL. 32/U.S. CLS. 45, 46 AND 48
FOR ENERGY DRINKS.
FIRST USE 12-18-2007; IN COMMERCE 12-18-2007.

ELEMENTS CORRECTED
MARK

3,566,055. REG. 1-20-2009. SANRIO COMPANY, LTD. (JAPAN CORPORATION) 1-6-1 OSAKI, SHINAGAWA-KU, TOKYO, JAPAN, 141, SN 78-946,778. FILED 8-7-2006. PRINCIPAL REGISTER.

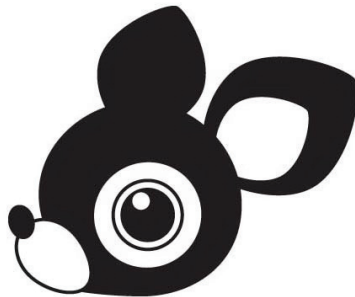

THE MARK CONSISTS OF A STYLIZED PROFILE FACE OF A DEER.
INT. CL. 18/U.S. CLS. 1, 2, 3, 22 AND 41

FOR TOTE BAGS, SHOULDER BAGS, TRAVEL BAGS, SCHOOL BAGS, BEACH BAGS, BACKPACKS, PURSES, COIN PURSES, WALLETS, HANDBAGS, [BOOK BAGS,] COSMETIC BAGS SOLD EMPTY, LUGGAGE TAGS.
FIRST USE 6-1-2004; IN COMMERCE 6-1-2004.

ELEMENTS AMENDED
GOODS/SERVICES

3,568,691. REG. 1-27-2009. SICA, DANIELE (ITALY INDIVIDUAL) VIA SANDRO PERTINI #13, PONTECAGNANO-FAIANO, SALERNO, ITALY, 84098, SN 78-952,545. FILED 8-15-2006. PRINCIPAL REGISTER.

PROCORE&FIT

THE MARK CONSISTS OF STANDARD CHARACTERS WITHOUT CLAIM TO ANY PARTICULAR FONT, STYLE, SIZE, OR COLOR.
INT. CL. 41/U.S. CLS. 100, 101 AND 107
FOR PHYSICAL FITNESS CONSULTATION; PHYSICAL FITNESS INSTRUCTION; PROVIDING FITNESS AND EXERCISE FACILITIES; PERSONAL TRAINING SERVICES, NAMELY, STRENGTH AND CONDITIONING TRAINING; PERSONAL COACHING SERVICES IN THE FIELD OF PHYSICAL FITNESS AND PERSONAL TRAINING.
FIRST USE 11-25-2008; IN COMMERCE 11-25-2008.

ELEMENTS CORRECTED
MARK

3,576,283. REG. 2-17-2009. RICOH COMPANY, LTD. (JAPAN CORPORATION) 3-6, 1-CHOME, NAKA-MAGOME, OHTA-KU, TOKYO, JAPAN., SN 78-977,864. FILED 1-25-2006. PRINCIPAL REGISTER.

CREATE, SHARE & THINK AS ONE

THE MARK CONSISTS OF STANDARD CHARACTERS WITHOUT CLAIM TO ANY PARTICULAR FONT, STYLE, SIZE, OR COLOR.
OWNER OF JAPAN REG. NO. 5083018, DATED 10-12-2007, EXPIRES 10-12-2017.

INT. CL. 35/U.S. CLS. 100, 101 AND 102
FOR ADVERTISING AND PUBLICITY; BUSINESS MANAGEMENT ANALYSIS AND BUSINESS CONSULTANCY REGARDING INFORMATION SECURITIES MANAGEMENT SYSTEM; BUSINESS CONSULTANCY REGARDING INTRODUCTION OF INFORMATION TECHNOLOGY; BUSINESS MANAGEMENT ANALYSIS AND BUSINESS CONSULTANCY; MARKETING RESEARCH; PROVIDING INFORMATION ON COMMODITY SALES REGARDING PRINTERS, FACSIMILE MACHINES, ELECTRONIC COPYING MACHINES WITH MULTI-FUNCTIONS OF PRINTER, SCANNER AND FACSIMILE MACHINE AND COMPUTER SOFTWARE FOR ELECTRONIC COPYING MACHINES AND PRINTERS; RECORDS MANAGEMENT SERVICES, NAMELY, DOCUMENT INDEXING; RENTAL OF OFFICE EQUIPMENT, NAMELY, TYPEWRITERS AND COPYING MACHINES/WORD PROCESSORS.
FIRST USE ; IN COMMERCE .
INT. CL. 42/U.S. CLS. 100 AND 101

FOR DESIGN, PROGRAMMING AND MAINTENANCE OF COMPUTER SOFTWARE FOR ELECTRONIC COPYING MACHINES; [INK-JET PRINTERS AND LASER-BEAM PRINTERS; COMPUTER SOFTWARE DESIGN, COMPUTER PROGRAMMING, MAINTENANCE OF COMPUTER SOFTWARE;] CONSULTANCY REGARDING DESIGN AND CREATION OF COMPUTER SYSTEMS FOR ELECTRONIC COPYING MACHINES; RENTAL OF COMPUTERS; PROVIDING ON-LINE NON-DOWNLOADABLE SOFTWARE FOR CONNECTING PERSONAL COMPUTERS WITH PRINTERS, FACSIMILE MACHINES AND ELECTRONIC COPYING MACHINES WITH MULTI-FUNCTIONS OF PRINTER, SCANNER AND FACSIMILE MACHINE.
FIRST USE ; IN COMMERCE .

3,581,276. REG. 2-24-2009. IMI CORNELIUS, INC. (MINNESOTA CORPORATION) 101 REGENCY DRIVE, GLENDALE HEIGHTS, IL, 60139, SN 77-267,454. FILED 8-29-2007. PRINCIPAL REGISTER.

NORDIC

ELEMENTS CORRECTED
GOODS/SERVICES

THE MARK CONSISTS OF STANDARD CHARACTERS WITHOUT CLAIM TO ANY PARTICULAR FONT, STYLE, SIZE, OR COLOR.
INT. CL. 11/U.S. CLS. 13, 21, 23, 31 AND 34
FOR COMMERCIAL ICE MAKING MACHINES AND ICE CUBE DISPENSING MACHINES.
FIRST USE 9-0-2008; IN COMMERCE 9-0-2008.

3,577,806. REG. 2-17-2009. MEADWESTVACO CORPORATION (DELAWARE CORPORATION) MEADWESTVACO CORPORATE CENTER, 11013 WEST BROAD STREET, GLEN ALLEN, VA, 23060, SN 77-460,666. FILED 4-29-2008. PRINCIPAL REGISTER.

ELEMENTS CORRECTED
ENTITY

IDEA BUILDERS

THE MARK CONSISTS OF STANDARD CHARACTERS WITHOUT CLAIM TO ANY PARTICULAR FONT, STYLE, SIZE, OR COLOR.
INT. CL. 16/U.S. CLS. 2, 5, 22, 23, 29, 37, 38 AND 50
FOR CHILDREN'S ACTIVITY BOOKS, EDUCATIONAL WRITING AND DRAWING TABLETS AND PADS.
FIRST USE 9-21-2008; IN COMMERCE 9-21-2008.

3,583,854. REG. 3-3-2009. RSM MCGLADREY, INC. (DELAWARE CORPORATION) THIRD FLOOR, 3600 AMERICAN BLVD. WEST, BLOOMINGTON, MN, 55431, SN 77-119,843. FILED 3-1-2007. PRINCIPAL REGISTER.

FIRM FOUNDATION

ELEMENTS CORRECTED
MARK

THE MARK CONSISTS OF STANDARD CHARACTERS WITHOUT CLAIM TO ANY PARTICULAR FONT, STYLE, SIZE, OR COLOR.
INT. CL. 9/U.S. CLS. 21, 23, 26, 36 AND 38
FOR COMPUTER SOFTWARE AND APPLICATIONS FOR USE IN ACCOUNTING PRACTICE MANAGEMENT AND HUMAN RESOURCES MANAGEMENT; PUBLICATIONS, NAMELY, ELECTRONIC MANUALS IN THE FIELDS OF ACCOUNTING PRACTICE MANAGEMENT, TAX ADVISORY SERVICES, AUDIT AND ASSURANCE SERVICES, FINANCIAL STATISTICS AND HUMAN RESOURCES MANAGEMENT.
FIRST USE 7-18-2007; IN COMMERCE 7-18-2007.

3,577,892. REG. 2-17-2009. ROUND HILL CELLARS (CALIFORNIA CORPORATION), DBA RUTHERFORD WINE COMPANY, 1680 SILVERADO TRAIL, ST. HELENA, CA, 94574, SN 78-640,100. FILED 5-31-2005. PRINCIPAL REGISTER.

INT. CL. 35/U.S. CLS. 100, 101 AND 102
FOR CONSULTING SERVICES IN THE FIELDS OF ACCOUNTING PRACTICE MANAGEMENT AND HUMAN RESOURCES MANAGEMENT.
FIRST USE 7-18-2007; IN COMMERCE 7-18-2007.
INT. CL. 38/U.S. CLS. 100, 101 AND 104
FOR PROVIDING ACCESS TO ACCOUNTING PRACTICE MANAGEMENT TOOLS, ACCOUNTING FUNCTIONAL TOOLS AND HUMAN RESOURCES MANAGEMENT TOOLS VIA A WEBSITE ON A GLOBAL COMPUTER NETWORK; PROVIDING ACCESS TO COMPUTER SOFTWARE FOR USE IN ACCOUNTING PRACTICE MANAGEMENT, FUNCTIONAL SERVICES AND HUMAN RESOURCES MANAGEMENT OVER A GLOBAL COMPUTER NETWORK.
FIRST USE 7-18-2007; IN COMMERCE 7-18-2007.

PEMBROOK

THE MARK CONSISTS OF STANDARD CHARACTERS WITHOUT CLAIM TO ANY PARTICULAR FONT, STYLE, SIZE, OR COLOR.
INT. CL. 33/U.S. CLS. 47 AND 49
FOR WINES.
FIRST USE 11-14-2007; IN COMMERCE 11-14-2007.

ELEMENTS CORRECTED
MARK

ELEMENTS CORRECTED
MARK

3,584,643. REG. 3-3-2009. ABSINTHE KÜBLER SA (SWITZERLAND CORPORATION) RUE DU CREUX-AUX-LOUPS 2, 2112 MÔTIERS NE, MÔTIERS, SWITZERLAND., SN 78-625,861. FILED 5-9-2005. PRINCIPAL REGISTER.

3,589,850. REG. 3-17-2009. DUNDAS DATA VISUALIZATION INC. (CANADA CORPORATION) 500 - 250 FERRAND DRIVE, TORONTO, ONTARIO, CANADA, M3C3G8, SN 77-350,983. FILED 12-13-2007. PRINCIPAL REGISTER.



NO CLAIM IS MADE TO THE EXCLUSIVE RIGHT TO USE "GRAIN NEUTRAL SPIRITS WITH HERBS AND SPICES", "SWISS ABSINTHE SUPERIEURE", "DISTILLE AU VAL-DE-TRAVERS", "NEUCHÂTEL", AND "SUISSE", APART FROM THE MARK AS SHOWN.

THE COLOR(S) LIGHT BLUE, BLUE, SILVER, YELLOW, GREEN, RED, AND BLACK IS/ARE CLAIMED AS A FEATURE OF THE MARK.

THE MARK CONSISTS OF A LIGHT BLUE LABEL WITH A BLUE OUTLINE; A BLUE DIAMOND WITH A YELLOW STRIPE, ON WHICH APPEARS GREEN BRANCHES AND A RED AND SILVER DIAMOND; THE WORDING "GRAIN NEUTRAL SPIRITS WITH HERBS AND SPICES" IN BLACK ON A YELLOW BANNER WITH A BLUE OUTLINE; THE WORDING "SWISS ABSINTHE SUPERIEURE" IN SILVER ON A BLUE BANNER WITH WHITE DETAILING; THE WORD "KÜBLER" IN BLACK ON A YELLOW BANNER WITH A BLUE OUTLINE; THE WORDING "DISTILLÉE AU VAL-DE-TRAVERS" IN BLACK, BENEATH WHICH APPEARS A BLACK, DOUBLE SIDED ARROW FOLLOWED BY THE WORD "NEUCHÂTEL" IN BLACK; THE WORD "SUISSE" APPEARS IN SILVER ON A BLUE OVAL WITH SILVER AND BLUE BORDERS; AND BENEATH "SUISSE" IS A YELLOW CIRCLE WITH GREEN AND BLACK BORDERS AROUND WHICH APPEARS GREEN BRANCHES WITH GREEN, WHITE AND RED RIBBONS.

THE ENGLISH TRANSLATION OF THE WORD "SUPERIEURE" IN THE MARK IS SUPERIOR. THE WORDING "DISTILLE AU VAL-DE-TRAVERS" MEANS DISTILLED IN "VAL-DE-TRAVERS" IN ENGLISH AND THE WORD "SUISSE" MEANS SWISS.

INT. CL. 33/U.S. CLS. 47 AND 49

FOR ALCOHOLIC BEVERAGES, NAMELY, WINES, APERITIFS, DISTILLED LIQUORS AND DISTILLED SPIRITS, ALL THE AFORESAID GOODS ORIGINATING FROM VAL-DE-TRAVERS.

FIRST USE 0-0-2005; IN COMMERCE 0-0-2007.

ELEMENTS AMENDED
MARK

DUNDAS DATA VISUALIZATION

THE MARK CONSISTS OF STANDARD CHARACTERS WITHOUT CLAIM TO ANY PARTICULAR FONT, STYLE, SIZE, OR COLOR.

PRIORITY CLAIMED UNDER SEC. 44(D) ON CANADA APPLICATION NO. 1375322, FILED 12-7-2007.

NO CLAIM IS MADE TO THE EXCLUSIVE RIGHT TO USE "DATA VISUALIZATION", APART FROM THE MARK AS SHOWN.

INT. CL. 9/U.S. CLS. 21, 23, 26, 36 AND 38

FOR COMPUTER SOFTWARE FOR THE DIGITAL DISPLAY AND REAL-TIME ANALYSIS OF USER DATA AND KEY PERFORMANCE INDICATORS (KPIs); COMPUTER SOFTWARE FOR TRAINING USERS ON THE FUNCTIONALITY OF COMPUTER SOFTWARE FOR THE DIGITAL DISPLAY AND REAL-TIME ANALYSIS OF USER DATA AND KEY PERFORMANCE INDICATORS (KPIs); NAMELY, COMPUTER SOFTWARE FOR DATA MINING, BUILDING CHARTS, GRAPHS, DIAGRAMS, MAPS, DIGITAL DASHBOARDS, AND SCORECARDS; COMPUTER SOFTWARE FOR TRAINING USERS ON DATA MINING AND HOW TO INTEGRATE USER DATA INTO CHARTS, GRAPHS, DIAGRAMS, MAPS, DIGITAL DASHBOARDS, AND SCORECARDS.

FIRST USE 3-1-2004; IN COMMERCE 3-1-2004.

INT. CL. 42/U.S. CLS. 100 AND 101

FOR COMPUTER SOFTWARE DESIGN FOR THE DIGITAL DISPLAY AND REAL-TIME ANALYSIS OF USER DATA AND KEY PERFORMANCE INDICATORS (KPIs); NAMELY, DATA ANALYSIS, DATA MINING, CHARTS, GRAPHS, DIAGRAMS, MAPS, DIGITAL DASHBOARDS, AND SCORECARDS; DEVELOPING CUSTOM-BUILT COMPUTER SOFTWARE FOR THE DIGITAL DISPLAY AND REAL-TIME ANALYSIS OF USER DATA AND KEY PERFORMANCE INDICATORS (KPIs); NAMELY, DATA ANALYSIS, DATA MINING, CHARTS, GRAPHS, DIAGRAMS, MAPS, DIGITAL DASHBOARDS, AND SCORECARDS; COMPUTER CONSULTING SERVICES FOR THE DIGITAL DISPLAY AND REAL-TIME ANALYSIS OF USER DATA AND KEY PERFORMANCE INDICATORS (KPIs); NAMELY, DATA ANALYSIS, DATA MINING, CHARTS, GRAPHS, DIAGRAMS, MAPS, DIGITAL DASHBOARDS, AND SCORECARDS; CUSTOMIZED COMPUTER TRAINING SERVICES ON THE USE OF COMPUTER SOFTWARE FOR THE DIGITAL DISPLAY AND REAL-TIME ANALYSIS OF USER DATA AND KEY PERFORMANCE INDICATORS (KPIs); NAMELY, DATA ANALYSIS, DATA MINING, CHARTS, GRAPHS, DIAGRAMS, MAPS, DIGITAL DASHBOARDS, AND SCORECARDS.

FIRST USE 3-1-2004; IN COMMERCE 3-1-2004.

ELEMENTS CORRECTED
FOREIGN REG. NO.

3,593,677. REG. 3-24-2009. MITSUBISHI ELECTRIC CORPORATION (JAPAN CORPORATION) 7-3 MARUNOUCHI 2-CHOME, CHIYODA-KU, TOKYO, JAPAN., SN 77-168,105. FILED 4-27-2007. PRINCIPAL REGISTER.

3,608,352. REG. 4-21-2009. PODLASKA WYTWORNIA WODEK "POLMOS" SPOLKA AKCYJNA (POLAND JOINT STOCK COMPANY) UL. KOLEJOWA 10, SIEDLCE, POLAND, 08110, SN 77-469,606. FILED 5-8-2008. PRINCIPAL REGISTER.

DIATOM

THE MARK CONSISTS OF STANDARD CHARACTERS WITHOUT CLAIM TO ANY PARTICULAR FONT, STYLE, SIZE, OR COLOR.

PRIORITY CLAIMED UNDER SEC. 44(D) ON JAPAN APPLICATION NO. 2007-038228, FILED 4-17-2007, REG. NO. 5130414, DATED 4-18-2008.

THE WORDING "DIATOM" HAS NO MEANING IN A FOREIGN LANGUAGE.

INT. CL. 9/U.S. CLS. 21, 23, 26, 36 AND 38

FOR * ELECTRIC * CONTROL PANELS AND * ELECTRIC CONTROL * BOARDS, EQUIPPED WITH AND CONTAINING CONTROL SWITCHES, TOUCH PANELS, DISPLAY SCREENS AND MONITORS, INDICATORS AND RECORDERS, FOR USE IN MONITORING, SUPERVISING AND CONTROLLING THE STATUS OF OPERATIONS OF NUCLEAR POWER PLANTS.

FIRST USE ; IN COMMERCE .

ELEMENTS AMENDED
GOODS/SERVICES

3,595,067. REG. 3-24-2009. MOLLYDOOKER WINES PTY LTD (AUSTRALIA COMPANY) LEVEL 1, BUILDING 8; 938 SOUTH ROAD; EDWARDSTOWN SA 5039, AUSTRALIA., SN 79-051,823. FILED 1-16-2008. PRINCIPAL REGISTER.

THE MOLLYDOOKER SHAKE

THE MARK CONSISTS OF STANDARD CHARACTERS WITHOUT CLAIM TO ANY PARTICULAR FONT, STYLE, SIZE, OR COLOR.

PRIORITY DATE OF 9-3-2007 IS CLAIMED. OWNER OF INTERNATIONAL REGISTRATION 0958519 DATED 1-16-2008, EXPIRES 1-16-2018.

OWNER OF U.S. REG. NO. 3,249,827.

INT. CL. 41/U.S. CLS. 100, 101 AND 107

FOR EDUCATIONAL TRAINING IN THE FIELD OF WINE PREPARATION FOR CONSUMPTION, NAMELY, FOR WINE CONSUMERS AS TO THE RECOMMENDED PREPARATION OF YOUNG [MOLLYDOOKER] WINES PRIOR TO CONSUMPTION.

FIRST USE ; IN COMMERCE .

INT. CL. 43/U.S. CLS. 100 AND 101

FOR PROVIDING OF INFORMATION RELATING TO THE PREPARING OF YOUNG [MOLLYDOOKER] WINES FOR DRINKING, NAMELY, ABOUT THE ENHANCEMENT OF YOUNG WINE'S SENSORY CHARACTERISTICS, PARTICULARLY THOSE YOUNG WINES CONTAINING HIGH LEVELS OF DISSOLVED NITROGEN; INFORMATION ABOUT THE PREPARATION AND ENJOYMENT OF YOUNG [MOLLYDOOKER] WINES, NAMELY, SOMMELIER SERVICES THAT PROVIDE ADVICE ON [MOLLYDOOKER] WINE AND FOOD PAIRING.

FIRST USE ; IN COMMERCE .

ELEMENTS CORRECTED
GOODS/SERVICES



OWNER OF U.S. REG. NOS. 2,574,786 AND 3,010,460. NO CLAIM IS MADE TO THE EXCLUSIVE RIGHT TO USE "IMPORTED DISTILLED AND BOTTLED IN POLAND BY POLMOS SIEDLCE" AND "40% ALC./VOL. (80 PROOF) 750 ML", APART FROM THE MARK AS SHOWN.

THE STIPPLING IS FOR SHADING PURPOSES ONLY. THE NAME(S), PORTRAIT(S), AND/OR SIGNATURE(S) SHOWN IN THE MARK DOES NOT IDENTIFY A PARTICULAR LIVING INDIVIDUAL.

THE COLOR(S) BLACK, WHITE AND SILVER IS/ARE CLAIMED AS A FEATURE OF THE MARK.

THE MARK CONSISTS OF THE DESIGN OF A BOTTLE WITH THE WORD "CHOPIN" IN WHITE LETTERING ON THE BLACK NECK OF THE BOTTLE WITH A SILVER STRIP AT THE BOTTOM OF THE BLACK NECK, AND THE BODY OF THE BOTTLE BEARING A BLACK AND WHITE IMAGE OF FREDERICK CHOPIN WITHIN A NON-FROSTED OVAL ABOVE THE WORD "CHOPIN" IN BLACK STYLIZED SCRIPT AND THE WORDS "POTATO VODKA" IN SILVER STYLIZED SCRIPT ABOVE THE WORDS "IMPORTED DISTILLED AND BOTTLED IN POLAND BY POLMOS SIEDLCE" IN BLACK LETTERING ABOVE THE WORDS "40% ALC./VOL. (80 PROOF) 750 ML" IN BLACK LETTERING, ALL ON A FROSTED WHITE BACKGROUND. THE MATTER SHOWN IN BROKEN LINES IS NOT PART OF THE MARK AND SERVES ONLY TO SHOW THE POSITION OR PLACEMENT OF THE MARK ON THE PACKAGING FOR THE GOODS.

INT. CL. 33/U.S. CLS. 47 AND 49

FOR DISTILLED SPIRITS .

FIRST USE 11-0-2005; IN COMMERCE 11-0-2005.

ELEMENTS AMENDED
MARK

3,611,115. REG. 4-28-2009. MCAFEE HEATING & AIR CONDITIONING CO., INC. (OHIO CORPORATION) 4770 HEMPSTEAD STATION DRIVE, KETTERING, OH, 45429, SN 77-406,286. FILED 2-26-2008. PRINCIPAL REGISTER.

8:00 TO 8:00 SAME GREAT RATE

THE MARK CONSISTS OF STANDARD CHARACTERS WITHOUT CLAIM TO ANY PARTICULAR FONT, STYLE, SIZE, OR COLOR.

INT. CL. 37/U.S. CLS. 100, 103 AND 106

FOR INSTALLATION AND REPAIR SERVICES RELATING TO HEATING SYSTEMS, AIR CLEANING SYSTEMS, AIR FILTRATION SYSTEMS, AIR COOLING SYSTEMS, DEHUMIDIFYING SYSTEMS; DUCT CLEANING SERVICES AND CARPET CLEANING SERVICES.
FIRST USE 4-0-2007; IN COMMERCE 4-0-2007.

ELEMENTS CORRECTED
OWNER NAME

3,616,135. REG. 5-5-2009. ZASS HAUSGERÄTE ENTWICKLUNGS GMBH (FED REP GERMANY LIMITED LIABILITY COMPANY) NÜRTINGER STRASSE 83, 72074 TÜBINGEN, FED REP GERMANY., SN 79-038,447. FILED 12-1-2006. PRINCIPAL REGISTER.

ZASS

THE MARK CONSISTS OF STANDARD CHARACTERS WITHOUT CLAIM TO ANY PARTICULAR FONT, STYLE, SIZE, OR COLOR.

PRIORITY DATE OF 6-2-2006 IS CLAIMED.

OWNER OF INTERNATIONAL REGISTRATION 0924090 DATED 12-1-2006, EXPIRES 12-1-2016.

INT. CL. 7/U.S. CLS. 13, 19, 21, 23, 31, 34 AND 35

FOR HIGH RACK STORAGE MACHINES, NAMELY, MACHINE OPERATED PLATFORMS CAPABLE OF ELEVATION ABOVE GROUND LEVEL AND USED FOR STORAGE; ELEVATORS AND ELEVATOR PARTS, NAMELY, ELEVATOR BELTS, ELEVATOR CHAINS; FREIGHT ELEVATORS; TRAVELATORS FOR PASSENGER TRANSPORTATION, NAMELY, MOVING SIDEWALKS; OVERHEAD TRAVELLING CRANES; ESCALATORS; LIFTING DEVICES AND EQUIPMENT, NAMELY, LIFTING INSTALLATIONS FOR THE TRANSPORT OF PERSONS AND GOODS; TRANSPORTATION BELTS; CONVEYORS; CONSTRUCTION MACHINES, NAMELY, EXCAVATORS, BULLDOZERS, LOADERS, STONE CUTTING MACHINES, GRINDERS, CONCRETE MIXING MACHINES; ROAD CONSTRUCTION MACHINES, NAMELY, ROAD SWEEPERS; ASPHALT COVERING MACHINES; MOTORS AND ENGINES FOR THE GENERATION OF ELECTRICITY; MACHINE TOOLS FOR THE CUTTING AND FORMING OF MATERIALS; MACHINE COUPLING AND TRANSMISSION COMPONENTS, NAMELY, INCORPORATORS, SEED DRILLS; AGRICULTURAL MACHINES, NAMELY, TILLERS, THRESHERS, COMBINES; INCUBATORS FOR EGGS; HIGH PRESSURE WATER BLASTERS FOR CLEANING SURFACES; STEAM CLEANERS; VACUUM CLEANERS; VACUUM CLEANING SYSTEMS COMPRISING VACUUM CLEANERS, VACUUM CLEANER BAGS, VACUUM CLEANER HOSES AND ACCESSORIES FOR SPRAYING SCENTS AND DISINFECTANTS, ALL SOLD AS A UNIT; SUCTION MACHINES FOR CLEANING PURPOSES; CARPET CLEANING MACHINES, NAMELY, ELECTRIC SHAMPPOOING MACHINES AND DEVICES FOR CARPETS AND CARPETED FLOORS; VEHICLE WASHING MACHINES; ELECTRIC PUMPS; PUMPS FOR HEATING SYSTEMS; VACUUM PUMPS; INDUSTRIAL ROBOTS; ELECTRICAL HOUSEHOLD APPLIANCES, NAMELY, STEAM IRONS, ELECTRIC CLOTHES PRESSING MACHINES, DISHWASHERS, WASHING MACHINES FOR CLOTHES, SEWING MACHINES; KITCHEN APPLIANCES, NAMELY, ELECTRIC FOOD PROCESSORS, JUICERS, ELECTRIC KNIVES, FOOD MIXERS, BREAD CUTTING MACHINES, ELECTRIC POTATO MASHERS, POWER-OPERATED COFFEE GRINDERS; ELECTRIC MACHINES FOR MAKING PASTA FOR DOMESTIC USE.

FIRST USE ; IN COMMERCE .

INT. CL. 8/U.S. CLS. 23, 28 AND 44

FOR HAND OPERATED CUTTING TOOLS; CUTLERY; KNIVES; SPOONS; FORKS; SIDE ARMS, NOT INCLUDING FIREARMS, NAMELY, SWORDS, HUNTING KNIVES; SCISSORS; NON-ELECTRIC EGG SLICERS; NON-ELECTRIC PIZZA CUTTERS; NON-ELECTRIC CHEESE CUTTERS; NON-ELECTRIC FRUIT AND VEGETABLE PEELERS; VEGETABLE SLICERS; ELECTRIC AND NON-ELECTRIC RAZORS; ELECTRIC AND NON-ELECTRIC PERSONAL CARE ACCESSORIES, NAMELY, MANICURE SETS, NAIL SCISSORS, PEDICURE SETS, EPILATORY APPLIANCES, SHAVING BLADES; HAND OPERATED DEVICES FOR MECHANICAL ENGINEERING, NAMELY, DRAW TAPE REELS; HAND-OPERATED DEVICES FOR VEHICLE CONSTRUCTION, NAMELY, EXTENSIONS FOR HAND TOOLS ; HAND-OPERATED DEVICES FOR STRUCTURAL ENGINEERING, NAMELY, DRAWKNIVES, SOCKET WRENCHES; HAND-OPERATED DEVICES FOR FORESTRY, FOR HORTICULTURE AND AGRICULTURE, NAMELY, DIGGING SPADES, HOES.

FIRST USE ; IN COMMERCE .

INT. CL. 9/U.S. CLS. 21, 23, 26, 36 AND 38

FOR WEIGHING EQUIPMENT, NAMELY, SCALES AND BALANCES, MEASURING INSTRUMENTS AND APPARATUS, NAMELY, RULES AND MEASURING SPOONS, LASER MEASURING SYSTEMS; SIGNALING INSTRUMENTS AND CHECKING INSTRUMENTS, NAMELY, CALIBRATION CHECKERS, APPARATUS AND INSTRUMENTS FOR CONDUCTING, SWITCHING, TRANSFORMING, ACCUMULATING, REGULATING OR CONTROLLING ELECTRICITY, NAMELY, ADAPTERS, CONDUITS, STARTERS, SWITCHES, CIRCUIT CUTTERS, FUSES, CONNECTORS; APPARATUS FOR RECORDING, TRANSMISSION OR REPRODUCTION OF SOUND AND IMAGES, BLANK MAGNETIC DATA CARRIERS AND MAGNETIC DISCS, AUTOMATIC VENDING MACHINES AND MECHANISMS FOR COIN-OPERATED APPARATUS, NAMELY, VENDING MACHINES AND COIN OPERATED GATES, CASH REGISTERS, SOUND AMPLIFIERS; ELECTRIC HAIR CURLERS; SLIDE PROJECTORS; CD-PLAYERS, DVD PLAYERS; MOBILE TELEPHONES; SCALES; LOUD-SPEAKERS; COMPUTER MONITORS, PRINTERS FOR COMPUTERS; RADIOS; TAPE AND VIDEOTAPE PLAYERS; TELEPHONE APPARATUS; TELEVISION SETS; WALKIE-TALKIES; VIDEO TAPE AND VIDEO CASSETTE RECORDERS; VIDEO CAMERAS; DIGITAL CAMERAS; FAX DEVICES; ANTENNAS; AMPLIFIERS; SOUND AMPLIFIERS AND PARTS THEREOF; MEASURING DEVICES, NAMELY, ELECTRIC TAPE MEASURES, MEASURING HOUR GLASSES, MEASURING INSTRUMENTS, NAMELY, HOUR GLASSES, TIMERS, GASOMETERS, FUEL GAUGES, FUEL AND MOTOR FUEL PUMPS FOR GAS STATIONS; ALARM DEVICES, NAMELY, SMOKE ALARMS; ACOUSTIC BURGLAR ALARMS; ELECTRIC FIRE AND BURGLAR ALARM BELLS AND WARNING ALARM WHISTLES; ELECTRIC DOOR BELLS; SIGNAL ALARM BELLS; SIRENS; ELECTRIC ACCESS CONTROL ANTI-THEFT ALARM MONITORING SYSTEMS; ANTI-THEFT ALARMS; SOLAR CELLS; SOLAR COLLECTORS FOR POWER GENERATION; ELECTRICAL BATTERIES; ELECTRICAL STORAGE BATTERIES; ELECTRICAL BATTERIES FOR VEHICLES; VOLTAGE STABILIZING POWER SUPPLIES, NAMELY, DEVICES FOR INTERRUPTION-FREE POWER SUPPLY AND SYSTEMS BASED THEREON FOR COMPUTER SYSTEMS; ELECTRIC DEVICES FOR ATTRACTING AND KILLING INSECTS; ELECTRIC DOOR OPENERS; REMOTE CONTROL DOOR OPENERS FOR VEHICLES; REMOTE CONTROL DEVICES FOR TELEVISIONS; NAVIGATION DEVICES FOR VEHICLES, NAMELY, GLOBAL POSITIONING SYSTEM CONSISTING OF ON-BOARD COMPUTERS, COMPUTER SOFTWARE, TRANSMITTERS, RECEIVERS, AND NETWORK INTERFACE DEVICES; ELECTRIC NAVIGATIONAL INSTRUMENTS; BAR CODE READERS; SATELLITES FOR SCIENTIFIC PURPOSES.

FIRST USE ; IN COMMERCE .

INT. CL. 11/U.S. CLS. 13, 21, 23, 31 AND 34

FOR STEAM GENERATORS; COOKING RANGES; REFRIGERATORS; DRYING APPARATUS, NAMELY, INDUSTRIAL DRYERS FOR HEATING AND DEHUMIDIFYING; VENTILATING APPARATUS, NAMELY, VENTILATING HOODS AND LOUVERS; APPARATUS FOR WATER SUPPLY AND SANITARY PURPOSES, NAMELY, WATER FILTERS; WATER DISTILLATION UNITS, HOT WATER TANKS; ELECTRIC BABY BOTTLE WARMERS; ELECTRIC TUMBLE CLOTHING DRYERS, ELECTRIC COFFEE MAKERS; ELECTRIC TEA KETTLES AND POTS; ELECTRIC TOASTERS; ELECTRIC COOLING FANS FOR AIR-CONDITIONING; BARBECUES; ELECTRIC COOKERS; COOKING RANGES; GAS AND ELECTRIC STOVES; HOT WATER HEATERS; DRINKING WATER FILTERS; STEAM RADIATORS FOR HEATING BUILDINGS; ELECTRIC RADIATORS FOR HEATING BUILDINGS; ELECTRIC DEEP FRYERS; BARBECUE GRILLS; AIR-CONDITIONING UNITS; MICROWAVE OVENS; MICROWAVE OVENS WITH INTEGRATED GRILL; HAIR DRYERS; VEHICLE HEAD LAMPS, NAMELY, AUTOMOTIVE HEAD LAMPS; ELECTRIC YOGHURT MAKERS; STEAM IRONS; ELECTRIC EGG COOKERS; AUTOMATIC BAKING DEVICES, NAMELY, BAKING OVENS; ELECTRIC HEATING FANS; HOT AIR SPACE HEATING APPARATUS; ELECTRIC WAFFLE IRONS; FILTERS AS PARTS OF DOMESTIC OR INDUSTRIAL SYSTEMS, NAMELY, INDUSTRIAL AIR FILTER MACHINES, HEPA FILTERS FOR HOUSEHOLD USE; HEATING DEVICES FOR SOLID, LIQUID OR GASEOUS FUELS, NAMELY, COAL STOVES, GAS WATER HEATERS, WATER HEATERS FOR DOMESTIC AND INDUSTRIAL USE; THERMOSTATIC VALVES AS PARTS OF HEATING SYSTEMS; HEAT PUMPS; HEAT REGENERATORS, NAMELY, SOLAR HEAT COLLECTION PANELS; HEAT ACCUMULATORS; HEAT EXCHANGERS NOT BEING PARTS OF MACHINES; SOLAR COLLECTORS FOR HEATING; STEAM GENERATING SYSTEMS COMPRISED OF STEAM GENERATORS, STEAM ACCUMULATORS, STEAM RADIATORS FOR HEATING BUILDINGS, HOT WATER RADIATORS FOR HEATING BUILDINGS, PANEL RADIATORS, RADIATOR HEATING SYSTEMS, RADIATOR CAPS, VALVES AS PARTS OF RADIATORS; FIRING CHANNELS FOR BOILERS; FURNACES, NAMELY, ELECTRICAL IGNITERS, HEAT DIFFUSION COLLARS AND DISCS; AIR-CONDITIONERS FOR VEHICLES; AIR-CONDITIONING APPARATUS AND COMPONENT PARTS THEREFOR, NAMELY, COMPRESSORS FOR AIR CONDITIONERS, VALVES FOR AIR CONDITIONERS, AIR CONDITIONING PANELS FOR USE IN WALK-IN COOLERS, EVAPORATIVE AIR COOLERS, AIR COOLING AND VENTILATION APPARATUS AND INSTRUMENTS, AIR CONDITIONING INSTALLATIONS, AND CENTRAL AIR-CONDITIONING INSTALLATIONS FOR INDUSTRIAL PURPOSES; REFRIGERATING SYSTEMS AND APPARATUS, NAMELY, FOOD AND BEVERAGE CHILLING UNITS, PORTABLE REFRIGERATED ROOMS; REFRIGERATORS; DEEP FREEZING APPARATUS AND SYSTEMS, NAMELY, WALK-IN FREEZERS, FREEZING SHOWCASES; AIR CLEANING APPARATUS AND MACHINES, NAMELY, AIR CLEANING UNITS, SEPARATORS FOR THE CLEANING AND PURIFICATION OF AIR; AIR HUMIDIFIERS FOR CENTRAL HEATERS; CONTROL AND SAFETY ACCESSORIES FOR WATER OR GAS DEVICES AND FOR WATER AND GAS PIPES, NAMELY, LEVEL CONTROL VALVES FOR TANKS, ELECTRIC GENERATOR FOR CONTROLLING HUMIDITY IN THE AIR, VARIOUS GAS AND WATER PIPE CONTROL VALVES; OVEN GAS IGNITERS, SPARK IGNITERS FOR GAS APPLIANCES; DRYING APPARATUS, SYSTEMS AND DEVICES, NAMELY, HAND DRYERS FOR WASHROOMS, INDUSTRIAL DRYERS FOR HEATING AND DEHUMIDIFYING; AIR FILTERS FOR AIR CONDITIONING SYSTEMS; EVAPORATORS FOR AIR CONDITIONERS; VENTILATORS AS PARTS OF AIR-CONDITIONING SYSTEMS; WATER CHILLERS; AIR-HANDLING UNITS; HOT-WATER HEATING SYSTEMS COMPRISED OF HOT WATER SPACE HEATING APPARATUS; GAS-OPERATED COMBINATION DEVICES FOR HOT WATER AND HEATING SUPPLY, NAMELY, GAS FURNACES; FURNACE BOILERS; OIL BURNERS AND GAS BURNERS FOR INDUSTRIAL AND DOMESTIC USE, WATER FILTERS; WATER CLEANING SYSTEMS, NAMELY, INDUSTRIAL WATER PURIFYING RING APPARATUS; WATER SOFTENING UNITS; DRINKING WATER FILTERS; BATHTUBS; SITZ

BATHS; BIDETS; SHOWER CABINETS COMPLETE WITH FAUCETS, DOORS AND SHOWER HEADS; WASH BASINS AS PARTS OF SANITARY EQUIPMENT; URINALS AS SANITATION FIXTURE, TOILETS AS WATER CLOSETS (WC), TOILET BOWLS AS WATER CLOSETS (WC), TOILET SEATS FOR WATER CLOSETS (WC); ELECTRIC BLANKETS NOT FOR MEDICINAL PURPOSES; ELECTRIC HEATING PADS, NOT FOR MEDICINAL PURPOSES; ELECTRIC FOOT WARMERS; HOT-WATER BOTTLES; PASTEURIZERS FOR USE IN FOOD, BEVERAGE AND PHARMACEUTICAL INDUSTRIES; STERILIZERS NOT FOR MEDICINAL PURPOSES.
FIRST USE ; IN COMMERCE .

INT. CL. 12/U.S. CLS. 19, 21, 23, 31, 35 AND 44

FOR AUTOMOBILES; TRUCKS; AUTOBUSES; CONCRETE MIXER TRUCKS; COACHES; TRAILERS; MOTORIZED GOLF CARTS; AMBULANCES; REFRIGERATED VEHICLES, NAMELY, TRAILERS, TRUCKS, WAGONS; SPORTS MOTOR CARS; SPRINKLER TRUCKS FOR STREET CLEANING; TRACTORS; MOBILE HOMES; CARAVANS; LAND VEHICLES WITH BEDS FOR SLEEPING; VEHICLE WINDOWS; VEHICLE WHEELS FOR AUTOMOBILES, TRUCKS; VEHICLE TIRES FOR LAND VEHICLES; INNER TUBES FOR TIRES; TUBELESS TIRES FOR LAND VEHICLES; VEHICLE WHEEL SPOKES; VEHICLE SEATS; VEHICLE TOPS, NAMELY, CONVERTIBLE TOPS; RIMS FOR VEHICLE WHEELS; FRONT SPOILERS FOR VEHICLES; FOOT PEDALS FOR VEHICLES; TRANSMISSIONS FOR LAND VEHICLES; HOOPER HORNS AND SIGNAL HORNS FOR VEHICLES; TORSION SHAFTS FOR LAND VEHICLES; HYDRAULIC CIRCUITS FOR LAND VEHICLES; SUPPORT AND SUSPENSION SPRINGS FOR LAND VEHICLES; DRIVE CHAINS FOR LAND VEHICLES; ENGINES FOR LAND VEHICLES; AXLE BOOTS FOR LAND VEHICLES; HUBS FOR VEHICLE WHEELS; HUB RINGS, STEERING KNUCKLES, DRIVE SHAFTS FOR LAND VEHICLES; DRIVE SHAFT JOINTS FOR LAND VEHICLES; CHAINS FOR AUTOMOTIVE VEHICLES; COUPLINGS FOR LAND VEHICLES; GEARS FOR LAND VEHICLES; WHEEL COVERS; CLUTCHES FOR LAND VEHICLES; JET ENGINES FOR LAND VEHICLES; AIR TURBINES FOR LAND VEHICLES; BODIES FOR AUTOMOTIVE VEHICLES; CHASSIS FOR AUTOMOTIVE VEHICLES; MUDGUARDS FOR VEHICLES; BUMPERS FOR AUTOMOTIVE VEHICLES; FENDERS AS PARTS OF LAND VEHICLES; ENGINE HOODS FOR VEHICLES; VEHICLE DOORS, NAMELY, DOOR HANDLES, DOOR PANELS; MOTORCYCLES AND STRUCTURAL PARTS THEREFOR; BICYCLES AND STRUCTURAL PARTS THEREFOR; MOPEDS AND STRUCTURAL PARTS THEREFOR; MOTORIZED SCOOTERS; SHOCK ABSORBERS FOR LAND VEHICLES; BRAKE SYSTEMS FOR LAND VEHICLES; BRAKE SHOES FOR LAND VEHICLES; BRAKE DISCS FOR LAND VEHICLES; BRAKE HOSES AS PART OF HYDRAULIC DISC BRAKES FOR LAND VEHICLES; SNOW CHAINS FOR TIRES; ANTI-SKID CHAINS FOR VEHICLES; SKI RACKS FOR AUTOMOTIVE VEHICLES; LUGGAGE RACKS FOR LAND VEHICLES; ANTI-THEFT DEVICES FOR MOTOR CARS; ALARM SYSTEMS FOR VEHICLES; AIRBAGS AS SAFETY DEVICES FOR CARS; SAFETY BELTS FOR MOTOR CARS; SLIP-COVERS FOR VEHICLE SEATS; BABY BUGGIES; WHEELCHAIRS; SHOPPING CARTS; SKI LIFTS; AERIAL TRAMWAYS, NAMELY, CABINS FOR CABLE-WAY TRANSPORTATION SYSTEMS; LOCOMOTIVES; STREETCARS, NAMELY, TROLLEYS; RAILWAY VEHICLES, NAMELY, PASSENGER CARRIAGES, TRAINS AND STRUCTURAL PARTS THEREFOR; RAILWAY COUPLINGS; RAILWAY CARS; BOATS FOR TRANSPORTING CARGO; SHIP; SHIPS FENDERS; SHIP FUNNELS; SHIP PROPELLERS FOR SEAGOING VESSELS; SHIP STEERING DEVICES, NAMELY, STEERING GEARS AND RUDDERS; YACHTS; BOATS; BOAT DAVITS; BOAT MASTS; PADDLES FOR CANOES AND KAYAKS; SCREW PROPELLERS; AIRCRAFT; HELICOPTERS; BALLOONS; PARACHUTES; SPACE VEHICLES; ROCKETS FOR SPACE VEHICLES.
FIRST USE ; IN COMMERCE .

INT. CL. 13/U.S. CLS. 2 AND 9

FOR FIREARMS; AMMUNITION AND PROJECTILES; EXPLOSIVES; FIREWORKS.
FIRST USE ; IN COMMERCE .

INT. CL. 17/U.S. CLS. 1, 5, 12, 13, 35 AND 50

FOR ELECTRICAL INSULATING MATERIALS; INSULATORS FOR RAILWAY TRACKS; INSULATING PAINTS, ELECTRICAL INSULATING TAPE; INSULATING VARNISHES; INSULATING FOILS OF METAL FOR BUILDING INSULATION; INSULATING GLOVES; INSULATING OIL FOR TRANSFORMERS; INSULATING PLASTER; ASBESTOS FELT; GLASS WOOL, ROCK WOOL OR MINERAL WOOL FOR HEAT AND SOUND INSULATION IN BUILDINGS AND AIR-CONDITIONING SYSTEMS.

FIRST USE ; IN COMMERCE .

INT. CL. 19/U.S. CLS. 1, 12, 33 AND 50

FOR NON-METALLIC TRANSPORTABLE BUILDINGS; NON-METALLIC OUTDOOR VENETIAN BLINDS; EXTERIOR ROLLING SHUTTERS, NOT OF METAL AND NOT OF TEXTILE MATERIAL; NON-METAL WINDOWS; NON-METAL WINDOW SHUTTERS; NON-METAL WINDOW FRAMES; WOOD FIBER CONCRETE; WOOD VENEERS; WOOD PAVING BLOCKS; WOOD PANELING; PARQUET FLOORING; PARQUET BLOCKS OF WOOD; NON-METALLIC GUTTERS; NON-METALLIC WALL PANELING; WATER PIPES, NOT OF METAL; NON-METALLIC WASTE PIPES; NON-METALLIC BRANCH PIPES; NON-METALLIC RIGID PIPES FOR VENTILATION AND AIR-CONDITIONING SYSTEMS; PLYWOOD; NON-METALLIC SUPPORTS USED FOR CONSTRUCTION; NON-METALLIC PARTITION WALL PANELS; NON-METALLIC STAIRCASES; NON-METALLIC DOORS; NON-METALLIC DOOR PANELS; NON-METALLIC DOOR FRAMES AND CASINGS.

FIRST USE ; IN COMMERCE .

INT. CL. 21/U.S. CLS. 2, 13, 23, 29, 30, 33, 40 AND 50

FOR HOUSEHOLD OR KITCHEN UTENSILS AND CONTAINERS NOT OF PRECIOUS METAL BUT MADE OF PLASTICS, PORCELAIN, CERAMIC, SYNTHETIC MATERIAL, NAMELY, STRAINERS, PICNIC BAGS, BAGS, PLATES, POTS, BUCKETS, DIPPERS, TUBS, BOWLS, BINS, FLOWER POTS; BRUSH MAKING MATERIALS; COMBS; STEEL WOOL FOR CLEANING; UNWORKED OR SEMI- WORKED GLASS EXCEPT GLASS USED IN BUILDING; BEVERAGE GLASSWARE; TOOTHBRUSHES; ELECTRIC TOOTHBRUSHES; IRONING BOARDS, IRON STANDS; SMALL HAND-OPERATED HOUSEHOLD AND KITCHEN DEVICES, NAMELY, MIXERS, BLENDERS, JUICERS, FRUIT AND VEGETABLE PEELERS, COFFEE GRINDERS; OBJECTS OF ART MADE OF PORCELAIN, CLAY, GLASS, BOTTLE OPENERS, SHOE HORNS; NON-ELECTRIC BARBECUES, GRILLS, COOKERS; DEVICES FOR PERSONAL HYGIENE AND BEAUTY CARE AND COSMETIC DEVICES, NAMELY, BRUSHES FOR HAIR, NAILS, MAKE-UP AND TEETH.

FIRST USE ; IN COMMERCE .

INT. CL. 22/U.S. CLS. 1, 2, 7, 19, 22, 42 AND 50

FOR ROPES; STRINGS; TENTS; AWNINGS; SAILS; UNFITTED COVERS FOR AUTOMOBILES.

FIRST USE ; IN COMMERCE .

INT. CL. 24/U.S. CLS. 42 AND 50

FOR SHOWER CURTAINS OF TEXTILE MATERIAL OR OF PLASTIC SHEETING; BED COVERS; BED COVERS OF PAPER; BED LINEN; COVERS FOR CUSHIONS AND PILLOWS; CURTAINS OF TEXTILES OR PLASTICS; HOUSEHOLD LINEN; MATTRESS COVERS; TABLE COVERS.

FIRST USE ; IN COMMERCE .

INT. CL. 25/U.S. CLS. 22 AND 39

FOR CLOTHING, NAMELY, PANTS, SWEATERS, JACKETS, DRESSES; FOOTWEAR; HEADWEAR, NAMELY, HATS AND CAPS.

FIRST USE ; IN COMMERCE .

INT. CL. 27/U.S. CLS. 19, 20, 37, 42 AND 50

FOR CARPETS; MATS AND MATTING FOR COVERING FLOORS; MATS FOR AUTOMOBILES; LINOLEUM FOR COVERING EXISTING FLOORS; NON-TEXTILE WALL HANGINGS; WALL PAPER; ARTIFICIAL GRASS.

FIRST USE ; IN COMMERCE .

INT. CL. 35/U.S. CLS. 100, 101 AND 102

FOR ADVERTISING SERVICES; ARRANGING AND CONDUCTING AUCTIONS; ONLINE AUCTION SERVICES AND ORGANIZATION OF INTERNET AUCTIONS; RETAIL STORE SERVICES FEATURING LARGE AND SMALL HOME APPLIANCES.

FIRST USE ; IN COMMERCE .

INT. CL. 37/U.S. CLS. 100, 103 AND 106

FOR INSTALLATION AND REPAIR OF HEATING EQUIPMENT; INSTALLATION AND REPAIR OF VENTILATION AND AIR-CONDITIONING SYSTEMS; INSTALLATION AND REPAIR OF COOLING APPARATUS.

FIRST USE ; IN COMMERCE .

INT. CL. 42/U.S. CLS. 100 AND 101

FOR DEVELOPMENT AND RESEARCH FOR NEW PRODUCTS FOR OTHERS; SCIENTIFIC RESEARCH AND DEVELOPMENT; SERVICES OF ENGINEERS CONCERNED WITH ASSESSMENTS, ESTIMATES, ANALYSES AND EXPERT OPINION IN THE SCIENTIFIC AND TECHNOLOGICAL FIELD, NAMELY, CHEMICAL RESEARCH, MINING EXPERTISE, GEOLOGICAL RESEARCH, PRODUCT TESTING SERVICES, QUALITY CONTROL SERVICES, ARCHITECTURAL SERVICES, TECHNICAL PROJECT SERVICES IN THE HEATING, VENTILATING AND AIR-CONDITIONING FIELD.

FIRST USE ; IN COMMERCE .

ELEMENTS CORRECTED
GOODS/SERVICES

3,625,421. REG. 5-26-2009. ALEXANDRIA SANITATION AUTHORITY (VIRGINIA LIMITED LIABILITY COMPANY) 1500 EISENHOWER AVENUE, ALEXANDRIA, VA, 22314, SN 77-404,378. FILED 2-22-2008. PRINCIPAL REGISTER.



NO CLAIM IS MADE TO THE EXCLUSIVE RIGHT TO USE "ALEXANDRIA SANITATION AUTHORITY", APART FROM THE MARK AS SHOWN.

THE MARK CONSISTS OF A WATER DROPLET WEARING A POLICE HAT AND BLOWING A WHISTLE WITH THE WORDS "ALEXANDRIA SANITATION AUTHORITY" ENCIRCLING THE BOTTOM.

AS TO "SANITATION AUTHORITY".

INT. CL. 35/U.S. CLS. 100, 101 AND 102

FOR PROMOTING PUBLIC AWARENESS OF THE NEED FOR REDUCING OIL AND GREASE DISCHARGES TO SEWERS AND TO PROMOTE GREASE RECYCLING.

FIRST USE 4-30-2005; IN COMMERCE 4-22-2006.

ELEMENTS CORRECTED
CITIZENSHIP
[ENTITY]

3,626,904. REG. 5-26-2009. VON LEE INTERNATIONAL SCHOOL OF AESTHETICS, INC. (MARYLAND CORPORATION) 309 REISTERSTOWN ROAD, PIKESVILLE, MD, 21208. SN 77-604,832. FILED 10-31-2008. PRINCIPAL REGISTER.

3,628,497. REG. 5-26-2009. FREEDOM ARIZONA INFORMATION INC. (CALIFORNIA CORPORATION), DBA FAZI, 2873 N. NEVADA ST., CHANDLER, AZ, 85225. SN 77-485,576. FILED 5-28-2008. PRINCIPAL REGISTER.

VON LEE

THE MARK CONSISTS OF STANDARD CHARACTERS WITHOUT CLAIM TO ANY PARTICULAR FONT, STYLE, SIZE, OR COLOR.

OWNER OF U.S. REG. NO. 1,145,284.
THE NAME(S), PORTRAIT(S), AND/OR SIGNATURE(S) SHOWN IN THE MARK DOES NOT IDENTIFY A PARTICULAR LIVING INDIVIDUAL.
INT. CL. 44/U.S. CLS. 100 AND 101
FOR BEAUTY AND SKIN CARE SALON SERVICES.
FIRST USE 5-9-1979; IN COMMERCE 12-0-1979.

ELEMENTS CORRECTED
DATE OF FIRST USE

3,626,905. REG. 5-26-2009. VON LEE INTERNATIONAL SCHOOL OF AESTHETICS, INC. (MARYLAND CORPORATION) 309 REISTERSTOWN ROAD, PIKESVILLE, MD, 21208. SN 77-604,841. FILED 10-31-2008. PRINCIPAL REGISTER.



OWNER OF U.S. REG. NO. 1,145,284.
THE NAME(S), PORTRAIT(S), AND/OR SIGNATURE(S) SHOWN IN THE MARK DOES NOT IDENTIFY A PARTICULAR LIVING INDIVIDUAL.
THE MARK CONSISTS OF AN IMAGE OF A WOMAN'S HEAD FACING FORWARD, WITH A PAIR OF HANDS UNDERNEATH HER CHIN.
INT. CL. 44/U.S. CLS. 100 AND 101
FOR BEAUTY AND SKIN CARE SALON SERVICES.
FIRST USE 5-9-1978; IN COMMERCE 12-0-1979.

ELEMENTS CORRECTED
DATE OF FIRST USE

Veep

THE MARK CONSISTS OF STANDARD CHARACTERS WITHOUT CLAIM TO ANY PARTICULAR FONT, STYLE, SIZE, OR COLOR.

INT. CL. 35/U.S. CLS. 100, 101 AND 102
FOR ADVERTISING AND ADVERTISEMENT SERVICES.
FIRST USE 1-1-2009; IN COMMERCE 1-1-2009.

ELEMENTS CORRECTED
OWNER NAME

3,628,708. REG. 5-26-2009. DISNEY ENTERPRISES, INC. (DELAWARE CORPORATION) 500 SOUTH BUENA VISTA STREET, BURBANK, CA, 91521. SN 77-976,978. FILED 4-5-2007. PRINCIPAL REGISTER.

WHERE IMAGINATION BEGINS

THE MARK CONSISTS OF STANDARD CHARACTERS WITHOUT CLAIM TO ANY PARTICULAR FONT, STYLE, SIZE, OR COLOR.

INT. CL. 25/U.S. CLS. 22 AND 39
FOR BABY BIBS NOT OF PAPER; CLOTH BIBS; DRESSES; FOOTWEAR; HEAD WEAR; HOSIERY; INFANTWEAR; JACKETS; PAJAMAS; PANTS; SHIRTS; SHOES; SKIRTS; SHORTS; SLEEPWEAR; SOCKS; SWEATERS; SWIMSUITS; T-SHIRTS; VESTS.
FIRST USE 7-14-2007; IN COMMERCE 7-14-2007.

ELEMENTS AMENDED
DATE OF FIRST USE

3,630,319. REG. 6-2-2009. LYNN AB (SWEDEN CORPORATION) IDEON SCIENCE PARK, LUND, SWEDEN, 22370. SN 77-568,897. FILED 9-12-2008. PRINCIPAL REGISTER.



THE MARK CONSISTS OF IMAGE SIMILAR TO AN EYE AND THE WORD "LYYN".
INT. CL. 9/U.S. CLS. 21, 23, 26, 36 AND 38

FOR SYSTEMS COMPRISING SOFTWARE AND HARDWARE FOR PROVIDING PICTURE, VIDEO, ALARM STATUS AND OTHER INFORMATION TO USER OR REMOTE STATION; APPARATUS FOR TRANSMISSION OR REPRODUCTION OF IMAGES INCLUDING IMAGE ENHANCEMENT FEATURE; SOFTWARE FOR THE PURPOSE OF TRANSMISSION OR REPRODUCTION OF IMAGES INCLUDING IMAGE ENHANCEMENT FEATURE.

FIRST USE 12-0-2004; IN COMMERCE 12-0-2004.

ELEMENTS CORRECTED
OWNER NAME
MARK

3,631,442. REG. 6-2-2009. DANFOSS A/S (DENMARK CORPORATION) NORDBORGVEJ 81, NORDBORG, DENMARK, DK-6430, SN 78-932,055. FILED 7-18-2006. PRINCIPAL REGISTER.

POLYPOWER

THE MARK CONSISTS OF STANDARD CHARACTERS WITHOUT CLAIM TO ANY PARTICULAR FONT, STYLE, SIZE, OR COLOR.

PRIORITY CLAIMED UNDER SEC. 44(D) ON ERP CMNTY TM OFC APPLICATION NO. CTM005200605, FILED 7-17-2006, REG. NO. 005200605, DATED 6-21-2007, EXPIRES 7-17-2016.

INT. CL. 7/U.S. CLS. 13, 19, 21, 23, 31, 34 AND 35

FOR NON-ELECTRIC LINEAR ACTUATORS, NAMELY, ARTIFICIAL MUSCLES, FORCE ACTUATORS, AND PUSH PULL ACTUATORS.

INT. CL. 9/U.S. CLS. 21, 23, 26, 36 AND 38

FOR ELECTRIC ACTUATORS.

INT. CL. 17/U.S. CLS. 1, 5, 12, 13, 35 AND 50

FOR ELASTOMER FILM FOR USE IN THE MANUFACTURE OF ACTUATORS AND MEDICAL DEVICES; ELECTRO ACTIVE POLYMERIC FILM FOR USE IN THE MANUFACTURE OF ACTUATORS AND MEDICAL DEVICES; ELECTRO ACTIVE ELASTOMER FILM FOR USE IN THE MANUFACTURE OF ACTUATORS AND MEDICAL DEVICES; ELECTRO RESPONSIVE SHAPE CHANGING FILM FOR USE IN THE MANUFACTURE OF ACTUATORS AND MEDICAL DEVICES.

ELEMENTS CORRECTED
FOREIGN APPLICATION NO.

3,631,546. REG. 6-2-2009. HERLITZ PBS AG; PAPIER-, BÜRO UND SCHREIBWAREN (FED REP GERMANY AKTIENGESELLSCHAFT) AM BORSIGTURM 100, 13507 BERLIN, FED REP GERMANY., SN 79-051,278. FILED 6-29-2007. PRINCIPAL REGISTER.



PRIORITY DATE OF 12-29-2006 IS CLAIMED.
OWNER OF INTERNATIONAL REGISTRATION 0957079
DATED 6-29-2007, EXPIRES 6-29-2017.

OWNER OF U.S. REG. NO. 2,354,387.

THE COLOR(S) RED AND WHITE IS/ARE CLAIMED AS A FEATURE OF THE MARK.

THE MARK CONSISTS OF THE COLORS RED AND WHITE, WITH THE COLOR WHITE APPEARING IN THE WORDING "HERLITZ" AND IN THE STYLIZED CRESCENT AND SWIRL DESIGN, AND THE COLOR RED APPEARING AS A BACKGROUND TO THE WORDING AND DESIGNS WITHIN THE OBLONG SHAPE.

INT. CL. 2/U.S. CLS. 6, 11 AND 16

FOR PAINTS, FINGER PAINTS.

INT. CL. 9/U.S. CLS. 21, 23, 26, 36 AND 38

FOR POCKET CALCULATORS, FAX MACHINES, TELEPHONE ANSWERING MACHINES, DICTATION MACHINES, COMPUTER PRINTERS, DESK CALCULATORS, PHOTOCOPYING MACHINES; DATA PROCESSING EQUIPMENT, NAMELY, PERSONAL COMPUTERS, COMPUTER PRINTERS, ALTERATION SWITCHES FOR USE WITH DATA PROCESSING EQUIPMENT; OPTICAL FILTERS, COMPUTER MONITORS, COMPUTER MOUSE, INFRARED COMPUTER MOUSE, COMPUTER GAME TRACKBALLS, COMPUTER GAME JOYSTICKS, COMPUTER CABLES, COMPUTER PRINTER CABLES, COMPUTER LAPTOPS, ELECTRICAL POWER EXTENSION CORDS, ELECTRICAL CONNECTORS, COMPATIBLE COMPUTER CONNECTORS, COMPUTER MONITOR CABLES, ZERO MODEM COAXIAL CABLES, ADAPTERS IN THE FORM OF ELECTRIC OR ELECTRONIC COMPONENTS FOR CONNECTING DEVICES OF DIFFERENT TYPES, TELECOMMUNICATIONS EQUIPMENT, NAMELY, ANALOG TERMINAL ADAPTERS, CABLES FOR ANALOG TERMINAL ADAPTERS, ELECTRICAL POWER EXTENSION CORDS, ELECTRICAL SOCKETS, SURFACE MOUNTING BOXES AND FLUSH FACE BOXES; BLANK AUDIO CASSETTES, BLANK AUDIO MICRO-CASSETTES, BLANK FLOPPY DISKS FOR COMPUTERS, BOXES AND CONTAINERS SPECIALLY ADAPTED FOR STORING A COMPUTER MOUSE; STORAGE MEDIA FOR COMPUTERS, NAMELY, BLANK FLOPPY DISKS, BLANK DISK COMPUTER CASSETTES, BLANK DISK, ELECTRONIC MEMORY CARDS, MEMORY MODULES * NOT RECORDED, * BLANK DATA CARTRIDGES, BLANK OPTICAL DISKS, BLANK RE-INSCRIBABLE COMPACT DISKS, STORAGE BOXES FOR COMPUTER DISKS, CASSETTES, MEMORY CARDS AND CARTRIDGES; COMPUTER GRAPHICS CARDS FOR DATA PROCESSING SYSTEMS; DUST COVERS FOR COMPUTER MONITORS KEYBOARDS AND LAPTOPS.

FIRST USE ; IN COMMERCE .

INT. CL. 16/U.S. CLS. 2, 5, 22, 23, 29, 37, 38 AND 50

FOR PAPER AND CARDBOARD GOODS, NAMELY, NOTE PAPER, GREETING CARDS, ENVELOPES, PAPER ENVELOPES FOR PACKAGING, BUSINESS CARDS, HANDMADE WRITING PAPER WITH DECKLED EDGES, WRITING PADS AND NOTE PADS, SKETCH PADS, NOTE PADS WITH ADHESIVE BACKING, PRINTED FORMS, CASH REGISTER PAPER, HEAT SENSITIVE PRINTING PAPER, PRESSURE SENSITIVE PRINTING PAPER, COPY PAPER, PAPER FOR ELECTRONIC DATA PROCESSING, PROOF PAPER, BLANK FORMS, FACSIMILE TRANSMISSION PAPER, INDEX CARDS, EXERCISE BOOKS, THREE RING BINDERS * EXCEPT FOR TRAVEL, INSTRUCTIONAL AND TEACHING MATERIALS, * FILE FOLDERS, SUSPENDED FILE FOLDERS, DOCUMENT FILES, FOLDERS, SPRING FOLDERS, PRINTED LABELS, PAPER SIGNS, CARDBOARD SIGNS, SIGNS OF FELT PAPER, PARCHMENT PAPER SIGNS, PAPER STICKERS, STICKERS FOR ELECTRONIC DATA PROCESSING, WRITING FOILS FOR OVERHEAD PROJECTORS, PA-

PER JACKETS FOR COVERS OF FLOPPY DISKS, FLOPPY DISK MAILING ENVELOPES, PRINTER'S SHOP PRODUCTS, NAMELY, GIFT WRAPPING PAPER; PRINTED PUBLICATIONS, NAMELY, NEWSPAPERS, MAGAZINES AND BOOKS IN THE FIELD OF COMPUTERS AND DATA PROCESSING, STATIONERY; WRITING, PAINTING AND DRAWING IMPLEMENTS; ARTISTS' BRUSHES, PAINT BRUSHES, MODELING COMPOUNDS, TYPEWRITERS; OFFICE SUPPLIES, NAMELY, STAPLE REMOVERS, TYPEWRITER RIBBONS, STAPLERS, EMBOSSERS, ADDRESS BOOKS, FILE BOXES FOR STORAGE OF BUSINESS AND PERSONAL RECORDS, COPYHOLDERS, COPYHOLDER ARMS, WRITING INSTRUMENTS, PENS AND PENCILS, COLOR PENCILS, CASES FOR SCHOOL SUPPLIES, PAPER GLUES, PAPER CLIP TRAYS, OFFICE PERFORATING MACHINES, STAPLE REMOVER TONGS, PEN HOLDERS, PEN TRAYS, PAPER CLIP DISPENSERS, LETTER TRAYS, BLOTTERS, INK STAMP STANDS, LETTER RACKS, ADHESIVE TAPE DISPENSERS FOR HOUSEHOLD OR STATIONERY USE, CORRESPONDENCE HOLDERS, BOOKENDS, SLATE BOARDS FOR WRITING, CHALK, GLOBES, PRINTING LETTERS, PRINTING PLATES, OFFICE SETS COMPRISING PERFORATORS, STAPLERS, ERASERS, SHARPENERS, RULERS, STENCILS, PAPER CLIP HOLDERS AND DISPENSERS, FELT TIP MARKERS AND INDEX CARD BOXES; ART AND PHOTOGRAPH PORTFOLIO CASES; CASES FOR CHECKS; FLIP CHART CASES; PASSPORT CASES; PEN AND PENCIL CASES AND BOXES; PEN AND PENCIL CASES; PEN CASE; PENCIL CASES; STAMP CASES; STATIONERY CASES; STENCIL CASES; PENCIL BOXES; DOCUMENT PORTFOLIOS; STATIONERY-TYPE PORTFOLIOS; POUCHES FOR WRITING INSTRUMENTS.

FIRST USE ; IN COMMERCE .

3,632,797. REG. 6-2-2009. HAYS, GARRY (UNITED STATES INDIVIDUAL) 1122 SE BARNES ROAD, GRESHAM, OR, 97080, SN 77-458,778. FILED 4-25-2008. PRINCIPAL REGISTER.



THE COLOR(S) RED AND GREEN IS/ARE CLAIMED AS A FEATURE OF THE MARK.

THE MARK CONSISTS OF A CIRCLE CONTAINING A TRANSPARENT DEPICTION OF THE COUNTRY OF MEXICO, WITH RED SHADING WITHIN THE TOP OF THE CIRCLE AND GREEN SHADING WITHIN THE BOTTOM OF THE CIRCLE.

INT. CL. 36/U.S. CLS. 100, 101 AND 102

FOR REAL ESTATE BROKERAGE; REAL ESTATE SERVICES, NAMELY, REAL ESTATE ACQUISITION SERVICES, REAL ESTATE LISTING SERVICES FOR THE HOUSING RENTALS AND APARTMENT RENTALS, REAL ESTATE MULTIPLE LISTING SERVICES, REAL ESTATE VALUATION SERVICES, REAL ESTATE CONSULTATION; REAL ESTATE EQUITY SHARING, NAMELY, MANAGING AND ARRANGING FOR CO-OWNERSHIP OF REAL ESTATE; REAL ESTATE INVESTMENT; REAL ESTATE LISTING; REAL ESTATE MANAGEMENT; REAL ESTATE MANAGEMENT CONSULTATION; REAL ESTATE RENTAL SERVICES, NAMELY, RENTAL OF RESIDENTIAL HOUSING; REAL ESTATE SERVICES, NAMELY, PROVIDING ONLINE QUESTIONNAIRE TO HELP USERS DETERMINE THE BEST NEIGHBORHOODS AND COMMUNITIES SUITED TO THEIR INDIVIDUAL NEEDS AND PREFERENCES; REAL ESTATE TIME-SHARING; PROVIDING A DATABASE OF INFORMATION ABOUT RESIDENTIAL REAL ESTATE LISTINGS IN DIFFERENT NEIGHBORHOODS AND COMMUNITIES; PROVIDING INFORMATION IN THE FIELD OF REAL ESTATE BY MEANS OF LINKING THE WEB SITE TO OTHER WEB SITES FEATURING REAL ESTATE INFORMATION; PROVIDING REAL ESTATE LISTINGS AND REAL ESTATE INFORMATION VIA THE INTERNET.

FIRST USE 12-20-2007; IN COMMERCE 3-31-2009.

INT. CL. 18/U.S. CLS. 1, 2, 3, 22 AND 41

FOR LEATHER AND IMITATIONS OF LEATHER, GOODS MADE OF LEATHER, NAMELY, HANDBAGS, KEY CASES, BRIEF CASES; TRUNKS AND TRAVELING BAGS, UMBRELLAS, PARASOLS, WALKING STICKS, NECK POUCHES, SCHOOL BAGS, SATCHELS, BACKPACKS; BAGS, NAMELY, PURSES, LEISURE BAGS, ATHLETIC BAGS, HIKING BAGS, CLUTCH BAGS, DIAPER BAGS; ATTACHE CASES; BRIEFCASES AND ATTACHE CASES; BUSINESS CARD CASES; BUSINESS CASES; CALLING CARD CASES; CARRYING CASES; CARRYING CASES FOR DOCUMENTS; CATALOG CASES; COSMETIC CARRYING CASES SOLD EMPTY; COSMETIC CASES SOLD EMPTY; CREDIT CARD CASES; DOCUMENT CASES; KEY CASE; LEATHER POUCHES; POUCHES FOR HOLDING SCHOOL SUPPLIES THAT FITS OVER THE BACK OF A CHAIR; POUCHES FOR HOLDING KEYS.

FIRST USE ; IN COMMERCE .

ELEMENTS CORRECTED
GOODS/SERVICES

ELEMENTS AMENDED
OWNER NAME

3,633,617. REG. 6-9-2009. KRAUSE-BIAGOSCH GMBH (FED REP GERMANY CORPORATION) PAUL-SCHWARZE-STR. 5, BIELEFELD, FED REP GERMANY, 33649, SN 77-170,967. FILED 5-2-2007. PRINCIPAL REGISTER.

KRAUSE

THE MARK CONSISTS OF STANDARD CHARACTERS WITHOUT CLAIM TO ANY PARTICULAR FONT, STYLE, SIZE, OR COLOR.

OWNER OF FED REP GERMANY REG. NO. 30679395.4, DATED 7-10-2007, EXPIRES 7-10-2017.

SEC. 2(F).

INT. CL. 1/U.S. CLS. 1

FOR CHEMICALS PRODUCTS, NAMELY, ADHESIVES, DIAZO PAPER, DISTILLED WATER, PHOTOGRAPHIC CHEMICALS, AND WALLPAPER PASTE, FOR TECHNICAL USE IN THE GRAPHIC TRADE.

FIRST USE ; IN COMMERCE .

INT. CL. 7/U.S. CLS. 13, 19, 21, 23, 31, 34 AND 35

FOR MACHINES AND MECHANICAL APPARATUSSES, IN PARTICULAR FOR THE GRAPHIC TRADE, NAMELY, MACHINES FOR THE PRODUCTION OF PRINTING PLATES AND PRINTING FORMS, NAMELY, EXPOSURE MACHINES, DEVELOPING MACHINES, CUTTING MACHINES, EMBOSSING PRESSES, AUTOMATIC STAMPING MACHINES, FEEDERS, HANDLING DEVICES FOR HANDLING PRINTING PLATES; PRINTING MACHINES, FLEXO PRINTING MACHINES, OFFSET PRINTING MACHINES; MACHINES AND MECHANICAL APPARATUSSES FOR PAPER AND/OR CARDBOARD PROCESSING, NAMELY, FOLDERS, PAPER FOLDING MACHINES, FOLDING APPARATUSSES FOR FOLLOWING A PRINTING UNIT, COLLECTING DEVICES, NAMELY, COLLECTORS, STAMPING MACHINES, DIE CUTTING MACHINES, CUTTERS, GUILLOTINE TYPE CUTTERS, CROSS CUTTERS, STAPLERS, GLUING UNITS, GLUING MACHINES, BOOK BINDING MACHINES, AUTOMATED SHEET DISPENSERS, SHEET FEEDERS, TRANSPORT DISTANCE UNITS, DISPOSERS, STREAM PAPER FEEDING UNITS, PERFORATING, INDUSTRIAL LABELING MACHINES, INDUSTRIAL NUMBERING MACHINES, BAR CODING MACHINES, MACHINES FOR THE PRODUCTION OF SACS, BAGS, AND FOLDED BOXES; REPLACEMENT PARTS FOR ALL OF THE PRECEDING GOODS; PRINTING PLATES AND PRINTING FORMS.

FIRST USE ; IN COMMERCE .

INT. CL. 9/U.S. CLS. 21, 23, 26, 36 AND 38

FOR COMPUTER HARDWARE AND SOFTWARE FOR PRINTING PAPER AND CARDBOARD PROCESSING, PRINTING PLATES PROCESSING, WORK FLOW PLANES FOR THE PRINTING INDUSTRY, ELECTROSTATIC COPYING MACHINES; ELECTRONIC CODING UNITS.

FIRST USE ; IN COMMERCE .

INT. CL. 9/U.S. CLS. 21, 23, 26, 36 AND 38

FOR COMPUTER HARDWARE AND SOFTWARE FOR PRINTING PAPER AND CARDBOARD PROCESSING, PRINTING PLATES PROCESSING, WORK FLOW PLANES FOR THE PRINTING INDUSTRY, ELECTROSTATIC COPYING MACHINES; ELECTRONIC CODING UNITS.

FIRST USE ; IN COMMERCE .

INT. CL. 16/U.S. CLS. 2, 5, 22, 23, 29, 37, 38 AND 50

FOR PAPER, CARDBOARD, PAPERBOARD, PRINTING BLOCKS, PRINTER TYPES; OFFICE LABELING MACHINES; NUMBERING MACHINES; PHOTO-COPYING MACHINES.

FIRST USE ; IN COMMERCE .

INT. CL. 35/U.S. CLS. 100, 101 AND 102

FOR PROVIDING PRODUCT INFORMATION FOR THIRD PARTIES REGARDING CHEMICAL PRODUCTS FOR TECHNICAL PURPOSES, MACHINES AND MECHANICAL APPARATUSSES, IN PARTICULAR FOR THE GRAPHIC TRADE, SUCH AS MACHINES FOR THE PRODUCTION OF PRINTING PLATES AND PRINTING FORMS, FOR EXAMPLE EXPOSURE MACHINES, DEVELOPING MACHINES, CUTTING MACHINES, EMBOSSING PRESSES, STAMPING MACHINES, FEEDERS, HANDLING DEVICES, PRINTING MACHINES, FLEXO PRINTING MACHINES, OFFSET PRINTING MACHINES, COPYING MACHINES AND COPYING DEVICES, MACHINES AND MECHANICAL APPARATUSSES FOR PAPER AND/OR CARDBOARD PROCESSING, IN PARTICULAR FOLDERS, FOLDING MACHINES, FOLDING APPARATUSSES, COLLECTING DEVICES, STAMPING MACHINES, CUTTERS, GUILLOTINE TYPE CUTTERS, CROSS CUTTERS, STAPLERS,

GLUING UNITS, GLUING MACHINES, BOOK BINDING MACHINES, SHEET DISPENSERS, SHEET FEEDERS, TRANSPORT DISTANCES, CANTILEVERS, STREAM FEEDING UNITS, PERFORATING, LABELING, NUMBERING, CODING DEVICES, MACHINES FOR THE PRODUCTION OF SACS, BAGS, AND FOLDED BOXES, PARTS OF THE PRECEDING GOODS, COMPUTER HARDWARE, SOFTWARE, PAPER, CARDBOARD, PAPERBOARD, GOODS MADE OF PAPER, CARDBOARD, PAPERBOARD, BOOK BINDING MATERIAL, PRINTING PLATES, PRINTING FORMS, PRINTING BLOCKS, AND PRINTER TYPES; WHOLESALE AND RETAIL STORE SERVICES FEATURING CHEMICAL PRODUCTS FOR TECHNICAL PURPOSES, MACHINES AND MECHANICAL APPARATUSSES, IN PARTICULAR FOR THE GRAPHIC TRADE, SUCH AS MACHINES FOR THE PRODUCTION OF PRINTING PLATES AND PRINTING FORMS, FOR EXAMPLE EXPOSURE MACHINES, DEVELOPING MACHINES, CUTTING MACHINES, EMBOSSING PRESSES, STAMPING MACHINES, FEEDERS, HANDLING DEVICES, PRINTING MACHINES, FLEXO PRINTING MACHINES, OFFSET PRINTING MACHINES, COPYING MACHINES AND COPYING DEVICES, MACHINES AND MECHANICAL APPARATUSSES FOR PAPER AND/OR CARDBOARD PROCESSING, IN PARTICULAR FOLDERS, FOLDING MACHINES, FOLDING APPARATUSSES, COLLECTING DEVICES, STAMPING MACHINES, CUTTERS, GUILLOTINE TYPE CUTTERS, CROSS CUTTERS, STAPLERS, GLUING UNITS, GLUING MACHINES, BOOK BINDING MACHINES, SHEET DISPENSERS, SHEET FEEDERS, TRANSPORT DISTANCES, CANTILEVERS, STREAM FEEDING UNITS, PERFORATING, LABELING, NUMBERING, CODING DEVICES, MACHINES FOR THE PRODUCTION OF SACS, BAGS, AND FOLDED BOXES, PARTS OF THE PRECEDING GOODS, COMPUTER HARDWARE, SOFTWARE, PAPER, CARDBOARD, PAPERBOARD, GOODS MADE OF PAPER, CARDBOARD, PAPERBOARD, BOOK BINDING MATERIAL, PRINTING PLATES, PRINTING FORMS, PRINTING BLOCKS, AND PRINTER TYPES.

FIRST USE ; IN COMMERCE .

INT. CL. 42/U.S. CLS. 100 AND 101

FOR ENGINEERING SERVICES AND CONSULTING SERVICES, DESIGN AND DEVELOPMENT FOR OTHERS OF COMPUTER HARDWARE AND COMPUTER SOFTWARE, WORK FLOW PLANS, MACHINES, MECHANICAL PLANTS AND APPARATUSSES IN PARTICULAR FOR THE GRAPHIC TRADE AND THE PAPER AND/OR CARDBOARD PROCESSING INDUSTRY.

FIRST USE ; IN COMMERCE .

ELEMENTS CORRECTED
FOREIGN REG. NO.

3,634,791. REG. 6-9-2009. 1-800-FLOWERS.COM, INC. (DELAWARE CORPORATION) ONE OLD COUNTRY ROAD, SUITE 500, CARLE PLACE, NY, 11514, SN 77-606,478. FILED 11-4-2008. PRINCIPAL REGISTER.



OWNER OF U.S. REG. NO. 2,302,484.

NO CLAIM IS MADE TO THE EXCLUSIVE RIGHT TO USE "REWARDS", APART FROM THE MARK AS SHOWN. THE MARK CONSISTS OF A FANCIFUL GIFT BOX WITH A BOW ON TOP OF THE GIFT BOX AND THE WORDING "FRESH REWARDS" WITHIN THE GIFT BOX.

INT. CL. 35/U.S. CLS. 100, 101 AND 102

FOR PROVIDING AN INCENTIVE REWARDS PROGRAM WHICH ENABLES A PURCHASER TO EARN REWARDS AND REDEEM THE REWARDS, TO PROMOTE THE SALE OF ARTIFICIAL, FRESH CUT AND DRIED FLOWERS, FLORAL BOUQUETS AND ARRANGEMENTS, PLANTS, TREES, GIFTS, GIFT BASKETS, GOURMET FOODS, POPCORN, PRODUCE, CANDY, CHOCOLATE, BAKERY ITEMS, HOME FURNISHINGS, HOME DECORATING ITEMS AND ACCESSORIES, KITCHENWARE AND ACCESSORIES, COLLECTIBLES, STATIONERY ITEMS AND ACCESSORIES, AROMATHERAPY GIFT BASKETS, CANDLES AND CANDLE ACCESSORIES, JEWELRY, WATCHES, GAMES, TOYS, PLUSH TOYS AND ANIMALS, BOOKS, PRERECORDED AUDIO AND VIDEOTAPES, CASSETTES AND DISKS, PICTURE FRAMES, PHOTO ALBUMS, AND GENERAL MERCHANDISE.

FIRST USE 10-13-2008; IN COMMERCE 10-13-2008.

ELEMENTS CORRECTED
MARK

3,636,124. REG. 6-9-2009. TEVA WOMEN'S HEALTH, INC. (DELAWARE CORPORATION) 5040 DURAMED DRIVE, CINCINNATI, OH, 45213, SN 77-340,250. FILED 11-29-2007. PRINCIPAL REGISTER.

LOSEASONIQUE

THE MARK CONSISTS OF STANDARD CHARACTERS WITHOUT CLAIM TO ANY PARTICULAR FONT, STYLE, SIZE, OR COLOR.

NO CLAIM IS MADE TO THE EXCLUSIVE RIGHT TO USE "LOW", APART FROM THE MARK AS SHOWN.

INT. CL. 5/U.S. CLS. 6, 18, 44, 46, 51 AND 52

FOR ORAL CONTRACEPTIVES.

FIRST USE 3-16-2009; IN COMMERCE 3-16-2009.

ELEMENTS CORRECTED
MARK

3,636,087. REG. 6-9-2009. FRATELLI BRANCA DISTILLERIE S.R.L. (ITALY LIMITED LIABILITY COMPANY) VIA BROLETTO 35, MILANO, ITALY., SN 77-313,633. FILED 10-25-2007. PRINCIPAL REGISTER.



OWNER OF U.S. REG. NO. 2,954,110.
NO CLAIM IS MADE TO THE EXCLUSIVE RIGHT TO USE "SAMBUCA", APART FROM THE MARK AS SHOWN. THE COLOR(S) YELLOW, LIGHT BLUE, DARK BLUE, GOLD, WHITE, BLACK, GRAY AND RED IS/ARE CLAIMED AS A FEATURE OF THE MARK.

THE MARK CONSISTS OF THE WORD "BORGHETTI" IN YELLOW WHICH SITS IN A BLACK RECTANGLE WITH A GOLD BORDER. THE BLACK RECTANGLE WITH THE WORD "BORGHETTI" SITS UPON A RED STAR WITH A GOLD OUTLINE. AT THE BOTTOM OF THE RECTANGLE IS A BLACK SEMI-CIRCLE BORDERED IN GOLD. THE RECTANGLE AND THE STAR SIT ON TOP OF A DARK AND LIGHT BLUE QUADRILATERAL WHICH IS BORDERED ON BOTH SIDES IN GOLD. IN THE MIDDLE OF THE QUADRILATERAL THE WORD "SAMBUCA" APPEARS IN WHITE. THE COLOR GRAY OUTLINES THE WORD "SAMBUCA".

INT. CL. 33/U.S. CLS. 47 AND 49

FOR SAMBUCA .

FIRST USE 1-1-2004; IN COMMERCE 1-16-2009.

ELEMENTS CORRECTED
GOODS/SERVICES

3,637,263. REG. 6-16-2009. NIPPON DENSHIN DENWA KABUSHIKI KAISHA (JAPAN JOINT STOCK COMPANY), DBA NIPPON TELEGRAPH AND TELEPHONE CORPORATION, 3-1 OTEMACHI 2-CHOME, CHIYODAKU, TOKYO, JAPAN., SN 77-134,067. FILED 3-19-2007. PRINCIPAL REGISTER.



OWNER OF JAPAN REG. NO. 4318763, DATED 9-24-1999, EXPIRES 9-24-2009.

OWNER OF U.S. REG. NOS. 2,436,071, 2,568,744 AND 2,599,867.

INT. CL. 36/U.S. CLS. 100, 101 AND 102

FOR PROVIDING ELECTRONIC COMMERCE SERVICES, NAMELY, TELECOMMUNICATION PREPAID DEBIT CARD SERVICES; ON-LINE FINANCIAL PLANNING; FINANCIAL RESEARCH AND FINANCIAL ANALYSIS SERVICES; FINANCIAL SERVICES, NAMELY, AGENCIES FOR COLLECTING CHARGES FOR INFORMATION PROVIDERS RENDERED BY TELECOMMUNICATION FEE COLLECTING SYSTEM; PREPAID STORED VALUE CARD SERVICES FOR PAYMENT OF TELEPHONE CALLS, SUBWAY AND BUS AND RAILROAD FARES, BRIDGE AND TUNNEL TOLLS, MERCHANDISE COSTS AND LOW VALUE ELECTRONIC DEBIT TRANSACTIONS.

ELEMENTS CORRECTED
FOREIGN APPLICATION NO.

3,637,887. REG. 6-16-2009. SAINT-GOBAIN GLASS FRANCE (FRANCE SOCIÉTÉ ANONYME (SA)) LES MIROIRS 18, AVENUE D'ALSACE, COURBEVOIE, FRANCE, 92400, SN 77-487,569. FILED 5-30-2008. PRINCIPAL REGISTER.

SECURIPPOINT

THE MARK CONSISTS OF STANDARD CHARACTERS WITHOUT CLAIM TO ANY PARTICULAR FONT, STYLE, SIZE, OR COLOR.

OWNER OF FRANCE REG. NO. 95585228, DATED 1-26-1996, EXPIRES 1-26-2016.

OWNER OF U.S. REG. NO. 2,133,681.

INT. CL. 19/U.S. CLS. 1, 12, 33 AND 50

FOR GLASS AND GLASS PRODUCTS FOR USE IN BUILDING, NAMELY, WINDOW GLASS; SAFETY GLASS; GLASS PANES; GLASS PANELS.

ELEMENTS CORRECTED
FOREIGN REG. DATE
FOREIGN REG. EXPIRATION DATE



3,638,362. REG. 6-16-2009. TRIDONICATCO GMBH & CO. KG (AUSTRIA KOMMANDITGESELLSCHAFT (KG)) FARBERGASSE 15, DORNBIRN, AUSTRIA, 6850, SN 77-584,104. FILED 10-2-2008. PRINCIPAL REGISTER.

TALEXX

THE MARK CONSISTS OF STANDARD CHARACTERS WITHOUT CLAIM TO ANY PARTICULAR FONT, STYLE, SIZE, OR COLOR.

OWNER OF AUSTRIA REG. NO. 241504, DATED 10-23-2007, EXPIRES 10-31-2017.

THE WORDING "TALEXX" HAS NO MEANING IN A FOREIGN LANGUAGE.

INT. CL. 9/U.S. CLS. 21, 23, 26, 36 AND 38

FOR ELECTRIC AND ELECTRONIC EQUIPMENT FOR THE OPERATION OF LIGHT-EMITTING DIODES AND ELECTROLUMINESCENT FOILS, NAMELY, MAGNETIC AND ELECTRONIC BALLASTS AND STARTERS, THROTTLES, CONDENSERS, TRANSFORMERS, RECTIFIERS, RELAYS, RESISTANCES; ELECTRONIC REGULATING AND CONTROL DEVICES FOR THE OPERATION OF LIGHT EMITTING DIODES; SOURCES OF LIGHT, NAMELY, LIGHT EMITTING DIODES; FLASHLIGHTS WITH LIGHT EMITTING DIODES FOR USE IN PHOTOGRAPHY.

FIRST USE : IN COMMERCE .

INT. CL. 11/U.S. CLS. 13, 21, 23, 31 AND 34

FOR ELECTRIC LAMPS; LIGHTS, NAMELY, ELECTRIC LIGHTING FIXTURES AND LAMPS; LIGHT MODULES AND LIGHTS WITH LIGHT EMITTING DIODES OR ELECTROLUMINESCENT FOILS.

FIRST USE : IN COMMERCE .

ELEMENTS CORRECTED
FOREIGN REG. EXPIRATION DATE



3,653,554. REG. 7-14-2009. AMERICAN WEST INSURANCE COMPANY (NORTH DAKOTA CORPORATION) 1101 1ST AVENUE NORTH, P.O. BOX 2502, FARGO, ND, 581082502, SN 77-512,603. FILED 7-1-2008. PRINCIPAL REGISTER.



THE MARK CONSISTS OF OUTLINE OF SHIELD WITH DESIGN OF EAGLE'S HEAD AND FOUR LINES EMERGING FROM EAGLE DESIGN.

INT. CL. 36/U.S. CLS. 100, 101 AND 102

FOR PROPERTY AND CASUALTY INSURANCE UNDERWRITING AND ADMINISTRATION PRIMARILY IN THE FIELD OF AGRICULTURE.

FIRST USE 3-0-2008; IN COMMERCE 3-0-2008.

ELEMENTS CORRECTED
GOODS/SERVICES

* * * * *

TRADEMARK REGISTRATIONS—NEW CERTIFICATES

New Certificates issued under section 7(d) of the Trademark Act of 1946 for the unexpired term of the original registrations.

954,496. BRAGARD (STYLIZED). U.S. CL. 42. ETABLISSE-
MENTS BRAGARD, SAULXURES SUR MOSELOTTE,
FRANCE. REG. 3-6-1973. NEW CERT. SEC. 7(D) TO
BRAGARD, S.A., 88290 SAULXURES SUR MOSELOTTE,
FRANCE.

CERT. SEC. 7(D) TO REGISTRANT.

2,881,276. UTA ULTIMATE TECHNICAL ACADEMY. INT.
CL. 41. ULTIMATE TECHNICAL ACADEMY, L.L.C.,
SAINT PETERS, MO. REG. 9-7-2004. NEW CERT. SEC.
7(D) TO REGISTRANT.

1,553,203. FINANCIAL DYNAMICS AND DESIGN. INT.
CL. 35. FINANCIAL DYNAMICS, INC., OMAHA, NE.
REG. 8-22-1989. NEW CERT. SEC. 7(D) TO REGISTRANT.

2,972,324. TOP TECHNICANS IN WEEKS...NOT YEARS.
INT. CL. 41. ULTIMATE TECHNICAL ACADEMY,
L.L.C., SAINT PETERS, MO. REG. 7-19-2005. NEW CERT.
SEC. 7(D) TO REGISTRANT.

2,747,973. PRO-VISION. INT. CL. 9. OPTICAL ACCESS OAL
LTD., 20692 YOKNEAM, ISRAEL. REG. 8-5-2003. NEW

* * * * *

This page is intentionally blank

INDEX OF REGISTRANTS

SEPT. 8, 2009

(Registered; Renewed; Canceled; Amended, Corrected, etc.; New Certificates; 12c Publications.)

The designation "U.S. Cl." appearing in this section refers to the U.S. class in effect prior to Sep. 1, 1973 rather than the international class which applies to applications filed on or after that date. For adoption of international classification see notice in the OFFICIAL GAZETTE of Jun. 26, 1973 (911 O.G. TM 210).

- /PHIL MUSUMECI/, SANTA CRUZ, CA AND /BARNEY LANGNER JR/, SANTA CRUZ, CA:
3,679,219, PUB. 6-23-2009. INT. CL. 25.
3,679,222, PUB. 6-23-2009. INT. CL. 25.
- "DR. MARTENS" INTERNATIONAL TRADING GMBH, D-82166 GRÄFELFING, FED REP GERMANY:
2,162,299, AM. MULTIPLE CLASS, INT. CLS. 14 AND 16.
- "WEIGH TO GO", ANDERSONVILLE, TN:
3,679,827, PUB. 5-19-2009. MULTIPLE CLASS, INT. CLS. 5 AND 44.
- A BAR AND GRILL WITH A BITE, INC., NEW ORLEANS, LA, DBA THE CRAZY LOBSTER BAR & GRILL:
3,678,969, PUB. 6-23-2009. INT. CL. 43.
- A BRITWAY CORPORATION, SALIDA, CO, DBA CAPTAIN ZIPLINE, L.L.C.:
3,678,980, PUB. 6-23-2009. INT. CL. 39.
- A K INDUSTRIAL COMPANY, LTD., SAN PO KONG, KOWLOON, HONG KONG:
2,214,195, CANC. INT. CL. 7.
- A NEW FOUND GLORY, INC., SAN DIEGO, CA:
2,666,699, CANC. INT. CL. 41.
- A RIVER BLACK INCORPORATED, WALNUT CREEK, CA:
2,665,892, CANC. MULTIPLE CLASS, INT. CLS. 40 AND 42.
- A SITE FOR MORE EYES, ORLANDO, FL:
2,667,230, CANC. INT. CL. 36.
- A. GOLDBERGER CONTROLS, INC., KUTZTOWN, PA:
3,680,389, INT. CL. 7.
- A. H. BENNETT COMPANY, MINNEAPOLIS, MN:
2,215,588, CANC. INT. CL. 35.
- A. KIRSCH COMPANY LLC, WEST BLOOMFIELD, MI:
3,680,421, INT. CL. 25.
- A.R. AND S.B. WHITE PARTNERSHIP, THE, ALRESFORD HAMPSHIRE, UNITED KINGDOM, DBA BLACKTHORN NURSERY:
2,666,852, CANC. INT. CL. 31.
- A + F GMBH, FED REP GERMANY:
3,680,016, PUB. 6-23-2009. MULTIPLE CLASS, INT. CLS. 6, 9 AND 19.
- A&E TELEVISION NETWORKS, NEW YORK, NY:
2,737,832, CANC. INT. CL. 41.
- A&J INTERNATIONAL TRADE COMPANY, LTD., RANCHO CUCAMONGA, CA:
3,681,063, INT. CL. 5.
- A-LIST SERVICES LLC, NEW YORK, NY, DBA A-LIST:
3,678,406, PUB. 3-24-2009. MULTIPLE CLASS, INT. CLS. 16 AND 41.
- A-TECH, SAN ANTONIO, TX:
2,666,808, CANC. INT. CL. 9.
- A-1 EXTERMINATORS, INC., LYNN, MA:
3,678,432, PUB. 1-20-2009. INT. CL. 37.
- A/P LOGIC INTERNATIONAL, LTD., WONDER LAKE, IL:
2,341,356, REN. 8-3-09. INT. CL. 35.
2,341,357, REN. 8-3-09. INT. CL. 35.
- AAA CENTRAL-WEST JERSEY, INC., ROBBINSVILLE, NJ:
2,666,723, CANC. MULTIPLE CLASS, INT. CLS. 35, 36, 37, 39, 41 AND 42.
- AAP BIOMATERIALS GMBH & CO. KG, FED REP GERMANY:
3,516,706, COR. MULTIPLE CLASS, INT. CLS. 5 AND 10.
- AARON ACCEPTANCE CORPORATION, CALGARY, CANADA:
3,678,220, PUB. 6-23-2009. INT. CL. 42.
- AARON LARSON, ANN ARBOR, MI:
2,666,517, CANC. MULTIPLE CLASS, INT. CLS. 35 AND 42.
- AB MAURI TECHNOLOGY PTY LIMITED, CHATSWOOD, AUSTRALIA:
3,678,483, PUB. 6-23-2009. INT. CL. 30.
- ABBEY OF GETHSEMANI, TRAPPIST, KY:
2,667,158, CANC. INT. CL. 21.
- ABBOTT CARDIOVASCULAR SYSTEMS, INC., SANTA CLARA, CA:
3,681,482, INT. CL. 10.
- ABBOTT ENTERPRISES, INC., PINE BLUFF, AR, DBA ABBOTT TACHOGRAPH:
1,510,764, REN. 8-6-09. INT. CL. 9.
- ABBOTT GMBH & CO. KG, WIESBADEN, FED REP GERMANY:
2,213,662, CANC. MULTIPLE CLASS, INT. CLS. 1, 3, 5, 29, 30, 31, 32 AND 40.
- ABBOTT SPINE INC., AUSTIN, TX:
2,214,578, CANC. INT. CL. 10.
- ABC IMAGING, LLC, WASHINGTON, DC:
2,665,205, CANC. MULTIPLE CLASS, INT. CLS. 35, 37, 40 AND 42.
- ABC, INC., FARGO, ND:
3,680,224, INT. CL. 37.
- ABERCROMBIE & FITCH TRADING CO., NEW ALBANY, OH:
3,681,679, INT. CL. 3.
- ABP INTERNATIONAL, INC., NEW YORK, NY:
3,678,991, PUB. 6-23-2009. INT. CL. 41.
- ABRAMS, MARTA LISA, LOS ANGELES, CA AND ROSEMARIN, ALISSA, LOS ANGELES, CA:
3,680,570, INT. CL. 18.
3,680,571, INT. CL. 18.
- ABSINTHE KÜBLER SA, MÔTIERS, SWITZERLAND:
3,584,643, AM. INT. CL. 33.
- ACADEMY, LTD., KATY, TX:
3,680,953, INT. CL. 24.
- ACCELEGROW TECHNOLOGIES, INC., WEST POINT, GA:
3,608,179, CANC. INT. CL. 1.
- ACCELERATED CHRISTIAN EDUCATION, INC., NASHVILLE, TX:
3,679,192, PUB. 6-23-2009. INT. CL. 9.
- ACCENT ENERGY GROUP LLC, DUBLIN, OH:
3,681,673, INT. CL. 35.
- ACCESS LIBERTY, LLC, TREMONT, IL:
3,680,542, MULTIPLE CLASS, INT. CLS. 9 AND 35.
- ACCESS PUBLIC RELATIONS, LLC, SAN FRANCISCO, CA:
2,911,733, COR. INT. CL. 41.
- ACCESSORIES BY JOANN HUTH, INC., BRYN MAWR, PA:
3,681,750, INT. CL. 18.
- ACCESSORY TIME, INC., OCEAN, NJ:
2,666,455, CANC. INT. CL. 14.
- ACCO BRANDS CORPORATION, LINCOLNSHIRE, IL:
3,681,479, MULTIPLE CLASS, INT. CLS. 9, 16 AND 20.
- ACCUCHEX CORPORATION, NOVATO, CA:
3,679,206, PUB. 6-23-2009. INT. CL. 42.
- ACCURIDE CORPORATION, EVANSVILLE, IN:
3,680,117, INT. CL. 12.

- ACCUVAL ASSOCIATES, INC., MEQUON, WI:
3,678,467, PUB. 6-23-2009. MULTIPLE CLASS, INT. CLS.
35 AND 36.
- ACE ANCHORS, LLC, HOLCOMB, MS:
2,665,364, CANC. INT. CL. 28.
- ACE CAFE LONDON LIMITED, STONEBRIDGE, UNITED
KINGDOM:
3,678,324, PUB. 6-23-2009. INT. CL. 12.
- ACE CAFE LONDON LIMITED, LONDON, UNITED KING-
DOM:
3,681,503, INT. CL. 26.
- ACE LIMITED, HAMILTON HM 08, BERMUDA:
2,667,015, CANC. INT. CL. 42.
- ACE LIMITED, ZURICH, SWITZERLAND:
3,678,711, PUB. 6-23-2009. INT. CL. 36.
- ACF MORTGAGE, LLC, MIDDLETOWN, OH:
2,667,091, CANC. INT. CL. 39.
- ACKERMAN, VICTOR, LOS ANGELES, CA:
3,678,314, PUB. 6-23-2009. INT. CL. 25.
- ACME ELECTRIC CORPORATION, BUTLER, WI:
2,260,869. REN. 8-5-09. INT. CL. 9.
2,274,146. REN. 8-5-09. INT. CL. 9.
- ACORDIS ACRYLIC FIBRES, S.A., 08820 EL PRAT DE
LLOBREGAT, SPAIN:
2,665,538, CANC. INT. CL. 40.
- ACQUA DI ROMA, INC., SAN FRANCISCO, CA:
3,680,720, INT. CL. 44.
- ACTIO SOFTWARE CORPORATION, PORTSMOUTH, NH:
2,311,771. REN. 8-5-09. INT. CL. 42.
2,321,241. REN. 8-3-09. INT. CL. 35.
- ACTIONEER, INC., CAMBRIDGE, MA:
2,213,962, CANC. INT. CL. 9.
- ACTIVE ORGANICS, LP, LEWISVILLE, TX:
3,680,225, MULTIPLE CLASS, INT. CLS. 1, 3 AND 5.
- ACTIVEO, LLC, INCLINE VILLAGE, NV:
3,679,158, PUB. 6-23-2009. INT. CL. 10.
- ACTIVIDENTITY (AUSTRALIA) PTY LTD., FREMONT, CA:
3,680,416, INT. CL. 9.
- ACTOGENIX., NAAMLOZE VENNOOTSCHAP, BELGIUM:
3,679,879, PUB. 6-23-2009. MULTIPLE CLASS, INT. CLS.
29 AND 42.
- ACUSHNET COMPANY, FAIRHAVEN, MA:
2,666,725, CANC. INT. CL. 42.
- AD LUNAM LABS, INC., SPEARFISH, SD:
3,679,372, PUB. 6-23-2009. INT. CL. 3.
- ADBRITE, INC., SAN FRANCISCO, CA:
3,679,177, PUB. 6-23-2009. INT. CL. 35.
3,679,179, PUB. 6-23-2009. INT. CL. 35.
- ADHESIVE TECHNOLOGIES, INC., HAMPTON, NH:
3,681,506, INT. CL. 1.
- ADIDAS INTERNATIONAL MARKETING B.V., AMSTER-
DAM ZO, NETHERLANDS:
1,128,704. REN. 8-3-09. INT. CL. 28.
- ADLER NOMINEES PTY. LIMITED, AUSTRALIA:
3,679,860, PUB. 6-23-2009. MULTIPLE CLASS, INT. CLS.
35 AND 41.
- ADMAR INTERNATIONAL, INC., REHOBOTH, DE:
2,214,437, CANC. INT. CL. 20.
- ADMIRAL WINE & LIQUOR CO., INC., CEDAR GROVE, NJ:
3,680,425, INT. CL. 33.
- ADMMICRO PROPERTIES, L.L.C., ROANOKE, VA:
3,681,103, INT. CL. 9.
- ADTP, INC., NEW MARKET, AL:
3,680,930, INT. CL. 41.
- ADVAL TECH HOLDING AG, SWITZERLAND:
3,679,988, PUB. 6-23-2009. MULTIPLE CLASS, INT. CLS.
6, 7, 17 AND 20.
- ADVANCE E-MARKETING, INC., BROOKLYN, NY:
3,680,362, INT. CL. 35.
- ADVANCE MAGAZINE PUBLISHERS INC., NEW YORK,
NY TO ADVANCE MAGAZINE PUBLISHERS INC., NEW
YORK, NY:
2,214,976, CANC. INT. CL. 16.
- ADVANCE PAYROLL FUNDING LTD., BEACHWOOD, OH:
3,679,215, PUB. 6-23-2009. INT. CL. 36.
- ADVANCED BEAUTY SYSTEMS, INC., DALLAS, TX:
2,998,041, AM. INT. CL. 3.
3,020,240, AM. INT. CL. 3.
- ADVANCED BIOTECHNOLOGIES, INC., COLUMBIA, MD:
3,679,081, PUB. 6-23-2009. INT. CL. 1.
- ADVANCED CLINICAL RESEARCH, INC., WEST JORDAN,
UT:
2,297,235. REN. 7-31-09. INT. CL. 42.
- ADVANCED HOMECARE MANAGEMENT, INC., DALLAS,
TX:
3,678,244, PUB. 4-22-2008. MULTIPLE CLASS, INT. CLS.
44 AND 45.
3,678,245, PUB. 4-22-2008. MULTIPLE CLASS, INT. CLS.
44 AND 45.
- ADVANCED SPORTS, INC., PHILADELPHIA, PA:
2,216,132. REN. 7-31-09. INT. CL. 12.
- ADVANCED TECHNOLOGIES GROUP LIMITED, BED-
FORDSHIRE MK42 OTJ, UNITED KINGDOM:
2,666,514, CANC. MULTIPLE CLASS, INT. CLS. 9 AND
12.
2,666,515, CANC. MULTIPLE CLASS, INT. CLS. 9 AND
12.
- ADVANCED TECHNOLOGY LLC, OSBORNE, KS:
3,679,474, PUB. 6-23-2009. INT. CL. 1.
- ADVANTAGE METALS RECYCLING, KANSAS CITY, MO:
3,679,231, PUB. 6-23-2009. INT. CL. 40.
- ADVENTURE TRAVEL SOCIETY, INC., SALIDA, CO:
2,667,379, CANC. INT. CL. 35.
- ADVICE INTERACTIVE GROUP LLC, ALLEN, TX, DBA
GOSPELVILLE.COM:
3,679,315, PUB. 6-23-2009. INT. CL. 35.
3,679,768, PUB. 6-23-2009. INT. CL. 42.
- ADVNT BIOTECHNOLOGIES, LLC, PHOENIX, AZ:
3,681,618, MULTIPLE CLASS, INT. CLS. 1, 9 AND 10.
- ADVUS CORPORATION, NEW YORK, NY:
3,680,415, INT. CL. 35.
- AEC SCIENCE & TECHNOLOGY, LLC, CHADDS FORD, PA:
3,681,170, INT. CL. 41.
- AEEFFECT, INCORPORATED, DEERFIELD, IL:
2,247,204. REN. 8-5-09. INT. CL. 35.
- AEGIS TECHNOLOGIES GROUP, INC., THE, HUNTS-
VILLE, AL, AEGIS TECHNOLOGIES GROUP, INC., THE,
HUNTSVILLE, AL:
2,360,512. REN. 8-4-09. INT. CL. 42.
- AEKO KULA, INC., HONOLULU, HI:
3,679,377, PUB. 6-23-2009. INT. CL. 39.
3,679,378, PUB. 6-23-2009. INT. CL. 39.
3,679,379, PUB. 6-23-2009. INT. CL. 39.
- AENTRA, MIAMI, FL:
3,680,653, INT. CL. 36.
- AEQUITAS TECHNOLOGIES LLC, HERNDON, VA:
3,681,244, INT. CL. 9.
- AERO RUBBER COMPANY, INC., TINLEY PARK, IL:
2,215,244, CANC. INT. CL. 40.
- AERODYNAMIC TRAILER SYSTEMS, LTD., AUBURN
TOWNSHIP, OH:
3,681,475, INT. CL. 12.
- AEROSOURCE INC., SOMERSET, NJ:
1,543,877. REN. 7-31-09. MULTIPLE CLASS, INT. CLS. 37
AND 42.
- AEROTEK, INC., COLUMBIA, MD:
2,665,202, CANC. INT. CL. 35.
- AETNA INC., BLUE BELL, PA:
3,679,741, PUB. 6-23-2009. MULTIPLE CLASS, INT. CLS.
44 AND 45.
3,679,746, PUB. 6-23-2009. MULTIPLE CLASS, INT. CLS.
44 AND 45.
- AFC ENTERPRISES, INC., ATLANTA, GA:
3,681,086, MULTIPLE CLASS, INT. CLS. 29 AND 43.
3,681,087, MULTIPLE CLASS, INT. CLS. 29 AND 43.
3,681,088, MULTIPLE CLASS, INT. CLS. 29 AND 43.
3,681,089, MULTIPLE CLASS, INT. CLS. 29 AND 43.
- AFFILIATED FM INSURANCE COMPANY, JOHNSTON, RI:
3,679,430, PUB. 6-23-2009. INT. CL. 36.
- AFFINITY MECHANICAL, INC., FORT LAUDERDALE, FL:
3,678,480, PUB. 6-23-2009. INT. CL. 37.
- AFFLINK, LLC, TUSCALOOSA, AL:
3,679,013, PUB. 6-23-2009. INT. CL. 3.
- AFR APPAREL INTERNATIONAL, INC., NORTHRIDGE,
CA:
3,680,197, MULTIPLE CLASS, INT. CLS. 18 AND 25.

AFRICAN MARKETPLACE, INC., LOS ANGELES, CA:
2,665,874, CANC. INT. CL. 35.

AFTERMARKET AUTO PARTS ALLIANCE, INC., SAN ANTONIO, TX:
3,678,840, PUB. 6-23-2009. MULTIPLE CLASS, INT. CLS. 6, 7, 9, 11, 12 AND 17.

AG CONTAINER RECYCLING COUNCIL, LEXINGTON, VA:
3,679,062, PUB. 6-23-2009. INT. CL. 35.

AGA RANGEMASTER GROUP PLC, WARWICKSHIRE, UNITED KINGDOM:
3,681,640, MULTIPLE CLASS, INT. CLS. 8, 16, 21, 24 AND 25.

AGC, LLC, CLEVELAND, OH:
2,666,454, CANC. INT. CL. 35.

AGI BUSINESS MEDIA PRODUCTIONS GMBH, 70469 STUTTGART, FED REP GERMANY:
2,666,499, CANC. MULTIPLE CLASS, INT. CLS. 9, 35 AND 42.

AGILIS INTERNATIONAL, INC., ROCKVILLE, MD:
3,680,429, INT. CL. 9.

AGILIX CORPORATION, NEW HAVEN, CT:
2,666,383, CANC. INT. CL. 42.

AGRI LABORATORIES, LTD., ST. JOSEPH, MO:
1,517,749, CANC. INT. CL. 5.

AGRICOLA SAN FELICE S.P.A., MILANO, ITALY:
1,518,198, CANC. INT. CL. 33.

AGRO WORLD, INC., MIAMI, FL:
3,679,333, PUB. 6-23-2009. INT. CL. 30.

AGROFRESH INC., PHILADELPHIA, PA:
3,680,216, INT. CL. 1.

AGROPUR COOPERATIVE, GRANBY, QUEBEC, CANADA:
2,954,201, CANC. MULTIPLE CLASS, INT. CLS. 5 AND 32.

AHF INDUSTRIES, INC., FRENCH LICK, IN, DBA PLUTO CORPORATION:
2,366,474, REN. 8-5-09. INT. CL. 35.

AHNUTRA, INC., PETALUMA, CA:
3,679,497, PUB. 6-23-2009. INT. CL. 3.

AHOLD LICENSING SA, GENEVA, SWITZERLAND:
3,679,262, PUB. 6-23-2009. MULTIPLE CLASS, INT. CLS. 35 AND 43.

AHSAY SYSTEMS CORPORATION LIMITED, CAUSEWAY BAY, HONG KONG:
3,680,573, MULTIPLE CLASS, INT. CLS. 9, 39 AND 42.

AIKEN. CLAY, ATLANTA, GA:
3,679,541, PUB. 6-23-2009. INT. CL. 41.

AIR FILTER & EQUIPMENT, INC., KALAMAZOO, MI:
2,287,935, REN. 8-1-09. INT. CL. 35.

AIRCELL LLC, ITASCA, IL:
3,680,364, INT. CL. 9.
3,680,528, INT. CL. 9.

AIRE SERV HEATING & AIR CONDITIONING, INC., WACO, TX:
2,763,655, CANC. INT. CL. 11.
2,763,656, CANC. INT. CL. 11.

AIRFIBER, INC., SAN DIEGO, CA:
2,666,787, CANC. INT. CL. 9.

AIXAM MEGA, AIX LES BAINS, FRANCE:
3,678,699, PUB. 6-23-2009. INT. CL. 12.

AK DESIGNS, LLC, LOS ANGELES, CA:
3,679,706, PUB. 6-23-2009. INT. CL. 25.

AKBAR PRODUCTS, INC., WASHINGTON, DC, TA NATURAL OASIS DISTRIBUTORS:
2,665,334, CANC. INT. CL. 5.

AKDO INTERTRADE, INC., BRIDGEPORT, CT:
2,666,680, CANC. INT. CL. 35.

AKINS, THEODORA, VICKSBURG, MI:
3,680,765, INT. CL. 35.

AKZO NOBEL CHEMICALS B.V., 3818 LE AMERSFOORT, NETHERLANDS:
2,665,266, CANC. INT. CL. 1.

ALABAMA BASS BUDDY TRAIL, FORT PAYNE, AL:
3,681,781, INT. CL. 41.

ALABAMA FARMERS COOPERATIVE, INC., DECATUR, AL:
3,680,398, INT. CL. 31.

ALADDIN TEMP-RITE, LLC, HENDERSONVILLE, TN:
3,680,612, INT. CL. 21.

ALADON LLC, ASHEVILLE, NC:
2,215,631, CANC. INT. CL. 41.

ALAJLAN COMPANY, RIYADH 11441, SAUDI ARABIA:
2,666,778, CANC. INT. CL. 25.

ALAMO REFRIGERATION, L.P., SAN ANTONIO, TX:
3,678,350, PUB. 6-23-2009. INT. CL. 35.

ALARIE, KEVIN, CROFTON, MD:
3,681,173, INT. CL. 16.

ALASKA AIRLINES, INC., SEATTLE, WA:
1,518,346, CANC. INT. CL. 39.

ALBACROME, SOCIEDAD ANONIMA DE CAPITAL VARIABLE, SAN SALVADOR, EL SALVADOR:
3,678,437, PUB. 6-23-2009. INT. CL. 40.

ALBANY INTERNATIONAL CORP., ALBANY, NY:
2,667,046, CANC. INT. CL. 7.

ALBARRAN, RUBEN, LOS ANGELES, CA:
2,305,099, REN. 8-1-09. INT. CL. 16.

ALBERT B. SABIN VACCINE INSTITUTE, INC., WASHINGTON, DC, DBA SABIN VACCINE INSTITUTE:
3,679,245, PUB. 6-23-2009. MULTIPLE CLASS, INT. CLS. 35 AND 42.

ALCON, INC., CH-6331 HUNENBERG, SWITZERLAND:
3,680,402, INT. CL. 10.
3,680,403, INT. CL. 10.

ALCOS, INC., STERLING HTS, MI TO BROWN & BROWN OF DETROIT, INC., STERLING HEIGHTS, MI:
2,738,104, CANC. MULTIPLE CLASS, INT. CLS. 35 AND 42.

ALDA INC., DENVER, NC:
3,680,763, INT. CL. 25.

ALDIS, INC., OAK RIDGE, TN:
3,681,075, MULTIPLE CLASS, INT. CLS. 39 AND 45.

ALEX AND ANI, INC., CRANSTON, RI:
3,680,906, INT. CL. 14.
3,680,907, INT. CL. 14.

ALEXANDER HAAS MARTIN, INC., ATLANTA, GA:
3,681,771, INT. CL. 36.

ALEXANDRIA SANITATION AUTHORITY, ALEXANDRIA, VA:
3,625,421, COR. INT. CL. 35.

ALEXIOUS FIERO, LOGANVILLE, GA:
3,679,680, PUB. 6-23-2009. INT. CL. 38.

ALEXX, INC., WEST HILLS, CA:
3,680,908, INT. CL. 18.

ALI, KAREEM B., WALDORF, MD, DBA OBSIDIAN:
2,666,850, CANC. INT. CL. 25.

ALISON PARIS, OSPREY, FL:
3,680,807, INT. CL. 25.

ALKERMES, INC., CAMBRIDGE, MA:
3,681,273, INT. CL. 5.

ALL I AM, INC., MILL VALLEY, CA:
3,678,223, PUB. 6-23-2009. INT. CL. 35.

ALL READY, L.L.C., CASPER, WY:
2,666,724, CANC. INT. CL. 16.

ALLEN KNIGHT, INC., LOS ANGELES, CA:
2,665,213, CANC. INT. CL. 25.

ALLEN PRINTING COMPANY, INC., CLARION, IA:
2,667,404, CANC. INT. CL. 16.

ALLIANCE ENTERPRISES, INC., LACEY, WA:
3,679,345, PUB. 6-23-2009. MULTIPLE CLASS, INT. CLS. 9 AND 42.

ALLIANCE FOR LUPUS RESEARCH, INC., NEW YORK, NY:
3,680,853, MULTIPLE CLASS, INT. CLS. 16 AND 36.

ALLIANCEBERNSTEIN L.P., NEW YORK, NY:
2,665,534, CANC. INT. CL. 36.

ALLIANT TECHSYSTEMS INC., EDEN PRAIRIE, MN:
3,679,736, PUB. 6-23-2009. INT. CL. 13.

ALLIED BLENDING & INGREDIENTS, INC., KEOKUK, IA:
3,679,331, PUB. 6-23-2009. INT. CL. 1.

ALLOY MEDIA, NEW YORK, NY, DBA ALLOY ENTERTAINMENT:
3,679,803, PUB. 11-18-2008. INT. CL. 16.

ALLSEATING CORPORATION, MISSISSAUGA, CANADA:
3,680,967, INT. CL. 20.

- ALLSTATE ENTERPRISES, LLC, NORTHBROOK, IL:
1,128,756, REN. 8-3-09. INT. CL. 35.
- ALLSTATE HOSIERY SALES INC., GRAHAM, NC:
1,934,305, CANC. INT. CL. 25.
- ALLSTATE INSURANCE COMPANY, NORTHBROOK, IL:
3,680,258, MULTIPLE CLASS, INT. CLS. 35 AND 41.
3,680,259, MULTIPLE CLASS, INT. CLS. 35 AND 41.
3,681,217, INT. CL. 36.
- ALLTITE, INC., WICHITA, KS:
3,679,460, PUB. 6-23-2009. INT. CL. 42.
- ALMACO GROUP OY, 21200 RAISIO, FINLAND:
3,678,349, PUB. 6-23-2009. MULTIPLE CLASS, INT. CLS.
35, 37 AND 42.
- ALMATEC AG, SWITZERLAND:
2,665,428, CANC. MULTIPLE CLASS, INT. CLS. 6, 20
AND 37.
- ALMONDY HOLDING AB, GOTEBOURG, SWEDEN:
2,215,577, CANC. INT. CL. 30.
- ALPACA REGISTRY, INC., LINCOLN, NE:
3,679,098, PUB. 6-23-2009. MULTIPLE CLASS, INT. CLS.
35 AND 44.
- ALPHA EPSILON OMEGA, GLENDALE, CA:
3,679,311, PUB. 6-23-2009. U.S. CL. 200.
3,679,312, PUB. 6-23-2009. U.S. CL. 200.
- ALPHA I MARKETING CORP., WHITE PLAINS, NY:
1,518,408, CANC. INT. CL. 42.
- ALPHA WOLFE PUBLISHING, L.P., CARNEGIE, PA:
2,666,893, CANC. INT. CL. 16.
- ALPHONSE DI-TSIMBA MBAMBI-NGOMA, SWITZER-
LAND:
3,679,917, PUB. 6-23-2009. MULTIPLE CLASS, INT. CLS.
14 AND 25.
- ALPINE COWBOY, LLC, AUSTIN, TX:
3,678,412, PUB. 3-17-2009. INT. CL. 25.
- ALPINE OVERHEAD DOORS, INC., EAST SETAUKET, NY:
2,284,254, REN. 8-3-09. INT. CL. 6.
2,287,192, REN. 8-3-09. INT. CL. 6.
- ALSTOM, LEVALLOIS-PERRET, FRANCE:
3,678,690, PUB. 6-23-2009. INT. CL. 9.
- ALSTOM POWER CENTRALES, LEVALLOIS-PERRET CE-
DEX, FRANCE:
3,678,436, PUB. 3-3-2009. INT. CL. 9.
- ALTA SKI LIFTS COMPANY, ALTA, UT:
2,247,032, REN. 8-5-09. INT. CL. 41.
- ALTARATIONS, LLC, BLOWING ROCK, NC:
3,681,240, INT. CL. 28.
- ALTER, AARON, CARLSBAD, CA, DBA AARON'S COMPU-
TER RELIEF:
1,575,759, REN. 8-5-09. INT. CL. 42.
- ALTERED IMAGES DESIGN, NEWCASTLE, WA:
2,214,681, CANC. INT. CL. 30.
- ALTIA PLC, FINLAND:
3,679,916, PUB. 6-23-2009. INT. CL. 33.
- ALTITUDE CAPITAL PARTNERS, LLC, NEW YORK, NY:
3,678,267, PUB. 6-23-2009. INT. CL. 36.
3,678,268, PUB. 6-23-2009. INT. CL. 36.
- ALTITUDE MARKETING, LLC, COOPERSBURG, PA:
3,680,458, INT. CL. 35.
- ALTMAN, JEREMY, MARTINEZ, GA:
3,680,526, INT. CL. 28.
- ALTO U.S. INC., SPRINGDALE, AR:
2,666,437, CANC. INT. CL. 7.
- ALTOVA GMBH, VIENNA A-1010, AUSTRIA:
2,665,927, CANC. MULTIPLE CLASS, INT. CLS. 9, 16
AND 42.
- ALUMINUM COIL ANODIZING CORPORATION,
STREAMWOOD, IL:
1,518,554, CANC. INT. CL. 6.
- ALUTA, INC., CINCINNATI, OH:
3,678,938, PUB. 6-23-2009. INT. CL. 3.
3,678,939, PUB. 6-23-2009. INT. CL. 5.
3,678,940, PUB. 6-23-2009. INT. CL. 21.
- ALVARO, RODOLFO, SANTA BARBARA, CA:
2,214,274, CANC. INT. CL. 42.
- AMA S.N.C. DI MASSIMO E; CARLO ALBERTO ROVERE,
ITALY:
3,679,903, PUB. 6-23-2009. INT. CL. 32.
- AMACIS LIMITED, BELFAST BT12 6SJ, UNITED KING-
DOM:
2,666,157, CANC. INT. CL. 9.
- AMANRESORTS LIMITED, CENTRAL, HONG KONG:
2,749,080, CANC. INT. CL. 3.
- AMATEUR TRAPSHOOTING ASSOCIATION, VANDALIA,
OH:
3,678,956, PUB. 6-23-2009. MULTIPLE CLASS, INT. CLS.
35 AND 41.
- AMAXX RISK SOLUTIONS INC, MANSFIELD CENTER,
CT:
3,681,751, INT. CL. 36.
3,681,752, INT. CL. 36.
- AMBIR TECHNOLOGY, INC., OAKBROOK, IL:
2,666,439, CANC. INT. CL. 9.
- AMC CONCEPTS LLC, NORTHVALE, NJ:
2,265,807, REN. 8-4-09. INT. CL. 16.
- AMCORP INSURANCE AND FINANCIAL SERVICES, INC,
SAN ANTONIO, TX:
1,548,613, REN. 8-1-09. INT. CL. 36.
- AMEDICA BIOTECH, INC., HAYWARD, CA:
3,679,666, PUB. 6-23-2009. INT. CL. 5.
- AMERA SALES, INC., KENNEWICK, WA, AMERA COS-
METICS, INC., KENNEWICK, WA:
1,505,279, REN. 7-31-09. INT. CL. 42.
- AMERICAN ACADEMY OF OPHTHALMOLOGY, INC.,
SAN FRANCISCO, CA:
3,679,472, PUB. 6-23-2009. INT. CL. 16.
3,679,473, PUB. 6-23-2009. INT. CL. 44.
- AMERICAN AGRITECH, LLC, CHANDLER, AZ:
3,678,997, PUB. 6-23-2009. INT. CL. 1.
- AMERICAN AIRLINES FEDERAL CREDIT UNION, DFW
AIRPORT, TX:
3,681,112, INT. CL. 36.
- AMERICAN AUTO GUARDIAN, INC., ARLINGTON
HEIGHTS, IL:
3,679,543, PUB. 6-23-2009. INT. CL. 36.
- AMERICAN AUTOMOBILE ASSOCIATION, INC., HEA-
THROW, FL:
3,680,792, MULTIPLE CLASS, INT. CLS. 38 AND 39.
3,680,793, INT. CL. 35.
- AMERICAN AVIATION ACADEMY, INC., EL CAJON, CA:
3,679,106, PUB. 6-23-2009. MULTIPLE CLASS, INT. CLS.
39 AND 41.
- AMERICAN BIO MEDICA, KINDERHOOK, NY:
3,678,186, PUB. 3-17-2009. INT. CL. 5.
- AMERICAN BOOKSELLERS ASSOCIATION, INC., TARRY-
TOWN, NY:
3,678,485, PUB. 11-18-2008. INT. CL. 16.
- AMERICAN BRITTANY CLUB, INC., CARTERVILLE, IL:
1,130,146, REN. 8-3-09. INT. CL. 42.
- AMERICAN BUILDING RESTORATION PRODUCTS, INC.,
FRANKLIN, WI, AMERICAN BUILDING RESTORATION
CHEMICALS, INC., FRANKLIN, WI:
1,550,687, REN. 7-31-09. INT. CL. 3.
- AMERICAN BUS ASSOCIATION, WASHINGTON, DC:
2,305,505, REN. 8-2-09. INT. CL. 42.
- AMERICAN CAR CARE CENTERS, INC., MEMPHIS, TN:
3,678,779, PUB. 6-23-2009. INT. CL. 35.
- AMERICAN CHROME CHICAGO CO., BOLINGBROOK, IL:
3,679,101, PUB. 6-23-2009. INT. CL. 12.
- AMERICAN COLLEGE OF SPORTS MEDICINE, INC.,
INDIANAPOLIS, IN:
3,680,871, MULTIPLE CLASS, INT. CLS. 35 AND 44.
- AMERICAN COMPANIES, THE, TOPEKA, KS:
1,518,205, CANC. INT. CL. 35.
- AMERICAN CULINARY CHEFSBEST, INC., SAN FRAN-
CISCO, CA:
2,665,831, CANC. INT. CL. 35.
- AMERICAN DIABETES ASSOCIATION, INC., ALEXAN-
DRIA, VA:
2,667,016, CANC. INT. CL. 36.
- AMERICAN EXPRESS MARKETING & DEVELOPMENT
CORP., NEW YORK, NY:
3,679,733, PUB. 6-23-2009. INT. CL. 35.
- AMERICAN FAMILY FUNDS, INC., MOBILE, AL:
2,667,445, CANC. INT. CL. 36.
2,667,446, CANC. INT. CL. 36.

AMERICAN FAMILY LIFE ASSURANCE COMPANY OF COLUMBUS, COLUMBUS, GA:
3,678,427, PUB. 6-23-2009. INT. CL. 36.

AMERICAN FAMILY SKATE CENTERS, LLC, ALPHARETTA, GA:
2,303,540, REN. 7-31-09. INT. CL. 41.
2,303,540, CANC. INT. CL. 25.
2,305,425, REN. 7-31-09. INT. CL. 41.
2,305,425, CANC. INT. CL. 25.

AMERICAN FARM BUREAU FEDERATION, PARK RIDGE, IL:
2,666,765, CANC. INT. CL. 41.

AMERICAN FEDERATION OF VIOLIN AND BOW MAKERS, INC., THE, COSTA MESA, CA, AKA A.F.V. & B.M., INC.:
1,518,541, CANC. U.S. CL. 200.

AMERICAN FRANCHISE SYSTEMS, LLC, WARREN, MI:
3,679,426, PUB. 6-23-2009. INT. CL. 37.

AMERICAN GIRL, LLC, EL SEGUNDO, CA:
2,272,344, REN. 7-31-09. INT. CL. 42.
3,681,453, INT. CL. 16.

AMERICAN HEALTH & NUTRITION, INC., ANN ARBOR, MI:
2,665,016, CANC. INT. CL. 30.

AMERICAN HEALTH PARTNERS LLC, OKLAHOMA CITY, OK:
3,333,010, AM. INT. CL. 35.

AMERICAN HEALTHCARE SYSTEMS, LA JOLLA, CA:
1,518,250, CANC. INT. CL. 36.

AMERICAN HOLDCO, INC., LYNN, MA:
2,665,712, CANC. MULTIPLE CLASS, INT. CLS. 29 AND 31.

AMERICAN HOME REALTY NETWORK, INC., SAN FRANCISCO, CA:
3,680,390, MULTIPLE CLASS, INT. CLS. 35 AND 36.

AMERICAN HOSPITAL ASSOCIATION, CHICAGO, IL:
3,678,943, PUB. 6-23-2009. MULTIPLE CLASS, INT. CLS. 16 AND 41.

AMERICAN HYDROTECH, INC., CHICAGO, IL:
1,595,391, REN. 7-31-09. INT. CL. 19.

AMERICAN INSTITUTE OF CHEMICAL ENGINEERS, THE, NEW YORK, NY:
1,517,986, CANC. INT. CL. 16.

AMERICAN INTERNATIONAL GROUP, INC., NEW YORK, NY:
2,299,319, REN. 7-31-09. INT. CL. 36.
2,665,604, CANC. INT. CL. 36.
2,667,258, CANC. INT. CL. 36.
3,681,398, INT. CL. 36.

AMERICAN ITALIAN CANCER FOUNDATION, NEW YORK, NY:
2,320,634, REN. 8-5-09. MULTIPLE CLASS, INT. CLS. 36 AND 42.

AMERICAN LEGALNET, INC., ENCINO, CA:
3,679,077, PUB. 6-23-2009. INT. CL. 42.

AMERICAN LIFE LEAGUE, INC., STAFFORD, VA:
3,679,644, PUB. 6-23-2009. INT. CL. 35.

AMERICAN MEDIA OPERATIONS, INC., BOCA RATON, FL:
2,751,537, AM. INT. CL. 41.

AMERICAN MULTI-CINEMA, INC., KANSAS CITY, MO, DBA NATIONAL CINEMA NETWORK:
1,518,589, CANC. INT. CL. 35.

AMERICAN MULTI-CINEMA, INC., KANSAS CITY, MO:
3,678,137, PUB. 6-23-2009. INT. CL. 41.

AMERICAN NATIONAL PROPERTY & CASUALTY INSURANCE COMPANY, SPRINGFIELD, MO:
3,680,590, INT. CL. 36.

AMERICAN NURSES CREDENTIALING CENTER, SILVER SPRING, MD:
3,681,775, MULTIPLE CLASS, INT. CLS. 16, 41 AND 44.

AMERICAN PIN & FASTENER CORPORATION, TEMPE, AZ:
1,517,809, CANC. INT. CL. 9.

AMERICAN PLANNING ASSOCIATION, WASHINGTON, DC:
1,517,940, CANC. INT. CL. 16.

AMERICAN PRODUCTIVITY & QUALITY CENTER, HOUSTON, TX:
2,277,346, REN. 8-3-09. INT. CL. 16.
2,299,342, REN. 8-3-09. INT. CL. 41.

AMERICAN SOCIETY OF CONTEMPORARY MEDICINE, SURGERY & OPHTHALMOLOGY, LINCOLNWOOD, IL:
3,678,156, PUB. 6-23-2009. INT. CL. 16.

AMERICAN SPECIALTY HEALTH INCORPORATED, SAN DIEGO, CA:
3,680,457, INT. CL. 25.
3,680,628, INT. CL. 35.
3,681,011, MULTIPLE CLASS, INT. CLS. 41 AND 44.

AMERICAN SPORT TEES, OOLTEWAH, TN:
3,680,599, INT. CL. 25.

AMERICAN SPORTING GOODS CORPORATION, ALISO VIEJO, CA:
2,256,870, REN. 8-1-09. INT. CL. 25.

AMERICAN SPORTS LICENSING, INC., WILMINGTON, DE:
2,664,930, CANC. INT. CL. 35.

AMERICAN SUZUKI MOTOR CORPORATION, BREA, CA:
1,518,380, CANC. INT. CL. 41.

AMERICAN VALVE, INC., GREENSBORO, NC:
3,562,286, COR. INT. CL. 11.

AMERICAN VINYL CONCEPTS, INC., TOMS RIVER, NJ, DBA AVCON:
2,666,200, CANC. INT. CL. 19.

AMERICAN WEST INSURANCE COMPANY, FARGO, ND:
3,653,554, COR. INT. CL. 36.

AMERICAN WHOLESALE INSURANCE GROUP, INC., CHARLOTTE, NC:
3,678,143, PUB. 3-16-2004. MULTIPLE CLASS, INT. CLS. 35 AND 36.

AMERICANS FOR FAIR TAXATION, HOUSTON, TX:
2,266,332, REN. 8-3-09. INT. CL. 42.

AMERICATEL CORPORATION, MIAMI, FL:
2,301,297, REN. 8-3-09. INT. CL. 38.

AMERICHEM, INC., CUYAHOGA FALLS, OH:
3,680,643, MULTIPLE CLASS, INT. CLS. 1, 2 AND 40.
3,680,644, MULTIPLE CLASS, INT. CLS. 1, 2 AND 40.
3,680,645, MULTIPLE CLASS, INT. CLS. 1, 2 AND 40.

AMERIMAX BUILDING PRODUCTS, INC., DALLAS, TX:
2,667,108, CANC. INT. CL. 20.

AMERISERV FINANCIAL, INC., JOHNSTON, PA:
2,666,902, CANC. INT. CL. 36.

AMERITAS HOLDING COMPANY, LINCOLN, NE:
3,678,901, PUB. 6-23-2009. INT. CL. 35.

AMES SAFETY ENVELOPE COMPANY, INC., SOMERVILLE, MA:
2,294,854, REN. 8-1-09. INT. CL. 16.

AMETEK, INC., PAOLI, PA:
862,999, REN. 8-3-09. U.S. CL. 13 (INT. CL. 6).

AMGEN INC., THOUSAND OAKS, CA:
2,253,545, REN. 7-31-09. INT. CL. 41.
2,260,883, REN. 7-31-09. INT. CL. 41.

AMIC TECHNOLOGY CORPORATION, HSIN CHU, TAIWAN:
2,665,952, CANC. INT. CL. 9.

AMITA KAPUR, ANAND BHATT, NANDAN MALUSTE, AND GERSON DACUNHA AND RATAN BATLIBOI ALL ARE INDIAN CITIZENS AND THE AS TRUSTEES OF THE CRY CHILD RELIEF AND YOU, NEW DELHI - 110003, INDIA:
2,666,728, CANC. INT. CL. 42.

AMITY HOSIERY CO., INC., GARDEN CITY PARK, NY, ASKIN BROTHERS COMPANY, INC., OWINGS MILLS, MD:
1,136,262, REN. 8-5-09. INT. CL. 25.

AMOREPACIFIC CORPORATION, SEOUL, REPUBLIC OF KOREA:
3,678,355, PUB. 6-23-2009. INT. CL. 3.

AMPLIFIER RESEARCH CORPORATION, SOUDERTON, PA:
3,681,097, INT. CL. 9.

AMR CORPORATION, FORT WORTH, TX:
1,850,845, CANC. INT. CL. 35.

AMSTED RAIL COMPANY, INC., GRANITE CITY, IL:
3,678,201, PUB. 6-23-2009. INT. CL. 12.

- AMSTRAD PUBLIC LIMITED COMPANY, BRENTWOOD, ESSEX, ENGLAND:
1,517,983, CANC. INT. CL. 16.
- ANA LOMBA EARLY LANGUAGES LLC, PRINCETON JUNCTION, NJ:
3,680,274, INT. CL. 41.
3,680,276, INT. CL. 41.
- ANADARKO PETROLEUM CORPORATION, HOUSTON, TX:
3,679,824, PUB. 2-10-2009. MULTIPLE CLASS, INT. CLS. 4, 25, 36, 37 AND 42.
3,679,825, PUB. 2-10-2009. MULTIPLE CLASS, INT. CLS. 4, 25, 36, 37 AND 42.
- ANALYTICAL RESEARCH LABORATORIES, OKLAHOMA CITY, OK:
2,666,673, CANC. INT. CL. 44.
- ANANI, SUMYA S., OVERLAND PARK, KS:
3,678,415, PUB. 6-23-2009. INT. CL. 41.
- ANASPEC, INC., SAN JOSE, CA:
3,680,987, INT. CL. 1.
- ANASTASIA BEVERLY HILLS, INC., BEVERLY HILLS, CA:
3,679,514, PUB. 6-23-2009. MULTIPLE CLASS, INT. CLS. 3 AND 21.
- ANCHOR COATINGS OF LEESBURG, INC., LEESBURG, FL:
3,679,172, PUB. 6-23-2009. MULTIPLE CLASS, INT. CLS. 2, 17 AND 35.
- ANCHOR WALL SYSTEMS, INC., MINNETONKA, MN:
3,679,114, PUB. 6-23-2009. INT. CL. 19.
- ANDERSON KILL & OLICK, P.C., NEW YORK, NY:
3,681,467, INT. CL. 9.
- ANDERSON, RICHARD, MORRISON, CO:
3,679,650, PUB. 6-23-2009. INT. CL. 21.
- ANDIAMO SYSTEMS, INC. SAN FRANCISCO, CA:
3,678,163, PUB. 6-23-2009. INT. CL. 35.
- ANDREA OBSTON MARKETING COMMUNICATIONS, LLC, BLOOMFIELD, CT:
3,680,167, MULTIPLE CLASS, INT. CLS. 35 AND 41.
- ANDREW BAGG, LOS ANGELES, CA:
3,680,210, MULTIPLE CLASS, INT. CLS. 9 AND 41.
- ANDREW P. NESTING, EL PASO, TX AND TERRY L. BACA, EL PASO, TX:
3,680,743, INT. CL. 30.
- ANDREW WINCH DESIGNS LIMITED, LONDON, GREAT BRITAIN:
2,824,285, CANC. INT. CL. 25.
- ANDRITZ KUESTERS GMBH, KREFELD D- 47805, FED REP GERMANY:
1,518,556, CANC. INT. CL. 7.
- ANDROSCIENCE CORPORATION, SAN DIEGO, CA:
3,679,458, PUB. 6-23-2009. INT. CL. 5.
- ANDY GOULD MANAGEMENT, INC., LOS ANGELES, CA:
3,680,163, INT. CL. 35.
- ANGEL PLAYING CARDS CO., LTD., CHUO-KU OSAKA, JAPAN:
3,681,683, INT. CL. 28.
- ANGEL, DAVID W, AURORA, IL, DBA THE WILLING AND COOPER, KENT S, SOUTH ELGIN, IL, DBA THE WILLING AND SMITH, DANIEL E, PLANO, IL, DBA THE WILLING AND GOUGH, CHRIS J, DEKALB, IL, DBA THE WILLING AND KRAHENBUHL, JOHN D, ST. CHARLES, IL, DBA THE WILLING AND WIGSTONE, RICH A, PLANO, IL, DBA THE WILLING:
3,681,375, INT. CL. 41.
- ANGILBERTO AND ISABEL SERRANO, BULLHEAD CITY, AZ:
2,352,008. REN. 8-4-09. INT. CL. 42.
- ANGLES BEAUTYCARE GROUP, INC., SAN DIEGO, CA:
3,681,449, MULTIPLE CLASS, INT. CLS. 9 AND 11.
3,681,450, MULTIPLE CLASS, INT. CLS. 9 AND 11.
- ANGLO DESIGN HOLDINGS PLC, UNITED KINGDOM:
3,679,934, PUB. 6-23-2009. INT. CL. 9.
- ANHEUSER-BUSCH, INCORPORATED, ST. LOUIS, MO:
2,215,384, CANC. INT. CL. 32.
2,333,424, REN. 8-3-09. INT. CL. 32.
2,667,147, CANC. INT. CL. 32.
2,667,148, CANC. INT. CL. 21.
3,678,829, PUB. 6-23-2009. INT. CL. 32.
3,678,830, PUB. 6-23-2009. INT. CL. 32.
- ANI CORPORATION LIMITED, THE, PORT MELBOURNE VIC 3207, AUSTRALIA:
2,665,076, CANC. INT. CL. 6.
- ANIMAL SCIENCE PRODUCTS, INC., NACOGDOCHES, TX:
3,681,357, INT. CL. 5.
3,681,358, INT. CL. 5.
- ANITA'S NEW MEXICO STYLE MEXICAN FOOD, INC., CHANTILLY, VA:
1,122,096. REN. 8-3-09. INT. CL. 42.
- ANN MCGEE-COOPER AND ASSOCIATES, INC., DALLAS, TX:
3,681,704, INT. CL. 41.
- ANTON HUMMEL VERWALTUNGS GMBH, WALDKIRCH, FED REP GERMANY:
2,734,092, CANC. INT. CL. 6.
- ANTON PLATTNER, FED REP GERMANY:
3,680,034, PUB. 6-23-2009. INT. CL. 31.
- ANTONIO PUIG, S.A., 08021 BARCELONA, SPAIN:
2,666,168, CANC. INT. CL. 3.
- ANVIL MORTGAGE CORPORATION, ROCKVILLE, MD:
2,666,254, CANC. INT. CL. 36.
- APEX INVESTIGATIVE SERVICES, INC., RANCHO CORDOVA, CA:
3,678,809, PUB. 3-17-2009. MULTIPLE CLASS, INT. CLS. 35 AND 45.
- APOLLO AVIATION HOLDINGS LIMITED, HAMILTON, BERMUDA:
3,678,450, PUB. 6-23-2009. INT. CL. 35.
- APON RECORD COMPANY, INC., LONG ISLAND CITY, NY:
2,214,444, CANC. INT. CL. 25.
- APOSTOLIC CHURCH, INC., THE, NEWARK, NJ:
2,665,206, CANC. INT. CL. 42.
- APOTHECARY DEVELOPMENT CORPORATION, MARCO ISLAND, FL, DBA ISLAND DRUG:
1,560,434, REN. 8-3-09. INT. CL. 5.
1,560,435, REN. 8-3-09. INT. CL. 5.
- APPLE & EVE, LLC, PORT WASHINGTON, NY:
2,667,168, CANC. INT. CL. 32.
- APPLE BANK FOR SAVINGS, NEW YORK, NY:
3,680,084, INT. CL. 36.
- APPLE CORPS LIMITED, LONDON, ENGLAND:
3,680,063, MULTIPLE CLASS, INT. CLS. 6, 26 AND 28.
- APPLE INC., CUPERTINO, CA:
3,679,056, PUB. 6-23-2009. INT. CL. 9.
- APPLE, JOSEPH V., WINTER PARK, FL:
3,679,117, PUB. 6-23-2009. INT. CL. 42.
- APPLERA CORPORATION, FOSTER CITY, CA:
2,260,626. REN. 7-31-09. INT. CL. 1.
- APPLIED BIKINETICS LLC, HOUSTON, TX:
3,681,135, INT. CL. 10.
- APPLIED COMPUTING DEVICES, INC., TERRE HAUTE, IN:
1,517,853, CANC. INT. CL. 9.
- APPLIED MOLECULAR EVOLUTION, INC., SAN DIEGO, CA:
2,665,532, CANC. INT. CL. 42.
- AQUA FINA AG, VADUZ, LIECHTENSTEIN:
2,665,023, CANC. MULTIPLE CLASS, INT. CLS. 1 AND 42.
- AQUA LOGIC, INC., SAN DIEGO, CA:
2,353,216. REN. 8-3-09. MULTIPLE CLASS, INT. CLS. 11 AND 16.
- AQUA VITAE, INC, NEVADA CITY, CA:
2,666,316, CANC. INT. CL. 3.
- AQUA-LEISURE INDUSTRIES, INC., AVON, MA:
1,518,094, CANC. INT. CL. 28.
- AQUAFIL S.P.A., ITALY:
3,679,977, PUB. 6-23-2009. MULTIPLE CLASS, INT. CLS.

22 AND 23.
3,679,978, PUB. 6-23-2009. MULTIPLE CLASS, INT. CLS. 22 AND 23.

AQUAPEUTICS LLC, PALMER, MA:
3,679,664, PUB. 6-23-2009. INT. CL. 11.

AQUATROLS CORPORATION OF AMERICA, INC., PAULSBORO, NJ:
2,288,991, REN. 8-4-09. INT. CL. 1.

AQRON CORPORATION, ROCKWALL, TX:
2,666,135, CANC. INT. CL. 1.

ARACAZINHO, S.L., MARBELLA, SPAIN:
3,678,400, PUB. 6-23-2009. MULTIPLE CLASS, INT. CLS. 36 AND 37.

ARAMARK CORPORATION, PHILADELPHIA, PA:
3,680,913, INT. CL. 35.

ARBONNE INTERNATIONAL, LLC, IRVINE, CA:
3,679,754, PUB. 6-23-2009. INT. CL. 3.

ARBY'S FOUNDATION, INC., FT. LAUDERDALE, FL:
2,215,438, CANC. INT. CL. 36.

ARC ABRASIVES, INC., TROY, OH:
3,681,141, MULTIPLE CLASS, INT. CLS. 3 AND 7.

ARCADIA GROUP, ATLANTA, GA:
3,680,508, MULTIPLE CLASS, INT. CLS. 3 AND 10.

ARCELOMITTAL (SOCIÉTÉ ANONYME), BENELUX, LUXEMBOURG:
3,679,868, PUB. 6-23-2009. MULTIPLE CLASS, INT. CLS. 6, 7, 9, 12, 19, 21, 39, 40, 41 AND 42.

ARCHSTONE COMMUNITIES LLC, ENGLEWOOD, CO:
3,678,428, PUB. 6-23-2009. MULTIPLE CLASS, INT. CLS. 35, 36 AND 37.

ARCOR S.A.I.C., (1006) BUENOS AIRES, ARGENTINA:
2,666,387, CANC. INT. CL. 30.

ARCTIC CAT INC., THIEF RIVER FALLS, MN:
1,548,214, REN. 8-6-09. INT. CL. 12.

ARD RI ENTERTAINMENT LTD., DUBLIN 2, IRELAND:
3,680,514, INT. CL. 41.

ARDILL SERVICES PTY LTD, KENT TOWN, AUSTRALIA, TA REILLY'S WINES:
3,681,182, INT. CL. 33.

ARDISTIA DESIGN WORKS INC., NEW YORK, NY:
3,679,848, PUB. 2-27-2007. INT. CL. 25.

ARES TRADING S.A., AUBONNE, SWITZERLAND:
3,678,530, PUB. 6-23-2009. INT. CL. 10.

ARGEN CORPORATION, THE, SAN DIEGO, CA:
2,249,067, REN. 7-31-09. INT. CL. 5.

ARGENTO FOODS LLC, ALPHARETTA, GA:
3,680,679, INT. CL. 30.

ARGO TEA, INC., CHICAGO, IL:
3,681,757, INT. CL. 30.
3,681,758, INT. CL. 30.

ARGUS ASSET MANAGEMENT, INC., WILMINGTON, DE:
1,517,931, CANC. INT. CL. 16.

ARISTOCRAT TECHNOLOGIES AUSTRALIA PTY LTD., NEW SOUTH WALES, AUSTRALIA:
2,665,197, CANC. INT. CL. 9.

ARISTOCRAT TECHNOLOGIES AUSTRALIA PTY LTD, LANE COVE, NEW SOUTH WALES 2066, AUSTRALIA:
2,665,397, CANC. INT. CL. 9.

ARKANSAS EDUCATIONAL TELEVISION COMMISSION, CONWAY, AR, DBA ARKANSAS EDUCATIONAL TELEVISION NETWORK AND/OR AETN:
2,666,868, CANC. INT. CL. 9.

ARKEMA FRANCE, 92700 COLOMBES, FRANCE:
2,767,323, CANC. INT. CL. 1.
3,678,512, PUB. 11-25-2008. INT. CL. 1.

ARKIDATA CORPORATION, DOWNERS GROVE, IL:
2,665,672, CANC. INT. CL. 9.
2,665,674, CANC. INT. CL. 9.

ARM LIMITED, CAMBRIDGE, UNITED KINGDOM:
3,681,247, INT. CL. 16.

ARMAG CORPORATION, BARDSTOWN, KY:
2,330,851, REN. 8-3-09. MULTIPLE CLASS, INT. CLS. 6 AND 13.
2,365,636, REN. 8-3-09. MULTIPLE CLASS, INT. CLS. 6 AND 13.

ARMOR, 44100 NANTES, FRANCE:
2,264,483, REN. 8-5-09. INT. CL. 16.

ARMOUTH INTERNATIONAL INC., BROOKLYN, NY:
3,680,081, INT. CL. 25.

ARMSTRONG INTERNATIONAL, INC., THREE RIVERS, MI:
1,553,464, REN. 8-3-09. MULTIPLE CLASS, INT. CLS. 7 AND 11.

ARNHOELTER, KRISTEN, LOS ANGELES, CA:
3,680,891, INT. CL. 24.

ARNOLD & PORTER LLP, WASHINGTON, DC:
2,295,953, REN. 8-3-09. INT. CL. 42.

ARNOLD, MARK S., ST. CHARLES, MO:
2,667,124, CANC. INT. CL. 19.

AROW GLOBAL, INC., WINNIPEG, CANADA:
3,678,357, PUB. 6-23-2009. MULTIPLE CLASS, INT. CLS. 40 AND 42.

ARROYO GRAND USA, GROVER BEACH, CA:
2,214,469, CANC. INT. CL. 25.

ART OF DEFENCE GMBH, REGENSBURG, FED REP GERMANY:
3,678,208, PUB. 1-13-2009. INT. CL. 42.

ARTECNICA, INC., LOS ANGELES, CA:
3,679,157, PUB. 6-23-2009. MULTIPLE CLASS, INT. CLS. 11, 14, 20, 21 AND 42.

ARTEZANOS, INC., MIAMI, FL:
2,666,409, CANC. INT. CL. 19.

ARTISAN'S RESOURCE, INC., TEMPE, AZ, DBA SPACES INTERIOR DESIGN:
3,679,171, PUB. 6-23-2009. INT. CL. 42.

ARTSHOWS AND PRODUCTS, NEWPORT, RI:
2,214,116, CANC. INT. CL. 3.
2,214,117, CANC. INT. CL. 20.

ARYSTA LIFESCIENCE NORTH AMERICA, LLC, CARY, NC:
1,517,744, CANC. INT. CL. 5.

ASAF DAVID FULKS, SANTA ANA, CA, DBA THE OC RECORDING COMPANY:
3,678,327, PUB. 6-23-2009. INT. CL. 41.

ASAHI KOGAKU KOGYO KABUSHIKI KAISHA, ITABASHI-KU, TOKYO 174, JAPAN, DBA ASAHI OPTICAL CO., LTD.:
2,666,987, CANC. INT. CL. 9.

ASAHI/AMERICA, INC., MALDEN, MA:
2,322,353, REN. 8-5-09. INT. CL. 17.

ASAMER BASALTIC FIBERS GMBH, OHLSDORF, AUSTRIA:
3,678,277, PUB. 5-5-2009. MULTIPLE CLASS, INT. CLS. 17, 19, 21, 22 AND 24.

ASANTE TECHNOLOGIES, INC., SAN JOSE, CA:
2,666,141, CANC. INT. CL. 9.

ASC SIGNAL CORPORATION, CLEVELAND, OH:
3,680,127, MULTIPLE CLASS, INT. CLS. 9, 37 AND 38.

ASCENSION ORTHOPEDICS, INC., AUSTIN, TX:
3,681,204, INT. CL. 10.

ASCO CONTROLS, L.P., FLORHAM PARK, NJ:
2,291,065, REN. 8-5-09. INT. CL. 35.

ASHBA MEDIA, INC., WEST HOLLYWOOD, CA:
3,679,252, PUB. 6-23-2009. INT. CL. 35.

ASHER A KALEM, JACKSONVILLE, FL:
3,678,678, PUB. 2-17-2009. INT. CL. 25.

ASHER, SAM M, EUGENE, OR:
3,678,922, PUB. 6-23-2009. INT. CL. 20.

ASHLEA SCHAUMBURG, ROCHESTER, MN, DBA MOTO-DUDS:
3,678,310, PUB. 6-23-2009. INT. CL. 9.

ASHLEN, INC., SANTA FE, NM:
1,518,467, CANC. INT. CL. 42.

ASHWOOD WAY PTY. LTD., VICTORIA, AUSTRALIA AND WALTER DELL PTY. LTD., VICTORIA, AUSTRALIA:
2,260,473, REN. 8-4-09. INT. CL. 35.

ASIANSPECTION, SHUENG WAN, HONG KONG:
3,133,195, AM. MULTIPLE CLASS, INT. CLS. 35 AND 42.
3,278,136, AM. MULTIPLE CLASS, INT. CLS. 35 AND 42.

ASIANIC, INC., OAK PARK, IL:
2,667,064, CANC. INT. CL. 30.

ASIS INTERNATIONAL, INC., ALEXANDRIA, VA:
3,681,645, MULTIPLE CLASS, INT. CLS. 35 AND 41.

ASPEN HOLDINGS, INC., OMAHA, NE:
3,678,403, PUB. 6-23-2009. INT. CL. 36.

- ASPEN PUBLISHERS, INC., NEW YORK, NY, PENNFAIR COMMUNICATIONS, INC., STAMFORD, CT:
1,555,351. REN. 8-6-09. INT. CL. 16.
- ASPEN PUBLISHERS, INC., NEW YORK, NY:
3,678,996. PUB. 6-23-2009. INT. CL. 9.
- ASPEN SKIING COMPANY, ASPEN, CO:
3,681,315. INT. CL. 32.
- ASSERTIVE CREATIVITY LLC, BROOKLYN, NY:
3,679,546. PUB. 6-23-2009. INT. CL. 25.
3,679,740. PUB. 6-23-2009. INT. CL. 25.
- ASSET-MAP, INC., RADNOR, PA:
3,680,766. INT. CL. 36.
3,680,845. INT. CL. 36.
- ASSOCIATED STEEL COMPANY, INC., CLEVELAND, OH:
3,679,558. PUB. 6-23-2009. INT. CL. 6.
- ASSOCIATION OF CLINICAL RESEARCH PROFESSIONALS, ALEXANDRIA, VA:
3,680,480. INT. CL. 35.
- ASSOCIATION OF NATIONAL ADVERTISERS, INC., NEW YORK, NY:
3,680,754. INT. CL. 35.
3,681,580. MULTIPLE CLASS, INT. CLS. 9 AND 16.
- ASSOCIATION OF TELEMESSAGING SERVICES INTERNATIONAL INC., ALEXANDRIA, VA:
1,518,546. CANC. MULTIPLE CLASS, INT. CLS. 16 AND 41.
- ASSOCIATION OF WOMEN'S HEALTH, OBSTETRICS AND NEONATAL NURSES, WASHINGTON, D.C., DC:
2,308,328. REN. 8-3-09. INT. CL. 42.
- ASSORT PTY. LTD., CHELTCNHAM, VICTORIA, 3192, AUSTRALIA:
2,304,585. REN. 8-4-09. INT. CL. 9.
- ASSURANT, INC., NEW YORK, NY:
3,679,028. PUB. 6-23-2009. INT. CL. 36.
- ASTRA AKTIEBOLAG, S-151 85 SODERTALJE, SWEDEN:
2,664,927. CANC. INT. CL. 5.
- ASTRAMED PHYSICIAN P.C., MELVILLE, NY:
3,679,224. PUB. 6-23-2009. INT. CL. 44.
- ASTRO-MED, INC., WEST WARWICK, RI:
2,213,740. CANC. INT. CL. 9.
- ASX OPERATIONS PTY LIMITED, SYDNEY NSW 2000, AUSTRALIA:
2,665,248. CANC. MULTIPLE CLASS, INT. CLS. 9, 16, 35, 36, 38, 41 AND 42.
- AT BATTERY CO., VALENICA, CA:
3,678,424. PUB. 6-23-2009. INT. CL. 9.
- AT LAST SPORTSWEAR INC., SECAUCUS, NJ:
2,666,153. CANC. INT. CL. 25.
- AT PLASTICS INC., BRAMPTON, ONTARIO, L6W 3G4, CANADA:
2,664,973. CANC. INT. CL. 1.
- ATG CEYLON (PVT) LIMITED, IPZ KATUNAYAKE, SRI LANKA:
3,680,608. INT. CL. 9.
- ATG SPORTS INDUSTRIES, INC., ANDOVER, KS:
3,678,962. PUB. 6-23-2009. INT. CL. 27.
- ATHENA COSMETICS, INC., HENDERSON, NV:
3,681,136. INT. CL. 3.
- ATI PROPERTIES, INC., ALBANY, OR:
3,679,556. PUB. 6-23-2009. MULTIPLE CLASS, INT. CLS. 9 AND 16.
- ATIT DIAMOND CORPORATION, NEW YORK CITY, NY:
3,681,513. INT. CL. 14.
- ATLANTA BAR FOUNDATION, INC., THE, ATLANTA, GA:
2,263,092. REN. 8-3-09. INT. CL. 41.
- ATLANTA NATIONAL LEAGUE BASEBALL CLUB, INC., ATLANTA, GA:
2,214,663. CANC. INT. CL. 28.
- ATLANTIC CITY COIN & SLOT SERVICE COMPANY, INC., PLEASANTVILLE, NJ:
3,680,142. INT. CL. 9.
- ATLANTIC ENVELOPE COMPANY LLC, SMYRNA, GA:
2,666,752. CANC. INT. CL. 16.
- ATLANTIC EQUIPMENT & LEASING CORPORATION, NEWBURY, MA:
1,518,330. CANC. INT. CL. 39.
- ATLANTIC REFINING & MARKETING CORP., PHILADELPHIA, PA:
1,518,303. CANC. INT. CL. 37.
- ATLANTIC RICHFIELD COMPANY, LISLE, IL:
2,215,332. CANC. INT. CL. 28.
- ATLAS COPCO AIRPOWER, NAAMLOZE VEN-NOOTSCHAP, WILRIJK, BELGIUM:
2,665,259. CANC. MULTIPLE CLASS, INT. CLS. 7 AND 8.
- ATLAS PAPER MILLS, LLC, MIAMI, FL:
3,679,332. PUB. 6-23-2009. INT. CL. 16.
- ATLAS ROOFING CORPORATION, MERIDIAN, MS, VERTEX DISTRIBUTING INC., LOS ANGELES, CA:
869,913. REN. 8-5-09. U.S. CL. 12 (INT. CL. 17).
- ATLASSIAN PTY LTD, AUSTRALIA:
3,679,994. PUB. 6-23-2009. MULTIPLE CLASS, INT. CLS. 9, 38 AND 42.
3,679,995. PUB. 6-23-2009. MULTIPLE CLASS, INT. CLS. 9, 38 AND 42.
- ATOMICO INVESTMENT HOLDINGS LIMITED, TORTOLA, BR.VIRGIN ISLANDS:
3,679,910. PUB. 6-23-2009. MULTIPLE CLASS, INT. CLS. 16, 35 AND 36.
- ATSUMI ELECTRIC CO., LTD., JAPAN:
3,680,011. PUB. 6-23-2009. INT. CL. 9.
- ATTIQ MARVIN J., SAN DIEGO, CA:
3,680,426. INT. CL. 3.
- ATTO TECHNOLOGY, INC., AMHERST, NY:
2,665,904. CANC. INT. CL. 9.
- AUDINATE PTY LTD, AUSTRALIA:
3,679,882. PUB. 6-23-2009. MULTIPLE CLASS, INT. CLS. 9, 38 AND 42.
- AUDIOBASKET.COM, INC., SAN FRANCISCO, CA:
2,665,145. CANC. INT. CL. 38.
- AUNTIE LITTER, INC., BIRMINGHAM, AL:
3,678,417. PUB. 3-17-2009. INT. CL. 35.
- AURORA NETWORKS, INC., SANTA CLARA, CA:
3,678,453. PUB. 6-23-2009. INT. CL. 9.
- AUSTRALIA ZOO PTY LTD, BEERWAH, QUEENSLAND, AUSTRALIA:
3,678,227. PUB. 6-23-2009. MULTIPLE CLASS, INT. CLS. 9, 16, 18, 21, 24, 25, 28, 35, 41, 42, 43 AND 44.
- AUTHENTIC SPECIALTY FOODS, INC., CHINO, CA:
2,215,048. CANC. INT. CL. 30.
3,680,157. INT. CL. 30.
- AUTISM NEW JERSEY, INC., EWING, NJ:
3,681,399. MULTIPLE CLASS, INT. CLS. 35, 36 AND 41.
- AUTOMATED ARTISTS CORP., CLEARWATER, FL:
1,518,515. CANC. INT. CL. 42.
- AUTOMED TECHNOLOGIES, INC., BUFFALO GROVE, IL:
3,680,112. INT. CL. 35.
- AUTONOMY CORPORATION PLC, CAMBRIDGE, UNITED KINGDOM:
3,679,572. PUB. 6-23-2009. MULTIPLE CLASS, INT. CLS. 9 AND 45.
- AUTONOMY CORPORATION PLC, CAMBRIDGE, CB4 0WZ, UNITED KINGDOM:
3,679,705. PUB. 6-23-2009. MULTIPLE CLASS, INT. CLS. 9 AND 45.
- AUTOTESTER, INC., DALLAS, TX:
2,665,007. CANC. MULTIPLE CLASS, INT. CLS. 9 AND 35.
- AVAIL MEDIA, INC., RESTON, VA:
3,680,223. MULTIPLE CLASS, INT. CLS. 9, 35 AND 38.
- AVANI MEDIA INC., SAUSALITO, CA:
3,679,346. PUB. 6-23-2009. INT. CL. 35.
- AVAYA INC., BASKING RIDGE, NJ:
3,680,377. INT. CL. 38.
- AVECIA BIOLOGICS LIMITED, MANCHESTER M9 8ZS, UNITED KINGDOM:
3,678,481. PUB. 6-23-2009. MULTIPLE CLASS, INT. CLS. 1, 40 AND 42.
- AVOCA INSURANCE HOLDINGS, LTD., HAMILTON HN11, BERMUDA:
3,678,182. PUB. 2-24-2009. INT. CL. 36.
- AVOCENT HUNTSVILLE CORP., HUNTSVILLE, AL:
2,213,975. CANC. INT. CL. 9.
- AVON PRODUCTS, INC., NEW YORK, NY:
2,665,947. CANC. INT. CL. 3.

AVUE TECHNOLOGIES CORPORATION, TACOMA, WA:
3,681,493, MULTIPLE CLASS, INT. CLS. 35 AND 42.

AWI ACQUISITION COMPANY, SYLMAR, CA, DBA ALLIED INTERNATIONAL, INC.:
2,666,081, CANC. INT. CL. 8.

AXIS AB, S-223 70 LUND, SWEDEN:
2,664,939, CANC. MULTIPLE CLASS, INT. CLS. 9, 16, 35, 37, 38, 41 AND 42.

AZRIA, FLORENCE A., BEVERLY HILLS, CA:
3,679,701, PUB. 6-23-2009. INT. CL. 41.

AZUDA INTERNATIONAL LTD., TAIPEI CITY, TAIWAN:
3,679,019, PUB. 6-23-2009. MULTIPLE CLASS, INT. CLS. 20 AND 21.

A123 SYSTEMS, INC., WATERTOWN, MA:
3,680,565, INT. CL. 9.

B & G FOODS, PARSIPPANY, NJ:
2,667,019, CANC. INT. CL. 29.

B.J. ALAN COMPANY, YOUNGSTOWN, OH:
3,678,882, PUB. 6-23-2009. INT. CL. 13.

B&O FOODART A.G., FREINBACH, SWITZERLAND:
3,679,174, PUB. 6-23-2009. INT. CL. 43.

B&W GROUP LTD., WEST SUSSEX, UNITED KINGDOM:
2,665,400, CANC. INT. CL. 9.

B-YOUNG A/S, KOLDING, DENMARK:
3,678,914, PUB. 6-23-2009. MULTIPLE CLASS, INT. CLS. 14, 18 AND 25.

B'S INTERNATIONAL, TOKYO, JAPAN:
2,218,800, REN. 8-5-09. INT. CL. 25.

BAB, INC., DEERFIELD, IL:
2,260,385, REN. 8-3-09. MULTIPLE CLASS, INT. CLS. 30, 35 AND 42.
2,261,664, REN. 8-3-09. INT. CL. 32.

BABCOCK & WILCOX COMPANY, THE, NEW ORLEANS, LA:
1,518,309, CANC. INT. CL. 37.

BABCOCK & WILCOX TECHNICAL SERVICES Y-12, LLC, OAK RIDGE, TN:
3,680,598, INT. CL. 3.

BABOLAT VS. S.A., LYON, FRANCE:
1,518,113, CANC. INT. CL. 28.

BABY WORLD INC., BROOKLYN, NY:
2,666,089, CANC. INT. CL. 35.

BACARDI IMPORTS, INC., MIAMI, FL:
1,396,062, CANC. INT. CL. 33.

BACH, VIET T., GARDEN GROVE, CA:
2,665,014, CANC. INT. CL. 42.

BACHOCO S.A. DE C.V., CELAYA, GUANAJUATO, MEXICO:
3,680,529, INT. CL. 29.

BACKHUS GMBH, EDEWECHT, FED REP GERMANY:
3,681,653, MULTIPLE CLASS, INT. CLS. 7, 37 AND 41.

BACNET INTERNATIONAL INC., MARIETTA, GA:
3,679,064, PUB. 6-23-2009. U.S. CL. 200.

BAD CROWD MOTOR CLUB, LLC, LAS VEGAS, NV:
3,679,695, PUB. 6-23-2009. U.S. CL. 200.
3,679,702, PUB. 6-23-2009. U.S. CL. 200.

BAD HERSFELDER DESSOUS; BÜTEFÜR & HENSEL GMBH, FED REP GERMANY:
3,680,006, PUB. 6-23-2009. INT. CL. 25.

BADGE BOMB LLC, PORTLAND, OR:
3,678,967, PUB. 6-23-2009. INT. CL. 35.

BADIA SPICES, INC., MIAMI, FL:
1,562,404, REN. 7-31-09. MULTIPLE CLASS, INT. CLS. 29 AND 30.

BAEJIN CORPORATION, SEOUL, REPUBLIC OF KOREA:
2,334,365, REN. 8-1-09. INT. CL. 22.

BAER, ALEXANDER R., CINCINNATI, OH:
3,680,867, INT. CL. 41.

BAHAMA MAMAS, LLC, LAS VEGAS, NV:
3,681,432, INT. CL. 34.

BAIHER L.L.C., ROCKVILLE, MD:
2,666,573, CANC. INT. CL. 21.

BAIRD, MEGHAN ELIZABETH BRUNNER, MAPLE GROVE, MN, AKA MEGHAN BRUNNER:
3,678,326, PUB. 6-23-2009. MULTIPLE CLASS, INT. CLS. 9, 14, 16, 21, 25, 26, 35 AND 38.

BAISDEN FILMWORKS LLC, DALLAS, TX:
3,678,266, PUB. 6-23-2009. INT. CL. 41.

BAKER & DANIELS, INDIANAPOLIS, IN:
2,215,382, CANC. INT. CL. 42.

BAKER BAND WEAR, L.L.C., BERNICE, OK:
3,681,352, MULTIPLE CLASS, INT. CLS. 6, 14, 18 AND 25.

BAKER BARNES ASSOCIATES, INC., CARY, NC:
2,665,303, CANC. MULTIPLE CLASS, INT. CLS. 35 AND 41.

BAKER HUGHES INCORPORATED, HOUSTON, TX:
2,214,053, CANC. INT. CL. 9.

BAKOGEOGE, DEMITRIOS S., CHESAPEAKE, VA:
3,678,973, PUB. 6-23-2009. INT. CL. 25.

BAKU AUSTRALIA PTY LTD, NEW SOUTH WALES, AUSTRALIA:
2,665,160, CANC. MULTIPLE CLASS, INT. CLS. 3, 18 AND 25.

BALANCE DESIGN, L.L.C., ROCKFORD, IL:
2,261,831, REN. 8-3-09. INT. CL. 35.
2,261,834, REN. 8-3-09. MULTIPLE CLASS, INT. CLS. 35 AND 42.

BALCHEM CORPORATION, NEW HAMPTON, NY:
3,681,202, INT. CL. 5.

BALESTRIERI ENVIRONMENTAL & DEVELOPMENT, INC., ELKHORN, WI:
3,678,591, PUB. 6-23-2009. MULTIPLE CLASS, INT. CLS. 37 AND 42.

BALFOUR BEATTY PLC, UNITED KINGDOM:
3,679,874, PUB. 6-23-2009. INT. CL. 9.

BALL AND CHAIN, INC., ATLANTA, GA:
3,679,685, PUB. 6-23-2009. INT. CL. 43.

BALLANTYNE OF OMAHA, INC., OMAHA, NE:
2,667,236, CANC. INT. CL. 9.

BALLARINI PAOLO & FIGLI S.P.A., ITALY:
3,679,976, PUB. 6-23-2009. INT. CL. 21.

BALLOU PLUM WEALTH ADVISORS, LLC, LAFAYETTE, CA:
3,681,245, INT. CL. 36.

BALLOU, CAROLINE, MEDFIELD, MA:
2,214,022, CANC. INT. CL. 14.

BALTIMORE & OHIO RAILROAD MUSEUM, BALTIMORE, MD:
3,680,339, INT. CL. 41.
3,680,372, INT. CL. 41.

BALTIMORE CONFECTIONS, LLC, OLNEY, MD:
3,681,802, INT. CL. 35.

BANCA POPOLARE DI MILANO SOCIETA' COOPERATIVA A R.L., 20121 MILAN, ITALY:
2,665,050, CANC. MULTIPLE CLASS, INT. CLS. 9, 35, 38 AND 42.

BANCO DE CHILE, SANTIAGO, CHILE:
2,665,326, CANC. INT. CL. 36.

BAND-TYPE SUPPLY CORPORATION, KNOXVILLE, TN:
1,517,951, CANC. INT. CL. 16.

BANK OF AMERICA CORPORATION, CHARLOTTE, NC:
2,214,310, CANC. INT. CL. 36.
2,215,067, CANC. INT. CL. 36.

BANK OF THE WEST, SAN FRANCISCO, CA:
3,680,664, INT. CL. 36.
3,680,786, INT. CL. 36.

BANKSIA WINES PTY LTD, ADELAIDE, SOUTH AUSTRALIA, AUSTRALIA:
2,665,044, CANC. INT. CL. 33.

BANNER SEVENTEEN LLC, BOSTON, MA:
3,678,666, PUB. 6-23-2009. INT. CL. 41.
3,678,667, PUB. 6-23-2009. INT. CL. 41.

BARCLAYS CAPITAL INC., NEW YORK, NY:
3,680,557, INT. CL. 36.

BARCO NV, BELGIUM:
3,680,025, PUB. 6-23-2009. INT. CL. 11.

BARD, ANNETTE, KAPAA, HI:
3,610,747, CANC. MULTIPLE CLASS, INT. CLS. 3 AND 35.

BARGOLD SOFTWARE SOLUTIONS, LLC, LONG ISLAND CITY, NY:
3,680,719, INT. CL. 9.

BARKER, JEAN YVONNE, D'IBERVILLE, MS:
3,680,082, INT. CL. 16.

BARNES GROUP INC., BRISTOL, CT:
1,517,764, CANC. INT. CL. 6.

- BARNES, INC., MADISON, WI:
3,678,508, PUB. 6-23-2009. MULTIPLE CLASS, INT. CLS.
37 AND 44.
- BARNES, SANDRA L., LEESBURG, AL:
1,517,999, CANC. INT. CL. 18.
- BARNETT ENTERPRISES CORP., LAKEWOOD, CO:
3,681,644, INT. CL. 37.
- BARPOINT.COM, INC., FORT LAUDERDALE, FL:
2,665,386, CANC. INT. CL. 35.
- BAR LABORATORIES, INC., MONTVALE, NJ:
3,680,756, INT. CL. 5.
- BARRELMAN ENTERPRISES, LLC, FREMONT, MI:
3,680,681, INT. CL. 35.
- BARRETT PRODUCTIONS, WABAN, MA:
3,680,544, INT. CL. 9.
- BARROW INDUSTRIES INC., NORWOOD, MA:
3,681,325, INT. CL. 24.
- BARRY CALLEBAUT AG, SWITZERLAND:
3,679,971, PUB. 6-23-2009. MULTIPLE CLASS, INT. CLS.
5, 29, 30, 40, 41 AND 42.
- BARTLETT INVESTMENT CORPORATION, GREEN-
ACRES, WA:
2,666,600, CANC. INT. CL. 36.
- BARTLETT, CHRISTY D., SAN DIEGO, CA, DBA SAN
DIEGO BATH AND BODY COMPANY:
3,678,929, PUB. 6-23-2009. INT. CL. 3.
- BASCIANO, RICHARD, NEW YORK, NY, DBA 303 WEST
42ND STREET REALTY COMPANY:
3,483,663, CANC. MULTIPLE CLASS, INT. CLS. 35 AND
41.
- BASEBALL EXPRESS, INC., SAN ANTONIO, TX:
3,680,794, INT. CL. 35.
- BASEBALL PERFORMANCE LLC, CHULA VISTA, CA, AKA
BASEBALL-PERFORMANCE:
3,678,615, PUB. 6-23-2009. INT. CL. 28.
- BASF CATALYSTS LLC, ISELIN, NJ:
2,213,682, CANC. INT. CL. 1.
2,213,683, CANC. INT. CL. 1.
- BASF CONSTRUCTION CHEMICALS, LLC, BEACHWOOD,
OH:
2,218,462, REN. 8-5-09. INT. CL. 2.
- BASF SE, LUDWIGSHAFEN AM RHEIN, FED REP GER-
MANY:
3,679,531, PUB. 6-23-2009. INT. CL. 1.
- BASF VENTURE CAPITAL GMBH, FED REP GERMANY:
3,679,907, PUB. 6-23-2009. MULTIPLE CLASS, INT. CLS.
1, 42, 44 AND 45.
- BASKETBALL SPOTLIGHT, EATONTOWN, NJ:
3,679,278, PUB. 6-23-2009. INT. CL. 41.
- BASMATI-RICE GMBH-EUROPE, D-47809 KREFELD, FED
REP GERMANY:
2,666,002, CANC. MULTIPLE CLASS, INT. CLS. 29, 30
AND 32.
- BASSETT MIRROR COMPANY, INCORPORATED, BAS-
SETT, VA:
3,681,338, INT. CL. 20.
- BASTIANELLI GROUP, INC., WILMINGTON, DE:
3,680,507, MULTIPLE CLASS, INT. CLS. 35 AND 41.
- BATESVILLE SERVICES, INC., BATESVILLE, IN:
3,681,714, INT. CL. 20.
3,681,715, INT. CL. 20.
- BATH & BODY WORK BRAND MANAGEMENT, INC.,
REYNOLDSBURG, OH:
2,666,582, CANC. INT. CL. 3.
2,667,447, CANC. MULTIPLE CLASS, INT. CLS. 3 AND 4.
- BATISTA, WILLIAM, COPAIGUE, NY:
3,678,461, PUB. 6-23-2009. INT. CL. 25.
- BATTAT INCORPORATED, PLATTSBURGH, NY:
3,679,829, PUB. 7-10-2007. INT. CL. 28.
- BATTERY GIANT, INC., STERLING HEIGHTS, MI:
3,679,480, PUB. 6-23-2009. INT. CL. 35.
3,679,744, PUB. 6-23-2009. INT. CL. 35.
- BATTY, MATTHEW TRAVIS, CEDAR CITY, UT:
2,666,655, CANC. INT. CL. 37.
- BAUER CORPORATION, WOOSTER, OH:
2,214,748, CANC. INT. CL. 42.
- BAUSCH & LOMB INCORPORATED, ROCHESTER, NY:
2,261,437, REN. 8-3-09. INT. CL. 10.
- BAXTER INTERNATIONAL INC., DEERFIELD, IL:
2,666,114, CANC. INT. CL. 10.
- BAY HARBOR COMPANY, L.L.C., SOUTHFIELD, MI:
2,666,761, CANC. INT. CL. 37.
- BAYER HEALTHCARE LLC, PITTSBURGH, PA:
2,214,146, CANC. INT. CL. 10.
- BAYER SCHERING PHARMA AKTIENGESELLSCHAFT,
BERLIN, FED REP GERMANY:
3,681,633, INT. CL. 5.
- BAYERISCHE MOTOREN WERKE; AKTIENGE-
SELLSCHAFT, 80809 MÜNCHEN, FED REP GERMANY:
3,680,017, PUB. 6-23-2009. INT. CL. 12.
- BAYSHORE AG, 4104 OBERWIL, SWITZERLAND:
3,678,896, PUB. 6-23-2009. MULTIPLE CLASS, INT. CLS.
29 AND 31.
- BBY SOLUTIONS, INC., RICHFIELD, MN:
3,681,682, INT. CL. 35.
- BCD TRAVEL GERMANY HOLDING GMBH, FED REP
GERMANY:
3,679,965, PUB. 6-23-2009. MULTIPLE CLASS, INT. CLS.
9, 16, 35, 36, 38, 39, 41, 42 AND 43.
- BCS STAFFING, INC., LOS ANGELES, CA:
3,679,406, PUB. 6-23-2009. INT. CL. 35.
- BDI, PHARMA, INC., COLUMBIA, SC:
3,681,062, INT. CL. 35.
- BEACON EDUCATION MANAGEMENT, INC., WESTBOR-
OUGH, MA:
2,665,573, CANC. INT. CL. 35.
- BEALL MANUFACTURING., INC., EAST ALTON, IL:
3,678,876, PUB. 6-23-2009. INT. CL. 7.
- BEAMONSTAR PRODUCTS, QUEEN CREEK, AZ:
3,678,870, PUB. 3-10-2009. INT. CL. 5.
- BEAR NAKED, INC., BATTLE CREEK, MI:
3,681,619, INT. CL. 30.
- BEARD, JOAN, RAPID CITY, SD:
2,666,328, CANC. INT. CL. 32.
- BEARING FRUIT COMMUNICATIONS, INC., OKLAHOMA
CITY, OK:
3,678,309, PUB. 6-23-2009. INT. CL. 41.
- BEAUTIFUL MACHINE, INC., THE, CAMBRIDGE, MA:
2,215,002, CANC. INT. CL. 35.
- BEAUTY ALERT, LLC, SEATTLE, WA:
3,679,256, PUB. 6-23-2009. INT. CL. 16.
- BEAUTY ATTICA, INC., ONTARIO, CA:
2,256,453, REN. 7-31-09. INT. CL. 3.
- BEAUTY HOLDING LLC, DENTON, TX, DBA BEAUTY
HOLDING COMPANY, INC.:
3,680,876, INT. CL. 3.
- BECKER-UNDERWOOD, INC., AMES, IA:
1,549,711, REN. 7-31-09. INT. CL. 2.
2,302,010, REN. 7-31-09. INT. CL. 2.
3,681,122, INT. CL. 2.
- BECKER, ALLISON L, MARYVILLE, TN:
3,679,249, PUB. 6-23-2009. INT. CL. 41.
- BEDRYDER, INC., AUSTELL, GA:
3,678,722, PUB. 3-17-2009. INT. CL. 12.
- BEELINE ENTERPRISES, INC., CARROLLTON, GA, DBA
MULTI-PEST SERVICES, INC.:
3,678,835, PUB. 6-23-2009. INT. CL. 37.
- BEHAVIOR MANAGEMENT ASSOCIATES, INC., CLEVEL-
LAND, OH:
3,679,370, PUB. 6-23-2009. INT. CL. 41.
- BEHR, VALERY PINE, BOULDER CITY, NV:
3,679,578, PUB. 6-23-2009. INT. CL. 39.
- BEIJING COMPASS TECHNOLOGY DEVELOPMENT CO.,
LTD., CHAO YANG, BEIJING, CHINA:
3,681,036, INT. CL. 36.
- BEIJING SEVENSTAR; SCIENCE & TECHNOLOGY CO.,
LTD. CHINA:
3,680,029, PUB. 6-23-2009. MULTIPLE CLASS, INT. CLS.
7, 9 AND 11.
- BELCOMAR NORTH AMERICA, INC., MANHEIM, PA:
2,667,266, CANC. INT. CL. 28.
- BELL, ANTONY I., COLUMBIA, SC:
2,665,692, CANC. INT. CL. 41.
- BELL, ELIZABETH ANN, CLEARWATER, FL:
3,680,076, INT. CL. 35.

BELL, JENNIFER, LAKE WORTH, FL, AKA JENNIFER REED:
3,679,089, PUB. 6-23-2009. MULTIPLE CLASS, INT. CLS. 30 AND 40.

BELLA CLARK, UNITED KINGDOM AND GEORGE CLARK, UNITED KINGDOM:
3,679,885, PUB. 6-23-2009. MULTIPLE CLASS, INT. CLS. 24 AND 25.

BELLAH BRANDS INCORPORATED, LOS ANGELES, CA:
3,681,437, INT. CL. 3.

BELLER, IRIS L., BROOKLYN, NY:
3,681,525, INT. CL. 39.

BELLEZZA PRODUCTS, LLC, HOBOKEN, NJ:
3,678,751, PUB. 1-20-2009. INT. CL. 3.

BELLON ENTERTAINMENT INC., PORT WASHINGTON, NY:
3,680,200, INT. CL. 9.

BEN & JERRY'S HOMEMADE, INC., BURLINGTON, VT:
2,665,090, CANC. INT. CL. 30.

BENDER, NORMAN L., WOODBRIDGE, CT:
2,665,114, CANC. MULTIPLE CLASS, INT. CLS. 25 AND 35.

BENEFIT PLANS OF AMERICA, L.P., DALLAS, TX:
2,665,688, CANC. INT. CL. 36.

BENGAL COAST RESTAURANTS, L.P., DALLAS, TX:
3,678,164, PUB. 6-23-2009. INT. CL. 43.

BENNIS, JAELEEN, CAPITOLA, CA:
3,679,507, PUB. 6-23-2009. INT. CL. 41.

BENTLEY SYSTEMS, INCORPORATED, EXTON, PA:
2,666,167, CANC. INT. CL. 9.
2,667,383, CANC. INT. CL. 9.
3,678,298, PUB. 6-23-2009. INT. CL. 9.

BENTLEY, MEGAN, AURORA, ONTARIO, CANADA AND BENTLEY, JMI, AURORA, ONTARIO, CANADA:
1,114,920. REN. 8-5-09. INT. CL. 21.

BENTYLER ENTERPRISES, INC., SUNNYVALE, CA:
3,680,201, INT. CL. 9.

BERG, NORM, CARDIFF-BY-THE-SEA, CA:
2,215,607, CANC. INT. CL. 36.

BERN'S STEAK HOUSE, TAMPA, FL:
2,214,719, CANC. INT. CL. 42.

BERNE FURNITURE COMPANY, BERNE, IN:
2,215,083, CANC. INT. CL. 40.

BEST BUY ENTERPRISE SERVICES, INC., RICHFIELD, MN:
3,680,164, INT. CL. 9.

BEST HARVEST, LLC, MIAMI, FL:
2,666,999, CANC. INT. CL. 29.

BEST OF WHAT'S AROUND, LLC, CHARLOTTESVILLE, VA:
3,680,087, INT. CL. 32.

BESTLINE INTERNATIONAL RESEARCH INC., BLAINE, WA:
3,681,419, MULTIPLE CLASS, INT. CLS. 1 AND 4.

BETRUSTED US, INC., NEW YORK, NY:
2,665,010, CANC. INT. CL. 9.

BETTA, INC., SANTA MONICA, CA:
3,680,386, INT. CL. 45.

BETTY CUPCAKE, INC, DALLAS, TX AND SILVERMAN, EVELYN H, DALLAS, TX:
3,678,316, PUB. 6-23-2009. INT. CL. 35.

BEVERAGES UNLIMITED LLC, CHARLESTOWN, ST. CHRIST-NEVIS:
3,565,325, COR. INT. CL. 32.

BEYOND THE BEAN LIMITED, BRISTOL, UNITED KINGDOM:
3,681,495, INT. CL. 35.

BEZZERIDES COMPANY, BENICIA, CA:
2,280,114. REN. 8-3-09. INT. CL. 29.

BHALLA, FRANCE J., CAMARILLO, CA:
3,680,568, INT. CL. 3.

BHP STEEL (JLA) PTY. LIMITED, SYDNEY, NEW SOUTH WALES 2000, AUSTRALIA:
2,665,399, CANC. MULTIPLE CLASS, INT. CLS. 6 AND 9.

BICKMORE & ASSOCIATES, INC., SACRAMENTO, CA, DBA BICKMORE RISK SERVICES:
3,681,796, INT. CL. 42.
3,681,797, INT. CL. 41.
3,681,798, INT. CL. 42.
3,681,799, INT. CL. 42.
3,681,800, INT. CL. 42.
3,681,801, INT. CL. 42.

BIELOMATIK LEUZE GMBH + CO KG, FED REP GERMANY:
3,679,866, PUB. 6-23-2009. MULTIPLE CLASS, INT. CLS. 7, 9 AND 16.

BIEN, RICHARD S., LAGUNA HILLS, CA:
3,678,177, PUB. 6-23-2009. INT. CL. 10.

BIERMANN PRODUCTIONS LLC, WICHITA, KS:
3,681,481, INT. CL. 41.

BIG ANT STUDIOS PTY LTD, MELBOURNE, VICTORIA, AUSTRALIA:
3,678,784, PUB. 6-23-2009. INT. CL. 9.

BIG ANT STUDIOS PTY LTD, MELBOURNE, AUSTRALIA:
3,678,785, PUB. 6-23-2009. INT. CL. 9.
3,678,786, PUB. 6-23-2009. INT. CL. 9.
3,678,787, PUB. 6-23-2009. INT. CL. 9.

BIG BOOM BRANDS, LLC, WEST PALM BEACH, FL:
3,681,792, MULTIPLE CLASS, INT. CLS. 5, 9 AND 44.

BIG BURRITO, INC., THE, KALAMAZOO, MI:
2,214,685, CANC. INT. CL. 42.

BIG FISH GAMES, INC., SEATTLE, WA:
3,680,320, INT. CL. 9.

BIG MOUTH MARKETING, LLC, DEERFIELD BEACH, FL:
3,678,764, PUB. 6-23-2009. INT. CL. 35.

BIG SKY BREWING COMPANY, MISSOULA, MT:
3,679,052, PUB. 6-23-2009. INT. CL. 32.
3,679,053, PUB. 6-23-2009. INT. CL. 32.

BIG TICKET TELEVISION INC., STUDIO CITY, CA:
2,289,179. REN. 8-2-09. INT. CL. 41.

BIGELOW MANAGEMENT, INC., LAS VEGAS, NV:
2,214,783, CANC. INT. CL. 42.

BIGEYE, INC., CHICAGO, IL:
3,680,745, INT. CL. 9.

BIGGER INVESTMENTS S.A., LUXEMBOURG, LUXEMBOURG:
3,678,249, PUB. 6-23-2009. MULTIPLE CLASS, INT. CLS. 42 AND 44.

BIGGS AND FEATHERBELLE, LLC, GAMBRILLS, MD:
3,680,121, INT. CL. 25.

BIGSEA, INC., CHARLOTTE, NC:
2,247,842. REN. 7-31-09. INT. CL. 42.

BIJOUTERIE ADLER S.A., 1204 GENEVA, SWITZERLAND:
2,665,224, CANC. INT. CL. 14.

BIKECOLOGY, INC., SANTA MONICA, CA:
2,667,146, CANC. MULTIPLE CLASS, INT. CLS. 9 AND 12.

BILANTIC SOFTWARE, LLC, ALBERTSON, NY:
3,681,807, INT. CL. 9.

BILCO COMPANY, THE, WEST HAVEN, CT:
684,304. REN. 8-1-09. U.S. CL. 12 (INT. CLS. 6 AND 19).

BILL LAWRENCE, CORONA, CA:
3,680,194, INT. CL. 9.

BILLINGS, ROGER E., GALLATIN, MO, DBA BILLINGS INTELLECTUAL PROPERTY:
2,320,541. REN. 8-3-09. INT. CL. 9.

BILLINGSLEY, SHERMAN JOY, NEW YORK, NY:
3,680,067, INT. CL. 18.

BILLINGSLEY, SHERMANE JOY, NEW YORK, NY:
3,680,065, INT. CL. 25.
3,680,066, INT. CL. 25.

BILLY J ATTINGER, SAN DIEGO, CA:
3,679,347, PUB. 6-23-2009. MULTIPLE CLASS, INT. CLS. 16 AND 25.

BIOALLIANCE PHARMA, FRANCE:
3,680,047, PUB. 6-23-2009. INT. CL. 5.

BIOFARMA, FRANCE:
3,679,906, PUB. 6-23-2009. INT. CL. 5.

BIOFORM MEDICAL, INC., SAN MATEO, CA:
2,666,875, CANC. INT. CL. 3.

- BIOMED MANAGEMENT SERVICES, INC., REDWOOD CITY, CA, DBA THE MENDEL GROUP, INC.:
2,666,847, CANC. INT. CL. 16.
- BIOMET 3I, LLC, PALM BEACH GARDENS, FL:
3,681,196, INT. CL. 16.
- BIONIX DEVELOPMENT CORPORATION, TOLEDO, OH:
3,679,318, PUB. 6-23-2009. INT. CL. 10.
- BIOPOLYMER ENGINEERING, INC., EAGAN, MN, DBA BIOTHERA:
3,679,778, PUB. 6-23-2009. INT. CL. 5.
- BIOPURE CORPORATION, BALTIMORE, OH TO BIOPURE CORPORATION, BALTIMORE, OH:
2,214,902, CANC. INT. CL. 11.
- BIOVIGILANT SYSTEMS, INC., TUCSON, AZ:
3,681,575, INT. CL. 9.
3,681,576, MULTIPLE CLASS, INT. CLS. 9 AND 41.
- BIRDPOINT, INC., MOBILE, AL:
2,666,456, CANC. INT. CL. 25.
- BISCUITS LECLERC LTEE, ST-AUGUSTIN-DE-DESMAR, CANADA, AKA BISCUITS LECLERC LTD.:
3,678,920, PUB. 6-23-2009. INT. CL. 30.
- BISHOP OF THE NORTH AMERICAN REGION OF SUKYO MAHIKARI, RANCHO SANTA MARGARITA, CA:
3,680,673, MULTIPLE CLASS, INT. CLS. 16, 25 AND 45.
3,680,676, INT. CL. 16.
- BISHOP OF THE NORTH AMERICAN REGION OF SUKYO MAHIKARI, RANCHO SANTA MARGARITA, CA:
3,681,418, INT. CL. 16.
- BISON BASEBALL, INC., BUFFALO, NY:
1,518,017, CANC. INT. CL. 20.
- BISON BOB'S CHUCKWAGON LLC, GRAND JUNCTION, CO:
3,678,775, PUB. 6-23-2009. INT. CL. 43.
- BISON GEAR & ENGINEERING CORP., ST. CHARLES, IL:
3,681,308, INT. CL. 7.
3,681,309, INT. CL. 7.
- BITSA, INC., ST. LOUIS, MO:
2,665,609, CANC. INT. CL. 39.
- BITTLE, JAMES J, SAN DIEGO, CA:
3,679,242, PUB. 6-23-2009. INT. CL. 40.
- BIZEQUITY CORP., SPRING HOUSE, PA:
3,679,385, PUB. 6-23-2009. INT. CL. 35.
- BLACK & DECKER CORPORATION, THE, TOWSON, MD:
2,666,660, CANC. INT. CL. 7.
3,681,007, INT. CL. 20.
3,681,008, INT. CL. 20.
- BLACK DIRT ORGANICS, LLC, OREM, UT:
3,679,146, PUB. 6-23-2009. INT. CL. 1.
- BLACK EYED PIGS BARBECUE CORPORATION, COLLEGE PARK, MD:
3,679,291, PUB. 6-23-2009. INT. CL. 43.
- BLACK LILY ACCESSORIES A/S, DENMARK:
3,679,904, PUB. 6-23-2009. MULTIPLE CLASS, INT. CLS. 18 AND 24.
- BLACK, JEREMY, TUSTIN, CA:
2,666,590, CANC. INT. CL. 42.
- BLACKSTONE CALLING CARD, INC., MIAMI, FL:
2,666,264, CANC. INT. CL. 16.
2,666,265, CANC. INT. CL. 16.
- BLAKE, TRACEY LYNN, DENVER, CO:
3,678,816, PUB. 6-23-2009. INT. CL. 42.
- BLOCKHEAD'S BURRITOS, INC., NEW YORK, NY:
2,371,044, REN. 8-5-09. INT. CL. 42.
- BLOW IN BLANKET, GLEN ALLEN, VA:
2,310,217, REN. 7-31-09. INT. CL. 37.
- BLUE GAMUT LLC, ALBUQUERQUE, NM:
2,665,731, CANC. INT. CL. 42.
- BLUE MARTINI RED MARTINI, INC., PRINCETON, NJ:
3,680,448, INT. CL. 25.
- BLUE RIDGE INTERNATIONAL PRODUCTS COMPANY, FREEPORT, FL:
2,665,933, CANC. INT. CL. 28.
- BLUE SEAL EXTRACT COMPANY, CAMBRIDGE, MA TO SENSIENT FLAVORS LLC, INDIANAPOLIS, IN:
256,633, AM. U.S. CL. 45.
- BLUE SHOP SRL, 10143 TORINO, ITALY:
2,665,262, CANC. MULTIPLE CLASS, INT. CLS. 16, 35, 38 AND 42.
- BLUEGOLF, LLC, WAYNE, PA:
3,679,087, PUB. 6-23-2009. INT. CL. 42.
- BLUETRONICS AKTIEBOLAG, 601 86 NORRKPING, SWEDEN:
2,665,880, CANC. MULTIPLE CLASS, INT. CLS. 9, 38 AND 42.
- BLVD WEST, INC., NEWPORT BEACH, CA:
2,667,192, CANC. INT. CL. 35.
- BLYTHEDALE CHILDREN'S HOSPITAL, VALHALLA, NY:
3,678,504, PUB. 6-23-2009. INT. CL. 41.
- BML ISTISHARAT SAL, BEIRUT, LEBANON:
2,247,243, REN. 8-6-09. INT. CL. 9.
- BMS ENTERTAINMENT PTY LTD., 3141 VICTORIA, AUSTRALIA:
2,666,815, CANC. MULTIPLE CLASS, INT. CLS. 41 AND 42.
- BOARD OF REGENTS OF THE UNIVERSITY OF OKLAHOMA, THE, NORMAN, OK:
2,665,781, CANC. INT. CL. 41.
- BOARD OF REGENTS, THE UNIVERSITY OF TEXAS SYSTEM, AUSTIN, TX:
2,214,241, CANC. INT. CL. 16.
- BOARDHOUSE SANDWICHES, INC., LAS VEGAS, NV:
3,681,222, INT. CL. 43.
- BOBAK SAUSAGE COMPANY, CHICAGO, IL:
3,680,935, INT. CL. 35.
3,680,936, INT. CL. 35.
- BOBBEE O'S BBQ, INC., CHARLOTTE, NC:
3,679,307, PUB. 6-23-2009. INT. CL. 43.
- BOBBY MOSCOW, LLC, CLARKSTON, MI:
3,681,538, INT. CL. 25.
- BOCABEAR FOODS, INC., RENO, NV:
2,665,685, CANC. INT. CL. 29.
- BODACION TECHNOLOGIES, LLC, BARRINGTON, IL:
2,667,292, CANC. INT. CL. 9.
- BODEGA DEL DESIERTO S.A., BUENOS AIRES, ARGENTINA:
3,678,954, PUB. 6-23-2009. INT. CL. 33.
- BODEN, ROBERT OGDEN, ALTADENA, CA:
1,490,799, REN. 8-5-09. INT. CL. 6.
- BODINE ELECTRIC COMPANY, CHICAGO, IL:
1,112,193, REN. 8-3-09. INT. CL. 9.
- BODY BALANCE FOR PERFORMANCE, INC., CONSHOHOCKEN, PA:
2,247,673, REN. 7-31-09. INT. CL. 41.
2,247,720, REN. 7-31-09. INT. CL. 41.
- BODY BY JAKE GLOBAL, LLC, LOS ANGELES, CA:
3,681,605, INT. CL. 11.
- BODYCARE COMPANIONS, AUBURN, CA:
2,666,846, CANC. INT. CL. 3.
- BOEHRINGER INGELHEIM INTERNATIONAL GMBH, INGELHEIM AM RHEIN, FED REP GERMANY:
2,666,127, CANC. INT. CL. 5.
- BOEING MANAGEMENT COMPANY, SEAL BEACH, CA:
3,681,595, INT. CL. 28.
- BOGHRATY, FARROKH, MISSION VIEJO, CA, DBA PRIME INSURANCE SERVICES:
2,665,673, CANC. INT. CL. 36.
- BOHNKE, FAITH HOSTETTER, GLEN ALLEN, VA:
2,667,314, CANC. INT. CL. 42.
- BOISE BUILDING SOLUTIONS MANUFACTURING, L.L.C., BOISE, ID:
2,215,433, CANC. INT. CL. 19.
- BOKUM TOOL COMPANY, INC., MADISON HEIGHTS, MI, BOKUM TOOL COMPANY, INC., DETROIT, MI:
682,171, REN. 8-5-09. U.S. CL. 23 (INT. CL. 7).
- BOLTHOUSE JUICE PRODUCTS, LLC, BAKERSFIELD, CA:
3,681,534, INT. CL. 32.
- BOMAG GMBH, FED REP GERMANY:
3,680,035, PUB. 6-23-2009. MULTIPLE CLASS, INT. CLS. 7, 37 AND 42.
- BONAR, BRIAN JAMES, MOUNDSVILLE, WV:
3,679,571, PUB. 6-23-2009. INT. CL. 45.
- BONTEX INC., BUENA VISTA, VA:
2,208,505, REN. 8-6-09. INT. CL. 18.
2,208,505, CANC. INT. CL. 17.
- BONZOLIO, INCORPORATED, OCEANSIDE, CA:
3,678,360, PUB. 6-23-2009. INT. CL. 42.

BOOK OF HOPE INTERNATIONAL, POMPAÑO BEACH, FL:
2,767,479, CANC. MULTIPLE CLASS, INT. CLS. 9, 16 AND 41.

BOOKETTE SOFTWARE COMPANY, MONTEREY, CA:
2,267,508. REN. 8-3-09. INT. CL. 42.

BOOT SCOOTS LLC, KIRTLAND, OH:
3,678,617, PUB. 6-23-2009. INT. CL. 25.

BORGES USA, INC., FRESNO, CA, A. GIURLANI & BRO., INC., SUNNYVALE, CA:
1,136,943. REN. 8-3-09. INT. CL. 29.

BORGO SCOPETO E CAPARZO S.R.L. SOCIETA AGRICOLA, MONTALCINO, ITALY:
1,547,617. REN. 8-4-09. INT. CL. 33.

BORRAS, S.L. DE PRODUCTOS ALIMENTICIOS, CEUTA, SPAIN:
3,678,735, PUB. 2-3-2009. INT. CL. 30.

BOSCO DEVELOPMENT LTD., BEIJING, CHINA, DBA AVANT BROWSER:
3,678,692, PUB. 6-23-2009. INT. CL. 9.

BOSKOVICH FARMS, INC., OXNARD, CA:
1,550,424. REN. 8-3-09. INT. CL. 31.

BOSS COMMERCE, LLC, AUSTIN, TX:
2,666,364, CANC. INT. CL. 42.

BOTTLEWISE, LLC, MADISON, WI, DBA BOTTLEWISE:
3,678,680, PUB. 4-7-2009. INT. CL. 18.

BOURDON, JUSTIN, DRIPPING SPRINGS, TX:
3,681,459, INT. CL. 41.

BOURLAND, KERRI, LITCHFIELD PARK, AZ:
3,680,408, INT. CL. 9.

BOWTIE, INC., IRVINE, CA:
2,264,094. REN. 8-3-09. MULTIPLE CLASS, INT. CLS. 16 AND 42.

BOYDS COLLECTION, LTD., THE, MCSHERRYSTOWN, PA:
2,667,195, CANC. INT. CL. 28.
3,680,068, MULTIPLE CLASS, INT. CLS. 16 AND 24.

BP MICROSYSTEMS LP, HOUSTON, TX, DBA BPM MICROSYSTEMS:
3,680,302, INT. CL. 9.
3,680,303, INT. CL. 9.
3,680,304, INT. CL. 9.

BRADLEY FIXTURES CORPORATION, MEMOMONEE FALLS, WI:
3,678,834, PUB. 6-23-2009. INT. CL. 11.

BRADSHAW INTERNATIONAL, INC., RANCHO CUCA-MONGA, CA:
3,680,326, INT. CL. 21.

BRAINSTORMS, INC., SANTA FE, NM:
3,681,523, INT. CL. 41.

BRAINWORKS, INC., CARROLLTON, TX:
1,518,377, CANC. INT. CL. 41.

BRANSCH GMBH, 22303 HAMBURG, FED REP GERMANY:
3,679,862, PUB. 6-23-2009. MULTIPLE CLASS, INT. CLS. 16, 35 AND 41.

BRATTAIN, JOHN FRANK, VERO BEACH, FL:
2,667,179, CANC. INT. CL. 30.

BRAUN, MURRY R., HOLBROOK, NY:
2,214,259. REN. 7-31-09. INT. CL. 19.

BREATHABLEBABY, LLC, EAGAN, MN:
3,419,804, AM. MULTIPLE CLASS, INT. CLS. 24 AND 28.

BREEDLOVE, JESSE RAY, SAN JACINTO, CA, DBA CALIFORNIA KEEP RIGHT:
3,679,037, PUB. 6-23-2009. INT. CL. 16.

BREMER, JILL, OAK PARK, IL:
2,214,484, CANC. INT. CL. 41.

BRIAN R STEARNS, BROOMFIELD, CO:
3,681,228, INT. CL. 5.

BRIANZA BELLA, LLC, CARLINVILLE, IL:
3,681,215, INT. CL. 3.

BRICKYARD TRADEMARKS, INC., HENDERSON, NV:
2,665,457, CANC. INT. CL. 41.

BRIDGES, C. RUSSELL, NASHVILLE, TN:
2,666,580, CANC. INT. CL. 41.

BRIDINGSOLUTIONS LLC, MILWAUKEE, WI:
2,666,509, CANC. INT. CL. 42.

BRIDWELL, NORMAN, EDGARTOWN, MA:
2,665,648, CANC. INT. CL. 20.

BRIGGS & STRATTON POWER PRODUCTS GROUP, LLC, JEFFERSON, WI:
1,517,785, CANC. INT. CL. 7.
2,215,295, CANC. INT. CL. 28.

BRIGHT IDEAS, INC., AGOURA HILLS, CA:
3,678,698, PUB. 5-19-2009. INT. CL. 9.

BRIGHTERION, INC., SAN FRANCISCO, CA:
2,667,142, CANC. INT. CL. 9.

BRIGHTHOUSE, LLC, ATLANTA, GA:
3,680,335, INT. CL. 35.

BRIGHTON EQUIPMENT CORPORATION, PARAMUS, NJ:
2,262,588. REN. 8-5-09. INT. CL. 35.

BRIGHTSTAR MUSIC FESTIVAL, INC., CHARLOTTE, NC:
2,666,469, CANC. INT. CL. 41.

BRISCO LLC, JACKSONVILLE, FL:
3,680,441, INT. CL. 35.

BRITISH AMERICAN TOBACCO (BRANDS) LIMITED, LONDON, UNITED KINGDOM:
3,678,253, PUB. 6-23-2009. INT. CL. 34.

BRITTEN BANNERS, INC., TRAVERSE CITY, MI, DBA BRITTEN MEDIA, INC.:
2,667,363, CANC. INT. CL. 20.

BRITTON-GALLAGHER & ASSOCIATES, INC., CLEVELAND, OH:
3,681,117, INT. CL. 36.
3,681,118, INT. CL. 36.
3,681,132, INT. CL. 36.
3,681,133, INT. CL. 36.

BROADLANE, INC., DALLAS, TX:
3,678,644, PUB. 6-23-2009. MULTIPLE CLASS, INT. CLS. 35, 39 AND 42.

BROADREACH INC., RALEIGH, NC:
2,264,215. REN. 8-4-09. INT. CL. 39.

BROADWAY BOUND, INC., NEW YORK, NY:
2,283,402. REN. 8-4-09. INT. CL. 41.

BROCK INTERNATIONAL, INC., ATLANTA, GA TO FIRST-WAVE TECHNOLOGIES, INC., ATLANTA, GA:
2,215,025, CANC. INT. CL. 42.

BROOK-SCHWARTZ, DENISE, SAN DIEGO, CA:
3,680,788, INT. CL. 16.

BROOKS DESIGN/BUILD INC., STEAMBOAT SPRINGS, CO:
3,678,637, PUB. 6-23-2009. INT. CL. 37.

BROOKS, ROBERT E. LOS ANGELES, CA, DBA RBA CONSULTANTS:
2,666,040, CANC. INT. CL. 9.

BROOKSHIRE GROCERY COMPANY, TYLER, TX:
2,665,774, CANC. INT. CL. 30.

BROOKVILLE WOOD PRODUCTS, INC., BROOKVILLE, PA:
2,666,355, CANC. INT. CL. 28.
2,666,356, CANC. INT. CL. 28.

BROUWERIJ VERHAEGHE VICHTE N.V., B-8570 VICHTE, BELGIUM:
3,680,030, PUB. 6-23-2009. INT. CL. 32.

BROWN & BROWN OF DETROIT, INC., STERLING HEIGHTS, MI:
2,787,196, CANC. MULTIPLE CLASS, INT. CLS. 35 AND 42.

BROWN, DAVID H., VISTA, CA:
3,680,250, INT. CL. 28.

BROWN, LOUIS GARDNER, JR., VIRGINIA BEACH, VA:
2,664,958, CANC. INT. CL. 41.

BROWN, STEPHEN M., TOLUCA LAKE, CA, DBA PANT PLANET:
3,678,955, PUB. 6-23-2009. INT. CL. 35.

BROWNCROFT ENTERPRISES, INC, ROCHESTER, NY:
3,679,542, PUB. 6-23-2009. INT. CL. 43.

BROWNING, MORGAN, UT:
3,678,867, PUB. 3-31-2009. INT. CL. 13.

BRPP LLC, CANTON, NC:
2,665,661, CANC. INT. CL. 16.

BRUCE CLAYPOOL, INC., VOORHEES, NJ:
2,665,167, CANC. INT. CL. 42.

BRUCE TEMESY, PALOS VERDES ESTATES, CA, DBA YIKESID:
3,681,364, INT. CL. 6.

- BRUNDAGE MINI STORAGES, LTD., SAN ANTONIO, TX:
2,311,825. REN. 8-5-09. INT. CL. 39.
2,314,521. REN. 8-5-09. INT. CL. 39.
- BSH BOSCH UND SIEMENS HAUSGERAETE GMBH,
MUNICH, FED REP GERMANY:
3,678,821, PUB. 6-23-2009. INT. CL. 11.
3,678,822, PUB. 6-23-2009. INT. CL. 11.
3,678,823, PUB. 6-23-2009. INT. CL. 11.
3,678,824, PUB. 6-23-2009. INT. CL. 7.
3,678,837, PUB. 6-23-2009. INT. CL. 11.
- BSP PHARMA, INC., EGG HARBOR TOWNSHIP, NJ:
3,680,838, INT. CL. 5.
- BTA, INC., JACKSON, WY:
3,681,490, INT. CL. 41.
- BTU INTERNATIONAL, INC., NORTH BILLERICA, MA:
3,681,178, INT. CL. 9.
- BUBAR, DAVID N., DELMAR, NY:
2,665,297, CANC. MULTIPLE CLASS, INT. CLS. 9, 16
AND 41.
- BUBBLES, INC., VIENNA, VA:
3,680,624, INT. CL. 3.
- BUCHTAL CORPORATION USA, ROSWELL, GA:
1,518,011, CANC. INT. CL. 19.
- BUCKHORN INVESTORS, LTD., SAN ANTONIO, TX:
3,681,613, MULTIPLE CLASS, INT. CLS. 21 AND 25.
- BUCKINGHAM MANUFACTURING COMPANY, INC.,
BINGHAMTON, NY:
3,678,183, PUB. 6-23-2009. INT. CL. 9.
- BUCKLE, INC., THE, KEARNEY, NE:
2,683,902, CANC. MULTIPLE CLASS, INT. CLS. 6 AND
25.
- BUCKWALTER, MARI ANN, CROFTON, MD:
2,636,704, CANC. INT. CL. 16.
- BUFFALO EXCHANGE, LTD., TUCSON, AZ:
2,849,421, CANC. INT. CL. 24.
- BUGLE BOY INDUSTRIES, INC., SIMI VALLEY, CA:
1,518,076, CANC. INT. CL. 25.
- BUILD-A-BEAR RETAIL MANAGEMENT, INC., ST. LOUIS,
MO, BUILD-A-BEAR WORKSHOP, L.L.C., ST. LOUIS, MO:
2,355,598. REN. 8-5-09. INT. CL. 41.
- BUILD-A-BEAR WORKSHOP, L.L.C., ST. LOUIS, MO TO
BUILD-A-BEAR RETAIL MANAGEMENT, INC., ST.
LOUIS, MO:
2,355,598, CANC. INT. CL. 42.
- BUILDINGREPORTS.COM, INC., DULUTH, GA:
2,665,175, CANC. INT. CL. 42.
- BUNTING BEARINGS, LLC, HOLLAND, OH:
507,349. REN. 8-5-09. U.S. CL. 14 (INT. CL. 6).
- BURGER KING BRANDS, INC., WILMINGTON, DE:
2,665,241, CANC. INT. CL. 28.
- BURLINGTON INDUSTRIES LLC, GREENSBORO, NC,
BURLINGTON MILLS CORPORATION, GREENSBORO,
NC:
504,046. REN. 7-31-09. U.S. CL. 42 (INT. CLS. 22, 24, 26
AND 27).
- BURLINGTON INDUSTRIES LLC, GREENSBORO, NC:
2,215,038, CANC. INT. CL. 24.
- BURN WORLD-WIDE LTD., MIAMI, FL, DBA BGT PART-
NERS:
3,679,095, PUB. 6-23-2009. MULTIPLE CLASS, INT. CLS.
35 AND 42.
- BURRIS, KELLY, HENDERSON, NV, DBA THE BURRIS
LIFE COACH:
3,681,762, INT. CL. 44.
- BURWASH BRAND HORSE GEAR LTD., ALBERTA, CA-
NADA:
2,214,575, CANC. MULTIPLE CLASS, INT. CLS. 18 AND
22.
- BUSCH ENTERTAINMENT CORPORATION, ST. LOUIS,
MO:
2,363,258. REN. 7-31-09. INT. CL. 41.
2,667,092, CANC. INT. CL. 41.
- BUSINESS GUIDES, INC., NEW YORK, NY:
1,518,568, CANC. INT. CL. 16.
- BUSSERI, FRANK, INDIO, CANADA:
1,549,531. REN. 8-5-09. INT. CL. 41.
- BUTCHER COMPANY, INC, THE, MARLBORO, MA, DBA
THE BUTCHER COMPANY:
2,665,290, CANC. INT. CL. 3.
- BUTCHER POLISH COMPANY, THE, MARLBORO, MA TO
BUTCHER COMPANY, INC., THE, MARLBOROUGH,
MA:
1,517,733, CANC. INT. CL. 3.
- BUYERS BROKERS ONLY, LLC, HAVERHILL, MA:
3,679,116, PUB. 6-23-2009. INT. CL. 36.
- BVS ENTERTAINMENT, INC., LOS ANGELES, CA:
2,666,612, CANC. INT. CL. 28.
- BYUNG JOO CHOI, ELK GROVE VILLAGE, IL, DBA
KONEX:
3,678,496, PUB. 6-23-2009. INT. CL. 26.
- B2B VENTURES, LLC, DALLAS, TX:
3,679,694, PUB. 6-23-2009. INT. CL. 35.
- C. E. CONOVER & CO., INC., BENSALEM, PA:
873,001. REN. 8-3-09. U.S. CL. 35 (INT. CL. 17).
- C. MADDEN PRODUCTIONS, L.L.C., NEW YORK, NY:
2,295,717. REN. 8-3-09. INT. CL. 35.
- C. R. BARD, INC., MURRAY HILL, NJ:
3,680,446, MULTIPLE CLASS, INT. CLS. 16 AND 41.
- C. TOMLINSON INC., ORLANDO, FL:
3,680,986, INT. CL. 43.
- C.E. SHEPHERD COMPANY, L.P., HOUSTON, TX:
3,680,491, INT. CL. 6.
- C.H. ROBINSON WORLDWIDE, INC., EDEN PRAIRIE, MN:
2,666,037, CANC. INT. CL. 31.
- C&S OPERATIONS, INC., SYRACUSE, NY:
3,680,684, INT. CL. 9.
- CABALLERO TELEVISION, L.L.C., NEW YORK, NY:
2,664,929, CANC. INT. CL. 41.
- CABLE NEWS NETWORK LP, LLLP, ATLANTA, GA:
2,664,951, CANC. INT. CL. 41.
- CABLE USA, INC., NAPLES, FL, TELEFONAKTIEBOLA-
GET L M ERICSSON, STOCKHOLM, SWEDEN:
1,506,891. REN. 7-31-09. INT. CL. 9.
- CADBURY ADAMS USA LLC, PARSIPPANY, NJ:
3,681,168, INT. CL. 30.
- CADENT TECHNOLOGIES CORP., WATERTOWN, MA:
2,666,203, CANC. INT. CL. 42.
- CAFES PONT, S.L., BARCELONA, SPAIN:
3,678,167, PUB. 6-23-2009. INT. CL. 30.
- CAICE SOFTWARE CORPORATION, TAMPA, FL:
2,665,594, CANC. INT. CL. 9.
- CAIRNS & BROTHER, INC., CLIFTON, NJ:
1,517,995, CANC. INT. CL. 17.
- CAL AGRI PRODUCTS, LLC, LOS ANGELES, CA:
2,666,341, CANC. INT. CL. 5.
- CALAVO GROWERS, INC., SANTA PAULA, CA:
1,560,041. REN. 8-3-09. INT. CL. 29.
- CALEDONIA AMERICAN CAPITAL, LLC, LADERA
RANCH, CA:
3,678,441, PUB. 1-20-2009. INT. CL. 12.
- CALEDONIAN PACIFIC LTD., SAN ANTONIO, TX:
2,214,848, CANC. INT. CL. 14.
- CALGARY ACADEMY, CALGARY, ALBERTA, CANADA:
2,665,108, CANC. MULTIPLE CLASS, INT. CLS. 9, 16
AND 41.
- CALIFORNIA CERTIFIED FARMERS MARKET, CALABA-
SAS, CA:
3,678,713, PUB. 6-23-2009. INT. CL. 35.
- CALIFORNIA MILK PRODUCERS ADVISORY BOARD,
SOUTH SAN FRANCISCO, CA:
3,679,722, PUB. 6-23-2009. U.S. CL. A.
- CALIFORNIA NEWSPAPER PARTNERSHIP, SAN JOSE, CA:
876,556. REN. 8-4-09. U.S. CL. 38 (INT. CL. 16).
- CALIFORNIA RESTAURANT ASSOCIATION, SACRAMEN-
TO, CA:
2,666,026, CANC. INT. CL. 42.
- CALIFORNIA STATE UNIVERSITY OF LONG BEACH
FOUNDATION, LONG BEACH, CA:
1,518,052, CANC. MULTIPLE CLASS, INT. CLS. 25 AND
26.
- CALL MOTIONS, LLC, NEW YORK, NY:
3,678,827, PUB. 6-23-2009. INT. CL. 42.
- CALLAWAY GOLF COMPANY, CARLSBAD, CA:
3,681,674, INT. CL. 28.

CALYSTO COMMUNICATIONS, INC., ATLANTA, GA:
3,678,755, PUB. 6-23-2009. INT. CL. 41.

CAMACHO, RAFAEL, SAN DIEGO, CA:
3,681,300, INT. CL. 29.

CAMBRIDGE HOUSE OF O'FALLON, INC., O'FALLON, IL:
3,679,316, PUB. 6-23-2009. INT. CL. 43.

CAMBRIDGE INVESTMENT RESEARCH, INC., FAIRFIELD, IA:
3,679,492, PUB. 6-23-2009. INT. CL. 36.
3,679,495, PUB. 6-23-2009. INT. CL. 36.

CAMBRIDGE THERANOSTICS LIMITED, UNITED KINGDOM:
3,679,876, PUB. 6-23-2009. INT. CL. 5.
3,679,878, PUB. 6-23-2009. INT. CL. 5.

CAMBRO MANUFACTURING COMPANY, HUNTINGTON BEACH, CA:
2,305,583. REN. 7-31-09. INT. CL. 21.

CAMINO REAL FOODS, INC., CYPRESS, CA:
2,665,915, CANC. INT. CL. 30.

CAMP BOW WOW DISTRIBUTION LLC, BOULDER, CO:
3,681,382, MULTIPLE CLASS, INT. CLS. 37, 41, 44 AND 45.

CAMPBELL, TERRILL JAMES, SONORA, CA, DBA LOSHA-LEGRO:
2,665,138, CANC. INT. CL. 9.

CAMPERS FOR CHRIST MINISTRIES, INC., YORK, PA:
2,289,994. REN. 8-4-09. INT. CL. 42.

CANADIAN HOME PUBLISHERS, TORONTO, CANADA:
3,679,806, PUB. 11-6-2007. MULTIPLE CLASS, INT. CLS. 4, 6, 8, 9, 11, 16, 18, 20, 22, 24 AND 27.

CANADIAN NATIONAL RAILWAY COMPANY, MONTREAL, H3B 2M9, QUEBEC, CANADA:
2,665,319, CANC. MULTIPLE CLASS, INT. CLS. 16, 39 AND 41.

CANANDAIGUA BRANDS, INC., FAIRPORT, NY:
2,666,789, CANC. MULTIPLE CLASS, INT. CLS. 16 AND 25.

CANNONBALL MUSICAL INSTRUMENTS, L.L.C., SANDY, UT:
3,679,832, PUB. 6-23-2009. INT. CL. 15.

CANOPY FINANCIAL, INC., SAN FRANCISCO, CA:
2,739,729, CANC. INT. CL. 44.

CANSAK PRODUCTS LIMITED, TORONTO, ONTARIO M8Z 5H7, CANADA:
2,214,123, CANC. INT. CL. 28.

CANTERRA ELECTRONICS INTERNATIONAL, INC., EDMONTON, ALBERTA, CANADA:
1,517,867, CANC. INT. CL. 9.

CANTURI CORPORATION PTY LTD, AUSTRALIA:
3,679,979, PUB. 6-23-2009. MULTIPLE CLASS, INT. CLS. 3, 4, 35 AND 42.

CAPE SAFFRON, LTD., SOUTHALL, MIDDLESEX, ENGLAND, DBA ILOCUS.COM:
2,665,369, CANC. INT. CL. 35.

CAPGEMINI DEUTSCHLAND GMBH, 10719 BERLIN, FED REP GERMANY:
3,679,909, PUB. 6-23-2009. MULTIPLE CLASS, INT. CLS. 35, 41 AND 42.

CAPITA TECHNOLOGIES, INC., IRVINE, CA:
3,679,412, PUB. 6-23-2009. INT. CL. 42.

CAPITAL ANALYTICS, INC., DURHAM, NC:
2,665,605, CANC. INT. CL. 9.

CAPITAL INTELLECT, INC., BOSTON, MA:
2,665,794, CANC. INT. CL. 9.

CAPITAL IQ, INC., NEW YORK, NY:
2,665,349, CANC. MULTIPLE CLASS, INT. CLS. 35, 36 AND 42.

CAPITAL LIFEWORKS, WASHINGTON, DC:
3,681,278, INT. CL. 41.

CAPITAL NEWSPAPERS - A DIVISION OF HEARST CORPORATION, ALBANY, NY:
2,666,762, CANC. INT. CL. 35.

CAPITOL COMMUNICATIONS, INC., COLUMBUS, OH:
2,666,003, CANC. MULTIPLE CLASS, INT. CLS. 40 AND 42.

CAPO, INC., ORMOND BEACH, FL:
1,517,806, CANC. INT. CL. 9.

CAPPELLA, INC., AUBURNDALE, MA:
3,681,549, INT. CL. 10.

CAPSTAR RADIO OPERATING COMPANY, SAN ANTONIO, TX:
2,260,224. REN. 8-3-09. INT. CL. 38.

CAPT'N NEMO'S GROUP, L.L.C., CHICAGO, IL:
1,556,228. REN. 8-1-09. INT. CL. 42.

CAPTAIN MUSIC, INC., MERRITT ISLAND, FL:
3,680,588, INT. CL. 41.

CAPTECH VENTURES, INC., RICHMOND, VA:
2,666,190, CANC. INT. CL. 9.

CARAVAN TRADING USA, CORP., GUELPH, ONTARIO, CANADA:
2,665,051, CANC. INT. CL. 24.

CARBON PLANET LIMITED, AUSTRALIA:
3,680,003, PUB. 6-23-2009. MULTIPLE CLASS, INT. CLS. 36 AND 42.

CARDEAUX COSMETICS, NORTH MIAMI BEACH, FL:
3,681,264, INT. CL. 3.

CARDENAS, ANTHONY J, CHICO, CA:
3,680,460, INT. CL. 41.

CARDINAL HEALTH 303, INC., SAN DIEGO, CA:
3,680,249, INT. CL. 9.

CARDINAL MEDICAL SPECIALTIES, INC., LOUISVILLE, KY:
2,665,981, CANC. INT. CL. 10.

CARDONE INDUSTRIES, INC., PHILADELPHIA, PA:
3,680,533, INT. CL. 12.
3,680,534, INT. CL. 12.

CARE-A-LOT, INC., VIRGINIA BEACH, VA:
2,794,293, AM. INT. CL. 35.

CAREER PORTFOLIO SYSTEMS, INC., MINNEAPOLIS, MN:
3,679,605, PUB. 6-23-2009. MULTIPLE CLASS, INT. CLS. 16 AND 35.

CAREIN' CONNECTIONS UNLIMITED, ST. CHARLES, IL:
3,681,488, INT. CL. 44.

CARESTREAM HEALTH, INC., ROCHESTER, NY:
2,665,157, CANC. INT. CL. 10.

CARGILL, INCORPORATED, WAYZATA, MN:
2,667,215, CANC. INT. CL. 36.
3,681,412, INT. CL. 9.
3,681,563, INT. CL. 19.

CARIDIANBCT, INC., LAKEWOOD, CO:
2,214,994, CANC. MULTIPLE CLASS, INT. CLS. 9 AND 10.

CARING FOR PEOPLE SERVICES INC, OMAHA, NE:
3,680,296, INT. CL. 45.

CARL MILES FOOD SERVICE, INC., ODESSA, TX:
2,214,745, CANC. INT. CL. 30.

CARL SCHENCK AG, 64293 DARMSTADT, FED REP GERMANY:
3,678,212, PUB. 6-23-2009. MULTIPLE CLASS, INT. CLS. 6, 7, 9, 20 AND 35.

CARLISLE FOODSERVICE PRODUCTS, INCORPORATED, OKLAHOMA CITY, OK:
2,666,479, CANC. INT. CL. 21.
2,666,487, CANC. INT. CL. 21.

CARLSON GRACIE, JR., CHICAGO, IL:
3,681,018, INT. CL. 25.

CARLSON SOFTWARE, INC., MAYSVILLE, KY:
3,680,972, INT. CL. 9.

CARLSON, LLC, WALNUT CREEK, CA:
2,241,331. REN. 8-4-09. INT. CL. 16.

CARME, INC., NOVATO, CA:
1,517,722, CANC. INT. CL. 3.

CARMEL WHOLESALE, INC., LAWRENCEVILLE, GA:
2,665,940, CANC. INT. CL. 32.

CARNEY TIMBER COMPANY, BARRIE, ONTARIO, CANADA:
2,665,385, CANC. INT. CL. 19.

CARNIVAL CORPORATION, MIAMI, FL:
3,679,775, PUB. 6-23-2009. INT. CL. 41.

CAROL PORTER, HOUSTON, TX:
2,666,605, CANC. INT. CL. 43.

CAROLS EXPRESS, LLC, NEW YORK, NY:
3,679,160, PUB. 6-23-2009. INT. CL. 3.

- CARROWS RESTAURANTS, INC., CARLSBAD, CA:
2,261,211. REN. 8-4-09. INT. CL. 30.
- CARTECHINI, GIANLUCA, CIVITANOVA, ITALY:
2,666,523, CANC. MULTIPLE CLASS, INT. CLS. 18 AND 25.
- CARTESIS S.A., PARIS, FRANCE:
2,665,351, CANC. INT. CL. 9.
- CARTOSOFT, LLC, PORTLAND, OR:
3,678,971, PUB. 6-23-2009. INT. CL. 42.
- CARUSO, PAUL, NORTH LAS VEGAS, NV:
3,681,790, INT. CL. 36.
- CAS MEDICAL SYSTEMS, INC., BRANFORD, CT:
1,517,858, CANC. INT. CL. 9.
- CASAL THAUERO S.R.L., ORTONA (CH), ITALY:
2,214,041, CANC. INT. CL. 33.
- CASCADE POLE AND LUMBER COMPANY, TACOMA, WA:
2,666,950, CANC. INT. CL. 19.
- CASCAL B.V., 1221 KC HILVERSUM, NETHERLANDS:
2,665,444, CANC. MULTIPLE CLASS, INT. CLS. 11, 35, 37, 39, 40 AND 42.
- CASH ZONE OHIO, CINCINNATI, OH, DBA CASH BIZ AND CASH ZONE, CINCINNATI, OH, DBA CASH BIZ AND CASH ZONE, CINCINNATI, OH, DBA CASH BIZ:
3,681,749, INT. CL. 36.
- CASSELL, THOMAS C., VENTURA, CA:
2,666,607, CANC. INT. CL. 15.
- CAST ART INDUSTRIES, INC. ("CAI"), CORONA, CA:
2,666,821, CANC. INT. CL. 20.
- CASTE PUBLISHING LLC, PEPPER PIKE, OH:
3,681,385, INT. CL. 9.
- CATAPULTA, LLC, WAKE FOREST, NC:
2,665,191, CANC. INT. CL. 35.
- CATERPILLAR FOREST PRODUCTS INC., LAGRANGE, GA:
2,665,218, CANC. INT. CL. 7.
- CATHAY PIGMENTS (INTERNATIONAL) LIMITED, EWELL, SURREY KT17 1RW, UNITED KINGDOM:
2,665,723, CANC. MULTIPLE CLASS, INT. CLS. 1 AND 2.
- CATHEY, TRACY, INGLEWOOD, CA:
3,681,719, INT. CL. 25.
- CATHOLIC HEALTH CORPORATION, OMAHA, NE:
1,518,269, CANC. INT. CL. 36.
- CATHOLIC HEALTHCARE WEST, SAN FRANCISCO, CA:
3,680,851, MULTIPLE CLASS, INT. CLS. 16 AND 35.
- CATLETT, VIRGINIA R, LEAWOOD, KS:
2,666,125, CANC. INT. CL. 29.
- CAVALIER HOMES, INC., ADDISON, AL:
2,667,253, CANC. INT. CL. 19.
- CAVALIER SERVICES, INC., FAIRFAX, VA, AKA CAVALIER SERVICES:
3,681,333, INT. CL. 37.
- CAYUSE VINEYARDS, L.L.C., WALLA WALLA, WA:
3,681,570, INT. CL. 33.
3,681,571, INT. CL. 33.
- CAZ & ASSOCIATES, INC., CHARLES TOWN, WV:
3,679,654, PUB. 6-23-2009. INT. CL. 43.
- CB RESOURCES CORPORATION, EDMONTON, CANADA:
3,678,470, PUB. 11-11-2008. INT. CL. 37.
- CBS BROADCASTING INC., NEW YORK, NY:
3,679,725, PUB. 6-23-2009. INT. CL. 38.
3,679,727, PUB. 6-23-2009. INT. CL. 41.
3,679,728, PUB. 6-23-2009. INT. CL. 9.
- CBS RADIO STATIONS INC., NEW YORK, NY:
1,518,596, CANC. INT. CL. 41.
- CCU GROUP, INC., COSTA MESA, CA:
2,666,832, CANC. MULTIPLE CLASS, INT. CLS. 35 AND 36.
- CEDO-GAUDIER, ROBERTO, SAN JUAN, PUERTO RICO:
3,679,326, PUB. 6-23-2009. INT. CL. 30.
- CEG SERVICES, INC., LA VERNE, CA:
2,666,649, CANC. INT. CL. 35.
- CELAVIE BIOSCIENCES LLC, READING, PA:
3,680,634, INT. CL. 5.
- CELINE, FRANCE:
3,679,912, PUB. 6-23-2009. MULTIPLE CLASS, INT. CLS. 18, 24 AND 25.
- CELLCO PARTNERSHIP, BEDMINSTER, NJ, DBA VERIZON WIRELESS:
2,213,915, CANC. INT. CL. 38.
- CELLEBRITE USA, CORP., FRANKLIN LAKES, NJ:
3,678,338, PUB. 6-23-2009. INT. CL. 9.
- CELLULAR BIOENGINEERING, INC., HONOLULU, HI:
3,679,014, PUB. 6-23-2009. MULTIPLE CLASS, INT. CLS. 1 AND 3.
- CELORIO, VICTOR, GAINESVILLE, FL:
2,664,975, CANC. MULTIPLE CLASS, INT. CLS. 16 AND 35.
- CEMBEX CARE SOLUTIONS, LLC, CINCINNATI, OH:
2,260,990, REN. 8-3-09. INT. CL. 35.
- CEMEX UK OPERATIONS LIMITED, SURREY TW20 8TD, UNITED KINGDOM:
3,680,153, MULTIPLE CLASS, INT. CLS. 35, 37, 39 AND 42.
- CENTER FOR CITIZEN LEADERSHIP, ST. LOUIS, MO, AKA THE MISSION CONTINUES:
3,679,787, PUB. 6-23-2009. INT. CL. 35.
- CENTER FOR COGNITIVE FITNESS & INNOVATIVE THERAPIES, SANTA BARBARA, CA:
3,681,047, INT. CL. 44.
- CENTER FOR FIDUCIARY STUDIES, LLC, SEWICKLEY, PA:
3,428,864, COR. U.S. CL. B.
- CENTER FOR ULTRASOUND RESEARCH & EDUCATION CORP., NEW ROCHELLE, NY:
3,678,937, PUB. 6-23-2009. INT. CL. 41.
- CENTER FOR VALUE-BASED MEDICINE, LLC, FLOUR-TOWN, PA:
3,559,073, COR. INT. CL. 35.
- CENTEX CORPORATION, DALLAS, TX:
2,666,781, CANC. MULTIPLE CLASS, INT. CLS. 25, 28, 36, 41 AND 42.
3,681,216, INT. CL. 37.
3,681,577, INT. CL. 9.
- CENTRAL BOILER, INC., GREENBUSH, MN:
2,266,828, REN. 8-5-09. INT. CL. 11.
- CENTRAL DYNAMICS CORP., BOCA RATON, FL, DBA CENDYN:
3,681,651, INT. CL. 42.
- CENTRAL GARDEN & PET COMPANY, WALNUT CREEK, CA:
3,680,496, INT. CL. 5.
- CENTRAL LAKE ARMOR EXPRESS, INC., CENTRAL LAKE, MI:
3,679,526, PUB. 6-23-2009. INT. CL. 9.
- CENTRAL MINNESOTA TASK FORCE ON BATTERED WOMEN, ST. CLOUD, MN:
3,678,961, PUB. 6-23-2009. INT. CL. 41.
- CENTRAL PARKING CORPORATION, NASHVILLE, TN:
2,264,440, REN. 8-3-09. MULTIPLE CLASS, INT. CLS. 35 AND 39.
- CENTRE D'EXPERIMENTATION DE PEPINIERS-C.E.P., LYON, FRANCE:
1,580,375, REN. 8-5-09. INT. CL. 31.
- CENTURY PRODUCTS COMPANY, MACEDONIA, OH:
1,517,902, CANC. INT. CL. 12.
- CENZONE TECH, INC., SAN MARCOS, CA:
3,679,500, PUB. 6-23-2009. MULTIPLE CLASS, INT. CLS. 5 AND 31.
- CEQUENT CONSUMER PRODUCTS, INC., SOLON, OH:
3,678,634, PUB. 6-23-2009. INT. CL. 6.
- CERAGEM CO, LTD., CHOONGCHUNGNAM-DO, REPUBLIC OF KOREA:
3,678,301, PUB. 6-23-2009. MULTIPLE CLASS, INT. CLS. 11 AND 27.
- CERBA, FRANCE:
3,679,941, PUB. 6-23-2009. MULTIPLE CLASS, INT. CLS. 42 AND 44.
- CERNER INNOVATION, INC., OVERLAND PARK, KS:
3,681,183, INT. CL. 9.
- CERRUTI 1881, 75008 PARIS, FRANCE:
3,680,077, INT. CL. 16.
- CERTA PROPAINTERS, LTD., OAKS, PA:
3,680,165, INT. CL. 37.

CERTAIN AFFINITY, INC., AUSTIN, TX:
3,681,138, INT. CL. 9.

CF PREMIUM PRODUCTS, LLC, ORANGE, CA AND
FIORETTO FRANCHISING CORP, CITY OF INDUSTRY,
CA:
3,679,489, PUB. 6-23-2009. INT. CL. 30.

CFS HOLDINGS, INC., RICHMOND, VA:
2,263,222. REN. 8-3-09. INT. CL. 29.
2,267,340. REN. 8-4-09. INT. CL. 29.

CFYC, INC., DAYTONA BEACH, FL:
2,666,353, CANC. INT. CL. 11.

CHA, YOUNG DAE, SILVER SPRING, MD:
2,666,732, CANC. INT. CL. 20.

CHAIDEMENOS, SPYROS, LONDON, ONTARIO, CANADA:
3,680,113, INT. CL. 7.

CHALRICH ENTERPRISE CO., LTD., TAICHUNG HSIEN,
TAIWAN:
2,666,005, CANC. INT. CL. 25.

CHAMBERLAIN COLLEGE OF NURSING LLC, OAK-
BROOK TERRACE, IL:
3,680,091, INT. CL. 16.
3,680,139, INT. CL. 16.

CHAMBERS, PAULA D., RENTON, WA:
2,666,537, CANC. INT. CL. 36.

CHAMPAGNE HENRI ABLE, 51100 REIMS, FRANCE:
2,664,944, CANC. INT. CL. 33.

CHAMPION HOME BUILDERS CO., TROY, MI:
2,667,141, CANC. INT. CL. 35.

CHAMPION PERFORMANCE PRODUCTS, INC., SUNRISE,
FL:
3,681,181, INT. CL. 5.

CHANG-HO FIBRE CORPORATION, TAoyUAN HSIEN,
TAIWAN:
2,262,102. REN. 8-1-09. INT. CL. 24.

CHANNELCORP MANAGEMENT CONSULTANTS INC.,
VANCOUVER, B.C., CANADA:
2,665,120, CANC. INT. CL. 41.

CHANNOINE COSMETICS AG, LIECHTENSTEIN:
3,680,043, PUB. 6-23-2009. INT. CL. 3.

CHARACTER LLC, PORTLAND, OR:
3,679,395, PUB. 6-23-2009. INT. CL. 35.

CHARLES SCHWAB & CO., INC., SAN FRANCISCO, CA:
2,666,888, CANC. INT. CL. 36.

CHARLOTTE MOSS LLC, NEW YORK, NY:
3,680,166, MULTIPLE CLASS, INT. CLS. 24, 35, 42 AND
45.

CHART MARKETING, INC., WICHITA, KS:
2,214,693, CANC. INT. CL. 29.

CHARTER CONSTRUCTION, INC., SEATTLE, WA:
2,665,156, CANC. INT. CL. 37.

CHARVET PLACE VENDOME S.A., PARIS, FRANCE:
866,015. REN. 8-4-09. MULTIPLE CLASS, U.S. CLS. 3
(INT. CL. 18), 28 (INT. CL. 14) AND 39 (INT. CL. 25).
866,015, CANC. U.S. CL. 41.

CHASE CORPORATION, BRIDGEWATER, MA:
1,517,717, CANC. INT. CL. 2.

CHAVEZ, ROBERT, SAN ANTONIO, TX:
3,678,846, PUB. 6-23-2009. INT. CL. 41.

CHAVEZ, VALARIE L., ALBUQUERQUE, NM:
3,680,370, INT. CL. 20.

CHEF AMERICA, INC., CHATSWORTH, CA:
1,518,163, CANC. INT. CL. 30.

CHEFS GARDEN, INC., THE, HURON, OH:
2,665,504, CANC. MULTIPLE CLASS, INT. CLS. 31 AND
35.

CHEFWEAR, INC., CHICAGO, IL:
3,681,612, MULTIPLE CLASS, INT. CLS. 25 AND 35.

CHELLAPPAN, RAGHAVAN V, LEESBURG, VA:
3,678,221, PUB. 6-23-2009. INT. CL. 42.

CHELSEA GROUP LTD., ITASCA, IL:
2,666,625, CANC. INT. CL. 40.

CHEMGLASS, INC., VINELAND, NJ:
3,681,369, INT. CL. 35.
3,681,370, INT. CL. 35.

CHEMINOVA, INC., RESEARCH TRIANGLEPARK, NC:
3,680,801, INT. CL. 5.

CHEMINOVA, INC., RESEARCH TRIANGLE PARK, NC:
3,680,806, INT. CL. 5.

CHEREAU, PIERRE, 3960 SIERRE, SWITZERLAND:
2,665,601, CANC. MULTIPLE CLASS, INT. CLS. 9, 35, 38
AND 42.

CHERYL GOWDY INTERNATIONAL, INC., WEST PALM
BEACH, FL:
2,214,985, CANC. MULTIPLE CLASS, INT. CLS. 25 AND
36.

CHEVYS RESTAURANTS, LLC, EMERYVILLE, CA:
2,213,618, CANC. INT. CL. 42.

CHIKARANOMOTO COMPANY CO. LTD., FUKUOKA,
JAPAN:
3,678,490, PUB. 6-23-2009. INT. CL. 43.
3,678,491, PUB. 6-23-2009. INT. CL. 43.

CHILD S.R.L., SERRAVALLE SESIA, ITALY:
2,665,194, CANC. INT. CL. 25.

CHILDREN OF CHORNOBYL RELIEF AND DEVELOP-
MENT FUND, INC., WHIPPANY, NJ:
2,666,017, CANC. INT. CL. 36.

CHILDREN'S BUREAU OF SOUTHERN CALIFORNIA, LOS
ANGELES, CA:
2,301,501. REN. 8-3-09. INT. CL. 41.

CHILDREN'S CANCER RESEARCH FUND, MINNEAPOLIS,
MN:
3,681,079, INT. CL. 35.

CHILDREN'S HOUR ACADEMY, THE, LAKE OSWEGO,
OR:
2,665,087, CANC. INT. CL. 41.

CHILDTIME CHILDCARE, INC., NOVI, MI:
1,518,358, CANC. INT. CL. 41.

CHINA CONSTRUCTION (SHENZHEN) DESIGN INTER-
NATIONAL, SHENZHEN, CHINA:
3,225,152, CANC. INT. CL. 42.

CHINA PETROCHEMICAL CORPORATION, CHINA:
3,679,946, PUB. 6-23-2009. MULTIPLE CLASS, INT. CLS.
1, 4, 17, 19, 37 AND 42.

CHLOE LOVE FOUNDATION, VENICE, CA:
3,680,159, INT. CL. 41.

CHOCO, COÖPERATIEVE; VENNOOTSCHAP MET BE-
PERKTE; AANSPRAKELIJKHEID, B-2500 LIER, BEL-
GIUM:
3,679,953, PUB. 6-23-2009. MULTIPLE CLASS, INT. CLS.
35 AND 41.

CHOICE GROUP INCORPORATED, LOS ANGELES, CA:
3,679,181, PUB. 6-23-2009. INT. CL. 41.

CHOPPING BLOCK, INC. THE, NEW YORK, NY:
2,665,530, CANC. INT. CL. 42.

CHOPRA, RAJ K., WESTBURY, NY:
3,681,537, INT. CL. 41.

CHOYA UMESHU CO., LTD, OSAKA, JAPAN:
2,307,634. REN. 8-4-09. INT. CL. 33.

CHRISTENSEN, BRIAN, TORRANCE, CA AND LUZURIA-
GA, CHRISTIAN, TORRANCE, CA AND MCCOLLAM,
MARK, TORRANCE, CA:
2,665,806, CANC. INT. CL. 41.

CHRISTO LEFROY BROOKS, LUCCA, ITALY:
3,678,228, PUB. 3-10-2009. INT. CL. 11.

CHRISTOPHER, Nanci NEIDORF, BEVERLY HILLS, CA,
DBA SKATERQUEEN/SUPERBOY PRODUCTIONS:
3,678,339, PUB. 6-23-2009. INT. CL. 41.

CHRISTUS HEALTH, HOUSTON, TX:
3,680,707, INT. CL. 5.

CHUDLEIGH'S LTD., MILTON, CANADA:
3,681,190, INT. CL. 29.

CHUNG TAI GARMENT FACTORY LIMITED, NEW TER-
RITORIES, HONG KONG:
3,679,054, PUB. 6-23-2009. MULTIPLE CLASS, INT. CLS.
25, 35 AND 40.

CHURCH COMMUNITIES NY, INC., RIFTON, NY:
2,038,399, CANC. U.S. CL. 200.

CHYUAN SHYANG STATIONERY CO., TAIPEI, TAIWAN:
2,666,857, CANC. INT. CL. 16.
2,666,858, CANC. INT. CL. 16.

CIANELLI, WILLIAM A, ELSMFORD, NY:
3,681,295, INT. CL. 3.

CIGNA INTELLECTUAL PROPERTY, INC, CLAYMONT,
DE:
2,361,698. REN. 8-4-09. INT. CL. 36.

- CIMA TELECOM, INC., DORAL, FL:
3,679,802, PUB. 4-10-2007. INT. CL. 36.
- CIRLARE LLC, LITTLE NECK, NY:
3,678,452, PUB. 6-23-2009. INT. CL. 42.
- CIRRUS MEDICAL STAFFING, INC., HOUSTON, TX:
3,679,635, PUB. 6-23-2009. INT. CL. 35.
- CISCO TECHNOLOGY, INC., SAN JOSE, CA:
3,680,804, INT. CL. 9.
- CITIGROUP INC., NEW YORK, NY:
2,263,621. REN. 8-3-09. INT. CL. 36.
- CITY AND COUNTY OF SAN FRANCISCO - FINE ARTS MUSEUMS OF SAN FRANCISCO, SAN FRANCISCO, CA:
3,678,611, PUB. 6-23-2009. MULTIPLE CLASS, INT. CLS. 16 AND 41.
- CITY OF BELLA VISTA, ARKANSAS, BELLA VISTA, AR:
3,678,932, PUB. 6-23-2009. INT. CL. 35.
- CITY OF DANA POINT, DANA POINT, CA:
3,681,539, INT. CL. 16.
- CITY OF HOPE, DUARTE, CA:
3,680,160, MULTIPLE CLASS, INT. CLS. 36, 42 AND 44.
- CITY OF LA MIRADA, LA MIRADA, CA:
2,665,121, CANC. MULTIPLE CLASS, INT. CLS. 35, 36 AND 42.
- CITY OF LA QUINTA, LA QUINTA, CA:
3,681,461, MULTIPLE CLASS, INT. CLS. 39, 41 AND 43.
- CITYPROOF CORP., LONG ISLAND CITY, NY:
855,794. REN. 7-31-09. U.S. CL. 12 (INT. CL. 19).
- CITYSOURCE INCORPORATED, CAMBRIDGE, MA:
2,213,634, CANC. INT. CL. 9.
- CIVIL ENGINEERING CERTIFICATION, INC., RESTON, VA:
3,681,791, INT. CL. 42.
- CJ YOUNGBLOOD ENTERPRISES, INC., BRYAN, TX:
3,679,343, PUB. 6-23-2009. INT. CL. 28.
- CJ'S BBQ NO. 1, LLC, LAS VEGAS, NV:
3,680,355, INT. CL. 43.
- CKA SALES, INC., AKRON, OH:
2,214,314, CANC. INT. CL. 19.
- CLAIM MANAGEMENT SERVICES, INC., GREEN BAY, WI:
2,665,958, CANC. INT. CL. 36.
- CLAIRE II, LLC, HUTCHINSON, MN:
2,666,299, CANC. INT. CL. 21.
- CLAM CORPORATION, PLYMOUTH, MN:
3,679,822, PUB. 7-18-2006. MULTIPLE CLASS, INT. CLS. 24 AND 25.
- CLAMP SWING PRICING CO., OAKLAND, CA:
1,548,331. REN. 8-3-09. INT. CL. 20.
- CLAMP-SWING PRICING COMPANY, INC., OAKLAND, CA:
1,530,886. REN. 8-3-09. INT. CL. 20.
- CLARK HOSPITALITY, INC., KNOXVILLE, TN, DBA OLD COLLEGE INN RESTAURANT:
3,678,708, PUB. 6-23-2009. INT. CL. 43.
- CLARK, RICK, CHELSEA, AL:
3,679,629, PUB. 6-23-2009. INT. CL. 43.
- CLARK, SCHAEFER, HACKETT & CO., CINCINNATI, OH:
3,681,162, INT. CL. 35.
- CLARUS MEDICAL, LLC, MINNEAPOLIS, MN:
2,256,059. REN. 8-4-09. INT. CL. 10.
- CLASSIFIED TECHNOLOGIES GROUP, L.L.C., TAMPA, FL:
2,665,363, CANC. INT. CL. 35.
- CLEAN CASH TECHNOLOGIES, INC., CLEARWATER, FL:
3,680,427, INT. CL. 7.
- CLEANER'S SUPPLY, INC., CONKLIN, NY:
3,680,498, INT. CL. 35.
- CLEAR CHANNEL BROADCASTING, INC., SAN ANTONIO, TX:
1,536,804. REN. 8-1-09. INT. CL. 38.
- CLEAR WIND RENEWABLE POWER, INC., MINNEAPOLIS, MN:
3,680,518, MULTIPLE CLASS, INT. CLS. 35 AND 37.
3,680,636, MULTIPLE CLASS, INT. CLS. 35 AND 37.
- CLEARACCESS, INC., VANCOUVER, WA:
3,678,342, PUB. 6-23-2009. MULTIPLE CLASS, INT. CLS. 9 AND 38.
- CLEARWATER MANAGEMENT COMPANY (UK) LIMITED, CHRISTCHURCH, UNITED KINGDOM:
3,426,773, COR. MULTIPLE CLASS, INT. CLS. 36 AND 37.
- CLEAR2CARE, INC., BATON ROUGE, LA:
3,679,645, PUB. 6-23-2009. INT. CL. 41.
- CLICK MANAGEMENT, INC., SPOKANE, WA:
3,679,366, PUB. 6-23-2009. INT. CL. 42.
- CLIENT MONITOR, CANYON COUNTRY, CA:
3,679,363, PUB. 6-23-2009. INT. CL. 40.
- CLIF BAR & CO., BERKELEY, CA:
2,667,367, CANC. INT. CL. 30.
- CLIFFORD CO., LTD., GYENGGI-DO, REPUBLIC OF KOREA:
3,678,225, PUB. 11-11-2008. MULTIPLE CLASS, INT. CLS. 18 AND 25.
- CLINGMAN, CHARLES LEE, MORRO BAY, CA:
2,666,804, CANC. INT. CL. 16.
- CLIQUE MARKETING, LLC, FT. LAUDERDALE, FL:
2,666,301, CANC. INT. CL. 35.
- CLIVE COLMAN, CHORLEYWOOD, HERTS WD3 5SN, UNITED KINGDOM AND KELLY COLMAN, CHORLEYWOOD, HERTS WD3 5SN, UNITED KINGDOM:
3,679,895, PUB. 3-17-2009. INT. CL. 3.
- CLOCKWORK IP, LLC, SARASOTA, FL:
3,681,568, INT. CL. 37.
- CLOSECALL AMERICA, INC., STEVENSVILLE, MD:
2,665,345, CANC. INT. CL. 38.
- CLOUD SYSTEMS INC., SAN FRANCISCO, CA:
3,681,607, INT. CL. 9.
- CLOUDED LEOPARD PROJECT, GIG HARBOR, WA:
3,678,639, PUB. 6-23-2009. INT. CL. 35.
- CLOUSE, FRANK A., FRESNO, CA:
2,667,246, CANC. INT. CL. 28.
- CLYDE BERGEMANN, INC., ATLANTA, GA:
3,680,300, INT. CL. 7.
- CM FRANCHISE SYSTEMS, INC., LOS ANGELES, CA:
2,214,476, CANC. MULTIPLE CLASS, INT. CLS. 25, 30 AND 42.
- CMI CORPORATION, OKLAHOMA CITY, OK:
1,517,789, CANC. INT. CL. 7.
- CNH AMERICA LLC, RACINE, WI:
3,679,839, PUB. 6-23-2009. INT. CL. 7.
- CO-LABS, INC., BOULDER, CO:
3,680,737, INT. CL. 41.
- COA NETWORK, INC., PISCATAWAY, NJ:
3,681,093, INT. CL. 38.
- COALITION FOR COMMUNITY COLLABORATION, OVERLAND PARK, KS:
2,665,454, CANC. INT. CL. 42.
- COALITION OF INDEPENDENT MUSIC STORES, LLC, BIRMINGHAM, AL:
3,679,791, PUB. 6-23-2009. INT. CL. 35.
- COAST BEVERAGE GROUP, LLC, ORANGE, CA:
3,680,586, INT. CL. 32.
- COASTAL CAROLINA BANCSHARES, INC., MYRTLE BEACH, SC:
3,681,005, INT. CL. 36.
- COBANK, ACB, GREENWOOD VILLAGE, CO, NATIONAL BANK FOR COOPERATIVES, ENGLEWOOD, CO:
1,562,560. REN. 8-3-09. INT. CL. 36.
- COBANK, ACB, ENGLEWOOD, CO:
2,287,337. REN. 8-3-09. INT. CL. 36.
- COBRA ELECTRONICS CORPORATION, CHICAGO, IL:
3,681,335, INT. CL. 39.
- COBRA SYSTEMS, INC., ANAHEIM, CA:
3,680,949, INT. CL. 9.
- COCA-COLA COMPANY, THE, ATLANTA, GA:
1,518,194, CANC. INT. CL. 32.
- COCO BAY, INC., MIAMI, FL:
1,518,047, CANC. INT. CL. 25.
- COCO'S RESTAURANTS, INC., CARLSBAD, CA:
1,554,183. REN. 8-4-09. INT. CL. 42.
- COCOA LILLY CORPORATION, IRVINE, CA:
3,680,842, INT. CL. 16.
3,680,847, INT. CL. 25.
- COCONUT COASTERS LLC, KAPAA, HI:
3,679,244, PUB. 6-23-2009. INT. CL. 39.

CODEFLARE, LLC, PLANO, TX:
3,680,950, INT. CL. 42.
3,680,951, INT. CL. 42.
3,681,185, INT. CL. 42.

CODONICS, INC., MIDDLEBURG HEIGHTS, OH:
3,680,671, INT. CL. 9.

COGNAC ONE, LLC, NEW YORK, NY:
3,681,022, INT. CL. 33.

COGNIS IP MANAGEMENT GMBH, DUESSELDORF, FED REP GERMANY:
2,665,705, CANC. INT. CL. 1.

COGNIT A.S, 1754 HALDEN, NORWAY:
2,665,591, CANC. MULTIPLE CLASS, INT. CLS. 35, 41 AND 42.

COHERENT, INC., SANTA CLARA, CA:
3,681,307, INT. CL. 9.

COI CERAMICS, INC., SAN DIEGO, CA:
3,678,464, PUB. 6-23-2009. INT. CL. 1.

COLDER PRODUCTS COMPANY, ST. PAUL, MN:
3,680,760, MULTIPLE CLASS, INT. CLS. 6 AND 17.

COLDWATER CREEK INC., SANDPOINT, ID:
3,680,357, INT. CL. 35.

COLEMAN COMPANY, INC., THE, WICHITA, KS:
2,665,431, CANC. INT. CL. 25.
2,666,895, CANC. MULTIPLE CLASS, INT. CLS. 11, 18, 20 AND 21.

COLGATE-PALMOLIVE COMPANY, NEW YORK, NY:
3,681,058, INT. CL. 3.

COLLABORATIVE SOLUTIONS, LLC, HERNDON, VA:
3,681,582, INT. CL. 42.

COLLEGIO TOSCANO DEGLI OLIVICOLTORI OL.MA.-SAC, ITALY:
3,679,865, PUB. 6-23-2009. MULTIPLE CLASS, INT. CLS. 29 AND 30.

COLLET INVESTMENTS LLC, SAN DIEGO, CA:
2,666,989, CANC. INT. CL. 36.

COLLEXIS B.V., 4191 NW GELDERMALSEN, NETHERLANDS:
3,680,185, INT. CL. 9.

COLLIER PETER, BILPIN, AUSTRALIA:
3,680,617, INT. CL. 19.

COLLIERS BENNETT & KAHNWEILER, INC., DENVER, CO:
3,679,570, PUB. 6-23-2009. INT. CL. 36.

COLLINS, WALL, NEW YORK, NY:
3,680,758, INT. CL. 25.

COLON HEALTH CENTERS OF AMERICA, LLC, MENDENHALL, PA:
3,681,724, INT. CL. 44.
3,681,725, INT. CL. 44.

COLONIAL WILLIAMSBURG FOUNDATION, THE, WILLIAMSBURG, VA:
2,284,708, REN. 8-3-09. INT. CL. 24.

COLORKEYS INCORPORATED, TORONTO, ONTARIO, CANADA:
3,680,079, INT. CL. 15.

COLUMBIA DIAGNOSTICS, INC., HAMPTON, NH:
2,665,134, CANC. INT. CL. 35.

COLUMBIA INSURANCE COMPANY, OMAHA, NE:
1,549,373, REN. 8-3-09. INT. CL. 30.
3,678,598, PUB. 6-23-2009. INT. CL. 27.

COLUMBIA RESOURCE GROUP, LLC, SEATTLE, WA, DBA CRG - TOTAL EVENT SOLUTIONS:
2,666,212, CANC. INT. CL. 42.

COLUMBIA STEEL CASTING CO., INC., PORTLAND, OR:
3,681,147, MULTIPLE CLASS, INT. CLS. 6 AND 7.

COMBINATURE BIOPHARM AG., 13125 BERLIN, FED REP GERMANY:
2,665,586, CANC. MULTIPLE CLASS, INT. CLS. 1, 5 AND 42.

COMFORT SERVICES, INC., WEST COLUMBIA, SC:
3,681,360, INT. CL. 37.

COMFORTE INC., OLD TAPPAN, NJ:
2,353,372, REN. 8-3-09. INT. CL. 9.

COMFORTEX CORPORATION, MAPLE WOOD, NY:
2,214,969, CANC. INT. CL. 20.

COMM-WORKS, LLC, PLYMOUTH, MN:
2,354,591, REN. 8-3-09. INT. CL. 37.

COMM, JOEL, LOVELAND, CO:
3,678,960, PUB. 6-23-2009. INT. CL. 35.

COMMONWEALTH FOREIGN EXCHANGE, INC., PROVIDENCE, RI:
2,263,674, REN. 8-3-09. INT. CL. 36.
2,263,674, CANC. INT. CL. 9.

COMMSCOPE, INC. OF NORTH CAROLINA, HICKORY, NC:
2,263,526, REN. 8-3-09. INT. CL. 9.

COMMUNITY BASEBALL CLUB OF CENTRAL NEW YORK, INC., SYRACUSE, NY:
2,214,303, CANC. MULTIPLE CLASS, INT. CLS. 16 AND 25.

COMMUNITY CARE NETWORK, INC., SAN DIEGO, CA:
1,518,468, CANC. INT. CL. 42.

COMMUNITY PARTNERS FBO AMAZING KIDS!, LOS ANGELES, CA:
3,680,843, INT. CL. 41.

COMMUNITY POWER CORPORATION, LITTLETON, CO:
3,678,715, PUB. 6-23-2009. INT. CL. 7.

COMMUNITY PRESERVATION CORPORATION, THE, NEW YORK, NY:
2,303,897, REN. 8-5-09. INT. CL. 36.

COMPAGNIE GÉNÉRALE DE LOCATION D'EQUIPEMENTS, FRANCE:
3,679,949, PUB. 6-23-2009. MULTIPLE CLASS, INT. CLS. 35 AND 36.

COMPANY, STEVEN LEO, BOYNTON BEACH, FL:
3,681,347, MULTIPLE CLASS, INT. CLS. 30 AND 32.

COMPASS BANCSHARES, INC., BIRMINGHAM, AL:
3,678,609, PUB. 6-23-2009. INT. CL. 36.
3,680,414, INT. CL. 36.

COMPASS FILMS INTERNATIONAL, INC., MINNEAPOLIS, MN:
2,666,194, CANC. INT. CL. 9.

COMPETITOR GROUP, INC., SAN DIEGO, CA:
3,678,509, PUB. 6-23-2009. INT. CL. 41.

COMPREHENSIVE HEALTH SERVICES, INC., VIENNA, VA:
3,680,331, INT. CL. 44.

COMPREHENSIVE MANUFACTURING SERVICES, L.L.C., ST. LOUIS, MO:
681,350, REN. 8-1-09. U.S. CL. 12 (INT. CLS. 6, 17 AND 19).

COMPREHENSIVE MEDICAL ACCESS (CMA), INC., MIAMI, FL, DBA CENTROS MEDICOS LAS AMERICAS:
3,678,502, PUB. 6-23-2009. INT. CL. 44.

COMPUCOMPANY, INC., LINCOLNWOOD, IL:
2,667,138, CANC. INT. CL. 24.

COMPUTERIZED SECURITY SYSTEMS, INC., MADISON HEIGHTS, MI:
3,679,761, PUB. 6-23-2009. INT. CL. 9.

COMPUTIZE! CONSULTING, INC., BROOKLYN, NY:
3,681,069, INT. CL. 9.

CONAGRA FOODS LAMB WESTON, INC., OMAHA, NE:
1,551,147, REN. 8-6-09. INT. CL. 29.

CONAIR CORPORATION, STAMFORD, CT:
3,678,524, PUB. 11-25-2008. INT. CL. 11.
3,680,286, INT. CL. 20.

CONAVI BANCO COMERCIAL Y DE AHORROS S.A., MEDELLIN, COLOMBIA:
2,215,568, CANC. INT. CL. 36.

CONCEPT AND PRODUCT SOLUTIONS, INC., SANTA MONICA, CA:
2,666,061, CANC. INT. CL. 42.

CONCISE CONSULTANTS, LTD., NEW YORK, NY:
3,681,191, MULTIPLE CLASS, INT. CLS. 29 AND 30.
3,681,192, MULTIPLE CLASS, INT. CLS. 29 AND 30.

CONCORD MUSIC GROUP, INC., BEVERLY HILLS, CA, PARAMOUNT PICTURES CORPORATION, NEW YORK, NY:
868,197, REN. 8-5-09. U.S. CL. 36 (INT. CL. 9).

CONCORD MUSIC GROUP, INC., BERKELEY, CA, PARAMOUNT PICTURES CORPORATION, NEW YORK, NY:
868,198, REN. 8-6-09. U.S. CL. 36 (INT. CL. 9).

CONNELLAN GROUP, INC., THE, CHICAGO, IL:
1,112,483, REN. 7-31-09. INT. CL. 41.

- CONNOR SPORTS FLOORING CORPORATION, ARLINGTON HEIGHTS, IL:
2,667,162, CANC. INT. CL. 27.
- CONOCOPHILLIPS COMPANY, HOUSTON, TX:
2,215,282, CANC. INT. CL. 1.
- CONSERVATIVE CONCEPTS, LTD., PUYALLUP, WA:
2,214,873, CANC. INT. CL. 11.
- CONSOLIDATED NATURAL GAS COMPANY, PITTSBURGH, PA:
1,518,328, CANC. INT. CL. 39.
- CONSOLIDATED RUTILE LIMITED, MURARRIE QUEENSLAND, AUSTRALIA:
1,532,494, REN. 8-3-09, INT. CL. 1.
- CONSONA CRM INC., INDIANAPOLIS, IN:
2,665,054, CANC. INT. CL. 35.
- CONSORCIO COMERCIAL ZEPPELIN, S.A. DE C.V., NAVOLATO, MEXICO:
3,678,844, PUB. 3-17-2009, INT. CL. 33.
- CONSTRUCTION RESEARCH & TECHNOLOGY GMBH, TROSTBERG, FED REP GERMANY, MASTER BUILDERS COMPANY, THE, CLEVELAND, OH:
260,656, REN. 7-31-09, U.S. CL. 12 (INT. CLS. 6, 17 AND 19).
- CONSTRUCTION RESEARCH & TECHNOLOGY, GMBH, TROSTBERG, FED REP GERMANY:
3,679,145, PUB. 6-23-2009, INT. CL. 1.
- CONSULTING GROUP, INC., MALVERN, PA:
2,664,954, CANC. INT. CL. 36.
- CONSUMER CREDIT COUNSELING SERVICE OF VENTURA COUNTY, CAMARILLO, CA:
3,680,840, MULTIPLE CLASS, INT. CLS. 36 AND 41.
- CONSUMER OPINION CORP., BROOKLYN, NY:
3,679,454, PUB. 6-23-2009, INT. CL. 42.
- CONSUMER SALES NETWORK, INC., BLOOMINGTON, MN:
3,681,603, INT. CL. 7.
- CONTINENTAL COMMERCIAL PRODUCTS, BRIDGETON, MO, DBA CONTINENTAL:
3,681,262, INT. CL. 35.
3,681,263, INT. CL. 35.
- CONTINENTAL CONVEYOR & EQUIPMENT COMPANY, WINFIELD, AL:
2,263,463, REN. 7-31-09, INT. CL. 7.
- CONTINUOUS LEARNING GROUP, INC., CORAOPOLIS, PA:
3,680,592, INT. CL. 35.
- CONTINUUM WORLDWIDE CORPORATION, OMAHA, NE:
3,681,668, INT. CL. 41.
- CONTOUR HARDENING, INC., INDIANAPOLIS, IN:
3,680,094, INT. CL. 7.
- CONVENTION NEWS, INC., THE, MIDLAND PARK, NJ:
2,552,622, COR. INT. CL. 42.
- CONWAY STORES, INC., NEW YORK, NY:
3,680,517, INT. CL. 25.
- COOKING WITH CANCER, INC., VESTAVIA, AL:
3,679,532, PUB. 6-23-2009, INT. CL. 41.
3,679,757, PUB. 6-23-2009, MULTIPLE CLASS, INT. CLS. 41 AND 43.
- COOLEY GROUP HOLDINGS, INC., PAWTUCKET, RI:
3,681,142, INT. CL. 17.
- COOLSAVINGS, INC., CHICAGO, IL:
2,215,402, CANC. INT. CL. 35.
- COOPER IMPORTS, INC., TONAWANDA, NY:
2,665,394, CANC. INT. CL. 25.
- COOPER MARTIN, LLC, VAIL, CO:
3,680,563, INT. CL. 25.
- COOPER TECHNOLOGIES COMPANY, HOUSTON, TX:
3,678,652, PUB. 6-23-2009, INT. CL. 11.
- COOPER, EBONI S., NEW YORK, NY, DBA SUMMER COOPER COMPANY:
3,678,628, PUB. 6-23-2009, INT. CL. 25.
- COOPER, RICHARD P., BEND, OR:
3,680,424, INT. CL. 19.
- COOPERSVISION, INC., PLEASANTON, CA, OCULAR SCIENCES, INC., SOUTH SAN FRANCISCO, CA:
2,261,510, REN. 8-4-09, INT. CL. 9.
- COPELAN, JAMES B., SANTA CLARITA, CA:
2,665,437, CANC. INT. CL. 10.
- COPELAND, KRIS, JACKSONVILLE, FL:
3,588,137, CANC. INT. CL. 5.
- CORAL TRADEMARKS LIMITED, ST. HELIER JERSEY JE48SZ, CHANNEL ISLANDS:
2,665,758, CANC. INT. CL. 41.
- CORE GROUPE, LLC, MIAMI, FL:
3,681,606, INT. CL. 33.
- CORE INTELLECTUAL PROPERTIES HOLDINGS, LLC, GOODYEAR, AZ:
3,680,532, MULTIPLE CLASS, INT. CLS. 1, 3, 5, 31 AND 42.
- COREALCREDIT BANK AG, FED REP GERMANY:
3,679,890, PUB. 6-23-2009, MULTIPLE CLASS, INT. CLS. 35, 36 AND 38.
- CORINTH PIPEWORKS S.A., ATHENS, GREECE:
2,666,451, CANC. INT. CL. 6.
- CORLEY, CAROLE, GARDEN CITY, KS:
3,681,474, INT. CL. 18.
- CORNELL UNIVERSITY, ITHACA, NY:
3,679,046, PUB. 6-23-2009, INT. CL. 45.
3,679,047, PUB. 6-23-2009, INT. CL. 45.
- CORNELL, KEVIN R., RICHMOND, VA:
3,678,892, PUB. 6-23-2009, INT. CL. 41.
- CORNING CABLE SYSTEMS BRANDS, INC., WILMINGTON, DE, SIECOR BRANDS, INC., WILMINGTON, DE:
2,262,147, REN. 8-3-09, INT. CL. 9.
- CORNUCOPIA BEVERAGES, INC., BEDFORD, NH:
3,679,783, PUB. 6-23-2009, INT. CL. 16.
3,679,784, PUB. 6-23-2009, INT. CL. 9.
- CORPORATE ASSETS INC., TORONTO, ONTARIO, CANADA:
2,268,049, REN. 8-4-09, INT. CL. 35.
- CORPORATE COMPENSATION PLANS, INC., DANBURY, CT:
3,678,202, PUB. 6-23-2009, INT. CL. 36.
- CORPORATE RELOCATION SERVICES, INC., SPRINGFIELD, VA:
2,213,749, CANC. MULTIPLE CLASS, INT. CLS. 36, 39 AND 42.
- CORTEZ, ROBERT M., LUBBOCK, TX:
3,679,408, PUB. 6-23-2009, INT. CL. 25.
- CORVENTIS, INC., MENLO PARK, CA:
3,680,248, MULTIPLE CLASS, INT. CLS. 9, 10, 42 AND 44.
- COSEN MACHINERY INDUSTRIAL CO., LTD., HSINCHU CITY 300, TAIWAN:
3,678,936, PUB. 6-23-2009, INT. CL. 7.
- COSMED GROUP, INC., JAMESTOWN, RI:
3,680,739, INT. CL. 40.
- COSMETIC DERMATOLOGY, INC., MIAMI, FL:
3,681,438, INT. CL. 3.
- COULTER ROBERT W., NEW YORK, NY:
3,680,311, INT. CL. 9.
- COUNCIL FOR AFFORDABLE QUALITY HEALTHCARE, INC., WASHINGTON, DC:
3,680,818, INT. CL. 35.
- COUNTERBALANCE FOUNDATION, SEATTLE, WA:
2,215,522, CANC. INT. CL. 42.
- COUNTRY COACH LLC, JUNCTION CITY, OR:
3,680,962, INT. CL. 12.
- COUNTRY KITCHENWARE SUPPLIES LIMITED, UNITED KINGDOM:
3,679,938, PUB. 6-23-2009, MULTIPLE CLASS, INT. CLS. 8, 9, 21 AND 35.
- COUNTRYMARK COOPERATIVE, LLP, INDIANAPOLIS, IN, DBA COUNTRYMARK COOPERATIVE:
3,680,290, MULTIPLE CLASS, INT. CLS. 4, 25, 35, 36, 39 AND 40.
- COUNTY OF LOS ANGELES SHERIFF'S DEPARTMENT, MONTEREY PARK, CA:
2,257,895, REN. 8-1-09, INT. CL. 41.
- COUPONS, LLC, ATLANTA, GA:
3,679,548, PUB. 6-23-2009, INT. CL. 35.
- COURTNEY SLOANE DESIGNS, LLC, NEW YORK, NY:
3,678,422, PUB. 6-23-2009, INT. CL. 42.

COVARRUBIAS, MANUEL CONTRERAS, GUADALAJARA, JALISCO, MEXICO:
3,681,102, MULTIPLE CLASS, INT. CLS. 9 AND 41.

COVENANT RELIANCE PRODUCERS, LLC, NASHVILLE, TN:
3,680,974, INT. CL. 41.

COVERAGEEXPRESS, LLC, FRISCO, TX:
2,666,421, CANC. INT. CL. 36.

COVIDIEN AG, NEUHAUSEN AM RHEINFALL, SWITZERLAND:
1,548,995, REN. 8-3-09, INT. CL. 9.
3,679,078, PUB. 6-23-2009, INT. CL. 36.
3,679,086, PUB. 6-23-2009, INT. CL. 36.

COWLES BUSINESS MEDIA, INC., STAMFORD, CT:
1,517,927, CANC. INT. CL. 16.

COX AUTO TRADER, INC., ATLANTA, GA:
2,664,935, CANC. INT. CL. 35.

COX HOLDINGS, INC., ATLANTA, GA:
2,215,371, CANC. INT. CL. 41.

COZZINI, INC., CHICAGO, IL:
3,678,546, PUB. 6-23-2009, INT. CL. 7.

CQG, INC., DENVER, CO:
3,679,842, PUB. 12-26-2006, INT. CL. 36.

CRACO MANUFACTURING INC., YORK, SC:
3,679,602, PUB. 6-23-2009, INT. CL. 6.

CRAFTMADE INTERNATIONAL, INC., COPPELL, TX:
2,667,262, CANC. INT. CL. 11.

CRANE COMPOSITES, INCORPORATED, CHANNAHON, IL:
2,249,235, REN. 8-4-09, INT. CL. 19.

CRE BOCA OPCO, LLC, NEW YORK, NY:
3,681,061, INT. CL. 36.

CREANOVA INC., SOMERSET, NJ:
2,665,773, CANC. INT. CL. 2.

CREATIVE BEDDING TECHNOLOGIES, INC., CRYSTAL, IL:
2,214,987, CANC. INT. CL. 10.

CREATIVE MERCHANDISING CONCEPTS, INC., MISSISSAUGA, CANADA:
3,680,306, INT. CL. 9.

CREDIT AMERICA USED CAR CENTER, MOBILE, AL:
2,214,015, CANC. INT. CL. 35.

CREDIT FORGET IT, INC., NEW YORK, NY:
3,679,033, PUB. 6-23-2009, INT. CL. 36.

CREEK RATZ, INC., MURRELLS INLET, SC:
2,665,298, CANC. INT. CL. 42.

CRESCENT METAL PRODUCTS, INC., MENTOR, OH:
2,213,598, CANC. MULTIPLE CLASS, INT. CLS. 6, 11, 12, 20 AND 21.

CRESTWOOD TECHNOLOGY GROUP, YONKERS, NY:
3,678,354, PUB. 6-23-2009, MULTIPLE CLASS, INT. CLS. 35 AND 39.

CRF BOX OY, FIN-00120 HELSINKI, FINLAND:
2,665,598, CANC. INT. CL. 38.

CRIMSON CIRCLE IP, INC., GOLDEN, CO:
3,680,702, U.S. CL. 200.
3,680,705, U.S. CL. 200.

CRISPIN CIDER COMPANY, MINNEAPOLIS, MN:
3,681,779, MULTIPLE CLASS, INT. CLS. 32 AND 33.

CRISTAL CERAMICAS, S.A., ONDA (CASTELLON), SPAIN:
2,666,526, CANC. INT. CL. 19.

CRITICAL SIGNAL TECHNOLOGIES, FARMINGTON HILLS, MI:
3,514,695, AM. INT. CL. 44.

CROESUS TRADE CO., KAOHSIUNG CITY, TAIWAN:
2,292,077, REN. 8-1-09, INT. CL. 5.
2,305,286, REN. 8-1-09, INT. CL. 5.

CROMWELL CORPORATION, BILLINGS, MT:
3,679,280, PUB. 6-23-2009, MULTIPLE CLASS, INT. CLS. 35 AND 43.

CROP TECH SERVICES, INC., CEDAR RAPIDS, IA:
2,275,292, REN. 8-3-09, INT. CL. 35.

CROSBY GROUP, INC., THE, TULSA, OK:
683,522, REN. 8-5-09, U.S. CL. 13 (INT. CLS. 6, 7, 11, 17, 20 AND 21).

CROSS FARMS, INC., WILMINGTON, DE:
3,681,528, INT. CL. 34.

CROSS POINT INDUSTRIES, INC., ENCINITAS, CA:
3,681,787, INT. CL. 9.

CRS HOLDINGS, INC., WILMINGTON, DE, CARPENTER STEEL COMPANY, THE, READING, PA:
512,195, REN. 8-4-09, U.S. CL. 14 (INT. CL. 6).

CRUIZIN, INC., HARTLAND, WI:
3,680,744, INT. CL. 42.

CRUTCHFIELD, RADFORD DANIEL, SR., JAYESS, MS AND CRUTCHFIELD, ELLEN K., JAYESS, MS:
2,666,608, CANC. INT. CL. 42.

CRYTUR, SPOL.S R.O., CZECH REPUBLIC:
3,679,859, PUB. 6-23-2009, MULTIPLE CLASS, INT. CLS. 1 AND 9.

CSE ASSOCIATES, WINDSOR, CA:
3,680,285, INT. CL. 16.

CSK HOLDINGS LLC, PEACHTREE CITY, GA:
3,679,356, PUB. 6-23-2009, INT. CL. 28.

CSL BEHRING L.L.C., KING OF PRUSSIA, PA:
3,680,246, MULTIPLE CLASS, INT. CLS. 35, 41 AND 44.

CSX IP, INC., RICHMOND, VA:
2,665,595, CANC. INT. CL. 35.
2,665,619, CANC. INT. CL. 35.

CTI INDUSTRIES INC., BOCA RATON, FL:
2,666,029, CANC. INT. CL. 34.

CUATRO DIRECCIONES, S.A., GUATEMALA CITY, GUATEMALA:
2,215,587, CANC. INT. CL. 42.

CUBAN CIGAR BRANDS, N.V., FORT LAUDERDALE, FL:
3,679,724, PUB. 6-23-2009, MULTIPLE CLASS, INT. CLS. 34 AND 41.
3,681,480, INT. CL. 34.

CUISINE SOLUTIONS, INC., ALEXANDRIA, VA:
3,681,283, MULTIPLE CLASS, INT. CLS. 29 AND 30.

CUMMINS INTELLECTUAL PROPERTY, INC., COLUMBUS, IN:
3,680,865, INT. CL. 1.

CUNDIFF, JEREMIAH JAMES, QUEEN CREEK, AZ, DBA MONUMENT COACHING AND KRISTI CUNDIFF, QUEEN CREEK, AZ, DBA MONUMENT COACHING:
3,678,993, PUB. 6-23-2009, INT. CL. 41.

CUPID FOUNDATIONS, INC., NEW YORK, NY:
3,680,552, INT. CL. 25.
3,680,633, INT. CL. 25.

CURB YOUR CRAVINGS, LLC, BELLMORE, NY:
3,678,684, PUB. 6-23-2009, INT. CL. 35.

CURLYCUE DESIGNS, NORTH SALEM, NY:
3,678,857, PUB. 6-23-2009, MULTIPLE CLASS, INT. CLS. 16 AND 42.

CURRENT MEDIA, LLC, SAN FRANCISCO, CA:
3,678,149, PUB. 3-17-2009, INT. CL. 38.

CURTIS PACKING COMPANY, GREENSBORO, NC:
1,543,760, REN. 8-5-09, INT. CL. 29.

CURTIS STONE, LONDON, UNITED KINGDOM:
3,680,181, INT. CL. 8.

CUSHMAN AND MARDEN, INC., PEABODY, MA:
2,214,184, CANC. INT. CL. 24.

CUSTOM AXIS, INC., LODI, CA:
2,665,081, CANC. INT. CL. 12.

CUSTOM BUILDING PRODUCTS, INC., SEAL BEACH, CA:
1,604,678, REN. 8-4-09, INT. CL. 19.

CUSTOM CUTS, INC., MILWAUKEE, WI:
1,576,669, REN. 8-3-09, INT. CL. 31.

CUSTOM PHOTO ART, INC., BIRMINGHAM, AL:
2,667,362, CANC. INT. CL. 35.

CUSTOM PRESSED, LLC, LOS FELIX, CA:
3,680,358, MULTIPLE CLASS, INT. CLS. 16 AND 35.

CUSTOM VALUE SERVICES, LLC, MAPLEWOOD, MN, DBA LONE OAK IRRIGATION:
3,679,348, PUB. 6-23-2009, INT. CL. 37.

CUT AND RUN PRODUCTIONS LIMITED, HANWELL, LONDON W7 3UP, ENGLAND:
2,665,493, CANC. INT. CL. 28.

CUTTING EDGE FITNESS OF BOCA RATON, LLC, BOCA RATON, FL:
3,678,705, PUB. 6-23-2009, INT. CL. 41.

CVN COMPANIES, INC., WEST CHESTER, PA:
1,518,443, CANC. INT. CL. 42.

- CYCLEUROPE AB, 432 82 VARBERG, SWEDEN:
2,665,676, CANC. MULTIPLE CLASS, INT. CLS. 9, 25 AND 28.
- CYCLONE RANGE HOODS INC., LONG ISLAND CITY, NY:
3,680,723, INT. CL. 11.
- CYMCORP INTERNATIONAL INC., KIRKLAND, CANADA:
3,681,483, INT. CL. 5.
- CYMETRIX CORPORATION, IRVINE, CA:
3,678,287, PUB. 6-23-2009. MULTIPLE CLASS, INT. CLS. 35, 36 AND 42.
- CYNTHIA ALEXANDER, LLC, WILTON, CT:
3,678,304, PUB. 6-23-2009. INT. CL. 20.
- CYPRESS COMMUNICATIONS, INC., ATLANTA, GA:
3,678,305, PUB. 6-23-2009. INT. CL. 38.
- CYTEC TECHNOLOGY CORP., WILMINGTON, DE:
1,594,222, REN. 7-31-09. INT. CL. 17.
- CYTH SYSTEMS, LLC, SAN DIEGO, CA:
3,680,626, INT. CL. 42.
- CZAUS, STEPHEN, SIGNAL HILL, CA:
3,681,260, INT. CL. 9.
- CZECH, DAVID, LUCERNE VALLEY, CA AND OLSEN, CHRIS, LUCERNE VALLEY, CA AND WEATHFORD, LAUREN, LUCERNE VALLEY, CA AND MARSHALL, JORDEN, LUCERNE VALLEY, CA:
3,678,731, PUB. 6-23-2009. INT. CL. 41.
- C10, INC., MILL VALLEY, CA:
3,680,378, INT. CL. 35.
3,681,197, INT. CL. 41.
3,681,198, INT. CL. 35.
- C4MEDIA INC., TORONTO, ONTARIO:
3,680,549, MULTIPLE CLASS, INT. CLS. 9, 35, 38 AND 42.
- D & D ICS GROUP INC., WOODSTOCK, ONTARIO, CANADA:
1,518,327, CANC. INT. CL. 39.
- D.B.R., INC., SUFFERN, NY:
3,681,422, MULTIPLE CLASS, INT. CLS. 25 AND 35.
- D.C. ENTERPRIZES, INC., BURLINGTON, VT:
3,679,170, PUB. 6-23-2009. INT. CL. 30.
- D.C. PRODUCTION CORP., NEW YORK, NY:
1,518,498, CANC. INT. CL. 42.
- D.O.G. INC., LONG BEACH, CA, DBA BIRMINGHAM CONSULTING:
3,680,824, INT. CL. 41.
- D&K CUSTOM MACHINE DESIGN, INC., ELK GROVE VILLAGE, IL:
1,604,364, REN. 8-3-09. INT. CL. 7.
- D&N IPROPERTIES LLC, ALTAMONTE SPRINGS, FL:
3,681,767, INT. CL. 35.
- D-GENERATION, INC., ORMOND BEACH, FL:
2,666,824, CANC. MULTIPLE CLASS, INT. CLS. 9, 21, 30, 36 AND 38.
- D'ARENBERG PTY LTD, AUSTRALIA:
3,680,048, PUB. 6-23-2009. INT. CL. 33.
- D'ARRIGO BROS. CO. OF CALIFORNIA, SALINAS, CA:
1,518,191, CANC. INT. CL. 31.
- DÖHLER S/A, JOINVILLE, SANTA CATARINA, BRAZIL:
3,679,799, PUB. 3-17-2009. MULTIPLE CLASS, INT. CLS. 24 AND 25.
- DAF, INC., SPARTANBURG, SC, DBA J.P. CARLTON COMPANY:
2,294,097, REN. 8-5-09. INT. CL. 7.
- DAHAN, PHILLIP E., M.D., RENO, NV, DBA ADVANCED AESTHETIC PLASTIC SURGERY, LTD:
3,678,629, PUB. 6-23-2009. INT. CL. 44.
- DAHLIN, CRAIG STEVEN, HUACHUCA CITY, AZ:
3,680,353, INT. CL. 28.
- DAIMLER AG, STUTTGART, FED REP GERMANY:
3,678,849, PUB. 6-23-2009. INT. CL. 12.
3,678,871, PUB. 6-23-2009. INT. CL. 12.
3,678,879, PUB. 6-23-2009. INT. CL. 12.
- DAIRY AUSTRALIA LIMITED, AUSTRALIA:
3,680,020, PUB. 6-23-2009. MULTIPLE CLASS, INT. CLS. 16, 25, 29, 30, 35 AND 41.
- DAIRY FARMERS OF AMERICA, INC., KANSAS CITY, MO:
3,678,778, PUB. 2-3-2009. INT. CL. 29.
- DAIWA SEIKO, INC., TOKYO, JAPAN:
3,680,547, INT. CL. 28.
- DAKOTA MOON, INC., PALM SPRINGS, CA:
2,666,423, CANC. INT. CL. 41.
- DALLAS CUP, INC., DALLAS, TX:
2,260,044, REN. 8-3-09. MULTIPLE CLASS, INT. CLS. 16 AND 41.
- DAMIRUS CORPORATION, THE, BURLINGTON, MA:
1,517,828, CANC. INT. CL. 9.
- DAN-MAR MFG., CO. INC., OWINGS MILLS, MD:
3,681,425, INT. CL. 25.
- DANDRIDGE, EDWARD LEE, NEW YORK, NY:
2,666,884, CANC. MULTIPLE CLASS, INT. CLS. 9, 35, 38 AND 41.
- DANESI CAFFE', S.P.A., ROME, ITALY:
1,518,186, CANC. INT. CL. 30.
- DANFOSS A/S, NORDBORG, DENMARK:
3,631,442, COR. MULTIPLE CLASS, INT. CLS. 7, 9 AND 17.
- DANIEL BAUM COMPANY, LANCASTER, PA:
3,680,120, INT. CL. 5.
- DANIEL INDUSTRIES, INC., HOUSTON, TX:
872,428, REN. 8-3-09. MULTIPLE CLASS, U.S. CLS. 13 (INT. CL. 6) AND 26 (INT. CL. 9).
- DANIEL VERROCHI, CANTON, MA:
3,680,269, INT. CL. 25.
- DANSK ETERNIT HOLDING A/S, DENMARK:
3,679,960, PUB. 6-23-2009. MULTIPLE CLASS, INT. CLS. 19 AND 37.
- DAOU, SASSINE SASSOON, RIDGEFIELD PARK, NJ:
2,667,196, CANC. INT. CL. 3.
- DAOU, SASSINE SASSOON, RIDGEFIELD PARK, NJ:
2,667,203, CANC. INT. CL. 3.
- DAOU, SASSINE SASSOON, RIDGEFIELD PARK, NJ:
2,667,214, CANC. INT. CL. 3.
- DARE COUNTY TOURISM BOARD, MANTEO, NC, DBA OUTER BANKS TRAVEL BUREAU:
3,678,674, PUB. 6-23-2009. INT. CL. 35.
3,678,723, PUB. 6-23-2009. INT. CL. 35.
- DATA EXCHANGE CORPORATION, CAMARILLO, CA:
2,266,257, REN. 7-31-09. INT. CL. 37.
- DATA SYSTEMS INTERNATIONAL, INC., OVERLAND PARK, KS:
3,678,152, PUB. 6-23-2009. MULTIPLE CLASS, INT. CLS. 35 AND 42.
- DATACOLOR HOLDING AG, LUZERN, SWITZERLAND:
2,665,871, CANC. INT. CL. 9.
- DATALIGN INC., HOUSTON, TX:
2,666,912, CANC. INT. CL. 35.
- DAUBERT CROMWELL, LLC, ALSIP, IL:
3,681,026, INT. CL. 16.
- DAVID C. COOK PUBLISHING CO. DAYSRING CARDS DIVISION, SILOAM SPRINGS, AR:
2,214,640, CANC. INT. CL. 16.
- DAVID MICHAEL AMON AND MAVIS LORRAINE AMON, DUNCAN, BRITISH COLUMBIA, CANADA:
2,665,867, CANC. INT. CL. 25.
- DAVID PUTTERMAN, MONTREAL, CANADA:
3,678,447, PUB. 6-23-2009. INT. CL. 10.
- DAVID WU INVESTMENTS, INC., TAMPA, FL:
3,680,873, INT. CL. 43.
- DAVINCI INSURANCE SERVICES, INC., WOODSTOCK, GA:
3,679,127, PUB. 6-23-2009. INT. CL. 36.
- DAVIS, PETER, SAN DIEGO, CA, DBA INTERNATIONAL DANCE-EXERCISE ASSOCIATION:
1,517,917, CANC. INT. CL. 16.
- DAWNBREAKER, INC., ROCHESTER, NY:
3,681,184, MULTIPLE CLASS, INT. CLS. 35 AND 42.
- DAYCATCH A/S, 9500 HOBRO, DENMARK:
3,678,718, PUB. 6-23-2009. INT. CL. 29.
- DAYTON SUPERIOR CORPORATION, DAYTON, OH:
3,681,671, MULTIPLE CLASS, INT. CLS. 1 AND 2.
- DB AVIATION, INC., WAUKEGAN, IL:
3,679,394, PUB. 6-23-2009. MULTIPLE CLASS, INT. CLS. 39 AND 45.

DC COMICS, NEW YORK, NY:
2,667,302, CANC. INT. CL. 16.
3,680,537, INT. CL. 9.
3,680,538, INT. CL. 25.
3,680,539, INT. CL. 28.

DCI MARKETING, INC., MILWAUKEE, WI:
3,680,994, INT. CL. 20.

DDS DISCOUNT DUMPSTER SERVICES, LLC, PHOENIX, AZ:
2,665,279, CANC. INT. CL. 42.

DE LA SIMONE SANDRINE, BL 2-4; F-75020 PARIS, FRANCE:
3,679,888, PUB. 6-23-2009. INT. CL. 18.

DE NEEF CONSTRUCTION CHEMICALS, INC., HOUSTON, TX:
2,313,674, CANC. INT. CL. 42.

DEALSPIN, INC., NEW YORK, NY:
2,666,956, CANC. INT. CL. 35.

DEALTEK, LTD., LOS ALTOS, CA:
2,748,337, CANC. INT. CL. 35.

DEBARTOLO, H.M. JR.M.D.,S.C., SUGAR GROVE, IL:
3,680,119, INT. CL. 44.

DEBENEDETTI, STEPHEN, BOISE, ID:
3,681,140, MULTIPLE CLASS, INT. CLS. 35 AND 37.

DEBENEDETTO FRUIT CO., LLC, FRESNO, CA:
3,679,677, PUB. 6-23-2009. INT. CL. 31.

DEBOER, WILLIAM D, SANDOVAL, IL, DBA LWB ENTERPRISES:
3,679,533, PUB. 6-23-2009. U.S. CL. 200.

DEBT MEDIATION SERVICES, INC., UPLAND, CA:
2,666,142, CANC. INT. CL. 36.

DECIDIA, INC., NEW YORK, NY:
2,667,277, CANC. INT. CL. 42.

DECISIONSTEP, INC., BELTSVILLE, MD:
3,680,727, INT. CL. 42.

DECKER, ALAN R., HOUSTON, TX:
2,666,218, CANC. INT. CL. 37.

DECKER, ROBERT J., CHARLOTTESVILLE, VA:
3,680,069, MULTIPLE CLASS, INT. CLS. 16 AND 25.

DECOLETAJE Y TORNILLERIA, S.A., BANYOLES (GERONA), SPAIN:
3,679,637, PUB. 6-23-2009. INT. CL. 6.

DECORE-ATIVE SPECIALTIES, INC., MONROVIA, CA:
3,678,210, PUB. 6-23-2009. INT. CL. 20.

DEEPPBREEZE LTD., OR AKIVA, ISRAEL:
3,678,945, PUB. 6-23-2009. INT. CL. 10.
3,678,946, PUB. 6-23-2009. INT. CL. 10.

DEEPTONE, INC., DENVER, CO:
2,266,270, REN. 8-1-09. INT. CL. 41.

DEFENSE GROUP INCORPORATED, FALLS CHURCH, VA:
2,666,775, CANC. MULTIPLE CLASS, INT. CLS. 35 AND 42.

DEFFENBAUGH INDUSTRIES, INC., KANSAS CITY, KS:
3,681,051, MULTIPLE CLASS, INT. CLS. 39 AND 40.

DEFINED FITNESS, INC., ALBUQUERQUE, NM:
3,679,471, PUB. 6-23-2009. INT. CL. 41.

DEFRAN SYSTEMS, INC., NEW YORK, NY:
1,517,868, CANC. INT. CL. 9.

DEGUDENT GMBH, FED REP GERMANY:
3,679,935, PUB. 6-23-2009. MULTIPLE CLASS, INT. CLS. 5, 9 AND 10.

DEHN, MICHAEL, STREAMWOOD, IL:
3,680,439, INT. CL. 41.

DEIDOX, LLC, PASADENA, CA:
3,681,254, INT. CL. 9.

DEL CONTE, DAVID C., CAPISTRANO BEACH, CA:
3,678,352, PUB. 6-23-2009. INT. CL. 41.

DEL MONTE CORPORATION, SAN FRANCISCO, CA:
3,681,547, INT. CL. 31.

DELAVAL TURBINE, INC., PRINCETON, NJ TO IMO INDUSTRIES INC., LAWRENCEVILLE, NJ:
1,111,207, AM. INT. CL. 7.

DELAWARE CAPITAL FORMATION, INC., WILMINGTON, DE:
1,557,637, REN. 8-3-09. INT. CL. 7.
3,681,129, INT. CL. 7.

DELAWARE COUNTY MEMORIAL HOSPITAL, MANCHESTER, IA, DBA REGIONAL MEDICAL CENTER:
3,679,011, PUB. 6-23-2009. INT. CL. 44.

DELAWARE TECHNOLOGY PARK, INC., NEWARK, DE:
2,665,560, CANC. INT. CL. 41.

DELTA CARBONA, L.P., FAIRFIELD, NJ:
3,681,161, INT. CL. 1.

DELTA DENTAL PLAN OF ARIZONA INC., PHOENIX, AZ:
2,215,373, CANC. INT. CL. 41.

DELTARAIL GROUP LTD, DERBY, UNITED KINGDOM:
2,665,624, CANC. INT. CL. 9.
2,665,625, CANC. INT. CL. 9.

DELTASOLUTIONS S.R.L., I-42100 REGGIO EMILIA, ITALY:
3,679,991, PUB. 6-23-2009. INT. CL. 7.

DELUXE LABORATORIES, INC., HOLLYWOOD, CA:
3,678,250, PUB. 6-23-2009. INT. CL. 39.
3,678,251, PUB. 6-23-2009. INT. CL. 39.
3,678,252, PUB. 6-23-2009. INT. CL. 42.

DEMARAY, LINDA, ARVADA, CO:
2,747,911, CANC. MULTIPLE CLASS, INT. CLS. 35 AND 41.

DEMBE, ELAINE, TORONTO, ONTARIO, CANADA:
2,666,716, CANC. MULTIPLE CLASS, INT. CLS. 9, 16 AND 41.

DEMERT BRANDS, INC., LUTZ, FL:
2,246,975, REN. 8-4-09. INT. CL. 3.

DEMETER F.L. INC., GREAT NECK, NY:
3,681,770, INT. CL. 3.

DEMONOS CAR CLUB, TACOMA, WA:
3,679,154, PUB. 6-23-2009. U.S. CL. 200.

DENEL (PROPRIETARY) LIMITED, ERASMUSKLOOF, PRETORIA, GAUTENA, SOUTH AFRICA:
2,664,936, CANC. INT. CL. 7.

DENISE E. VARNER, PLYMOUTH, MI:
3,680,982, INT. CL. 28.

DENNIS, FELIX, LONDON, UNITED KINGDOM:
3,680,810, INT. CL. 9.

DENNISON, JUDY, BRYAN, MD:
2,214,427, CANC. INT. CL. 41.

DENTAURUM J. P. WINKELSTROETER KG, ISPRINGEN, FED REP GERMANY:
1,517,878, CANC. INT. CL. 10.

DENTSPLY INTERNATIONAL INC., YORK, PA:
374,045, REN. 8-3-09. U.S. CL. 44 (INT. CL. 10).
515,900, REN. 8-3-09. U.S. CL. 44 (INT. CL. 10).
2,299,871, REN. 8-3-09. INT. CL. 5.

DENVER HOTEL TEATRO, LLC, DENVER, CO:
3,678,590, PUB. 6-23-2009. INT. CL. 39.

DEPARTMENT OF EXPORT PROMOTION OF THE MINISTRY OF COMMERCE, ROYAL THAI GOVERNMENT, AN AGENCY OF THE KINGDOM OF THAILAND, NEW YORK, NY:
3,678,539, PUB. 6-23-2009. U.S. CL. B.
3,678,540, PUB. 6-23-2009. U.S. CL. B.

DEPARTMENT OF TECHNICAL AND ADULT EDUCATION, ATLANTA, GA:
2,740,094, COR. INT. CL. 41.

DEPUY, INC., WARSAW, IN:
3,680,602, INT. CL. 10.

DERMA HAIR CARE, LLC, BOYDS, MD:
3,678,457, PUB. 6-23-2009. INT. CL. 3.

DESALT, INC., SANTA CLARA, CA:
2,666,564, CANC. MULTIPLE CLASS, INT. CLS. 36, 37 AND 42.

DESCO VON SCHULTHESS AG, ZURICH, SWITZERLAND:
2,665,251, CANC. INT. CL. 14.
2,665,252, CANC. INT. CL. 14.
2,665,253, CANC. INT. CL. 14.

DESIGN BY NUI, LOS ANGELES, CA:
3,679,648, PUB. 6-23-2009. INT. CL. 25.

DESIGN CENTER SOLUTIONS, INC., MILL VALLEY, CA:
2,665,496, CANC. INT. CL. 35.

DESIGN NINE, INC., BLACKSBURG, VA:
3,678,866, PUB. 6-23-2009. INT. CL. 42.

DETROIT SAUSAGE COMPANY, INC., DETROIT, MI:
2,216,895, REN. 8-1-09. INT. CL. 29.

- DEUK COMPANY, CAMBRIDGE, MA:
2,666,510, CANC. MULTIPLE CLASS, INT. CLS. 35, 36, 41 AND 42.
- DEUTECHE BANK, AG, NEW YORK BRANCH, NEW YORK, NY:
2,665,824, CANC. MULTIPLE CLASS, INT. CLS. 35 AND 42.
- DEUTSCHE BANK AKTIENGESELLSCHAFT, FRANKFURT AM MAIN, FED REP GERMANY:
3,680,704, INT. CL. 36.
- DEUTSCHE TELEKOM, BONN, FED REP GERMANY:
3,678,425, PUB. 4-14-2009. INT. CL. 38.
3,678,426, PUB. 4-14-2009. INT. CL. 42.
3,678,492, PUB. 4-7-2009. INT. CL. 9.
3,678,493, PUB. 4-14-2009. INT. CL. 38.
- DEUTSCHE TELEKOM AG, BONN, FED REP GERMANY:
3,678,356, PUB. 3-17-2009. INT. CL. 9.
- DEUTZ AKTIENGESELLSCHAFT, KOELN, FED REP GERMANY:
3,680,202, MULTIPLE CLASS, INT. CLS. 7, 9 AND 12.
- DEVOTION, INC., HEALDSBURG, CA:
2,665,533, CANC. INT. CL. 35.
- DEWOOLFSON DOWN INTERNATIONAL, INC., BANNER ELK, NC:
2,666,161, CANC. INT. CL. 35.
- DEXADINE, INC., SHAKOPEE, MN:
2,667,189, CANC. INT. CL. 9.
- DEXTER-RUSSELL, INC., SOUTHBRIDGE, MA:
3,681,177, INT. CL. 21.
- DHARMA SINGH KHALSA, M.D., TUCSON, AZ:
3,678,334, PUB. 6-23-2009. MULTIPLE CLASS, INT. CLS. 5, 16, 41 AND 44.
- DH2 INTERNATIONAL, INC., ORLANDO, FL:
3,681,119, INT. CL. 16.
- DIAGEO CHATEAU & ESTATE WINES COMPANY, NAPA, CA:
3,680,478, INT. CL. 33.
- DIAMAX INDUSTRIES, INC., ATLANTA, GA, DBA DIAMAX:
3,678,676, PUB. 6-23-2009. MULTIPLE CLASS, INT. CLS. 7 AND 8.
- DIAMOND M. LLC, BETHEL, CT:
2,665,645, CANC. MULTIPLE CLASS, INT. CLS. 41 AND 42.
- DIAMOND RESORTS HOLDINGS, LAS VEGAS, NV:
3,681,417, INT. CL. 36.
- DIAMOND TWINS CORPORATION, LAWRENCE, NY:
3,680,380, INT. CL. 14.
- DIEBOLD, INCORPORATED, NORTH CANTON, OH:
3,681,344, INT. CL. 9.
- DIET BLAST, INC., BOWLING GREEN, KY:
2,666,104, CANC. INT. CL. 5.
- DIGI INTERNATIONAL INC., MINNETONKA, MN:
3,681,108, INT. CL. 9.
- DIGI-KEY CORPORATION, THIEF RIVER FALLS, MN:
3,681,175, INT. CL. 35.
3,681,176, INT. CL. 35.
- DIGIBLINK, INC., WINSTON-SALEM, NC:
2,666,540, CANC. INT. CL. 42.
- DIGITAL ATOMS, INC., CLEVELAND, OH:
2,665,404, CANC. MULTIPLE CLASS, INT. CLS. 9 AND 35.
- DIGITAL CONTRACTS, INC., ROSWELL, GA:
2,667,392, CANC. INT. CL. 42.
- DIGITAL CONTROL INCORPORATED, KENT, WA:
3,681,331, INT. CL. 9.
- DIGITAL EDUCATION CORPORATION, HUNTSVILLE, AL:
2,665,877, CANC. INT. CL. 41.
- DIGITAL FAIRWAY CORPORATION, TORONTO, ONTARIO, CANADA:
3,680,966, MULTIPLE CLASS, INT. CLS. 9 AND 42.
- DIGITAL GARDEN GMBH & CO. KG, D-52070 AACHEN, FED REP GERMANY:
2,665,141, CANC. INT. CL. 42.
- DIGITAL IMAGE LTD, BINGLEY, UNITED KINGDOM, FORMERLY DIGITAL IMAGE LLP:
3,678,878, PUB. 6-23-2009. INT. CL. 9.
- DIGITAL RAPIDS CORPORATION, MARKHAM, CANADA:
3,681,048, INT. CL. 9.
- DIGITAL SITE SYSTEMS, INC., PITTSBURGH, PA:
2,301,907, REN. 7-31-09. INT. CL. 9.
- DILECTICA CONSULTING, INC., PIPERSVILLE, PA:
2,667,072, CANC. INT. CL. 35.
- DILLARD'S INC., LITTLE ROCK, AR:
2,739,668, CANC. MULTIPLE CLASS, INT. CLS. 11, 16, 20 AND 24.
- DILLON SUNGLASS COMPANY, SCOTTSDALE, AZ:
3,680,805, INT. CL. 9.
- DIMARZIO, INC., STATEN ISLAND, NY:
1,135,012, REN. 7-31-09. INT. CL. 9.
- DIRECT SUPPLY, INC., MILWAUKEE, WI:
2,665,476, CANC. INT. CL. 35.
- DIRECTV, INC., EL SEGUNDO, CA:
2,666,279, CANC. INT. CL. 38.
3,681,589, INT. CL. 41.
- DISCOVERY GREEN CONSERVANCY, HOUSTON, TX:
3,680,141, INT. CL. 41.
- DISCUS DENTAL, LLC, CULVER CITY, CA:
2,743,139, CANC. INT. CL. 5.
- DISNEY ENTERPRISES, INC., BURBANK, CA:
3,628,708, AM. INT. CL. 25.
3,678,843, PUB. 6-23-2009. INT. CL. 39.
3,680,116, MULTIPLE CLASS, INT. CLS. 38, 41 AND 42.
3,681,435, INT. CL. 25.
3,681,439, INT. CL. 16.
3,681,440, INT. CL. 18.
- DISPLAY COMPONENTS INCORPORATED, WESTFORD, MA:
1,517,810, CANC. INT. CL. 9.
- DISTASIO, ANTHONY, SAN ANTONIO, TX:
2,666,034, CANC. INT. CL. 41.
- DISTRIBUTION SHOE TRANSIT, S.L., 28019 MADRID, SPAIN:
2,215,177, CANC. INT. CL. 25.
- DISTRICT BOARD OF TRUSTEES OF MIAMI-DADE COMMUNITY COLLEGE, THE, MIAMI, FL:
2,666,685, CANC. MULTIPLE CLASS, INT. CLS. 20, 21, 25, 28 AND 35.
- DIVERSITY INVESTMENTS, INC., FREEDOM, WI, DBA VALENTINE PLUMBING & HEATING, INC.:
3,679,530, PUB. 6-23-2009. INT. CL. 37.
- DIVINE MOVING & STORAGE LTD, NEW YORK, NY:
3,678,507, PUB. 6-23-2009. MULTIPLE CLASS, INT. CLS. 35 AND 39.
- DIXON, DUANE A., DULUTH, GA:
3,678,732, PUB. 6-23-2009. INT. CL. 16.
- DMG DESIGN LOUNGE, LLC, THORNTON, CO:
3,678,665, PUB. 6-23-2009. INT. CL. 25.
- DMSO MARKETING, INC., RANCHO PALOS VERDES, CA:
2,264,485, REN. 8-5-09. INT. CL. 1.
- DOC INTERNATIONAL, INC., SOMERSET, NJ:
3,679,068, PUB. 6-23-2009. MULTIPLE CLASS, INT. CLS. 35, 39, 41 AND 43.
- DOCTOR'S ASSOCIATES INC., PLANTATION, FL:
3,678,989, PUB. 6-23-2009. INT. CL. 43.
3,679,096, PUB. 6-23-2009. INT. CL. 43.
3,679,100, PUB. 6-23-2009. INT. CL. 43.
- DOCUDATA SOLUTIONS, L.L.C., DALLAS, TX:
3,678,161, PUB. 6-23-2009. MULTIPLE CLASS, INT. CLS. 35, 40 AND 42.
3,678,162, PUB. 6-23-2009. MULTIPLE CLASS, INT. CLS. 35, 40 AND 42.
- DODSON, VYASA M., PORTLAND, OR:
3,679,309, PUB. 6-23-2009. INT. CL. 41.
- DOGFRIENDLY.COM, INC., POLLOCK PINES, CA:
3,678,702, PUB. 6-23-2009. INT. CL. 35.
- DOGSTER, INC., SAN FRANCISCO, CA:
3,680,418, INT. CL. 45.
- DOGWHISTLE, INC., CHICAGO, IL:
3,678,873, PUB. 6-23-2009. INT. CL. 41.
- DOLLARWORKS, INC., SAN MARINO, CA:
2,666,122, CANC. INT. CL. 36.
- DOLLY'S PIZZA FRANCHISING, INC., WEST BLOOMFIELD, MI, DBA DOLLY'S PIZZA:
3,679,212, PUB. 6-23-2009. INT. CL. 43.

DOMANTAY, GREG A., OAK PARK, IL:
2,214,467, CANC. INT. CL. 41.

DOMINION BEARING COMPANY, PORTLAND, OR:
3,680,866, MULTIPLE CLASS, INT. CLS. 6 AND 7.

DOMINION VIDEO SATELLITE, NAPLES, FL:
2,665,566, CANC. INT. CL. 38.

DON KING PRODUCTIONS, INC., DEERFIELD BEACH, FL:
2,666,347, CANC. INT. CL. 18.

DONESA, MANUEL ALCANTARA, FREMONT, CA:
3,679,687, PUB. 6-23-2009. INT. CL. 45.

DONLEN GOVERNMENT SERVICES, INC., NORTH-BROOK, IL:
3,680,850, INT. CL. 35.

DORAN, PAUL S., COLUMBIA FALLS, MT:
3,680,783, INT. CL. 11.

DOREEN VIRTUE, LLC, KAILUA KONA, HI:
3,678,463, PUB. 6-23-2009. U.S. CL. B.

DORF INDUSTRIES PTY LTD., VICTORIA 3167, AUSTRALIA:
1,517,884, CANC. INT. CL. 11.

DORF INDUSTRIES PTY. LTD., OAKLEIGH SOUTH, AUSTRALIA:
1,517,885, CANC. INT. CL. 11.

DORPAN, S.L., PALMA DE MALLORCA, SPAIN:
3,679,093, PUB. 6-23-2009. MULTIPLE CLASS, INT. CLS. 36 AND 43.

DOSHI, SATISH, WALNUT CREEK, CA:
3,679,094, PUB. 6-23-2009. INT. CL. 45.

DOTNSF, INC., WILMINGTON, DE:
2,666,866, CANC. INT. CL. 16.

DOUBLE TAKE FASHIONS, INC., BROOKLYN, NY:
3,679,449, PUB. 6-23-2009. INT. CL. 25.

DOUG WATSON, LAKE OSWEGO, OR, DBA JUST PLANE FUN:
3,678,890, PUB. 6-23-2009. INT. CL. 28.

DOUGH NUTTY INTERNATIONAL, LLC, LOUISVILLE, KY:
2,665,868, CANC. MULTIPLE CLASS, INT. CLS. 39 AND 43.

DOUGLAS CARPA, A U.S. CITIZEN, AS TRUSTEE OF THE ICC TRUST, SCOTTSDALE, AZ:
2,214,864, CANC. INT. CL. 35.

DOUGLAS DYNAMICS, L.L.C., MILWAUKEE, WI:
2,354,584, REN. 8-1-09. INT. CL. 7.

DOUGLASS, LISA LOMAX, UPPER MARLBORO, MD:
3,681,294, INT. CL. 16.

DOVER ASSOCIATES, L.L.C., PHOENIX, AZ:
2,257,142, REN. 8-1-09. INT. CL. 28.
2,297,662, REN. 8-1-09. INT. CL. 25.

DOVER ASSOCIATES, L.L.C., PHOENIX, AZ:
2,271,949, REN. 8-1-09. INT. CL. 41.

DOW JONES & COMPANY, INC., NEW YORK, NY:
370,285, REN. 8-3-09. U.S. CL. 38 (INT. CL. 16).
1,518,597, CANC. INT. CL. 42.
2,273,813, REN. 8-3-09. INT. CL. 16.

DOWDY, PAUL J., INDIANAPOLIS, IN:
2,667,206, CANC. INT. CL. 14.

DOWNES & READER HARDWOOD CO., INC., STOUGHTON, MA:
2,364,739, REN. 8-4-09. INT. CL. 35.

DOWNEY INSURANCE AGENCY, INC, MARLBORO, MA:
3,484,665, CANC. INT. CL. 36.

DOWNTOWN DELI'S, INC., PITTSBURGH, PA:
1,518,459, CANC. INT. CL. 42.

DOYON, PAUL C., WICHITA, KS:
1,518,404, CANC. INT. CL. 42.

DOZOIS, MICHEL, WEST HOLLYWOOD, CA, DBA NEVE LUXURY ICE COMPANY:
3,678,958, PUB. 6-23-2009. INT. CL. 30.
3,678,959, PUB. 6-23-2009. INT. CL. 30.

DPG, RUSSIAN FED.:
3,680,014, PUB. 6-23-2009. INT. CL. 41.

DR. MARTENS INTERNATIONAL TRADING GMBH, D-82166 GRÄFELFING, FED REP GERMANY:
2,397,734, AM. INT. CL. 25.
2,416,348, AM. INT. CL. 18.
3,330,342, AM. INT. CL. 25.

DRAGONFLY TEAS LIMITED, BERKSHIRE, UNITED KINGDOM:
2,667,210, CANC. INT. CL. 30.

DRAKE DESIGN ASSOCIATES, INC., NEW YORK, NY:
3,678,636, PUB. 6-23-2009. INT. CL. 42.

DRAKE KRYTERION, INC., PHOENIX, AZ:
2,665,490, CANC. MULTIPLE CLASS, INT. CLS. 9, 16 AND 41.

DREAM HOUSE DESIGNS P.C., FRAMINGHAM, MA:
2,666,594, CANC. INT. CL. 42.

DREAM SHEET, LLC, LITCHFIELD, NH:
2,667,033, CANC. INT. CL. 24.

DRESSER RAND COMPANY, A GENERAL PARTNERSHIP OF NEW YORK, COMPOSED OF DRESSER-RAND GROUP, INC., A CORPORATION OF DELAWARE, AND DRESSER-RAND L.L.C., A LIMITED LIABILITY COMPANY OF DELAWARE., OLEAN, NY:
3,678,484, PUB. 6-23-2009. INT. CL. 7.

DRIVAS, KONSTANTINOS, LAKE IN THE HILLS, IL:
3,679,200, PUB. 6-23-2009. INT. CL. 43.

DRIVE4LIFE, LLC, DRAPER, UT:
3,678,550, PUB. 6-23-2009. INT. CL. 45.

DRM LABS, INC., DALLAS, TX:
3,679,335, PUB. 6-23-2009. INT. CL. 35.
3,679,336, PUB. 6-23-2009. INT. CL. 35.

DROR, GIL, JACKSONVILLE BEACH, FL:
3,679,669, PUB. 6-23-2009. INT. CL. 25.

DRRT LIMITED DUBAI, DUBAI, UNITED ARAB EMIR.:
3,679,616, PUB. 6-23-2009. INT. CL. 45.

DRS TECHNOLOGIES, INC., PARSIPPANY, NJ:
2,303,120, REN. 8-1-09. MULTIPLE CLASS, INT. CLS. 9, 37, 40, 41 AND 42.
2,347,941, REN. 8-1-09. INT. CL. 9.

DSM IP ASSETS B.V., HEERLEN, NETHERLANDS:
2,221,114, REN. 7-31-09. MULTIPLE CLASS, INT. CLS. 37 AND 42.
2,221,115, REN. 7-31-09. MULTIPLE CLASS, INT. CLS. 6, 37 AND 42.

DUBEK LTD., PETACH TIKVA, ISRAEL:
3,621,419, CANC. IIRN. RESTORED TO S.N. 77-238,137.

DUFFNEY, THOMAS M., JOHNSTON, RI:
2,665,911, CANC. INT. CL. 35.

DUKE ENGINEERING AND SERVICES, INC., CHARLOTTE, NC:
1,518,298, CANC. MULTIPLE CLASS, INT. CLS. 37 AND 42.

DUKE UNIVERSITY, DURHAM, NC:
2,214,659, CANC. INT. CL. 16.

DUKE, C. FRANK, GRAY, GA:
2,667,205, CANC. INT. CL. 6.

DULANY INDUSTRIES, INC., SAVANNAH, GA:
3,679,388, PUB. 6-23-2009. MULTIPLE CLASS, INT. CLS. 1 AND 39.
3,679,415, PUB. 6-23-2009. MULTIPLE CLASS, INT. CLS. 1 AND 39.
3,679,416, PUB. 6-23-2009. MULTIPLE CLASS, INT. CLS. 1 AND 39.

DUNDAS DATA VISUALIZATION INC., TORONTO, ONTARIO, CANADA:
3,589,850, COR. MULTIPLE CLASS, INT. CLS. 9 AND 42.

DUNHAM'S ATHLEISURE CORPORATION, WATERFORD, MI:
3,678,138, PUB. 6-23-2009. INT. CL. 35.

DUNNELL, JEFF, SEATTLE, WA:
3,678,910, PUB. 6-23-2009. INT. CL. 11.

DUNSTER, JEFFREY, HONOLULU, HI:
3,679,044, PUB. 6-23-2009. MULTIPLE CLASS, INT. CLS. 9 AND 44.

DUPAGE LIGHTING SERVICE AND REPAIR, INC., ELGIN, IL:
3,681,763, MULTIPLE CLASS, INT. CLS. 35, 37, 39 AND 42.

DURAMED PHARMACEUTICALS, INC., WOODCLIFF LAKE, NJ:
3,636,124, COR. INT. CL. 5.

DUSCH, DANIEL R, MIAMI, FL:
3,679,367, PUB. 6-23-2009. INT. CL. 35.

- DVI, INC., JAMISON, PA:
2,666,338, CANC. INT. CL. 36.
- DVIGEAR, INC., MARIETTA, GA:
3,678,181, PUB. 6-23-2009. INT. CL. 9.
- DYAL COMPASS, LLC, BOSTON, MA:
3,680,825, INT. CL. 37.
- DYE PRECISION, INC., SAN DIEGO, CA:
3,681,635, INT. CL. 28.
- DYMOND MODELSPORT USA, LTD, SANTEE, CA:
3,679,282, PUB. 6-23-2009. INT. CL. 9.
- DYNA TORQUE TECHNOLOGIES, INC., HOUSTON, TX:
2,361,902, REN. 7-31-09. INT. CL. 7.
- DYNACRAFT BSC, INC., AMERICAN CANYON, CA:
1,551,816, REN. 8-3-09. INT. CL. 12.
2,258,322, REN. 8-3-09. INT. CL. 12.
3,679,409, PUB. 6-23-2009. INT. CL. 12.
- DYNAMIC NETWORK SERVICES, INC., MANCHESTER, NH:
3,678,487, PUB. 6-23-2009. MULTIPLE CLASS, INT. CLS. 38, 42 AND 45.
- DYNASTUDY, INC., LEAGUE CITY, TX:
3,678,654, PUB. 6-23-2009. INT. CL. 16.
- DYNETICS, INC., HUNTSVILLE, AL:
2,261,839, REN. 8-3-09. MULTIPLE CLASS, INT. CLS. 9 AND 40.
- DYNO LLC, POMPANO BEACH, FL:
3,678,514, PUB. 6-23-2009. INT. CL. 21.
3,678,515, PUB. 6-23-2009. INT. CL. 21.
- E CONSULTING UK LTD, BRADFORD, UNITED KINGDOM:
3,678,760, PUB. 6-23-2009. MULTIPLE CLASS, INT. CLS. 25 AND 40.
- E. ARTHUR BROWN COMPANY, INC., GARFIELD, MN:
3,678,987, PUB. 6-23-2009. MULTIPLE CLASS, INT. CLS. 9 AND 13.
- E. I. DU PONT DE NEMOURS AND COMPANY, WILMINGTON, DE:
3,680,675, INT. CL. 5.
3,681,550, MULTIPLE CLASS, INT. CLS. 35, 41 AND 42.
- E. MISHAN & SONS, INC., NEW YORK, NY:
3,679,595, PUB. 6-23-2009. MULTIPLE CLASS, INT. CLS. 11 AND 21.
- E. REMY MARTIN & CO, 16100 COGNAC, FRANCE:
3,680,764, INT. CL. 33.
- E. W. KNAUSS & SONS, INC., QUAKERTOWN, PA:
1,518,147, CANC. INT. CL. 29.
- E.B. EXPRESS PROVISIONS, INC., NEWARK, NJ:
3,680,826, INT. CL. 29.
- E.C. DE WITT & COMPANY LIMITED, CHESHIRE WA7 1 SZ, UNITED KINGDOM:
2,665,328, CANC. INT. CL. 3.
- E.ON SVERIGE AB, MALMO, SWEDEN AND GDF SUEZ, PARIS, FRANCE:
2,580,635, AM. INT. CL. 42.
- E.R. SQUIBB & SONS, L.L.C., PRINCETON, NJ:
2,667,322, CANC. INT. CL. 42.
- E.S. ORIGINALS, INC., NEW YORK, NY:
3,680,709, INT. CL. 25.
- E.SPIRE COMMUNICATIONS, INC., HERNDON, VA:
2,666,593, CANC. INT. CL. 38.
- E.Z. INDUSTRIES, INC., WEST JORDAN, UT:
2,214,842, CANC. INT. CL. 6.
- E&B EXERCISE LLC, YONKERS, NY:
2,248,052, REN. 8-4-09. INT. CL. 28.
- E-WATCH, INC., SAN ANTONIO, TX:
2,667,439, CANC. INT. CL. 9.
- EAGLE BOOK SUPPLY, INC., HOPEWELL JUNCTION, NY:
2,270,745, REN. 8-4-09. INT. CL. 16.
- EAGLE, JAKE G, TESUQUE, NM AND EAGLE, HANNAH, TESUQUE, NM:
3,678,942, PUB. 6-23-2009. INT. CL. 41.
- EAGLEHAWK INC, GEORGETOWN, MA:
2,666,862, CANC. INT. CL. 42.
- EARL OF SANDWICH (FAMILYCO) AG, KLOSTERS, SWITZERLAND:
3,678,455, PUB. 6-23-2009. INT. CL. 30.
- EARL, ROBERT I., ORLANDO, FL:
3,681,451, INT. CL. 21.
- EARTHLIGHT, INC., BOYNTON BEACH, FL:
2,665,903, CANC. INT. CL. 20.
- EARTHWORKS SYSTEMS, LLC, SOLON, OH:
3,681,569, INT. CL. 17.
- EASON, HARVEY J., CEDAREDDGE, CO:
3,680,131, INT. CL. 31.
- EASSIST GLOBAL SOLUTIONS, INC., SAN DIEGO, CA:
2,667,041, CANC. INT. CL. 35.
- EAST BOSTON SAVINGS BANK, EAST BOSTON, MA:
1,518,257, CANC. INT. CL. 36.
- EAST CAROLINA UNIVERSITY, GREENVILLE, NC:
2,266,402, REN. 8-3-09. MULTIPLE CLASS, INT. CLS. 25 AND 41.
- EAST-WEST PRODUCTIONS, LLC, LAS VEGAS, NV:
2,666,074, CANC. INT. CL. 41.
- EASTER UNLIMITED, INC., CARLE PLACE, NY:
2,666,807, CANC. MULTIPLE CLASS, INT. CLS. 20 AND 28.
- EASTERN SLEEP PRODUCTS CO., INC., RICHMOND, VA, DBA SYMBOL MATTRESS COMPANY:
3,679,288, PUB. 6-23-2009. INT. CL. 20.
- EASTMAN KODAK COMPANY, ROCHESTER, NY:
2,243,855, REN. 7-31-09. INT. CL. 1.
2,665,420, CANC. INT. CL. 9.
- EASY GRASS, LLC, MIAMI, FL:
3,680,835, INT. CL. 27.
- EASY INDUSTRIES, LLC, DALLAS, TX:
3,678,600, PUB. 6-23-2009. MULTIPLE CLASS, INT. CLS. 3 AND 25.
- EASY RENT SYSTEMS, INC., NEW YORK, NY:
3,679,482, PUB. 6-23-2009. INT. CL. 44.
- EASY2.COM, INC., CLEVELAND, OH:
3,681,670, INT. CL. 42.
- EAT'N PARK HOSPITALITY GROUP, INC., HOMESTEAD, PA:
2,665,284, CANC. INT. CL. 42.
- EATON AEROQUIP LLC, CLEVELAND, OH, BOSTON WOVEN HOSE & RUBBER COMPANY, CAMBRIDGE, MA:
512,553, REN. 8-1-09. U.S. CL. 35 (INT. CLS. 7, 12 AND 17).
683,893, REN. 8-3-09. U.S. CL. 13 (INT. CL. 17).
- EATON CORPORATION, CLEVELAND, OH, SAMUEL MOORE & COMPANY, MANTUA, OH:
698,515, REN. 8-4-09. U.S. CL. 22 (INT. CL. 28).
- EBSCO INDUSTRIES, INC., BIRMINGHAM, AL, MILLE LACS MANUFACTURING COMPANY, ISLE, MN:
698,515, REN. 8-4-09. U.S. CL. 22 (INT. CL. 28).
- EBSCO INDUSTRIES, INC., BIRMINGHAM, AL, EBSCO INDUSTRIES, INC., LEEDS, AL:
1,603,880, REN. 7-31-09. INT. CL. 28.
- EBSCO INDUSTRIES, INC., BIRMINGHAM, AL:
2,215,425, CANC. INT. CL. 28.
- ECHO, INCORPORATED, LAKE ZURICH, IL:
3,355,736, CANC. INT. CL. 7.
3,355,742, CANC. INT. CL. 7.
- ECHOCATH, INC., MONMOUTH JUNCTION, NJ:
2,665,077, CANC. INT. CL. 10.
- ECKART GMBH, FED REP GERMANY:
3,680,021, PUB. 6-23-2009. INT. CL. 2.
- ECOAST SALES SOLUTIONS, INC., ROCHESTER, NH:
3,679,196, PUB. 6-23-2009. INT. CL. 35.
- ECOLAB INC., ST. PAUL, MN:
2,667,324, CANC. INT. CL. 3.
2,741,907, CANC. INT. CL. 11.
- ECOLOCHEM, INC., NORFOLK, VA:
2,214,763, CANC. INT. CL. 40.
- ECONCONTACTS, INC., NEEDHAM, MA:
2,665,063, CANC. INT. CL. 35.
- ECREAMERY, LLC, OMAHA, NE:
3,678,378, PUB. 6-23-2009. INT. CL. 35.
- ECUTEL - PCS, LLC, ALEXANDRIA, VA:
2,666,730, CANC. INT. CL. 9.
- ED SORENSEN, MONROVIA, CA:
3,678,782, PUB. 6-23-2009. INT. CL. 6.
- EDCOACH, INC., SEATTLE, WA:
2,667,048, CANC. INT. CL. 41.
- EDDIE BAUER, INC., REDMOND, WA:
2,215,435, CANC. INT. CL. 35.

EDDIE MARC & CO INC, BROOKLYN, NY:
3,679,025, PUB. 6-23-2009. INT. CL. 25.

EDELBROCK CORPORATION, TORRANCE, CA, EDELBROCK EQUIPMENT COMPANY, EL SEGUNDO, CA:
871,738. REN. 8-3-09. U.S. CL. 23 (INT. CL. 7).

EDEN BRIDALS, INC., MONROVIA, CA:
3,678,689, PUB. 6-23-2009. INT. CL. 25.

EDFUND, SACRAMENTO, CA:
2,213,818, CANC. MULTIPLE CLASS, INT. CLS. 35 AND 36.

EDUCATION AND TRAINING PROGRAMS, INC., EAST HARTFORD, CT:
2,665,942, CANC. MULTIPLE CLASS, INT. CLS. 35, 41 AND 42.

EDWARD D. JONES & CO., LP, ST. LOUIS, MO:
3,680,803, INT. CL. 36.

EDWARD LEWIS TOBINICK M.D., A MEDICAL CORPORATION, LOS ANGELES, CA:
3,681,709, INT. CL. 44.

EDWARDS, ROBERTS, BROOKLYN, NY, DBA GUMBALL RUBBISH REMOVAL:
2,665,969, CANC. INT. CL. 37.
2,665,970, CANC. INT. CL. 37.

EGAN COMPANY, BROOKLYN PARK, MN:
2,337,565. REN. 8-1-09. INT. CL. 37.

EGENOMICS, INC., NEW YORK, NY:
3,678,160, PUB. 6-23-2009. INT. CL. 42.

EHRHART AMMERSCHWIHR SA; (SOCIÉTÉ ANONYME), FRANCE:
3,679,958, PUB. 6-23-2009. MULTIPLE CLASS, INT. CLS. 32, 33 AND 42.

EICHBAUM-BRAUEREIEN AG, FED REP GERMANY:
3,680,008, PUB. 6-23-2009. INT. CL. 32.

EIGHT20EIGHT, LLC, LOS ANGELES, CA, DBA EVANGELIZE.COM:
3,679,108, PUB. 6-23-2009. INT. CL. 35.

EIKO, LTD., SHAWNEE, KS:
2,214,947, CANC. INT. CL. 11.

EIWEISS CHEMICAL CORPORATION, SUNTO-GUN, SHIZUOKA-PREF., JAPAN:
2,666,069, CANC. INT. CL. 1.

EJAX CORROSION CONTROL, GARDEN GROVE, CA:
1,572,427. REN. 7-31-09. INT. CL. 37.

EK ASSOCIATES, INC., PALATINE, IL:
3,679,325, PUB. 6-23-2009. INT. CL. 35.

EK SUCCESS, LTD., CLIFTON, NJ:
3,680,732, INT. CL. 14.

EKLUTNA, INC., EAGLE RIVER, AK:
3,681,434, MULTIPLE CLASS, INT. CLS. 35, 36, 37 AND 42.

EL CHICO RESTAURANTS, INC., DALLAS, TX:
2,667,427, CANC. INT. CL. 42.

EL PASO CORPORATION, HOUSTON, TX:
2,666,663, CANC. INT. CL. 39.
2,666,664, CANC. INT. CL. 40.
2,666,665, CANC. INT. CL. 36.

EL RANCHO DE JONAS CORPORATION, JACKSON HEIGHTS, NY:
2,666,555, CANC. INT. CL. 42.

ELECTION CFO, LLC, WASHINGTON, DC:
3,679,374, PUB. 6-23-2009. INT. CL. 45.

ELECTION SYSTEMS & SOFTWARE, INC., OMAHA, NE:
1,549,979. REN. 8-3-09. INT. CL. 9.

ELECTRIC EYE ENTERTAINMENT CORPORATION, HOUSTON, TX:
2,285,737. REN. 7-31-09. INT. CL. 9.

ELEMENT ELECTRONICS, LLC, MINNEAPOLIS, MN:
3,681,448, INT. CL. 9.

ELEPHANT GROUP, INC, FORT LAUDERDALE, FL:
3,678,820, PUB. 6-23-2009. INT. CL. 35.

ELEVATED EXISTENCE, LLC, ELMWOOD PARK, NJ:
3,680,889, INT. CL. 16.

ELEVATED LIVING LTD., DENVER, CO:
3,678,921, PUB. 6-23-2009. INT. CL. 45.

ELITE BROKERAGE SERVICES, INC., EXTON, PA:
2,260,282. REN. 8-3-09. INT. CL. 36.

ELITE SALES INC., HINGHAM, MA:
1,518,063, CANC. MULTIPLE CLASS, INT. CLS. 25 AND 28.

ELKAY MANUFACTURING COMPANY, OAK BROOK, IL, ELKAY MANUFACTURING COMPANY, OAK BROOK, IL:
685,394. REN. 8-5-09. U.S. CL. 13 (INT. CL. 11).

ELKINS EARTHWORKS, LLC, MEDINA, OH:
3,680,660, INT. CL. 9.
3,680,661, INT. CL. 9.

ELLACOYA NETWORKS, INC., MERRIMACK, NH:
2,667,397, CANC. INT. CL. 9.

ELLIOT GROUP, LLC, THE, TARRYTOWN, NY:
2,274,546. REN. 8-3-09. INT. CL. 35.

ELMER'S PRODUCTS, INC., COLUMBUS, OH:
2,291,481. REN. 7-31-09. INT. CL. 16.

ELSAG NORTH AMERICA, LLC, GREENSBORO, NC:
3,678,479, PUB. 6-23-2009. INT. CL. 9.

ELVEBAKK, RANVEIG, SAN FRANCISCO, CA:
3,680,097, INT. CL. 44.

EMBASSY UNIVERSITY, INC., MARIANNA, FL:
3,679,436, PUB. 6-23-2009. INT. CL. 41.

EMC DOCUMENT TECHNOLOGIES, LLC, LANSING, MI:
2,214,954, CANC. INT. CL. 7.

EMC TELECOM CORPORATION, MESA, AZ, AKA EMC TELECOM:
3,681,314, INT. CL. 38.

EMD CHEMICALS INC., GIBBSTOWN, NJ:
2,254,080. REN. 8-3-09. INT. CL. 6.
2,269,872. REN. 8-3-09. INT. CL. 1.

EMERALD BABY, ROCHESTER, NY:
3,680,751, INT. CL. 35.

EMERITUS CORPORATION, SEATTLE, WA:
3,680,647, MULTIPLE CLASS, INT. CLS. 41, 43 AND 44.
3,680,649, MULTIPLE CLASS, INT. CLS. 41, 43 AND 44.
3,680,650, MULTIPLE CLASS, INT. CLS. 41, 43 AND 44.

EMERSON CLIMATE TECHNOLOGIES, INC., SIDNEY, OH:
890,471. REN. 8-1-09. U.S. CL. 31 (INT. CL. 11).

EMERSON ELECTRIC CO., ST. LOUIS, MO:
2,667,366, CANC. INT. CL. 7.

EMERSON NETWORK POWER CO., LTD., SHENZHEN, CHINA:
2,666,764, CANC. INT. CL. 35.

EMHART GLASS S.A., CHAM, SWITZERLAND:
3,681,120, INT. CL. 7.

EMISSIVE ENERGY CORPORATION, NORTH KINGSTOWN, RI:
3,681,413, INT. CL. 13.

EMMIS PUBLISHING, L.P., INDIANAPOLIS, IN:
3,681,764, INT. CL. 16.

EMPI CORP., HENDERSON, NV:
2,214,185, CANC. INT. CL. 10.

EMPIRE GRAPE COMPANY, LLC, FRESNO, CA:
3,679,176, PUB. 6-23-2009. INT. CL. 33.

EMPIRE OF CAROLINA, INC., TARBORO, NC:
1,518,121, CANC. INT. CL. 28.

EMPOWERMENT ASSOCIATES, LLC, OAKLAND, NJ:
3,678,872, PUB. 3-17-2009. INT. CL. 41.

EMPOWERMENT SOLUTIONS, LLC, WOODWARD, IA, DBA EMPOWERMENT SOLUTIONS:
3,679,707, PUB. 6-23-2009. INT. CL. 36.
3,679,708, PUB. 6-23-2009. INT. CL. 36.
3,679,709, PUB. 6-23-2009. INT. CL. 36.

EMX INDUSTRIES, INC., CLEVELAND, OH:
3,681,157, INT. CL. 9.

ENCOMPASS GROUP, LLC, MCDONOUGH, GA, DBA ALBAHEALTH, LLC:
3,681,080, INT. CL. 10.

ENCORE LEGAL SOLUTIONS, LOS ANGELES, CA:
3,680,790, MULTIPLE CLASS, INT. CLS. 35, 42 AND 45.
3,680,791, MULTIPLE CLASS, INT. CLS. 35, 39, 41, 42 AND 45.

ENCORE, INC., SARASOTA, FL:
2,307,479. REN. 8-5-09. INT. CL. 10.

ENDURA-TAPE PTY. LIMITED, CLAREVILLE, NEW SOUTH WALES, 2107, AUSTRALIA:
2,325,219. REN. 8-3-09. INT. CL. 5.

ENERGETICS PTY LIMITED, NORTH SYDNEY, NEW SOUTH WALES 2060, AUSTRALIA:
2,666,643, CANC. MULTIPLE CLASS, INT. CLS. 9, 35

- AND 42.
2,666,644, CANC. MULTIPLE CLASS, INT. CLS. 9, 35 AND 42.
- ENERGY KITCHEN INC., NEW YORK, NY:
3,680,979, INT. CL. 43.
- ENERGY PROCESS TECHNOLOGIES, INC., TULSA, OK:
2,665,830, CANC. INT. CL. 11.
- ENERGYSEAL AIR BARRIER SYSTEMS, MCCALL, ID:
3,680,437, INT. CL. 17.
- ENERSECTION.COM, INC., HOUSTON, TX:
2,666,898, CANC. INT. CL. 42.
2,666,914, CANC. INT. CL. 42.
2,666,923, CANC. INT. CL. 42.
- ENFIELD LUMBER COMPANY, INC., ENFIELD, CT, DBA KELLY-FRADET:
3,679,125, PUB. 6-23-2009. INT. CL. 19.
3,679,126, PUB. 6-23-2009. INT. CL. 19.
- ENGELHART, MATTHEW, SAN FRANCISCO, CA:
3,678,646, PUB. 6-23-2009. INT. CL. 16.
- ENGINEERED BIOMECHANICS, BIRMINGHAM, MI:
2,667,390, CANC. INT. CL. 10.
- ENGINEERED STUDIO LIGHTING, LLC, EL MONTE, CA:
2,665,708, CANC. INT. CL. 11.
- ENGLANDER SLEEP PRODUCTS, L.L.C., BATON ROUGE, LA. ENGLANDER SPRING BED COMPANY, BROOKLYN, NY:
257,599, REN. 8-5-09. U.S. CL. 32 (INT. CL. 20).
- ENJOY PLASTICS USA, INC., VERNON, CA:
3,681,744, INT. CL. 20.
- ENOZZLES, INC., SCOTTSDALE, AZ:
2,667,013, CANC. INT. CL. 35.
- ENPLAS CORPORATION, SAITAMA-KEN, 332-0034, JAPAN:
2,742,391, CANC. MULTIPLE CLASS, INT. CLS. 40 AND 42.
- ENSTAGE.COM INC., CUPERTINO, CA:
2,665,337, CANC. MULTIPLE CLASS, INT. CLS. 9, 35 AND 42.
- ENTELEGENCE, INC., HOUSTON, TX:
2,261,660, REN. 8-5-09. INT. CL. 35.
- ENTERPRISE ELECTRONICS CORPORATION, ENTERPRISE, AL:
3,681,617, MULTIPLE CLASS, INT. CLS. 9 AND 37.
- ENTERPRISE RENT-A-CAR COMPANY, ST. LOUIS, MO:
3,679,466, PUB. 6-23-2009. INT. CL. 39.
3,679,720, PUB. 6-23-2009. INT. CL. 39.
- ENTERTAINMENT PUBLICATIONS, INC., TROY, MI:
1,517,965, CANC. INT. CL. 16.
- ENTERTAINMENT PUBLICATIONS, LLC, TROY, MI:
1,546,338, REN. 8-1-09. INT. CL. 16.
- ENVESTNET ASSET MANAGEMENT, INC., CHICAGO, IL:
3,680,784, INT. CL. 36.
- ENVIRO-SAFE PRODUCTS, INC., LAS VEGAS, NV:
3,678,150, PUB. 6-23-2009. INT. CL. 3.
- ENVIROLAND, INC., DEWITT, MI:
1,517,707, CANC. MULTIPLE CLASS, INT. CLS. 1 AND 40.
- ENVIRONMENTAL DATA RESOURCES, INC., MILFORD, CT:
3,680,973, INT. CL. 36.
- ENVIRONMENTS GROUP, INC., THE, CHICAGO, IL:
2,665,842, CANC. INT. CL. 42.
- ENVISTA CORPORATION, BEVERLY, MA:
3,680,171, INT. CL. 9.
- ENWISEN, INC., NOVATO, CA:
3,679,633, PUB. 6-23-2009. INT. CL. 42.
- ENYFCU HOLDINGS, LLC, FERNDALE, NY:
3,681,229, INT. CL. 36.
- ENZA LIMITED, AUCKLAND, NEW ZEALAND:
3,679,847, PUB. 1-20-2009. INT. CL. 31.
- EONME.COM INC., BEAMSVILLE, ONTARIO, CANADA:
2,666,921, CANC. INT. CL. 35.
- EPAM SYSTEMS, INC., NEWTOWN, PA:
3,679,793, PUB. 7-22-2008. INT. CL. 9.
3,679,794, PUB. 7-29-2008. INT. CL. 9.
3,679,795, PUB. 7-22-2008. INT. CL. 9.
- EPIR TECHNOLOGIES, INC., BOLINGBROOK, IL:
3,679,630, PUB. 6-23-2009. MULTIPLE CLASS, INT. CLS.
- 40 AND 42.
3,679,631, PUB. 6-23-2009. MULTIPLE CLASS, INT. CLS. 40 AND 42.
- EPKO INDUSTRIES, INC., ELK GROVE VILLAGE, IL:
3,679,208, PUB. 6-23-2009. MULTIPLE CLASS, INT. CLS. 27 AND 35.
- EPOCH STOCKHOLM AB, SWEDEN:
3,680,040, PUB. 6-23-2009. INT. CL. 14.
- EPOCORP CORPORATION, MIAMI, FL:
3,680,655, MULTIPLE CLASS, INT. CLS. 36 AND 37.
- ERKIE, INC., WOODLAND HILLS, CA:
2,346,012, REN. 8-4-09. INT. CL. 16.
- ERM-DELAWARE, INC., WILMINGTON, DE:
3,678,668, PUB. 6-23-2009. MULTIPLE CLASS, INT. CLS. 35, 37, 40, 42 AND 45.
3,678,669, PUB. 6-23-2009. MULTIPLE CLASS, INT. CLS. 35, 37, 40, 42 AND 45.
- ERNEST PACKAGING, COMMERCE, CA, FORMERLY ERNEST PAPER PRODUCTS, INC.:
3,678,753, PUB. 6-23-2009. INT. CL. 16.
- ERO-GUARD, INC, MAPLETON, MN:
3,679,285, PUB. 6-23-2009. INT. CL. 19.
- ESPS, INC., FORT WASHINGTON, PA:
2,665,529, CANC. INT. CL. 9.
- ESSEX PRODUCTS GROUP, CENTERBROOK, CT:
3,678,688, PUB. 6-23-2009. INT. CL. 9.
- ESTEE LAUDER INC., THROUGH ITS WHOLLY-OWNED SUBSIDIARY, PRESCRIPTIVES INC., NEW YORK, NY:
2,666,657, CANC. INT. CL. 3.
- ESTEY INTERNATIONAL, INC., CHATSWORTH, CA:
2,665,433, CANC. MULTIPLE CLASS, INT. CLS. 3 AND 28.
- ESTHETIC FORMULA, HUNTINGTON BEACH, CA:
3,678,367, PUB. 9-2-2008. INT. CL. 5.
- ETABLISSEMENTS BRAGARD, SAULXURES SUR MOSELOTTE, FRANCE TO BRAGARD, S.A., 88290 SAULXURES SUR MOSELOTTE, FRANCE:
954,496 NEW CERT. 9-8-2009. U.S. CL. 42.
- ETHOX CHEMICALS, LLC, GREENVILLE, SC:
3,680,589, INT. CL. 1.
- EUDORA INTERNATIONAL, LOS ANGELES, CA:
2,666,628, CANC. INT. CL. 5.
- EULGEN, LEE, CHICAGO, IL:
2,667,328, CANC. INT. CL. 9.
- EURO-LOG TELEKOMMUNIKATIONSMEHRWERTDIENSTE GMBH, 85399 HALLBERGMOOS, FED REP GERMANY:
2,665,552, CANC. INT. CL. 39.
- EURO-PRO OPERATING LLC, WEST NEWTON, MA:
3,554,904, COR. INT. CL. 7.
- EUROCOATING S.P.A., ITALY:
3,679,892, PUB. 6-23-2009. MULTIPLE CLASS, INT. CLS. 5 AND 40.
- EUROPA EYE WEAR CORP., BUFFALO GROVE, IL, DBA EUROPA INTERNATIONAL:
3,679,671, PUB. 6-23-2009. INT. CL. 9.
3,679,717, PUB. 6-23-2009. INT. CL. 9.
- EUROPEAN TOUCH HOLDINGS, INC., MILWAUKEE, WI:
3,680,685, INT. CL. 11.
3,680,686, INT. CL. 11.
- EUROTECH S.P.A., ITALY:
3,679,947, PUB. 6-23-2009. MULTIPLE CLASS, INT. CLS. 9, 14 AND 25.
- EV'S SOX FOR HORSES, INC., HAVANA, FL:
3,679,700, PUB. 6-23-2009. INT. CL. 18.
- EVANS, BRAD, MONROVIA, CA:
3,681,765, INT. CL. 28.
- EVANS, RICHARD PAUL, SALT LAKE CITY, UT:
3,681,561, INT. CL. 16.
- EVERT FRESH CORPORATION, KATY, TX:
2,280,244, REN. 8-3-09. INT. CL. 17.
- EVERYDAY SHORTS INC, CALGARY, ALBERTA, CANADA:
3,681,312, INT. CL. 3.
- EVERYTHING FOR A DOLLAR STORE (CANADA) INC., MARKHAM, ONTARIO:
3,680,073, INT. CL. 35.

- EVODIE, LTD., NEW YORK, NY:
2,665,777, CANC. INT. CL. 25.
- EVOLUTION PERFORMANCE, INC., HOUSTON, TX:
1,518,521, CANC. INT. CL. 42.
- EVRIKART, INC., WHITE SULPHUR SPRINGS, WV:
3,679,232, PUB. 6-23-2009. INT. CL. 42.
3,679,765, PUB. 6-23-2009. INT. CL. 42.
3,679,766, PUB. 6-23-2009. INT. CL. 35.
- EWING AND CLARK, INCORPORATED, SEATTLE, WA:
3,679,066, PUB. 6-23-2009. INT. CL. 36.
- EWM EICHELHARDTER WERKZEUG-; UND MASCHINENBAU GMBH, 57612 EICHELHARDT, FED REP GERMANY:
3,679,951, PUB. 6-23-2009. MULTIPLE CLASS, INT. CLS. 7 AND 12.
- EXCELLENCE IN ACTION, INC., SOUTHFIELD, MI:
2,665,977, CANC. INT. CL. 35.
2,665,978, CANC. INT. CL. 35.
2,665,979, CANC. INT. CL. 35.
- EXCITWERKS, INC., IRVINE, CA:
3,678,685, PUB. 6-23-2009. INT. CL. 9.
3,678,686, PUB. 6-23-2009. INT. CL. 42.
- EXD3, PAHRUMP, NV:
3,680,430, INT. CL. 35.
- EXECUTIVE DEVELOPMENT ARCHITECTS LLC, DENVER, CO:
3,678,580, PUB. 6-23-2009. INT. CL. 35.
- EXEMPLAR COMPANIES INC., BOSTON, MA:
3,679,484, PUB. 6-23-2009. MULTIPLE CLASS, INT. CLS. 36 AND 45.
- EXOPACK-TECHNOLOGY, LLC, SPARTANBURG, SC:
2,666,057, CANC. MULTIPLE CLASS, INT. CLS. 35 AND 42.
- EXPERIAN INFORMATION SOLUTIONS, INC., COSTA MESA, CA:
2,667,012, CANC. INT. CL. 9.
- EXPERIMENTAL AIRCRAFT ASSOCIATION INC., OSHKOSH, WI:
2,666,278, CANC. MULTIPLE CLASS, INT. CLS. 28 AND 41.
- EXPERT FOODS, INC., ELLICOTT CITY, MD:
2,666,688, CANC. INT. CL. 30.
- EXPRESS DIAGNOSTICS INT'L, INC., MARION, IA:
3,681,500, INT. CL. 5.
- EXPRESS FOODS, INC., NEWARK, NJ:
3,678,733, PUB. 2-24-2009. INT. CL. 32.
- EXTENDED DEMARC, ANTONIO, TX:
3,678,619, PUB. 6-23-2009. INT. CL. 37.
- EXTIMATA INC, TUCSON, AZ:
3,679,199, PUB. 6-23-2009. MULTIPLE CLASS, INT. CLS. 35 AND 41.
- EZ CONNECT, LODI, CA:
3,678,585, PUB. 6-23-2009. INT. CL. 35.
- EZ SLIDER, LLC, POYNETTE, WI:
2,667,450, CANC. INT. CL. 28.
- EZCORP, INC., AUSTIN, TX:
2,257,872, REN. 8-1-09. INT. CL. 36.
- EZTAKES, INC., NORTHAMPTON, MA:
3,679,023, PUB. 6-23-2009. INT. CL. 9.
- F. E. KNIGHT, INC., FRANKLIN, MA, F. E. KNIGHT, INC., WESTPORT, CT:
1,123,274, REN. 8-3-09. INT. CL. 17.
- F. E. KNIGHT, INC., FRANKLIN, MA:
1,123,275, REN. 8-3-09. INT. CL. 17.
- F. W. RICKARD SEEDS, INC., WINCHESTER, KY:
2,666,402, CANC. INT. CL. 31.
2,666,403, CANC. INT. CL. 31.
2,666,405, CANC. INT. CL. 31.
- FÁBRICA DE ARTEFATOS DE LÁTEX ESTRELA - EPRIS-TINTA LTDA., GOIANA, SÃO ROQUE, BRAZIL:
3,680,412, INT. CL. 2.
- FABER S.P.A., ITALY:
3,679,920, PUB. 6-23-2009. INT. CL. 11.
- FABRICA DE JABON MARIANO SALGADO, S.A. DE C.V., TOLUCA, MEXICO:
1,517,724, CANC. INT. CL. 3.
1,517,725, CANC. INT. CL. 3.
- FABRICATED FOAM, LLC, INDIANAPOLIS, IN:
2,667,424, CANC. INT. CL. 17.
- FABRICUT, INC., TULSA, OK:
3,681,160, INT. CL. 24.
- FACE TO FACE INTERNATIONAL, INC., NEW YORK, NY:
2,665,876, CANC. INT. CL. 42.
- FACENTE, BRUCE, WEST WARWICK, RI:
3,680,901, INT. CL. 30.
- FACEPLANT, PASADENA, TX:
2,666,682, CANC. MULTIPLE CLASS, INT. CLS. 9 AND 41.
- FACOM, 91420 MORANGIS, FRANCE:
2,213,637, CANC. MULTIPLE CLASS, INT. CLS. 7 AND 8.
- FAIER & FAIER P.C., CHICAGO, IL:
2,366,877, REN. 8-3-09. INT. CL. 42.
- FAIRCHILD KOREA SEMICONDUCTOR LTD., PUCHON-SI, KYONGGI-DO, REPUBLIC OF KOREA:
2,665,144, CANC. INT. CL. 9.
- FAKE WORK, INC., SHERMAN OAKS, CA:
3,678,456, PUB. 10-28-2008. INT. CL. 25.
- FALKEN, GREGORY A., TWAIN HARTE, CA:
2,666,668, CANC. INT. CL. 42.
- FALLON, JOHN KEVIN, CHAPEL HILL, NC:
3,678,469, PUB. 6-23-2009. INT. CL. 41.
- FALSETTI, CHRISTINE MARIE, LOS ALTOS, CA:
3,678,752, PUB. 1-20-2009. INT. CL. 36.
- FAMILIES THRU INTERNATIONAL ADOPTION, INC., EVANSVILLE, IN:
2,214,098, CANC. INT. CL. 42.
- FAMILY FINANCIAL PARTNERS, INC., LEXINGTON, KY:
3,678,418, PUB. 6-23-2009. INT. CL. 36.
- FAMILY SERVICES CENTER, INC., HUNTSVILLE, AL:
3,679,390, PUB. 6-23-2009. INT. CL. 39.
- FAMOUS STARS & STRAPS, INC., ONTARIO, CA:
3,680,694, INT. CL. 25.
3,680,695, INT. CL. 25.
3,680,696, INT. CL. 18.
- FARKHONDEH, SORAYA, BEVERLY HILLS, CA:
2,667,110, CANC. INT. CL. 3.
- FARM FRESH CATFISH COMPANY, HOLLANDALE, MS:
2,666,266, CANC. INT. CL. 29.
- FARM TO MARKET, INC., SAN ANTONIO, TX:
2,666,233, CANC. INT. CL. 31.
- FARMER, JEFFREY BERNARD, CLINTON, MD:
3,679,045, PUB. 6-23-2009. INT. CL. 35.
- FARMERS MARKET MUSIC, LLC, BROOKLYN, NY:
3,678,616, PUB. 6-23-2009. MULTIPLE CLASS, INT. CLS. 9 AND 41.
- FAROUK SYSTEMS, INC., HOUSTON, TX:
3,679,218, PUB. 5-19-2009. INT. CL. 8.
3,680,174, MULTIPLE CLASS, INT. CLS. 9, 11 AND 21.
- FASMA, LLC, FOREST PARK, IL:
2,667,331, CANC. INT. CL. 3.
- FAST CASH HOUSE BUYERS, LLC, PORTLAND, OR:
3,678,521, PUB. 6-23-2009. INT. CL. 36.
- FASTEK INTERNATIONAL, LTD., CEDAR RAPIDS, IA:
3,679,502, PUB. 6-23-2009. INT. CL. 42.
- FASTENER INNOVATION TECHNOLOGY, INC., GARDENA, CA:
2,294,133, REN. 8-3-09. MULTIPLE CLASS, INT. CLS. 6, 7 AND 8.
- FAT GOOSE, INC., SAN FRANCISCO, CA:
3,680,747, MULTIPLE CLASS, INT. CLS. 42 AND 45.
- FAT JACK'S, INC., PAYSON, UT:
1,518,400, CANC. INT. CL. 42.
- FAUGHT, JEAN, CAMARILLO, CA:
2,215,130, CANC. INT. CL. 25.
- FAULTLESS STARCH/BON AMI COMPANY, KANSAS CITY, MO:
3,681,783, MULTIPLE CLASS, INT. CLS. 4 AND 11.
3,681,784, MULTIPLE CLASS, INT. CLS. 4 AND 11.
3,681,785, MULTIPLE CLASS, INT. CLS. 4 AND 11.
3,681,786, MULTIPLE CLASS, INT. CLS. 4 AND 11.
- FAZE APPAREL, SAN FRANCISCO, CA:
3,680,738, INT. CL. 25.
- FBC WORLDWIDE, LLC, HOUSTON, TX:
3,679,661, PUB. 6-23-2009. INT. CL. 30.

- FC INTERNATIONAL SA, 92316 SEVRES CEDEX, FRANCE:
2,664,964, CANC. INT. CL. 42.
- FEAGLES PACIFIC, INC., SEATTLE, WA:
1,518,152, CANC. INT. CL. 29.
- FEDERATION VOVINAM; VIET VO DAO FRANCE, FRANCE:
3,679,966, PUB. 6-23-2009. INT. CL. 41.
- FEDERICO, NOELLE K., FRANKLIN, TN:
3,679,140, PUB. 6-23-2009. INT. CL. 35.
- FEEL MORE SCENTS U' ALL., SAN FRANCISCO, CA:
2,246,987. REN. 8-5-09. MULTIPLE CLASS, INT. CLS. 3, 4, 14, 21 AND 35.
- FEHLMANN AG, SWITZERLAND:
3,680,012, PUB. 6-23-2009. INT. CL. 7.
- FEMME DE CARRIERE U.S.A., INC., MONTREAL, CANADA:
2,667,426, CANC. INT. CL. 35.
- FEMMED, INC., MINNETONKA, MN:
3,681,150, INT. CL. 20.
- FENDALL, FLORA ANITA, UPPER MARLBORO, MD:
2,665,620, CANC. INT. CL. 41.
- FENWAY BARR, LLC, ANNANDALE, VA:
2,666,363, CANC. MULTIPLE CLASS, INT. CLS. 25 AND 43.
- FERGUSON ENTERPRISES, INC., NEWPORT NEWS, VA:
2,664,985, CANC. INT. CL. 11.
- FERRIS STATE UNIVERSITY, BIG RAPIDS, MI:
2,281,972. REN. 8-3-09. MULTIPLE CLASS, INT. CLS. 16, 21, 25 AND 41.
- FERROSAN A/S, DK-2860 SOBORG, DENMARK:
2,755,148, CANC. INT. CL. 3.
- FFS HOLDINGS, LLC, KENNESAW, GA:
3,680,494, INT. CL. 35.
- FIBERGRATE COMPOSITE STRUCTURES INCORPORATED, DALLAS, TX:
1,123,292. REN. 8-4-09. INT. CL. 19.
- FIBERMARK NORTH AMERICA, INC., BRATTLEBORO, VT:
2,273,994. REN. 7-31-09. INT. CL. 16.
2,297,039. REN. 7-31-09. INT. CL. 16.
- FIBERWEB, INC., OLD HICKORY, TN:
2,667,245, CANC. MULTIPLE CLASS, INT. CLS. 11 AND 24.
- FIELDING, ROY RUSSELL, CHARLOTTE, NC:
2,665,559, CANC. INT. CL. 9.
- FIERO, ALEXIOUS, LOGANVILLE, GA:
3,679,587, PUB. 6-23-2009. INT. CL. 42.
- FIEROTEC, INC., BALTIMORE, MD:
2,740,894, CANC. INT. CL. 16.
- FIFTH AVENUE OF LONG ISLAND REALTY ASSOCIATES, MANHASSET, NY:
3,678,230, PUB. 6-23-2009. MULTIPLE CLASS, INT. CLS. 35, 36, 37, 41 AND 45.
- FIGARO'S ITALIAN PIZZA, INC., SALEM, OR:
2,665,742, CANC. INT. CL. 35.
- FIGG ENGINEERING GROUP, TALLAHASSEE, FL:
3,681,508, MULTIPLE CLASS, INT. CLS. 35 AND 42.
- FIKE, WILLIAM C. JR., BLOOMINGTON, IL:
2,666,447, CANC. INT. CL. 25.
- FILLMORE DESIGN INC., LA CANADA, CA:
3,679,381, PUB. 6-23-2009. INT. CL. 18.
- FIMAT PREFERRED, LLC, SAN FRANCISCO, CA:
2,665,980, CANC. MULTIPLE CLASS, INT. CLS. 9 AND 36.
- FINAF 92, S.A., 08034 BARCELONA, SPAIN:
2,665,693, CANC. MULTIPLE CLASS, INT. CLS. 5 AND 30.
- FINANCIAL DEVELOPMENT HOLDCO LLC, RYE BROOK, NY:
3,678,517, PUB. 6-23-2009. INT. CL. 36.
- FINANCIAL OPERATIONS NETWORKS LLC, ATLANTA, GA:
3,681,667, INT. CL. 35.
- FINANCIAL RESEARCH ASSOCIATES, LLC., SANTA CRUZ, CA:
2,666,171, CANC. INT. CL. 35.
- FINDATA LIMITED, AUCKLAND, NEW ZEALAND:
3,678,729, PUB. 6-23-2009. INT. CL. 36.
- FINISHRICH, INC., NEW YORK, NY:
3,680,293, INT. CL. 41.
- FIRE MONITORING TECHNOLOGIES INTERNATIONAL INC., TORONTO, ONTARIO M5R 3K4, CANADA:
2,665,639, CANC. INT. CL. 42.
- FIRE POINT (UK) LTD., BERKSHIRE, UNITED KINGDOM:
2,665,164, CANC. INT. CL. 9.
2,665,165, CANC. INT. CL. 9.
- FIREFLY DISTILLERY, LLC, WADMALAW ISLAND, SC:
3,511,792, CANC. INT. CL. 33.
- FIRESTONE VINEYARD, L.P., SANTA BARBARA, CA:
3,680,510, INT. CL. 33.
- FIRMENICH SA, GENÈVE, SWITZERLAND:
3,680,007, PUB. 6-23-2009. MULTIPLE CLASS, INT. CLS. 1, 3, 16, 30 AND 35.
- FIRST BANK OF BEVERLY HILLS, F.S.B., CALABASAS, CA:
2,666,041, CANC. INT. CL. 36.
- FIRST CALL FAMILIES, SANDY, OR:
3,681,225, INT. CL. 45.
- FIRST COLONIAL GROUP, INC., NAZARETH, PA:
1,518,272, CANC. INT. CL. 36.
- FIRST HORIZON NATIONAL COPRORATION, MEMPHIS, TN:
3,681,327, INT. CL. 36.
- FIRST INTERSTATE BANCORP, LOS ANGELES, CA:
1,518,264, CANC. INT. CL. 36.
- FIRST IRELAND SPIRITS COMPANY LIMITED, ABBEY-LEIX, COUNTY LAOIS, IRELAND:
2,665,730, CANC. MULTIPLE CLASS, INT. CLS. 32 AND 33.
- FIRST NATIONAL OF NEBRASKA, INC., OMAHA, NE:
2,735,324, CANC. MULTIPLE CLASS, INT. CLS. 35, 40 AND 42.
- FIRST NIAGARA FINANCIAL GROUP, INC., LOCKPORT, NY:
3,680,064, MULTIPLE CLASS, INT. CLS. 35, 37 AND 39.
- FIRST TEAM REAL ESTATE - ORANGE COUNTY, COSTA MESA, CA:
1,546,692. REN. 8-3-09. INT. CL. 36.
- FIRST TO THE FINISH KIM AND MIKE VIANO SPORTS INC., CARLINVILLE, IL:
3,681,665, INT. CL. 35.
- FIRST UTAH BANK, SALT LAKE CITY, UT:
3,680,098, INT. CL. 36.
- FIRSTCALL STUDIO EQUIPMENT, SYLMAR, CA:
3,681,163, INT. CL. 6.
- FIRSTCREDIT INTERNATIONAL CORPORATION, AKRON, OH:
2,313,266. REN. 8-5-09. INT. CL. 36.
- FISCHER & KRECKE GMBH, BIELEFELD, FED REP GERMANY:
3,679,008, PUB. 6-23-2009. MULTIPLE CLASS, INT. CLS. 7 AND 9.
- FISCHER PRODUCTIONS, LLC, PARK CITY, UT:
3,678,519, PUB. 6-23-2009. MULTIPLE CLASS, INT. CLS. 9 AND 41.
- FISHER AND PAYKEL HEALTHCARE LIMITED, AUCKLAND, NEW ZEALAND:
3,678,842, PUB. 6-23-2009. INT. CL. 10.
- FISHER CLINICAL SERVICES UK LIMITED, UNITED KINGDOM:
3,679,928, PUB. 6-23-2009. MULTIPLE CLASS, INT. CLS. 16 AND 39.
- FISHER VINEYARDS, SANTA ROSA, CA:
3,680,212, INT. CL. 33.
- FISHER, HAIG, SANTA BARBARA, CA:
2,213,843, CANC. MULTIPLE CLASS, INT. CLS. 35 AND 42.
- FIVE SEASONS SPORTS COUNTRY CLUBS, LLC, COVINGTON, KY:
2,213,769, CANC. INT. CL. 41.
- FKG HOLDING LTD., LIECHTENSTEIN:
2,667,054, CANC. INT. CL. 35.
- FKP ARCHITECTS, INC., HOUSTON, TX:
3,678,393, PUB. 6-23-2009. INT. CL. 42.
- FLAGSHIP GAMES INTERNATIONAL, LLC, MIAMI, FL:
3,679,815, PUB. 6-23-2009. INT. CL. 35.

FLAMETREE GLASS, INC., ROSWELL, GA:
3,678,736, PUB. 6-23-2009. INT. CL. 35.

FLASH DIRECT & MEMORY SOLUTIONS LLC, LAKE FOREST, CA:
3,681,806, INT. CL. 35.

FLASH TECHNOLOGY CORPORATION OF AMERICA, FRANKLIN, TN:
2,665,658, CANC. INT. CL. 9.

FLD BIOMASS TECHNOLOGY, CHESTERVILLE, CANADA, DBA FLD BIOMASS TECHNOLOGY:
3,679,169, PUB. 6-23-2009. INT. CL. 7.

FLEET STREET, LTD., NEW YORK, NY:
3,679,665, PUB. 6-23-2009. INT. CL. 25.

FLEET WHOLESALE SUPPLY CO., INC., APPLETON, WI:
2,305,357. REN. 8-5-09. INT. CL. 1.

FLEXIBLE SOLUTIONS INTERNATIONAL INC., VICTORIA, CANADA:
3,679,584, PUB. 6-23-2009. INT. CL. 1.

FLINT GROUP INCORPORATED, PLYMOUTH, MI:
1,517,718, CANC. INT. CL. 2.

FLIPO GROUP, LASALLE, IL:
2,665,009, CANC. MULTIPLE CLASS, INT. CLS. 25 AND 35.

FLIR SYSTEMS, INC., WILSONVILLE, OR:
3,680,217, INT. CL. 9.

FLORAL FUTURES, INC., YPSILANTI, MI:
2,313,111. REN. 8-1-09. MULTIPLE CLASS, INT. CLS. 35 AND 42.

FLORDIS PTY LIMITED, GORDON, AUSTRALIA:
3,678,679, PUB. 6-23-2009. INT. CL. 5.

FLORES, MARY, STUDIO CITY, CA:
2,666,689, CANC. INT. CL. 41.

FLORISTS TRANSWORLD DELIVERY, INC., DOWNERS GROVE, IL:
2,664,996, CANC. MULTIPLE CLASS, INT. CLS. 36, 38 AND 39.

FLORISTS' MUTUAL INSURANCE COMPANY, EDWARDSVILLE, IL:
1,518,284, CANC. INT. CL. 36.

FLORMERA S.N.C. DI LAZZERI ANDREA & CO., I-39012 MERANO, BZ, ITALY:
2,665,492, CANC. INT. CL. 31.

FLOWMASTER, INC., SANTA ROSA, CA:
3,678,583, PUB. 6-23-2009. MULTIPLE CLASS, INT. CLS. 7, 16 AND 25.

FLUIDMASTER, INC., SAN JUAN CAPISTRANO, CA:
3,680,267, INT. CL. 11.

FM LEGAL CIRCLE SERVICES PVT. LTD., NOIDA, INDIA:
3,681,205, INT. CL. 35.

FMC CORPORATION, PHILADELPHIA, PA:
872,406. REN. 8-4-09. U.S. CL. 6 (INT. CL. 1).
1,121,687. REN. 8-3-09. INT. CL. 1.

FMR LLC, BOSTON, MA:
2,273,928. REN. 7-31-09. INT. CL. 36.

FN HOLDINGS, L.L.C., RICHMOND, VA:
3,680,733, INT. CL. 43.

FNF INTELLECTUAL PROPERTY HOLDINGS, INC., JACKSONVILLE, FL:
3,679,782, PUB. 6-23-2009. INT. CL. 42.

FOCUSED IMAGES PHOTOGRAPHY, INC., RESTON, VA:
2,666,310, CANC. INT. CL. 41.

FOGAL, DARLENE CARROLLE, CHENEY, WA:
2,665,500, CANC. INT. CL. 42.

FOLSOM RESEARCH, INC., RANCHO CORDOVA, CA:
2,666,585, CANC. INT. CL. 9.

FONTAINE, KATHRYN DOMINIS, SAN ANTONIO, TX:
3,680,667, INT. CL. 45.

FOOD GROUPIE, INC., MT. PROSPECT, IL:
2,213,674, CANC. INT. CL. 28.

FOPPA PEDRETTI S.P.A., GRUMELLO DEL MONTE (BERGAMO), ITALY:
2,215,080, CANC. INT. CL. 20.

FOR FITNESS SAKE, LLC, LEXINGTON, KY:
3,679,017, PUB. 6-23-2009. INT. CL. 41.

FORBES INC, NEW YORK, NY:
2,214,415, CANC. INT. CL. 36.

FORCHE, INC., LEVELLAND, TX:
1,547,844. REN. 8-3-09. INT. CL. 1.

FORD, THOMAS, C., AUSTIN, TX:
3,680,394, INT. CL. 3.

FORECROSS CORPORATION, SAN FRANCISCO, CA:
2,667,281, CANC. INT. CL. 9.

FOREMOST FARMS USA, COOPERATIVE, BARABOO, WI:
2,665,898, CANC. INT. CL. 29.

FOREMOST GROUPS, INC., EAST HANOVER, NJ:
3,679,414, PUB. 6-23-2009. INT. CL. 20.

FORENSIC SCIENCE SERVICE LTD., SOLIHULL, UNITED KINGDOM:
3,678,204, PUB. 6-23-2009. MULTIPLE CLASS, INT. CLS. 1, 9, 37, 41 AND 42.

FORESTWEB, INC., LOS ANGELES, CA:
2,665,332, CANC. INT. CL. 42.

FORM & FUNCTION DESIGN GROUP, LLC, BEVERLY HILLS, CA:
3,680,482, INT. CL. 42.

FORM FONTS, SAN DIEGO, CA:
3,680,260, INT. CL. 41.

FORMAX, INC., MOKENA, IL:
3,681,290, INT. CL. 7.

FORSYTHE TECHNOLOGY, INC., SKOKIE, IL:
3,679,569, PUB. 6-23-2009. INT. CL. 42.

FORTE INTERNET SOFTWARE, INC., ESCONDIDO, CA:
3,680,449, MULTIPLE CLASS, INT. CLS. 38 AND 41.

FORTE, INC., COLUMBIA, SC:
2,666,839, CANC. INT. CL. 16.

FORTNA, INC., WEST READING, PA:
3,681,529, INT. CL. 9.

FORZAFRUT USA, MAPLE VALLEY, WA:
3,678,949, PUB. 6-23-2009. INT. CL. 31.
3,678,950, PUB. 6-23-2009. INT. CL. 39.

FOSSIL, INC., RICHARDSON, TX:
2,007,109, AM. INT. CL. 9.
2,130,256, AM. MULTIPLE CLASS, INT. CLS. 9, 14, 18 AND 25.

FOSTER, JAMES W., SCOTTSDALE, AZ:
1,518,455, CANC. INT. CL. 42.

FOUNDATION DU FESTIVAL DE MONTREUX, TERRITET-MONTREUX, SWITZERLAND:
2,665,212, CANC. INT. CL. 41.

FOUNDATION FOR INTERNATIONAL MEDICAL RELIEF OF CHILDREN, PHILADELPHIA, PA:
3,679,300, PUB. 6-23-2009. INT. CL. 35.

FOUNDATION FOR OSTEOPOROSIS RESEARCH AND EDUCATION, OAKLAND, CA:
3,680,365, MULTIPLE CLASS, INT. CLS. 16 AND 44.

FOUNDATION INCUBATOR, INC., PALO ALTO, CA:
2,665,916, CANC. INT. CL. 35.

FOUNDATIONS, INC., MOORESTOWN, NJ:
3,679,566, PUB. 6-23-2009. INT. CL. 41.

FOUNDRY MEDIA, LLC, AUSTIN, TX:
3,678,683, PUB. 6-23-2009. INT. CL. 41.

FOUR M CAPITAL, LLC, VALHALLA, NY:
3,679,576, PUB. 6-23-2009. INT. CL. 43.

FOUR RIVERS SOFTWARE SYSTEMS, INC., MONROEVILLE, PA, HRL ASSOCIATES, INC., VIENNA, VA:
1,527,856. REN. 7-31-09. MULTIPLE CLASS, INT. CLS. 9 AND 16.

FOX SPORTS NET NATIONAL NETWORK HOLDINGS, LLC., LOS ANGELES, CA:
2,214,810, CANC. INT. CL. 41.

FOXCHASE IMAGE PRODUCTS, INC., STEVENS, PA:
3,679,204, PUB. 6-23-2009. MULTIPLE CLASS, INT. CLS. 35 AND 42.

FOY, BRIAN T, GIG HARBOR, WA, FORMERLY TACTICAL TECHNOLOGY LLC:
3,681,745, INT. CL. 35.

FPI FIREPLACE PRODUCTS INTERNATIONAL LTD., DELTA BRITISH COLUMBIA, CANADA:
3,680,456, INT. CL. 11.

FRACTURED ATLAS PRODUCTIONS, INC., NEW YORK, NY:
2,667,387, CANC. INT. CL. 41.

FRALICK, MARK C, MONTGOMERY, TX:
3,679,226, PUB. 6-23-2009. INT. CL. 42.

- FRAN WILSON CREATIVE COSMETICS, INC., NEW YORK, NY:
2,269,122. REN. 8-3-09. INT. CL. 3.
- FRANCE TELECOM INTERACTIVE, F-92130, FRANCE:
2,665,064, CANC. MULTIPLE CLASS, INT. CLS. 9, 38 AND 42.
- FRANCHISE BUSTERS, LLC, NAPLES, FL:
3,679,357, PUB. 6-23-2009. INT. CL. 45.
- FRANK, KELLY G., BOCA RATON, FL:
2,667,449, CANC. INT. CL. 25.
- FRANK'S NURSERY & CRAFTS, INC., DETROIT, MI:
1,518,190, CANC. INT. CL. 31.
- FRANKEN-INDUSTRIE GMBH & CO. KG, VEITSHÖCHEIM, FED REP GERMANY:
3,678,215, PUB. 5-13-2008. MULTIPLE CLASS, INT. CLS. 6, 12 AND 17.
3,681,705, MULTIPLE CLASS, INT. CLS. 6 AND 12.
- FRANKLIN COVEY, CO., SALT LAKE CITY, UT:
3,679,490, PUB. 6-23-2009. MULTIPLE CLASS, INT. CLS. 16 AND 41.
- FRANKSTONE, LAURA M., CHAPEL HILL, NC:
3,678,614, PUB. 6-23-2009. INT. CL. 41.
- FRATELLI BRANCA DISTILLERIE S.R.L., MILANO, ITALY:
3,636,087, COR. INT. CL. 33.
- FRAUNHOFER-GESELLSCHAFT ZUR; FÖRDERUNG DER ANGEWANDTEN FORSCHUNG E.V., FED REP GERMANY:
3,680,042, PUB. 6-23-2009. MULTIPLE CLASS, INT. CLS. 35 AND 40.
- FREDERIC MALLE CONSULTANTS, 75001 PARIS, FRANCE:
3,680,251, INT. CL. 3.
- FREEDOM ARIZONA INFORMATION, INC., CHANDLER, AZ, DBA FAZI:
3,628,497, COR. INT. CL. 35.
- FREEIQ, LLC, NORCROSS, GA:
3,678,243, PUB. 6-23-2009. INT. CL. 38.
- FREELIFE INTERNATIONAL HOLDINGS, LLC, PHOENIX, AZ:
3,679,267, PUB. 6-23-2009. INT. CL. 41.
- FREEMAN CAPITAL COMPANY, LAS VEGAS, NV:
2,667,409, CANC. INT. CL. 35.
- FRESENIUS MEDICAL CARE DEUTSCHLAND GMBH, BAD HOMBURG, FED REP GERMANY:
3,679,063, PUB. 6-23-2009. MULTIPLE CLASS, INT. CLS. 10 AND 44.
- FRESH EXPRESS INCORPORATED, SALINAS, CA:
2,363,302. REN. 8-5-09. INT. CL. 29.
- FRESH, LLC, BRENTWOOD, TN:
3,681,230, INT. CL. 9.
- FREUDENBERG, CARL, 69465 WEINHEIM, FED REP GERMANY, STACY FABRICS CORP., NEW YORK, NY:
863,578. REN. 8-1-09. U.S. CL. 42 (INT. CLS. 22, 24, 26 AND 27).
- FRICKE JR., LAWRENCE R., LISLE, IL, JECTRON COMPANY, THE, TOLEDO, OH:
668,428. REN. 8-6-09. U.S. CL. 44 (INT. CL. 5).
- FRIENDS OF THE ZOO, INC. OF KANSAS CITY, MISSOURI, KANSAS CITY, MO:
2,214,056, CANC. INT. CL. 35.
- FRIESLAND BRANDS BV, NETHERLANDS:
3,679,936, PUB. 6-23-2009. INT. CL. 29.
- FRITO-LAY NORTH AMERICA, INC., PLANO, TX:
2,666,843, CANC. MULTIPLE CLASS, INT. CLS. 29, 30 AND 35.
3,679,674, PUB. 6-23-2009. INT. CL. 30.
3,679,721, PUB. 6-23-2009. MULTIPLE CLASS, INT. CLS. 29 AND 30.
3,680,535, MULTIPLE CLASS, INT. CLS. 29 AND 30.
- FRITZ GYGER AG, SWITZERLAND:
3,679,930, PUB. 6-23-2009. MULTIPLE CLASS, INT. CLS. 7, 9, 40 AND 42.
- FRITZ, ANDREAS W., D-81679 MUNICH, FED REP GERMANY:
2,664,902, CANC. INT. CL. 14.
- FRITZ, STACY KAM, LEXINGTON, SC, DBA FIT2ORDER:
3,681,128, MULTIPLE CLASS, INT. CLS. 35, 41 AND 44.
- FRONT OFFICE STAFF, LODI, CA:
3,678,542, PUB. 6-23-2009. INT. CL. 35.
- FRONTERA CORPORATION, LOS ANGELES, CA:
2,667,063, CANC. INT. CL. 42.
- FRONTIER DISTRIBUTION LLC, NORWAY, IA:
2,263,361. REN. 8-3-09. MULTIPLE CLASS, INT. CLS. 3, 5, 29 AND 30.
- FRONTIER IMPORTS, INC., BROOKLYN, NY:
2,666,053, CANC. INT. CL. 29.
- FROSH, ROBIN D., SILVER SPRING, MD:
1,518,395, CANC. INT. CL. 41.
- FROST, LE ANN, PENNSAUKEN, NJ, DBA ALL DOGS POOP:
3,679,060, PUB. 6-23-2009. INT. CL. 37.
- FRP, INC., NASHVILLE, TN:
3,681,426, INT. CL. 16.
- FRUCOR BEVERAGES LTD., AUCKLAND, NEW ZEALAND:
2,666,132, CANC. INT. CL. 32.
- FSV PAYMENT SYSTEMS, INC., HOUSTON, TX:
3,679,549, PUB. 6-23-2009. INT. CL. 36.
- FU-HUA MA, STEVE, TORONTO, ONTARIO, CANADA:
2,665,317, CANC. INT. CL. 6.
- FUBICOM AB OY, FINLAND:
3,680,046, PUB. 6-23-2009. INT. CL. 12.
- FUCHS, SVETLANA, LAS VEGAS, NV:
3,680,155, MULTIPLE CLASS, INT. CLS. 14, 18, 25, 35, 42 AND 45.
- FUENTE MARKETING LTD., TORTOLA, BR. VIRGIN ISLANDS:
3,681,554, INT. CL. 34.
- FUGRO SEISMIC IMAGING, INC., HOUSTON, TX:
2,666,991, CANC. INT. CL. 9.
- FUHR, DAVID C., MILWAUKEE, WI, DBA THE PHILLY WAY:
3,679,251, PUB. 6-23-2009. INT. CL. 43.
- FUJI JUKOGYO KABUSHIKI KAISHA, SHINJUKU-KU TOKYO, JAPAN, TA FUJI HEAVY INDUSTRIES LTD.:
1,567,022. REN. 8-3-09. INT. CL. 12.
- FUJI JYUKOGYO KABUSHIKI KAISHA, SHINJUKU-KU, TOKYO, JAPAN, AKA FUJI HEAVY INDUSTRIES LTD.:
689,801. REN. 8-3-09. U.S. CL. 19 (INT. CL. 12).
- FUJI JYUKOGYO KABUSHIKI KAISHA, SHINJUKU-KU, TOKYO, JAPAN, DBA FUJI HEAVY INDUSTRIES, LTD.:
878,538. REN. 8-3-09. U.S. CL. 23 (INT. CLS. 9 AND 12).
- FUJITSU LIMITED, KANAGAWA, 211-8588, JAPAN:
3,681,030, INT. CL. 9.
- FUKUHARA, RYAN, FOREST GROVE, OR:
3,680,132, INT. CL. 25.
- FULL HOUSE RESORTS, INC., LAS VEGAS, NV:
3,680,085, INT. CL. 41.
- FULL SERVICE DELI DISTRIBUTORS, INC., DANA POINT, CA:
3,681,066, MULTIPLE CLASS, INT. CLS. 25, 30 AND 43.
- FULL SPEED AHEAD, INC., WOODINVILLE, WA:
3,680,553, INT. CL. 12.
- FULLBAR LLC, GREENWOOD VILLAGE, CO:
3,681,259, INT. CL. 5.
- FULLERTON-UNIVERSITY VILLAGE, LLC, FULLERTON, CA:
3,678,725, PUB. 6-23-2009. MULTIPLE CLASS, INT. CLS. 36 AND 43.
- FULTON FINANCIAL CORPORATION, LANCASTER, PA:
3,679,193, PUB. 6-23-2009. INT. CL. 36.
3,679,194, PUB. 6-23-2009. INT. CL. 36.
- FUN-4-ALL CORP., NEW YORK, NY:
2,666,226, CANC. INT. CL. 28.
- FUNCTIONAL TECHNOLOGIES CORPORATION, VANCOUVER, CANADA:
3,681,040, INT. CL. 5.
3,681,077, INT. CL. 5.
3,681,395, INT. CL. 30.
- FUNDACION MAPFRE, 28220 MAJADAHONDA MADRID, SPAIN:
1,548,608. REN. 8-3-09. INT. CL. 36.
- FUNKY DIVAS, LOS ANGELES, CA:
3,679,185, PUB. 6-23-2009. MULTIPLE CLASS, INT. CLS. 25 AND 41.

FUNKYTOWNMALL.COM, INC., NORTH PALM BEACH, FL:
3,679,586, PUB. 6-23-2009. INT. CL. 8.

FUNRISE TOYS LTD., TSIMSHATSUI, KOWLOON, HONG KONG:
1,547,521. REN. 8-3-09. INT. CL. 28.

FURLONG, MARK, GROVE CITY, OH:
3,679,540, PUB. 6-23-2009. INT. CL. 36.

FURRYTAILS LTD., LONDON, UNITED KINGDOM:
2,665,445, CANC. INT. CL. 28.

FUSION GOURMET, INC., GARDENA, CA:
3,681,657, INT. CL. 30.

FUTON EXPRES', INC., ST. LOUIS, MO:
2,213,816, CANC. INT. CL. 35.

FUTRIX IP LIMITED, WELLINGTON, NEW ZEALAND:
3,678,904, PUB. 6-23-2009. INT. CL. 9.
3,678,905, PUB. 6-23-2009. INT. CL. 9.

FUTURE ADS INC., IRVINE, CA:
3,679,407, PUB. 6-23-2009. INT. CL. 41.

FUTURE FABRICS, INC, LOS ANGELES, CA, DBA ROSE FABRICS:
2,665,902, CANC. INT. CL. 24.

G & S COLLECTION INC., LOS ANGELES, CA, DBA GRACE IN LA:
3,681,131, INT. CL. 25.

G NELSON INSURANCE AGENCY INC., SANDY, UT:
3,679,320, PUB. 6-23-2009. INT. CL. 36.

GA MODEFINE S.A., MENDRISIO CH6850, SWITZERLAND:
3,678,765, PUB. 6-23-2009. INT. CL. 3.

GABRIELLE A. FRIEDLAND, LAS VEGAS, NV:
3,679,161, PUB. 6-23-2009. INT. CL. 35.

GADO S.R.L., ITALY:
3,679,955, PUB. 6-23-2009. INT. CL. 3.

GALKIN, KATHLEEN, ASHBURN, VA:
3,681,655, INT. CL. 41.

GALLAGHER, BABARA M., DENVER, CO:
2,666,860, CANC. INT. CL. 16.

GALLAGHER, PATRICK, CHINO, CA:
3,681,330, INT. CL. 25.

GALLAHER LIMITED, WEYBRIDGE, SURREY, UNITED KINGDOM:
3,680,591, INT. CL. 34.

GAMBRO RENAL PRODUCTS, INC., LAKEWOOD, CO:
2,223,225. REN. 8-6-09. INT. CL. 10.

GAMCO INVESTORS, INC., RYE, NY:
3,680,703, INT. CL. 36.

GAME SHOW NETWORK, LLC, SANTA MONICA, CA:
3,681,024, INT. CL. 41.

GAMES FOR ALL REASONS, LLP, ARLINGTON, MA:
2,666,736, CANC. INT. CL. 28.

GAMMA PLASTICS, INC., SAN DIEGO, CA:
2,665,461, CANC. INT. CL. 21.

GARCIA GROUP, INC., ATLANTA, GA:
2,264,078. REN. 7-31-09. INT. CL. 35.

GARCIA, RICHARD J., VISALIA, CA:
2,256,466. REN. 7-31-09. INT. CL. 21.

GARDEN STATE BULB COMPANY, VINELAND, NJ:
3,681,123, INT. CL. 31.

GARDENBURGER, INC., IRVINE, CA:
2,214,768, CANC. INT. CL. 29.

GARRETT, KAREN M., OYSTERVILLE, WA:
2,667,452, CANC. INT. CL. 41.

GAS TURBINE EFFICIENCY PLC, LONDON, ENGLAND:
3,678,706, PUB. 3-24-2009. INT. CL. 37.

GASWORK.COM, INC., SULPHUR SPRINGS, TX:
2,214,280, CANC. INT. CL. 35.

GATON TECHNOLOGIES LTD., TEL-AVIV, ISRAEL:
2,665,306, CANC. MULTIPLE CLASS, INT. CLS. 9 AND 38.

GAYLEE/BITNER TOOLING TECHNOLOGIES, INC., SOUTH BELOIT, IL:
3,678,825, PUB. 6-23-2009. INT. CL. 7.

GAYLORD ENTERTAINMENT COMPANY, NASHVILLE, TN:
2,735,041, CANC. INT. CL. 41.

GAYMAN, ROBERT, SAN DIEGO, CA:
3,679,614, PUB. 6-23-2009. MULTIPLE CLASS, INT. CLS.

42 AND 44.

GB II CORPORATION, TUALATIN, OR, DBA COLUMBIA RIVER KNIFE & TOOL COMPANY:
3,681,248, INT. CL. 8.

GB INTERNET SOLUTIONS INC., REGINA, CANADA:
3,679,597, PUB. 6-23-2009. INT. CL. 42.
3,679,604, PUB. 6-23-2009. INT. CL. 43.

GBP SOFTWARE, LLC, RESTON, VA, DBA CLUETRUST:
3,681,372, INT. CL. 9.

GDC ENTERPRISES, INC., GAINESVILLE, GA:
3,678,995, PUB. 6-23-2009. INT. CL. 6.

GDG ENTERPRISES LLC, PHOENIX, AZ:
3,680,344, INT. CL. 43.

GE MONEY BANK, SALT LAKE CITY, UT:
3,680,179, INT. CL. 36.

GEA GROUP AKTIENGESELLSCHAFT, 44809 BOCHUM, FED REP GERMANY:
3,679,925, PUB. 6-23-2009. MULTIPLE CLASS, INT. CLS. 11 AND 37.

GEA GROUP AKTIENGESELLSCHAFT, FED REP GERMANY:
3,679,926, PUB. 6-23-2009. MULTIPLE CLASS, INT. CLS. 11 AND 37.

GEA PROCESS ENGINEERING A/S, SOEBORG, DENMARK, DEC INTERNATIONAL, INC., MADISON, WI:
1,119,526. REN. 8-3-09. INT. CL. 7.

GEAN, KASANDRA T., BELMONT, CA:
3,678,562, PUB. 6-23-2009. MULTIPLE CLASS, INT. CLS. 9 AND 41.

GEBRÜDER LÖDIGE; MASCHINENBAU-GESELLSCHAFT; MIT BESCHRÄNKTER HAFT, FED REP GERMANY:
3,679,899, PUB. 6-23-2009. MULTIPLE CLASS, INT. CLS. 7 AND 11.

GEELY HOLDING GROUP CO., LTD., CHINA:
3,679,901, PUB. 6-23-2009. INT. CL. 12.

GEIGER, LOUIS C., SEVERNA PARK, MD:
2,215,170, CANC. INT. CL. 42.

GELSEY, ANDREW, WEST BLOOMFIELD, MI:
3,681,179, INT. CL. 31.

GELSUS RESEARCH & CONSULTING, INC., NEW YORK, NY:
2,665,200, CANC. INT. CL. 42.

GEMMILL, TERRENCE N., MILL CREEK, WA:
3,681,587, INT. CL. 7.

GEMPLUS, GEMENOS, FRANCE:
2,665,302, CANC. MULTIPLE CLASS, INT. CLS. 16 AND 42.

GENEANET, 75003 PARIS, FRANCE:
2,682,531, CANC. INT. CL. 9.

GENENEWS LIMITED, RICHMOND HILL, CANADA:
3,678,147, PUB. 9-30-2008. MULTIPLE CLASS, INT. CLS. 1, 5, 42 AND 44.

GENERAL ALUM & CHEMICAL CORPORATION, SEASPORT, ME:
1,546,953. REN. 8-1-09. INT. CL. 1.

GENERAL ATOMICS INTERNATIONAL SERVICES CORPORATION, FORT MADISON, IA:
2,298,648. REN. 8-4-09. INT. CL. 1.

GENERAL CABLE TECHNOLOGIES CORPORATION, HIGHLAND HEIGHTS, KY:
3,680,736, INT. CL. 36.

GENERAL ELECTRIC COMPANY, CLEVELAND, OH:
881,579. REN. 8-5-09. U.S. CL. 16 (INT. CL. 1).

GENERAL ELECTRIC COMPANY, SCHENECTADY, NY:
3,681,469, INT. CL. 35.
3,681,516, MULTIPLE CLASS, INT. CLS. 7 AND 11.

GENERAL HYDROPONICS, INC., SEBASTOPOL, CA:
2,287,107. REN. 8-3-09. INT. CL. 11.
3,678,935, PUB. 6-23-2009. INT. CL. 21.

GENERAL MILLS IP HOLDINGS II, LLC, MINNEAPOLIS, MN:
2,667,272, CANC. INT. CL. 30.

GENERAL MOTORS CORPORATION, DETROIT, MI:
2,214,881, CANC. INT. CL. 12.
2,666,513, CANC. INT. CL. 36.

GENERATION PARTNERS MANAGEMENT LLC, NEW YORK, NY:
2,898,471, COR. INT. CL. 36.

- GENERATIONS OF SONOMA, LLC, SONOMA, CA:
3,681,346, INT. CL. 33.
- GENERATION21 LEARNING SYSTEMS, LLC, GOLDEN, CO:
2,665,441, CANC. MULTIPLE CLASS, INT. CLS. 9 AND 41.
- GENERITON CO., LTD., HSINCHU CITY, TAIWAN:
3,680,558, INT. CL. 9.
3,680,559, INT. CL. 42.
- GENOLOGICS LIFE SCIENCES SOFTWARE, INC., VICTORIA, B.C., CANADA:
3,678,819, PUB. 2-17-2009. INT. CL. 42.
- GENOVIQUE SPECIALTIES HOLDINGS CORPORATION, ROSEMONT, IL:
3,680,257, INT. CL. 1.
- GENUINE HEALTH INC., TORONTO, ONTARIO, CANADA:
2,665,910, CANC. MULTIPLE CLASS, INT. CLS. 5, 29, 30 AND 35.
- GENX INTERNATIONAL, INC., GUILFORD, CT:
3,678,187, PUB. 6-23-2009. INT. CL. 9.
- GEOFFREY, LLC, WAYNE, NJ:
2,667,399, CANC. INT. CL. 28.
3,680,872, INT. CL. 28.
- GEORGE FISCHER SLOANE, INC., LITTLE ROCK, AR:
3,679,655, PUB. 6-23-2009. INT. CL. 9.
- GEORGE, DAVID, HOUSTON, TX:
3,681,052, INT. CL. 36.
3,681,053, INT. CL. 36.
3,681,114, INT. CL. 36.
- GEOTECHNICAL & ENVIRONMENTAL SERVICES, INC., LAS VEGAS, NV:
3,680,136, INT. CL. 42.
- GERBIG SNELL/WEISHEIMER ADVERTISING, LLC, WESTERVILLE, OH:
3,680,619, INT. CL. 35.
- GERDING/EDLEN DEVELOPMENT COMPANY, LLC, PORTLAND, OR:
3,678,368, PUB. 6-23-2009. MULTIPLE CLASS, INT. CLS. 37 AND 42.
- GERMANIA OF AMERICA, INC., ATLANTA, GA:
2,283,080, REN. 7-31-09. MULTIPLE CLASS, INT. CLS. 36 AND 37.
- GERUS, SHEILA JANE, PENNINGTON, NJ:
3,680,262, MULTIPLE CLASS, INT. CLS. 35, 41, 42 AND 44.
- GES EXPOSITION SERVICES, INC., LAS VEGAS, NV:
3,678,170, PUB. 6-23-2009. INT. CL. 35.
- GET GOOD, LLC, BETHESDA, MD:
3,678,673, PUB. 6-23-2009. INT. CL. 25.
- GETTY IMAGES (US), INC., SEATTLE, WA, FRIED KANNEY ASSOCIATES LTD., NEW YORK, NY:
1,121,161, REN. 8-1-09. INT. CL. 35.
- GFSI, INC., LENEXA, KS:
2,214,609, CANC. INT. CL. 25.
- GIANNI VERSACE S.P.A., 20121 MILAN, ITALY, GIANNI VERSACE & C. S.A.S., 89100 REGGIO CALABRIA, ITALY:
1,123,748, REN. 8-4-09. INT. CL. 25.
- GIANNI VERSACE S.P.A., MILAN, ITALY:
2,278,257, REN. 8-3-09. INT. CL. 42.
- GIBLIM DESIGN PTY. LIMITED, TELOPEA, AUSTRALIA:
3,681,334, INT. CL. 9.
- GIBMEY, THOMAS R., PORT ST. LUCIE, FL:
2,214,673, CANC. INT. CL. 28.
- GIBSON GUITAR CORPORATION, NASHVILLE, TN, WURLITZER COMPANY, THE, CHICAGO, IL:
865,930, REN. 7-31-09. U.S. CL. 101 (INT. CL. 35).
- GIBSON, KATHERINE D., ARLINGTON, TX, DBA KATE'S TRACK SHACK:
3,679,248, PUB. 6-23-2009. INT. CL. 9.
- GIESECKE & DEVRIENT GMBH, MUNICH, FED REP GERMANY:
2,665,489, CANC. MULTIPLE CLASS, INT. CLS. 9, 16, 38 AND 42.
- GILLESPIE, JERRY C., UTICA, KS AND GILLESPI, KAREN D., UTICA, KS:
1,562,191, REN. 8-3-09. INT. CL. 20.
- GILPIN, INC., DECATUR, IN:
3,678,640, PUB. 6-23-2009. INT. CL. 6.
- GILSON, CLAIRE, CHILMARK, MA:
1,518,536, CANC. INT. CL. 42.
- GILT GROUPE, INC., NEW YORK, NY:
3,680,404, INT. CL. 35.
- GINGER CONSULTING, LLC, MINNEAPOLIS, MN:
3,679,138, PUB. 6-23-2009. INT. CL. 35.
- GINSANA SA, SWITZERLAND:
3,679,893, PUB. 6-23-2009. INT. CL. 5.
- GIORDANO, MICHAEL P., ORLANDO, FL:
3,680,742, INT. CL. 28.
- GIRL SCOUTS OF THE UNITED STATES OF AMERICA, NEW YORK, NY:
3,680,746, INT. CL. 41.
- GIVAUDAN S.A., SWITZERLAND:
3,679,932, PUB. 6-23-2009. INT. CL. 1.
- GIVAUDAN SA, 1214 VERNIER, SWITZERLAND:
2,666,120, CANC. MULTIPLE CLASS, INT. CLS. 1 AND 42.
- GLAMI CO., LTD., KANGWON-DO, REPUBLIC OF KOREA:
3,680,143, MULTIPLE CLASS, INT. CLS. 35 AND 40.
- GLAS WELD SYSTEMS, INC., BEND, OR:
2,260,892, AM. INT. CL. 8.
- GLASS ART IMAGING, LLC, GREER, SC:
3,681,804, INT. CL. 40.
- GLAXO GROUP LIMITED, GREENFORD, MIDDLESEX, UNITED KINGDOM:
2,666,550, CANC. INT. CL. 5.
- GLAXOSMITHKLINE BIOLOGICALS, S.A., RIXENSART, BELGIUM:
3,678,771, PUB. 6-23-2009. INT. CL. 5.
- GLAZER-KENNEDY INSIDER'S CIRCLE, LLC, TOWSON, MD:
3,680,235, MULTIPLE CLASS, INT. CLS. 9, 16, 25 AND 41.
- GLENN MILLER LAW, INC., REDWOOD CITY, CA:
3,679,512, PUB. 6-23-2009. INT. CL. 45.
- GLOBAL CREDIT ADVISERS LLC, NEW YORK, NY:
3,678,449, PUB. 6-23-2009. INT. CL. 36.
- GLOBAL CURRENTS INVESTMENT MANAGEMENT LLC, BALTIMORE, MD:
3,681,010, INT. CL. 36.
- GLOBAL EDUCATIONAL CONCEPTS, INC., NASHVILLE, TN:
3,679,214, PUB. 6-23-2009. MULTIPLE CLASS, INT. CLS. 35 AND 39.
- GLOBAL FOODS INTERNATIONAL, INC., SCHILLER PARK, IL:
3,679,425, PUB. 6-23-2009. INT. CL. 29.
- GLOBAL GAMING GROUP, INC., LAS VEGAS, NV:
3,681,212, INT. CL. 9.
- GLOBAL HEALTHCARE EXCHANGE, LLC, LOUISVILLE, CO:
3,681,736, INT. CL. 42.
- GLOBAL MARKETING LIGHTING, LLC, PARSIPPANY, NJ:
3,678,655, PUB. 6-23-2009. INT. CL. 11.
- GLOBAL NEOTECH CORP., WORCESTER, MA:
2,667,453, CANC. INT. CL. 35.
- GLOBAL NETWORK SYSTEMS OF MARYLAND, INC., ROCKVILLE, MD, TAGNS:
3,678,925, PUB. 6-23-2009. INT. CL. 42.
- GLOBAL TELEMANN SYSTEMS, INC., SAN JOSE, CA:
2,665,296, CANC. INT. CL. 9.
- GLOBAL VINEYARD IMPORTERS, INC., BERKELEY, CA:
2,215,449, CANC. INT. CL. 33.
- GLOBALCOM INC., CHICAGO, IL:
3,678,740, PUB. 6-23-2009. INT. CL. 38.
- GLOBALPARK AG, FED REP GERMANY:
3,679,883, PUB. 6-23-2009. MULTIPLE CLASS, INT. CLS. 9, 35 AND 42.
- GLOBALSTREAMS, INC., EMERYVILLE, CA:
2,666,147, CANC. INT. CL. 9.
- GLOBO MEDIA, S.A., 28036 MADRID, SPAIN:
2,666,201, CANC. INT. CL. 41.
- GLOBUS MEDICAL, INC., AUDUBON, PA:
3,680,509, INT. CL. 10.

GLOECKNER, KATHRYN, MISSION VIEJO, CA, DBA CORAL BLUE DESIGNS:
3,679,265, PUB. 6-23-2009. INT. CL. 42.

GMA NETWORK, INCORPORATED, QUEZON CITY, PHILIPPINES:
3,532,413, COR. MULTIPLE CLASS, INT. CLS. 38 AND 41.

GN RESOUND A/S, DENMARK:
3,679,933, PUB. 6-23-2009. INT. CL. 10.

GNOSIS S.P.A., DESIO (MI), ITALY:
3,680,332, INT. CL. 5.

GNS DEVELOPMENT CORPORATION, NORWALK, CA, DBA GOLF N STUFF:
1,518,375, CANC. INT. CL. 41.

GO FAST SPORTS & BEVERAGE COMPANY, DENVER, CO:
3,680,887, INT. CL. 32.

GOAUPAIR.COM, INC., SALT LAKE CITY, UT:
2,667,267, CANC. INT. CL. 35.

GODINET, WAYNE P., OCEANSIDE, CA:
3,679,361, PUB. 6-23-2009. INT. CL. 35.

GOLD BARS, INC., SCOTTSDALE, AZ:
1,518,511, CANC. INT. CL. 42.

GOLDART INTERNATIONAL INC., NEW YORK, NY:
3,681,540, MULTIPLE CLASS, INT. CLS. 14 AND 19.

GOLDEN PRIDE, INC., WEST PALM BEACH, FL:
2,667,291, CANC. INT. CL. 5.

GOLDEN ROAD FOOD SERVICES, LLC, MANHATTAN BEACH, CA:
3,680,893, MULTIPLE CLASS, INT. CLS. 39 AND 43.

GOLDEN, JOSEPH, HOPLAND, CA:
3,680,597, INT. CL. 44.

GOLDTECH, INC., SADDLE RIVER, NJ:
3,681,777, INT. CL. 9.

GOLDWATER'S FOODS OF ARIZONA, SCOTTSDALE, AZ:
2,258,695, REN. 8-3-09. MULTIPLE CLASS, INT. CLS. 16, 29 AND 30.
2,258,695, CANC. INT. CL. 32.

GOLF CAR SYSTEMS, INCORPORATED, CLEARWATER, FL:
1,518,300, CANC. INT. CL. 37.

GOLF LIQUIDATION USA, LLC, MINNEAPOLIS, MN:
3,679,250, PUB. 6-23-2009. INT. CL. 35.

GOLGI LLC, FRISCO, TX:
3,678,899, PUB. 6-23-2009. INT. CL. 9.

GOMEZ DOMENECH, JOSE ANTONIO, CARBONDALE, CO:
2,666,546, CANC. INT. CL. 41.

GOOD RIDDANCE, INC., BUFFALO, NY:
1,518,311, CANC. INT. CL. 37.

GOODCENTS CONCEPTS, INC., ATLANTA, GA:
2,267,718, REN. 7-31-09. INT. CL. 42.

GOODGIRLS PR. TARZANA, CA:
3,679,353, PUB. 6-23-2009. INT. CL. 35.

GOODLIFE.COM, INC., SANTA MONICA, CA:
3,679,446, PUB. 6-23-2009. INT. CL. 35.
3,679,448, PUB. 6-23-2009. INT. CL. 38.
3,679,450, PUB. 6-23-2009. INT. CL. 41.

GORDON E. CONWELL ASSOCIATES, INC., FLOURTOWN, PA:
2,667,371, CANC. INT. CL. 36.

GOSSETT, GREGORY, OGDEN, UT:
3,681,143, INT. CL. 30.

GOVEL, GRANT, BUENA PARK, CA:
3,679,682, PUB. 6-23-2009. INT. CL. 32.

GOYA FOODS, INC., SECAUCUS, NJ:
2,264,042, REN. 8-5-09. INT. CL. 30.

GRADLAUNCH, LLC, AUSTIN, TX:
3,679,638, PUB. 6-23-2009. INT. CL. 41.

GRAFF FAUCETS, MILWAUKEE, WI:
3,678,745, PUB. 6-23-2009. INT. CL. 11.

GRAND BRANDS, LLC, GRAND RAPIDS, MI, AKA LANDER BRANDS:
2,666,317, CANC. INT. CL. 3.

GRAND CANAL SHOPS MALL CONSTRUCTION, LLC, LAS VEGAS, NV:
2,665,987, CANC. INT. CL. 41.

GRAND SIERRA OPERATING CORP., RENO, NV:
3,680,192, MULTIPLE CLASS, INT. CLS. 36 AND 43.

GRANDUCA OPERATING COMPANY, L.P., HOUSTON, TX:
3,678,154, PUB. 6-23-2009. INT. CL. 43.

GRANT COMPANY, L.L.C., THE, OVERLAND PARK, KS:
3,680,551, INT. CL. 35.

GRAPHIC SHOP, INC., THE, BALTIMORE, MD:
2,664,986, CANC. INT. CL. 25.

GRAVER TECHNOLOGIES LLC, GLASGOW, DE:
3,680,929, INT. CL. 11.

GREAT AMERICAN MARKETING, INC., VALENCIA, CA:
3,678,974, PUB. 6-23-2009. MULTIPLE CLASS, INT. CLS. 8, 9, 16, 17 AND 21.

GREAT HARVEST FRANCHISING, INC., DILLON, MT:
1,518,173, CANC. INT. CL. 30.

GREAT LAKES CHEESE COMPANY, INC., HIRAM, OH:
3,679,812, PUB. 6-23-2009. INT. CL. 29.

GREAT LAKES ORTHODONTICS, LTD., TONAWANDA, NY:
3,680,849, MULTIPLE CLASS, INT. CLS. 3 AND 5.

GREAT-WEST LIFE & ANNUITY INSURANCE COMPANY, GREENWOOD VILLAGE, CO:
3,681,189, INT. CL. 36.

GREAT-5 INTERNATIONAL INC., L3P 6G8, CANADA:
3,678,783, PUB. 6-23-2009. INT. CL. 3.

GREATSCAPE ADVENTURES, INC., SANTA MONICA, CA:
2,666,508, CANC. INT. CL. 39.

GREATLAND ELECTRONICS TAIWAN LTD., HSIN TIEN, TAIPE HSIEN, TAIWAN:
3,678,638, PUB. 6-23-2009. INT. CL. 9.

GRECCO, RICHARD J/GRASSO, SYLVIA L, VICTORVILLE, CA, DBA SICOTIC WEAR:
3,680,921, INT. CL. 25.

GREEN BLUE INSTITUTE, CHARLOTTESVILLE, VA, AKA GREENBLUE:
3,679,080, PUB. 6-23-2009. INT. CL. 42.

GREEN SCHOOLS ALLIANCE, INC., NEW YORK, NY:
3,681,733, MULTIPLE CLASS, INT. CLS. 35 AND 41.

GREEN VALLEY RANCH GAMING, LLC, LAS VEGAS, NV:
3,679,186, PUB. 6-23-2009. INT. CL. 43.

GREENBERG, STEPHEN, T., WOODBURY, NY:
3,681,345, INT. CL. 44.

GREENCODE TECHNOLOGIES, INC., MIRAMAR, FL:
3,681,218, INT. CL. 35.

GREENLEAF, MICHAEL, SEATTLE, WA:
3,680,281, INT. CL. 9.

GREENLIGHT LIMITED, UNITED KINGDOM:
3,679,962, PUB. 6-23-2009. MULTIPLE CLASS, INT. CLS. 9, 38 AND 41.

GREENMASTER INDUSTRIAL CORP., TAIPING, TAIWAN:
3,680,407, INT. CL. 28.

GREENPAGES, INC., KITTERY, ME:
3,681,732, INT. CL. 42.

GREENSPRING MEDIA GROUP INC, MINNEAPOLIS, MN:
3,681,286, INT. CL. 35.

GREENSPRING MEDIA GROUP, INC, MINNEAPOLIS, MN:
2,214,289, CANC. INT. CL. 42.

GREENSTONE VENTURES, INC., OAKLAND, CA:
3,678,864, PUB. 3-17-2009. MULTIPLE CLASS, INT. CLS. 9, 16 AND 41.

GREENWOODY, LTD., NORTH CANTON, OH:
3,679,191, PUB. 6-23-2009. MULTIPLE CLASS, INT. CLS. 25 AND 28.

GRESTEL-PRODUCTOS CERAMICOS, S.A., PORTUGAL:
3,679,959, PUB. 6-23-2009. INT. CL. 21.

GREYSTONE MEDICAL, INC., MEMPHIS, TN:
3,680,481, INT. CL. 5.

GRIDPOINT, INC., ARLINGTON, VA:
3,680,522, INT. CL. 9.
3,680,523, INT. CL. 35.

GRIEVE CORPORATION, THE, ROUND LAKE, IL:
1,124,692, REN. 7-31-09. INT. CL. 11.

GRIFFIN, GERALD, REDFORD, MI:
3,678,581, PUB. 6-23-2009. INT. CL. 41.

GRIFFIN, ROMINA, VAN NUYS, CA:
3,681,076, INT. CL. 18.

- GRILLSLINGER INTERNATIONAL LIMITED, WELLINGTON, NEW ZEALAND:
3,680,875, INT. CL. 8.
- GRIMCO, INC., FENTON, MO:
3,678,497, PUB. 6-23-2009. INT. CL. 6.
3,678,498, PUB. 6-23-2009. INT. CL. 6.
- GRIMMWAY ENTERPRISES, INC., BAKERSFIELD, CA:
3,679,142, PUB. 6-23-2009. MULTIPLE CLASS, INT. CLS. 29 AND 31.
- GROH PRODUCTIONS, INC., CHICAGO, IL:
3,679,051, PUB. 6-23-2009. MULTIPLE CLASS, INT. CLS. 35 AND 41.
- GROPPETTI LTD., INC., VISALIA, CA:
3,679,003, PUB. 6-23-2009. MULTIPLE CLASS, INT. CLS. 35, 37 AND 39.
- GROUP TECHNOLOGIES AG, EISENACH, FED REP GERMANY:
2,667,037, CANC. INT. CL. 9.
2,667,038, CANC. INT. CL. 9.
2,667,039, CANC. INT. CL. 9.
- GROUP 1 FOODS, INC., WESTPORT, CT:
2,666,251, CANC. INT. CL. 29.
- GROVE MEDICAL LLC, MIAMI, FL:
3,681,073, INT. CL. 10.
3,681,074, INT. CL. 10.
- GROVER MUSICAL PRODUCTS, INC., CLEVELAND, OH:
2,667,204, CANC. MULTIPLE CLASS, INT. CLS. 15 AND 28.
2,667,247, CANC. MULTIPLE CLASS, INT. CLS. 15 AND 28.
- GRQ (CORPORATE) LIMITED, HARPENDEN, UNITED KINGDOM:
3,678,328, PUB. 3-31-2009. MULTIPLE CLASS, INT. CLS. 16, 35 AND 41.
- GRUPO FITSIMONS SOCIEDAD ANONIMA, SABANA SUR, SAN JOSE, COSTA RICA:
2,665,207, CANC. INT. CL. 41.
- GRUPPO EDITORIALE OGGI, INC., WESTWOOD, NJ:
2,666,249, CANC. INT. CL. 16.
- GRZESIAK, RAY, NEW LENOX, IL:
3,681,004, INT. CL. 28.
- GSF SYSTEMS, LLC, KATY, TX:
3,679,247, PUB. 6-23-2009. INT. CL. 41.
- GUADALUPE WEDDING CHAPEL, LOS ANGELES, CA:
2,666,610, CANC. INT. CL. 42.
- GUARD-A-KID FRANCHISING CORP., MIAMI, FL, DBA GUARD-A-KID:
3,678,351, PUB. 6-23-2009. INT. CL. 9.
- GUARDED NETWORKS, INC., COOPER CITY, FL:
2,666,645, CANC. MULTIPLE CLASS, INT. CLS. 41 AND 42.
- GUARDIAN TELEVISION ENTERPRISES, INC., COLUMBUS, OH:
3,680,450, MULTIPLE CLASS, INT. CLS. 38 AND 41.
3,680,451, MULTIPLE CLASS, INT. CLS. 38 AND 41.
3,680,452, MULTIPLE CLASS, INT. CLS. 38 AND 41.
3,680,453, MULTIPLE CLASS, INT. CLS. 38 AND 41.
3,680,454, MULTIPLE CLASS, INT. CLS. 38 AND 41.
3,680,455, MULTIPLE CLASS, INT. CLS. 38 AND 41.
- GUERLAIN S.A., 75008 PARIS, FRANCE:
2,665,988, CANC. INT. CL. 3.
- GUERRA NUT SHELLING CO., INC., HOLLISTER, CA, DBA GUERRA NUT SHELLING COMPANY:
1,123,389, REN. 7-31-09. MULTIPLE CLASS, INT. CLS. 29 AND 31.
- GUESTLOGIX INC., TORONTO, CANADA:
3,681,731, INT. CL. 36.
- GUIDED DELIVERY SYSTEMS INC., SANTA CLARA, CA:
3,681,583, INT. CL. 10.
- GUIDEPOSTS A CHURCH CORPORATION, CARMEL, NY:
3,681,769, INT. CL. 16.
- GUILD OF CARILLONNEURS IN NORTH AMERICA, THE, BERKELEY, CA:
2,667,443, CANC. INT. CL. 16.
- GUITAR CENTER, INC., WESTLAKE VILLAGE, CA:
3,681,099, INT. CL. 35.
3,681,431, INT. CL. 41.
- GULF COMPUTERS, INC., QUINCY, MA:
2,667,417, CANC. INT. CL. 9.
- GUM PRODUCTS INTERNATIONAL INC., NEWMARKET, ONTARIO, CANADA:
2,250,548, REN. 7-31-09. INT. CL. 30.
- GUST, DAVID, CHICAGO, IL:
3,680,384, MULTIPLE CLASS, INT. CLS. 9 AND 10.
- GUYOT DESIGNS, LLC, DEER ISLE, ME:
3,678,934, PUB. 6-23-2009. INT. CL. 11.
- GWENDOLYN FREMPONG BOADU, POUND RIDGE, NY:
3,680,487, MULTIPLE CLASS, INT. CLS. 25 AND 35.
- GWR MEDICAL, L.L.P., CHADDS FORD, PA:
2,215,226, CANC. INT. CL. 5.
- H. BEST LTD., NEW YORK, NY:
3,681,504, INT. CL. 25.
- H.H. FLUORESCENT PARTS, INC., CHELTENHAM, PA:
2,665,912, CANC. INT. CL. 11.
- HA PRODUCTIONS, LLC., CLEARWATER, FL:
2,667,259, CANC. INT. CL. 9.
- HADIYA M JOHNSON AND HILARY A. OLIPHANT PARTNERSHIP, THE, BROOKLYN, NY:
2,665,689, CANC. INT. CL. 3.
- HADLEY, JEFFREY R., COLORADO SPRINGS, CO:
2,666,154, CANC. INT. CL. 42.
- HAFNER, STONE MOUNTAIN, GA:
2,666,512, CANC. INT. CL. 29.
- HAGEMEYER NORTH AMERICA, INC., CHARLESTON, SC:
3,680,080, INT. CL. 9.
3,681,485, INT. CL. 6.
- HAIN CELESTIAL GROUP, INC., THE, MELVILLE, NY:
3,680,785, INT. CL. 30.
- HAIR FLAIR LIMITED, UNITED KINGDOM:
3,679,861, PUB. 6-23-2009. MULTIPLE CLASS, INT. CLS. 3, 8 AND 26.
- HAJARI, KHOSRO B., WESLEY CHAPEL, FL:
3,680,651, INT. CL. 28.
- HALBRO, LLC, CHERRY HILL, NJ:
3,552,395, CANC. IIRN. RESTORED TO S.N. 76-579,951.
- HALLIBURTON ENERGY SERVICES, INC., CARROLLTON, TX:
695,508, REN. 8-3-09. U.S. CL. 6 (INT. CL. 1).
3,679,756, PUB. 6-23-2009. INT. CL. 1.
3,681,541, INT. CL. 40.
- HAMAMATSU PHOTONICS K.K., SHIZUOKA, JAPAN:
3,678,682, PUB. 6-23-2009. INT. CL. 9.
- HAMILTON BONADUZ AG, 7402 BONADUZ, SWITZERLAND:
2,666,522, CANC. INT. CL. 9.
- HAMPDEN PAPERS, INC., HOLYOKE, MA:
3,678,528, PUB. 6-23-2009. INT. CL. 16.
- HAMS AND FAD LIMITED, LONDON, UNITED KINGDOM:
3,680,305, INT. CL. 44.
- HANCOCK LUMBER COMPANY, INC., CASCO, ME:
3,679,534, PUB. 6-23-2009. INT. CL. 42.
- HANDBAG MILAN, NEW YORK, NY:
3,681,365, INT. CL. 18.
- HANDS ARE NOT FOR HURTING PROJECT, SALEM, OR:
3,678,192, PUB. 6-23-2009. INT. CL. 41.
- HANDYSITT A/S, DENMARK:
3,679,985, PUB. 6-23-2009. INT. CL. 20.
- HANES, CHARLES M. III, LOUISVILLE, CO:
3,681,646, INT. CL. 28.
- HANLON, TIMOTHY J., DEERFIELD, IL:
3,681,641, INT. CL. 41.
- HANNIBAL BASEBALL INVESTMENT GROUP, LLC, SACRAMENTO, CA:
3,680,506, INT. CL. 41.
- HANNON, DANIEL, SIMPSONVILLE, SC AND LYMON, TONY, SIMPSONVILLE, SC:
2,665,515, CANC. INT. CL. 41.
- HANSEN BEVERAGE COMPANY, CORONA, CA:
3,679,213, PUB. 6-23-2009. INT. CL. 32.
3,679,308, PUB. 6-23-2009. MULTIPLE CLASS, INT. CLS. 5 AND 32.
- HANSMEIER & SONS, INC., BRISTOL, SD:
1,119,383, REN. 8-5-09. INT. CL. 31.

HAPPYWELL, MT. PROSPECT, IL:
3,679,777, PUB. 6-23-2009. INT. CL. 5.

HARBERT MANAGEMENT CORPORATION, BIRMINGHAM, AL:
3,679,263, PUB. 6-23-2009. INT. CL. 36.

HARBOR SEAFOOD, INC., NEW HYDE PARK, NY:
2,215,268, CANC. INT. CL. 29.

HARBOR SWEETS, INC., SALEM, MA:
1,122,500, REN. 8-3-09. MULTIPLE CLASS, INT. CLS. 30 AND 42.
1,122,932, REN. 8-3-09. INT. CL. 30.
1,122,933, REN. 8-3-09. INT. CL. 30.

HARDINGE INC., ELMIRA, NY:
2,263,899, REN. 8-5-09. INT. CL. 7.

HARDINGE, INC., ELMIRA, NY:
3,680,471, INT. CL. 7.

HARDY INSTRUMENTS, INC., SAN DIEGO, CA:
2,301,329, REN. 8-3-09. INT. CL. 9.

HARGRODER COMPANIES, INC., LAFAYETTE, LA:
3,681,124, INT. CL. 36.

HARGRODER COMPANIES, INC., LAFAYETTE, LA:
3,681,125, INT. CL. 35.

HARLAND CLARKE CORP., SAN ANTONIO, TX:
2,666,818, CANC. INT. CL. 9.

HARMONIC INC., SUNNYVALE, CA:
3,678,344, PUB. 6-23-2009. INT. CL. 9.

HARO BICYCLE CORPORATION, VISTA, CA:
2,277,395, REN. 8-4-09. INT. CL. 12.

HARRAH'S LICENSE COMPANY, LLC, LAS VEGAS, NV:
2,666,369, CANC. INT. CL. 41.
3,678,372, PUB. 6-23-2009. INT. CL. 41.
3,678,552, PUB. 6-23-2009. MULTIPLE CLASS, INT. CLS. 41 AND 43.
3,678,700, PUB. 6-23-2009. INT. CL. 41.

HARRIS CORPORATION, MELBOURNE, FL:
2,666,797, CANC. INT. CL. 9.

HARRIS NATIONAL ASSOCIATION, CHICAGO, IL, DBA HARRIS TRUST AND SAVINGS BANK:
3,680,797, INT. CL. 36.

HARRIS TEETER, INC., MATTHEWS, NC:
2,667,021, CANC. INT. CL. 32.

HARRIS TRUST AND SAVINGS BANK, CHICAGO, IL:
2,666,073, CANC. INT. CL. 16.

HARRISON, MATTHEW, SANTA MONICA, CA:
2,354,960, REN. 8-3-09. INT. CL. 41.

HART SCHAFFNER & MARX, CHICAGO, IL, CLUETT, PEABODY & CO., INC., NEW YORK, NY:
1,445,272, REN. 8-4-09. INT. CL. 25.

HARTFORD FIRE INSURANCE COMPANY, HARTFORD, CT:
2,214,618, CANC. INT. CL. 36.
2,264,316, REN. 8-6-09. MULTIPLE CLASS, INT. CLS. 5, 6, 8, 14, 16, 18, 21, 24, 25, 26 AND 28.
2,264,316, CANC. MULTIPLE CLASS, INT. CLS. 3, 9, 11 AND 20.

HARTING KGAA, D-32325 ESPELKAMP, FED REP GERMANY:
2,260,305, REN. 8-3-09. INT. CL. 9.

HARTMAN EW, INC., PITTSBURGH, PA:
2,665,943, CANC. INT. CL. 19.

HARVE BENARD, LTD., CLIFTON, NJ:
2,215,279, CANC. INT. CL. 25.

HARVEY ENTERPRISES, LLC, ST. LOUIS, MO:
3,680,204, INT. CL. 16.

HASBRO, INC., PAWTUCKET, RI:
3,680,104, INT. CL. 24.
3,680,111, INT. CL. 28.

HASLETT, WALTER V. JR., MOUNT LAUREL, NJ:
2,666,553, CANC. INT. CL. 36.

HASSLER ROMA S.P.A., ROME, ITALY:
3,678,363, PUB. 6-23-2009. MULTIPLE CLASS, INT. CLS. 16 AND 35.

HASTINGS, MERRILL G., JR., MCCOY, CO:
2,665,860, CANC. INT. CL. 36.

HATCHOOTUCKNEE, KOI, CHANDLER, AZ, DBA/ HAMBONE ART:
3,678,525, PUB. 6-23-2009. MULTIPLE CLASS, INT. CLS. 16 AND 35.
3,678,526, PUB. 6-23-2009. MULTIPLE CLASS, INT. CLS. 16 AND 35.

HATHAWAY PROCESS INSTRUMENTATION CORP., DALLAS, TX:
2,665,788, CANC. INT. CL. 9.

HAUSER TRUCKING CORPORATION, WATERVLIET, NY:
2,226,185, REN. 8-3-09. INT. CL. 39.

HAUSER, HERMANN, FED REP GERMANY:
3,680,001, PUB. 6-23-2009. INT. CL. 15.

HAVANA CLUB HOLDING, S.A., 2453 LUXEMBOURG, LUXEMBOURG:
3,679,301, PUB. 6-23-2009. INT. CL. 33.
3,679,302, PUB. 6-23-2009. INT. CL. 33.
3,679,748, PUB. 6-23-2009. INT. CL. 33.

HAVANA CLUB HOLDING, S.A., L-2453 LUXEMBOURG, LUXEMBOURG:
3,679,786, PUB. 6-23-2009. INT. CL. 33.

HAWAII ENERGY CONNECTION, MILILANI, HI:
3,679,107, PUB. 6-23-2009. INT. CL. 42.

HAWAIIAN RAINFOREST, PLAINVIEW, NY:
2,665,211, CANC. INT. CL. 3.

HAWKEYE INDUSTRIES, INC., KNOXVILLE, TN:
3,679,610, PUB. 6-23-2009. INT. CL. 4.
3,679,613, PUB. 6-23-2009. INT. CL. 3.

HAYDEN-MCNEIL, LLC, PLYMOUTH, MI:
3,679,401, PUB. 6-23-2009. INT. CL. 35.

HAYS, GARRY, GRESHAM, OR:
3,632,797, AM. INT. CL. 36.

HAYWOOD MATERIALS HANDLING LIMITED, ROCHDALE OL162QN, UNITED KINGDOM:
3,678,448, PUB. 4-21-2009. INT. CL. 12.

HB ARTWORKS, INC., TAYLORSVILLE, GA:
2,665,922, CANC. INT. CL. 12.

HBI BRANDED APPAREL ENTERPRISES, LLC, WINSTON-SALEM, NC:
2,666,429, CANC. INT. CL. 25.

HDS IP HOLDING, LLC, LAS VEGAS, NV:
3,679,438, PUB. 6-23-2009. INT. CL. 35.
3,679,770, PUB. 6-23-2009. INT. CL. 24.

HEAD ACQUISITION, L.P., CHICAGO, IL:
2,665,247, CANC. MULTIPLE CLASS, INT. CLS. 35 AND 36.

HEAD SPORT AG, A-6921 KENNELBACH, AUSTRIA:
2,665,727, CANC. INT. CL. 25.

HEADCASE RECORDS, LLC, GREENWOOD VILLAGE, CO, AKA HEADCASE PRODUCTIONS, LLC:
3,681,292, MULTIPLE CLASS, INT. CLS. 9, 35 AND 41.

HEADLIGHT SOFTWARE, INC., SEATTLE, WA:
2,666,659, CANC. INT. CL. 9.

HEALING HEARTS INTERNATIONAL, INC., OOLTEWAH, TN:
2,666,939, CANC. INT. CL. 41.

HEALTH & MEDICAL TECHNIQUES, INC., HAUPPAUGE, NY:
1,518,024, CANC. INT. CL. 20.
1,518,025, CANC. INT. CL. 20.
1,518,026, CANC. INT. CL. 20.
1,518,027, CANC. INT. CL. 20.

HEALTH CARE CONCEPTS, INC, AUSTIN, TX:
3,679,508, PUB. 6-23-2009. INT. CL. 42.

HEALTH MAINTENANCE PROGRAMS, INC., ELMSFORD, NY:
2,737,958, COR. INT. CL. 5.

HEALTHCARE ACCREDITATION COLLOQUIUM, INC., THE, COLUMBUS, OH:
3,680,883, INT. CL. 42.

HEALTHY DIRECTIONS PUBLISHING, LLC, POTOMAC, MD:
2,665,185, CANC. INT. CL. 16.

HEALTHY DIRECTIONS, LLC, POTOMAC, MD:
3,681,121, INT. CL. 5.
3,681,301, INT. CL. 5.

HEALTHY GAIN INVESTMENTS, LIMITED, TORTOLA, BR. VIRGIN ISLANDS:
3,681,037, INT. CL. 7.

HEARST HOLDINGS, INC., NEW YORK, NY:
3,678,462, PUB. 6-23-2009. INT. CL. 41.

- HEARST NEWSPAPERS, LLC, HOUSTON, TX:
2,263,095. REN. 7-31-09. INT. CL. 35.
- HEARTFELT, INC., ROANOKE, VA:
3,679,538. PUB. 6-23-2009. INT. CL. 5.
- HEATH, DEREK, VERO BEACH, FL:
2,666,748. CANC. INT. CL. 21.
- HEB GROCERY COMPANY LP, SAN ANTONIO, TX:
3,681,033. INT. CL. 8.
- HEB GROCERY COMPANY, LP, SAN ANTONIO, TX:
3,681,001. INT. CL. 31.
3,681,034. INT. CL. 21.
- HECHO LATINO, INC., DALLAS, TX:
3,680,442. MULTIPLE CLASS, INT. CLS. 14, 25 AND 35.
3,680,443. MULTIPLE CLASS, INT. CLS. 14, 25 AND 35.
- HEEBNER, TONI, SHERMAN OAKS, CA:
3,678,569. PUB. 6-23-2009. MULTIPLE CLASS, INT. CLS.
38 AND 45.
- HEELING SPORTS LIMITED, CARROLLTON, TX:
3,679,845. PUB. 3-17-2009. MULTIPLE CLASS, INT. CLS.
9, 25 AND 28.
- HEIDERER, CONRAD ELMER, GLEN ARBOR, MI:
2,665,810. CANC. INT. CL. 28.
- HEIMBUCH ESTATE VINEYARDS AND WINERY, L.L.C.,
HARWOOD, MD, DBA HEIMBUCH ESTATE:
3,681,299. INT. CL. 33.
- HELEN ELAINE NEWMAN, KENT, WA:
3,678,468. PUB. 6-23-2009. INT. CL. 5.
- HELENA LABORATORIES CORPORATION, BEAUMONT,
TX:
2,666,033. CANC. INT. CL. 5.
- HELICOPTER ASSOCIATION INTERNATIONAL, INC.,
ALEXANDRIA, VA:
3,678,331. PUB. 6-23-2009. INT. CL. 41.
- HELLS ANGELS MOTORCYCLE CORPORATION, LACO-
NIA, NH:
3,678,907. PUB. 3-17-2009. INT. CL. 14.
3,678,951. PUB. 3-17-2009. INT. CL. 26.
- HELMS, STEVEN W., SNOHOMISH, WA:
2,245,493. REN. 8-1-09. INT. CL. 9.
- HELPHIVE, INC., SHORELINE, WA:
3,681,310. INT. CL. 35.
- HENRI DE VILLAMONT S.A., 21420 SAVIGNY LES
BEAUNE, FRANCE:
2,665,553. CANC. INT. CL. 33.
- HENRICUS ANTONIUS KEMPS, AUSTRALIA:
3,679,931. PUB. 6-23-2009. INT. CL. 16.
- HENRY-GRIFFITTS, INC., HAYDEN LAKE, ID:
1,518,401. CANC. INT. CL. 42.
- HENRY, STEVEN, MORENO VALLEY, CA:
3,681,324. INT. CL. 12.
- HERAEUS KULZER GMBH, D-63450 HANAU, FED REP
GERMANY:
2,214,033. CANC. MULTIPLE CLASS, INT. CLS. 5 AND
10.
- HERBAL SOURCE LLC, ROSEMEAD, CA:
3,678,442. PUB. 6-23-2009. INT. CL. 3.
- HERBALIFE INTERNATIONAL, INC., LOS ANGELES, CA:
3,681,471. INT. CL. 32.
- HERBST GAMING, INC., LAS VEGAS, NV:
3,678,981. PUB. 6-23-2009. INT. CL. 43.
- HERBTRONICS.COM, INC., DALLAS, TX:
2,665,225. CANC. INT. CL. 9.
- HERCULES TIRE & RUBBER COMPANY, THE, FINDLAY,
OH:
893,739. REN. 8-3-09. U.S. CL. 35 (INT. CL. 12).
- HERE STUDIOS, LLC, DALLAS, TX:
3,681,531. INT. CL. 9.
- HERFF JONES, INC., INDIANAPOLIS, IN:
3,678,703. PUB. 6-23-2009. INT. CL. 9.
- HERLITZ PBS AG; PAPIER-, BÜRO UND SCHREIBWAREN,
13507 BERLIN, FED REP GERMANY:
3,631,546. COR. MULTIPLE CLASS, INT. CLS. 2, 9, 16
AND 18.
- HERMAN MILLER, INC., ZEELAND, MI:
2,667,023. CANC. MULTIPLE CLASS, INT. CLS. 20, 24
AND 40.
- HERMAN, BRANDAL, HONOLULU, HI:
3,681,376. INT. CL. 29.
- HERMES SCHLEIFMITTEL GMBH & CO. KG, FED REP
GERMANY:
3,679,927. PUB. 6-23-2009. MULTIPLE CLASS, INT. CLS.
3, 7 AND 8.
- HERRERO, ANTONIO LUIS GARCIA, SANT VICENC DE
MONTALT, SPAIN:
2,665,729. CANC. INT. CL. 16.
- HERSHEY CHOCOLATE & CONFECTIONERY CORPORA-
TION, WHEAT RIDGE, CO:
3,679,745. PUB. 6-23-2009. INT. CL. 30.
3,681,592. INT. CL. 30.
- HERTZ, DAVID R., VERMILLION, SD:
3,678,387. PUB. 6-23-2009. INT. CL. 19.
- HESCO BASTION LTD., CROSS GREEN INDUSTRIAL
ESTATE, LEEDS, ENGLAND:
2,213,890. CANC. MULTIPLE CLASS, INT. CLS. 6 AND
19.
- HEWLETT-PACKARD DEVELOPMENT COMPANY, L.P.,
HOUSTON, TX:
3,681,414. INT. CL. 9.
- HI COUNTRY SNACK FOODS, INC., LINCOLN, MT:
2,665,509. CANC. INT. CL. 29.
- HI-TECH TRANSPORT ELECTRONICS, EUGENE, OR:
3,680,292. INT. CL. 9.
- HICKEY-FREEMAN CO., INC., ROCHESTER, NY:
251,048. CANC. U.S. CL. 39.
- HICKORY TECH CORPORATION, MANKATO, MN:
3,681,110. MULTIPLE CLASS, INT. CLS. 35, 38 AND 42.
- HIGH END SYSTEMS, INC., AUSTIN, TN:
2,667,002. CANC. INT. CL. 9.
- HIGH TECH GUTTER SUPPLY, CLIFTON, NJ:
3,680,993. INT. CL. 6.
- HIGH-YIELD LIVING LLP, NEW YORK, NY:
3,679,124. PUB. 6-23-2009. MULTIPLE CLASS, INT. CLS. 9
AND 41.
- HIGHMARK INC., PITTSBURGH, PA:
3,681,231. INT. CL. 36.
- HIGHWAY 46 HOLDINGS, LLC, LAKE MARY, FL:
3,681,710. INT. CL. 41.
- HILARY'S VANITY LLC, RESEDA, CA:
3,680,829. INT. CL. 25.
- HILCO TAG LLC, NORTHBROOK, IL, TEARDROP RAM
GOLF COMPANY, MORTON GROVE, IL:
2,286,912. REN. 8-6-09. INT. CL. 28.
- HILL-ROM SERVICES, INC., BATESVILLE, IN:
2,665,740. CANC. INT. CL. 10.
- HILL, NICOLE C., OREM, UT:
3,678,259. PUB. 6-23-2009. INT. CL. 35.
- HINDA, INC., CHICAGO, IL:
2,262,948. REN. 8-3-09. INT. CL. 35.
- HIP DIGITAL MEDIA INC., VANCOUVER, BC, CANADA:
3,679,834. PUB. 12-9-2008. MULTIPLE CLASS, INT. CLS.
35, 38 AND 42.
3,679,835. PUB. 12-16-2008. MULTIPLE CLASS, INT. CLS.
35, 38 AND 42.
- HIPPO B.V., NL-1017 WT AMSTERDAM, NETHERLANDS:
3,679,980. PUB. 6-23-2009. MULTIPLE CLASS, INT. CLS. 9
AND 42.
3,679,983. PUB. 6-23-2009. MULTIPLE CLASS, INT. CLS. 9
AND 42.
- HIRESHARP PARTNERS, LLC, PHILADELPHIA, PA:
2,666,615. CANC. INT. CL. 35.
- HISAMITSU PHARMACEUTICAL CO., INC., TOSU-SHI,
SAGA, JAPAN:
3,678,712. PUB. 6-23-2009. INT. CL. 5.
- HISHTIL LTD., NECHALIM, ISRAEL:
3,681,546. INT. CL. 31.
- HISPANIC ASSOCIATION ON CORPORATE RESPONSIBIL-
ITY, WASHINGTON, DC, AKA HACR:
3,681,718. INT. CL. 35.
- HITACHI CHEMICAL COMPANY, LTD., SHINJUKU-KU,
TOKYO, JAPAN:
1,546,927. REN. 8-4-09. INT. CL. 1.
- HM PUBLISHING LIMITED, ADMIRALTY, HONG KONG:
3,679,697. PUB. 6-23-2009. INT. CL. 41.
- HOC INDUSTRIES, INC., WICHITA, KS:
2,294,445. REN. 8-3-09. INT. CL. 1.

HOCKENSMITH, TOM E, NASHVILLE, TN AND FISHER, MATTHEW, NASHVILLE, TN AND SCHWANDT, MATTHEW D, NASHVILLE, TN AND HORTON, MICAH J, NASHVILLE, TN AND ZUEHLKE, JEFFREY S, NASHVILLE, TN:
2,666,599, CANC. INT. CL. 41.

HODGES MANAGEMENT ENTERPRISE INC., OCEANSIDE, CA:
2,666,106, CANC. INT. CL. 36.

HODGES, DONALD M., JONESBORO, GA:
1,549,018, REN. 8-6-09, INT. CL. 9.

HOEGANAES CORPORATION, CINNAMINSON, NJ:
2,335,740, REN. 8-1-09, INT. CL. 6.

HOFMEISTER VERMÖGENSVERWALTUNGS; GMBH & CO. KG, FED REP GERMANY:
3,679,982, PUB. 6-23-2009, INT. CL. 29.

HOGAN & HARTSON L.L.P., WASHINGTON, DC:
2,667,093, CANC. INT. CL. 42.

HOLLAND & KNIGHT LLP, CHICAGO, IL:
2,311,350, REN. 8-3-09, INT. CL. 42.

HOLLEY PERFORMANCE PRODUCTS, INC., BOWLING GREEN, KY:
3,680,103, INT. CL. 7.

HOLLIDAY, STEWART, PHOENIX, AZ:
3,678,704, PUB. 6-23-2009, INT. CL. 9.

HOLOGRAPHIC HEALTH, INC., WAYNESVILLE, NC:
3,681,663, INT. CL. 41.

HOMAX PRODUCTS, INC., BELLINGHAM, WA:
3,678,218, PUB. 6-23-2009, MULTIPLE CLASS, INT. CLS. 1, 2, 3, 8 AND 17.

HOME BOX OFFICE, INC., NEW YORK, NY:
3,680,560, INT. CL. 41.
3,680,582, INT. CL. 21.
3,681,253, INT. CL. 9.

HOMELITE TECHNOLOGIES, LTD., ANDERSON, SC:
1,517,778, CANC. INT. CL. 7.

HOMENATURE INC., SOUTHAMPTON, NY:
3,679,797, PUB. 10-21-2008, MULTIPLE CLASS, INT. CLS. 4, 8, 11 AND 21.

HOMENET PCS, INC., GREENVILLE, SC:
3,678,926, PUB. 6-23-2009, INT. CL. 37.

HOMES AMERICA, INC., RONKONKOMA, NY:
1,518,273, CANC. INT. CL. 36.

HOMESHOW MAGAZINE, INC., LONGWOOD, FL:
1,517,958, CANC. INT. CL. 16.

HOMESTEAD, INC., NEW CASTLE, DE:
1,518,157, CANC. INT. CL. 29.

HOMTEX, INC., VINEMONT, AL:
3,680,798, INT. CL. 24.

HONDA GIKEN KOGYO KABUSHIKI KAISHA, MINATOKU, TOKYO, JAPAN, TA HONDA MOTOR CO., LTD.:
3,680,075, INT. CL. 37.

HONEYWELL INTERNATIONAL INC., MORRISTOWN, NJ:
2,215,362, CANC. INT. CL. 37.

HOPE PARTNERSHIPS INTERNATIONA, INC., TULSA, OK:
3,678,957, PUB. 6-23-2009, INT. CL. 41.

HOPPER, ROBERT J., FAIRFAX, CA:
2,666,890, CANC. INT. CL. 35.

HORIZON GROUP USA, INC., WARREN, NJ:
3,680,740, INT. CL. 28.

HORIZON MEDIA GROUP LLC, HARTFORD, CT:
2,739,035, CANC. INT. CL. 41.

HORNE, DELOIS C., FLORENCE, SC:
2,667,275, CANC. INT. CL. 41.

HORST SCHLUCKWERDER OHG, FED REP GERMANY:
3,680,038, PUB. 6-23-2009, INT. CL. 30.

HORTECH, INC., SPRING LAKE, MI:
3,680,748, INT. CL. 31.

HOSMER, WILLIAM C., RALEIGH, NC:
2,667,055, CANC. INT. CL. 9.
2,667,056, CANC. INT. CL. 9.

HOSOKAWA, HISASHI, AOBA-KU, YOKOHAMA-SHI, KANAGAWA, JAPAN:
3,680,074, MULTIPLE CLASS, INT. CLS. 7 AND 37.

HOSPITALITY DELIVERED, LLC, MARYVILLE, TN:
3,679,675, PUB. 6-23-2009, INT. CL. 35.
3,679,678, PUB. 6-23-2009, INT. CL. 35.

HOSTWAY SERVICES, INC., FORT LAUDERDALE, FL:
2,665,366, CANC. MULTIPLE CLASS, INT. CLS. 35, 38 AND 42.

HOT STICKS MANUFACTURING CO., INC., WAVELAND, MS:
2,367,620, REN. 7-31-09, INT. CL. 15.

HOT STIX GOLF, LLC, SCOTTSDALE, AZ:
3,680,385, INT. CL. 28.

HOTBODS CREATURES PTY LTD., BELMONT, WESTERN AUSTRALIA, AUSTRALIA:
2,666,889, CANC. INT. CL. 10.

HOTEL DISCOUNTS NETWORK CORP., ORLANDO, FL:
2,667,243, CANC. INT. CL. 42.

HOTWIRE, INC., SAN FRANCISCO, CA:
3,678,696, PUB. 6-23-2009, MULTIPLE CLASS, INT. CLS. 35, 39 AND 43.

HOUCHENS INDUSTRIES, INC., BOWLING GREEN, KY:
2,667,221, CANC. INT. CL. 35.

HOURLASS WINE COMPANY, INC., ST. HELENA, CA:
3,680,170, INT. CL. 33.

HOUSTON, SHERARD, BOCA RATON, FL:
3,681,318, INT. CL. 44.

HOWARD GROTE & SONS, INC., MCFARLAND, WI:
3,681,373, INT. CL. 2.

HOWARD, JEFF, ELGIN, IL:
3,680,154, INT. CL. 16.

HOYA PHOTONICS, INC., FREMONT, CA:
3,678,999, PUB. 6-23-2009, INT. CL. 10.

HRL ASSOCIATES, INC., VIENNA, VA TO FOUR RIVERS SOFTWARE SYSTEMS, INC., MONROEVILLE, PA:
1,527,856, CANC. INT. CL. 37.

HRVALUE GROUP, LLC, PLYMOUTH, MI:
3,678,217, PUB. 6-23-2009, MULTIPLE CLASS, INT. CLS. 35, 36 AND 41.

HS TM, LLC, NEWARK, DE:
3,681,560, INT. CL. 10.

HSSEGUE, LLC, CAMARILLO, CA, DBA HSSEGUE:
3,678,982, PUB. 6-23-2009, INT. CL. 42.

HS1 MEDICAL MANAGEMENT, INC., HALLANDALE, FL:
2,802,634, CANC. INT. CL. 36.

HTI IP, LLC, ATLANTA, GA:
3,681,420, INT. CL. 9.

HUBBARD FEEDS INC., MANKATO, MN:
2,215,482, CANC. INT. CL. 31.

HUBBELL INCORPORATED, ORANGE, CT:
2,254,553, REN. 8-5-09, INT. CL. 6.

HUCK INTERNATIONAL INC., TUCSON, AZ, HUCK MANUFACTURING COMPANY, IRVINE, CA:
1,553,462, REN. 8-3-09, INT. CL. 6.

HUFF, LISA J., HACKETTSTOWN, NJ:
2,666,684, CANC. INT. CL. 41.

HUGO SOLOMON & SON, INC., DETROIT, MI:
1,121,285, REN. 8-3-09, MULTIPLE CLASS, INT. CLS. 6 AND 37.

HUGO VOGELANG MASCHINENBAU GMBH, ESSEN, FED REP GERMANY:
3,681,699, MULTIPLE CLASS, INT. CLS. 7, 12 AND 37.

HUHTAMAKI COMPANY MANUFACTURING, DESOTO, KS, KEYES FIBRE COMPANY, INC., WATERVILLE, ME:
264,917, REN. 8-2-09, U.S. CL. 2 (INT. CL. 21).

HUHTAMAKI FINANCE B.V., HOOFDDORP, NETHERLANDS:
3,112,010, COR. INT. CL. 16.
3,120,110, COR. INT. CL. 16.

HUMANE SOCIETY OF THE UNITED STATES, THE, WASHINGTON, DC:
2,665,272, CANC. MULTIPLE CLASS, INT. CLS. 16, 36 AND 42.

HUMANOPTICS AG, D-91054 ERLANGEN, FED REP GERMANY:
2,665,547, CANC. MULTIPLE CLASS, INT. CLS. 5, 9 AND 10.

HUMBOLDT WHOLESALE, INC., EUREKA, CA:
3,681,708, INT. CL. 1.

HUMMEL, JEANNETTE B., PAINESVILLE, OH, DBA MY YOGA:
3,678,807, PUB. 6-23-2009, INT. CL. 41.

- HUNTER DOUGLAS, INC., UPPER SADDLE RIVER, NJ:
2,214,612, CANC. INT. CL. 24.
- HUNTER FAN COMPANY, MEMPHIS, TN:
2,667,240, CANC. INT. CL. 11.
2,667,241, CANC. INT. CL. 11.
- HUNTER, THOMAS G., MEDFORD, MA:
2,667,407, CANC. INT. CL. 42.
- HUNTER'S SPECIALTIES, INC., CEDAR RAPIDS, IA:
3,681,159, INT. CL. 28.
- HUNTERS ADVANTAGE, LLC, ATLANTA, GA:
3,680,088, MULTIPLE CLASS, INT. CLS. 16 AND 41.
- HUNTINGTON MARK, LLC, ORADELL, NJ:
3,679,599, PUB. 6-23-2009, INT. CL. 41.
- HUNTSMAN CANCER INSTITUTE AT THE UNIVERSITY
OF UTAH (A DEPARTMENT OF THE UNIVERSITY OF
UTAH), SALT LAKE CITY, UT:
3,678,248, PUB. 6-23-2009, INT. CL. 42.
- HUPFER METALLWERKE GMBH & CO. KG, 48653 COES-
FELD, FED REP GERMANY:
2,315,459, REN. 8-1-09, MULTIPLE CLASS, INT. CLS. 12
AND 20.
- HURON CONSULTING GROUP INC., CHICAGO, IL:
3,680,440, INT. CL. 45.
- HURT, RICKEY A., ST. LOUIS, MO:
2,665,843, CANC. INT. CL. 9.
- HUSTLAZ ENTERPRIZE, LLC, FRIONA, TX:
3,678,300, PUB. 6-23-2009, MULTIPLE CLASS, INT. CLS. 9
AND 41.
- HUSUMER MINERALBRUNNEN HMB GMBH & CO. KG,
HUSUM, FED REP GERMANY:
3,678,382, PUB. 11-11-2008, INT. CL. 32.
- HUTSON, GARRY, CARL JUNCTION, MO:
2,667,254, CANC. INT. CL. 9.
- HWANG, KWANGCHUL, FLUSHING, NY:
2,666,559, CANC. INT. CL. 25.
- HYATT CORPORATION, CHICAGO, IL:
2,214,068, CANC. INT. CL. 36.
3,680,236, MULTIPLE CLASS, INT. CLS. 43 AND 44.
- HYATT GAMING SERVICES, L.L.C., CHICAGO, IL:
2,666,376, CANC. INT. CL. 41.
- HYDE, AARON JUNIOR, JAMAICA, NY, AKA HYDEAWAY
OF LUTZ, FLORIDA:
3,678,721, PUB. 6-23-2009, INT. CL. 36.
- HYDRA FORCE POWERWASHING, TUCSON, AZ:
3,679,072, PUB. 6-23-2009, INT. CL. 37.
- HYGREX TECHNOLOGIES, INC., TORONTO, CANADA:
3,679,123, PUB. 6-23-2009, INT. CL. 11.
- HYPOXI PRODUKTIONS- UND VERTRIEBS GMBH, AUS-
TRIA:
3,680,024, PUB. 6-23-2009, MULTIPLE CLASS, INT. CLS.
28, 41 AND 44.
- H2O TECHNOLOGIES, LTD., MILWAUKIE, OR:
2,666,587, CANC. INT. CL. 40.
- H2O 911, INC., FORT MYERS, FL:
3,678,439, PUB. 6-23-2009, INT. CL. 40.
- I LOVE REWARDS INC., NEW YORK, NY:
3,680,769, MULTIPLE CLASS, INT. CLS. 9 AND 35.
- I PLAY, INC., ASHEVILLE, NC:
3,679,042, PUB. 6-23-2009, INT. CL. 24.
- I.D.B. INDUSTRIA DOLCIARIA; BELPASSO S.P.A., ITALY:
3,680,036, PUB. 6-23-2009, INT. CL. 30.
- IAC SEARCH & MEDIA, INC., OAKLAND, CA:
3,680,609, INT. CL. 42.
- IBA HEALTH AND LIFE ASSURANCE COMPANY, KALA-
MAZOO, MI:
1,518,210, CANC. INT. CL. 35.
- IBASIS, INC., BURLINGTON, MA:
3,678,761, PUB. 6-23-2009, INT. CL. 16.
- IBIS GROUP L.L.C., MIAMI, FL:
2,666,613, CANC. INT. CL. 29.
- IBSEN, GARY, CARMEL, CA:
2,689,257, CANC. INT. CL. 30.
- ICAD, INC., NASHUA, NH:
3,680,243, INT. CL. 9.
- ICEBERG ENTERPRISES, LLC, PARK RIDGE, IL:
2,263,050, REN. 8-3-09, INT. CL. 9.
- ICON MANAGEMENT SYSTEMS, INC., PHOENIX, AZ:
3,680,401, INT. CL. 30.
- ICORIA, INC., RESEARCH TRIANGLE PARK, NC:
2,666,883, CANC. INT. CL. 42.
- ICX TECHNOLOGIES, INC., ARLINGTON, VA:
3,681,511, MULTIPLE CLASS, INT. CLS. 42 AND 45.
- ID ANALYTICS, INC., SAN DIEGO, CA:
3,680,613, INT. CL. 41.
3,680,614, INT. CL. 42.
3,680,615, INT. CL. 45.
- IDEA FACTORY ASSOCIATES, LLC, NEW YORK, NY:
3,679,321, PUB. 6-23-2009, INT. CL. 25.
- IDEA GATEWAY LLC, TULSA, OK:
3,679,070, PUB. 6-23-2009, INT. CL. 35.
- IDEA GROUP, LLC, HENDERSON, NV:
1,518,084, CANC. INT. CL. 25.
- IDEABLOB CORP., SPRING HOUSE, PA:
3,679,103, PUB. 6-23-2009, INT. CL. 35.
3,679,105, PUB. 6-23-2009, INT. CL. 35.
- IDEAL SCANNERS & SYSTEMS, INC., ROCKVILLE, MD:
2,665,429, CANC. INT. CL. 42.
- IDEAMAX CORP., ALHAMBRA, CA:
2,665,402, CANC. INT. CL. 9.
2,665,403, CANC. INT. CL. 35.
- IDEAMAX CORPORATION, ALHAMBRA, CA:
2,666,314, CANC. INT. CL. 9.
2,667,435, CANC. INT. CL. 9.
2,667,436, CANC. INT. CL. 9.
2,667,437, CANC. INT. CL. 9.
2,667,438, CANC. INT. CL. 9.
- IDEAVILLAGE PRODUCTS CORP., WAYNE, NJ:
3,680,683, INT. CL. 5.
- IDEXX LABORATORIES, INC., WESTBROOK, ME:
3,678,458, PUB. 6-23-2009, MULTIPLE CLASS, INT. CLS. 1
AND 10.
- IE DISCOVERY, INC., AUSTIN, TX:
3,681,658, INT. CL. 42.
- IES ENTERPRISES, INC., NEW YORK, NY:
3,678,347, PUB. 6-23-2009, INT. CL. 3.
3,678,361, PUB. 6-23-2009, INT. CL. 3.
- IFORMATA LLC, DAYTON, OH:
3,681,654, MULTIPLE CLASS, INT. CLS. 37 AND 38.
- IFS DEVELOPMENT GROUP, LLC, SPRING HILL, FL:
3,679,603, PUB. 6-23-2009, INT. CL. 36.
3,679,606, PUB. 6-23-2009, INT. CL. 36.
- IGENE BIOTECHNOLOGY, INC., COLUMBIA, MD:
3,679,149, PUB. 6-23-2009, INT. CL. 5.
- IGO, INC., SCOTTSDALE, AZ:
2,665,278, CANC. MULTIPLE CLASS, INT. CLS. 36 AND
42.
- IGRAS, EDMUND, KINDERHOOK, NY:
1,517,769, CANC. INT. CL. 6.
- IGT, RENO, NV:
2,666,920, CANC. INT. CL. 9.
3,680,428, INT. CL. 9.
3,681,039, INT. CL. 9.
3,681,214, INT. CL. 9.
- IGT CORPORATION, RENO, NV:
3,680,809, INT. CL. 9.
- IHD PUBLISHING, LLC, EDNA, TX:
3,680,463, MULTIPLE CLASS, INT. CLS. 9, 16 AND 44.
3,680,464, MULTIPLE CLASS, INT. CLS. 9, 16 AND 44.
3,680,465, MULTIPLE CLASS, INT. CLS. 9, 16 AND 44.
3,680,466, MULTIPLE CLASS, INT. CLS. 9, 16 AND 44.
- IJJ AMERICA, INC., NEW YORK, NY:
3,679,306, PUB. 6-23-2009, INT. CL. 42.
- ILINX, INC., TENNOUJI-KU, OSAKA, JAPAN:
2,667,040, CANC. INT. CL. 9.
- ILLINOIS COUNCIL OF TEACHERS OF MATHEMATICS,
LISLE, IL:
2,213,961, CANC. INT. CL. 16.
- ILLINOIS TECHNOLOGY DEVELOPMENT ALLIANCE,
CHICAGO, IL:
3,678,582, PUB. 6-23-2009, INT. CL. 35.
- ILLUSTRATED ESCAPES, INC., ORLANDO, FL:
3,679,850, PUB. 6-23-2009, MULTIPLE CLASS, INT. CLS.
9, 20 AND 25.
- ILLYCAFFÈ S.P.A., ITALY:
3,679,989, PUB. 6-23-2009, MULTIPLE CLASS, INT. CLS.
7, 9, 11, 16, 21, 24, 25, 30, 32, 33, 35 AND 41.

IMAGE CLEAR ULTRASOUND, INC., AKRON, OH:
3,679,667, PUB. 6-23-2009. INT. CL. 44.
3,679,668, PUB. 6-23-2009. INT. CL. 44.

IMAGE MEDICAL CORPORATION, PALO ALTO, CA:
2,667,356, CANC. MULTIPLE CLASS, INT. CLS. 9 AND 42.

IMAGINATION HOLDINGS PTY LTD, KENT TOWN, AUSTRALIA:
3,678,923, PUB. 6-23-2009. INT. CL. 28.

IMAGINOVA CORP., NEW YORK, NY:
3,680,693, MULTIPLE CLASS, INT. CLS. 38 AND 41.

IMATION CORP, OAKDALE, MN:
1,557,540. REN. 7-31-09. INT. CL. 3.

IMC HOLDINGS I, LLC, BLAINE, WA:
3,680,726, INT. CL. 9.

IMG WORLDWIDE, INC., CLEVELAND, OH:
2,333,751. REN. 8-3-09. INT. CL. 41.

IMI CORNELIUS, INC., GLENDALE HEIGHTS, IL:
3,581,276, COR. INT. CL. 11.

IMIS, PLLC, WEST PALM BEACH, FL:
3,678,895, PUB. 3-17-2009. INT. CL. 44.

IMMUNOSCREEN, INC., COVINA, CA:
2,213,987, CANC. INT. CL. 16.

IMPACT GUIDANCE SYSTEMS, INC., HOUSTON, TX:
3,681,094, INT. CL. 9.

IMPEDIMED LIMITED, QUEENSLAND, AUSTRALIA:
3,678,241, PUB. 6-23-2009. MULTIPLE CLASS, INT. CLS. 9, 10 AND 44.

IMPERIAL PIPE CORPORATION, TORONTO, ONTARIO:
2,665,316, CANC. INT. CL. 9.

IMPORTADORA Y EXPORTADORA BATRA, S.A. DE C.V., MEXICO, D.F., MEXICO:
3,680,567, INT. CL. 33.

IMPOSSIBLE POSSIBILITIES, FORT WORTH, TX:
3,680,620, INT. CL. 36.
3,680,621, INT. CL. 36.

IN CLOVER, INC., BOULDER, CO:
2,317,677. REN. 8-3-09. INT. CL. 5.
2,317,678. REN. 8-3-09. INT. CL. 5.

IN SYNC INCORPORATED, DOVER, MA:
3,679,651, PUB. 6-23-2009. INT. CL. 41.

IN TOUCH CONCEPTS, INC., HICKSVILLE, NY:
3,680,926, MULTIPLE CLASS, INT. CLS. 9 AND 35.

IN-FUSIO, INC., BLOOMINGDALE, IL:
2,666,313, CANC. INT. CL. 9.

IN-STORE EXPERIENCE, WESTPORT, CT:
3,678,366, PUB. 6-23-2009. INT. CL. 42.

INAEXPO, QUITO, ECUADOR:
2,285,687. REN. 8-4-09. INT. CL. 29.

INCOGNITO ENTERTAINMENT, INC., SALT LAKE CITY, UT:
2,666,214, CANC. INT. CL. 9.

INDEPENDENCE BLUE CROSS, PHILADELPHIA, PA:
3,678,768, PUB. 6-23-2009. MULTIPLE CLASS, INT. CLS. 35 AND 36.

INDEPENDENCE VISITOR CENTER CORPORATION, PHILADELPHIA, PA:
3,680,910, MULTIPLE CLASS, INT. CLS. 35, 39, 41 AND 43.
3,680,911, MULTIPLE CLASS, INT. CLS. 41 AND 43.
3,680,912, MULTIPLE CLASS, INT. CLS. 35, 39, 41 AND 43.

INDEPENDENT DESIGN GROUP LOS ANGELES, HOLLYWOOD, CA:
3,681,151, INT. CL. 25.

INDEPENDENT DISTRIBUTORS ASSOCIATION, LLC, COLUMBIA, SC:
3,678,918, PUB. 6-23-2009. INT. CL. 35.

INDIA TEA & SPICES, INC., BELMONT, MA:
3,678,226, PUB. 6-23-2009. MULTIPLE CLASS, INT. CLS. 29, 30 AND 35.

INDIAN S.R.L., ITALY:
3,679,857, PUB. 6-23-2009. INT. CL. 30.

INDIANA MILLS & MANUFACTURING, INC., WESTFIELD, IN:
3,309,270, CANC. INT. CL. 12.

INDUSTRIAL BANK OF KOREA, CHUNG-GU, SEOUL, REPUBLIC OF KOREA:
3,680,561, INT. CL. 36.

INDUSTRIAL HEAT TECHNOLOGIES, INC., ORINDA, CA:
2,215,580, CANC. INT. CL. 35.

INDUSTRIAL RIVET & FASTENER CO., NORTHVALE, NJ:
3,678,927, PUB. 6-23-2009. INT. CL. 6.
3,678,928, PUB. 6-23-2009. INT. CL. 6.
3,678,941, PUB. 6-23-2009. MULTIPLE CLASS, INT. CLS. 6 AND 7.

INDUSTRIAS AUXILIARES FAUS, S.L., 46700 GANDIA, SPAIN:
2,260,079. REN. 8-3-09. INT. CL. 19.

INFINITY CASUALTY INSURANCE COMPANY, BIRMINGHAM, AL:
2,664,908, CANC. INT. CL. 36.

INFIN8 BODY WORKS, INC., BUFFALO, NY:
3,680,291, MULTIPLE CLASS, INT. CLS. 30 AND 41.

INFLEXION, INC., NEWTON, MA:
2,740,041, CANC. INT. CL. 41.

INFLIGHT NEWSPAPER, INC., VALLEY STREAM, NY:
2,664,910, CANC. INT. CL. 35.

INFORMASERV INC., DOVER, DE:
2,664,976, CANC. INT. CL. 42.

INFORMATION SYSTEMS CONSORTIUM, INC., FAIRFAX, VA:
2,664,965, CANC. INT. CL. 41.

INFORS AG, BOTTMINGEN, SWITZERLAND:
3,678,353, PUB. 3-17-2009. MULTIPLE CLASS, INT. CLS. 7 AND 9.

ING. IVAN DUCKO, SK-831 02 BRATISLAVA, SLOVAKIA:
3,680,028, PUB. 6-23-2009. INT. CL. 32.

INGRAM ENTERPRISES, INC., SPRINGFIELD, MO:
2,346,116. REN. 8-5-09. INT. CL. 13.

INGRIAN NETWORKS, INC., REDWOOD CITY, CA:
2,666,389, CANC. INT. CL. 9.

INLET COVE CAPITAL, LLC, KIAWAH ISLAND, SC:
2,665,592, CANC. INT. CL. 36.

INLINER TECHNOLOGIES, INC., PAOLI, IN:
2,666,965, CANC. INT. CL. 37.

INMAR, INC., WINSTON SALEM, NC:
3,679,132, PUB. 6-23-2009. INT. CL. 35.
3,679,133, PUB. 6-23-2009. INT. CL. 35.

INNCOM INTERNATIONAL, INC., NIANTIC, CT:
3,680,546, INT. CL. 9.

INNER OCEAN PUBLISHING, INC., MAUI, HI:
2,665,628, CANC. INT. CL. 41.

INNOMINATE SECURITY TECHNOLOGIES AG, BERLIN, FED REP GERMANY:
3,678,383, PUB. 6-23-2009. INT. CL. 9.

INNOVATIA DESIGN GROUP, L.L.C., PALISADES PARK, NJ:
2,666,904, CANC. MULTIPLE CLASS, INT. CLS. 3 AND 25.

INNOVATION LUGGAGE, INC., SECAUCUS, NJ:
1,518,003, CANC. INT. CL. 18.

INNOVATIONS – SUCCESSFUL SALON SERVICES, INC., DENTON, TX:
3,678,570, PUB. 6-23-2009. INT. CL. 35.
3,678,571, PUB. 6-23-2009. INT. CL. 35.

INNOVATIVE BEVERAGE GROUP, INC., HOUSTON, TX:
3,679,005, PUB. 6-23-2009. INT. CL. 32.
3,679,006, PUB. 6-23-2009. INT. CL. 32.

INOGEN, INC., GOLETA, CA:
3,681,661, INT. CL. 10.

INSTITUTE FOR LEARNING STRATEGIES INC., CORTLANDT MANOR, NY:
1,518,361, CANC. INT. CL. 41.

INSTITUTE OF CERTIFIED PROFESSIONAL MANAGERS, HARRISONBURG, VA:
2,665,607, CANC. INT. CL. 42.

INSTITUTIONAL SHAREHOLDER SERVICES, INC., ROCKVILLE, MD:
2,664,920, CANC. INT. CL. 35.

INSURANCE SPECIALISTS, INC., NORCROSS, GA:
2,665,964, CANC. INT. CL. 36.

INSURANCESOUTH, LLC, BIRMINGHAM, AL:
2,667,256, CANC. INT. CL. 36.

- INTEGRATED GROUP ASSETS, INC., DALLAS, TX:
3,681,533, INT. CL. 35.
- INTEGRATED MORTGAGE ORIGINATION SYSTEMS, INC., AUBURN, WA:
3,681,257, INT. CL. 9.
- INTEGRATED SOLUTIONS, INC., HOLMDEL, NJ:
3,680,574, INT. CL. 9.
- INTEGRITY MEDIA, INC. MOBILE, AL:
2,214,516, CANC. INT. CL. 9.
- INTEGRYS ENERGY GROUP, INC., CHICAGO, IL:
3,680,177, MULTIPLE CLASS, INT. CLS. 35, 36, 37, 39 AND 40.
- INTELLECTUAL PROPERTY HOLDING CO, WILMINGTON, DE:
1,517,735, CANC. INT. CL. 3.
- INTELLIGENT NUTRIENTS, LLC, MINNEAPOLIS, MN:
3,680,603, INT. CL. 35.
- INTELSAT CORPORATION, WILTON, CT:
2,770,908, CANC. INT. CL. 35.
- INTELTECH CORPORATION, FORT LAUDERDALE, FL:
3,680,701, INT. CL. 11.
3,680,729, INT. CL. 11.
- INTENTIONALLY URBAN MAGAZINE, LLC, PORTLAND, OR:
3,680,995, INT. CL. 41.
3,680,996, INT. CL. 16.
3,680,997, INT. CL. 41.
- INTERACTIVE DIGITAL SOFTWARE ASSOCIATION, WASHINGTON, DC:
2,666,738, CANC. U.S. CL. B.
- INTERCALL, INC., OMAHA, NE:
2,665,613, CANC. INT. CL. 38.
2,665,660, CANC. INT. CL. 38.
- INTERCONTINENTAL PACKAGING CO., ST. PAUL, MN:
3,681,408, INT. CL. 33.
- INTERDESIGN, INC., SOLON, OH:
3,325,152, CANC. MULTIPLE CLASS, INT. CLS. 6, 20 AND 21.
- INTERFLEX DATENSYSYSTEME GMBH & CO. KG, STUTTGART, FED REP GERMANY:
2,676,077, CANC. MULTIPLE CLASS, INT. CLS. 37 AND 42.
- INTERIM FURNISHINGS, SUDBURY, MA:
3,681,702, INT. CL. 43.
- INTERIOR SYSTEMS, INC., MILWAUKEE, WI:
3,681,776, INT. CL. 42.
- INTERMEC TECHNOLOGIES CORPORATION, EVERETT, WA:
2,667,095, CANC. INT. CL. 35.
- INTERMOOR, INC., HOUSTON, TX:
3,678,738, PUB. 6-23-2009. INT. CL. 6.
- INTERNAL COMBUSTION, LLC, RYE, NY:
3,681,548, INT. CL. 35.
- INTERNATIONAL ACADEMY OF COMPOUNDING PHARMACISTS FOUNDATION, MISSOURI CITY, TX:
3,678,806, PUB. 6-23-2009. INT. CL. 36.
- INTERNATIONAL ALLIED PRINTING TRADES ASSOCIATION, INDIANAPOLIS, IN:
507,088. REN. 8-4-09. U.S. CL. 38 (INT. CL. 16).
- INTERNATIONAL ASSOCIATION OF ELECTRICAL INSPECTORS, RICHARDSON, TX:
2,255,061. REN. 8-5-09. U.S. CL. 200.
- INTERNATIONAL ASSOCIATION OF PLUMBING AND MECHANICAL OFFICIALS, ONTARIO, CA:
3,681,029, INT. CL. 42.
- INTERNATIONAL AUDIO HOLDING B.V., NETHERLANDS:
3,679,894, PUB. 6-23-2009. INT. CL. 9.
- INTERNATIONAL BROTHERHOOD OF TEAMSTERS, WASHINGTON, DC:
2,742,997, CANC. INT. CL. 25.
- INTERNATIONAL BUSINESS MACHINES CORPORATION, ARMONK, NY:
3,681,462, MULTIPLE CLASS, INT. CLS. 9, 37 AND 42.
3,681,466, MULTIPLE CLASS, INT. CLS. 9 AND 16.
- INTERNATIONAL CONSORTIUM, HENDERSONVILLE, TN:
3,680,432, INT. CL. 7.
3,680,433, INT. CL. 7.
3,680,436, INT. CL. 7.
- INTERNATIONAL DATA BASE CORP., ALBANY, NY:
2,288,421. REN. 7-31-09. MULTIPLE CLASS, INT. CLS. 16 AND 35.
- INTERNATIONAL DATA GROUP, INC., FRAMINGHAM, MA:
2,665,037, CANC. MULTIPLE CLASS, INT. CLS. 16 AND 42.
2,666,365, CANC. INT. CL. 16.
- INTERNATIONAL ESSENTIAL TREMOR FOUNDATION, LENEXA, KS, AKA IETF:
3,679,129, PUB. 6-23-2009. INT. CL. 36.
- INTERNATIONAL LONGSHORE & WAREHOUSE UNION, LOCAL 13, WILMINGTON, CA:
3,679,830, PUB. 6-23-2009. MULTIPLE CLASS, INT. CLS. 16, 25 AND 45.
- INTERNATIONAL LUTHERAN LAYMEN'S LEAGUE, THE, ST. LOUIS, MO:
1,112,481. REN. 8-3-09. INT. CL. 41.
- INTERNATIONAL MODAPTS ASSOCIATION, INC., SOUTHERN SHORES, NC:
3,678,653, PUB. 6-23-2009. INT. CL. 16.
- INTERNATIONAL PAPER COMPANY, STAMFORD, CT:
2,665,555, CANC. INT. CL. 36.
- INTERNATIONAL PAPER COMPANY, MEMPHIS, TN:
3,679,755, PUB. 6-23-2009. INT. CL. 16.
- INTERNATIONAL PLANT MANAGEMENT, INC., LAWRENCE, MI:
2,666,098, CANC. INT. CL. 31.
- INTERNATIONAL PROGRAM GROUP, LAGUNA BEACH, CA:
3,679,692, PUB. 6-23-2009. INT. CL. 45.
- INTERNATIONAL RESISTIVE CO. OF TEXAS, L.P., CORPUS CHRISTI, TX:
2,250,841. REN. 8-5-09. INT. CL. 9.
- INTERNATIONAL SPACE OPTICS, S.A., COSTA MESA, CA:
2,249,401. REN. 8-5-09. INT. CL. 9.
- INTERNATIONAL THOMSON TRANSPORT PRESS, INC., NEW YORK, NY TO K-III DIRECTORY CORPORATION, NEW YORK, NY:
1,518,220, CANC. INT. CL. 35.
- INTERNATIONAL TRUCK INTELLECTUAL PROPERTY COMPANY, LLC, WARRENVILLE, IL:
2,215,430, CANC. INT. CL. 12.
- INTERNATIONAL YOUTH FOUNDATION, BALTIMORE, MD:
2,665,805, CANC. INT. CL. 9.
- INTERNET WORLD BROADCASTING CORPORATION, EVERETT, WA:
2,215,114, CANC. INT. CL. 41.
- INTERNEWS NETWORK, ARCATA, CA:
2,325,077. REN. 7-31-09. MULTIPLE CLASS, INT. CLS. 41 AND 42.
2,327,528. REN. 8-5-09. MULTIPLE CLASS, INT. CLS. 41 AND 42.
- INTERSIGN CORPORATION, CHATTANOOGA, TN:
3,680,749, INT. CL. 35.
- INTERSPORT NORH AMERICA LTD., CALGARY, ALBERTA, CANADA:
3,679,836, PUB. 6-23-2009. INT. CL. 28.
- INTERVIDEO, INC., FREMONT, CA:
2,666,773, CANC. INT. CL. 9.
- INTEVEP, S.A., CARACAS 1070A, VENEZUELA:
2,664,925, CANC. MULTIPLE CLASS, INT. CLS. 9 AND 16.
- INTRASWEEP LLC, NEW YORK, NY:
3,679,118, PUB. 6-23-2009. INT. CL. 36.
3,679,120, PUB. 6-23-2009. INT. CL. 36.
- INTUIT INC., MOUNTAIN VIEW, CA:
2,665,052, CANC. INT. CL. 21.
- INVENTEAM, LLC, BEND, OR:
3,680,988, INT. CL. 9.
- INVENTIO AG, HERGISWILL (NW), SWITZERLAND:
2,257,099. REN. 7-31-09. INT. CL. 9.

INVENTIO AG, 6052 HERGISWIL, SWITZERLAND:
2,665,415, CANC. MULTIPLE CLASS, INT. CLS. 17, 22
AND 40.

INVERLINK CONSULTORES S.A., SANTIAGO, CHILE:
2,665,263, CANC. INT. CL. 36.

INVERNESS MEDICAL INNOVATIONS AUSTRALIA PTY
LIMITED, SINNAMON PARK, QUEENSLAND, AUSTRALIA:
2,365,067, REN. 7-31-09, INT. CL. 5.

INVINTAGE DESIGNS, INC., ATLANTA, GA:
2,666,700, CANC. INT. CL. 42.

INVISTA NORTH AMERICA S.A.R.L., WILMINGTON, DE:
2,274,982, REN. 8-4-09, INT. CL. 25.

IO DATA CENTERS, LLC, PHOENIX, AZ:
3,679,611, PUB. 6-23-2009, INT. CL. 42.

IP MOBILENET, INC., IRVINE, CA:
3,678,140, PUB. 6-23-2009, INT. CL. 9.

IPME, LLLP, WESTMINSTER, CO:
3,681,521, INT. CL. 16.

IPP OF AMERICA, INC., FAIRFIELD, NJ:
2,213,685, CANC. MULTIPLE CLASS, INT. CLS. 16 AND
36.

IPSEN BIOPHARM LIMITED, UNITED KINGDOM:
3,679,929, PUB. 6-23-2009, MULTIPLE CLASS, INT. CLS.
3, 5, 10, 42 AND 44.

IRAGZ, LEHI, UT:
3,678,373, PUB. 6-23-2009, INT. CL. 21.

IRON MAVERICK, INC., SAN FRANCISCO, CA:
3,678,575, PUB. 6-23-2009, MULTIPLE CLASS, INT. CLS.
37 AND 40.

IRON POINT PARTNERS, LLC, WASHINGTON, D.C., DC:
3,680,264, INT. CL. 36.

IRON POINT PARTNERS, LLC, WASHINGTON, DC:
3,680,265, INT. CL. 36.

IRONKEY, INC., LOS ALTOS, CA:
3,680,175, MULTIPLE CLASS, INT. CLS. 9, 38, 42 AND 45.
3,680,176, MULTIPLE CLASS, INT. CLS. 9, 38, 42 AND 45.

IS PRINTING SYSTEMS, INC., CORNELIUS, NC:
2,665,857, CANC. INT. CL. 7.

ISAAC W. BERNHEIM FOUNDATION, CLERMONT, KY:
3,678,805, PUB. 6-23-2009, MULTIPLE CLASS, INT. CLS.
16 AND 44.

ISAACSON, MICHAEL, BEL AIR, CA:
3,681,454, INT. CL. 25.

ISD EDUCATION, INC., HOLLAND, MI:
2,665,925, CANC. INT. CL. 42.

ISECURE INC., GRANTS PASS, OR:
3,679,672, PUB. 6-23-2009, INT. CL. 40.

ISEEMEDIA, INC., CONCORD, ONTARIO, CANADA:
2,219,616, REN. 7-31-09, INT. CL. 9.

ISI BRANDS INC., GRAND RAPIDS, MI:
2,264,046, REN. 8-6-09, INT. CL. 5.
3,680,981, INT. CL. 5.

ISK AMERICAS INCORPORATED, CONCORD, OH:
3,678,198, PUB. 6-23-2009, INT. CL. 2.

ISLAND VACATIONS, LLC, KINGSTON, JAMAICA:
2,665,714, CANC. MULTIPLE CLASS, INT. CLS. 39 AND
42.

ISLES INC., TRENTON, NJ:
3,681,279, INT. CL. 41.

ISOLA IMPORTS, INC., CHICAGO, IL:
3,679,113, PUB. 6-23-2009, INT. CL. 35.

ISRAEL WEAPON INDUSTRIES (I.W.I.) LTD., RAMAT
HASHARON, ISRAEL:
3,678,206, PUB. 6-23-2009, INT. CL. 13.

ISSANNI COMMUNICATIONS, INC., EATONTOWN, NJ:
2,665,679, CANC. INT. CL. 9.

IT FOR PROFESSIONALS, INCORPORATED, HAZLET, NJ,
DBA ITP:
3,679,205, PUB. 6-23-2009, INT. CL. 42.

IT WORLDWIDE, LLC, NEW YORK, NY:
3,681,343, INT. CL. 35.

IT'S WHAT IT IS, LLC, HOUSTON, TX:
3,680,978, MULTIPLE CLASS, INT. CLS. 16 AND 24.

IT'S WHO YOU KNOW LTD., SAN ANTONIO, TX:
2,665,603, CANC. INT. CL. 41.

ITALIAN FOOD DEVELOPMENT CORP., MIAMI, FL:
3,680,391, MULTIPLE CLASS, INT. CLS. 30, 35, 38, 41
AND 43.

3,680,392, MULTIPLE CLASS, INT. CLS. 30, 35, 38, 41
AND 43.

ITAUEIRA AGROPECUARIA S/A, FORTALEZA, BRAZIL:
3,681,083, INT. CL. 31.

ITBRIX LLC, COLORADO SPRINGS, CO:
3,680,706, INT. CL. 9.

ITM RESEARCH, EAST HAMPTON, NY:
3,681,261, MULTIPLE CLASS, INT. CLS. 35 AND 41.

ITOCHU CORPORATION, OSAKA-SHI, OSAKA, JAPAN:
1,517,998, CANC. INT. CL. 18.

ITT CORPORATION, WHITE PLAINS, NY:
2,666,319, CANC. INT. CL. 16.

ITT MANUFACTURING ENTERPRISES, INC., WILMING-
TON, DE:
2,665,512, CANC. MULTIPLE CLASS, INT. CLS. 35, 41
AND 42.

IVAX LABORATORIES, INC., MIAMI, FL:
2,666,064, CANC. INT. CL. 5.

IVILLAGE PARENTING NETWORK, INC., NEW YORK,
NY:
2,666,755, CANC. INT. CL. 9.

IXL ENTERPRISES, INC., ATLANTA, GA:
2,665,612, CANC. MULTIPLE CLASS, INT. CLS. 35, 36
AND 42.

IZI MEDICAL PRODUCTS, LLC, BALTIMORE, MD:
3,681,754, INT. CL. 10.

IZZYPAGES.COM, LLC, DENVER, CO:
3,680,965, INT. CL. 42.

I2G GLOBAL (JERSEY) LTD, ST HELIER, JERSEY:
3,678,377, PUB. 4-7-2009, MULTIPLE CLASS, INT. CLS.
16, 35 AND 36.

I365 INC., EMERYVILLE, CA:
3,680,502, MULTIPLE CLASS, INT. CLS. 9, 38, 39 AND 42.

J & A SHOE CO., INC., GARDENA, CA:
1,550,239, REN. 8-4-09, INT. CL. 25.

J AND N ENTERPRISES, INC., VALPARAISO, IN:
3,680,955, INT. CL. 37.

J E PISTONS, INC., HUNTINGTON BEACH, CA:
3,681,455, INT. CL. 7.

J. P. GORDON, LTD., VIRGINIA BEACH, VA:
2,279,137, REN. 8-4-09, INT. CL. 14.

J. R. CARLSON LABORATORIES, INC., ARLINGTON
HEIGHTS, IL:
1,604,336, REN. 8-3-09, INT. CL. 5.

J. W. PRODUCTIONS, INC., HOUSTON, TX:
2,214,571, CANC. INT. CL. 42.

J.A. WOOLLAM CO. INC., LINCOLN, NE:
2,665,808, CANC. INT. CL. 42.

J.C. RAGS B.V., NETHERLANDS:
3,680,000, PUB. 6-23-2009, INT. CL. 25.

J.H. FENNER & CO. LIMITED, YORKSHIRE, ENGLAND:
3,680,244, INT. CL. 9.

J.R. UNITED INDUSTRIES, INC., MIAMI, FL:
3,681,014, INT. CL. 24.

J.S. MUSIC CORPORATION, MAYFIELD VILLAGE, OH:
3,678,155, PUB. 6-23-2009, INT. CL. 35.

J.S. STAEDTLER GMBH & CO. KG, FED REP GERMANY:
3,680,050, PUB. 6-23-2009, INT. CL. 16.

J.V. TRADING (GLENDALE) LTD, HICKSVILLE, NY:
2,665,556, CANC. INT. CL. 30.

J&J SNACK FOODS CORP., PENNSAUKEN, NJ:
2,666,442, CANC. INT. CL. 11.

J-NAS, INC., SAN ANTONIO, TX:
2,666,277, CANC. INT. CL. 28.

JA WORLDWIDE, COLORADO SPRINGS, CO:
3,678,694, PUB. 6-23-2009, MULTIPLE CLASS, INT. CLS.
16 AND 41.
3,678,848, PUB. 6-23-2009, MULTIPLE CLASS, INT. CLS.
16 AND 41.

JACK HERNANDEZ, BOYNTON BEACH, FL:
3,680,371, INT. CL. 41.

JACKLIN, COLLEEN, PALM DESERT, CA:
3,680,892, INT. CL. 25.

- JACKSON NATIONAL LIFE INSURANCE COMPANY, LANSING, MI:
3,680,231, INT. CL. 36.
3,680,232, INT. CL. 36.
3,681,567, INT. CL. 36.
- JACKSON WINE ESTATES INTERNATIONAL LIMITED, LOUGHLINSTOWN, COUNTY DUBLIN, IRELAND:
2,666,222, CANC. INT. CL. 33.
- JACKSON, EVANDER, BROOKLYN, NY:
3,680,622, INT. CL. 25.
- JACMEL JEWELRY, INC., LONG ISLAND CITY, NY:
1,539,271. REN. 8-3-09. INT. CL. 14.
- JACOBS, JOHN, ERIE, CO:
3,678,408, PUB. 6-23-2009. INT. CL. 9.
- JACOBS, ROSALIE ANN, HOGANSBURG, NY:
3,681,354, INT. CL. 34.
- JACOBSON, GOLDFARB & SCOTT, INC., HOLMDEL, NJ:
3,678,274, PUB. 6-23-2009. INT. CL. 36.
- JACQUES FATH, PARIS, FRANCE, SOCIETE JACQUES F. FATH, PARIS, FRANCE:
511,998. REN. 8-3-09. U.S. CL. 51 (INT. CL. 3).
- JACQUES, FRANCIS L., NORTH SMITHFIELD, RI:
3,680,227, INT. CL. 35.
- JADA TOYS, INC., LOS ANGELES, CA:
2,667,164, CANC. INT. CL. 28.
- JAI MA CREATION INC., LITTLE NECK, NY:
2,215,357, CANC. INT. CL. 25.
2,215,400, CANC. INT. CL. 25.
- JAKKS PACIFIC, INC., MALIBU, CA:
2,666,940, CANC. INT. CL. 28.
3,678,826, PUB. 6-23-2009. INT. CL. 28.
- JAMES CAIRD ASSET MANAGEMENT LLP, LONDON, UNITED KINGDOM:
3,678,410, PUB. 3-17-2009. INT. CL. 36.
- JAMES HARDIE INTERNATIONAL FINANCE, B.V., AMSTERDAM, NETHERLANDS:
2,213,755, CANC. INT. CL. 19.
2,215,174, CANC. INT. CL. 19.
- JAMES K. PAULIN, CLEVELAND, OH AND JOSEPH SEKERAK, CLEVELAND, OH:
3,681,322, INT. CL. 11.
- JAMES NORMAN LTD., ENGLEWOOD, NJ:
2,301,076. REN. 8-4-09. INT. CL. 34.
- JAMES SAGIN ASSOCIATES, MENLO PARK, CA TO ARUNDEL HOLDINGS INCORPORATED, HILLSBOROUGH, CA. DBA JSA INTERNATIONAL:
1,518,219, CANC. MULTIPLE CLASS, INT. CLS. 35 AND 36.
- JAN MARINI SKIN RESEARCH, SAN JOSE, CA:
3,679,327, PUB. 6-23-2009. MULTIPLE CLASS, INT. CLS. 3 AND 35.
- JAN VAN GOOL B.V., 1069 CB AMSTERDAM, NETHERLANDS:
2,214,047, CANC. INT. CL. 25.
- JAPAN AIRLINES INTERNATIONAL CO., LTD., TOKYO, JAPAN:
3,678,264, PUB. 6-23-2009. INT. CL. 39.
- JAQK, INC., SAN FRANCISCO, CA:
3,680,960, INT. CL. 33.
3,680,961, INT. CL. 33.
3,680,963, INT. CL. 33.
- JARAD, BASSAM ALI MOHAMMAD, PO BOX 240210 AMMAN, JORDAN:
3,679,389, PUB. 6-23-2009. INT. CL. 9.
- JARVIS, SUZI, BEREAS, KY:
3,681,760, INT. CL. 29.
- JAXBARS.COM, LLC, JACKSONVILLE, FL:
3,679,714, PUB. 6-23-2009. INT. CL. 41.
- JAYARAM, NIKHIL S., LOS ANGELES, CA, DBA MOTIVE RETOUCHING AND WEINSTEIN, JOSHUA L., LOS ANGELES, CA, DBA MOTIVE RETOUCHING:
3,681,236, INT. CL. 40.
- JAZZ INFORMATION TECHNOLOGY LIMITED T/A FILMIT, RICHMOND, UNITED KINGDOM:
3,679,804, PUB. 3-31-2009. MULTIPLE CLASS, INT. CLS. 9, 16, 35 AND 42.
- JB MATSOL, LLC, HUDSON, WI:
3,679,237, PUB. 6-23-2009. INT. CL. 11.
- JC RESORTS LLC, LA JOLLA, CA:
2,665,236, CANC. MULTIPLE CLASS, INT. CLS. 35, 41 AND 42.
- JCM FARMING, INC., VISALIA, CA:
2,215,037, CANC. INT. CL. 31.
- JD TECHNOLOGIES, LLC, MIDDLETON, MA:
3,679,352, PUB. 6-23-2009. INT. CL. 35.
- JDR ENTERPRISES, LLC, CEDAR SPRINGS, MI:
3,681,028, INT. CL. 33.
- JEAN-CLAUDE BOISSET WINES USA, INC., SAUSALITO, CA:
3,681,271, INT. CL. 21.
- JEAN-RENÉ GERMANIER SA, SWITZERLAND:
3,680,032, PUB. 6-23-2009. INT. CL. 33.
- JEE WON KIM, LOS ANGELES, CA:
3,681,803, INT. CL. 25.
- JEFFREY R. BARNES, MISSION VIEJO, CA:
3,678,693, PUB. 6-23-2009. INT. CL. 35.
- JEL SERT CO., THE, WEST CHICAGO, IL:
2,261,806. REN. 8-1-09. INT. CL. 30.
- JENKINS, BRETT, PORTLAND, OR:
2,666,227, CANC. INT. CL. 28.
- JENNIFER BELL, LAKE WORTH, FL, AKA JENNIFER REED:
3,679,088, PUB. 6-23-2009. MULTIPLE CLASS, INT. CLS. 30 AND 40.
- JESSICA MCCORMACK LIMITED, LONDON EC1N 8AH, UNITED KINGDOM:
3,678,560, PUB. 6-23-2009. INT. CL. 14.
- JEVIC TRANSPORTATION, INC, DELANCO, NJ:
2,667,157, CANC. INT. CL. 39.
- JEWISH PRO-LIFE FOUNDATION, INC., PITTSBURGH, PA:
3,681,174, MULTIPLE CLASS, INT. CLS. 16 AND 41.
- JIE CHEN, IVANHOE, AUSTRALIA:
3,681,596, INT. CL. 30.
- JIFF AND JEFF FOODS CORP., MERRICK, NY:
3,679,418, PUB. 6-23-2009. INT. CL. 30.
- JIM BEAM BRANDS CO., DEERFIELD, IL, DBA MUNSON SHAW CO.:
2,214,923, CANC. INT. CL. 33.
- JIM BEAM BRANDS CO., DEERFIELD, IL:
3,680,213, MULTIPLE CLASS, INT. CLS. 6, 16 AND 21.
- JIMAPCO, INC., ROUND LAKE, NY:
2,329,365. REN. 8-3-09. INT. CL. 16.
- JIMMY JOHN'S ENTERPRISES, LLC, CHAMPAIGN, IL:
3,678,610, PUB. 6-23-2009. INT. CL. 43.
- JIN WOO VET. PHARM. CO., LTD., CHUNGNAM, REPUBLIC OF KOREA:
3,678,205, PUB. 6-23-2009. INT. CL. 31.
- JINGLEBELL INC., ARMONK, NY, DBA JINGLENOG:
3,679,368, PUB. 6-23-2009. INT. CL. 28.
- JIST PUBLISHING, INC., ST. PAUL, MN:
1,554,659. REN. 8-1-09. MULTIPLE CLASS, INT. CLS. 16 AND 41.
- JIVAGO, INC., AVENTURA, FL:
2,666,708, CANC. INT. CL. 25.
- JIVOIN, CORNELL P., CASTLE ROCK, CO:
3,679,203, PUB. 6-23-2009. INT. CL. 9.
- JLG INDUSTRIES, INC., MCCONNELLSBURG, PA:
3,681,517, INT. CL. 25.
- JMP INDUSTRIES, INC., CLEVELAND, OH:
3,681,578, INT. CL. 7.
3,681,579, INT. CL. 7.
3,681,600, INT. CL. 7.
- JOAQUIN REBOLLEDO, S.A., OURENSE, SPAIN:
3,680,161, INT. CL. 33.
- JOBSITE123.COM, INC., DAVIE, FL:
3,680,475, MULTIPLE CLASS, INT. CLS. 35, 37, 39 AND 45.
- JOE BOXER COMPANY, LLC, WILMINGTON, DE:
2,666,784, CANC. INT. CL. 9.
- JOHN GEESINK AND BONNIE SONTAG, PARTNERSHIP, THE, NEWBURYPORT, MA:
2,214,977, CANC. MULTIPLE CLASS, INT. CLS. 16 AND 41.
- JOHN HANCOCK LIFE INSURANCE COMPANY, BOSTON, MA:
2,666,747, CANC. INT. CL. 36.

JOHN HARDY LIMITED, NORTH POINT, HONG KONG:
2,214,237, CANC. INT. CL. 14.

JOHN HENRY HOLDINGS, LLC, PHOENIX, AZ:
3,680,410, INT. CL. 35.

JOHN K. PONTIKES, MDM, LLC, ARLINGTON HEIGHTS,
IL:
3,679,322, PUB. 6-23-2009. INT. CL. 44.

JOHN PAUL MITCHELL SYSTEMS, SANTA CLARITA, CA:
3,681,689, INT. CL. 3.

JOHN T. MORGAN, CHARLOTTE, NC:
3,681,050, INT. CL. 42.
3,681,065, INT. CL. 42.

JOHNS MANVILLE, DENVER, CO, ZESTON, INC., FORDS,
NJ:
872,421. REN. 8-1-09. U.S. CL. 12 (INT. CL. 17).

JOHNS MANVILLE, DENVER, CO:
3,678,534, PUB. 6-23-2009. INT. CL. 35.

JOHNSON & JOHNSON, NEW BRUNSWICK, NJ:
1,116,815. REN. 8-5-09. INT. CL. 5.
3,680,090, INT. CL. 3.
3,680,147, INT. CL. 5.
3,680,148, INT. CL. 5.

JOHNSON COUNTY CHILDREN'S ADVOCACY CENTER,
CLEBURNE, TX:
3,678,902, PUB. 6-23-2009. INT. CL. 45.
3,678,909, PUB. 6-23-2009. INT. CL. 45.

JOHNSON, DARRELL, HOUSTON, TX AND WILLIAMS,
HARVEY, HOUSTON, TX:
3,679,040, PUB. 6-23-2009. INT. CL. 25.

JOHNSON, LAURA LEAH, HEALDSBURG, CA:
3,678,261, PUB. 6-23-2009. INT. CL. 16.

JOHNSON, LUANN D., BLOOMINGTON, MN:
3,679,582, PUB. 6-23-2009. INT. CL. 21.

JOHNSON, MICHAEL SCOTT, ST. PAUL, MN:
3,681,016, INT. CL. 30.

JOHNSON, THOMAS W., ENCINITAS, CA:
3,680,130, INT. CL. 30.

JOHNSONS, INC., BOSSIER CITY, LA:
2,224,058. REN. 7-31-09. INT. CL. 35.

JOINT ITALY, INC., DENVER, CO:
3,426,791. COR. INT. CL. 44.

JOINTVITALITY, INC., DENVER, CO:
3,426,788, COR. INT. CL. 44.
3,426,789, COR. INT. CL. 44.
3,426,790, COR. INT. CL. 44.
3,426,792, COR. INT. CL. 44.
3,435,949, COR. INT. CL. 44.

JOISTEN & KETTENBAUM GMBH & CO. KG, D-51429
BERGISCHE GLADBACH, FED REP GERMANY:
2,675,805, CANC. INT. CL. 20.

JON WARREN LENTZ, LLC, CARLSBAD, CA:
2,665,587, CANC. INT. CL. 35.

JON-DON, INC., ROSELLE, IL:
2,260,361. REN. 8-6-09. INT. CL. 35.

JONAH CORP, TAINAN COUNTY, TAIWAN:
3,678,662, PUB. 6-23-2009. INT. CL. 25.
3,678,663, PUB. 6-23-2009. INT. CL. 25.

JONES BREWING COMPANY, SMITHTON, PA, AKA JBC
BEVERAGE GROUP, INC.:
3,679,470, PUB. 6-23-2009. INT. CL. 32.

JONES INVESTMENT CO., INC., WILMINGTON, DE:
2,214,543, CANC. INT. CL. 25.

JONES, CINDY L., EDMOND, OK:
2,666,062, CANC. INT. CL. 10.

JONES, DAVID, FALMOUTH, ME:
1,518,086, CANC. INT. CL. 26.

JONES, JEFFREY, ATLANTA, GA:
2,214,479, CANC. INT. CL. 41.

JONTI-CRAFT, INC., WABASSO, MN:
2,307,454. REN. 8-3-09. INT. CL. 20.
2,307,455. REN. 8-3-09. INT. CL. 20.

JOSEPH C. PETERS, SANTA CLARITA, CA:
3,679,559, PUB. 6-23-2009. INT. CL. 3.

JOVANOVSKI, ED, MISSISSAUGA, ONTARIO L5B 2TF,
CANADA:
2,666,709, CANC. MULTIPLE CLASS, INT. CLS. 25 AND
28.

JT SPORTS LLC, BENTONVILLE, AR:
2,258,732. REN. 8-6-09. INT. CL. 28.
2,666,427, CANC. INT. CL. 13.

JUBII A/S, KØBENHAVN K, DENMARK:
3,561,310, CANC. IIRN. RESTORED TO S.N. 79-048,190.

JUDGE, JR., ALEXANDER LEE, RIVERDALE, GA, DBA DJ
JUDGE MENTAL:
3,678,545, PUB. 3-17-2009. INT. CL. 35.

JUERGEN FEUERSTEIN, FED REP GERMANY:
3,680,044, PUB. 6-23-2009. MULTIPLE CLASS, INT. CLS.
2, 16 AND 25.

JULIE CHARETTE, HUDSON, OH:
1,517,968, CANC. MULTIPLE CLASS, INT. CLS. 16 AND
23.

JULIE STAV, INC., BEVERLY HILLS, CA:
3,680,096, MULTIPLE CLASS, INT. CLS. 36 AND 41.

JULIUS J. LARRY III, CHANNELVIEW, TX:
3,681,337, INT. CL. 20.

JULIUS SAMANN LTD., HAMILTON HM12, BERMUDA:
2,741,364, CANC. INT. CL. 28.

JUMPING J-JAYS USA, LLC, FRISCO, TX:
3,680,295, INT. CL. 28.

JUNE BUG ENTERPRISES, INC., BEVERLY HILLS, CA:
3,678,985, PUB. 6-23-2009. INT. CL. 44.

JUNK BEE GONE OF MINNESOTA, INC., LINO LAKES,
MN:
3,680,870, INT. CL. 37.

JUST BRAKES OF NEVADA, INC., DALLAS, TX:
3,678,798, PUB. 6-23-2009. INT. CL. 37.

JUST IN CASE, INC., LOS ANGELES, CA:
3,678,433, PUB. 6-23-2009. INT. CL. 18.

JUST KOSHER CAFE & BAKERY, LLC, NEW YORK, NY:
3,679,067, PUB. 6-23-2009. INT. CL. 30.

JUST PLAIN ENTERPRISES, HARRISBURG, PA:
3,679,344, PUB. 6-23-2009. INT. CL. 41.

JUST PRICE INDUSTRIES, PASADENA, CA:
3,680,771, INT. CL. 36.

JUST PRODUCTS, INC., KAMUELA, HI:
2,667,130, CANC. INT. CL. 20.

JUVENIA MONTRES SA, LA CHAUX-DE-FONDS, SWIT-
ZERLAND:
3,679,998, PUB. 6-23-2009. INT. CL. 14.

JUZA, THOMAS J., ONEIDA, WI AND JUZA, MICHELLE
M., ONEIDA, WI:
3,680,536, MULTIPLE CLASS, INT. CLS. 25 AND 26.

JV/GLOBAL, LLC., NEW YORK, NY:
2,667,169, CANC. INT. CL. 25.

J2R2 ASSOCIATES, BELMONT, CA:
3,680,369, INT. CL. 28.

K-SUN CORPORATION, SOMERSET, WI:
3,679,189, PUB. 6-23-2009. INT. CL. 16.

KABUSHIKI KAISHA HUDSON, TOKYO, JAPAN:
3,680,333, INT. CL. 9.

KABUSHIKI KAISHA KURETAKE SEISHODO, NARA-SHI,
JAPAN:
2,665,398, CANC. INT. CL. 1.

KABUSHIKI KAISHA MORPHO, TOKYO, JAPAN, AKA
MORPHO, INC.:
3,681,430, INT. CL. 9.

KABUSHIKI KAISHA SEGA, TOKYO, JAPAN, DBA SEGA
CORPORATION:
2,215,103, CANC. INT. CL. 9.
2,751,753, CANC. INT. CL. 28.

KABUSHIKI KAISHA TOSHIBA, MINATO-KU, TOKYO,
JAPAN, DBA TOSHIBA CORPORATION:
3,680,578, INT. CL. 9.
3,680,579, INT. CL. 9.
3,680,580, INT. CL. 9.
3,680,581, INT. CL. 9.

KABUSHIKI KAISHA XANAX, OSAKA-SHI, OSAKA-FU,
JAPAN, DBA XANAX CORPORATION:
2,265,922. REN. 8-3-09. INT. CL. 28.

KAIROS INSTITUTE OF SOUND HEALING, LLC, LLANO
DE SAN JUAN, NM:
3,680,198, MULTIPLE CLASS, INT. CLS. 10, 41 AND 44.

KALCORP ENTERPRISES, INC., BRYAN, TX:
3,678,596, PUB. 6-23-2009. INT. CL. 5.

- KALEXO, INC., BURLINGAME, CA:
3,679,065, PUB. 6-23-2009. MULTIPLE CLASS, INT. CLS. 9 AND 42.
- KALMATRON CORPORATION, SAN FRANCISCO, CA:
3,680,881, MULTIPLE CLASS, INT. CLS. 1 AND 2.
- KALPLAS, INC., VICKSBURG, ACCRO-SEAL, VICKSBURG, MI:
1,552,872, REN. 8-3-09. INT. CL. 17.
- KALSEC, INC., KALAMAZOO, MI:
3,680,280, MULTIPLE CLASS, INT. CLS. 2 AND 30.
- KAM MANUFACTURING, INC., VAN WERT, OH:
3,681,233, INT. CL. 18.
- KAMAS HOLDINGS, LLC, NEW YORK, NY:
1,106,942, REN. 7-31-09. INT. CL. 3.
- KAMCRETE, LLC, MESA, AZ:
3,680,396, INT. CL. 2.
- KANEKA CORPORATION, KITA-KU, OSAKA, JAPAN:
3,678,538, PUB. 6-23-2009. INT. CL. 10.
- KAON INTERACTIVE INC., MAYNARD, MA:
2,667,312, CANC. INT. CL. 9.
- KAON INTERACTIVE, INCORPORATED, MAYNARD, MA:
3,679,128, PUB. 6-23-2009. INT. CL. 9.
- KAPLAN, ABRAM W., GRANVILLE, OH:
3,678,180, PUB. 6-23-2009. INT. CL. 16.
- KARAN GLEDDIE, CHERTERMERE, ALBERTA:
3,680,270, MULTIPLE CLASS, INT. CLS. 16, 18, 25 AND 41.
- KARAN IT, LLC, HARTFORD, CT:
3,678,358, PUB. 6-23-2009. MULTIPLE CLASS, INT. CLS. 35 AND 42.
- KARINA CORP INC, ATLANTIC BEACH, FL:
3,679,521, PUB. 6-23-2009. INT. CL. 25.
- KARL STORZ GMBH, & CO KG, D-78532 TUTTLINGEN, FED REP GERMANY:
2,665,101, CANC. INT. CL. 10.
- KARMA NOW PTY LTD, SALISBURY SOUTH, AUSTRALIA:
3,678,380, PUB. 6-23-2009. MULTIPLE CLASS, INT. CLS. 35 AND 41.
- KARTA TECHNOLOGY, INC., SAN ANTONIO, TX:
2,213,860, CANC. INT. CL. 42.
- KAUFMAN, NANCY, WEST BLOOMFIELD, MI:
3,679,083, PUB. 6-23-2009. INT. CL. 44.
- KAUNISTO, SANDRA L, CENTENNIAL, CO:
2,667,347, CANC. INT. CL. 16.
- KAWNEER COMPANY, INC., NORCROSS, GA:
1,517,757, CANC. INT. CL. 6.
- KAYEM FOODS, INC., CHELSEA, MA:
2,263,771, REN. 8-3-09. INT. CL. 29.
- KAYSER-ROTH CORPORATION, GREENSBORO, NC:
3,681,768, INT. CL. 25.
- KDA SOFTWARE, INC., CENTRALIA, IL:
1,517,854, CANC. INT. CL. 9.
- KEANE, INC., BOSTON, MA:
3,680,359, INT. CL. 9.
- KEBTA CASES, FORT WORTH, TX:
2,666,557, CANC. INT. CL. 15.
- KEHE FOOD DISTRIBUTORS, INC., ROMEVILLE, IL:
3,679,009, PUB. 6-23-2009. INT. CL. 30.
- KELCO SALES AND MARKETING CORP., CRANFORD, NJ:
2,366,531, REN. 8-5-09. INT. CL. 32.
- KELD NORGAARD, KOLDING, DENMARK:
3,680,927, INT. CL. 8.
- KELLER WILLIAMS REALTY, INC., AUSTIN, TX:
3,680,253, INT. CL. 36.
- KELLER, AVE, FT. LAUDERDALE, FL:
2,666,536, CANC. INT. CL. 35.
- KELLWOOD COMPANY, CHESTERFIELD, MO:
3,680,680, INT. CL. 35.
- KEMPA GROUP REALTY, INC., HOMER GLEN, IL:
3,681,672, INT. CL. 35.
- KEN CRAFT INC, NEW YORK, NY:
3,679,091, PUB. 6-23-2009. INT. CL. 14.
- KENEXA BRASSRING, INC., WAYNE, PA:
2,664,937, CANC. INT. CL. 35.
- KENNAMETAL INC., LATROBE, PA:
2,215,428, CANC. INT. CL. 7.
- KENNETH E. LAROE, EUSTIS, FL:
3,680,874, INT. CL. 36.
3,680,877, INT. CL. 36.
- KENWOOD APPLIANCES LUXEMBOURG SA, LUXEMBOURG, LUXEMBOURG:
3,678,405, PUB. 6-23-2009. INT. CL. 11.
- KERDOON, DAVID, LOS ANGELES, CA:
3,680,226, INT. CL. 3.
- KETER PLASTIC LTD., HERZELIA, ISRAEL:
3,678,335, PUB. 3-17-2009. MULTIPLE CLASS, INT. CLS. 19, 20 AND 21.
- KEYES FIBRE CORPORATION, WENATCHEE, WA:
2,666,282, CANC. INT. CL. 16.
- KEYS FITNESS PRODUCTS, INC., GARLAND, TX:
2,214,350, CANC. INT. CL. 42.
- KEYSTONE DENTAL, INC., BURLINGTON, MA:
3,680,916, INT. CL. 5.
- KFV KARL FLIETHER GMBH & CO. KG, FED REP GERMANY:
3,679,970, PUB. 6-23-2009. MULTIPLE CLASS, INT. CLS. 6, 9 AND 20.
- KHACHIAN, ANI, DARIEN, CT, DBA LILLIAN'S GIRL:
3,678,900, PUB. 6-23-2009. INT. CL. 14.
- KHILAWAN, REENA NATASHA, WILMINGTON, CA:
3,681,258, INT. CL. 35.
- KHM MANAGEMENT AG, BASEL, SWITZERLAND:
3,678,257, PUB. 6-23-2009. MULTIPLE CLASS, INT. CLS. 8 AND 19.
- KHODADADI, MEHDI ABDOLREZA, DUBAI, NULL UNITED, UNITED ARAB EMIR.:
2,666,071, CANC. INT. CL. 14.
- KHONG GUAN CORPORATION, UNION CITY, CA, DBA KGC AND TO WEI INC., UNION CITY, CA, DBA KING WAI TRADING CO.:
3,678,391, PUB. 6-23-2009. INT. CL. 29.
- KICKZ AG, MUNICH, FED REP GERMANY, TIDELINES IMPORT COMPANY INC., EDMONTON, ALBERTA, CANADA:
1,523,564, REN. 8-4-09. INT. CL. 25.
- KIDDE-FENWAL, INC., ASHLAND, MA, FYR-FYTER COMPANY, THE, DAYTON, OH:
514,054, REN. 8-3-09. U.S. CL. 6 (INT. CL. 1).
- KIERNAN, MICHAEL T, ST LOUIS, MO AND KATON, DEBORAH N, MAPLEWOOD, MO:
3,679,034, PUB. 6-23-2009. INT. CL. 12.
- KIETRA CORPORATION, PORTLAND, OR:
2,667,227, CANC. INT. CL. 42.
- KIKO FOODS, INC., KENNER, LA:
2,214,943, CANC. INT. CL. 32.
- KILTIE CORPORATION, OAKDALE, MN:
1,559,851, REN. 8-4-09. INT. CL. 20.
- KIM, KWANG NAM, MIAMI, FL:
2,665,276, CANC. INT. CL. 9.
- KIM, KYOMSONG JIMMY, FLUSHING, NY:
1,518,074, CANC. INT. CL. 25.
- KIMRAY, INC., OKLAHOMA CITY, OK:
1,596,133, REN. 8-3-09. INT. CL. 9.
1,596,233, REN. 8-6-09. INT. CL. 11.
- KINETIC MARKETING, LLC, LOUISVILLE, KY:
2,214,461, CANC. MULTIPLE CLASS, INT. CLS. 16 AND 25.
- KING CHAPMAN & BROUSSARD CONSULTING GROUP, INC., HOUSTON, TX:
2,664,978, CANC. MULTIPLE CLASS, INT. CLS. 35 AND 41.
- KING PHARMACEUTICALS, INC., BRISTOL, TN, HOFFMANN-LA ROCHE INC., NUTLEY, NJ:
684,353, REN. 7-31-09. U.S. CL. 18 (INT. CL. 5).
- KING'S SEAFOOD CO., LLC, COSTA MESA, CA:
3,678,505, PUB. 6-23-2009. INT. CL. 43.
3,678,506, PUB. 6-23-2009. INT. CL. 43.
- KINGCADE, RICHARD DAN, IOWA PARK, TX:
2,666,622, CANC. INT. CL. 28.
- KINGSTON BRASS INC., CHINO, CA:
3,678,933, PUB. 6-23-2009. INT. CL. 11.
3,678,947, PUB. 6-23-2009. INT. CL. 11.
3,678,948, PUB. 6-23-2009. INT. CL. 11.
3,678,968, PUB. 6-23-2009. INT. CL. 11.

KINTERA, INC., SAN DIEGO, CA:
2,666,806, CANC. INT. CL. 36.

KIRKEY, PATTI SUE, GRAPEVINE, TX, DBA PATTI-KAKE'S:
3,678,444, PUB. 6-23-2009. INT. CL. 35.

KIRSTIE PIKES, GUNNISON, CO:
3,680,399, INT. CL. 25.

KISCO SENIOR LIVING, LLC, CARLSBAD, CA:
3,678,460, PUB. 6-23-2009. MULTIPLE CLASS, INT. CLS. 35, 43 AND 44.

KIT MANUFACTURING COMPANY, LONG BEACH, CA:
2,665,049, CANC. INT. CL. 19.

KJC INC., LOS ANGELES, CA:
2,665,084, CANC. INT. CL. 30.

KLEBER & ASSOCIATES, INC., ATLANTA, GA:
3,680,572, INT. CL. 35.

KLEIN TOOLS, INC., SKOKIE, IL:
2,665,545, CANC. INT. CL. 8.
2,665,546, CANC. INT. CL. 8.

KLEIN, LAURA, BEVERLY HILLS, CA, DBA ORGANIC AUTHORITY:
3,681,038, INT. CL. 3.

KLS BOER GOATS, FORT WORTH, TX:
2,666,505, CANC. INT. CL. 42.

KLUS, KENNETH F., CAPISTRANO BEACH, CA:
1,517,776, CANC. MULTIPLE CLASS, INT. CLS. 7 AND 12.

KNAUST, CHRISTIAN, NEW YORK, NY:
3,680,199, MULTIPLE CLASS, INT. CLS. 9 AND 41.

KNIGHT CORPORATION, HONOLULU, HI:
3,680,070, INT. CL. 25.

KNISPO SOLUTIONS, INC., AIRDRIE, CANADA:
3,681,604, MULTIPLE CLASS, INT. CLS. 35, 36 AND 41.

KNOLL, INC., EAST GREENVILLE, PA:
2,272,597, REN. 8-3-09. INT. CL. 20.

KNOTICE, LTD, AKRON, OH:
3,678,346, PUB. 6-23-2009. INT. CL. 9.

KNOWLEDGE ADVISORS, INC., CHICAGO, IL:
2,665,436, CANC. INT. CL. 41.

KOBIE MARKETING, INC., ST. PETERSBURG, FL:
3,679,386, PUB. 6-23-2009. INT. CL. 35.

KOCH, JEREMY B., NEW YORK, NY:
3,681,458, INT. CL. 16.

KOESTER GMBH & CO KG, D-96146 ALTENDORF, FED REP GERMANY:
2,259,379, REN. 8-3-09. INT. CL. 16.

KOHLER CO., KOHLER, WI:
3,680,284, INT. CL. 11.

KOLLHOPP, FRED W., SOUTHAMPTON, NY:
2,665,370, CANC. INT. CL. 36.

KOLOA RUM CO., KOLOA, KAUAI, HI:
3,679,688, PUB. 6-23-2009. INT. CL. 33.

KONAMI (AMERICA) INC., BUFFALO GROVE, IL:
1,518,142, CANC. INT. CL. 28.

KONINKLIJKE PHILIPS ELECTRONICS N.V., EINDHOVEN, NETHERLANDS:
2,665,078, CANC. INT. CL. 42.
2,665,188, CANC. INT. CL. 42.
2,665,379, CANC. INT. CL. 42.
2,665,823, CANC. INT. CL. 9.

KONUWA, DENNIS KINI, NEWARK, NJ:
3,678,165, PUB. 6-23-2009. INT. CL. 29.

KOSTIDIS, JOHN N., VALPARAISO, IN, DBA SPINAL RELIEF CENTERS AND KOSTIDIS, NICK J., VALPARAISO, IN, DBA SPINAL RELIEF CENTERS:
3,681,761, INT. CL. 44.

KOWAR, BONNIE L., BASALT, CO, DBA CREATIVE WEDDINGS:
2,214,457, CANC. INT. CL. 41.

KRAFT FOODS GLOBAL BRANDS LLC, NORTHFIELD, IL:
2,261,718, REN. 8-3-09. INT. CL. 30.
2,262,538, REN. 8-5-09. INT. CL. 30.

KRASS, EDGAR B., BRANDON, FL:
3,680,240, INT. CL. 25.

KRAUCUNAS, ROBERT W., INDIANAPOLIS, IN:
3,678,743, PUB. 6-23-2009. INT. CL. 36.

KRAUSE-BIAGOSCH GMBH, BIELEFELD, FED REP GERMANY:
3,633,617, COR. MULTIPLE CLASS, INT. CLS. 1, 7, 9, 16, 35 AND 42.

KRAUSE, LINDA, DIMONDALE, MI:
2,666,589, CANC. INT. CL. 24.

KRAY, RICHARD, LOS ANGELES, CA, DBA JOHNNY SKUNK PRODUCTIONS:
1,552,298, REN. 8-4-09. INT. CL. 41.

KRIEGER-KRAUS, SUSAN A., CUYAHOGA FALLS, OH:
2,314,548, REN. 8-3-09. INT. CL. 6.

KRINGS, RONALD L., COTTAGE GROVE, MN, DBA PRO INSIGNIA:
1,518,347, CANC. INT. CL. 40.

KRIPALU CENTER FOR YOGA & HEALTH, STOCK-BRIDGE, MA:
3,678,742, PUB. 6-23-2009. INT. CL. 41.

KRIZIA S.P.A., MILAN, ITALY:
1,518,050, CANC. INT. CL. 25.

KROGER CO. OF MICHIGAN, THE, LIVONIA, MI:
2,747,287, CANC. MULTIPLE CLASS, INT. CLS. 7, 9 AND 21.

KRUEGER HOLDINGS LLC, HOUSTON, TX:
3,679,230, PUB. 6-23-2009. INT. CL. 41.
3,679,233, PUB. 6-23-2009. INT. CL. 41.

KRUPP THYSSEN STAINLESS GMBH, 47166 DUISBURG, FED REP GERMANY:
2,665,957, CANC. INT. CL. 6.

KS TACOMA HOTEL, LLC, PORTLAND, OR:
3,680,899, INT. CL. 43.

KUAI KE LI ENTERPRISE CO., LTD., NAN-KANG, TAIPEI, TAIWAN:
2,666,975, CANC. INT. CL. 29.

KUBAN, JOHN, ELKHORN, WI, DBA DECKJET WATER-CRAFT LLC:
3,681,695, INT. CL. 12.

KUKREJA INVESTORS, WEST NEW YORK, NJ:
2,213,949, CANC. MULTIPLE CLASS, INT. CLS. 6, 14 AND 26.

KUO JOANN S, SUNNYVALE, CA, DBA TEESTALK AND FRIENDS:
3,679,591, PUB. 6-23-2009. INT. CL. 25.

KUO, ROGER J., SAN FRANCISCO, CA, DBA THEFINEST-JEWELRY:
3,679,364, PUB. 6-23-2009. INT. CL. 14.
3,679,026, PUB. 6-23-2009. INT. CL. 43.

KUREHA CORPORATION, TOKYO, JAPAN:
3,681,149, INT. CL. 28.

KURTZ, NICOLE, GREENSBORO, NC AND LUNNINGHAM, ALEXIA, GREENSBORO, NC:
3,679,292, PUB. 6-23-2009. INT. CL. 9.

KUSAR-ESTORGA, JERI LU, LONG BEACH, CA, DBA KUSAR COURT REPORTERS AND LEGAL TECHNOLOGIES:
3,678,839, PUB. 6-23-2009. MULTIPLE CLASS, INT. CLS. 38 AND 43.

KUTNER, RICHARD B., BROOMALL, PA:
2,215,372, CANC. INT. CL. 25.

KWH MIRKA LTD, FINLAND:
3,680,005, PUB. 6-23-2009. INT. CL. 3.

KWHL USA ENTERPRISE, NEWPORT BEACH, CA:
2,214,213, CANC. INT. CL. 30.
2,214,214, CANC. INT. CL. 30.
2,214,215, CANC. INT. CL. 30.
2,214,216, CANC. INT. CL. 30.

KWHL USA ENTERPRISE, LOS ANGELES, CA:
2,214,217, CANC. INT. CL. 30.

KWHL USA ENTERPRISE, NEWPORT BEACH, CA:
2,214,218, CANC. INT. CL. 30.

KWIK-WAY PRODUCTS INC., MARION, IA:
2,252,532, REN. 8-5-09. INT. CL. 7.
2,266,115, REN. 8-5-09. INT. CL. 7.

KY-ANI SUN, INC., IDAHO FALLS, ID:
3,679,111, PUB. 6-23-2009. MULTIPLE CLASS, INT. CLS. 5, 32 AND 35.

KYDD , PHILLIP, WARWICK, RI:
3,681,243, INT. CL. 25.

- L. TICK, INC., ATLANTA, GA:
3,679,099, PUB. 6-23-2009. INT. CL. 43.
- L'ARENA DES CANADIENS INC. (THROUGH ITS DIVISION GILLETT ENTERTAINMENT GROUP), MONTREAL, QUEBEC, CANADA:
3,465,182, COR. INT. CL. 41.
- L'OREAL, PARIS, FRANCE:
3,678,632, PUB. 6-23-2009. INT. CL. 3.
3,678,944, PUB. 6-23-2009. INT. CL. 3.
3,681,652, INT. CL. 3.
- L'OREAL USA CREATIVE, INC., NEW YORK, NY:
3,678,471, PUB. 6-23-2009. INT. CL. 3.
- LA CHÂTELAINE CHOCOLAT CO., BOZEMAN, MT, DBA LA CHÂTELAINE CHOCOLAT CO.:
3,678,737, PUB. 6-23-2009. MULTIPLE CLASS, INT. CLS. 29 AND 30.
- LA EXPORT, INC., KENNER, LA:
2,666,217, CANC. INT. CL. 3.
- LA FAMILIA DISTRIBUTING, INC., BONHAM, TX:
2,667,413, CANC. INT. CL. 30.
- LA GANTERIE B.C.L. LTÉE, SAINT-PACÔME, CANADA:
3,678,242, PUB. 6-23-2009. INT. CL. 9.
3,678,302, PUB. 6-23-2009. INT. CL. 9.
- LA RURAL VIÑEDOS Y BODEGAS S.A. LTDA., COQUIMBITO, MAIPU, ARGENTINA:
3,681,452, INT. CL. 33.
- LA VENDEMMIA, INC., LINDENHURST, NY:
3,679,010, PUB. 6-23-2009. INT. CL. 33.
- LAB-AIDS INC, RONKONKOMA, NY:
3,680,777, INT. CL. 41.
- LAB-LINE INSTRUMENTS, INC., MELROSE PARK, IL:
1,517,883, CANC. INT. CL. 11.
- LABORATOIRES BIOCOCODEX, 92120 MONTROUGE, FRANCE:
2,665,589, CANC. INT. CL. 5.
- LABORATOIRES DE BIOLOGIE VEGETALE YVES ROCHER, 56201 LA GACILLY, FRANCE:
2,215,406, CANC. INT. CL. 3.
- LABORATORIOS COSMETICOS FELTOR, S.A., BARCELONA, SPAIN:
2,665,721, CANC. INT. CL. 3.
- LACHRISBREN CORPORATION, PINNACLE, NC:
3,681,171, INT. CL. 16.
- LACY DISTRIBUTION, INC., INDIANAPOLIS, IN:
2,277,577, REN. 8-4-09. INT. CL. 12.
- LAF ENTERPRISES, INC., MT. LAUREL, NJ:
2,667,027, CANC. MULTIPLE CLASS, INT. CLS. 9 AND 28.
- LAFARGE NORTH AMERICA INC., HERNDON, VA:
2,667,047, CANC. INT. CL. 19.
- LAINCO MANAGEMENT GROUP, LLC, LAGUNA BEACH, CA:
3,679,452, PUB. 6-23-2009. INT. CL. 41.
- LAKE RESTORATION INC., ROGERS, MN:
3,679,536, PUB. 6-23-2009. INT. CL. 44.
3,679,742, PUB. 6-23-2009. INT. CL. 5.
- LAKEPORT BREWING CORPORATION, HAMILTON, ONTARIO, CANADA:
2,665,632, CANC. INT. CL. 32.
- LALETIN, WILLIAM H., SLIDELL, LA:
2,667,340, CANC. INT. CL. 9.
- LAM RESEARCH CORPORATION, FREMONT, CA:
2,214,984, CANC. INT. CL. 9.
- LAMB, CORY, KINGSTON, IL:
3,681,274, INT. CL. 41.
- LAMETCO INTERNATIONAL LLC, BUCKNER, KY AND METALLO, TODD S., LOUISVILLE, KY:
3,681,156, INT. CL. 5.
- LAMM, CONNIE, SEDALIA, MO:
3,680,896, INT. CL. 28.
- LAMPTRONIX CO., LTD., NORTHBROOK, IL:
1,553,626, REN. 8-1-09. INT. CL. 11.
- LANARD TOYS, LTD., TSIMSHATSUI EAST, KOWLOON, HONG KONG:
2,214,726, CANC. INT. CL. 28.
- LANCE ARMSTRONG FOUNDATION, AUSTIN, TX:
3,680,140, INT. CL. 25.
- LANCOME PARFUMS ET BEAUTE & CIE, PARIS, FRANCE:
3,678,739, PUB. 6-23-2009. INT. CL. 3.
- LANDESGIROKASSE OFFENTLICHE BANK UND LANDESSPARKASSE, STUTTGART, FED REP GERMANY:
1,518,279, CANC. INT. CL. 36.
- LANE, JULES V., HICKSVILLE, NY:
1,518,598, CANC. INT. CL. 42.
- LARK, SHANNON, CARLSBAD, NM, DBA THE CHAINSAW MAFIA:
3,679,038, PUB. 6-23-2009. INT. CL. 41.
- LARS FINDSEN, 3140 ALSGARDE, DENMARK:
2,665,045, CANC. MULTIPLE CLASS, INT. CLS. 18, 24 AND 25.
- LARSON TEXTS, INC., ERIE, PA:
3,681,416, MULTIPLE CLASS, INT. CLS. 16 AND 41.
- LASTING IMPRESSIONS FOR PAPER, INC., WOODS CROSS, UT:
3,681,591, INT. CL. 9.
- LAU, KAWAI, BELLEVUE, WA:
3,680,242, INT. CL. 45.
- LAUER TOYS INCORPORATED, ST. LOUIS, MO:
3,680,662, INT. CL. 28.
- LAUGHRIDGE, WILLIAM R., FREMONT, NE AND GUTEKUNST, RALPH M., NORTH BEND, NE:
3,681,368, INT. CL. 13.
- LAUREN P. JONES, WASHINGTON, DC:
3,678,858, PUB. 6-23-2009. MULTIPLE CLASS, INT. CLS. 25, 26 AND 41.
- LAURUS MASTER FUND, LTD., RALEIGH, NC:
2,667,042, CANC. INT. CL. 5.
- LAUSON, MARY FRANCES, MANHATTAN BEACH, CA:
2,666,811, CANC. INT. CL. 35.
- LAW ENFORCEMENT TECHNOLOGIES, INC., MISHAWAKA, IN:
3,681,472, INT. CL. 9.
- LAW SCHOOL ADMISSION COUNCIL, INC., NEWTOWN, PA:
3,678,865, PUB. 6-23-2009. INT. CL. 16.
- LAWSON'S SALES COMPANY, INC., MANCHESTER, TN:
3,679,801, PUB. 1-20-2009. INT. CL. 25.
- LAZY MAN, INC., GLENDALE, CA:
3,681,096, INT. CL. 25.
- LC TRADEMARKS, INC., DETROIT, MI:
3,678,190, PUB. 6-23-2009. MULTIPLE CLASS, INT. CLS. 30 AND 43.
- LE CORDON BLEU INTERNATIONAL B.V., AMSTERDAM, NETHERLANDS:
1,641,838, AM. MULTIPLE CLASS, INT. CLS. 5, 9, 14, 24, 25, 28, 32, 34, 41 AND 42.
- LE CORRE, VINCENT B., PARIS, FRANCE:
3,681,489, INT. CL. 39.
- LE MARS AREA CHAMBER OF COMMERCE, INC., LE MARS, IA:
3,679,340, PUB. 6-23-2009. INT. CL. 35.
- LE SIRENUSE S.P.A., POSITANO (SA), ITALY:
2,749,295, CANC. INT. CL. 35.
- LEAGUE DESIGN PARTNERS, LLC, JACKSON, NJ:
3,680,945, INT. CL. 16.
- LEANIN' TREE INC., BOULDER, CO:
3,681,329, INT. CL. 16.
- LEAPING LIZARDS NATURE AWARENESS PRESCHOOL, PALO ALTO, CA:
3,679,036, PUB. 6-23-2009. INT. CL. 41.
- LEAR BAYLOR, INC., GARDEN GROVE, CA:
3,680,095, INT. CL. 12.
3,680,099, INT. CL. 7.
- LEARNSTAR, L.P., DALLAS, TX:
2,667,182, CANC. INT. CL. 41.
- LEASON, JELESTER, GARY, IN, DBA SMOK'N ROB'N:
3,679,670, PUB. 6-23-2009. INT. CL. 11.
- LEATHERMAN TOOL GROUP, INC., PORTLAND, OR:
3,680,337, INT. CL. 8.
- LEBHAR-FRIEDMAN, INC., NEW YORK, NY:
3,678,527, PUB. 6-23-2009. INT. CL. 41.
3,678,529, PUB. 6-23-2009. INT. CL. 41.
- LEBLON HOLDINGS LLC, NEW YORK, NY:
3,678,595, PUB. 6-23-2009. INT. CL. 41.

LEDTRONICS, INC., TORRANCE, CA:
2,214,509, CANC. INT. CL. 9.
2,214,510, CANC. INT. CL. 9.
2,214,511, CANC. INT. CL. 9.

LEE ENTERPRISES INCORPORATED, DAVENPORT, IA:
3,681,720, INT. CL. 35.

LEE PRODUCTS COMPANY, BLOOMINGTON, MN:
2,265,662, REN. 8-4-09, INT. CL. 16.

LEE, HOWARD YUE, SANTA MONICA, CA:
2,666,483, CANC. INT. CL. 41.

LEE, JOHN, SAN FRANCISCO, CA:
2,665,812, CANC. INT. CL. 41.

LEE, MIE-YUN, SOMERVILLE, MA:
2,666,671, CANC. INT. CL. 42.

LEEMIS MARKETING CONSULTANTS INC., OAKBROOK TERRACE, IL:
2,666,538, CANC. INT. CL. 35.

LEGEND & LORE COUTURE INC., BROOKLYN, NY:
3,680,214, INT. CL. 25.

LEHDER ENVIRONMENTAL SERVICES LIMITED, POINT EDWARD, ONTARIO, CANADA:
3,678,374, PUB. 6-23-2009, INT. CL. 42.

LEHEL INTERNATIONAL LIMITED, MAIDSTONE, KENT, UNITED KINGDOM:
3,679,867, PUB. 6-23-2009, MULTIPLE CLASS, INT. CLS. 12 AND 16.

LEHRMITT ASSOCIATES INC., SUNSET VALLEY, TX:
3,680,656, MULTIPLE CLASS, INT. CLS. 14 AND 18.

LEICA MICROSYSTEMS HOLDINGS GMBH, FED REP GERMANY:
3,679,911, PUB. 6-23-2009, INT. CL. 9.

LEMKEN GMBH & CO. KG, FED REP GERMANY:
3,679,913, PUB. 6-23-2009, INT. CL. 7.

LENDERS FINANCIAL SERVICES, LLC, AGOURA HILLS, CA:
2,665,125, CANC. MULTIPLE CLASS, INT. CLS. 35 AND 36.

LENSRENTALS, INC., CORDOVA, TN:
3,679,243, PUB. 6-23-2009, MULTIPLE CLASS, INT. CLS. 35 AND 41.

LEO ARCHER, INC., BLADENSBURG, MD:
2,665,359, CANC. INT. CL. 3.

LEO BURNETT WORLDWIDE, INC., CHICAGO, IL:
2,665,935, CANC. INT. CL. 35.

LEO'S BAGELS HANOVER SQUARE LLC, BROOKLYN, NY:
3,679,457, PUB. 6-23-2009, MULTIPLE CLASS, INT. CLS. 30, 35 AND 43.
3,679,462, PUB. 6-23-2009, MULTIPLE CLASS, INT. CLS. 35 AND 43.

LEON, RICHARD J., OCEANSIDE, CA:
3,680,368, INT. CL. 20.

LEONE, MATTHEW, CHICAGO, IL:
3,679,590, PUB. 6-23-2009, INT. CL. 41.
3,679,592, PUB. 6-23-2009, INT. CL. 25.
3,679,594, PUB. 6-23-2009, INT. CL. 9.
3,679,636, PUB. 6-23-2009, INT. CL. 16.

LEONID KOVALKOV, SINGAPORE:
3,679,887, PUB. 6-23-2009, INT. CL. 12.

LERCHEY, DAVID, BROOKLYN, NY AND NORMAN A. WRIGHT, BROOKLYN, NY:
1,602,940, CANC. INT. CL. 41.

LERNER, ERIK, BRADENTON, FL, DBA WAYNA, LLC AND LERNER, TRACI W., BRADENTON, FL, DBA WAYNA, LLC:
3,679,148, PUB. 6-23-2009, INT. CL. 25.

LERNER, MICHAEL H., NEW YORK, NY:
3,681,581, INT. CL. 25.

LES PARFUMS DE DANA, INC., NEW YORK, NY:
392,022, CANC. U.S. CL. 51.

LES SCHWAB WAREHOUSE CENTER, INC., BEND, OR:
1,600,474, REN. 8-3-09, MULTIPLE CLASS, INT. CLS. 9, 12 AND 42.

LESRIDGE HOLDINGS, LLC, DENTON, TX:
3,680,144, INT. CL. 43.

LESSO, ELKE, GLENDALE, CA:
2,667,051, CANC. INT. CL. 25.

LEVEL CLOTHING COMPANY LIMITED, VANCOUVER, BRITISH COLUMBIA:
2,665,304, CANC. MULTIPLE CLASS, INT. CLS. 25 AND 35.

LEVENTI'S RESTAURANTS INTERNATIONAL, INC., DANIELSON, CT:
1,518,437, CANC. INT. CL. 42.

LEVINE, MEL, DURHAM, NC:
3,679,178, PUB. 6-23-2009, INT. CL. 41.

LEVINE, MILON HENRY, NEW YORK, NY:
3,678,975, PUB. 6-23-2009, INT. CL. 35.

LEVITON MANUFACTURING CO., INC., LITTLE NECK, NY:
2,666,220, CANC. INT. CL. 16.

LEVITT AND SONS, LLC, BOCA RATON, FL:
2,665,813, CANC. INT. CL. 37.

LEXINGTON FURNITURE INDUSTRIES, INC., LEXINGTON, NC:
2,215,405, CANC. INT. CL. 20.

LXTEL, INC., NORTH ANDOVER, MA, DBA BIG4 SYSTEMS:
3,679,032, PUB. 6-23-2009, INT. CL. 42.

LF, LLC, WILMINGTON, DE:
3,681,543, INT. CL. 11.

LG HOUSEHOLD & HEALTH CARE LTD., SEOUL, REPUBLIC OF KOREA:
3,678,232, PUB. 4-28-2009, INT. CL. 3.

LHERITIER, GERARD, 06300 NICE, FRANCE:
2,665,582, CANC. INT. CL. 3.

LIANG, BOBBY, ARCADIA, CA, DBA HEAVENLY RICHES CORP.:
2,667,252, CANC. INT. CL. 25.

LIBERTY MUTUAL INSURANCE COMPANY, BOSTON, MA:
3,679,058, PUB. 6-23-2009, INT. CL. 36.

LIBRARY VIDEO COMPANY, WYNNWOOD, PA:
3,678,420, PUB. 6-23-2009, INT. CL. 9.

LIDL STIFTUNG & CO. KG, D-74167 NECKARSULM, FED REP GERMANY:
2,665,367, CANC. MULTIPLE CLASS, INT. CLS. 29 AND 30.
2,665,426, CANC. MULTIPLE CLASS, INT. CLS. 29 AND 30.
2,665,804, CANC. MULTIPLE CLASS, INT. CLS. 29 AND 30.

LIDL STIFTUNG & CO. KG, 74172 NECKARSULM, FED REP GERMANY:
2,667,422, CANC. INT. CL. 29.

LIDL STIFTUNG & CO. KG, 74167 NECKARSULM, FED REP GERMANY:
3,679,975, PUB. 6-23-2009, MULTIPLE CLASS, INT. CLS. 5, 29, 30, 31 AND 32.
3,681,675, INT. CL. 34.

LIFE INDUSTRIES CORPORATION, NORTH CHARLESTON, SC:
2,266,863, REN. 8-6-09, INT. CL. 17.

LIFE LEAPS, PORTLAND, OR:
3,681,446, INT. CL. 9.

LIFE OF CIRCLE LIMITED, CENTRAL, HONG KONG:
3,680,811, INT. CL. 35.

LIFE ROLLS ON FOUNDATION, CULVER CITY, CA:
3,679,328, PUB. 6-23-2009, MULTIPLE CLASS, INT. CLS. 25, 36 AND 44.

LIFEMESSAGES, INC., COLORADO SPRINGS, CO:
2,665,368, CANC. INT. CL. 9.

LIFESCAPES INTERNATIONAL, INC., NEWPORT BEACH, CA:
3,679,704, PUB. 6-23-2009, INT. CL. 42.

LIFESCIENCE SETTLEMENT TRUST, AUSTIN, TX:
3,679,554, PUB. 6-23-2009, INT. CL. 5.

LIFESTYLE BENEFITS NETWORK, LTD., AUSTIN, TX:
2,667,261, CANC. INT. CL. 35.

LIFESTYLES CONSULTING, LLC, AUSTIN, TX:
3,678,594, PUB. 6-23-2009, INT. CL. 16.

LIFESTYLES INTERNATIONAL HOLDINGS CORPORATION, GIBRALTAR, GIBRALTAR:
2,230,664, REN. 8-6-09, INT. CL. 5.

- LIFETECH S.R.O., CZECH REPUBLIC:
3,679,940, PUB. 6-23-2009. MULTIPLE CLASS, INT. CLS. 5, 10 AND 11.
- LIFETIME PRODUCTS, INC., CLEARFIELD, UT:
3,678,727, PUB. 6-23-2009. INT. CL. 19.
- LIFT BRIDGE BREWING TECHNOLOGIES, LLC, STILLWATER, MN:
3,681,116, INT. CL. 32.
- LIFTED RESEARCH GROUP INC., IRVINE, CA:
3,681,542, INT. CL. 14.
- LIGHT SCIENCES ONCOLOGY, INC., BELLEVUE, WA:
3,680,195, INT. CL. 10.
- LIGHTFOOT, GREG, KITSCOTY ALBERTA, CANADA:
3,678,299, PUB. 6-23-2009. INT. CL. 8.
- LIGNUM-2, INC., BOWLING GREEN, KY:
1,548,567. REN. 7-31-09. INT. CL. 34.
1,548,568. REN. 8-3-09. INT. CL. 34.
1,548,569. REN. 7-31-09. INT. CL. 34.
1,549,434. REN. 7-31-09. INT. CL. 34.
1,550,480. REN. 7-31-09. INT. CL. 34.
1,550,481. REN. 7-31-09. INT. CL. 34.
1,562,488. REN. 7-31-09. INT. CL. 34.
1,563,674. REN. 8-3-09. INT. CL. 34.
- LILIKOI WELLNESS, LLC, MILL VALLEY, CA:
3,681,778, INT. CL. 44.
- LIME, JOANN M., GLEN ELLEN, CA:
3,680,525, INT. CL. 25.
- LIMERICK TEA & COFFEE USA, L.P., NEW YORK, NY:
2,262,833. REN. 8-4-09. INT. CL. 30.
- LIMIARTO, DANNY, JAKARTA BARAT, INDONESIA:
3,680,263, INT. CL. 5.
- LINAMAR CORPORATION, GUELPH, CANADA:
3,678,607, PUB. 6-23-2009. MULTIPLE CLASS, INT. CLS. 40 AND 42.
- LINCOLN ELECTRIC HOLDINGS, INC., CLEVELAND, OH,
CENTRAL PRO-ARC INDUSTRIES, INC., POLO, IL:
1,111,633. REN. 8-3-09. INT. CL. 7.
- LINCOLN INDUSTRIAL CORPORATION, ST. LOUIS, MO:
3,678,986, PUB. 6-23-2009. INT. CL. 7.
- LINCOLN INVESTMENT PLANNING, INC., WYNCOTE, PA:
3,678,645, PUB. 6-23-2009. INT. CL. 36.
- LINDAMOOD, L. STUART, SNOWMASS VILLAGE, CO:
3,681,501, MULTIPLE CLASS, INT. CLS. 25 AND 35.
- LINDE AKTIENGESELLSCHAFT, 80331 MÜNCHEN/MUNICH, FED REP GERMANY:
3,680,600, MULTIPLE CLASS, INT. CLS. 41 AND 44.
- LINDSEY, TYRHA, LOVELAND, OH:
3,678,322, PUB. 6-23-2009. INT. CL. 44.
- LINE SHARE DEVICES INC., DON MILLS, ONTARIO, CANADA:
2,273,218. REN. 8-4-09. INT. CL. 9.
- LINE 12 BUSINESS DEVELOPMENT BV, NETHERLANDS:
3,680,019, PUB. 6-23-2009. INT. CL. 21.
- LINEAPIU' S.P.A., PRATO, ITALY:
2,665,827, CANC. MULTIPLE CLASS, INT. CLS. 23, 24 AND 25.
- LINKS CHOICE LLC, SCOTTSVILLE, VA:
3,679,272, PUB. 6-23-2009. INT. CL. 35.
- LINSANG MANUFACTURING, INC., BELTSVILLE, MD:
2,665,853, CANC. MULTIPLE CLASS, INT. CLS. 35, 37, 39, 40 AND 42.
- LINVATEC CORPORATION, LARGO, FL:
3,680,184, INT. CL. 10.
- LINZER PRODUCTS CORP, WYANDANCH, NY, AMERICAN BRUSH COMPANY, INC., CLAREMONT, NH:
1,550,926. REN. 7-31-09. INT. CL. 16.
- LINZER PRODUCTS CORP., WYANDANCH, NY:
2,335,325. REN. 8-3-09. INT. CL. 16.
- LIPO CHEMICALS, INC., PATERSON, NJ:
3,680,129, INT. CL. 3.
- LIPOMED AG, CH-4144 ARLESHEIM, SWITZERLAND:
2,258,601. REN. 8-6-09. MULTIPLE CLASS, INT. CLS. 5 AND 42.
- LIPSTEIN, JAFFE AND LAWSON L.L.P., WASHINGTON, DC:
2,666,006, CANC. INT. CL. 42.
- LIQUID CONTROLS, LLC, LAKE BLUFF, IL:
2,199,231. REN. 8-1-09. INT. CL. 9.
2,200,887. REN. 8-1-09. INT. CL. 9.
2,200,888. REN. 8-1-09. INT. CL. 9.
2,200,891. REN. 8-1-09. INT. CL. 9.
2,204,782. REN. 8-1-09. INT. CL. 9.
- LIQUOR EXPO, INC., GRENADA, CA:
3,681,186, INT. CL. 35.
- LISA DELFINI, TEMPE, AZ:
3,678,158, PUB. 11-27-2007. INT. CL. 30.
3,678,159, PUB. 11-27-2007. INT. CL. 43.
- LISELOTTE ZEH, 60325 FRANKFURT AM MAIN, FED REP GERMANY:
3,679,898, PUB. 6-23-2009. MULTIPLE CLASS, INT. CLS. 14, 20 AND 25.
- LISSE GROUP (INTERNATIONAL) COMPANY LIMITED, SAN PO KONG, KOWLOON, HONG KONG:
3,680,105, INT. CL. 25.
- LIST INDUSTRIES INC., DEERFIELD BEACH, FL:
2,247,303. REN. 8-4-09. MULTIPLE CLASS, INT. CLS. 6 AND 7.
- LITTLE RAPIDS CORPORATION, GREEN BAY, WI:
3,678,660, PUB. 6-23-2009. INT. CL. 24.
- LITTLE STITCHES, INC., ATLANTA, GA:
1,517,987, CANC. INT. CL. 16.
- LITTLINE ENVIRONMENTAL TECHNOLOGIES LLC, COEUR D'ALENE, ID:
3,679,496, PUB. 6-23-2009. INT. CL. 7.
- LIVE GAMER, INC., NEW YORK, NY:
3,680,503, INT. CL. 35.
- LIVEMERCIAL, INC., VALPARAISO, IN:
3,680,920, INT. CL. 35.
3,680,924, INT. CL. 35.
- LIZ CLAIBORNE, INC., NEW YORK, NY:
508,951. REN. 8-3-09. U.S. CL. 28 (INT. CLS. 8 AND 14).
3,681,433, INT. CL. 14.
- LIZ EARLE BEAUTY CO., LIMITED, LONDON, UNITED KINGDOM:
3,678,260, PUB. 6-23-2009. MULTIPLE CLASS, INT. CLS. 3, 35 AND 44.
3,678,365, PUB. 6-23-2009. INT. CL. 3.
- LKW PROPERTIES, LLC, CHARLOTTE, NC:
3,679,299, PUB. 6-23-2009. INT. CL. 37.
- LLOYD IP LIMITED, CUMBRIA, UNITED KINGDOM:
3,680,299, MULTIPLE CLASS, INT. CLS. 9 AND 25.
- LOCASCIO, THOMAS, EAST NORWICH, NY:
3,681,207, INT. CL. 25.
- LOCKHART, LISA, LAGUNA NIGUEL, CA:
3,679,413, PUB. 6-23-2009. INT. CL. 41.
- LOCOMOTION CHANNEL, THE, MIAMI BEACH, FL:
2,665,249, CANC. MULTIPLE CLASS, INT. CLS. 38 AND 41.
- LODESTAR ANSTALT, FL-9490 VADUZ, LIECHTENSTEIN:
3,679,964, PUB. 6-23-2009. INT. CL. 32.
- LODESTAR ANSTALT, LIECHTENSTEIN:
3,679,974, PUB. 6-23-2009. INT. CL. 32.
- LOESER, SHAUN W., SHERMAN OAKS, CA:
3,681,597, INT. CL. 41.
- LOFIELD CORP., CORNELIA, GA:
2,667,181, CANC. INT. CL. 35.
2,667,183, CANC. INT. CL. 35.
- LOGICENGINE, INC., NEW YORK, NY:
2,666,207, CANC. INT. CL. 42.
- LOGOS RESEARCH SYSTEMS, INC., BELLINGHAM, WA:
3,681,532, INT. CL. 16.
- LOKESEA CORP., MIAMI BEACH, FL:
2,666,188, CANC. INT. CL. 25.
- LONE PINE CAPITAL LLC, GREENWICH, CT:
3,680,687, INT. CL. 36.
- LONESOME PINE, GIG HARBOR, WA:
3,679,323, PUB. 6-23-2009. INT. CL. 35.
- LONG BAY PARTNERS, L.L.C., BONITA SPRINGS, FL:
3,679,486, PUB. 6-23-2009. MULTIPLE CLASS, INT. CLS. 25, 36 AND 37.
- LONG LIFE MAXX, INC., LOS ANGELES, CA:
2,666,544, CANC. INT. CL. 5.
- LONG VINEYARDS, ST. HELENE, CA:
2,329,738. REN. 8-5-09. INT. CL. 33.

LONG, WEIHAO ALEXANDER, KIRKLAND, WA:
3,679,112, PUB. 6-23-2009. INT. CL. 9.

LOOK PHOTOGRAPHY, INC., SAN CLEMENTE, CA:
3,679,258, PUB. 6-23-2009. INT. CL. 45.
3,679,259, PUB. 6-23-2009. INT. CL. 45.

LOOK! NO-FAULT AUTO INSURANCE AGENCIES, INC.,
MONROE, MI:
2,267,654, REN. 8-1-09. INT. CL. 36.

LOPEZ, JOSE E. R., SUNNYVILLE, CA:
2,701,502, CANC. INT. CL. 9.

LOPEZ, STEVEN M. SOUTH PASADENA, CA:
3,678,716, PUB. 6-23-2009. INT. CL. 16.

LOS ANGELES CONVENTION AND VISITOR'S BUREAU,
LOS ANGELES, CA:
2,667,308, CANC. INT. CL. 35.

LOS ANGELES LAKERS, INC., THE, EL SEGUNDO, CA:
2,256,493, REN. 8-5-09. INT. CL. 18.

LOTUS DEVELOPMENT CORPORATION, CAMBRIDGE,
MA:
1,517,941, CANC. MULTIPLE CLASS, INT. CLS. 16 AND
42.

LOUISVILLE WINNELSON COMPANY, LOUISVILLE, KY:
3,678,176, PUB. 6-23-2009. INT. CL. 35.

LOUVRETEC INTERNATIONAL PTY LTD, EASTERN
CREEK, NEW SOUTH WALES, AUSTRALIA:
3,678,256, PUB. 6-23-2009. INT. CL. 6.

LOVE UNITED. LLC, LAKELAND, FL:
3,681,275, INT. CL. 35.

LOVE, MARNELL, W., CHICAGO, IL:
3,679,451, PUB. 6-23-2009. INT. CL. 35.

LOVER'S LANE I.P., LTD., PLYMOUTH, MI, DBA LOVER'S
LANE:
3,679,771, PUB. 6-23-2009. INT. CL. 35.

LOVETT, DAVID, EWA BEACH, HI:
3,681,721, INT. CL. 16.

LOWE, MARVIN W., MARKLEVILLE, IN:
2,227,141, REN. 7-31-09. INT. CL. 41.

LPG SYSTEMS, 26000 VALENCE, FRANCE:
2,745,629, CANC. INT. CL. 9.

LRC PRODUCTS LIMITED, LONDON, UNITED KING-
DOM:
3,679,488, PUB. 6-23-2009. MULTIPLE CLASS, INT. CLS. 3
AND 10.
3,679,494, PUB. 6-23-2009. INT. CL. 5.

LSQ MANUFACTURING, INC., MEDINA, OH, DBA
ARTHUR PRODUCTS CO.:
3,678,579, PUB. 6-23-2009. INT. CL. 7.

LUBRIFILM INTERNATIONAL, INC., ARVADA, CO:
1,517,736, CANC. INT. CL. 4.
1,517,737, CANC. INT. CL. 4.

LUCASFILM LTD., SAN FRANCISCO, CA:
3,681,512, MULTIPLE CLASS, INT. CLS. 9 AND 41.

LUCIEN ALBRECHT, 68500 ORSCHWIHR, FRANCE:
2,268,687, REN. 8-3-09. INT. CL. 33.

LUCKY BRAND DUNGAREES, INC., VERNON, CA:
2,667,353, CANC. MULTIPLE CLASS, INT. CLS. 18 AND
25.

LUCKY2CREATIONS, LLC, BOISE, ID:
3,679,434, PUB. 6-23-2009. INT. CL. 28.

LUCOBIT AG, 50389 WESSELING, FED REP GERMANY:
3,679,973, PUB. 6-23-2009. MULTIPLE CLASS, INT. CLS.
17, 19 AND 35.

LUDWIG SCHOKOLADE GMBH, AACHEN, FED REP
GERMANY:
1,518,168, CANC. INT. CL. 30.

LUMA ARCADE, BLAIRGOWRIE, RANDBURG, GAU-
TENG, SOUTH AFRICA:
3,679,421, PUB. 6-23-2009. INT. CL. 9.
3,679,422, PUB. 6-23-2009. INT. CL. 9.

LUMA ARCADE, BLAIRGOWRIE, RANDBURG, SOUTH
AFRICA:
3,679,423, PUB. 6-23-2009. INT. CL. 9.

LUMBEE TRIBE OF NORTH CAROLINA, PEMBROKE, NC:
3,681,572, INT. CL. 36.

LUMEX, INC., BAY SHORE, NY:
1,517,876, CANC. INT. CL. 10.

LUMINYS, INC., IRVINE, CA:
3,679,144, PUB. 6-23-2009. INT. CL. 42.

LUND, INC., SUWANEE, GA:
1,518,563, CANC. INT. CL. 12.

LUNDBERG SURVEY INCORPORATED, CAMARILLO, CA:
1,557,903, REN. 8-3-09. INT. CL. 16.

LUNDEEN, JOYCE E., WHITE BEAR LAKE, MN:
3,679,275, PUB. 6-23-2009. INT. CL. 16.
3,679,276, PUB. 6-23-2009. INT. CL. 16.

LUTRON ELECTRONICS CO., INC., COOPERSBURG, PA:
1,595,134, REN. 8-4-09. INT. CL. 9.

LUTZ, ELLEN, PHILADELPHIA, PA:
3,680,937, INT. CL. 35.

LUXOTTICA GROUP S.P.A., ITALY:
3,680,051, PUB. 6-23-2009. INT. CL. 9.
3,680,052, PUB. 6-23-2009. INT. CL. 9.
3,680,053, PUB. 6-23-2009. INT. CL. 9.
3,680,055, PUB. 6-23-2009. INT. CL. 9.
3,680,056, PUB. 6-23-2009. INT. CL. 9.
3,680,057, PUB. 6-23-2009. INT. CL. 9.
3,680,058, PUB. 6-23-2009. INT. CL. 9.
3,680,059, PUB. 6-23-2009. INT. CL. 9.
3,680,060, PUB. 6-23-2009. INT. CL. 9.

LUZENAC EUROPE SAS, 31100 TOULOUSE, FRANCE:
3,678,207, PUB. 7-15-2008. MULTIPLE CLASS, INT. CLS.
1, 16 AND 20.

LYDALL, INC., MANCHESTER, CT:
2,213,887, CANC. INT. CL. 11.

LYNN, JOHN M., AUSTIN, TX:
2,666,791, CANC. INT. CL. 16.

LYNX GOLF, INC., CITY OF INDUSTRY, CA:
1,518,085, CANC. INT. CL. 25.

LYON METAL PRODUCTS, INCORPORATED, AURORA,
IL:
1,548,323, REN. 8-3-09. INT. CL. 20.

LYONS, JOHN, VERDUN, CANADA:
3,679,188, PUB. 6-23-2009. INT. CL. 10.

LYNN AB, LUND, SWEDEN:
3,630,319, COR. INT. CL. 9.

M & J IMPORTS INC., BROOKLYN, NY:
3,681,078, INT. CL. 25.

M MARKETING GROUP, INC., DELRAY BEACH, FL:
1,518,333, CANC. INT. CL. 39.

M. ARGUESO & CO., INC., MAMARONECK, NY:
2,665,921, CANC. INT. CL. 1.

M. J. AINGE & CO. LIMITED, HEREFORDSHIRE, UNITED
KINGDOM:
3,678,789, PUB. 4-21-2009. INT. CL. 18.

M.D. INTENSIVE, COSTA MESA, CA:
3,679,811, PUB. 6-23-2009. INT. CL. 3.

M.I.F. SAN FRANCISCO, INC., BRISBANE, CA, DBA MADE
IN FRANCE:
2,667,287, CANC. INT. CL. 32.

M.J. SOFFE, LLC, FAYETTEVILLE, NC:
3,680,146, INT. CL. 25.

M.T.H. MANIFATTURE TECNOLOGNO HARTZ S.R.L., I-
10040 ALMESE (TO), ITALY:
2,666,720, CANC. MULTIPLE CLASS, INT. CLS. 6 AND
19.

M&M MERCHANDISERS, INC, FORT WORTH, TX:
3,681,282, INT. CL. 9.

M-SYSTEMS FLASH DISK PIONEERS, LTD., KFAR SABA
44425, ISRAEL:
2,665,633, CANC. INT. CL. 9.

M'PINGO, L.L.C., HOLYOKE, MA:
2,666,457, CANC. INT. CL. 42.

MACDONALD & MUIR LIMITED, BROXBURN, WEST
LOTHIAN, UNITED KINGDOM:
3,679,918, PUB. 6-23-2009. INT. CL. 33.

MACERICH PARTNERSHIP, L.P., THE, SANTA MONICA,
CA:
2,665,377, CANC. INT. CL. 35.

MACHINE TOOL SERVICE AND TRAINING GROUP, INC.,
WAUKESHA, WI:
3,680,206, INT. CL. 41.

MACNAUGHT PTY LIMITED, TURRELLA, AUSTRALIA:
3,679,919, PUB. 6-23-2009. INT. CL. 9.

MADHUKAR, GAWANDE SANDESH, STAMFORD, CT:
3,681,697, INT. CL. 42.

- MADIX, INC., TERRELL, TX:
3,680,710, INT. CL. 20.
- MAENG, SEOP, KYUNGGI-DO, KOREA, REPUBLIC OF KOREA:
2,665,053, CANC. INT. CL. 28.
- MAESTROSOFT INC., BELLEVUE, WA:
2,284,957, REN. 8-3-09, INT. CL. 9.
- MAGGY LONDON INTERNATIONAL, LTD., NEW YORK, NY:
3,259,242, COR. INT. CL. 25.
- MAGIC MELT COMPANY, L.L.C., SILEX, MO:
2,214,605, CANC. INT. CL. 1.
- MAGIC WAND LLC, BRISTOL, VA:
3,678,379, PUB. 6-23-2009, INT. CL. 7.
- MAGIX COMPUTER PRODUCTS INTERNATIONAL TRADING CORP, LOS ANGELES, CA:
2,666,636, CANC. INT. CL. 9.
- MAGNA CENTRAL CO., LTD., TAIPEI, TAIWAN:
2,665,060, CANC. INT. CL. 35.
- MAGNITUDE ELECTRONICS, LLC, BURLINGAME, CA:
2,214,589, CANC. INT. CL. 35.
- MAGUIRE PARTNERS-SOLANA LIMITED PARTNERSHIP, WESTLAKE, TX:
1,576,767, REN. 8-1-09, INT. CL. 36.
- MAHARISHI AYUR-VED PRODUCTS INTERNATIONAL, INC., COLORADO SPRINGS, CO:
2,666,863, CANC. INT. CL. 3.
- MAJOR LEAGUE BASEBALL PROPERTIES, INC., NEW YORK, NY:
3,680,207, INT. CL. 41.
- MAKE YOUR MARK, INC., MANSFIELD, TX, DBA SPIRIT MARK:
3,678,894, PUB. 6-23-2009, INT. CL. 25.
- MAKKOS OF BROOKLYN, LTD., NEW YORK, NY:
3,680,381, INT. CL. 30.
- MAKUNSI AROMA (HONG KONG) COMPANY LIMITED, CONNAUGHT ROAD CENTRAL, HONG KONG:
3,678,730, PUB. 6-23-2009, MULTIPLE CLASS, INT. CLS. 3 AND 21.
- MALCOLM & CO. LLC, NEW YORK, NY:
3,678,438, PUB. 6-23-2009, INT. CL. 25.
- MALINI, GENE, BROOKLYN, NY:
2,875,725, CANC. INT. CL. 10.
- MALLINCKRODT BAKER, INC., ST. LOUIS, MO:
2,215,308, CANC. INT. CL. 1.
- MAMBO SEAFOOD #1, INC., HOUSTON, TX:
3,680,317, INT. CL. 43.
- MAMITA'S ICES LTD., QUEENS, NY:
3,679,821, PUB. 6-23-2009, INT. CL. 30.
- MAMMOTH-WEBCO, INC., EDEN PRAIRIE, MN, INTER-THERM INVESTMENTS, INC., PROVIDENCE, RI:
1,552,577, REN. 8-4-09, INT. CL. 9.
- MANA PRODUCTS, INC., LONG ISLAND CITY, NY:
3,680,980, INT. CL. 3.
- MANAGEMENT ASSOCIATES OF THE AMERICAS, INC., ST. PAUL, MN:
2,341,436, REN. 8-3-09, MULTIPLE CLASS, INT. CLS. 35 AND 41.
- MANAGEMENT SERVICES INTERNATIONAL, INC., HOUSTON, TX:
2,215,516, CANC. INT. CL. 28.
- MANAKA, FUMIO, NODA-SHI CHIBA-KEN, JAPAN:
2,665,132, CANC. INT. CL. 41.
- MANCHESTER FARMS, INC., DALZELL, SC:
3,681,098, INT. CL. 29.
- MANDISA, INC., BELL, CA:
2,665,954, CANC. MULTIPLE CLASS, INT. CLS. 30 AND 32.
- MANDRIEN CORPORATION, CORAL SPRINGS, FL:
3,678,359, PUB. 6-23-2009, MULTIPLE CLASS, INT. CLS. 35 AND 36.
- MANE, INC., MILFORD, OH:
3,680,282, INT. CL. 30.
- MANIFATTURE GENERALI SRL, VIA CARRIONA, 261, ITALY:
2,214,793, CANC. MULTIPLE CLASS, INT. CLS. 18 AND 25.
- MANITOWOC CRANE COMPANIES, INC., RENO, NV:
872,527, REN. 8-2-09, U.S. CL. 23 (INT. CL. 7).
- MANN & SCHRÖDER GMBH, SIEGELSBACH/BADEN, FED REP GERMANY:
3,678,472, PUB. 4-7-2009, INT. CL. 3.
- MANN WIRELESS, LTD., GREENFIELD CENTER, NY:
2,666,374, CANC. MULTIPLE CLASS, INT. CLS. 37 AND 38.
- MANNA FREIGHT SYSTEMS, INC., MENDOTA HEIGHTS, MN:
3,681,730, INT. CL. 39.
- MANOSTAT CORPORATION, NEW YORK, NY:
1,517,864, CANC. INT. CL. 9.
- MANSOFT, 92700 COLOMBES, FRANCE:
2,665,083, CANC. INT. CL. 9.
- MANTECH INTERNATIONAL CORPORATION, FAIRFAX, VA:
3,680,983, INT. CL. 9.
- MANTELCRAFT INC., FLORENCE, AL:
2,666,464, CANC. MULTIPLE CLASS, INT. CLS. 19 AND 20.
- MAPEI INC., LAVAL, QUEBEC, CANADA:
1,478,715, AM. INT. CL. 19.
- MAPEI INC., LAVAL (PROVINCE OF QUEBEC), CANADA:
1,510,135, AM. INT. CL. 19.
- MAPEI INC., LAVAL, QUEBEC, CANADA:
1,595,883, AM. INT. CL. 1.
- MAPEI INC., VIMONT, LAVAL, PROVINCE OF QUEBEC, CANADA:
1,679,409, AM. INT. CL. 19.
- MAPEI INC., LAVAL, PROVINCE OF QUEBEC, CANADA:
1,730,337, AM. INT. CL. 19.
- MAPEI INC., LAVAL, QUEBEC H7L 3J5, CANADA:
1,832,210, AM. INT. CL. 19.
- MAPLE STREET MUSIC LLC, NASHVILLE, TN:
2,215,049, CANC. INT. CL. 9.
- MARAIS, STEPHANE, PARIS, FRANCE:
2,665,563, CANC. MULTIPLE CLASS, INT. CLS. 3, 38 AND 42.
- MARATHON INDUSTRIES, INC., KENT, WA:
3,678,641, PUB. 5-19-2009, INT. CL. 12.
- MARBLE SPORTSWEAR, INC., BEVERLY HILLS, CA:
2,667,283, CANC. INT. CL. 25.
- MARC JACOBS TRADEMARKS L.L.C., UNITED STATES:
3,680,004, PUB. 6-23-2009, MULTIPLE CLASS, INT. CLS. 18 AND 25.
- MARCAL PAPER MILLS, INC., ELMWOOD PARK, NJ:
1,517,957, CANC. INT. CL. 16.
- MARCOLIN ALESSANDRO, ITALY:
3,680,026, PUB. 6-23-2009, MULTIPLE CLASS, INT. CLS. 18 AND 25.
- MARGARITELLI ITALIA S.P.A., SAN VENANZO (TR), ITALY:
2,665,569, CANC. INT. CL. 19.
- MARIA DAVIS, TAMPA, FL:
3,678,446, PUB. 6-23-2009, INT. CL. 14.
- MARICOPA PACKERS, L.P., LOS ANGELES, CA:
3,681,625, INT. CL. 31.
3,681,626, INT. CL. 31.
3,681,627, INT. CL. 31.
- MARINE POLLUTION CONTROL CORPORATION, DETROIT, MI:
2,267,104, REN. 8-6-09, INT. CL. 37.
2,267,105, REN. 8-5-09, INT. CL. 37.
- MARITZ INC., FENTON, MO:
2,667,219, CANC. INT. CL. 35.
- MARK ANTHONY INTERNATIONAL SRL, WEST INDIES, BARBADOS:
3,681,009, INT. CL. 25.
- MARK D RAINVILLE, MALVERN, PA, DBA MDR HOLDINGS LLC:
3,681,379, MULTIPLE CLASS, INT. CLS. 16 AND 41.
- MARK HOLDER JEWELLER, GREENSBORO, NC:
3,679,059, PUB. 6-23-2009, INT. CL. 35.
- MARK L. ANDERSON, SPRING VALLEY, WI:
3,679,769, PUB. 6-23-2009, INT. CL. 10.
- MARK MORRIS, EAST PALO ALTO, CA:
2,215,245, CANC. INT. CL. 9.

- MARK TRAVEL CORPORATION, THE, MILWAUKEE, WI:
1,137,030. REN. 8-3-09. INT. CL. 39.
- MARKET FORGE INDUSTRIES INC., EVERETT, MA, AKA
MF ACQUISITION, MARKET FORGE CO., EVERETT,
MA:
1,507,990. REN. 8-6-09. INT. CL. 11.
- MARKETEAM, INC., MISSION VIEJO, CA:
3,680,802. INT. CL. 35.
- MARLENE CHISM, SPRINGFIELD, MO:
3,679,433. PUB. 6-23-2009. INT. CL. 41.
- MARLOW FOODS LIMITED, NORTH YORKSHIRE, UNI-
TED KINGDOM:
2,695,008. CANC. INT. CL. 16.
- MARQUES, JACQUELINE, SAN CARLOS, CA:
3,679,175. PUB. 6-23-2009. INT. CL. 41.
- MARRIOTT INTERNATIONAL, INC., BETHESDA, MD:
3,680,741. INT. CL. 43.
- MARRS SCHNEIDER LIAISON, INCORPORATED, DAL-
LAS, DALLAS COUNTY, TX:
1,518,221. CANC. MULTIPLE CLASS, INT. CLS. 35 AND
42.
- MARSHALL CREEK, LTD., PONTE VEDRA BEACH, FL:
2,667,178. CANC. MULTIPLE CLASS, INT. CLS. 36, 37, 41
AND 42.
- MARSTELLER, MARILYN ANDERSON, CINCINNATI, OH:
3,681,535. INT. CL. 18.
- MARTHA STEWART LIVING OMNIMEDIA, LLC, NEW
YORK, NY:
2,666,830. CANC. INT. CL. 31.
- MARTIS, PAUL GOEKEN, NAPERVILLE, IL:
2,667,067. CANC. MULTIPLE CLASS, INT. CLS. 35 AND
42.
- MARX, DAVID P., CRYSTAL LAKE, IL, DBA FRONT
RUNNER CONSULTING:
3,681,401. INT. CL. 35.
- MARY KAY INC., DALLAS, TX:
2,667,127. CANC. MULTIPLE CLASS, INT. CLS. 16, 35
AND 36.
- MASACVA INC., NEW YORK, NY:
3,681,445. INT. CL. 25.
- MASDON PROFESSIONAL SERVICES, INC, CARROLL-
TON, TX, DBA ENJOY YOUR LIFE FAMILY SERVICES,
INC:
3,681,302. INT. CL. 44.
- MASHELL TELECOM, INC., TACOMA, WA, DBA RAINIER
CONNECT:
3,679,131. PUB. 6-23-2009. INT. CL. 38.
- MASON, DEREK, OAKLAND, CA:
3,680,272. INT. CL. 25.
- MASS CONNECTIONS, INC., CERRITOS, CA:
3,678,284. PUB. 6-23-2009. INT. CL. 35.
- MASSIMO ZANETTI BEVERAGE USA, INC., HOUSTON,
TX:
2,666,556. CANC. MULTIPLE CLASS, INT. CLS. 29 AND
30.
- MASTER APPLIANCE CORPORATION, RACINE, WI:
2,262,209. REN. 8-4-09. INT. CL. 11.
- MASTER PAINTERS INSTITUTE, INC., BUMABY, BRITISH
COLUMBIA V5C 3T6, CANADA:
3,025,415. COR. MULTIPLE CLASS, INT. CLS. 9, 16 AND
41.
- MASTER PAINTERS INSTITUTE, INC., BURNABY, BRIT-
ISH COLUMBIA V5C 3T6, CANADA:
3,031,132. COR. MULTIPLE CLASS, INT. CLS. 9, 16 AND
41.
- MASTERWOOD S.P.A., RIMINI, ITALY:
2,351,217. REN. 8-1-09. INT. CL. 7.
- MATCHMAKING INSTITUTE INC., NEW YORK, NY:
3,678,239. PUB. 12-23-2008. MULTIPLE CLASS, INT. CLS.
35, 41 AND 45.
- 3,678,272. PUB. 9-16-2008. MULTIPLE CLASS, INT. CLS.
35, 41 AND 45.
- MATE, HAYLEY, MEDFORD, OR:
3,679,274. PUB. 6-23-2009. INT. CL. 35.
3,679,289. PUB. 6-23-2009. INT. CL. 35.
- MATHENA, INC., EL RENO, OK:
3,681,664. MULTIPLE CLASS, INT. CLS. 7, 11 AND 37.
- MATHESON TRI-GAS, INC., BASKING RIDGE, NJ, HER-
CULES INCORPORATED, WILMINGTON, DE:
1,548,794. REN. 7-31-09. INT. CL. 1.
- MATÉRIAUX SPÉCIALISÉS LOUISEVILLE INC., LOUISE-
VILLE, CANADA:
3,678,390. PUB. 6-23-2009. INT. CL. 19.
- MATMA, S.A., BARCELONA, SPAIN, SABI, ARMAND BASI,
BARCELONA, SPAIN:
1,483,533. REN. 8-6-09. INT. CL. 25.
- MATRIX DATA SOLUTIONS, INC., JACKSONVILLE, FL:
2,665,524. CANC. INT. CL. 42.
- MATSUSHITA ELECTRIC INDUSTRIAL CO., LTD., KADO-
MA-SHI, OSAKA PREFECTURE, JAPAN:
2,213,631. CANC. INT. CL. 25.
- MATSUSHITA ELECTRIC INDUSTRIAL CO., LTD., OSA-
KA, JAPAN:
3,680,646. INT. CL. 9.
- MATTEL, INC., EL SEGUNDO, CA:
2,666,737. CANC. INT. CL. 28.
2,666,749. CANC. INT. CL. 28.
2,666,790. CANC. INT. CL. 28.
2,666,819. CANC. INT. CL. 28.
2,666,882. CANC. INT. CL. 28.
2,667,288. CANC. INT. CL. 9.
2,667,297. CANC. INT. CL. 28.
2,667,301. CANC. INT. CL. 28.
2,678,386. CANC. INT. CL. 8.
3,678,728. PUB. 6-23-2009. INT. CL. 28.
3,678,762. PUB. 6-23-2009. INT. CL. 28.
3,678,799. PUB. 6-23-2009. INT. CL. 28.
3,680,196. INT. CL. 28.
3,680,334. INT. CL. 28.
- MATTHEW WILLIAMSON, LONDON, UNITED KINGDOM:
3,678,276. PUB. 3-17-2009. MULTIPLE CLASS, INT. CLS.
3, 18 AND 25.
- MATTHEWS, DOUGLAS L., JACKSONVILLE, FL:
2,667,336. CANC. INT. CL. 16.
- MATTHEWS, VANESSA, WEST HOLLYWOOD, CA AND
MANCINI, NANCY, WEST HOLLYWOOD, CA:
3,680,854. MULTIPLE CLASS, INT. CLS. 25 AND 28.
- MAUNA LANI RESORT (OPERATION), INC., KOHALA
COAST, HI:
2,665,488. COR. INT. CL. 42.
- MAVEN BRANDS, LLC, ATLANTA, GA:
3,680,796. INT. CL. 33.
- MAVERICK RESTAURANT GROUP LLC, MCLEAN, VA:
3,680,944. INT. CL. 43.
- MAVETY MEDIA GROUP LTD., NEW YORK, NY:
2,285,852. REN. 8-5-09. MULTIPLE CLASS, INT. CLS. 41
AND 42.
- MAX ROHR, INC., WILMINGTON, DE, TE-AMO GERYL,
INC., MOONACHIE, NJ:
1,558,362. REN. 8-3-09. INT. CL. 34.
- MAXIAM, MONTREUIL, FRANCE:
3,679,902. PUB. 6-23-2009. MULTIPLE CLASS, INT. CLS.
20, 24 AND 35.
- MAXITECH, FORT WORTH, TX:
3,679,565. PUB. 6-23-2009. INT. CL. 17.
- MAXSPIRITS GROUP, S.A., PROVINCE OF COLON, PANAMA:
3,680,516. INT. CL. 33.
- MAXWELL INCORPORATED, FORT LAUDERDALE, FL:
2,666,568. CANC. INT. CL. 35.
- MAY MANUFACTURING, LLC, CHATTANOOGA, TN:
3,681,266. INT. CL. 19.
- MAYA ROMANOFF CORPORATION, SKOKIE, IL:
3,680,654. INT. CL. 27.
- MAYA WRAP, INC., YADKINVILLE, NC:
3,679,711. PUB. 6-23-2009. INT. CL. 18.
- MAZZALI SYSTEMS S.P.A., MONZA (MILANO), ITALY:
2,665,749. CANC. MULTIPLE CLASS, INT. CLS. 7 AND
11.
- MBC HOLDINGS, INC., ARCHBOLD, OH:
2,666,016. CANC. INT. CL. 37.
- MBF AGENCY, LLC, AUSTIN, TX:
3,678,171. PUB. 6-23-2009. INT. CL. 35.

- MCAFFEE HEATING & AIR CONDITIONING CO., INC., KETTERING, OH:
3,611,115, COR. INT. CL. 37.
- MCBARNETTE, CATHY, PRINCETON, NJ:
2,215,235, CANC. INT. CL. 28.
- MCCAFFERTY, JAMES R., SANTA ANA, CA:
2,667,155, CANC. INT. CL. 28.
- MCCALLUM, TIM, LA JOLLA, CA:
3,678,407, PUB. 6-23-2009, INT. CL. 25.
- MCCLORY, MICHAEL R., ARLINGTON, VA, DBA QED COMMUNICATIONS:
2,665,186, CANC. INT. CL. 41.
- MCCOMBS, JEFFREY S., LOS ANGELES, CA, DBA MCCOMBS CENTER FOR HEALTH:
3,679,049, PUB. 6-23-2009, INT. CL. 5.
- MCCOY, NANCY R., LAWRENCEVILLE, GA:
2,665,123, CANC. INT. CL. 35.
- MCD TECHNOLOGIES, INC, TACOMA, WA:
2,666,504, CANC. INT. CL. 11.
- MCDANDEE, INC., FARGO, ND:
2,215,256, CANC. INT. CL. 18.
2,215,259, CANC. INT. CL. 18.
- MCDONALD'S CORPORATION, OAK BROOK, IL:
3,680,663, INT. CL. 41.
- MCDONOUGH BRAUNGART DESIGN CHEMISTRY, LLC, CHARLOTTESVILLE, VA:
3,680,190, MULTIPLE CLASS, INT. CLS. 35, 41 AND 42.
3,680,191, MULTIPLE CLASS, INT. CLS. 35, 41 AND 42.
3,680,287, MULTIPLE CLASS, INT. CLS. 35, 41 AND 42.
- MCERON LTD., KOWLOON, HONG KONG:
3,680,497, INT. CL. 25.
- MCGAVICK/BROICH COMPANY, OLYMPIA, WA:
2,665,908, CANC. INT. CL. 36.
- MCGIVNEY, JULIE M., WADING RIVER, NY AND CONNOLLY, KERYN, FLORAL PARK, NY:
3,681,374, INT. CL. 26.
- MCGRATH, PHILIP M., COLORADO SPRINGS, CO AND MCGRATH, CYNTHIA A., COLORADO SPRINGS, CO:
3,678,197, PUB. 6-23-2009, INT. CL. 12.
- MCGRAW-HILL COMPANIES, INC., THE, NEW YORK, NY:
2,667,190, CANC. INT. CL. 9.
- MCMILLAN, JAMES L, DALLAS, TX:
2,665,184, CANC. INT. CL. 41.
- MCNB BANKS, WELCH, WV:
3,678,235, PUB. 11-6-2007, INT. CL. 36.
- MCNEEL, THOMAS E., COSTA MESA, CA:
3,680,864, INT. CL. 25.
- MCPEAK, NANA PATRICIA, EL DORADO HILLS, CA:
3,678,613, PUB. 6-23-2009, INT. CL. 5.
- MCPHEARSONS HEATING AND COOLING LLC, DAYTON, OH:
3,678,612, PUB. 6-23-2009, INT. CL. 37.
- MCPOLO (USA) CORP., CORONA, NY:
3,678,362, PUB. 3-17-2009, MULTIPLE CLASS, INT. CLS. 9 AND 18.
- MCR PASSIONS, INC., MIAMI, FL:
3,681,235, INT. CL. 14.
- MCSPORT GROUP LIMITED, CHESTER CH1 2AU, ENGLAND, UNITED KINGDOM:
3,680,092, MULTIPLE CLASS, INT. CLS. 25 AND 28.
- MDU RESOURCES GROUP, INC., BISMARCK, ND:
3,679,135, PUB. 6-23-2009, MULTIPLE CLASS, INT. CLS. 16 AND 45.
- MEAD CORPORATION, THE, DAYTON, OH:
2,665,800, CANC. INT. CL. 9.
- MEADWESTVACO CORPORATION, GLEN ALLEN, VA:
3,577,806, COR. INT. CL. 16.
3,680,674, INT. CL. 21.
3,681,559, INT. CL. 16.
- MEBCO INDUSTRIES, INC., MINNEAPOLIS, MN:
1,815,435, CANC. INT. CL. 21.
- MECC - USA, LLC, KINGS MILL, OH:
2,598,296, CANC. MULTIPLE CLASS, INT. CLS. 11 AND 42.
- MECHANISING HOUSE, INC., CHICAGO, IL:
2,214,710, CANC. INT. CL. 16.
- MECHANIX WEAR, INC., VALENCIA, CA:
3,680,575, INT. CL. 9.
3,680,576, INT. CL. 9.
- MECO CORPORATION, GREENEVILLE, TN:
2,214,386, CANC. INT. CL. 11.
- MED-STAFF, LLC, ST. LOUIS, MO:
1,547,635, REN. 8-3-09, INT. CL. 35.
- MEDA PHARMA GMBH & CO KG, BAD HOMBURG, FED REP GERMANY:
2,665,745, CANC. INT. CL. 5.
- MEDAC, INC., AUGUSTA, GA:
3,679,241, PUB. 6-23-2009, INT. CL. 35.
- MEDALLION BRANDS INTERNATIONAL COMPANY, HOUSTON, TX:
2,665,627, CANC. INT. CL. 34.
- MEDARC, LLC, VICTORIA, TX:
3,680,858, INT. CL. 35.
- MEDI MULTIMEDIA, INC., IRVINE, CA:
2,665,803, CANC. MULTIPLE CLASS, INT. CLS. 35, 38 AND 42.
- MEDIA PLAN, INC., SANDY, UT:
2,666,718, CANC. INT. CL. 9.
- MEDIA TECHNOLOGY CELLTEN LLC, NEW YORK, NY:
2,665,033, CANC. INT. CL. 36.
- MEDIACROSS, INC., SAINT LOUIS, MO:
3,678,695, PUB. 6-23-2009, INT. CL. 35.
- MEDIAMAN, LLC, SWAMPSCOTT, MA:
3,679,498, PUB. 6-23-2009, INT. CL. 35.
- MEDIAMOST INTERNATIONAL, INC., NEW YORK, NY:
2,666,253, CANC. INT. CL. 38.
- MEDIAWAY, INC., MILPITAS, CA:
2,664,904, CANC. INT. CL. 9.
- MEDICAL QUANT USA, INC., SOLON, OH, DBA MULTI RADIANCE MEDICAL:
3,678,988, PUB. 6-23-2009, INT. CL. 10.
- MEDICAL WORLD BUSINESS PRESS, INC., JAMESBURG, NJ:
2,214,066, CANC. INT. CL. 16.
- MEDICAP PHARMACIES INCORPORATED, ST. LOUIS, MO:
3,679,253, PUB. 6-23-2009, INT. CL. 35.
- MEDICREA INTERNATIONAL, F-01700 NEYRON, FRANCE:
3,679,987, PUB. 6-23-2009, INT. CL. 10.
- MEDIMEDIA USA, INC., YARDLEY, PA:
2,353,674, REN. 8-2-09, INT. CL. 42.
- MEDIMMUNE, LLC, GAITHERSBURG, MD:
3,679,391, PUB. 6-23-2009, INT. CL. 44.
3,679,676, PUB. 6-23-2009, INT. CL. 44.
- MEDIXMEDIA, INC., NEW YORK, NY:
2,667,372, CANC. INT. CL. 44.
- MEDPORT LLC, PROVIDENCE, RI:
3,679,620, PUB. 6-23-2009, INT. CL. 21.
- MEDQIA, LOS ANGELES, CA:
3,681,691, INT. CL. 44.
3,681,700, INT. CL. 44.
- MEDTECH PRODUCTS INC., IRVINGTON, NY:
3,681,303, INT. CL. 5.
3,681,304, INT. CL. 5.
- MEDTRONIC, INC., MINNEAPOLIS, MN:
1,551,794, REN. 8-6-09, INT. CL. 10.
- MEEKER, MARY ANN, VISALIA, CA:
2,666,701, CANC. INT. CL. 41.
- MEGA BRANDS INTERNATIONAL, LUXEMBOURG, ZUG BRANCH, ZUG, SWITZERLAND:
2,666,112, CANC. INT. CL. 28.
- MEGA STAR MEDIA INC., RENO, NV:
3,680,122, INT. CL. 42.
- MEGAMEDIA LTD., WANCHAI, HONG KONG:
3,679,693, PUB. 6-23-2009, INT. CL. 36.
- MEGUMI CHARM, INC., SANTA MONICA, CA:
3,681,558, INT. CL. 14.
- MEIKO MASCHINENBAU GMBH & CO. KG, OFFENBURG, FED REP GERMANY:
3,681,555, INT. CL. 7.
- MELINDA MYERS LLC, MILWAUKEE, WI:
3,555,488, COR. MULTIPLE CLASS, INT. CLS. 16, 41 AND 44.

MELITA INTELLECTUAL PROPERTY, WILMINGTON, DE:
2,666,501, CANC. INT. CL. 9.
2,666,502, CANC. INT. CL. 9.

MELLING SPORTSCARS, INC., BIG LAKE, MN:
3,680,504, INT. CL. 12.

MELOGRANO, RICHARD, HERMOSA BEACH, CA:
2,214,598, CANC. INT. CL. 25.

MELTON-JOHNSON, BRENNAN W., SAN LUIS OBISPO, CA
AND MELTON-JOHNSON, JENNIFER M., SAN LUIS
OBISPO, CA:
3,681,081, INT. CL. 31.

MEME DELRAY BEACH, LLC, DELRAY BEACH, FL:
3,678,578, PUB. 6-23-2009. INT. CL. 3.

MEMPHIS CHAMPIONSHIP BARBECUE COMMISSARY,
INC., LAS VEGAS, NV:
2,256,568, REN. 8-1-09. INT. CL. 42.

MEN'S JOURNAL LLC, NEW YORK, NY:
2,665,647, CANC. MULTIPLE CLASS, INT. CLS. 16 AND
41.

MENARD, INC., EAU CLAIRE, WI:
3,680,577, INT. CL. 3.

MENDLESTEIN, RICHARD, ANSONIA, CT:
3,681,621, INT. CL. 28.

MENNONITE/ANABAPTIST INFORMATION CENTER,
INC., SHIPSHAWANA, IN:
1,551,344, REN. 8-4-09. INT. CL. 41.

MENTADO MEDINA, ANTONIO LUIS, SPAIN:
3,679,981, PUB. 6-23-2009. INT. CL. 25.

MERCEDES RESTAURANTS, INC., SAN DIEGO, CA:
2,214,466, CANC. INT. CL. 35.

MERCHANT GUY LLC, LENEXA, KS:
3,678,811, PUB. 6-23-2009. INT. CL. 36.

MERCHANT MEDIA, LLC, FRAMINGHAM, MA:
3,679,780, PUB. 6-23-2009. INT. CL. 6.

MERCHANTS NATIONAL BANK OF KITTANNING, KIT-
TANNING, PA:
2,667,386, CANC. INT. CL. 36.

MERCK KGAA, DARMSTADT D-264293, FED REP GER-
MANY:
2,234,097, REN. 8-3-09. INT. CL. 2.

MERCK KGAA, DARMSTADT, FED REP GERMANY:
2,667,225, CANC. INT. CL. 41.
3,678,750, PUB. 6-23-2009. MULTIPLE CLASS, INT. CLS. 1
AND 9.

MERCURY ENTERPRISES, INC., CLEARWATER, FL:
2,332,502, REN. 8-3-09. INT. CL. 16.

MERGENT, INC., FORT MILL, SC:
3,679,627, PUB. 6-23-2009. MULTIPLE CLASS, INT. CLS.
36 AND 42.
3,681,678, MULTIPLE CLASS, INT. CLS. 36 AND 42.

MERITOR WABCO VEHICLE CONTROL SYSTEMS, TROY,
MI:
3,681,355, INT. CL. 9.

MERLIN'S MAGIK LLC, CORVALLIS, MT:
3,681,020, MULTIPLE CLASS, INT. CLS. 3 AND 25.

MERMENTAU RICE, INC., MERMENTAU, LA:
2,666,270, CANC. INT. CL. 30.

MERUELO, BELINDA, MIAMI BEACH, FL, DBA DEAU-
VILLE BEACH RESORT:
3,679,294, PUB. 6-23-2009. INT. CL. 43.

MERVIS, KURT, LAHAINA, MAUI, HI:
2,667,400, CANC. INT. CL. 20.

MESHBESHER HEALTH CORPORATION, CLEARWATER,
FL:
3,681,573, INT. CL. 44.
3,681,586, INT. CL. 44.

MESI, JOSEPH J. II, TONAWANDA, NY:
2,666,269, CANC. MULTIPLE CLASS, INT. CLS. 35, 36
AND 41.

METAL CONSTRUCTION ASSOCIATION, GLENVIEW, IL:
3,681,793, U.S. CL. A.

METAL IMPROVEMENT COMPANY, LLC, PARAMUS, NJ:
3,679,369, PUB. 6-23-2009. MULTIPLE CLASS, INT. CLS. 2
AND 4.
3,679,760, PUB. 6-23-2009. MULTIPLE CLASS, INT. CLS. 2
AND 4.

METAL SUPERMARKETS CORPORATION, MISSISSAUGA,
ONTARIO, CANADA:
2,256,284, REN. 8-1-09. INT. CL. 35.

METALLIC POWER, INC., SAN FRANCISCO, CA:
2,215,095, CANC. INT. CL. 9.

METALLURG VANADIUM CORPORATION, CAMBRIDGE,
OH:
3,681,242, INT. CL. 35.

METALWORKING PROCESS MANAGEMENT, PERRYS-
BURG, OH:
2,665,127, CANC. INT. CL. 11.

METEOR VINEYARD, LLC, NAPA, CA:
3,681,238, INT. CL. 33.
3,681,277, INT. CL. 33.
3,681,280, INT. CL. 33.

METRETEK INCORPORATED, MELBOURNE, FL:
2,665,951, CANC. MULTIPLE CLASS, INT. CLS. 35 AND
42.

METRO FRANCHISING LLC, NEW YORK, NY:
2,665,073, CANC. INT. CL. 35.

METRO-GOLDWYN-MAYER STUDIOS INC., LOS AN-
GELES, CA:
1,122,758, REN. 8-3-09. MULTIPLE CLASS, INT. CLS. 16,
25 AND 28.

METROLACROSSE, INC., DORCHESTER, MA:
3,678,340, PUB. 6-23-2009. INT. CL. 41.
3,678,341, PUB. 6-23-2009. INT. CL. 41.

METROMARK MARKET RESEARCH, INC., COLUMBIA,
SC:
3,678,681, PUB. 6-23-2009. MULTIPLE CLASS, INT. CLS.
35 AND 45.

METROPOLITAN, I.D.A., INC., SOUTHFIELD, MI:
1,518,429, CANC. INT. CL. 42.

MEVERDEN ENTERPRISES, INC., WHITE BEAR LAKE,
MN:
3,679,545, PUB. 6-23-2009. INT. CL. 41.

MEXDER, MERCADO MEXICANO DE DERIVADOS, S.A.
DE C.V., C.P. 06500, MEXICO, AKA MEXDER:
3,678,801, PUB. 6-23-2009. INT. CL. 16.
3,678,802, PUB. 6-23-2009. INT. CL. 36.
3,678,803, PUB. 6-23-2009. MULTIPLE CLASS, INT. CLS.
9, 16 AND 36.
3,678,804, PUB. 6-23-2009. MULTIPLE CLASS, INT. CLS.
9, 16 AND 36.

MEYER PRODUCTS, CLEVELAND, OH:
3,680,938, INT. CL. 7.
3,680,939, INT. CL. 7.

MEYER PRODUCTS LLC, CLEVELAND, OH:
3,680,941, INT. CL. 7.

MFM INTERNATIONAL, INC., NEW YORK, NY:
2,665,834, CANC. INT. CL. 25.

MG BROWN INVESTMENT GROUP, LLC, HOUSTON, TX:
3,681,320, INT. CL. 44.

MGM RETAIL PROPERTIES, INC., CATHEDRAL CITY, CA,
DBA PIZZA PAI USA:
3,679,279, PUB. 6-23-2009. INT. CL. 43.

MHB FILTRATION GMBH & CO. KG, ERKRATH, FED REP
GERMANY:
2,665,838, CANC. MULTIPLE CLASS, INT. CLS. 11 AND
12.

MICAH PARKER ARTWORKS, INC., SARASOTA, FL:
2,666,280, CANC. INT. CL. 16.

MICHAEL BEAUDRY, INC., LOS ANGELES, CA:
2,215,591, CANC. INT. CL. 14.

MICHAEL FOODS, INC., MINNETONKA, MN:
2,666,741, CANC. INT. CL. 29.

MICHAEL SCHNEIDER, HOUSTON, TX:
3,678,883, PUB. 6-23-2009. INT. CL. 12.
3,678,884, PUB. 6-23-2009. INT. CL. 12.

MICHAEL W. FENDLEY, LITTLE ROCK, AR:
3,680,992, INT. CL. 36.

MICHAEL, DEBORAH M., GLENVIEW, IL, DBA NORTH
SHORE PEDIATRIC THERAPY:
3,678,568, PUB. 6-23-2009. INT. CL. 44.

MICHELMAN, INC., CINCINNATI, OH:
3,678,675, PUB. 6-23-2009. INT. CL. 1.

- MICHIGAN ORTHOPAEDICS AND SPORTS MEDICINE, PC, GRAND RAPIDS, MI:
3,678,364, PUB. 1-27-2009. INT. CL. 44.
- MICOR INDUSTRIES, INC., DECATUR, AL:
3,679,122, PUB. 5-19-2009. INT. CL. 40.
- MICRO TARGET MEDIA HOLDINGS INC., TORONTO, CANADA:
3,681,551, MULTIPLE CLASS, INT. CLS. 6, 35 AND 40.
- MICROPORE, INC., COOKEVILLE, TN:
1,517,786, CANC. INT. CL. 7.
- MICROSOFT CORPORATION, REDMOND, WA, GUPTA TECHNOLOGIES, INC., MENLO PARK, CA:
1,558,816, REN. 7-31-09. INT. CL. 9.
- MICROSOFT CORPORATION, REDMOND, WA:
3,681,092, INT. CL. 39.
- MID AMERICA MOTORWORKS, INC., EFFINGHAM, IL:
2,262,980, REN. 8-1-09. INT. CL. 35.
- MID-CONTINENT RAILWAY HISTORICAL SOCIETY, INC., NORTH FREEDOM, WI:
1,518,376, CANC. INT. CL. 41.
- MIDAS YELLOW LTD., DRY DRAYTON, CAMBRIDGE, UNITED KINGDOM:
3,681,477, INT. CL. 9.
- MIDICA ESTABLISHMENT, VADUZ, LIECHTENSTEIN:
2,275,800, REN. 8-3-09. INT. CL. 35.
- MIDMARK CORPORATION, VERSAILLES, OH:
3,678,773, PUB. 6-23-2009. INT. CL. 10.
- MIDTECH R&D INC, FAIRMONT, MN:
2,290,011, REN. 8-1-09. INT. CL. 5.
- MIDWAY AMUSEMENT GAMES, LLC, CHICAGO, IL:
2,666,908, CANC. INT. CL. 9.
- MIDWEST CENTER FOR HOME, HOSPICE & PALLIATIVE CARE EDUCATION, DUBLIN, OH:
3,679,371, PUB. 6-23-2009. INT. CL. 41.
- MIELE, INC., PRINCETON, NJ:
3,679,396, PUB. 6-23-2009. INT. CL. 7.
3,679,398, PUB. 6-23-2009. INT. CL. 7.
3,679,399, PUB. 6-23-2009. INT. CL. 7.
3,679,402, PUB. 6-23-2009. INT. CL. 7.
3,679,403, PUB. 6-23-2009. INT. CL. 7.
- MIGHTY RIVERS CLEANING SERVICE, BLACKWOOD, NJ:
2,666,139, CANC. INT. CL. 37.
- MIGI LLC, BEVERLY HILLS, CA:
3,679,338, PUB. 6-23-2009. MULTIPLE CLASS, INT. CLS. 11, 21 AND 24.
- MIKASA CORPORATION, HIROSHIMA NISHI-KU, JAPAN:
3,680,106, MULTIPLE CLASS, INT. CLS. 9, 12, 14, 28 AND 41.
- MILL CREEK TOWN CENTER BUSINESS ASSOCIATION, SEATTLE, WA:
3,681,669, INT. CL. 35.
- MILLARD, CATHERINE, SPRINGFIELD, VA:
3,678,185, PUB. 6-23-2009. INT. CL. 9.
- MILLARD, LEE (LEROY EDWARD MILLARD), LAS VEGAS, NV:
2,666,004, CANC. INT. CL. 38.
- MILLENNIUM GAMES & CRAFTS, INC., TOLEDO, OH:
2,214,970, CANC. INT. CL. 28.
- MILLENNIUM HEALTHCARE CONSULTING, INC., LANSDALE, PA:
2,281,416, REN. 8-1-09. INT. CL. 35.
- MILLENNIUM MINISTRIES, INC., JACKSON, NJ:
2,667,052, CANC. MULTIPLE CLASS, INT. CLS. 21, 25 AND 42.
- MILLER, CALUM T, COLDSTREAM, UNITED KINGDOM AND HODGSON, PATRICK, SOUTHPORT, UNITED KINGDOM:
3,678,236, PUB. 1-20-2009. MULTIPLE CLASS, INT. CLS. 9 AND 42.
- MILLER, INGRID, IRVINE, CA:
3,681,746, INT. CL. 41.
- MILLER, JONATHAN D., SAN FRANCISCO, CA:
2,666,638, CANC. INT. CL. 44.
- MILLER, WILLIAM R., ROBBINSVILLE, NC:
2,666,733, CANC. U.S. CL. A.
- MILLERS FIRST INSURANCE COMPANY, ALTON, IL:
1,518,244, CANC. INT. CL. 36.
- MILLIPORE CORPORATION, BILLERICA, MA:
2,260,858, REN. 8-3-09. INT. CL. 9.
3,680,275, INT. CL. 11.
3,681,188, INT. CL. 9.
- MILLS DISTRIBUTING COMPANY, SALINAS, CA:
2,666,650, CANC. INT. CL. 31.
- MILWAUKEE BREWERS BASEBALL CLUB, LIMITED PARTNERSHIP, MILWAUKEE, WI:
2,546,925, COR. INT. CL. 16.
- MILWAUKEE HEART RESEARCH FOUNDATION, INC., THE, MILWAUKEE, WI:
1,518,259, CANC. INT. CL. 36.
- MINI-SKOOL EARLY LEARNING CENTERS, INC., SCOTTSDALE, AZ:
2,305,386, REN. 8-5-09. INT. CL. 42.
- MINKEL ENTERPRISES, INC., OJAI, CA:
3,679,585, PUB. 6-23-2009. INT. CL. 36.
- MINKIN, PATRICIA, COSTA MESA, CA:
3,680,393, INT. CL. 35.
- MINNESOTA WASTE WISE FOUNDATION, ST. PAUL, MN:
3,679,424, PUB. 6-23-2009. INT. CL. 35.
3,679,427, PUB. 6-23-2009. INT. CL. 41.
- MIRAGE PLANTS INC, LAS VEGAS, NV:
3,679,085, PUB. 6-23-2009. INT. CL. 26.
- MIROLIN INDUSTRIES, INC., TORONTO, ONTARIO, CANADA, MIROLIN INDUSTRIES INC., TORONTO, ONTARIO, CANADA:
1,548,172, REN. 8-5-09. INT. CL. 11.
- MISS MEGHAN MEDIA, INC., NEW YORK, NY:
3,680,294, INT. CL. 41.
- MISSION PLAYGROUND, LLC, PETALUMA, CA:
3,680,254, MULTIPLE CLASS, INT. CLS. 16, 18, 25 AND 35.
- MISSION: IMPAWSIBLE DOG TRAINING, LLC, KINGSTON, NH:
3,653,160, CANC. IIRN. RESTORED TO S.N. 77-379,371.
- MISSOURI BASIN MUNICIPAL POWER AGENCY, SIOUX FALLS, SD:
2,831,094, CANC. INT. CL. 36.
- MISTER PIZZA CO., LTD., SEOUL, REPUBLIC OF KOREA:
3,681,137, MULTIPLE CLASS, INT. CLS. 30 AND 43.
- MISTERART.COM, L.P., HOUSTON, TX:
2,250,203, REN. 7-31-09. INT. CL. 35.
- MITCH-STUART, INC., NORTH MIAMI BEACH, FL:
3,680,382, INT. CL. 35.
- MITEK CORPORATION, WINSLOW, IL:
3,679,261, PUB. 6-23-2009. INT. CL. 9.
- MITEL NETWORKS CORPORATION, OTTAWA, CANADA:
3,679,055, PUB. 6-23-2009. INT. CL. 16.
- MITSUBISHI ELECTRIC CORPORATION, CHIYODA-KU, TOKYO, JAPAN:
3,593,677, AM. INT. CL. 9.
- MITSUBISHI ENPITSU KABUSHIKI KAISHA, TOKYO, JAPAN:
2,667,216, CANC. INT. CL. 16.
- MITSUBISHI PAPER MILLS LIMITED, TOKYO, JAPAN:
1,560,327, REN. 8-4-09. INT. CL. 1.
- MMP SOLUTIONS, INC., TARZANA, CA:
2,665,216, CANC. INT. CL. 42.
- MNI HOLDING GMBH, AUSTRIA:
3,679,990, PUB. 6-23-2009. INT. CL. 7.
- MO'S NOSE, LLC, SANTA MONICA, CA:
3,678,482, PUB. 6-23-2009. MULTIPLE CLASS, INT. CLS. 16, 25, 35 AND 41.
- MOAEC, INC., BILLERICA, MA:
3,680,855, INT. CL. 9.
3,680,897, INT. CL. 9.
- MOBILE AIR, INC., MADISON HEIGHTS, MI:
3,680,722, INT. CL. 37.
- MOBILEYE TECHNOLOGIES LIMITED, NICOSIA 1034, CYPRUS:
3,680,093, INT. CL. 9.
- MOBYKO LIMITED, LONDON W1F 9RU, UNITED KINGDOM:
3,679,844, PUB. 4-21-2009. MULTIPLE CLASS, INT. CLS. 9, 35, 38 AND 42.

MOCANA CORPORATION, SAN FRANCISCO, CA:
 3,678,551, PUB. 6-23-2009. INT. CL. 9.
 3,678,553, PUB. 6-23-2009. INT. CL. 9.
 3,678,554, PUB. 6-23-2009. INT. CL. 9.
 3,678,555, PUB. 6-23-2009. INT. CL. 9.
 3,678,557, PUB. 6-23-2009. INT. CL. 9.
 3,678,558, PUB. 6-23-2009. INT. CL. 9.
 3,678,559, PUB. 6-23-2009. INT. CL. 9.
 3,678,561, PUB. 6-23-2009. INT. CL. 9.

MODA MILAN INC., POMPANO BEACH, FL:
 3,681,684, MULTIPLE CLASS, INT. CLS. 9 AND 25.

MODAS SHING COMPANY LTD., TAIPEI, TAIWAN:
 2,666,326, CANC. INT. CL. 12.

MODERN SPIRITS LLC, MONOVIA, CA:
 3,679,716, PUB. 6-23-2009. INT. CL. 33.

MODEROW, DAVID, FORT WORTH, TX:
 3,678,898, PUB. 6-23-2009. INT. CL. 25.

MOHACSI, DRINA LEE, N. HOLLYWOOD, CA:
 2,665,427, CANC. INT. CL. 26.

MOHAWK BRANDS, INC., WILMINGTON, DE:
 2,667,349, CANC. INT. CL. 27.

MOHAWK CARPET CORPORATION, CALHOUN, GA TO
 MOHAWK CARPET DISTRIBUTION, INC, CALHOUN,
 GA:
 2,750,703, CANC. INT. CL. 19.

MOLDAVON, ILONA, CALABASAS, CA:
 3,678,599, PUB. 6-23-2009. INT. CL. 3.

MOLLYDOOKER WINES PTY LTD, AUSTRALIA:
 3,595,067, COR. MULTIPLE CLASS, INT. CLS. 41 AND
 43.

MOLLYGUARD CORPORATION, SAN FRANCISCO, CA:
 3,680,905, INT. CL. 35.

MOLTRUP, JANIE CAROL, SMITHSBURG, MD:
 2,666,506, CANC. MULTIPLE CLASS, INT. CLS. 16 AND
 21.

MOMENTUM MANAGEMENT LLC, BEVERLY HILLS, CA:
 3,681,049, INT. CL. 5.

MONESSEN HEARTH SYSTEMS COMPANY, PARIS, KY:
 3,679,608, PUB. 6-23-2009. INT. CL. 11.

MONITOR TECHNOLOGIES LLC, ELBURN, IL TO MONI-
 TOR TECHNOLOGIES LLC, ELBURN, IL:
 2,215,586, CANC. INT. CL. 9.

MONROVIA NURSERY, AZUSA, CA:
 3,679,269, PUB. 6-23-2009. INT. CL. 41.

MONSANTO TECHNOLOGY LLC, ST. LOUIS, MO:
 3,678,537, PUB. 6-23-2009. INT. CL. 36.

MONSTER BURGER CORP., LAUDERHILL, FL:
 2,667,428, CANC. INT. CL. 43.

MONSTER CABLE PRODUCTS, INC., BRISBANE, CA:
 2,215,211, CANC. INT. CL. 9.

MONSTER DADDY, LLC, GREENVILLE, SC:
 3,681,514, INT. CL. 43.

MONTANO, JAVIER, MIAMI, FL:
 3,678,597, PUB. 6-23-2009. INT. CL. 45.

MONTES, JILLIAN, STUART, FL:
 3,681,154, INT. CL. 41.

MONTOYA, PETER, COSTA MESA, CA, DBA MILLEN-
 NIUM ADVERTISING:
 2,666,805, CANC. INT. CL. 9.

MONTRES TUDOR SA, 1211 GENEVE 26, SWITZERLAND:
 3,680,354, INT. CL. 14.

MOOD MENDERS, LLC, PUEBLO WEST, CO, AKA MOOD
 MENDERS, TO GO SPA:
 3,679,354, PUB. 6-23-2009. INT. CL. 3.

MOORE COMPANY, INC., THE, CHARLESTON, WV:
 2,666,123, CANC. INT. CL. 21.

MOORE INDUSTRIES - INTERNATIONAL, INC., NORTH
 HILLS, CA:
 1,552,719, REN. 8-1-09. INT. CL. 9.

MORDANT/CONVENTO - SOCIEDADE VITICOLA, S.A.,
 5120 TABUAGO, PORTUGAL:
 2,665,140, CANC. INT. CL. 33.

MORE CUPCAKES, LLC, CHICAGO, IL:
 3,680,957, MULTIPLE CLASS, INT. CLS. 25, 30 AND 43.
 3,680,958, INT. CL. 25.

MOREFUNNER, LLC, GREENWOOD, IN, DBA BRAIN
 BENDER GAMES:
 3,679,342, PUB. 6-23-2009. INT. CL. 28.
 3,679,505, PUB. 6-23-2009. INT. CL. 28.
 3,679,506, PUB. 6-23-2009. INT. CL. 28.
 3,679,509, PUB. 6-23-2009. INT. CL. 28.

MOREL ACOUSTIC LTD., NES ZIONA 70400, ISRAEL:
 1,549,884, REN. 8-1-09. INT. CL. 9.

MORGAN TIRE & AUTO, INC., CLEARWATER, FL:
 3,679,162, PUB. 6-23-2009. INT. CL. 35.
 3,679,163, PUB. 6-23-2009. INT. CL. 37.

MORGAN, REBECCA L., SAN JOSE, CA, DBA DATING
 GODDESS:
 3,681,371, INT. CL. 16.

MORIDGE MANUFACTURING, INC., MOUNDRIDGE, KS:
 3,680,658, INT. CL. 7.

MORPHIC TECHNOLOGIES AKTIEBOLAG; (PUBL.), SWE-
 DEN:
 3,679,889, PUB. 6-23-2009. MULTIPLE CLASS, INT. CLS.
 6, 7, 9, 37, 40 AND 42.
 3,679,900, PUB. 6-23-2009. MULTIPLE CLASS, INT. CLS.
 6, 7, 9, 11, 12, 19, 37, 40 AND 42.

MORRIS, MANNING & MARTIN, LLP, ATLANTA, GA:
 2,666,976, CANC. INT. CL. 42.

MORRIS, REV. DANIELLE DUBOIS, WINTER PARK, FL:
 2,666,259, CANC. INT. CL. 44.

MORRIS, RODNEY J, HUMBLE, TX:
 3,680,261, INT. CL. 32.

MORRISON HOMES, INC., ALPHARETTA, GA:
 2,666,879, CANC. INT. CL. 37.
 2,666,880, CANC. INT. CL. 37.

MORTGAGE MARKET GUIDE, LLC, HOLMDEL, NJ:
 3,678,333, PUB. 6-23-2009. MULTIPLE CLASS, INT. CLS. 9
 AND 41.

MORTON INTERNATIONAL, INC., CHICAGO, IL:
 3,680,878, INT. CL. 1.

MOSAIC DCPI HOLDINGS LLC, SANTA MONICA, CA:
 2,666,285, CANC. INT. CL. 9.

MOSER, DIRK, FOREST GROVE, OR:
 3,679,073, PUB. 6-23-2009. INT. CL. 41.

MOSHE INC, LOS ANGELES, CA, DBA SCENT-SATIONS:
 3,678,307, PUB. 3-17-2009. INT. CL. 3.

MOSHE INC, LOS ANGELES, CA, DBA SCENT-SATION:
 3,678,308, PUB. 3-17-2009. INT. CL. 3.

MOSKOVITS, WILLIAM, NORTH HOLLYWOOD, CA AND
 MAJER, SOL C., NORTH HOLLYWOOD, CA:
 2,667,113, CANC. INT. CL. 3.

MOSS, PHILLIP W, MCKINNEY, TX, DBA LIFETHATWINS:
 3,679,573, PUB. 6-23-2009. INT. CL. 41.

MOTIVANO LIMITED, LONDON EC4A 4HT, GREAT BRIT-
 AIN TO MOTIVANO LIMITED, LONDON EC4A 4HT,
 GREAT BRITAIN:
 2,751,688, CANC. INT. CL. 39.
 2,757,860, CANC. INT. CL. 39.

MOTRICITY, INC., BELLEVUE, WA:
 2,942,913, CANC. INT. CL. 9.

MOTT, JAMES H., ROCHESTER, NY:
 3,679,043, PUB. 6-23-2009. INT. CL. 28.

MOUNT GAY DISTILLERIES LIMITED, BRANDONS,
 SAINT MICHAEL, BARBADOS:
 3,679,109, PUB. 6-23-2009. INT. CL. 33.

MOUNT OLIVE PICKLE COMPANY, INC., MT. OLIVE, NC:
 3,681,794, INT. CL. 29.

MOUNTAIN FOREST, LLC, PRAIRIE VILLAGE, KS:
 3,679,483, PUB. 6-23-2009. INT. CL. 30.

MOUNTAIN HORSE INTL. AB, 434 93 VALLDA, SWEDEN:
 2,665,020, CANC. INT. CL. 25.

MOVA PHARMACEUTICAL CORPORATION, CAGUAS,
 PUERTO RICO:
 2,666,800, CANC. INT. CL. 5.

MOVADO LLC, WILMINGTON, DE:
 2,664,952, CANC. INT. CL. 14.

MPHASIZE, LLC, NORWALK, CT:
 3,680,918, INT. CL. 35.

MPM PAN PACIFIC, INC., WEST COVINA, CA:
 3,680,109, INT. CL. 18.

MPS GROUP, INC., JACKSONVILLE, FL:
 2,665,361, CANC. INT. CL. 35.

- MR. W. FIREWORKS, INC., SOMERSET, TX:
2,291,143. REN. 8-3-09. INT. CL. 35.
- MRV COMMUNICATIONS (NETWORKS) LTD., 20692 YO-KNEAM, ISRAEL:
2,747,973 NEW CERT. 9-8-2009. INT. CL. 9.
- MSC GROUP, INC., JACKSONVILLE, FL:
3,678,818. PUB. 6-23-2009. INT. CL. 35.
- MSJ ENTERPRISE INC., ALEXANDRIA, VA, DBA AMTEL COMMUNICATIONS:
2,665,630. CANC. INT. CL. 16.
- MSM PROTEIN TECHNOLOGIES, INC., MEDFORD, MA:
3,680,118. INT. CL. 42.
- MST. INC., HICKSVILLE, OH:
1,548,747. REN. 8-4-09. INT. CL. 11.
- MSTATION AUDIO, INC., EL MONTE, CA:
3,681,443. INT. CL. 9.
3,681,444. INT. CL. 9.
- MTG.COM, NORWALK, CT:
3,679,820. PUB. 6-23-2009. MULTIPLE CLASS, INT. CLS. 39 AND 43.
- MUELLER, JOSHUA JAMES, CHELTENHAM, MD:
2,666,653. CANC. INT. CL. 44.
- MULTI MEDIA ELECTRONICS, INC., FARMINGDALE, NY:
2,666,284. CANC. INT. CL. 11.
- MULTI-COLOR CORPORATION, CINCINNATI, OH:
2,667,249. CANC. INT. CL. 16.
- MULTILATERAL INVESTMENT GUARANTEE AGENCY, WASHINGTON, DC:
2,667,405. CANC. INT. CL. 36.
- MULTIMANIA PRODUCTION, 75010 PARIS, FRANCE:
2,664,990. CANC. MULTIPLE CLASS, INT. CLS. 9, 38 AND 41.
- MULTIPLY PROPERTIES, INC., WILMINGTON, DE, CI-NEMARK USA, INC., DALLAS, TX:
1,598,964. REN. 8-4-09. INT. CL. 41.
- MULTIQUIP, INC., CARSON, CA:
3,681,234. INT. CL. 7.
- MULTISORB TECHNOLOGIES, INC., BUFFALO, NY:
3,680,816. INT. CL. 1.
- MULTNOMAH ATHLETIC CLUB, PORTLAND, OR:
2,294,175. REN. 8-2-09. INT. CL. 16.
2,294,176. REN. 8-3-09. INT. CL. 42.
2,295,390. REN. 8-3-09. INT. CL. 25.
2,295,393. REN. 8-3-09. INT. CL. 41.
2,295,394. REN. 8-3-09. INT. CL. 41.
2,295,398. REN. 8-3-09. INT. CL. 42.
2,299,564. REN. 8-3-09. INT. CL. 25.
- MURPHY ADAMS RESTAURANT GROUP, LP, AUSTIN, TX:
3,681,297. INT. CL. 43.
- MUSIAL, F JOHN, SEYMOUR, CT:
2,666,533. CANC. INT. CL. 35.
- MUSTANG SURVIVAL CORPORATION, RICHMOND, BRITISH COLUMBIA V6V 1Y6, CANADA:
2,665,275. CANC. INT. CL. 9.
- MUSTANG SYSTEMS INCORPORATED, GREENWICH, CT:
2,666,820. CANC. INT. CL. 42.
- MV-10, L.L.C., RICHMOND, VA:
2,665,778. CANC. INT. CL. 35.
- MV-10, L.L.C., RICHMOND, VA:
2,665,779. CANC. INT. CL. 35.
2,665,780. CANC. INT. CL. 35.
- MWH GLOBAL, INC., PASADENA, CA:
2,665,825. CANC. MULTIPLE CLASS, INT. CLS. 35, 36, 37, 38, 40 AND 42.
- MWH SOFT, INC., BROOMFIELD, CO:
3,680,731. INT. CL. 9.
- MXT CARD SERVICES, LLC, NEW CASTLE, DE:
3,681,042. MULTIPLE CLASS, INT. CLS. 35 AND 36.
- MY FOOT INTERNATIONAL PTE. LTD., CENTREPOINT, SINGAPORE:
2,666,936. CANC. INT. CL. 42.
- MY SECRET TREASURES, LLC, HUNTINGTON, NY:
3,679,750. PUB. 6-23-2009. INT. CL. 3.
- MYBODYSITE, LLC, LAKE WORTH, FL:
3,680,531. INT. CL. 42.
- MYERS INDUSTRIES, INC., AKRON, OH:
2,318,216. REN. 8-3-09. INT. CL. 4.
- MYERS, THOMAS, GRASS VALLEY, CA:
3,678,478. PUB. 6-23-2009. INT. CL. 35.
- MYORX CORP., SEATTLE, WA:
2,261,259. REN. 8-4-09. INT. CL. 5.
- MYSTIC SCENIC STUDIOS, INC., NORWOOD, MA:
3,678,850. PUB. 6-23-2009. INT. CL. 40.
3,678,851. PUB. 6-23-2009. INT. CL. 40.
3,678,852. PUB. 6-23-2009. INT. CL. 40.
3,678,853. PUB. 6-23-2009. INT. CL. 40.
- MYTHRYN LLC, EVANSTON, IL:
2,666,528. CANC. INT. CL. 42.
2,666,529. CANC. INT. CL. 42.
2,666,530. CANC. INT. CL. 42.
- MÖLNLYCKE HEALTH CARE AB, SWEDEN:
3,679,924. PUB. 6-23-2009. INT. CL. 10.
- M2 INNOVATIVE CONCEPTS, INC., TACOMA, WA:
2,665,991. CANC. INT. CL. 19.
- MÜLLER, WOLF-RÜDLGER, FED REP GERMANY AND KUTSCHER, AXEL, FED REP GERMANY:
3,679,854. PUB. 6-23-2009. MULTIPLE CLASS, INT. CLS. 9, 12, 28 AND 42.
- N.C.S. DISTRIBUTION, INC., WESTMONT, IL:
3,094,585. AM. INT. CL. 21.
- N.V. SUMATRA TOBACCO TRADING COMPANY, SUMATERA UTARA, INDONESIA:
2,665,565. CANC. INT. CL. 34.
- NABAVI, PARVIZ, LAHAINA, HI:
3,681,491. INT. CL. 30.
- NAIAD PRESS, INC., THE, TALLAHASSEE, FL:
2,665,856. CANC. INT. CL. 16.
- NAIM AUDIO LIMITED, UNITED KINGDOM:
3,680,027. PUB. 6-23-2009. INT. CL. 9.
- NAKED WINES, LLC, HOOD RIVER, OR:
3,680,587. MULTIPLE CLASS, INT. CLS. 35 AND 39.
- NALEPA, SUSAN M, FREDONIA, NY:
3,679,441. PUB. 6-23-2009. INT. CL. 44.
- NANOBIO CORPORATION, ANN ARBOR, MI:
3,681,530. INT. CL. 5.
- NANOMETRICS INCORPORATED, MILPITAS, CA:
3,681,748. INT. CL. 9.
- NANOSTATICS, LLC, CIRCLEVILLE, OH:
3,681,637. INT. CL. 1.
- NAPLES LUMBER AND SUPPLY COMPANY, INC., NAPLES, FL:
2,665,449. CANC. INT. CL. 35.
- NARRAGANSETT JEWELRY CO., INC., PROVIDENCE, RI:
2,215,375. CANC. INT. CL. 14.
- NATIONAL ACADEMY OF RECORDING ARTS & SCIENCES, SANTA MONICA, CA:
2,667,359. CANC. INT. CL. 41.
2,667,360. CANC. INT. CL. 41.
- NATIONAL ASSOCIATION OF ESTATE PLANNERS & COUNCILS, CLEVELAND, OH:
3,681,046. INT. CL. 41.
- NATIONAL ASSOCIATION OF MUSIC MERCHANTS, INC., CARLSBAD, CA:
3,678,522. PUB. 6-23-2009. MULTIPLE CLASS, INT. CLS. 14, 16 AND 25.
3,678,523. PUB. 6-23-2009. INT. CL. 16.
- NATIONAL ASSOCIATION OF SECONDARY SCHOOL PRINCIPALS, RESTON, VA:
3,681,356. INT. CL. 41.
- NATIONAL ASSOCIATION OF THE REMODELING INDUSTRY, ALEXANDRIA, VA:
2,665,287. CANC. MULTIPLE CLASS, INT. CLS. 16 AND 42.
- NATIONAL AUDUBON SOCIETY, INC., NEW YORK, NY:
2,321,150. AM. INT. CL. 42.
3,680,521. INT. CL. 41.
- NATIONAL AUTOMOBILE DEALERS ASSOCIATION, MCLEAN, VA:
3,681,378. INT. CL. 36.
- NATIONAL AUTOMOTIVE PARTS ASSOCIATION, ATLANTA, GA:
2,252,471. REN. 8-3-09. INT. CL. 12.

NATIONAL CATTLEMEN'S BEEF ASSOCIATION, CENTENNIAL, CO:
2,231,697. REN. 8-6-09. INT. CL. 16.
2,231,697, AM. INT. CL. 16.

NATIONAL CHILD SAFETY COUNCIL, JACKSON, MI:
1,543,910. REN. 8-3-09. INT. CL. 41.

NATIONAL CITY CORPORATION, CLEVELAND, OH:
2,667,109, CANC. INT. CL. 36.

NATIONAL CONFLICT RESOLUTION CENTER, SAN DIEGO, CA:
3,679,547, PUB. 6-23-2009. INT. CL. 41.

NATIONAL COWBOY AND WESTERN HERITAGE MUSEUM, OKLAHOMA CITY, OK:
2,751,636, CANC. INT. CL. 30.

NATIONAL DAIRY COUNCIL, ROSEMONT, IL:
2,214,697, CANC. INT. CL. 16.

NATIONAL EHEALTH COLLABORATIVE, INC., ALEXANDRIA, VA:
3,681,747, INT. CL. 41.

NATIONAL ENERGY PARTNERS, LP, DALLAS, TX:
3,680,499, INT. CL. 42.

NATIONAL EXPRESS, INC., NORWALK, CT:
2,665,990, CANC. INT. CL. 8.

NATIONAL FEDERATION OF THE BLIND, THE, BALTIMORE, MD:
2,277,502. REN. 8-5-09. MULTIPLE CLASS, INT. CLS. 21 AND 25.
2,277,502, CANC. INT. CL. 28.

NATIONAL FOOD COMPANY, N.F.C. SA, THESI PATIMA, GREECE:
3,680,445, INT. CL. 30.

NATIONAL INFORMATION SOLUTIONS COOPERATIVE, INC., LAKE ST. LOUIS, MO:
3,679,735, PUB. 6-23-2009. INT. CL. 41.

NATIONAL INSTITUTE FOR LEARNING DEVELOPMENT, INC., NORFOLK, VA:
3,678,168, PUB. 6-23-2009. INT. CL. 41.

NATIONAL LIFE INSURANCE COMPANY, MONTPELIER, VT, DBA NATIONAL LIFE OF VERMONT:
2,664,900, CANC. INT. CL. 36.

NATIONAL PACKING CORPORATION, BRONX, NY:
3,681,256, MULTIPLE CLASS, INT. CLS. 29 AND 30.

NATIONAL PUBLIC RADIO, INC., WASHINGTON, DC:
3,678,451, PUB. 6-23-2009. INT. CL. 42.

NATIONAL SELF-DEFENSE INSTITUTE, INC., MIAMI BEACH, FL:
2,253,174. REN. 8-2-09. INT. CL. 41.

NATIONAL SPORTS CENTER FOR THE DISABLED, INC., WINTER PARK, CO:
2,326,691. REN. 8-3-09. INT. CL. 41.

NATIONAL TRADE ASSOCIATION, INC., NILES, IL:
2,665,583, CANC. INT. CL. 35.

NATIONAL TRUST FOR HISTORIC PRESERVATION IN THE UNITED STATES, WASHINGTON, DC:
2,659,539, CANC. INT. CL. 2.

NATURAL BEAUTY INNOVATIONS, LLC, NEW YORK, NY:
3,681,556, INT. CL. 3.

NATURAL BODY INTERNATIONAL, INC., ATLANTA, GA:
2,286,382. REN. 8-3-09. INT. CL. 3.

NATURAL SELECTION FOODS, LLC, SAN JUAN BAUTISTA, CA:
2,365,489. REN. 8-3-09. INT. CL. 29.

NATURE BABY LIMITED, WEST LYNN, AUCKLAND, NEW ZEALAND:
3,680,178, MULTIPLE CLASS, INT. CLS. 20, 24 AND 25.

NATUREX, INC., SOUTH HACKENSACK, NJ:
3,680,469, INT. CL. 5.
3,680,470, INT. CL. 5.

NATURMAMA HOLDINGS PTY LTD, COOMERA QLD 4209, AUSTRALIA:
3,679,869, PUB. 6-23-2009. INT. CL. 35.

NAVIGATORS, THE, COLORADO SPRINGS, CO:
3,680,841, INT. CL. 25.

NAVIGON AG, HAMBURG, FED REP GERMANY:
3,679,884, PUB. 3-17-2009. MULTIPLE CLASS, INT. CLS. 9, 12, 35, 38, 39 AND 42.

NAVINTA LLC, EWING, NJ:
3,681,598, INT. CL. 1.

NBA PROPERTIES, INC., NEW YORK, NY:
2,214,493, CANC. INT. CL. 25.

NBA PROPERTIES, INC., SECAUCUS, NJ:
2,272,799. REN. 8-3-09. INT. CL. 25.

NBD INTERNATIONAL, INC., RAVENNA, OH:
2,665,416, CANC. INT. CL. 9.

NBTY ACQUISITION LLC, RONKONKOMA, NY, P. LEINER NUTRITIONAL PRODUCTS, INC., TORRANCE, CA:
1,537,889. REN. 8-1-09. INT. CL. 5.

NBTY, INC., BOHEMIA, NY:
2,666,325, CANC. INT. CL. 30.

NCIRCLE NETWORK SECURITY, INC., EMERYVILLE, CA:
2,665,391, CANC. MULTIPLE CLASS, INT. CLS. 9 AND 42.

NDCHEALTH CORPORATION, ATLANTA, GA:
2,741,655, CANC. INT. CL. 16.

NEC BUSINESS NETWORK SOLUTIONS, INC., IRVING, TX:
2,666,565, CANC. MULTIPLE CLASS, INT. CLS. 35, 37 AND 42.

NEC INFRONTIA KABUSHIKI KAISHA, KANAGAWAKEN, JAPAN, TA NEC INFRONTIA CORPORATION:
2,214,900, CANC. INT. CL. 9.

NEC SYSTEM TECHNOLOGIES, LTD., OSAKA-SHI, OSAKA, JAPAN:
3,681,106, INT. CL. 9.

NEGMA-L.E.R.A.D.S., 78117 TOUSSUS-LE-NOBLE, FRANCE:
2,664,933, CANC. INT. CL. 5.

NEIGHBORHOOD CO. LTD., TOKYO, JAPAN:
3,680,543, MULTIPLE CLASS, INT. CLS. 16 AND 25.

NEIGHBORS FOOD STORES, INC., WHITE PLAINS, NC:
2,353,139. REN. 8-5-09. INT. CL. 30.

NEIL BENSON, STAFFORD, UNITED KINGDOM:
3,679,097, PUB. 6-23-2009. INT. CL. 9.
3,679,102, PUB. 6-23-2009. INT. CL. 9.

NEIL PHILLIPS, BETHESDA, MD, DBA VISIBLE MEN:
3,679,359, PUB. 6-23-2009. MULTIPLE CLASS, INT. CLS. 35 AND 41.

NEILSON, STEVE, NEPEAN, ONTARIO, K2H 5J1, CANADA:
2,666,872, CANC. INT. CL. 16.

NEJAD, AFSHIN, ANAHEIM, CA, DBA SEARCHENGINE-PROJECTS.COM:
3,680,607, INT. CL. 35.

NELA TERNES REGISTER GROUP, WHITE BEAR TOWNSHIP, MN:
2,666,531, CANC. INT. CL. 40.

NELLCOR PURITAN BENNETT LLC, BOULDER, CO:
3,679,698, PUB. 6-23-2009. INT. CL. 10.
3,679,699, PUB. 6-23-2009. INT. CL. 10.

NELLE'S NIBBLES, LLC, WESTPORT, CT:
3,681,187, MULTIPLE CLASS, INT. CLS. 30 AND 35.

NELSON, BILL, TUCSON, AZ:
1,518,416, CANC. INT. CL. 42.

NEO, INC., SHELTON, CT:
1,518,207, CANC. INT. CL. 35.

NEPTCO, INCORPORATED, PAWTUCKET, RI:
3,680,999, INT. CL. 17.

NERDHEALTH LLC, POMPANO BEACH, FL:
3,680,605, INT. CL. 16.

NERITES CORPORATION, MADISON, WI:
3,681,522, INT. CL. 5.

NESTLE WATERS, ISSY-LES-MOULINEAUX, FRANCE:
3,680,356, INT. CL. 32.

NET-A-PORTER LIMITED, LONDON W2 4YN, ENGLAND:
3,678,286, PUB. 6-23-2009. MULTIPLE CLASS, INT. CLS. 35 AND 36.

NET-IT SOFTWARE CORPORATION, SAN FRANCISCO, CA TO INFORMATIVE GRAPHICS CORPORATION, SCOTTSDALE, AZ:
2,215,223, CANC. INT. CL. 9.

NETDOX, INC., DEERFIELD, IL:
2,215,454, CANC. INT. CL. 38.

NETROPA CORPORATION, IRVINE, CA:
2,666,740, CANC. MULTIPLE CLASS, INT. CLS. 9 AND 42.

- NETSCAPE COMMUNICATIONS CORPORATION, MOUNTAIN VIEW, CA:
2,214,962, CANC. INT. CL. 9.
- NETSUDS.COM, INC., CHANHASSEN, MN:
2,666,175, CANC. INT. CL. 35.
- NETWORK AUTOMATION, INC., LOS ANGELES, CA:
3,678,769, PUB. 6-23-2009. INT. CL. 9.
3,678,770, PUB. 6-23-2009. INT. CL. 9.
- NEUBERGER BERMAN GROUP LLC, NEW YORK, NY:
2,214,159, CANC. INT. CL. 36.
- NEULEVEL, INC., WASHINGTON, DC:
2,667,020, CANC. MULTIPLE CLASS, INT. CLS. 35 AND 42.
- NEUROMATION STUDIO LLC, MIAMI BEACH, FL:
3,680,461, INT. CL. 9.
- NEUTRIK AKTIENGESSELLSCHAFT, SCHAAN, FUERSTENTUM LIECHTENSTEIN, LIECHTENSTEIN:
1,561,877. REN. 8-3-09. INT. CL. 9.
- NEVADA CORPORATE HEADQUARTERS, INC., LAS VEGAS, NV:
3,678,394, PUB. 6-23-2009. MULTIPLE CLASS, INT. CLS. 35, 36, 41 AND 45.
- NEVADA PUBLIC RADIO, LAS VEGAS, NV:
3,679,537, PUB. 6-23-2009. INT. CL. 16.
- NEW CUSTOM COATINGS, LLC, QUEENCREEK, AZ:
3,679,183, PUB. 6-23-2009. INT. CL. 37.
- NEW DAY BUSINESS ADVISORS LLC, APEX, NC:
3,681,332, INT. CL. 35.
- NEW LINE PRODUCTIONS, INC., NEW YORK, NY:
3,680,205, INT. CL. 41.
- NEW MEDIA DISTRIBUTION COMPANY, L.L.C., GREENWICH, CT:
3,679,150, PUB. 6-23-2009. INT. CL. 41.
- NEW MILLENNIUM SALES EXCHANGE, LLC, RED OAK, IA:
3,218,728, CANC. INT. CL. 29.
- NEW ORLEANS REALTY, INCORPORATED, NEW ORLEANS, LA:
3,678,917, PUB. 6-23-2009. INT. CL. 36.
- NEW TORQUE, INC., TAICHUNG, TAIWAN:
2,666,311, CANC. INT. CL. 7.
- NEW VISION ENTERPRISES INC, EL PASO, TX:
3,681,306, INT. CL. 5.
- NEW WORLD BEVERAGES, BEACHWOOD, OH:
2,665,255, CANC. INT. CL. 32.
- NEW WORLD BEVERAGES, LLC, BEACHWOOD, OH:
2,665,250, CANC. INT. CL. 32.
- NEW WORLD PASTA COMPANY, HARRISBURG, PA, HERSHEY FOODS CORPORATION, HERSHEY, PA:
1,547,584. REN. 8-3-09. INT. CL. 30.
- NEW YORK / ROMA PIZZA & PASTA, CORP, COCONUT GROVE, FL:
3,679,039, PUB. 6-23-2009. INT. CL. 43.
- NEW YORK STATE SOCIETY OF CERTIFIED PUBLIC ACCOUNTANTS, THE, NEW YORK, NY:
2,301,629. REN. 8-3-09. INT. CL. 16.
- NEW YORK-NEW YORK HOTEL & CASINO, LLC, LAS VEGAS, NV:
3,680,173, INT. CL. 25.
- NEWAYS, INC., SPRINGVILLE, UT:
3,679,800, PUB. 6-23-2009. INT. CL. 3.
- NEWCO DINING, LLC, OXFORD, MS:
3,678,588, PUB. 6-23-2009. INT. CL. 30.
- NEWELL OPERATING COMPANY, ALTANTA, GA:
3,681,473, INT. CL. 6.
- NEWHOSUE, DIANA A., WEST SPRINGFIELD, MA:
2,666,384, CANC. INT. CL. 35.
- NEWLEAF CONSULTING INTERNATIONAL, LLC, NASHVILLE, TN:
2,666,878, CANC. MULTIPLE CLASS, INT. CLS. 35 AND 41.
- NEWPEX, FREMONT, CA:
3,680,138, INT. CL. 11.
- NEWPORT ELECTRONICS, INC., STAMFORD, CT:
2,263,919. REN. 8-6-09. INT. CL. 9.
- NEWPORT PACIFIC CORPORATION, NEWPORT, OR:
2,214,531, CANC. INT. CL. 21.
- NEWS AND CROWD CASTING AB, STOCKHOLM, SWEDEN:
3,679,969, PUB. 6-23-2009. MULTIPLE CLASS, INT. CLS. 35, 41 AND 42.
- NEWSDAY LLC, MELVILLE, NY:
2,667,358, CANC. INT. CL. 16.
- NEWTEK BUSINESS SERVICES, INC., NEW YORK, NY:
3,680,700, MULTIPLE CLASS, INT. CLS. 39 AND 42.
- NEXITY FINANCIAL CORPORATION, BIRMINGHAM, AL:
2,666,802, CANC. INT. CL. 36.
- NEXSTAR, INC., LITTLE CANADA, MN:
3,680,989, INT. CL. 9.
3,680,990, INT. CL. 16.
- NEXTBODY LLC, ORLAND PARK, IL:
3,680,234, MULTIPLE CLASS, INT. CLS. 5 AND 30.
- NEXTERA ENERGY POWER MARKETING, LLC, JUNO BEACH, FL:
3,680,750, MULTIPLE CLASS, INT. CLS. 36 AND 42.
- NEXTSET SOFTWARE, INC., PALO ALTO, CA:
2,666,945, CANC. INT. CL. 35.
- NEXTSTEP DSL INC., TOLEDO, OH:
2,665,550, CANC. INT. CL. 38.
- NEXUS ENERGY SOFTWARE, INC., WELLESLEY, MA:
2,666,909, CANC. INT. CL. 35.
- NIEMACKL, DOUGLAS J., TOPEKA, KS:
3,680,115, INT. CL. 28.
- NIESSEN, CHRISTIAN, NEW YORK, NY:
3,680,100, INT. CL. 25.
- NIKON CORPORATION, TOKYO 100, JAPAN:
2,666,734, CANC. INT. CL. 9.
- NILSON, MERWYN D., RAPID CITY, SD:
2,667,086, CANC. INT. CL. 9.
- NIMBUS GLOBAL GROUP, INC., THE, ARLINGTON, TX:
2,665,967, CANC. INT. CL. 35.
- NINTENDO OF AMERICA INC., REDMOND, WA:
3,680,467, INT. CL. 9.
3,680,484, INT. CL. 9.
- NIPPON DENSHIN DENWA KABUSHIKI KAISHA, TOKYO, JAPAN, DBA NIPPON TELEGRAPH AND TELEPHONE CORPORATION:
3,637,263, COR. INT. CL. 36.
- NIPPON KODO CO., LTD., CHUO-KU, TOKYO, JAPAN:
2,292,317. REN. 7-31-09. INT. CL. 3.
- NISSEI PLASTIC INDUSTRIAL CO., LTD., NAGANO-KEN, JAPAN:
3,680,956, INT. CL. 7.
- NO FADE COATINGS, INC., GARDEN GROVE, CA, DBA ALLEGRO INDUSTRIES:
2,282,946. REN. 8-3-09. MULTIPLE CLASS, INT. CLS. 7, 9 AND 11.
- NO LIMIT, LLC, WESTPORT, CT:
3,679,763, PUB. 6-23-2009. INT. CL. 33.
- NOBLE SYSTEMS CORPORATION, ATLANTA, GA:
2,276,439. REN. 8-5-09. INT. CL. 9.
- NOIR, ILLUMINATI II HOLDING APS, DENMARK:
3,679,856, PUB. 6-23-2009. MULTIPLE CLASS, INT. CLS. 24 AND 25.
- NOIZE MAGAZINE, LLC, STUDIO CITY, CA, DBA CIRCUIT NOIZE MAGAZINE, LLC:
3,678,603, PUB. 6-23-2009. MULTIPLE CLASS, INT. CLS. 9 AND 16.
- NOK CORPORATION, TOKYO, JAPAN:
3,681,484, INT. CL. 17.
- NOKIA CORPORATION, FINLAND:
3,680,061, PUB. 6-23-2009. MULTIPLE CLASS, INT. CLS. 9, 38 AND 41.
- NOMINET UK, OXFORD OX4 4DQ, UNITED KINGDOM:
2,739,511, CANC. INT. CL. 35.
- NOMINUM, INC., REDWOOD CITY, CA:
2,667,005, CANC. INT. CL. 42.
- NON-LINEAR PRODUCTIONS, INC., NEW YORK, NY:
2,666,591, CANC. INT. CL. 41.
- NORANDA INCOME LIMITED PARTNERSHIP, VANCOUVER, B.C., CANADA, CANADIAN ELECTROLYTIC ZINC LIMITED, VALLEYFIELD, QUEBEC, CANADA:
1,125,142. REN. 8-4-09. INT. CL. 6.
- NORDSON CORPORATION, WESTLAKE, OH:
2,275,811. REN. 7-31-09. INT. CL. 7.

NORDSTROM, INC., SEATTLE, WA:
1,518,530, CANC. INT. CL. 42.

NORRIS, CARLOS RAY, DALLAS, TX, AKA CHUCK NORRIS:
3,679,730, PUB. 6-23-2009. INT. CL. 9.

NORTH AMERICAN BEVERAGES, LTD., WACO, TX:
3,680,330, INT. CL. 32.

NORTH AMERICAN REFRACTORIES COMPANY, MOON TOWNSHIP, PA:
3,680,800, INT. CL. 19.

NORTH AMERICAN SOLUTIONS, INC., CALGARY, AB T1Y 6B6, CANADA:
2,665,388, CANC. INT. CL. 35.

NORTH CAROLINA PRESS SERVICES, RALEIGH, NC:
2,665,929, CANC. INT. CL. 35.

NORTHMAN HOLDINGS INC., WATERLOO, ONTARIO, CANADA:
2,666,757, CANC. INT. CL. 6.

NOT GUILTY GASTRONOMIE AG, SWITZERLAND:
3,679,963, PUB. 6-23-2009. MULTIPLE CLASS, INT. CLS. 30, 32 AND 43.

NOTHING BUT SALT LLC, PIKESVILLE, MD:
3,680,860, MULTIPLE CLASS, INT. CLS. 3 AND 30.

NOTHING TO IT, INC., RENO, NV:
2,273,851, REN. 8-3-09. INT. CL. 41.

NOUVELLE PARFUMERIE GANDOUR, MIAMI, FL:
3,681,460, INT. CL. 3.

NOVA, MIGUEL ANGEL, NAPLES, FL:
3,679,257, PUB. 6-23-2009. INT. CL. 9.

NOVAFORUM INC., OTTAWA, ONTARIO K1S 1Y9, CANADA:
2,667,268, CANC. MULTIPLE CLASS, INT. CLS. 35 AND 42.

NOVARTIS AG, BASEL, SWITZERLAND:
3,680,361, INT. CL. 5.

NOVARTIS CORPORATION, SUMMIT, NJ, NOVARTIS CORPORATION, SUMMIT, NJ:
2,177,116, REN. 8-5-09. INT. CL. 5.

NOVATECH ENTERPRISE CO., LTD., TAICHUNG HSIEN, TAIWAN:
3,678,836, PUB. 6-23-2009. INT. CL. 28.

NOVEDA TECHNOLOGIES, INC., BRANCHBURG, NJ:
3,681,703, MULTIPLE CLASS, INT. CLS. 37 AND 42.

NOVOLOGIX, INC., EDEN PRAIRIE, MN:
3,681,209, MULTIPLE CLASS, INT. CLS. 35, 36 AND 42.
3,681,210, MULTIPLE CLASS, INT. CLS. 35, 36 AND 42.

NTH DEGREE DESIGN & VISUAL FX, INC., WINTER GARDEN, FL:
3,372,962, AM. MULTIPLE CLASS, INT. CLS. 9, 41 AND 42.

NU-WA INDUSTRIES, INC., CHANUTE, KS:
1,095,910, REN. 8-1-09. INT. CL. 12.

NUART, INC., NORTH MANKATO, MN:
1,517,980, CANC. INT. CL. 16.

NUCLEAR RESEARCH CORPORATION, WARRINGTON, PA:
1,517,872, CANC. INT. CL. 9.

NUCON STEEL CORPORATION, WILMINGTON, DE:
3,681,507, MULTIPLE CLASS, INT. CLS. 6, 40 AND 42.

NUCORE TECHNOLOGY INC., SANTA CLARA, CA:
2,667,143, CANC. INT. CL. 9.

NUCO2 IP LLC, STUART, FL:
3,679,557, PUB. 6-23-2009. MULTIPLE CLASS, INT. CLS. 1, 37 AND 39.
3,679,632, PUB. 6-23-2009. INT. CL. 39.

NUDO PRODUCTS INC., SPRINGFIELD, IL:
3,680,126, INT. CL. 19.

NUFARM AMERICAS, BURR RIDGE, IL:
3,680,271, INT. CL. 5.

NUMANO SHOJI, LTD., LOS ANGELES, CA:
1,518,199, CANC. INT. CL. 33.

NUTRI-HEALTH SUPPLEMENTS, L.L.C., COTTONWOOD, AZ:
3,680,959, INT. CL. 5.

NUTRIENT CONTROL SYSTEMS, INC., CHAMBERSBURG, PA, DBA INTEGRITY AG SYSTEMS:
3,679,656, PUB. 6-23-2009. INT. CL. 5.
3,679,657, PUB. 6-23-2009. INT. CL. 5.
3,679,658, PUB. 6-23-2009. INT. CL. 5.

NUTRO PRODUCTS, INC., FRANKLIN, TN:
3,679,683, PUB. 6-23-2009. INT. CL. 31.
3,679,758, PUB. 6-23-2009. INT. CL. 31.
3,679,759, PUB. 6-23-2009. INT. CL. 31.
3,679,781, PUB. 6-23-2009. INT. CL. 31.

NUTROLOGY, LLC, LOS ANGELES, CA:
3,678,348, PUB. 6-23-2009. INT. CL. 5.

NUTTY OCCASIONS, LLC, COLLIERVILLE, TN:
3,678,701, PUB. 6-23-2009. INT. CL. 29.

NYC & COMPANY, INC., NEW YORK, NY:
3,678,229, PUB. 6-23-2009. INT. CL. 41.

NYFIX, INC., STAMFORD, CT:
2,666,511, CANC. MULTIPLE CLASS, INT. CLS. 9 AND 36.

NYLINT CORPORATION, ROCKFORD, IL:
1,518,137, CANC. INT. CL. 28.

O'HALLORAN BLANKET COMPANY, LLC, MILLERTON, NY:
2,666,111, CANC. INT. CL. 20.

O'KEEFFE, JOEL, MELBOURNE, AUSTRALIA AND O'KEEFFE, RYAN, MELBOURNE, AUSTRALIA:
3,681,636, INT. CL. 25.

O'NEIL, BERNIE, LONG BEACH, CA AND O'NEIL, WENDY, LONG BEACH, CA:
2,665,012, CANC. INT. CL. 41.

OAKLEY, INC., FOOTHILL RANCH, CA:
2,221,047, REN. 8-3-09. INT. CL. 9.
2,237,511, REN. 8-3-09. INT. CL. 9.
3,680,975, INT. CL. 9.

OASYS TECHNOLOGIES, INC., SUNNYVALE, CA:
2,665,093, CANC. INT. CL. 9.

OBELISK HOME LLC, SPRINGFIELD, MO:
3,681,289, INT. CL. 35.

OBSHCHESTVO S OGRANICHENNOY OTVETCTVENNOSTYU: "VOLGA-DNEPR-MOSKVA", RU-119048 MOSKVA, RUSSIAN FED.:
3,679,870, PUB. 6-23-2009. MULTIPLE CLASS, INT. CLS. 12 AND 37.

OBSHCHESTVO S OGRANITCHENNOI; OTVETSTVENNOSTYU; "ALEXANDROVY POGREBA", MOSCOW, RUSSIAN FED.:
3,679,897, PUB. 6-23-2009. INT. CL. 33.

OCEAN OPTICS, INC., DUNEDIN, FL:
3,681,270, INT. CL. 9.

OCEANIC PRZEDSIĘBIORSTWO FARMACEUTYCZNO KOSMETYCZNE SOSZYNSKI WOJCIECH, Sopot, POLAND:
3,678,144, PUB. 11-29-2005. MULTIPLE CLASS, INT. CLS. 3 AND 5.

OCHOA, MARCO, MELROSE PARK, IL:
3,679,358, PUB. 6-23-2009. INT. CL. 41.

OCTOPUS PUBLISHING GROUP LIMITED, LONDON, ENGLAND:
3,678,336, PUB. 6-23-2009. MULTIPLE CLASS, INT. CLS. 9 AND 16.

ODS TECHNOLOGIES, L.P., LOS ANGELES, CA:
2,273,129, REN. 8-3-09. INT. CL. 41.

ODYSSEY CORPORATION, SEATTLE, WA:
2,304,343, REN. 8-5-09. INT. CL. 29.

OFFICIAL BUGLE BOY, LLC, COLUMBUS, OH:
3,678,888, PUB. 6-23-2009. INT. CL. 24.
3,678,889, PUB. 6-23-2009. MULTIPLE CLASS, INT. CLS. 14 AND 24.

OGDEN PUBLICATIONS, INC., TOPEKA, KS:
3,681,293, INT. CL. 16.

OGI SYSTEMS LTD., RAMAT GAN 52522, ISRAEL:
2,665,614, CANC. INT. CL. 9.

OHIO FARMERS INSURANCE COMPANY, WESTFIELD CENTER, OH:
3,679,561, PUB. 6-23-2009. INT. CL. 35.

OHMEDA MEDICAL DEVICES DIVISION INC., MURRAY HILL, NEW PROVIDENCE, NJ:
1,517,879, CANC. INT. CL. 10.

- OHTOMO CHEMICAL INS., CORP., TOKYO 131-0041, JAPAN:
3,678,520, PUB. 6-23-2009. MULTIPLE CLASS, INT. CLS. 1 AND 4.
- OILMEN'S EQUIPMENT CORPORATION, SPARTANBURG, SC:
1,123,214. REN. 8-6-09. INT. CL. 12.
- OLAJIDE, ADENIYI O., WICHITA, KS:
3,679,428, PUB. 6-23-2009. INT. CL. 41.
- OLD RUSSIA GIFTS AND COLLECTIBLES, LEAVENWORTH, KS:
2,666,714, CANC. INT. CL. 35.
- OLD WORLD INDUSTRIES, INC., NORTHBROOK, IL:
3,681,139, INT. CL. 12.
- OLEG CASSINI, INC., NEW YORK, NY:
2,664,950, CANC. INT. CL. 25.
- OLEVA GROUP ENTERPRISES, INC., RICHMOND, BRITISH COLUMBIA:
3,681,520, INT. CL. 3.
- OLIVA CIGAR CO., MIAMI LAKES, FL:
3,679,790, PUB. 6-23-2009. INT. CL. 34.
- OLIVIA GARDEN INTERNATIONAL, WALNUT CREEK, CA:
2,274,994. REN. 7-31-09. INT. CL. 21.
2,283,977. REN. 7-31-09. INT. CL. 21.
- OLIVIERS & CO., MANE, FRANCE:
2,665,715, CANC. INT. CL. 29.
- OLYMPUS CORPORATION, TOKYO, JAPAN:
2,751,716, CANC. INT. CL. 40.
- OMAHA STANDARD, INC., COUNCIL BLUFFS, IA:
1,307,677, AM. INT. CL. 7.
1,673,994, AM. INT. CL. 7.
2,112,561, AM. INT. CL. 12.
2,274,836, AM. MULTIPLE CLASS, INT. CLS. 7 AND 12.
3,104,398, AM. INT. CL. 7.
3,237,752, AM. MULTIPLE CLASS, INT. CLS. 7 AND 12.
- OMAHA STEAKS INTERNATIONAL, INC., OMAHA, NE:
3,680,917, INT. CL. 35.
- OMEGA ENGINEERING, INC., STAMFORD, CT:
1,518,566, CANC. INT. CL. 16.
- OMNI BUILDERS RISK, INC., WINDER, GA:
2,666,825, CANC. MULTIPLE CLASS, INT. CLS. 9 AND 36.
- OMNI 2000, INC., CAMDEN, NJ:
2,666,770, CANC. INT. CL. 9.
- OMNICOGNIC, BEVERLY HILLS, CA:
3,679,653, PUB. 6-23-2009. INT. CL. 9.
- OMNITURE, INC., OREM, UT:
2,805,438, CANC. INT. CL. 35.
- OMRON CORPORATION, JAPAN:
3,680,039, PUB. 6-23-2009. INT. CL. 9.
- OMS INVESTMENTS, INC., LOS ANGELES, CA:
2,297,201. REN. 8-3-09. INT. CL. 36.
- ON TECHNOLOGIES, INC., ST. GEORGE, UT:
3,680,203, MULTIPLE CLASS, INT. CLS. 41 AND 42.
- ONECAP, LAS VEGAS, NV:
3,248,965, CANC. INT. CL. 36.
- ONEPIN, INC., WESTBOROUGH, MA:
2,667,355, CANC. INT. CL. 35.
- ONEWIRE, INC., NEW YORK, NY:
3,681,090, MULTIPLE CLASS, INT. CLS. 35, 41 AND 42.
- ONLYSPORT FRANCE, 92150 SURESNES, FRANCE:
2,665,465, CANC. MULTIPLE CLASS, INT. CLS. 12, 18, 22, 25, 28, 38, 41 AND 42.
- ONTARIO LOTTERY AND GAMING CORPORATION, TORONTO, ONTARIO, CANADA:
3,681,643, MULTIPLE CLASS, INT. CLS. 35, 36, 41 AND 43.
- ONWARD KASHIYAMA USA, INC., NEW YORK, NY:
2,666,971, CANC. INT. CL. 35.
2,666,980, CANC. INT. CL. 35.
- OOA-FONDEN, DENMARK:
3,679,948, PUB. 6-23-2009. MULTIPLE CLASS, INT. CLS. 16 AND 25.
- OPEN INTERFACE, INC., KANAGAWA, JAPAN:
2,667,077, CANC. INT. CL. 9.
- OPTEX CORPORATION, DON MILLS, ONTARIO, CANADA TO GENTEC, MARKHAM, ONTARIO, CANADA:
1,518,558, CANC. INT. CL. 9.
- OPTICAL FASHION CENTER, INC., BEVERLY HILLS, CA:
1,717,772, CANC. INT. CL. 9.
- OPTION ONE MORTGAGE CORPORATION, IRVINE, CA:
2,666,982, CANC. INT. CL. 36.
- OPTO ELETRÔNICA S/A, SÃO PAULO, BRAZIL:
3,680,859, INT. CL. 10.
- ORALDENT LIMITED, CAMBRIDGESHIRE, UNITED KINGDOM:
3,678,269, PUB. 1-13-2009. INT. CL. 3.
- ORAMEDIX, INC., LANCASTER, CA:
3,679,726, PUB. 6-23-2009. INT. CL. 21.
- ORCA BAY BASKETBALL LIMITED PARTNERSHIP, VANCOUVER, BRITISH COLUMBIA:
2,664,901, CANC. INT. CL. 25.
- ORCA BEVERAGE, INC., MUKILTEO, WA:
2,214,092, CANC. INT. CL. 32.
- ORDWAY, JEREMIAH, FAIRFIELD, CT:
2,666,713, CANC. INT. CL. 16.
- OREGON CHILDREN'S FOUNDATION, PORTLAND, OR:
2,667,170, CANC. INT. CL. 36.
- ORGANIC MATERIALS REVIEW INSTITUTE, EUGENE, OR:
3,678,145, PUB. 6-23-2009. U.S. CL. B.
- ORGANON TEKNIKA BV, 5281 RM BOXTEL, NETHERLANDS TO BIOMERIEUX B.V., BOXTEL, NETHERLANDS:
2,213,552, CANC. INT. CL. 10.
- ORIENTAL MOTOR CO., LTD., TOKYO, JAPAN:
1,566,994, REN. 8-2-09. INT. CL. 11.
- ORIENTAL SYSTEM TECHNOLOGY INC., HSINCHU R.O.C., TAIWAN:
2,304,612. REN. 8-4-09. INT. CL. 10.
- ORIGINAL V LLC, MIDDLETON, WI:
3,680,220, INT. CL. 30.
- ORIGINS NATURAL RESOURCES INC., NEW YORK, NY:
3,680,405, MULTIPLE CLASS, INT. CLS. 35 AND 44.
- ORIN, RHONDA D., BETHESDA, MD:
2,667,074, CANC. INT. CL. 16.
- ORION ADVISOR SERVICES, LLC, OMAHA, NE:
3,679,330, PUB. 6-23-2009. INT. CL. 35.
- ORLANDO BATHING SUIT, LLC, ORLANDO, FL:
3,681,499, INT. CL. 35.
- ORLANDO R. PADILLA & LOBORIO MOLINA, PASADENA, CA:
3,679,387, PUB. 6-23-2009. INT. CL. 41.
- ORLANDO UTILITIES COMMISSION, ORLANDO, FL:
2,666,892, CANC. INT. CL. 16.
- ORMECON GMBH, 22949 AMMERSBEK, FED REP GERMANY:
3,678,421, PUB. 3-17-2009. MULTIPLE CLASS, INT. CLS. 1, 2 AND 17.
- ORNELAS, FAWNETTA R, ORANGE, CA:
2,667,335, CANC. INT. CL. 16.
- ORPHEUS WEB SOLUTIONS, INC, NEW ORLEANS, LA:
2,666,667, CANC. INT. CL. 41.
- ORVIS, SUSAN, TORRANCE, CA:
3,680,169, INT. CL. 24.
- OSG CORPORATION, JAPAN:
3,679,950, PUB. 6-23-2009. INT. CL. 7.
- OSHO INTERNATIONAL FOUNDATION, ZURICH, SWITZERLAND:
1,815,840, CANC. INT. CL. 16.
2,174,607, CANC. INT. CL. 42.
2,180,173, CANC. INT. CL. 9.
- OSHO INTERNATIONAL FOUNDATION, CH-8001, ZURICH, SWITZERLAND:
2,322,901, CANC. INT. CL. 16.
- OSI INDUSTRIES, LLC, AURORA, IL:
3,681,091, MULTIPLE CLASS, INT. CLS. 40 AND 42.
- OSRAM SYLVANIA, INC., DANVERS, MA:
3,680,902, INT. CL. 11.
- OSSUR HF, REYKJAVIK, ICELAND:
3,681,237, INT. CL. 10.
- OSTEOTECH, INC., EATONTOWN, NJ:
3,680,435, INT. CL. 10.

- OTTO JOS. KLIER MUSIKINSTRUMENTE GMBH INH. HEIDI FABER E.K., D-91088 BUBENREUTH, FED REP GERMANY:
2,730,370, COR. INT. CL. 15.
- OUNCE LABS, INC., WALTHAM, MA:
3,679,455, PUB. 6-23-2009. INT. CL. 9.
- OUR OWN HARDWARE COMPANY, FORT WAYNE, IN:
2,215,043, CANC. INT. CL. 2.
- OUTRAGEOUS VENTURES, INC., HARTFORD, CT, DBA BIG MOUTH TOYS:
3,679,528, PUB. 6-23-2009. INT. CL. 28.
- OVERLORD CW CORPORATION, NEW YORK, NY:
2,681,796, CANC. INT. CL. 3.
- OVERSEAS SAVE CHINESE CHILDREN FOUNDATION, TOLEDO, OH:
3,681,193, INT. CL. 36.
- OVERSTOCK.COM, INC., SALT LAKE CITY, UT:
3,680,419, INT. CL. 20.
- OVERSWING INCORPORATED, NEWARK, NJ:
2,666,869, CANC. INT. CL. 28.
- OVERTURE SERVICES, INC., PASADENA, CA:
2,665,789, CANC. MULTIPLE CLASS, INT. CLS. 35, 38 AND 42.
- OWEN RENTAL AND SERVICE CENTER, INC., ROSENBERG, TX:
3,679,550, PUB. 6-23-2009. INT. CL. 35.
- OWENS, KEVIN, PERTH, AUSTRALIA:
3,680,863, MULTIPLE CLASS, INT. CLS. 41 AND 44.
- OWENS, KEVIN, ANTONIO, NORFOLK, VA:
2,666,584, CANC. INT. CL. 16.
- OWUSU, HENRY KWAME, BROOKLYN, NY:
3,678,151, PUB. 6-23-2009. INT. CL. 25.
- OXXON PHARMACCINES LIMITED, OXFORD OX4 4GP, UNITED KINGDOM:
3,018,090, COR. MULTIPLE CLASS, INT. CLS. 5, 9, 16 AND 42.
- OXY-DRY CORPORATION, ITASCA, IL:
2,665,707, CANC. INT. CL. 1.
- OXYMORON ENTERTAINMENT, INC., LOS ANGELES, CA:
3,678,911, PUB. 6-23-2009. INT. CL. 41.
- OZARK FLUORINE SPECIALTIES, INC., ANAHEIM, CA:
2,665,531, CANC. MULTIPLE CLASS, INT. CLS. 1, 40 AND 42.
- P & M PRODUCTS, LLC, REDMOND, WA:
3,679,641, PUB. 6-23-2009. INT. CL. 11.
- P. J. VALCKENBERG GMBH, D-67547 WORMS AM RHEIN, FED REP GERMANY:
3,268,849, CANC. INT. CL. 33.
- P. M. KEELING CORPORATION, LOS ANGELES, CA:
3,679,818, PUB. 6-23-2009. INT. CL. 35.
3,679,819, PUB. 6-23-2009. INT. CL. 43.
- P.H.E., INC., OMAHA, NE, DBA MCCARTHY'S ONE HOUR HEATING & AIR CONDITIONING, BENJAMIN FRANKLIN PLUMBING, & MISTER SPARKY:
3,681,726, INT. CL. 37.
- P-VALUE COMMUNICATIONS, PARSIPPANY, NJ:
3,679,442, PUB. 6-23-2009. INT. CL. 5.
- PA DENTAL MANAGEMENT, BOOTHWYN, PA:
3,679,615, PUB. 6-23-2009. INT. CL. 44.
- PA LAREDO INC., LAREDO, TX:
3,680,657, INT. CL. 32.
- PAC-DENT INTERNATIONAL, INC., WALNUT, CA, DBA DENTAL APPARATUS:
3,681,317, INT. CL. 10.
- PACHIRA IP INC., OTTAWA, ONTARIO, CANADA:
3,678,255, PUB. 6-23-2009. MULTIPLE CLASS, INT. CLS. 36 AND 45.
- PACIFIC ATLANTIC LINES, INC., THOUSAND OAKS, CA:
3,679,718, PUB. 6-23-2009. MULTIPLE CLASS, INT. CLS. 35 AND 39.
- PACIFIC BEARING CO., ROSCOE, IL:
2,260,945, REN. 8-3-09. INT. CL. 4.
- PACIFIC BIOENERGY CORPORATION, PRINCE GEORGE, CANADA:
2,299,654, REN. 7-31-09. INT. CL. 4.
- PACIFIC COAST BUILDING PRODUCTS, INC., RANCHO CORDOVA, CA:
3,680,611, MULTIPLE CLASS, INT. CLS. 19 AND 20.
- PACIFIC COAST FEATHER COMPANY, SEATTLE, WA:
3,679,383, PUB. 6-23-2009. INT. CL. 24.
- PACIFIC CONTINENTAL APPAREL, INC., RANCHO DOMINGUEZ, CA:
2,666,907, CANC. INT. CL. 25.
- PACIFIC SOUTHWEST CONFERENCE OF THE EVANGELICAL COVENANT CHURCH, THE, SCOTTS VALLEY, CA:
2,301,762, REN. 8-4-09. INT. CL. 41.
- PACIFIC VET GROUP - USA, INC., FAYETTEVILLE, AR:
3,679,723, PUB. 6-23-2009. INT. CL. 5.
- PACKAGING CONCEPTS ASSOC. INC., BOYNTON BEACH, FL:
2,667,120, CANC. INT. CL. 3.
- PACKAGING PRODUCTS CORPORATION, NEW BEDFORD, MA:
1,560,840, REN. 7-31-09. INT. CL. 16.
- PADGETT, CAMBRIA LAVECK, ASHEVILLE, NC:
2,665,832, CANC. INT. CL. 42.
- PADRY LLC, ROSWELL, GA:
3,681,717, INT. CL. 6.
- PAF HOLDING APS, DENMARK:
3,679,922, PUB. 6-23-2009. MULTIPLE CLASS, INT. CLS. 5, 9, 21 AND 37.
- PAINTMATES, LLC, ATLANTIC HIGHLANDS, NJ:
3,680,767, INT. CL. 16.
- PAKERSON INDUSTRIE CALZATURE FIORENTINE S.R.L., 9 - CERRETO GUIDI (FLORENCE), ITALY:
2,213,828, CANC. INT. CL. 25.
- PALISADES BASEBALL, SANTA MONICA, CA:
2,665,561, CANC. INT. CL. 25.
- PALLOTTA, DANIEL, LOS ANGELES, CA:
3,679,689, PUB. 6-23-2009. INT. CL. 36.
- PALMER PERFORMANCE ENGINEERING, INC., OREM, UT:
3,680,447, INT. CL. 9.
- PALTRONICS, INC, CRYSTAL LAKE, IL:
3,680,352, INT. CL. 9.
- PANAC CO., LTD, JAPAN:
3,680,010, PUB. 6-23-2009. MULTIPLE CLASS, INT. CLS. 16 AND 17.
- PANASONIC CORPORATION, OSAKA, JAPAN:
3,681,362, INT. CL. 9.
- PANASONIC CORPORATION OF NORTH AMERICA, SECAUCUS, NJ:
2,214,308, CANC. INT. CL. 9.
- PANHEALTH.COM, INC., LIVINGSTON, NJ:
2,667,282, CANC. INT. CL. 42.
- PAOLUCCI, MARYLOU A., SMITHTOWN, NY, AKA MARYLOU A. PILEWSKI:
3,678,966, PUB. 6-23-2009. INT. CL. 45.
- PAPAS, ALEX, LANTANA, FL:
3,681,403, INT. CL. 30.
- PAPER MOON VINEYARDS, LLC, VERMILION, OH:
3,681,386, INT. CL. 33.
- PAPP INTERNATIONAL, INC., MONTREAL, QUEBEC, CANADA AND PAPP INTERNATIONAL, INC., MONTREAL, QUEBEC, CANADA:
3,558,985, AM. MULTIPLE CLASS, INT. CLS. 16 AND 41.
- PAPPAS TELECASTING COMPANIES, VISALIA, CA:
3,679,501, PUB. 6-23-2009. INT. CL. 38.
3,679,503, PUB. 6-23-2009. INT. CL. 38.
- PAR PHARMACEUTICAL, INC., SPRING VALLEY, NY:
2,667,060, CANC. INT. CL. 5.
- PARACHA, ABDUL WAHEED, STATEN ISLAND, NY:
3,680,218, MULTIPLE CLASS, INT. CLS. 30 AND 31.
- PARAGON AG, 33129 DELBRUCK, FED REP GERMANY:
2,666,426, CANC. INT. CL. 9.
- PARAGON REAL ESTATE ADVISORS, INC., SEATTLE, WA:
3,681,035, INT. CL. 36.
- PARALUX, FRANCE:
3,680,002, PUB. 6-23-2009. MULTIPLE CLASS, INT. CLS. 3, 5 AND 21.

- PARAMOUNT PICTURES CORPORATION, HOLLYWOOD, CA:
3,680,618, INT. CL. 25.
- PARAMOUNT WIRELESS, INC., VAN NUYS, CA:
3,678,772, PUB. 6-23-2009. INT. CL. 9.
- PARATA SYSTEMS, LLC, DURHAM, NC:
3,680,289, INT. CL. 17.
- PAREDES, CENIA, JERSEY CITY, NJ:
3,679,593, PUB. 6-23-2009. INT. CL. 25.
- PARENTS' ACTION FOR CHILDREN, WASHINGTON, DC:
2,215,298, CANC. INT. CL. 41.
2,215,299, CANC. INT. CL. 16.
- PARFLEUR, PARFUMS FUNEL (SARL), BASTELICACCIA, FRANCE:
2,664,988, CANC. MULTIPLE CLASS, INT. CLS. 3 AND 5.
- PARFUMS BY CHRISTOPHER JOSEPH, LLC, IRVINE, CA:
3,681,390, INT. CL. 3.
3,681,391, INT. CL. 3.
- PARFUMS DE COEUR, LTD., DARIEN, CT:
3,680,492, INT. CL. 3.
- PARFUMS GIVENCHY, 92300 LEVALLOIS PERRET, FRANCE:
2,258,692, REN. 8-2-09. INT. CL. 3.
- PARK, GEORGE, NEW YORK, NY:
3,679,355, PUB. 6-23-2009. INT. CL. 25.
- PARKS, NORMAN GARY, NASHVILLE, TN:
2,666,666, CANC. INT. CL. 9.
- PARSEK S.R.L., ITALY:
3,680,033, PUB. 6-23-2009. INT. CL. 9.
- PARSON JACK'S CAFE OF GOODS AND EVILS, LLC, CHARLESTON, SC:
3,678,419, PUB. 1-20-2009. INT. CL. 43.
- PARSONS, CHARLES B., LONG BEACH, CA:
3,681,285, INT. CL. 25.
- PARTNERS NATIONAL HEALTH PLANS OF NORTH CAROLINA, INC., WINSTON-SALEM, NC:
2,262,316, REN. 8-4-09. INT. CL. 36.
- PASSPORT HEALTH COMMUNICATIONS, FRANKLIN, TN:
2,345,697, REN. 8-3-09. INT. CL. 42.
- PASTICCERIA TORINO S.R.L., 10093 COLLEGNO, TORINO, ITALY:
2,261,976, REN. 8-1-09. INT. CL. 30.
- PATAGONIA, INC., VENTURA, CA:
2,260,188, REN. 7-31-09. MULTIPLE CLASS, INT. CLS. 35 AND 42.
- PATEL, VIMAA, FAIRFIELD, CA:
3,679,184, PUB. 6-23-2009. INT. CL. 44.
- PATH PARTNERS, LOS ANGELES, CA:
3,680,238, INT. CL. 36.
3,680,325, INT. CL. 36.
- PATHFINDER ASSOCIATES INC., NORTH MUSKEGON, MI:
2,214,377, CANC. INT. CL. 41.
- PATIENT CARE TECHNOLOGY SYSTEMS, INC., CHARLOTTE, NC:
2,666,635, CANC. INT. CL. 9.
- PATIENT EDU, LLC, EAST LONGMEADOW, MA:
3,679,048, PUB. 6-23-2009. INT. CL. 9.
- PATIRE, TOM J., PARK RIDGE, NJ:
3,679,626, PUB. 6-23-2009. INT. CL. 41.
- PATRICIA SILVA, NY, NY:
3,679,270, PUB. 6-23-2009. INT. CL. 45.
- PATRICK YARN MILL, INC., KINGS MOUNTAIN, NC:
3,679,732, PUB. 6-23-2009. INT. CL. 22.
- PATRICK, JENNIFER, THOROLD, ON, CANADA AND FISHMAN, MAXIM, TORONTO, ON, CANADA:
2,667,031, CANC. INT. CL. 41.
- PATTON ENTERPRISE, INC., TULSA, OK:
2,261,383, REN. 7-31-09. INT. CL. 9.
- PATTON SURGICAL CORPORATION, AUSTIN, TX:
2,725,628, COR. INT. CL. 10.
- PAUL CAPITAL ADVISORS, LLC, SAN FRANCISCO, CA:
3,466,033, AM. INT. CL. 36.
- PAUL E. CUTARELLI, M.D., PLLC, DENVER, CO:
3,679,041, PUB. 6-23-2009. INT. CL. 44.
- PAUL SHELDEN GLOBAL PRODUCTIONS, INC., HEWLETT, NY:
2,665,683, CANC. INT. CL. 35.
2,665,684, CANC. INT. CL. 35.
- PAULIG LTD., 00980 HELSINKI, FINLAND:
2,664,995, CANC. MULTIPLE CLASS, INT. CLS. 5, 29, 30 AND 31.
- PAULO PORTUGAL LLC, LADERA RANCH, CA:
3,681,348, INT. CL. 36.
- PAVE TECH, INC., PRIOR LAKE, MN:
3,681,741, INT. CL. 41.
- PAXAR AMERICAS, INC., MIAMISBURG, OH:
2,214,391, CANC. INT. CL. 9.
- PAXTON PATTERSON LLC, CHICAGO, IL:
2,335,395, REN. 8-3-09. MULTIPLE CLASS, INT. CLS. 9 AND 16.
- PAYPAL, INC., SAN JOSE, CA:
3,680,256, MULTIPLE CLASS, INT. CLS. 9, 16, 21, 25, 36 AND 45.
- PB PARTNERSHIP, CARLSBAD, CA:
2,665,347, CANC. INT. CL. 36.
- PCI-SIG, BEAVERTON, OR:
2,737,861, AM. INT. CL. 35.
- PEACEFUL RESOLUTIONS FOR LIVING, INC., SYRACUSE, NY:
3,678,767, PUB. 6-23-2009. MULTIPLE CLASS, INT. CLS. 9, 16 AND 41.
- PEAK VENTURES, INC., LEBANON, PA, DBA CONESTOGA LOG CABINS AND HOMES AND CONESTOGA LOG CABINS:
3,678,990, PUB. 6-23-2009. INT. CL. 19.
- PEAKCARE LLC, SAN DIEGO, CA:
2,215,113, CANC. INT. CL. 9.
- PEARLE, INC., MASON, OH:
2,330,661, REN. 8-3-09. INT. CL. 42.
- PEBBLE BEACH COMPANY, PEBBLE BEACH, CA:
3,680,524, INT. CL. 41.
- PECAN RIDGE VINEYARDS, L.L.C., OKEMAH, OK:
3,678,213, PUB. 6-23-2009. INT. CL. 33.
- PEDIATRIC THERAPY NETWORK, TORRENCE, CA:
3,678,440, PUB. 6-23-2009. INT. CL. 41.
- PEEKABOO KIDS CLUB, LLC, SAN FRANCISCO, CA:
3,680,511, INT. CL. 25.
3,680,512, INT. CL. 35.
- PEGASUS SOLUTIONS COMPANIES, PHOENIX, AZ:
2,214,446, CANC. INT. CL. 9.
- PENDLETON WOOLEN MILLS, INC., PORTLAND, OR:
3,680,928, MULTIPLE CLASS, INT. CLS. 22 AND 23.
- PENG, LISA, SHANGHAI, CHINA:
3,680,692, INT. CL. 35.
- PENMARA WINES PTY LTD, CAMPERDOWN, AUSTRALIA:
3,681,199, INT. CL. 33.
- PENN HERB COMPANY, LTD., PHILADELPHIA, PA:
3,681,740, INT. CL. 5.
- PENN TRAFFIC COMPANY, SYRACUSE, NY:
1,518,534, CANC. INT. CL. 42.
- PENNSYLVANIA EDUCATIONAL COMMUNICATION SYSTEMS, CAMP HILL, PA, DBA PENNSYLVANIA CABLE NETWORK:
3,679,577, PUB. 6-23-2009. INT. CL. 41.
- PENNSYLVANIA PURE DISTILLERIES, LLC, GLENSHAW, PA:
3,680,672, INT. CL. 33.
- PENNZOIL-QUAKER STATE COMPANY, HOUSTON, TX:
3,678,141, PUB. 8-30-2005. INT. CL. 1.
- PENSACOLA CHRISTIAN COLLEGE, INC., PENSACOLA, FL:
2,297,820, REN. 8-4-09. MULTIPLE CLASS, INT. CLS. 16 AND 41.
- PENTON BUSINESS MEDIA, INC., NEW YORK, NY:
3,679,562, PUB. 6-23-2009. INT. CL. 41.
- PENUMBRA, INC., SAN LEANDRO, CA:
3,678,273, PUB. 6-23-2009. INT. CL. 10.
- PEOPLELINK, INC., SANTA MONICA, CA:
2,665,066, CANC. INT. CL. 38.

- PEPSI/LIPTON TEA PARTNERSHIP, PURCHASE, NY:
2,665,797, CANC. INT. CL. 30.
2,665,798, CANC. INT. CL. 30.
- PEPSICO, INC., PURCHASE, NY:
3,681,394, INT. CL. 32.
- PERDUE HOLDINGS, INC., WILMINGTON, DE:
1,553,062, REN. 8-3-09, INT. CL. 29.
- PERELL, WILLIAM S., SAN FRANCISCO, CA:
2,666,865, CANC. INT. CL. 17.
- PERFECT PERFORMANCE, LLC, SILVER SPRING, MD:
3,679,082, PUB. 6-23-2009, INT. CL. 41.
- PERFECT 10 ANTENNA COMPANY INC., NORTH LITTLE ROCK, AR:
3,681,105, INT. CL. 9.
- PERFORM GROUP, LLC, YORK, PA:
3,678,511, PUB. 6-23-2009, INT. CL. 25.
- PERFORMANCE BRANDS, INC., SUNRISE, FL:
3,680,831, INT. CL. 3.
3,680,832, INT. CL. 3.
3,680,833, INT. CL. 3.
- PERFUME SOURCE, INC., LOS ANGELES, CA:
3,680,820, INT. CL. 3.
- PERKINS, JEFFREY MICHAEL, FORT WORTH, TX:
2,215,193, CANC. INT. CL. 11.
- PERKOWITZ, THOMAS M., ROUND LAKE, IL:
3,681,167, INT. CL. 20.
- PERRY PROPERTIES, LLC, COSTA MESA, CA:
3,678,915, PUB. 6-23-2009, INT. CL. 9.
- PERRY, ROBB, CHICAGO, IL AND WOODS, SADIE, CHICAGO, IL:
3,678,564, PUB. 6-23-2009, INT. CL. 41.
- PERSONNEL POLICY SERVICE, INC., LOUISVILLE, KY:
2,264,838, REN. 8-3-09, MULTIPLE CLASS, INT. CLS. 16 AND 42.
- PERVASIVE SOFTWARE INC., AUSTIN, TX:
2,306,518, REN. 7-31-09, INT. CL. 9.
- PESCE, E. VICTOR, KENNETT SQUARE, PA, DBA AT-MAR GLASS COMPANY:
2,284,720, REN. 7-31-09, MULTIPLE CLASS, INT. CLS. 9 AND 40.
- PET SITTERS INTERNATIONAL, INC., KING, NC:
3,679,628, PUB. 6-23-2009, INT. CL. 35.
- PETCHEL, JOSEPH JOHN, WINCHESTER, CA, DBA PC RACING:
3,679,209, PUB. 6-23-2009, INT. CL. 12.
- PETER BRAMS DESIGNS, LTD., NEW YORK, NY:
1,517,910, CANC. INT. CL. 14.
- PETER MALONEY, PORT MELBOURNE VIC 3207, AUSTRALIA:
3,679,864, PUB. 6-23-2009, INT. CL. 3.
- PETER PAN SEAFOODS, INC., SEATTLE, WA:
2,265,120, REN. 8-3-09, INT. CL. 29.
- PETKIND PET PRODUCTS INC., WHITE ROCK, CANADA:
3,681,666, INT. CL. 3.
- PETREYKO, JOHN R., SAN MARCOS, CA, DBA FULL-GORILLA APPAREL AND ULLRICH, BRIAN, SAN MARCOS, CA, DBA FULL-GORILLA APPAREL:
3,679,283, PUB. 6-23-2009, INT. CL. 25.
- PETROTECHNICS USA, INC., HOUSTON, TX:
3,679,136, PUB. 6-23-2009, MULTIPLE CLASS, INT. CLS. 35 AND 42.
- PETSUITES OF AMERICA, LLC, ERLANGER, KY:
2,665,756, CANC. INT. CL. 42.
- PETTALEZ, CHATSWORTH, CA:
3,678,913, PUB. 6-23-2009, INT. CL. 45.
- PETTIBON SYSTEM, INC., GIG HARBOR, WA:
3,678,604, PUB. 6-23-2009, INT. CL. 16.
- PEYAK SOLUTIONS, INC., COLUMBIA, MD:
3,678,976, PUB. 6-23-2009, INT. CL. 42.
3,678,977, PUB. 6-23-2009, INT. CL. 42.
- PEYTON, BETTIE SUSAN, LEESBURG, FL, DBA BEACHALITY PLAY, UNWIND, SHINE.:
3,680,856, MULTIPLE CLASS, INT. CLS. 35 AND 40.
- PGI INTERNATIONAL, LTD., HOUSTON, TX:
3,678,281, PUB. 6-23-2009, INT. CL. 7.
- PH. ORTH CO., OAK CREEK, WI:
1,518,146, CANC. MULTIPLE CLASS, INT. CLS. 29 AND 30.
- PHIATON CORPORATION, IRVINE, CA:
3,680,828, INT. CL. 9.
- PHIL MUSUMECI, SANTA CRUZ, CA AND BARNEY LANGNER JR, SANTA CRUZ, CA:
3,679,220, PUB. 6-23-2009, INT. CL. 25.
- PHIL WALDREP EVANGELISTIC ASSOCIATION, TRINITY, AL:
3,679,317, PUB. 6-23-2009, INT. CL. 41.
- PHILIP MORRIS USA INC., RICHMOND, VA:
3,678,886, PUB. 6-23-2009, INT. CL. 34.
3,678,887, PUB. 6-23-2009, INT. CL. 34.
- PHILLIPS, MICHELLE C., LANCASTER, PA:
3,679,210, PUB. 6-23-2009, INT. CL. 21.
- PHILOSOPHY, INC., PHOENIX, AZ:
3,681,524, INT. CL. 3.
3,681,565, INT. CL. 3.
- PHOENIX BRANDS LLC, STAMFORD, CT:
2,702,629, CANC. INT. CL. 3.
- PHOENIX INTANGIBLES HOLDING COMPANY, GREENVILLE, DE:
3,681,476, INT. CL. 30.
3,681,478, INT. CL. 30.
- PHYSICAL ENTERPRISES INCORPORATED, VANCOUVER, CANADA:
3,680,505, INT. CL. 14.
- PICSEL (RESEARCH) LIMITED, GLASGOW, G51 4BP, UNITED KINGDOM:
3,679,851, PUB. 7-4-2006, MULTIPLE CLASS, INT. CLS. 9 AND 42.
- PIER HOUSE JOINT VENTURE, CLEVELAND, OH:
1,603,060, REN. 8-6-09, INT. CL. 42.
- PIERANGELI GROUP, INC., SHARON HILL, PA:
3,679,104, PUB. 6-23-2009, MULTIPLE CLASS, INT. CLS. 16 AND 35.
- PIERCE SALES CO. INC., ORLANDO, FL:
2,321,181, REN. 8-2-09, INT. CL. 35.
2,321,182, REN. 8-3-09, INT. CL. 35.
2,321,734, REN. 8-2-09, INT. CL. 35.
2,321,737, REN. 8-2-09, INT. CL. 35.
2,321,820, REN. 8-2-09, INT. CL. 35.
2,321,821, REN. 8-2-09, INT. CL. 35.
2,321,875, REN. 8-3-09, INT. CL. 35.
- PIERCE SALES CO., INC., ORLANDO, FL:
2,321,376, REN. 8-3-09, INT. CL. 35.
- PIERCE, STEPHEN, TEMPE, AZ:
3,680,229, MULTIPLE CLASS, INT. CLS. 9, 35, 38, 41 AND 45.
- PINEAPPLE PLANET, INC., REDONDO BEACH, CA:
3,679,696, PUB. 6-23-2009, INT. CL. 28.
- PINGYI SEED CO.LTD, CHINA:
3,679,896, PUB. 6-23-2009, INT. CL. 31.
- PINKHAM, MARY ELLEN, EDINA, MN:
1,518,463, CANC. INT. CL. 42.
- PINNACLE AMMUNITION COMPANY, ST. LOUIS, MO:
3,680,954, INT. CL. 13.
- PINNACLE FOODS GROUP LLC, MOUNTAIN LAKES, NJ:
2,667,348, CANC. INT. CL. 30.
- PIONEER DRILLING COMPANY, SAN ANTONIO, TX:
3,680,770, INT. CL. 37.
- PIONEER PLASTICS, L.L.C., ROGER, AR:
3,680,808, INT. CL. 21.
- PIONEER VALLEY FEDERAL CREDIT UNION, SPRINGFIELD, MA:
3,681,006, INT. CL. 36.
- PIRANHA ENTERTAINMENT LLC, SEATTLE, WA:
3,680,942, INT. CL. 41.
- PITURRO, GENEVIEVE, RIVERDALE, NY:
2,667,029, CANC. INT. CL. 18.
- PIZZUTO-WILKINS, MARIA E., NORTH BARRINGTON, IL:
2,667,094, CANC. INT. CL. 25.
- PLANATOL KLEBETECHNIK GMBH, THANSAU, FED REP GERMANY, PLANATOLWERK WILLY HESSELMANN CHEMISCHE-UND MASCHINENFABRIK FUR KLEBETECHNIK, THANSAU., FED REP GERMANY:
1,123,520, REN. 8-4-09, MULTIPLE CLASS, INT. CLS. 1, 9 AND 16.

- PLANETE CABLE SA, 92659 BOULOGNE BILLANCOURT, FRANCE:
2,664,903, CANC. MULTIPLE CLASS, INT. CLS. 38 AND 41.
- PLANT BROTHERS INC., MIAMI, FL:
3,678,188, PUB. 6-23-2009. INT. CL. 35.
- PLANTPEDDLER, INC., CRESCO, IA:
3,679,567, PUB. 6-23-2009. INT. CL. 31.
- PLANTRONICS, INC., SANTA CRUZ, CA:
3,680,328, INT. CL. 9.
3,680,341, INT. CL. 9.
- PLAST-O-MATIC VALVES, INC., CEDAR GROVE, NJ:
1,548,077, REN. 8-3-09. INT. CL. 9.
- PLASTIC-PLATE, INC., GRAND RAPIDS, MI:
1,523,819, REN. 8-3-09. MULTIPLE CLASS, INT. CLS. 37 AND 40.
- PLATINO ELECTRICAL AND ELECTRONICS COMPANY LIMITED, HA8 6DE, UNITED KINGDOM:
2,665,005, CANC. MULTIPLE CLASS, INT. CLS. 7, 9 AND 11.
- PLATINUM GLOBAL ADVANTAGE, LLC, YAKIMA, WA:
2,666,918, CANC. INT. CL. 38.
- PLATINUM HOME MORTGAGE CORPORATION, ROLLING MEADOWS, IL:
2,297,278, REN. 8-2-09. INT. CL. 36.
- PLAYCORE IP SUB, INC., CHATTANOOGA, TN:
3,681,232, MULTIPLE CLASS, INT. CLS. 16, 35 AND 41.
- PLAYMATES TOYS INC., COSTA MESA, CA:
2,215,441, CANC. INT. CL. 28.
2,215,466, CANC. INT. CL. 28.
- PLAYTEX PRODUCTS, INC., WESTPORT, CT:
3,681,685, INT. CL. 3.
3,681,686, INT. CL. 3.
3,681,687, INT. CL. 3.
3,681,688, INT. CL. 3.
- PLESMAN, PAUL, RICHMOND HILL, CANADA:
3,679,197, PUB. 6-23-2009. INT. CL. 42.
- PLESSER, STANLEY Z., PRAIRIE VILLAGE, KS:
1,518,119, CANC. INT. CL. 28.
- PLEWINSKI, CYNTHIA J., LAGRANGE, KY:
2,214,913, CANC. INT. CL. 16.
- PLIBRICO COMPANY, LLC, CHICAGO, IL:
3,678,832, PUB. 6-23-2009. INT. CL. 19.
- PNC BANK, NATIONAL ASSOCIATION, PHILADELPHIA, PA:
2,665,356, CANC. INT. CL. 21.
- PNEUTEK, INC., HUDSON, NH, PNEUTEK, INC., BILLERICA, MA:
1,112,602, REN. 8-1-09. MULTIPLE CLASS, INT. CLS. 6 AND 7.
- PNG GEROLYMATOS; HEALTH AND BEAUTY SA; TRADING AS; PNG GEROLYMATOS SA. GREECE:
3,679,942, PUB. 6-23-2009. MULTIPLE CLASS, INT. CLS. 3 AND 5.
- PNP PETRO-N-PROVISIONS, INC., CEDAR RAPIDS, IA:
2,666,642, CANC. MULTIPLE CLASS, INT. CLS. 35 AND 43.
- PNS & WSS INCORPORATED, THOROFARE, NJ, DBA SLACK INCORPORATED:
3,679,719, PUB. 6-23-2009. INT. CL. 16.
3,679,749, PUB. 6-23-2009. INT. CL. 16.
3,679,753, PUB. 6-23-2009. INT. CL. 16.
- PODANGO, LLC, BOUNTIFUL, UT:
3,679,840, PUB. 6-12-2007. MULTIPLE CLASS, INT. CLS. 38 AND 42.
- PODLASKA WYTWORNIA WODEK "POLMOS" SPOLKA AKCYJNA, SIEDLCE, POLAND:
3,608,352, AM. INT. CL. 33.
- PODOLSKI, ZDRAVKO, SAN JOSE, CA:
3,679,349, PUB. 6-23-2009. MULTIPLE CLASS, INT. CLS. 4, 37, 39 AND 41.
- POETIC MEDIA, INC., SAN FRANCISCO, CA:
2,666,632, CANC. MULTIPLE CLASS, INT. CLS. 41 AND 42.
- POINT2 INTERACTIVE ADVERTISING, INC., DETROIT, MI:
2,667,125, CANC. INT. CL. 35.
- POLAR WARE COMPANY, KIEL, WI:
3,680,233, INT. CL. 21.
- POLICY MANAGEMENT SYSTEMS CORPORATION, BLYTHEWOOD, SC:
1,518,204, CANC. INT. CL. 35.
- POLIMENTO ITALIANO LTDA., ES CEP 29321-000, BRAZIL:
2,667,102, CANC. INT. CL. 35.
- POLK AUDIO, INC., BALTIMORE, MD:
3,680,677, INT. CL. 9.
- POLLAK, ALAN H., EDISON, NJ:
2,665,004, CANC. MULTIPLE CLASS, INT. CLS. 35, 38 AND 41.
- POLMOS ZYRARDOW SPOLKA OGRANICZONA ODPOWIEDZIALNOSCIA, ZYRARDOW, POLAND:
3,678,855, PUB. 4-14-2009. INT. CL. 33.
- POLYGON ENTERTAINMENT, SAN RAFAEL, CA:
3,681,194, INT. CL. 41.
- POLYMER TECHNOLOGY SYSTEMS, INC., INDIANAPOLIS, IN:
3,681,134, INT. CL. 9.
- PONY EXPRESS LEATHER, SAN FRANCISCO, SAN FRANCISCO, CA:
2,666,838, CANC. INT. CL. 28.
- POOCH AND PALS ACCESSORIES FOR PETS, INC., WILMETTE, IL, DBA POOCH & PALS ACCESSORIES FOR PETS, INC.:
2,666,257, CANC. INT. CL. 18.
- POOL, MARK D., HAMPSTEAD, NC:
3,679,380, PUB. 6-23-2009. INT. CL. 9.
- POPOVERS ON THE SQUARE, LLC, PORTSMOUTH, NH:
3,678,930, PUB. 6-23-2009. INT. CL. 43.
- POPPEL, SHERMAN R., MUSKEGON, MI:
1,518,101, CANC. INT. CL. 28.
- PORTA-NAILS, INC., WILMINGTON, NC:
2,214,859, CANC. INT. CL. 7.
- PORTER ATHLETIC, INC., BROADVIEW, IL:
1,518,581, CANC. INT. CL. 28.
- PORTH, DIETER, BOVENDEN, FED REP GERMANY:
2,665,274, CANC. MULTIPLE CLASS, INT. CLS. 9 AND 42.
- PORTIONPAC CHEMICAL CORPORATION, CHICAGO, IL:
3,681,585, MULTIPLE CLASS, INT. CLS. 3, 5 AND 41.
- POSDATA CO., LTD., REPUBLIC OF KOREA:
3,318,619, COR. MULTIPLE CLASS, INT. CLS. 9, 35 AND 38.
- POSITION TECHNOLOGY INC., QUEBEC J7R 5V3, CANADA:
2,665,770, CANC. INT. CL. 9.
- POUDRE VALLEY HEALTH CARE, INC., FORT COLLINS, CO, DBA HEART CENTER OF THE ROCKIES:
2,665,861, CANC. INT. CL. 42.
- POURMIRZAEI, FEREDOUN, SAN RAMON, CA:
3,680,830, INT. CL. 17.
- POWELL, ROSEPHANYE DUNN, AUBURN, AL:
3,679,147, PUB. 6-23-2009. INT. CL. 9.
- POWER HUNGRY FOODS LLC, SARTELL, MN:
3,680,486, INT. CL. 29.
- POWER PRODUCTS, INC., KANSAS CITY, MO:
3,681,502, INT. CL. 9.
- POWER, PAUL T., OVERLAND PARK, KS:
2,666,598, CANC. INT. CL. 42.
- POWERBOWS, LLC, ROYSE CITY, TX:
3,679,313, PUB. 6-23-2009. INT. CL. 26.
- POWERTRAVELLER LIMITED, ALTON, HAMPSHIRE, ENGLAND:
3,679,002, PUB. 6-23-2009. INT. CL. 9.
- POWLOWSKI, WILLIAM, OCALA, FL:
3,678,402, PUB. 6-23-2009. INT. CL. 45.
- PPG INDUSTRIES OHIO, INC., CLEVELAND, OH:
3,680,150, INT. CL. 3.
- PPN SA, VILLERS SUR LE ROULE, FRANCE:
3,678,293, PUB. 6-23-2009. MULTIPLE CLASS, INT. CLS. 32 AND 33.
- PRACTICE PARTNERS, INC., MIRAMAR, FL:
3,681,328, INT. CL. 9.
- PRAD UNLIMITED, LLC, TUCKER, GA, DBA COSTUME UNIVERSE:
3,678,513, PUB. 6-23-2009. INT. CL. 35.

PRATT & LAMBERT, INC., BUFFALO, NY:
 1,518,548, CANC. INT. CL. 2.
 PRAVDA RECORDS, INC., CHICAGO, IL:
 1,557,703, REN. 8-3-09, INT. CL. 9.
 PRAYDIS, ROBERT, HANOVER, PA:
 3,681,195, INT. CL. 16.
 PRECIOUS FORMALS INC., LEAGUE CITY, TX:
 3,680,819, INT. CL. 25.
 PRECISION COMPANIES, INC., THE, INDEPENDENCE,
 MO:
 2,665,936, CANC. INT. CL. 37.
 PREDATOR TRAILCAMS, SAXON, WI:
 3,383,325, CANC. INT. CL. 9.
 REFERRED NUTRITION INC., ACTON, ONTARIO, CA-
 NADA:
 3,679,747, PUB. 6-23-2009, INT. CL. 16.
 REFERRED PET CARE, INC., SAN CLEMENTE, CA:
 3,678,544, PUB. 6-23-2009, INT. CL. 44.
 PREGAME MIX, LLC, NORTH LITTLE ROCK, AR:
 3,678,792, PUB. 6-23-2009, MULTIPLE CLASS, INT. CLS.
 35 AND 41.
 3,678,793, PUB. 6-23-2009, MULTIPLE CLASS, INT. CLS.
 35 AND 41.
 PREMIER DENTAL PRODUCTS COMPANY, PLYMOUTH
 MEETING, PA:
 3,680,072, INT. CL. 3.
 PREMIER LEGENDS, INC., MALVERN, PA:
 3,678,697, PUB. 6-23-2009, INT. CL. 25.
 PREMIER MONEY SOURCE, INC., NEWPORT BEACH, CA:
 3,681,172, INT. CL. 36.
 PREMIER PAINT ROLLER MFG. CO., INC., RICHMOND
 HILL, NY:
 2,359,743, REN. 8-3-09, INT. CL. 16.
 PREMIER SALONS, INC., MARKHAM, CANADA:
 3,678,315, PUB. 6-23-2009, INT. CL. 44.
 PREMIERE COMMISSION, INC., NEW YORK, NY:
 3,680,585, MULTIPLE CLASS, INT. CLS. 9 AND 41.
 PREMIUM DENIM, LLC, CULVER CITY, CA:
 3,679,774, PUB. 6-23-2009, INT. CL. 25.
 3,681,441, INT. CL. 25.
 PREPARED RESPONSE, INC., SEATTLE, WA:
 3,678,592, PUB. 6-23-2009, MULTIPLE CLASS, INT. CLS.
 41 AND 45.
 3,678,593, PUB. 6-23-2009, MULTIPLE CLASS, INT. CLS.
 41 AND 45.
 PRESIDENT AND BOARD OF TRUSTEES OF SANTA
 CLARA COLLEGE, THE, SANTA CLARA, CA:
 3,681,470, INT. CL. 25.
 PRESS COMMUNICATIONS, LLC, NEPTUNE, NJ:
 3,678,216, PUB. 6-23-2009, INT. CL. 38.
 PRESS CONTROL CO., LTD., JAPAN:
 3,679,944, PUB. 6-23-2009, INT. CL. 25.
 PRESTIGE TIME, LLC, AIRMONT, NY:
 3,678,756, PUB. 6-23-2009, INT. CL. 35.
 3,678,757, PUB. 6-23-2009, INT. CL. 35.
 PRESTIGE TIME, LLC., AIRMONT, NY:
 3,678,726, PUB. 6-23-2009, INT. CL. 35.
 PRETTY UGLY LLC, EDISON, NJ AND HORVATH, DAVID,
 EDISON, NJ AND KIM, SUN-MIN, EDISON, NJ:
 3,679,404, PUB. 6-23-2009, INT. CL. 28.
 PREVO'S FAMILY MARKETS, INC., GRAND RAPIDS, MI:
 3,679,071, PUB. 6-23-2009, INT. CL. 35.
 PRICE COLD STORAGE AND PACKING COMPANY, INC.,
 YAKIMA, WA:
 2,665,244, CANC. INT. CL. 29.
 PRIMA NEST, INC., ORANGE, CA:
 2,665,245, CANC. INT. CL. 29.
 PRIME FINANCIAL PARTNERS, L.P., SCOTTSDALE, AZ:
 1,518,256, CANC. INT. CL. 36.
 PRIME TIME BUTCHER, INC., WOODBURY, NY:
 3,680,273, INT. CL. 35.
 PRIMEKEY MORTGAGE, L.L.C., BATON ROUGE, LA:
 2,665,471, CANC. INT. CL. 36.
 PRIMERA TECHNOLOGY, INC., PLYMOUTH, MN:
 2,666,935, CANC. INT. CL. 9.
 PRIMESOLUTIONS SECURITIES, INC., CLEVELAND, OH:
 3,679,568, PUB. 6-23-2009, INT. CL. 36.
 PRIMESOURCE BUILDING PRODUCTS, INC., CARROLL-
 TON, TX:
 3,680,836, INT. CL. 17.
 3,680,837, INT. CL. 17.
 3,681,272, INT. CL. 6.
 PRIMO LUXE, LONG ISLAND CITY, NY:
 3,680,145, INT. CL. 25.
 PRIMUS KNOWLEDGE SOLUTIONS, INC., SEATTLE, WA:
 2,666,731, CANC. INT. CL. 9.
 PRINCE AGRI PRODUCTS, INC., QUINCY, IL:
 3,679,493, PUB. 6-23-2009, INT. CL. 42.
 PRINCE DONUTS, INC., AVENEL, NJ:
 3,679,075, PUB. 6-23-2009, INT. CL. 30.
 PRINCE OF SALSA, LLC, PHOENIX, AZ, DBA THE SALSA
 KING:
 3,678,431, PUB. 6-23-2009, MULTIPLE CLASS, INT. CLS.
 29 AND 30.
 PRINT IT UP, INC, ALTAMONTE SPRINGS, FL:
 2,666,507, CANC. INT. CL. 42.
 PRINTINGFORLESS.COM, INC., LIVINGSTON, MT:
 3,679,659, PUB. 6-23-2009, INT. CL. 40.
 PRINTWEAR XPRESS FRANCHISING, LLC, DENVER, CO:
 3,678,880, PUB. 6-23-2009, INT. CL. 35.
 PRIORITY NETWORKS, INC., LAS VEGAS, NV:
 3,678,240, PUB. 6-23-2009, INT. CL. 37.
 PRMSOFT INC., STRATFORD, CT:
 2,665,754, CANC. MULTIPLE CLASS, INT. CLS. 35 AND
 41.
 2,665,759, CANC. MULTIPLE CLASS, INT. CLS. 35 AND
 41.
 PRO CONSULTING SPECIALISTS ENGINEERING, OSSEO,
 MN, DBA PM TECHNOLOGIES:
 3,681,268, INT. CL. 7.
 PRO GEAR TACKLE DISTRIBUTORS LLC, FULLERTON,
 CA:
 2,667,408, CANC. INT. CL. 28.
 PRO KIDS PRODUCTIONS, INC., NASHVILLE, TX:
 2,666,786, CANC. MULTIPLE CLASS, INT. CLS. 9, 25, 28
 AND 38.
 PRO-LINK, INC., CANTON, MA:
 2,215,491, CANC. INT. CL. 3.
 PROASSURANCE CORPORATION, BIRMINGHAM, AL:
 3,681,241, INT. CL. 36.
 3,681,296, INT. CL. 36.
 PROCESS FILTRATION LLC, HOUSTON, TX:
 3,680,422, INT. CL. 11.
 PROCORP INSURANCE SOLUTIONS, SACRAMENTO, CA:
 3,680,890, INT. CL. 36.
 PROCTER & GAMBLE COMPANY, THE, CINCINNATI, OH:
 2,215,509, CANC. INT. CL. 3.
 2,215,510, CANC. INT. CL. 3.
 2,667,284, CANC. INT. CL. 3.
 3,681,226, INT. CL. 3.
 PROCTER & GAMBLE HOLDING GMBH, D-65824
 SCHWALBACH AM TAUNUS, FED REP GERMANY:
 2,665,924, CANC. INT. CL. 16.
 PRODUCTION RESOURCE GROUP, L.L.C., NEW WIND-
 SOR, NY:
 3,679,609, PUB. 6-23-2009, INT. CL. 11.
 PROFESSIONAL AUDIO SYSTEMS, CARLSBAD, CA:
 2,214,082, CANC. INT. CL. 9.
 PROFESSIONAL BULL RIDERS, INC., PUEBLO, CO:
 3,681,213, MULTIPLE CLASS, INT. CLS. 14, 25 AND 41.
 PROFESSIONAL EDUCATION INTERNATIONAL, INC.,
 CHICAGO, IL:
 3,178,511, CANC. INT. CL. 41.
 PROFESSIONAL RODEO COWBOYS ASSOCIATION, INC.,
 COLORADO SPRINGS, CO:
 2,214,882, CANC. INT. CL. 25.
 PROFESSIONAL TRANSLATING SERVICES, INC., MIAMI,
 FL:
 3,680,947, INT. CL. 41.
 PROFITLOGIC, INC., CAMBRIDGE, MA:
 2,665,470, CANC. INT. CL. 42.
 PROGRAMMER'S PARADISE, INC., SHREWSBURY, NJ:
 1,571,423, REN. 8-4-09, INT. CL. 42.
 1,574,038, REN. 8-4-09, INT. CL. 42.
 2,215,239, CANC. INT. CL. 35.

- PROGRESSIVE CASUALTY INSURANCE COMPANY, MAYFIELD VILLAGE, OH:
3,681,429, MULTIPLE CLASS, INT. CLS. 9 AND 36.
- PROJECT EVERGREEN FOUNDATION, INC., NEW PRA-GUE, MN:
3,680,221, INT. CL. 35.
- PROJECT MANAGEMENT INSTITUTE, INC., NEWTOWN SQUARE, PA:
2,665,914, CANC. INT. CL. 35.
- PROJECTIONDESIGN AS, 1630 GAMLE FREDRIKSTAD, NORWAY:
3,678,189, PUB. 6-23-2009. INT. CL. 9.
- PROKOZ, INC, ALPHARETTA, GA:
3,681,316, INT. CL. 5.
- PROLIANCE ENERGY LLC, INDIANAPOLIS, IN:
3,679,134, PUB. 6-23-2009. MULTIPLE CLASS, INT. CLS. 35, 36 AND 42.
- PROMETHEUS SPRINGS LLC, CORAL GABLES, FL:
3,678,964, PUB. 6-23-2009. INT. CL. 32.
3,678,965, PUB. 6-23-2009. INT. CL. 32.
- PROMGIRL LLC, NEW YORK, NY:
3,679,238, PUB. 6-23-2009. INT. CL. 35.
- PROMO INK, NEW YORK, NY:
2,667,139, CANC. INT. CL. 35.
- PROMONTORY MARK, LLC, WASHINGTON, DC:
3,680,149, MULTIPLE CLASS, INT. CLS. 9, 35, 42 AND 45.
- PROPERTY REFINEMENT, DRIFTWOOD, TX:
3,680,755, INT. CL. 36.
- PROPHET FINANCIAL SYSTEMS, INC., PALO ALTO, CA:
2,665,034, CANC. INT. CL. 36.
- PROQUEST LLC, BETHESDA, MD, CAMBRIDGE INFORMATION GROUP, BETHESDA, MD:
1,542,517. REN. 8-5-09. INT. CL. 16.
- PROQUEST LLC, BETHESDA, MD:
2,671,250, CANC. INT. CL. 9.
- PROSAN INTERNATIONAL B.V., ARNHEM, NETHERLANDS:
3,678,828, PUB. 6-23-2009. INT. CL. 10.
- PROSPECT FASTENER CORPORATION, WAUCONDA, IL:
3,678,196, PUB. 6-23-2009. INT. CL. 6.
- PROSPER BUSINESS DEVELOPMENT CORPORATION, WORTHINGTON, OH:
3,679,228, PUB. 6-23-2009. INT. CL. 35.
- PROTEK INTERNATIONAL, INC., CLARENDON HILLS, IL:
3,678,748, PUB. 6-23-2009. MULTIPLE CLASS, INT. CLS. 42 AND 45.
- PROTEK-INTL LTD, ALLENTOWN, PA:
3,679,831, PUB. 12-18-2007. INT. CL. 10.
- PROTHERICS SALT LAKE CITY, INC., WEST VALLEY CITY, UT:
2,215,105, CANC. INT. CL. 5.
- PROUT AG, D-64291 DARMSTADT, FED REP GERMANY:
2,665,153, CANC. MULTIPLE CLASS, INT. CLS. 9 AND 42.
- PROVE WORLD, LLC, SAN DIEGO, CA:
3,679,143, PUB. 6-23-2009. INT. CL. 38.
- PROVIDENT TRAVEL CORPORATION, CINCINNATI, OH:
2,215,171, CANC. INT. CL. 9.
- PRP HOLDING, FRANCE:
3,680,009, PUB. 6-23-2009. MULTIPLE CLASS, INT. CLS. 1, 5 AND 31.
- PRUITT, DANIEL GRAVES, MARIETTA, GA:
3,679,715, PUB. 6-23-2009. INT. CL. 41.
- PSC INDUSTRIAL OUTSOURCING, LP, WILMINGTON, DE:
2,215,595, CANC. MULTIPLE CLASS, INT. CLS. 37 AND 40.
- PTI TECHNOLOGIES, INC., OXNARD, CA, BELL AEROSPACE CORPORATION, BURBANK, CA:
863,511. REN. 7-31-09. U.S. CL. 31 (INT. CL. 11).
- PTS SALES COMPANY, WARREN, MI:
3,678,812, PUB. 6-23-2009. INT. CL. 8.
3,678,813, PUB. 6-23-2009. INT. CL. 35.
3,678,814, PUB. 6-23-2009. INT. CL. 35.
- PTZ INSURANCE BROKERS LTD., OAKVILLE, CANADA:
3,680,948, INT. CL. 42.
- PUBLICIS GROUPE S.A., PARIS, FRANCE:
3,680,278, MULTIPLE CLASS, INT. CLS. 35 AND 42.
- PUBLISHING GROUP OF AMERICA, INC., FRANKLIN, TN:
3,678,234, PUB. 6-23-2009. INT. CL. 16.
3,680,366, INT. CL. 16.
- PUGSLEY, ALAN J., PORTLAND, ME:
2,253,922. REN. 8-5-09. INT. CL. 21.
- PULSE ENGINEERING, INC., SAN DIEGO, CA, PULSE ENGINEERING, INC., SAN DIEGO, CA:
1,568,116. REN. 8-4-09. INT. CL. 9.
- PUMPS & PROCESS EQUIPMENT, INC., ELGIN, IL, DBA PUMPS & PROCESS EQUIPMENT:
3,678,720, PUB. 6-23-2009. MULTIPLE CLASS, INT. CLS. 7, 11 AND 37.
- PUNCH SOFTWARE LLC, KANSAS CITY, MO:
3,680,823, INT. CL. 9.
- PURE & NATURAL COMPANY, SCOTTSDALE, AZ:
3,678,763, PUB. 6-23-2009. INT. CL. 3.
- PURE INTEGRATION, LLC, HERNDON, VA:
3,679,382, PUB. 6-23-2009. MULTIPLE CLASS, INT. CLS. 35 AND 42.
3,679,384, PUB. 6-23-2009. MULTIPLE CLASS, INT. CLS. 35 AND 42.
- PURUS ARZBERG GMBH, FED REP GERMANY:
3,679,986, PUB. 6-23-2009. MULTIPLE CLASS, INT. CLS. 17 AND 19.
- PYRO SPECTACULARS, INC., RIALTO, CA, PYROTRO-NICS CORPORATION, ANAHEIM, CA:
1,123,014. REN. 8-4-09. INT. CL. 41.
- P3 INGENIEURGESELLSCHAFT FÜR; MANAGEMENT & ORGANISATION MBH, FED REP GERMANY:
3,679,871, PUB. 6-23-2009. MULTIPLE CLASS, INT. CLS. 35 AND 42.
- P4P LLC, ATLANTA, GA:
3,680,713, INT. CL. 25.
- Q INDUSTRIES, INC., FT. LAUDERDALE, FL:
3,681,045, INT. CL. 7.
- Q-BAM, INC., FORT WORTH, TX:
3,678,224, PUB. 6-23-2009. MULTIPLE CLASS, INT. CLS. 9, 35 AND 42.
- QI MOUNTAIN, INC., GREENVILLE, SC:
3,680,327, INT. CL. 41.
- QIAGEN GMBH, D-40724 HILDEN, FED REP GERMANY:
2,667,516, CANC. INT. CL. 42.
- QIAGEN GMBH, 40724 HILDEN, FED REP GERMANY:
2,736,981, CANC. INT. CL. 5.
- QINETIQ LIMITED, LONDON, UNITED KINGDOM:
2,665,293, CANC. INT. CL. 9.
- QINGWEN XU, LOS ANGELES, CA:
3,459,897, AM. INT. CL. 18.
- QIP HOLDER LLC, DENVER, CO:
3,681,380, INT. CL. 43.
- QUADROGAMMON L. L. C., NOVELTY, OH:
2,666,913, CANC. INT. CL. 28.
- QUALITY AIRCRAFT PART, INC., MIAMI GARDENS, FL:
3,681,536, INT. CL. 37.
- QUALITY CASES, LTD., NEW YORK, NY:
2,664,909, CANC. INT. CL. 18.
- QUATTROCI S.R.L., 28041 ARONA (NOVARA), ITALY:
2,743,619, CANC. INT. CL. 18.
- QUEENER, JIM, WENTZVILLE, MO:
3,681,383, INT. CL. 16.
- QUEST INTERNATIONAL B.V., 1411 GP NAARDEN, NETHERLANDS:
2,665,003, CANC. MULTIPLE CLASS, INT. CLS. 1, 2, 3, 5, 29, 30 AND 32.
- QUESTER LINGUISTICS CORPORATION, WEST DES MOINES, IA:
1,518,502, CANC. INT. CL. 42.
- QUESTEX MEDIA GROUP, INC., NEWTON, MA:
2,329,175. REN. 8-1-09. INT. CL. 35.
- QUICK TECHNOLOGIES, INC., CARROLLTON, TX:
3,681,632, INT. CL. 38.
- QUICK TEL, INC., ELIZABETH, NJ:
2,666,219, CANC. MULTIPLE CLASS, INT. CLS. 16 AND 38.

QUORUM INTERNATIONAL, L.P., FORT WORTH, TX:
 2,666,475, CANC. INT. CL. 11.
 QUOVERA, INC., MOUNTAIN VIEW, CA:
 2,664,998, CANC. INT. CL. 35.
 QVC, INC., WEST CHESTER, PA:
 3,681,381, INT. CL. 20.
 QWEST COMMUNICATIONS INTERNATIONAL, INC.,
 DENVER, CO:
 2,307,750. REN. 8-3-09. INT. CL. 9.
 R. A. HAMED INTERNATIONAL IMPORTS, INC., AKRON,
 OH:
 2,666,433, CANC. INT. CL. 20.
 R. D. BUTLER P.C., PHOENIX, AZ:
 2,666,651, CANC. INT. CL. 41.
 R. L. ALBERT & SON, INC., GREENWICH, CT:
 3,680,857, INT. CL. 30.
 R.S. MEANS COMPANY, INC., KINGSTON, MA:
 2,213,870, CANC. MULTIPLE CLASS, INT. CLS. 9 AND
 16.
 R&G SCHATZ FARM INC, LOCKEFORD, CA, DBA PEL-
 TIER STATION:
 3,678,780, PUB. 6-23-2009. INT. CL. 33.
 R-TRACK TECHNOLOGIES, INC., MEMPHIS, TN:
 1,512,399. REN. 7-31-09. INT. CL. 9.
 RAAB, RACHEL M., SANTA BARBARA, CA:
 3,680,288, MULTIPLE CLASS, INT. CLS. 16, 25, 26 AND
 41.
 RABCO CORPORATION, THE, OCOEE, FL:
 2,666,463, CANC. INT. CL. 42.
 RACING SPEED ASSOCIATES, LLC, DAYTONA, FL:
 3,681,727, INT. CL. 41.
 RADIANTGRID TECHNOLOGIES, LLC, KINGSTON, WA:
 3,678,992, PUB. 6-23-2009. MULTIPLE CLASS, INT. CLS. 9
 AND 42.
 RADIATION ONCOLOGY INSTITUTE, FAIRFAX, VA:
 3,681,649, INT. CL. 36.
 RADIO COMPUTING SERVICES, INC., WHITE PLAINS,
 NY:
 3,437,931, CANC. INT. CL. 9.
 3,437,933, CANC. INT. CL. 9.
 RADIO ONE, INC., LANHAM, MD:
 3,680,761, INT. CL. 35.
 RADISYS CORPORATION, HILLSBORO, OR:
 1,556,654. REN. 8-3-09. INT. CL. 9.
 RAEDE, ROBERT, SANTA BARBARA, CA:
 3,679,121, PUB. 6-23-2009. INT. CL. 41.
 RAFIN SPA, VIA ROMA 73/75, ITALY:
 2,212,174, CANC. MULTIPLE CLASS, INT. CLS. 18 AND
 25.
 RAG'S STYLE, LOS ANGELES, CA:
 3,681,766, INT. CL. 25.
 RAGS UNLIMITED INC, GASTONIA, NC:
 3,680,417, INT. CL. 25.
 RAICO BAUTECHNIK GMBH, FED REP GERMANY:
 3,554,243, CANC. IIRN. RESTORED TO S.N. 79-025,264.
 RAINEY, MONTIE, JACKSON, TN:
 3,679,268, PUB. 6-23-2009. INT. CL. 35.
 RAINFOREST NUTRITIONALS, INC., RALEIGH, NC:
 3,680,444, INT. CL. 5.
 3,681,497, INT. CL. 5.
 RAINWAVE, LLC, AUBURN, AL:
 3,680,970, INT. CL. 42.
 3,680,971, INT. CL. 42.
 RAKO PRODUCTS LIMITED, STONEHOUSE, UNITED
 KINGDOM:
 3,678,630, PUB. 6-23-2009. INT. CL. 7.
 RAL VENTURES, COLUMBIA CITY, LA:
 3,680,757, MULTIPLE CLASS, INT. CLS. 25 AND 37.
 RALCORP FROZEN BAKERY PRODUCTS, INC., WEST-
 MONT, IL:
 3,681,795, INT. CL. 30.
 RALPH RYDMAN, INC., RIPON, CA, DBA MEDICALIBRA-
 TION:
 2,666,570, CANC. INT. CL. 9.
 RANCH, PAUL ECKE, ENCINITAS, CA:
 2,666,627, CANC. INT. CL. 31.
 RANDALL RESIDENCE, LLC, LAWTON, MI:
 3,681,366, INT. CL. 43.
 3,681,367, INT. CL. 43.
 RANDY KEMPER CORPORATION, NEW YORK, NY:
 1,518,055, CANC. INT. CL. 25.
 RANGER ELECTRONIC COMMUNICATIONS, INC., SHU-
 LIN 238, TAIPEI HSIEN, TAIWAN:
 2,665,451, CANC. INT. CL. 9.
 RANIR, LLC, GRAND RAPIDS, MI:
 3,681,072, INT. CL. 21.
 3,681,411, INT. CL. 21.
 RAPER, DAVID W., HOLT, MO:
 3,681,566, INT. CL. 20.
 RAPHAEL H.J. SEILER, SWITZERLAND:
 3,679,915, PUB. 6-23-2009. MULTIPLE CLASS, INT. CLS.
 9, 35, 38 AND 42.
 RAPOZA, DARYL LYN, WOODLAND HILLS, CA, DBA
 BODYWEALTH:
 3,679,076, PUB. 6-23-2009. INT. CL. 3.
 RAQUEL FLORES, SANTA MONICA, CA, DBA P.O.P
 CANDY CO. AND WILLIAM WAISTE, SANTA MONICA,
 CA, DBA P.O.P CANDY CO.:
 3,679,031, PUB. 6-23-2009. INT. CL. 30.
 RARDIN, JACOB C., IV, VERO BEACH, FL:
 2,213,568, CANC. INT. CL. 35.
 RARE HOSPITALITY MANAGEMENT, INC., ORLANDO,
 FL:
 3,678,258, PUB. 6-23-2009. INT. CL. 43.
 RAREBASIC (COMBINATIONS) LIMITED, LONDON, UNI-
 TED KINGDOM:
 3,678,401, PUB. 6-23-2009. MULTIPLE CLASS, INT. CLS.
 6, 20 AND 37.
 RASCH, MORGANA S., LOS ANGELES, CA:
 3,680,775, INT. CL. 41.
 RAW THRILLS, INC., SKOKIE, IL:
 3,680,716, MULTIPLE CLASS, INT. CLS. 9 AND 28.
 RAYCOM SPORTS, INC., MONTGOMERY, AL:
 2,263,495. REN. 8-3-09. INT. CL. 41.
 RAYDA DEVELOPMENT CORP., NEWARK, DE:
 3,680,998, INT. CL. 35.
 RAYMARINE UK LIMITED, UNITED KINGDOM:
 3,679,993, PUB. 6-23-2009. INT. CL. 9.
 RAYMOND, MELNIK B., JR., SALISBURY MILLS, NY:
 2,665,535, CANC. INT. CL. 35.
 RBC MINISTRIES, GRAND RAPIDS, MI:
 2,665,119, CANC. INT. CL. 41.
 RCADIA MEDICAL IMAGING LTD., HAIFA, ISRAEL:
 3,680,162, INT. CL. 9.
 RCJP ACQUISITION, INC., DALLAS, TX:
 681,947. REN. 8-3-09. U.S. CL. 51 (INT. CL. 3).
 RCR ENTERPRISES LLC, WELCOME, NC:
 3,681,084, INT. CL. 41.
 3,681,085, INT. CL. 41.
 RDMAX INC, WASHINGTON, DC, DBA RDMAX:
 3,679,581, PUB. 6-23-2009. INT. CL. 42.
 REACHLOCAL, INC., WOODLAND HILLS, CA:
 3,680,718, INT. CL. 35.
 REAL EARTH PRODUCTS, LLC, KOKOMO, IN:
 3,679,074, PUB. 6-23-2009. INT. CL. 3.
 REAL EQUITY ASSETS, INC., SAN DIEGO, CA:
 2,666,661, CANC. INT. CL. 36.
 REAL ESTATE BUSINESS SERVICES, INC., LOS ANGELES,
 CA:
 3,681,780, INT. CL. 41.
 REAL ESTATE EQUITIES VACATION INVESTMENTS, LLC,
 ST. PAUL, MN:
 3,679,833, PUB. 6-23-2009. INT. CL. 36.
 REAL ESTATE PRESS, LLC., OCALA, FL:
 3,681,742, INT. CL. 36.
 3,681,743, INT. CL. 36.
 REALCAPITALMARKETS.COM, LLC, CARLSBAD, CA:
 2,665,411, CANC. MULTIPLE CLASS, INT. CLS. 35, 36
 AND 41.
 REALINK.COM CORPORATION, TEMPE, AZ:
 2,665,189, CANC. INT. CL. 36.
 REALITY FINDERS, FLEETWOOD, PA:
 3,679,652, PUB. 6-23-2009. INT. CL. 45.

- REALLY RIGHT STUFF, LLC, SAN LUIS OBISPO, CA:
2,281,438. REN. 8-3-09. INT. CL. 9.
- REALNET PROPERTIES, LTD., DALLAS, TX:
3,679,246. PUB. 6-23-2009. MULTIPLE CLASS, INT. CLS.
38 AND 42.
- REALTY PROGRAMMING CORPORATION, THE, CITY OF
FAIRFAX, VA, DBA NMLS AND DBA NATIONAL
MULTI-LIST SERVICE:
1,518,278. CANC. INT. CL. 36.
- REBA REDD, PHILADELPHIA, PA:
3,681,082. INT. CL. 25.
- RECALL MEDIA GROUP HOLDINGS LLC, POMPANO
BEACH, FL:
3,678,535. PUB. 5-19-2009. MULTIPLE CLASS, INT. CLS.
35 AND 38.
- RECKITT BENCKISER INC., PARSIPPANY, NJ:
3,681,457. INT. CL. 5.
- RECOVERY ROAD MEDICAL CENTER, INC., SANTA
BARBARA, CA:
3,678,576. PUB. 6-23-2009. INT. CL. 44.
- RECREATIVOS FRANCO, S.A., 28037 MADRID, SPAIN:
2,665,376. CANC. INT. CL. 28.
- RECRUIT CO., LTD., TOKYO, JAPAN:
2,665,938. CANC. INT. CL. 35.
- RED APPLE, LLC, WOODLAND HILLS, CA:
2,261,585. REN. 7-31-09. INT. CL. 28.
- RED CARD, INC., LOUISVILLE, JEFFERSON COUNTY,
KY:
2,666,473. CANC. INT. CL. 28.
- RED CHIP COMPANY LTD., ROAD TOWN, TORTOLA,
BR. VIRGIN ISLANDS:
3,680,156. INT. CL. 9.
- RED LION HOTELS HOLDING, INC., SPOKANE, WA:
3,678,549. PUB. 6-23-2009. INT. CL. 41.
- RED ROCK TECHNOLOGIES, INC., SCOTTSDALE, AZ:
2,251,393. REN. 8-5-09. INT. CL. 9.
2,260,826. REN. 8-5-09. INT. CL. 9.
- RED WING SHOE COMPANY, INC., RED WING, MN:
3,681,032. INT. CL. 25.
- RED X HOLDINGS, LLC, RENO, NV:
3,678,370. PUB. 6-23-2009. MULTIPLE CLASS, INT. CLS.
35 AND 41.
- RED.COM, INC., LAKE FOREST, CA:
3,681,599. INT. CL. 9.
- REDLINE NETWORKS, INC., CAMPBELL, CA:
2,666,981. CANC. INT. CL. 9.
- REDNESS FINANCIAL LLC, LORTON, VA, DBA WE FIX
MONEY:
3,679,190. PUB. 6-23-2009. INT. CL. 36.
- REED, CRAIG, ELIZABETH, CO:
2,666,579. CANC. INT. CL. 42.
- REFLECTIONS, INC., MACEDONIA, OH:
1,518,528. CANC. INT. CL. 42.
- REG-ROOM LLC, NEW YORK, NY:
3,679,334. PUB. 6-23-2009. MULTIPLE CLASS, INT. CLS.
16 AND 36.
- REGAL BELOIT ELECTRIC MOTORS, INC., FORT WAYNE,
IN:
3,680,520. INT. CL. 7.
- REGENT HOSPITALITY WORLDWIDE, INC., MINNEAPO-
LIS, MN:
2,665,336. CANC. INT. CL. 42.
- REGENTS OF THE UNIVERSITY OF CALIFORNIA, THE,
OAKLAND, CA:
2,295,162. REN. 8-5-09. INT. CL. 9.
- REGENTS OF THE UNIVERSITY OF MICHIGAN, THE,
ANN ARBOR, MI:
2,666,260. CANC. INT. CL. 41.
- REHABCARE GROUP, INC., ST. LOUIS, MO:
3,678,841. PUB. 6-23-2009. INT. CL. 35.
- REIMA HOLDING OY, FINLAND:
3,509,016. COR. MULTIPLE CLASS, INT. CLS. 9, 24 AND
25.
- REIMERS ELECTRA STEAM, INC., CLEAR BROOK, VA,
REIMERS ELECTRA STEAM, INC., CLEAR BROOK, VA:
882,109. REN. 8-3-09. U.S. CL. 34 (INT. CLS. 7 AND 11).
- REIN & CO., LTD., SAITAMA 332-0031, JAPAN:
3,678,199. PUB. 6-23-2009. INT. CL. 28.
- RELIABILITY BRANDS, LLC, OSWEGO, IL:
3,680,266. MULTIPLE CLASS, INT. CLS. 6, 20, 21 AND 40.
- RELIABLE KNITTING WORKS, INC., MILWAUKEE, WI,
DBA RELIABLE OF MILWAUKEE:
3,678,707. PUB. 6-23-2009. INT. CL. 25.
- RELIANCE COMM/TEC CORPORATION, CLEVELAND,
OH TO METRO-TEL CORP., JERICO, NY:
1,517,871. CANC. INT. CL. 9.
- RELIASTAR LIFE INSURANCE COMPANY, MINNEAPO-
LIS, MN:
2,274,291. REN. 8-5-09. INT. CL. 36.
2,277,925. REN. 8-5-09. INT. CL. 36.
- RELIV' INTERNATIONAL, INC., CHESTERFIELD, MO:
2,311,243. REN. 8-1-09. INT. CL. 5.
- REMAC, INC., CARROLLTON, TX:
1,518,001. CANC. MULTIPLE CLASS, INT. CLS. 18 AND
25.
- REMNANT FELLOWSHIP, BRENTWOOD, TN:
2,666,060. CANC. INT. CL. 9.
- REMO, INC., VALENCIA, CA:
3,678,173. PUB. 6-23-2009. INT. CL. 15.
- REMOTE DATA BACKUPS INC., FORT COLLINS, CO:
3,678,754. PUB. 6-23-2009. INT. CL. 39.
- REMOTE PHYSICAL MONITORING LLC, WICHITA, KS:
3,681,774. INT. CL. 9.
- REMOTE RESPONSE CORPORATION, MIAMI, FL:
2,666,809. CANC. INT. CL. 35.
- REMOTE VIDEO PATROL, INC., GREENWOOD VILLAGE,
CO:
2,665,784. CANC. INT. CL. 37.
- REMOTIAN SYSTEMS, INC., MESA, AZ:
3,681,410. INT. CL. 39.
- REMY FINANCE B.V., 2514 EM'S-GRAVENHAGE, NETH-
ERLANDS:
2,665,617. CANC. INT. CL. 33.
- RENEGADE DIVISION, LLC, LEWISBURG, KY:
3,681,545. INT. CL. 4.
- REPROCESSING PRODUCTS CORPORATION (RPC), TUC-
SON, AZ:
3,679,809. PUB. 6-23-2009. INT. CL. 10.
- REPUBLIC OF TEXAS BIKER RALLY, INC., AUSTIN, TX:
3,678,565. PUB. 6-23-2009. MULTIPLE CLASS, INT. CLS.
25, 35 AND 41.
- RESCUE INK PRODUCTIONS LLC, FARMINGVILLE, NY:
3,679,731. PUB. 6-23-2009. INT. CL. 39.
- RESET MEDICAL, INC., BALTIMORE, MD:
3,679,738. PUB. 6-23-2009. INT. CL. 10.
- RESORT BOOKINGS, INC., CHARLEVOIX, MI:
2,286,052. REN. 8-5-09. INT. CL. 35.
- RESORT PROPERTY HOLDING, LLC, ST. LOUIS, MO:
2,214,322. CANC. MULTIPLE CLASS, INT. CLS. 25, 41
AND 42.
- RESULTS UNLIMITED, MINOT, ND:
3,679,453. PUB. 6-23-2009. INT. CL. 35.
3,679,773. PUB. 6-23-2009. INT. CL. 16.
- RESURGENS ORTHOPAEDICS, P.C., ATLANTA, GA:
3,679,691. PUB. 6-23-2009. INT. CL. 44.
- RETHCEIF ENTERPRISES, LLC, BLUFFTON, IN, DBA
RETHCEIF PACKAGING:
3,678,434. PUB. 6-23-2009. INT. CL. 7.
- RETIRED OFFICERS UNIFORMS, LLC, CLEVELAND, OH:
3,679,004. PUB. 6-23-2009. INT. CL. 35.
- RETIREE INC., LEAWOOD, KS:
3,681,755. INT. CL. 36.
- RETIREMENT BENCHMARK LLC, LEAWOOD, KS:
3,681,756. INT. CL. 36.
- RETIREMENT FINANCIAL SERVICES, INC., FORT
WAYNE, IN:
2,667,310. CANC. INT. CL. 36.
- REVIEWMY401K.COM, LLC, BRADENTON, FL:
3,680,880. INT. CL. 36.
- REVILL, TERENCE, EDGWARE, MIDDLESEX, HA8 9JG,
ENGLAND:
2,214,121. CANC. INT. CL. 3.
- REY, JOE, PORTLAND, OR:
3,680,886. INT. CL. 41.

- REYNOLDS AND REYNOLDS HOLDINGS, INC., KETTERING, OH:
2,665,972, CANC. INT. CL. 35.
2,665,973, CANC. INT. CL. 35.
- REYNOLDS CONSUMER PRODUCTS, INC., RICHMOND, VA:
1,550,134, REN. 8-3-09. INT. CL. 16.
1,550,135, REN. 8-3-09. INT. CL. 16.
- REYNOLDS CONSUMER PRODUCTS, INC., RICHMOND, VA, DBA PRESTO PRODUCTS COMPANY:
1,554,703, REN. 8-3-09. INT. CL. 19.
- REYNOLDS CONSUMER PRODUCTS, INC., APPLETON, WI:
1,559,818, REN. 8-5-09. INT. CL. 17.
2,257,410, REN. 8-5-09. INT. CL. 16.
- RFC INTERMEDIARIES, INC., ATLANTA, GA:
1,518,246, CANC. INT. CL. 36.
- RGB SYSTEMS, INCORPORATED, ANAHEIM, CA:
3,679,621, PUB. 6-23-2009. INT. CL. 9.
- RGI TECHNOLOGIES, LLC, CARROLLTON, TX, DBA VIDEOCHAMP, LLC:
3,681,211, INT. CL. 42.
- RGK FOUNDATION, AUSTIN, TX:
2,321,031, REN. 8-3-09. INT. CL. 36.
- RGS PATTERN BOOK CO LTD, WEST YORKSHIRE WF5 9DA, UNITED KINGDOM:
2,666,954, CANC. INT. CL. 9.
- RHINO LININGS CORPORATION, SAN DIEGO, CA:
2,682,202, CANC. INT. CL. 7.
- RHYNO PRODUCTIONS, INC., LEXINGTON, KY:
2,666,124, CANC. INT. CL. 41.
- RHYTHM & BLUE INC. LIMITED, WEST SUSSEX, UNITED KINGDOM:
3,678,817, PUB. 6-23-2009. INT. CL. 3.
- RHYTHM EARTH, OAKHURST, CA:
3,679,461, PUB. 6-23-2009. INT. CL. 15.
- RIC INVESTMENTS, LLC, WILMINGTON, DE:
1,520,737, REN. 8-6-09. INT. CL. 10.
- RICECO LLC, MEMPHIS, TN:
3,680,519, INT. CL. 5.
- RICHARD H. JODOIN, WAXHAW, NC:
3,679,477, PUB. 6-23-2009. INT. CL. 7.
- RICHARD SCOTT INC., ALBANY, NY, DBA BROADWAY AUTO CLINIC:
3,681,148, INT. CL. 37.
- RICHARDSON, ED, CHARLOTTE, NC:
3,680,255, INT. CL. 25.
- RICHARDSON, LOUISE, SAN DIEGO, CA:
2,666,551, CANC. INT. CL. 18.
- RICHIE, KARLA, KENOSHA, WI:
3,678,435, PUB. 6-23-2009. INT. CL. 25.
- RICHIN TRADING INC., ALHAMBRA, CA:
3,678,376, PUB. 3-31-2009. INT. CL. 29.
- RICHLAND PARTNERS, LLC, MOUNT JOY, PA:
3,678,856, PUB. 6-23-2009. INT. CL. 37.
- RICHLINE GROUP, INC., NEW YORK, NY:
1,542,444, REN. 8-1-09. INT. CL. 14.
- RICHMOND RELOCATION SERVICES, INC., RICHMOND, VA:
1,518,211, CANC. INT. CL. 35.
- RICHRELEVANCE, INC., SAN FRANCISCO, CA:
3,680,635, INT. CL. 35.
- RICK CODY, GEORGETOWN, TX, DBA CODY GLOBAL CONSULTING, INC.:
3,681,734, INT. CL. 42.
- RICOH COMPANY, LTD., OHTA-KU, TOKYO, JAPAN:
1,562,890, REN. 8-4-09. MULTIPLE CLASS, INT. CLS. 1, 2 AND 9.
- RICOH COMPANY, LTD., TOKYO, JAPAN:
3,576,283, COR. MULTIPLE CLASS, INT. CLS. 35 AND 42.
- RICOH SILICON VALLEY, INC., CUPERTINO, CA:
2,666,992, CANC. INT. CL. 35.
- RIDE ME RECYCLES, INC., ST. CHARLES, MO:
2,666,604, CANC. MULTIPLE CLASS, INT. CLS. 25 AND 39.
- RIDGID, INC., WILMINGTON, DE, RIDGE TOOL COMPANY, ELYRIA, OH:
866,405, REN. 8-3-09. U.S. CL. 38 (INT. CL. 16).
- RIDLEY U.S. HOLDINGS INC., MANKATO, MN:
3,681,130, INT. CL. 5.
- RIGALT S.A., BUENOS AIRES, ARGENTINA:
3,679,826, PUB. 5-19-2009. INT. CL. 3.
- RIGHT DOWN BROADWAY, LLC, FRISCO, TX:
3,678,863, PUB. 6-23-2009. INT. CL. 10.
- RIGHTAIR COMPRESSOR ENGINEERING, INC., BLOOMFIELD, CT:
1,518,308, CANC. INT. CL. 37.
- RIGHTSASSIST, WASHINGTON, DC:
2,667,323, CANC. INT. CL. 9.
- RIGO, MARIE ELENA, SANTA MONICA, CA:
3,679,660, PUB. 6-23-2009. INT. CL. 41.
- RIMEX METALS (UK) LTD, ENFIELD, MIDDLESEX, UNITED KINGDOM:
3,679,459, PUB. 6-23-2009. INT. CL. 6.
- RINEHART, CATHY L., LIBERTY, MO:
2,666,340, CANC. INT. CL. 25.
- RIOWELL, LLC, HOUSTON, TX:
2,262,785, REN. 8-1-09. MULTIPLE CLASS, INT. CLS. 35 AND 41.
- RIPE KITCHEN & BAR, INC, MOUNT VERNON, NY:
3,678,709, PUB. 6-23-2009. INT. CL. 43.
- RIPENSA A/S, RIBE, DENMARK:
2,665,344, CANC. INT. CL. 30.
- RISK MANAGEMENT RESOURCES, LLC, CALIFON, NJ:
3,681,463, INT. CL. 36.
- RISSENBERG, MARIAN, KATONAH, NY:
2,214,060, CANC. MULTIPLE CLASS, INT. CLS. 9 AND 42.
- RITA'S WATER ICE FRANCHISE COMPANY, LLC, TREVISO, PA:
2,260,069, REN. 8-3-09. INT. CL. 30.
- RITZ-CARLTON HOTEL COMPANY, L.L.C., THE, BETHESDA, MD:
2,298,901, REN. 8-3-09. INT. CL. 36.
- RIVA TEXTILES LLC, NEW YORK, NY:
3,681,002, INT. CL. 25.
- RIVERSWEET CITRUS SALES, INC., LARGO, FL:
2,350,009, REN. 8-3-09. INT. CL. 31.
- RIVERWEST ENGINEERING & DESIGN, INC., WEST ALLIS, WI:
3,680,114, INT. CL. 6.
- ROAD CLOTHING LIMITED, DERBYSHIRE S40 1LA, UNITED KINGDOM:
3,680,690, INT. CL. 25.
- ROAD RUNNERS CLUB OF AMERICA, THE, ARLINGTON, VA:
2,255,106, REN. 7-31-09. INT. CL. 36.
- ROADSIDE AMERICA, INC., SHARTLESVILLE, BERKS COUNTY, PA:
1,518,350, CANC. INT. CL. 41.
- ROARING SPRING PAPER PRODUCTS CO., ROARING SPRING, PA:
2,667,153, CANC. INT. CL. 16.
- ROBERT KARTHÄUSER, 12105 BERLIN, FED REP GERMANY:
3,202,376, COR. INT. CL. 37.
- ROBERTS, FRANCIS L., JR., DURHAM, NC:
3,678,290, PUB. 9-23-2008. INT. CL. 41.
- ROBERTS, JR., FRANCIS L., DURHAM, NC:
3,678,289, PUB. 12-9-2008. INT. CL. 41.
- ROBLEY, CHAD, SAN DIEGO, CA, DBA LOGO GEAR:
2,264,269, REN. 8-3-09. MULTIPLE CLASS, INT. CLS. 40 AND 42.
- ROBONICA (PROPRIETARY) LIMITED, ROOIHUISKRAAL, CENTURION, SOUTH AFRICA:
3,680,373, MULTIPLE CLASS, INT. CLS. 9 AND 28.
- ROBROY INDUSTRIES, INC., VERONA, PA:
872,052, REN. 8-2-09. U.S. CL. 21 (INT. CL. 9).
- ROC, LLC, FRANKLIN, TN:
3,680,490, INT. CL. 25.
- ROCHE MOLECULAR SYSTEMS, INC., PLEASANTON, CA:
2,260,196, REN. 7-31-09. MULTIPLE CLASS, INT. CLS. 1 AND 5.

- ROCKET GAMING SYSTEMS, LLC, GROVE, OK:
3,681,023, INT. CL. 41.
- ROCKET SOFTWARE, INC., NEWTON, MA:
2,753,960, CANC. INT. CL. 35.
- ROCKHURST UNIVERSITY CONTINUING EDUCATION CENTER, INC., KANSAS CITY, MO:
3,679,555, PUB. 6-23-2009. INT. CL. 41.
- RODA MANUFACTURING, INC., HULL, IA:
2,667,429, CANC. INT. CL. 7.
- RODENHOUSE INC., GRAND RAPIDS, MI:
2,332,089, REN. 8-5-09. INT. CL. 17.
- RODRIGUEZ, REBECCA WINTERS, CANYON LAKE, TX:
3,680,688, INT. CL. 35.
- ROEDER, RICK, MONROVIA, CA:
3,681,701, INT. CL. 10.
- ROGER CLEVELAND GOLF COMPANY, INC., HUNTINGTON BEACH, CA:
3,679,684, PUB. 6-23-2009. INT. CL. 28.
- ROHM AND HAAS ELECTRONIC MATERIALS LLC, MARLBOROUGH, MA:
3,679,152, PUB. 6-23-2009. INT. CL. 1.
- ROKNICH, MARK, DANA POINT, CA:
2,666,871, CANC. MULTIPLE CLASS, INT. CLS. 35 AND 42.
- ROLF C. HAGEN (USA) CORP., MANSFIELD, MA:
1,589,695, REN. 8-5-09. INT. CL. 5.
- ROLLABELS, INK., INCORPORATED, DOYLESTOWN, PA:
1,592,978, REN. 8-6-09. INT. CL. 16.
- ROLLER STAR CORPORATION, FORT LAUDERDALE, FL:
2,665,528, CANC. MULTIPLE CLASS, INT. CLS. 6 AND 7.
- ROLLO, JONATHAN, BEVERLY HILLS, CA:
3,680,363, INT. CL. 43.
- ROMAN CATHOLIC ARCHDIOCESE OF INDIANAPOLIS, THE, INDIANAPOLIS, IN:
2,260,281, REN. 8-3-09. MULTIPLE CLASS, INT. CLS. 9 AND 16.
- ROMERO & MILLER, LLC, BEL AIR, MD:
3,680,187, INT. CL. 33.
- RONALD J. STEPHANO AND ASSOCIATES, TWINSBURG, OH:
2,665,472, CANC. INT. CL. 16.
- RONALD REAGAN PRESIDENTIAL FOUNDATION, INC., THE, SIMI VALLEY, CA:
2,666,977, CANC. INT. CL. 25.
2,666,979, CANC. INT. CL. 25.
- RONDEAU, PAUL ERIC, WATERFORD, VA:
3,681,676, INT. CL. 41.
- ROS FERNANDEZ, MANUEL, PICASSENT (VALENCIA), SPAIN:
3,678,734, PUB. 3-3-2009. MULTIPLE CLASS, INT. CLS. 25 AND 35.
- ROSA, JIM, BRIGANTINE, NJ:
3,678,203, PUB. 6-23-2009. INT. CL. 28.
- ROSETTA STONE LTD., ARLINGTON, VA:
3,680,367, INT. CL. 9.
- ROSIE'S PLATE, LLC, RALEIGH, NC:
3,680,669, INT. CL. 43.
- ROSS, ROBERT, DR., NEW YORK, NY:
3,680,409, INT. CL. 41.
- ROTH, SHELLEY RAE, HOUSTON, TX, DBA SPRINGBOARD VENTURES:
2,665,103, CANC. INT. CL. 35.
- ROTHBARD, MICHAEL, CARPINTERIA, CA:
3,678,790, PUB. 6-23-2009. INT. CL. 24.
3,678,791, PUB. 6-23-2009. INT. CL. 24.
3,678,897, PUB. 6-23-2009. INT. CL. 24.
- ROTO-MIX, LLC, DODGE CITY, KS:
2,667,338, CANC. INT. CL. 7.
- ROFORMATIC PLUMBING & PIPE CLEANING, INC., DELMAR, NY:
2,665,686, CANC. INT. CL. 37.
- ROUND HILL CELLARS, ST. HELENA, CA, DBA RUTHERFORD WINE COMPANY:
3,577,892, COR. INT. CL. 33.
- ROUX LABORATORIES, INC., JACKSONVILLE, FL:
2,213,776, CANC. INT. CL. 3.
- ROW BALANCE, INC., SPRINGFIELD, VA:
3,678,657, PUB. 6-23-2009. INT. CL. 28.
- ROY DEAN ACADEMY, LLC, BEND, OR:
3,679,119, PUB. 6-23-2009. INT. CL. 41.
- ROYAL APPLIANCE MFG. CO., GLENWILLOW, OH:
2,213,641, CANC. INT. CL. 7.
- ROYAL INTERNATIONAL OPTICAL, INC., DALLAS, TX:
2,666,707, CANC. MULTIPLE CLASS, INT. CLS. 9 AND 42.
- ROYAL TREASURE, INC., MARIETTA, GA:
2,666,619, CANC. INT. CL. 16.
- RPM WOOD FINISHES GROUP, INC., HICKORY, NC:
3,680,555, INT. CL. 4.
- RSC THE QUALITY MEASUREMENT COMPANY, EVANSVILLE, IN:
2,666,743, CANC. INT. CL. 35.
- RSM MCGLADREY, INC., BLOOMINGTON, MN:
3,583,854, COR. MULTIPLE CLASS, INT. CLS. 9, 35 AND 38.
- RTD INVESTMENTS, LLC, ROSWELL, NM:
3,681,650, INT. CL. 43.
- RTG TRADING, JOHANNESBURG, SOUTH AFRICA:
3,679,439, PUB. 6-23-2009. INT. CL. 33.
- RTP-U.S.A., INC., NEWARK, NJ:
1,518,322, CANC. INT. CL. 38.
- RUANGATAGOO, RAVADEE, VILLA PARK, CA:
2,665,065, CANC. INT. CL. 42.
- RUBEN, MARSHALL S., HARTFORD, CT:
3,680,083, INT. CL. 43.
- RUBYCO, INCORPORATED, DETROIT, MI:
2,666,198, CANC. INT. CL. 43.
- RUDOLPH GONZALES III, CORPUS CHRISTI, TX:
3,680,237, INT. CL. 16.
- RUHLE COMPANIES, INC., VALHALLA, NY:
1,110,829, REN. 8-3-09. INT. CL. 9.
- RUIZ FOOD PRODUCTS, INC., DINUBA, CA:
3,678,877, PUB. 6-23-2009. INT. CL. 30.
- RUN WITH THE BAND, INC., CHATHAM, NY:
2,665,976, CANC. INT. CL. 42.
- RUNE2E, ALPHARETTA, GA:
3,679,647, PUB. 6-23-2009. INT. CL. 9.
- RUNTIME GAMES LIMITED, POOLE, UNITED KINGDOM:
3,679,393, PUB. 6-23-2009. MULTIPLE CLASS, INT. CLS. 9 AND 28.
- RUPP SEEDS, INC., WAUSEON, OH:
3,679,646, PUB. 6-23-2009. INT. CL. 44.
- RUPP, BAASE, PFALZGRAF & CUNNINGHAM LLC, BUFFALO, NY:
2,666,315, CANC. INT. CL. 42.
- RUSHTON ATLANTIC, LLC, CHESHIRE, SK 8 5AF, UNITED KINGDOM:
3,680,931, INT. CL. 35.
- RUSSELL FLOWERS, LLC, CLINTON TOWNSHIP, MI:
2,666,428, CANC. INT. CL. 5.
- RUSSELL P. TROCANO, RIDGEWOOD, NJ:
3,678,288, PUB. 6-23-2009. INT. CL. 35.
- RUSSELL TECHNOLOGIES INC., EDMONTON, ALBERTA, CANADA, CYBERSCOPE INDUSTRIES INC., EDMONTON, ALBERTA, CANADA:
1,547,135, REN. 8-3-09. INT. CL. 9.
- RV RIVER CHARTERS, INC., NEW ORLEANS, LA:
2,214,928, CANC. MULTIPLE CLASS, INT. CLS. 39 AND 41.
- RWACHSBERG HOLDINGS INC., CONCORD, CANADA:
3,679,823, PUB. 6-23-2009. MULTIPLE CLASS, INT. CLS. 3 AND 5.
- RYAN, RONALD D., MURFREESBORO, TN AND RYAN, MARTHA B., MURFREESBORO, TN AND PATER, EDWIN R., MURFREESBORO, TN AND BOOTH, JOHN M., MURFREESBORO, TN:
2,214,031, CANC. INT. CL. 41.
- RYDER CLIPS UNLIMITED, INC., LIGHTHOUSE POINT, FL:
3,680,316, INT. CL. 6.
- RYLO PRODUCTS LLC, DENVER, CO:
3,678,815, PUB. 6-23-2009. INT. CL. 30.
- S. C. JOHNSON & SON, INC., RACINE, WI:
1,517,753, CANC. INT. CL. 5.

- S.A.E. AFIKIM SPECIAL AGRICULTURAL EQUIPMENT, KIBBUTZ AFIKIM, ISRAEL:
3,678,214, PUB. 6-23-2009. MULTIPLE CLASS, INT. CLS. 7 AND 9.
- S.B. RESTAURANT CO., LA MIRADA, CA:
3,680,728, INT. CL. 43.
- S.C. AEROSTAR S.A., ROMANIA:
3,679,875, PUB. 6-23-2009. MULTIPLE CLASS, INT. CLS. 6, 7 AND 12.
3,679,877, PUB. 6-23-2009. MULTIPLE CLASS, INT. CLS. 6, 7, 9, 12, 37 AND 42.
- S.L. START & ASSOCIATES, INC., SPOKANE, WA:
2,666,138, CANC. MULTIPLE CLASS, INT. CLS. 35 AND 42.
- S.L.T. JAPAN CO., LTD., TOKYO 192-0081, JAPAN:
2,665,354, CANC. INT. CL. 10.
- S.N.F., SAINT-ETIENNE, FRANCE:
2,665,974, CANC. INT. CL. 1.
- S.P.E.C. GROUP LTD., THE, COLUMBUS, OH:
2,665,551, CANC. INT. CL. 42.
- S&F SUPPLIES INC., BROOKLYN, NY:
3,680,795, INT. CL. 20.
- SA INTERNATIONAL INC., SALT LAKE CITY, UT:
3,681,593, INT. CL. 9.
- SACHEM, INC., AUSTIN, TX:
3,681,200, INT. CL. 1.
3,681,201, INT. CL. 1.
3,681,203, INT. CL. 1.
- SACKEL, GARY D., POMPAÑO BEACH, FL:
2,667,065, CANC. INT. CL. 32.
- SADDLE RIVER INN, INC., SADDLE RIVER, NJ:
2,318,099, REN. 7-31-09. INT. CL. 42.
- SAEILLO ENTERPRISES, INC., PEARL RIVER, NY:
3,678,983, PUB. 6-23-2009. INT. CL. 13.
- SAFARI ASSOCIATES, INC., AMSTERDAM, NY:
2,665,375, CANC. INT. CL. 13.
- SAFDIE & CO. INC., TOWN OF MOUNT ROYAL, CANADA:
3,678,573, PUB. 6-23-2009. INT. CL. 24.
- SAFE ETCH CORPORATION, OVERLAND PARK, KS:
2,214,388, CANC. INT. CL. 40.
- SAFETYTAT, LLC, PHOENIX, MD:
3,681,387, INT. CL. 16.
- SAFeway INSURANCE COMPANY, WESTMONT, IL:
3,681,000, INT. CL. 39.
3,681,384, INT. CL. 39.
- SAGATIBA BRASIL S.A., SAO PAULO, BRAZIL:
3,680,839, INT. CL. 33.
- SAGINAW VALLEY STATE UNIVERSITY, SAGINAW, MI:
1,580,705, REN. 8-2-09. INT. CL. 42.
1,580,707, REN. 8-2-09. INT. CL. 42.
1,593,466, REN. 8-2-09. INT. CL. 41.
- SAHA, PAMELA, BROOKLYN, NY:
3,680,078, INT. CL. 28.
- SAINT-GOBAIN EMBALLAGE, FRANCE:
3,679,954, PUB. 6-23-2009. MULTIPLE CLASS, INT. CLS. 16, 21 AND 40.
- SAINT-GOBAIN GLASS FRANCE, COURBEVOIE, FRANCE:
3,637,887, COR. INT. CL. 19.
- SAKAR ACQUISITION L.L.C., EDISON, NJ:
2,666,261, CANC. INT. CL. 9.
- SAKURA PROPERTIES, LLC, SALEM, UT:
3,680,308, INT. CL. 3.
- SALAMAN, ROSE MARIE, PLANTATION, FL:
1,518,336, CANC. INT. CL. 39.
- SALES INNOVATION, LLC, WESTBROOK, CT:
3,679,255, PUB. 6-23-2009. INT. CL. 41.
- SALESTRATION, INC., SCOTTSDALE, AZ:
2,665,656, CANC. INT. CL. 41.
2,665,657, CANC. INT. CL. 41.
- SALLEN, CHRISTOPHER R., PALM BEACH GARDENS, FL AND DAVIS, RICHARD J., PALM BEACH GARDENS, FL:
2,268,825, REN. 8-5-09. INT. CL. 42.
- SALLIE MAE, INC., RESTON, VA:
3,679,475, PUB. 6-23-2009. INT. CL. 36.
3,679,481, PUB. 6-23-2009. INT. CL. 36.
3,679,552, PUB. 6-23-2009. INT. CL. 36.
- SALOMON SMITH BARNEY INC., NEW YORK, NY:
2,665,891, CANC. INT. CL. 36.
2,666,223, CANC. INT. CL. 36.
- SALTON, INC., MOUNT PROSPECT, IL:
2,665,513, CANC. INT. CL. 10.
- SAMANTHA SPRINGS, INC., KELLER, TX:
2,257,299, REN. 7-31-09. INT. CL. 32.
- SAMBODHA INC., EASTSOUND, WA:
3,678,672, PUB. 6-23-2009. MULTIPLE CLASS, INT. CLS. 9, 16 AND 41.
- SAMENA CAPITAL, UGLAND HOUSE, CAYMAN ISLANDS:
3,680,780, INT. CL. 36.
- SAMENA CAPITAL, CAYMAN ISLANDS, CAYMAN ISLANDS:
3,680,789, INT. CL. 36.
- SAMSONITE CORPORATION, MANSFIELD, MA:
2,269,046, REN. 8-3-09. INT. CL. 18.
- SAMSUNG ELECTRONICS CO., LTD., GYEONGGI-DO, REPUBLIC OF KOREA:
3,678,404, PUB. 6-23-2009. INT. CL. 9.
- SAMUEL J. KUNTZ, SEATTLE, WA, DBA MY TOWN PHOTOGRAPHY:
3,680,668, INT. CL. 41.
- SAN DIEGO SOCCER DEVELOPMENT CORPORATION, SAN DIEGO, CA:
2,666,370, CANC. INT. CL. 16.
- SAN DIEGO WORKFORCE PARTNERSHIP, INC., SAN DIEGO, CA, DBA SAN DIEGO WORKFORCE PARTNERSHIP:
2,665,330, CANC. MULTIPLE CLASS, INT. CLS. 35 AND 41.
- SAN JOAQUIN REFINING CO., INC., BAKERSFIELD, CA:
2,361,615, REN. 7-31-09. INT. CL. 4.
- SAN MAR CORPORATION, PRESTON, WA:
3,681,588, MULTIPLE CLASS, INT. CLS. 18 AND 25.
- SANDBERG & SIKORSKI CORPORATION, NEW YORK, NY:
2,219,615, REN. 8-6-09. INT. CL. 14.
- SANDBERG & SIKORSKI CORPORATION, NEW YORK, NY:
2,262,297, REN. 8-6-09. INT. CL. 14.
- SANDBERG LTD, PINEHURST, NC:
3,681,737, INT. CL. 41.
- SANDERS, MARCUS E., EL PRADO, NM:
2,666,224, CANC. INT. CL. 41.
- SANDISK CORPORATION, MILPITAS, CA:
2,665,717, CANC. INT. CL. 9.
- SANDISK IL LTD., KFAR SABA, ISRAEL:
2,665,634, CANC. INT. CL. 9.
- SANRIO COMPANY, LTD., TOKYO, JAPAN:
3,566,055, AM. INT. CL. 18.
3,679,187, PUB. 6-23-2009. INT. CL. 22.
- SANTA MARIA FOODS ULC, BRAMPTON, ONTARIO, CANADA:
2,731,057, CANC. MULTIPLE CLASS, INT. CLS. 30 AND 32.
- SANTA'S TOY CORPORATION, LOS ANGELES, CA:
3,679,297, PUB. 6-23-2009. INT. CL. 28.
- SANYO ELECTRIC CO., LTD., OSAKA, JAPAN:
2,666,849, CANC. INT. CL. 9.
- SANYO ELECTRIC CO., LTD., MORIGUCHI CITY, OSAKA, JAPAN:
3,678,477, PUB. 6-23-2009. INT. CL. 9.
- SARA LEE FOODS, INC., CINCINNATI, OH:
2,666,586, CANC. INT. CL. 29.
- SARATOGA DESIGN, INC., KEY WEST, FL:
2,665,438, CANC. INT. CL. 34.
2,665,439, CANC. INT. CL. 34.
- SARTOMER TECHNOLOGY COMPANY, INC., WILMINGTON, DE, SARTOMER TECHNOLOGY COMPANY, INC., WILMINGTON, DE:
2,350,449, REN. 8-1-09. INT. CL. 1.
- SARTORIUS STEDIM BIOTECH GMBH, GOETTINGEN, FED REP GERMANY:
3,681,041, INT. CL. 9.

- SASAKURA ENGINEERING CO., LTD., OSAKA 555-0012, JAPAN:
3,678,385, PUB. 6-23-2009. INT. CL. 11.
- SAT CORPORATION, SUNNYVALE, CA:
2,667,144, CANC. INT. CL. 9.
- SATISFIED BRAKE PRODUCTS INC./LES PRODUITS DE FREINS SATISFAIT INC., DORVAL, QUEBEC, CANADA:
3,678,146, PUB. 5-19-2009. INT. CL. 12.
- SATORI WORLD MEDICAL, INC., SAN DIEGO, CA:
3,678,659, PUB. 6-23-2009. MULTIPLE CLASS, INT. CLS. 39 AND 44.
3,678,661, PUB. 6-23-2009. MULTIPLE CLASS, INT. CLS. 39 AND 44.
- SAUL AMARISTA, FOREST KNOLLS, CA:
3,680,879, MULTIPLE CLASS, INT. CLS. 29 AND 30.
- SAVANTIC SOFTWARE, INC., RANDOLPH, MA:
2,666,629, CANC. INT. CL. 42.
- SAVE YOUR WORLD, L.L.C., SHORT HILLS, NJ:
3,679,792, PUB. 2-24-2009. MULTIPLE CLASS, INT. CLS. 3 AND 25.
- SAVES GOALTENDING INTERNATIONAL INC., TOTTENHAM, ONTARIO, CANADA:
2,665,104, CANC. MULTIPLE CLASS, INT. CLS. 25 AND 41.
- SAWGRASS TECHNOLOGIES, INC., MOUNT PLEASANT, SC:
3,680,596, INT. CL. 2.
- SAXON ENERGY SERVICES, INC., CALGARY, CANADA:
3,680,186, INT. CL. 7.
- SAYEGH, SAM J., BROOKLYN, NY:
2,667,441, CANC. INT. CL. 42.
- SAZERAC COMPANY, INC., NEW ORLEANS, LA:
3,679,487, PUB. 6-23-2009. INT. CL. 33.
- SBARRO, INC., MELVILLE, NY:
2,666,799, CANC. INT. CL. 42.
- SBE ENTERTAINMENT GROUP, LLC, LOS ANGELES, CA:
3,680,479, INT. CL. 43.
- SCANCOM INTERNATIONAL A/S, 4220 KORSOR, DENMARK:
2,755,470, CANC. MULTIPLE CLASS, INT. CLS. 17 AND 24.
2,763,561, CANC. INT. CL. 17.
- SCANDICRAFTS CUISINE INTERNATIONAL, INC., CAMARILLO, CA:
2,666,897, CANC. INT. CL. 21.
- SCHAFFER PARTNERS, INC., CLEVELAND, OH:
2,285,446, REN. 8-1-09. INT. CL. 42.
- SCHENCK, JAMES ANDREW, HOUSTON, TX:
2,213,667, CANC. INT. CL. 41.
- SCHIFF NUTRITION INTERNATIONAL, INC., SALT LAKE CITY, UT:
2,666,225, CANC. INT. CL. 5.
- SCHILL, RANDY T., CHARLOTTE, NC:
3,680,915, INT. CL. 35.
- SCHILLING, ROBERT, L. SEBASTOPOL, CA:
2,666,646, CANC. INT. CL. 30.
- SCHLAGE LOCK COMPANY, SAN FRANCISCO, CA:
2,666,539, CANC. INT. CL. 41.
- SCHLEIFRING UND APPARATEBAU GMBH, D-82256 FÜRSTENFELDBRÜCK, FED REP GERMANY:
3,680,086, MULTIPLE CLASS, INT. CLS. 9 AND 42.
- SCHLUMBERGER TECHNOLOGY CORPORATION, HOUSTON, TX:
2,214,312, CANC. INT. CL. 9.
- SCHLUTER-SYSTEMS KG, ISERLOHN, FED REP GERMANY:
3,678,295, PUB. 4-21-2009. MULTIPLE CLASS, INT. CLS. 1, 6, 11, 17 AND 19.
- SCHNEIDER, DAVID L., SAN DIEGO, CA:
2,666,332, CANC. INT. CL. 35.
2,666,333, CANC. INT. CL. 35.
2,666,334, CANC. INT. CL. 35.
2,666,335, CANC. INT. CL. 35.
- SCHOLARGROUP EQUITY PARTNERS, LLC, BLAINE, MN:
3,679,235, PUB. 6-23-2009. INT. CL. 36.
- SCHOLASTIC INC., NEW YORK, NY:
2,265,594, REN. 8-3-09. INT. CL. 41.
- SCHOOL APPAREL, INC., SAN BRUNO, CA:
2,231,320, REN. 8-1-09. INT. CL. 25.
- SCHOOL OF VISUAL ARTS INC., NEW YORK, NY:
2,270,802, REN. 8-6-09. INT. CL. 41.
- SCHWARTZ, MAX A., LEXINGTON, KY:
3,679,153, PUB. 6-23-2009. INT. CL. 29.
3,679,155, PUB. 6-23-2009. INT. CL. 43.
- SCHWARZMANN, THOMAS D., ANDALUSIA, PA:
2,665,133, CANC. INT. CL. 41.
- SCHWEITZER-MAUDUIT INTERNATIONAL, INC., ALPHARETTA, GA:
3,680,501, INT. CL. 16.
- SCOTTSDALE INSURANCE COMPANY, SCOTTSDALE, AZ:
3,680,641, INT. CL. 36.
- SCOVILL FASTENERS, INC., CLARKESVILLE, GA:
1,518,088, CANC. INT. CL. 26.
- SCRILLA HILL ENTERTAINMENT, INC., NEW YORK, NY:
3,679,061, PUB. 6-23-2009. INT. CL. 41.
- SD IP HOLDINGS COMPANY, CINCINNATI, OH:
2,667,298, CANC. MULTIPLE CLASS, INT. CLS. 5 AND 32.
- SE ELECTRONICS INTERNATIONAL, INC., ROHNERT PARK, CA:
3,488,352, COR. INT. CL. 17.
- SEA BREEZE FRUIT FLAVORS, INC., TOWACO, NJ:
2,333,383, REN. 7-31-09. INT. CL. 32.
- SEA STRIKER INTERNATIONAL LLC, MOREHEAD CITY, NC:
3,679,673, PUB. 6-23-2009. INT. CL. 28.
3,679,679, PUB. 6-23-2009. INT. CL. 28.
- SEA TIES, INC., BATON ROUGE, LA:
3,678,166, PUB. 6-23-2009. INT. CL. 28.
- SEA TOW SERVICES INTERNATIONAL, INC., SOUTHOLD, NY:
3,678,375, PUB. 6-23-2009. INT. CL. 39.
- SEABULK INTERNATIONAL, INC., FORT LAUDERDALE, FL:
2,362,504, REN. 8-5-09. INT. CL. 12.
- SEALANT EQUIPMENT & ENGINEERING, INC., PLYMOUTH, MI:
2,282,220, REN. 8-3-09. INT. CL. 9.
- SEALED AIR CORPORATION (US), ELMWOOD PARK, NJ:
3,681,377, INT. CL. 9.
- SEAMILES, L.L.C., FORT LAUDERDALE, FL:
2,667,411, CANC. INT. CL. 36.
- SEARCHERS 4WD SUPPLY & OUTFITTERS, LLC, FRENCH SETTLEMENT, LA:
3,678,643, PUB. 6-23-2009. INT. CL. 40.
- SEARS BRANDS, LLC, HOFFMAN ESTATES, IL, SEARS, ROEBUCK AND CO., HOFFMAN ESTATES, IL:
2,258,348, REN. 8-3-09. INT. CL. 8.
- SEARS BRANDS, LLC, HOFFMAN ESTATES, IL:
3,680,515, INT. CL. 25.
- SEARS, ROEBUCK AND CO., HOFFMAN ESTATES, IL TO PRINCIPLE BUSINESS ENTERPRISES, INC., DUNBRIDGE, OH:
1,956,636, CANC. INT. CL. 25.
- SEASILVER USA, INC., LAS VEGAS, NV:
2,665,913, CANC. INT. CL. 5.
- SEATTLE GOURMET FOODS, INC., KENT, WA:
3,681,349, INT. CL. 3.
- SEBASTIAN (CHARLES) KING, LOS ANGELES, CA, DBA BIG MONEY RECORDS (FORMERLY NU MU RECORDS):
3,680,476, INT. CL. 9.
- SEBASTIAN (CHARLES) KING, LOS ANGELES, CA, DBA SALVATION RECORDS:
3,680,477, INT. CL. 9.
- SECO INTERNATIONAL, LLC, ATLANTA, GA:
3,679,431, PUB. 6-23-2009. MULTIPLE CLASS, INT. CLS. 35 AND 41.
- SECOM GROUP, INC., STERLING HEIGHTS, MI:
2,665,486, CANC. MULTIPLE CLASS, INT. CLS. 35 AND 38.
- SECOND CITY, INC., CHICAGO, IL:
3,681,456, MULTIPLE CLASS, INT. CLS. 9 AND 41.

SECOND LICENSE APPLICATION CORPORATION, D/FW AIRPORT, TX:
 3,680,343, MULTIPLE CLASS, INT. CLS. 42 AND 45.
 SECTOR, INC., NEW YORK, NY:
 2,665,896, CANC. INT. CL. 42.
 SECURE SYSTEMS LIMITED, WESTERN PERTH, AUSTRALIA:
 2,666,067, CANC. INT. CL. 9.
 SECURITIES AMERICA, INC., LAVISTA, NE:
 1,553,203 NEW CERT. 9-8-2009. INT. CL. 35.
 SECURITIES INDUSTRY AND FINANCIAL MARKETS ASSOCIATION, NEW YORK, NY:
 3,680,459, MULTIPLE CLASS, INT. CLS. 16, 35 AND 41.
 SECURITY DISTRIBUTORS, INC., DALLAS, TX, SECURITY DISTRIBUTORS, INC., DALLAS, TX:
 2,222,606. REN. 8-6-09. INT. CL. 6.
 SECURITY INDUSTRY SPECIALISTS, INC., CULVER CITY, CA:
 3,679,173, PUB. 6-23-2009. INT. CL. 45.
 SECUSTREAM TECHNOLOGIES AS, NORWAY:
 3,679,908, PUB. 6-23-2009. MULTIPLE CLASS, INT. CLS. 9, 38 AND 42.
 SEDO.COM, LLC, CAMBRIDGE, MA:
 2,733,905, CANC. INT. CL. 36.
 SEDONA SOUL ADVENTURES, INC., SEDONA, AZ:
 3,681,584, INT. CL. 39.
 SEEKING CONSULTANTS, INC., JAMAICA, NY:
 3,681,772, INT. CL. 41.
 SELECT INTELLECTUAL, LLC, PITTSBURGH, PA:
 3,681,287, INT. CL. 35.
 SELECTED BIOPRODUCTS INC., ALMA, ONTARIO, N0B1A0, CANADA:
 2,214,035, CANC. INT. CL. 31.
 SELECTMARK, INC., WILMINGTON, DE:
 3,679,339, PUB. 6-23-2009. INT. CL. 35.
 SELIGSON & GIANNATTASIO, LLP, NORTH WHITE PLAINS, NY:
 2,665,452, CANC. INT. CL. 36.
 SELKIRK CANADA CORPORATION, STONEY CREEK, CANADA:
 3,680,724, INT. CL. 11.
 SELLERS & JOSEPHSON, INC., ENGLEWOOD, NJ:
 2,215,345, CANC. INT. CL. 16.
 SELLSTATE REALTY SYSTEMS NETWORK, INC., FORT MYERS, FL:
 3,678,516, PUB. 6-23-2009. INT. CL. 35.
 SEMCKEN, KEVIN R., WHEAT RIDGE, CO:
 2,261,144. REN. 8-3-09. INT. CL. 35.
 SEMICONDUCTOR DIAGNOSTICS, INC., TAMPA, FL:
 2,276,047. REN. 8-5-09. INT. CL. 9.
 SEMPERIT TECHNISCHE PRODUKTE GESELLSCHAFT M.B.H., A-1031 VIENNA, AUSTRIA:
 2,271,024. REN. 8-3-09. INT. CL. 10.
 SEMTECH CORPORATION, CAMARILLO, CA:
 3,680,495, INT. CL. 9.
 SENAPPS LLC, SALT LAKE CITY, UT:
 3,681,340, INT. CL. 9.
 SENARIO LLC, WOODSTOCK, IL:
 3,680,844, INT. CL. 16.
 SENATOR GMBH & CO. KGAA, GROSS-BIEBERAU, FED REP GERMANY:
 2,665,142, CANC. INT. CL. 16.
 SENOR CELLULAR, INC., HOUSTON, TX:
 2,665,362, CANC. MULTIPLE CLASS, INT. CLS. 35 AND 38.
 SENSOCOM, INC., SAN DIEGO, CA:
 2,666,964, CANC. INT. CL. 42.
 SENSE NETWORKS, INC., NEW YORK, NY:
 3,681,012, INT. CL. 9.
 3,681,013, INT. CL. 9.
 SENTIES, SEGURA ANGEL, CAMBRIDGE, MA, DBA ANGEL SENTIES:
 3,678,605, PUB. 6-23-2009. INT. CL. 41.
 SEQUENCE, INC., ENGLEWOOD, NJ:
 3,680,247, INT. CL. 3.
 SERTA, INC., HOFFMAN ESTATES, IL:
 3,680,314, INT. CL. 20.
 SERV-A-LITE PRODUCTS, INC., EAST MOLINE, IL:
 2,350,101. REN. 8-5-09. INT. CL. 8.
 SERVICE ELECTRIC CABLE TV, INC., BETHLEHEM, PA:
 2,666,867, CANC. INT. CL. 41.
 SERVICE SOFTWARE LLC, PUEBLO, CO:
 2,667,391, CANC. INT. CL. 9.
 SERVICIOS AVENSA, S.A., CARACAS, VENEZUELA, DBA SERVIVENSA:
 2,666,088, CANC. INT. CL. 39.
 SERVO-DYNAMICS, INC., CORPUS CHRISTI, TX:
 1,518,348, CANC. INT. CL. 40.
 SERVOMED AB, S-511 21 KINNA, SWEDEN:
 1,045,844, CANC. INT. CL. 10.
 SET MAGAZINE, INC., BOCA RATON, FL:
 3,680,648, MULTIPLE CLASS, INT. CLS. 16 AND 41.
 SETT INCORP., SHIBUYA-KU, TOKYO 150-0022, JAPAN:
 2,666,826, CANC. MULTIPLE CLASS, INT. CLS. 18 AND 25.
 SEVEN-STAR, INC., ASHEVILLE, NC:
 3,681,713, INT. CL. 41.
 SEYMOUR MANUFACTURING CO., INC., SEYMOUR, IN:
 3,678,533, PUB. 6-23-2009. INT. CL. 8.
 SF INVESTMENTS, INC., WILMINGTON, DE:
 2,665,460, CANC. MULTIPLE CLASS, INT. CLS. 35 AND 42.
 SHAFFER, MARK T., SAN LUIS OBISPO, CA:
 3,680,550, INT. CL. 39.
 SHAFRAN, JOSHUA, CAPE CORAL, FL:
 3,680,623, INT. CL. 41.
 SHAKLEE CORPORATION, PLEASANTON, CA:
 1,547,230. REN. 8-3-09. INT. CL. 11.
 SHALON VENTURES RESEARCH LLC, PALO ALTO, CA:
 3,681,518, INT. CL. 10.
 SHANDONG BCN SPORT INDUSTRY CO., LTD., SHANDONG PROVINCE, CHINA:
 3,680,964, INT. CL. 28.
 SHANGHAI DEKORMAN FLOORING CO., LTD., SHANGHAI, CHINA:
 3,678,577, PUB. 6-23-2009. INT. CL. 19.
 SHANGHAI TRADING CO., INC., LAGUNA HILLS, CA:
 2,667,186, CANC. INT. CL. 20.
 SHANNON JAY STOWELL, SALIDA, CO:
 2,667,378, CANC. INT. CL. 35.
 SHAPIRO, MELISSA J, MIAMI, FL:
 3,680,753, INT. CL. 25.
 SHC DIRECT, LLC, DOWNERS GROVE, IL:
 2,260,848. REN. 7-31-09. INT. CL. 35.
 SHEARER'S FOODS, INC., BREWSTER, OH:
 2,666,406, CANC. MULTIPLE CLASS, INT. CLS. 29 AND 30.
 2,666,407, CANC. MULTIPLE CLASS, INT. CLS. 29 AND 30.
 SHELCORE INC., SOMERSET, NJ:
 2,664,919, CANC. INT. CL. 28.
 SHENANDOAH LIFE INSURANCE COMPANY, ROANOKE, VA:
 2,665,600, CANC. INT. CL. 9.
 SHESCONNECTED MULTIMEDIA CORP., FRAMINGHAM, MA:
 3,680,468, MULTIPLE CLASS, INT. CLS. 35, 38, 39, 42 AND 45.
 SHIMADZU CORPORATION, KYOTO, JAPAN:
 3,678,586, PUB. 6-23-2009. INT. CL. 9.
 SHIMANO INC., SAKAI CITY, OSAKA, JAPAN:
 3,680,493, INT. CL. 12.
 SHIN'S TRADING CO., INC., LOS ANGELES, CA:
 3,680,123, INT. CL. 3.
 SHIRLEYPEAR LINGERIE LLC, MIAMI, FL:
 3,678,413, PUB. 6-23-2009. INT. CL. 25.
 SHISEIDO COMPANY, LTD., TOKYO, JAPAN:
 3,680,730, INT. CL. 3.
 SHIT FACE INDUSTRIA E COMERCIO DE CONF, SAO PAULO, BRAZIL:
 2,665,687, CANC. INT. CL. 25.
 SHIVELY, PETER, VILLA HILLS, KY:
 3,679,266. PUB. 6-23-2009. INT. CL. 41.
 SHOEHOLE DESIGNS, LLC, FORT COLLINS, CO:
 3,679,579, PUB. 6-23-2009. INT. CL. 42.

- SHOGUN TRADING CO., INC., WHITE PLAINS, NY:
2,234,227. REN. 8-5-09. INT. CL. 14.
- SHOOK, HARDY & BACON L.L.P., KANSAS CITY, MO:
2,665,736. CANC. INT. CL. 42.
- SHOPKO STORES OPERATING CO., LLC, GREEN BAY, WI:
3,679,686. PUB. 6-23-2009. INT. CL. 25.
- SHOPPERS' CRITIQUE INTERNATIONAL, L.L.C., LONGWOOD, FL:
3,678,556. PUB. 6-23-2009. INT. CL. 35.
- SHOW WINNERS CORPORATION, MIAMI, FL, DBA DAPP PRODUCTIONS:
2,667,303. CANC. INT. CL. 16.
- SHOWCORE, INC., EAGAN, MN:
3,681,336. INT. CL. 41.
- SHOWTIME NETWORKS INC., NEW YORK, NY:
3,680,610. INT. CL. 21.
- SHREDFORCE, INC., FALLBROOK, CA:
2,665,956. CANC. INT. CL. 40.
- SHROOMBOB, LLC, BOZEMAN, MT:
3,680,569. INT. CL. 28.
- SHUHSIENLIN, INC, BAYSIDE, NY:
3,678,501. PUB. 3-10-2009. INT. CL. 25.
- SHUO WANG, MONTCLAIR, CA:
3,678,279. PUB. 5-20-2008. INT. CL. 25.
- SICA, DANIELE, SALERNO, ITALY:
3,568,691. COR. INT. CL. 41.
- SIEMENS ENERGY & AUTOMATION, INC., ALPHARETTA, GA:
3,680,604. INT. CL. 9.
- SIEMENS WATER TECHNOLOGIES CORP., LOWELL, MA:
872,563. REN. 8-3-09. U.S. CL. 31 (INT. CL. 11).
- SIEMENS WATER TECHNOLOGIES CORP., WARRENDALE, PA, E.I. DU PONT DE NEMOURS AND COMPANY, WILMINGTON, DE:
1,123,471. REN. 8-3-09. INT. CL. 40.
- SIERRA NEVADA BREWING CO., CHICO, CA:
3,680,821. INT. CL. 32.
- SIERRA PRESS, INC., MARIPOSA, CA:
1,517,979. CANC. INT. CL. 16.
- SIGMA ALIMENTOS, S.A. DE C.V., SAN PEDRO GARZA GARCIA, MEXICO:
3,680,827. INT. CL. 29.
- SIGMAKALON DECO NEDERLAND B.V., UITHOORN, NETHERLANDS:
2,665,041. CANC. MULTIPLE CLASS, INT. CLS. 1, 2, 16, 19, 27 AND 35.
- SIGNUM INTERNATIONAL S.A.R.L., LUXEMBOURG, LUXEMBOURG:
2,271,348. REN. 8-5-09. INT. CL. 39.
- SIKA AG, BAAR, SWITZERLAND:
1,578,445. REN. 7-31-09. MULTIPLE CLASS, INT. CLS. 1 AND 2.
- SIKA AG, SWITZERLAND:
3,679,873. PUB. 6-23-2009. MULTIPLE CLASS, INT. CLS. 1, 2, 17 AND 19.
- SILK THREADS, INC., IRVING, TX:
3,680,985. INT. CL. 25.
- SILKS INTERNATIONAL, INC., WYOMISSING, PA:
3,678,283. PUB. 6-23-2009. INT. CL. 35.
- SILTECH LLC, DACULA, GA:
3,679,362. PUB. 6-23-2009. INT. CL. 1.
3,679,762. PUB. 6-23-2009. INT. CL. 1.
- SILVANA USA, INC., LOS ANGELES, CA:
2,665,893. CANC. INT. CL. 18.
- SILVER CREEK TECHNOLOGIES, LLC, JOHNSON CITY, TN:
2,667,269. CANC. INT. CL. 9.
- SILVER MOON CREATIONS, INC., ORLANDO, FL:
3,678,746. PUB. 6-23-2009. MULTIPLE CLASS, INT. CLS. 6, 14 AND 16.
- SILVER PALATE KITCHENS, INC., CRESSKILL, NJ:
3,681,692. INT. CL. 30.
- SILVER SLIPPER LICENSING, LLC, PASADENA, CA:
3,681,464. MULTIPLE CLASS, INT. CLS. 6, 14, 18, 21, 25, 28, 34, 35, 36 AND 41.
- SILVER STAR DISTRIBUTION COMPANY, INC., SAN CLEMENTE, CA:
3,678,209. PUB. 4-1-2008. MULTIPLE CLASS, INT. CLS. 14, 25 AND 26.
- SILVER STATE TIRE COMPANY, INC., SPARKS, NV:
2,665,540. CANC. INT. CL. 35.
- SILVER, JASON, PORT WASHINGTON, NY:
3,681,350. INT. CL. 25.
- SILVERBROOK RESEARCH PTY LTD, AUSTRALIA:
3,679,945. PUB. 6-23-2009. MULTIPLE CLASS, INT. CLS. 1, 2, 7, 9 AND 16.
- SILVERLINE AMERICA, S.A. DE C.V., MEXICO, D.F., MEXICO:
3,679,303. PUB. 6-23-2009. INT. CL. 7.
- SILVERSUN INDUSTRIES, MOKENA, IL:
3,680,714. INT. CL. 3.
- SIMAS, JEFFREY P., FORT MYERS, FL:
2,666,853. CANC. MULTIPLE CLASS, INT. CLS. 37 AND 42.
- SIMASKO, PATRICK M., MOUNT CLEMENS, MI:
3,681,735. INT. CL. 36.
- SIMATEX GMBH, D-63303 DREIEICH-SPRENGZLINGEN, FED REP GERMANY:
2,665,413. CANC. INT. CL. 25.
- SIMBIOTE DEVELOPMENT, LLC, OLIVE BRANCH, MS:
3,678,193. PUB. 6-23-2009. INT. CL. 9.
3,678,194. PUB. 6-23-2009. INT. CL. 9.
3,678,195. PUB. 6-23-2009. INT. CL. 9.
- SIMCO PLASTICS INC., COMMERCE TOWNSHIP, MI, DBA WEE BEE JAMMIN:
3,680,894. INT. CL. 29.
3,680,895. INT. CL. 29.
- SIMDESK TECHNOLOGIES, INC., HOUSTON, TX, DBA MEZEO SOFTWARE CORPORATION:
3,680,922. INT. CL. 9.
3,680,923. INT. CL. 9.
- SIMON PROPERTY GROUP, L.P., INDIANAPOLIS, IN:
2,667,121. CANC. INT. CL. 35.
- SIMON R. DANIEL, LONDON, UNITED KINGDOM:
3,679,843. PUB. 6-23-2009. MULTIPLE CLASS, INT. CLS. 9 AND 42.
- SIMON, VERONIQUE, PARIS, FRANCE:
2,667,137. CANC. INT. CL. 3.
- SIMONIZ USA, INC., BOLTON, CT:
3,679,734. PUB. 6-23-2009. INT. CL. 3.
- SIMPLE PRODUCTS CORP, DRAPER, UT, DBA ADAIR PRODUCTS CORP:
3,678,510. PUB. 6-23-2009. INT. CL. 3.
- SIMPLY FASHION STORES, LTD., BIRMINGHAM, AL:
2,362,387. REN. 8-3-09. INT. CL. 25.
2,362,388. REN. 8-3-09. INT. CL. 25.
- SIMPLY MAC, INC., SALT LAKE CITY, UT:
3,679,467. PUB. 6-23-2009. INT. CL. 35.
- SIMPLYSHE, INC., SAN FRANCISCO, CA:
3,678,381. PUB. 6-23-2009. MULTIPLE CLASS, INT. CLS. 14 AND 18.
- SIMPLYSWISS INC., LOS ANGELES, CA:
2,666,705. CANC. INT. CL. 35.
- SIMS VIBRATION LABORATORY, INC., SHELTON, WA:
3,681,492. INT. CL. 25.
- SINGER BROTHERS ACQUISITION LLC, ELMSFORD, NY:
3,678,714. PUB. 6-23-2009. MULTIPLE CLASS, INT. CLS. 35, 37, 39 AND 42.
- SINGLE PARENT SCHOLARSHIP FUND OF BENTON COUNTY, INC., BENTONVILLE, AR:
3,678,749. PUB. 6-23-2009. INT. CL. 36.
- SINT, LLC, BETHPAGE, NY:
2,322,385. REN. 8-1-09. INT. CL. 35.
- SIRONAHEALTH, INC., SOUTH PORTLAND, ME:
3,679,444. PUB. 6-23-2009. INT. CL. 44.
3,679,445. PUB. 6-23-2009. INT. CL. 44.
- SIRS ELECTRONICS INC, MCALLEN, TX:
3,678,179. PUB. 6-23-2009. INT. CL. 11.
- SIRUVAI INC, PLANO, TX:
3,680,168. INT. CL. 41.
- SISSOM, DAVID, HOLLYWOOD, FL:
3,680,698. INT. CL. 20.
- SITTERS IN THE CITY INC., NEW YORK, NY:
3,678,608. PUB. 6-23-2009. MULTIPLE CLASS, INT. CLS. 35 AND 43.

SIXNET, LLC, CLIFTON PARK, NY:
2,286,706, REN. 8-3-09. INT. CL. 9.

SKATE ONE CORPORATION, SANTA BARBARA, CA:
2,665,237, CANC. INT. CL. 28.

SKERKAVICH, BONNIE L, FOUNTAIN HILLS, AZ:
3,680,329, INT. CL. 14.

SKETCHWORKS, INC., DISTRICT HEIGHTS, MD, DBA SKETCHWORKS:
3,679,000, PUB. 6-23-2009. MULTIPLE CLASS, INT. CLS. 35 AND 42.

SKI MARKETING CORPORATION, HOUSTON, TX:
2,665,100, CANC. INT. CL. 39.

SKI-EZE PRODUCTS INTERNATIONAL INC., BRIDGEPORT, CT:
3,681,313, INT. CL. 20.

SKILLUS CORPORATION, DAVIE, FL:
3,679,618, PUB. 6-23-2009. MULTIPLE CLASS, INT. CLS. 14 AND 35.
3,679,619, PUB. 6-23-2009. MULTIPLE CLASS, INT. CLS. 14 AND 35.

SKIRTS DE SOLEIL, VERO BEACH, FL:
3,678,270, PUB. 5-6-2008. INT. CL. 25.

SKODA HOLDING A.S., PSC 110 00, CZECH REPUBLIC, ZAVODY V. I. LENINA PLZEN, NARODNI PODNIK, PLZEN, CZECHOSLOVAKIA:
682,500, REN. 8-3-09. U.S. CL. 23 (INT. CLS. 6, 7, 8, 9, 11, 12, 16, 21 AND 28).

SKOOKUM CREEK TOBACCO CO., INC., SHELTON, WA:
3,455,298, COR. INT. CL. 34.

SKY CATCHER COMMUNICATIONS, INC., RUTHERFORDTON, NC:
3,678,788, PUB. 6-23-2009. INT. CL. 38.

SKYHAWKS SPORTS ACADEMY, INC., MEAD, WA:
3,678,292, PUB. 6-23-2009. INT. CL. 35.

SKYLARK MEATS, LLC, FAIRMONT, MN:
2,296,198, REN. 8-1-09. INT. CL. 29.

SKYTERRA LP, RESTON, VA:
3,680,387, INT. CL. 38.

SLEEP INNOVATIONS, INC., WEST LONG BRANCH, NJ:
3,680,868, INT. CL. 20.

SLEEPING WELL, LLC, SHELburne, VT:
3,681,265, INT. CL. 10.

SLEJKO, FRANK L., LITTLETON, CO:
2,355,346, REN. 8-3-09. INT. CL. 16.

SLENDER/ONE BODY CONTOURING CENTRES, INC., WILMINGTON, NC:
2,665,086, CANC. INT. CL. 42.

SLICKLEIN, KIM, NEW YORK, NY:
3,678,265, PUB. 6-23-2009. INT. CL. 37.

SLING MEDIA, INC., FOSTER CITY, CA:
3,680,189, INT. CL. 9.

SLOAN VALVE COMPANY, FRANKLIN PARK, IL:
2,286,617, REN. 8-1-09. INT. CL. 11.

SMAGARD LTD., GIBRALTAR:
3,679,891, PUB. 6-23-2009. INT. CL. 2.

SMALLPRINT (FRANCHISING) LIMITED, BRISTOL, UNITED KINGDOM:
3,678,566, PUB. 6-23-2009. INT. CL. 14.
3,678,567, PUB. 6-23-2009. INT. CL. 14.

SMARTERVILLE PRODUCTIONS LLC, BALTIMORE, MD:
3,681,631, INT. CL. 16.

SMARTFORCE PLC, DUBLIN, IRELAND:
2,666,606, CANC. MULTIPLE CLASS, INT. CLS. 9 AND 41.

SMARTPAK EQUINE, LLC., PLYMOUTH, MA:
3,680,678, INT. CL. 25.

SMARTREVENUE.COM, RIDGEFIELD, CT:
3,679,624, PUB. 6-23-2009. INT. CL. 35.

SMARTSERV ONLINE, INC., STAMFORD, CT:
2,665,642, CANC. INT. CL. 9.

SMITH & HAWKEN, LTD., NOVATO, CA:
3,681,389, INT. CL. 20.

SMITH & NEPHEW, INC., MEMPHIS, TN:
3,680,474, INT. CL. 10.

SMITH, KEITH C., WEBSTER, NY:
2,666,571, CANC. INT. CL. 38.

SMITH, MICHAEL, PALOS PARK, IL, AKA MICHAEL NIGHTMARE:
3,679,527, PUB. 6-23-2009. INT. CL. 41.

SMITH,GAIL E., YUBA CITY, CA:
3,678,306, PUB. 6-23-2009. INT. CL. 35.

SMITHKLINE BEECHAM CORPORATION, PHILADELPHIA, PA:
1,518,479, CANC. INT. CL. 42.
2,214,384, CANC. INT. CL. 5.
3,679,202, PUB. 6-23-2009. INT. CL. 5.

SMR DISTRIBUTING CORP, BROOKLYN, NY, DBA HAD-DAR FOODS:
3,678,647, PUB. 6-23-2009. MULTIPLE CLASS, INT. CLS. 2, 3, 29, 30 AND 32.

SMS DEMAG AKTIENGESSELLSCHAFT, FED REP GERMANY:
2,665,181, CANC. INT. CL. 9.

SMURFIT-STONE CONTAINER ENTERPRISES, INC., CHICAGO, IL:
3,680,813, INT. CL. 7.
3,680,814, INT. CL. 16.

SNACK DADDY, LLC, SEATTLE, WA:
3,680,513, INT. CL. 9.

SNAG, INC., LAKELAND, FL:
2,665,507, CANC. INT. CL. 28.

SNO-ENGINEERING, INC., BELLEVUE, WA, DBA SE GROUP:
3,678,330, PUB. 6-23-2009. INT. CL. 37.

SNOW, ROBERT L., HASTINGS, MI, DBA SNOWNCRAFT, TRIPPETT, LEE, EUGENE, OR:
878,575, REN. 8-3-09. U.S. CL. 22 (INT. CL. 28).

SNOWSPORTS INDUSTRIES AMERICA, INCORPORATED, MCLEAN, VA:
2,214,843, CANC. INT. CL. 42.

SNPCHIP, L.L.C., SAN ANTONIO, TX:
2,665,469, CANC. INT. CL. 38.

SNYDER, DAVID, NEW YORK, NY AND SCHNEIDER, PAUL, BROOKLYN, NY:
2,667,265, CANC. INT. CL. 41.

SNYPER SA, SWITZERLAND:
3,680,045, PUB. 6-23-2009. INT. CL. 14.

SOAK RECORDS, LAUDERHILL, FL:
3,678,833, PUB. 6-23-2009. INT. CL. 41.

SOC. ITTICA EUROPEA S.P.A, LUCCA, ITALY:
2,665,459, CANC. INT. CL. 29.

SOCIETÀ AGRICOLA CIÙ CIÙ; DI BARTOLOMEI MASSI-MILIANO E; BARTOLOMEI WALTER S.S., ITALY:
3,679,996, PUB. 6-23-2009. INT. CL. 33.

SOCIETA PER AZIONI LUCHESE OLII E VINI, 55100 LUCCA, ITALY, DBA FPO BERIO & CO.:
1,524,715, REN. 8-6-09. MULTIPLE CLASS, INT. CLS. 29 AND 30.

SOCIETE DES PRODUITS NESTLE S.A., VEVEY, SWITZERLAND:
3,680,632, INT. CL. 36.
3,680,774, INT. CL. 31.
3,681,405, INT. CL. 28.
3,681,406, INT. CL. 28.
3,681,407, INT. CL. 28.

SOCIETE DES PRODUITS NESTLE, S.A., 1800 VEVEY, SWITZERLAND:
2,260,704, REN. 8-3-09. INT. CL. 5.
3,681,681, INT. CL. 5.

SOCIETY OF VACUUM COATERS, ALBUQUERQUE, NM:
2,221,355, REN. 7-31-09. U.S. CL. 200.

SOCIÉTÉ CHARENTAISE D'ENTREPÔT, LA ROCHELLE 17000, FRANCE:
3,680,089, INT. CL. 33.

SODALICIOUS, LLC, PORTLAND, OR:
3,680,545, INT. CL. 43.

SODEXO, F-92130 ISSY-LES-MOULINEAUX, FRANCE:
3,679,943, PUB. 6-23-2009. MULTIPLE CLASS, INT. CLS. 38 AND 41.

SOFTEX, INC., JACKSONVILLE, FL:
2,260,294, REN. 8-3-09. INT. CL. 9.

SOFTWARE SOLUTIONS SUPPLY, INC., FOLEY, AL:
2,666,679, CANC. INT. CL. 9.

- SOHK SPORTSWEAR, INC., CORONA, NY:
2,665,506, CANC. INT. CL. 25.
- SOKA GAKKAI INTERNATIONAL-USA, SANTA MONICA, CA, AKA SGI-USA:
3,679,410, PUB. 6-23-2009. MULTIPLE CLASS, INT. CLS. 41 AND 45.
3,679,411, PUB. 6-23-2009. MULTIPLE CLASS, INT. CLS. 41 AND 45.
- SOL ELIXIRS, LLC, GLENVIEW, IL:
3,681,146, INT. CL. 32.
- SOLARKING, INC., GLENDALE, AZ:
3,678,584, PUB. 6-23-2009. INT. CL. 11.
- SOLARNET, LLC, MANHATTAN BEACH, CA:
3,681,427, MULTIPLE CLASS, INT. CLS. 35, 37, 40, 41 AND 42.
- SOLARTRAX LTD., CORONA DEL MAR, CA:
3,680,312, INT. CL. 9.
3,680,313, INT. CL. 9.
- SOLERS, LTD., HONG KONG, HONG KONG:
3,678,278, PUB. 6-23-2009. INT. CL. 9.
- SOLO CUP OPERATING CORPORATION, HIGHLAND PARK, IL:
1,518,037, CANC. INT. CL. 21.
- SOLVAY (SOCIÉTÉ ANONYME), BRUXELLES, BELGIUM:
3,679,972, PUB. 6-23-2009. MULTIPLE CLASS, INT. CLS. 1 AND 5.
- SOMANETICS CORPORATION, TROY, MI:
3,681,250, MULTIPLE CLASS, INT. CLS. 9, 16 AND 41.
- SOMISPO, INCORPORATED, CHEYENNE, WY, DBA MORTGAGE SCIENCE CORPORATION:
3,679,216, PUB. 6-23-2009. INT. CL. 42.
- SONAFI S.A., 78220 VIROFLAY, FRANCE:
2,666,783, CANC. INT. CL. 30.
- SONERA ZED OY, 00510 HELSINKI, FINLAND:
2,665,059, CANC. INT. CL. 41.
- SONIC SOLUTIONS, NOVATO, CA:
2,667,421, CANC. INT. CL. 9.
- SONICMULE, INC., PALO ALTO, CA:
3,678,777, PUB. 6-23-2009. INT. CL. 9.
- SONOPATH, SPARTA, NJ:
3,679,376, PUB. 6-23-2009. INT. CL. 44.
- SONY COMPUTER ENTERTAINMENT AMERICA INC., FOSTER CITY, CA:
3,679,767, PUB. 6-23-2009. INT. CL. 9.
- SONY CORPORATION, TOKYO, JAPAN:
1,517,856, CANC. INT. CL. 9.
- SONY MUSIC ENTERTAINMENT, NEW YORK, NY:
2,214,354, CANC. INT. CL. 9.
- SOPHIA'S HERITAGE COLLECTION, INC., MALVERN, PA:
3,679,001, PUB. 6-23-2009. INT. CL. 35.
- SOUND ERGONOMICS, L.L.C., KENMORE, WA:
2,844,461, CANC. INT. CL. 41.
- SOUNDINGS PUBLICATIONS, L.L.C., NORFOLK, VA, SOUNDINGS PUBLICATIONS, INC., ESSEX, CT:
1,122,364, REN. 8-3-09. INT. CL. 16.
- SOUTH BEACH CLINIC, LLC, MIAMI BEACH, FL:
3,681,753, INT. CL. 44.
- SOUTH CAROLINA BAPTIST CONVENTION, COLUMBIA, SC:
2,267,232, REN. 8-4-09. MULTIPLE CLASS, INT. CLS. 41 AND 42.
- SOUTH CAROLINA DEPARTMENT OF AGRICULTURE, COLUMBIA, SC:
3,681,311, INT. CL. 35.
- SOUTH TEXAS FOODS, INC., SAN ANTONIO, TX:
1,518,174, CANC. INT. CL. 30.
- SOUTHCO, INC., CONCORDVILLE, PA:
3,678,153, PUB. 6-23-2009. MULTIPLE CLASS, INT. CLS. 6 AND 20.
- SOUTHERN COMMUNITY HOSPICE, INC., VIDALIA, GA:
3,678,476, PUB. 6-23-2009. INT. CL. 44.
- SOUTHERN DEVELOPMENT RESOURCES, LLC, HATTIESBURG, MS:
2,666,268, CANC. INT. CL. 44.
- SOUTHERNMOST BEACH MOTELS LIMITED PARTNERSHIP, KEY WEST, FL:
2,214,256, CANC. INT. CL. 35.
- SOUTHWEST HEALTH SOLUTIONS, INC., LEWISVILLE, TX:
2,666,395, CANC. INT. CL. 35.
- SOUTHWESTERN/GREAT AMERICAN, INC., NASHVILLE, TN, DBA THE SOUTHWESTERN COMPANY:
3,681,101, INT. CL. 41.
- SOUTHWIRE COMPANY, CARROLLTON, GA:
1,519,628, REN. 8-1-09. INT. CL. 9.
- SOUTHWORTH COMPANY, AGAWAM, MA:
2,665,652, CANC. INT. CL. 16.
- SOVEBEC INC., CHARNY, QUEBEC, G6X 1L5, CANADA:
2,214,260, CANC. INT. CL. 19.
- SOVEREIGN GRACE MINISTRIES, INC., GAITHERSBURG, MD:
2,214,129, CANC. INT. CL. 9.
- SOVEREIGN HOSPITALITY INTERNATIONAL, LLC, BRECKENRIDGE, CO:
3,678,500, PUB. 6-23-2009. MULTIPLE CLASS, INT. CLS. 35 AND 43.
- SOVREMENNIY COMMERCESKIY FLOT, SAINT PETERSBURG, RUSSIAN FED.:
3,681,738, MULTIPLE CLASS, INT. CLS. 35 AND 39.
- SOW FORTH PUBLISHING, LLC, LEWIS CENTER, OH:
3,681,342, INT. CL. 16.
- SPAGNOLI, JOE, CHICAGO, IL:
3,679,290, PUB. 6-23-2009. INT. CL. 43.
- SPANGLER, RANDAL, KANSAS CITY, MO:
3,681,611, INT. CL. 16.
- SPANKIN' KLEEN, LLC, SANTA ROSA, CA:
3,681,251, INT. CL. 3.
- SPARKLE INTERNATIONAL, INC., CLEVELAND, OH:
871,508, AM. U.S. CL. 103.
- SPARROW HEALTH SYSTEM, LANSING, MI, SPARROW, INC., LANSING, MI:
1,553,288, REN. 8-6-09. MULTIPLE CLASS, INT. CLS. 41 AND 42.
- SPEAKEASY ALES & LAGERS, INC., SAN FRANCISCO, CA:
3,679,397, PUB. 6-23-2009. INT. CL. 32.
3,679,400, PUB. 6-23-2009. INT. CL. 32.
- SPEAKMAN COMPANY, NEW CASTLE, DE:
3,681,025, INT. CL. 11.
- SPECIALTY CONSTRUCTION BRANDS, INC., SAINT PAUL, MN:
3,681,249, INT. CL. 17.
- SPECIALTY EQUIPMENT FABRICATION COMPANY, HOUSTON, TX:
2,321,389, REN. 8-4-09. INT. CL. 7.
- SPECIALTY MERCHANDISE CORPORATION, CHATSWORTH, CA:
2,665,221, CANC. INT. CL. 35.
- SPECTRA PRODUCTS INC., ETOBICOKE, CANADA:
3,680,595, MULTIPLE CLASS, INT. CLS. 2 AND 4.
- SPECTRUM LABORATORIES, INC., RANCHO DOMINGUEZ, CA:
2,665,671, CANC. INT. CL. 1.
- SPECTRUM SYSTEMS, INC., PENSACOLA, FL:
2,365,763, REN. 8-5-09. INT. CL. 9.
- SPEEDLINE SOLUTIONS, INC., ABBOTSFORD, B.C., BRITISH COLUMBIA:
2,271,897, REN. 8-3-09. INT. CL. 9.
- SPEEDY SIGN-A-RAMA USA, INC., WEST PALM BEACH, FL:
1,518,398, CANC. INT. CL. 42.
- SPENCER GIFTS LLC, EGG HARBOR TOWNSHIP, NJ:
3,681,402, INT. CL. 14.
- SPENCER GIFTS, INC., PLEASANTVILLE, NJ:
1,518,073, CANC. INT. CL. 25.
- SPERRY AND HUTCHINSON COMPANY, INC., THE, NEW YORK, NY:
1,518,230, CANC. INT. CL. 35.
- SPIEGEL, INC., DOWNERS GROVE, IL:
1,518,457, CANC. INT. CL. 42.
- SPIELO MANUFACTURING ULC, MONCTON, NEW BRUNSWICK, CANADA:
3,680,182, INT. CL. 9.
3,680,183, INT. CL. 9.
- SPIPKER, MARK W., KNIGHTSEN, CA:
2,667,096, CANC. INT. CL. 35.

SPINTEK FILTRATION, INC., LOS ALAMITOS, CA:
3,678,169, PUB. 6-23-2009. INT. CL. 11.

SPIRIT OF MATH SCHOOLS INC., NORTH YORK, ONTARIO:
3,679,807, PUB. 10-17-2006. MULTIPLE CLASS, INT. CLS. 16 AND 41.

SPIRIT OF MATH SCHOOLS INC., NORTH YORK, ONTARIO, ONTARIO:
3,679,808, PUB. 10-17-2006. MULTIPLE CLASS, INT. CLS. 16 AND 41.

SPIRITSEARCH COMPANY, MINNEAPOLIS, MN:
3,680,652, INT. CL. 41.

SPIRN, DANIEL, SAN FRANCISCO, CA:
2,665,292, CANC. INT. CL. 41.

SPOC AUTOMATION, INC., TRUSSVILLE, AL:
3,679,499, PUB. 6-23-2009. INT. CL. 7.

SPOONER INDUSTRIES LIMITED, WEST YORKSHIRE, ENGLAND:
1,531,625, REN. 8-3-09. INT. CL. 7.

SPOONJACK LLC, SAN FRANCISCO, CA, DBA SPOONJACK:
3,679,551, PUB. 6-23-2009. INT. CL. 9.

SPORT MASKA INC., ST. LAURENT, QUEBEC, CANADA:
1,518,093, CANC. INT. CL. 28.

SPORTSBLOGS, INC., IRVINE, CA:
3,678,587, PUB. 12-30-2008. MULTIPLE CLASS, INT. CLS. 38 AND 41.

SPOSTO, JORGE, MONTEVIDEO, URUGUAY:
3,680,772, INT. CL. 23.
3,680,773, INT. CL. 23.

SPOT AND COMPANY OF MANHATTAN, INC., NEW YORK, NY:
2,264,243, REN. 8-1-09. INT. CL. 35.

SPOT ME ID, INC., CELEBRATION, FL:
3,680,708, INT. CL. 20.

SPOTI U.S.A. LIMITED:
1,518,197, CANC. INT. CL. 33.

SPRATT CYCLE SUPPORT, INC, PONTE VEDRA BEACH, FL:
3,679,223, PUB. 6-23-2009. INT. CL. 12.

SPRAYMAX INDUSTRIAL COATINGS, INC., JACKSONVILLE, FL:
3,678,474, PUB. 6-23-2009. INT. CL. 17.

SPRI, INC., WALTHAM, MA:
2,214,627, CANC. MULTIPLE CLASS, INT. CLS. 16, 41 AND 42.

SPRING BOLT AND NUT MFG. LLC, HOUSTON, TX:
2,667,318, CANC. INT. CL. 6.

SPRING COMMUNICATIONS II, LLC, ENCINO, CA:
2,665,631, CANC. INT. CL. 41.

SPRINGS GLOBAL US, INC., FORT MILL, SC:
2,214,470, CANC. INT. CL. 20.

SPROUT, CORP., DENVER, CO, DBA SPROUT STRATEGY:
3,679,221, PUB. 6-23-2009. INT. CL. 35.

SPX CORPORATION, CHARLOTTE, NC:
2,778,176, CANC. INT. CL. 42.

SQI DIAGNOSTICS SYSTEMS INC., TORONTO, ONTARIO, CANADA:
3,678,247, PUB. 6-23-2009. INT. CL. 9.

SQUIRE BOONE CAVERNS, INC., NEW ALBANY, IN:
3,681,677, INT. CL. 9.

SRJ, INC., ADDISON, IL:
3,681,305, INT. CL. 12.

SRM CHEMICAL, LTD. CO., NAPA, CA:
3,679,151, PUB. 6-23-2009. INT. CL. 1.

SSANGYONG MOTOR COMPANY, REPUBLIC OF KOREA:
3,237,711, COR. INT. CL. 12.

SSG, LLC, RENO, NV:
2,281,844, REN. 8-3-09. INT. CL. 41.

SSP FINANCING UK LIMITED, SURREY, UNITED KINGDOM:
2,245,310, REN. 7-31-09. INT. CL. 42.

SST COMMUNICATIONS, INC., CHICAGO, IL:
2,665,435, CANC. INT. CL. 41.

ST LOUIS MUSIC, INC., ST. LOUIS, MO:
2,666,495, CANC. INT. CL. 15.
2,666,496, CANC. INT. CL. 15.

ST. JOHN KNITS, INC., IRVINE, CA:
2,215,531, CANC. INT. CL. 21.

ST. JUDE MEDICAL, CARDIOLOGY DIVISION, INC., ST. PAUL, MN, DBA ST. JUDE MEDICAL, CARDIOVASCULAR DIVISION:
3,679,539, PUB. 6-23-2009. INT. CL. 10.

ST. LOUIS COMMUNITY CREDIT UNION, ST. LOUIS, MO:
3,680,969, INT. CL. 36.

ST. LUKE'S HOSPITAL, MAUMEE, OH:
2,368,055, REN. 7-31-09. INT. CL. 41.

ST. PETER PROJECTS, INC., FAIRHOPE, AL, HALLELUJAH ENTERPRISES, INC., MARIETTA, GA:
1,515,751, REN. 7-31-09. INT. CL. 36.

ST. ROMAIN, REGINA, HOUSTON, TX:
2,665,854, CANC. INT. CL. 35.

STAEDTLER, INC., CHATSWORTH, CA:
2,265,697, REN. 8-5-09. INT. CL. 16.

STAFF BUILDERS, INC., LAKE SUCCESS, NY:
2,213,802, CANC. INT. CL. 42.

STAFFORD TEXTILES LIMITED, TORONTO, ONTARIO, ONTARIO:
2,666,372, CANC. INT. CL. 24.

STAGE LOGIC PRODUCT GROUP, INC, TERRE HAUTE, IN:
3,679,663, PUB. 6-23-2009. INT. CL. 11.

STAIRCASE PUBLISHING, L.L.C., NORMAN, OK:
2,256,636, REN. 8-3-09. INT. CL. 16.

STALLEX SKIN CARE, INC., TENAFLY, NJ:
3,680,215, MULTIPLE CLASS, INT. CLS. 3 AND 5.

STANBIO LABORATORY, INC., BOERNE, TX:
3,680,388, INT. CL. 5.

STANDARD & POOR'S FINANCIAL SERVICES LLC, NEW YORK, NY:
3,679,575, PUB. 6-23-2009. MULTIPLE CLASS, INT. CLS. 9 AND 36.
3,679,598, PUB. 6-23-2009. MULTIPLE CLASS, INT. CLS. 9 AND 36.

STANDING STONE NATIONAL BANK, LANCASTER, OH:
3,681,326, INT. CL. 36.

STANEK VINYL WINDOWS, CORP, CUYAHOGA HEIGHTS, OH, DBA STANEK WINDOWS:
3,681,107, INT. CL. 19.

STANFIELD, JAMES W., HIGH POINT, NC, DBA OTR PUBLICATIONS:
3,681,400, INT. CL. 16.

STANFIELD'S LIMITED, TRURO B2N 5C2, CANADA:
3,678,337, PUB. 6-23-2009. INT. CL. 9.

STANLEY JIGS, INC., HUNTINGTON, TX:
3,680,822, INT. CL. 28.

STANNARD, JOHN, CLEARWATER, FL:
3,681,557, INT. CL. 15.

STAR MARKET, INC., HUNTSVILLE, AL:
3,679,437, PUB. 6-23-2009. INT. CL. 30.
3,679,440, PUB. 6-23-2009. INT. CL. 30.
3,679,465, PUB. 6-23-2009. INT. CL. 35.

STAR SHOOTER COMPANY LLC, RICHMOND, WI:
3,678,303, PUB. 6-23-2009. INT. CL. 41.

STAR SYSTEMS, INC., SAN DIEGO, CA:
2,666,957, CANC. INT. CL. 36.
2,667,327, CANC. INT. CL. 36.

STARBUCKS U.S. BRANDS, LLC, MINDEN, NV:
2,667,076, CANC. INT. CL. 30.

STARFISH NETWORK, INC., DRAPER, UT, DBA RSA NETWORK, INC.:
3,679,069, PUB. 6-23-2009. MULTIPLE CLASS, INT. CLS. 9 AND 41.

STARWORKS LLC, NEW YORK, NY:
3,679,180, PUB. 6-23-2009. MULTIPLE CLASS, INT. CLS. 35 AND 41.

STATDOC CONSULTING, INC., GULF BREEZE, FL:
2,326,817, REN. 8-3-09. INT. CL. 42.

STATE AVIATION ADMINISTRATION OF THE STATE OF MARYLAND, THE, BALTIMORE, MD:
1,518,341, CANC. INT. CL. 39.

STATE BAR OF GEORGIA, ATLANTA, GA:
3,678,321, PUB. 6-23-2009. MULTIPLE CLASS, INT. CLS. 16, 35, 41, 44 AND 45.

- STATE FARM MUTUAL AUTOMOBILE INSURANCE COMPANY, BLOOMINGTON, IL:
2,666,231, CANC. INT. CL. 36.
- STATE OF ALASKA DEPARTMENT OF COMMERCE COMMUNITY & ECONOMIC DEVELOPMENT, ANCHORAGE, AK:
3,678,800, PUB. 6-23-2009. U.S. CL. A.
- STATE OF FLORIDA DEPARTMENT OF CITRUS, THE, LAKELAND, FL:
2,263,176. REN. 8-6-09. U.S. CL. A.
- STATON HOLDING, INC., DALLAS, TX, DBA STATON D/B/A STATON WHOLESALE D/B/A STATON CORPORATE AND CASUAL:
3,680,101, INT. CL. 35.
- STATUSONE HEALTH SYSTEMS, HOPKINTON, MA:
2,665,384, CANC. INT. CL. 42.
- STAY ONLINE, INC., ATLANTA, GA:
2,665,968, CANC. MULTIPLE CLASS, INT. CLS. 38 AND 42.
- STAY-N-PLAY PET RANCH, INC., DRIPPING SPRINGS, TX:
2,307,105. REN. 8-6-09. MULTIPLE CLASS, INT. CLS. 35, 41 AND 42.
- STEEL INDUSTRY HERITAGE CORPORATION, HOMESTEAD, PA:
3,680,799, MULTIPLE CLASS, INT. CLS. 9 AND 41.
- STEINBERG MEDIA TECHNOLOGIES GMBH, FED REP GERMANY:
3,680,023, PUB. 6-23-2009. MULTIPLE CLASS, INT. CLS. 9 AND 42.
- STEINER-OPTIK GMBH, FED REP GERMANY:
3,680,049, PUB. 6-23-2009. INT. CL. 9.
- STELLA D'ORO BISCUIT CO., INC., BRONX, NY:
1,518,175, CANC. INT. CL. 30.
- STELLA HAMELIN HOLDINGS INC., MONTREAL, CANADA:
3,680,768, INT. CL. 28.
- STELLA MARIS, INC., ST. PAUL, OR:
3,679,029, PUB. 6-23-2009. INT. CL. 33.
- STEMMONS FOUNDATION, LOS COLINAS, TX:
3,680,241, INT. CL. 36.
- STEMSAVE, INC., SCOTTSDALE, AZ:
3,678,423, PUB. 6-23-2009. INT. CL. 44.
- STEPHAN CO., THE, FORT LAUDERDALE, FL:
368,070. REN. 8-3-09. U.S. CL. 18 (INT. CL. 5).
- STEPHENS & ASSOCIATES ADVERTISING, INC, OVERLAND PARK, KS:
3,679,574, PUB. 6-23-2009. INT. CL. 41.
- STEPOVER GMBH, 70599 STUTTGART, FED REP GERMANY:
3,678,285, PUB. 6-16-2009. INT. CL. 9.
- STEP2 COMPANY, THE, STREETSBORO, OH:
2,667,401, CANC. MULTIPLE CLASS, INT. CLS. 20 AND 21.
- STERLING COLLISION CENTERS, INC., NATICK, MA, STERLING COLLISION CENTERS, INC., NATICK, MA:
2,302,879. REN. 8-3-09. INT. CL. 37.
- STERLING JEWELERS INC., AKRON, OH:
3,678,429, PUB. 6-23-2009. INT. CL. 14.
- STEVE SEUNG CHOI, CARPENTERSVILLE, IL:
3,680,815, INT. CL. 26.
- STEVE VAUBEL DESIGNS, BROOKLYN, NY, DBA ROUX ROUX:
2,664,971, CANC. INT. CL. 6.
- STEVE, AYANRUOH, YONKERS, NY:
3,680,374, INT. CL. 10.
- STEVEN MADDEN, LTD., LONG ISLAND CITY, NY:
3,681,153, INT. CL. 25.
- STEVEN SCHEER MD INC., SARASOTA, FL:
3,678,861, PUB. 6-23-2009. INT. CL. 44.
- STICHTING ARCCUS, ROTTERDAM, NETHERLANDS:
3,680,031, PUB. 6-23-2009. MULTIPLE CLASS, INT. CLS. 35, 41 AND 45.
- STICHTING LODESTAR, 1077 WV AMSTERDAM, NETHERLANDS:
3,678,139, PUB. 6-23-2009. INT. CL. 32.
- STILOLINEA, S.R.L., SAN MAURO TORINESE (TORINO), ITALY:
1,547,319. REN. 7-31-09. INT. CL. 16.
- STODDARD, JILL A, SAN DIEGO, CA:
3,681,169, INT. CL. 9.
- STOKELY-VAN CAMP, INC., CHICAGO, IL:
3,681,221, INT. CL. 5.
3,681,223, INT. CL. 5.
3,681,341, MULTIPLE CLASS, INT. CLS. 18, 21, 24, 25 AND 28.
- STOKES CANADA INC., TOWN OF MOUNT ROYAL, QUEBEC, CANADA:
3,679,810, PUB. 6-23-2009. MULTIPLE CLASS, INT. CLS. 8 AND 21.
- STONEXPRESS, INC., KENNESAW, GA:
3,681,155, INT. CL. 19.
- STORK SCREENS B.V., 5851 AT BOXMEER, NETHERLANDS:
2,665,615, CANC. MULTIPLE CLASS, INT. CLS. 6 AND 17.
- STORMWATER MAINTENANCE, LLC, HUNT VALLEY, MD:
3,679,260, PUB. 6-23-2009. INT. CL. 37.
- STORY ORNAMENTS, LLC, CLERMONT, FL:
3,679,478, PUB. 6-23-2009. INT. CL. 28.
- STORYSACK LIMITED, BURY, LANCASHIRE BL9 6BU, UNITED KINGDOM:
2,646,444, CANC. INT. CL. 9.
- STOVER, ELAINE, GREENSBORO, NC:
3,679,217, PUB. 6-23-2009. INT. CL. 44.
- STRADA SHOE LIMITADA, CAMPO BOM - RS, BRAZIL:
3,680,762, INT. CL. 25.
- STRANDS, INC., CORVALLIS, OR:
3,680,462, MULTIPLE CLASS, INT. CLS. 9, 35, 38, 41 AND 42.
- STRATEGIC COACH INC., THE, TORONTO, ONTARIO, CANADA:
2,265,935. REN. 8-5-09. MULTIPLE CLASS, INT. CLS. 9 AND 16.
- STRATEGIS ASSET VALUATION AND MANAGEMENT, INC., PLYMOUTH MEETING, PA:
1,518,217, CANC. MULTIPLE CLASS, INT. CLS. 35 AND 36.
- STRATIDIS, IOANNIS M., ASTORIA, NY:
3,679,420, PUB. 6-23-2009. INT. CL. 42.
- STRATIS CONSULTING, LLC, WEXFORD, PA:
3,093,948, CANC. INT. CL. 35.
3,133,802, CANC. INT. CL. 35.
3,216,614, CANC. INT. CL. 35.
- STRATOS INTERNATIONAL, INC., CHICAGO, IL:
2,667,131, CANC. INT. CL. 9.
- STREETRAGE LLC, UNION, NJ, DBA SYNDICATED CLOTHING:
3,681,392, INT. CL. 25.
- STRETCH-O-RAMA, INC., NEW YORK, NY:
3,681,359, INT. CL. 25.
- STRICKLAND'S MARKETING CORPORATION, AKRON, OH:
3,230,812, COR. INT. CL. 30.
- STRIPES LLC, CORPUS CHRISTI, TX, DBA SSP PARTNERS:
3,680,307, INT. CL. 32.
3,680,309, INT. CL. 32.
3,680,310, INT. CL. 32.
- STROKIN, LLC, CHASKA, MN:
3,681,659, INT. CL. 35.
3,681,660, INT. CL. 35.
- STROM, ROBERT, RANCHO MIRAGE, CA AND WHITTE-MORE, JERRY, RANCHO MIRAGE, CA:
3,678,430, PUB. 6-23-2009. INT. CL. 3.
- STRONG, STEVEN J., HARVARD, MA:
3,678,642, PUB. 6-23-2009. MULTIPLE CLASS, INT. CLS. 37 AND 42.
- STROUD TECHNOLOGY GROUP, INC., BAKERSFIELD, CA:
3,679,580, PUB. 6-23-2009. INT. CL. 35.
- STRYKER CORPORATION, HOPKINTON, MA:
2,667,069, CANC. INT. CL. 10.

STRYKER CORPORATION, KALAMAZOO, MI:
3,681,465, INT. CL. 10.

STUDCO BUILDING SYSTEMS US, LLC, WEBSTER, NY:
3,680,952, INT. CL. 17.

STUDIOPOTTERY.CO.UK LTD., HOVE, UNITED KINGDOM:
3,678,291, PUB. 3-24-2009. MULTIPLE CLASS, INT. CLS. 9, 35 AND 41.

STUHLMILLER, MARK J., WILLIAMSVILLE, NY:
2,666,848, CANC. INT. CL. 35.

STULL LOGISTICS INC., AUSTIN, TX:
3,681,227, MULTIPLE CLASS, INT. CLS. 35 AND 39.

STURDIWHEAT INC., RED WING, MN, KAEHLER; ARNOLD ADOLPH, RED WING, MN, DBA STURDIWHEAT COMPANY:
369,326, REN. 8-4-09. U.S. CL. 46 (INT. CLS. 1, 5, 29, 30, 31 AND 32).

STUSSY, INC., IRVINE, CA:
3,679,588, PUB. 6-23-2009. INT. CL. 25.
3,679,589, PUB. 6-23-2009. INT. CL. 25.

STYLE CREST ENTERPRISES, INC., FREMONT, OH:
2,675,965, CANC. INT. CL. 37.

STYLECASTER MEDIA GROUP LLC, NEW YORK, NY:
3,681,423, MULTIPLE CLASS, INT. CLS. 35, 41, 42 AND 45.

STYLEMARK, INC., ORMOND BEACH, FL:
1,517,865, CANC. INT. CL. 9.

STYLMARK, INC., FRIDLEY, MN:
2,215,101, CANC. MULTIPLE CLASS, INT. CLS. 6 AND 11.
2,215,102, CANC. MULTIPLE CLASS, INT. CLS. 6 AND 11.

SUBSTANCETV, INC., AUSTIN, TX:
2,667,212, CANC. INT. CL. 25.

SUCCESS COMMUNICATIONS, INC., CHARLOTTE, MI:
3,678,633, PUB. 6-23-2009. INT. CL. 41.

SUD-CHEMIE, INC., LOUISVILLE, KY:
2,666,440, CANC. INT. CL. 9.

SUISAKU KABUSHIKI KAISHA, TOKYO, JAPAN:
1,549,121, REN. 8-3-09. INT. CL. 16.

SUKI, INC., NORTHAMPTON, MA:
3,681,396, INT. CL. 3.
3,681,397, INT. CL. 3.

SULLIVAN, LEO D., LOS ANGELES, CA, DBA LEO SULLIVAN MULTIMEDIA, INC.:
3,678,313, PUB. 6-23-2009. INT. CL. 41.

SULLIVAN, MICHELLE, GREENBRAE, CA:
3,679,553, PUB. 6-23-2009. INT. CL. 5.

SULLIVAN, THOMAS M., INDIANAPOLIS, IN:
2,214,227, CANC. INT. CL. 1.

SUM-BO-SHINE, WOODSTOCK, GA AND SUM-BO-SHINE, INC., WOODSTOCK, GA:
3,680,375, INT. CL. 3.

SUMITOMO ELECTRIC CARBIDE, INC., MT. PROSPECT, IL:
2,292,146, REN. 8-3-09. INT. CL. 7.
2,294,052, REN. 8-3-09. INT. CL. 7.

SUMITOMO MITSUI CARD COMPANY, LIMITED, OSAKA, JAPAN:
3,680,054, PUB. 6-23-2009. INT. CL. 36.

SUMMIT PRODUCTS, LLC, TRUSSVILLE, AL:
3,680,137, INT. CL. 28.

SUMMITAS LLC, BOSTON, MA:
3,680,812, MULTIPLE CLASS, INT. CLS. 36, 42 AND 45.

SUMMITSOFT CORPORATION, OMAHA, NE:
2,666,398, CANC. INT. CL. 9.

SUN BROTHERS, LLC, OVERTON, NV:
3,680,898, INT. CL. 5.
3,680,900, INT. CL. 5.

SUN CHEMICAL CORPORATION, PARSIPPANY, NJ:
3,680,283, INT. CL. 2.

SUN MICROSYSTEMS, INC., SANTA CLARA, CA:
2,215,388, CANC. INT. CL. 9.
2,667,090, CANC. INT. CL. 9.
3,681,468, INT. CL. 9.

SUN WATER SYSTEMS, INC., FORT WORTH, TX:
2,111,024, REN. 8-4-09. INT. CL. 11.

SUN WHOLESALE SUPPLY, CLEARWATER, FL, DBA SUNCOAST CHEMICALS CO.:
2,336,759, REN. 8-3-09. INT. CL. 1.

SUNIVA, INC., NORCROSS, GA:
3,679,110, PUB. 6-23-2009. INT. CL. 9.

SUNMIRAGE LLC, BAKERSFIELD, CA:
2,666,841, CANC. INT. CL. 29.

SUNOPTA FRUIT GROUP, INC., BUENA PARK, CA:
3,680,438, INT. CL. 29.

SUNOPTA, INC., BRAMPTON, ONTARIO, CANADA:
3,679,443, PUB. 6-23-2009. INT. CL. 32.

SUNPOWER CORPORATION, SYSTEMS, BERKELEY, CA:
2,666,845, CANC. INT. CL. 9.

SUNTRUST BANKS, INC., ORLANDO, FL:
3,679,295, PUB. 6-23-2009. INT. CL. 36.

SUNTRUST BANKS, INC., ORLANDO, FL:
3,680,472, INT. CL. 36.
3,680,473, INT. CL. 36.
3,681,409, INT. CL. 36.

SUNVIEW MARKETING INTERNATIONAL, MCFARLAND, CA:
370,194, REN. 8-3-09. U.S. CL. 46 (INT. CL. 31).

SUNWA LTD., SHIBUYA-KU, TOKYO, JAPAN:
2,270,105, REN. 8-3-09. INT. CL. 7.

SUPER FREEZE COMPANY, BURBANK, CA:
862,380, CANC. U.S. CL. 31.

SUPER MERCADO JALISCO, INC., NORCROSS, GA AND SUPER MERCADO JALISCO II, INC., LAWRENCEVILLE, GA AND SUPER MERCADO JALISCO #3, INC., MARIETTA, GA AND SUPER MERCADO JALISCO #4, INC., NORCROSS, GA AND CARNICERIA JALISCO INC., LILBURN, GA, DBA SUPER MERCADO JALISCO #5 AND SUPER MERCADO JALISCO #6, INC., ROSWELL, GA:
3,679,463, PUB. 6-23-2009. INT. CL. 35.
3,679,464, PUB. 6-23-2009. INT. CL. 35.

SUPER VISIONS INTERNATIONAL LIMITED, TORTOLA, BR. VIRGIN ISLANDS:
3,678,572, PUB. 6-23-2009. INT. CL. 6.

SUPERCAR SENSATION, LLC, CORNELIUS, NC:
3,679,622, PUB. 6-23-2009. INT. CL. 39.
3,679,625, PUB. 6-23-2009. INT. CL. 39.

SUPERIOR COUNCIL OF THE UNITED STATES, SOCIETY OF ST. VINCENT DE PAUL, INC., SAINT LOUIS, MO:
2,277,318, REN. 8-3-09. MULTIPLE CLASS, INT. CLS. 35 AND 42.

SUPERNAL SOFTWARE, LLC, LA CROSSE, WI:
3,679,392, PUB. 6-23-2009. INT. CL. 42.

SUPERSOCIAL INC., BURKE, VA:
3,681,224, INT. CL. 45.

SUPPLEMENT RX, LLC, PARK CITY, UT:
3,680,817, U.S. CL. B.

SUPREME CHEMICALS OF GEORGIA, INC., CUMMING, GA:
3,681,288, INT. CL. 3.

SUR LA TABLE, INC., SEATTLE, WA:
3,679,513, PUB. 6-23-2009. MULTIPLE CLASS, INT. CLS. 16, 35 AND 41.

SURFACE, PARK RIDGE, NJ:
3,681,526, INT. CL. 24.

SURFATECH CORPORATION, DACULA, GA:
3,681,321, INT. CL. 1.

SURFMARK L.L.C., CRYSTAL LAKE, IL:
2,665,311, CANC. INT. CL. 1.

SURFMARK L.L.C., OVERLAND PARK, KS:
2,665,323, CANC. INT. CL. 1.
2,665,324, CANC. INT. CL. 2.
2,665,325, CANC. INT. CL. 1.

SURFWAX, INC., MENLO PARK, CA:
2,664,991, CANC. INT. CL. 42.

SURGICRAFT, LTD., REDDITCH, UNITED KINGDOM:
3,680,564, INT. CL. 10.

SURSUN ENTERPRISE CO., LTD., TAIPEI, TAIWAN:
1,518,130, CANC. INT. CL. 28.

SURVIVORS OF INCEST ANONYMOUS, INC., BENSON, MD:
2,274,491, REN. 7-31-09. INT. CL. 42.

- SUSHI HOUSE, INC., LONG ISLAND CITY, NY:
2,666,087, CANC. INT. CL. 35.
- SUSQUEHANNA CAPITAL MANAGEMENT, SWAMPS-COTT, MA:
2,667,235, CANC. INT. CL. 28.
- SUSTAINABILITY FOR EDUCATORS & THE ENVIRONMENT, INC., KENT, OH:
3,680,787, INT. CL. 35.
- SUTTON, HARVEY MCVADIAN, PORT ORANGE, FL:
3,679,435, PUB. 6-23-2009. INT. CL. 41.
- SUZANO PAPEL E CELULOSE S.A., SALVADOR, BAHIA, BRAZIL:
3,679,027, PUB. 6-23-2009. INT. CL. 16.
- SVENGIRLY MUSIC, INC., PASADENA, CA:
3,678,148, PUB. 8-5-2008. INT. CL. 25.
- SWANSON TOOL CO., INC., FRANKFORT, IL:
3,681,421, INT. CL. 16.
- SWATCH S.A., BIENNER 2502, SWEDEN:
1,252,863, CANC. INT. CL. 14.
- SWEDA COMPANY, LLC, CITY OF INDUSTRY, CA:
3,679,137, PUB. 6-23-2009. INT. CL. 35.
- SWEET POCKETS, LLC, ATLANTA, GA:
3,678,649, PUB. 6-23-2009. INT. CL. 25.
- SWEET REVENGE ENTERPRISES, INC., NEW YORK CITY, NY:
3,680,554, MULTIPLE CLASS, INT. CLS. 30 AND 43.
3,680,556, MULTIPLE CLASS, INT. CLS. 30 AND 43.
- SWEETS DIMENSION, S.A. DE C.V., AGUASCALIENTES, MEXICO:
3,681,614, INT. CL. 30.
- SWEZEY, ROBERT, SANTA MONICA, CA:
2,236,747, REN. 7-31-09. INT. CL. 10.
- SWIFTY'S, LLC, NEW YORK, NY:
2,665,146, CANC. INT. CL. 42.
- SWIMMIN' THIGHWEAR, SIMI VALLEY, CA:
3,681,319, INT. CL. 25.
- SWISSQUOTE GROUP HOLDINGS S.A., CH-1196 GLAND, SWITZERLAND:
2,665,280, CANC. MULTIPLE CLASS, INT. CLS. 35 AND 36.
- SWITCHBACK, LLC, SAN DIEGO, CA:
3,679,798, PUB. 9-2-2008. INT. CL. 25.
- SY KESSLER SALES, INC., DALLAS, TX:
3,680,882, INT. CL. 3.
- SYMANTEC CORPORATION, CUPERTINO, CA:
3,680,301, INT. CL. 42.
- SYNCHRONET INDUSTRIES, INC., WEST SENECA, NY:
3,679,504, PUB. 6-23-2009. INT. CL. 42.
- SYNCO CHEMICAL CORPORATION, BOHEMIA, NY:
2,262,385, REN. 8-4-09. INT. CL. 4.
- SYNCRA SYSTEMS, INC., WALTHAM, MA:
2,665,986, CANC. MULTIPLE CLASS, INT. CLS. 41 AND 42.
- SYSCO CORPORATION, HOUSTON, TX:
3,679,281, PUB. 6-23-2009. INT. CL. 41.
- SYSTEMS ADVISORY GROUP ENTERPRISES, INC., AMARILLO, TX:
2,665,886, CANC. INT. CL. 9.
2,665,887, CANC. INT. CL. 9.
- SYSTOLE CORPORATION, PLANO, TX:
2,666,567, CANC. INT. CL. 35.
- S2 SYNERGY LLC, DALLAS, TX:
3,678,445, PUB. 6-23-2009. INT. CL. 5.
- T J SMITH & NEPHEW LIMITED, HULL HU3 2BN, UNITED KINGDOM:
2,214,631, CANC. INT. CL. 5.
- T WILLIAMS CONSULTING, LLC, AUDUBON, PA:
2,666,272, CANC. INT. CL. 35.
- T.C.E. ASSOCIATES, LLC, RIDGEWOOD, NJ:
2,664,956, CANC. INT. CL. 41.
2,664,957, CANC. INT. CL. 41.
- T-MOBILE USA, INC., BELLEVUE, WA:
3,680,420, INT. CL. 9.
- TAAM, ANDREW M.O., HONOLULU, HI, DBA HAWAIIAN FIGHTGEAR-HFG LLC:
3,681,694, INT. CL. 35.
- TABERNA DEL TEQUILA S.A. DE C.V., MEXICO D.F., MEXICO:
2,301,280, REN. 7-31-09. INT. CL. 42.
- TABLEWARE SOLUTIONS, LTD., MISSISSAUGA, ONTARIO, CANADA:
3,678,233, PUB. 6-23-2009. MULTIPLE CLASS, INT. CLS. 35 AND 39.
- TAC-FAST SYSTEMS CANADA LIMITED, RICHMOND HILL, CANADA:
3,681,808, INT. CL. 27.
- TAC, LLC, LOVES PARK, IL:
2,213,852, CANC. MULTIPLE CLASS, INT. CLS. 9 AND 42.
- TACO JOHN'S SEASONINGS LIMITED PARTNERSHIP, CHEYENNE, WY:
3,681,100, INT. CL. 30.
- TACOMA COMMUNITY COLLEGE FOUNDATION, TACOMA, WA:
2,667,213, CANC. INT. CL. 36.
- TAFLIN, NANCY R., IVYLAND, PA:
2,666,202, CANC. INT. CL. 25.
- TAI FOONG USA INC., SEATTLE, WA:
2,263,291, REN. 8-3-09. INT. CL. 29.
- TAIWAN STRONG SPORTING GOODS INC., FENGYUAN, TAICHUNG, TAIWAN:
1,518,102, CANC. INT. CL. 28.
- TAKE BACK THE NIGHT, WAYNE, PA, AKA TBTN:
3,679,351, PUB. 6-23-2009. INT. CL. 35.
- TAKEDA PHARMACEUTICAL; COMPANY LIMITED, JAPAN:
3,654,998, CANC. IIRN. RESTORED TO S.N. 79-060,084.
- TAL, YARON AND DOAN, SHMUEL, PARTNERS, WOODLAND HILLS, CA:
3,679,405, PUB. 6-23-2009. INT. CL. 45.
- TAMARA MAGEL HOME, INC., NEW YORK, NY:
3,680,298, INT. CL. 20.
- TAMKO BUILDING PRODUCTS, INC., JOPLIN, MO:
2,665,176, CANC. MULTIPLE CLASS, INT. CLS. 3 AND 24.
- TAMSAN BAGLANTI ELEMANLARI; YEDEK PARÇA VE MAKINA; EKIPMANLARI TURIZM INSAAT; SANAYI VE TICARET ANONIM SIRKETI, CUMHURİYET CD GEBZE; KOCAELI, TURKEY:
3,680,015, PUB. 6-23-2009. INT. CL. 6.
- TANDBERG TELEVISION, INC., DULUTH, GA:
2,213,864, CANC. INT. CL. 9.
- TANGERINE MOON PRODUCTIONS, LLC, CLAWSON, MI:
2,665,743, CANC. INT. CL. 41.
- TAR HEELS TRADING COMPANY, LLC, PHILADELPHIA, PA:
3,680,530, INT. CL. 35.
- TARAFI, RACHID, BROOKLYN, NY:
3,678,912, PUB. 6-23-2009. INT. CL. 43.
- TARKETT INC., FARNHAM, CANADA:
3,681,696, INT. CL. 19.
- TASK FORCE PROPERTIES; & INVESTMENTS LTD, UNITED KINGDOM:
3,679,880, PUB. 6-23-2009. INT. CL. 28.
3,679,881, PUB. 6-23-2009. INT. CL. 28.
- TASMANIA RESOURCE, INC., NEWARK, DE:
2,666,896, CANC. INT. CL. 9.
- TASNER JR., MICHAEL, NORTH TONAWANDA, NY, DBA TAZ SOLUTIONS:
3,678,369, PUB. 3-17-2009. INT. CL. 35.
- TASQ TECHNOLOGY, INC., ROCKLIN, CA:
2,666,785, CANC. INT. CL. 35.
- TASTEFULLY SIMPLE, INC., ALEXANDRIA, MN:
3,679,293, PUB. 6-23-2009. MULTIPLE CLASS, INT. CLS. 35 AND 36.
- TATA CONSULTANCY SERVICES, MUMBAI 400 021, INDIA:
2,665,949, CANC. INT. CL. 35.
2,665,950, CANC. INT. CL. 35.
- TATHAM, SUSAN, ST. LOUIS, MO, DBA LOLLIPOP PUBLISHING:
2,667,079, CANC. INT. CL. 16.
- TATTINI S.P.A., ITALY:
3,679,957, PUB. 6-23-2009. MULTIPLE CLASS, INT. CLS.

- 3, 18 AND 25.
TATTOO, SAN FRANCISCO, CA:
3,678,781, PUB. 6-23-2009. MULTIPLE CLASS, INT. CLS.
35 AND 42.
TAWARAYA LIMITED, CHARLESTOWN, ST. CHRIST-NE-
VIS:
3,680,252, INT. CL. 21.
TAWIL ASSOCIATES, INC., CARTERET, NJ:
2,214,205, CANC. INT. CL. 25.
TAYLOR MADE GOLF COMPANY, INC., CARLSBAD, CA:
3,680,379, INT. CL. 28.
3,680,848, INT. CL. 28.
TAYLOR, BEAN & WHITAKER MORTGAGE CORP., OCA-
LA, FL:
3,679,476, PUB. 6-23-2009. INT. CL. 36.
3,679,785, PUB. 6-23-2009. INT. CL. 45.
TAYLOR, FLADGATE & YEATMAN LIMITED, ST HELIER,
JERSEY, CHANNEL ISLANDS:
2,281,832, REN. 8-4-09. INT. CL. 33.
TBC BRANDS, LLC, RENO, NV:
560,428, AM. U.S. CL. 35.
TBC BRANDS, LLC, LAS VEGAS, NV, TIRE & BATTERY
CORPORATION, THE, MEMPHIS, TN:
1,122,304, REN. 8-3-09. INT. CL. 12.
TBC BRANDS, LLC, LAS VEGAS, NV:
2,266,907, REN. 8-3-09. INT. CL. 12.
TBD2, INC., MANITOWOC, WI:
3,678,710, PUB. 6-23-2009. INT. CL. 7.
TCMZONE, LLC, CHANDLER, AZ:
3,681,269, INT. CL. 5.
TEA FORTÉ, INC., CONCORD, MA:
3,679,560, PUB. 6-23-2009. INT. CL. 30.
TECH MUSEUM OF INNOVATION, THE, SAN JOSE, CA:
2,213,773, CANC. INT. CL. 36.
TECH 4 KIDS INC., MISSISSAUGA, ONTARIO, CANADA:
3,680,413, INT. CL. 28.
TECHLINKS MEDIA HOLDINGS, INC., ATLANTA, GA:
3,678,488, PUB. 6-23-2009. MULTIPLE CLASS, INT. CLS.
35, 41 AND 42.
TECHMED MANAGEMENT CORPORATION, HOUSTON,
TX:
2,664,921, CANC. INT. CL. 36.
TECHNICAL EDUCATION RESEARCH CENTERS, INC.,
CAMBRIDGE, MA:
2,288,625, REN. 8-4-09. INT. CL. 16.
2,297,499, REN. 8-5-09. INT. CL. 9.
TECHNIQUE GOLF, L.L.C., BRIGHTON, MI:
2,273,213, REN. 8-3-09. INT. CL. 28.
TECHNISERVE CORPORATION, CLEVELAND, OH:
1,517,849, CANC. INT. CL. 9.
TECHNOLOGIES NTER INC., MONTREAL, QUEBEC:
2,665,285, CANC. INT. CL. 42.
TECHNOLOGY & MARKETING VENTURES, INC., NEW
YORK, NY:
2,213,782, CANC. MULTIPLE CLASS, INT. CLS. 16, 35
AND 41.
TECHNOLOGY FOR ENERGY CORPORATION, KNOX-
VILLE, TN:
3,678,211, PUB. 6-23-2009. INT. CL. 9.
TECHNOLOGY INVESTMENT PARTNERS, LLC, BLOOM-
FIELD HILLS, MI:
3,679,207, PUB. 6-23-2009. MULTIPLE CLASS, INT. CLS.
35 AND 36.
TECHNOLOGY LIFELINE INC., INDIANAPOLIS, IN:
3,681,628, MULTIPLE CLASS, INT. CLS. 35, 37, 38 AND
42.
TECHNOLOGY MARKETING CORPORATION, NOR-
WALK, CT:
2,666,255, CANC. INT. CL. 41.
TECHRX, INC., GREEN BAY, WI:
3,679,225, PUB. 6-23-2009. INT. CL. 42.
TECHTARGET.COM, INC., NEEDHAM, MA:
2,859,438, CANC. INT. CL. 16.
TECMO, LTD., TOKYO, JAPAN:
1,518,143, CANC. INT. CL. 28.
TECNOCOSMESI S.P.A., 20121 MILANO MI, ITALY:
3,678,389, PUB. 6-23-2009. INT. CL. 3.
TECSIS GMBH, FED REP GERMANY:
3,679,984, PUB. 6-23-2009. INT. CL. 9.
TEFEN MANUFACTURE & MARKETING PLASTIC PRO-
DUCTS 1990 LTD., M.P. HOF HACARMEL, ISRAEL:
3,678,325, PUB. 6-23-2009. INT. CL. 7.
TEGRANT DIVERSIFIED BRANDS, INC., NEW BRIGHT-
ON, PA:
1,517,704, CANC. INT. CL. 1.
TEIKEN LIMITED, CHUO-KU, OSAKA, JAPAN:
3,681,180, INT. CL. 23.
TEK-TOOLS, INC., DALLAS, TX:
2,667,317, CANC. INT. CL. 9.
TEKNON CORPORATION, SCOTTSALE, AZ, DBA SYMME-
TRY SOFTWARE:
3,681,281, INT. CL. 42.
TELCORDIA TECHNOLOGIES, INC., MORRISTOWN, NJ:
2,666,293, CANC. INT. CL. 42.
TELECOM ITALIA S.P.A., TORINO, ITALY:
2,758,081, CANC. INT. CL. 9.
TELEFLORA LLC, LOS ANGELES, CA:
2,215,589, CANC. INT. CL. 16.
TELEFONICA, S.A., 28013 MADRID, SPAIN:
2,665,219, CANC. MULTIPLE CLASS, INT. CLS. 9 AND
38.
TELEHOUSE INTERNATIONAL CORPORATION OF
AMERICA, STATEN ISLAND, NY AND INTEC WEB
AND GENOME CORPORATION, SAN JOSE, CA:
2,665,895, CANC. INT. CL. 38.
TELEMANUTENCAO - ASSISTENCIA REMOTA A COMPU-
TADORES, S.A., 2780-343 OEIRAS, PORTUGAL:
2,664,969, CANC. MULTIPLE CLASS, INT. CLS. 38, 41
AND 42.
TELEVISUAL COMMUNICATIONS, INC., CLEARWATER,
FL:
2,309,123, REN. 8-1-09. MULTIPLE CLASS, INT. CLS. 9
AND 16.
TEMA MARKETING AG, ZUG, SWITZERLAND:
2,665,537, CANC. MULTIPLE CLASS, INT. CLS. 6, 9 AND
17.
TEMPEST SOFTWARE, INC., NEW YORK, NY:
2,664,992, CANC. INT. CL. 9.
TEMPLEMAIL INC., BELIZE CITY, BH-1000, BELIZE:
2,666,084, CANC. INT. CL. 38.
TEMPO GRAPHICS, INC., CAROL STREAM, IL:
2,303,791, REN. 8-5-09. INT. CL. 42.
TEMPUR-PEDIC NORTH AMERICA, LLC, LEXINGTON,
KY:
2,667,191, CANC. INT. CL. 35.
TENDER CORPORATION, LITTLETON, NH:
2,335,096, REN. 8-1-09. INT. CL. 5.
TENNIS PROPERTIES B.V., AMSTERDAM, NETHER-
LANDS:
2,665,155, CANC. MULTIPLE CLASS, INT. CLS. 18, 25, 28,
38 AND 41.
TEQUILA SAUZA, S.A. DE C.V., ZAPOPAN JALISCO,
MEXICO:
3,681,494, INT. CL. 33.
TERADYNE, INC., NORTH READING, MA:
3,678,885, PUB. 6-23-2009. INT. CL. 9.
TERESI ENTERPRISES, LLC, FORT LAUDERDALE, FL:
2,666,952, CANC. INT. CL. 25.
TERRA INTERNATIONAL, INC., SIOUX CITY, IA:
1,548,244, REN. 8-3-09. INT. CL. 16.
TERRA-MULCH PRODUCTS, L.L.C., BUFFALO GROVE, IL:
2,268,869, REN. 8-4-09. INT. CL. 31.
2,268,870, REN. 8-3-09. INT. CL. 31.
TERRABOOST MEDIA, LLC, MIAMI, FL:
3,681,021, INT. CL. 5.
TERRAFIX GEOSYNTHETICS INC., ETOBICOKE, ONTAR-
IO, CANADA:
3,681,608, INT. CL. 17.
TERRAMARK MARKENCREATION GMBH, FED REP
GERMANY:
3,680,013, PUB. 6-23-2009. INT. CL. 30.
TERRAPIN PRESENTS, INC., WESTON, CT:
2,666,870, CANC. INT. CL. 41.
TERRY, KEITH H., SPEARFISH, SD:
3,680,752, INT. CL. 9.

- TERUMO KABUSHIKI KAISHA, SHIBUYA-KU, TOKYO, JAPAN, AKA TERUMO CORPORATION:
3,678,931, PUB. 6-23-2009. INT. CL. 10.
- TEST UNIVERSITY, INC., NEW YORK, NY:
2,665,383, CANC. INT. CL. 41.
- TESTAMERICA LABORATORIES, INC., ASHEVILLE, NC:
2,666,092, CANC. MULTIPLE CLASS, INT. CLS. 35 AND 42.
- TESTHEALTH.COM LLC, BOULDER, CO, DBA GOOD-GLASSES.COM:
3,678,320, PUB. 6-23-2009. INT. CL. 9.
- TETKO INC., ELMSFORD, NY:
1,517,783, CANC. INT. CL. 7.
- TETLEY USA INC., SHELTON, CT, SOUTHERN TEA COMPANY, MARIETTA, GA:
1,550,374, REN. 7-31-09. INT. CL. 30.
- TETRA TECHNOLOGIES, INC., THE WOODLANDS, TX:
3,678,838, PUB. 6-23-2009. INT. CL. 41.
- TEXAS BEEF, AMARILLO, TX:
2,664,999, CANC. INT. CL. 29.
- TEXAS HEART INSTITUTE, HOUSTON, TX:
2,248,460, REN. 8-4-09. INT. CL. 42.
- TEXAS INSTRUMENTS TUCSON CORPORATION, TUCSON, AZ:
2,666,834, CANC. INT. CL. 9.
- TEXAS RANGERS BASEBALL PARTNERS, ARLINGTON, TX:
3,680,400, INT. CL. 16.
- TEXAS SKI RANCH, L.P., NEW BRAUNFELS, TX:
3,679,273, PUB. 6-23-2009. INT. CL. 41.
- TEXAS UNITED CHEMICAL COMPANY, LLC, HOUSTON, TX:
2,225,826, REN. 7-31-09. INT. CL. 1.
- TEXT PILOT LLC, SAN FRANCISCO, CA, DBA HITUP.COM:
3,680,395, MULTIPLE CLASS, INT. CLS. 38 AND 45.
- TEXTRON INC., PROVIDENCE, RI:
3,678,658, PUB. 6-23-2009. INT. CL. 12.
- TGC HOLDINGS LLC, NORCROSS, GA:
3,678,868, PUB. 6-23-2009. INT. CL. 35.
3,678,869, PUB. 6-23-2009. INT. CL. 35.
- TGI FRIDAY'S OF MINNESOTA, INC., CARROLLTON, TX:
3,680,711, INT. CL. 43.
- TH FOODS, INC., LOVES PARK, IL:
2,234,394, REN. 8-1-09. MULTIPLE CLASS, INT. CLS. 29 AND 30.
- THAI STORAGE BATTERY PUBLIC COMPANY LIMITED, SAMUTPRAKARN PROVINCE 10280, THAILAND:
2,291,220, REN. 8-3-09. INT. CL. 9.
- THARPERROBBINS COMPANY, INC., STATESVILLE, NC:
3,678,650, PUB. 6-23-2009. INT. CL. 35.
- THAT'S RACING, LLC, BALTIMORE, MD:
3,678,465, PUB. 6-23-2009. INT. CL. 25.
- THATSMYTRUCK.COM, L.L.C., ANKENY, IA:
3,681,602, INT. CL. 35.
- THE ADVENTURE PAGES, LLC, PLEASANTON, CA:
2,666,569, CANC. MULTIPLE CLASS, INT. CLS. 16, 35 AND 42.
- THE AMERICAN DREAM COMPANY, MCLEAN, VA:
2,666,001, CANC. INT. CL. 36.
- THE ANTIQUE MOTORCYCLE CLUB OF AMERICA, INC., LAKELAND, FL:
2,310,637, REN. 8-1-09. INT. CL. 42.
- THE BAZAR GROUP, EAST PROVIDENCE, RI:
3,679,198, PUB. 6-23-2009. INT. CL. 14.
- THE BIG TEN CONFERENCE, INC., PARK RIDGE, IL:
3,679,050, PUB. 6-23-2009. MULTIPLE CLASS, INT. CLS. 38 AND 41.
- THE BLACK & DECKER CORPORATION, TOWSON, MD:
3,680,691, INT. CL. 11.
- THE BODY, BEAUTY AND BRAVERY PROJECT, LLC, MARIETTA, GA:
3,679,229, PUB. 6-23-2009. MULTIPLE CLASS, INT. CLS. 16 AND 41.
- THE CANADIAN INSTITUTE OF CHARTERED BUSINESS VALUATORS, TORONTO, CANADA:
3,679,018, PUB. 6-23-2009. U.S. CL. B.
- THE CARTOON NETWORK, INC., ATLANTA, GA:
3,681,515, INT. CL. 20.
- THE CENTER FOR RURAL HEALTH DEVELOPMENT, INC., HURRICANE, WV:
3,679,304, PUB. 6-23-2009. MULTIPLE CLASS, INT. CLS. 35 AND 41.
- THE CHIEF INFORMATION GROUP, INC., FALLS CHURCH, VA:
3,680,991, INT. CL. 42.
- THE CHRISTI HARRIS COMPANIES, INC., DALLAS, TX:
3,679,563, PUB. 6-23-2009. INT. CL. 3.
- THE CIGAR AGENCY, L.L.C., NASHUA, NH:
3,679,429, PUB. 6-23-2009. INT. CL. 34.
- THE COCA-COLA COMPANY, ATLANTA, GA:
3,680,903, INT. CL. 30.
- THE CODEMASTERS SOFTWARE COMPANY LIMITED, WARWICKSHIRE CV47 2DL, UNITED KINGDOM:
3,679,846, PUB. 6-23-2009. MULTIPLE CLASS, INT. CLS. 9, 28 AND 41.
- THE COLEMAN COMPANY, INC., WICHITA, KS:
3,678,808, PUB. 6-23-2009. INT. CL. 9.
3,681,527, INT. CL. 11.
- THE CORYN GROUP II, LLC, NEWTOWN SQUARE, PA:
3,681,351, INT. CL. 43.
- THE DISCRETEHEAT COMPANY LIMITED, PRESTBURY, UNITED KINGDOM:
3,678,280, PUB. 6-23-2009. MULTIPLE CLASS, INT. CLS. 6 AND 11.
- THE DISPATCH PRINTING COMPANY, COLUMBUS, OH:
3,679,612, PUB. 6-23-2009. INT. CL. 35.
- THE DWAYNE A. ROSCOE AND JOHN R. ROSCOE PARTNERSHIP, LONG BEACH, CA:
3,680,852, INT. CL. 30.
- THE FIRST NATIONAL BANK OF JEFFERSONVILLE, JEFFERSONVILLE, NY:
3,680,601, INT. CL. 36.
- THE FORCE, INC., HUNTSVILLE, AL:
3,681,609, INT. CL. 9.
- THE GENERAL COUNCIL OF THE ASSEMBLIES OF GOD, SPRINGFIELD, MO:
3,680,642, INT. CL. 25.
- THE GODDESS NEXT DOOR, PORTLAND, OR:
3,679,417, PUB. 6-23-2009. INT. CL. 3.
- THE GOURMET ENTERTAINMENT NETWORK, L.L.C., SOUTH BLOOMINGVILLE, OH:
3,681,656, MULTIPLE CLASS, INT. CLS. 35 AND 45.
- THE GREEN BEAR COMPANY, LLC, STRATFORD, CT:
3,681,060, INT. CL. 12.
- THE GREENVILLE PROJECT, SAN ANTONIO, TX:
3,679,617, PUB. 6-23-2009. INT. CL. 36.
3,679,623, PUB. 6-23-2009. INT. CL. 36.
- THE GROVE, INC., WESTCHESTER, IL:
2,666,146, CANC. INT. CL. 35.
- THE GUND COMPANY, INC., ST. LOUIS, MO:
3,678,794, PUB. 6-23-2009. INT. CL. 17.
- THE HARRINGTON GROUP, INC., ORLANDO, FL, DBA HARRINGTON GROUP AND H3, INC, WINTER PARK, FL:
3,678,454, PUB. 6-23-2009. INT. CL. 9.
- THE HARTZ MOUNTAIN CORPORATION, SECAUCUS, NJ:
2,666,934, CANC. INT. CL. 31.
- THE HONEST KITCHEN, INC., SAN DIEGO, CA:
3,681,043, INT. CL. 31.
- THE IDENTITY CIRCLE LLC, WESTPORT, CT:
3,680,500, MULTIPLE CLASS, INT. CLS. 35 AND 41.
- THE INSTITUTE OF ELECTRICAL AND ELECTRONICS ENGINEERS, INC., PISCATAWAY, NJ, AKA IEEE:
3,679,729, PUB. 6-23-2009. INT. CL. 16.
- THE INVENTION MACHINE, LLC, CHICAGO, IL:
3,680,932, INT. CL. 42.
- THE ISLAMIC SOCIETY OF NORTH AMERICA, PLAINFIELD, IN:
3,679,092, PUB. 6-23-2009. INT. CL. 16.
- THE JOHNSON GROUP, MCLEAN, VA:
3,681,442, INT. CL. 9.

- THE KEISER SCHOOL, INC., FT. LAUDERDALE, FL:
3,678,618, PUB. 6-23-2009. INT. CL. 41.
3,678,620, PUB. 6-23-2009. INT. CL. 41.
3,678,621, PUB. 6-23-2009. INT. CL. 41.
- THE KELLY SUPPLY COMPANY, GRAND ISLAND, NE:
3,678,795, PUB. 3-17-2009. INT. CL. 20.
- THE KINSEY INSTITUTE FOR RESEARCH IN SEX, GENDER, AND REPRODUCTION, INC., BLOOMINGTON, IN:
3,680,943, INT. CL. 25.
3,680,946, INT. CL. 25.
- THE KNOWLEDGE PHARMACY, INC., BELLEVIEW, FL, AKA KNOWLEDGE PHARMACY:
3,678,744, PUB. 6-23-2009. INT. CL. 41.
- THE KROGER CO. OF MICHIGAN, LIVONIA, MI:
3,678,664, PUB. 6-23-2009. INT. CL. 4.
3,678,903, PUB. 6-23-2009. INT. CL. 4.
3,678,972, PUB. 3-17-2009. INT. CL. 30.
3,680,383, MULTIPLE CLASS, INT. CLS. 5 AND 30.
- THE LIBRARY SQUARE FOUNDATION FOR ART, CULTURE AND SCIENCE, SALT LAKE CITY, UT:
3,680,340, INT. CL. 41.
- THE LITTLE GIRAFFE, INC., VAN NUYS, CA:
3,680,976, MULTIPLE CLASS, INT. CLS. 18, 20 AND 24.
- THE LOS ANGELES KINGS HOCKEY CLUB, L.P., EL SEGUNDO, CA:
3,680,933, INT. CL. 25.
3,680,934, INT. CL. 41.
- THE LUXURY HOLIDAYS, INC., MILTON, DE:
3,678,414, PUB. 9-9-2008. INT. CL. 39.
- THE MAGIC OF CURTIS ADAMS, INC., LAS VEGAS, NV:
3,680,338, MULTIPLE CLASS, INT. CLS. 9, 14, 16, 25, 28 AND 41.
- THE MILLS LIMITED PARTNERSHIP, INDIANAPOLIS, IN:
3,678,486, PUB. 6-23-2009. INT. CL. 36.
- THE MONKEY HOOK, LLC, SAN JUAN CAPISTRANO, CA:
3,679,703, PUB. 6-23-2009. INT. CL. 20.
3,679,752, PUB. 6-23-2009. INT. CL. 6.
3,679,779, PUB. 6-23-2009. INT. CL. 20.
- THE NATIONAL PRESS CLUB OF WASHINGTON, D.C., INC., WASHINGTON, DC:
3,681,698, INT. CL. 35.
- THE NEIMAN SPORTS GROUP, INC., CENTER VALLEY, PA, DBA PRIDE OF THE DIAMOND AND IT'S THE ONLY GAME:
3,678,443, PUB. 6-23-2009. INT. CL. 25.
- THE OCCASIONS GROUP, INC., NORTH MANKATO, MN:
2,665,829, CANC. INT. CL. 40.
- THE OLIVE ORCHARD, INC., CHAGRIN FALLS, OH:
3,681,553, MULTIPLE CLASS, INT. CLS. 29 AND 35.
- THE ONTARIO KNIFE COMPANY, FRANKLINVILLE, NY:
3,680,152, INT. CL. 8.
3,681,615, INT. CL. 8.
3,681,616, INT. CL. 8.
- THE ORIGINAL CREATORS MÉXICO, S.A DE C.V., COL. LOMAS DE CHAPULTE, MEXICO:
3,680,319, MULTIPLE CLASS, INT. CLS. 25 AND 28.
- THE PLANNING CENTER, INC., MOLINE, IL:
3,678,473, PUB. 6-23-2009. INT. CL. 36.
- THE PROCTER & GAMBLE COMPANY, CINCINNATI, OH:
3,681,291, INT. CL. 3.
- THE PURSE HOOK, INC., ROCHESTER, NY:
3,679,298, PUB. 6-23-2009. INT. CL. 6.
- THE QUILLIAN TATTOO, INC., ALLENTOWN, PA:
3,680,659, INT. CL. 44.
- THE REAL CO., INC, RENTON, WA:
3,679,596, PUB. 6-23-2009. INT. CL. 25.
- THE REALTY ASSOCIATES, DALLAS, TX:
3,678,231, PUB. 6-23-2009. INT. CL. 36.
- THE RESIDENCE HOTELS & RESORTS; PTE. LTD., SINGAPORE:
3,680,018, PUB. 6-23-2009. MULTIPLE CLASS, INT. CLS. 35, 36, 43 AND 44.
- THE ROUGH GUIDES LIMITED, LONDON, UNITED KINGDOM:
3,678,222, PUB. 6-23-2009. MULTIPLE CLASS, INT. CLS. 9 AND 41.
- THE SALVATION ARMY, LONG BEACH, CA:
3,681,805, INT. CL. 41.
- THE SEABERG COMPANY, INC., PORTLAND, OR, AKA SAM MEDICAL PRODUCTS:
3,681,711, INT. CL. 10.
3,681,712, INT. CL. 10.
- THE SINCLAIR GROUP NEVADA, LLC., INCLINE VILLAGE, NV:
3,680,606, INT. CL. 41.
- THE SISTERHOOD BOUTIQUE LLC, ATLANTA, GA:
3,681,415, INT. CL. 28.
- THE SPA AT NORTH BEACH LLC, NORTH MYRTLE BEACH, SC:
3,679,375, PUB. 6-23-2009. MULTIPLE CLASS, INT. CLS. 35 AND 44.
- THE STARLIGHT STARBRIGHT CHILDREN'S FOUNDATION, LOS ANGELES, CA:
2,667,066, CANC. INT. CL. 9.
- THE STATE OF CONNECTICUT, DEPARTMENT OF TRANSPORTATION, NEWINGTON, CT:
3,681,722, INT. CL. 39.
- THE STEP2 COMPANY, STREETSBORO, OH:
2,665,621, CANC. INT. CL. 28.
- THE STOLAR PARTNERSHIP LLP, ST. LOUIS, MO:
3,679,468, PUB. 6-23-2009. INT. CL. 45.
3,679,469, PUB. 6-23-2009. INT. CL. 45.
- THE STRATEGIC COACH INC., TORONTO, CANADA:
3,678,984, PUB. 6-23-2009. MULTIPLE CLASS, INT. CLS. 9 AND 16.
- THE SUNRIDER CORPORATION, TORRANCE, CA:
3,523,266, AM. MULTIPLE CLASS, INT. CLS. 3, 5, 29, 30 AND 32.
- THE TJIFFEN COMPANY, LLC, HAUPPAUGE, NY:
3,680,712, INT. CL. 9.
- THE TORONTO-DOMINION BANK, TORONTO, CANADA:
2,664,917, CANC. INT. CL. 36.
- THE TOUR DE GEORGIA FOUNDATION, INC., ATLANTA, GA:
2,666,178, CANC. MULTIPLE CLASS, INT. CLS. 35, 36 AND 41.
- THE TRAVELERS INDEMNITY COMPANY, HARTFORD, CT:
3,417,048, AM. INT. CL. 36.
3,417,049, AM. INT. CL. 36.
3,494,647, AM. MULTIPLE CLASS, INT. CLS. 35, 36, 41 AND 42.
- THE TRUSTEES OF EMERGING TECHNOLOGIES TRUST, A MASSACHUSETTS TRUST, THE TRUSTEES COMPRISING WILLIAM CHARLES JONES, A U.S. CITIZEN, OSTERVILLE, MA:
2,665,713, CANC. INT. CL. 40.
- THE TRUSTEES OF THE COPPOLA FAMILY TRUST, RUTHERFORD, CA:
3,680,566, MULTIPLE CLASS, INT. CLS. 33 AND 35.
- THE TRUSTEES OF THE CRYSTAL ROCK OLGA AUDIGIER IRREVOCABLE TRUST, A CALIFORNIA TRUST, THE TRUSTEES COMPRISING VINCENT AUDIGIER, A FRENCH CITIZEN, AND BLAISE E. ABERGEL, A FRENCH CITIZEN, BEVERLY HILLS, CA:
3,680,397, INT. CL. 25.
- THE TRUSTEES OF THE TRAPANI FAMILY TRUST DATED OCTOBER 23, 2008, ALAMO, CA, DBA "T" DEVELOPMENT & SALES:
3,679,016, PUB. 6-23-2009. INT. CL. 12.
- THE TRUSTEES OF THE UNIVERSITY OF PENNSYLVANIA, PHILADELPHIA, PA:
3,681,219, INT. CL. 44.
- THE TUG MCGRAW FOUNDATION, NAPA, CA:
3,680,219, INT. CL. 14.
- THE TYLER UGOLYN FOUNDATION, RIDGFIELD, CT:
3,680,846, INT. CL. 36.
- THE UNICOVER CORPORATION, CHEYENNE, WY:
2,214,334, CANC. INT. CL. 35.
- THE VANGUARD GROUP, INC., MALVERN, PA:
3,679,324, PUB. 6-23-2009. INT. CL. 41.
- THE VMI ALUMNI ASSOCIATION, INC., LEXINGTON, VA:
3,679,607, PUB. 6-23-2009. INT. CL. 35.
- THE WALLACE ENTERPRISES, INC., NASHVILLE, TN:
2,667,412, CANC. INT. CL. 10.

- THE WEDGE, BRANDYWINE, MD, DBA EATINGTOLIVE:
3,678,845, PUB. 3-17-2009. INT. CL. 29.
- THE WEST AMERICA CORPORATION, LAYTON, UT:
3,680,209, INT. CL. 9.
- THE WILLIAM AND EVA FOX FOUNDATION, NEW YORK, NY:
3,679,816, PUB. 5-9-2006. INT. CL. 36.
3,679,817, PUB. 5-9-2006. INT. CL. 36.
- THE YOUNG MEN'S CHRISTIAN ASSOCIATION OF METROPOLITAN MILWAUKEE, INC., MILWAUKEE, WI:
3,680,527, INT. CL. 44.
- THE-MAT-COMPANY GERMANY GMBH, D-44143 DORTMUND, FED REP GERMANY:
2,665,820, CANC. MULTIPLE CLASS, INT. CLS. 27, 35 AND 37.
- THEOCHEM LABORATORIES, INC., TAMPA, FL:
3,678,397, PUB. 3-17-2009. INT. CL. 3.
- THERACLONE SCIENCES, INC., SEATTLE, WA:
3,680,336, INT. CL. 42.
- THERAMETICS, L.L.C., OKLAHOMA CITY, OK:
3,680,977, INT. CL. 3.
- THERMO JARRELL ASH CORPORATION, FRANKLIN, MA:
1,517,827, CANC. INT. CL. 9.
- THIAM, ALIAUNE, ATLANTA, GA:
3,680,268, INT. CL. 41.
- THIERRY MUGLER PARFUMS S.A.S., NEUILLY-SUR-SEINE, FRANCE:
3,680,781, INT. CL. 3.
3,680,782, INT. CL. 3.
- THIERRY MUGLER S.A.S., FRANCE:
3,679,992, PUB. 6-23-2009. INT. CL. 3.
- THIRALAND, LLC, FRENCHTOWN, NJ:
3,681,486, INT. CL. 35.
- THOMAS & BETTS INTERNATIONAL, INC., WILMINGTON, DE:
3,679,030, PUB. 6-23-2009. INT. CL. 1.
- THOMAS INDUSTRIES INC., LOUISVILLE, KY:
1,517,887, CANC. INT. CL. 11.
- THOMAS J. SISK AND COMPANY, DENVER, CO:
3,678,536, PUB. 6-23-2009. MULTIPLE CLASS, INT. CLS. 35 AND 41.
- THOMAS MEDICAL PRODUCTS, INC., MALVERN, PA:
3,680,277, INT. CL. 10.
- THOMAS PUBLISHING COMPANY, NEW YORK, NY:
2,666,484, CANC. INT. CL. 42.
- THOMAS, LEONARD, JAMAICA, NY:
2,666,735, CANC. INT. CL. 25.
- THOMPSON, VERONICA LEE, LAKEWOOD, CA:
3,678,384, PUB. 6-23-2009. INT. CL. 25.
- THOMSON, BOULOGNE-BILLANCOURT, FRANCE:
2,676,166, CANC. INT. CL. 38.
- THOR TECH, INC., SAGINAW, MI:
1,577,678, REN. 8-5-09. INT. CL. 12.
- THORNBERRY CONSULTING, LLC, INDIANAPOLIS, IN:
3,679,365, PUB. 6-23-2009. INT. CL. 37.
- THORNE RESEARCH, INC., DOVER, ID:
3,678,191, PUB. 4-21-2009. INT. CL. 5.
- THOROUGHBRED TIMES COMPANY, INC., LEXINGTON, KY:
2,264,093, REN. 8-3-09. MULTIPLE CLASS, INT. CLS. 16 AND 42.
- THOROWGOOD LIMITED, BLOXWICH WALSALL, UNITED KINGDOM:
3,679,600, PUB. 6-23-2009. INT. CL. 18.
- THREE TREES HOLDINGS II LLC, SAN FRANCISCO, CA:
2,667,305, CANC. INT. CL. 42.
- THULE TOWING SYSTEMS LLC, LODI, CA:
3,681,447, INT. CL. 9.
- THYBONY WALLCOVERINGS CO., CHICAGO, IL:
2,667,025, CANC. MULTIPLE CLASS, INT. CLS. 24 AND 27.
- THYSSEN KRUPP STAHL AG, DUSSELDORF, FED REP GERMANY:
2,666,180, CANC. INT. CL. 6.
- TIB CHEMICALS AG, FED REP GERMANY:
3,679,956, PUB. 6-23-2009. MULTIPLE CLASS, INT. CLS. 1, 2, 6 AND 14.
- TICKETMASTER ENTERTAINMENT, INC., WEST HOLLYWOOD, CA:
3,678,747, PUB. 6-23-2009. MULTIPLE CLASS, INT. CLS. 16, 35 AND 41.
- TICMATE AB, SWEDEN:
3,679,914, PUB. 6-23-2009. MULTIPLE CLASS, INT. CLS. 39, 41 AND 43.
- TIFOSI OPTICS, INC., WATKINSVILLE, GA:
3,679,529, PUB. 6-23-2009. INT. CL. 9.
- TIKI VENTURES LLC, NEW YORK, NY:
3,680,682, MULTIPLE CLASS, INT. CLS. 35 AND 36.
- TILCO INTERNATIONAL INC., QUEBEC, CANADA:
2,667,097, CANC. INT. CL. 28.
- TILLICUM INTERNATIONAL, INC., BRIGHAM CITY, UT, DBA VENTURE OUTDOORS:
3,679,310, PUB. 6-23-2009. INT. CL. 12.
- TIM HAYS, MATTHEWS, NC, DBA HAYS MACHINE WORKS:
3,681,759, INT. CL. 12.
- TIMBERLINE TOTAL SOLUTIONS, LLC, OMAHA, NE:
2,666,498, CANC. INT. CL. 35.
- TIME INC., NEW YORK, NY:
3,681,622, INT. CL. 41.
- TIME SPORT INTERNATIONAL, 38090 VAULX-MILIEU, FRANCE:
1,542,411, REN. 7-31-09. MULTIPLE CLASS, INT. CLS. 12 AND 25.
- TIME WARNER INC., NEW YORK, NY:
3,678,635, PUB. 6-23-2009. INT. CL. 38.
- TIMEGATE STUDIOS, INC., SUGARLAND, TX:
3,681,498, INT. CL. 9.
- TINBONE LTD, ABERGAVENNY, UNITED KINGDOM:
3,678,409, PUB. 6-23-2009. INT. CL. 11.
3,678,411, PUB. 6-23-2009. INT. CL. 11.
- TIPTON, RONALD B., LAS CRUCES, NM, DBA TDL ELECTRONICS:
2,252,597, REN. 8-6-09. INT. CL. 9.
- TISHCON CORP., WESTBURY, NY:
2,666,951, CANC. INT. CL. 5.
- TISHMAN SPEYER PCVST MANAGEMENT, L.L.C., NEW YORK, NY:
3,678,623, PUB. 6-23-2009. INT. CL. 41.
3,678,624, PUB. 6-23-2009. INT. CL. 41.
3,678,625, PUB. 6-23-2009. INT. CL. 41.
3,678,626, PUB. 6-23-2009. INT. CL. 41.
- TITAN INTERNATIONAL, INC., QUINCY, IL:
2,665,480, CANC. INT. CL. 12.
- TJM PRODUCTS PTY LTD, GEEBUNG QLD 4064, AUSTRALIA:
3,679,923, PUB. 6-23-2009. INT. CL. 12.
- TL HOELL BOOKS, EXETER, NH:
2,666,891, CANC. INT. CL. 16.
- TMG PERFORMANCE PRODUCTS, LLC, WADSWORTH, OH:
3,679,139, PUB. 6-23-2009. INT. CL. 7.
- TMP WORLDWIDE INC., LOS ANGELES, CA:
2,665,606, CANC. INT. CL. 35.
- TMS INTERNATIONAL, INC., PEMBROKE PINES, FL:
2,215,481, CANC. INT. CL. 30.
- TNS NORTH AMERICA, INC., NEW YORK, NY:
2,667,085, CANC. INT. CL. 35.
- TOASTMASTER INC., COLUMBIA, MO:
2,215,188, CANC. INT. CL. 11.
- TODD LABS, LLC, ARROYO GRANDE, CA:
3,680,107, INT. CL. 35.
- TOGETHER IN HOPE, HOUSTON, TX:
3,681,044, INT. CL. 36.
- TOKAR, CHRISTINA, PLANTATION, FL:
2,665,941, CANC. INT. CL. 35.
- TOLEDANO SYLVIA, FRANCE:
3,679,967, PUB. 6-23-2009. MULTIPLE CLASS, INT. CLS. 14 AND 18.
- TOLEDO & CO., INC., DORADO, PUERTO RICO:
3,678,343, PUB. 6-23-2009. INT. CL. 6.
- TOM DAVID, INC., NANTUCKET ISLAND, MA:
1,596,503, REN. 8-3-09. INT. CL. 21.

TOMAS E. ROMERO, CORONADO, CA, DBA PANACEA WINES:
3,678,318, PUB. 6-23-2009. INT. CL. 33.
3,678,319, PUB. 6-23-2009. INT. CL. 35.

TONGLING NONFERROUS METALS; GROUP HOLDINGS LTD., ANHUI, CHINA:
3,679,997, PUB. 6-23-2009. INT. CL. 6.

TONOGA, INC., PETERSBURGH, NY:
3,680,208, INT. CL. 21.

TONY TIENDAS S.A. DE C.V., VERACRUZ, MEXICO:
3,678,332, PUB. 6-23-2009. INT. CL. 35.

TOP & TOP ENTERPRISE, LTD., NEW YORK, NY:
2,666,271, CANC. INT. CL. 26.

TOP 24 INC., DOLLARD-DES-ORMEAUX, QUEBEC, CANADA:
2,665,110, CANC. INT. CL. 9.

TOPCO ASSOCIATES, LLC, SKOKIE, IL:
3,680,434, INT. CL. 32.
3,680,485, INT. CL. 30.
3,680,909, INT. CL. 21.
3,680,984, INT. CL. 29.

TOPCO HOLDINGS, INC., SKOKIE, IL:
3,678,796, PUB. 6-23-2009. MULTIPLE CLASS, INT. CLS. 29 AND 30.
3,678,797, PUB. 6-23-2009. INT. CL. 29.

TOPICS ENTERTAINMENT, INC., RENTON, WA:
3,680,630, INT. CL. 9.
3,680,631, INT. CL. 9.

TORN & GLASSER, INC., LOS ANGELES, CA:
3,679,849, PUB. 5-6-2008. INT. CL. 29.

TORRENT, INC., NEEDHAM, MA:
3,678,741, PUB. 1-20-2009. INT. CL. 9.

TOSHIBA AMERICA BUSINESS SOLUTIONS, IRVINE, CA:
3,681,276, MULTIPLE CLASS, INT. CLS. 35 AND 37.

TOSHIBA AMERICA MEDICAL SYSTEMS, INC., TUSTIN, CA:
2,214,919, CANC. INT. CL. 9.

TOTAL LIVING INTERNATIONAL, INCORPORATED, AURORA, IL, DBA CHRISTIAN COMMUNICATIONS OF CHICAGOLAND, INC.:
1,538,537, REN. 8-6-09. INT. CL. 41.

TOTES ISOTONER CORPORATION, CINCINNATI, OH:
2,667,098, CANC. INT. CL. 25.

TOWERS CAPITAL S.L., SPAIN:
3,679,999, PUB. 6-23-2009. INT. CL. 25.

TOWN & COUNTRY SUPERMARKET, INC., SALEM, MO:
1,518,465, CANC. INT. CL. 42.

TOWNSON 3 MUSIC LLC, ROCKLAND, MA:
3,680,914, INT. CL. 35.

TOY STATE INDUSTRIAL LTD., TSTE, KOWLOON, HONG KONG:
3,680,869, INT. CL. 28.

TOYO BOSEKI KABUSHIKI KAISHA, KITA-KU, OSAKA, JAPAN:
2,666,928, CANC. INT. CL. 9.

TOYO VALVE CO., LTD., NAGANO-KEN, JAPAN:
857,355, REN. 8-1-09. U.S. CL. 13 (INT. CL. 6).

TOYOTA JIDOSHA KABUSHIKI KAISHA, T/A TOYOTA MOTOR CORPORATION, TOYOTA-SHI, AICHI-KEN, JAPAN:
3,678,246, PUB. 6-23-2009. MULTIPLE CLASS, INT. CLS. 35, 36, 37, 39 AND 44.

TOYS IN BABELAND, LLC, SEATTLE, WA:
3,680,245, INT. CL. 35.

TPI HOLDINGS, INC., ATLANTA, GA:
3,512,396, COR. MULTIPLE CLASS, INT. CLS. 16 AND 35.

TPK PHARMACEUTICAL, L.L.C., OREM, UT:
2,666,076, CANC. INT. CL. 5.

TRA GLOBAL, INC., NEW YORK, NY, DBA TRA, INC.:
3,680,697, INT. CL. 35.

TRAC OUTDOOR PRODUCTS COMPANY, BRENTWOOD, TN:
3,679,456, PUB. 6-23-2009. MULTIPLE CLASS, INT. CLS. 8 AND 12.

TRACFONE WIRELESS, INC., MIAMI, FL:
3,680,734, INT. CL. 35.
3,680,735, INT. CL. 9.

TRACK STARS COLLECTABLES PTY. LTD., HENDERSON, NV:
2,667,135, CANC. INT. CL. 28.

TRADEMARKS LLC, RICHMOND, VA:
3,680,345, INT. CL. 34.
3,680,346, INT. CL. 34.
3,680,347, INT. CL. 34.
3,680,348, INT. CL. 34.
3,680,349, INT. CL. 34.
3,680,350, INT. CL. 34.
3,680,351, INT. CL. 34.
3,680,778, INT. CL. 34.

TRADES PUBLISHING INC., LAMBERTVILLE, NJ:
2,260,561, REN. 8-3-09. INT. CL. 16.

TRAFFIC AUDIT BUREAU FOR MEDIA MEASUREMENT, INC., NEW YORK, NY:
3,680,431, INT. CL. 41.

TRAFFICMARKETPLACE, INC., EL SEGUNDO, CA:
3,678,859, PUB. 6-23-2009. INT. CL. 35.

TRAIBER, S.L., 43206 REUS (TARRAGONA), SPAIN:
3,680,193, INT. CL. 10.

TRAN, LIEU, OAKLAND, CA:
3,678,466, PUB. 6-23-2009. INT. CL. 43.

TRANS WORLD NEW YORK, LLC, ALBANY, NY:
1,600,036, REN. 8-3-09. INT. CL. 42.

TRANSAMERICA CORPORATION, CEDAR RAPIDS, IA:
3,679,130, PUB. 6-23-2009. INT. CL. 36.

TRANSCENDIGITAL, INC., LOS ANGELES, CA:
3,679,277, PUB. 6-23-2009. INT. CL. 35.

TRANSCREDIT, INC., JACKSONVILLE, FL:
3,679,240, PUB. 6-23-2009. INT. CL. 36.

TRANSGROUP EXPRESS, INC., SEATTLE, WA:
2,279,043, REN. 8-4-09. INT. CL. 39.

TRANSPORTATION GENERAL, INC., WEST HAVEN, CT:
3,679,314, PUB. 6-23-2009. INT. CL. 39.

TRANSPORTNATION, INC., AUGUSTA, GA:
2,666,172, CANC. INT. CL. 35.

TRANSTEK RECYCLING, INC., MORGANTOWN, KY:
3,355,289, CANC. INT. CL. 40.

TRANZ-SEND BROADCASTING NETWORK, INC, SAN FRANCISCO, CA:
2,665,124, CANC. INT. CL. 38.

TRAPANE, KEVIN E, CRESTLINE, CA:
3,678,998, PUB. 6-23-2009. INT. CL. 9.

TREEHOUSE GROUP, LLC, TEMPE, AZ:
3,678,489, PUB. 6-23-2009. INT. CL. 36.

TREESWING, SEATTLE, WA:
3,678,388, PUB. 6-23-2009. MULTIPLE CLASS, INT. CLS. 36 AND 44.

TREG, INC., REDDING, CA, DBA THE REAL ESTATE GROUP:
3,678,970, PUB. 6-23-2009. INT. CL. 36.

TREL RESTAURANT INC., NEW YORK, NY:
3,678,648, PUB. 6-23-2009. INT. CL. 43.

TRELAY SEED COMPANY, SAINT LOUIS, MO:
3,678,396, PUB. 6-23-2009. INT. CL. 31.

TREMEL, JEANNE M, BROOKLYN, NY:
3,679,057, PUB. 6-23-2009. INT. CL. 20.

TREMENDOUS ENTERTAINMENT, INC., MINNEAPOLIS, MN:
2,665,017, CANC. INT. CL. 9.

TRENCHLESS TECHNOLOGY, INC., PENINSULA, OH:
2,665,983, CANC. INT. CL. 35.

TRENDMASTERS, INC., ST. LOUIS, MO:
2,666,641, CANC. INT. CL. 21.

TRIB TOTAL MEDIA, INC., PITTSBURGH, PA:
3,678,541, PUB. 6-23-2009. INT. CL. 16.

TRIBALFOOTBALL.COM PTY LTD, AUSTRALIA:
3,679,858, PUB. 9-9-2008. MULTIPLE CLASS, INT. CLS. 9, 16, 25, 28, 35, 38 AND 41.

TRIBUNE PARTNERSHIP LIMITED, BUCKINGHAMSHIRE, UNITED KINGDOM AND SERVICE SKILLS INTERNATIONAL LIMITED, LANTAU ISLAND, BR. VIRGIN ISLANDS:
2,664,905, CANC. INT. CL. 16.

TRICERAT, INC., COLUMBIA, MD:
3,679,690, PUB. 6-23-2009. INT. CL. 9.

- TRIDENT MICROSYSTEMS, INC., SUNNYVALE, CA:
3,681,574, INT. CL. 9.
- TRIDONICATCO GMBH & CO. KG, DORNBIERN, AUSTRIA:
3,638,362, COR. MULTIPLE CLASS, INT. CLS. 9 AND 11.
- TRILEGIANT CORPORATION, NORWALK, CT:
3,681,707, MULTIPLE CLASS, INT. CLS. 35 AND 36.
- TRILOGI, INC., LAKELAND, FL:
3,681,363, MULTIPLE CLASS, INT. CLS. 35 AND 36.
- TRIM-GARD COMPANY LIMITED, LONDON, ONTARIO, CANADA:
2,332,326, REN. 8-6-09, INT. CL. 12.
- TRINH TRAN PHARMACEUTICAL COMPANY LIMITED, HO CHI MINH CITY, VIETNAM:
3,679,201, PUB. 6-23-2009, INT. CL. 5.
- TRINITY BAPTIST CHURCH OF SAN ANTONIO, INC., SAN ANTONIO, TX:
3,679,286, PUB. 6-23-2009, INT. CL. 43.
3,679,287, PUB. 6-23-2009, INT. CL. 43.
- TRISTAR PRODUCTIONS, INC., HOUSTON, TX:
3,679,024, PUB. 6-23-2009, INT. CL. 16.
- TRISTAR PRODUCTS, INC., FAIRFIELD, NJ:
3,680,488, INT. CL. 9.
- TROPICAL FOREST FOUNDATION, INC., ALEXANDRIA, VA:
2,214,236, CANC. INT. CL. 41.
- TROPICANA PRODUCTS, INC., BRADENTON, FL:
3,679,564, PUB. 6-23-2009, INT. CL. 32.
- TROY FILTERS, LTD., HILLIARD, OH:
3,678,606, PUB. 6-23-2009, INT. CL. 11.
- TRUCK ARMOR, LLC, PARKSTON, SD:
3,678,311, PUB. 6-23-2009, INT. CL. 12.
3,678,312, PUB. 6-23-2009, INT. CL. 12.
- TRUE WORLD HOLDINGS LLC, FALLS CHURCH, VA:
3,678,398, PUB. 6-23-2009, INT. CL. 29.
- TRUGREEN LIMITED PARTNERSHIP, MEMPHIS, TN:
1,518,305, CANC. INT. CL. 37.
- TRUMPF GMBH + CO. KG, DITZINGEN, FED REP GERMANY:
3,680,779, INT. CL. 9.
- TRUOX, INC., MCCLELLAN, CA:
3,681,145, INT. CL. 5.
- TRUSTEES OF THE UNIVERSITY OF PENNSYLVANIA, THE, PHILADELPHIA, PA:
2,666,043, CANC. INT. CL. 36.
- TSAI, NIECO MING HUAN, VERNON, CA:
2,666,377, CANC. INT. CL. 9.
- TSG SKI & GOLF, LLC, TELLURIDE, CO:
3,680,062, MULTIPLE CLASS, INT. CLS. 16, 20, 21, 28 AND 41.
- TSIHLAS, GEORGE, SACRAMENTO, CA:
3,679,510, PUB. 6-23-2009, INT. CL. 42.
- TTX COMPANY, CHICAGO, IL:
3,681,505, INT. CL. 39.
- TUBCRAFT, WOODBRIDGE, VA:
3,680,135, INT. CL. 37.
- TUFFDOCK SYSTEMS, LLC, GERMANTOWN, OH:
3,680,968, MULTIPLE CLASS, INT. CLS. 9, 11 AND 19.
3,681,064, MULTIPLE CLASS, INT. CLS. 9, 11 AND 19.
- TULALIP TRIBE, TULALIP, WA:
3,678,184, PUB. 6-23-2009, INT. CL. 9.
- TULSA TECHNOLOGY CENTER EDUCATION FOUNDATION INC., TULSA, OK:
3,678,860, PUB. 6-23-2009, INT. CL. 41.
- TUPPERWARE PRODUCTS S.A., FRIBOURG, SWITZERLAND:
3,680,318, INT. CL. 3.
3,680,321, INT. CL. 3.
3,680,322, INT. CL. 3.
3,680,323, INT. CL. 3.
3,680,324, INT. CL. 3.
3,681,017, INT. CL. 3.
3,681,055, INT. CL. 3.
3,681,056, INT. CL. 3.
3,681,059, INT. CL. 3.
3,681,068, INT. CL. 3.
3,681,070, INT. CL. 3.
- TURBO ENGINEERING INTERNATIONAL CORPORATION, WINDSOR, CT:
2,628,578, AM. INT. CL. 7.
- TURNKEY FINANCIAL SOLUTIONS, LP, FLOWER MOUND, TX:
3,681,552, INT. CL. 35.
- TV ONE LLC, SILVER SPRING, MD:
3,678,687, PUB. 6-23-2009, INT. CL. 41.
- TWEEDLE, WILLIAM EDWARD JR., ATLANTIC CITY, NJ:
2,647,058, CANC. INT. CL. 25.
2,647,059, CANC. INT. CL. 25.
- TWEEN BRANDS INVESTMENT, LLC, NEW ALBANY, OH:
3,681,782, INT. CL. 25.
- TWEEN PARENT LLC, NEW YORK, NY:
3,680,616, MULTIPLE CLASS, INT. CLS. 41, 42, 44 AND 45.
- TWENTIETH CENTURY FOX FILM CORPORATION, LOS ANGELES, CA:
3,679,710, PUB. 6-23-2009, INT. CL. 36.
3,679,737, PUB. 6-23-2009, INT. CL. 41.
3,679,739, PUB. 6-23-2009, INT. CL. 38.
- TWIN ANCHORS, INC., CHICAGO, IL:
2,308,390, REN. 7-31-09, INT. CL. 42.
- TWIN CITIES TRIVIA CHALLENGE, LLC, BROOKLYN PARK, MN:
3,681,788, INT. CL. 28.
- TWIN MARQUIS, INC., BROOKLYN, NY:
2,214,669, CANC. MULTIPLE CLASS, INT. CLS. 29 AND 30.
- TWINSTRATA, INC., NATICK, MA:
3,678,494, PUB. 6-23-2009, INT. CL. 42.
- TWINTEL SOLUTIONS, INC., GARDEN GROVE, CA:
3,679,583, PUB. 6-23-2009, INT. CL. 42.
- TY NANT SPRING WATER LIMITED, CEREDIGION SY23 5LS, UNITED KINGDOM:
2,665,475, CANC. INT. CL. 32.
- TYCO ELECTRONICS CORPORATION, BERWYN, PA:
3,681,323, INT. CL. 9.
- TYCO HEALTHCARE GROUP LP, NORTH HAVEN, CT:
3,681,126, INT. CL. 10.
- TYCO INDUSTRIES, INC., MOUNT LAUREL, NJ:
1,518,107, CANC. INT. CL. 28.
- TYCO THERMAL CONTROLS LLC, REDWOOD CITY, CA:
3,678,893, PUB. 6-23-2009, INT. CL. 11.
- TYLER CANDLE COMPANY, L.L.C., TYLER, TX:
3,681,723, INT. CL. 4.
- TYNDALE HOUSE PUBLISHERS INC., CAROL STREAM, IL:
2,667,053, CANC. INT. CL. 41.
- TYSON FOODS, INC., SPRINGDALE, AR:
3,678,906, PUB. 6-23-2009, INT. CL. 29.
- U. S. COEXCELL, INC., MAUMEE, OH:
3,679,432, PUB. 6-23-2009, INT. CL. 20.
- U.S. CHEMICAL STORAGE, LLC, BOONE, NC:
2,665,939, CANC. INT. CL. 6.
- U.S. LAND TITLE, LLC, ATLANTA, GA:
3,680,759, MULTIPLE CLASS, INT. CLS. 36, 38 AND 45.
- U.S. MILLS, LLC, NEEDHAM, MA:
2,214,924, CANC. INT. CL. 30.
- U.S. RUBBER RECYCLING, INC., COLTON, CA:
2,291,569, REN. 8-1-09, INT. CL. 27.
- UBS AG, CH-8001 ZURICH, SWITZERLAND:
2,774,410, CANC. MULTIPLE CLASS, INT. CLS. 9, 16, 35, 38, 41 AND 42.
- UBS FINANCIAL SERVICES INC., WEEHAWKEN, NJ:
1,518,265, CANC. INT. CL. 36.
- UDDEHOLM TOOLING AKTIEBOLAG, HAGFORS, SWEDEN:
2,299,940, REN. 8-2-09, INT. CL. 6.
- UDOR - S.R.L., ITALY:
3,679,939, PUB. 6-23-2009, INT. CL. 7.
- UGIVIS, FRANCE:
3,679,905, PUB. 6-23-2009, INT. CL. 6.
- UHLIG, LLC, OVERLAND PARK, KS:
3,678,237, PUB. 5-13-2008, MULTIPLE CLASS, INT. CLS. 16, 35, 41 AND 42.
3,678,238, PUB. 1-27-2009, MULTIPLE CLASS, INT. CLS. 16, 35, 41 AND 42.

ULTIMATE EVENT SERVICES, LLC, TEMPE, AZ:
 3,679,012, PUB. 6-23-2009. MULTIPLE CLASS, INT. CLS.
 40 AND 44.

ULTIMATE LIFE, INC., THE, SANTA BARBARA, CA:
 2,065,977, CANC. INT. CL. 5.

ULTIMATE MUZZLELOADING PRODUCTS, LLC, AZTEC,
 NM:
 3,680,670, INT. CL. 13.

ULTIMATE TECHNICAL ACADEMY, L.L.C., SAINT PE-
 TERS, MO:
 2,881,276 NEW CERT. 9-8-2009. INT. CL. 41.
 2,972,324 NEW CERT. 9-8-2009. INT. CL. 41.

ULTRA ELECTRONICS ADVANCED TACTICAL SYSTEMS,
 INC., AUSTIN, TX:
 2,273,608. REN. 8-3-09. INT. CL. 9.

ULTRADENT PRODUCTS, INC., SOUTH JORDAN, UT:
 3,681,284, INT. CL. 10.

ULTRATECH, INC., SAN JOSE, CA:
 2,213,787, CANC. INT. CL. 9.

UMICORE AG & CO. KG, FED REP GERMANY:
 3,679,855, PUB. 6-23-2009. MULTIPLE CLASS, INT. CLS.
 1, 6, 9 AND 14.

UNDERWOOD, NEUHAUS & CO. INCORPORATED, JACK-
 SONVILLE, FL:
 1,518,283, CANC. INT. CL. 36.

UNICA CORPORATION, WALTHAM, MA:
 2,666,101, CANC. INT. CL. 9.

UNICOVER CORPORATION, THE, CHEYENNE, WY:
 2,214,788, CANC. INT. CL. 16.

UNIDRAIN A/S, 3520 FARUM, DENMARK:
 3,678,371, PUB. 10-14-2008. MULTIPLE CLASS, INT. CLS.
 11 AND 37.

UNIED STATES LUGGAGE COMPANY, L.P., HAUP-
 PAUGE, NY, AKA UNITED STATES LUGGAGE:
 2,215,164, CANC. INT. CL. 9.

UNIFI, INC., GREENSBORO, NC:
 2,667,070, CANC. INT. CL. 23.

UNIFIED DISPATCH, LLC, ALTADENA, CA:
 3,678,919, PUB. 6-23-2009. INT. CL. 38.

UNIFIED INTELLIGENCE INC., HENDERSON, NV:
 3,679,159, PUB. 6-23-2009. INT. CL. 35.

UNILEVER N.V., ROTTERDAM, NETHERLANDS:
 2,667,008, CANC. INT. CL. 29.

UNILEVER SUPPLY CHAIN, INC., CLINTON, CT:
 2,667,299, CANC. INT. CL. 3.
 3,680,594, INT. CL. 3.

UNIMETA NEDERLAND B.V., 7514 AA ENSCHEDE, NETH-
 ERLANDS:
 2,665,215, CANC. INT. CL. 20.

UNION NATIONAL MORTGAGE CO., STRONGSVILLE,
 OH:
 3,678,589, PUB. 6-23-2009. INT. CL. 36.

UNIQCO, INC., HUNTSVILLE, AL:
 2,665,517, CANC. INT. CL. 33.

UNIQUE BRANDS ENTERPRISES, LLC, CORAL GABLES,
 FL:
 3,678,651, PUB. 6-23-2009. MULTIPLE CLASS, INT. CLS.
 39 AND 43.

UNIQUE PHOTO, INC., FLORHAM PARK, NJ:
 2,335,605. REN. 8-3-09. INT. CL. 35.

UNISEN, INC., IRVINE, CA:
 3,680,717, INT. CL. 28.

UNISHIPERS ASSOCIATION, INC., SALT LAKE CITY, UT:
 1,518,213, CANC. INT. CL. 35.

UNISOURCE WORLDWIDE, INC., NORCROSS, GA, SAXON
 PAPER CORPORATION, NEW YORK, NY:
 672,502. REN. 8-3-09. U.S. CL. 37 (INT. CL. 16).

UNISYS CORPORATION, BLUE BELL, PA:
 2,665,235, CANC. INT. CL. 42.

UNITECH, CENTREVILLE, WV:
 3,678,271, PUB. 6-23-2009. MULTIPLE CLASS, INT. CLS.
 41 AND 42.

UNITED BICYCLE INSTITUTE, ASHLAND, OR, DBA UNI-
 TED BICYCLE INSTITUTE:
 3,679,115, PUB. 6-23-2009. INT. CL. 41.

UNITED BUSINESS BROKERS, INC., MIDVALE, UT:
 2,733,014, COR. INT. CL. 36.

UNITED BUSINESS MEDIA LLC, MANHASSET, NY:
 2,665,082, CANC. INT. CL. 41.

UNITED DAIRYMEN OF ARIZONA, TEMPE, AZ:
 3,679,789, PUB. 6-23-2009. INT. CL. 29.

UNITED FORWARD, INC, BOCA RATON, FL:
 2,666,099, CANC. INT. CL. 6.

UNITED METHODIST PUBLISHING HOUSE, THE, NASH-
 VILLE, TN:
 2,666,823, CANC. INT. CL. 16.

UNITED PARCEL SERVICE OF AMERICA, INC., ATLAN-
 TA, GA:
 2,667,188, CANC. INT. CL. 39.
 3,681,054, INT. CL. 39.

UNITED ROAD SERVICES, INC., ROMULUS, MI:
 3,678,776, PUB. 6-23-2009. MULTIPLE CLASS, INT. CLS.
 35 AND 39.

UNITED STATES DISTILLED PRODUCTS COMPANY,
 PRINCETON, MN:
 3,681,298, INT. CL. 33.
 3,681,353, INT. CL. 33.

UNITED STATES EQUESTRIAN TEAM FOUNDATION,
 INC., GLADSTONE, NJ:
 2,337,710. REN. 8-1-09. INT. CL. 25.

UNITED STATES GYPSUM COMPANY, CHICAGO, IL:
 3,680,725, INT. CL. 19.

UNITED STATES OF AMERICA RUGBY FOOTBALL UN-
 ION, INC., BOULDER, CO, DBA USA RUGBY:
 3,681,246, INT. CL. 16.

UNITED STATES OLYMPIC COMMITTEE, COLORADO
 SPRINGS, CO:
 2,739,462, CANC. MULTIPLE CLASS, INT. CLS. 35 AND
 41.
 2,739,492, CANC. MULTIPLE CLASS, INT. CLS. 16 AND
 35.

UNITED STATES PARACHUTE ASSOCIATION, INC., FRE-
 DERICKSBURG, VA:
 1,548,715. REN. 7-31-09. INT. CL. 42.

UNITED STATES PATENT MODEL FOUNDATION, WA-
 SHINGTON, DC:
 1,518,357, CANC. INT. CL. 41.

UNITED STATES PLAYING CARD COMPANY, THE, CIN-
 CINNATI, OH:
 2,665,172, CANC. INT. CL. 16.

UNITED STATES POSTAL SERVICE, WASHINGTON, DC:
 3,681,639, MULTIPLE CLASS, INT. CLS. 16 AND 25.

UNITED TELECOMP, LLC., TOTOWA, NJ:
 3,678,810, PUB. 6-23-2009. INT. CL. 42.

UNITEDHEALTH GROUP INCORPORATED, MINNETON-
 KA, MN:
 2,679,582, CANC. INT. CL. 16.

UNITUS COMMUNITY CREDIT UNION, PORTLAND, OR:
 3,679,601, PUB. 6-23-2009. INT. CL. 36.

UNIVERSAL CITY STUDIOS LLLP, UNIVERSITY CITY, CA:
 2,292,221. REN. 8-5-09. INT. CL. 41.

UNIVERSAL CITY STUDIOS LLLP, UNIVERSITY CITY, CA:
 3,681,642, INT. CL. 28.

UNIVERSAL STONE, INC., BETHLEHEM, PA:
 2,666,480, CANC. INT. CL. 19.

UNIVERSAL SYNDICATIONS, INC., CANTON, OH:
 3,680,180, MULTIPLE CLASS, INT. CLS. 14, 16 AND 35.

UNIVERSAL WATER SYSTEMS, LLC, ALBUQUERQUE,
 NM:
 3,681,031, INT. CL. 21.

UNIVERSITY AT ALBANY, STATE UNIVERSITY OF NEW
 YORK, ALBANY, NY:
 3,679,373, PUB. 6-23-2009. INT. CL. 25.

UNIVERSITY COMMUNITY HOSPITAL, INC., TAMPA, FL:
 2,767,770, CANC. INT. CL. 36.

UNIVERSITY OF ARIZONA ARTHRITIS CENTER, TUC-
 SON, AZ:
 2,667,032, CANC. INT. CL. 42.

UNIVERSITY OF CENTRAL FLORIDA, ORLANDO, FL:
 2,318,526. REN. 8-1-09. MULTIPLE CLASS, INT. CLS. 9,
 16 AND 42.
 2,665,491, CANC. MULTIPLE CLASS, INT. CLS. 16, 25, 41
 AND 42.

UNIVERSITY OF KENTUCKY, LEXINGTON, KY:
 3,678,908, PUB. 6-23-2009. INT. CL. 44.

- UNIVERSITY OF MARYLAND MEDICAL SYSTEM FOUNDATION, INC., BALTIMORE, MD:
3,678,963, PUB. 6-23-2009. MULTIPLE CLASS, INT. CLS. 25 AND 41.
- UNIVERSITY OF RICHMOND, UNIVERSITY OF RICHMOND, VA:
2,665,930, CANC. MULTIPLE CLASS, INT. CLS. 25 AND 41.
- UNIVERSITY OF WASHINGTON, SEATTLE, WA:
2,667,112, CANC. MULTIPLE CLASS, INT. CLS. 38, 41 AND 42.
3,681,739, INT. CL. 41.
- UNIVERSITY PRODUCTS, INC., HOLYOKE, MA:
2,665,682, CANC. INT. CL. 16.
- UNIVEX LICENSING GROUP, INC., NEW CANAAN, CT:
1,518,497, CANC. INT. CL. 42.
- UNIVISION COMMUNICATIONS INC., LOS ANGELES, CA:
3,680,919, INT. CL. 35.
- UNLIMITED CAD SERVICES, LLC, PACIFIC PALISADES, CA:
3,681,424, MULTIPLE CLASS, INT. CLS. 35 AND 39.
- UPCOMING TM S.A., LUXEMBOURG, LUXEMBOURG:
3,680,108, MULTIPLE CLASS, INT. CLS. 18 AND 25.
- UPMC MERCY, PITTSBURGH, PA:
2,215,176, CANC. MULTIPLE CLASS, INT. CLS. 35 AND 42.
- UPPER SKAGIT INDIAN TRIBE, THE, BOW, WA, DBA SKAGIT VALLEY CASINO RESORT:
2,735,419, CANC. INT. CL. 16.
- UPPERCASE LIVING, LLC, SANDY, UT:
3,678,952, PUB. 6-23-2009. INT. CL. 16.
3,678,953, PUB. 6-23-2009. INT. CL. 35.
- URBAN MINISTRIES, INC., CALUMET CITY, IL:
2,262,239, REN. 7-31-09. INT. CL. 16.
- URBANSTONE PTY LTD., JANDAKOT, WESTERN AUSTRALIA, AUSTRALIA:
2,665,425, CANC. INT. CL. 19.
- URCUTE ENTERTAINMENT, LLC, BRIDGEPORT, CT:
3,681,648, INT. CL. 20.
- URETEK USA, INC., TOMBALL, TX:
3,679,164, PUB. 6-23-2009. INT. CL. 37.
3,679,165, PUB. 6-23-2009. INT. CL. 37.
3,679,167, PUB. 6-23-2009. INT. CL. 37.
3,679,168, PUB. 6-23-2009. INT. CL. 37.
- US AIRWAYS, INC., TEMPE, AZ:
2,261,361, REN. 8-5-09. INT. CL. 39.
2,261,361, AM. INT. CL. 39.
- US LEC CORP., CHARLOTTE, NC:
2,213,670, CANC. INT. CL. 42.
- USA FRAMETEK, LTD., ROUND ROCK, TX:
2,666,611, CANC. INT. CL. 6.
- USANA HEALTH SCIENCES, INC., SALT LAKE CITY, UT:
2,291,813, REN. 8-3-09. INT. CL. 5.
- USERSPACE CORPORATION, KIRKLAND, WA:
2,667,271, CANC. INT. CL. 42.
- USINOR INDUSTRIEL (FRANCE), PUTEAUX, FRANCE:
2,666,527, CANC. MULTIPLE CLASS, INT. CLS. 6 AND 40.
- UZIN UTZ AKTIENGESELLSCHAFT, FED REP GERMANY:
3,679,921, PUB. 6-23-2009. MULTIPLE CLASS, INT. CLS. 7 AND 8.
- V-ENABLE, INC., SAN DIEGO, CA:
3,680,625, INT. CL. 38.
- VACCUMSCHMELZE GMBH & CO. KG, HANAU, FED REP GERMANY:
2,280,279, REN. 7-31-09. MULTIPLE CLASS, INT. CLS. 6, 7 AND 9.
- VACUUMSCHMELZE GMBH & CO. KG, HANAU, FED REP GERMANY:
2,268,263, REN. 8-3-09. INT. CL. 6.
2,271,497, REN. 8-3-09. INT. CL. 6.
- VAIL MOUNTAIN SCHOOL, VAIL, CO:
3,678,386, PUB. 6-23-2009. INT. CL. 36.
- VALENITE, LLC, MADISON HEIGHTS, MI:
3,680,884, INT. CL. 7.
- VALENTI BUILDERS, INC., NORTHFIELD, IL:
3,678,881, PUB. 6-23-2009. INT. CL. 37.
- VALERO MARKETING AND SUPPLY COMPANY, SAN ANTONIO, TX, DBA TA:
3,678,724, PUB. 6-23-2009. INT. CL. 40.
- VALLEJO, MARICELA, RANCHO CUCAMONGA, CA:
3,678,178, PUB. 6-23-2009. INT. CL. 9.
- VALLEY GROUP HOSPITAL SERVICE CORPORATION, HARLINGEN, TX:
2,666,295, CANC. INT. CL. 44.
- VALUE GARDEN SUPPLY, LLC, ST. JOSEPH, MO:
2,667,136, CANC. INT. CL. 1.
- VALUSOFT, INC., WACONIA, MN:
2,667,350, CANC. INT. CL. 9.
- VANDERBILT UNIVERSITY, NASHVILLE, TN:
2,665,695, CANC. MULTIPLE CLASS, INT. CLS. 16, 21, 25 AND 41.
- VANDOR CORPORATION, RICHMOND, IN:
3,678,766, PUB. 6-23-2009. INT. CL. 20.
- VANPORT COFFEE COMPANY, LLC, PORTLAND, OR:
3,679,329, PUB. 6-23-2009. MULTIPLE CLASS, INT. CLS. 30 AND 43.
- VANRICH CASTING CORP., PORTLAND, OR:
1,518,302, CANC. INT. CL. 37.
- VARIAN MEDICAL SYSTEMS, INC., PALO ALTO, CA:
3,681,496, INT. CL. 9.
- VARSAM, GEORGE, FLUSHING, NY:
3,681,127, INT. CL. 30.
- VAST RESOURCES, INC., CHATSWORTH, CA:
3,681,544, MULTIPLE CLASS, INT. CLS. 3 AND 10.
- VAST.COM, INC., SAN FRANCISCO, CA:
3,680,715, INT. CL. 42.
- VATTEROTT EDUCATIONAL CENTERS, INC., BERKELEY, MO:
3,681,693, INT. CL. 41.
- VAYBEE.COM AG, KOLN 50933, FED REP GERMANY:
2,665,232, CANC. INT. CL. 38.
- VCH TRADEMARK, INC., ORLANDO, FL:
1,518,343, CANC. INT. CL. 39.
- VEACH, DALE, LOCUST GROVE, GA:
3,681,339, INT. CL. 41.
- VECTOR CORPORATION, MARION, IA:
3,678,691, PUB. 6-23-2009. MULTIPLE CLASS, INT. CLS. 7 AND 9.
- VEDANTE, BOULDER, CO:
3,681,109, INT. CL. 25.
- VEDENTE CORPORATION, BOULDER, CO:
3,681,158, INT. CL. 9.
- VELONATION LLC, CHEVY CHASE, MD:
3,681,206, MULTIPLE CLASS, INT. CLS. 41 AND 42.
- VENDOR DEVELOPMENT GROUP, INC., GOLDEN VALLEY, MN:
3,681,487, INT. CL. 20.
- VENEERCRETE, LLC, JENSEN BEACH, FL:
3,680,562, INT. CL. 19.
- VENTURA FOODS, LLC, BREA, CA, COTTON PRODUCTS COMPANY, INC., OPELOUSAS, LA, DOING BUSINESS AS OPELOUSAS OIL REFINERY AND ALSO AS OPELOUSAS OIL MILL:
368,868, REN. 8-3-09. U.S. CL. 46 (INT. CL. 29).
- VENTURE MILLING, INC., SALISBURY, MD:
2,666,831, CANC. MULTIPLE CLASS, INT. CLS. 5 AND 31.
- VENTURE RESEARCH INC., PLANO, TX:
3,679,712, PUB. 6-23-2009. INT. CL. 9.
- VENUS WAFERS, INC., HINGHAM, MA:
3,681,255, INT. CL. 30.
- VERACOM, L.L.C., WICHITA, KS:
2,665,056, CANC. INT. CL. 42.
- VERANDAGLOBAL.COM, INC., CLEARWATER, FL, DBA FIRST PLACE INTERNET, INC.:
3,678,717, PUB. 6-23-2009. INT. CL. 39.
- VERISIGN, INC., MOUNTAIN VIEW, CA:
3,679,020, PUB. 6-23-2009. INT. CL. 45.
3,679,021, PUB. 6-23-2009. INT. CL. 45.
3,679,022, PUB. 6-23-2009. INT. CL. 45.
- VERMATIC, INC., NEW BERLIN, WI:
2,366,234, REN. 8-5-09. INT. CL. 6.

- VERMONT FISH & WILDLIFE DEPARTMENT, WATERBURY, VT:
3,678,622, PUB. 6-23-2009. MULTIPLE CLASS, INT. CLS. 8, 16, 20 AND 21.
- VERMONT PURE HOLDINGS, LTD., WHITE PLAINS, NY:
1,692,202, CANC. MULTIPLE CLASS, INT. CLS. 32 AND 42.
- VERONICA CHONG, LLC, FRISCO, TX:
3,680,885, INT. CL. 25.
- VERSO VERILINK, LLC F/K/A WINSLOW ASSET HOLDINGS, LLC, MADISON, AL:
2,666,759, CANC. INT. CL. 9.
- VERSUS, L.P., PHILADELPHIA, PA:
3,440,499, AM. INT. CL. 41.
- VERTEC BIOSOLVENTS, INC., DOWNERS GROVE, IL:
3,679,305, PUB. 6-23-2009. INT. CL. 1.
- VERY BEARY VENTURE I, LLC, AGOURA HILLS, CA:
2,666,241, CANC. INT. CL. 35.
- VERY FETCHING COMPANY, INC., NEW YORK, NY:
3,678,543, PUB. 6-23-2009. INT. CL. 3.
- VETERANS OBSERVER, THE, CANOGA PARK, CA:
2,666,637, CANC. INT. CL. 16.
- VETPREP CORP., SAN DIEGO, CA:
3,678,317, PUB. 6-23-2009. MULTIPLE CLASS, INT. CLS. 25 AND 41.
- VEYANCE TECHNOLOGIES, INC., FAIRLAWN, OH:
3,680,406, MULTIPLE CLASS, INT. CLS. 35 AND 40.
- VIACOM INTERNATIONAL INC., NEW YORK, NY:
2,214,771, CANC. INT. CL. 41.
3,680,640, INT. CL. 39.
- VIALUXE INC., SUNNYVALE, CA:
3,679,796, PUB. 6-10-2008. INT. CL. 45.
- VIBRANT BRAINS LLC, SAN FRANCISCO, CA:
3,680,540, INT. CL. 41.
- VIC FIRTH, INC., BOSTON, MA:
2,320,589, REN. 8-3-09. INT. CL. 15.
- VICEROY CERAMICS, INC., UPPER SANDUSKY, OH:
3,680,925, INT. CL. 27.
- VICTOR M. KASATSHKO, TARPON SPRINGS, FL:
3,680,699, INT. CL. 36.
- VICTOR SABINO, SCOTTSDALE, AZ, DBA SABINO INTERNATIONAL, LLC:
3,679,254, PUB. 6-23-2009. INT. CL. 3.
- VICTORIA'S SECRET STORES BRAND MANAGEMENT, INC., REYNOLDSBURG, OH:
2,667,059, CANC. INT. CL. 3.
2,667,068, CANC. INT. CL. 25.
2,667,100, CANC. INT. CL. 8.
2,667,339, CANC. INT. CL. 3.
3,681,436, INT. CL. 3.
- VICTORY INTERNATIONAL GROUP, INC., NORCROSS, GA:
3,678,574, PUB. 6-23-2009. INT. CL. 11.
- VIDEOEGG, INC., SAN FRANCISCO, CA:
3,679,776, PUB. 6-23-2009. INT. CL. 35.
- VIENNA PEDIATRIC DENTISTRY, P.C., VIENNA, VA, DBA VIENNAPEDIATRIC DENTISTRY:
3,681,706, INT. CL. 44.
- VISSMANN KÄLTETECHNIK AG, HOF, FED REP GERMANY:
3,678,631, PUB. 6-23-2009. MULTIPLE CLASS, INT. CLS. 6, 11, 12, 20, 35, 37 AND 39.
- VIEWZI, INC., DALLAS, TX:
3,680,279, INT. CL. 42.
- VILLAGE RESORTS, LTD., KINGSTOWN 5, JAMAICA:
2,664,981, CANC. INT. CL. 39.
- VILLAMA MUSIC, INC., MINNEAPOLIS, MN:
2,667,343, CANC. INT. CL. 9.
- VINA CASA SILVA S.A., SAN FERNANDO, CHILE:
3,681,601, INT. CL. 33.
- VINAS, RICARDO, LOS ANGELES, CA:
3,678,294, PUB. 6-23-2009. INT. CL. 9.
- VINIFICADORA ACONCAGUA S.A., SAN ISIDRO, ARGENTINA:
3,680,627, INT. CL. 33.
- VINTAGE PHARMACEUTICALS, LLC, HUNTSVILLE, AL:
3,681,267, INT. CL. 5.
- VINTAGE WINE ESTATES, INC., WINDSOR, CA:
3,681,690, MULTIPLE CLASS, INT. CLS. 33 AND 35.
- VIRGO PUBLISHING, INC., PHOENIX, AZ:
2,667,430, CANC. INT. CL. 16.
- VIRTUAL INVENTORIES, INC., LENEXA, KS:
3,679,234, PUB. 6-23-2009. INT. CL. 35.
- VIÑEDOS Y BODEGAS PABLO, S.C, ALMONACID DE LA SIERRA, SPAIN:
3,680,584, INT. CL. 33.
- VISA INTERNATIONAL SERVICE ASSOCIATION, FOSTER CITY, CA:
1,549,454, REN. 7-31-09. MULTIPLE CLASS, INT. CLS. 35, 36, 38 AND 42.
3,680,861, INT. CL. 35.
3,680,862, INT. CL. 35.
- VISATAXES, INC., LEWES, DE:
3,522,859, CANC. INT. CL. 35.
- VISCAPE LTD., ARLINGTON, VA:
3,680,637, INT. CL. 43.
3,680,638, INT. CL. 39.
3,680,639, INT. CL. 42.
- VISION CAPITAL MANAGEMENT CORPORATION, DAVIDSON, NC:
2,666,085, CANC. MULTIPLE CLASS, INT. CLS. 35 AND 36.
- VISION GLOBAL, SAN DIEGO, CA:
3,679,813, PUB. 6-23-2009. INT. CL. 16.
- VISION OPTICS TECHNOLOGIES LTD., LOUISVILLE, KY:
3,678,831, PUB. 3-17-2009. INT. CL. 2.
- VISIONSERVE ALLIANCE, INC., ST. LOUIS, MO:
3,681,057, INT. CL. 35.
- VISTA MEDIA GROUP, INC., BATON ROUGE, LA:
3,394,937, CANC. INT. CL. 35.
- VISUALIMITS, LLC, HENDERSON, MI:
3,681,590, MULTIPLE CLASS, INT. CLS. 9, 35 AND 41.
- VITA ZAHNFABRIK H. RAUTER GMBH & CO. KG, BAD SACKINGEN, FED REP GERMANY, VITA ZAHNFABRIK H. RAUTER K.G., SACKINGEN, FED REP GERMANY:
873,134, REN. 8-1-09. U.S. CL. 44 (INT. CLS. 5 AND 10).
- VITA-PAKT CITRUS PRODUCTS CO., COVINA, CA, BIRELEY'S INC., HOLLYWOOD, CA:
370,634, REN. 8-5-09. U.S. CL. 45 (INT. CL. 32).
- VITACOST.COM INC., BOCA RATON, FL:
3,680,297, INT. CL. 5.
- VITAL VOICES GLOBAL PARTNERSHIP, WASHINGTON, DC:
3,678,627, PUB. 6-23-2009. INT. CL. 41.
- VITAMIN COTTAGE II, LLC, LAKEWOOD, CO:
2,697,734, COR. MULTIPLE CLASS, INT. CLS. 5 AND 35.
- VITAMIN WORLD, INC., RONKONKOMA, NY:
2,316,726, REN. 8-4-09. INT. CL. 16.
2,316,727, REN. 8-3-09. INT. CL. 16.
- VITANZA, MARK, WOODLAND HILLS, CA:
2,664,962, CANC. INT. CL. 25.
- VIVERITO & ALTMAN, INC., NEW YORK, NY:
2,666,288, CANC. INT. CL. 42.
- VIZ MEDIA, LLC, SAN FRANCISCO, CA:
3,681,509, INT. CL. 25.
3,681,510, INT. CL. 28.
- VKR HOLDING A/S, 2970 HØRSBOLM, DENMARK:
1,547,446, REN. 8-3-09. INT. CL. 22.
- VNU BUSINESS MEDIA, INC., NEW YORK, NY:
2,666,937, CANC. INT. CL. 16.
- VODKA SLAVIANSKAYA LIMITED, LONDON, UNITED KINGDOM:
3,679,805, PUB. 9-20-2005. INT. CL. 33.
- VOGEL PAINT, INC., ORANGE CITY, IA:
1,570,533, REN. 8-5-09. INT. CL. 2.
- VOICEWRITE DIGITAL, INC., NEW ORLEANS, LA:
3,681,562, INT. CL. 38.
- VOLVO COMMERCIAL FINANCE LLC THE AMERICAS, GREENSBORO, NC:
2,665,844, CANC. INT. CL. 42.
2,665,845, CANC. INT. CL. 42.
- VOMED VOLZER MEDIZINTECHNIK; GMBH & CO. KG, FED REP GERMANY:
3,680,022, PUB. 6-23-2009. INT. CL. 10.

- VOMRAIS INNOVATIONS, INC., CHANDLER, AZ:
3,681,629, INT. CL. 5.
3,681,630, INT. CL. 10.
- VON LEE INTERNATIONAL SCHOOL OF AESTHETICS,
INC., PIKESVILLE, MD:
3,626,904, COR. INT. CL. 44.
3,626,905, COR. INT. CL. 44.
- VONAGE MARKETING LLC, HOLMDEL, NJ:
3,681,594, MULTIPLE CLASS, INT. CLS. 9 AND 38.
- VONDERHEIDE, GREGORY J., WESLEY CHAPEL, FL:
3,680,342, INT. CL. 45.
- VOSS OF NORWAY ASA, OSLO, NORWAY:
3,678,547, PUB. 6-23-2009, INT. CL. 36.
3,678,548, PUB. 6-23-2009, INT. CL. 36.
- VOX R&D LIMITED, BLETCHLEY, UNITED KINGDOM:
3,679,828, PUB. 9-25-2007, INT. CL. 9.
- VOYETRA TURTLE BEACH, INC., YONKERS, NY:
2,666,399, CANC. INT. CL. 9.
- VT HALTER MARINE, INC., PASCAGOULA, MS:
3,679,007, PUB. 5-19-2009, MULTIPLE CLASS, INT. CLS.
37 AND 42.
- VI BBQ & CAFE, DULUTH, GA:
3,678,677, PUB. 6-23-2009, INT. CL. 43.
- W. DÖLLKEN & CO. GMBH, GLADBECK, FED REP
GERMANY:
3,550,292, COR. MULTIPLE CLASS, INT. CLS. 19 AND
20.
- W. L. GORE & ASSOCIATES, INC., NEWARK, DE:
2,667,276, CANC. INT. CL. 9.
- W.I.N.O.S., INC., BLOWING ROCK, NC:
3,680,904, INT. CL. 36.
- W.T.F., INC., KANSAS CITY, MO, DBA MHS CASTER &
EQUIPMENT CO.:
2,666,296, CANC. MULTIPLE CLASS, INT. CLS. 6, 12
AND 20.
- W-H CORPORATION, CENTRAL FALLS, RI, WHITTET-
HIGGINS COMPANY, PROVIDENCE, RI:
442,798, REN. 7-31-09, U.S. CL. 13 (INT. CL. 6).
- WABASH NATIONAL L.P., LAFAYETTE, IN:
1,547,270, REN. 8-1-09, INT. CL. 12.
- WACKENHUT CORRECTIONS CORPORATION, PALM
BEACH GARDENS, FL:
2,664,912, CANC. MULTIPLE CLASS, INT. CLS. 35 AND
42.
2,664,913, CANC. MULTIPLE CLASS, INT. CLS. 35 AND
42.
- WAGNER'S, LLC, PURCHASE, NJ:
2,215,554, CANC. INT. CL. 31.
- WAKEBY FIRE AND ASSOCIATES, LLC, MASHPEE, MA:
3,681,404, INT. CL. 35.
- WAKEFERN FOOD CORP., KEASBEY, NJ:
3,681,027, INT. CL. 28.
- WAL-MART STORES, INC., BENTONVILLE, AK:
2,214,702, CANC. INT. CL. 32.
2,214,712, CANC. INT. CL. 32.
- WAL-MART STORES, INC., BENTONVILLE, AR:
2,260,658, REN. 8-3-09, INT. CL. 18.
- WAL-MART STORES, INC., BENSTONVILLE, AR:
2,260,679, REN. 8-3-09, INT. CL. 18.
- WAL-MART STORES, INC., BENTONVILLE, AR:
3,680,211, INT. CL. 35.
3,681,104, INT. CL. 35.
- WALBRO ENGINE MANAGEMENT, L.L.C., TUCSON, AZ:
3,678,282, PUB. 6-23-2009, MULTIPLE CLASS, INT. CLS.
6, 7, 9, 12 AND 17.
- WALDEMAR LINK GMBH & CO. KG, HAMBURG, FED
REP GERMANY:
2,665,703, CANC. INT. CL. 10.
- WALDREP, LISA JANKS, THOUSAND OAKS, CA:
3,679,662, PUB. 6-23-2009, MULTIPLE CLASS, INT. CLS.
41 AND 45.
3,679,743, PUB. 6-23-2009, INT. CL. 41.
- WALGREEN CO., DEERFIELD, IL:
3,679,751, PUB. 6-23-2009, INT. CL. 5.
- WALKAWAY CANADA INCORPORATED, TORONTO, ON-
TARIO, CANADA:
3,678,345, PUB. 6-23-2009, INT. CL. 36.
- WALKER, MICAH SHARAI, HOUSTON, TX:
3,681,067, INT. CL. 41.
- WALKER, PAT, BELTON, MO, DBA BEARHEART DE-
SIGNS:
2,665,442, CANC. INT. CL. 25.
- WALLEN, PATRICK HAROLD, SAN RAFAEL, CA, DBA
ARTISTIC WINE CELLARS AND WALLEN, MADELINE
F, SAN RAFAEL, CA, DBA ARTISTIC WINE CELLARS:
3,678,847, PUB. 3-17-2009, INT. CL. 20.
- WALSH, BERNARD, URGLIN, IRELAND:
3,680,689, INT. CL. 33.
- WALSH, JOHN G., MENANDS, NY:
3,681,003, INT. CL. 25.
- WALTER ELECTRONIC CO., LTD., TAIPEI, TAIWAN:
2,263,139, REN. 8-4-09, INT. CL. 9.
- WALTER KIDDE PORTABLE EQUIPMENT INC., MEBANE,
NC:
2,259,768, REN. 8-3-09, INT. CL. 9.
- WAMPFLER AG, FED REP GERMANY:
2,664,926, CANC. MULTIPLE CLASS, INT. CLS. 6, 7 AND
9.
- WAMPOLE LABORATORIES, LLC, PRINCETON, NJ:
3,679,079, PUB. 6-23-2009, INT. CL. 5.
- WARD, MARK DUANE, DALLAS, TX:
2,666,561, CANC. INT. CL. 41.
- WARD, STANTON, LAWTON, OK:
3,678,475, PUB. 6-23-2009, MULTIPLE CLASS, INT. CLS.
30 AND 43.
- WARNER CHILCOTT COMPANY, LLC, FAJARDO, PUER-
TO RICO:
2,289,177, REN. 8-3-09, INT. CL. 5.
- WARNER ELECTRIC TECHNOLOGY LLC, BRAINTREE,
MA, WARNER ELECTRIC BRAKE & CLUTCH COM-
PANY, SOUTH BELOIT, IL:
681,746, REN. 7-31-09, U.S. CL. 21 (INT. CL. 7).
- WARNER-ELEKTRA-ATLANTIC CORPORATION, NEW
YORK, NY:
3,680,230, MULTIPLE CLASS, INT. CLS. 9, 35 AND 41.
- WARNER-LAMBERT COMPANY, PARSIPPANY, NJ:
2,678,284, CANC. INT. CL. 30.
- WARNER-LAMBERT COMPANY LLC, NEW YORK, NY:
2,362,489, REN. 8-1-09, INT. CL. 5.
- WARNOCK HERSEY PROFESSIONAL SERVICES LTD.,
LASALLE, QUEBEC, CANADA:
1,518,406, CANC. INT. CL. 42.
- WASHINGTON CAPITALS L.P., LANDOVER, MD:
2,200,047, REN. 7-31-09, INT. CL. 41.
- WASHINGTON NATIONAL INSURANCE COMPANY, LIN-
COLNSHIRE, IL:
1,518,243, CANC. INT. CL. 36.
- WASHINGTON/BALTIMORE CELLULAR TELEPHONE
COMPANY, GREENBELT, MD TO CELLULAR ONE
PROPERTIES, LLC, OKLAHOMA CITY, OK:
1,518,318, CANC. INT. CL. 38.
- WASTE CRETE SYSTEMS, LLC., HOUSTON, TX:
3,678,329, PUB. 6-23-2009, MULTIPLE CLASS, INT. CLS.
39 AND 40.
- WASTE MANAGEMENT, INC., HOUSTON, TX:
3,678,531, PUB. 6-23-2009, INT. CL. 40.
- WATCHDOG GROUP LC, ST. LOUIS, MO:
3,681,716, INT. CL. 9.
- WATER ENVIRONMENT FEDERATION, ALEXANDRIA,
VA:
2,223,536, REN. 8-1-09, MULTIPLE CLASS, INT. CLS. 35
AND 42.
- WATER GREMLIN CO., WHITE BEAR LAKE, MN:
3,679,141, PUB. 6-23-2009, MULTIPLE CLASS, INT. CLS. 9
AND 28.
- WATER JOURNEY LTD., LIVINGSTON, NJ:
2,214,449, CANC. INT. CL. 5.
- WATER TIGHT TECHNOLOGIES, LLC, PAYSON, AZ:
3,678,916, PUB. 6-23-2009, INT. CL. 2.
- WATERWORKS IP CO., LLC, DANBURY, CT:
1,122,575, REN. 8-3-09, INT. CL. 42.
- WATSON PHARMACEUTICALS, INC., CORONA, CA:
1,759,395, AM. INT. CL. 5.
3,680,666, INT. CL. 5.
3,681,361, INT. CL. 5.

WAUSAU FINANCIAL SYSTEMS, INC., MOSINEE, WI:
2,666,966, CANC. INT. CL. 9.

WAVESPLITTER TECHNOLOGIES, INC., FREMONT, CA:
2,665,030, CANC. INT. CL. 9.
2,665,381, CANC. INT. CL. 9.

WEA LATINA INC., MIAMI BEACH, FL:
2,215,204, CANC. INT. CL. 9.

WEALTHTEC, LLC, CLARKSVILLE, MD:
3,679,479, PUB. 6-23-2009. INT. CL. 9.

WEAST, SUZANNE, DEL MAR, CA:
3,680,834, INT. CL. 21.

WEAVER, DAVID L., COATESVILLE, PA:
3,681,680, INT. CL. 7.

WEB&CIRCUS AS, NORWAY:
3,680,037, PUB. 6-23-2009. MULTIPLE CLASS, INT. CLS.
28, 35, 41 AND 42.

WEBER & OTT AG, FED REP GERMANY:
3,679,852, PUB. 5-16-2006. INT. CL. 25.
3,679,853, PUB. 5-16-2006. INT. CL. 25.

WEBMD, INC., ATLANTA, GA:
2,665,254, CANC. MULTIPLE CLASS, INT. CLS. 9 AND
41.
2,666,972, CANC. MULTIPLE CLASS, INT. CLS. 35 AND
42.

WEBQUEST INTERNATIONAL, INCORPORATED, MIND-
EN, NV:
2,665,261, CANC. INT. CL. 41.

WEIGHT WATCHERS INTERNATIONAL, INC., NEW
YORK, NY:
2,272,683, REN. 8-4-09. INT. CL. 9.

WEINER, GABRIEL I., LOS ANGELES, CA:
3,681,662, INT. CL. 9.

WEINER, LORI, BOCA RATON, FL AND STONER, JODI,
BOCA RATON, FL:
3,481,849, CANC. INT. CL. 16.

WEINSTEIN, LEE, ROSLYN HTS, NY:
2,214,423, CANC. INT. CL. 42.

WEINSTOCK, DAVID M., EDMONDS, WA:
3,679,350, PUB. 6-23-2009. INT. CL. 9.

WELCHER, ROBERT B., COLUMBUS, OH, DBA RESTAU-
RANT CONSULTANTS, INC.:
3,679,681, PUB. 6-23-2009. INT. CL. 35.

WELLPOINT, INC., INDIANAPOLIS, IN:
2,213,932, CANC. INT. CL. 36.
2,665,401, CANC. INT. CL. 35.

WENDLER GMBH, 72379 HECHINGEN, FED REP GER-
MANY AND BLINDAJES ALEMANES SA DE CV, 55340
MEXICO CITY, MEXICO:
2,676,043, CANC. INT. CL. 6.

WENGER CORPORATION, OWATONNA, MN:
3,680,411, INT. CL. 15.

WENGER'S FEED MILL, INC., RHEEMS, PA:
3,681,208, INT. CL. 9.

WEQ LLC, KENT, OH:
3,681,071, INT. CL. 41.

WERMA HOLDING GMBH + CO. KG, FED REP GER-
MANY:
3,679,937, PUB. 6-23-2009. INT. CL. 9.

WERNER WATTINGER, GENEVA, SWITZERLAND:
3,679,271, PUB. 6-23-2009. INT. CL. 7.

WESCAM INC., BURLINGTON ONTARIO, CANADA:
3,678,219, PUB. 6-23-2009. INT. CL. 9.

WEST COAST DENTAL, LOS ANGELES, CA:
3,679,511, PUB. 6-23-2009. INT. CL. 44.

WEST PENN ALLEGHENY HEALTH SYSTEM, PITTS-
BURGH, PA:
3,680,376, INT. CL. 35.

WESTBOUND BANK, KATY, TX:
3,680,940, INT. CL. 36.

WESTERN FAMILY FOODS, INC., TIGARD, OR:
3,680,239, MULTIPLE CLASS, INT. CLS. 29, 30 AND 32.

WESTERN TEMPORARY SERVICES, INC., WALNUT
CREEK, CA:
1,518,233, CANC. INT. CL. 35.

WESTHEIMER CORPORATION, NORTHBROOK, IL:
1,517,914, CANC. INT. CL. 15.

WESTLAKE CONSULTING GROUP, INC., NEWBURY
PARK, CA:
2,665,112, CANC. INT. CL. 9.

WESTON SOLUTIONS (IPR), INC., WEST CHESTER, PA:
1,566,410, REN. 8-3-09. INT. CL. 40.

WFAA-TV, INC., DALLAS, TX:
3,680,541, MULTIPLE CLASS, INT. CLS. 35 AND 41.

WGBH EDUCATIONAL FOUNDATION, BOSTON, MA:
2,341,567, REN. 8-6-09. INT. CL. 41.

WHARTON, R. P., HOUSTON, TX:
2,213,696, CANC. INT. CL. 35.

WHATALOVELYHOME, LLC, CLEVELAND, OH:
3,678,297, PUB. 6-23-2009. INT. CL. 35.

WHEAT FIELD WIND POWER PROJECT LLC, HOUSTON,
TX:
3,678,719, PUB. 6-23-2009. INT. CL. 40.

WHEATLEY, TERRY, HUGHSON, CA:
3,680,665, INT. CL. 33.

WHITE SMILE TECHNOLOGIES, LLC, NAPLES, FL:
3,678,656, PUB. 6-23-2009. INT. CL. 3.

WHITE, CHRISTOPHER B, SAN JOSE, CA, DBA NEX-
CHANGE:
3,679,713, PUB. 6-23-2009. INT. CL. 35.

WHITE, KEVIN, TODD, NC:
3,679,544, PUB. 6-23-2009. INT. CL. 41.

WHITE, KRISTEN, ST. LOUIS, MO:
3,679,447, PUB. 6-23-2009. INT. CL. 41.

WHITE, MAURICE, MOBILE, AL:
2,666,093, CANC. INT. CL. 35.

WHITE, RICK M, HERMOSA BEACH, CA:
3,681,388, INT. CL. 22.

WHITEFLASH.COM, INC., HOUSTON, TX:
3,678,323, PUB. 6-23-2009. INT. CL. 14.

WHITEHILL ORAL TECHNOLOGIES, INC., STAFFORD,
TX:
2,215,544, CANC. INT. CL. 10.

WHITETAIL INSTITUTE OF NORTH AMERICA, INC.,
PINTLALA, AL:
2,363,722, REN. 8-4-09. INT. CL. 31.

WHITMIRE MICRO-GEN RESEARCH LABORATORIES,
INC., ST. LOUIS, MO:
3,680,158, INT. CL. 5.

WHOLE LEAF CO., LLC, SALINAS, CA:
2,267,861, REN. 8-3-09. INT. CL. 31.

WICK'S PIES, INC., WINCHESTER, IN:
1,548,539, REN. 8-4-09. INT. CL. 30.

WIDEPENWEST NETWORKS, LLC, CASTLE ROCK, CO:
2,665,321, CANC. INT. CL. 38.

WIDGEROW, ALAN D, SANDTON, GAUTENG, SOUTH
AFRICA AND DEVILLIERS, MALAN, LYTTLETON,
SOUTH AFRICA:
3,678,891, PUB. 6-23-2009. INT. CL. 5.

WIGIX, INC., OAKLAND, CA, DBA WWW.WIGIX.COM:
3,678,416, PUB. 6-23-2009. INT. CL. 35.

WIGWAM MILLS, INC., SHEBOYGAN, WI:
3,482,545, COR. MULTIPLE CLASS, INT. CLS. 3 AND 25.

WILBERT, CATHERINE, MANDEVILLE, LA:
3,679,639, PUB. 6-23-2009. INT. CL. 30.

WILBUR CURTIS COMPANY, MONTEBELLO, CA:
3,680,110, INT. CL. 9.

WILCOX BANCSHARES, INC., GRAND RAPIDS, MN:
3,678,862, PUB. 6-23-2009. INT. CL. 36.

WILD PLANET FOODS, INC., MCKINLEYVILLE, CA:
3,679,090, PUB. 6-23-2009. INT. CL. 31.

WILDE TOOL CO., INC., HIAWATHA, KS:
1,552,534, REN. 8-5-09. INT. CL. 8.

WILDERNESS SYSTEMS, INC., HIGH POINT, NC TO
CONFLUENCE HOLDINGS CORP., TRINITY, NC:
2,214,870, CANC. INT. CL. 12.

WILEY PUBLISHING, INC., HOBOKEN, NJ:
2,742,153, CANC. INT. CL. 41.

WILINSKI, CHRISTOPHER, J., CAPISTRANO BEACH, CA:
2,667,280, CANC. INT. CL. 6.

WILLAMETTE VALLEY VINEYARDS, INC., TURNER, OR:
3,679,634, PUB. 6-23-2009. INT. CL. 33.

WILLARD AGRI-SERVICE, INC., WORTON, MD:
3,680,776, MULTIPLE CLASS, INT. CLS. 42 AND 44.

- WILLIAM A. GRAHAM COMPANY, PHILADELPHIA, PA, DBA THE GRAHAM COMPANY:
3,679,211, PUB. 6-23-2009. INT. CL. 41.
- WILLIAM J. LALLY, ORLANDO, FL:
3,678,518, PUB. 6-23-2009. MULTIPLE CLASS, INT. CLS. 9, 35 AND 42.
- WILLIAM MARSH RICE UNIVERSITY, HOUSTON, TX:
3,678,200, PUB. 6-23-2009. INT. CL. 27.
- WILLIAMS JR., JAMES, EDDIE, MIAMI, FL:
3,680,888, INT. CL. 28.
- WILLIAMS JR, BARRY, CALUMET CITY, IL:
3,679,535, PUB. 6-23-2009. INT. CL. 45.
- WILLIAMS-HAYWARD PROTECTIVE COATINGS, INC., SUMMIT, IL, AKA WILLIAMS-HAYWARD INTERNATIONAL COATINGS, INC.:
3,679,788, PUB. 6-23-2009. INT. CL. 2.
- WILLIAMS, CHRISTINA, ANAHEIM, CA:
3,678,175, PUB. 6-23-2009. INT. CL. 41.
- WILLIAMS, MICHAEL J., NEWARK, OH:
3,681,164, INT. CL. 15.
3,681,165, INT. CL. 15.
- WILLY RUSCH GMBH, D-71394 KERNEN-ROMMELSHAUSEN, FED REP GERMANY, RUSCH, WILLY, ROMMELSHAUSEN, FED REP GERMANY:
863,986. REN. 8-6-09. U.S. CL. 44 (INT. CL. 10).
- WILMAR CORPORATION, RENTON, WA:
3,678,994, PUB. 6-23-2009. INT. CL. 9.
- WILMSHURST, RICHARD, SUTTER CREEK, CA:
3,681,239, INT. CL. 25.
- WILSON SPORTING GOODS CO., CHICAGO, IL:
2,259,785. REN. 8-1-09. INT. CL. 28.
- WIN IT TOO, SANTA BARBARA, CA:
2,215,242, CANC. INT. CL. 32.
- WIN 3 INCORPORATED, EDINA, MN:
1,518,223, CANC. INT. CL. 35.
- WINDSTORM INSURANCE NETWORK, INC., PENSACOLA, FL:
3,678,532, PUB. 6-23-2009. MULTIPLE CLASS, INT. CLS. 35 AND 41.
3,678,563, PUB. 6-23-2009. MULTIPLE CLASS, INT. CLS. 35 AND 41.
- WINE CELLAR CLUB, INC., IRVINE, CA:
3,678,172, PUB. 6-23-2009. INT. CL. 39.
- WINIFRED ADAMS, MALIBU, CA:
3,678,979, PUB. 6-23-2009. INT. CL. 14.
- WINKLER INCORPORATED, DALE, IN, J. WINKLER & SONS, INC., DALE, IN:
1,549,576. REN. 7-31-09. INT. CL. 42.
- WINLORD INDUSTRIAL GROUP CO., LTD., WANCHAI, HONG KONG:
3,680,583, INT. CL. 25.
- WINNEBAGO INDUSTRIES, INC., FOREST CITY, IA:
2,285,158. REN. 8-5-09. INT. CL. 12.
3,680,133, INT. CL. 20.
3,680,134, INT. CL. 9.
- WINSLOW, EVANS & CROCKER, INC., BOSTON, MA:
3,680,172, MULTIPLE CLASS, INT. CLS. 35 AND 36.
- WINSTON BROTHERS, INC., BOSTON, MA:
3,678,601, PUB. 6-23-2009. MULTIPLE CLASS, INT. CLS. 35 AND 44.
3,678,602, PUB. 6-23-2009. MULTIPLE CLASS, INT. CLS. 35 AND 44.
- WINTER CREEK STORE, INC., LEHIGH VALLEY, PA:
3,679,227, PUB. 6-23-2009. INT. CL. 35.
- WINWOOD CHILDREN'S CENTER I, LLC, SCOTTSDALE, AZ:
2,281,800. REN. 7-31-09. INT. CL. 42.
- WIRECO WORLDGROUP INC., KANSAS CITY, MO:
1,517,770, CANC. INT. CL. 6.
- WISCONSIN MILK MARKETING BOARD, INC., MADISON, WI:
3,678,854, PUB. 6-23-2009. INT. CL. 35.
- WISHNATZKI, INC., PLANT CITY, FL:
3,679,319, PUB. 6-23-2009. INT. CL. 31.
- WISNIA, CHRISTOPHER TODD, DAVIS, CA:
3,679,084, PUB. 6-23-2009. INT. CL. 16.
- WISTA LABORATORIES LTD, SINGAPORE 139948, SINGAPORE:
3,679,872, PUB. 6-23-2009. MULTIPLE CLASS, INT. CLS. 5, 9, 10, 16, 35, 42 AND 44.
- WISZNEAUCKAS, NICKI TABOR, DARNESTOWN, MD:
3,680,102, INT. CL. 16.
- WITZIG & FRANK GMBH, OFFENBURG, FED REP GERMANY:
2,247,980. REN. 8-3-09. INT. CL. 7.
- WIVIOTT, ROBERT N., LAS VEGAS, CA:
2,272,505. REN. 7-31-09. INT. CL. 16.
- WM. H. LEAHY ASSOCIATES, INC., GLENVIEW, IL:
3,679,841, PUB. 6-23-2009. INT. CL. 30.
- WM. WRIGLEY JR. COMPANY, CHICAGO, IL:
2,262,270. REN. 8-1-09. INT. CL. 30.
- WNBA ENTERPRISES, LLC, SECAUCUS, NJ:
2,215,269, CANC. INT. CL. 41.
2,263,736. REN. 7-31-09. INT. CL. 25.
2,269,541. REN. 8-5-09. INT. CL. 28.
2,269,837. REN. 8-5-09. INT. CL. 41.
2,274,792. REN. 8-3-09. INT. CL. 41.
2,363,071. REN. 8-3-09. INT. CL. 25.
- WOHL, ANDREW, CONGERS, NY:
2,346,908. REN. 8-5-09. INT. CL. 42.
- WOLF, RAYMOND T., MANORVILLE, NY, DBA RAY WOLF PRODUCTIONS:
3,679,284, PUB. 6-23-2009. INT. CL. 41.
- WOLSELEY PLC, READING, UNITED KINGDOM:
3,679,838, PUB. 6-23-2009. MULTIPLE CLASS, INT. CLS. 1, 2, 3, 6, 7, 8, 9, 11, 12, 16, 17, 19, 20, 21, 22, 24, 25, 27, 35, 36, 37, 38, 39, 40 AND 41.
- WOLVERINE OUTDOORS, INC., ROCKFORD, MI:
3,680,548, INT. CL. 25.
- WOMBLE CARLYLE SANDRIDGE & RICE, PLLC, WINSTON-SALEM, NC:
3,681,728, INT. CL. 42.
- WOMEN'S BASKETBALL COACHES ASSOCIATION, INC., LILBURN, GA:
3,680,124, INT. CL. 36.
3,680,125, INT. CL. 36.
- WOMENS BUSINESS MASTERMIND GROUP, INC, DAVIE, FL:
3,678,978, PUB. 6-23-2009. INT. CL. 35.
- WOOD ROYALTY MANAGEMENT COMPANY, WILMINGTON, DE:
3,681,252, INT. CL. 43.
- WOODBIDGE FOAM CORPORATION, MISSISSAUGA, ONTARIO L4Z 2G6, CANADA:
2,258,440. REN. 8-3-09. MULTIPLE CLASS, INT. CLS. 35, 40 AND 42.
- WOODBURY AUTOMOTIVE WAREHOUSE, LLC, N. AMITYVILLE, NY:
2,665,217, CANC. MULTIPLE CLASS, INT. CLS. 7 AND 12.
- WOODWARD CAMP PROPERTIES, INC., WOODWARD, PA:
2,666,133, CANC. INT. CL. 28.
- WOOLMARK AMERICAS, INC., NEW YORK, NY, DBA THE WOOLMARK COMPANY:
2,214,533, CANC. INT. CL. 35.
- WORKERS TEMPORARY STAFFING, INC., LAKE MARY, FL:
2,666,007, CANC. INT. CL. 35.
- WORLD BASEBALL CLASSIC, INC., NEW YORK, NY:
3,681,519, INT. CL. 16.
- WORLD CLASS LEARNING MATERIALS INC., REISTER-TOWN, MD:
3,551,894, COR. MULTIPLE CLASS, INT. CLS. 16 AND 28.
- WORLD CLASS LEARNING MATERIALS INC., REISTERS-TOWN, MD:
3,555,286, COR. INT. CL. 16.
- WORLD EVENT MANAGEMENT LIMITED, WEST YORKSHIRE, UNITED KINGDOM:
3,679,863, PUB. 6-23-2009. MULTIPLE CLASS, INT. CLS. 9 AND 41.

WORLD GOLF FOUNDATION, INC., ST. AUGUSTINE, FL,
 WORLD GOLF FOUNDATION, INC., ST. AUGUSTINE,
 FL:
 2,261,303. REN. 8-3-09. INT. CL. 14.
 WORLD HARVEST CHURCH, INC., COLUMBUS, OH:
 1,518,480. CANC. INT. CL. 42.
 WORLD INSPECTION NETWORK INTERNATIONAL, INC.,
 SEATTLE, WA:
 3,681,634. INT. CL. 42.
 WORLD SPORTS TECHNOLOGY, INC., KENOSHA, WI:
 3,679,035. PUB. 6-23-2009. INT. CL. 41.
 WORLD WIDE STATIONERY MFG. CO. LTD., KWAI
 CHUNG, N.T., HONG KONG, CHINA:
 2,214,694. CANC. INT. CL. 16.
 WORLD WRESTLING ENTERTAINMENT, INC., STAM-
 FORD, CT:
 3,680,423. INT. CL. 41.
 WORLD WRESTLING ENTERTAINMETNT, INC., STAM-
 FORD, CT:
 3,680,222. INT. CL. 41.
 WORLDSPAN, L.P., ATLANTA, GA:
 2,189,417. REN. 7-31-09. INT. CL. 42.
 WORTHEN, MICHELLE I., MUSKOGEE, OK:
 3,680,228. INT. CL. 25.
 WPP PROPERTIES, SAN FRANCISCO, CA:
 2,214,010. CANC. INT. CL. 35.
 WPP PROPERTIES, NEW YORK, CA:
 3,680,188. INT. CL. 35.
 WPPI ENERGY, SUN PRAIRIE, WI:
 3,681,015. MULTIPLE CLASS, INT. CLS. 35, 39 AND 40.
 WRG WALRUS RESEARCH, INC., WALDO, WI:
 1,518,218. CANC. INT. CL. 35.
 WRIGHT MEDICAL TECHNOLOGY, INC., ARLINGTON,
 TN:
 3,681,095. INT. CL. 10.
 3,681,152. INT. CL. 10.
 WRITT, MICHAEL E., INDIANAPOLIS, IN:
 2,667,425. CANC. MULTIPLE CLASS, INT. CLS. 5 AND
 30.
 WYNDHAM RESORT DEVELOPMENT CORPORATION,
 ORLANDO, FL:
 3,680,629. INT. CL. 30.
 W2005 RSI REALTY LLC, NEW YORK, NY:
 3,678,874. PUB. 6-23-2009. MULTIPLE CLASS, INT. CLS.
 41, 43, 44 AND 45.
 3,678,875. PUB. 6-23-2009. MULTIPLE CLASS, INT. CLS.
 41, 43, 44 AND 45.
 W2007 LA COSTA RESORT CO., LLC, LA QUINTA, CA:
 2,665,300. CANC. INT. CL. 41.
 XANTOS BIOMEDICINE GMBH, D-82152 MARTINSRIED,
 FED REP GERMANY:
 2,665,137. CANC. MULTIPLE CLASS, INT. CLS. 1, 5 AND
 42.
 XASE XETECHE CORPORATION, LEAGUE CITY, TX, DBA
 XASE XETECHE CORPORATION:
 3,681,144. INT. CL. 44.
 XCESSORIES PLUS, INC., MARIETTA, GA:
 2,665,062. CANC. INT. CL. 25.
 XCEL HOLDINGS, LLC, JACKSON, WY:
 2,666,829. CANC. INT. CL. 16.
 XEBA, PHOENIX, AZ:
 2,665,231. CANC. INT. CL. 9.
 XENITH, LLC, LOWELL, MA:
 3,681,113. INT. CL. 35.
 XETAPHARM, INC., NEW BRUNSWICK, NJ:
 2,215,042. CANC. INT. CL. 5.
 XLLERATE CONSULTING, LLC, GARLAND, TX:
 3,680,151. INT. CL. 9.
 3,681,623. INT. CL. 9.
 3,681,624. INT. CL. 42.
 XM SATELLITE RADIO INC., WASHINGTON, DC:
 2,666,915. CANC. INT. CL. 41.
 XMA, L.L.C., MIDWEST CITY, OK:
 3,681,564. INT. CL. 35.
 XNEXT, INC., WINTER HAVEN, FL:
 2,667,286. CANC. INT. CL. 9.
 XO COMMUNICATIONS, LLC, HERNDON, VA:
 2,665,855. CANC. MULTIPLE CLASS, INT. CLS. 35, 38
 AND 42.
 XPOINT TECHNOLOGIES, INC., BOCA RATON, FL:
 3,679,182. PUB. 6-23-2009. INT. CL. 9.
 XSTREAM ACCESS LLC, DALLAS, TX:
 3,678,142. PUB. 6-23-2009. INT. CL. 9.
 XTRACT RESEARCH LLC, RIDGEFIELD, CT:
 3,679,296. PUB. 6-23-2009. MULTIPLE CLASS, INT. CLS.
 36, 38 AND 42.
 XTREME SPORTS IMPORTACAO, EXPORTACAO E CO-
 MERCIO LTDA., SAO PAULO, SAO PAULO, BRAZIL:
 3,680,071. MULTIPLE CLASS, INT. CLS. 9, 12, 14, 16, 28,
 35 AND 42.
 XTREME TRAFFIC BUILDERS, INC., ROLLING MEA-
 DOWS, IL:
 2,666,706. CANC. INT. CL. 35.
 XW TECHNOLOGIES, INC., MERCER ISLAND, WA:
 2,666,855. CANC. MULTIPLE CLASS, INT. CLS. 9, 35, 36
 AND 42.
 YAMAHA HATSUDOKI KABUSHIKI KAISHA, SHIZUOKA-
 KEN, JAPAN:
 2,215,383. CANC. INT. CL. 7.
 YAMAHA HATSUDOKI KABUSHIKI KAISHA, JAPAN:
 2,665,223. CANC. INT. CL. 9.
 YANKTON MEDICAL CLINIC, P.C., YANKTON, SD:
 2,364,760. REN. 8-3-09. INT. CL. 42.
 YANNITTE, THOMAS, ROCKY HILL, NJ:
 3,679,166. PUB. 6-23-2009. INT. CL. 41.
 YAPOR, IRMA G., ORLANDO, FL:
 2,666,873. CANC. INT. CL. 35.
 YARBOUGH, RICHARD, GLENDALE, AZ:
 3,681,638. INT. CL. 25.
 YARBOUGH, D.B., WINTER PARK, FL:
 2,343,181. REN. 8-4-09. INT. CL. 36.
 YASHA FABRIC, INC., LOS ANGELES, CA:
 2,666,066. CANC. INT. CL. 24.
 YASMINE KHALI, F-74240 GAILLARD, FRANCE:
 3,679,952. PUB. 6-23-2009. INT. CL. 25.
 YASUTOMO & COMPANY, SOUTH SAN FRANCISCO, CA:
 2,259,021. REN. 8-3-09. INT. CL. 16.
 YELLOW BOOK USA, INC., CARY, NC:
 2,215,463. CANC. INT. CL. 16.
 YENKIN-MAJESTIC PAINT CORPORATION, COLUMBUS,
 OH:
 1,517,715. CANC. MULTIPLE CLASS, INT. CLS. 2 AND
 20.
 YES! SUPERBABY LIMITED, LONDON, UNITED KING-
 DOM:
 3,678,774. PUB. 6-23-2009. MULTIPLE CLASS, INT. CLS.
 25, 28 AND 35.
 YKK CORPORATION, TOKYO, JAPAN:
 2,665,036. CANC. INT. CL. 26.
 YOO, DANIEL JHIN, EAST PALO ALTO, CA:
 3,679,239. PUB. 6-23-2009. INT. CL. 9.
 YOOGO CORPORATION, SAN FRANCISCO, CA, DBA
 TUTIMELON:
 3,680,721. INT. CL. 30.
 YOUMAIL, INC., ALISO VIEJO, CA:
 3,679,649. PUB. 6-23-2009. INT. CL. 38.
 YOUNG-ESPEUT, JUDITH, CROWNSVILLE, MD, DBA
 YOUNG, JUDITH:
 3,678,275. PUB. 6-23-2009. MULTIPLE CLASS, INT. CLS.
 16 AND 41.
 YOUNG, VINCENT, NEW CARROLLTON, MD:
 2,665,485. CANC. INT. CL. 41.
 YOUNGER MANUFACTURING COMPANY, TORRANCE,
 CA:
 1,123,115. REN. 8-6-09. INT. CL. 9.
 YOUNGEVITY, INC., CHULA VISTA, CA:
 2,215,026. CANC. INT. CL. 3.
 YOURSPHERE MEDIA, INC., DAVIS, CA:
 3,680,593. MULTIPLE CLASS, INT. CLS. 35, 38 AND 42.
 YTV CANADA, INC., TORONTO, CANADA:
 3,679,814. PUB. 6-23-2009. INT. CL. 41.
 YUD YUD, LLC, NEW YORK, NY:
 3,678,395. PUB. 6-23-2009. INT. CL. 25.
 YUGEN KAISHA COMTECH, TOKYO, JAPAN:
 2,665,963. CANC. MULTIPLE CLASS, INT. CLS. 18 AND
 25.

- YUNG, YUEN L., AUSTIN, TX:
3,680,128, INT. CL. 43.
- Z DESIGN GROUP LLC, BOULDER, CO:
3,681,393, INT. CL. 42.
- Z-PRO INTERNATIONAL, INC., PORTLAND, OR:
3,473,229, CANC. INT. CL. 6.
- ZABECOR PHARMACEUTICALS, LLC, BALA CYNWYD, PA:
3,681,428, INT. CL. 42.
- ZAFARALLA, JEREMY F, WAIPAHU, HI, AKA JEREMY:
3,679,642, PUB. 6-23-2009. INT. CL. 25.
- ZAGULA, MATTHEW J., GEORGETOWN, KY, DBA COMFORT STEPZ:
3,681,220, INT. CL. 10.
- ZALMA, ALYSA, LAKE OSWEGO, OR:
3,681,115, MULTIPLE CLASS, INT. CLS. 9 AND 44.
- ZAMBRANA, OSCAR, FAIRFAX, VA:
3,678,503, PUB. 6-23-2009. INT. CL. 25.
- ZANDER, CRIS, SAN FRANCISCO, CA:
3,679,360, PUB. 6-23-2009. INT. CL. 35.
- ZARKS INTERNATIONAL, INC., SAN GABRIEL, CA:
2,666,049, CANC. INT. CL. 30.
- ZASS HAUSGERÄTE ENTWICKLUNGS GMBH, FED REP GERMANY:
3,616,135, COR. MULTIPLE CLASS, INT. CLS. 7, 8, 9, 11, 12, 13, 17, 19, 21, 22, 24, 25, 27, 35, 37 AND 42.
- ZAYAN FINANCE, LLC., WESTBURY, NY:
3,681,610, MULTIPLE CLASS, INT. CLS. 35 AND 36.
- ZBD DISPLAYS LIMITED, MALVERN, UNITED KINGDOM:
3,678,157, PUB. 12-30-2008. MULTIPLE CLASS, INT. CLS. 9 AND 35.
- ZBESTOFFER.COM, INC., CENTEREACH, NY:
2,665,835, CANC. INT. CL. 35.
- ZEC S.P.A., CINISELLO BALSAMO (PROVINCE OF MILANO), ITALY:
1,548,881, REN. 8-6-09. INT. CL. 7.
- ZEL SKIN & LASER SPECIALISTS, LLC, EDINA, MN:
3,678,924, PUB. 6-23-2009. INT. CL. 44.
- ZEMI ENTERTAINMENT L.L.C., GRAND RAPIDS, MI:
2,665,268, CANC. MULTIPLE CLASS, INT. CLS. 35 AND 41.
- ZENITH GLOBAL LOGISTICS, LLC, CONOVER, NC:
3,679,485, PUB. 6-23-2009. MULTIPLE CLASS, INT. CLS. 35 AND 39.
3,679,491, PUB. 6-23-2009. MULTIPLE CLASS, INT. CLS. 35 AND 39.
- ZENSYS A/S, DK-2100 KOBENHAVN 0, DENMARK:
2,665,147, CANC. MULTIPLE CLASS, INT. CLS. 9 AND 16.
- ZEPHYR TECHNOLOGY LIMITED, AUCKLAND, NEW ZEALAND:
3,678,262, PUB. 4-7-2009. INT. CL. 10.
3,678,263, PUB. 4-7-2009. INT. CL. 10.
- ZETEC, INC., DULUTH, GA:
2,666,946, CANC. INT. CL. 9.
- ZEUS INDUSTRIAL PRODUCTS, INC., ORANGEBURG, SC:
3,681,019, INT. CL. 43.
- ZEUS RECORDS LTD, NEW BARNET, UNITED KINGDOM:
2,666,609, CANC. MULTIPLE CLASS, INT. CLS. 9 AND 41.
- ZHEJIANG CONTINENTS & XINCHUN; GROUP CO., LTD, CHINA:
3,679,968, PUB. 6-23-2009. INT. CL. 7.
- ZHEJIANG JINDELI BEAUTY AND HAIRDRESSING HOUSEHOLD APPLIANCES CO., LTD., WENZHOU, CHINA:
3,678,759, PUB. 6-23-2009. MULTIPLE CLASS, INT. CLS. 8, 9 AND 11.
- ZHEJIANG JUEDING PRECIOUS CHEMICAL INDUSTRIAL CO.,LTD., WENZHOU CITY, ZHEJIANG PROVINCE, CHINA:
2,666,558, CANC. INT. CL. 3.
- ZHEJIANG TIANHUANG MEDICINAL PLANT PHARMACEUTICAL CO., LTD, ZHEJIANG PROVINCE, CHINA:
3,680,483, INT. CL. 5.
- ZHEJIANG WEIHUA CHEMICAL CO., LTD., CHINA:
3,680,041, PUB. 6-23-2009. INT. CL. 1.
- ZHEJIANG XINCHANG REALM ELECTRIC; APPLIANCE CO., LTD, ZHEJIANG PROVINCE, CHINA:
3,679,961, PUB. 6-23-2009. INT. CL. 7.
- ZHONGSHAN RISING DRAGON FOREIGN TECHNOLOGY COMPANY LTD., NANTOU TOWN, ZHONGSHAN, GUANGDONG, CHINA:
3,679,837, PUB. 4-21-2009. MULTIPLE CLASS, INT. CLS. 11, 20, 35, 39 AND 40.
- ZHOU, JAMES, MIDDLETOWN, CT:
2,667,326, CANC. INT. CL. 5.
- ZI HE, WU, ROME, NY:
3,681,789, INT. CL. 29.
- ZIEBART INTERNATIONAL CORPORATION, TROY, MI:
872,779, REN. 8-4-09. U.S. CL. 106 (INT. CL. 40).
- ZIEMER HOLDING AG, PORT, SWITZERLAND:
3,678,296, PUB. 10-14-2008. MULTIPLE CLASS, INT. CLS. 9, 10 AND 44.
- ZIEVERINK, ROBERT M., WAKE FOREST, NC:
2,666,024, CANC. INT. CL. 14.
- ZIFF DAVIS PUBLISHING HOLDINGS INC., NEW YORK, NY:
2,665,544, CANC. MULTIPLE CLASS, INT. CLS. 16 AND 42.
- ZIMMER, INC., WARSAW, IN:
2,724,623, AM. INT. CL. 10.
- ZIMPLE, INC., COSTA MESA, CA, TA ZIMPLEMONEY:
3,679,195, PUB. 6-23-2009. INT. CL. 35.
- ZING INTERACTIVE MEDIA, INC., PHILADELPHIA, PA:
2,665,392, CANC. MULTIPLE CLASS, INT. CLS. 35 AND 41.
- ZIONS BANCORPORATION, SALT LAKE CITY, UT:
3,679,643, PUB. 6-23-2009. INT. CL. 36.
- ZIPPMARK, INC., WILMINGTON, DE:
3,680,360, INT. CL. 34.
- ZMC HOTELS, INC., DULUTH, MN:
3,679,236, PUB. 6-23-2009. INT. CL. 43.
3,679,764, PUB. 6-23-2009. INT. CL. 43.
- ZOLL MEDICAL CORPORATION, CHELMSFORD, MA:
3,678,459, PUB. 6-23-2009. INT. CL. 10.
- ZONDERVAN CORPORATION, THE, GRAND RAPIDS, MI:
2,215,393, CANC. INT. CL. 16.
- ZONK DESIGNS, INC., ATLANTA, GA:
3,680,315, MULTIPLE CLASS, INT. CLS. 20 AND 24.
- ZOOLA, LLC, PALOS VERDES, CA:
3,678,254, PUB. 6-23-2009. INT. CL. 25.
- ZOOLIFE, INC., ESCONDIDO, CA:
3,681,620, MULTIPLE CLASS, INT. CLS. 5 AND 31.
- ZOOM IN, LLC, RAINSVILLE, AL:
3,678,670, PUB. 6-23-2009. INT. CL. 41.
3,678,671, PUB. 6-23-2009. INT. CL. 41.
- ZOOM WORLDWIDE LLC, SIDNEY, OH:
3,679,264, PUB. 6-23-2009. INT. CL. 32.
- ZOOMERS, INC., BROOKLYN, NY:
2,735,270, CANC. MULTIPLE CLASS, INT. CLS. 3, 5, 18, 30 AND 32.
- ZOOMP CONFECOES LTDA, SAN PAULO, BRAZIL:
2,665,098, CANC. INT. CL. 25.
- ZOOMPOOL, INC., SANTA CRUZ, CA:
3,681,111, INT. CL. 39.
- ZOOMPOOL, INC., SANTA CRUZ, CA:
3,681,166, INT. CL. 39.
- ZOTOS INTERNATIONAL, INC., DARIEN, CT:
3,678,758, PUB. 6-23-2009. INT. CL. 3.
- ZUMO SMOOTHIE BARS INTERNATIONAL LIMITED, DUBLIN 7, IRELAND:
3,681,647, INT. CL. 43.
- ZYVAX, INC., E. ELLIJAY, GA:
3,678,499, PUB. 6-23-2009. INT. CL. 17.
- OMS INVESTMENTS, INC., WILMINGTON, DE:
2,667,380, CANC. INT. CL. 1.
- OY OMS OPTOMEDICAL SYSTEMS LTD, HELSINKI, FINLAND:
2,666,543, CANC. MULTIPLE CLASS, INT. CLS. 40 AND 42.
- 1 BAG AT AT TIME, LOS ANGELES, CA:
3,679,156, PUB. 6-23-2009. INT. CL. 16.
- 1-800-FLOWERS.COM, INC., CARLE PLACE, NY:
3,634,791, COR. INT. CL. 35.

ITON TECHNOLOGIES, INC., MISHAWAKA, IN:
2,666,851, CANC. INT. CL. 42.

10TH ILLINOIS VOLUNTEER CAVALRY REGIMENT NFP,
LOWPOINT, IL:
3,681,773, INT. CL. 41.

1000MERCIS, F-75009 PARIS, FRANCE:
3,679,886, PUB. 6-23-2009. MULTIPLE CLASS, INT. CLS.
9, 35, 38, 41 AND 42.

12 ZODIACS, INC., SAN GABRIEL, CA:
3,679,515, PUB. 6-23-2009. INT. CL. 33.
3,679,516, PUB. 6-23-2009. INT. CL. 33.
3,679,517, PUB. 6-23-2009. INT. CL. 33.
3,679,518, PUB. 6-23-2009. INT. CL. 33.
3,679,519, PUB. 6-23-2009. INT. CL. 33.
3,679,520, PUB. 6-23-2009. INT. CL. 33.
3,679,522, PUB. 6-23-2009. INT. CL. 33.
3,679,523, PUB. 6-23-2009. INT. CL. 33.
3,679,524, PUB. 6-23-2009. INT. CL. 33.
3,679,525, PUB. 6-23-2009. INT. CL. 33.

1888 MILLS, LLC, GRIFFIN, GA:
2,750,944, CANC. INT. CL. 25.

2 AM CLUB RECORDING, LLC, ENCINO, CA:
3,679,419, PUB. 6-23-2009. MULTIPLE CLASS, INT. CLS. 9
AND 41.

206 MACOPIN CORP., BLOOMINGDALE, NJ:
2,666,309, CANC. INT. CL. 5.

3CINTERACTIVE, LLC, BOCA RATON, FL:
3,678,392, PUB. 6-23-2009. INT. CL. 38.

3E TECHNOLOGIES INTERNATIONAL, INC., ROCKVILLE,
MD:
3,681,729, INT. CL. 9.

3IC, INC., SUNGNAM-CITY, KYUNGKO-DO, REPUBLIC
OF KOREA:
2,665,897, CANC. MULTIPLE CLASS, INT. CLS. 9 AND
42.

3M COMPANY, ST. PAUL, MN:
1,549,676, REN. 8-5-09. MULTIPLE CLASS, INT. CLS. 1, 9
AND 10.
2,260,451, REN. 8-1-09. INT. CL. 17.

3M COMPANY, ST. PAUL, MN, MINNESOTA MINING AND
MANUFACTURING COMPANY, ST. PAUL, MN:
2,272,726, REN. 8-3-09. INT. CL. 9.

350 MARKET STREET, INC., ST. PAUL, MN:
1,546,884, REN. 8-3-09. INT. CL. 42.

360 IN ACTION CORP., MIAMI, FL, DBA BLUE DASHER
TECHNOLOGIES:
3,678,399, PUB. 6-23-2009. MULTIPLE CLASS, INT. CLS.
39 AND 41.

360I LLC, NEW YORK, NY:
3,679,772, PUB. 6-23-2009. INT. CL. 35.

5 STAR ROBOTICS, INC., SANTA ROSA, CA:
2,666,795, CANC. INT. CL. 28.
2,666,796, CANC. INT. CL. 28.

5TH AVENUE PARTNERS, LLC, NEWPORT BEACH, CA:
3,679,640, PUB. 6-23-2009. MULTIPLE CLASS, INT. CLS.
43 AND 44.

50+ DIGITAL LLC, EVANSTON, IL:
3,678,495, PUB. 6-23-2009. INT. CL. 36.

7-ELEVEN, INC., DALLAS, TX:
3,679,337, PUB. 6-23-2009. INT. CL. 35.

7-ELEVEN, INC., DALLAS, TX:
3,679,341, PUB. 6-23-2009. INT. CL. 35.

8 ONE STUDIO, INC., RICHMOND, CANADA:
3,679,015, PUB. 6-23-2009. INT. CL. 12.

9 VOLT, LLC, GRAND RAPIDS, MI:
3,678,174, PUB. 6-23-2009. INT. CL. 43.

9082-9912 QUÉBEC INC., BOISBRIAND, CANADA:
3,680,489, INT. CL. 10.

* * * * *